

VOLUME 22

DECEMBER, 1934

NUMBER 12

W. J. M

PROCEEDINGS
of
The Institute of Radio
Engineers



Walter J. Malone WHAM

Form for Change of Mailing Address or Business Title on Page XIV

N 8 G Z X

Institute of Radio Engineers Forthcoming Meetings

CONNECTICUT VALLEY SECTION

December 20, 1934

DETROIT SECTION

December 20, 1934

NEW YORK MEETING

December 5, 1934

January 2, 1935

PHILADELPHIA SECTION

December 6, 1934

January 3, 1935

PITTSBURGH SECTION

December 18, 1934

SAN FRANCISCO SECTION

December 19, 1934

PROCEEDINGS OF
The Institute of Radio Engineers

Volume 22

December, 1934

Number 12

Board of Editors

ALFRED N. GOLDSMITH, *Chairman*

R. R. BATCHER

H. H. BEVERAGE

F. W. GROVER

G. W. KENRICK

G. W. PICKARD

K. S. VAN DYKE

L. P. WHEELER

L. E. WHITEMORE

WILLIAM WILSON

CONTENTS

PART I

Frontispiece, Georg Heinrich Barkhausen, Vice-President-Elect, 1935...	1322
Institute News and Radio Notes.....	1323
November Meeting of the Board of Directors.....	1323
Radio Transmissions of Standard Frequencies.....	1323
Committee Work.....	1325
Institute Meetings.....	1327
Personal Mention.....	1334

PART II

Technical Papers

Generation and Utilization of Ultra-Short Waves in Radio Communication.....	FREDERICK A. KOLSTER	1335
A Lapel Microphone of the Velocity Type.....	HARRY F. OLSON AND RICHARD W. CARLISLE	1354
Control of Radiating Properties of Antennas.....	C. A. NICKLE, R. B. DOME, AND W. W. BROWN	1362
An Electron Oscillator with Plane Electrodes.....	B. J. THOMPSON AND P. D. ZOTTU	1374
Theory of Electron Gun.....	I. G. MALOFF AND D. W. EPSTEIN	1386
Contributors to this Issue.....		1412

Copyright, 1934, by the Institute of Radio Engineers

The Institute of Radio Engineers

GENERAL INFORMATION

INSTITUTE. The Institute of Radio Engineers was formed in 1912 through the amalgamation of the Society of Wireless Telegraph Engineers and the Wireless Institute. Its headquarters were established in New York City and the membership has grown from less than fifty members at the start to several thousand.

AIMS AND OBJECTS. The Institute functions solely to advance the theory and practice of radio and allied branches of engineering and of the related arts and sciences, their application to human needs, and the maintenance of a high professional standing among its members. Among the methods of accomplishing this is the publication of papers, discussions, and communications of interest to the membership.

PROCEEDINGS. The PROCEEDINGS is the official publication of the Institute and in it are published all of the papers, discussions, and communications received from the membership which are accepted for publication by the Board of Editors. Copies are sent without additional charge to all members of the Institute. The subscription price to nonmembers is \$10.00 per year, with an additional charge for postage where such is necessary.

RESPONSIBILITY. It is understood that the statements and opinions given in the PROCEEDINGS are views of the individual members to whom they are credited, and are not binding on the membership of the Institute as a whole. Papers submitted to the Institute for publication shall be regarded as no longer confidential.

REPRINTING PROCEEDINGS MATERIAL. The right to reprint portions or abstracts of the papers, discussions, or editorial notes in the PROCEEDINGS is granted on the express condition that specific reference shall be made to the source of such material. Diagrams and photographs published in the PROCEEDINGS may not be reproduced without making specific arrangements with the Institute through the Secretary.

MANUSCRIPTS. All manuscripts should be addressed to the Institute of Radio Engineers, 330 West 42nd Street, New York City. They will be examined by the Papers Committee and the Board of Editors to determine their suitability for publication in the PROCEEDINGS. Authors are advised as promptly as possible of the action taken, usually within two or three months. Manuscripts and illustrations will be destroyed immediately after publication of the paper unless the author requests their return. Information on the mechanical form in which manuscripts should be prepared may be obtained by addressing the secretary.

MAILING. Entered as second-class matter at the post office at Menasha, Wisconsin. Acceptance for mailing at special rate of postage is provided for in the act of February 28, 1925, embodied in Paragraph 4, Section 412, P. L. and R., and authorization was granted on October 26, 1927.

Published monthly by

THE INSTITUTE OF RADIO ENGINEERS, INC.

Publication office, 450-454 Ahnaip St., Menasha, Wis.

BUSINESS, EDITORIAL, AND ADVERTISING OFFICES

Harold P. Westman, *Secretary*

330 West 42nd Street, New York, N. Y.

INSTITUTE SECTIONS

- ATLANTA—Chairman, Henry L. Reid; Secretary, Philip C. Bangs, 23 Kensington Road, Avondale Estates, Ga.
- BOSTON—Chairman, E. L. Chaffee; Secretary, Roland G. Porter, Northeastern University, Boston, Mass.
- BUFFALO-NIAGARA—Chairman, L. E. Hayslett; Secretary, E. C. Waud, 235 Huntington Avenue, Buffalo, N. Y.
- CHICAGO—Chairman, Hugh S. Knowles; Secretary, John S. Meck, The Fensholt Company, 549 W. Washington St., Chicago, Ill.
- CINCINNATI—Chairman R. E. Kolo; Secretary, Helen Hymans, Crosley Radio Corporation, Cincinnati, Ohio.
- CLEVELAND—Chairman, F. G. Bowditch; Secretary, C. H. Shipman, 14805 Ardenall Ave., East Cleveland, Ohio.
- CONNECTICUT VALLEY—Chairman, K. S. Van Dyke; Secretary, C. B. De Soto, American Radio Relay League, 38 La Salle Rd., W. Hartford, Conn.
- DETROIT—Chairman, Samuel Firestone; Secretary, E. C. Denstaedt, Detroit Police Department, Detroit, Mich.
- LOS ANGELES—Chairman, H. C. Silent; Secretary, N. B. Neely, 1569 Munson Ave., Los Angeles, Calif.
- NEW ORLEANS—Chairman, J. A. Courtenay; Secretary, C. B. Reynolds, Radiomarine Corporation, 512 St. Peter St., New Orleans, La.
- PHILADELPHIA—Chairman, E. D. Cook; Secretary, R. L. Snyder, 103 Franklin Road, Glassboro, N. J.
- PITTSBURGH—Chairman, C. K. Krause; Secretary, H. V. Noble, c/o Gulf Research and Development Company, 327 Craft Ave., Pittsburgh, Pa.
- ROCHESTER—Chairman, H. J. Klumb; Secretary, H. A. Brown, 89 East Ave., Rochester, N. Y.
- SAN FRANCISCO—Chairman A. H. Brolly; Secretary, R. D. Kirkland, Mackay Radio and Telegraph Company, 22 Battery St., San Francisco, Calif.
- SEATTLE—Chairman, Howard Mason; Secretary, Raymond C. Fisher, 602 N. C. St., Tacoma, Wash.
- TORONTO—Chairman, A. B. Oxley; Secretary, S. A. Goldhamer, Northern Electric Company, 131 Simcoe St., Toronto, Ont., Canada.
- WASHINGTON—Chairman T. McL. Davis; Secretary, C. L. Davis, Washington Building, 15th and G Sts. N. W., Washington, D. C.

GEOGRAPHICAL LOCATION OF MEMBERS ELECTED NOVEMBER 7, 1934

Elected to the Fellow Grade

England London N.W.4, 3 Mayfield Gardens, Shirehall Park..... Mathieu, G. A.

Transferred to the Fellow Grade

District of Columbia Washington, Coast and Geodetic Survey..... Dorsey, H. G.

Elected to the Member Grade

Illinois	Chicago, 1033 W. Van Buren St.....	Smith, A. B.
New Jersey	Ridgefield Park, General Communications Labs.....	Lent, W. C.
New York	Manhasset, 11 Beachwood Ave.....	Cawein, M.
	New York City, c/o Radio and Technical Pub. Co., 45 Astor Pl.....	Ghirardi, A. A.
	New York City, The Alden, 225 Central Park West.....	Grossman, H.
	Port Jefferson, L.I., 117 Tuthill St.....	Lindenblad, N. E.
Ohio	Cincinnati, 3231 Bishop St.....	Hultberg, C. A.
Pennsylvania	Emporium, Box 750.....	Kievit, B., Jr.
Australia	Brisbane, Queensland, Engineering Branch G.P.O.....	Ross, S. J.
	Sydney, c/o New System Telephones Pty. Ltd., 278 Castle-reagh St.....	Kennell, R. J. W.
England	London N.W.11, 41 Litchfield Way.....	Bedford, L. H.
Germany	Berlin-Lichterfelde-Ost, Jungfernstieg 7.....	Riepka, H. C.

Transferred to the Member Grade

California	San Francisco, 249 Colon Ave.....	Brolly, A. H.
Missouri	St. Louis, Rm. 606, Telephone Bldg.....	McDaniel, O. S.
New Jersey	Morristown, 85 Washington Ave.....	Poole, R. E.
Pennsylvania	Philadelphia, 127 E. Mermaid Lane, Chestnut Hill.....	Farnsworth, P. T.
England	Bromley, Kent, 51 Foxbury Rd.....	Minter, R. W.

Elected to the Associate Grade

District of Columbia	Washington, 1652 Newton St. N. W.....	Colegrove, T. H.
Illinois	Chicago, 5746 Kenmore Ave.....	Ragsdale, W. E.
New Jersey	Atlantic City, 211 N. Brighton Ave.....	Smith, S. S.
	East Orange, 88 Ashland Ave., Apt. 404.....	Pearce, C. J.
	Harrison, Research and Development Lab., RCA Radiotron Co.....	Gray, W. A.
	Montclair, 60 Edgemont Rd.....	Brown, H. J.
	Newark, Federal Telegraph Co., 200 Mt. Pleasant Ave.....	Backer, L. A.
	Newark, 666 Ridge St.....	Smith, H. J.
	Newark, 808 S. 15th St.....	Vogel, C. P.
New York	South Orange, 136 Seton Pl.....	Rose, D. W.
	Bayside, L. I., 39-25-214th Pl.....	Goodale, E. D.
	Brooklyn, 1378 W. 7th St.....	DiToro, M. J.
	Brooklyn, 127 McKinley Ave.....	Steinberg, J.
	Flushing, 151-10 State St.....	Syme, D. W.
	New York City, c/o R.C.A. Institutes, Inc., 75 Varick St.....	Peterson, I.
	New York City, USS New Mexico, c/o Postmaster.....	Reese, J. S.
	New York City, 142 W. 83rd St.....	Uptcher, D.
	Schenectady, 1109 Union St.....	Thomas, H. P.
Oregon	Portland, KOIN, New Heathman Hotel.....	Bookwalter, L. S.
Pennsylvania	Philadelphia, 5722 Greene St., Germantown.....	Bowers, L. G.
	Wilkinsburg, 1450 Sloan Ave.....	Kozanowski, H. N.
West Virginia	Morgantown, 316 Forest Ave.....	Friend, A. W.
Australia	Brunswick, Victoria, 131 Brunswick Rd.....	Chittock, K. H.
Brazil	Rio de Janeiro, c/o RCA Victor Brasileira, Inc., Caixa Postal 2726.....	Pinto, O. D.
Canada	Camp Borden, Ont., Royal Canadian Signals.....	Cumming, J. E.
England	Bexley Heath, Kent, 85 May Place Rd. E., Barnehurst.....	Crosoer, R. L.
	Bolton, Lancs, 78 Sharples Ave.....	Herczeg, A.
	Derby, Highfield Lawn.....	Harris, J. W.
	Hollinwood, Lancs., c/o Turner, Bowling Green Hotel.....	Davidson, T. D.
	London, c/o Marconi's Wireless Tel. Co., Ltd., Electra House.....	Collings, R. H. P.
	London W.1, c/o Thomas Cook and Son.....	Rao, V. B.
	London S.W.7, 21 Cromwell Rd.....	Row, D. P.
	Wembley, Middlesex, G.E.C. Research Labs.....	Stewart, J.

Geographical Location of Members Elected

France	Lyon, 8 Place de l'Abondance	Warin, M. P.
India	Bombay, Petit Mansions, Sleater Rd., Grant Rd.	Major, D. S.
	Glenmorgan, Power Station, Singara	Sundaram, P. R.
Japan	Tokyo, The Japan Wireless Telegraph Co., Nisshin Bldg., Otemachi	Okamoto, S.
Lithuania	Jonava, Vytauto Didziojo Kuopa	Gabriunas, K.
New Zealand	Auckland, 10 Cecil Rd. Epsom	Rudd, C. G.
South Africa	Johannesburg, P.O. Box 6938	England, R. G. W.

Elected to the Student Grade

California	Oakland, 479-65th St.	Winlund, E. S.
Illinois	Chicago, 7321 S. Shore Dr.	Stanton, J. W., II



APPLICATIONS FOR MEMBERSHIP

Applications for transfer or election to the various grades of membership have been received from the persons listed below, and have been approved by the Admissions Committee. Members objecting to transfer or election of any of these applicants should communicate with the Secretary on or before December 31, 1934. These applications will be considered by the Board of Directors at its meeting on January 2, 1935.

For Transfer to the Fellow Grade

England Frinton-on-Sea, Harlow Labs. Scott-Taggart, J.

For Transfer to the Member Grade

New York New York City, 463 West St. Aiken, C. B.
 Rye, 61 Halls' Lane. Johnson, J. K.
 Australia Sydney, N.S.W., 47 York St. Brooker, V. M.
 Federated
 Malay States Johore Bharu, c/o Posts and Telegraph Dept. Carson, A. H.

For Election to the Member Grade

District of Washington, 922 National Press Bldg. Garrison, M. M.
 Columbia New York City, 300 W. 23rd St. Bunting, T. R.
 New York

For Election to the Associate Grade

California Half Moon Bay. Murray, D. A.
 Los Angeles, 928 W. 8th Pl. Faust, F. D.
 Los Angeles, 7821 S. Hobart Blvd. Paul B.
 Oakland, 3873 Forest Hill Ave. Nuttall, W. R.
 Petaluma, Box 799. Sales, J. P.
 Bridgeport, General Electric Co., Bldg. 33-E. Coykendall, J. C.

Connecticut Washington, c/o George Washington Inn. Buchanan, J. P., Jr.
 District of Miami, 1809 N. E. 2nd Ave. White, W. R.
 Columbia Angola, Box 183. Atwood, S.
 Florida Valparaiso, Stiles Hall. McMurray, H. H.
 Indiana West Lafayette, 218 Sheetz St. Lutz, S. G.
 Maryland Baltimore, 401 Calvert Bldg. Kann, M. L.
 Montana Billings, 323 N. 29th St. Stacey, T.
 New Jersey Boonton, 324 Cornelia St. Redington, J. H.
 Harrison, RCA Radiotron Company, Inc. Law, R. R.
 Harrison, RCA Radiotron Company, Inc. North, D. O.
 Kearny, c/o Western Electric Company, 100 Central Ave. Slezskinsky, G. N.
 Whippany, Bell Telephone Labs. Robinson, A. L.

New York Brooklyn, 668 Bedford Ave. Schiffman, S.
 Hempstead, L.I., 80 Parsons Dr. Ruth, R. A.
 New York City, 463 West St. Beins, J. K.
 New York City, Rm. 536 Chrysler Bldg., 405 Lexington Ave. Crews, F. H.
 New York City, c/o Swedish Iron and Steel Corp., 17 Battery
 Pl. McMaster, L. L., Jr.
 New York City, 103 W. 43rd St. Sampson, H. E.
 New York City, 500 Riverside Dr. Soi, B. N.
 New York City, 360 E. 55th St. Wittlig, P. F.
 Syracuse, 1814 E. Colvin St. Wood, R. J.
 Ohio Cleveland, 2908 E. 114th St. Laczko, E.
 Pennsylvania Bethlehem, Moravian College. Hoyler, C. N.
 North Hills, 33 Central Ave. Stahl, R. W.
 Tennessee Knoxville, Radio Station WROL. Arnold, D. H.
 Texas Marshall, 906 N. Franklin St. Lea, N. J.
 Vermont Waterbury, 9 Elm St. Stickle, M.
 Wisconsin Milwaukee, 709 E. Juneau Ave. Weller, D. A.
 Australia Bondi, Sydney, 260 Bondi Rd. Piddington, J. H.
 Corowa, N.S.W., 5 Betterment Parade. Jones, C. R.
 Hurstville, Sydney, 189 Connells Pt. Rd. Whittorn, R. H.
 England London S.W. 3, 43 Ovington Sq. Denman, R. P.
 London, N. 19, 33 Whitehall Park. Radford, E. R.
 Sutton, Surrey, 146 Brighton Rd. Mears, S. C. P.
 France Paris, 119 rue de Montreuil. Salles, G.
 India Bangalore, Dept. of Elec. Tech., Indian Institute of Science. Chakradeo, L. M.
 Bangalore, Dept. of Elec. Communication Eng., Indian Insti-
 tute of Science. Mukerji, S. N.
 Bombay, Thakarsi Keshawji Bldg., Navroaj Lane, Gharkoper,
 G. I. P. Railway. Khandhar, J. P.

Applications for Membership

South Africa	Durban, Natal, African Broadcasting Co.....	Harris, A. P.
	Durban, Natal, African Broadcasting Co.....	Southorn, B. E.
Switzerland	Solothurn, Hasenmattstrasse 11.....	Blochlinger, J.

For Election to the Junior Grade

New York	New York City, 2536 Hering Ave.....	Nekut, A. G.
Utah	Salt Lake City, 1199 Laird Ave.....	Wilson, T. L.

For Election to the Student Grade

Georgia	Atlanta, 698 Greenwood St. S. W.....	Markillie, R. G.
	Atlanta, 713 Spring St.....	Mayer, I. S.
Massachusetts	Boston, Phi Gamma Pi, 922 Beacon St.....	Cahalan, E. T.
	Lexington, 94 Forest St.....	Cook, J. H.
New York	Ithaca, 122 Eddy St.....	Scutt, J. M.
	Syracuse, 615 S. Beech St.....	Hastings, H. D.
Pennsylvania	Philadelphia, 1848 N. Leithgow St.....	Gohn, C. T.



OFFICERS AND BOARD OF DIRECTORS, 1934

(Terms expire January 1, 1935, except as otherwise noted)

President

C. M. JANSKY, JR.

Vice President

BALTH. VAN DER POL, JR.

Treasurer

MELVILLE EASTMAN

Secretary

HAROLD P. WESTMAN

Editor

ALFRED N. GOLDSMITH

Directors

W. G. CADY, *Junior Past President*

O. H. CALDWELL

J. V. L. HOGAN

L. C. F. HORLE

C. W. HORN

E. L. NELSON

E. R. SHUTE

A. F. VAN DYCK

H. A. WHEELER

Serving until January 1, 1936

R. A. HEISING

L. M. HULL, *Junior Past President*

F. A. KOLSTER

H. M. TURNER

Serving until January 1, 1937

ARTHUR BATCHELLER

WILLIAM WILSON





GEORG HEINRICH BARKHAUSEN
Vice-President-Elect, 1935
Recipient Morris Liebmann Memorial Prize, 1933

Georg Heinrich Barkhausen was born in Bremen on December 2, 1881. After completing high school in 1901, he did practical work for six months in the railroad shops at Bremen. He then studied at the Technical High School at Munich and at the Universities of Berlin, Munich, and Göttingen. He served as an assistant at the Institute for Instruction in Applied Electricity at Göttingen during 1906 and 1907. While studying for a doctor's degree in 1907, he worked on the problem of generating high-frequency oscillations.

From 1907 to 1911 he was an electrical engineer for Siemens and Halske in Berlin. He worked on telephone offices, both manual and automatic, relays, control apparatus, and problems in underwater acoustics. In 1910 he served as a special professor of electrotechnics at the Technical High School in Berlin. Since 1911 he has served as Professor and Director of the Institute of Low Current Technics at Dresden. From 1915 to 1918 he was furloughed to the Imperial Navy at Kiel for the development of acoustic underwater signaling and radio.

He was awarded the Heinrich Hertz gold medal in 1929, the Gauss Weber Memorial Medal, and the Morris Liebmann Memorial Prize in 1933. He joined the Institute as an Associate in 1926 and was transferred to the grade of Fellow in 1930.

INSTITUTE NEWS AND RADIO NOTES

November Meeting of the Board of Directors

The regular monthly meeting of the Board of Directors was held on November 7 at the Institute office. Those present were J. V. L. Hogan, acting chairman; Melville Eastham, treasurer; Arthur Batchelder, O. H. Caldwell; Alfred N. Goldsmith, L. C. F. Horle, E. L. Nelson, E. R. Shute, H. M. Turner, H. A. Wheeler, William Wilson, and H. P. Westman, secretary.

H. G. Dorsey was transferred to Fellow and G. A. Mathieu admitted to the grade of Fellow. Those transferred to the Member grade were A. H. Brolly, P. T. Farnsworth, O. S. McDaniel, R. W. Minter, and R. E. Poole. Admitted to the grade of Member were L. H. Bedford, Madison Cawein, A. A. Ghirardi, Henry Grossman, C. A. Hultberg, R. J. W. Kennell, Ben Kievit, Jr., W. C. Lent, W. E. Lindenblad, H. C. Riepka, S. J. Ross, and A. B. Smith. Forty Associate and two Student applications were approved.

The Tellers Committee presented its report on the count of ballots cast for new officers and the following were declared elected:

President, 1935—Stuart Ballantine

Vice President, 1935—Georg Heinrich Barkhausen

Directors, 1935-1937—E. L. Nelson, Haraden Pratt, and L. E. Whitemore

The Emergency Employment Service placed fourteen members during October and has a registration which now totals 746 of whom 567 are members of the Institute.

An invitation to hold the Tenth Annual Convention of the Institute in Detroit was accepted. The precise date will be established later.

In order to improve the cash position of the Institute and to provide funds to cover the deficit for operation during 1934, the sale of approximately \$8000 worth of securities was authorized.

Radio Transmissions of Standard Frequencies

Standard frequency transmissions at 5000 kilocycles are made from the Bureau of Standards Station WWV at Beltsville, Md., every Tuesday, except on legal holidays, continuously from 12 noon to 2 p.m. and from 10 p.m. to midnight, Eastern Standard Time. The accuracy of the frequency of transmission is at all times better than one cycle per second (one in five million).

For the first five minutes the general call (CQ de WWV) and announcement of the frequency is transmitted, the frequency and call letters being given every ten minutes thereafter. The main portion of the transmissions consist of the continuous unkeyed carrier wave. Information on the utilization of these signals is given in a pamphlet obtainable from the Bureau of Standards.

The Bureau would appreciate reports on field intensity, fading characteristics, and suitability of the transmissions for frequency measurements. If field intensity measurement apparatus is not available, it is suggested that the following intensity designations be used: (1) hardly perceptible, unreadable; (2) weak, readable, now and then; (3) fairly good, readable with difficulty; (4) good, readable; (5) very good, perfectly readable. Fading reports giving characteristics, such as time between peaks of signal intensity, are desired. Information as to the receiving equipment and antenna used is helpful. Reports on the use of these transmissions for all purposes would be appreciated, and communications should be addressed to the Bureau of Standards, Washington, D. C.

Proceedings Binders

Binders for the PROCEEDINGS, which may be used as permanent covers or for temporary transfer purposes, are available from the Institute office. These binders are of handsome Spanish grain fabrikoid, in blue and gold. Wire fasteners hold each copy in place, and permit removal of any issue from the binder in a few seconds. All issues lie flat when the binder is open. Each binder will accommodate a full year's supply of the PROCEEDINGS, and they are available at one dollar and fifty cents (\$1.50) each. Your name, or PROCEEDINGS volume number, will be stamped in gold for fifty cents (50¢) additional.

Annual Index

An annual index of the material published in Volume 22 (1934) of the PROCEEDINGS will be found following page 1413 of this issue. The papers are listed in the chronological order of their publication, a cross index under subject headings and an authors' index are provided.

Incorrect Addresses

A list of members whose correct addresses are not known to the Institute and to whom we have been unable to forward PROCEEDINGS

or other material will be found on pages IX and X of the advertising section. The last known addresses are given for these members and anyone who has more recent information as to their whereabouts will be doing a service to these members and the Institute by forwarding this information to the Secretary.

Committee Work

ADMISSIONS COMMITTEE

The Admissions Committee met on November 7 and those present were E. R. Shute, chairman; Austin Bailey, Arthur Batcheller, L. C. F. Horle, and H. P. Westman, secretary.

An application for transfer to the grade of Fellow was approved. Four applications for transfer to Member grade were approved and one rejected while two applications for admission to the grade of Member were approved and one denied.

MEMBERSHIP COMMITTEE

A meeting of the Membership Committee was held on October 16 in the Institute office and was attended by I. S. Coggeshall, chairman; F. W. Cunningham, H. C. Gawler, L. C. F. Horle, H. C. Humphrey, T. A. McCann, L. G. Pacent, C. R. Rowe, E. W. Schafer, C. E. Scholz, and H. P. Westman, secretary.

At the November 7 meeting of the committee there were present I. S. Coggeshall, chairman; F. W. Cunningham, H. C. Humphrey, C. R. Rowe, E. W. Schafer, and C. E. Scholz. At these meetings, letters were prepared for forwarding to the entire membership in solicitation for new members and some special purpose letters were prepared for distribution to particular groups which it is considered might be effective in obtaining new members.

TELLERS COMMITTEE

Arthur Batcheller, chairman, and H. P. Westman, secretary, met as the Tellers Committee on November 2 to supervise the counting of ballots cast in the election of officers for next year.

STANDARDIZATION COMMITTEES

TECHNICAL COMMITTEE ON ELECTRONICS—IRE

The first meeting of the Technical Committee on Electronics of the Institute was held on September 27 in the office of the Institute and those present were B. J. Thompson, acting chairman; M. J. Kelly, E. A. Lederer, G. A. Metcalf, O. W. Pike, and H. P. Westman, secretary. The scope of the committee's operations and the general field that is

to be covered by it was discussed. Five subcommittees were considered necessary for the handling of this work and were proposed to cover the following subjects:

1. Small high vacuum tubes.
2. Large high vacuum tubes.
3. Gas-filled tubes.
4. Photo-electric devices.
5. Electron beam and miscellaneous tubes.

Chairmen were appointed for these committees and instructed to prepare tentative lists of members for consideration at the next meeting.

Present standards in this field are to be reviewed and in particular all definitions appearing in the report of the Sectional Committee on Electrical Definitions, which are not identical with those established by the Institute will be reviewed for the purpose of making such modifications as seem essential.

On November 2 another meeting of the committee was held at which B. E. Shackelford, chairman; John Glauber (representing George Lewis), G. F. Metcalf, O. W. Pike, B. J. Thompson, Dayton Ulrey, P. T. Weeks, and H. P. Westman, secretary, were present.

The personnel of the five subcommittees established at the previous meeting was considered in detail and a number of modifications and additions suggested. The members of these subcommittees are to be appointed shortly and meetings started during the next few weeks.

It was pointed out that in some cases it becomes necessary for organizations to establish new symbols where existing symbols do not fit recently developed devices. It is recommended that in such cases the organizations bring this need to the attention of the secretary who will submit it to the proper committee. It is hoped that this will permit the committee to guide in the establishment of new symbols.

Further discussion of the scope of activities of the subcommittees was held.

TECHNICAL COMMITTEE ON ELECTRO-ACOUSTICS—ASA

A meeting of the Technical Committee on Electro-Acoustics of the Sectional Committee on Radio operating under the American Standards Association was held at the Institute office on October 11 and was attended by Julius Weinberger, chairman; J. B. Lodge, H. B. Marvin, Benj. Olney, L. J. Sivian, W. F. Snyder, G. R. Waller (representing E. E. Hemberger), V. E. Whitman, and H. P. Westman, secretary.

After discussing the scope of the committee's operations, portions of the 1933 report of the Institute's Standards Committee were examined. A number of recommendations were made for the benefit of the Institute's Standards Committee when these sections are reviewed.

Some data on microphone calibration now being used by the Sectional Committee on Accoustic Measurements and Terminology are to be obtained and distributed to the committee members.

Standards in the electro-acoustic field adopted by the RMA were reviewed but none considered suitable for acceptance at the present time as American standards.

TECHNICAL COMMITTEE ON RADIO TRANSMITTERS—ASA

A meeting of the Technical Committee on Radio Transmitters of the Sectional Committee on Radio was held at the Institute office on November 7 and those present were Haraden Pratt, chairman; W. B. Lodge (representing H. A. Chinn), A. A. Oswald, E. J. Ports, D. S. Rau (representing J. L. Finch), and H. P. Westman, secretary.

This was the first meeting of the committee and was devoted to general organization problems. A discussion of material to be considered by the committee assisted in crystalizing opinions as to suitable material and methods of procedure. The individual members of the committee will review material appearing in the 1933 Report of the I.R.E. Standards Committee and submit written comments on its acceptability as American standards. These comments will be given further consideration at the next meeting of the committee.

Institute Meetings

ATLANTA SECTION

The Atlanta Athletic Club was the place at which the September 27 meeting of the Atlanta Section was held. H. L. Reid, chairman, presided and twenty-one members and guests were present. Nine attended the informal dinner which preceded the meeting.

W. J. Holey, radio inspector at the Atlanta office of the Federal Communications Commission presented a paper on "Methods and Equipment Used in Making Field Strength Measurements." The equipment needed for a field strength survey was discussed in detail. Circuit arrangements developed for such equipment were described and explained in detail. The paper was discussed by Messrs. Bangs, Smith, Fowler, and Gerks.

BOSTON SECTION

A meeting of the Boston Section was held on October 26 at Massachusetts Institute of Technology. It was presided over by R. G. Porter, secretary, and the attendance was ninety, twenty of whom were present at the informal dinner which preceded the meeting.

A paper on "Recent Developments in Methods of Selective and Corrective Network Design" was presented by E. A. Guillemin, Assistant Professor of Electrical Engineering at Massachusetts Institute of Technology. Dr. Guillemin pointed out that in the design of radio communication facilities, selective and corrective networks are playing an increasingly important part. Methods of designing these networks have kept pace with the demands of minimized distortion, better economy, and decreased weight as dictated by high fidelity and low cost. Such advances have been achieved through a more thorough study of the properties of networks without the restriction to conventionality of form so evident in the earlier design procedures, which are to be classified more as an outgrowth of the long-line and collateral problems rather than as an independent attack on a new, although related, field.

Instead of yielding to the limitations of a conventional form, the newer methods recognize only the restrictions required by the fact that the network shall be physically realizable. The resulting design procedures lead to greater latitude and increased precision in meeting desired behavior. At the same time they are able to meet more fully the requirements for distortionless transmission in so far as the latter may be attained by a selective system. Thus not only the desired selective properties but also maximum tolerances in allowable distortion may be specified in a given design. This latter point is intimately related to the part played by incidental resistances, and its proper consideration in the design leads not only to better performance but also to lower cost and weight. In the final process of finding a suitable form of network, the questions of tolerance in circuit elements and manufacturing economy and facility are the primary guiding principles.

The paper was discussed by Messrs. Cabot and Counihan.

BUFFALO-NIAGARA SECTION

The Buffalo-Niagara Section met on October 17 at the University of Buffalo. The meeting was presided over by L. E. Hayslett, chairman, and 107 members and guests were present. Seven attended the informal dinner which preceded the meeting.

A paper by R. U. Clark, condenser engineer for the Magnavox Company, on the subject of "Development and Manufacture of Electrolytic Condensers" was presented. The paper was preceded by motion pictures giving views of the plant of the Magnavox Company and explaining the manufacturing processes employed. The paper covered research details, descriptions of manufacturing processes and the application to radio apparatus and small motors of both wet and dry electrolytic condensers. The great advantages of etching the electrodes was stressed. Condenser specifications as to their effective capacitance, leakage, resistance, frequency, voltage and other factors were discussed. The paper was discussed by Messrs. Crom, Hayslett, Huntsinger, Waud, Wesselman and others in attendance.

CONNECTICUT VALLEY SECTION

K. S. Van Dyke, chairman, presided at the October 18 meeting of the Connecticut Valley Section held at the Hotel Charles in Springfield, Mass.

A paper on "Comparison of Output Systems of Radio Receivers" was presented by J. R. Nelson of the Raytheon Production Corporation. He then outlined the development of output tubes through the triode and pentode types, illustrating graphically the improved performance gained by the successive stages of high-mu, low-mu, and pentode types. He mentioned briefly the coplanar grid type and illustrated certain of its possibilities. Overbiased triodes in push-pull class B and modified versions were discussed. A method of computing the output power of an overbiased push-pull stage through the use of the graphical characteristics of a single tube was shown. He then discussed a new type of direct coupled circuit in which a 27 or a 56 drives a high-mu connected 46 to outputs about 50 per cent greater than that obtained from similarly operated pentodes. Approximately seven and one-half watts were obtained from a single 46 with tolerable distortion. In the smaller outputs the distortion was appreciably less than a pentode. The paper was discussed by a number of the fifty-one members and guests in attendance.

DETROIT SECTION

Samuel Firestone, chairman, presided at the October 26 meeting of the Detroit Section held in the Detroit News Conference Room. Forty-five members attended the meeting and ten were present at the informal dinner prior to it.

R. H. Dreisbach of the Electro-Acoustic Products Company presented a paper on "The World's Fair Public Address System." He out-

lined first the public address system used at the World's Fair and then gave a general description of the type and location of the loud speaker units and associated amplifiers. The switching arrangements which were incorporated to provide flexibility of operation were treated. The design and performance of the various units of the system were described and by means of graphs their characteristics were illustrated. The meeting was closed with a discussion of the high fidelity audio equipment which was displayed at the Fair.

NEW YORK MEETING

The regular monthly New York meeting of the Institute was held on November 7 at the Engineering Societies Building. A paper on "Photoradio Apparatus and Operating Technique Improvements" by J. L. Callahan, Henry Shore, and J. W. Whitaker of RCA Communications was presented by Mr. Callahan. The paper covered improvements in photoradio apparatus and operating technique dating from 1928 which in general have been the result of careful attention to details. A new method of dot transmission has brought about improvements of major importance and does away with the irregular dot pattern method of producing half-tone detail. It substitutes a regular cross-hatch pattern similar in appearance to newspaper half-tone reproduction. The new system has been called "constant-frequency variable dot" or "CFVD." Radio circuit distortion was recognized and methods to minimize its effect were described. A mathematical analysis of the keying speed requirements of the new system was given.

The second paper of the evening by Maurice Artzt and C. J. Young on "Simplified Facsimile Equipment Based on the Direct Printing Carbon Recorder" was presented by Mr. Young. Both authors are affiliated with the RCA Victor Company. The simplified facsimile equipment is designed for transmission or reception of black-and-white or half-tone pictures and incorporates in one apparatus both scanning and recording devices. The scanning system is similar to those used in other picture transmitting systems. In the recorder, carbon paper is used for marking and the machine is directly printing, continuous in its operation and simple in mechanical construction. It has been applied to the recording of weather maps on shipboard and samples of its performance were shown.

Both the commercial transoceanic equipment described in the first paper and the simplified version were in operation at the meeting and a lively discussion followed the presentation of the papers. The attendance was about 400.

PHILADELPHIA SECTION

The Philadelphia Section held a meeting on October 2 at the University of Pennsylvania with E. D. Cook, chairman, presiding. The attendance was 107 and nineteen were present at the informal dinner which preceded the meeting.

A paper by C. J. Young of the Research Department of the RCA Victor Company on "A Direct Printing Facsimile Recorder and its Application" was presented. In it he described the new direct printing carbon paper facsimile recorder recently developed. Details of construction and methods of operation were described and both the transmitting and receiving equipment covered. The equipment will transmit half-tone pictures and record them directly on a strip of paper eight and one-half inches wide and in sufficient detail to make ordinary newspaper print readable. The picture is completely finished upon issuing from the receiving recorder and does not require developing or other operations. The material on a standard sheet of paper eight and one-half by eleven inches can be transmitted in about eight minutes and samples were shown of weather maps transmitted to ships at sea as far away from New York as Le Havre, France. Maps were easily readable even though some were transmitted and received during severe static conditions. The paper was discussed by Messrs. Artzt, Gartley, Kellogg, Murray, Snyder and others.

PITTSBURGH SECTION

The first meeting of the fall season of the Pittsburgh Section was held at the Fort Pitt Hotel on October 16. C. K. Krause, chairman, presided and the attendance totaled thirty-eight.

A paper on "Mechanical Filters Suitable for Single Signal Superheterodynes" was presented by H. V. Noble, a research engineer for the Gulf Research and Development Corporation. In it he summarized briefly the action of the conventional tuned circuits and filters used in radio reception from the earliest crystal detector receivers up to the present bridge circuits employing quartz crystals as filters. He then discussed a new type of filter employing a quartz bar as a mechanical coupling unit receiving energy from a pair of electrodes at one end and delivering energy to a second pair of electrodes at the other end. These pairs of electrodes are electrically and magnetically shielded from each other. Selectivity curves show the filter to have a band width of about thirty cycles, about one tenth that of conventional quartz filters. A completely shielded unit was shown which required only the connection of one lead to the plate of the first detector tube and a

second connection to the grid of the first intermediate-frequency amplifier tube.

Messrs. Armstrong, Best, Kozanowski, Osbon, Sunnergren, Sutherland, Swedlund, Williamson and others participated in the general discussion. Several motion picture films, obtained through the courtesy of the General Electric Company, were shown.

ROCHESTER SECTION

A joint meeting of the Rochester Section and Rochester Engineering Society was held on October 25 at the Sagamore Hotel and presided over by W. A. Young, chairman of the Rochester Section of the American Institute of Electrical Engineers. Sixty-five members and guests were present.

A paper on "Radio Engineering in Australia" was presented by A. W. Scott, assistant chief engineer of Stromberg-Carlson, Australia, Ltd. He spoke first of the business conditions, customs, and home life of the people of Australia, and then outlined the broadcast system used. The number of broadcast transmitters, their location, and their coverage of the country was then given. Short-wave reception especially from this country was discussed, and the beam transmission and reception of short waves to this country developed with the thought of establishing regular telephone communication with the United States were described. The paper was discussed by a number of those present.

SAN FRANCISCO SECTION

A meeting of the San Francisco Section was held on October 17 at the Bellevue Hotel. Ralph Shermund, vice president, presided and the attendance was thirty-eight.

A paper on "Industrial Applications of Vacuum Tubes" was presented by H. C. Stanley of the General Electric Company. He outlined the many uses made of vacuum tubes in industrial operations with special emphasis on the applications of the photo-electric tube to counting, sorting, and initiating intermittent mechanical operations.

SEATTLE SECTION

A meeting of the Seattle Section was held on June 8 at the University of Washington with C. E. Williams, vice chairman, presiding. The attendance was sixty-four.

A paper on "Sound Transmission and Related Topics" by D. H. Loughridge, Professor of Physics at the University of Washington was presented. His paper outlining accoustical theory was followed by

a demonstration of mechanical and accoustical wave filters and of biacoustic reproduction employing two- and three-channel transmission systems. Messrs. J. R. Tolmie and T. M. Libby assisted in the demonstration. The paper was discussed by Messrs. Bach, Eastman, Hackett, Parrot, and Renfro.

TORONTO SECTION

The October meeting of the Toronto Section was held on the 25th at the University of Toronto and was presided over by A. B. Oxley, chairman. The attendance was forty-two.

"Receiver Distortion Analysis by Means of Cathode Ray Tubes" by H. W. Parker of Rogers Radio Tubes and F. J. Fox, chief engineer of the Rogers Majestic Corporation was presented by Mr. Parker. A pure sine wave generator which is used in connection with the distortion analyzer was described. The mathematical and graphical explanation for nine different types of modulation was then presented. A demonstration was then given of the cathode ray distortion analyzer under operating conditions to check the characteristics of a broadcast receiver. One cathode ray tube showed the signal delivered to the receiver and another tube showed the output from the receiver under various conditions of operation. Both Messrs. Parker and Fox explained in detail the various circuits employed in the equipment.

Acknowledgment was made to Mr. Dawson for his part in the development of it. The paper was discussed by Messrs. Hackbusch, Hepburn, Nesbitt, Oxley, and Price.

WASHINGTON SECTION

A meeting of the Washington Section was held on September 10 in the auditorium of the Potomac Electric Power Company. T. McL. Davis, chairman, presided and 100 members and guests were in attendance. Thirty-four were present at the informal dinner which preceded the meeting.

A paper on "Direct Printing Facsimile Equipment and Some of Its Applications" was presented by C. J. Young of the RCA Victor Company. In it he outlined the purpose of facsimile transmission in general, discussed its advantages and limitations, and described the circuits and principles involved in a particular system in considerable detail. A number of those present participated in the discussion.

The October meeting of the section was held on the 8th at the Potomac Electric Power Company auditorium and was attended by 115 of whom thirty-five were present at the dinner which preceded the meeting. Chairman Davis presided.

F. X. Rettenmeyer of the Bell Telephone Laboratories presented a paper on "Some Recent Developments in Commercial Radio Receiving Equipment." In it he described several recently developed radio receivers showing views of the various assemblies, circuit diagrams, and performance graphs. Receivers described included point-to-point high-frequency units, aircraft beacon units, and rotating loop type of direction finder equipment. The paper was followed by several reels of sound motion pictures showing the intricate maintenance organization involved in providing dependable service to telephone and broadcast network subscribers.

Because of the resignation of Vice-Chairman V. Ford Greaves who is now located on the Pacific Coast, E. K. Jett of the Federal Communications Commission staff was appointed in his place, by action of the Executive Committee. The Nominating Committee to bring in a slate of officers for the following year was appointed and is comprised of Drs. Dellinger, Dorsey, and Wheeler.

Personal Mention

Previously with Standard Telephones and Cables, C. G. Crawford has joined the staff of the British Broadcasting Corporation in London.

R. B. Dome of the General Electric Company has been transferred from Schenectady to Bridgeport.

W. G. H. Finch formerly chief engineer of the Hearst radio activities has become assistant chief engineer of the Federal Communications Commission in Washington, D.C.

Previously with Aero Radio Corporation, B. M. Fox is now a recording engineer for Universal Pictures Corporation at Universal City, Calif.

R. H. Freeman formerly with United Air Lines is now in charge of the Electronics Division of the Eclipse Aviation Corporation.

E. J. Girard of the Mackay Radio and Telegraph Company has been transferred from New York City to Washington, D.C., as district manager.

J. G. Haas formerly with Bludworth, Inc., is now a radio engineer for the Ferris Instrument Corporation of Boonton, N.J.

F. A. Hinners recently with FADA Radio and Electric Corporation has joined the staff of the Hazeltine Corporation in New York City.

E. A. Lederer formerly chief engineer of the National Union Radio Corporation has joined the research staff of the RCA Radiotron Company.

TECHNICAL PAPERS

GENERATION AND UTILIZATION OF ULTRA-SHORT
WAVES IN RADIO COMMUNICATION*

BY
FREDERICK A. KOLSTER

(International Communications Laboratories, New York City)

Summary—In general, this paper deals with the generation and practical utilization of ultra-short waves below ten meters. The first part of the paper describes an ultra-high-frequency oscillator in which a "tank circuit" of novel design is used for the purpose of obtaining a high degree of frequency stabilization without resorting to frequency doubling or crystal control. Later, the feasibility of utilizing ultra-short waves as carriers of signal channels from a remote receiving station to the city operating room is discussed and preliminary experiments described.

I. INTRODUCTION

DURING the past two or three years, a great deal of experimental work has been conducted in this country and abroad, in the study of the propagation characteristics of radio waves below ten meters in length. Published accounts of these experiments have attracted wide interest and have encouraged consideration of extended practical application of this ultra-short wave region of the radio spectrum.

It is perhaps permissible to divide the ultra-short-wave spectrum logarithmically into two classes; one including wavelengths from one to ten meters and the other including those from ten to one hundred centimeters. A justification for such a division is based on the fact that in the generation and transmission of waves from one to ten meters no essentially new technique is required, while in the region from ten to one hundred centimeters we enter a new field which requires a somewhat different and new technique. Here we begin to depart from purely radio principles and become more closely bound by the principles of optics.

In dealing with ultra-short waves between one and ten meters we observe the following facts:

1. Transmission is effected directly through space and not via the sky route.

* Decimal classification: R355.5. Original manuscript received by the Institute, June 7, 1934. Presented before New York meeting, March 7, 1934.

2. Transmission is effective at a considerable distance below the line of sight, which means that we may go far beyond the horizon before we get out of range of transmission.

3. Reception is practically free from atmospheric disturbances and variations due to solar effects.

The great limitation in the practical utility of ultra-short waves is the matter of distance. For the present, at least, it seems obvious that they are useful only in cases where communication is to be established or successively relayed over comparatively short distances. However, there are many special types of services in which ultra-short waves are uniquely applicable because of the distance limitation, as, for example, for police control, for air services, for localized sound and picture broadcasts, and for high speed intercity telegraph and facsimile transmissions.

With extended knowledge of the physical laws of wave propagation through space, it is not unreasonable to predict that the seemingly inherent distance limitation of ultra-short waves will in time become much less conspicuous.

Certain it is that ultra-short waves are destined to open up new fields of communication and will without doubt play an important part in extending and supplementing our great national communication network.

II. GENERATION OF ULTRA-HIGH-FREQUENCY OSCILLATIONS

The generation of very high frequency oscillations required for the transmission of ultra-short waves, in the range between one and ten meters presents an interesting problem to the engineer. He is immediately impressed with the fact that everything appears to have inductance or capacitance or both which form impedances of magnified importance and which more often than not become extremely troublesome.

Let us take, for example, the internal structure of the vacuum tube with its plate, grid, filament, supporting wires, and connecting leads. These form a veritable network of reactances and resistances which unless minimized, neutralized, or otherwise controlled, will take complete charge of the electrical performance of the circuit with which the vacuum tube is associated.

In many of the conventional types of high-frequency generators this internal electrical network becomes a prominent part of the oscillatory circuit, with the result that the frequency and the amplitude of the oscillations are seriously affected by variations of supply voltages or other causes which may vary the internal impedances of the vacuum tube.

In the design of the oscillator to be described, an attempt has been made to minimize the importance of the vacuum tube impedances and to emphasize, by special design, the importance of the external circuit as the frequency stabilizing means.

The electrical counterpart of the mechanical flywheel is a circuit with inductance and capacitance connected in parallel. Such a circuit, therefore, may effectively be used as a frequency stabilizing means just as a flywheel is used to maintain constant rotational speed.

However, to effect good electrical flywheel action, important requirements have to be met. In this connection, it is of interest to review the parallel circuit theory and to examine some of the salient characteristics of such a circuit.

Let us take, for example, the simple case in which a pure capacitance C is connected in parallel with an inductance L whose resistance is R as in Fig. 1.

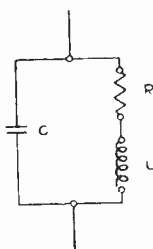

Fig. 1—Electrical equivalent of mechanical flywheel.

The parallel reactance and resistance of such a circuit may be expressed by the following formulas:

$$X' = \frac{1}{C\omega} \times \frac{(1 - LC\omega^2)LC\omega^2 - \frac{LC\omega^2}{Q^2}}{(1 - LC\omega^2)^2 + \frac{LC\omega^2}{Q^2}} = \frac{1}{C\omega} \times P \quad (1)$$

$$R' = R \times \frac{1}{(1 - LC\omega^2)^2 + \frac{LC\omega^2}{Q^2}} = R \times M. \quad (2)$$

This is not exactly the textbook form of the expressions for parallel circuit resistance and reactance but they are convenient because of the appearance therein of the term Q which has come into rather common usage in engineering practice. Q defines the oscillating persistency of the circuit and is therefore a measure of its flywheel efficiency.

The manner in which the term P in the reactance formula varies with $LC\omega^2$ depends upon the value of Q .

$$\text{when } LC\omega^2 = 1 - \frac{1}{Q} \quad P = \text{maximum } +$$

$$\text{when } LC\omega^2 = 1 + \frac{1}{Q} \quad P = \text{maximum } -$$

$$\text{when } LC\omega^2 = 1 - \frac{1}{Q^2} \quad P = 0$$

$$\text{when } LC\omega^2 = 1 \quad P = -1$$

$$\frac{1}{Q} = \sqrt{\frac{R^2 C}{L}} = \frac{\text{decrement}}{\pi}$$

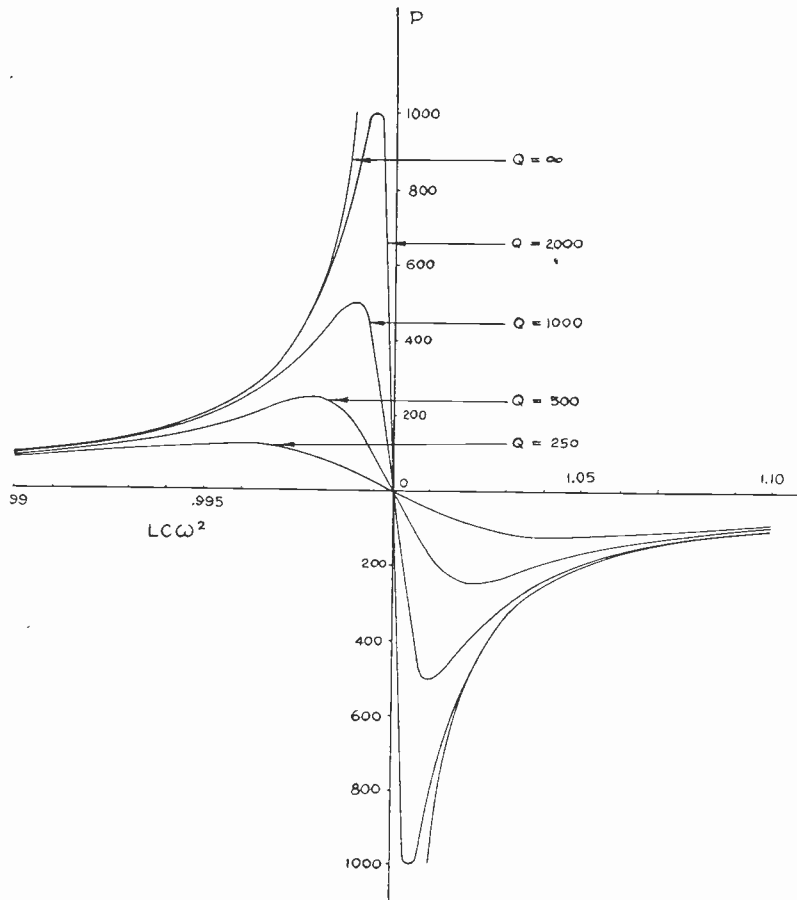

Fig. 2

The family of curves in Fig. 2 shows the variation of the P term with $LC\omega^2$ and for different values of Q . By drawing a three-dimensional curve, Fig. 3, with variations of the resistance term M plotted with

simultaneous variations of the reactance term P , a clear picture is obtained of the characteristics of the parallel circuit for values of $LC\omega^2$ close to resonance.

All of this, of course, is elementary and is given merely for the purpose of setting forth the important design requirements of a parallel circuit for good electrical flywheel action.

It is obvious that the circuit must have a high Q value and that it must be driven at a frequency as close as possible to its own natural frequency.

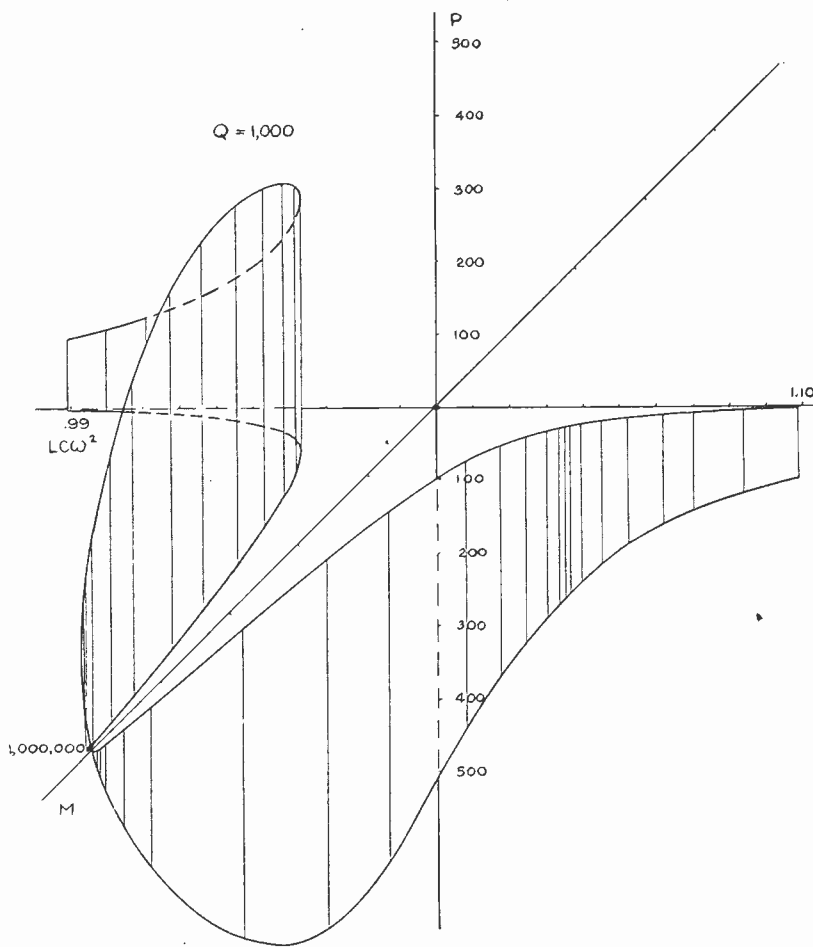

Fig. 3

The latter requirement is of considerable importance in the matter of circuit design as will be seen by reference to Fig. 4 which shows the method of connecting the vacuum tube to the parallel circuit for producing high-frequency oscillations.

It will be noted that the interelectrode capacitances of the vacuum tube are utilized as essential high-frequency paths through which the terminals of the parallel circuit L_0C_0 are connected to ground or neutral

point. The small capacitance formed by the plate and filament provides one of these paths while the capacitance formed by the grid and filament, as modified by the circuit $L'C'$ provides the other. Since the path from plate to ground inherently has negative reactance, the corresponding path from grid to ground must also have negative re-

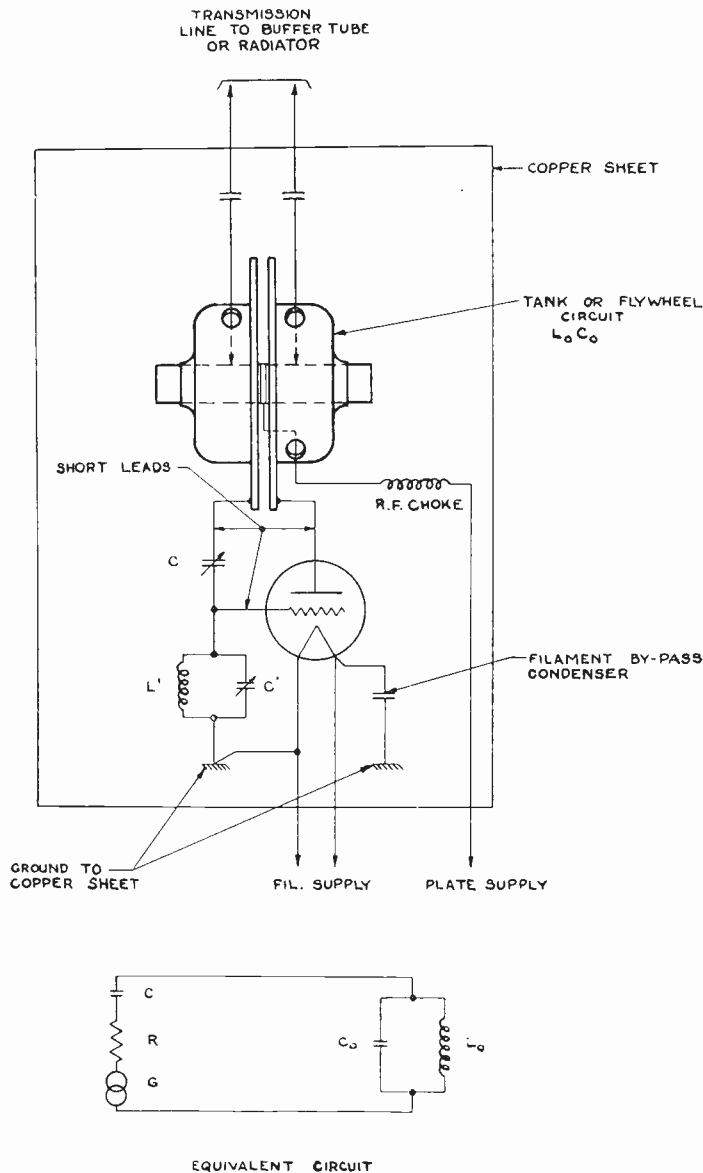

Fig. 4

actance. The circuit $L'C'$ provides means for adjusting this reactance to the proper value required for the generation of oscillations. The condenser C serves not only as a blocking condenser but also provides means for regulating grid excitation.

A simplified equivalent circuit of the oscillator is also shown in Fig. 4. Here, the parallel circuit L_0C_0 is shown as being driven by the

generator G through a resistance R and a capacitance C which represent, respectively, the effective grid and plate resistances and the capacitances formed by the two paths to ground.

From this it is readily observed that if the generated frequency is to be as close as possible to the natural frequency of the parallel circuit L_0C_0 , it is necessary that the capacitance of the condenser C_0 be large in comparison with the capacitance C .

Since the value of C , as represented in the equivalent diagram, is always something less than the plate-to-filament capacitance, it is not difficult in practice to make the ratio C_0/C large.

This requirement is somewhat in conflict with the high Q requirement of a parallel circuit for the reason that it places a limitation upon the choice of the L/C ratio of the circuit, and since,

$$Q = \sqrt{\frac{L}{R^2C}}$$

the problem becomes one of obtaining a high value of Q by virtue of low resistance rather than by a high L/C ratio.

Fortunately, it is quite easy in practice to obtain very high Q values by resorting to special circuit design in which large copper surfaces are used in the construction of the inductance. Such a construction is illustrated in Fig. 5.

The complete circuit is formed by mounting two flanged copper shells upon a copper tube. The spaced flanges provide the capacitance and the copper tube together with the concentric shells form the inductance. It is interesting to observe that the inductance thus formed may be looked upon as a single turn current sheet path of toroidal shape, the inductance of which may be calculated with a fair degree of accuracy by the formula

$$L = 0.0117l \times \log_{10} \frac{\sqrt{r_2}}{\sqrt{r_1}}$$

where

L = inductance in microhenrys

l = length of tube in inches

$\sqrt{r_2}$ = inside radius of copper shells

$\sqrt{r_1}$ = outside radius of tube.

The capacitance of the circuit as formed by the flanged copper shells and constructed as in Fig. 5(a) may be calculated by the formula

$$C = 0.1764 \times \frac{D_0^2 - D_1^2}{S}$$

where,

C = capacitance in micromicrofarads

D_0 = outside diameter of flanges in inches

D_1 = inside diameter of flanges in inches

S = separation between flanges in inches.

This, of course, does not take into account stray capacitances.

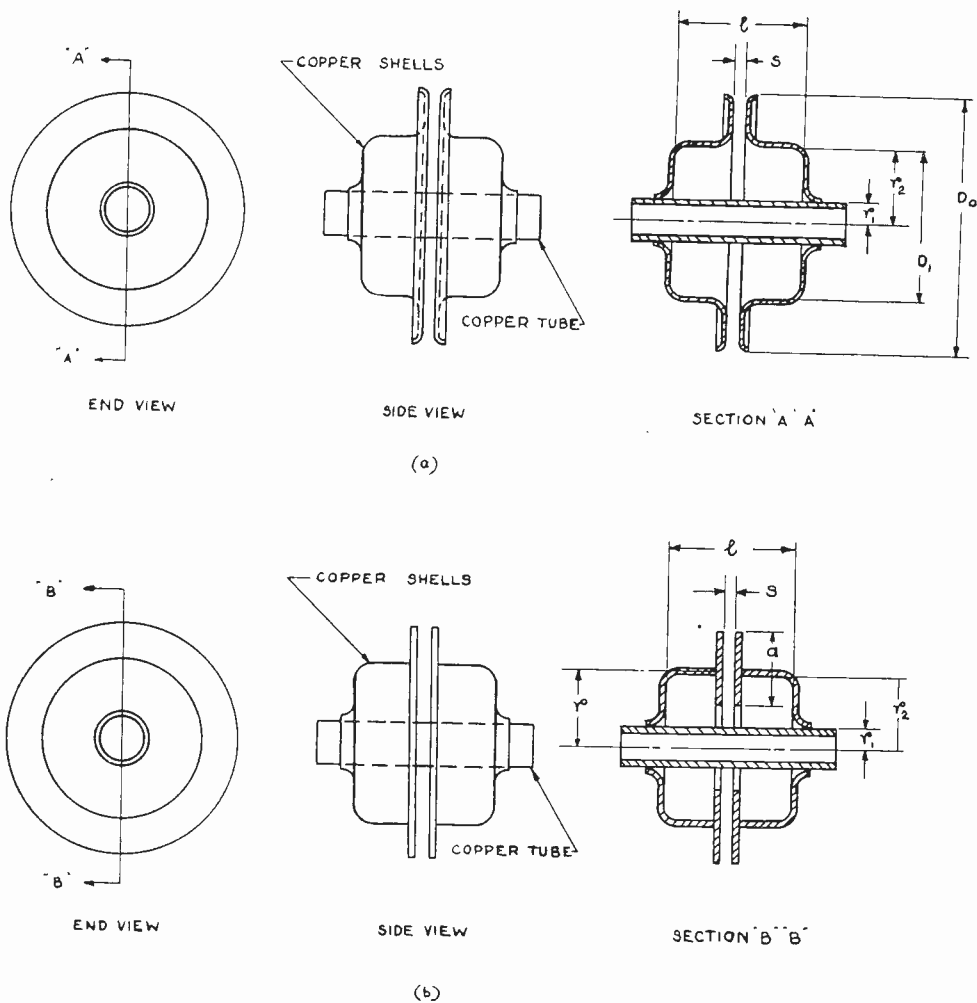

Fig. 5

Design data for circuits constructed in this manner suitable for a wavelength of approximately five meters are tabulated below for various tube sizes ranging from 3 inches to 1 inch in diameter. In each case the effective tube length l is $8\frac{1}{4}$ inches, the ratio r_2/r_1 is 5, and the spacing between flanges S is approximately one-fourth of an inch.

Tube diameter	D_1	D_0	Q
3 inches	15 inches	$19\frac{1}{2}$ inches	3000 approx.
2 "	10 "	$15\frac{3}{4}$ "	2000 "
$1\frac{3}{4}$ "	$8\frac{3}{4}$ "	$14\frac{7}{8}$ "	1750 "
$1\frac{1}{2}$ "	$7\frac{1}{2}$ "	$14\frac{1}{4}$ "	1500 "
$1\frac{1}{4}$ "	$6\frac{1}{4}$ "	$13\frac{1}{2}$ "	1250 "
1 "	5 "	13 "	1000 "

For the construction shown in Fig. 5(b), wherein the capacitance is formed by two rings centrally located upon the copper shells, calculation of capacitance is simplified by the formula

$$C = 1.41 \times \frac{ar}{s}$$

where,

C = capacitance in micromicrofarads

a = width of rings in inches

r = mean radius of copper shells in inches

s = separation between rings in inches.

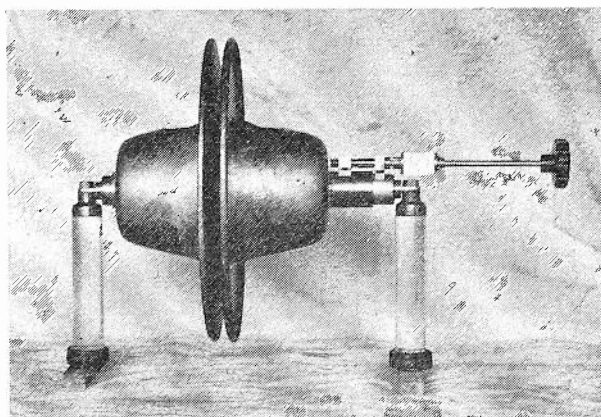

Fig. 6

This method of construction is preferable in cases where large tube diameters are used since the over-all size of the circuit is thus materially reduced as will be seen by the following tabulated design data for cases corresponding to those given above for the construction illustrated in Fig. 5(a):

Tube diameter		
3 inches	7½ inches	2½ inches
2 " "	5 " "	3¾ " "
1½ " "	4¾ " "	4¼ " "
1½ " "	3¾ " "	4⅞ " "

The actual tank circuit shown in Fig. 6 is typical in general appearance of one constructed in accordance with the design data given in connection with Fig. 5(a) for a tube diameter of 1½ inches. This is provided with means for varying the separation between flanges by movement of one of the shells along the tube, thus giving a wavelength variation of from about four to six meters.

Photographic views of various types of tanks are shown to illustrate variations in construction. Figs. 8 and 9 are extreme cases, one having an L/C ratio ten times as great as the other. Their respective Q values, however, are not very different. In neither case is the Q value

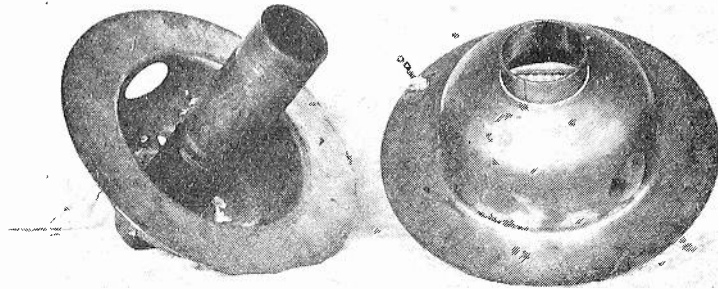

Fig. 7— $L = 0.05$ microhenry
 $C = 90$ micromicrofarads
 $Q = 2000$
 $\lambda = 4$ meters

very high, due to the fact that in one the resistance is comparatively high, on account of the extreme length of the copper tube, and in the other the L/C ratio is extremely low.

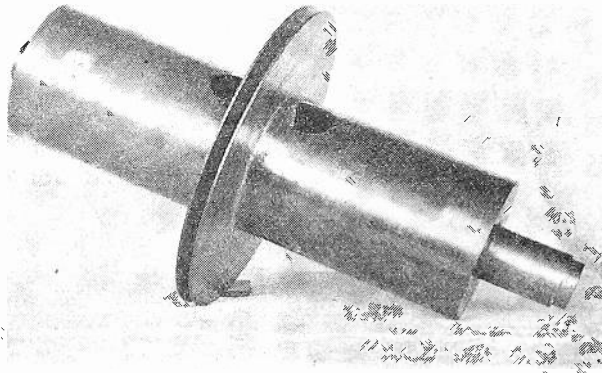

Fig. 8— $L = 0.10$ microhenry
 $C = 90$ micromicrofarads
 $Q = 650$
 $\lambda = 5-6$ meters
 $L/C = 1100$

It is entirely practicable to construct tank circuits as above described for high power and for wavelengths up to perhaps 20 meters. An example is shown in the photographic views of Figs. 10 and 11. This is a 20-kilowatt oscillator designed for a wavelength range of

from approximately 10 meters to 15 meters. The outside diameter of the condenser plates is four feet and the length of the copper tube between bearings is about two feet. Means are provided for water-cooling the copper tube to prevent excessive heating due to the very high circulating current set up in the tank circuit at high power.

Experimental observations have proved that the high Q tank or flywheel circuit is extremely effective as a frequency stabilizing means. In fact, in so far as the high Q value contributes to frequency stability,

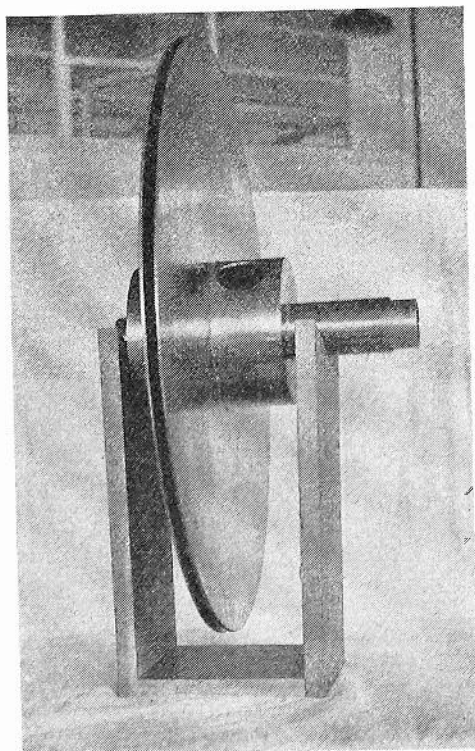

Fig. 9— $L = 0.03$ microhenry
 $C = 300$ micromicrofarads
 $Q = 850$
 $\lambda = 5-6$ meters
 $L/C = 100$

the circuit is superior at high frequencies to the quartz crystal and has none of the practical limitations of the latter.

When an extremely high degree of frequency stability is desired, it is necessary, of course, to maintain the tank circuit at a uniform thermostatically controlled temperature or to provide compensating means to take care of any changes in the physical dimensions of the tank with varying temperature.

A tank made completely of copper as illustrated in Fig. 6, for example, where the spacing between the flanges is about one-fourth of an

inch, will hold the frequency constant to within twenty-five parts in a million per degree centigrade change in temperature. It will be noted that the linear expansion of the copper tube due to heating will result in increasing the separation between the flanges of the copper shells thus tending to reduce the capacitance of the circuit. However, since the linear expansion of the concentric shells results in decreasing the separation of the flanges, variations of capacitance are partially neutralized. Complete compensation would result if the shells were con-

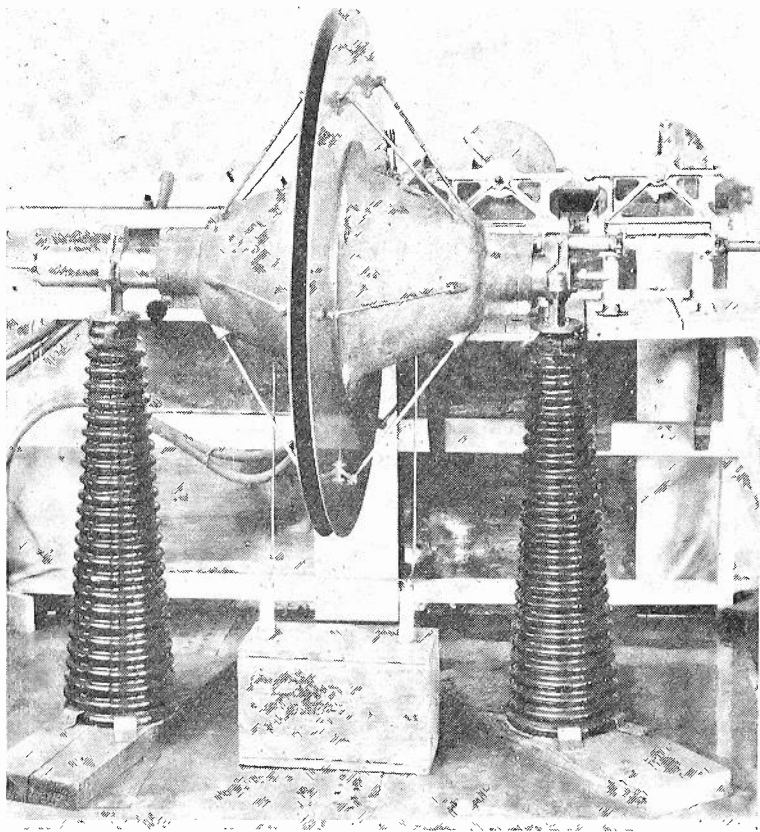

Fig. 10

structed of a material having a higher coefficient of linear expansion than that of the supporting tube.

In so far as changes of supply voltages directly contribute to frequency variations, it may be stated that such variations are entirely negligible. However, unless suitable temperature controlling or compensating means are employed, extreme changes of plate voltage will indirectly cause a frequency drift because of the consequent change in temperature of the tank circuit. Fig. 12 illustrates the performance of a tank circuit oscillator operating at a normal frequency of 60 megacycles. The tank was not temperature controlled to any further ex-

tent than to cool the copper tube by water circulation. Under these conditions, the frequency remained constant to within ± 100 cycles over a wide range of plate voltages. When the voltage was reduced beyond 60 per cent of its normal value the frequency gradually drifted to a lower value. This was probably due to a change in the characteristics of the vacuum tube as the plate voltage was decreased well below its normal value.

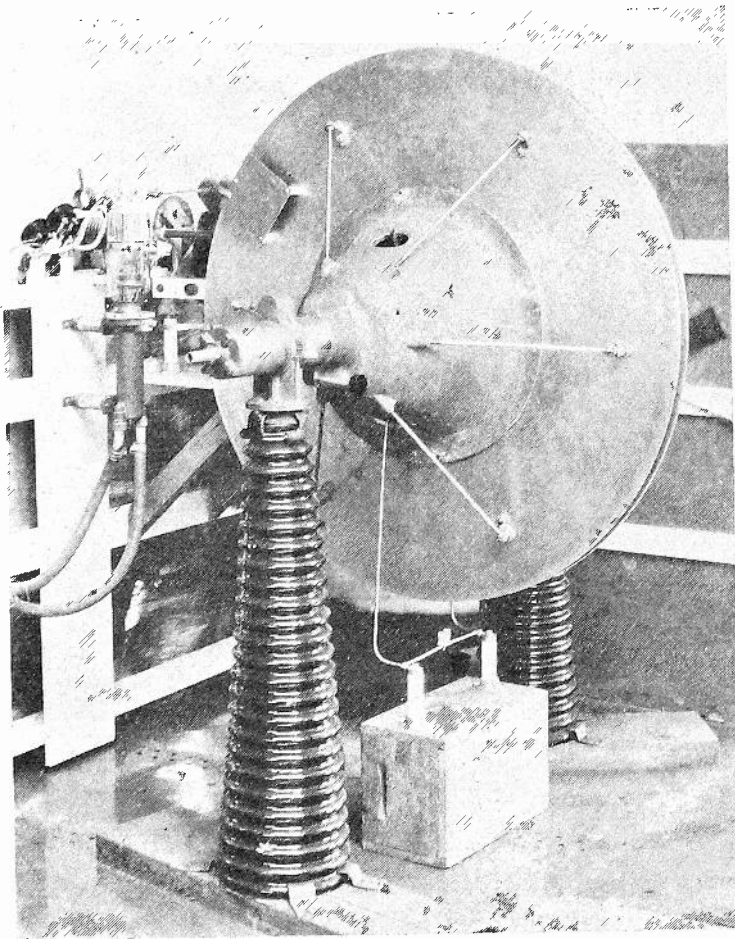

Fig. 11

III. UTILIZATION OF ULTRA-SHORT WAVES

In the practical utilization of ultra-short waves for any given purpose, it is important to give special consideration to the manner in which radiation is initiated. The choice of location and type of transmitting antenna will depend a great deal upon the nature of the terrain over which transmission is to be effected and the conditions surrounding the receiving location. In other words, ultra-short waves must be given a fair start on their journey through space.

Fortunately, the design and construction of antenna systems for ultra-short-wave transmission are simplified and facilitated because of the comparatively small dimensions required, and it is possible to do many things, which, for long waves would be entirely impracticable and too costly. We may, for example, choose between vertically and horizontally polarized radiation, we may readily concentrate radiation in various forms, and we may control the angle of radiation.

In this connection, it may be of interest to review some early experiments conducted on behalf of the Federal Telegraph Company at Palo Alto, California, about six or seven years ago.

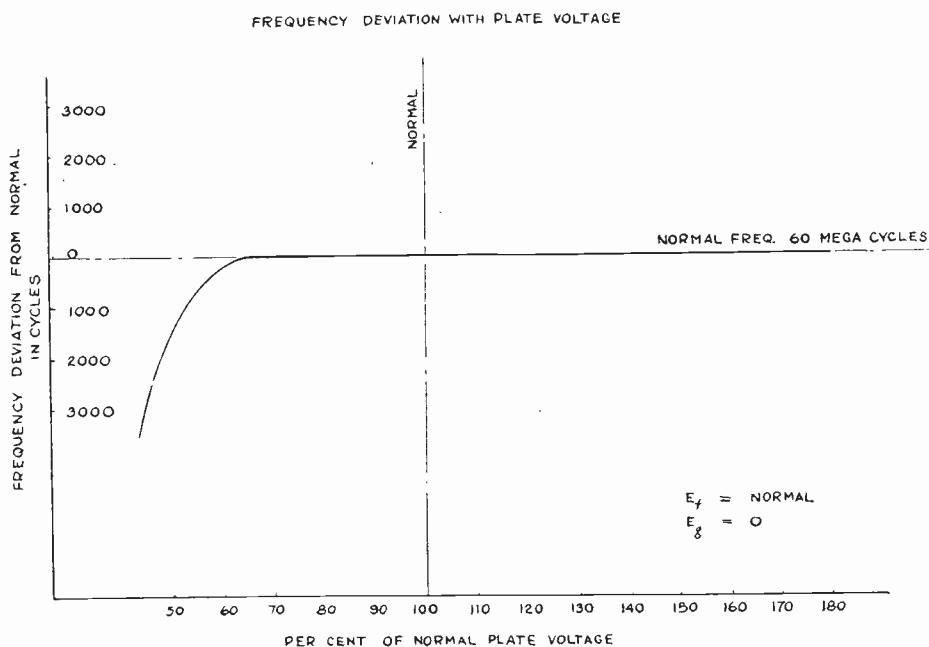

Fig. 12

Among other things, it was the purpose, at that time, to investigate the possibilities of utilizing ultra-short waves for ground-to-airplane signaling and for facilitating safe landing of aircraft in thick weather. This required concentrated or beamed radiation, the direction of which could be controlled both horizontally and vertically. Obviously, these requirements immediately suggested the use of very short waves. However at that time, the technique of generating very high frequency oscillations, corresponding to wavelengths of less than three or four meters, was not sufficiently well developed and the choice of wavelength was consequently limited by the facilities then available.

To accomplish the desired results, a wavelength of four meters was chosen and concentration of radiated energy was effected through the use of a parabolic reflector correspondingly designed and limited to an opening two wavelengths in diameter.

A photographic view of such a reflector is shown merely as a matter of general interest and to indicate that even at a wavelength as long as four meters, it is not entirely impracticable to concentrate and directionally control radiated radio energy.

The reflector is constructed of copper sheet which forms a paraboloid surface at the focal point of which is located the antenna system. The entire structure is rotatable upon a circular track, and the axis of the reflector may be set at any desired angle with respect to ground from zero to 90 degrees. The effect of the reflecting paraboloid surface is to project an intense electromagnetic field along its axis

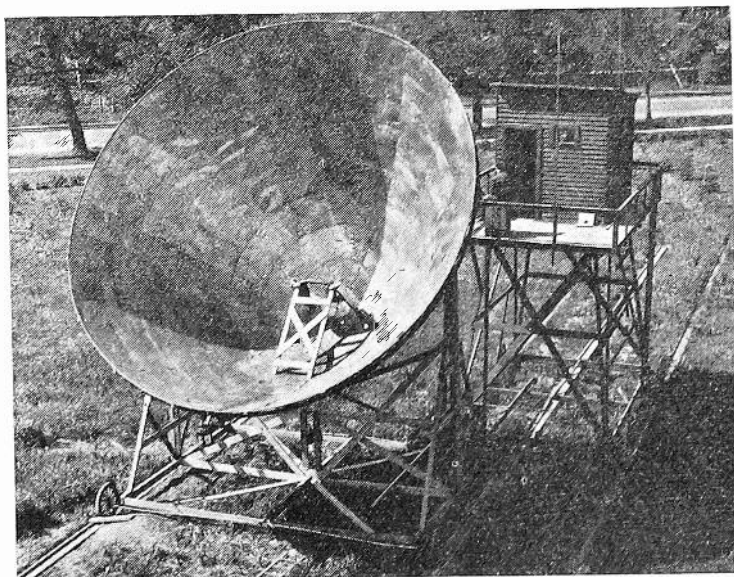

Fig. 13

which rapidly diminishes in intensity in all directions about the axis. In other words, the projected beam is very nearly circularly concentrated and the degree of concentration depends upon the manner in which radiation is initiated at the focal point of the reflector and/or upon the size of the opening of the reflector.

It is not the purpose of this paper to recite the results of these early experiments because they have since been superseded by more recent work along similar lines.

An interesting and useful application of ultra-short waves in radio communication is that of linking the remote receiving station with the city operating room. A single carrier wave may be used for the transmission of a number of signal or control channels and may thus provide a comparatively inexpensive substitute for wire connections.

Experiments along these lines have been conducted during the

past year on behalf of the Mackay Radio Company, first between Sayville, Long Island, and the City Office at 67 Broad Street, and more recently between Southampton, Long Island, and 67 Broad Street.

The purpose of the experiments has been to determine the necessary requirements to give consistent day-to-day service between these points.

The air-line distance between Sayville and lower Manhattan is about forty-eight miles and the topography of the intervening terrain is quite flat.

The receiving location on the roof of the International Telephone and Telegraph Corporation Building affords an elevation of 460 feet. For direct "line-of-sight" transmission, an elevation of approximately

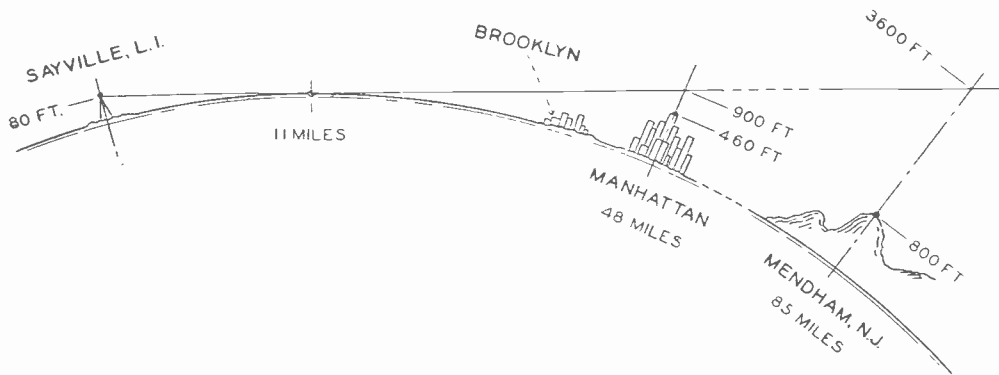

Fig. 14

300 feet would be required at the transmitting location at Sayville. However, for economic reasons, this elevation was limited to 80 feet, which is readily obtained with standard telegraph poles. With this arrangement (see Fig. 14), the receiving location is about 440 feet below the "line of sight." However, if we take into account the probable effect of atmospheric refraction, as suggested by Shelleng, Burrows, and Ferrell,¹ this distance will be reduced to something less than 200 feet.

The conditions, therefore, are very favorable for successful transmission notwithstanding the limited antenna height at Sayville, which, as a matter of fact, is advantageous rather than otherwise, for the reason that at the horizon, where radiation grazes the earth's surface, the nature of the terrain is flat, open country, free of interfering structures, and, further, for the reason that the center of radiation passes sufficiently above lower Manhattan to avoid serious absorption, reflection, and interference due to tall buildings and other obstructions.

Under these circumstances, the result was that very strong and

¹ Proc. I.R.E., vol. 21, pp. 427-463; March, (1933).

remarkably steady signals were observed at 67 Broad Street. The wavelength used was 5.83 meters, corresponding to 51.4 megacycles, and the radiated power at Sayville was approximately 200 watts.

The receiving equipment used was not highly sensitive, consisting merely of three tuned stages of radio amplification with a number of tone filters to amplify and select out the modulating tone frequencies. These were then piped down to the central operating room where they were tape-recorded in the usual manner and performance was comparable with that of a good metallic circuit.

The situation as it exists between Southampton and lower Manhattan is illustrated in Fig. 15. In this case, the air-line distance is about 86 miles. With the transmitting antenna at an elevation of about 80 feet, as in the previous case, it will be observed that the receiving

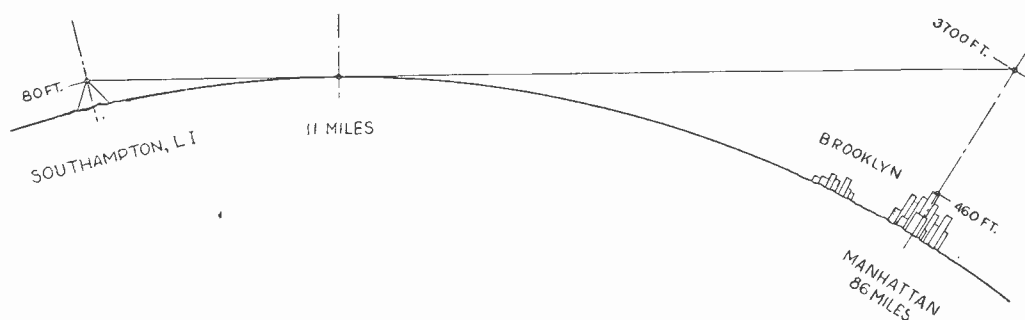

Fig. 15

location is now at a considerable distance below the "line of sight," or 3240 feet. Applying the correction for atmospheric refraction based on average conditions, this distance is reduced by about 1000 feet.

With the receiving location so far below the "line of sight" day-to-day variations in signal intensity are observed and there are occasional short periods of fading during the day. Observations taken over a period of a week show that the signal is generally well above the noise level. On a few occasions it has dropped to the noise level and only rarely has it completely disappeared.

Theoretically, it is not difficult to account for such variations on the basis of variable atmospheric refraction. This is suggested by R. Jouaust² and it serves as a completely satisfactory explanation of the observed results in the case under discussion.

The situation is graphically represented by the hypothetical case shown in Fig. 16 in which signal intensity is plotted against elevation of the receiving location above ground. If curve 1 represents the change of signal intensity with height for a period of minimum re-

² PROC. I.R.E., vol. 19, pp. 479-488; March, (1931).

fraction and curve 2 represents the corresponding change of signal intensity for a period of maximum refraction, then it will be noted that if the receiving location is at h_1 , not far below the "line of sight," there will be very little change in signal intensity with variations of refraction. If, however, the receiving location is at h_2 well below the "line of sight," much greater changes in signal intensity will occur as the degree of atmospheric refraction varies from minimum to maximum. This represents, approximately, the observed performance between Southampton and 67 Broad Street under conditions as previously described, namely, transmitting antenna height at Southampton about 80 feet, radiated power about 200 watts, and receiving location 3240 feet below "line of sight."

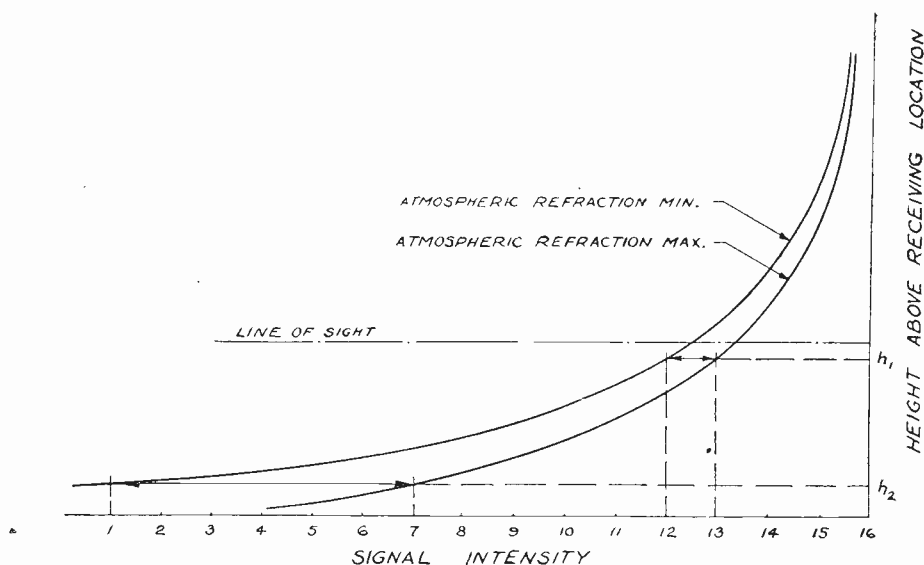

Fig. 16

During periods of maximum refraction the signal received at 67 Broad Street is strong and amply sufficient for commercial purposes. During periods of minimum refraction, however, the signal intensity falls below commercial requirements.

In order to maintain a commercial signal under all atmospheric conditions, it will be necessary to increase the height of the transmitting antenna or to increase the radiated power. Calculations indicate that by increasing the transmitting antenna height to 350 feet, the signal intensity during periods of minimum refraction will be approximately equal to that now observed during average conditions. It is more economical, however, to increase radiated power by concentrating or beaming radiation by means of a suitable antenna array of moderate height.

IV. CONCLUSION

The results of the preliminary experiments indicate that it is entirely feasible to establish commercial ultra-short-wave communication between two points even when the receiving location is well below the "line of sight." It appears necessary, however, to minimize the effects of variable atmospheric refraction by controlling the manner in which radiation is initiated at the transmitting end. In fact, it is not entirely unreasonable to predict that means will be discovered by which ultra-short waves may be artificially refracted to a degree far greater than that caused by the atmosphere. Such a discovery would materially enhance the value of ultra-short waves in the field of communication.

No one who has experienced the fascination of working with ultra-short waves can feel satisfied to leave the subject without departing a little from the crudely practical side. There is scientific romance in such an experience which recalls the very early days of radio when there were no beaten tracks to follow and when it was always good hunting. Then, too, one is reminded of the classical experiments of Hertz of nearly fifty years ago. It is nothing short of amazing to read his works today in the light of our present knowledge of ultra-high-frequency electric waves.



A LAPEL MICROPHONE OF THE VELOCITY TYPE*

BY

HARRY F. OLSON AND RICHARD W. CARLISLE

(RCA Victor Company, Inc., Camden, New Jersey)

Summary—The requirements for satisfactory operation of a lapel microphone are shown to be (1) a wide band frequency characteristic compensated for diffraction of the voice around the head, (2) means for keeping the output constant while the head is turned, (3) satisfactory sensitivity, and (4) light weight. The first is accomplished by calculating the diffraction and compensating for it. The second is accomplished by utilizing the velocity principle and so orienting the microphone that the region of optimum sensitivity lies in the direction of the mouth when the head is turned to the side away from the microphone. Suitable compensation is used to make the output proportional to sound pressure rather than wave velocity. Satisfactory sensitivity is attained with only three ounces of total weight by carefully proportioning the microphone. The latter consists of a very thin aluminum ribbon suspended between the poles of a small permanent magnet. It occupies only one fortieth the volume of a standard velocity microphone. The over-all effective frequency characteristic is flat from 80 to 7000 cycles with a deviation of ± 2 decibels.

INTRODUCTION

THE principal purpose of using a lapel microphone as contrasted to a stationary microphone in front of a speaker is to permit the speaker to move freely around a studio, stage, or lecture platform or turn away from the audience without there being any appreciable change in the intensity or quality of his voice, as heard by the audience, due to the variation in distance and azimuth with respect to the microphone. This reduces the amount of monitoring to a minimum. There is also some advantage to be gained in the fact that the lapel microphone does not obstruct the audience's view of the speaker.

In ordinary public address, sound reënforcing, news-reel pick-up and for many broadcast purposes, convenience in microphone placement is an important factor. With the lapel microphone it is sufficient merely to hook the microphone into the buttonhole of the speaker's coat lapel in order to permit him to proceed with his speech.

GENERAL REQUIREMENTS

The general requirement of a microphone is uniform response over a specified frequency range. In the case of the ordinary microphone

* Decimal classification: R385.5. Original manuscript received by the Institute, June 11, 1934. Presented before Ninth Annual Convention, Philadelphia, Pa., May 28, 1934.

this means that the ratio of the voltage impressed upon the grid of a vacuum tube to the pressure in free space shall be relatively independent of frequency.

It is well known that the quality of the human voice changes as the speaker's head is turned relative to the auditor. In the case of the ordinary microphone, we neglect to compensate for this effect because we seek to transport the auditor's hearing mechanism to the position occupied by the microphone and any frequency discrimination merely adds to the naturalness of the action.

In the case of the lapel microphone we are primarily interested in obtaining maximum articulation. The articulation depends essentially upon the shape of the frequency-response characteristic and the width and location in the frequency spectrum of the transmission band. It seems logical, therefore, to adjust the frequency characteristic approximately to that obtained with a close-talking microphone directly in front of the speaker, which is generally accepted as the ultimate in articulation. To find the compensation required to obtain the same response characteristic with the lapel microphone in its normal position as obtained with a close-talking microphone directly in front of the speaker, we must know the directional characteristics of the human voice.

The diffraction of a plane sound wave around a spherical obstacle was first investigated mathematically by Rayleigh.¹ The theoretical analysis was extended by Stewart² who applied it over a limited frequency range to the diffraction of sound around the human head. Ballantine³ also extended the theory by indicating the form taken by the solution when expressed in terms of Bessel-functions whose order is half an odd integer. For this particular analysis we shall assume, following the analysis by Stewart, that a small source (at $\theta = 0$) located on the surface of a sphere 7.5 inches in diameter represents the human voice. The approximate angular position of the lapel microphone is where $\theta = 90$ degrees.

The ratio of the pressure on the surface of the sphere at $\theta = 0$ degrees, Fig. 1, to that where $\theta = 90$ degrees was calculated, assuming a plane wave impinging on the bottom of the sphere (curve A). Measurements were made of a small source of sound at various distances from a condenser microphone, which indicated that little change in frequency characteristic occurred as the source was moved from a great distance up to the vicinity of the microphone. This justifies

¹ Rayleigh, "Theory of Sound," vol. II, p. 274.

² Stewart, *Phys. Rev.*, p. 467, (1911).

³ Ballantine, *Phys. Rev.*, December, (1928).

the use of curve *A* as the ratio of pressure at zero to 90 degrees due to a source at some point, zero, a short distance below the sphere. Now by Helmholtz' reciprocal theorem we may interchange the source and observation point; therefore curve *A* may be considered to be the ratio of pressure at zero due to a point source at $\theta=0$ degrees (which simulates the condition where the mouth is at $\theta=0$ degrees and a lapel microphone at zero) to the pressure at zero due to a point source at $\theta=90$ degrees. (If the circle be turned through 90 degrees, as in the second diagram, this may be seen to be the condition where a direct-talking microphone is in front of the mouth.) Hence curve *A* represents the ratio of the pressure which exists at the point occupied by a lapel

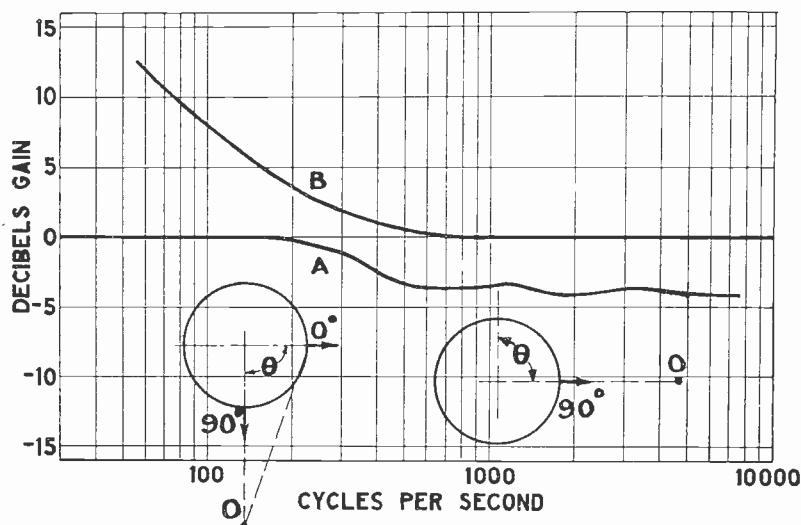

Fig. 1—*A* Ratio of pressure at θ equals 90 degrees to pressure in front of sphere 7.5 inches in diameter.

B Ratio of response of velocity microphone to pressure microphone at 9 inches from source.

microphone to that which would exist at a point an equal distance from the mouth but directly in front of it. It will be seen that there is considerable discrimination against the higher frequencies.

Two types of microphones may be used for this particular purpose; namely, one whose response corresponds to the pressure in the sound wave, or one whose response is proportional to the particle velocity. Each type has certain inherent advantages and disadvantages for this application.

One of the problems encountered with a lapel microphone is that when a speaker turns his head towards the side away from the microphone, there is a serious loss in intensity of the sound striking the microphone, due to the increased distance between microphone and sound source. The directional characteristics of the bidirectional

velocity microphone can be employed to compensate for this change in intensity.

The characteristics of the velocity microphone, consisting of a thin aluminum ribbon freely suspended in a magnetic field, have been described previously.⁴ These may be summarized by stating that the differential pressure on the ribbon, resulting from the impact of a sound wave, is proportional to the mean distance between the front and rear surfaces, and proportional to frequency. The velocity of the ribbon (and hence the induced voltage) is proportional to this pressure and inversely proportional to the mechanical impedance of the ribbon.

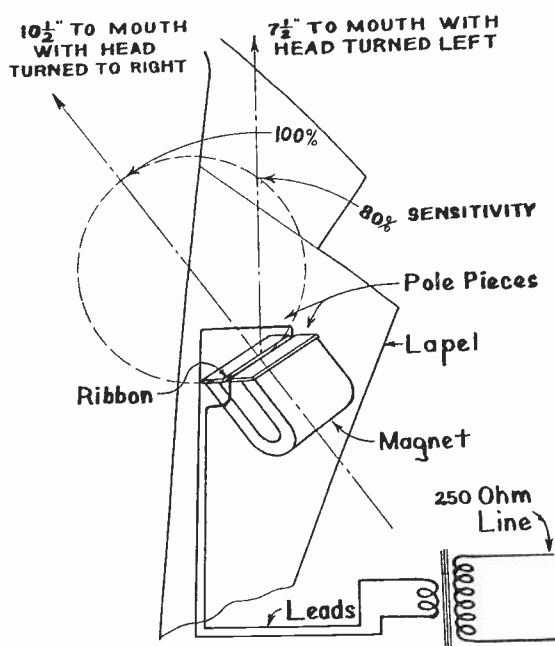

Fig. 2—Schematic view of mechanism and directional characteristics of velocity microphone on lapel.

The latter is due to the ribbon mass and the air load, and is proportional to frequency. The ratio of ribbon velocity to free-space sound pressure is, therefore, independent of frequency, if there are no obstructions to the path of the sound near the ribbon.

The particle velocity of a spherical wave builds up in the vicinity of the source. A velocity microphone located at a distance r inches from a source will accentuate a low frequency f in the ratio

$$R = \frac{\text{velocity}}{\text{pressure}} = \sqrt{\left(\frac{2100}{rf}\right)^2 + 1}.$$

⁴ H. F. Olson, *Jour. S. M. P. E.*, vol. 16, p. 695, (1931); *Jour. Acous. Soc. Amer.*, vol. 3, p. 56, (1931); *Proc. I.R.E.*, vol. 21, p. 655; May, (1933).

This is plotted in Fig. 1, curve *B*, for nine inches, the average distance from the mouth to a coat lapel. It was also shown⁴ that the sensitivity is a maximum normal to the ribbon and decreases off the axis to zero in the plane of the ribbon.

Suppose such a device were to be placed on the left lapel, as in Fig. 2, with the line normal to the ribbon pointing across the speaker's chest to the point occupied by his mouth when his head is turned away from the microphone. Then as the speaker turns his head towards or away from the microphone, the azimuth of his mouth varies from a region of low sensitivity to that of maximum sensitivity. The directional characteristic is shown, and the ratio of the directional factor to the distance of separation may be seen to be nearly the same for three

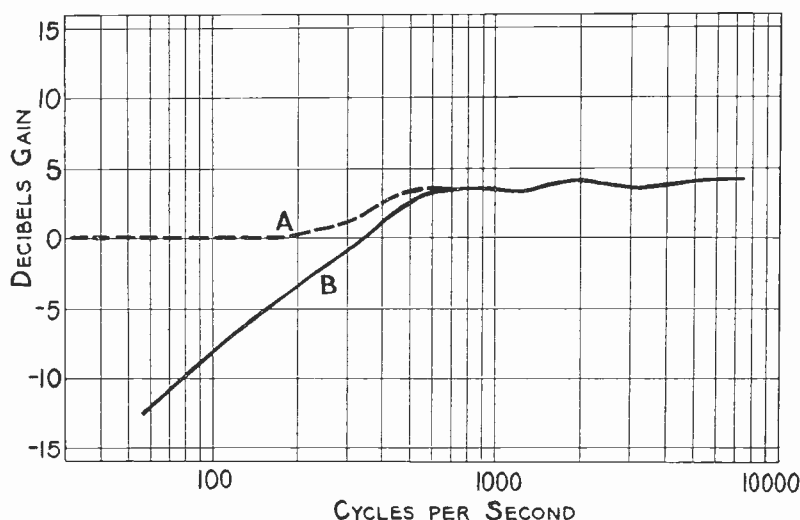

Fig. 3—Ideal characteristics of lapel microphone for *A* pressure operation and *B* velocity operation.

principal head positions. This invariance of pick-up as the head is turned is a fundamental advantage of the velocity lapel microphone.

Since the directions of minimum pick-up are over the speaker's left shoulder or to his lower right side, loud speakers may be placed there with optimum immunity from feed-back.

DETERMINATION OF REQUIRED FREQUENCY CHARACTERISTIC

The ideal frequency characteristic of a pressure-operated lapel microphone would be the inverse of the diffraction characteristic shown in curve *A*, Fig. 1. This is plotted in curve *A*, Fig. 3.

The ideal frequency characteristic of a velocity lapel microphone and its associated transformer may be obtained by correcting the latter curve for the ratio of velocity to pressure shown in curve *B*, Fig. 1. There is a further restriction. As the frequency range is ex-

tended, the ideal characteristic would rise steadily towards the higher frequencies. When used in a sound reënforcing system, this would increase the probability of pick-up from the loud speakers at the frequencies of accentuated sensitivity, with a consequent likelihood of howling. A definite limitation of 12 decibels maximum rise with no sharp peaks, using the frequency range of 80 to 7000 cycles, has given very good results. The theoretical characteristic conforming to these specifications is shown in curve *B*, Fig. 3.

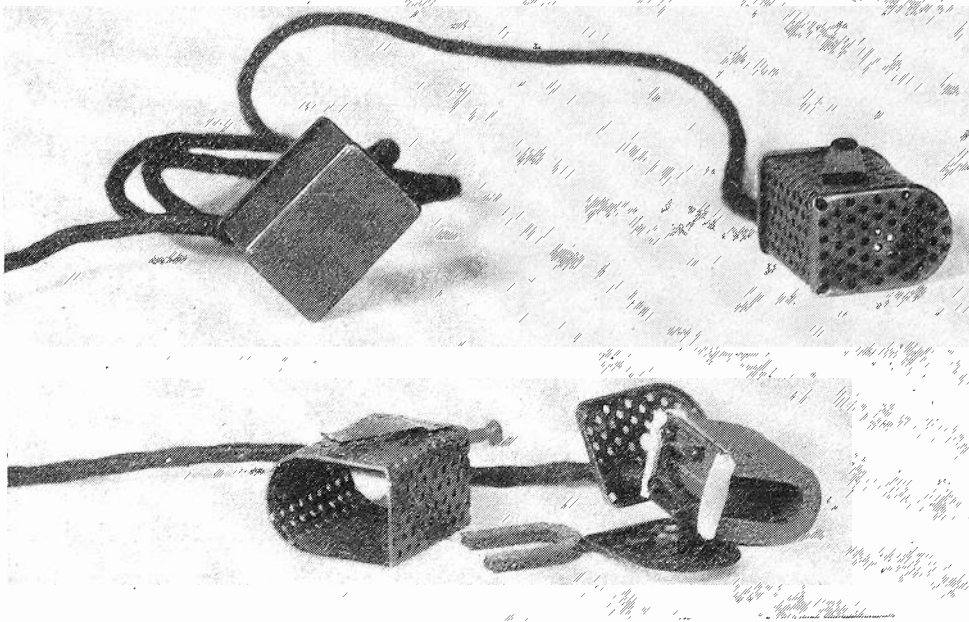

Fig. 4—Photograph showing parts of microphone and complete assembly with transformer and cable.

GENERAL CONSTRUCTION

The microphone consists of a small U-shaped permanent magnet with an extremely thin aluminum ribbon mounted between its poles. This ribbon is one inch long, one thirty-second of an inch wide and one ten-thousandth of an inch thick. A transformer couples the ribbon to a 250-ohm line. The theoretically desirable frequency characteristic was approached in the commercial design by appropriate proportioning of the transformer winding inductances, leakage reactance, and distributed capacitance.

The microphone is shown, in assembled and exploded views, in Fig. 4. The total weight of the microphone is three ounces. It is approximately one and one-fourth inches square and one inch thick. A

short lead extends from the microphone to the transformer, which may be placed in a side pocket. The microphone parts are enclosed in a perforated metal case lined with silk, with the ribbon on an angle of 45 degrees to the horizontal. A clip on the back of the case is designed to fit a lapel buttonhole.

EXPERIMENTAL RESULTS

Over-all measurements of the performance of the microphone and its associated transformer were made by the use of an artificial voice.⁵ This consisted of a two and one-quarter inch cone, dynamically driven and especially corrugated to give substantially flat response from 100 to 10,000 cycles. This was mounted in a closed rectangular box

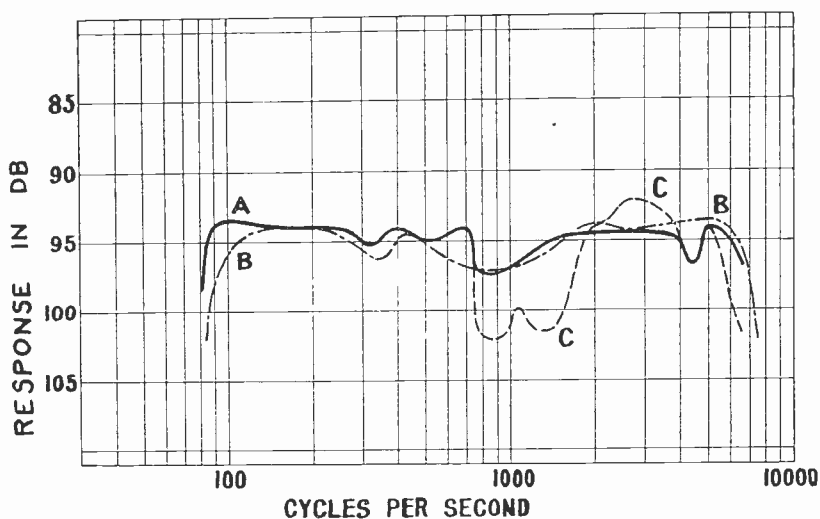

Fig. 5—*A* Output of velocity microphone used on lapel, tested with artificial voice in position ordinarily occupied by human voice.
B Ratio of output of lapel velocity microphone, tested in front of artificial voice, to ideal characteristic of Fig. 3*B*.
C Same as curve *A* without correction for artificial voice spatial characteristic.

(Zero decibels is one volt per bar open circuit electromotive force in 250-ohm line.)

slightly larger than a human head. Its directional characteristics were slightly different from those calculated for a head. Corrections were made for the directional characteristics attributable to the cone and box size in order to simulate head diffraction conditions as well as possible. The frequency characteristic of the sound source was determined by reference to a standard ribbon microphone.

The frequency characteristics of the lapel microphone and its associated transformer were investigated in the following ways:

⁵ Olson and Massa, "Applied Acoustics," p. 200, P. Blakiston's Son and Co., Philadelphia, Pa.

(1) A curve was taken using the artificial voice, letting a man sit under it holding the microphone on his lapel in a correct position relative to the artificial voice. This curve is shown, corrected for the spatial distribution of the artificial voice, in Fig. 5(A). The uncorrected curve is shown dotted in Fig. 5(C).

(2) A curve was taken using the lapel microphone as a remote pick-up microphone in front of the artificial voice. This is shown by ratio to the ideal characteristic of Fig. 3(B) in Fig. 5(B).

(3) Listening tests were made to ascertain that any change in frequency compensation produced only detrimental results.

It may be seen in Fig. 5 that curves (A) and (B) are in excellent agreement with each other under the condition that listening tests were satisfactory. This verifies the ideal characteristic as calculated and justifies the calibration of the artificial voice and the methods of using it.

The sensitivity is such that when worn on the lapel it gives the same output as a standard velocity microphone used four feet away from and in front of the speaker. The speaker's head may be turned 45 degrees to right or left with only one decibel variation in output.

The lapel microphone may also be used for picking up sound from solo musical instruments such as the banjo or violin, by placing it in a suitable position on the musician's coat, in close proximity to the instrument. It may also be clamped on the instrument, utilizing the directivity characteristics of the microphone to compensate for the directivity of the instrument.

ACKNOWLEDGMENT

We are indebted to Mr. Julius Weinberger, under whose direction this development was carried on, for assistance and coöperation, and to Mr. L. J. Anderson who designed the commercial model which is shown in the photograph.



CONTROL OF RADIATING PROPERTIES OF ANTENNAS*

BY

C. A. NICKLE, R. B. DOME, and W. W. BROWN

(General Electric Company, Schenectady, N. Y.)

Summary—A system of tuning is described by which the current distribution and therefore the radiating properties of an antenna, may be varied over an extremely wide range. This is effected by means of a localized capacity and inductance connected to the top of the radiator. The capacity may conveniently take the form of a sphere, a cylinder, or a disk. The inductance may take the form of a coil housed within the sphere or cylinder or it may consist of two parallel wires so adjusted for length as to supply the necessary inductive component. By appropriate adjustment the current distribution may be varied at will. The advantages are: (a) Increased radiation efficiency of antennas for any given length; (b) control of radiation angle and consequently the distance at which fading may become important; and (c) reduction of ground losses. The system is believed to be particularly adaptable to frequencies between 500 and 300,000 kilocycles.

IT HAS been known that for a given length of vertical antenna operated at a given frequency any change in the distribution of current along the radiator effects corresponding changes in the radiating properties of the radiator in these several ways: (1) The angle of radiation is affected by the change caused in the vertical field intensity pattern; (2) the new vertical field pattern results in a different antenna radiation resistance; (3) the new radiation resistance results in a change in the field strength in the ground wave from the antenna for the same antenna input power; (4) the redistribution of antenna current by changing the current at the base of the radiator affects the ground resistance connection losses; and (5) changes in the ground losses for a given transmitter output further affects the useful radiated power and field intensity.

It is known that with a simple vertical radiator without capacity loading at the top the distribution of current is such that zero current exists at the top of the radiator and that the current increases sinusoidally along the radiator toward the ground. The distribution is very nearly the same as that obtained along an open-ended transmission line; i.e., the first current peak occurs 90 degrees or a quarter wavelength down from the top of the radiator and the first node or current minimum occurs a half wavelength or 180 degrees from the top. The current then reverses in phase reaching another peak at 270 degrees

* Decimal classification: R120. Original manuscript received by the Institute, June 18, 1934. Presented before Ninth Annual Convention, Philadelphia, Pa., May 29, 1934.

and returning at 360 degrees to the same distribution as exists at the top of the antenna.

In the past, with few exceptions, operation at wavelengths in excess of 200 meters has been with radiators less than half a wave in length. In order to improve the radiating properties of this antenna it has been common practice to load the vertical section of the antenna with a capacity flat top resulting in the familiar T, inverted L, and umbrella antennas. Such loading increased the current from zero at the top of the vertical section to some finite value and resulted in an increased antenna resistance referred to the point of earth connection which in turn decreased the ground losses and improved the efficiency.

This form of loading to be at its ultimate effectiveness required an infinite capacity at the top to cause the current loop to come at the upper end of the radiator. To obtain such loading is of course a practical impossibility. Furthermore, such an arrangement, even if accomplished, will not reduce the earth-return current to that of a nodal point, but leaves it at a value of $I_e = I_t \cos \theta$, where I_e = earth current, I_t = current at top, and θ is the number of electrical degrees length of the radiator.

It is seen that a more desirable current distribution would be that which caused a nodal current point to occur at the earth connection with the top current equal to approximately $I_t' = I_e'$ where I_e' = base current under the condition of no top loading. This relation is not exact, due to a change in radiation resistance, but is given to indicate the type of distribution obtained.

A practical system for obtaining such a distribution has been devised. This consists essentially of a concentrated capacity at the top of the antenna with an inductance connected between the top of the antenna and the concentrated capacity so that the reactance to earth referred to the top of the antenna can be made positive, zero, or negative in any amount desired.

By the use of such a system it is possible to obtain the current distribution corresponding to any portion of the sine wave which can be contained within the electrical length of the vertical radiator. It is therefore possible to go from a minimum current at the top corresponding to an unloaded antenna to a condition of minimum current at the base and on through a condition of minimum current at the middle of the radiator and back again to the original condition of minimum current at the top.

The equation for the reactance at any point on the radiator is the same as that for a transmission line of length y where x is the distance from the far end corresponding to the top of the antenna.

$$Z_x = \frac{\frac{Z_2 \cosh nx + Z_0 \sinh nx}{Z_2 \cosh ny + Z_0 \sinh ny}}{\frac{\frac{Z_2}{Z_0} \sinh nx + \cosh nx}{Z_2 \cosh ny + Z_0 \sinh ny}} \quad (1)$$

where,

Z_2 = net reactance at the upper end

x = point on line measured from upper end

$n = j\omega\sqrt{LC}$ where L and C are line constants

y = total length of line

$Z_0 = \sqrt{L/C}$ = surge impedance.

The voltage at the point in question is

$$e_x = e_b \frac{Z_2 \cosh nx + Z_0 \sinh nx}{Z_2 \cosh ny + Z_0 \sinh ny} \quad (2)$$

where e_b = voltage at lower end.

The current at the point x will be

$$i_x = \frac{e_x}{Z_x} = e_b \frac{\frac{Z_2}{Z_0} \sinh nx + \cosh nx}{Z_2 \cosh ny + Z_0 \sinh ny} \quad (3)$$

If we are interested in Z , e , and i at the base of the antenna, $x = y$ and the above equations become

$$Z_y = \frac{Z_2 \cosh ny + Z_0 \sinh ny}{\frac{Z_2}{Z_0} \sinh ny + \cosh ny} \quad (4)$$

and,

$$e_y = e_b$$

and,

$$i_y = \frac{e_b}{Z_y} = \frac{e_b \left(\frac{Z_2}{Z_0} \sinh ny + \cosh ny \right)}{Z_2 \cosh ny + Z_0 \sinh ny} \quad (6)$$

It is seen that by choosing the proper Z_2 , e and i can be made to go through a complete cycle.

A special solution of the above equation is for the case where $Z_y = \infty$ or the current has a nodal point at the ground. Then (4) may be solved for Z_2 .

$$\begin{aligned} \frac{Z_2}{Z_0} \sinh ny + \cosh ny &= 0 \\ 1 + \frac{Z_2}{Z_0} \tanh ny &= 0 \\ \frac{Z_2}{Z_0} \tanh ny &= -1 \\ Z_2 &= -Z_0 \cotanh ny \\ &= jZ_0 \cot \theta \end{aligned} \quad (7)$$

where θ is the electrical length of the radiator.

The solution of (4) for Z_2 for any Z_v is

$$Z_2 = \frac{Z_0 \sinh ny - Z_v \cosh ny}{\frac{Z_v}{Z_0} \sinh ny - \cosh ny} \quad (8)$$

A practical arrangement for obtaining the desired Z_2 is that of suspending a concentrated capacitive body above the antenna and connecting an inductance in series with the top of the antenna and the body. Then Z_2 will be simply

$$Z_2 = j \left(\omega L - \frac{1}{\omega C} \right). \quad (9)$$

The capacitor may take the form of a sphere, disk, or cylinder, the capacities of which are, respectively,

1. Sphere. $C = 0.556d \mu\mu\text{f}$
where d = diameter in centimeters
2. Disk. $C = 0.354d \mu\mu\text{f}$
where d = diameter in centimeters
3. Cylinder. $C = 0.802d \mu\mu\text{f}$
where d = diameter in centimeters
and d = height in centimeters.
($d = h$)

In each case the object is assumed to be well above the earth. The capacity will be slightly greater as earth is approached.

It may be thought that this body could be made very small since a value of L could be arranged to satisfy (9). However, there is a limit to the smallness of C in a practical case on account of the losses in L , since the current is constant through L and C . For instance, for a radiator $\lambda/4$ long where it is desired to make $Z_2 = 0$ or the current a minimum at the base it is desirable to make $-j/\omega C$ not more than 1250

ohms for coils of 0.005 power factor. In the case of a sphere at 7500 kilocycles the diameter will be 12 inches. If a coil of 0.01 power factor is to be used, X_c must not be greater than 625 ohms, or the sphere must be at least 24 inches in diameter. It is seen then that the economics of the arrangement will generally determine the values of L and C . Curves should be plotted of the cost of the capacitor and of the cost of the inductance and of the sum of the two. The minimum point of the total curve will determine the size of L and C to use. It should be noted that as the wavelength is increased it may be desirable to shift to the disk because of the undesirable wind resistance offered by the sphere or cylinder. The disk need not be solid, but can be made up of a solid rim of copper pipe and filled in with wire stays in the form of a network.

The inductor may be conveniently located within the sphere for protection against the weather. The value of Z_2 may be adjusted by changing the value of L before hoisting the system up in the air. There may be required several lowerings and hoistings to obtain the desired value of Z_2 since the adjustment cannot be exactly made on the ground, because the value of C is affected by the proximity to the earth and the adjustment will be lost when the system is raised. A second method is to connect a variometer in series with L and C for fine tuning and to run a rope to ground to make it possible to vary L from the ground. Likewise, a variable capacitor may be connected either across L or in series with L and C and similarly tuned by a rope running to ground.

In an effort to devise some means for overcoming some of the disadvantages connected with operating such a mechanical system, especially in the case of very high structures, a novel method for obtaining L has been worked out. This consists essentially in making the inductance a distributed inductance instead of a concentrated one. This can be done as indicated in Fig. 1*a*. S is a sphere used for the capacity C . The wire A is the main antenna wire and is connected to S at its top. A second wire B runs down along the side of A but is insulated from A and is terminated at S by an insulator and thus A and B make up an open-ended transmission line. At a discrete distance t down from S , A and B are connected together. The inductance looking into the line from S will be the inductance as required in (9) and is

$$L = \frac{Z_0'}{\omega} \tan \phi \quad (10)$$

where Z_0' is the surge impedance of the line made up of A and B , and ϕ is the electrical distance from S down to the point where A and B are joined.

In case B cannot be made long enough to obtain the required L even by extending it to the ground, a concentrated inductance may be used to join A to B as shown in Fig. 1*b*. This can be varied easily from a ground position to obtain the correct L . Also it is seen that in case B would join A some distance above the ground to satisfy ϕ in (10) and it is still desired to tune at the ground, B can be extended to the ground and connected to A through a variable capacitor as shown in Fig. 1*c*. In some instances it may be desirable to break the L of (9) into two parts, the first part may be a concentrated inductance just beneath C and the rest made up of the line type of distributed inductance as shown in Fig. 1*d*.

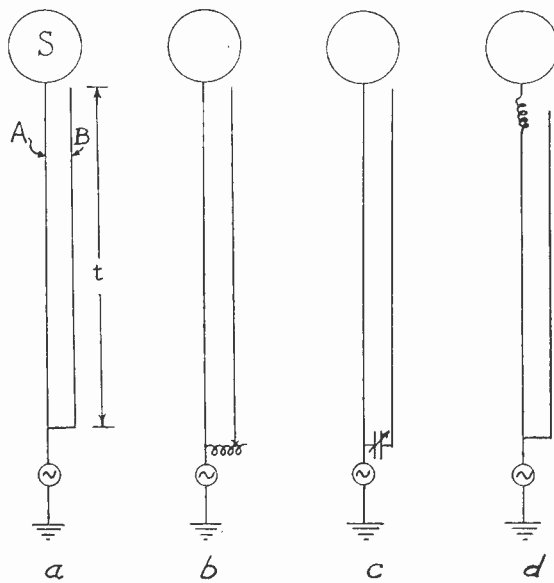

Fig. 1—Alternative methods for obtaining the necessary inductance to insert in series with capacity S .

There are two distinct advantages obtained by operating the antenna with a current minimum at the base. The first is that the ground loss is practically eliminated and all of the power used for radiation with the exception of the added loss in L , which may be reduced to a low value by designing a suitable inductance. The second advantage is that with the new current distribution a lower current loop radiation resistance is obtained which gives, (1) an increased ground-wave field intensity, and (2) a reduced sky-wave radiation. The two points are of special merit in the case of a broadcast station desiring to increase the nonfading range of the transmitter and the field strength of the ground wave.

In general, the first advantage, namely that of decreasing the ground resistance loss, is of greatest importance where antennas of less

than a quarter wave in length are being used. For instance, in the case of an eighth-wave long antenna the radiation resistance is 6.8 ohms. Now if the ground resistance were also 6.8 ohms, the ratio of the field strengths in the cases of the ground resistance to zero ground resistance would be

$$\frac{I_1}{I_0} = \sqrt{\frac{R_0}{R_1 + R_0}} = \sqrt{\frac{1}{2}} = 0.707.$$

If the value of Z_z were made such that the current at the base were essentially zero, the ratio of $I_1/I_0 = 1$ or an increase of 41 per cent would be obtained in field strength. Even a partial decrease in ground current would give an increased field strength.

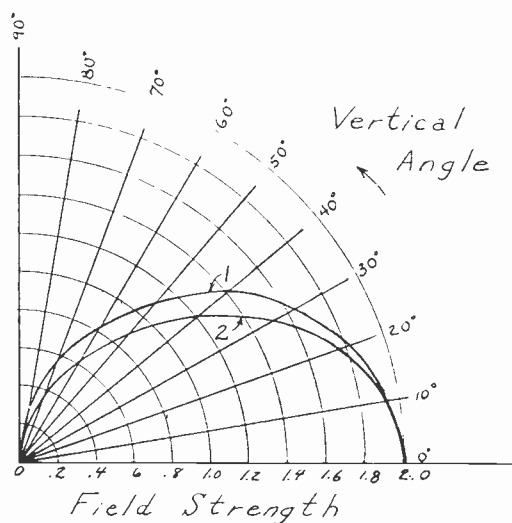

Fig. 2—Vertical field strength pattern of quarter-wave antennas with current distribution; (1) with current loop at ground; (2) with current loop at top.

The second gain, that of decreased loop radiation resistance, is of chief importance in the case of antennas of length from a quarter to a half wave. In the case of a quarter-wave antenna operated under the two conditions of (1) zero current at top, and (2) zero current at the bottom, we have the two curves of field strength in the vertical plane as given in Fig. 2.

The equation for the field strength in the vertical plane in the case of the quarter-wave antenna with maximum current at the base is

$$E_1 = \frac{2K}{\cos \theta} \cos \left(\frac{\pi}{2} \sin \theta \right) \quad (11)$$

where θ is the vertical angle measured from the horizon.¹ In the case of the quarter-wave antenna with minimum current at the base, the equation for the field strength in the vertical plane is

$$E_2 = \frac{2K_2}{\cos \theta} \left\{ 1 - \sin \theta \left[\sin \left(\frac{\pi}{2} \sin \theta \right) \right] \right\}. \quad (12)$$

The radiation resistance at the current loop in either case is

$$R = 30 \int_0^{\pi/2} [\phi(\theta)]^2 \cos \theta d\theta \quad (13)$$

where $\phi(\theta)$ is a function of θ given by (11) and (12). Carrying out the indicated integration,

$$\begin{aligned} R_1 &= 36 \text{ ohms} \\ R_2 &= 32 \text{ ohms.} \end{aligned}$$

Thus, neglecting ground connection resistance, the field strengths at $\theta = 0$ would bear the ratio of

$$\frac{E_2}{E_1} = \sqrt{\frac{36}{32}} = 1.06.$$

Furthermore, from Fig. 2, it is seen that the sky wave has been decreased with respect to the ground wave 15 per cent at 40 degrees, 18 per cent at 50 degrees, and 25 per cent at 60 degrees. The use of the second distribution therefore not only increases the horizontal field strength but also causes a substantial decrease in the sky wave, thereby extending the nonfading range of the transmitter.

By increasing the inductance of L in Z_2 still further, keeping C constant, the current node can be raised up the antenna to any point desired. If we stop increasing L at the point where the current node is at the middle point of the vertical radiator, the field strength is zero in the horizontal direction but is a maximum at some higher angle. This arrangement may be used where it is desired to suppress local field strengths which may have been the cause of local interference. The current distribution in this case is shown in Fig. 3.

The experimental checks made on antennas operating at 7150 kilocycles are shown graphically in Fig. 4. The antenna length was varied from zero to half a wavelength. Curve 1 shows the field strength obtained at $\theta = 0$ for a simple wire with equal power input at all heights. A sphere twelve inches in diameter was next placed at the top

¹ Equations for vertical plane field strengths and radiation resistances were obtained from Mr. Hans Roder, General Electric Company, a colleague of the writers.

of the antenna and the field strengths indicated by curve 2 were obtained, the power being kept the same as in curve 1. Note that the field strength varies linearly with height up to $5\lambda/16$ and that between

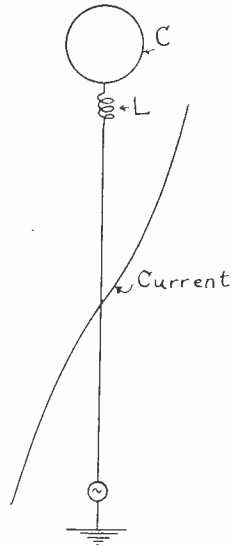

Fig. 3—Current distribution of antenna where $Z_2 = jZ_0 \cot (\theta/2)$, (θ = antenna length).

$5\lambda/16$ and $\lambda/2$ the increase is more gradual. Next, an inductance was inserted between the upper end of the radiator and the sphere, and in

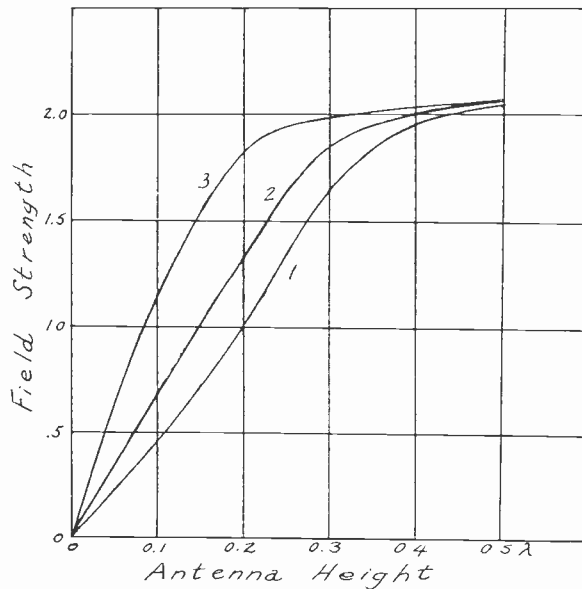

Fig. 4—Field strength in horizontal direction obtained with wire antennas of various heights operating (1) with no loading, (2) with a 12-inch sphere at top, and (3) with tuned sphere at top. 7150 kilocycles.

each case carefully tuned for maximum field strength. Curve 3 shows the relative field strengths obtained. Note that the curve has a dis-

tinct knee at the $\lambda/4$ point. At this height the field strength is 1.45 times that obtained when a simple wire was used. Our calculations have shown 6 per cent of this is due to the decreased radiation resistance. The remaining 39 per cent is due to decreased ground connection loss. The reason for the knee in these curves is that the amount of ground loss is less in any event after $\lambda/4$ so that our new antenna cannot take much advantage of decreased ground current but has to depend on decreased radiation resistance for the principal gains. Since this gain is relatively low (6 per cent in comparison to 39 per cent gain due to ground loss at $\lambda/4$) the curves come closer together after $\lambda/4$ is passed. The curves are seen to be nearly coincident at $\lambda/2$, as would be ex-

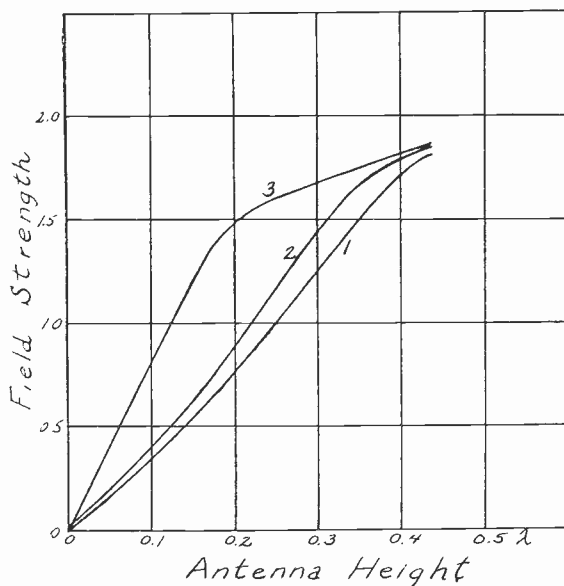

Fig. 5—Field strength in horizontal direction obtained with tower antennas of various heights operating (1) with no loading, (2) with a 12-inch sphere at top, and (3) with tuned sphere at top. 7150 kilocycles.

pected, since very little correction can be given to an antenna current distribution with an antenna $\lambda/2$ long which already has a minimum current at the base.

The same curves were run on a skeleton tower made up of four wires arranged to resemble the four legs of a tower in which the base width was kept at 10 per cent of the tower height for all heights of antennas. Fig. 5 shows the resultant curves. Curve 1 is for the simple tower, curve 2 is for the tower with an untuned 12-inch sphere at its top, and curve 3 is for the tower with a tuned sphere at its top. The power input was kept the same as in the case of the vertical wire. It is interesting to note that although these curves are arranged in order similar to those of Fig. 3, the field strengths obtained averaged but 80 per cent of those

obtained when the simple wire was used. This is explained by the uneven distribution of capacity of the sections of the tower to ground which tends to crowd the current near the base and increase the ground loss and decrease the effective height of the antenna.

A check of these data was made at 2000 kilocycles. In this case one point only was checked, the 0.114λ point. In this case the increase in field strength was 171 per cent, while at 7150 kilocycles it was 140 per cent. This is a fairly good check since a variable ground resistance enters into the picture.

A run was made at 7150 kilocycles on the alternative method of obtaining the inductance L as already explained by using the characteris-

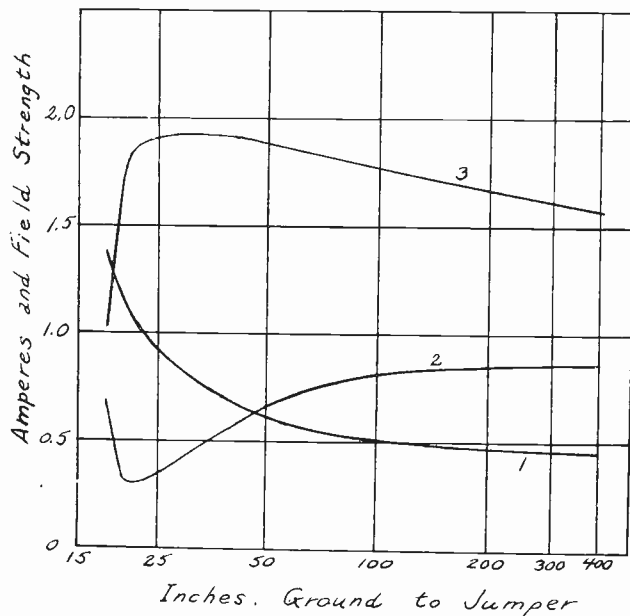

Fig. 6—Variation with height of jumper from ground for antenna shown in Fig. 1a, of (1) current at top of antenna, (2) current at base of antenna, and (3) field strength in horizontal direction. Antenna height $=\lambda/4$. 7150 kilocycles.

tics of a transmission line. A quarter-wave radiator was terminated at its top in a 12-inch sphere. A second wire insulated from the main radiator was run down along the side of the main radiator at a distance of three inches from the main radiator. A wire jumper was connected between the second wire and the radiator and its position was adjusted so that it was moved from a few inches above the ground up to a point just below the sphere. Fig. 6 shows the results obtained.

Curve 1 is a plot of the current at the top of the antenna where the radiator is attached to the sphere. Curve 2 is a plot of the current at the base where the current enters the ground. Curve 3 is a plot of the field strength. The abscissa is the distance up from the ground to the

jumper. This is of course inversely proportional to the inductance of the loop, since there is zero inductance inserted when the jumper is up to a point just beneath the sphere. The curve 3 of field intensity shows an increase of 22 per cent at the peak, representing a power increase of 50 per cent. When a concentrated inductance was used (see Fig. 4, curves 2 and 3) the increase in field strength was $(0.195/0.163) - 1 = 0.2$ or 20 per cent which indicates an agreement within the range of error in taking the data.

Although it has not been stated in so many words, it is seen that the antenna resistance measured at the base of the antenna varies over wide limits when using the top impedance Z_2 , and in the case of the adjustment of minimum current at the base the value will be quite high. For instance, in the case of Fig. 6, the resistance increases to $0.88^2/0.3^2$ or 8.6 times. If we assume 50 ohms for the original resistance (including ground resistance) the new value would be 430 ohms. The reactance to be tuned out at the base likewise varies over wide limits, and in some cases may be thousands of ohms. Precautions should be taken in the design of coupling and tuning apparatus to take care of these situations.

There is, of course, no limit to the number of applications of this system of tuning since advantage can be taken of the system for reduction of antenna heights to increase ease of erection, portability, decreased costs, decreased wind hazards, etc., for all frequencies from 500 kilocycles or lower to 300,000 kilocycles.



AN ELECTRON OSCILLATOR WITH PLANE ELECTRODES*

BY

B. J. THOMPSON AND P. D. ZOTTU

(Research and Development Laboratory, RCA Radiotron Company, Inc., Harrison, New Jersey)

Summary—This paper describes a new type of thermionic tube capable of producing ultra-high frequencies by means of electron oscillations. Tubes of this type are characterized by having parallel plane electrodes, instead of cylindrical electrodes as in the conventional Barkhausen-Kurz tubes, and a fourth element called a backing plate.

The relations between wavelength and amplitude of oscillation and the various electrode potentials are shown by measurements on a typical tube. It is found that in these tubes the filament voltage is not critical, space-charge-limited operation being satisfactory, and that only one mode of oscillation is obtained. Both of these factors appear to give these tubes an advantage in stability over cylindrical Barkhausen-Kurz tubes.

A tube of the flat type is described which has produced oscillations at a wavelength of less than 10 centimeters in the fundamental mode with a positive grid potential of 150 volts.

INTRODUCTION

THE difficulties inherent in the generation of oscillations at wavelengths of less than one meter and the growing interest in the applications of these wavelengths have encouraged many workers to study the properties of vacuum tube oscillators of the Barkhausen-Kurz type, in which the period is determined by the transit time of the electrons in the tube. Useful results have been reported only in the case of tubes of cylindrical symmetry. It is the purpose of this paper to describe filamentary tubes of plane construction which are capable of generating electron oscillations and which appear to possess certain valuable and unique properties.

In 1920 Barkhausen and Kurz¹ reported the production of oscillations of very short wavelength in a tube having a single straight filament and a cylindrical grid and plate coaxial with it, under certain conditions with positive grid and negative or zero plate. The frequency was dependent only on the potentials applied to the electrodes, hence it was concluded that the electrical oscillations were produced by an oscillatory motion of the electrons between filament and plate.

* Decimal classification: R334. Original manuscript received by the Institute, July 30, 1934. A preliminary report of this work was presented at the Washington meeting of the U.R.S.I. on April 27, 1933, under the title "A new type of ultra-high-frequency oscillator;" presented before Ninth Annual Convention, Philadelphia, Pa., May 30, 1934.

¹ H. Barkhausen and K. Kurz, "Shortest waves obtainable with valve generators," *Phys. Zeit.*, vol. 21, pp. 1-6; January 1, (1920).

In 1922 Gill and Morrell² reported a type of oscillation in a similar tube under similar conditions in which the frequency depended on the external circuit, as well as on the electrode potentials.

Since that date nearly all investigators³ have worked with tubes of the same cylindrical symmetry as those described by Barkhausen and Kurz. The characteristics of these oscillators which are of interest in connection with the work to be described are as follows:

(1) Oscillations are usually produced at only one critical value of filament voltage (or emission current) for given operating conditions.

(2) At a given grid potential the tube may oscillate at any one of two or more distinct frequencies, the higher of which are sometimes called harmonics.

While the useful results have been confined to tubes of cylindrical symmetry, other electrode arrangements have by no means been neglected. It has been observed by many workers that tubes of the conventional "flat-type" construction, such as the 202, 201A, 210, etc., having parallel plane electrodes and V or W filaments, do not produce electron oscillations.

In 1930 Wundt⁴ described a tube in which the cathode was a grid-like structure of fourteen parallel filaments connected between two parallel supports and the grid and plate were parallel planes disposed on only one side of the cathode. Electron oscillations were produced with positive grid and zero plate, though apparently not of great intensity.

In 1931 Gill⁵ described a tube of true parallel-plane construction, in which the cathode was an oxide-coated equipotential plane heated by electron bombardment. Electron oscillations were produced.

From these results and from theoretical considerations it is to be concluded that cylindrical symmetry is not an essential requirement for the production of electron oscillations. Because of difficulties in constructing cylindrical tubes for producing oscillations at wavelengths of less than 15 centimeters, it was felt that parallel plane tubes might offer definite advantages.

One of the difficulties encountered with cylindrical tubes is that, as the grid diameter is reduced to produce shorter wavelengths, the dis-

² E. W. B. Gill and J. H. Morrell, "Short electric waves obtainable by valves," *Phil. Mag.*, vol. 44, pp. 161-178; July, (1922).

³ A useful survey is given by E. C. S. Megaw: "Electronic oscillations," *Jour. I.E.E.* (London), vol. 72, no. 436, pp. 313-325; April, (1933).

⁴ R. Wundt, "On the natural frequency of oscillation of an electron tube associated with a Lecher system," *Zeit. für Hochfrequenz.*, vol. 36, pp. 133-146; October, (1930).

⁵ E. W. B. Gill, "Electrical oscillations of very short wavelength," *Phil. Mag.*, vol. 12, pp. 843-853; October, (1931).

sipating area of the grid is reduced, so that the power output obtainable at short wavelengths is very low. In addition, mechanical difficulties are encountered in supporting the grid in accurate alignment with the filament when the grid diameter becomes very small.

A tube of plane construction should be free from the first limitation, while the mechanical difficulties inherent in maintaining the spacing between planes appeared to be of a lower order than in the

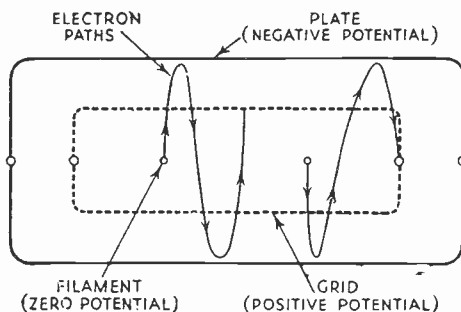

Fig. 1—Section through a V-type-filament triode showing the approximate paths of electrons under the conditions of positive grid and negative plate.

case of cylinders. Neither of the two previously described types of parallel plane tubes seemed to be suitable, however, for mechanical and/or electrical reasons. An analysis was therefore made of the causes of failure of the V- or W-filament flat-type tubes, means for eliminating these causes were suggested, tubes were made up incorporating these

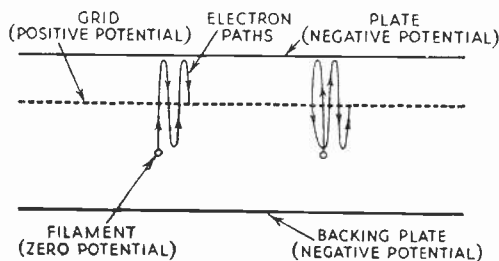

Fig. 2—Section through a proposed four-electrode V-type-filament tube showing the approximate paths of electrons.

means, and their behavior in the production of electron oscillations studied. This paper reports the results of this work.

THEORETICAL CONSIDERATIONS

In an electron oscillator of cylindrical symmetry, the cylindrical surface in which the grid lies is substantially equipotential, so that the electrons emitted from the cathode are drawn out radially by the positive potential on the grid, and most of them pass through the grid and come to rest near the negative plate, forming a virtual cathode.

They then reverse their direction of motion and return radially through the grid, finally coming to rest at the true cathode, the return flight taking the same time as the outgoing, neglecting changes in grid potential during the transit of the electron. It was considered that this oscillation of the electron between two cathodes, real or virtual, in equal times for both directions, might be essential to the production of electric oscillations.

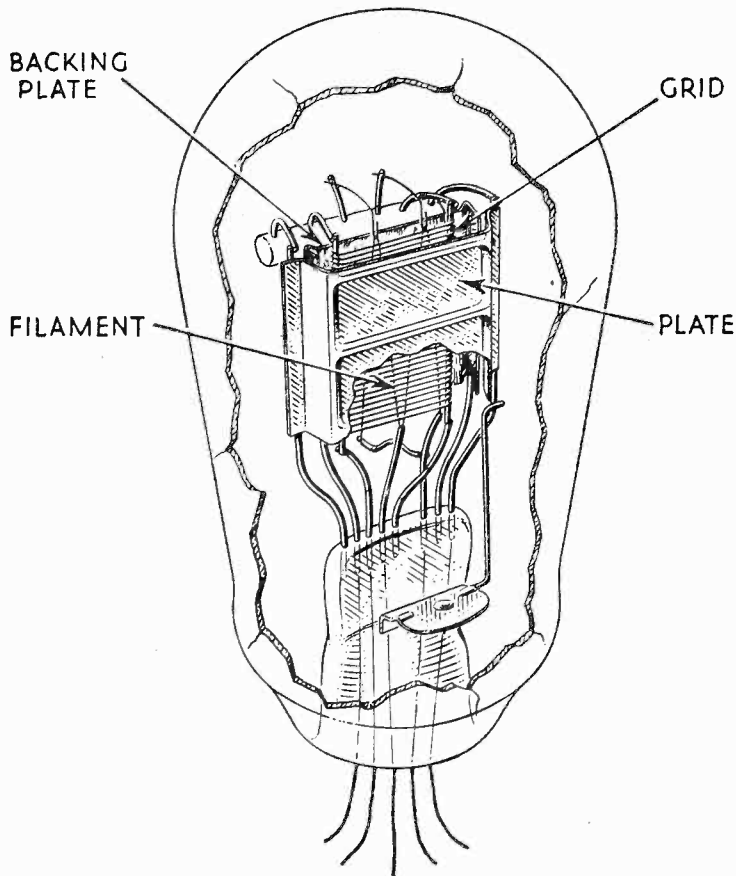

Fig. 3—Cutaway view of first tube made which incorporated a backing plate.

Fig. 1 represents a section through an ordinary V-filament flat-type tube operating with a positive potential on the grid and negative on the plate. The electron paths are indicated, showing that the electrons on the return flight pass through the region of positive potential between the filament strands or between the filament and the grid support wires. The time of transit on the return flight is less than on the outgoing, since the potential is higher. The electron does not return to a cathode, either real or virtual. Hence the two conditions for oscillation are not fulfilled.

Fig. 2 shows the arrangement of electrodes which was proposed to establish the essential conditions in a flat-type tube.⁶ The additional plate-like electrode, called a backing plate, is placed at a negative potential on one side of the V-type filament, while the plane grid and plate are disposed on the other side. With a proper value of negative potential on the backing plate, it was considered probable that conditions would be established so that the electron paths would be as

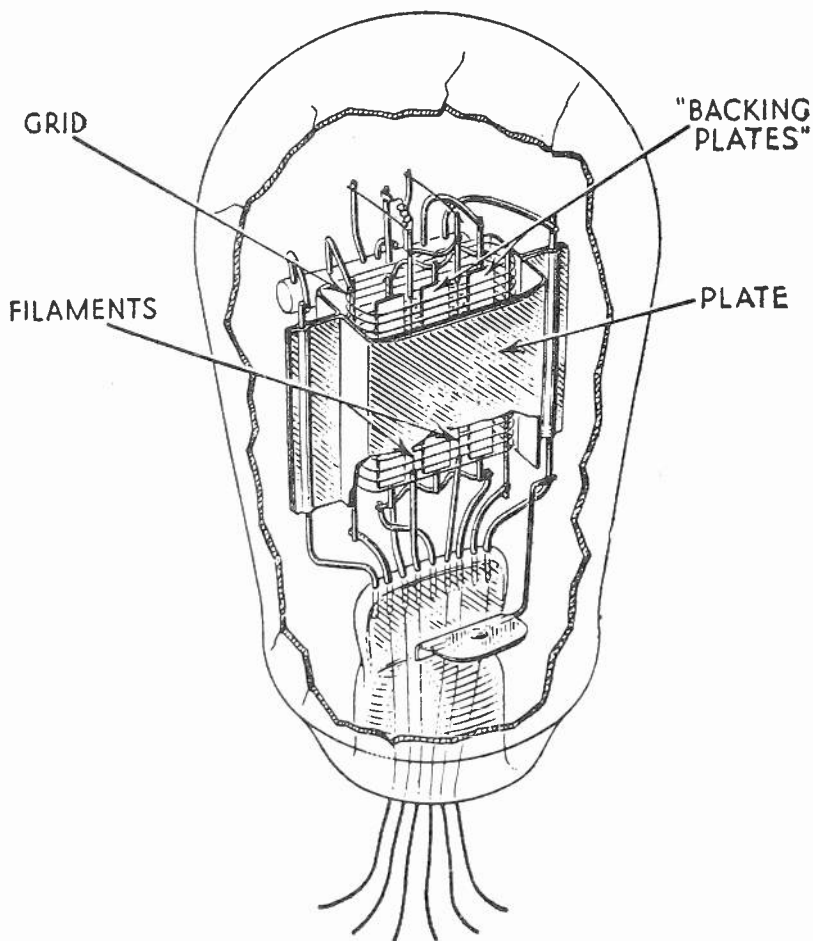

Fig. 4—Cutaway view of a two-sided tube incorporating a modification of the backing plate.

shown. The whole plane in which the filament lies would be substantially an equipotential surface which would behave as a virtual cathode and between which and the virtual cathode near the plate the electrons would pass in equal times in both directions.

⁶ After this work was completed the authors' attention was called to British Patent 344,448, issued March 3, 1931, to A. G. Clavier, showing electrode arrangements similar to some of those described in this paper. No results are given and it is not clear from the description precisely how the tube is expected to operate. The authors do not wish to stress here the novelty of their work, but do wish to present technical information which they feel to be of value.

EXPERIMENTAL WORK

A tube incorporating the backing plate was made up substantially as sketched in Fig. 3. This first tube produced oscillations when operated with a positive potential on the grid, zero on the plate, and a negative potential on the backing plate. There was an optimum value of backing-plate potential for each value of grid potential.

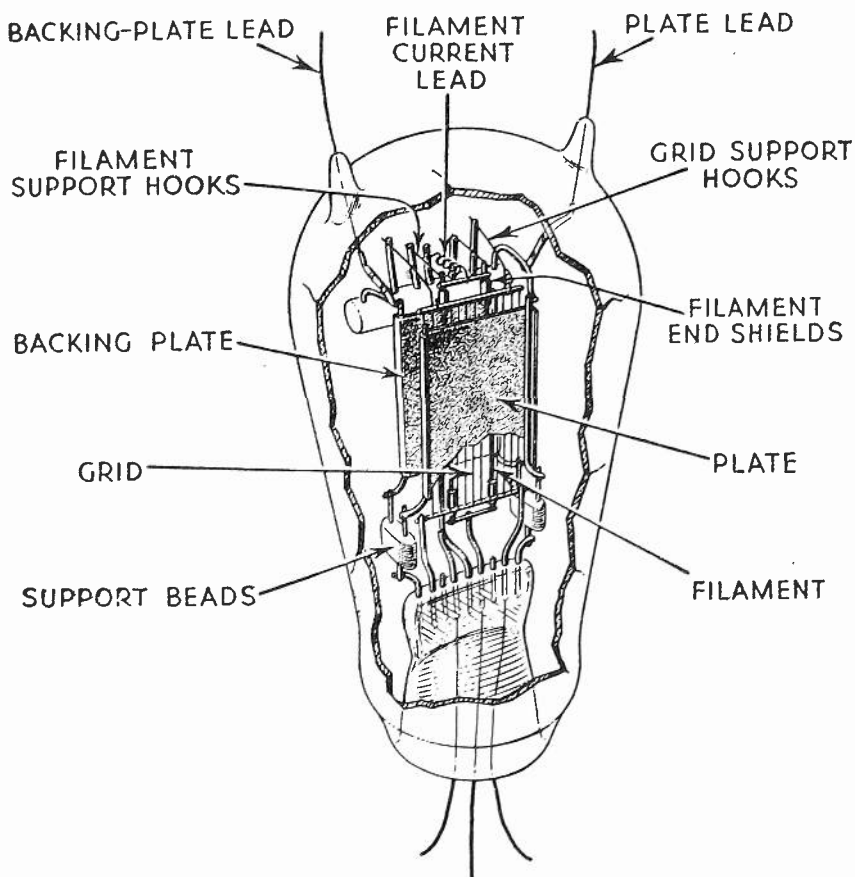

Fig. 5—Cutaway view of four-electrode tube on which data were taken. Details of construction are as follows. Filament diameter, 0.0045 inch; length, 25 millimeters each strand, two strands in parallel; material, carbonized thoriated tungsten. Grid wire diameter, 0.0022 inch; length, 28 millimeters; spacing, 20 strands per inch; material, tungsten. Plate thickness, 0.005 inch; length, 26 millimeters; width, 17 millimeters; material, carbonized (blackened) nickel. Distance between adjacent electrodes, 1.3 millimeters.

The success with this first tube was repeated in practically all later constructions embodying the backing plate in this general arrangement. Only the most significant results will be given, therefore, without regard for chronology.

Another form of tube intended to establish the same electrostatic conditions but to permit a two-sided construction to be used is sketched in Fig. 4. Oscillations were obtained with this tube with the additional electrode at zero or a slightly positive potential.

The typical performance of the backing-plate tubes (Fig. 3) may be illustrated by a series of measurements made on a single tube. The construction of this tube is sketched in Fig. 5. The tube consisted of two parallel strands of carbonized thoriated tungsten filament, a backing plate, a grid made of a number of parallel strands of tungsten wire, parallel to the filament strands, and a continuous plate. The grid and filament leads were brought out of the stem, while the leads of the two plates were brought out the top of the bulb. The total spacing between the two plates was four millimeters.

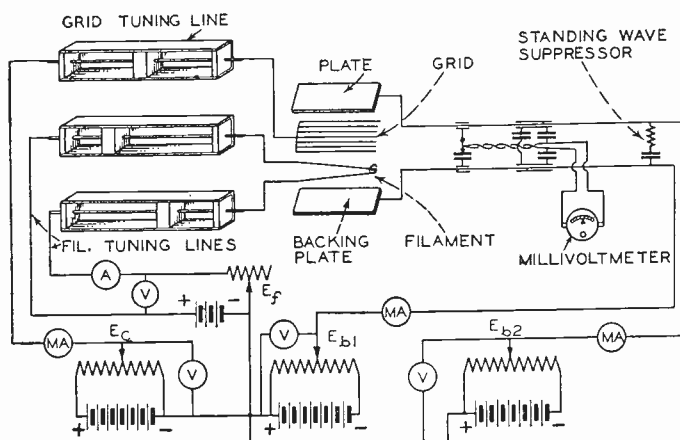

Fig. 6—Schematic diagram of circuit used. Plate and backing plate are connected to a parallel-wire system.

Measurements of wavelength, power output, and electrode currents and potentials were made in the circuit shown in Fig. 6. The leads to filament and grid were independently tuned to the optimum impedance by means of the individual semienclosed lines. It had been established previously that the connection of the output lines between the two plates is satisfactory from the viewpoint of output, and most convenient electrically since neither lead need be at high potential, and no considerable potential difference between the two lines is necessary. It is even possible to operate both plates at the same potential, thus permitting a direct short circuit between the lines. The power output was indicated by a calibrated thermocouple, while the wavelength was measured by an absorption wavemeter coupled to the parallel lines.

In Fig. 7 are plotted intensity of oscillation (power output) and wavelength against line length. It is of interest to observe that only one frequency range is produced. There are no other modes of oscillation.

Fig. 8 shows the plate current, backing-plate current, and power plotted against line length. It will be observed that the ratio between the two currents is nearly constant, and that they are at neither their maximum nor their minimum values when the power output is a maximum.

In Fig. 9 are plotted wavelength, power output, and grid current as functions of the backing-plate voltage. The lines are tuned for maximum output at each condition. It will be seen that the output is extremely low at zero volts on the backing plate and rises with increasing

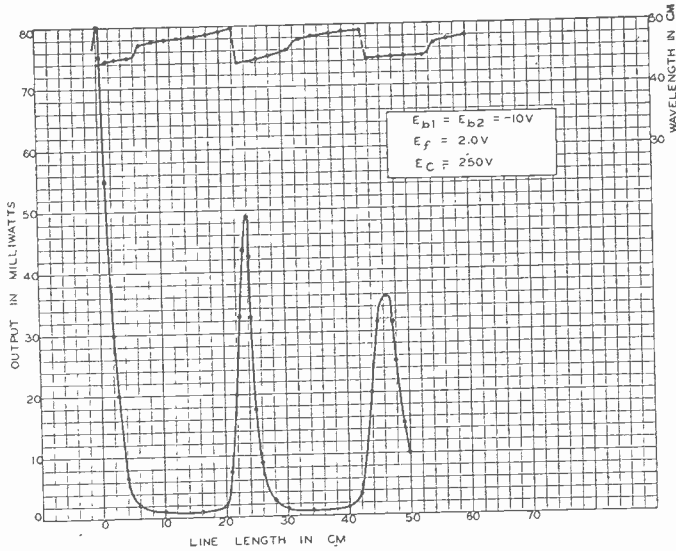

Fig. 7—Wavelength and power output of backing-plate tube plotted against length of parallel-wire system. The length is measured from an arbitrary zero point.

negative potentials to a maximum, and then continually falls to a low value at extreme negative potentials. No measurable oscillations have

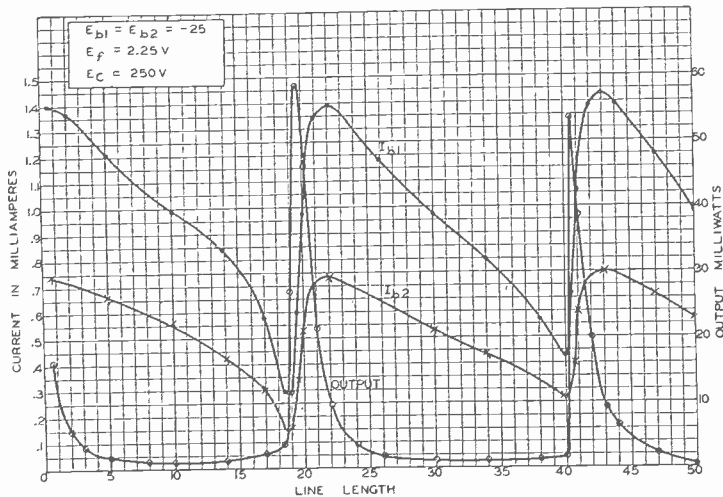

Fig. 8—Backing-plate current, plate current, and power output as functions of line length.

been produced with positive potentials on the backing plate. The wavelength continually shortens as the potential of the backing plate is made more negative.

Fig. 10 shows output and wavelength plotted against plate potential. The curves are similar to those of Fig. 9, except that the maximum in output is sharper, and positive potentials may be used on the plate.

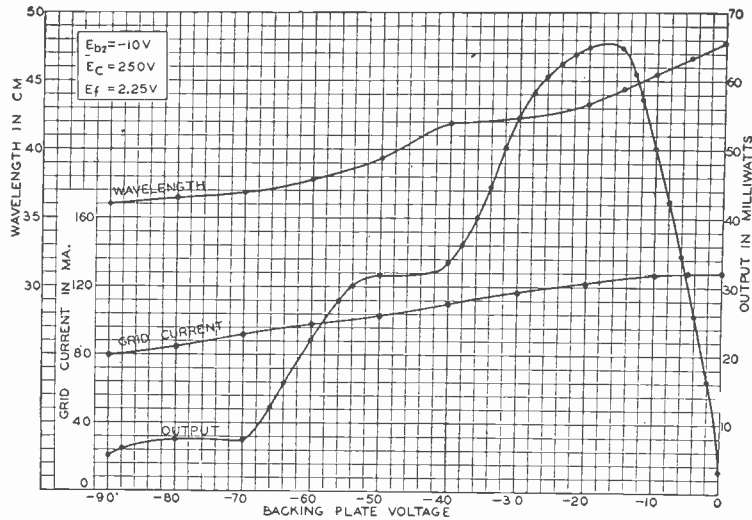

Fig. 9—Wavelength, power output, and grid current plotted against backing-plate voltage.

In Fig. 11 are plotted wavelength and output as functions of grid voltage. It is to be observed that the wavelength decreases and, in general, the power output increases with increasing grid voltage. The

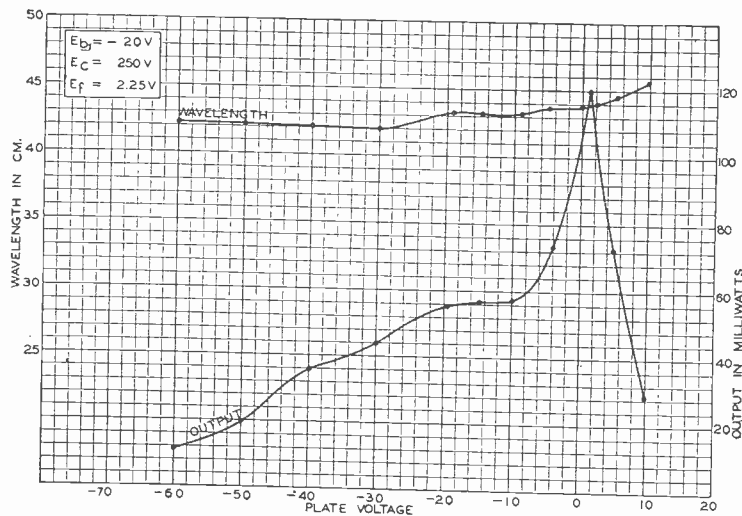

Fig. 10—Wavelength and power output as functions of plate voltage.

increased output may be accounted for largely by the increased power input to the grid. Fig. 12 shows the same wavelength data plotted on a logarithmic scale. It is of interest to observe that the theoretical

relation $\lambda E_c^{1/2} = K$ does not hold for this tube, the exponent being more nearly $1/4$. It is difficult to account for this.

Fig. 13 shows the relation between grid current and grid voltage for several filament voltages. It is apparent that there is no emission limitation of grid current at 2.25 volts filament voltage or higher even at 300 volts on the grid.

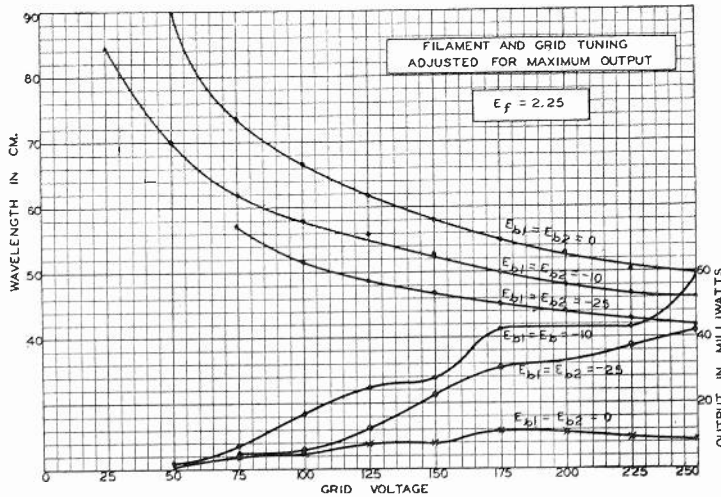

Fig. 11—Wavelength and power output plotted against grid voltage, for various plate and backing-plate voltages.

Fig. 14 depicts the effects of filament voltage on power output and wavelength. It is of importance to note that at 100 volts on the grid,

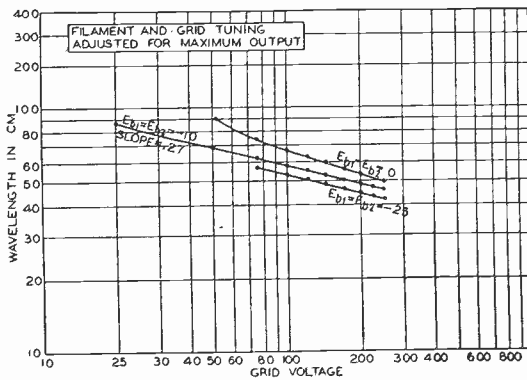

Fig. 12—The data of Fig. 11 plotted on a logarithmic scale of coordinates.

for example, oscillations begin at 1.2 volts filament voltage, the power increasing up to 1.5 volts and then remaining substantially constant to 3.2 volts. The wavelength decreases from 59 to 57 centimeters over this nearly threefold range of filament voltage. At higher grid potentials, the maximum output is not reached so soon, because the output increases as the grid current increases. Comparison with Fig. 13 will

establish the fact that this tube oscillates either emission limited or space charge limited.

The tube on which the above data were obtained was not useful

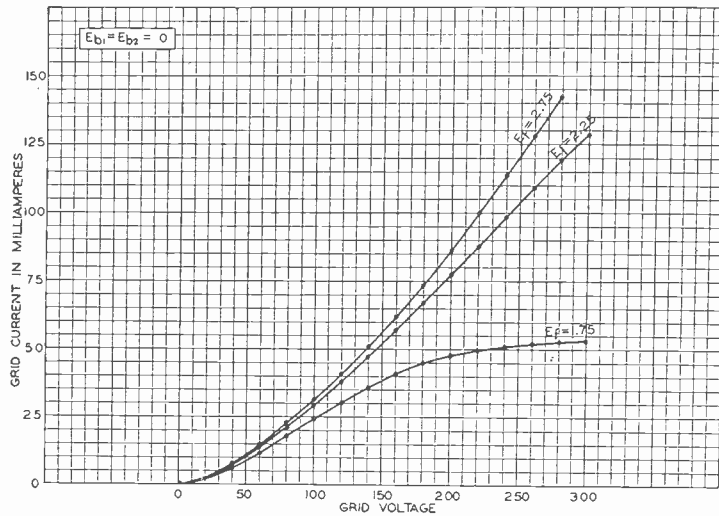

Fig. 13—Grid current plotted against grid voltage for several filament voltages.

for wavelengths less than about 44 centimeters, since only one mode of oscillation is obtained. With the same type of construction a tube having a spacing between plates of slightly less than 1 millimeter

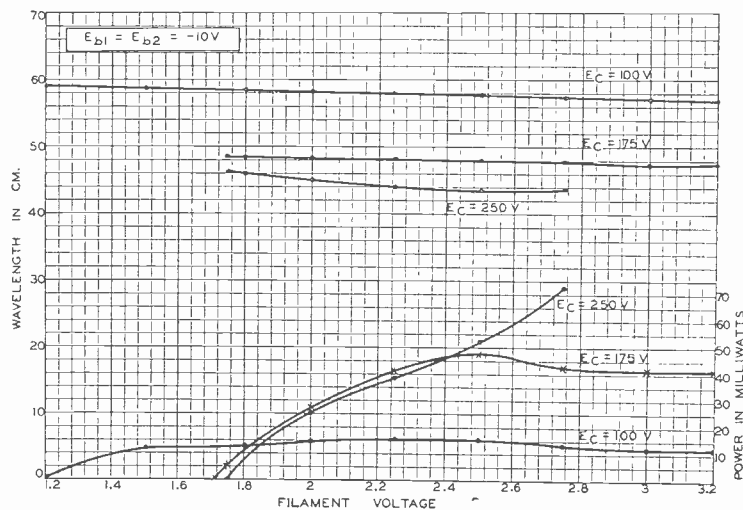

Fig. 14—Wavelength and power output shown as functions of filament voltage for several grid voltages.

oscillated at 9.5 centimeters with 150 volts on the grid. The filament was a single strand, while the grid was reduced to two parallel wires. The input to the grid was only three watts.

DISCUSSION OF RESULTS

It has been shown that electron oscillators of the backing-plate construction oscillate over only one range of frequencies, and that oscillations are produced with either emission or space-charge limited currents, the filament voltage not being critical. These points are in sharp contrast with the performance of cylindrical tubes, as stressed in the introduction to this paper. Both of these points may be considered advantageous from the viewpoint of stability of operation, as the tendency for the frequency to shift suddenly is sometimes embarrassing, while the maintenance of a very constant filament potential is difficult. It is this lack of a critical value of filament emission which permits the use of a thoriated filament rather than the conventional pure tungsten.

It is believed that these results, aside from any practical value, may shed some light on the nature of electron oscillators in general. The ability to operate with space-charge limitation is not strictly unique with these tubes, as the authors have observed the same thing with cylindrical tubes having oxide-coated equipotential cathodes.

CONCLUSION

It appears that the backing-plate tubes in some form will be capable of generating at least as short waves as cylindrical tubes. It is too early to state any conclusions with respect to power output and efficiency, but there are no reasons as yet to believe that these tubes will be inferior.

The results contained in this paper are presented as offering a possible new approach to the problems of constructing electron oscillators, as well as adding to the information concerning the operation of such tubes. The problems of producing satisfactory ultra-short-wave oscillators, in the authors' opinion, are still far from a complete solution.



THEORY OF ELECTRON GUN*

BY

I. G. MALOFF AND D. W. EPSTEIN

(RCA Victor Company, Inc., Camden, New Jersey)

Summary—The function of the electron gun irrespective of the purpose for which the cathode ray tube is used is to generate, to concentrate, to control, and to focus an electron beam to a spot of a desired size. This paper describes the theory of the above-mentioned functions. The point of view of electron optics is presented and the theory of thick electron lenses with variable indexes of refraction is given. A somewhat detailed analysis of the action of the various parts of the gun is given, using the concepts of electron optics whenever convenient. Then a relevant part of thermionic emission is treated, with an emphasis on the distribution of velocities of emission. The initial concentration in the proximity of the cathode, the control of the beam intensity, and the effects of space charge are presented next. In closing, the performance of the gun as a whole is given, and a mathematical and graphical design procedure, made possible by certain assumptions and approximations, is described.

INTRODUCTION

OF THE great number of cathode ray tube applications a radio engineer is interested mostly in three; namely, the oscillograph and its simpler form the oscilloscope, the kinescope or the television receiver tube, and the iconoscope or the television image pick-up tube.

In all of these three applications, the cathode ray tube consists essentially of five component parts: first, the glass envelope, sealed for the maintenance of vacuum; second, the cathode from which the cathode rays or, using a more up-to-date term, the electron beam, originates; third, a device for concentrating, controlling, and focusing of this electron beam; fourth, an arrangement (either internal or external) for deflecting the beam; and fifth, the screen or the target which is covered with fluorescent material in case of the oscillograph and the kinescope and photosensitive material in case of the iconoscope.

The term "electron gun" is fairly new and is used to describe the part of the cathode ray tube which comprises the arrangements for generation, concentration, control, and focusing of the electron beam. Fig. 1 shows a typical modern gun. The tubular cathode with a flat emitting surface is indirectly heated. The emitting surface *A* is coated with some

* Decimal classification: R388. Original manuscript received by the Institute, June 25, 1934. Presented before Ninth Annual Convention, Philadelphia, Pa., May 29, 1934.

oxide preparation. The grid sleeve *B* surrounds the cathode and has a circular opening just opposite the cathode emitting area. An insulator is inserted between the grid and an auxiliary anode *C*, the latter often being called the first anode. The electrostatic field created by the potential applied to the first anode penetrates the grid opening and draws the emitted electrons into the beam. The beam enters the first anode and passes through a central aperture. The purpose of this aperture, called the masking aperture, is to cut off some of the peripheral portions of the beam similar to a stop in a photographic lens. Then the beam enters the region of the field produced by the difference of potentials between the first and the second anodes. The second anode *D* is usually in the form of a cylinder surrounding the first anode. It may be either a separate electrode or it may be in the form of a con-

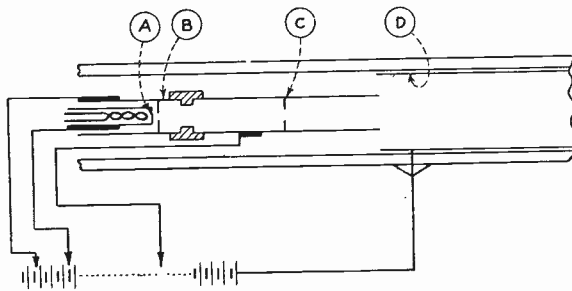

Fig. 1—Typical electron gun.

ducting coating on the inside of the glass tube. In this field a strong focusing action takes place, which gives the electrons a radial velocity component directed towards the axis of symmetry of the beam. The radial momentum acquired by the electrons is sufficient to bring them after a flight through the equipotential space of the main body of the bulb to a focus at the screen.

This explanation may be taken as an introduction to this paper which is devoted to a more detailed treatment of the theory of operation of electron guns for cathode ray tubes.

ELECTRON OPTICS

In order to treat the operation of the electron gun in detail it is very convenient to use a rather young branch of applied physics which is called electron optics. The original name of the electron beam was the cathode ray. Thus we see that the analogy of the behavior of streams of electrons in vacuum with the behavior of light rays was self-evident to even the very early explorers. At present this analogy is firmly established and electron optics plays a major part in theory and design of electron guns.

We are using electron optics for the explanation and prediction of the generation, concentration, control of intensity, and focusing of electron beams in high vacuum *only*. In a broader sense it applies to similar phenomena in rarified gases, but there the secondary phenomena complicate the analysis. In high vacuum the effects of electric and magnetic fields produced by various electrodes and poles are not obscured by the action of ions which result from collision of electrons with molecules of residual gas.

Much to be regretted is the fact that very little practical information can be found in the technical literature related to this interesting subject. That is, practical from the gun designer's standpoint. True enough there are two excellent theoretical articles by Bush¹ written in 1926 and 1927 (in German) proving that a sufficiently narrow bundle of electrons will focus in any nonuniform magnetic and electric field provided the fields have an axial symmetry with respect to the beam. Then comes a series of articles on electron optics and electron microscopes by Knoll and Ruska² and several others, dealing with simplified cases of thin electron lenses.

A recent article by Picht³ discusses a case where electrons go through a continuously varying electrostatic field. He treats the focusing system as a thick electronic lens. He uses analytical methods for treating his problem and indicates a particular solution. His methods are of limited practical value, however, because they imply that the potential along the axis has to be expressed by an analytical function. The accuracy of Picht's solution depends on the accuracy of this analytical expression and not only on the accuracy of the expression itself, but primarily on the accuracy of its first and second derivatives. Unfortunately, there is no such general analytical function and, furthermore, all the attempts by the writers to find simple particular functions to express some of the commonly used fields failed completely.

It is well known from the theory of geometric optics that when we are dealing with a thin lens, a knowledge of its focal length enables us to calculate the distance and the size of the image, if the distance and the size of the object are known. In case of a thick lens consisting of several separate lenses the story is somewhat different. It was proved by Gauss some ninety years ago that it is not necessary to treat the single surfaces of a thick lens separately, but a compound lens can be treated as a whole and some very simple formula can be used for com-

¹ *Ann. der Physik*, vol. 86, p. 974, (1926), and *Archiv für Elektrotech.*, vol. 18, p. 583, (1927).

² *Ann. der Physik*, series 5, vol. 12, Heft 6, p. 641, (1932).

³ *Ann. der Physik*, series 5, vol. 15, Heft 8, p. 56, (1932).

putation of the image size and position provided certain values or constants of the lens are known. It is also well known that it is impossible to find a single lens that, placed in any one position, will act the same way as a system of lenses does. For the prediction of image position and of optical magnification of a symmetrical optical system, it is sufficient to investigate the procedure of paraxial rays in any meridian plane containing the axis. A paraxial ray is a ray whose path lies very near the optical axis of the system, so that the sine of the angle between the path and the axis can be taken as equal to the angle. Taking into consideration the rays which are making larger angles with this axis brings out a number of secondary effects such as aberrations and involves considerably more work. In what follows, except when specified, the discussion is limited to paraxial rays.

For the prediction of a path of a single electron through a known electric or magnetic field in high vacuum, the laws of classical dynamics are sufficient. The general motion of electrons may be governed by, say, modern quantum theory, but since the concentrations of thermionically emitted electrons are very small, the principles of classical dynamics still apply to them. Richardson expressed this in nearly the same words as early as 1916 and just lately Professor Kennard showed definitely and with help of all the up-to-date information, that unless the distances between the electrons in a given phenomena are of the order of their radii, the classical dynamical laws apply and are sufficient for a detailed study of the phenomena. This simply means that we are justified in treating electrons as particles of known mass; the light phenomena are best explained by means of wave analogy.

Many years ago, Newton explained all the laws of geometric optics by means of particles. We are interested only in geometric electron optics. The Newton optics then apply for the prediction of the behavior of electrons in high vacuum and when forces between the particles are of a negligible magnitude. When these forces are of noticeable magnitude, certain simple precautions are needed, and the Newton optics still apply.

A general solution of the path of an electron through a known electrostatic field is briefly⁴ as follows (see Fig. 2): Suppose an electron, moving with a velocity v_0 enters a space, the electrostatic potential V of which is known at every point of the space. The force on the electron by the field will be $e \nabla V$, where e is the charge on the electron. The resultant acceleration is then $a = \nabla V e / m$.

⁴ A practical method of making actual computations is given in Appendix I.

The electron while going through a portion of the path Δs will undergo a change of velocity Δv and its velocity will become

$$v_1 = v_0 + \Delta v$$

where Δv is found as follows

$$\Delta v = \int_t a dt.$$

The actual path of the electron is given by the expression

$$\Delta s = v_0 t + \int dt \int a dt.$$

The velocities and the path of an electron through a known nonuniform electric field can be computed by successive approximations. By taking Δs of a magnitude small enough to consider the gradient ∇V as of a constant value throughout this element of path, the above equations can be very much simplified, becoming

$$\Delta v = \nabla V e / m t$$

and,

$$\Delta s = v_0 t + 1/2 \nabla V e / m t^2$$

where t is the time duration of the electron going through the path Δs .

The older cathode ray tube technique utilized the magnetic method of focusing. The present-day practice, especially on tubes for voltages lower than 10,000 volts on the second anode, is to use the electrostatic method almost exclusively. Therefore, in our discussion we shall limit ourselves to this method after mentioning, however, that there is no difference between the two methods in fundamentals (as was shown in the mentioned works of Bush) and all the derivations made for the electrostatic electron lenses could be easily modified for magnetic focusing.

Bush defined an electron focusing system. He showed that any system of electric or magnetic fields will bring an electron beam to a focus provided the fields have an axial symmetry with respect to the beam. Restricting this statement to electrostatic fields, it can be easily seen that the only fields possessing such symmetry are produced by electrodes having geometric axial symmetry, such as coaxial cylinders, combinations of cones, disks with apertures, rings arranged in the manner shown, etc., as on Fig. 3. It is customary to arrange these fields in such a way as to have regions of equipotential space in the regions just adjacent to the focusing fields of the electronic lenses. The

focusing fields are extremely difficult to compute, but are quite easy to determine by making enlarged water-emersed models⁵ and surveying the fields by means of a probe connected to a sensitive voltage bridge. The authors utilized a number of plots taken by L. B. Headrick of the RCA Radiotron Company's laboratories, whose coöperation in this work is hereby acknowledged.

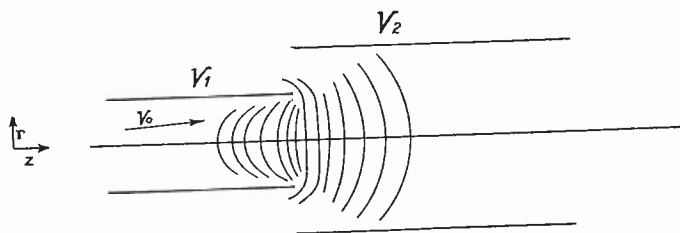

Fig. 2—Equipotential line plot of the main focusing field.

A typical plot of this kind is given on Fig. 2. The path of an electron through such a field can be computed by the method outlined earlier in this paper. A step-by-step method of successive approximations is recommended. It is the only workable way to do the job, since we are dealing with a field of a continuously varying potential. In normal op-

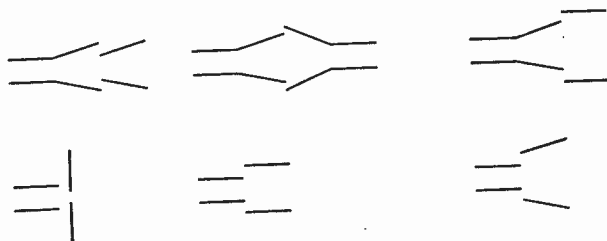

Fig. 3—Axial cross sections of focusing electrode combinations.

tics we seldom deal with such lenses, except in the case of the crystalline lens in the human eye. The reason for saying that this is the only suitable method for solving the path of an electron through an electron lens is the fact that the problem with which we are dealing is a rather difficult one. One way of stating it is in the form of two related integral equations.

Referring to Fig. 2, if the position of the electron at any time be denoted by its two coördinates r and z , then the equations of the path are as follows:

$$z = \iint_i e/m \cdot \nabla_z V dt dt \quad \text{where, } \nabla_z V = f_1(r, z)$$

$$\text{and, } t = F(r, z)$$

$$r = \iint_i e/m \nabla_r V dt dt \quad \text{where, } \nabla_r V = f_2(r, z)$$

$$\text{and } t = F(r, z).$$

⁵ *Electronics*, June, (1932).

So much for the general case. The case of paraxial rays is much more simple, especially because of the fact that only the axial distribution of potential is needed for its solution.

From a plot of equipotential surfaces such as on Fig. 2, we can take the values of the potential V along the axis and plot it as a function of

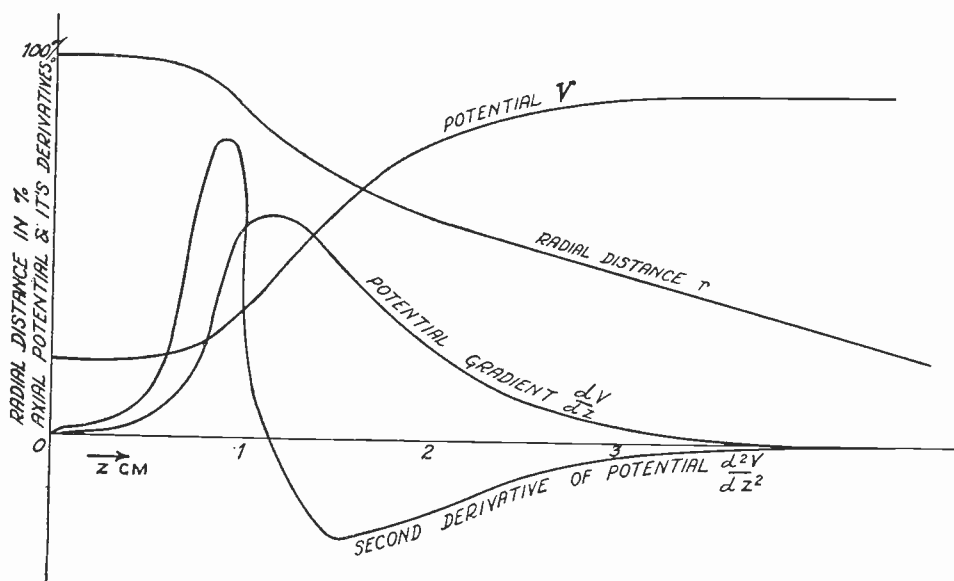

Fig. 4—Computed paraxial electron path.

z , as shown on Fig. 4. Then from this plot of V we can graphically compute the values of gradient of the potential V along the axis. It is dV/dz . In Appendix II it is shown that the value of the radius of curvature of the equipotential surface through a point on the axis is given by the relation

$$R = \frac{2f'(z)}{f''(z)}.$$

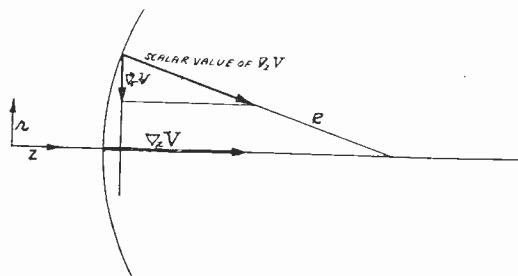

Fig. 5—Relation between axial and radial potential gradients.

The function $f''(z)$ or d^2V/dz^2 is also easily obtained graphically from the plot on Fig. 2.

For a paraxial case there is a very simple relation which is evident from Fig. 5, between the radial and axial gradients:

$\nabla_r V : r = \nabla_z V : R$ which can be transformed as follows:

$$\nabla_r V = r \cdot \frac{\nabla_z V}{R} = r \frac{f'(z) \cdot f''(z)}{2f'(z)} = 1/2r f''(z)$$

where r is the radial distance of the paraxial electron from the axis. The radial acceleration of an electron is therefore

$$\begin{aligned} \frac{d^2r}{dt^2} &= \frac{1}{2} \frac{e}{m} r \frac{d^2V}{dz^2} \quad \text{but} \quad \frac{dz}{dt} = \sqrt{2 \frac{e}{m} V} \\ \frac{d^2r}{dt^2} &= \frac{dz}{dt} \frac{d}{dz} \left(\frac{dr}{dz} \frac{dz}{dt} \right) = 2 \frac{e}{m} V \frac{d^2r}{dz^2} - \frac{e}{m} \frac{dr}{dz} \frac{dV}{dz} \\ \frac{d^2r}{dz^2} &= \frac{1}{4} r \frac{1}{V} \frac{d^2V}{dz^2} - \frac{1}{2} \frac{1}{V} \frac{dr}{dz} \frac{dV}{dz} \\ r &= \iint_z \frac{1}{4} r \frac{1}{V} \frac{d^2V}{dz^2} dz dz - \iint_z \frac{1}{2} \frac{1}{V} \frac{dr}{dz} \frac{dV}{dz} dz dz. \end{aligned}$$

On Fig. 4 a complete paraxial electron path computed by the above described method is shown.

One thing is important to note, that a close examination of the relation just given shows that the path depends only on r , z , and relative V , which in turns means that it depends on the geometry of the field and focusing voltage ratio only, and that the units of voltage and length can be arbitrarily chosen since all the converting factors and e/m drop out. Also the relation just given is a proof that an electron moving with a velocity corresponding to a drop through a voltage V_1 , and going through an electrostatic field caused by a potential difference $V_2 - V_1$, follows a path, which is independent of the individual values of V_1 and V_2 . This path is completely determined by the ratio V_2/V_1 and by the configuration of the electrodes to which these potentials are applied. This is a fundamental theorem of electron optics. It means that once we have a given configuration of electrodes and a fixed position of the object and the image screen, the image will always come to focus on that screen at the same ratio of voltages on the electrodes.

On the basis of the foregoing discussion we may state that if we know the distribution of the potential on the axis of an electron lens, we may compute the path of any paraxial electron through it. Now if we compute the paths of two paraxial electrons entering the field under consideration from opposite directions and both parallel to the axis, we shall have all of the optical constants of such lenses determined. Naturally the electrons must enter the field with velocities

corresponding to the equipotential spaces from which they enter the field.

Planes normal to the axis and passing through the points of intersections of the original directions of the respective electrons with the directions of their emergence from the field are called the principal planes of the optical system. Points of intersection of the directions of emergence and axis of symmetry are called the focal points of the system. The distances between the focal points and the respective principal planes are called focal distances. As seen from Fig. 6 these locations or "cardinal points" and distances (which constitute the set of optical constants of the system) are closely related to the object and

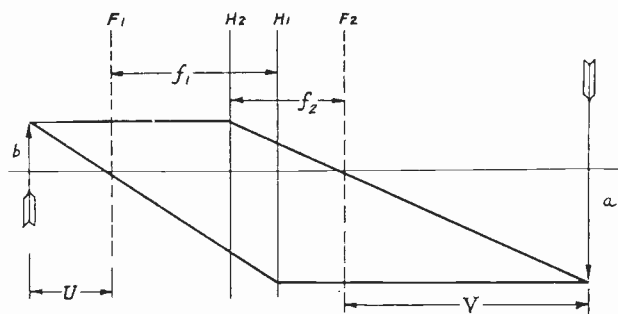

Fig. 6—Optical constants of a thick electron lens.

image distances. By plane geometry we find the following relations

$$m = a/b = V/f_2 = f_1/U \quad (1)$$

$$f_1 f_2 = UV \quad (2)$$

where m is the value of optical magnification.

So much for the general electron optics. We shall have to come back to it again when we consider the performance of the complete gun.

THEORY OF ELECTRON GUN

Cathode and Emission

We already mentioned that the cathode of a modern cathode ray tube is usually made in a tubular form with a flat emitting surface at its end and is indirectly heated by means of a coiled tungsten filament on the inside of the metal tube. The emitting surface is oxide coated. From the standpoint of electron optics, our source of rays is a plane. The electrons are emitted from a plane in accordance with Maxwell's law. There has been some question regarding the correctness of the law, which caused the authors to perform a number of computations of cases which could be easily checked by simple experiments. Results of these checks have convinced the authors that whether or not the law de-

scribes the phenomena completely, it can be considered as a law from the gun designer's standpoint. Various investigators claim that the total number of electrons emitted is predicted inaccurately by Maxwell's law, but in practice this number varies such a great deal with the methods of application and formation of the oxides that the theoretical number emitted is of very little interest. The point of great interest is the velocity distribution, and this Maxwell's law predicts very accurately.

One of the simple experiments made by the authors will be described. Two parallel metal disks about five centimeters in diameter were spaced one centimeter apart in high vacuum. A center point (or

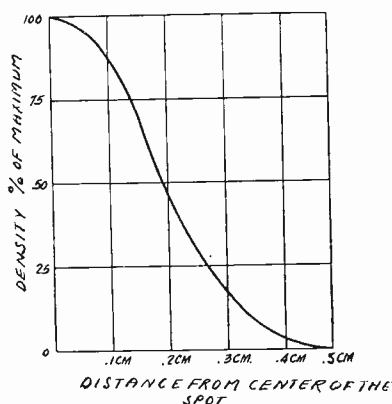

Fig. 7—Computed electron density distribution for the experimental check of Maxwell's law of velocity distribution of electron emission.

as nearly a point as practicable) was covered with an oxide preparation and heated to a normal cathode temperature. The inside surface of the second plate was covered with fluorescent material and a potential of 1000 volts was applied between the two plates. The electrons from the emitting point produced a luminous spot on the fluorescent plate. The diameter of the spot was then calculated from the Maxwellian distribution of velocities and was found to be the same as observed within the accuracy of the measurements. The density distribution of the electrons arriving at the fluorescent screen in the case just described is shown on Fig. 7.

Control

For many purposes for which cathode ray tubes are used it is necessary to vary the intensity of the beam. It is easiest to do so when the electrons have low speeds and so the controlling element is placed near the cathode. There are various methods of control but this paper will limit itself to aperture control as is the practice of today. The controlling element is usually called a grid, although no gratings or perforations may be present, as indicated in Fig. 1.

The action of the control aperture is twofold. It applies a negative potential near some parts of the cathode and so prevents any electrons from leaving these parts and, together with the first anode and cathode, it forms an electronic lens which is of great importance in determining the spot size. Fig. 8 shows the potential distribution near the cathode of a particular gun for zero and -30 volts on the grid. It is seen that in Fig. 8(B), for -30 volts bias, only the center portion of the cathode

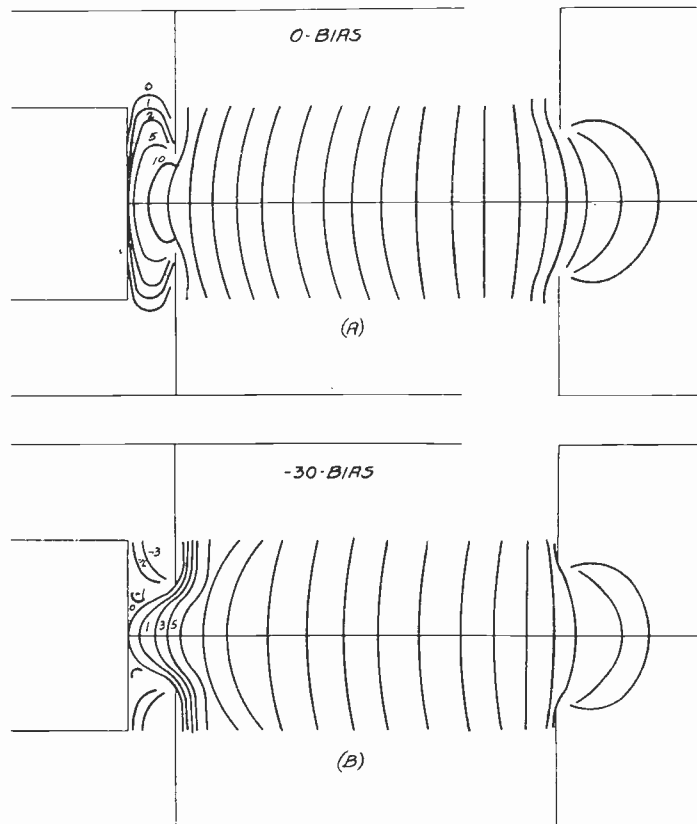

Fig. 8—Equipotential surfaces in proximity of cathode.

is emitting and the negative voltage near the outer edges of the cathode prevents any electrons from leaving the cathode. In the case of Fig. 8(A) nearly the entire cathode is emitting.

The space charge near the edge of the beam at the cathode further reduces the area of emission. This will be seen a little later under the discussion of space charge.

Fig. 8 shows the equipotential lines comprising the thick electronic lenses just mentioned and it is seen that one of the disadvantages of aperture control is the fact that the lens is changed whenever the intensity of the beam is varied, so that the spot on the target will vary somewhat with intensity.

The action of this electronic lens is rather complicated. One of the difficulties lies in the fact that the density of the electrons in the beam is sufficiently large so as not to be negligible. This is especially true close to the cathode where the electron velocity is low. Later in this paper a method for computing the effect of space charge will be outlined, and some of the results obtained will be given. At present an analysis of the action of the field near the cathode will be made, neglecting space charge. The effect of space charge does not radically alter the action of the lens.

An analysis of the focusing field near the cathode may be made by determining the cardinal points of the centered system of spherical refracting surfaces given in Fig. 8. This is somewhat involved by the fact that the electrons incident on the lens are not moving with constant speed. The cardinal points will, of course, depend upon the par-

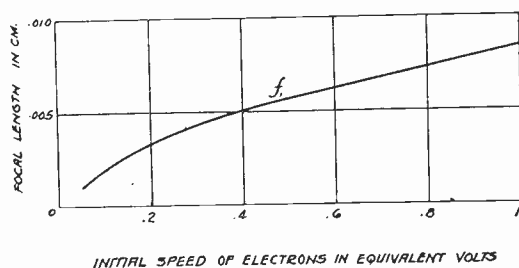

Fig. 9—Variation of first focal length with initial speed of electrons; second focal length does not vary and is equal to 0.38 centimeter.

ticular initial speed assumed. This corresponds to chromatic aberration in the case of light. To determine the effect of chromatic aberration, it is necessary to obtain the cardinal points of the field for several different initial speeds of the electrons. Some deductions regarding the chromatic aberration can be made directly by inspection of the equipotential line plots of Fig. 8. Thus, in the case of zero bias, the two-volt equipotential surface is very close to the cathode so that, regardless of the initial speed (zero to 0.35 equivalent volt) the electrons almost immediately assume speeds ranging from 2 to 2.3 equivalent volts and so the chromatic aberration will be small. In the case of the -30 -volt bias, the chromatic aberration is much larger.

In Fig. 9 are given the focal lengths, f_1 , computed for several values of initial speeds of electrons for the -30 -volt bias case. An interesting fact is that the effect of the initial speeds of chromatic aberration is to alter the cardinal points of the object space only; the cardinal points of the image space, viz., F_2 and H_2 , are not appreciably altered even up to 0.5 equivalent volt initial speeds.

Taking the cathode, the source of the electrons, as the object, we

can compute the position of the image of the cathode by means of (1) and the magnification by means of (2). Performing the computation for the -30 -volt bias case, there results a different image distance for each different initial electron speed assumed. In Fig. 10 are given the positions of the cathode image for several initial electron speeds. It is seen that the chromatic aberration is considerable.

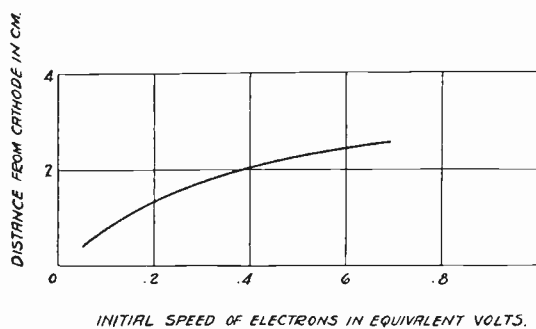

Fig. 10—Variation of position of cathode image with initial speed of electrons showing the chromatic aberration.

The cardinal points of the first lens for a particular set of voltages on the electrodes and initial speed of electrons are shown in Fig. 11.

A further analysis of the focusing field near the cathode may be made by calculating the paths of several special electrons. The paths of two electrons, one having the initial radial velocity of $+0.35$ equivalent volt, and the other of -0.35 equivalent volt (normal velocity

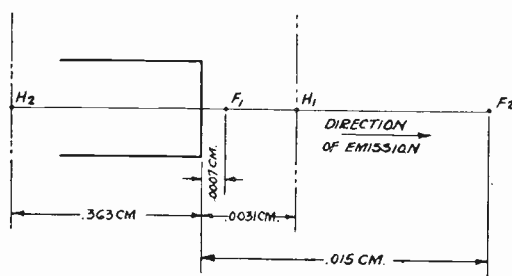

Fig. 11—Cardinal points of first electron lens.

assumed zero) was determined. Their paths are shown by curves (1) and (2) of Fig. 12. The paths of all the electrons emitted from this point on the cathode having initial radial velocities of less than 0.35 equivalent volt will lie in the region included between these two paths, and, similarly, no electrons of the assumed initial velocities emitted by the portion of the cathode above the axis will cross the path of the uppermost electrons when it is above the axis. Paths (3) and (4) of Fig. 12 are the corresponding paths below the axis.

Now consider the point A . Through point A pass electrons (1) and (4). Similarly, electrons of suitable velocities coming from every point of the cathode pass through point A . Point A is, therefore, a new source of electrons; similarly with point B and with every point of the cross section AB . The cross section AB is thus a new source of electrons and has been called the crossover, for lack of a better name. Thus AB can be considered as an object to be imaged and the position and size of the image can be found by extending rays (1) and (4) backward until they meet in C ; then C is the virtual image of A . Similarly, D is the virtual image of B . It is this virtual image of the crossover that is focused on the screen when the spot is a minimum.

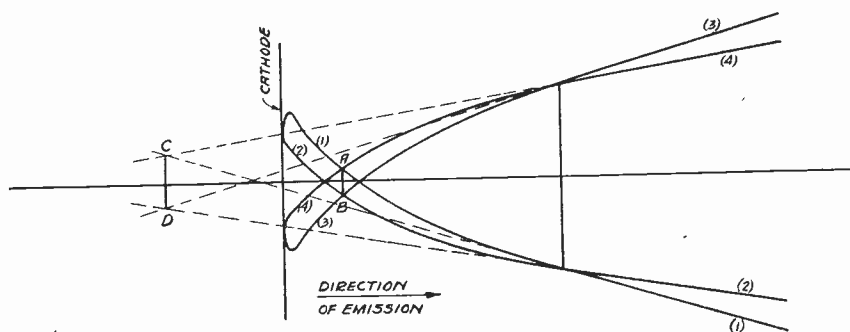

Fig. 12—Analytical determination of electron beam boundary in proximity of cathode.

Space Charge

If the space charge is negligible, then the path of an electron can be determined from the equipotential line plot shown in Fig. 8. If, however, the space charge is not negligible, then the potential distribution in space is no longer given by Fig. 8, but by a modified distribution. To find this modified distribution, it is necessary to find the potential distribution in space due to the space charge and the charges induced on the electrodes by the space charge, and add this to the distribution shown in Fig. 8. Having the modified field, we can forget space charge and proceed as though there were none there.

The equations necessary for the calculation of space charge are given in Appendix III. In this part of the paper only a general outline of the procedure used in obtaining the potential distribution in space due to the electron beam will be given and some of the results obtained presented. The process is as follows:

(1) Neglecting space charge, the shape of the beam near the cathode is obtained from the paths of several electrons through the fields of Fig. 8, or the shape of the beam may be experimentally determined. In Fig. 13 is shown the shape of the beam obtained from the paths of several electrons.

(2) From the equipotential line plot and the initial velocity of the electrons, the velocity of any electron at any point may be calculated. Knowing the velocity of the electrons, the shape of the beam and the

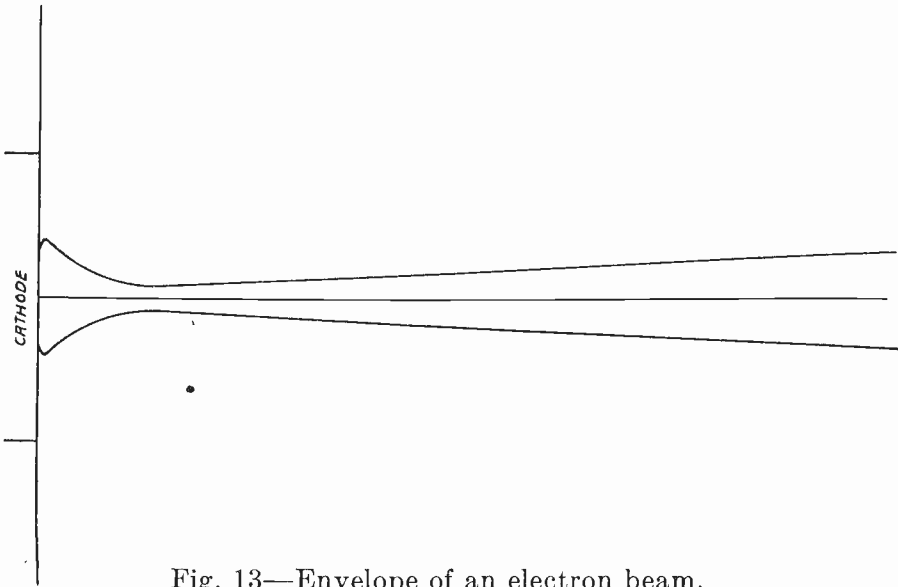

Fig. 13—Envelope of an electron beam.

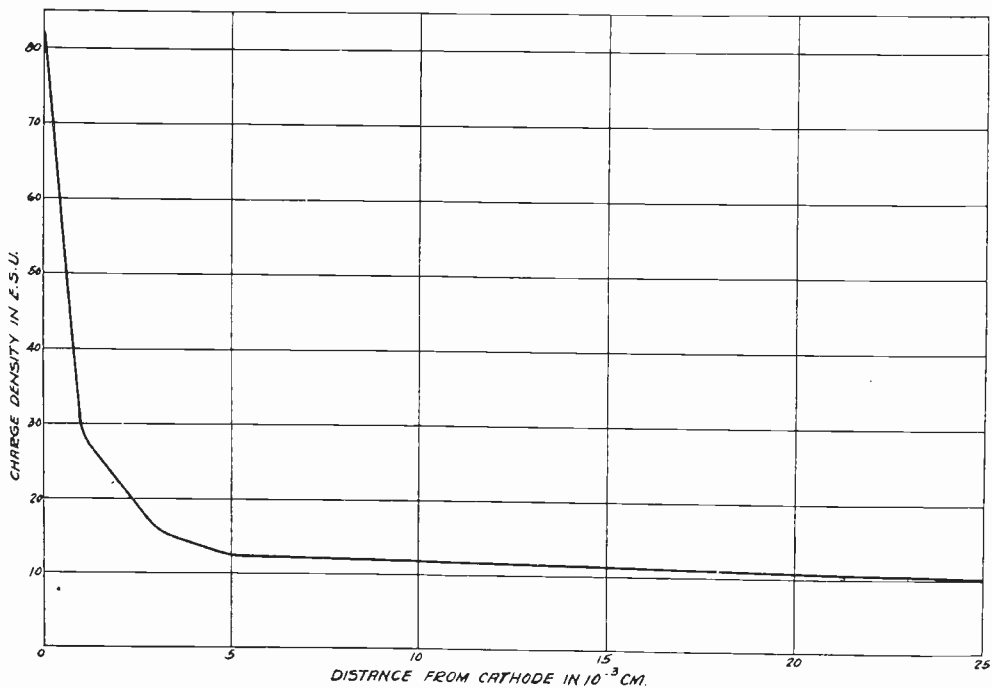

Fig. 14—Charge density along the axis of an electron beam.

current in the beam, the density of charge at any point may be calculated. Fig. 14 gives the charge density along the axis so calculated.

(3) From the charge density and the shape of the beam the potential at any point due to the beam can be calculated. Curve (1) Fig. 15, gives the calculated potential along the axis due to the beam.

(4) The charges induced on the electrodes are then calculated and the potential distribution in space due to these induced charges is obtained. Curve (2) Fig. 15 gives the calculated potential along the axis due to the charges on the electrodes induced by the space charge.

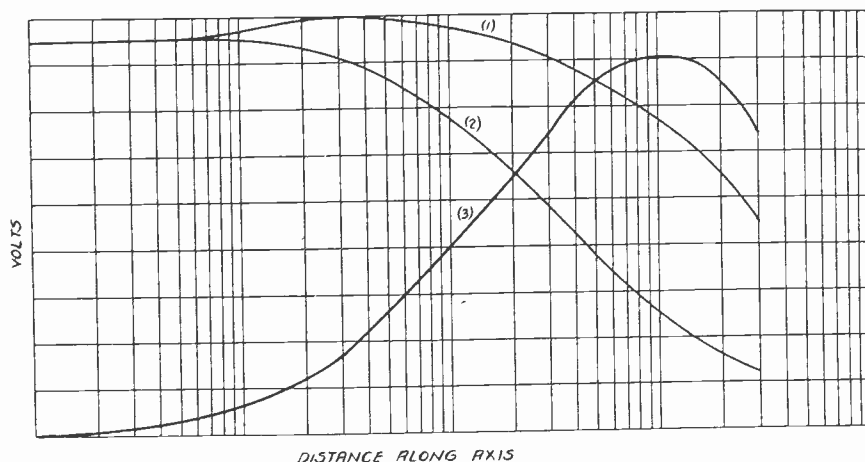

Fig. 15—Curve (1) potential along the beam axis due to beam itself. Curve (2) potential along the axis due to induced charges. Curve (3) difference between the two (half scale).

(5) The difference between the potential distributions obtained in paragraphs (3) and (4) above gives the potential distribution that is subtracted from that of Fig. 8 to get the distribution sought. Curve (3), Fig. 15, gives the potential along the axis obtained as the difference between curves (1) and (2).

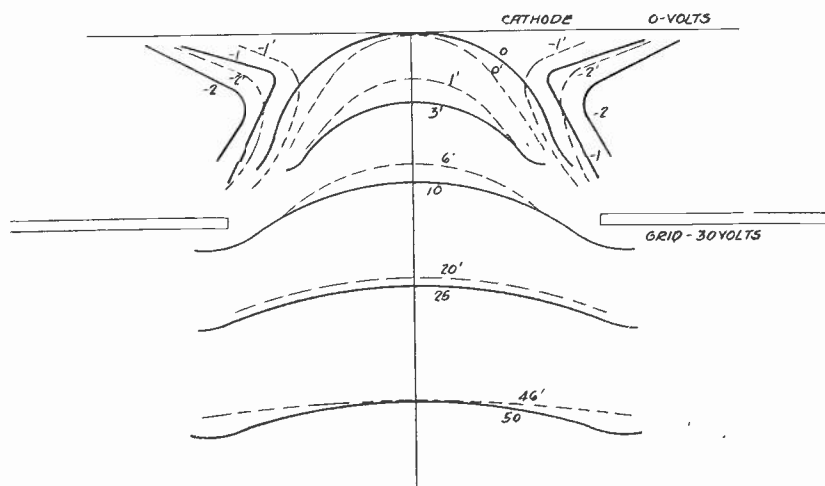

Fig. 16—Effect of the space charge on the potential distribution of first lens.

If a better approximation is desired, it is necessary to repeat the process starting with the potential distribution obtained in step (5) instead of the distribution of Fig. 8.

The solid lines of Fig. 16 give the distribution without space

charge, i.e., the distribution of Fig. 8, and the dotted lines give the potential distribution after the space charge has been accounted for.

Main (Second) Focusing Field

The divergent beam leaving the first focusing field strikes an aperture about midway in the first anode. This aperture serves as a stop to remove all the stray electrons on the periphery of the beam. The beam then enters the second or main focusing field. An equipotential line plot of the main focusing field is shown in Fig. 2.

When the electron beam enters the second focusing field, the electrons in the beam are already traveling at high velocity, and the cross section of the beam is such that the electron density of the beam is small so that the force exerted by the electrons in the beam on any electron is negligible. Hence the effect of space charge may be neglected in making an analysis of the second focusing field.

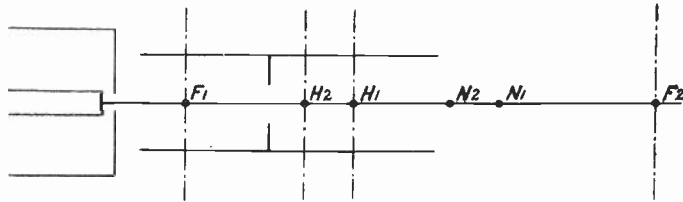

Fig. 17—Positions of cardinal points of second focusing field.

Inspection of Fig. 2 will convince one that near the axis the equipotential surfaces are portions of spheres. Hence, the second focusing field may be considered as a centered optical system of spherical refracting surfaces. As in the case of light, the focusing action of the field is obtained by considering only paraxial electrons. The effects of the nonparaxial electrons are then described as aberrations or failure of the electrons to arrive at the points calculated from the paraxial assumption.

The cardinal points of the second focusing field are found by the method previously outlined. Fig. 17 shows the positions of the cardinal points of the second focusing field of a kinescope for one set of voltages. In this diagram F_1 and H_1 are the focal and principal planes of the object space; F_2 and H_2 the focal and principal planes of the image space; N_1 and N_2 are the nodal points of the object and image space, respectively. The focal lengths f_1 and f_2 are then defined as

$$H_1F_1 = f_1, \quad H_2F_2 = f_2.$$

Further, let P in Fig. 18 be an object point and Q its image and denote PF_1 by U and F_2Q by V . Then as has already been given

$$UV = f_1f_2. \quad (2)$$

This equation determines the position of the image V providing the position of the object U and the focal lengths f_1 and f_2 are known; or it determines the position of the object U , if the location of the image and the focal lengths are known.

As already mentioned, the magnification of the focusing field is then determined from the relation

$$m = \frac{V}{U} = \frac{f_1}{f_2}. \quad (1)$$

It is to be noted that the second focusing system is one with crossed principal planes and that the first focal length is smaller than the second focal length. This result is not surprising if it is remembered that the indexes of refraction⁶ on the two sides of the focusing system are different.

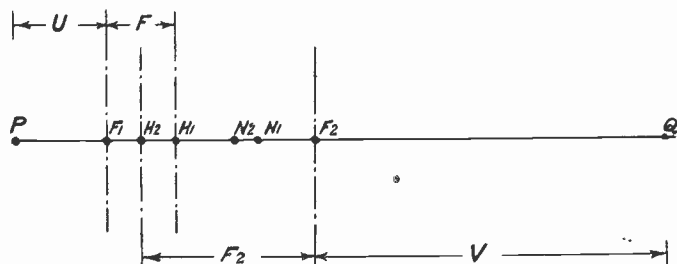

Fig. 18—Object and image positions and cardinal points of the first field.

For a given first and second anode diameter the cardinal points are determined solely by the ratio of second anode to first anode voltage. The actual value of the first or second anode voltage does not affect the cardinal points of the field; it is only their ratio that matters. In the design of a kinescope, however, the actual voltage on the anodes does matter, for although it does not affect the cardinal points of the focusing system, there are other factors in the tube which it does affect. Thus the brightness of the spot depends upon the actual voltages. Fig. 19 gives the variation of the first and second focal lengths with the ratio of second anode to first anode voltages.

In a given kinescope, the fluorescent screen is at a fixed distance from the end of the gun, say 30 centimeters. This fixes the position of the image, V , as $30 - F_2$. Knowing f_1 and f_2 , the object distance, U , may be calculated. Thus, with the position of the image fixed at the screen 30 centimeters away from the gun, the changes in location

⁶ As in the case of light, the relative index of refraction of two media is defined as the ratio of the velocities of the electrons in the two media and is given by $\mu = \sqrt{V_2/V_1}$ where V_2 and V_1 are the potentials of the second and first media, respectively.

(along the axis) of the object due to changes in the focusing voltage ratio may be computed from (2). The result is shown in Fig. 20 where it is seen that as the voltage ratio is decreased, the location of the object that is focused on the screen 30 centimeters away from the end of the gun, is moved further and further away from the screen.

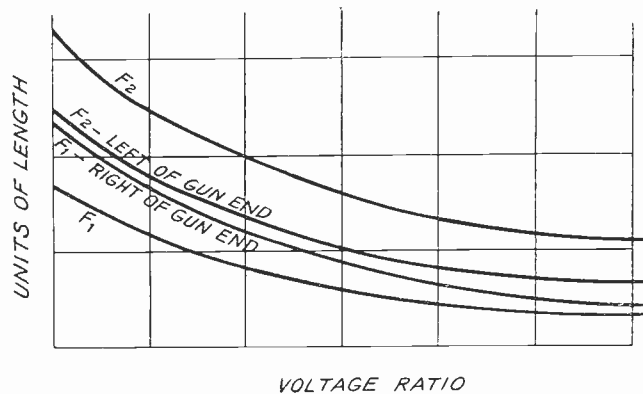

Fig. 19—Variation of optical constants of an electron gun with ratio of voltages on first and second anodes.

Similarly, by the use of (1) the magnification of the second focusing field for any given voltage ratio may be computed. The result is shown in Fig. 21 where it is seen that as the voltage ratio is increased, the magnification of the object, which is focused on the screen 30 centimeters away from the end of the gun, is increased. Fig. 22 shows how

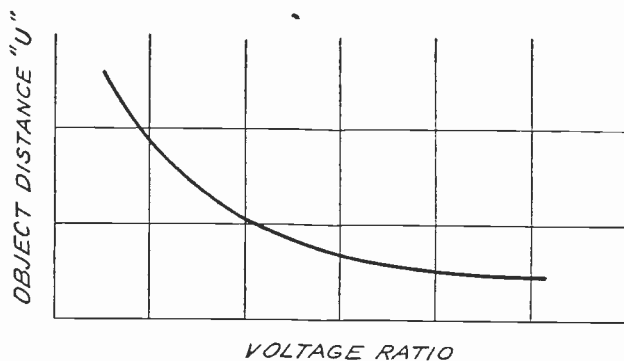

Fig. 20—Variation of object distance with voltage ratio keeping image distance constant.

the magnification varies with the position of the object, assuming the image to be on the screen.

Although Figs. 20 to 22 apply only in case the screen is 30 centimeters away from the end of the gun, similar curves can be obtained for any distance between screen and gun from the curves of Fig. 19, giving the cardinal points of the field, and (1) and (2).

Fig. 19 gives the variation of the cardinal points with varying voltage ratios on second and first anode for a given ratio of diameters between second and first anode. Similar curves can be obtained for other diameter ratios.

It is of importance to have some measure of the aberration of the second focusing field. To determine the spherical aberration, the path

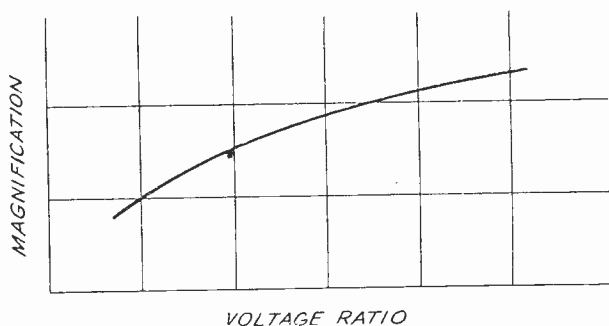

Fig. 21—Variation of optical magnification with voltage ratio keeping image distance constant.

of several electrons moving parallel to the axis at different distances from the axis is computed. The method of computing the path of a nonparaxial electron is given in Appendix II. Fig. 23 gives the path of several electrons so calculated. It is seen that electron (*a*), a nonparaxial electron, originally on the outside of the beam, intersects the

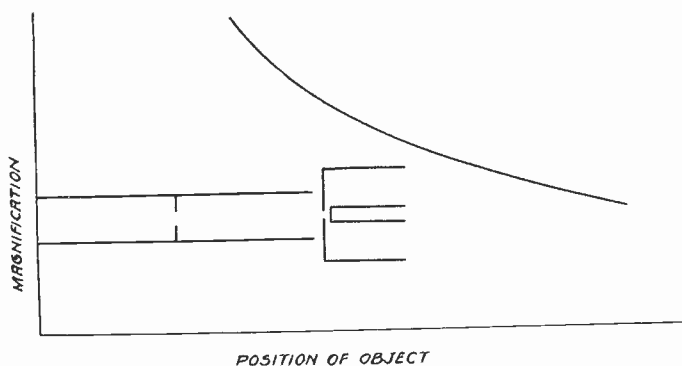

Fig. 22—Variation of optical magnification with position of the object keeping the image distance constant.

axis at L_2 , while electron (*b*), a paraxial electron, intersects the axis at F_2 . The distance L_2F_2 is a measure of the axial spherical aberration of a direct cylindrical bundle of incident electrons. The chromatic aberration of the second focusing field is negligible.

Although only the cylinder type of focusing electrodes has been considered so far, they are by no means the only ones that may be treated in the above manner. Cardinal points can be obtained, in the

above-described manner, for any focusing system having axial symmetry.

It is interesting to follow what is being focused on the fluorescent screen as the second anode voltage is varied, everything else remaining unchanged. If the second and first anodes are at the same potential, then there is a poorly focused inverted image of the cathode on the screen; as the voltage on the second anode is increased, the distance between the cross section being imaged and the second focusing field is decreased. As this distance is decreased, so is the diameter of the cross section being imaged. This continues until the image on the screen is that of the virtual image of the crossover; at this position the diameter of the cross section is a minimum.

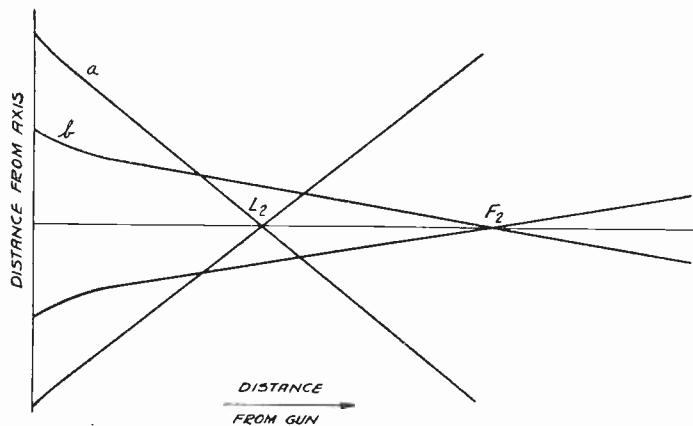

Fig. 23—Determination of spherical aberration of an electron lens.

As the second anode voltage is further increased, the spot on the screen increases as the cross section of the object being imaged increases. As the second anode voltage is still further increased, the image on the screen is that of the image of the cathode produced by the first focusing field; this image is, however, erect and a much better one than the inverted one produced when the second anode voltage is nearly that of the first anode.

CONCLUSION

It is only by considering the fields as thick lenses with indexes of refraction different on the two sides of the lens and variable inside the lens that we can obtain a fairly true picture of the mechanism of the tube, and so obtain sound information for design purposes in general.

For particular purposes a thin lens can be used. Thus it is possible to assign to a thin lens focal lengths and positions so that correct image distances and magnification values can be calculated for a limited range

of voltage ratios and image distances. As soon as this limited range is exceeded, it is necessary to find another thin lens with different focal lengths and probably another position. This lens will serve for another range of values and so on, until the entire range is covered.

The fact that different thin lenses will be required for different ranges would not be so objectionable. The real difficulty is in determining the right constants for different thin lenses and the exact region to which these constants apply.

For a real story of the performance of the gun, the theory of thick electron lenses seems to be the only satisfactory tool of analysis.

APPENDIX I

Approximate Calculation of the Path of an Electron through any Electrostatic Field with Axial Symmetry

Due to the axial symmetry the path of an electron through a field such as shown in Fig. 2 can be considered as a two-dimensional problem. From Fig. 2 it is seen that the force acting on an electron varies throughout its path. If, however, two equipotential lines are sufficiently close together both in distance and potential, the force acting on an electron in this interval can be taken as constant throughout this interval. The constant field is given by $\Delta V/\Delta S$ where ΔV is the difference in potential between the two equipotential lines and ΔS is the shortest distance between them at the place under consideration. Hence the force acting on the electron during the time it is between the two equipotential surfaces is

$$F = m \frac{d^2S}{dt^2} = e \frac{\Delta V}{\Delta S}. \quad (1)$$

This equation, after being broken up into its components, becomes

$$\begin{aligned} m \frac{d^2r}{dt^2} &= e \frac{\Delta V}{\Delta S} \sin \theta \\ m \frac{d^2z}{dt^2} &= e \frac{\Delta V}{\Delta S} \cos \theta \end{aligned} \quad (2)$$

where θ is the angle between the direction of the field (or ΔS) and the axis. Now $\sin \theta = r_0/\rho$ and $\cos \theta = \sqrt{\rho^2 - r_0^2}/\rho$ where ρ is the radius of curvature obtained by averaging the radii of the two surfaces and r_0 is the value of r at the first surface. Hence equations (2) become

$$\frac{d^2r}{dt^2} = \frac{e}{m} \frac{\Delta V}{\Delta S} \frac{r_0}{\rho} = K_1 = \text{constant} \quad (3)$$

$$\frac{d^2z}{dt^2} = \frac{e}{m} \frac{\Delta V}{\Delta S} \frac{\sqrt{\rho^2 - r_0^2}}{\rho} = K_2 = \text{constant.}$$

Integrating once

$$\frac{dr}{dt} = K_1 t + \left(\frac{dr}{dt} \right)_0 \quad (4)$$

$$\frac{dz}{dt} = K_2 t + \left(\frac{dz}{dt} \right)_0.$$

Integrating once more

$$\Delta r = r - r_0 = 1/2 K_1 t^2 + \left(\frac{dr}{dt} \right)_0 t \quad (5)$$

$$\Delta z = z - z_0 = 1/2 K_2 t^2 + \left(\frac{dz}{dt} \right)_0 t$$

where z_0 , r_0 , $(dz/dt)_0$, and $(dr/dt)_0$ represent the given location and velocity of the electron at the first surface. To find the location and velocity of the electron at the second surface it is necessary to solve (4) and (5). To do this the time t which the electron spends between the two surfaces has to be known. This time can be determined in any number of ways. In practice, with the attainment of a little skill, one can, in a single trial, estimate the time surprisingly accurately by using the relation $\Delta S/v$ as a guide; in this relation v is the average speed of the electron in the interval. The time may be calculated from the relation

$$1/2m \left[(K_1^2 + K_2^2)t^2 + 2 \left\{ K_1 \left(\frac{dr}{dt} \right)_0 + K_2 \left(\frac{dz}{dt} \right)_0 \right\} t \right] = e\Delta V \quad (6)$$

obtained from the law of conservation of energy. The calculation of the time by means of this relation becomes, however, quite laborious.

Having t , the position and velocity of the electron at the second surface is known and the process is continued until the path of the electron through the entire field is determined.

The case of a paraxial path¹ is much simpler. As $dr/dt \ll dz/dt$, $\Delta S \doteq \Delta z$, and t is entirely determined by the relation $\Delta z/v$. It is only necessary to compute r and dr/dt from the first equations of (4) and (5). The work required for the calculation of a paraxial path is less than half of that for an actual path.

APPENDIX II

The Determination of the Radii of Curvature at the Axis of a Coaxial System of Equipotential Surfaces

If, for a system having axial symmetry, the value of the potential and its derivatives along the axis are known, then the value of the potential off the axis can be obtained from the expansion⁷

$$V(z, r) = f(z) - \frac{r^2}{2^2} f''(z) + \frac{r^4}{2^2 4^2} f^{IV}(z) \dots \dots \dots \quad (1)$$

where $f(z) = V(z, 0)$ is the value of the potential along the axis.

If the equipotential lines such as shown in Fig. 2 are given in the form

$$V(z, r) - C = F(z, r) = 0 \quad (2)$$

then the expression⁸ for the radius of curvature is

$$\rho = - \frac{\left\{ \left(\frac{\partial F}{\partial z} \right)^2 + \left(\frac{\partial F}{\partial r} \right)^2 \right\}^{3/2}}{\frac{\partial^2 F}{\partial z^2} \left(\frac{\partial F}{\partial r} \right)^2 - 2 \frac{\partial^2 F}{\partial z \partial r} \frac{\partial F}{\partial z} \frac{\partial F}{\partial r} + \frac{\partial^2 F}{\partial r^2} \left(\frac{\partial F}{\partial z} \right)^2} \quad (3)$$

For points along the axis there results from (1) and (2) that

$$\left. \begin{aligned} \frac{\partial F(z, r)}{\partial r} &= \frac{\partial V(z, r)}{\partial r} = 0 \\ \frac{\partial^2 F(z, r)}{\partial z \partial r} &= \frac{\partial V(z, r)}{\partial z \partial r} = 0 \\ \frac{\partial F(z, r)}{\partial z} &= \frac{dV(z, 0)}{dz} = f'(z) \\ \frac{\partial^2 F(z, r)}{\partial z^2} &= - \frac{d^2 V(z, 0)}{dz^2} = - f''(z) \\ \frac{\partial^2 F(z, r)}{\partial r^2} &= \frac{\partial^2 V(z, r)}{\partial r^2} = - \frac{1}{2} \frac{d^2 V(z, 0)}{dz^2} = - \frac{1}{2} f''(z) \end{aligned} \right\} \quad (4)$$

By substituting (4) into (3) the expression for the radius of curvature along the axis becomes

⁷ H. Bateman, "Part. Diff. Equ. of Math. Physics," pp. 406.
⁸ "Smithsonian Mathematical Formulae," p. 38.

$$\rho = 2 \frac{\frac{dV(z, 0)}{dz}}{\frac{d^2V(z, 0)}{dz^2}} = \frac{2f'(z)}{f''(z)}.$$

APPENDIX III

Approximate Calculation of Space Charge

Due to the form of the equipotential surfaces near the cathode, the electrons on the periphery of the beam are moving slower than those near the axis of the beam. The density, therefore, increases with the distance from the axis. Along the axis the density varies as that shown in Fig. 17. The exact problem of determining the potential distribution in space due to the distributions of charge, as that existing in the beam, is almost hopeless.

The problem was approximately solved by considering only small portions of the beam at a time. The small portions were chosen so that in each portion: (a) the beam is either a disk or cylinder; (b) the density along the axis is either constant or varies linearly; and (c) the density normal to the axis is either constant throughout, or the disk or cylinder of charge can be obtained from the superposition of several disks or cylinders of various radii and charge densities.

To calculate the charges induced on the electrodes, the potential at the electrodes due to the charges in the beam was obtained and the induced charges were so determined so as to reduce this potential to zero. The induced charges were assumed to be in the forms of disks and rings of charges of constant density. It was later found that the effect of the induced charges for the -30 -volt bias case can be obtained to a sufficient degree of accuracy by assuming the cathode to be an infinite plane and considering the induced charges to be the image of the charges in the beam.

The equations found most useful in the calculation of the potential distribution due to the space charge are:

(a) The potential along the axis due to a cylinder of charge of constant density ρ , of length $2l$, and radius a , is given by

$$V = \pi\rho \left[(l-x)\sqrt{(x-l)^2+a^2} + (l-x)\sqrt{(x+l)^2+a^2} - 4xl \right. \\ \left. + a^2 \log \frac{\{\sqrt{(x-l)^2+a^2} + (l-x)\}}{\{\sqrt{(x+l)^2+a^2} - (l-x)\}} \right] \quad (1)$$

where x is measured from the center of the cylinder.

(b) The potential at any point (r, θ) due to a disk of total charge Q and radius a is

$$\begin{aligned}
 V &= \frac{2Q}{a} \left[\frac{1}{2} \frac{a}{r} - \frac{1.1}{2.4} \left(\frac{a}{r} \right)^3 P_2(\cos \theta) \right. \\
 &\quad \left. + \frac{1.1.3}{2.4.6} \left(\frac{a}{r} \right)^5 P_4(\cos \theta) - \dots \right] \quad r > a \quad (2) \\
 V &= \frac{2Q}{a} \left[1 - \frac{r}{a} P_1(\cos \theta) + \frac{1}{2} \left(\frac{r}{a} \right)^2 P_2(\cos \theta) \right. \\
 &\quad \left. - \frac{1.1}{2.4} \left(\frac{r}{a} \right)^4 P_4(\cos \theta) + \dots \right] \\
 &\quad r < a, \theta < \frac{\pi}{2}.
 \end{aligned}$$

(c) The potential at any point (r, θ) due to a circular ring of small cross section of total charge Q and radius a is

$$\begin{aligned}
 V &= \frac{Q}{a} \left[\frac{a}{r} - \frac{1}{2} \left(\frac{a}{r} \right)^3 P_2(\cos \theta) \right. \\
 &\quad \left. + \frac{1.3}{2.4} \left(\frac{a}{r} \right)^5 P_4(\cos \theta) - \dots \right] r > a \quad (3) \\
 &= \frac{Q}{a} \left[1 - \frac{1}{2} \left(\frac{r}{a} \right)^2 P_2(\cos \theta) \right. \\
 &\quad \left. + \frac{1.3}{2.4} \left(\frac{r}{a} \right)^4 P_4(\cos \theta) - \dots \right] r < a.
 \end{aligned}$$

(d) The potential at any point due to a line of charge of total charge Q and length l is

$$V = \frac{Q}{l} \log \frac{r + r' + l}{r + r' - l} \quad (4)$$

where r and r' are the distances from the point under consideration and the two ends of the line of charge.

(e) The potential at any point due to a point charge Q is

$$V = \frac{Q}{r}. \quad (5)$$

Equations (4) and (5) are used if the point at which the potential is desired is sufficiently far from the charges under consideration.

CONTRIBUTORS TO THIS ISSUE

Brown, W. Wilbur: Born November 11, 1889, at Hambleton, West Virginia. Received E.E. degree, I.C.S. Electrical construction, repair, and power station operation, Davis Coal and Coke Company, 1907-1910; electrical construction, repair, and power station operation, United Railways and Electric Company, 1910-1913. Test course, General Electric Company, 1913-1915. Radio development of Alexanderson high-frequency alternator system and installation of 200-kilowatt equipment at New Brunswick and Tuckertown, N. J., Marion, Mass., and Rocky Point, L.I., 1915-1921; radio development and design engineering, 1921 to date. Member, American Institute of Electrical Engineers, 1926. Member, Institute of Radio Engineers, 1918.

Carlisle, Richard W.: Born March 13, 1903, at Syracuse, New York. Received S.B. degree, College of the City of New York; B.S. degree in electrical engineering, Massachusetts Institute of Technology, 1926; M.S. degree, University of Pittsburgh, 1930. Power transmission and radio engineering departments, Westinghouse Electric and Manufacturing Company, 1926-1930; engineering and research divisions, RCA Victor Company, Inc., 1930-1934. Engaged in consulting work on acoustics and facsimile, 1934. Nonmember, Institute of Radio Engineers.

Dome, R. B.: Born October 12, 1905, at Tell City, Indiana. Received B.S. degree in electrical engineering, Purdue University, 1926; M.S. degree, Union College, 1929. Test course, General Electric Company, 1926-1928; radio (transmitter) engineering department, 1928-1934; radio (receiver) engineering department, 1934 to date. Member, Sigma Xi. Associate member, Institute of Radio Engineers, 1927.

Epstein, D. W.: Born January 11, 1908, in Russia. Received B.S. degree in engineering physics, Lehigh University, 1930; M.S. degree in electrical engineering, University of Pennsylvania, 1934. Research division, engineering department, RCA Victor Company, Inc., 1930 to date. Member, American Physical Society. Associate member, Institute of Radio Engineers, 1934.

Kolster, Frederick A.: Born January 13, 1883, at Geneva, Switzerland. Assistant to John Stone Stone, 1902-1908. Graduated from Harvard, 1908. Assistant to Lee de Forest, 1909-1911; assistant to Fritz Lowenstein, 1911-1912. Chief of the Radio Section, U. S. Bureau of Standards, 1912-1921; Federal Telegraph Company, 1921-1931; research engineer, International Communications Laboratories, 1931 to date. Associate member, Institute of Radio Engineers 1912; Member, 1913; Fellow, 1916.

Maloff, I. G.: Born 1899, at Vladivostock, Siberia. Educated at Naval Academy, St. Petersburg, Russia, and Union College, Schenectady, N. Y. General Electric Company's laboratories, 1923-1927; consulting engineer, associated with John P. Minton, 1927-1928; vice president, Valley Appliances, Inc., 1930; engineering department, RCA Victor Company, Inc., 1930 to date. Member, Institute of Radio Engineers, 1927.

Nickle, C. A.: Born May 6, 1894, at Sharpsville, Pennsylvania. Received B.S. degree, Pennsylvania State College, 1918. Alternating-current engineering department, Erie Works, General Electric Company, 1919-1922; consulting engineering section, engineering general department, General Electric Company, 1922 to date. Nonmember, Institute of Radio Engineers.

Olsen, Harry F.: See Proceedings for January, 1934.

Thompson, B. J.: Received B.S. degree in electrical engineering, University of Washington, 1925. Research laboratory, General Electric Company, 1926-1930; vacuum tube engineering department, 1930-1931; research section, research and development laboratory, RCA Radiotron Company, Inc., 1931 to date, Member, American Physical Society. Associate member, Institute of Radio Engineers, 1929; Member, 1932.

Zottu, Paul D.: Born March 21, 1906, at Bucharest, Roumania. Received B.A. degree in physics, Wesleyan University, 1931. Special research assistant to W. G. Cady, 1928-1932. Retained on inventors agreement by various organizations, 1928-1932. Vacuum tube development section, research laboratory, General Electric Company, summer, 1929; research section, research and development laboratory, RCA Radiotron Company, Inc., 1932 to date. Associate member, Institute of Radio Engineers, 1931.



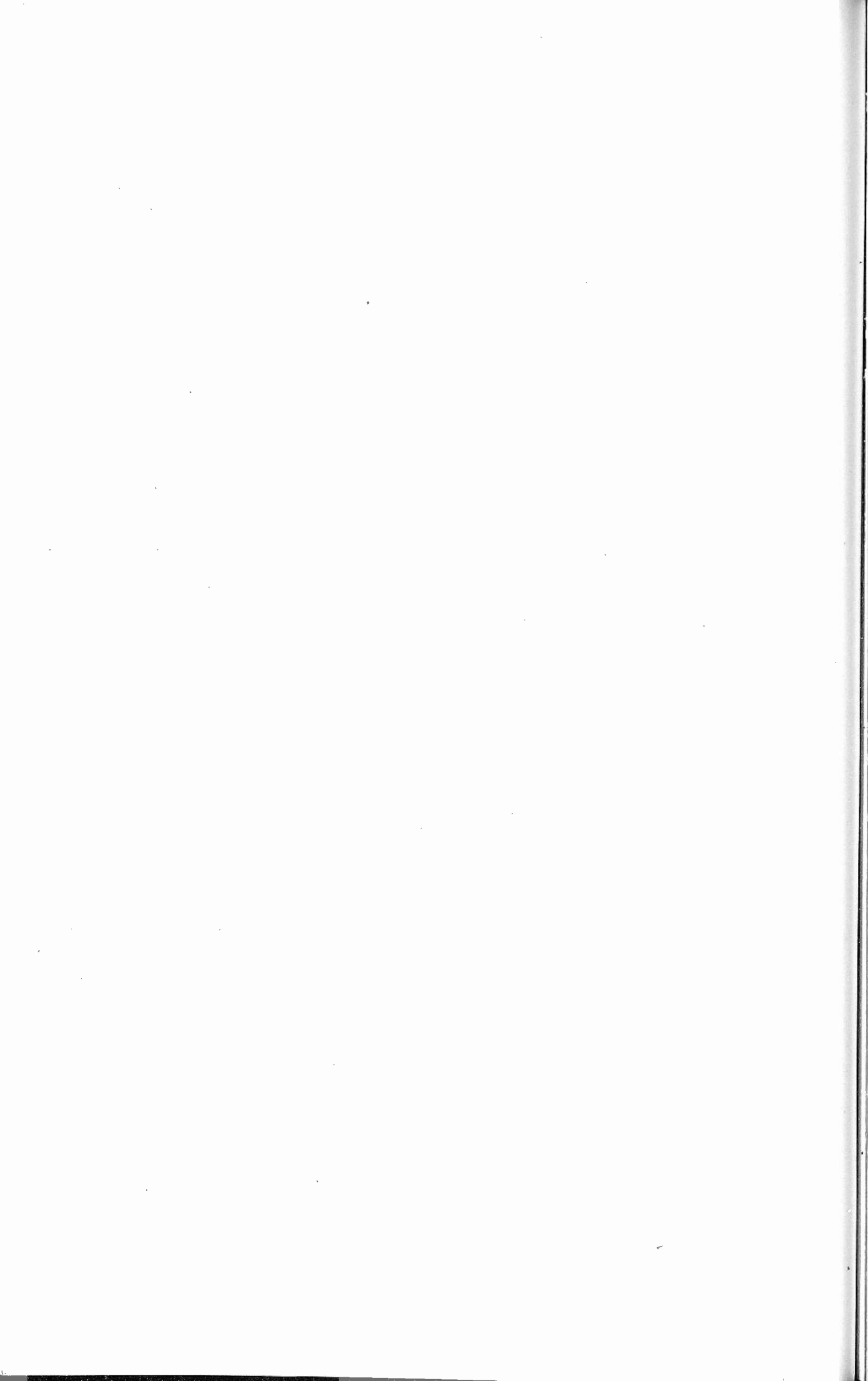

PROCEEDINGS
OF
THE INSTITUTE OF RADIO
ENGINEERS
(INCORPORATED)

VOLUME 22
1934



PUBLISHED MONTHLY BY
THE INSTITUTE OF RADIO ENGINEERS
(INC.)
330 WEST 42nd STREET, NEW YORK, N. Y.

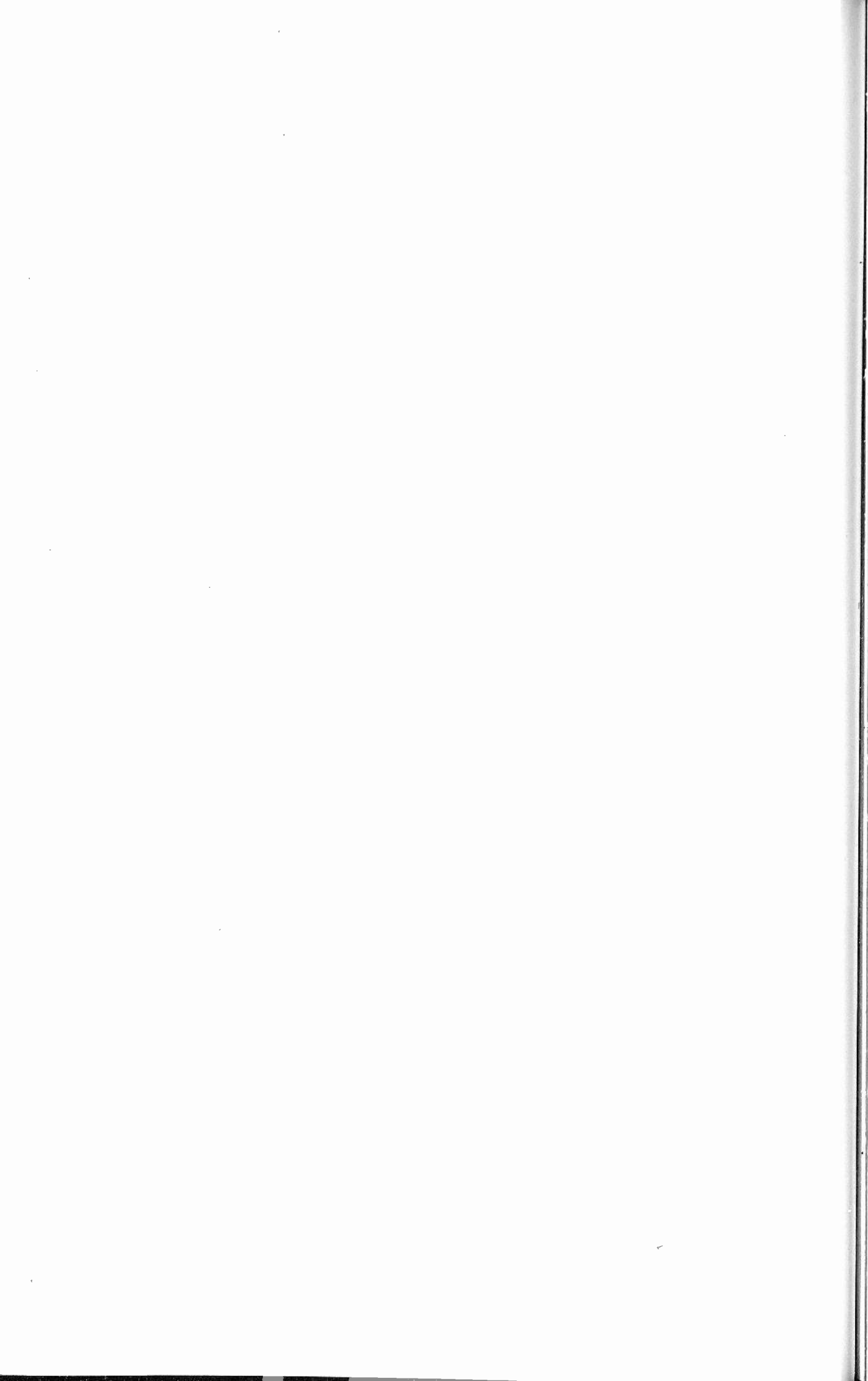

CONTENTS OF VOLUME 22

1934

An Index covering the years 1909 through 1930 is available in pamphlet form, and may be obtained from the Institute at \$1.00 per copy. A very few copies of the 1931 and 1933 Indexes, which were published in pamphlet form, are offered for distribution. The Index for 1932 is to be found in the December, 1932, issue of the PROCEEDINGS, following page 1986.

The Index for 1934 is a continuation of the previous ones. It is numbered chronologically, and the numbers at the left of the titles are keys for use in referring to it from the Authors Index and the Cross Index.

NUMBER 1; JANUARY, 1934

PART I

	<i>Page</i>
Institute News and Radio Notes.....	1
December Meeting of the Board of Directors.....	1
Rochester Fall Meeting, 1933.....	1
Committee Work.....	2
Institute Meetings.....	3
Personal Mention.....	8

PART II

Technical Papers

	<i>Year</i>	<i>Page</i>
1169. Conditions Necessary for an Increase in Usable Receiver Fidelity.....	1934	9
Alfred N. Goldsmith (Jan.)		
1170. The Iconoscope—A Modern Version of the Electric Eye..	1934	16
V. K. Zworykin (Jan.)		
1171. A New Cone Loud Speaker for High Fidelity Sound Reproduction.....	1934	33
Harry F. Olson (Jan.)		
1172. The Determination of the Direction of Arrival of Short Radio Waves.....	1934	47
H. T. Friis, C. B. Feldman, and W. M. Sharpless (Jan.)		
1173. Electron Oscillations with a Triple-Grid Tube.....	1934	79
Ferdinand Hamburger, Jr. (Jan.)		
1174. Visual Test Device.....	1934	89
Guenther Ulbricht (Jan.)		
1175. Rectangular Short-Wave Frame Aerials for Reception and Transmission.....	1934	93
L. S. Palmer and D. Taylor (Jan.)		
1176. A 200-Kilocycle Piezo Oscillator (abstract).....	1934	115
E. G. Lapham (Jan.)		
1177. Phase Synchronization in Directive Antenna Arrays with Particular Application to the Radio Range Beacon (abstract).....	1934	116
F. G. Kear (Jan.)		
1178. A Radio Direction Finder for Use on Aircraft (abstract)..	1934	117
W. S. Hinman, Jr. (Jan.)		
1179. A Method of Providing Course and Quadrant Identification with the Radio Range Beacon System (abstract)....	1934	119
F. W. Dunmore (Jan.)		
1180. Performance Tests of Radio System of Landing Aids (abstract).....	1934	120
H. Diamond (Jan.)		

1181.	Book Review: Electron Tubes and Their Applications. . .	1934	122
	J. H. Morecroft		
	Reviewed by B. E. Shackelford (Jan.)		
1182.	Book Review: Sub-Harmonics in Forced Oscillations in Dissipative Systems.	1934	122
	P. O. Pedersen		
	Reviewed by J. K. Clapp (Jan.)		
1183.	Book Review: The Inductance Authority.	1934	124
	E. M. Sheipe		
	Reviewed by H. A. Wheeler (Jan.)		
1184.	Handbook of Chemistry and Physics (18th Edition).	1934	124
	C. D. Hodgman		
	Reviewed by R. R. Ramsey (Jan.)		
	Booklets, Catalogs, and Pamphlets Received.	1934	125
	Radio Abstracts and References.	1934	126
	Contributors to This Issue.	1934	131

NUMBER 2; FEBRUARY, 1934

PART I

	<i>Page</i>
Institute News and Radio Notes.	133
January Meeting of the Board of Directors.	133
Radio Transmissions of Standard Frequencies.	133
Institute Meetings.	134
Personal Mention.	143

PART II

Technical Papers

	<i>Year</i>	<i>Page</i>
1185. Oscillators with Automatic Control of the Threshold of Regeneration.	1934	145
		Janusz Groszkowski (Feb.)
1186. Optimum Operating Conditions for Class C Amplifiers. . .	1934	152
		W. L. Everitt (Feb.)
1187. Magnetostrictive Alloys with Low Temperature Coeffi- cients of Frequency.	1934	177
		John McDonald Ide (Feb.)
1188. A Compact Radio Field Strength Meter.	1934	191
		Paul B. Taylor (Feb.)
1189. On the Oscillations of a Circuit Having a Periodically Vary- ing Capacitance.	1934	201
		W. L. Barrow (Feb.)
1190. Radiotelegraph Keying Transients.	1934	213
		Reuben Lee (Feb.)
1191. Note on a Multifrequency Automatic Recorder of Ion- osphere Heights.	1934	236
		T. R. Gilliland (Feb.)
1192. Radio Observations of the Bureau of Standards During the Solar Eclipse of August 31, 1932.	1934	247
		S. S. Kirby, L. V. Berkner, T. R. Gilliland, and K. A. Norton (Feb.)
1193. Development of Standard Frequency Transmitting Sets (abstract).	1934	265
		L. Mickey and A. D. Martin (Feb.)
1194. A Continuous Recorder of Radio Field Intensities (ab- stract).	1934	266
		K. A. Norton and S. E. Reymer (Feb.)
1118. Discussion on "Determination of Grid Driving Powers in Radio-Frequency Power Amplifiers," by H. P. Thomas (August, 1933).	1934	267
		W. H. Doherty (Feb.)

1195.	Book Review: Vocational Guidance in Engineering Lines. 1934	269
	American Association of Engineers Reviewed by F. W. Grover (Feb.)	
1196.	Book Review: A.S.T.M. Standards on Electrical Insulating Materials..... 1934	270
	American Society for Testing Materials Reviewed by L. E. Whittemore (Feb.)	
1197.	Book Review: Theory of Functions..... 1934	270
	K. Polhausen Reviewed by K. S. Van Dyke (Feb.)	
1198.	Book Review: Differential Equations for Electrical Engi- neers..... 1934	271
	Philip Franklin Reviewed by K. S. Van Dyke (Feb.)	
	Radio Abstracts and References..... 1934	272
	Contributors to This Issue..... 1934	277

NUMBER 3; MARCH, 1934

PART I

		<i>Page</i>
Frontispiece, John Harold Morecroft.....		280
Institute News and Radio Notes.....		281
January 31 Meeting of the Board of Directors.....		281
Report of the Secretary for 1933.....		282
Joint Meeting of the Institute and the American Section U.R.S.I....		285
Institute Meetings.....		286

PART II

Technical Papers

		<i>Year</i>	<i>Page</i>
1199.	Some Notes on Adjacent Channel Interference.....	1934	295
	I. J. Kaar (March)		
1200.	A New Type of Thyatron Relay.....	1934	314
	George Babat (March)		
1201.	The Polarization of Sky Waves in the Southern Hemisphere	1934	324
	A. L. Green (March)		
1202.	Phase Interference Phenomena in Low-Frequency Radio Transmission.....	1934	344
	G. W. Kenrick and G. W. Pickard (March)		
1203.	The Calculation of Class C Amplifier and Harmonic Gen- erator Performance of Screen-Grid and Similar Tubes	1934	359
	F. E. Terman and J. H. Ferns (March)		
1204.	Elimination of Phase Shifts Between the Currents in Two Antennas.....	1934	374
	Hans Roder (March)		
1205.	Inductance at High Frequencies and Its Relation to the Circuit Equation.....	1934	395
	J. G. Brainerd (March)		
	Radio Abstracts and References.....	1934	402
	Contributors to This Issue.....	1934	409

NUMBER 4; APRIL, 1934

PART I

		<i>Page</i>
Institute News and Radio Notes.....		411
March Meeting of the Board of Directors.....		411
Joint Meeting of I.R.E. and U.R.S.I.....		411
Radio Transmissions of Standard Frequencies.....		412
Committee Work.....		414
Institute Meetings.....		416
Personal Mention.....		421

PART II

Technical Papers

1206.	A New Method of Removing Distortions Due to the Space Charge in Gas-Filled Cathode Ray Oscillograph Tubes Manfred von Ardenne (April)	1934	<i>Page</i> 423
1207.	League of Nations Wireless Station..... G. F. Van Dissel (April)	1934	430
1208.	The Testing of Frequency Monitors for the Federal Radio Commission..... W. D. George (April)	1934	449
1209.	High-Frequency Models in Antenna Investigations..... G. H. Brown and Ronold King (April)	1934	457
1210.	Studies of the Ionosphere and Their Application to Radio Transmission..... S. S. Kirby, L. V. Berkner, and D. M. Stuart (April)	1934	481
1211.	Propagation of High-Frequency Currents in Ground Return Circuits..... W. H. Wise (April)	1934	522
	Booklets, Catalogs, and Pamphlets Received.....	1934	528
	Contributors to This Issue.....	1934	529

NUMBER 5; MAY, 1934

PART I

	Condensed Program of Ninth Annual Convention.....		<i>Page</i> Cover II
	Frontispiece, George Owen Squier.....		532
	Institute News and Radio Notes.....		535
	Ninth Annual Convention.....		535
	April Meeting of the Board of Directors.....		555
	Committee Work.....		556
	Institute Meetings.....		557
1211.	Errata to "Propagation of High-Frequency Currents in Ground Return Circuits," by H. W. Wise (April).....		563

PART II

Technical Papers

1212.	High Quality Radio Broadcast Transmission and Reception..... Stuart Ballantine (May)	<i>Year</i> 1934	<i>Page</i> 564
1213.	The Retarding-Field Tube as a Detector for any Carrier Frequency..... H. E. Hollmann (May)	1934	630
1214.	Some Notes on the Influence of Stray Capacitance Upon the Accuracy of Antenna Resistance Measurements.. Edmund A. Laport (May)	1934	657
1215.	Note on Audio-Frequency Atmosphericics..... E. T. Burton (May)	1934	670
1216.	A Chopper Utilizing Contacts Vibrating in a Vacuum.... F. G. Kelly (May)	1934	672
	Contributors to This Issue.....	1934	675

NUMBER 6; JUNE, 1934

PART I

	Institute News and Radio Notes.....		<i>Page</i> 677
	Election Notice.....		677
	Joint Meeting with U.R.S.I.....		678
	May Meeting of the Board of Directors.....		685
	Committee Work.....		686
	Radio Transmissions of Standard Frequencies.....		686
	Institute Meetings.....		688

PART II

Technical Papers

	<i>Year</i>	<i>Page</i>
1217. Suppression of Interlocking in First Detector Circuits: ... Paul W. Klipsch (June)	1934	699
1218. Resistance Tuning..... Sewall Cabot (June)	1934	709
1219. Quartz Crystal Controlled Oscillator Circuits..... Harry R. Meahl (June)	1934	732
1220. Electrodynamic Speaker Design Considerations..... J. D. Seabert (June)	1934	738
1221. The Inner-Grid Dynatron and the Duodynatron..... Tatuo Hayasi (June)	1934	751
1222. A Screen-Grid Voltmeter Without External Leak..... Ronold King (June)	1934	771
1223. Harmonic Production and Cross Modulation in Thermionic Valves with Resistive Loads..... D. C. Espley (June)	1934	781
1224. Note on an Ionized Gas Modulator for Short Radio Waves Ernest G. Linder and Irving Wolff (June)	1934	791
1225. Audio-Frequency Measurement by the Electrically-Excited Monochord..... Emrys Williams (June)	1934	794
1226. Book Review: The Physics of Electron Tubes..... R. L. Koller Reviewed by B. E. Shackelford (June)	1934	805
Contributors to This Issue.....	1934	806

NUMBER 7; JULY, 1934

PART I

	<i>Page</i>
Frontispiece, Chairmen of Ninth Annual Convention.....	810
Institute News and Radio Notes.....	811
June Meeting of the Board of Directors.....	811
Ninth Annual Convention.....	811
Annual Meeting of the Sections Committee.....	813
Institute Meetings.....	814
Personal Mention.....	817

PART II

Technical Papers

	<i>Year</i>	<i>Page</i>
1227. Some Notes on the Practical Measurement of the Degree of Amplitude Modulation..... L. F. Gaudernack (July)	1934	819
1228. Maintaining the Directivity of Antenna Arrays..... F. G. Kear (July)	1934	847
1229. Seventy-Five-Centimeter Radio Communication Tests... W. D. Hershberger (July)	1934	870
1230. Transmission Lines as Frequency Modulators..... Austin V. Eastman and Earl D. Scott (July)	1934	878
1231. The Action of a High-Frequency Alternating Magnetic Field on Suspended Metallic Rings and Disks..... Paul K. Taylor (July)	1934	886
1232. Distributed Capacity of Single-Layer Coils..... A. J. Palermo (July)	1934	897
1233. Continuous Recording of Retardation and Intensity of Echoes from the Ionosphere..... Lal C. Verman, S. T. Char, and Aijaz Mohammed (July)	1934	906
1234. Echoes of Radio Waves..... N. Janco (July)	1934	923

1127.	Discussion on "An Outline of the Action of a Tone Corrected Highly Selective Receiver," by E. B. Moullin (September, 1933).....	1934	926
	C. B. Fisher and E. B. Moullin (July)		
1235.	Book Review: Elements of Radio Communication.....	1934	929
	John H. Morecroft		
	Reviewed by R. R. Ramsey (July)		
1236.	Signals and Speech in Electrical Communication.....	1934	929
	John Mills		
	Reviewed by H. M. Turner (July)		
1237.	Book Review: Federal Radio Commission's Rules and Regulations (1934 Revision).....	1934	930
	Reviewed by R. D. Campbell (July)		
	Booklets, Catalogs, and Pamphlets Received.....	1934	932
	Contributors to This Issue.....	1934	934

NUMBER 8; AUGUST, 1934

PART I

	<i>Page</i>
Frontispiece, Vladimir K. Zworykin, Recipient of the Morris Liebmann Prize, 1934.....	938
Institute News and Radio Notes.....	939
Experimental Transmissions for Observing Long Delayed Echoes..	939
PROCEEDINGS Back Copies.....	940
Institute Meetings.....	941
Personal Mention.....	944

PART II

Technical Papers

	<i>Year</i>	<i>Page</i>
1238. Phase Angle of Vacuum Tube Transconductance at Very High Frequencies.....	1934	947
F. B. Lewellyn (Aug.)		
1239. The Analysis of Air Condenser Loss Resistance.....	1934	957
W. Jackson (Aug.)		
1240. Contribution to the Theory of Nonlinear Circuits with Large Applied Voltages.....	1934	964
W. L. Barrow (Aug.)		
1241. On Conversion Detectors.....	1934	981
M. J. O. Strutt (Aug.)		
1242. The Determination of Dielectric Properties at Very High Frequencies.....	1934	1009
J. G. Chaffee (Aug.)		
1243. Electron Oscillations Without Tuned Circuits.....	1934	1021
W. H. Moore (Aug.)		
1244. A Note on Magnetron Theory.....	1934	1037
F. T. McNamara (Aug.)		
1245. Note on a Cause of Residual Hum in Rectifier-Filter Systems.....	1934	1040
F. E. Terman and S. B. Pickles (Aug.)		
Booklets, Catalogs, and Pamphlets Received.....	1934	1042
Contributors to This Issue.....	1934	1043

NUMBER 9; SEPTEMBER, 1934

PART I

	<i>Page</i>
Institute News and Radio Notes.....	1045
Committee Work.....	1045
Radio Transmissions of Standard Frequencies.....	1045
Institute Meetings.....	1046
Personal Mention.....	1048

1225.	Errata to "Audio-Frequency Measurement by the Electrically-Excited Monochord," by Emrys Williams (June, 1934)	1050
1217.	Addenda to "Suppression of Interlocking in First Detector Circuits," by Paul W. Klipsch (June, 1934)	1050

PART II

Technical Papers

	<i>Year</i>	<i>Page</i>
1246.	The Nonlinear Theory of Electric Oscillations..... Balth. van der Pol (Sept.)	1934 1051
1247.	Note on the Synchronization of Broadcast Stations WJZ and WBAL..... K. A. Norton (Sept.)	1934 1087
1248.	A "Short-Cut" Method for Calculation of Harmonic Distortion in Wave Modulation..... I. E. Mouromtseff and H. N. Kozanowski (Sept.)	1934 1090
1249.	Report of Ionosphere Investigations at the Huancayo Magnetic Observatory (Peru) During 1933..... L. V. Berkner and H. W. Wells (Sept.)	1934 1102
1250.	Measurements of Electrical State of Upper Stratosphere in Polar Regions (Kennelly-Heaviside Layer)..... M. A. Bontch-Bruewitch (Sept.)	1934 1124
1186.	Discussion on "Optimum Operating Conditions for Class C Amplifiers," by W. L. Everitt (February, 1934)..... L. B. Hallman, Jr. and W. L. Everitt (Sept.)	1934 1139
1251.	Book Review: Applied Acoustics..... H. F. Olson and Frank Massa Reviewed by Knox McIlwain (Sept.)	1934 1141
1252.	Book Review: Magnetic Materials at Radio Frequencies.. F. M. Colebrook Reviewed by F. W. Grover (Sept.)	1934 1141
1253.	Book Review: Report of the Radio Research Board, January, 1932, to 30th September, 1933..... Reviewed by R. R. Ramsey (Sept.)	1934 1142
1254.	Book Review: The National Physical Laboratory—Report for 1933..... Reviewed by L. E. Whittemore (Sept.)	1934 1142
1255.	Book Review: Vector Conversion Chart..... O. W. Walter Reviewed by H. M. Turner (Sept.)	1934 1143
1256.	Book Review: Short-Wave Wireless Communication..... A. W. Ladner and C. R. Stoner Reviewed by H. O. Peterson (Sept.)	1934 1143
	Contributors to This Issue.....	1934 1144

NUMBER 10; OCTOBER, 1934

PART I

	<i>Page</i>
Frontispiece, S. C. Hooper, Recipient of Institute Medal of Honor, 1934.	1148
Institute News and Radio Notes.....	1149
Radio Transmissions of Standard Frequencies.....	1149
Personal Mention.....	1150

PART II

Technical Papers

	<i>Year</i>	<i>Page</i>
1257.	The WLW 500-Kilowatt Broadcast Transmitter..... J. A. Chambers, L. F. Jones, G. W. Fyler, R. H. Williamson, E. A. Leach, and J. A. Hutcheson (Oct.)	1934 1151

1258.	The Measurement of Harmonic Power Output of a Radio Transmitter	1934	1181
	P. M. Honnell and E. B. Ferrell (Oct.)		
1259.	Regeneration Theory and Experiment	1934	1191
	E. Peterson, J. G. Kreer, and L. A. Ware (Oct.)		
1260.	Some Aspects of Parallel Resonant Circuits	1934	1211
	L. M. Craft (Oct.)		
1261.	North Atlantic Ship-Shore Radiotelephone Transmission During 1932-1933	1934	1215
	C. N. Anderson (Oct.)		
1262.	Book Review: Loud Speakers (Theory, Performance, Testing and Design)	1934	1225
	N. W. McLachlan		
	Reviewed by Irving Wolff (Oct.)		
1263.	Book Review: Broadcasting Abroad, Revised Edition	1934	1225
	Reviewed by L. E. Whittemore (Oct.)		
1264.	Book Review: Present and Impending Applications to Education of Radio and Allied Arts	1934	1226
	Reviewed by R. R. Ramsey (Oct.)		
	Booklets, Catalogs, and Pamphlets Received	1934	1227
	Contributors to This Issue	1934	1228

NUMBER 11; NOVEMBER, 1934

PART I

	<i>Page</i>
Frontispiece, John Ambrose Fleming, Recipient of the Medal of Honor, 1933	1232
Institute News and Radio Notes	1235
October Meeting of the Board of Directors	1235
Rochester Fall Meeting	1235
Committee Work	1237
Institute Meetings	1238
Personal Mention	1240

PART II

Technical Papers

	<i>Year</i>	<i>Page</i>
An Experimental Television System		
1265. Introduction	1934	1241
		E. W. Engstrom (Nov.)
1266. The Transmitter	1934	1246
		R. D. Kell, A. V. Bedford, and M. A. Trainer (Nov.)
1267. The Receivers	1934	1266
		R. S. Holmes, W. L. Carlson, and W. A. Tolson (Nov.)
1268. The Radio Relay Link for Television Signals	1934	1286
		Charles J. Young (Nov.)
1269. The "Sound Prism"	1934	1295
		O. H. Schuck (Nov.)
1218. Discussion on "Resistance Tuning," by Sewall Cabot (June, 1934)	1934	1311
		E. W. Herold and Sewall Cabot (Nov.)
1228. Discussion on "Maintaining the Directivity of Antenna Arrays," by F. G. Kear (July, 1934)	1934	1313
		H. S. Stokes and F. G. Kear (Nov.)
1270. Book Review: Electrical Communication	1934	1315
		Arthur L. Albert
		Reviewed by H. A. Affel (Nov.)
1271. Book Review: Motor and Generator Standards, Carbon Graphite and Metal Graphite Brush Standards, Laminated Phenolic Products Standards	1934	1315
		National Electrical Manufacturers Association
		Reviewed by R. R. Ramsey (Nov.)

1272.	Book Review: Thermionic Emission	1934	1316
	Arnold L. Riemann Reviewed by B. E. Shackelford (Nov.)		
1273.	Book Review: Servicing Superheterodynes	1934	1316
	John F. Rider Reviewed by Harold A. Wheeler (Nov.)		
1274.	Book Review: Earth, Radio and the Stars	1934	1317
	Harlan True Stetson Reviewed by T. R. Gilliland (Nov.)		
	Contributors to This Issue	1934	1318

NUMBER 12; DECEMBER, 1934

PART I

			<i>Page</i>
	Frontispiece, Georg Heinrich Barkhausen, Vice-President-Elect, 1935..		1322
	Institute News and Radio Notes		1323
	November Meeting of the Board of Directors		1323
	Radio Transmissions of Standard Frequencies		1323
	Committee Work		1325
	Institute Meetings		1327
	Personal Mention		1334

PART II

Technical Papers

		<i>Year</i>	<i>Page</i>
1275.	Generation and Utilization of Ultra-Short Waves in Radio Communication	1934	1335
	Frederick A. Kolster (Dec.)		
1276.	A Lapel Microphone of the Velocity Type	1934	1354
	Harry F. Olson and Richard W. Carlisle (Dec.)		
1277.	Control of Radiating Properties of Antennas	1934	1362
	C. A. Nickle, R. B. Dome, and W. W. Brown (Dec.)		
1278.	An Electron Oscillator with Plane Electrodes	1934	1374
	B. J. Thompson and P. D. Zottu (Dec.)		
1279.	Theory of Electron Gun	1934	1386
	I. G. Maloff and D. W. Epstein (Dec.)		
	Contributors to This Issue	1934	1412

AUTHOR INDEX

Numbers refer to the chronological list. Bold-face type indicates papers, light-face type indicates discussions, and italics refer to book reviews.

- | | |
|--|---|
| <p style="text-align: center;">A</p> <p>Affel, H. A., <i>1270</i>
 Anderson, C. N., 1261</p> <p style="text-align: center;">B</p> <p>Babat, George, 1200
 Ballantine, Stuart, 1212
 Barrow, W. L., 1189, 1240
 Bedford, A. V., 1266
 Berkner, L. V., 1192, 1210, 1249
 Bontch-Bruewitch, M. A., 1250
 Brainerd, J. G., 1205
 Brown, G. H., 1209
 Brown, W. W., 1277
 Burton, E. T., 1215</p> <p style="text-align: center;">C</p> <p>Cabot, Sewall, 1218
 Campbell, R. D., <i>1237</i>
 Carlisle, R. W., 1276
 Carlson, W. L., 1267
 Chaffee, J. G., 1242
 Chambers, J. A., 1257
 Char, S. T., 1233
 Clapp, J. K., <i>1182</i>
 Craft, L. M., 1260</p> <p style="text-align: center;">D</p> <p>Diamond, H., 1180
 Doherty, W. H., 1118
 Dome, R. B., 1277
 Dunmore, F. W., 1179</p> <p style="text-align: center;">E</p> <p>Eastman, A. V., 1230
 Engstrom, E. W., 1265
 Epstein, D. W., 1279
 Espley, D. C., 1223
 Everitt, W. L., 1186</p> <p style="text-align: center;">F</p> <p>Feldman, C. B., 1172
 Ferns, J. H., 1203
 Ferrell, E. B., 1258
 Fisher, C. B., 1127
 Friis, H. T., 1172
 Fyler, G. W., 1257</p> <p style="text-align: center;">G</p> <p>Gaudernack, L. F., 1227
 George, W. D., 1208
 Gilliland, T. R., 1191, 1192, 1274
 Goldsmith, A. N., 1169
 Green, A. L., 1201
 Groszkowski, Janusz, 1185
 Grover, F. W., <i>1195, 1252</i></p> | <p style="text-align: center;">H</p> <p>Hallman, L. B., Jr., 1186
 Hamburger, Ferdinand, Jr., 1173
 Hayasi, Tatu, 1221
 Herold, E. W., 1218
 Hershberger, W. D., 1229
 Hinman, W. S., Jr., 1178
 Hollmann, H. E., 1213
 Holmes, R. D., 1267
 Honnell, P. M., 1258
 Hutcheson, J. A., 1257</p> <p style="text-align: center;">I</p> <p>Ide, J. McD., 1187</p> <p style="text-align: center;">J</p> <p>Jackson, W., 1239
 Janco, N., 1234
 Jones, L. F., 1257</p> <p style="text-align: center;">K</p> <p>Kaar, I. J., 1199
 Kear, F. G., 1177, 1228
 Kell, R. D., 1266
 Kelly, F. G., 1216
 Kenrick, G. W., 1202
 King, Ronold, 1209, 1222
 Kirby, S. S., 1192, 1210
 Klipsch, P. W., 1217
 Kolster, F. A., 1275
 Kozanowski, H. N., 1248
 Kreer, J. G., 1259</p> <p style="text-align: center;">L</p> <p>Lapham, E. G., 1176
 Laport, E. A., 1214
 Leach, E. A., 1257
 Lee, Reuben, 1190
 Linder, E. G., 1224
 Llewellyn, F. B., 1238</p> <p style="text-align: center;">M</p> <p>Maloff, I. G., 1279
 Martin, A. D., 1193
 Mellwain, Knox, <i>1251</i>
 McNamara, F. T., 1244
 Meahl, H. R., 1219
 Mickey, L., 1193
 Mohammed, Aijaz, 1233
 Moore, W. H., 1243
 Moullin, E. B., 1127
 Mouromtseff, I. E., 1248</p> <p style="text-align: center;">N</p> <p>Nickle, C. A., 1277
 Norton, K. A., 1192, 1194, 1247</p> |
|--|---|

O

Olson H. F., 1171, 1276

P

Palermo, A. J., 1232
 Palmer, L. S., 1175
 Peterson E., 1259
 Peterson H. O., 1256
 Pickard, G. W., 1202
 Pickles, S. B., 1245

R

Ramsey, R. R., 1184, 1235, 1253,
 1264, 1271
 Reymer, S. E., 1194
 Roder, Hans, 1204

S

Schuck, O. H., 1269
 Scott, E. D., 1230
 Seabert, J. D., 1220
 Shackelford, B. E., 1181, 1226, 1272
 Sharpless, W. M., 1172
 Stokes, H. S., 1228
 Strutt, M. J. O., 1241
 Stuart, D. M., 1210

T

Taylor, D., 1175
 Taylor, P. B., 1188
 Taylor, P. K., 1231

Terman, F. E., 1203, 1245
 Thompson, B. J., 1278
 Tolson, W. A., 1267
 Trainer, M. A., 1266
 Turner, H. M., 1236, 1255

U

Ulbright, Guenther, 1174

V

van der Pol, Balth., 1246
 Van Dissel, G. F., 1207
 Van Dyke, K. S., 1197, 1198
 Verman, L. C., 1233
 von Ardenne, Manfred, 1206

W

Ware, L. A., 1259
 Wells, H. W., 1249
 Wheeler, H. A., 1183, 1273
 Whittemore, L. E., 1196, 1254, 1263
 Williams, Emrys, 1225
 Williamson, R. H., 1257
 Wise, W. H., 1211
 Wolff, Irving, 1224, 1262

Y

Young, C. J., 1268

Z

Zottu, P. D., 1278
 Zworykin, V. K., 1170

SUBJECT INDEX

A

- Aircraft Radio:
 - Antenna Directivity: 1228
 - Course and Quadrant Identification: 1179
 - Direction Finder: 1178
 - Landing Aids: 1180
 - Range Beacon Directive Antenna: 1177
- Alloys:
 - Magnetostrictive, with Low Temperature Coefficients: 1187
- Amplifier:
 - Calculations of Class C: 1203
 - Grid Driving Power in Radio-Frequency: 1118
 - Operating Conditions for Class C: 1186
- Antenna:
 - Control of Radiating Properties: 1277
 - Directivity: 1228
 - High-Frequency Models: 1209
 - Phase Shift Between Two: 1204
 - Phase Synchronization in Directive: 1177
 - Rectangular Short-Wave: 1175
 - Resistance Measurements: 1214
- Atmospherics:
 - Audio-Frequency: 1215
- Audio-Frequency:
 - Atmospherics: 1215
 - Measurement: 1225

B

- Beacon:
 - See Radio Range Beacon:
- Book Reviews:
 - Applied Acoustics, by H. F. Olson and Frank Massa: 1251
 - A.S.T.M. Standards on Electrical Insulating Materials, by American Society of Testing Materials: 1196
 - Broadcasting Abroad, Revised Edition: 1263
 - Carbon Graphite and Metal Graphite Brush Standards, by National Electrical Manufacturers Association: 1271
 - Differential Equations for Electrical Engineers, by Philip Franklin: 1198
 - Earth, Radio and the Stars, by H. T. Stetson: 1274
 - Electrical Communication, by A. L. Albert: 1270
 - Electron Tubes and Their Applications, by J. H. Morecroft: 1181

- Elements of Radio Communication, by J. H. Morecroft: 1235
- Federal Radio Commission's Rules and Regulations: 1237
- Handbook of Chemistry and Physics, by C. D. Hodgman: 1184
- Laminated Phenolic Products Standards, by National Electrical Manufacturers Association: 1271
- Loud Speakers, by N. W. McLachlan: 1262
- Magnetic Materials at Radio Frequencies, by F. M. Colebrook: 1252
- Motor and Generator Standards, by National Electrical Manufacturers Association: 1271
- Present and Impending Applications to Education of Radio and Allied Arts: 1264
- Report of the Radio Research Board: 1253
- Servicing Superheterodynes, by J. F. Rider: 1273
- Short-Wave Wireless Communication, by A. W. Ladner and C. R. Stoner: 1256
- Signals and Speech in Electrical Communication, by John Mills: 1236
- Sub-Harmonics in Forced Oscillations in Dissipative Systems, by P. O. Pedersen: 1182
- The Inductance Authority, by E. M. Sheipe: 1183
- The National Physical Laboratory Report for 1933: 1254
- The Physics of Electron Tubes, by R. L. Koller: 1226
- Theory of Functions, by K. Polhausen: 1197
- Thermionic Emission, by A. L. Riemann: 1272
- Vector Conversion Chart, by O. W. Walter: 1255
- Vocational Guidance in Engineering Lines, by American Association of Engineers: 1195
- Broadcasting:
 - Increase in Receiver Fidelity: 1169
 - Synchronization of Station: 1247
 - WLW 500-Kilowatt Transmitter: 1257

C

- Capacitance:
 - Distributed, of Coils: 1232
 - Effect of Stray on Antenna Resistance Measurements: 1214

Cathode Ray:
Distortion due to Space Charge:
1206
Theory of Electron Gun: 1279

Chopper:
Utilizing Vacuum Contacts: 1216

Circuit Analyses:
Inductance at High Frequencies and
Relation to Circuit Equation:
1205
Nonlinear Circuits with Large Ap-
plied Voltages: 1240
Parallel Resonant: 1260

Coils:
Distributed Capacity: 1232

Condenser:
Loss Resistance: 1239

Cone Speaker:
High Fidelity: 1171

Contacts:
Chopper, in Vacuum: 1216

Conversion Detectors: 1241

Cross Modulation:
Harmonics and: 1223

Crystal Oscillator: 1176, 1219

D

Detector:
Conversion: 1241
Interlocking in First: 1217
Retarding-Field Tube as: 1213

Dielectric:
Properties at Very High Frequen-
cies: 1243

Direction Finder:
For Aircraft: 1178

Directive Antenna:
Phase Synchronization: 1177

Disks and Rings:
Effects of Magnetic Fields on: 1231

Distortion:
Calculation of Harmonic, in Wave
Modulation: 1248

Distributed Capacity:
Of Coils: 1232

Duodynatron:
Inner-Grid Dynatron and: 1221

Dynatron:
Inner-Grid and Duodynatron: 1221

E

Echoes:
Radio Waves: 1234
Retardation and, From Ionosphere:
1233

Electric Eye:
Iconoscope: 1170

Electrodynamic Speaker:
Design: 1219

Electron:
Oscillations With Triple Grid Tubes
1173

Electron Gun:
Theory of: 1279
Electron Oscillations:
Without Tuned Circuits: 1243

F

Fidelity:
Conditions for Increase: 1169

Field Strength:
Compact Meter: 1188
Recorder: 1194

Filter:
Hum in Rectifier, Systems: 1245

Frame Aerials:
Rectangular for Short Waves: 1175

Frequency Modulator:
Transmission Lines as: 1230

G

Generator:
See Oscillator
Ground Return Circuits:
High-Frequency Currents in: 1211

H

Harmonic:
Calculation of Distortion: 1248
Production and Cross Modulation:
1223

Harmonic Analyzer: 1269
Harmonic Generator:
Calculation of Performance: 1203

High Fidelity:
Broadcast Transmission and Recep-
tion: 1212

Hum:
In Rectifier-Filter Systems: 1245

I

Iconoscope: 1170
Inductance:
At High Frequencies: 1205

Interference:
Adjacent Channel: 1199
Phase, Phenomena: 1202

Ionization:
Gas Modulator: 1224

Ionosphere:
At Huancayo Observatory: 1249
Height Recorder: 1191
Measurements of Upper Strato-
sphere: 1250
Retardation and Echoes from: 1233
Studies of: 1210

K

Kennelly-Heaviside Layer:
See Ionosphere
Keying:
Radiotelegraph Transients: 1190

L

- League of Nations Wireless Station: 1207
- Loop Antenna:
 - Rectangular for Short Waves: 1175
- Loud Speaker:
 - Design: 1219
 - High Fidelity: 1171

M

- Magnetic Field:
 - Action on Rings and Disks: 1231
- Magnetostriction:
 - Low Temperature Coefficient Alloys: 1187
- Magnetron:
 - Theory: 1244
- Measurement:
 - Antenna Resistance: 1214
 - Audio-Frequency: 1225
 - Compact Field Strength Meter: 1188
 - Dielectric Properties at Very High Frequencies: 1242
 - Harmonics: 1269
 - Harmonic Power Output of Transmitter: 1258
 - Modulation: 1227
- Microphone:
 - Lapel Velocity: 1276
- Modulation:
 - Calculation of Harmonic Distortion in Wave: 1248
 - Measurement: 1227
- Modulator:
 - Ionized Gas: 1224
 - Transmission Lines as: 1230
- Monitors:
 - Testing of Frequency: 1208
- Mono-chord:
 - Audio-Frequency Measurements With: 1225

O

- Oscillator:
 - Automatic Control of Regeneration: 1185
 - Dynatron and Duodynatron: 1221
 - Electron with Plane Electrodes: 1278
 - Electron, Without Tuned Circuits: 1243
 - Low Temperature Coefficient Alloys for Magnetostrictive: 1187
 - Magnetron Theory: 1244
 - Nonlinear Theory of Electric: 1246
 - Periodically Varying Capacitance: 1189
 - Piezo: 1176
 - Ultra-Short Waves: 1275
 - With Triple Grid Tube: 1173
- Oscillograph:
 - Space Charge Distortion in Cathode Ray Tubes: 1206

P

- Phase Shift:
 - Elimination Between Antennas: 1204
- Photocells:
 - Iconoscope: 1170
- Piezo-Electric:
 - Oscillator: 1176
 - Oscillator Circuits: 1219
- Polarization:
 - Sky Wave in Southern Hemisphere: 1201
- Polar Regions:
 - Electrical Conditions of Upper Stratosphere in: 1250
- Power Output:
 - Measurement Harmonic, of Transmitter: 1258
- Propagation:
 - Control of Antenna Radiating Properties: 1277
 - Direction of Arrival of Short Waves: 1172
 - Echoes of Radio Waves: 1234
 - Electrical Conditions of Upper Stratosphere in Polar Regions: 1250
 - Frame Aerials for Short Wave: 1175
 - High-Frequency Currents in Ground Return Circuits: 1211
 - Huancayo Ionosphere Observations: 1249
 - Ionosphere Height Recorder: 1191
 - Ionosphere Studies: 1210
 - North Atlantic: 1261
 - Phase Interference Phenomena: 1202
 - Retardation and Echoes from Ionosphere: 1233
 - Seventy-Five Centimeter Waves: 1229
 - Sky-Wave Polarization in Southern Hemisphere: 1201
 - Solar Eclipse Observations: 1192

R

- Radiation:
 - Control of Antenna Properties: 1277
- Radio Range Beacon:
 - Antenna Directivity: 1228
 - Course and Quadrant Identification: 1179
 - Directive Antenna Phase Synchronization: 1177
- Radiotelegraph:
 - Keying Transients: 1190
- Radiotelephone:
 - Adjacent Channel Interference: 1199
 - North Atlantic Transmission: 1261
- Receivers:
 - Increase in Fidelity: 1169
 - Television: 1267
 - Tone Corrected Highly Selective: 1127
 - Visual Testing Device: 1174

Reception:
Broadcast Transmission and: 1212
Frame Aerials for Short-Wave: 1175
Recorder:
Field Strength: 1194
Ionosphere Height: 1191
Recording:
Echoes From Ionosphere: 1233
Rectifier:
Hum in, and Filter Systems: 1245
Regeneration:
Oscillators With Automatic Control: 1185
Theory and Experiment: 1259
Relay:
Television: 1268
Thyratron: 1200
Resistance:
Condenser Air Loss: 1239
Tuning: 1218
Resonance:
Parallel: 1260
Retardation:
and Echoes From Ionosphere: 1233
Retarding-Field Tube:
as Detector: 1213
Rings and Disks:
Effect of Magnetic Fields on: 1231

S

Screen-Grid Tubes:
Calculation of Amplifier and Generator: 1203
Voltmeter: 1222
Solar Eclipse:
Observations on August, 1932: 1192
Sound Prism: 1269
Sound Reproduction:
Electrodynamic Speaker Design: 1219
High Fidelity Loud Speaker: 1171
Standard Frequency:
Transmitting Sets for: 1193
Static:
See Atmospherics
Stratosphere:
Electrical Conditions in Polar Regions: 1250
Superheterodyne:
Interlocking in First Detector: 1217
Synchronization:
of Broadcast Stations: 1247

T

Television: 1265
Iconoscope: 1170
Receiver: 1267
Relay Link: 1268
Transmitter: 1266
Testing:
Devices for Visual: 1174
Frequency Monitors: 1208
Theory:
Magnetron: 1244

Nonlinear Circuits With Large Applied Voltages: 1240
Nonlinear, in Electric Oscillations: 1246
Parallel Resonant Circuits: 1260
Regeneration, and Experiment: 1259
Thyratron:
New Relay: 1200
Transconductance:
Phase Angle of, at High Frequencies 1238
Transients:
Radiotelegraph Keying: 1190
Transmission:
Broadcast, and Reception: 1212
See Propagation
Transmission Lines:
as Frequency Modulators: 1230
Transmitter:
Measurement of Harmonic Power Output: 1258
Standard Frequency: 1193
Television: 1266
WLW Broadcast: 1257

Tubes:

Distortion in Cathode Ray: 1206
Harmonics and Cross Modulation in: 1223
Ionized Gas Modulator: 1224
Oscillator With Plane Electrodes: 1278
Phase Angle of Transconductance: 1238
Retarding-Field as Detector: 1213
Triple Grid Oscillator: 1173
Tuning:
Resistance: 1218

U

Ultra-High Frequencies:
Dielectric Properties: 1242
Electron Oscillator With Plane Electrodes: 1278
Generation and Utilization: 1275
Phase Angle of Vacuum Tube Transconductance: 1238
Seventy-Five-Centimeter Tests: 1229

V

Velocity Microphone:
Lapel: 1276
Visual Test Devices: 1174
Voltmeter:
Screen-Grid: 1222

W

Wave Modulation:
Calculation of Harmonic Distortion in: 1248
Waves:
Direction of Arrival of Short: 1172

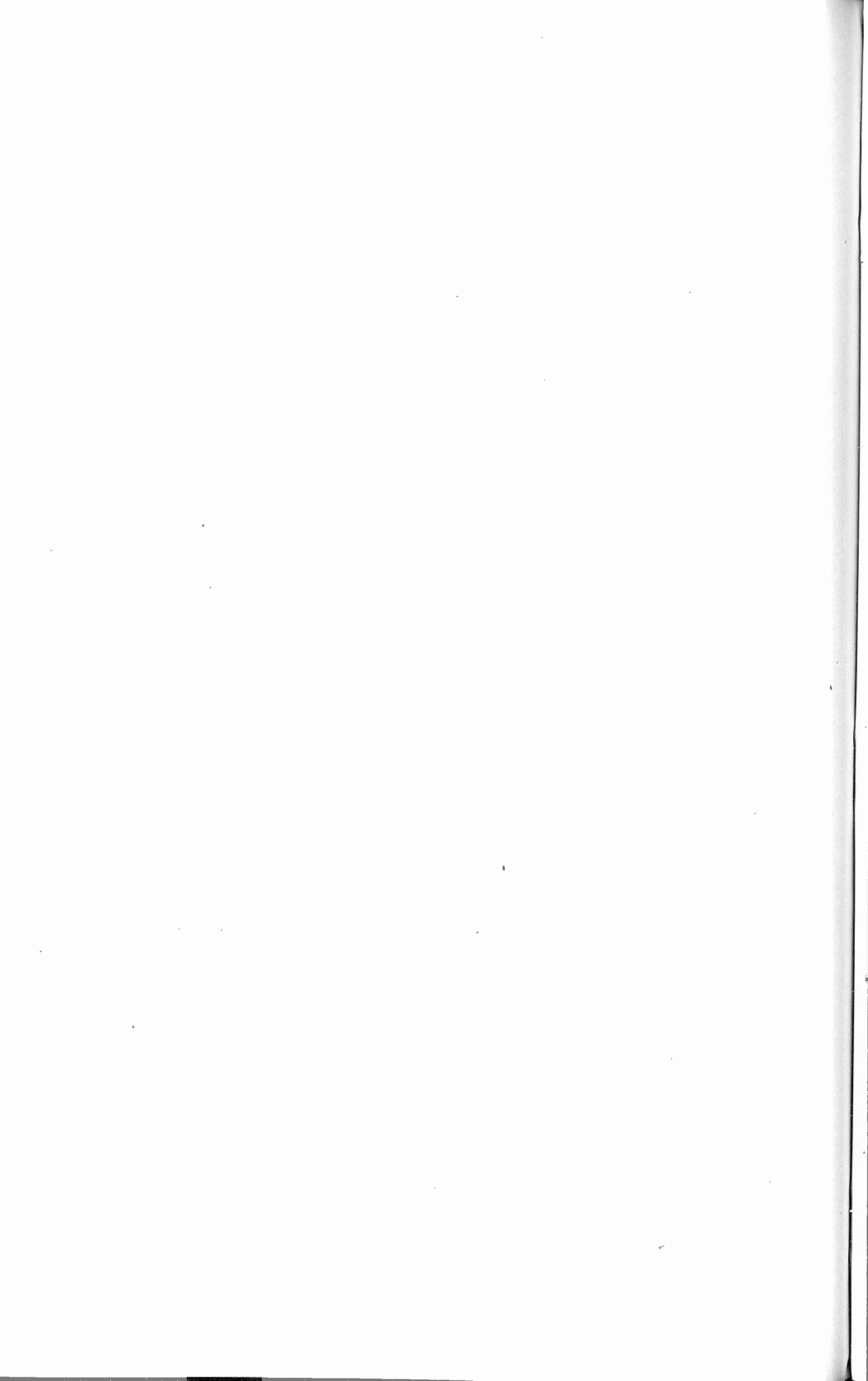

INCORRECT ADDRESSES

Listed below are the names and last known addresses of one hundred and thirty-four members of the Institute whose correct addresses are unknown. It will be appreciated if anyone having information concerning the present addresses of any of the persons listed will communicate with the Secretary of the Institute.

Allen, Jay M.	Stewart-Warner Corporation, 1826 Diversey Pkwy., Chicago, Ill.
Bailey, Benjamin F., Jr.	1715 Alvin St., Toledo, Ohio.
Banks, J. Vernon	Alhambra Radio Company, 1309 East 15th St., Tulsa, Okla.
Bargamian, John	214 W. 50th St., New York City.
Barnette, Allen F.	c/o William Rose, 314 W. 94th St., Los Angeles, Calif.
Barton, Fred C.	RCA Victor Company, Inc., Camden, N. J.
Bassler, Carl J.	6617 Plaske St., Huntington Park, Calif.
Berman, Henry O.	836 N. Howard St., Baltimore, Md.
Bernhardt, Edward E.	6 Emerson Ave., Baldwin, L. I., N. Y.
Blessing, G. W.	Gregory W. Blessing and Company, 106 Jarvis St., Toronto, Ont., Can.
Borek, John J.	1334 N. Marshall St., Milwaukee, Wis.
Bose, John H.	1133 John Jay Hall, Columbia University, New York City
Brickson, H. O.	208 Center Ave., Stevens Point, Wis.
Brown, J. Kenneth	3762 Ninth St., Riverside, Calif.
Bucher, E. E.	RCA Photophone, Inc., 411 Fifth Ave., New York City.
Cann, John O. G.	87 Columbia Ave., Westmount, Quebec, Can.
Carr, Edward Mayes	1628 Hilton Ave., Ashland, Ky.
Cartwright, Randle V.	1137 Pleasant St., Boulder, Colo.
Cole, Burton R.	641 Spruce St., Berkeley, Calif.
Compton, Robin D.	1031 Fremont St., Manhattan, Kan.
Cooper, William H.	7 Forest Ct., Passaic, N. J.
Corey, Harry E.	3725 Vinton Ave., Palms Station, Los Angeles, Calif.
Creim, Conrad	5827½ Virginia Ave., Los Angeles, Calif.
Culley, Pawson	116 Ralph Ave., Brooklyn, N. Y.
Dalton, Stuart P.	8749 S. Hobart Blvd., Los Angeles, Calif.
Davis, Harold	536½ N. San Vincente Blvd., West Hollywood, Calif.
DeBaun, James R.	356 W. 34th St., New York City.
De Grave, Claude	93 Lawrence Ave., W., Toronto, Ont., Can.
Dering, Fred J.	1029 Browning Blvd., Los Angeles, Calif.
Dolesh, Frank J.	924 Brant Ave., Box 155, Rahway, N. J.
Edwards, Lyman M.	1914 W. Cherokee St., Enid, Okla.
Ehlers, Paul	P. O. Box 584, Davenport, Ia.
Flickinger, J. H.	2019 Wilshire Blvd., Los Angeles, Calif.
Fogle, Charles E.	1712 Farnum St., Davenport, Ia.
Freeland, Claude E.	160 E. St. John St., San Jose, Calif.
Garant, Edward C.	2819 Linden Ave., Knoxville, Tenn.
Gardner, Leroy H.	2024 W. Government St., Pensacola, Fla.
Gebhart, Bernard R.	1318 N. Van Buren St., Milwaukee, Wis.
Gleason, Sterling	650 California Ave., Venice, Calif.
Gray, De Wayne R.	628 Benson St., Camden, N. J.
Grebe, Alfred H.	70 Van Wyck Blvd., Richmond Hill, L. I., N. Y.
Greenleaf, S. A.	2400 Russell Rd., Alexandria, Va.
Grey, Charles C.	41 Crescent Pl., Yonkers, N. Y.
Gritzner, Fred A.	c/o Radiomarine Corporation of America, 75 Varick St., New York City
Hecht, R. H.	c/o Electrical Research Products, Inc., 910 S. Michigan Ave., Chicago, Ill.
Huddy, Franklin S.	204 Bower St., Providence, R. I.
Herdman, William P.	9 Waller Ave., Ossining, N. Y.
Hisamoto, R. M.	Massachusetts Institute of Technology, Cambridge, Mass.
Hodson, Herbert O.	Norris, S. D.
Ingersoll, Wm. P.	251 E. Chestnut St., Canton, Ill.
Jones, A. B.	1-A Glenlyon Rd., Eltham S. E. 9, London, Eng.
Jorgenson, A. A.	167 Willow Road, Palo Alto, Calif.
Keim, Jacob A.	Box 21, Western Ave., Geneva, Ill.
Kelly, Earl L.	5510 Blackstone, Chicago, Ill.
Kidd, Andrew	Crosley Radio Corporation, Cincinnati, Ohio.
Kiebert, Martin P., Jr.	829 S. E. 15th Ave., Portland, Ore.
King, Frank	Rm. 300, 91 Seventh Ave., New York City.
Kirk, Walter C.	1422 Locust St., Owensboro, Ky.
Knight, W. W.	34 Winter St., Bangor, Me.

- Layne, Lieut. Frank C.
Lee, Donald C.
- Levy, A. K.
Levy, Lester
Liang, Shen
Libbey, Bradley E.
Lowry, Charles A.
Lucas, Earle F.
Lumb, Frank J.
Lyman, Frank, Jr.
- McFarland, Daniel C.
Megit, Walter M.
Menard, J. L.
Menon, Geoffrey J.
Minshall, Burton
Minton, John P.
Moore, Thomas H.
Moritz, Burt E.
Morris, William J.
Muirhead, John E.
- O'Brien, Daniel L.
Olin, R. C.
- Pape, Karl R.
Payne, Charles C.
Penrose, Lloyd A.
Percy, Faye W.
Pfeiff, Fred J.
Pitts, Lieut. Henry L.
Potter, Robert C.
Purefoy, Henry Bert
- Reifel, Harry
Rettig, Charles A.
Reville, T. A., Jr.
Reynolds, F. T.
Reynolds, George E.
Rosso, Thomas
Rush, Floyd M.
Ryall, Henry
Ruspoli, Edmondo
Sorensen, Carl P.
St. James, Robert T.
Sandifer, Norwood H.
Sattgast, J. Kenneth
Seymour Fred M.
Sheldon, C. C.
Sherwood, Leslie F.
Shomler, H. B.
Shortland, James W.
Sparks, Neil R.
Spratt, George G.
Starr, Alfred R.
Stevens, Edwin F.
Straw, Fred D.
Strobel, Charles J.
- Strommen, Einar
- Sutton, Robert B.
Swanson Merrill J.
Sweighert, D. V.
- Teunisson, John F.
Truax, John
Tumleson, James E.
- Vaill, Edward W.
Visintini, Edoardo
Vorie-Vorojeikin, I. N.
- Wallace, L. E.
Weagant, Roy A.
Weaver, Karl S.
Weiss, Earl
Welsh, Fred E.
Wiebach, William T.
Williams, Aaron F.
Wilm, Carl F.
Winfield, William A.
Wohlfart, Emil
- Yarmack, John E.
- District Communication Office, Ninth Naval District, Chicago, Ill.
Westinghouse Electric and Manufacturing Company, Chicopee Falls, Mass.
Kingdon Radio Company, 44 East 87th St., New York, N. Y.
1275 Boscobel Ave., Bronx, New York City.
217 Seymour Rd., Shanghai, China.
400 E. 57th St., New York City.
759 Windermere Ave., Toronto 9, Ont., Can.
68 Prospect Ave., Irvington, N. J.
10½ Pleasant St., Auburn, N. Y.
18A Shaler Lane, Cambridge, Mass.
- McFarland and Lambert, 604 Bankers Trust Bldg., Norfolk, Va.
159 Potgieter St., Pretoria, S. Africa.
7818 St. Denis St., Montreal, Que., Can.
17 Woolock Ave., East Kew, E. 5, Victoria, Australia.
495 Dundas St., London, Ont., Can.
18 E. Elm St., Chicago, Ill.
P.O. Box 491, Charleston, W. Va.
312 N. Central Ave., Chicago, Ill.
232 Newport Rd., Roath, Cardiff, Wales.
279 Henry St., Brooklyn, N. Y.
- 6440 Regent St., Oakland, Calif.
10118 N. Oswego Ave., Portland, Oregon.
- 2740 Mabel St., Berkeley, Calif.
8 W. 40th St., New York, N. Y.
6306 S. Hermitage Ave., Apt. 314, Chicago, Ill.
P.O. Box 4475, University of Arizona Station, Tucson, Ariz.
101 Terrace Ave., Hasbrouck Heights, N. J.
1311 Buchanan St., N. W., Washington, D. C.
29 Arthur Ave., N., Hamilton, Ont., Can.
Mack's Radio Service Company, 1819 Permanent Bldg., Mercury Lane, Durban, Natal, South Africa.
- 140 Norwood St., Newark, N. J.
132 E. Lemon St., Lancaster, Pa.
R.F.D. 3, Box 232, Amarillo, Tex.
364 Eddy St., San Francisco, Calif.
RCA Institutes, Inc., Room 1154, Merchandise Mart, Chicago, Ill.
U. S. Coast Guard, Rockefeller Bldg., Cleveland, Ohio.
c/o Radio Station KMED, Sparta Bldg., Medford, Ore.
67 Bradley St., Portland, Me.
Parrano, Italy.
3705 Byron St., Chicago, Ill.
1135 N. Cicero Ave., Chicago, Ill.
Cain Radio Distributor, Jacksonville, Fla.
2315 Gaebler Ave., Overland, Mo.
Seymour Radio Company, 3645 Nottingham Rd., Detroit, Mich.
2631 West Ave., 32, Los Angeles, Calif.
c/o Radio Station WIOD, Miami Beach, Fla.
721 N. Brand, Glendale, Calif.
221 Stratford Rd., Brooklyn, N. Y.
2462 Bancroft Way, Berkeley, Calif.
116 S. 11th Ave., Coatesville, Pa.
216 W. 102nd St., New York City.
314 W. 94th St., New York City.
222 W. 53rd St., Ashtabula, Ohio.
S. S. Margaret, c/o A. H. Bull and Company, 115 Broad St., New York City.
M-S Harboe Jensen, c/o Tropical Radio Telephone Company, Pier 3, N. R., New York City.
632 W. 20th Ave., Spokane, Wash.
Radio Station WRAK, Williamsport, Pa.
Royal Hotel, Bucyrus, Ohio.
- U. S. Department of Commerce, 6200 S. Cicero Ave., Chicago, Ill.
2 Rector St., New York City.
4 S. Portland Ave., Brooklyn, N. Y.
- 80 Maiden Lane, New York City.
Via Toscana 60, Bologna, Italy.
67 Beatrice St., Buffalo, N. Y.
- 1521 South West 7th St., Miami, Fla.
101 Forest Rd., Douglas Manor, L. I., N. Y.
27 Howe Ave., Montclair, N. J.
79 E. Depew Ave., Buffalo, N. Y.
125 E. 39th St., New York City.
207 Ave. C., Rochester, N. Y.
RCA Victor Company, Inc., Building 6, Camden, N. J.
4542 N. Kenneth Ave., Chicago, Ill.
205 N. Washington St., Marion, Ind.
Wohlfart's Radio Service, 25-12 Steinway St., Astoria, L. I., N. Y.
- 525 Lexington Ave., New York City.

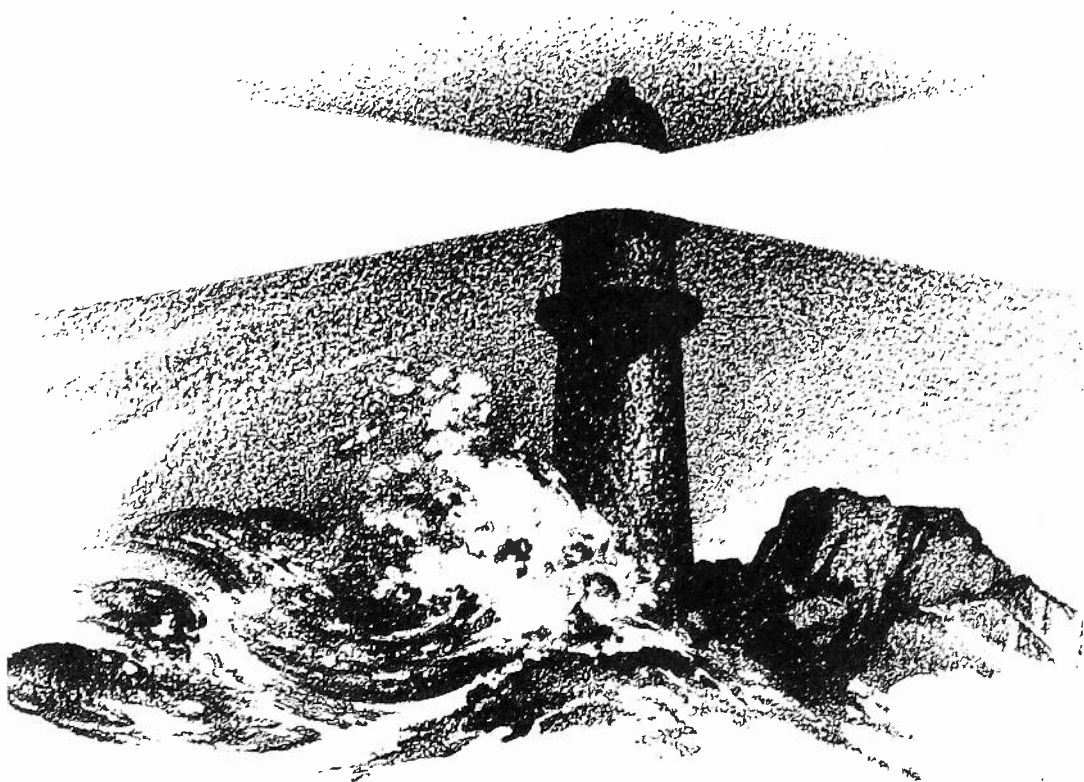

STEADFAST

TO MARINERS at sea, the mere sighting of a beacon is not enough. They must be able to identify the source . . . to know its dependability. So, also, you protect your organization by considering the stability of the companies from whom you purchase merchandise.

Here's how the Hygrade Sylvania Corporation measures up. Even during the depression years, Hygrade Sylvania with a rating of AaA1 has increased its financial strength



. . . a striking testimony of soundness!

And though Hygrade Sylvania is an old-timer in the electrical field, it is a leader in modern scientific development. Sylvania engineers pioneered in the development of the efficient new 6.3 volt tubes. And they are always ready to assist set manufacturers in solving circuit and design problems . . . without obligation. Hygrade Sylvania Corporation, Emporium, Penna.

Sylvania

(Reg. U. S. Pat. Off.)



THE SET-TESTED RADIO TUBE

© 1931, H. S. C.

When writing to advertisers mention of the PROCEEDINGS will be mutually helpful.

USE

Tilting Portables



The Handy Test Instruments

WHEN you make your "bread-board" circuit layouts, you don't want to be continually jumping up and down to get the proper line of vision to the scales of your instruments. But in no other way can anything approaching correct readings be secured if you use conventional instruments in fixed positions.

Triplet *Tilting* Type Portable Instruments, however, are instantly adjustable to whatever meter reading angles your particular tests may require. They give you accuracy combined with an entirely new convenience. They save you time, effort, and error. Yet their unequalled advantages represent a surprisingly low first cost—a lasting investment no greater than you had expected to put into equipment not possessing Triplet's *exclusive* features.

Learn for yourself this new freedom from tiring gymnastics which *only* Triplet Instruments can give you. Have a handy Triplet *Tilting* Portable ready for every test occasion. Send today for detailed literature covering our full line of Indicating Measuring Instruments and Radio Test Equipment.

THE TRIPLET ELECTRICAL INSTRUMENT COMPANY
107 Main St. Bluffton, Ohio, U. S. A.



MAIL COUPON TODAY

The Triplet Electrical Instrument Co.
107 Main St., Bluffton, Ohio

Send me your latest literature on
 Triplet Measuring Instruments Triplet Radio Test Equipment

Name

Street Address

City State

When writing to advertisers mention of the PROCEEDINGS will be mutually helpful.

AMERICA ON THE WIRE



AMERICANS get more out of the telephone than any other people in the world.

Partly it is because we still have the pioneer qualities. We are restless, inquisitive, ambitious, sociable, ingenious, enterprising. The telephone is adapted to us and we are adapted to the telephone. But another reason why the average American uses the telephone more is that there are more telephones to use—more than

thirteen million in the Bell System alone. And the service is better.

There are few persons in this country so isolated that the telephone cannot find them. Your telephone grows in value the more you use it and rely on it to help you through the day's activities.

More than 57,000,000 conversations a day are held over Bell System wires. It takes a telephone system of great size to render quick, reliable service to a great nation.



BELL TELEPHONE SYSTEM

When writing to advertisers mention of the PROCEEDINGS will be mutually helpful.

CHANGE IN MAILING ADDRESS OR BUSINESS TITLE

Members of the Institute are asked to use this form for notifying the Institute office of a change in their mailing address or the listing of their company affiliation or title in the Year Book.

The Secretary,
THE INSTITUTE OF RADIO ENGINEERS,
330 West 42nd Street,
New York, N.Y.

Dear Sir:

Effective please note change in my address
(date)
for mail as follows:

FROM

.....
(Name)

.....
(Street Address)

.....
(City and State)

TO NEW ADDRESS)

.....
(Street Address)

.....
(City and State)

Please note following change in my Year Book listing.

.....
(Title)

.....
(Company Name)

.....
(Company Address)

The Institute of Radio Engineers

Incorporated

330 West 42nd Street, New York, N.Y.

APPLICATION FOR ASSOCIATE MEMBERSHIP

(Application forms for other grades of membership are obtainable from the Institute)

To the Board of Directors
Gentlemen:

I hereby make application for Associate membership in the Institute of Radio Engineers on the basis of my training and professional experience given herewith, and refer to the members named below who are personally familiar with my work.

I certify that the statements made in the record of my training and professional experience are correct, and agree if elected, that I will be governed by the constitution of the Institute as long as I continue a member. Furthermore I agree to promote the objects of the Institute so far as shall be in my power, and if my membership shall be discontinued will return my membership badge.

.....
(Sign with pen)

.....
(Address for mail)

.....
(Date)

.....
(City and State)

Sponsors:

(Signature of references not required here)

Mr. Mr.

Address Address

City and State City and State

Mr.

Address

City and State

The following extracts from the Constitution govern applications for admission to the Institute in the Associate grade:

ARTICLE II—MEMBERSHIP

Sec. 1: The membership of the Institute shall consist of: * * * (c) Associates, who shall be entitled to all the rights and privileges of the Institute except the right to hold any elective office specified in Article V. * * *

Sec. 4. An Associate shall be not less than twenty-one years of age and shall be a person who is interested in and connected with the study or application of radio science or the radio arts.

ARTICLE III—ADMISSION AND EXPULSIONS

Sec. 2: * * * Applicants shall give references to members of the Institute as follows: * * * for the grade of Associate, to three Fellows, Members, or Associates; * * * Each application for admission * * * shall embody a full record of the general technical education of the applicant and of his professional career.

ARTICLE IV—ENTRANCE FEE AND DUES

Sec. 1: * * * Entrance fee for the Associate grade of membership is \$3.00 and annual dues are \$6.00.

ENTRANCE FEE SHOULD ACCOMPANY APPLICATION

WESTON *Selective Analyzers*

**ROTARY
SWITCH
MODEL**

**PIN
JACK
MODEL**

The Weston Method of Selective Analysis now is standard practice among radio engineers and servicemen. Combining as it does the known dependability of a Weston instrument measuring in fundamentals with a method of analysis which greatly simplifies testing procedure and banishes equipment obsolescence . . . it has proved a real asset for all testing needs.

To suit all requirements, two types of the Model 665 Weston Selective Analyzer now are avail-

able. Type 1 has a rotary switch for rapid selection of all ranges. Type 2, employs a series of pin jacks for the selection of ranges and is offered at lower cost. Both types have the same broad list of ranges, and combined with the Weston Socket Selector Set are truly universal in their capacity to analyze radio receivers. Bulletin is available describing this and other Weston radio instruments . . . Weston Electrical Instrument Corporation, 589 Frelinghuysen Ave., Newark, N. J.

WESTON *Radio Instruments*



When writing to advertisers mention of the PROCEEDINGS will be mutually helpful.

AEROVOX . . .



for All Your Radio Needs



A CHAIN can be no stronger than its weakest link . . . nor can the radio or electronic assembly be more reliable than its components.

For that reason the tried, tested and proven performance of countless Aerovox products in countless assemblies has taken the gamble out of Aerovox-equipped sets and electronic devices.

■ MICA ■

. . . Aerovox units are recognized as the most accurate units obtainable for precision work.

■ PAPER ■

. . . Conservative Aerovox ratings sought for longest life . . . adequate safety margin . . . lowest dielectric losses.

■ ELECTROLYTIC ■

. . . hermetic sealing . . . all-aluminum corrosion-proof construction . . . special composition surge-proof spacers . . . advanced chemical art . . . characteristically Aerovox.

■ and RESISTORS ■

. . . a complete line: carbon, wire-wound vitreous-enameled, wire-wound strip, lavite, grid leak . . . large and small . . . fixed and adjustable . . . different terminals . . . fit companions for Aerovox condensers.

NEW CATALOG

. . . just off the press . . . 1935 Edition . . . sent on request. Also sample copy of our monthly Research Worker. And remember always, your problems are our problems.

AEROVOX

C O R P O R A T I O N

71 Washington St. Brooklyn, N.Y.

When writing to advertisers mention of the PROCEEDINGS will be mutually helpful.

WHEREVER QUALITY CONDENSERS ARE USED

A SILVER *Anniversary*

Across one-quarter of a century the mind flashes back in retrospect.

The never-ending search for better methods of manufacture. The daily endeavor to create a finer condenser . . . painstaking research . . . more perfect materials. The courageous optimism in the face of competition . . . the unflinching refusal to sell condensers at the sacrifice of principle.

No drums or trumpets mark this turning point. On our Silver Anniversary we put the past behind us. We look to the future, clear-visioned and confident. Tomorrow, as yesterday, the years will not find us wanting.

Your inquiries are appreciated—

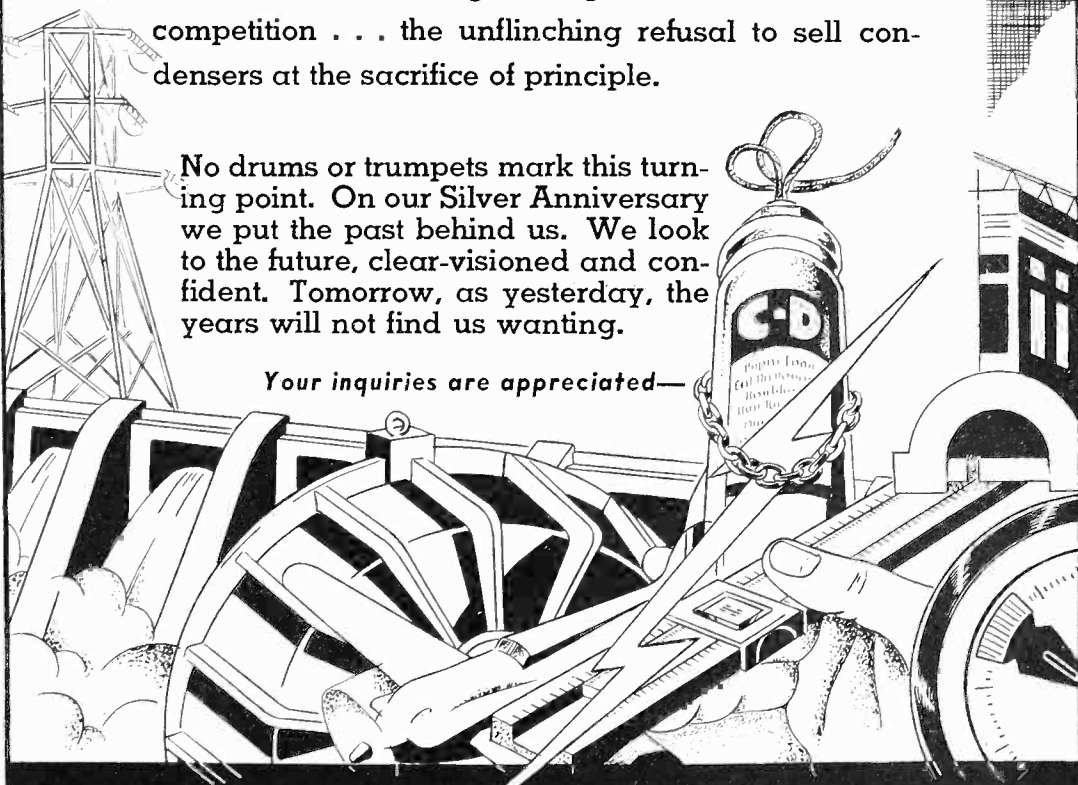

CORNELL - DUBILIER
CORPORATION

4379 BRONX BOULEVARD • NEW YORK

When writing to advertisers mention of the PROCEEDINGS will be mutually helpful.

RADIO AND SCIENTIFIC LITERATURE

● *Rider's Manuals* **VOLUME V**

of this series has just been published.

1200 pages.

946 models.

113 manufacturers.

The Rider Manual series, now consisting of five volumes, totals in excess of 5100 pages and contains technical information in the form of schematics, values, voltage, chassis data, etc., on more than 5200 models of American made commercial receivers, testing units and power amplifiers.

Engineers — Research Laboratories — Technical Schools—Broadcasting Stations—all who require information about the electrical structure of American receivers made during the past 15 years—turn to Rider's Manuals.

Up to date to October 1934

Write for descriptive literature

JOHN F. RIDER, Publisher
1440 Broadway New York City

PUBLISHERS

●
This Radio and Scientific Literature page is run to help you acquaint the readers of the Proceedings with your radio and technical publications.

For further information as to rates, etc., address:—

●
Advertising Department
Institute of Radio Engineers
330 West 42nd Street
New York, N.Y.

Alphabetical Index to Advertisements

	A	
Aerovox Corp.		XVIII
American Tel. & Tel. Co.		XIII
	C	
Central Radio Laboratories		XXIV
Cornell-Dubilier Corp.		XIX
	E	
Erie Resistor Corp.		XXIII
	G	
General Radio Co.		Outside Back Cover
	H	
Hygrade Sylvania Corp.		XI
	I	
International Resistance Co.		XXII
I.R.E.		XIV, XV, XVI, Inside Back Cover
	P	
Professional Eng. Directory		XXI
	R	
Radio and Scientific Literature		XX
	T	
Triplett Elec. Inst. Co.		XII
	W	
Weston Elec. Inst. Corp.		XVII

When writing to advertisers mention of the PROCEEDINGS will be mutually helpful.

PROFESSIONAL ENGINEERING DIRECTORY

BLILEY ELECTRIC CO.

*Designers and Manufacturers
of*

QUARTZ CRYSTALS

for

Standard or Special Requirements

226A Union Station Bldg.
ERIE, PENNA.

Cathode Ray Tubes and Associated Equipment For All Purposes

*Write for Complete
Technical Data*

ALLEN B. DUMONT
LABORATORIES
UPPER MONTCLAIR, N.J.

PRACTICAL RADIO ENGINEERING

One year Residence Course
Advanced Home Study Course
Combined Home Study-Residence
Course

Write for details

Capitol Radio Engineering
Institute
Washington, D.C.

FOR MANY YEARS

the Professional Engineering Directory has helped consulting engineers, designers, and laboratory men make the right contacts in the radio industry. Perhaps we can help you with your problems too. For further information write to

Advertising Department
INSTITUTE OF RADIO
ENGINEERS

330 West 42nd Street
NEW YORK, N.Y.

For the Engineering Consultant

who can handle a little extra business this year

For the designer

who can manage some additional work

For the Patent Attorney

who is anxious to develop a larger clientele

we suggest the Professional Engineering Directory 'of the PROCEEDINGS I.R.E. Manufacturers and organizations with special problems who need services such as yours come to the Professional Engineering Directory for information. Your name and special services announced here will tell them what you do and where to find you. Further information will be furnished on request. Special rates to members of the Institute.

When writing to advertisers mention of the PROCEEDINGS will be mutually helpful.

NOTE *the* FEATURES

IRC VOLUME CONTROLS

USING TIME-PROVED RESISTANCE
PRINCIPLE OF METALLIZED
RESISTORS

RESISTANCE ELEMENT—Conducting material applied to *Bakelite base* with automatic machinery gives scientific control of taper. The use of Bakelite makes possible permanent bonding at high temperature.

HUMIDITY CHARACTERISTICS—Non-hygroscopic bakelite base prevents absorption of moisture. Only a small change in resistance occurs at 90% relative humidity at 40° C. Upon drying, the control returns to its original value.

QUIET OPERATION—Unique, three finger contact, with spherical convex surfaces assure smooth change in resistance and low noise level.

NON-AGING—Practically unaffected by time. Nominal changes of only 1% or 2%.

WEAR—Average change in resistance is less than 10% with 50,000 rotations.

FLEXIBILITY—Standard controls from 200 ohms to 2 megohms. Can be made as high as 10 megohms. Special resistance curves supplied to order.

SWITCH—Underwriter's Approval. Low Internal resistance makes it suitable for auto radio use.

LOAD CHARACTERISTICS—Will carry up to 1 watt with power dissipated over entire element.

TAPPED CONTROLS—The IRC method of making fourth terminal contact eliminates obstructions in the path of the slider.

*Samples to your specifications gladly sent.
Write for Catalog RE-26 describing this new
IRC development in detail.*

INTERNATIONAL RESISTANCE COMPANY

2100 Arch Street Philadelphia, Pa.
(In Canada, 187 Duchess St., Toronto, Ont.)

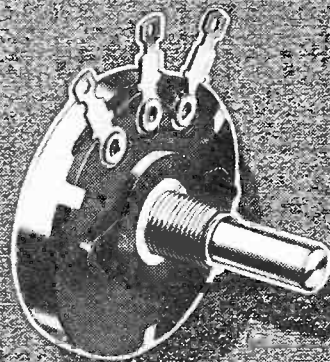
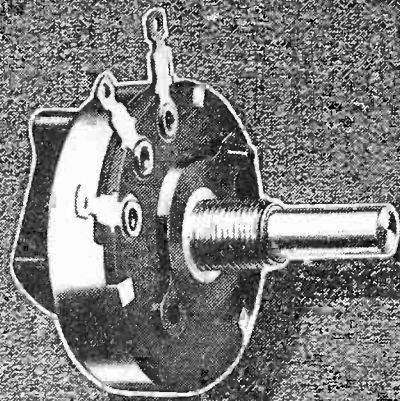

BY THE MAKERS OF METALLIZED, PRECISION AND POWER WIRE WOUND RESISTORS

When writing to advertisers mention of the PROCEEDINGS will be mutually helpful.

"WE CANCELED OUR FACTORY INSPECTION

AND RELY ON ERIE'S OWN TESTS"

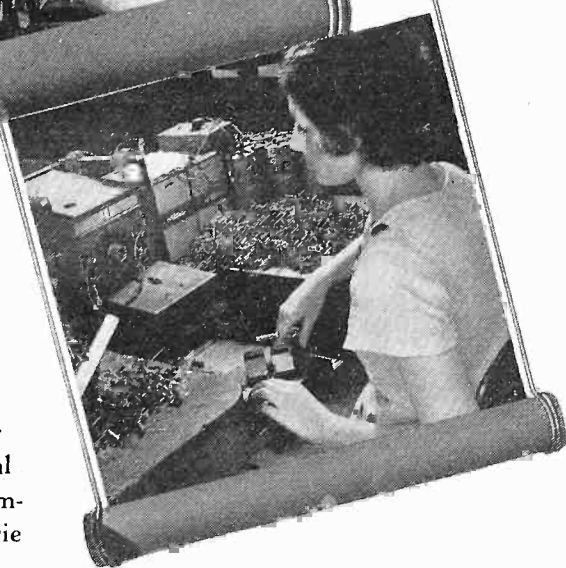
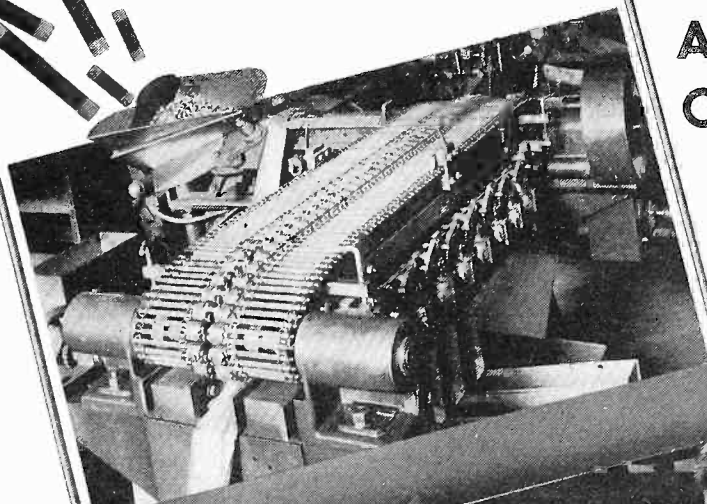

BECAUSE resistors furnished by us over a period of years have so consistently been well within their specified resistance tolerances, several leading radio manufacturers have eliminated their factory inspection of Erie Resistors.

Modern manufacturing methods on machinery of our own design, plus triple inspection of each resistor guarantees a finished product that satisfies the most rigid specification.

Every radio manufacturer can cut production costs by specifying Erie Resistors and eliminating factory tests. Why not take advantage of this large saving through the use of precision-tested Erie Resistors?

Top: An automatic machine of our own design that electrically tests and sorts Erie Resistors according to their tolerances.

Above: Finished resistors being checked by a skilled operator.



ERIE RESISTOR CORPORATION

ERIE, PA.

Factories in ERIE, PA. - TORONTO, CANADA - LONDON, ENG.

When writing to advertisers mention of the PROCEEDINGS will be mutually helpful.

CENTRALAB

Series 11 Sound Projection Controls

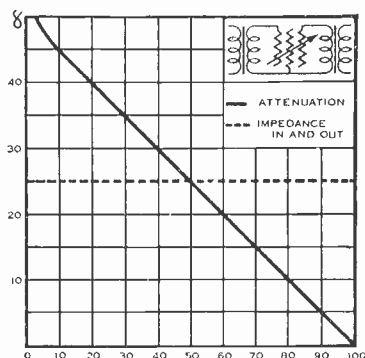

Graphical illustration of the variation in attenuation and impedance with knob rotation for a "T" Pad Attenuator.

*forever
smooth
and
never
noisy!*

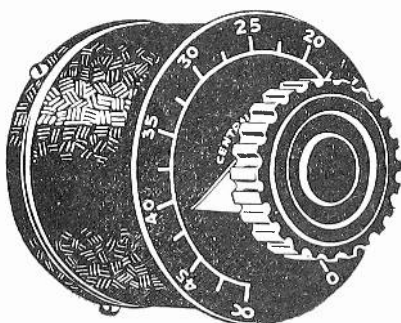

"T" Pad "L" Pad

The patented Centralab non-rubbing contact insures long life and remains noiseless and accurate through years of service . . . and *never requires cleaning*. These resistors of the non-inductive carbon type are specially tapered for constant impedance. Attenuation is continuously variable and practically straight line for 45 decibels at all frequencies up to 16,000 cycles.

Write today for descriptive booklet on the Series 11 Sound Projection Controls.

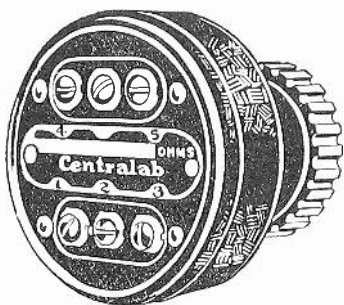

Gain Control Straight Fader

Centralab

Division of Globe Union Mfg. Co.
MILWAUKEE

When writing to advertisers mention of the PROCEEDINGS will be mutually helpful.

Take Your Choice

Every member of the Institute of Radio Engineers will want to wear one of these three attractive emblems. All of these emblems are appropriately colored to indicate the various grades of membership and each emblem is approximately the size of the following illustrations.



The **Lapel Button** is of 14k gold, with background enameled in the membership color, and with the lettering in gold. The screw-back on the back of this button fastens it securely to your coat.

\$2.75 postpaid—any grade.



The **Pin** is also of 14k gold. It is provided with a safety catch and is appropriately colored for the various grades of membership.

\$3.00 postpaid—any grade.



The **Watch Charm** handsomely finished on both sides, is also of 14k gold. This charm is equipped with a suspension ring for attaching to a watch fob or chain.

\$5.00 postpaid—any grade.

Orders, accompanied by checks made payable to the Institute of Radio Engineers, should be addressed to

THE INSTITUTE OF RADIO ENGINEERS

330 West 42nd Street

NEW YORK, N.Y.

Send in your order now!

STABILITY

PERFORMANCE

LOW POWER FACTOR

are the features of the Type 505 Condensers, developed for the requirements of circuits where frequency stability and permanence of calibration are essential. An unusual type of construction is employed which makes these condensers almost immune to the effects of temperature, humidity, barometric pressure and time.

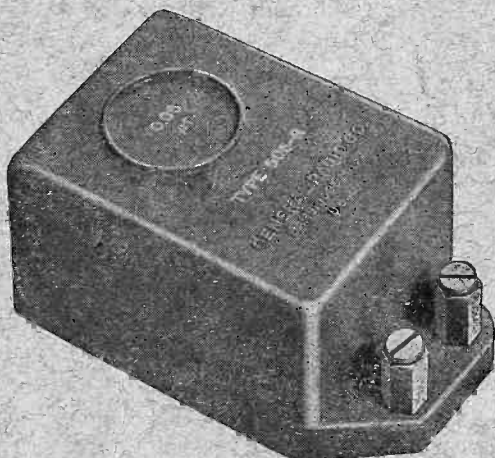

TYPE 505 CONDENSER

Available in 1, 2, 5 series from 100 micromicrofarads to 0.5 microfarad.

Price \$3.50 to \$20.00.

TYPE 509 CONDENSER

A laboratory standard condenser adjusted to 0.25%;
 $R \omega C = 0.05\%$.

Available in 1, 2, 5 series from 1,000 micromicrofarads to 1 microfarad.

Price \$12.50 to \$48.00.

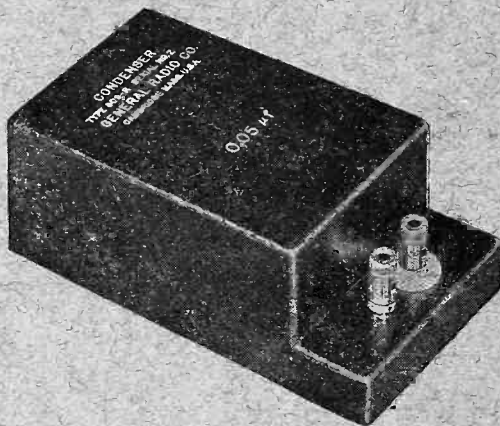

GENERAL RADIO COMPANY

CAMBRIDGE A MASSACHUSETTS