

VOLUME 22

OCTOBER, 1934

NUMBER 10

PROCEEDINGS
of
The Institute of Radio
Engineers



Application Blank for Associate Membership on Page XV

Institute of Radio Engineers Forthcoming Meetings

LOS ANGELES SECTION

October 16, 1934

NEW YORK MEETING

October 3, 1934

November 7, 1934

PHILADELPHIA SECTION

October 4, 1934

November 1, 1934

PITTSBURGH SECTION

October 16, 1934

SAN FRANCISCO SECTION

October 17, 1934

PROCEEDINGS OF

The Institute of Radio Engineers

Volume 22

October, 1934

Number 10

Board of Editors

ALFRED N. GOLDSMITH, *Chairman*

R. R. BATCHER
H. H. BEVERAGE
F. W. GROVER
G. W. KENRICK

G. W. PICKARD
K. S. VAN DYKE
L. P. WHEELER
L. E. WHITEMORE

WILLIAM WILSON

CONTENTS

PART I

Frontispiece, S. C. Hooper, Recipient of Institute Medal of Honor, 1934	1148
Institute News and Radio Notes	1149
Radio Transmissions of Standard Frequencies	1149
Personal Mention	1150

Part II

Technical Papers

The WLW 500-Kilowatt Broadcast Transmitter	
. J. A. CHAMBERS, L. F. JONES, G. W. FYLER, R. H. WILLIAMSON, E. A. LEACH, and J. A. HUTCHESON	1151
The Measurement of Harmonic Power Output of a Radio Transmitter	
. P. M. HONNELL and E. B. FERRELL	1181
Regeneration Theory and Experiment	
. E. PETERSON, J. G. KREER, and L. A. WARE	1191
Some Aspects of Parallel Resonant Circuits	L. M. CRAFT 1211
North Atlantic Ship-Shore Radiotelephone Transmission During 1932-1933	C. N. ANDERSON 1215
Book Reviews: "Loud Speakers (Theory, Performance, Testing and Design)," by N. W. McLachlan	IRVING WOLFF 1225
"Broadcasting Abroad, Revised Edition"	L. E. WHITEMORE 1225
"Present and Impending Applications to Education of Radio and Allied Arts"	R. R. RAMSEY 1226
Booklets, Catalogs, and Pamphlets Received	1227
Contributors to This Issue	1228

The Institute of Radio Engineers

GENERAL INFORMATION

INSTITUTE. The Institute of Radio Engineers was formed in 1912 through the amalgamation of the Society of Wireless Telegraph Engineers and the Wireless Institute. Its headquarters were established in New York City and the membership has grown from less than fifty members at the start to several thousand.

AIMS AND OBJECTS. The Institute functions solely to advance the theory and practice of radio and allied branches of engineering and of the related arts and sciences, their application to human needs, and the maintenance of a high professional standing among its members. Among the methods of accomplishing this is the publication of papers, discussions, and communications of interest to the membership.

PROCEEDINGS. The PROCEEDINGS is the official publication of the Institute and in it are published all of the papers, discussions, and communications received from the membership which are accepted for publication by the Board of Editors. Copies are sent without additional charge to all members of the Institute. The subscription price to nonmembers is \$10.00 per year, with an additional charge for postage where such is necessary.

RESPONSIBILITY. It is understood that the statements and opinions given in the PROCEEDINGS are views of the individual members to whom they are credited, and are not binding on the membership of the Institute as a whole. Papers submitted to the Institute for publication shall be regarded as no longer confidential.

REPRINTING PROCEEDINGS MATERIAL. The right to reprint portions or abstracts of the papers, discussions, or editorial notes in the PROCEEDINGS is granted on the express condition that specific reference shall be made to the source of such material. Diagrams and photographs published in the PROCEEDINGS may not be reproduced without making specific arrangements with the Institute through the Secretary.

MANUSCRIPTS. All manuscripts should be addressed to the Institute of Radio Engineers, 330 West 42nd Street, New York City. They will be examined by the Papers Committee and the Board of Editors to determine their suitability for publication in the PROCEEDINGS. Authors are advised as promptly as possible of the action taken, usually within two or three months. Manuscripts and illustrations will be destroyed immediately after publication of the paper unless the author requests their return. Information on the mechanical form in which manuscripts should be prepared may be obtained by addressing the secretary.

MAILING. Entered as second-class matter at the post office at Menasha, Wisconsin. Acceptance for mailing at special rate of postage is provided for in the act of February 28, 1925, embodied in Paragraph 4, Section 412, P. L. and R., and authorization was granted on October 26, 1927.

Published monthly by

THE INSTITUTE OF RADIO ENGINEERS, INC.

Publication office, 450-454 Ahnaip St., Menasha, Wis.

BUSINESS, EDITORIAL, AND ADVERTISING OFFICES

Harold P. Westman, *Secretary*

330 West 42nd Street, New York, N. Y.

INSTITUTE SECTIONS

- ATLANTA—Chairman, Henry L. Reid; Secretary, Philip C. Bangs, 23 Kensington Road, Avondale Estates, Ga.
- BOSTON—Chairman, E. L. Chaffee; Secretary, Roland G. Porter, Northeastern University, Boston, Mass.
- BUFFALO-NIAGARA—Chairman, L. E. Hayslett; Secretary, E. C. Waud, 235 Huntington Avenue, Buffalo, N. Y.
- CHICAGO—Chairman, Hugh S. Knowles; Secretary, John S. Meck, The Fensholt Company, 549 W. Washington St., Chicago, Ill.
- CINCINNATI—Chairman R. E. Kolo; Secretary, Helen Hymans, Crosley Radio Corporation, Cincinnati, Ohio.
- CLEVELAND—Chairman, F. G. Bowditch; Secretary, C. H. Shipman, 14805 Ardenall Ave., East Cleveland, Ohio.
- CONNECTICUT VALLEY—Chairman, K. S. Van Dyke; Secretary, C. B. De Soto, American Radio Relay League, 38 La Salle Rd., W. Hartford, Conn.
- DETROIT—Chairman, Samuel Firestone; Secretary, E. C. Denstaedt, Detroit Police Department, Detroit, Mich.
- LOS ANGELES—Chairman, H. C. Silent; Secretary, N. B. Neely, 1569 Munson Ave., Los Angeles, Calif.
- NEW ORLEANS—Chairman, J. A. Courtenay; Secretary, C. B. Reynolds, Radiomarine Corporation, 512 St. Peter St., New Orleans, La.
- PHILADELPHIA—Chairman, E. D. Cook; Secretary, R. L. Snyder, 103 Franklin Road, Glassboro, N. J.
- PITTSBURGH—Chairman, C. K. Krause; Secretary, H. V. Noble, c/o Gulf Research and Development Company, 327 Craft Ave., Pittsburgh, Pa.
- ROCHESTER—Chairman, H. J. Klumb; Secretary, H. A. Brown, 89 East Ave., Rochester, N. Y.
- SAN FRANCISCO—Chairman A. H. Brolly; Secretary, R. D. Kirkland, Mackay Radio and Telegraph Company, 22 Battery St., San Francisco, Calif.
- SEATTLE—Chairman, Howard Mason; Secretary, Raymond C. Fisher, 602 N. C. St., Tacoma, Wash.
- TORONTO—Chairman, A. B. Oxley; Secretary, S. A. Goldhamer, Northern Electric Company, 131 Simcoe St., Toronto, Ont., Canada.
- WASHINGTON—Chairman T. McL. Davis; Secretary, C. L. Davis, Washington Building, 15th and G Sts. N. W., Washington, D. C.

GEOGRAPHICAL LOCATION OF MEMBERS ELECTED SEPTEMBER 5, 1934

Elected to the Associate Grade

California	Los Angeles, 1341 W. 51st St.....	Edwards, W. E.
	San Francisco, 2030 Vallejo St.....	De Bretteville, A., Jr.
	San Pedro, 2838 S. Gaffey St.....	Penniwell, A. F.
District of Columbia	Washington, 2737 Devonshire Pl., N.W.....	Yeomans, R. W
Kansas	Salina, 534 S. 9th.....	Mitchell, W. R.
Kentucky	Owensboro, 535 Locust St.....	Haller, C. E.
Massachusetts	Cambridge, 10 Appian Way.....	Hall, H. H.
	New Bedford, 719 Ashley Blvd.....	Forster, H. D.
New Jersey	Jersey City, 2554 Hudson Blvd.....	Hamvas, L. U.
New York	Ithaca, 705 E. Seneca St.....	Smith, H. G.
	New York City, 324 E. 197th St.....	Borst, J. M.
	New York City, 309 W. 40th St.....	Toufexis, S. C.
	Poughkeepsie, 2 N. Randolph Ave.....	Underhill, G. H.
	Stapleton, S. I., 382 St. Pauls Ave.....	Newman, S. J.
	White Plains, 7 Greenridge Ct.....	Koerner, C. T.
Ohio	Mason, Box 133.....	Duncan, R. S.
	Van Wert, 311 N. Cherry St.....	Frick, C. S.
Pennsylvania	Emporium, 112½ W. 5th St.....	Bair, H. A.
	Emporium, 330 W. 5th St.....	Bolton, S. W.
	Emporium, 36½ E. 4th St.....	Bowie, R. M.
	Emporium, Christabelle Club.....	Brunner, G. W.
	Emporium, 113½ W. 4th St.....	Goodwin, V. D.
	Emporium, 512 Maple St.....	Herrick, W. W.
	Emporium, 31 W. 6th St.....	Mahaffy, G. N.
	Emporium.....	Merkle, R. S.
	Fort Washington, Montgomery Co., Randolph and Glencoe Aves.....	Schantz, J. S.
	McKeesport, 212-10th Ave.....	McConnell, G. H.
	St. Mary's, 252 N. St. Mary's St.....	Hoffman, R. R.
Washington	Seattle, USS Smith Thompson (212), c/o Postmaster....	Kirinich, A.
Wisconsin	Neenah, 523 Henry St.....	Corcoran, A. E.
Argentina	Buenos Aires, Moreno No. 1342, Dto. 14.....	Bonard, P. S.
Canada	Belle Plaine, Sask.....	Haggerty, A. S.
China	Shanghai, c/o China Electric Corp.....	Spagnoletti, P. H.
Colombia	Bogota, c/o American Commercial Attache.....	Lee, R. E.
England	Bournemouth, Hamps, 3 Queen's Park Ter.....	Cole, W. A.
	Chelmsford, Essex, c/o Marconi's Wireless Tel. Co. Ltd., Marconi Works.....	Griffiths, P. E.
	Guernsey, Channel Islands, "Harwell," Ville-au-Roi....	Richens, J. R., Jr
	Marlborough, Wilts, "Synnyside," London Rd.....	Campbell, A. D
France	Neuilly, Sur Seine, 9 Bis rue Casimir Pinel.....	Amiot, J. L.
India	Calcutta, c/o Station Director, Broadcasting House, 1 Garstin Pl.....	Khan, M. M.
	Madras, Physics Dept., Presidency College.....	Rajam, C. V.
	Nagpur, c/o W. N. Dharap, New Modi Lane, Seetabuldi..	Phatak, R. K
Japan	Shizuoka, Radio Station JOPK.....	Murase, K.
New Zealand	Whangarei, Telegraph Engineer.....	Connan, W. J.
Scotland	Kirkcaldy, Fife, c/o Gibb and Watson, High St.....	Marsh, G. S.
South Africa	Johannesburg, P.O. Box 3429.....	Gotz, M.

Elected to the Junior Grade

California	La Habra, Route 1, Box 223.....	Strupp, E. J.
Minnesota	Bronson.....	Naslund, R. S.

Elected to the Student Grade

District of Columbia	Washington, c/o U. S. Coast and Geodetic Survey.....	Bondurant, J. E.
Massachusetts	Cambridge, M.I.T. Dormitories.....	Tuttle, D. F., Jr.
New Jersey	East Orange, 214 Glenwood Ave.....	Grant, H. A., Jr.
Ohio	Cincinnati, 2911 Montclair Ave.....	Lepple, H.
	Miamitown.....	Gieringer, C. K
	Oberlin, Noah Hall.....	Denny, W. B.



APPLICATIONS FOR MEMBERSHIP

Applications for transfer or election to the various grades of membership have been received from the persons listed below, and have been approved by the Admissions Committee. Members objecting to transfer or election of any of these applicants should communicate with the Secretary or on before October 31, 1934. These applications will be considered by the Board of Directors at its meeting on November 7, 1934.

For Election to the Fellow Grade

England London N.W.4, 3 Mayfield Gardens, Shirehall Park.....Mathieu, G. A.

For Transfer to the Fellow Grade

District of Columbia Washington, Coast and Geodetic Survey.....Dorsey, H. G

For Election to the Member Grade

Illinois Chicago, 1033 W. Van Buren St.....Smith, A. B.
 New Jersey Ridgefield Park, General Communications Labs.....Lent, W. C.
 New York Manhasset, 11 Beachwood Ave.....Cawein, M.
 New York City, c/o Radio and Technical Pub. Co., 45 Astor Pl.....Ghirardi, A. A.
 New York City, Hotel Taft.....Grossman, H.
 Port Jefferson, L.I., 117 Tuthill St.....Lindenblad, N. E.
 Pennsylvania Emporium, 210 W. 4th St.....Hultberg, C. A.
 Emporium, Box 750.....Kievit, B., Jr.
 Australia Brisbane, Queensland, Engineering Branch G.P.O.....Ross, S. J.
 Sydney, c/o New System Telephones Pty. Ltd., 278 Castle-reagh St.....Kennell, R. J. W
 England London N.W.11, 41 Litchfield Way.....Bedford, L. H.
 Germany Berlin-Lichterfelde-Ost, Jungfernstieg 7.....Riepka, H. C.

For Transfer to the Member Grade

California San Francisco, 249 Colon Ave.....Brolly, A. H.
 Missouri St. Louis, Rm. 606, Telephone Bldg.....McDaniel, O. S.
 New Jersey Morristown, 85 Washington Ave.....Poole, R. E.
 Pennsylvania Philadelphia, 127 E. Mermaid Lane, Chestnut Hill.....Farnsworth, P. T.
 England Bromley, Kent, 51 Foxbury Rd.....Minter, R. W.

For Election to the Associate Grade

Florida Tampa, Box 453.....Colegrove, T. H.
 Illinois Chicago, 5746 Kenmore Ave.....Ragsdale, W. E.
 New Jersey Atlantic City, 211 N. Brighton Ave.....Smith, S. S.
 East Orange, 88 Ashland Ave., Apt. 404.....Pearce, C. J
 Harrison, Research and Development Lab., RCA Radiotron Co.....Gray, W. A.
 Montclair, 60 Edgemont Rd.....Brown, H. J.
 Newark, Federal Telegraph Co., 200 Mt. Pleasant Ave.....Backer, L. A
 Newark, 666 Ridge St.....Smith, H. J.
 Newark, 808 S. 15th St.....Vogel, C. P.
 New York South Orange, 136 Seton Pl.....Rose, D. W.
 Bayside, L.I., 39-25-214th Pl.....Goodale, E. D.
 Brooklyn, 1378 W. 7th St.....DiToro, M. J.
 Brooklyn, 127 McKinley Ave.....Steinberg, J.
 Flushing, 151-10 State St.....Syme, D. W.
 New York City, c/o R.C.A. Institutes, Inc., 75 Varick St.....Peterson, I.
 New York City, USS New Mexico, c/o Postmaster.....Reese, J. S.
 New York City, 142 W. 83rd St.....Uptcher, D.
 Schenectady, 1109 Union St.....Thomas, H. P.
 Oregon Portland, KOIN, New Heathman Hotel.....Bookwalter, L. S.
 Pennsylvania Philadelphia, 5722 Greene St., Germantown.....Bowers, L. G.
 Wilkensburg, 1450 Sloan Ave.....Kozanowski, H. N
 West Virginia Morgantown, 316 Forest Ave.....Friend, A. W.
 Australia Brunswick, Victoria, 131 Brunswick Rd.....Chittock, K. H.
 Brazil Rio de Janeiro, c/o RCA Victor Brasileira, Inc., Caixa Postal 2726.....Pinto, O. D.
 Canada Camp Borden, Ont., Royal Canadian Signals.....Cumming, J. E.

Applications for Membership

England	Bexley Heath, Kent, 85 May Place Rd. E., Barnehurst	Crosoer, R. L.
	Bolton, Lancs, 78 Sharples Ave.	Herczeg, A.
	Derby, Highfield Lawn.	Harris, J. W.
	Hollinwood, Lancs., c/o Turner, Bowling Green Hotel.	Davidson, T. D.
	London, c/o Marconi's Wireless Tel. Co., Ltd., Electra House.	Collings, R. H. P.
	London W. 1, c/o Thomas Cook and Son.	Rao, V. B.
	London S. W. 7, 21 Cromwell Rd.	Row, D. P.
	Wembley, Middlesex, G.E.C. Research Labs.	Stewart, J.
France	Lyon, 8 Place de l'Abondance.	Warin, M. P.
India	Bombay, Petit Mansions, Sleater Rd., Grant Rd.	Major, D. S.
	Glenmorgan, Power Station, Singara.	Sundaram, P. R.
Japan	Tokyo, The Japan Wireless Telegraph Co., Nisshin Bldg., Otemachi.	Okamoto, S.
Lithuania	Jonava, Vytauto Didziojo Kuopa.	Gabriunas, K.
New Zealand	Auckland, 10 Cecil Rd. Epsom.	Rudd, C. G.
South Africa	Johannesburg, P.O. Box 6938.	England, R. G. W.

For Election to the Student Grade

California	Oakland, 479-65th St.	Winlund, E. S.
Illinois	Chicago, 7321 S. Shore Dr.	Stanton, J. W., II



OFFICERS AND BOARD OF DIRECTORS, 1934

(Terms expire January 1, 1935, except as otherwise noted)

President

C. M. JANSKY, JR.

Vice President

BALTH. VAN DER POL, JR.

Treasurer

MELVILLE EASTMAN

Secretary

HAROLD P. WESTMAN

Editor

ALFRED N. GOLDSMITH

Directors

W. G. CADY, *Junior Past President*

O. H. CALDWELL

J. V. L. HOGAN

L. C. F. HORLE

C. W. HORN

E. L. NELSON

E. R. SHUTE

A. F. VAN DYCK

H. A. WHEELER

Serving until January 1, 1936

R. A. HEISING

L. M. HULL, *Junior Past President*

F. A. KOLSTER

H. M. TURNER

Serving until January 1, 1937

ARTHUR BATCHELLER

WILLIAM WILSON

COMMITTEES OF THE INSTITUTE OF RADIO ENGINEERS, 1934

Admissions Committee

E. R. SHUTE, *Chairman*

AUSTIN BAILEY
ARTHUR BATCHELLER
I. S. COGGESHALL
C. P. EDWARDS

L. C. F. HORLE
C. W. HORN
A. G. LEE
J. S. SMITH
A. F. VAN DYCK

Awards Committee

H. M. TURNER, *Chairman*

J. H. DELLINGER
R. H. LANGLEY

A. F. VAN DYCK
WILLIAM WILSON

Bibliography Committee

MELVILLE EASTHAM, *Chairman*

J. H. DELLINGER

ALFRED N. GOLDSMITH
WILLIAM WILSON

Board of Editors

ALFRED N. GOLDSMITH, *Editor*

R. R. BATCHER
H. H. BEVERAGE
F. W. GROVER
G. W. KENRICK

G. W. PICKARD
K. S. VAN DYKE
L. P. WHEELER
L. E. WHITTEMORE
WILLIAM WILSON

Broadcast Committee

E. L. NELSON, *Chairman*

S. L. BAILEY
E. K. COHAN
T. A. M. CRAVAN
E. L. GOVE

J. V. L. HOGAN
C. W. HORN
L. F. JONES
J. C. McNARY

Constitution and Laws Committee

J. V. L. HOGAN, *Chairman*

ARTHUR BATCHELLER
AUSTIN BAILEY
R. A. HEISING
C. M. JANSKY, JR., *ex officio*

E. R. SHUTE
A. F. VAN DYCK
H. P. WESTMAN, *ex officio*
H. A. ZEAMANS

Membership Committee

I. S. COGGESHALL, *Chairman*

L. A. BRIGGS
W. W. BROWN
C. J. BURNSIDE
H. A. CHINN
W. F. COTTER
F. W. CUNNINGHAM
H. C. GAWLER
S. A. GOLDHAMER
DAVID GRIMES
L. C. F. HORLE

H. C. HUMPHREY
A. V. LOUGHREN
T. A. McCANN
A. F. MURRAY
L. G. PACENT
D. E. REPLOGLE
C. R. ROWE
E. W. SCHAFER
C. E. SCHOLZ
J. E. SMITH

(*Chairmen of Membership Committees of Sections, ex officio*)

New York Program Committee

A. F. VAN DYCK, *Chairman*

AUSTIN BAILEY
H. H. BEVERAGE
E. K. COHAN
O. E. DUNLAP

W. G. H. FINCH
J. K. HENNEY
L. C. F. HORLE
C. W. HORN
R. H. LANGLEY

Nominations Committee

L. M. HULL, *Chairman*

W. G. CADY
O. H. CALDWELL

L. C. F. HORLE
R. H. MANSON

Papers Committee

WILLIAM WILSON, *Chairman*

H. A. AFFEL
J. K. CLAPP
E. K. COHAN
T. A. M. CRAVEN
P. O. FARNHAM
E. B. FERRELL
T. R. GILLILAND
E. L. HALL
L. F. JONES
F. B. LLEWELLYN
R. M. MORRIS
A. F. MURRAY

BENJAMIN OLNEY
H. O. PETERSON
R. K. POTTER
R. R. RAMSEY
F. M. RYAN
B. E. SHACKELFORD
G. C. SOUTHWORTH
G. G. THOMAS
H. M. TURNER
H. A. WHEELER
W. C. WHITE
IRVING WOLFF

Publicity Committee

O. H. CALDWELL, *Chairman*

C. E. BUTTERFIELD
L. M. COCKADAY
O. E. DUNLAP

W. G. H. FINCH
DONALD McNICOL
R. C. POULTER

K. B. WARNER

Sections Committee

DAVID GRIMES, *Chairman*

I. S. COGGESHALL
H. B. COXHEAD
V. M. GRAHAM

H. C. GAWLER
J. H. MILLER
B. E. SHACKELFORD

(*Chairmen of Sections, ex officio*)

Standards Committee

HARADEN PRATT, *Chairman*

J. K. CLAPP
J. H. DELLINGER
ALFRED N. GOLDSMITH
F. G. KEAR
R. H. LANGLEY
E. L. NELSON

H. O. PETERSON
F. E. TERMAN
H. M. TURNER
A. F. VAN DYCK
L. E. WHITTEMORE
WILLIAM WILSON

Tellers Committee

ARTHUR BATCHELLER, *Chairman*

DAVID GRIMES

WALTER MILTON-KING

H. P. WESTMAN, *Secretary*







S. C. HOOPER

Recipient of Institute Medal of Honor, 1934

Stanford Caldwell Hooper was born on August 16, 1884, in Colton, California. His early education was received in the public schools of San Bernardino, California, and he worked as a relief telegraph operator during his summer vacations.

He was graduated from the United States Naval Academy in 1905 and served on various naval vessels having command of a destroyer during the world War.

He instructed in electricity, physics, and chemistry at the Naval Academy from 1910 to 1911. From 1912 he served for two years as the first Fleet Radio Officer, resuming that post again from 1923 to 1925. For eleven years between 1914 and 1928 he was in charge of the Radio Division of the Navy Department, since then serving as Director of Naval Communications.

He was the first technical advisor to the Federal Radio Commission when that body was established, and attended various national and international radio conferences. He was awarded the Institute Medal of Honor in 1934 for the orderly planning and systematic organization of radio communication in the Government Service with which he is associated, and the concomitant and resulting advances in the development of radio equipment and procedure. The Navy Cross and Legion of Honor were awarded him for his war services.

He joined the Institute as a Fellow in 1928.

INSTITUTE NEWS AND RADIO NOTES

Radio Transmissions of Standard Frequencies

Standard frequency transmissions at 5000 kilocycles are made from the Bureau of Standards Station WWV at Beltsville, Md., every Tuesday, except on legal holidays, continuously from 12 noon to 2 P.M. and from 10 P.M. to midnight, Eastern Standard Time. The accuracy of the frequency of transmission is at all times better than one cycle per second (one in five million).

For the first five minutes the general call (CQ de WWV) and announcement of the frequency is transmitted, the frequency and call letters being given every ten minutes thereafter. The main portion of the transmissions consist of the continuous unkeyed carrier wave. Information on the utilization of these signals is given in a pamphlet obtainable from the Bureau of Standards.

The Bureau would appreciate reports on field intensity, fading characteristics, and suitability of the transmissions for frequency measurements. If field intensity measurement apparatus is not available, it is suggested that the following intensity designations be used: (1) hardly perceptible, unreadable; (2) weak, readable, now and then; (3) fairly good, readable with difficulty; (4) good, readable; (5) very good, perfectly readable. Fading reports giving characteristics, such as time between peaks of signal intensity, are desired. Information as to the receiving equipment and antenna used is helpful. Reports on the use of these transmissions for all purposes would be appreciated, and communications should be addressed to the Bureau of Standards, Washington, D. C.

Proceedings Binders

Binders for the PROCEEDINGS, which may be used as permanent covers or for temporary transfer purposes, are available from the Institute office. These binders are of handsome Spanish grain fabrikoid, in blue and gold. Wire fasteners hold each copy in place, and permit removal of any issue from the binder in a few seconds. All issues lie flat when the binder is open. Each binder will accommodate a full year's supply of the PROCEEDINGS, and they are available at one dollar and fifty cents (\$1.50) each. Your name, or PROCEEDINGS volume number, will be stamped in gold for fifty cents (50¢) additional.

Personal Mention

K. B. Austin of the General Electric Company has been transferred from Schenectady to Bridgeport.

C. R. Barhydt also has been transferred from Schenectady to the Bridgeport branch of the General Electric Company.

L. D. Boji of General Household Utilities Company is now at Marion, Ind. having formerly been at the Chicago, Ill., plant.

Previously with Hygrade Sylvania Corporation, W. J. Cahill has joined the staff of Naval Research Laboratory at Bellevue, Anacostia, D. C.

Formerly with Lincoln Export Company, R. H. dePasquale has formed an export company under the title Technical Products International in New York City.

Previously doing graduate work at Massachusetts Institute of Technology, C. W. Frank has joined the Associated Electric Laboratories of Chicago.

V. F. Greaves has been transferred from Washington to become chief inspector of the San Francisco office of the Federal Communications Commission.

Previously with Mullard Radio Valve Company, D. L. Hall has joined the staff of Cosmos Lamp Works, Ltd., of Brimsdown, Middlesex, England.

Guy Hill, Captain, U.S.A., has been transferred from Fort Monmouth to Patterson Field, Fairfield, Ohio.

J. H. Hinemon, Jr., Major, U.S.A., has been transferred to the War Department in Washington, D. C., from Fort Monmouth.

A. H. Hodge formerly with the Bureau of Standards has become a physicist at the Aberdeen Proving Ground, Aberdeen, Md.

I. J. Kaar has been transferred from Schenectady to the Bridgeport plant of the General Electric Company.

G. W. Kenrick of Tufts College, Mass., has joined the faculty of the University of Puerto Rico at Rio Piedras, P.R.

C. G. Lacombe previously with Companhia Radio Internacional do Brasil has become technical director of Radio Cinephone Brasileira, S.A. at Rio de Janeiro.

Formerly with George Brown and Company, J. C. Miller has established Millers Wireless in Edinburgh, Scotland.

M. C. Partello, Lieutenant Commander, U.S.N., has been transferred from the Philippine Islands to commanding officer of the U.S.S. Biddle basing at San Diego, Calif.

TECHNICAL PAPERS

THE WLW 500-KILOWATT BROADCAST TRANSMITTER*

Summary—In this paper the design, installation and, performance of the highest power broadcast station at present in America is described.

Considerations underlying WLW's decision to increase power are mentioned. The station is unique in a number of respects, the most outstanding being the high level class B modulator producing audio-frequency outputs of 350 kilowatts, the "isolation" operation of the control circuit, and the concentric transmission line.

The vertical radiator is pictured and data are presented comparing its performance to that of a standard T antenna immediately adjacent. The more important performance characteristics of the transmitter and antenna are given.

INITIAL CONSIDERATIONS

THE 500-kilowatt broadcast transmitter at Station WLW in Cincinnati was placed in regular operation on May 2, 1934.

This transmitter is of considerable interest to engineers, not because of the high power alone, but also because of the many unusual circuit and control devices incorporated.

WLW has consistently maintained its position as one of the most powerful broadcast stations in the United States, having been the first commercial broadcast station to utilize successive stages of increased power. It therefore is not surprising that this station, owned and operated by the Crosley Radio Corporation, is the first in this country to install a 500-kilowatt transmitter. Increased power is the most effective "static eliminator" yet devised.

The continuous improvement of transmitter and receiver design, with much improved receiver selectivity, has materially reduced adjacent channel interference. In addition, radio listeners have gradually

* Decimal classification: R612.1. Original manuscript received by the Institute, June 25, 1934. Presented before Ninth Annual Convention, Philadelphia, Pa., May 28, 1934.

Note: This paper was prepared by J. A. Chambers, Crosley Radio Corporation, in cooperation with L. F. Jones, RCA Victor Company, Inc., who prepared the sections devoted to the general engineering features and performance of the equipment; G. W. Fyler, General Electric Company, who described the radio-frequency power amplifier and antenna coupling system; R. H. Williamson, of the General Electric Company, who described the main rectifier and control circuits; E. A. Leach, of the General Electric Company, who prepared the section describing the physical layout; and J. A. Hutcheson, Westinghouse Electric and Manufacturing Company, who described the audio amplifier and modulator, as well as the cooling system and rotating equipment.

but surely changed their standards so that they now desire the high quality signal of considerable intensity in preference to their previous desire to hear stations on every channel irrespective of distance and quality. With present receivers, increased power is capable of improving the service rendered without creating appreciable interference. Furthermore, with the general use of automatic volume control in receiving sets, increased power of the broadcast station reduces fading in cases where the signal would otherwise fade below the noise level.

WLW, located near the center of population of the United States, endeavored to supply broadcast service to the millions of listeners located in rural communities and small cities, listeners who were at such distances from high quality broadcast stations that "secondary coverage" must be relied upon. In accordance with this endeavor, the WLW program policy of the last several years has been designed to serve a scattered audience rather than a highly concentrated audience.

It is assured that the service rendered by the use of 500 kilowatts will, in the case of WLW, justify its commercial operation. It is realized that the major audience increase will be in the secondary coverage area.

Preliminary plans to install a 500-kilowatt transmitter were started nearly four years ago. It was felt that 500 kilowatts was the next logical step above 50 kilowatts as any lesser increment of power would have shown relatively small improvement, whereas a greater increment would have involved large technical and economic risks. In May, 1932, the Crosley Radio Corporation application was filed with the Federal Radio Commission for a 500-kilowatt construction permit and was granted in the following month. The 50-kilowatt transmitter was to be retained as an exciter for the 500-kilowatt amplifier, with a means for switching from 50 to 500 kilowatts.

The total cost of the installation, including the equipment, the necessary addition to the building and the installation expense, but excluding the already existent 50-kilowatt exciter and the building housing it and studios or studio equipment, was approximately \$500,000. It is expected that the annual cost of material operation, including tube replacement, power cooling water, etc., will be \$170,000. This is based on twenty hours of operation daily. This figure does not include engineering personnel, depreciation and insurance, or any expenses related to studios or studio operation. The use of class B high level modulation resulted in a power saving of approximately \$25,000 annually as compared to a radio-frequency linear amplifier. The yearly operation cost of \$170,000 corresponds to approximately \$23.00 per hour, which is obviously quite low as compared with the over-all operating expenses of the station.

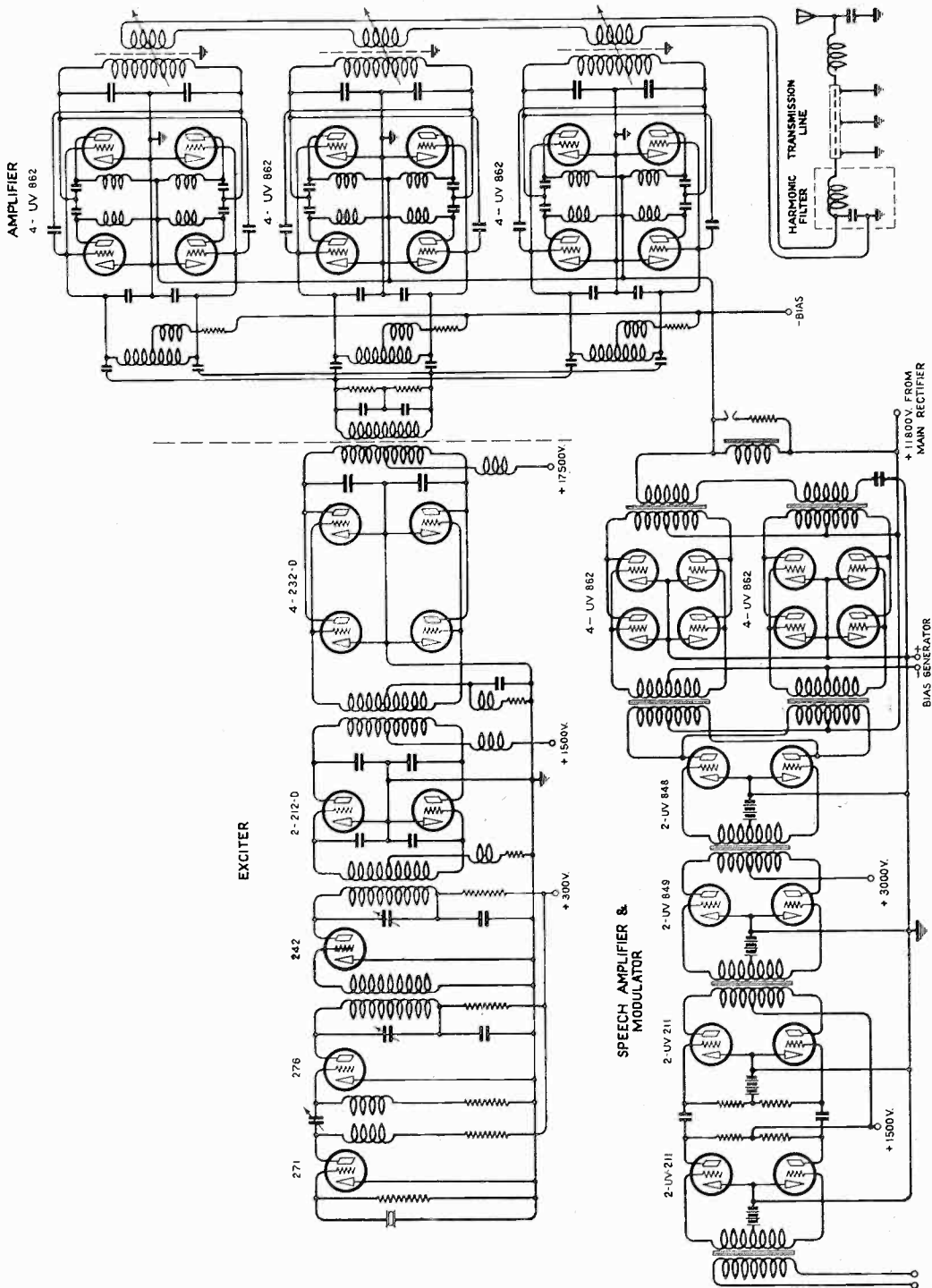

Fig. 1—Simplified schematic diagram.

GENERAL DESIGN

After analyzing several possible circuits it became apparent that the use of high level class B modulation offered important advantages, particularly economy of first cost and economy of maintenance. To insure reliability, it was decided to divide the power amplifiers into three units and to divide the modulators into two units, and to arrange for the automatic isolation of any unit in which a tube or any part becomes defective. (See Fig. 1.) The result is that a defect in a modulator or a power amplifier, regardless of whether this defect is merely a burned-out tube or something more serious, causes a minimum of interference with the program. Each modulator and each power

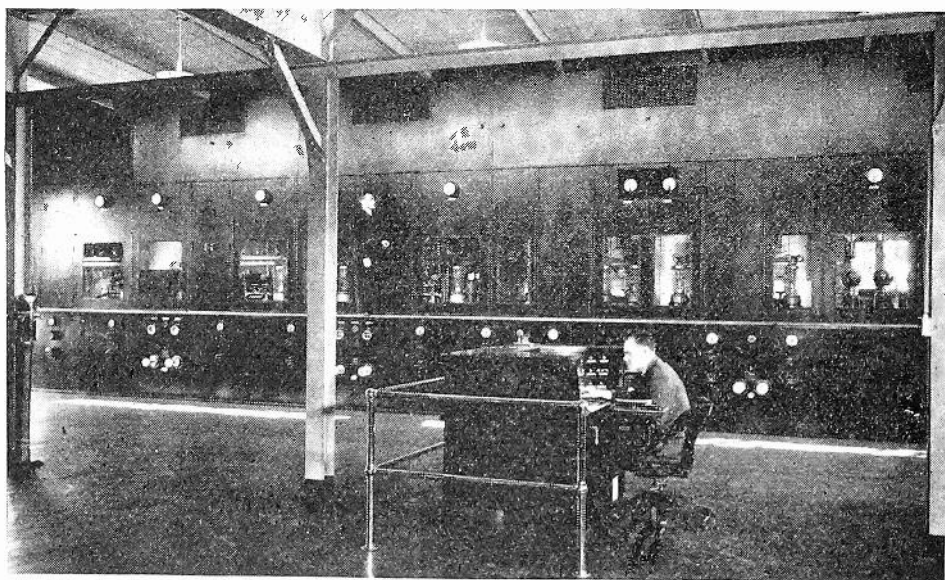

Fig. 2—General view of 500-kilowatt amplifier panel. Amplifiers are to the left, modulators to the right, and main rectifier to the extreme right.

amplifier unit employs four UV-862 tubes in push-pull. There are therefore twelve 100-kilowatt power amplifier tubes and eight 100-kilowatt modulator tubes. All tubes operate at a plate voltage of approximately 11,800 volts.

Conventional layout practice is followed in that all audio and radio equipment proper is located behind interlocked panels on the upper floor, whereas all rotating and power equipment is located in the basement, except for the larger transformers and reactors which are outdoors. The main panel of the transmitter is approximately fifty-five feet long and thirteen feet high. (See Fig. 2.) It is divided into six distinct, individually shielded and individually interlocked units. From left to right, the first three units contain the three power amplifiers, the next two units contain the modulators, and the last unit contains

the main rectifier. The low power audio stages are located behind the modulator units. All of the water controls, including valves, interlocks, and thermometers, and all main tuning controls are located on the front of the main panel. All controls that are used frequently in starting and stopping the equipment are located on the control console.

The main rectifier furnishes voltage for all of the 100-kilowatt tubes and for the 20-kilowatt high power audio tubes. Plate voltage for the lower power audio stages is supplied by a 3000-volt rectifier. For the main rectifier there was developed a new type of tube, the RCA-870. The cathode of this tube requires only 325 watts for heating but produces an actual emission close to 1500 amperes.

To minimize the radiation of radio-frequency harmonics, which are an increasing source of interference from broadcast stations, a low-pass filter is provided between the amplifier output and the transmission line. To reduce further the possibility of harmonic radiation, a concentric transmission line is used. It is supported one foot above the ground and its outer conductor is grounded every twenty feet at the transmitter end of the line. The line termination and antenna tuning circuit is of the simplest type. It forms another stage of low-pass filtering. It has proved itself to be impervious to lightning, having been struck many times.

The operation of the isolation feature of the control circuit is briefly described as follows: If a short circuit occurs in a power amplifier unit (or modulator unit) the plate overload relay associated with the particular tube through which the overload takes place immediately causes the main breaker to open. The total elapsed time from the occurrence of the short circuit to the complete interruption of the 2300-volt primary supply and the extinguishing of the arc is four cycles, whereupon the transmitter immediately goes back on the air. If the short circuit has in the meantime disappeared, operation continues in the normal manner. However if the short circuit persists, the transmitter again shuts down until the defective power amplifier unit has been automatically isolated from the remainder of the circuit, after which the transmitter automatically goes back on the air with a power of about 350 kilowatts. The entire time off the air does not exceed three seconds. A similar sequence of events takes place when a modulator unit isolates, except in this case the equipment goes back on the air after several seconds with full power but with somewhat reduced modulation. It is entirely possible, without any retuning or readjusting of any kind, to operate the equipment with three power amplifiers and two modulators, two power amplifiers and two modulators, two power amplifiers and one modulator, one power amplifier and one

modulator, or three power amplifiers and one modulator. When a unit has been isolated it may be entered with complete safety and the filament supply and water supply may be turned off for tube replacement, or other repairs may be made. Each amplifier and each modulator constitutes a complete unit with its own shielding, internal lighting, doors, water interlocks, and forced ventilation.

The major units of this transmitter will be described in more detail in the following sections of this paper.

SUBSTATION

Since continuity of operation and general performance of the station depend upon uninterrupted supply of properly regulated power, the power supply system and associated substation were carefully engineered with the cooperation of the Union Gas and Electric Company of Cincinnati. Two 33-kilovolt lines supply power from separate distribution centers and come to the transmitter location over widely separated routes. The substation includes an automatic induction voltage regulator as well as the necessary transformers, lightning arresters and associated equipment required to make available about 1250 kilowatts at 2300 volts and lesser powers at 440, 220, and 110 volts.

Automatically operated oil circuit breakers in each of the 33-kilovolt lines normally connect both lines to the substation input at all times. The control of these breakers is such that any irregularity in either of the power supply lines causes that breaker to open, allowing uninterrupted service from the other line. The opened breaker automatically recloses when power of the proper potential and phase is restored. These breakers may be controlled by push buttons in the transmitter control room when desired.

The use of high level class B modulation introduces a power problem in that there is variation of about 500 kilowatts in the power required by the transmitter occurring at a syllabic frequency. Excessive reactance in the power supply system would result in a type of modulation distortion. It therefore was necessary to use low reactance transformers and regulators and to keep the reactance of the entire system as low as possible. This introduced a protective problem inasmuch as the reactance of the lines and the substation could not be depended upon to limit properly the amount of energy fed into a major fault. To afford suitable protection under these conditions, the main breaker is rated at 50,000 kilovolt-amperes and is designed to open at a higher speed than ever previously used for breakers of this rating.

PHYSICAL LAYOUT

The physical layout is one of the most important phases of any transmitter of this type and in this case the size of the apparatus made some of the older constructional ideas look incongruous. The transmitter was made an integral part of the building, and consisted of five separate rooms. This method resulted in a certain constructional gain as the steel uprights within the walls of the rooms were also used to support the roof of the building, thereby using one member to serve

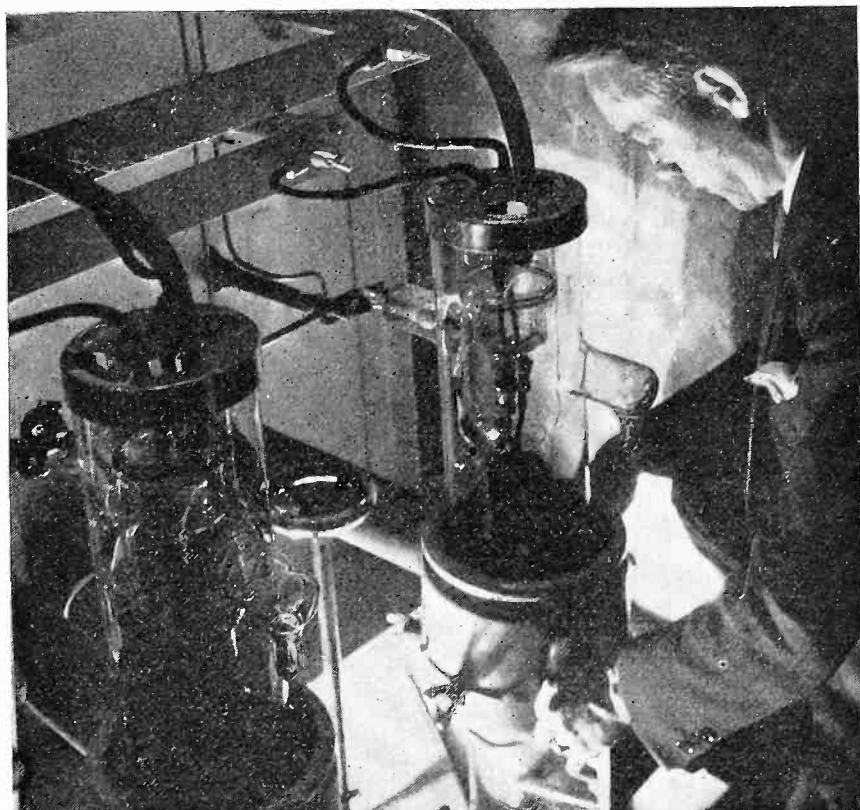

Fig. 3—Clamping a 100-kilowatt tube into its socket.

two functions. Each room or cell is entirely shielded as a unit and these shielded rooms are electrically bonded at numerous points.

The front panels of the transmitter are offset at a horizontal level four feet above the main transmitter floor, thus forming a platform or catwalk running the entire length of the front assembly. Within each cell is an inner catwalk at this same level which furnishes a place to stand to replace tubes, operate filament switches, etc. (See Fig. 3.) The outer catwalk is three feet wide and has covers which are easily removable so that access may be gained to those parts located beneath them. Under the catwalk are housed all of the internal water piping,

hose reels, and water temperature and flow instruments. This arrangement of water circuits provides an accessibility heretofore unknown in most broadcast transmitters. The controls are located on the four-foot high panels which run along the front of the transmitter just below the catwalk. All normal adjustments are made from the floor level.

The upper panels form the major frontal surface of the transmitter and are fitted with plate glass windows at eye level. In these upper front panels there are access doors for each cell, opening at catwalk level.

In the construction of the three identical radio-frequency amplifiers several unique features have been evolved. The problem of radio-frequency insulation made it necessary to resort to new styles of insulator design with particular attention given to the prevention of brush discharge. Long-bar green-tint Mycalex was produced by the General Electric Company for this specific application. Specially designed corona shields were added to Mycalex insulators to distribute more evenly the electrostatic gradients. Throughout the amplifier construction particular care was given towards maintaining mechanical symmetry. In addition to this every effort was made to keep the radio-frequency circuits as short as possible. Stray capacities of parts operating at high electrostatic potentials were kept low by grouping, thus tending to reduce the over-all volume to a minimum.

AUDIO AMPLIFIER AND MODULATOR

The problem presented in the design of the modulation system was unique in several particulars. In the first place the power required of the system was at least ten times greater than that ever before obtained from any audio amplifying system. Furthermore, the fidelity of the system had to be in keeping with the present standards if not somewhat in advance of them. Finally, the output power had to be obtained at an efficiency which was as high as possible. These main requirements governed the design of the modulation system.

After considerable thought had been given to the problem, the following arrangement was decided upon. There are five stages, each stage being connected in "push-pull." The input stage employs two UV-211 tubes. The plate circuit of this stage is coupled by means of a resistance-capacity network to the grid circuit of the second stage, which also uses a pair of UV-211 tubes. The output of the second stage is transformer coupled to the grid circuit of the two UV-849 tubes, which are used as the third stage. In the same manner, the output of the third stage is coupled to the grids of the two UV-848 tubes constituting the fourth stage.

Since the fifth or modulator stage is divided into two units, either one of which must be isolated at times, separate interstage transformers are used to couple the fourth stage to each unit of the fifth stage. These transformers weigh over two tons each. The fifth stage is transformer coupled to the load circuit by means of two identical transformers. These output transformers are rated at 180 kilovolt-amperes each at any frequency from 30 to 10,000 cycles. They are oil-immersed and weigh approximately nineteen tons each. The height over all is approximately eleven feet. The case around each unit is elliptical in shape, having a maximum dimension of seven feet and a minimum dimension of four and three-fourths feet. The direct-current component of the power amplifier plate current is passed through a modulation reactor rather than through the secondary windings of the transformers. The reactor has 4.5 henrys of inductance at 60 amperes. A 50-microfarad, 15,000-volt condenser is connected in series with the transformer secondaries for blocking purposes. The reactor is similar in shape to the modulator output transformers but weighs only twelve tons. The direct-current resistance of this reactor was made especially low to minimize heating losses.

With an input to the power amplifiers of 700 kilowatts, the output power of the modulation system required to give 100 per cent modulation is one half the input power or 350 kilowatts. The power input required for 100 per cent modulation is 12.5 milliwatts. This corresponds to a power amplification of 28,000,000 times.

Current limiting resistors are connected in series with the plates of each of the modulator tubes. These resistors are of such a size as to limit the surge current to approximately 1000 amperes. The power to be dissipated in them is, therefore, 12,000 kilowatts for a time of about one twelfth of a second. To prevent extremely high voltages from appearing across the modulation reactor when the normal plate current for the power amplifiers suddenly decreases in value, a horn gap with a series resistor is connected across the reactor. Had this not been done, it is calculated that voltages in the order of 60 to 80 kilovolts would appear across the reactor if the excitation to the power amplifiers failed suddenly. When a tube flashes internally, approximately the full plate voltage may appear momentarily across the bias supply. To prevent damage to the bias generator, it is by-passed with electrolytic type lightning arresters. These arresters are designed to carry 1000 amperes safely for a short time, and to keep the voltage from building up to more than twice the rating of the machine.

Power for the plate circuit of the first three stages is obtained from a 3000-volt, 2.5-ampere rectifier using six UV-872 type tubes in a conventional circuit.

POWER AMPLIFIER

The radio-frequency amplifier, designed and manufactured by the General Electric Company, is composed of three identical unit amplifiers, each delivering approximately 167 kilowatts carrier power. Each amplifier is complete in itself with its own radio-frequency and power circuits. (See Fig. 4.) The four UV-862 tubes in each amplifier are connected in push-pull. The cooling water is fed through special rubber hoses coiled up on a cylindrical form insulated for 50,000 volts

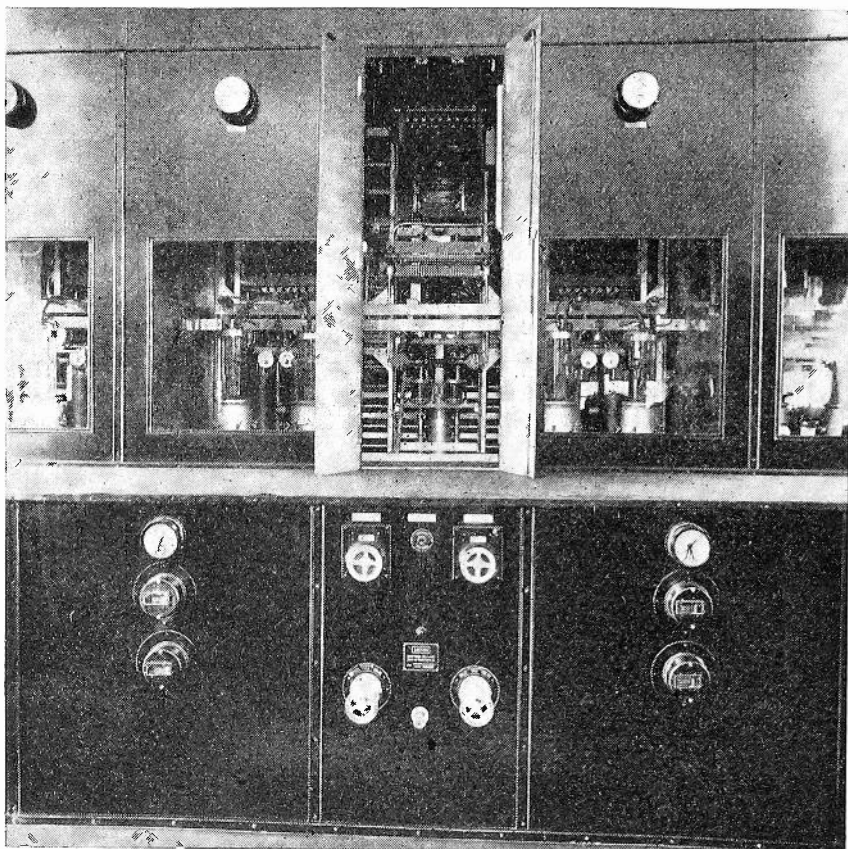

Fig. 4—Front view of power amplifier No. 2, doors opened.

peak potential. The water flowing through each tube is measured by a flow meter having electrical contacts which shut down the transmitter and remove all power from the tubes if the water flow should fall below a specified value. The temperature of the outlet water from each two tubes is checked by a contact-making thermometer which is appropriately connected to the control circuit. Thus the cooling water of each tube in the transmitter is automatically and continuously checked.

Cooling air is supplied to the filament and plate seals of each UV-862 tube. This air supply is checked by an electrical contact-making

device which insures protection to the tubes in the transmitter if the air supply should fail. Approximately 30 cubic feet of air per minute must be supplied to each tube anode and filament seal. A total of 3000 cubic feet per minute is available for cooling the various component

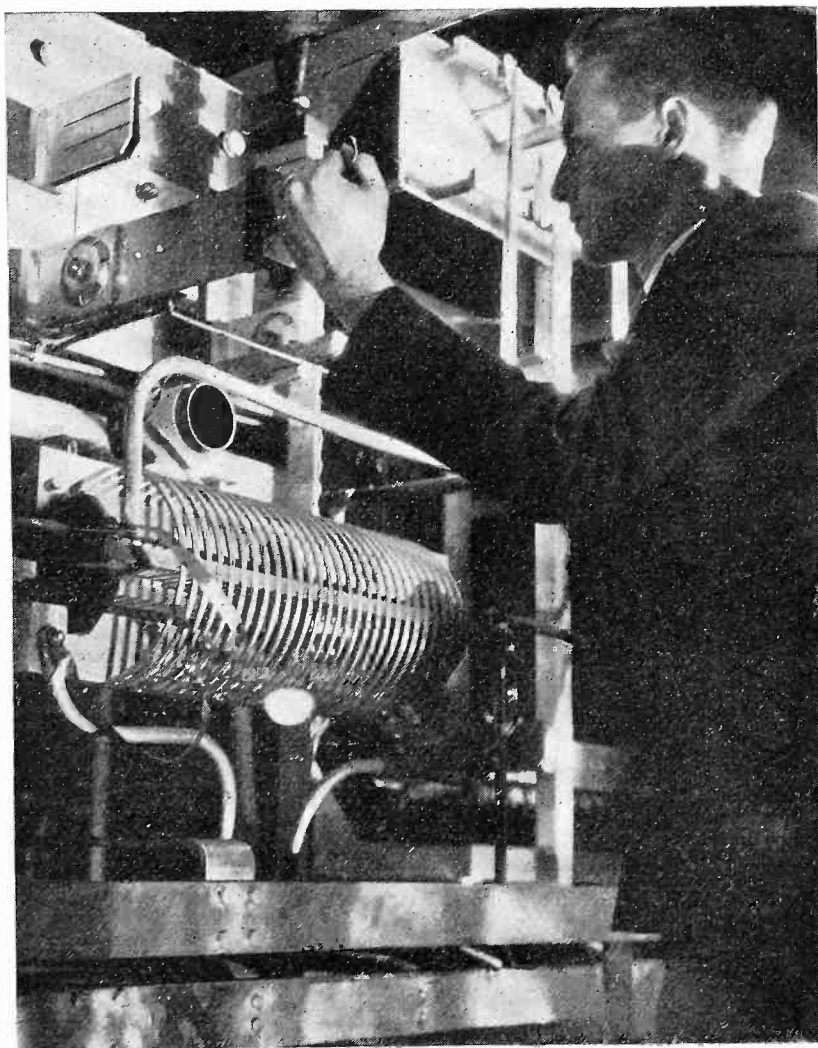

Fig. 5—Detail of filament switch and grid inductance assembly in each power amplifier.

parts of the three amplifiers. Air is drawn out of the top of each amplifier unit by a power-driven fan.

The filaments of the amplifier tubes are lighted from three direct-current generators at a potential of 33 volts. Each tube draws 207 amperes at this voltage. The total filament current for the three amplifiers and both modulators is approximately 4150 amperes. A current limiting resistor is connected in series with the voltage supply

circuit to permit gradual heating of the tube filaments in a unit after a tube has been changed.

The bias voltage is derived from a bias generator and self-biasing resistors connected in series with the bias circuit in each unit amplifier. The bias and filament generator voltages are adjusted by rheostats and measured by meters on the operator's control console. The total rectified grid current is measured in each amplifier by a meter on the amplifier panel.

Plate voltage is supplied to each tube through its associated plate choke, which is wound on a glass form. The plate current is measured by a specially developed highly damped meter connected in the plate circuit of each tube. Surge currents in the plate circuits of the amplifier tubes due to internal gas flashes are kept within reasonable limits by individual plate protective resistors having adequate thermal capacity to absorb the stored energy in the rectifier filter and in the modulation reactor, and the energy supplied by the rectifier in the short interval before the rectifier circuit breaker opens. Each amplifier tube has its own plate current overload relay.

The grid excitation circuits for the three amplifiers are connected in parallel and the output coupling coils are in series. After passing through the grid-loading resistor unit, the 500-kilowatt amplifier balanced grid line is shielded and split into three lines of equal length which lead to the amplifier grid tank circuits. The individual amplifier grid lines are made equally long to insure grid excitation voltages in phase and to simplify the tuning and loading of the amplifiers. The three grid tank circuits are permanently adjusted to be resonant at the operating frequency. (See Fig. 5.)

Fixed mica-dielectric neutralizing capacitors are used in the conventional balanced neutralizing circuit. This is believed to be the first commercial application of fixed neutralizing capacitors in a broadcast transmitter. The plate tank capacitor of each amplifier consists of two identical air-dielectric capacitors with their center point grounded. This capacitor is unique in broadcast transmitter practice since the plates of the capacitor are made of grids of aluminum tubes. The aluminum tubes are flattened and riveted at their ends to an aluminum angle support. Alternate plates are supported by vertical aluminum pipes. Mycalex insulation is used. The capacitors have been tested for flashover at 50,000 volts, 60 cycles, and normally operate with 7500 volts root-mean-square carrier.

The radio-frequency plate tank inductance consists of copper tubing bent into a spiral or "pancake" coil. (See Fig. 6.) Tuning of the amplifier plate circuit is accomplished by variation of the position of

a half turn of the tank coil about an axis in the plane of this coil, with the control on the front panel. The Q of the tank inductance is over 1200. The secondary or coupling coil consists of a similar spiral-wound coil coupled to the tank coil, with its position with respect to the tank coil adjustable by a control on the front panel. An electrostatic shield

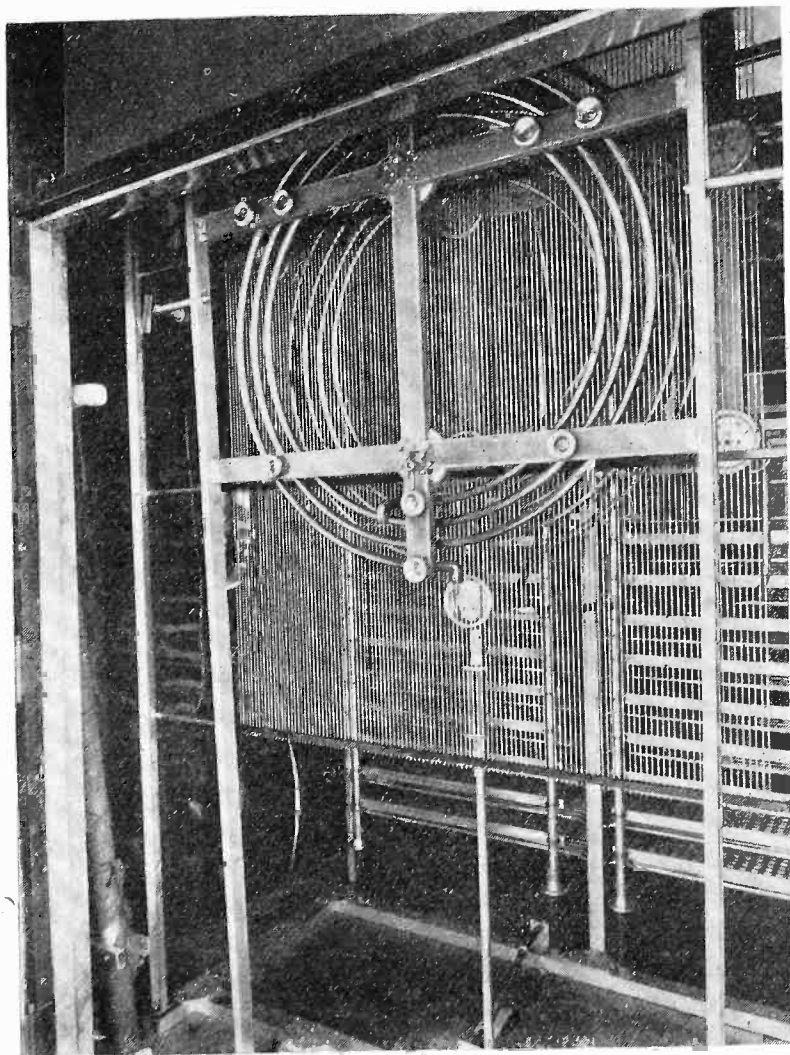

Fig. 6—Rear view of a power amplifier showing tank and coupling coils, electrostatic shield, and air dielectric tank condensers.

consisting of a number of parallel conductors in a plane, joined together and grounded at one end, is interposed between the tank and coupling coils to reduce the electrostatic coupling between these two coils.

The harmonic filter unit is located in the basement below ground level. It consists of a single T section low-pass filter with the three amplifier coupling coils forming the first inductive section. The input

circuit of the harmonic filter may be switched either to the 50-kilowatt output circuit or to the 500-kilowatt set. (See Fig. 7.)

The concentric transmission line which transmits the power to the antenna house is 780 feet long and is constructed close to the ground to reduce its effective height for harmonic radiation. (See Fig. 8.) It is well grounded at short intervals near the transmitter end. The

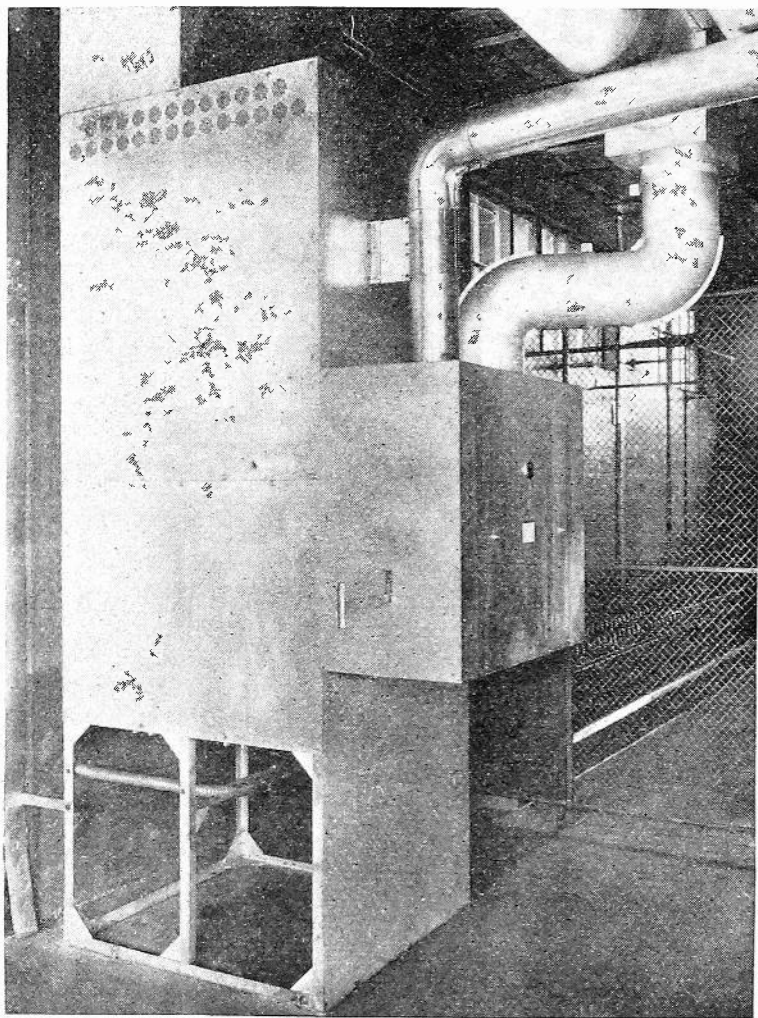

Fig. 7—Harmonic filter.

surge impedance of the line is 100 ohms, thereby making the line voltage 7070 volts and the line current 70.7 amperes for unmodulated 500 kilowatts. A surge impedance of 100 ohms was decided upon after a study of flashover potentials in this type of concentric line and after antenna resistance measurements were made. The ratio of outside to inside diameters for optimum flashover potential in a practical line is greater than the theoretical ratio $e = 2.718$ due to the necessity of using corona shields in conjunction with the inner conductor insulators. The

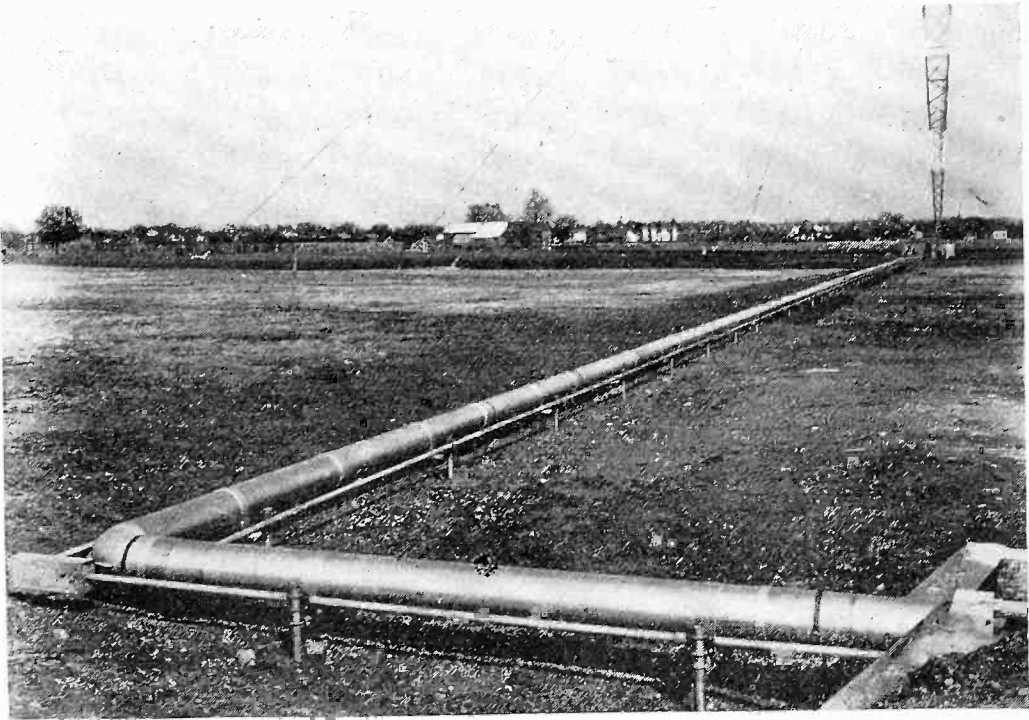

Fig. 8—Seven hundred and eighty foot concentric tube transmission line.

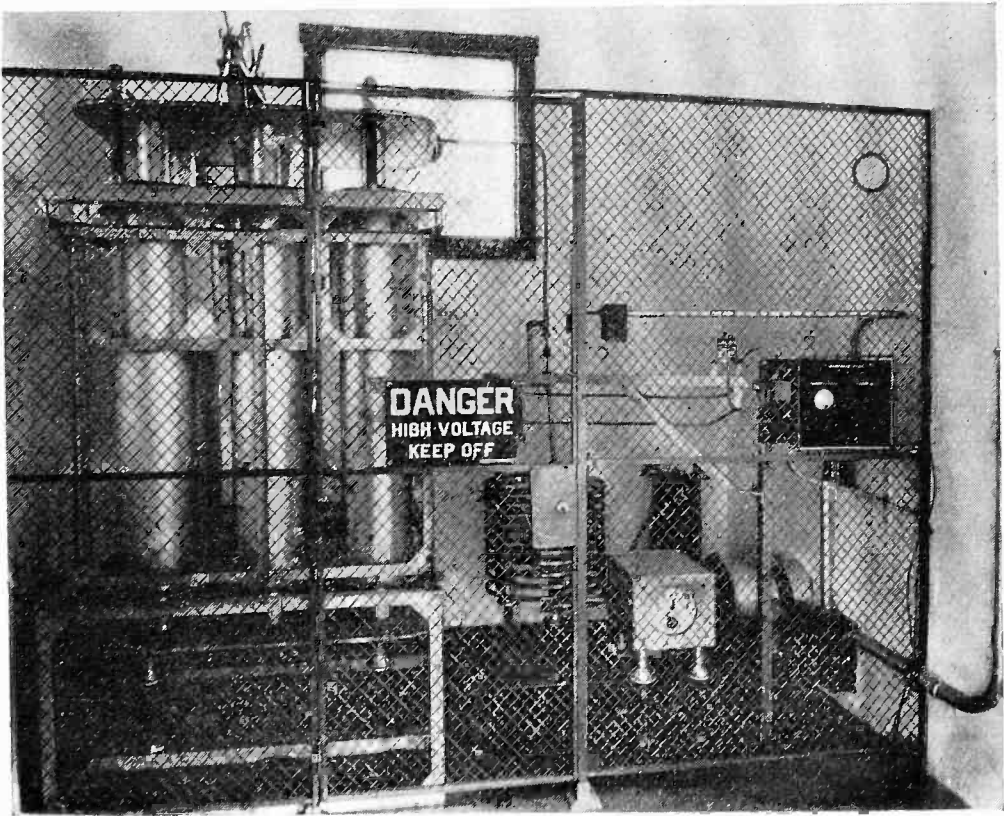

Fig. 9—Antenna tuning house equipment.

line is constructed of aluminum tubing. The outer tube is 10 inches in diameter and the inner concentric tube 1.875 inches in diameter. The joints of both tubes are at ten-foot intervals and are designed to take care of longitudinal thermal expansion.

ANTENNA COUPLING EQUIPMENT

The antenna house equipment is shown in Fig. 9. The transmission line is terminated in a simple impedance matching circuit consisting of an inductance coil between line and antenna, with a capacitor to

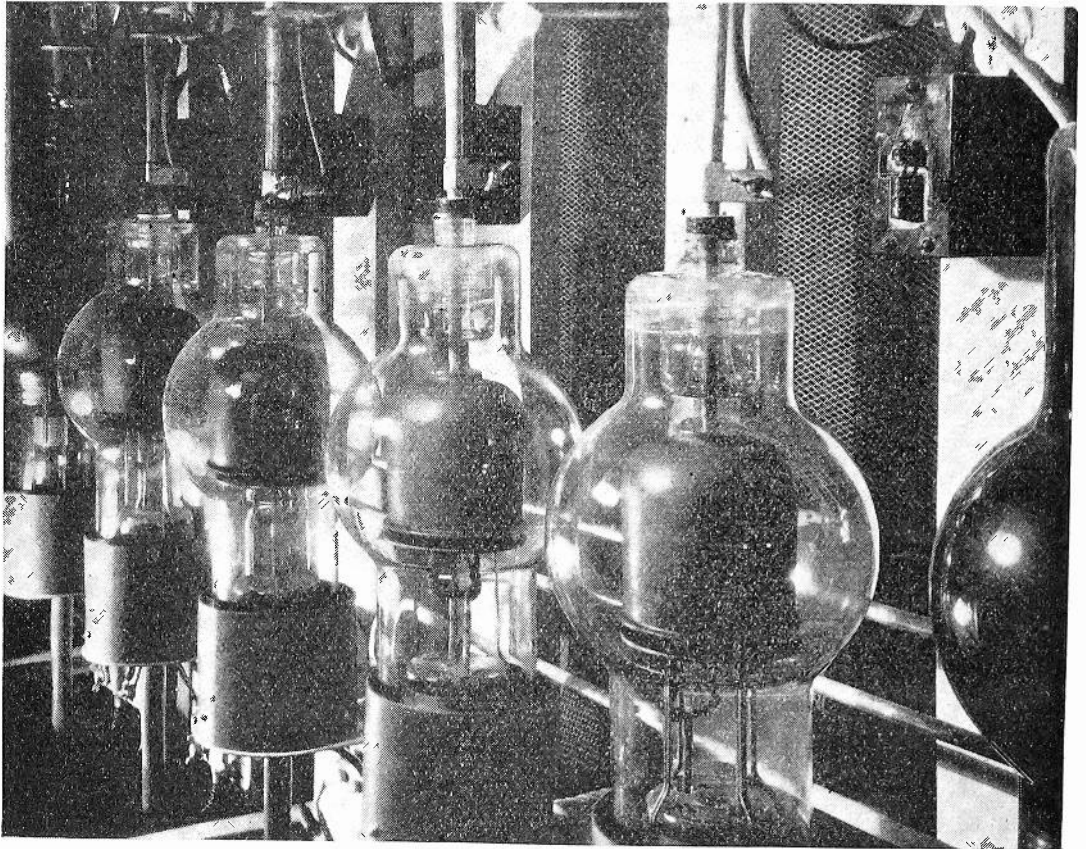

Fig. 10—RCA-870 tubes in 1250-kilowatt main rectifier.

ground from the antenna. The antenna-ground capacitor consists of six concentric tube units with the outer tubing of each unit 10 inches in diameter and the inside tube about one third as large. The voltage on the base of the antenna for 500-kilowatt output is approximately 14,000 volts root-mean-square with zero modulation. The capacitor was tested for flashover at 80,000 volts at 60 cycles. It is variable, and in conjunction with the antenna impedance and the series inductance, it permits the line to be terminated in a resistance of 100 ohms.

It is interesting to note that the size of the terminating equipment is only about one half that usually used in a 50-kilowatt transmitter.

It is believed that the concentric transmission line is being used for the first time in a high power broadcast transmitter in the United States, and that this line is the longest and largest in the world.

MAIN RECTIFIER

Plate power for all water-cooled tubes in the equipment is supplied by the main rectifier. Sufficient rectifier capacity has been provided in the main rectifier to supply plate power to the output stage of the 50-kilowatt exciter if desired.

Six RCA-870 hot-cathode, mercury-vapor rectifier tubes are used in the main rectifier (see Fig. 10), each approximately 24 and one-half inches long. The maximum peak inverse voltage rating of these tubes is 16,000 volts and the maximum instantaneous anode current is 450 amperes. The average anode current rating is 75 amperes, provided that the operating frequency is 25 cycles or more. These tubes are operating considerably under their maximum rating in this application.

The rectifier circuit employed is essentially the three-phase, full wave arrangement described previously by Steiner and Maser.¹ Three single phase plate transformers are used, weighing about 7000 pounds each. The primaries may be switched to either Y or delta connection by means of two solenoid operated oil circuit breakers. This scheme permits warming up or testing the equipment with the plate voltage lowered to approximately 7000 volts. Each plate transformer is provided with a manually operated primary tap changing switch to obtain output voltages five and ten per cent above and below the two normal values. The rectifier circuit differs slightly from the conventional three-phase, full wave connection in that the plate transformer secondaries are connected in delta. This arrangement provides one set of delta windings between the rectifier and the supply line for low voltage testing and two delta connections for full voltage operation of the rectifier, thus reducing third harmonics of supply frequency and odd multiples thereof in the power lines supplying the station.

The rectifier could be given a continuous output rating of 1250 kilowatts, but the nature of the load under conditions of varying percentage modulation makes this type of rating of little value as a criterion of performance. The direct-current load current varies from about 70 amperes at zero modulation up to approximately 110 amperes for 100 per cent sustained modulation, due to the class B operation of the high level modulator stage.

For this type of load, it is of prime importance that the rectifier

¹ H. C. Steiner and H. T. Maser, "Hot-cathode mercury-vapor rectifier tubes," *Proc. I.R.E.*, vol. 18, p. 80; January, (1930).

voltage varies a minimum amount. Factory tests on the three plate transformers indicate that the average alternating voltage drop for this load variation was 0.88 per cent of normal voltage, at 90 per cent power factor. The resistance of all circuit elements between the rectifier tubes and the modulator load is kept at a minimum. The reactance of all circuit elements on the alternating-current side of the rectifier is kept at a low value.

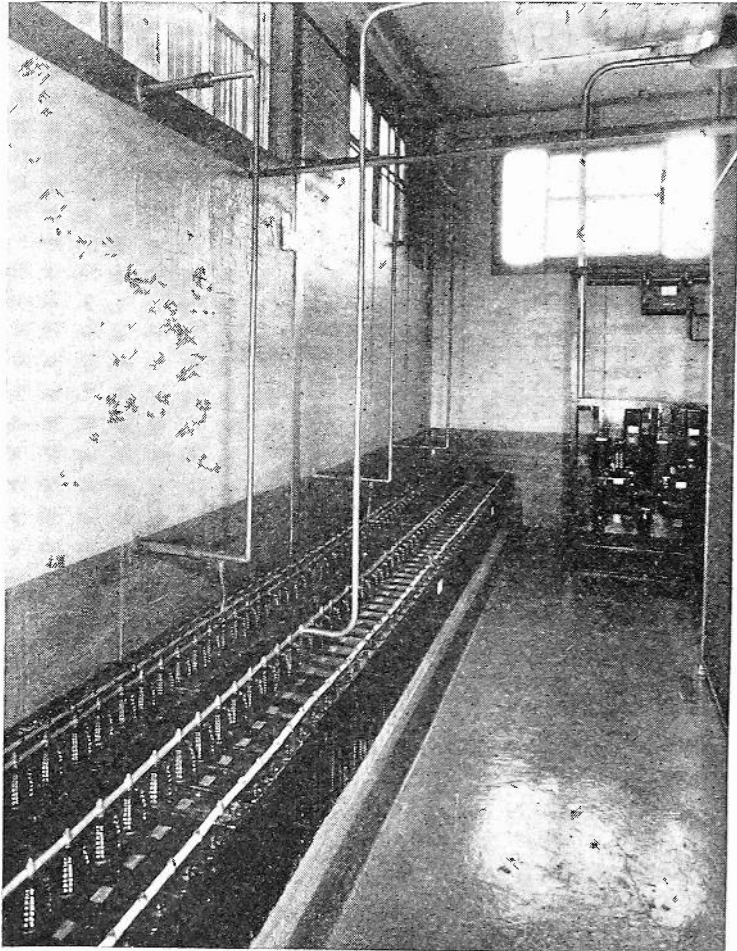

Fig. 11—Main filter condenser.

Since there is so little regulation producing impedance in the rectifier power supply and the rectifier itself, it was mandatory that high speed circuit protection be provided in case of rectifier tube arc-back or overload on the rectifier output. This was provided in the form of a specially developed high speed, solenoid operated oil circuit breaker. Factory tests showed that this circuit breaker required an average of 2.2 cycles (on a 60-cycle basis) from the energization of the trip coil to the parting of the contacts. The over-all time from the beginning of the overload to the actual interruption of the current in the 2300-volt

supply is about double this value, since relay time and arcing time at the power contacts must be included.

The rectifier proper is not required to supply power at an audio-frequency rate because the filter capacitor has adequate stored energy for this purpose. The filter capacitor bank is rated 171 microfarads, 15,000 volts direct current and is composed of 114 paralleled, 1.5-microfarad capacitor units of the Pyranol type. (See Fig. 11.) Direct current is blocked off the secondaries of the modulation transformers by a bank of 33 identical capacitor units. Considerable progress has been made in the reduction of space requirements for this type of capacitor since the dimensions of a single unit are $4\frac{1}{4}$ by $13\frac{1}{2}$ by $17\frac{1}{4}$ inches high over the terminal. A one-fourth henry reactor completes the rectifier output filter. The ripple in the direct load current is extremely low and the radio-frequency carrier ripple from all sources is approximately 66 decibels down from 100 per cent modulation. The resonant frequency of the filter system, including the modulation reactor and other elements in the power amplifier plate supply circuit, is about 26 cycles, which is well below the usable audio range. A high-pass filter is incorporated in the audio input system to prevent the possibility of frequencies as low as this from being supplied to the modulator. The possibility of audio distortion due to inadequate filter capacity has been previously suggested by Kaar.²

A starting resistor is used in series with each of the three 2300-volt, 3-phase, 60-cycle lines to the plate transformer primaries. These resistors are used to absorb the switching transient, and are automatically short-circuited by means of a solenoid operated oil circuit breaker after they have been in the circuit about one second.

The RCA-870 rectifier tube utilizes an indirectly heated type of cathode. The heater, which requires 65 amperes at 5 volts, must be energized 30 minutes before the application of plate voltage to insure adequate cathode emission and correct operating temperature of the mercury vapor. Provision was made in the control circuit of the rectifier to turn on the cathode heaters at a predetermined time each morning by the use of an automatic time switch. Provision is made to remove heater voltage at the end of the thirty-minute heating period if the rest of the equipment is not started up. It is also possible to preset the switch so as to omit automatic application of voltage any desired days each week. In normal starting, a direct-current motor-operated time delay relay prevents the application of plate voltage until the cathodes have heated thirty minutes.

² I. J. Kaar, "Adjacent channel interference," *Proc. I.R.E.*, vol. 22, p. 312: March, (1934).

Rectifier filament voltage is applied in two steps to prevent high initial inrush current. Since the entire transmitter is supplied from a voltage regulated source of power, the danger of operating the rectifier filaments at other than rated voltage is not great. However, since operation much below rated voltage is destructive to the tubes, a filament undervoltage warning and protective scheme is incorporated in the design. An induction type undervoltage relay was used since an inverse time characteristic is inherent in its operation; it is not desirable that a warning should be given on line voltage changes of a transient nature. If the primary voltage on the filament transformers drops more than five per cent below normal, a warning bell rings. If the operator has not readjusted the filament voltage after a few seconds, plate voltage is automatically removed. During operation, a spare rectifier tube is warmed up ready to be used in replacing any active tube which might fail.

Preheated air is supplied to the chamber around the base of each rectifier tube. The temperature of this air is thermostatically controlled to insure that the tube will always operate at a nearly constant temperature for which it is designed. A rectifier air temperature indicator is mounted on the front of the rectifier panel. Meters are provided on the front of the panel for rectifier output voltage, total rectifier load current, filament transformer primary voltage, and filament hours.

In common with the doors of all other transmitter units where dangerous voltages are present within, the rectifier access doors are interlocked to remove plate voltage when a door is opened. A safety bar must be raised before an operator can walk into the rectifier compartment. The raising of this bar mechanically operates a switch which disconnects the alternating-current line from the plate transformer secondaries and grounds the direct plate voltage circuit.

This equipment provides the first commercial application of RCA-870 rectifier tubes. It is believed that this rectifying equipment, which can be conventionally rated at 1250 kilowatts, has a higher output current rating than any rectifier previously built for operation at plate voltages as high as 12,000.

COOLING SYSTEM AND ROTATING EQUIPMENT

The cooling system provided to take care of the heat incident to the operation of the equipment may well be divided into two groups; namely, the water-cooling system and the air-cooling system. Each 100-kilowatt tube in the equipment requires about twenty gallons of water per minute. In addition, the cooling system is designed to be adequate for the existing 50-kilowatt exciter. Thus the total amount

of water required to be delivered by the pure water pump is about 525 gallons per minute. The pump is driven by a 20-horse-power motor and is made of bronze and brass. No ferrous materials are used anywhere in the pure water system. The pure water is circulated through two heat exchangers. These exchangers consist of a number of brass tubes fitted into headers at each end. The bundle of tubes thus formed is placed in a large pipe. The pure water is circulated through the brass tubes while the pond water is circulated through the pipe which encloses them. Each heat exchanger has 235 square feet of area across which heat is transferred from the pure water to the pond water. The two exchangers together will take care of 850 kilowatts of heat continuously with a temperature difference of about ten degrees Fahrenheit between the pure water and the pond water.

The pond water is discharged through spray nozzles into a pond seventy-five feet square holding about 120,000 gallons of water. Sixteen spray nozzles are available for use under the most adverse conditions. Provision has been made so that the amount of water flowing to the nozzles can be controlled from a maximum of 800 gallons per minute to any smaller amount desired. For operation in the winter the water is discharged directly into the pond without going through the spray nozzles.

The air-cooling system consists of a single motor-driven blower connected to a duct through which the air is forced. The main duct has branch ducts leading to each plate seal and each filament seal of the twenty UV-862 tubes used in this equipment. Each branch duct is fitted with butterfly valves by means of which the flow of air can be equalized between tubes. The blower is of the centrifugal type and is designed to blow 3000 cubic feet of air per minute against a static pressure of four inches of water. To permit the total amount of air delivered by the blower to be controlled to suit the conditions, the motor used is a direct-current, variable speed motor, rated at approximately three horse power. The speed is varied by means of a rheostat. The rotating equipment, aside from the water pumps and air blower, consists of the shop machine, the filament motor-generators, and the bias motor-generators.

There are three filament motor-generator units. Each motor, rated at 85 horse power at 1175 revolutions per minute operates from the 2300-volt, 3-phase, power supply. The motor is of the "line start" type which requires no voltage reducing device for starting and hence simplifies the starter problem. The generator driven by the motor is rated at 35 volts direct current, 1500 amperes. It is designed for minimum ripple. The ripple amplitude is less than one per cent of the

amplitude of the terminal voltage. The commutator has radiating fins which also act as a blower, keeping air blowing over the commutator bars. Three of these machines were chosen in place of one large machine so that if it becomes necessary to service any unit it will not be necessary to shut down the entire equipment. Each unit has an individual control panel by means of which the machines can be started or stopped independently if desired. An ammeter is supplied for each unit to facilitate load adjusting.

The bias motor-generators are supplied in duplicate, one machine being active and the other held in reserve as a spare. Each unit consists

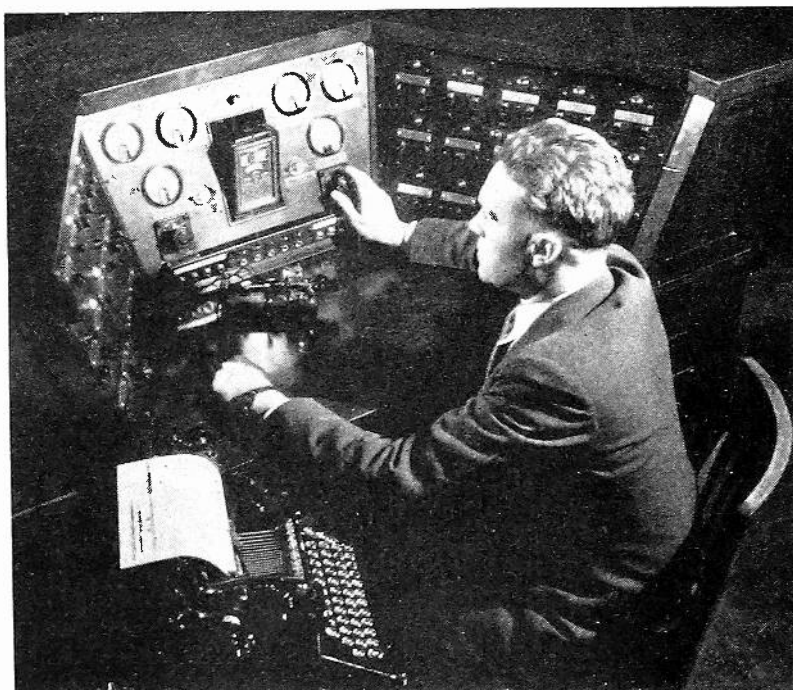

Fig. 12—Operator's control console.

of three generators driven by a common motor. Two of the generators are mounted in one frame. The motor is rated at 17.5 horse power at 1750 revolutions per minute. Of the three direct-current generators, the generator which supplies bias for the power amplifier tubes is rated at 12 kilowatts and delivers 1000 volts. The bias generator for the modulators is rated at 1.2 kilowatts at 100 volts. The generator furnishing bias for the first four audio stages is rated at 0.375 kilowatt at 1500 volts. These machines are designed to have a very low value of ripple voltage. The ripple voltage is less than one per cent of the terminal voltage. One interesting feature of the design is that the bias generator for the power amplifiers and to some extent the bias generator for the modulators really act as motors when the equipment op-

erates normally. Thus the motor normally driving the generators must be capable of acting as a generator supplying power to the 220-volt line.

CONTROL CIRCUIT

The control switches, indicator lights, relays and other devices associated with the automatic sequence and protective control cir-

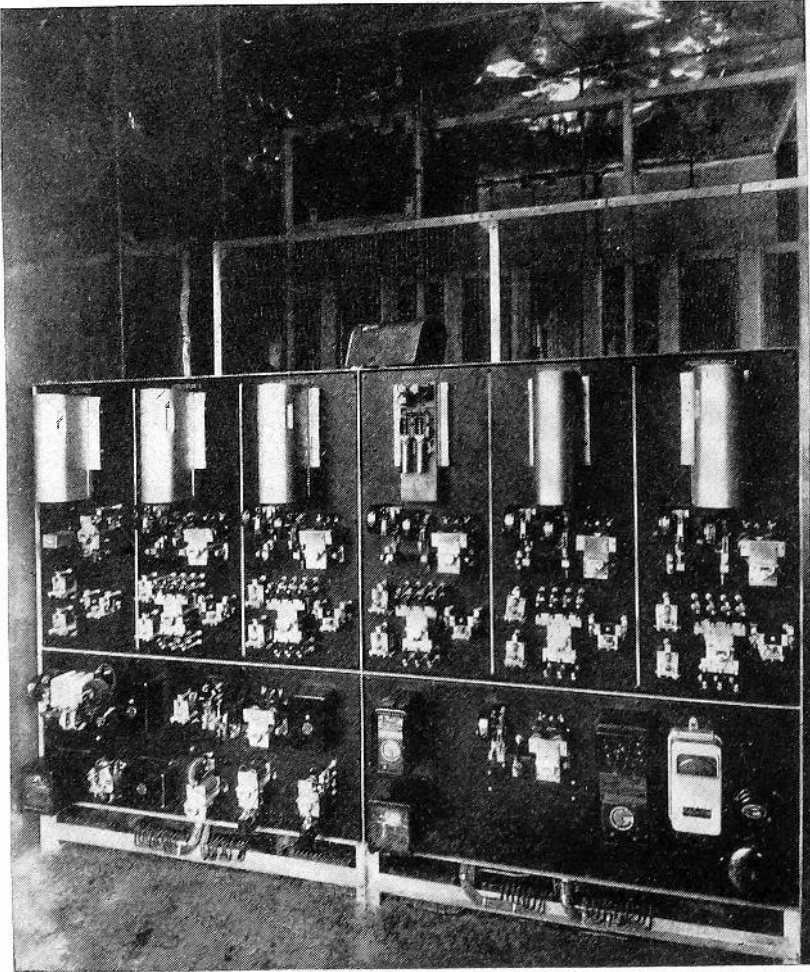

Fig. 13—Control relay panel.

cuits are centralized, rather than being located at various more or less inaccessible places about the transmitter. All of the sequence control switches and voltage changing controls with the associated meters and indicator lights are grouped on the operator's console. (See Fig. 12.) These devices are those normally used by the operator in starting or shutting down the equipment and in making adjustments during operation. The relays and contactors associated with these circuits are located on a control panel behind the main rectifier unit, Fig. 13.

All parts of the control panel and console are noninterlocked. They are completely accessible during transmitter operation. No dangerous voltages are present on either the control panel or the console. Relays having coils or contacts in high voltage or high current circuits are of necessity located at those places in the equipment where the high voltages and currents occur.

The sequence switches located on the console can be preset for automatic start-up of the equipment from a single push button (with the exception of two manual steps) and the equipment can be automatically shut down from another push button. All voltages and cooling agents are applied and removed in the proper sequence. Since the operator will generally wish to check instrument readings as the equipment is being started, sequence switches are provided on the console to permit starting the transmitter automatically, up to any preset status, where it will remain until another manual switch is operated to change the status. These sequence switches may also be utilized in shutting the transmitter down, step by step. The control circuits are so wired that operation of the sequence switches in improper order will result in no damage to the equipment.

No appreciable time delay occurs at shutdown except that the complete water- and air-cooling system operates for ten minutes after voltages are removed from the vacuum tubes, since the elements of the water-cooled tubes have considerable thermal capacity. Complete shutdown is effected by operating the "transmitter-off" switch. Each of the sequence switches is provided with a red indicator lamp which lights when the corresponding status has been reached in manual or automatic starting.

The direct filament voltage and the bias voltages for the radio-frequency power amplifiers, audio amplifier, and modulators may be separately varied and the voltages checked by rheostats and meters located on the console. An antenna ammeter, 2300-volt line voltmeter, and overmodulation alarm meter are also provided.

Transmitter and plate voltage controls and indicator lights for the 5-kilowatt broadcast transmitter WSAI and the high-frequency transmitter W8XAL are also located on the console. Among the items of general utility to be found on the console are an electric clock, status indicator lights for the two 33-kilovolt, alternating-current power lines, telephone and telegraph drop signals and jacks, two 115-volt alternating-current outlets, a folding typewriter stand, volume indicator jacks, and a radio-frequency "carrier-on" neon lamp.

Each water-cooled tube is provided with a direct-current overcurrent relay. Each of these relays is provided with an auxiliary set of

contacts connected to annunciator type drop signals. These drop signals are all located near the operator's position at the console so that he may immediately know the location of the relay which has operated.

The controls for a Thyatron type overmodulation alarm system are located on the console. An alarm, given when a given percentage modulation has been exceeded, consists of a buzzing noise and a flashing neon lamp. The percentage modulation above which the alarm is to be given can be adjusted by a voltmeter calibrated in negative modulation percentages between 50 and 96 per cent. The device is operated on the modulated direct-current output from a radio-frequency rectifier located in the antenna house.

Manual filament disconnect switches are provided in each power amplifier and modulator unit to permit removal or application of filament voltage in two steps. These filament switches are provided with interlocks which short-circuit the flow interlock contacts of an isolated unit when the switches are completely open. This permits the flow of cooling water to be shut off safely in the faulty unit without influencing the operation of the rest of the transmitter. Servicing operations, including tube changes, may thus be made in safety during the operation of the rest of the equipment. The carrier off time required to place manually or automatically a unit in service or remove it does not exceed three seconds.

A transmitter unit may be manually isolated by means of the appropriate unit "off" switch on the operator's console. It may be automatically isolated in two ways. The unit is automatically removed from service if a momentary opening of the series plate control circuit for that unit occurs twice within one minute, or if a sustained opening of this control circuit occurs for five seconds or longer. The momentary openings would generally be occasioned by the operation of a direct-current overcurrent relay in the unit, although they might be caused by transient operation of the water overtemperature interlocks or of access door interlocks. The sustained opening would generally be caused by water overtemperature or by the opening of an access door.

VERTICAL RADIATOR

The investment that is justified in the radiating system of a broadcast station depends chiefly on the investment in the transmitter, on the frequency being used, on the local ground characteristics, and on the type of service desired. For each broadcast station, a separate study is required to find the most economical type of radiator. A study

of the conditions existing at WLW indicated that, when using a power of 500 kilowatts, a very large investment in the radiator would be justified. Plans were therefore made to install a vertical radiator of 0.58 wavelength height since this was the best practical type of radiator known at the time.

The entire radiator, including insulators, was designed for 500-

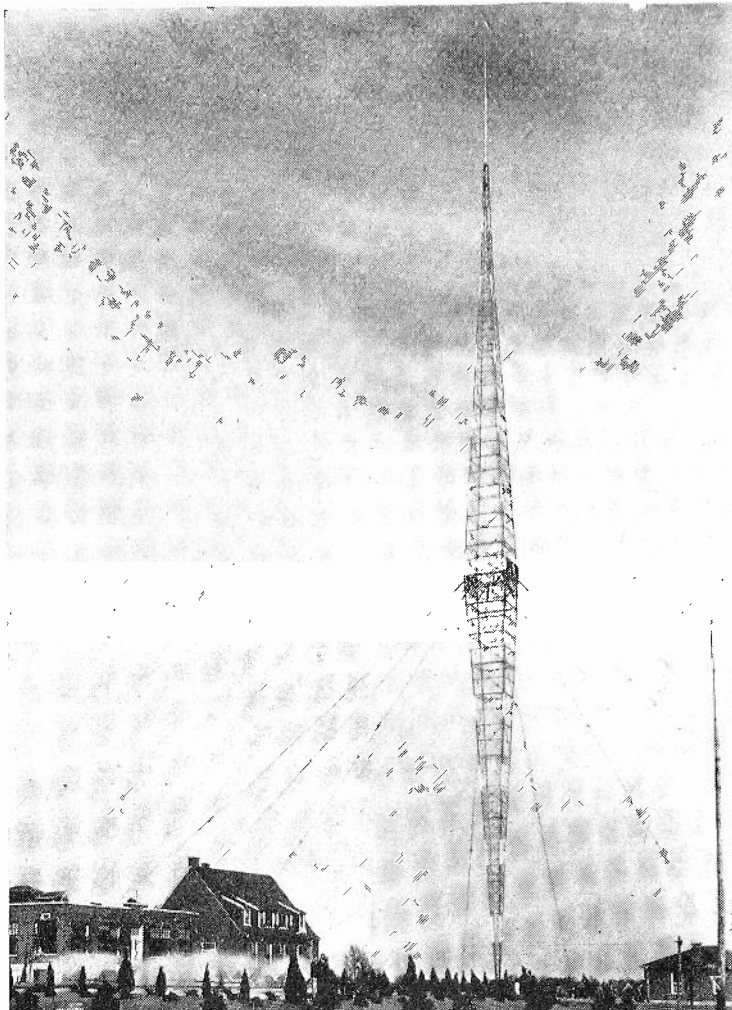

Fig. 14—The WLW 831-foot vertical radiator. 120,000-gallon spray pond in the foreground.

kilowatt operation. The height is 831 feet. (See Fig. 14.) The widest section, thirty-five feet across, is at the 350-foot level. The tower rests on a single porcelain base insulator and is held in position by eight two-inch guy cables. Each cable is broken up with seven insulators. The total load, including 136 tons for the tower proper and including additional loads due to the down-pull of the guy wires and to certain weather conditions, reaches peaks of 900,000 pounds. The base in-

sulator rests on a concrete foundation which spreads out under ground and is supported by twenty-four piles driven to a depth of approximately seventy feet.

Sufficient lighting for warning of airplanes is essential since the tower is only a short distance from an established air route. The lighting consists of two one-kilowatt red Fresnel beacons mounted at the top of the steel structure, and a number of 100-watt red obstruction lights at different elevations on the tower. A "WLW" sign, thirty-five feet across and ten feet high, is installed at the 350-foot level. This sign is constructed of double neon tubing and is visible for many miles

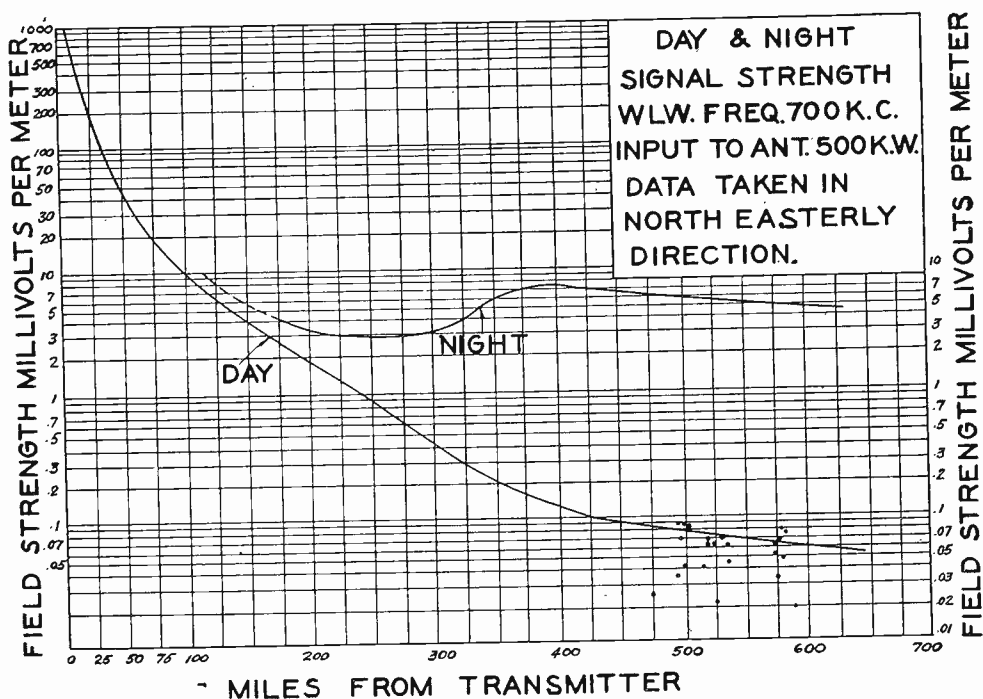

Fig. 15

at night. Both it and the Fresnel beacons are flashed on and off by a flasher mounted in the tower. In addition, there is a 24-inch red revolving beacon mounted near the base of the tower to indicate to all airmen a hazardous area. The 220-volt, 60-cycle power required to operate the tower lights is supplied through a filter system installed in the antenna house. This double conductor filter adequately passes the 60-cycle supply but presents a high impedance at 700 kilocycles. The high voltage end of the filter, instead of being connected directly to the antenna, is connected to the line end (low voltage end) of the antenna inductance. Thence the 60-cycle leads are threaded through the tubing of which the antenna inductance is wound.

The vertical radiator was put into service in June, 1933, and a quantity of data was obtained on the comparison of this antenna with the conventional T antenna that had been in use at WLW for many years. The T antenna was of the conventional type, supported by two 300-foot towers. It operated at approximately 0.75 of its fundamental wavelength. By leaving the T antenna installed and by arranging to switch the 50-kilowatt transmitter from it to the vertical antenna, there

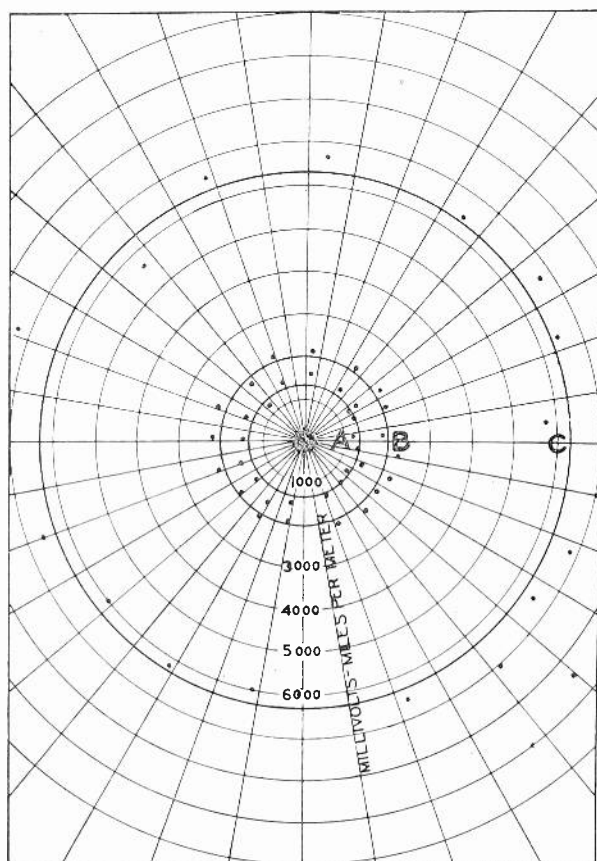

Fig. 16—Relative field intensities, quarter-wave antenna and vertical power.
 Curve A: Field intensity, 50-kilowatt input to quarter-wave antenna.
 Curve B: Field intensity, 50-kilowatt input to 0.58-wave antenna.
 Curve C: Field intensity, 500-kilowatt input to 0.58-wave antenna.

was afforded the opportunity of getting absolute comparisons between them at all times of the day and under various conditions. Absolute field strength measurements were taken with calibrated instruments and several recording instruments were used to record fading. So far as is known, this is the first case where absolute comparisons could be made between the two types of antennas, with all other conditions, including power, frequency, location, and radiation, remaining the same. The measured results agree with the calculated prediction within the limits of measurements. (See Fig. 15.)

Fig. 16 shows field strength contours for the two antennas. Assuming that receivers without automatic volume control produce satisfactory signals when the fading does not exceed six decibels, and assuming that receivers with automatic volume control produce satisfactory signals when the fading does not exceed twenty decibels, it is found that the area of nonfading service for the first type receiver was increased 66 per cent by the vertical radiator, and the nonfading area for the second type of receiver was increased 186 per cent. Both of these increases are due to the antenna alone as they are derived from measurements based on 50-kilowatt power. The average increase of field intensity in the secondary coverage area, based on hundreds of measurements, was 39 per cent. Thus the vertical radiator produces an increase of field strength equivalent to doubling the transmitter power, in the case of WLW. This would not necessarily be true at other locations since the efficiency of the vertical type radiator, both with regard to its intensification of the ground wave as well as to its reduction of sky wave, depends considerably upon the electrical properties of the immediately adjacent earth.

PERFORMANCE

The first equipment arrived on the field approximately July 1, 1933, and on November 1st of that year 500 kilowatts were put on the air. Within a few days this power was increased to well over 500 kilowatts with 100 per cent modulation. No change of major importance or appreciable expense was found necessary in the design. The installation progressed in accordance with a schedule formed many months before, an achievement all too rare in broadcast installation history. A brief summary of the tests is given below to indicate the general performance of the equipment under typical operating conditions.

The normal power output is 525 kilowatts. The normal power input to the 500-kilowatt amplifier including all auxiliary apparatus, but excluding the 50-kilowatt exciter, is 1150 kilowatts for zero modulation, 1600 kilowatts for 100 per cent sinusoidal modulation, and 1225 kilowatts for normal average modulation. The level of the residual carrier hum is 66 decibels below the level corresponding to 100 per cent modulation.

The over-all audio harmonics present in the modulation envelope increase from zero at zero percent modulation to 5.3 percent root-mean-square at 95 per cent modulation. The variation of audio harmonics with the per cent modulation is shown in Fig. 17. The reference frequency was 200 cycles. At lower frequencies the harmonic content is practically unchanged; at higher frequencies it is lower than indicated

in Fig. 17. In making these measurements, tubes that were somewhat unbalanced were purposely used so that the results would represent typical operating conditions rather than optimum conditions obtainable with tubes selected for balance.

The frequency characteristic, measured at 50 per cent modulation, is one decibel below the 1000-cycle value at 30 cycles, one decibel low at 50 cycles, one-half decibel low at 150 cycles, thence zero decibel to 5000 cycles, one-half decibel low at 8000 cycles, and two decibels low at 10,000 cycles. One hundred per cent modulation is obtainable at all frequencies between 30 and 10,000 cycles.

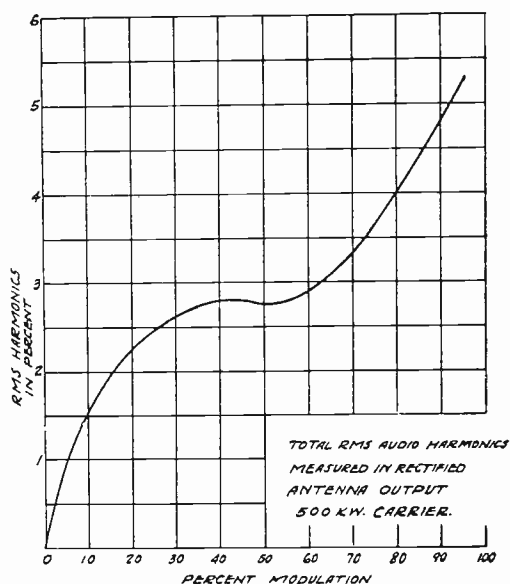

Fig. 17

With a fundamental field strength of six volts per meter at one mile, the strength of the strongest radio-frequency harmonic (the second) is 400 microvolts per meter at one mile. This means that this harmonic, so far as radiation along the ground is concerned, has a strength of 0.002 watt as compared to 525,000 watts for the fundamental. The fourth radio-frequency harmonic does not exceed 200 microvolts and the third, fifth, and sixth are below 50 microvolts.

It is believed that these performance characteristics are somewhat in advance of the present requirements of the broadcast art, and that in general they represent the greatest degree of excellence which is at present economically justifiable.

THE MEASUREMENT OF HARMONIC POWER OUTPUT OF A RADIO TRANSMITTER*

BY

P. M. HONNELL and E. B. FERRELL

(Bell Telephone Laboratories, Inc., Deal, New Jersey)

Summary—A method of determining the harmonic power output of a high-frequency radio transmitter is described. It is a method for measuring the power delivered by the transmitter to the antenna system, as distinguished from the more common method of measuring harmonic field strengths at specified locations. It is essentially a comparison method. The unknown harmonic power, present with the fundamental, is compared by means of a sufficiently selective receiving set with a known comparison power which is supplied in the absence of the fundamental. The method in practice seems to be accurate within about one decibel. It is applicable to the measurement of power other than harmonic power.

EFFORTS to obtain reasonable power outputs and efficiencies from radio transmitters have, in general, resulted in the use of the vacuum tubes in the last stage as nonlinear amplifiers. One of the results has been the generation of various undesired components, including harmonics of the carrier frequency. The harmonics are, in general, modulated in about the same manner as is the fundamental. Such radiations may cause interference with other services and their control therefore becomes important.

To formulate logical limits, and to know whether a transmitter is being held within proposed limits, there is required a method of measuring the amplitude of the spurious radiation and correlating that with the interfering effects. Considerable work has been done at frequencies below 1500 kilocycles toward establishing a correlation between the interfering effect at distant points and the field intensity of the harmonic at a fixed distance from the radiating system.

If we confine our attention to the short-wave range, however, we find it increasingly difficult to arrive at any such correlation. The nature of propagation of short waves is such that the interfering signal may appear at points hundreds of miles from the transmitter while not appearing at closer points. Since the physical dimensions of the antenna system are probably of the order of several wavelengths at the harmonic frequency, erratic directive radiation characteristics may result and interference may occur only in a few unpredictable directions. These considerations make measurements of harmonic field strengths

* Decimal classification: R251. Original manuscript received by the Institute, May 29, 1934. Presented before Ninth Annual Convention, Philadelphia, Pa., May 29, 1934.

at one or a few locations unconvincing, if not valueless, in predicting the amount of interference which may be produced.

The amount of harmonic power delivered by a particular transmitter to its antenna system is, however, a definite quantity. Its measurement constitutes the first step in the analysis of harmonic interference. Cases of interference may then be taken up as they arise and the correlation of interference with the harmonic power output of the transmitter may be determined through extended experience.

The purpose of this paper is to describe a method of measuring the harmonic power delivered to the antenna system. It is primarily a comparison method and involves, first, a measurement of the harmonic currents at some point in the load system by a measuring device which can operate in the presence of the fundamental and other frequencies and, second, a calibration of this current measuring device in terms of a known power applied to the load system at the harmonic frequency. This known comparison power is supplied in the absence of the fundamental. The calibration is valid since the load system is a linear device and the presence of fundamental currents will not affect harmonic impedances.

This method of harmonic power measurement can be applied directly to a load system which permits only one mode of propagation. An example of such a system is a single wire transmission line with ground return, or a concentric conductor line with outer conductor grounded. With other systems the problem may become more complicated. Consider a two-wire line at a finite distance above ground. Here two modes of propagation may exist; one involves equal and opposite currents in the two wires (push-pull or transverse currents) and will be referred to as the series mode, the other involves equal currents in the same direction in the two wires, with ground return (longitudinal currents) and will be referred to as the parallel mode.

If the load system is symmetric the two modes are conjugate to each other. That is, if a generator supplies power in one mode only, then currents of that mode only will flow. If the generator supplies power in both modes, the total power is the sum of the powers required to maintain the currents of either mode alone.

A convenient way to measure the total power is to measure each mode separately. This requires that the measuring device distinguish between currents of the two modes. This can be readily done by means of a small loop if, for example, the plane of the transmission line is parallel to the ground. With the loop in the vertical plane (of symmetry) the receiver responds to parallel currents. With the loop in a horizontal plane, the receiver responds to series currents.

In order to calibrate the measuring device it is necessary that comparison power be supplied, in turn, in each mode alone. This can be done if the antenna system is electrically symmetrical with respect to ground.

Experiment shows that a receiver of the type used can distinguish between currents of the two modes, and that the comparison power can be made to be of either mode alone. On systems so far tested the load has been symmetric with no coupling between modes. These statements are, of course, not absolutely true, and slight errors in measurement result. These errors will be discussed later.

The measuring device used was a double detection receiving set. To obtain the high predetector frequency selectivity required, a two-mesh antenna circuit was used. (Fig. 1.) To avoid the Marconi effect the loop and associated circuits were well shielded. The loop was rotatable about a horizontal axis by means of a vernier dial. The regular loop socket of the receiver allowed rotation about a vertical axis.

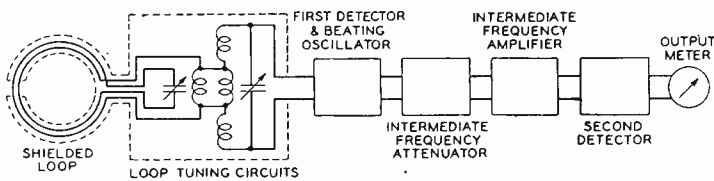

Fig. 1—Diagram of receiver. Note shielding of loop to avoid Marconi effect, and two-mesh circuit to improve frequency selectivity.

(Fig. 2.) The operation of the receiver was conventional except that there was an additional tuning control introduced by the two-mesh antenna circuit.

Loop voltages were compared by means of a calibrated attenuator in the intermediate-frequency amplifier, and a meter in the output of the second detector.

The two-mesh circuit, when tuned to the second harmonic, showed more than 50 decibels discrimination against the fundamental. This discrimination applies to the voltages reaching the grid of the first detector. The intermediate-frequency voltage output from the first detector (when the beating oscillator is correctly adjusted for reception of the second harmonic) due to the second harmonic is a second order product, while that due to the fundamental is a third order product. Other tests showed that third order products were in the order of 30 decibels below the second order products at normal operating levels. It may therefore be concluded that when the receiver was properly adjusted for the second harmonic there was a total discrimination of some 80 decibels against the fundamental. When adjusted for measurement

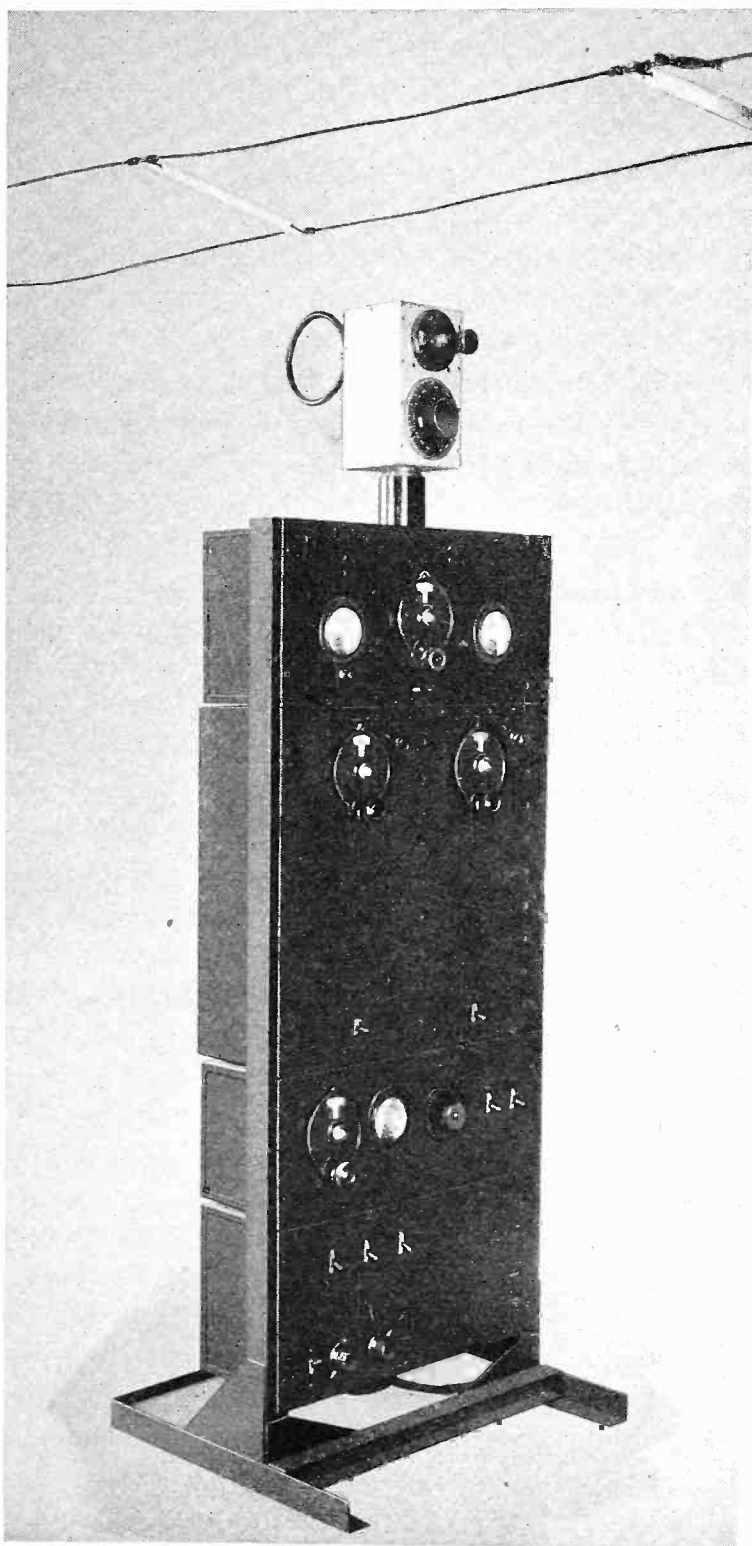

Fig. 2—Receiver. The loop may be rotated about its horizontal axis by means of the vernier dial associated with it.

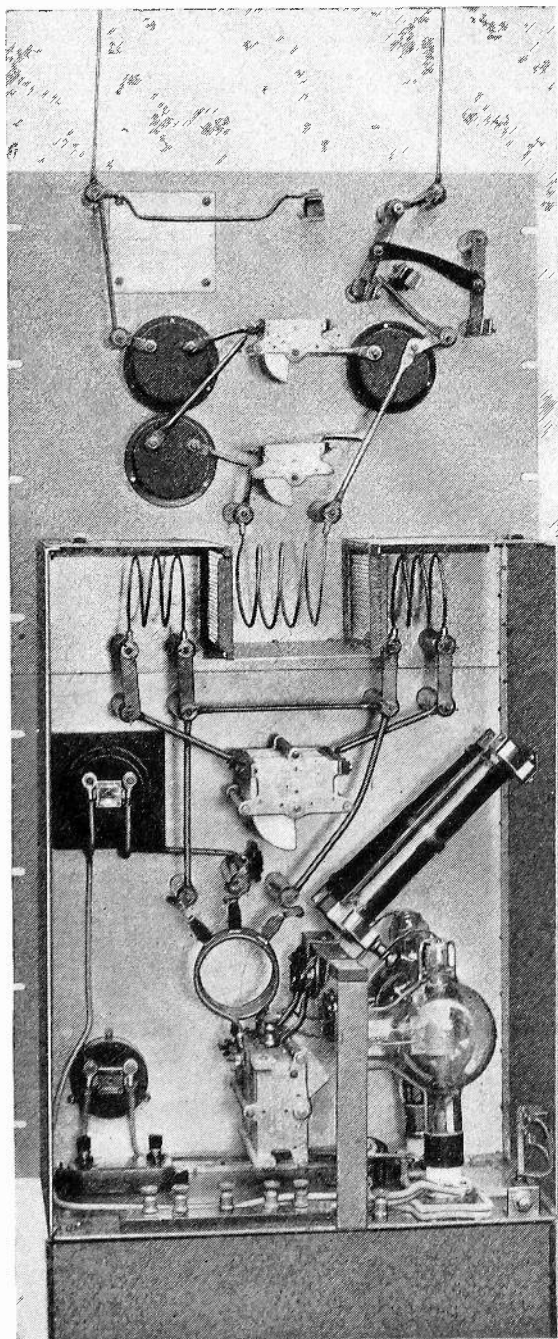

Fig. 3—Rear view of test oscillator unit with cover removed. The oscillator, at bottom, is electrostatically shielded from the power measuring circuit. At the right, above, is the switch for changing from series to parallel mode. Plate and filament voltages for the oscillator are supplied by a separate unit, not shown.

of the third harmonic, the receiver has an even greater discrimination against the fundamental.

Since the receiver is a device which measures the voltage induced in the loop, this voltage must be interpreted in terms of power in the antenna system. To do this the voltage in the loop resulting from the unknown harmonic power in the antenna system is compared to that resulting from a known amount of power supplied to the antenna system at the same harmonic frequency by a test oscillator unit to be described later. The ratio of the unknown harmonic power to the known comparison power is equal to the square of the ratio of the corresponding currents in the load system; this, in turn, is equal to the square of the ratio of the corresponding voltages in the loop of the receiver, and this last ratio can be measured by means of the attenuator in the intermediate-frequency amplifier. Since the attenuator is calibrated in decibels it is convenient to express all measurements in

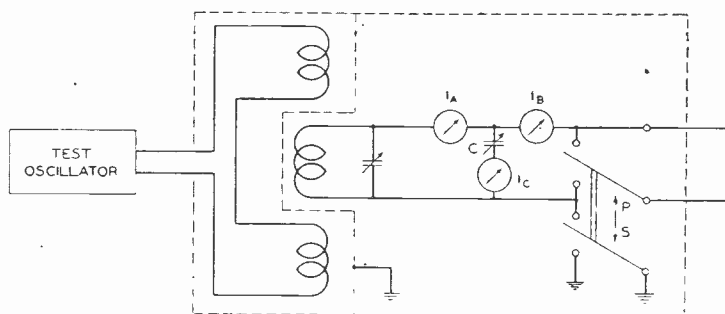

Fig. 4—Diagram of test oscillator unit.

decibels and thus reduce computations to additions and subtractions.

The test oscillator unit (Fig. 3) includes an oscillator of fairly stable frequency, a power measuring circuit, a coupling circuit insuring conditions of symmetry in the voltages supplied to the load, and a means of rapidly switching the comparison power from the parallel mode to the series, and vice versa.

A schematic diagram of the test oscillator unit is shown in Fig. 4. The output of the oscillator is coupled to a tuned circuit by electrostatically shielded coils. The power measuring circuit is the well-known three-ammeter—shunt-impedance method. If the shunt impedance is a capacitive reactance the power flow through the device, in watts, is

$$P = 2X_c \sqrt{S(S - I_a)(S - I_b)(S - I_c)}$$

where,

X_c is the reactance of the shunt condenser, in ohms,
 I_a, I_b, I_c are the three currents in amperes.

$$S = \frac{I_a + I_b + I_c}{2}$$

The precision of this method becomes small when the load is highly reactive. Under these circumstances it is desirable to include in the test oscillator unit a tuned circuit for the purpose of correcting the power factor of the load presented to the power measuring circuit.

The accuracy of this method of measuring power at radio frequencies has been tested by photometric methods. The error was determined by comparing the radio-frequency power as measured by this method to the direct-current power required to produce the same luminous intensity in the lamp. Powers ranging between 5 and 50 watts were measured at frequencies between 3 and 30 megacycles. Results of a

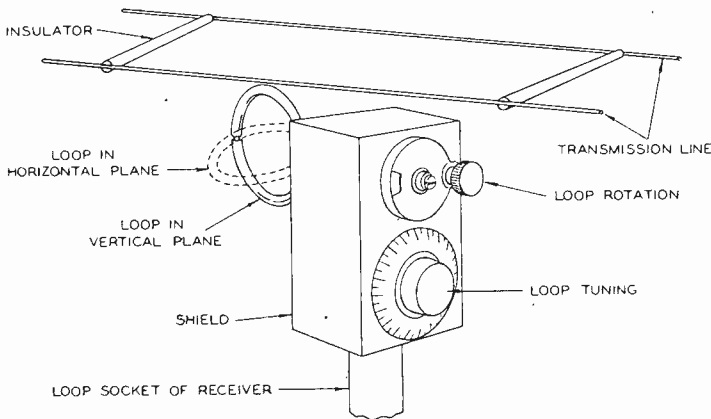

Fig. 5—Diagram showing location of loop with respect to transmission line. With the loop in the vertical position, parallel currents may be measured. With the loop in the horizontal position (dotted line), series currents may be measured.

large number of tests showed that the probable error was not more than about one decibel. This included the error of photometric comparison.

The change from series to parallel power was accomplished by a switch in the test oscillator unit. (Fig. 4.) With the switch in the series position the various stray capacitances and inductances were adjusted to obtain the best possible electric symmetry.

The detailed procedure to be followed and the precautions to be observed in measuring harmonic power by this method can best be illustrated by describing an actual measurement. The transmitter involved was a 5-kilowatt experimental radiotelephone transmitter employing in the last stage a pair of water-cooled tubes as a push-pull amplifier. The load was a long two-wire transmission line of twelve-inch spacing, the dissipating portion of which was made of iron wire. Near the receiver the two wires lay in a horizontal plane approxi-

mately eight feet from the ground, and for a distance of several feet on each side of the receiver were straight and free from discontinuities. The loop of the receiver was placed with fixed horizontal diameter in the vertical plane of symmetry, about 18 inches below the transmission line and parallel to it. The loop was capable of being rotated about this fixed diameter. (Fig. 5.)

The test oscillator unit was located close to the transmitter housing so that the transmission line could be swung from the test oscillator to the transmitter without appreciable change in length or electrical constants. The ground terminal of the test oscillator unit was connected to the metallic housing of the transmitter.

The detailed steps in measuring the parallel power component of the 12,850-kilocycle second harmonic of a 6425-kilocycle carrier were as follows:

(1) The transmission line was connected to the test oscillator unit and this was adjusted to give 12,850-kilocycle power in the series mode. This power was computed to be 16.4 watts which is 12.2 decibels above one watt.

(2) The receiver was tuned to 12,850 kilocycles and the loop was rotated about its horizontal axis until the loop voltage was a minimum. The attenuator was set to give an arbitrary standard second detector output, and its reading was noted. This was 84 decibels. The loop was in a nearly vertical plane.

(3) The switch on the test oscillator unit was thrown to supply parallel power, the frequency was checked, and the power was measured. This was 12.1 decibels above one watt.

(4) The attenuator on the receiver was again adjusted to give the standard second detector output, and was read as 106 decibels. Throughout this and the following steps, care was taken to maintain the loop position and receiver adjustments exactly as in step (2), except for attenuator settings.

So far two important things had been accomplished: In step (2) the receiver was adjusted, by loop position, to give the greatest discrimination against the series mode. In step (4), the receiver was calibrated for measuring parallel power. This calibration may be expressed as a figure proportional to volts squared per watt. Numerically this is $106 - 12.1$ which is 93.9 decibels.

In addition, an important check had been made on the accuracy of the measurements. The receiver, while adjusted to give maximum discrimination against series power, was calibrated for measuring series power as well as parallel power. These two calibrations were, respectively, $84 - 12.2 = 71.8$ decibels, from step (2), and $106 - 12.1 = 93.9$

decibels, from step (4). The difference, $93.9 - 71.8 = 22.1$ decibels, is the net discrimination. That infinite discrimination was not obtained may have been due to various causes: The test oscillator unit may have put out some parallel power when adjusted to the series mode. The load may have reflected back parallel currents when series power was applied to it. Or dissymmetry in the loop may have caused it to give some response to series currents when adjusted for the parallel mode. The important thing is that the sum of these errors was more than 20 decibels down, i.e., the sum of these errors was less than one per cent in power.

(5) The transmission line was finally connected to the transmitter and this was placed in normal operation. The attenuator in the receiver was again adjusted to give the standard second detector output (the receiver was still otherwise undisturbed) and its reading noted as 98 decibels.

The difference between this reading and the calibration, $98 - 93.9 = 4.1$ decibels, gave directly the amount of 12,850-kilocycle power flowing in the parallel mode. This is 2.6 watts.

By similar procedure the second harmonic power flowing in the series mode, the third harmonic, parallel mode, etc., were determined. In this continuation of the particular measurements described above, the series component of the second harmonic was found to be 0.016 watt. Since this is 22.1 decibels below 2.6 watts, the value of the parallel component, and 22.1 decibels was the extent of the discrimination, this indicates that 0.016 watt is an upper limit, but not necessarily the actual value of the series component.

The method described here is not limited to measurements of harmonic power. It may be used to measure subharmonic output from transmitters which employ frequency multiplication in their earlier stages. It may be used to measure spurious power at frequencies not related to the nominal carrier frequency of the transmitter. If the unwanted frequency is very close to the carrier, special precautions may be required in the design of the receiver.

The method may be useful in making power measurements at the fundamental frequency. It may be particularly applicable, for example, in measuring the amount of parallel power put out at the fundamental frequency by a transmitter which is designed to put out series power.

The principal error in the method lies in the measurement of the comparison power. The error here is in the order of 20 per cent, while errors due to failure to separate modes or frequencies are considerably smaller.

We have used the method described here in measuring the harmonics of different transmitters working into various types of antenna systems. It has been particularly useful in the study and design of circuits for suppressing the harmonic power in the output of high-frequency transmitters.

ACKNOWLEDGMENT

We wish to express our appreciation of the advice and constructive criticism given in the course of this work by Mr. J. C. Schelleng.



REGENERATION THEORY AND EXPERIMENT*

BY

E. PETERSON, J. G. KREER, and L. A. WARE

(Bell Telephone Laboratories, Inc., New York City)

Summary—A comprehensive criterion for the stability of linear feed-back circuits has recently been formulated by Nyquist, in terms of the transfer factor around the feed-back loop. The importance of any such general criterion lends interest to an experimental verification, with which this paper is primarily concerned.

The subject is dealt with under five principal headings. The first section reviews some of the criteria for oscillation to be found in the literature of vacuum tube oscillators. The second describes the derivation of Nyquist's criterion somewhat along the lines followed by Routh in one of his investigations of the stability of dynamical systems. The third part deals with two experimental methods used in measuring the transfer factor. The fourth is concerned with the particular amplifier circuit used in the test of Nyquist's criterion. The last section applies the criterion to a nonlinear case, and to circuits including two-terminal negative impedance elements.

IN A comparatively recent paper on "Regeneration Theory,"¹ Nyquist presented a mathematical investigation of the conditions under which instability² exists in a system made up of a linear amplifier and a transmission path connected between its input and output circuits. The results of the investigation are of interest because of their obvious application to amplifiers provided with feed-back paths,³ as well as to the starting conditions in oscillators. As a result of his general analysis, Nyquist arrived at a criterion for stability, expressed in a particularly simple and convenient form, which is not restricted in its range of application to particular amplifier and circuit configurations.

The great value attached to a criterion as precise and as general as Nyquist's makes it desirable to submit the criterion to an experimental test. One particularly striking conclusion drawn from this criterion is that under certain conditions a feed-back amplifier may sing within certain limits of gain, but either reduction or increase of gain beyond these limits may stop singing. A feed-back amplifier satisfying these conditions was set up, and the experimental results were found to be in agreement with this conclusion.

It is interesting to compare the criterion with those derived for the

* Decimal classification: R133. Original manuscript received by the Institute, June 20, 1934.

¹ *Bell. Sys. Tech. Jour.*, vol. 11, p. 126.

² Instability is used in the sense that a small impressed force, which dies out in course of time, gives rise to a response which does not die out.

³ *Electrical Engineering*, July, (1933); *Bell Sys. Tech. Jour.*, p. 258; July, (1933).

mechanical systems of classical dynamics. In his Adams Prize Paper on "The Stability of Motion,"⁴ and again in his "Advanced Rigid Dynamics,"⁵ Routh investigated the general problem of dynamic stability and established a number of criteria based upon various properties of dynamical systems. When applied to the problem of feedback amplifiers, keeping Nyquist's result in mind, one of them is found to be equivalent to Nyquist's criterion, although expressed in different terms and derived in a different way.

To provide a background for the experiments, we propose to state some of the criteria for stability which are to be found in the literature of vacuum tube oscillators, and to compare them with Nyquist's or Routh's criterion, the development of which is most conveniently described somewhat along the lines followed by Routh. Following this we shall deal with the experimental methods and apparatus which were used in testing the criterion, and conclude with some extensions of the criterion.

CIRCUIT ANALYSIS AND STABILITY

Conditions required for the starting of oscillations in linear feedback circuits, corresponding to instability, are to be found in the literature of vacuum tube oscillator circuits, expressed in a number of ostensibly different forms. These are usually based upon the familiar mesh differential equations for the system which involve differentiations and integrations of the mesh amplitudes with respect to time. Using the symbol p to denote differentiation with respect to time, each mesh equation becomes formally an algebraic one in p , involving the circuit constants and the mesh amplitudes. The solution of this system of equations is known to be expressible as the sum of steady state and transient terms. The transient terms are each of the form $B_k e^{p_k t}$, the B_k 's being fixed by initial conditions, and the p_k 's being determined from the circuit equations. If we set up the determinant of the system of equations—the discriminant—and equate it to zero, the roots of the resulting equation are the p_k 's above. In general each mesh equation involves p to the second degree at most, and with n meshes the discriminant is of degree $2n$ at most. Accordingly we may express the determinantal equation as

$$F(p) = 0 = K(p - p_1)(p - p_2) \cdots (p - p_{2n}). \quad (1)$$

As for the steady state term, in the simplest case in which a sinusoidal wave of frequency $\omega/2\pi$ is impressed, it is equal to the impressed voltage divided by the discriminant and multiplied by the appropriate

⁴ Macmillan, (1877).

⁵ Macmillan, 6th edition, (1905).

minor of the determinant, in which p is replaced by $j\omega$. The character of the response due to a slight disturbance and in the absence of any periodic force is determined by the exponentials. In general, p_k is a complex quantity which may be written as $a_k + j\omega_k$. It is apparent that in the critical case for which a_k is zero, the corresponding term becomes $e^{j\omega_k t}$, corresponding to an oscillation invariable in amplitude, of frequency $\omega_k/2\pi$. If a_k is negative, as is ordinarily the case when the system is passive (containing no amplifier or negative impedance), then the oscillation diminishes in course of time. When a_k is positive, however, the oscillation increases with time, and the system is said to be unstable. Evidently the stability of a system is determined by the signs of the a_k 's.

Several criteria which have previously been enunciated for the maintenance of free oscillations are deducible from the above. One states that the discriminant must vanish when p takes on the value $j\omega$. Another states that the damping (a_k) must be zero at the frequency of oscillation. These are clearly equivalent. Two derived criteria may also be mentioned, based upon the properties of the system when the circuit is broken. The first of these states that if the impedance is measured looking into the two terminals provided by the break, the impedance must be zero at the frequency of steady oscillation.

The second criterion involving the transfer factor has become fairly widespread, perhaps because it leads to a simple and plausible physical picture. To determine the transfer factor around the feed-back loop, the loop is broken at a convenient point, and the two sets of terminals formed by the break are each terminated in a passive impedance equal to that which is connected in the normal (unbroken) condition. Then when a voltage of frequency $\omega/2\pi$ is applied to one of the pairs of terminals so provided—the input terminals⁶—and the corresponding voltage is measured across the other pair, the transfer factor $A(j\omega)$ is obtained as the vector ratio of the output voltage to the input voltage.

The manner in which the transfer factor enters into the problem may be demonstrated directly by comparing the voltages at any point of the main amplifier circuit under the two conditions in which the feed-back path is opened and closed, respectively. If with the feed-back path open the voltage at any such point is Ee^{pt} , then when the feed-back path is closed the voltage will be changed¹ to

$$Ee^{pt}/[1 - A(p)].$$

⁶ Input terminals are those across which an impressed potential leads to propagation in the normal direction of amplifier transmission.

¹ *Loc. cit.*, p. 128.

This may be shown as follows with reference to the particular circuit of Fig. 1: If the feed-back circuit is broken and then properly terminated, the voltage existing across the input is taken as e . Now suppose the feed-back path to be restored. Designating the voltage existing across the input in the presence of feed-back as e_1 we have $e_1 = e + Ae_1$, from which the above equation follows.

If we let $F_1(p)$ represent the discriminant of the system when the loop is broken and terminated, then the roots of the equation formed by setting the discriminant equal to zero are assumed to have positive real parts. Now for the corresponding discriminant when the loop is restored, we have in accordance with the above considerations

$$F(p) = [(1 - A(p)]F_1(p).$$

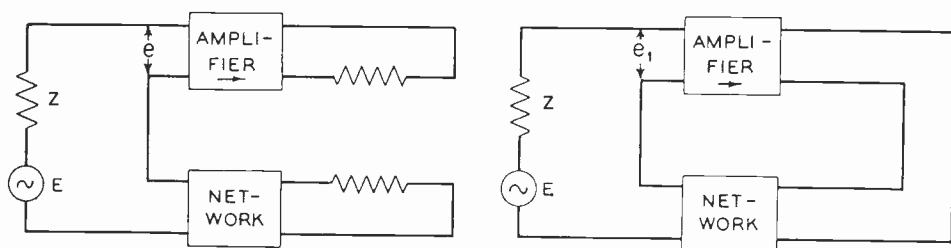

Fig. 1—Series type feed-back; loop broken and terminated at left, normal feed-back circuit at right.

In setting this discriminant equal to zero to obtain the roots, the only ones which have nonnegative real parts are those corresponding to the feed-back term

$$f(p) = 1 - A(p). \quad (2)$$

The above-mentioned criterion may be deduced from this expression. For steady oscillations to exist the output potential must be identical in amplitude and in phase with that existing across the input at the frequency of oscillation ($p = j\omega$), in which case the transfer factor is unity. This seems reasonable on the basis that when the input and output terminals are connected through, the oscillation will neither increase nor decrease with time. It may be demonstrated by direct analysis that these several criteria, framed for the critical case of undamped oscillations, all lead to the same correct conclusion.

Of course in any actual oscillating circuit it is practically impossible to get these conditions fulfilled exactly, and what is ordinarily done in the practical design of oscillating circuits is to ensure that the voltage fed back will be greater than that required to produce oscillation. This evidently goes a step further than the above criteria, and reliance is placed upon the nonlinear properties of the circuit to ful-

fill the criteria automatically. The procedure is known by experiment to be effective in the usual type of oscillating circuit. In particular forms of feed-back circuits, however, it may be demonstrated that *the transfer factor may be made greater than unity without giving rise to oscillations*. This situation was investigated experimentally, and found to be in accord with the stability criterion stated by Nyquist.

NYQUIST'S CRITERION

The explicit solution of (1) for the p_k 's demands an exact knowledge of the configuration of the amplifier and feed-back circuits. When the number of meshes is large, the solution involves much labor. If we wish simply to observe whether or not the system is stable, however,

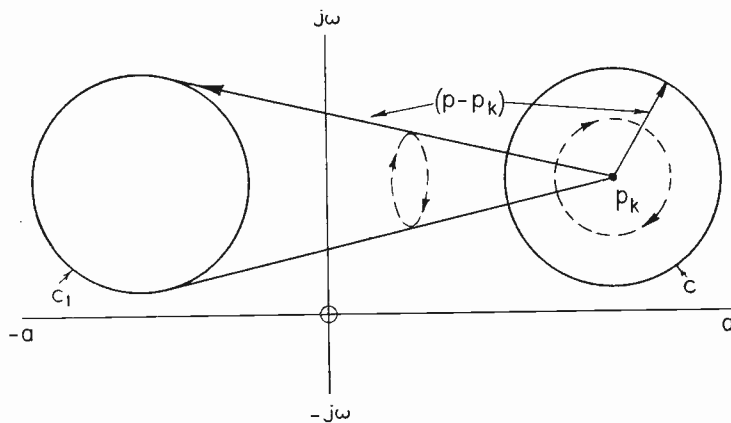

Fig. 2—Plot of two contours C and C_1 in the p plane. C encloses the root p_k while C_1 does not enclose p_k . The vector $p - p_k$ covers 360 degrees as p traverses C , and covers the net angle of zero as p traverses C_1 .

we need not obtain explicit solutions for the roots; in fact, all we need to know is whether or not any one of the p_k 's has its real part positive. It turns out that when we know the transfer factor as a function of frequency, by calculation or by measurement, a simple inspection of the transfer factor polar diagram suffices for this purpose. This diagram is constructed by plotting the imaginary part of the transfer factor against the real part for all frequencies from minus to plus infinity.⁷

To obtain Nyquist's criterion we consider the vector drawn from the point (1, 0) to a point moving along the polar diagram; if the net angle which the vector swings through in traversing the curve is zero,

⁷ The transfer factor for negative frequencies $A(-j\omega)$ is the complex conjugate of that for positive frequencies $A(j\omega)$. Thus, if,

$$A(j\omega) = X + jY,$$

then,

$$A(-j\omega) = X - jY.$$

the system is stable; if not, it is unstable. To express it in the terms used by Routh, if we set $1 - A(j\omega) = P + jQ$, and observe the changes of sign which the ratio P/Q makes when P goes through zero as the frequency steadily increases, the system is stable when there are the same number of changes from plus to minus as from minus to plus. It may be demonstrated that these two statements are equivalent.

The way in which the above procedures may be shown to reveal the existence of a root with positive real part may be outlined somewhat along the lines followed by Routh in his analysis.⁸ Since p is a complex quantity in general, any value which it may take is representable as a point on a plane—the p plane of Fig. 2. Since only values of p with positive real parts concern us, attention may be confined to the right-hand half of the p plane. Now draw a closed contour C in the right-hand half of the p plane which encloses the root p_k . It is evident upon inspection of Fig. 2 that the vector extending from the root p_k to the contour makes a complete revolution (360 degrees) in following the closed path. If the contour does not enclose the root, however, as for C_1 , then it is clear that when the vector from the root to the contour traverses the whole contour, the net angle turned through by the vector is zero. In the region under consideration we may write

$$f(p) = (p - p_k)\phi(p),$$

where $\phi(p)$ has no zeros within the contour. Hence, when p traverses a closed path and $(p - p_k)$ turns through 360 degrees or through zero the same angle is covered by $f(p)$. If for some different contour several roots are enclosed, it may be shown that $f(p)$ turns through one complete revolution for each of the enclosed roots when p traverses the contour.

In the form in which these considerations are stated, they are not suitable to practical application since complex values of p are involved. Ordinarily, of course, only imaginary values ($p = j\omega$) are con-

⁸ A number of restrictions on the generality of the analysis may be noted. It is assumed that $A(p)$ has no purely imaginary roots although the result in this case is otherwise evident. Further it is assumed that $A(p)$ goes to zero as $|p|$ becomes infinite, and that no negative resistance elements are included in the amplifier. Another point which should be mentioned is that the analysis does not apply to the stability in any conjugate paths that may exist. This point may be exemplified by the balanced tube or push-pull amplifier, in the normal transmission path of which the tubes of a stage act in series. When the series output is connected back to the series input, stability of the resultant loop has in general no bearing upon the stability of the path formed with the two tubes of each stage in parallel, since the series and shunt paths are conjugate to one another. To establish the stability of the shunt or parallel path, the transfer factor for that path must be separately determined. In general, the stability criterion applies only to the particular loop investigated, and not to any other existent loop.

veniently accessible to us since it is a comparatively simple matter to measure the response with a sinusoidal impressed wave, but it would involve great difficulties of experiment as well as of interpretation to determine the response with negatively damped waves corresponding to values of p in the right-hand half of the plane. However, these results may be brought within the field of practical experience by a procedure widely used for the purpose.

To include all roots in the right-hand half of the p plane, the contour must be taken of infinite extent. The path ordinarily followed for this purpose extends from the value $+R$ to $-R$ on the imaginary axis, and is closed by a semicircle of radius R , where R is assumed to expand

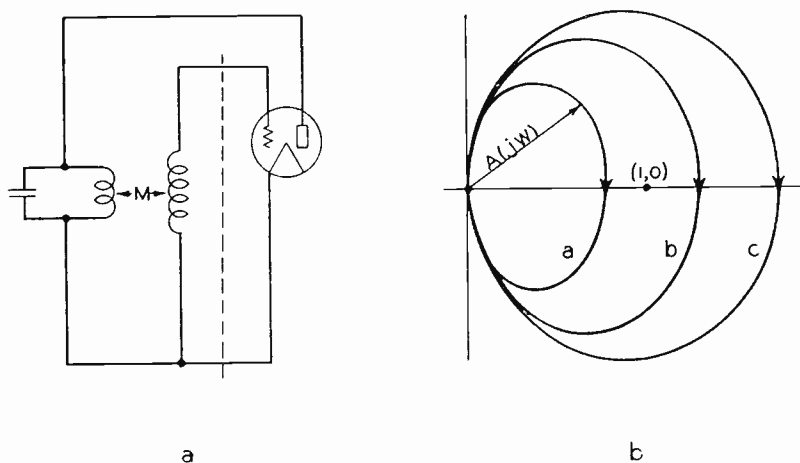

Fig. 3—Schematic of a reversed feedback oscillator circuit at the left. At the right, plot of the transfer factor $A(j\omega)$ around the feed-back loop of Fig. 3a over the frequency range from zero to very high frequencies. The imaginary part of the transfer factor is plotted as ordinate against the real part as abscissa for the three curves a , b , c , which correspond to increasing gains around the loop. Condition a is stable, while b and c are unstable.

without limit. It may be noted that in actual amplifier circuits the transfer factor becomes zero when $|p|$ becomes infinite, so that $A(p)$ is zero along the semicircular part of the closed contour. Consequently, the only values of $A(p)$ which differ from zero are those corresponding to finite values of p , along the imaginary axis. In other words, the plot of $A(p)$ under these conditions comes down to the plot of $A(j\omega)$ where ω is finite. Hence, if we plot $A(j\omega)$ for all values of ω from minus to plus infinity, there will be no roots with positive real parts and the system will be stable when the vector from $(1, 0)$ to the curve sweeps through a net angle of zero. The system will be unstable when the vector sweeps through 360 degrees, or an integral multiple thereof.

Two types of transfer factor curves may be considered as illustrations. The first of these shown in Fig. 3 corresponds to that for a re-

versed feed-back oscillator circuit, the three curves marked *a*, *b*, *c*, corresponding to progressively increasing gains around the loop. It will be observed that after the maximum gain has reached and exceeded unity, that the circuit is unstable, since the point (1, 0) is then enclosed. This state of affairs may be contrasted with that existing in the particular form of feed-back circuit to which Fig. 4 applies. Again the three curves *a*, *b*, *c*, correspond to progressively increasing gains around the feed-back loop. As the gain is increased the system is first stable (*a*), then unstable (*b*), and finally stable (*c*), since it is only within curve (*b*) that the point (1, 0) is enclosed. This striking example is the one which was investigated experimentally. The methods used in determining the transfer factor diagram form the subject of the next section.

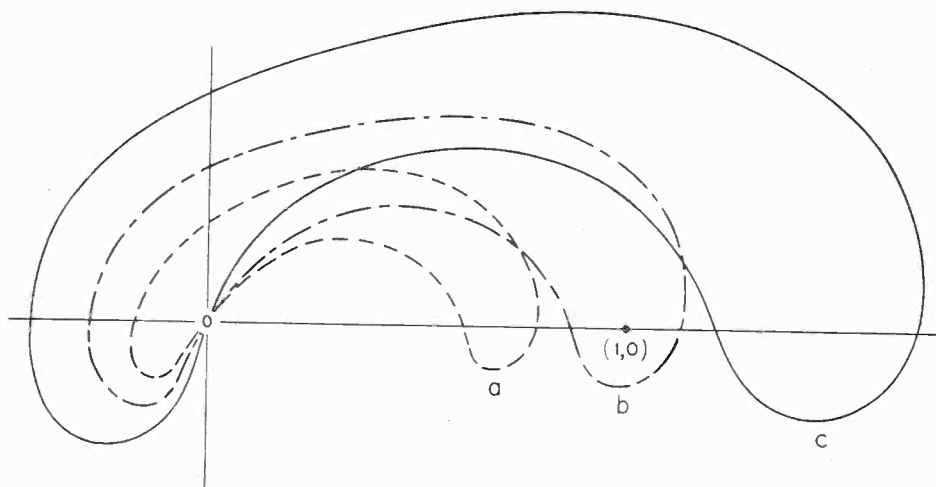

Fig. 4—Transfer factor diagram for a particular form of feed-back circuit, curves *a*, *b*, *c*, corresponding to increasing gains around the feed-back loop. Conditions *a* and *c* are stable, *b* is unstable.

MEASURING METHODS

Application of the Nyquist stability criterion requires the determination of the vector transfer constant around the feed-back loop at all frequencies. This is usually done by opening the circuit at any point which provides convenient impedances looking in both directions from the break. These points are then connected to an oscillator and to suitable measuring circuits, which are to be described. Care must be taken to ensure that the oscillator and measuring circuit impedances are equal to the output and input impedances, respectively, of the circuit under test. This precaution is necessary in order that the transfer factor in the measuring condition may not differ significantly from that existing in the operating condition.

Two methods of measurement have been found useful. The first is

a null method capable of good precision over a wide frequency range. The second is a visual method in which the transfer factor polar diagram is traced on the screen of a cathode ray oscillograph. This method is not capable of very great precision and, in the model used, the frequency range is somewhat restricted. However, it permits of a rapid survey of the situation, for which its precision is adequate, before proceeding with the slower and more precise measurements of the null method, where the latter are required. By making such a preliminary survey the critical frequency ranges can be mapped out for precise measurement, thereby eliminating a large amount of unnecessary labor.

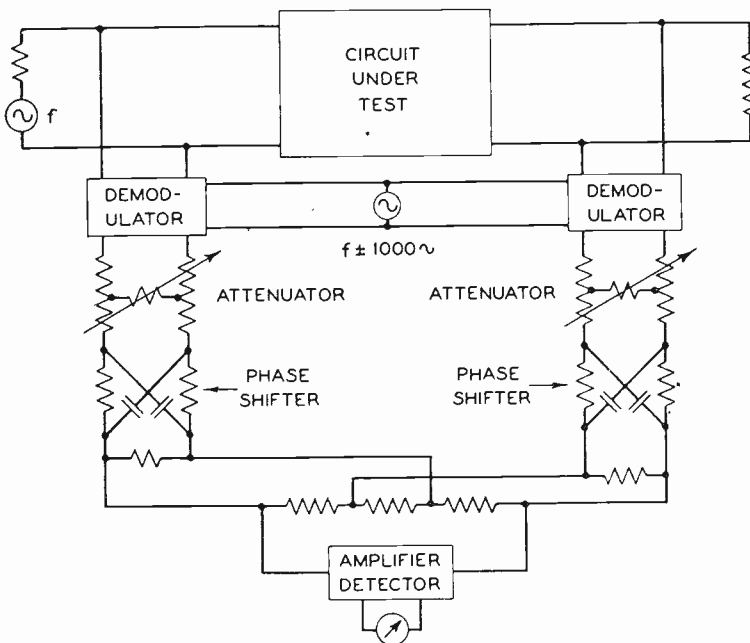

Fig. 5—Schematic diagram of the null method used to measure the transfer factor.

Null Method

In the more precise measurements extending over a wide frequency range, special care is required to ensure freedom from errors in the measurement of phase angles and amplitudes. Much of the difficulty associated with direct measurement over wide frequency ranges is avoided by the use of a simple demodulation scheme. In this scheme, the potentials to be compared are modulated down to a fixed frequency (in actual use 1000 cycles) regardless of the frequency at which the test is being made. In this way a minimum portion of the circuit carries the high frequency. Further this permits the use of voice frequency attenuators, phase shifters, and amplifiers which in fact require calibration at only a single frequency.

In this arrangement, as shown in Fig. 5, demodulators are shunted across the input and output terminals of the circuit under test. A single oscillator supplies the carrier to both demodulators, its frequency differing by 1000 cycles from the frequency supplied to the circuit under test. The demodulated outputs are connected through attenuators and phase shifters to a common amplifier detector. The attenuators and phase shifters are adjusted until the detector gives a null reading. When this condition obtains the difference in the attenuator settings in the two branches is equal to the gain or loss of the circuit under test, and the difference in the phase shifter settings is either equal to or the negative of the phase shift of the circuit under test. To show this, denote the amplifier output voltage by $P_0 \cos (2\pi ft - \phi)$, and the beat frequency voltage supplied to the demodulators by $P \cos 2\pi(f \pm 1000)t$. The demodulated output, proportional to the product of the two applied waves, is then

$$PP_0 \cos (2\pi \cdot 1000t \mp \phi).$$

Correspondingly, the demodulated output from the other demodulator connected across the input is given by

$$PP_i \cos (2\pi \cdot 1000t).$$

If now these two waves are to be made to cancel, there must be a difference in the attenuation of the two branches equal to the ratio P_0/P_i , and a difference in the phase shift equal to $\mp \phi$. The change in sign of the phase angle introduced by setting the beat oscillator above or below the test frequency is most conveniently handled by setting the carrier oscillator consistently on the same side of the test frequency in making a run over the frequency range.

By using a high gain amplifier preceding the detector, the precision may be made great, limited only by circuit noise and by interference. The attenuators and phase shifters are calibrated separately. It should be noted that any difference in the transfer constants of the two demodulator circuits may be compensated by an initial adjustment which is carried out by paralleling the input terminals of the two demodulators across a source of electromotive force. With the particular type of phase shifter used the phase shift may be changed without altering the attenuation, so that the two settings for amplitude and phase may be made independently.

Visual Method

In the visual method of observation, a steady potential proportional to the inphase component of the transfer constant is impressed across one pair of plates of a cathode ray oscillograph and another

steady potential proportional to the quadrature component is impressed across the other pair of plates, the constant of proportionality being the same for the two components. In this way the transfer constant at any frequency appears as a single point, the vector from the origin to the displaced beam constituting the transfer constant. The

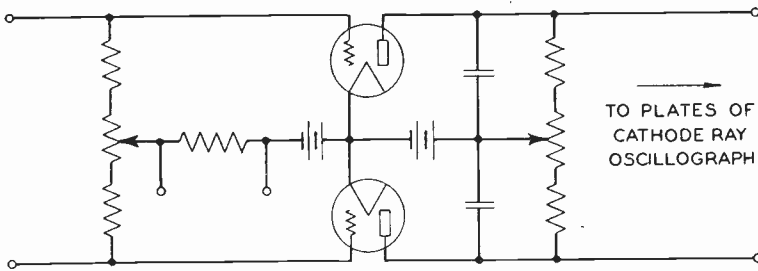

Fig. 6—Circuit of a vacuum tube wattmeter used to provide a rectified potential proportional to the product of the two impressed grid potentials (both of the same frequency) multiplied by the cosine of the phase angle between them.

locus of all these points, i.e., vector tips, over the frequency range constitutes the transfer factor polar diagram.

To provide rectified potentials proportional to inphase and to quadrature components, respectively, use is made of the properties of the so-called vacuum tube wattmeter.⁹ As used in practice, this device consists of two triodes in push-pull connection, (Fig. 6), the series arm of

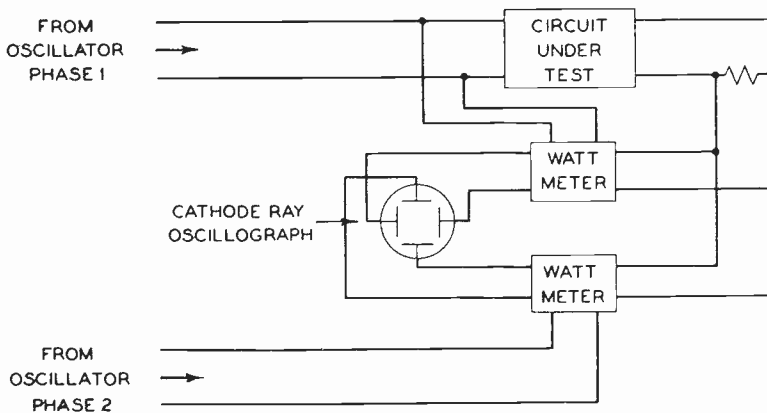

Fig. 7—Schematic diagram of the circuit used to plot the transfer factor diagram on the screen of a cathode ray oscillograph.

the grid circuit being connected to the unknown potential, and the shunt arm of the grid circuit being connected to a source of the same frequency but of standard phase. Under these conditions the rectified output in the plate circuit flowing in series with the two plates is pro-

⁹ U. S. Patent 1,586,533; Turner and McNamara, Proc, I.R.E., vol. 18, p. 1743; October, (1930).

portional to the product of the two impressed voltages multiplied by the cosine of the angle between them.

As shown in Fig. 7, two separate wattmeters are employed, one for each phase, their series input terminals being connected together across the output of the circuit under test. To the common branch of one of these wattmeters is supplied the same potential as is fed to the input of the circuit under test. The rectified output of this wattmeter therefore is proportional to the product of the input and output voltages multiplied by the cosine of the transfer factor phase angle. This potential is supplied to those plates of the oscillograph which produce a

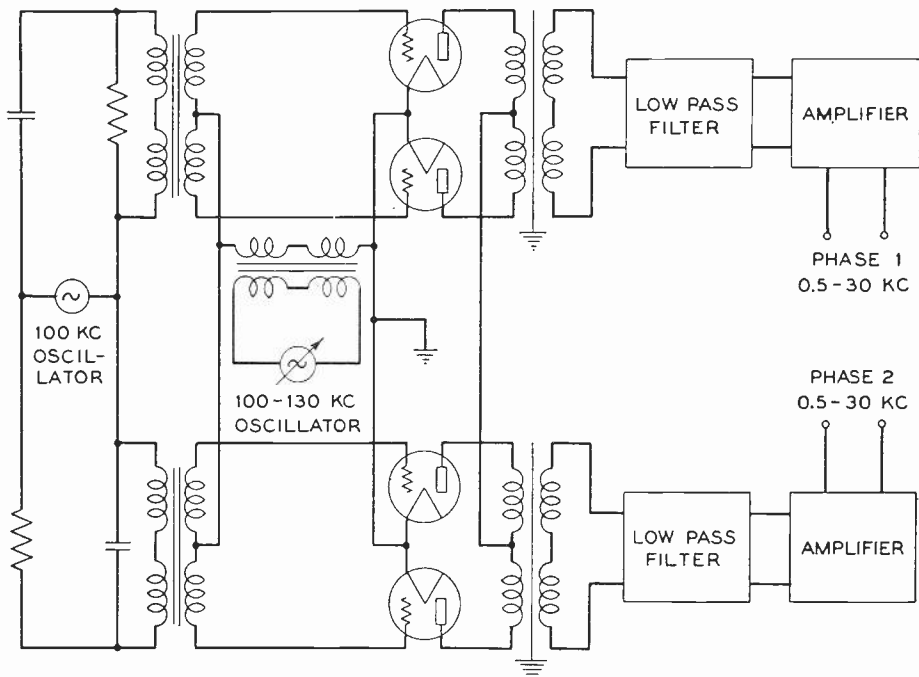

Fig. 8—Circuit diagram of a heterodyne type two-phase oscillator, the output frequency of which is continuously variable from 0.5 to 30 kilocycles. The output of each phase and the 90-degree difference between the two phases are practically constant over the frequency range.

horizontal deflection. To the common branch of the other wattmeter is applied a potential equal in amplitude to the input voltage but lagging behind it by 90 degrees. The rectified output of this wattmeter is proportional to the product of input and output voltages multiplied by the cosine of the transfer factor phase angle minus 90 degrees, or in other words proportional to the sine of the transfer factor phase angle. This voltage is supplied to those plates of the oscillograph which produce a vertical deflection. We have then across one pair of plates of the oscillograph a steady potential proportional to the real component of the transfer factor, and across the other pair of plates we have impressed a steady potential proportional to the imaginary component of the transfer factor. These two components act upon the beam of the oscil-

lograph to produce a deflection which in amplitude and in phase is the resultant of the two component deflections and so corresponds to the transfer factor.

It will be observed that the above procedure requires a two-phase source of constant amplitude, the frequency of which is variable over the range necessary to establish the properties of the amplifier. In the present instance the frequency range extends from 0.5 to 30 kilocycles, and the accuracy required is of the order of five per cent.

A schematic of the two-phase oscillator used is shown in Fig. 8. This oscillator is of the heterodyne type. Two independent sources are used, one of constant frequency (100 kilocycles), the other variable in frequency and practically constant in amplitude over the range of 100 to 130 kilocycles. As indicated in the figure, the variable frequency oscillator is connected to the common branches of the two push-pull modulators. The fixed frequency oscillator is connected in series with the grid circuits of the two modulators. The resistance-capacity networks shown in the circuits of the fixed frequency oscillator are provided to produce phase shifts of 90 degrees between the two series voltages of the two modulators. In the same manner as that discussed before in connection with the null method measuring circuit, the phase shift introduced to the fixed frequency is maintained in the beat frequency output, so that the phase difference of 90 degrees is preserved in the outputs of the two modulators when the variable frequency oscillator goes from about 100.5 to 130 kilocycles. The outputs of the two phases are connected to the test amplifier and to the wattmeters as shown in the preceding Fig. 7.

Comparison of the Methods

Measurements of transfer factors by the two methods outlined above were found to be in agreement within the error of measurement. The visual method as developed was capable of use over only a very restricted frequency range as compared to the null method, but it covered the region of particular interest in the experiments conducted for the purpose of testing the stability criterion. Through its use, measurements over its frequency range could be made in a few minutes time, whereas corresponding measurements by the more precise null method required three to six hours. Of course the time intervals cited do not include time occupied in setting up and adjusting the apparatus.

TEST AMPLIFIER AND EXPERIMENTAL RESULTS

Test Amplifier

The stability criterion indicates three distinct conditions of interest, one of which is unstable, the other two being stable. The un-

stable condition (1) is that in which the transfer factor curve encloses the point $(1, 0)$. Two stable conditions are those in which $(1, 0)$ is not enclosed by the curve, but in which (2) the curve crosses the zero phase shift axis at points greater than unity, and (3) the curve does not cross the zero phase shift axis at points greater than unity. Condition (2) is of particular interest because while it is judged stable on the basis of Nyquist's criterion it would appear to be unstable on the basis of the older transfer criterion discussed in the first and second sections.

For test purposes an amplifier was designed which, upon variation of an attenuator in the feed-back path, would satisfy each of the three above conditions in turn. The amplifier schematic is shown in Fig. 9. It has three stages, the first two tubes being space-charge grid pentodes, and the last one a triode. The interstage coupling circuits were made up of simple inductances and resistances as shown. The amplifier was

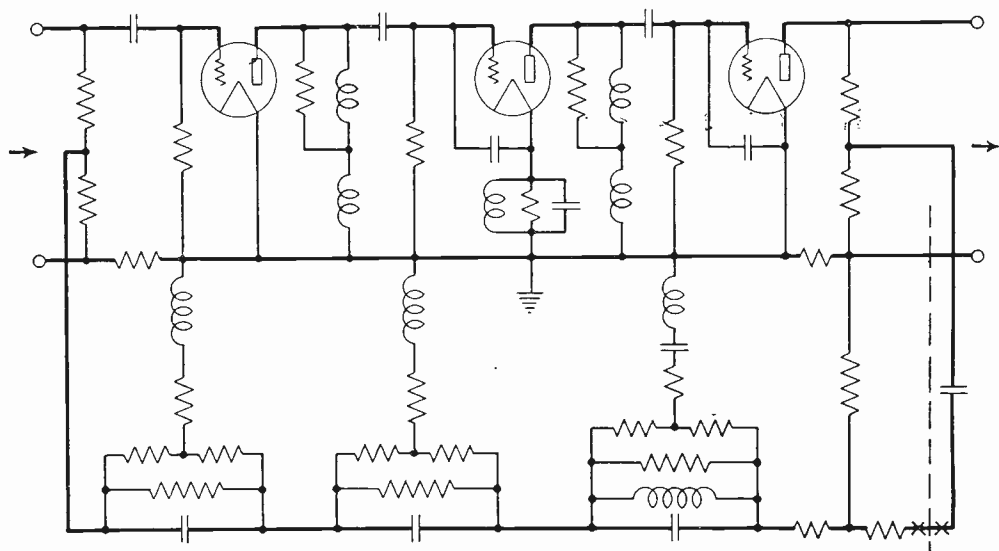

Fig. 9—Circuit diagram of the feed-back amplifier used in testing the stability criterion. The dashed line indicates the point at which the loop was broken for measurement of the transfer factor. At the left of this line is shown the resistance attenuator provided to vary the gain around the feed-back loop.

designed by E. L. Norton and E. E. Aldrich to provide a transfer factor characteristic having the desired shape, i.e., a loop crossing the zero phase axis in the neighborhood of 10 kilocycles. It will be observed that the feed-back circuit is connected between bridge networks in both input and output circuits, which were provided to eliminate reaction of the input and output circuits upon the feed-back network.¹⁰

Experimental Results

The transfer factor was measured for a zero setting of the feed-back attenuator over a frequency range of 0.5 to 1200 kilocycles. The results

¹⁰ H. S. Black, *Bell Sys. Tech. Jour.*, January, (1934).

are shown in Fig. 10. The method of plotting this figure requires some discussion. In order to keep the curve within a reasonable size and still show the necessary details the scale has been made logarithmic by plotting the gain around the loop in decibels instead of the corresponding numerical ratios. It is of course impossible to carry this out completely on a polar diagram since the transfer factor goes to zero at high frequencies. To take care of this the scale is made logarithmic only above zero gain, corresponding to unit transfer ratio, and is linear below. It should be noted that if the logarithmic portion of the scale is

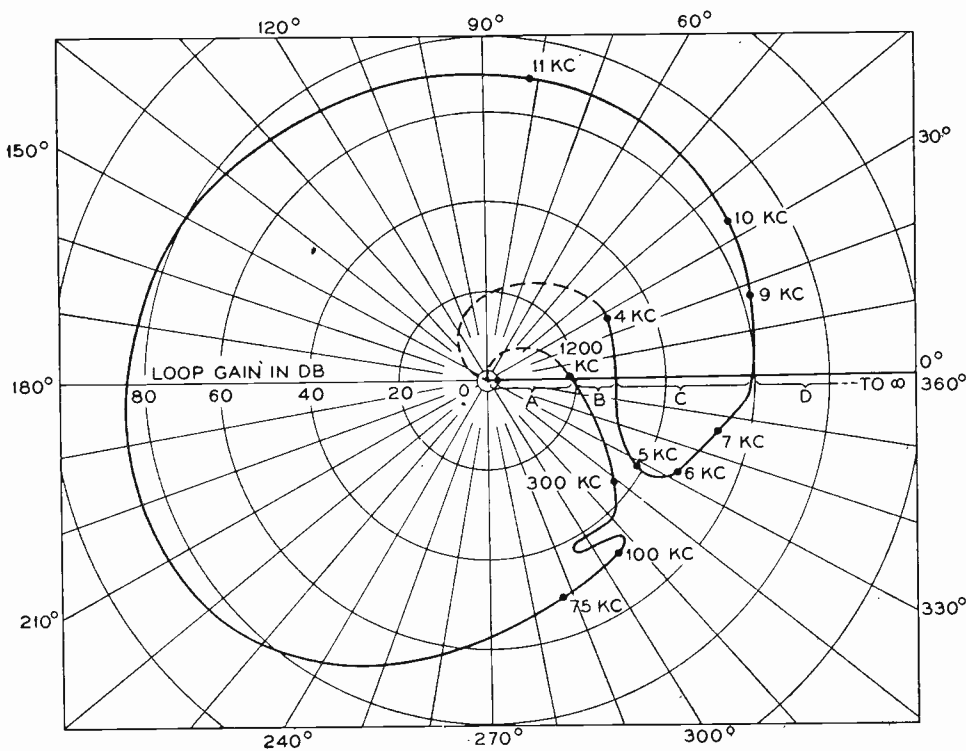

Fig. 10—Transfer factor diagram for the amplifier of Fig. 9 with the feed-back attenuator set at zero decibels.

translated outward so that the zero decibel point lies successively in the regions marked *A*, *B*, *C*, and *D*, the indicated amplifier conditions correspond to those designated above as (1), (2), (1), and (3) respectively. Experimentally an increase of the feed-back attenuator corresponds to such a translation of the logarithmic scale by an amount equal to the increase in attenuation. Therefore, the transition from one condition to another should occur when the attenuator setting is equal to the gain at a zero phase point in the curve as measured with a zero attenuator setting.

The test of the stability criterion consists of a determination of the

attenuator settings at which oscillations begin, and a comparison of these settings with those at which a transition from a stable to an unstable condition is predicted by the theory. Experimentally oscillations were found to occur in regions *A* and *C* and not in regions *B* and *D* which is in qualitative agreement with Nyquist's predictions. Quantitatively the measured and predicted transition points agreed within one decibel which is estimated to be within the experimental error.

It should be noted that the plotted curve has been drawn up for $A(j\omega)$, no points of $A(-j\omega)$ being shown, although both are required by the theoretical derivation. Where the transfer factor is zero at zero frequency, only $A(j\omega)$ is required since the loop then closes for positive values of ω . In amplifiers transmitting direct current, however, both positive and negative values⁷ of ω are needed to form a closed loop. In any case $A(-j\omega)$ is the mirror image of $A(j\omega)$ about the x-axis.

EXTENSIONS OF THE CRITERION

Nonlinear Amplifier

The stability criterion which was verified by the experiments reported in the preceding section is framed for linear systems, those in which the steady state response is linearly proportional to the applied force. In vacuum tube circuits, linearity is best approximated at small force amplitudes, and is departed from to an extent dependent upon the impressed potentials, as well as upon tube and circuit characteristics. The divergence from linearity becomes well marked when the load capacities of the tubes are approached, or when grid current is made to flow through large grid impedances. The question then arises as to the form which the stability criterion takes when a tube circuit is operated in a nonlinear region—let us say by impressing upon the circuit a sufficiently large alternating potential provided by an external independent generator.

To answer this question we may consider the response of the amplifier, loaded by the independent generator, to a small alternating potential introduced for test purposes. Since the response of the system is known to be linear from the theory of perturbations, we might attempt to apply the linear criterion to the small superposed force. To do this it is necessary to measure the transfer factor for the small superposed force over the frequency range at a particular load of interest.

Application of the experimental technique to this extended criterion introduces difficulties since the opening of the feed-back loop for measuring purposes disturbs to a certain extent the distribution of these loads, particularly the harmonics, and modulation products in general. This makes it difficult to get the same loading effect when the loop is

opened for measuring purposes as obtained when the loop is closed. Another consideration is that the response to the small component may be expected to vary in general at different points on the loading wave, so that the measuring procedure averages the response over a cycle of the loading wave. A method of measurement analogous to that of the flutter bridge would be required to evaluate the transfer factor at points of the loading cycle. Further, the measuring apparatus is affected by the presence of the loading currents when these are sufficiently large. In the present case in which the loading frequency (60

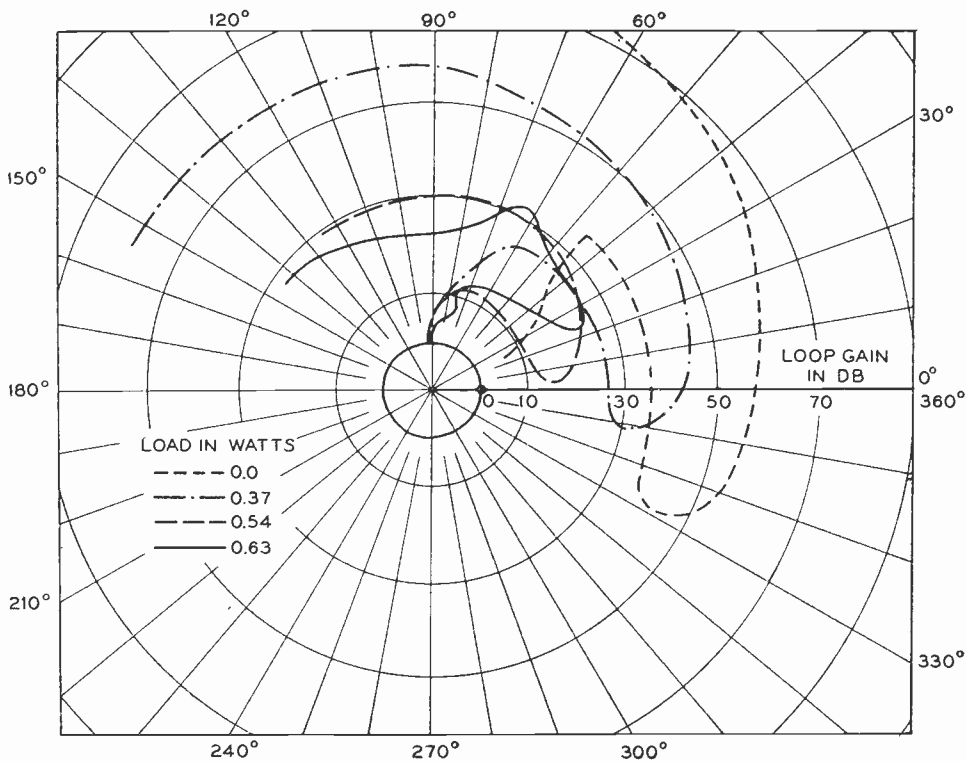

Fig. 11—Transfer factor diagrams for the amplifier of Fig. 9 with the feed-back attenuator set at zero decibels. The four curves shown correspond to different amounts of the 60-kilocycle load.

kilocycles) was far removed in the frequency scale from the test frequencies, it was found possible to approximate the necessary measurements by the insertion of selective circuits.

The curves of Fig. 11 represent portions of the transfer factor polar diagram for an amplifier similar to the one previously described, measured by the visual method with different loading amplitudes. The effect of the load on this particular amplifier is to change both phase shift and amplitude so that the curves shrink both radially and tangentially, pulling the loop back across the zero phase axis until, at the heaviest load, the two low-frequency crossings are completely eliminated. If the

extended criterion is valid, we should expect the amplifier to be stable at any setting of the feed-back attenuator. As the load is decreased from this value, the crossings occur at successively higher gains so that the start of oscillations would occur at progressively higher settings of the feed-back attenuator.

The curves of Fig. 12 show the attenuator settings predicted by the extended criterion and those determined by direct observation of the

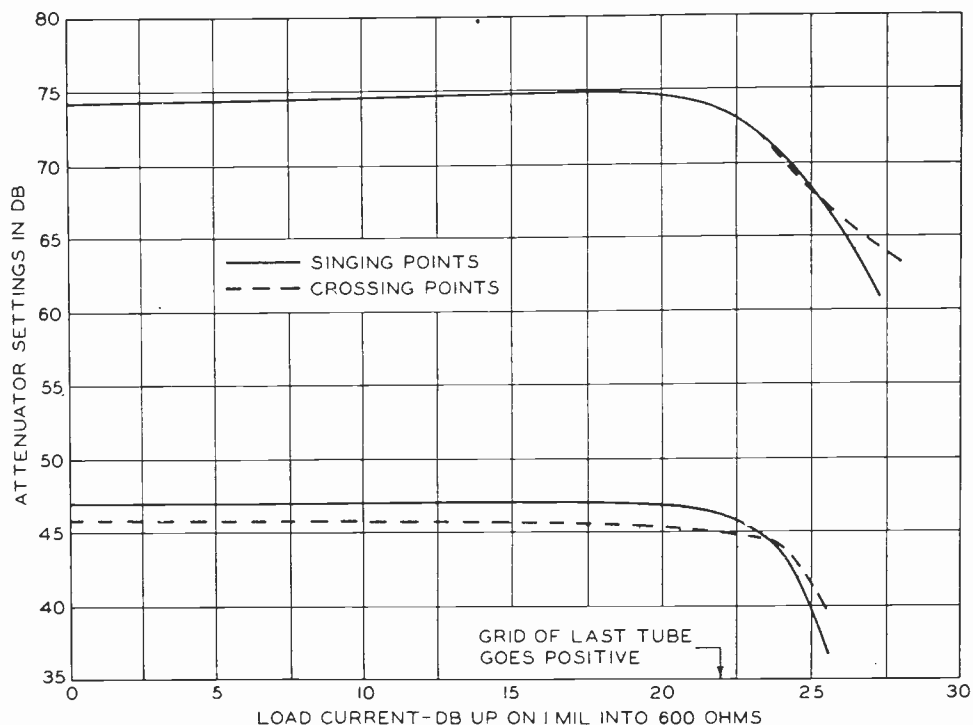

Fig. 12—Comparison of feed-back attenuator settings required for the starting of oscillations, and those deduced from the transfer diagram, plotted as functions of the 60-kilocycle load. The two dashed curves correspond to the two points (roughly 4.5 and 8 kilocycles) at which the transfer factor diagram (Fig. 11) crosses the zero phase axis. The gains of Figs. 11 and 12 cannot be compared directly because of a change made in the amplifier circuit of Fig. 12 which increased the loop gain.

attenuator setting required for oscillations when the feed-back circuit was closed. Two sets of curves are shown, one for each of the low-frequency crossings. These are plotted against the loading amplitude. The agreement between the experimental and predicted values is close for the higher gain crossing at small loading amplitudes, but a divergence is apparent at high loads. For the lower crossing there is a divergence of 1.5 decibels at low loads, which changes sign and becomes greater at the higher loads. These divergences may be ascribed to a variety of causes among which probably the most important are the effects of harmonics upon the amplifier loading, overloading of the

measuring apparatus by harmonics of the loading electromotive force, and phase shifts introduced by the selective circuits. The last two causes may be eliminated by improved technique, but the first cause in general introduces a fundamental difficulty, particularly important when large nonlinearities are involved.

NEGATIVE IMPEDANCES

One of the early forms of stability criterion mentioned in the first section was that relating to the measured impedance of the circuit. Nyquist's criterion involving the transfer factor may be transformed so as to formulate a more complete criterion involving such an impedance.

To do this we have to express the factor $(1-A)$, on which the stability criterion was based, in terms of the circuit impedances. For illustrative purposes we may quote the results obtained with the two fundamental forms of feed-back circuits, the series and shunt types.¹¹

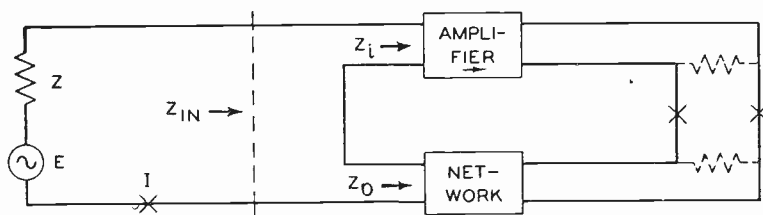

Fig. 13—Series type feed-back circuit. The dotted resistances indicate the terminations applied when the feed-back circuit was broken, to which the passive impedances (Z_i, Z_o) apply. Z_{in} represents the effective input impedance with the feed-back circuit connected through.

These results, while obtained for the input circuit of the amplifier, are valid for any other point of the feed-back loop. Further, combinations of the shunt and series type feed-back circuits may be used.

Series Feed-Back

The series circuit is shown in Fig. 13, so called because the feed-back is applied in series with the applied electromotive force and the amplifier input. The passive impedances marked are those existing when the feed-back loop is broken and terminated as indicated by the dotted lines. By direct circuit analysis, the current and voltage amplitudes in the feed-back condition are related by

$$E = (Z + Z_o + Z_i)(1 - A)I,$$

where A and the Z 's are functions of frequency. The total effective circuit impedance is obtained as the multiplier of I in the right mem-

¹¹ Crisson, *Bell Sys. Tech. Jour.*, vol. 10, p. 485.

ber. Subtracting the generator impedance Z from the total, the input impedance becomes

$$Z_{IN} = (Z_0 + Z_i)(1 - A) - AZ,$$

from which,

$$1 - A = \frac{Z}{Z + Z_0 + Z_i} \left(1 + \frac{Z_{IN}}{Z} \right).$$

Of the two factors of the right member, the first one, involving passive impedances alone, can have no roots with positive real part. Any such roots must, therefore, be contained in the second bracketed factor, and then only when Z_{in} is negative. Hence paraphrasing the transfer factor criterion, if we plot $-Z_{in}/Z$ over the frequency range, the circuit is stable when the point $(1, 0)$ is not enclosed by the resultant curve.

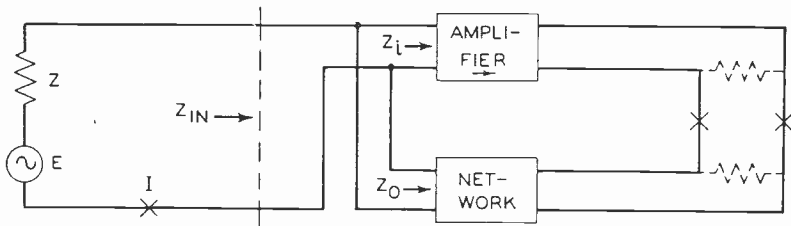

Fig. 14—Shunt type feed-back circuit. The notation corresponds to that of Fig. 13.

Shunt Feed-Back

Proceeding as in the series case with the circuit of Fig. 14 we get

$$1 - A = \frac{Z_a}{Z + Z_a} \left(1 + \frac{Z}{Z_{in}} \right),$$

where Z_a represents the impedance of Z_0 and Z_i in parallel. Again only the bracketed term can yield undamped transients so that the criterion involves plotting $-Z/Z_{in}$ over the frequency range; if the resultant curve does not enclose $(1, 0)$ the circuit is stable.

It may be remarked that these results are applicable to circuits including two-terminal negative impedances such as the oscillating arc and the dynatron, which are of the series and the shunt type, respectively.

ACKNOWLEDGMENT

The authors are indebted to Mr. L. W. Hussey for discussions of theoretical points, and to Mr. P. A. Reiling for his cooperation in the experiments.

SOME ASPECTS OF PARALLEL RESONANT CIRCUITS*

BY

L. M. CRAFT

(Ohio State University, Columbus, Ohio)

Summary—Factors that determine whether the impedance of a parallel resonant circuit is a maximum or a minimum with respect to frequency are considered. Analysis is made of such a circuit determining the relation between inductance, capacity, and resistances for a maximum or a minimum of impedance.

MANY radio and communication circuits contain branch circuits having inductance and resistance in one arm, and capacitance and resistance in the other. It is a well-known fact that for small resistances the impedance has a maximum at some frequency, being infinite for the case of zero resistances. In general, the frequency for which the maximum impedance occurs is different from the resonant

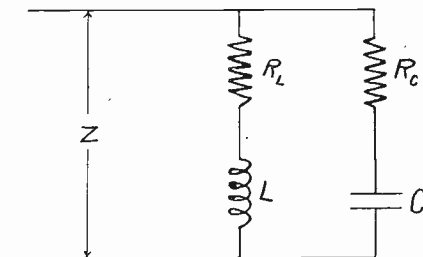

Fig. 1

frequency where the term resonance is used to mean unity power factor. The frequency of maximum impedance has been called anti-resonance by K. S. Johnson and others. It was first observed some time ago that for certain circuits, having resistances of relatively large magnitude in both arms, the impedance was a minimum instead of a maximum. Since the importance of this type of circuit is its impedance characteristic, it is important to know within what limits of resistance the impedance has the desired variation. It is the purpose of this paper to discuss the conditions for which the impedance is a minimum, and for purposes of discussion it is proposed that the minimum impedance shall also be called antiresonance.

The procedure is direct, applying the fundamental principles of calculus to determine points of maxima and minima. Since either is possible it is necessary to differentiate twice to determine which is represented. The principal difficulty is in carrying through the algebra,

* Decimal classification: R140. Original manuscript received by the Institute, May 21, 1934.

and in reducing the equations to such a form that they can be interpreted. The resulting equations only will be presented along with a graph to show to a better advantage the results of the investigation.

Referring to Fig. 1, the square of the absolute value of the impedance is

$$Z^2 = \frac{\left(R_C^2 + \frac{1}{\omega^2 C^2}\right)(R_L^2 + \omega^2 L^2)}{(R_C + R_L)^2 + \left(\omega L - \frac{1}{\omega C}\right)^2}$$

Upon reducing this equation to a form suitable for differentiation with respect to the angular velocity " ω ", this becomes

$$Z^2 = \frac{A\omega^4 + B\omega^2 + F}{D\omega^4 + E\omega^2 + 1}$$

where

$$A = R_C^2 L^2 C^2$$

$$B = R_C^2 R_L^2 C^2 + L^2$$

$$F = R_L^2$$

$$D = L^2 C^2$$

$$E = (R_L + R_C)^2 C^2 - 2LC$$

Since we are concerned with the absolute magnitude of the impedance Z without regard to its quadrant it is obvious from Fig. 1 and the first equation that the sign of Z is not material. By equating the first derivative to zero, the frequency of antiresonance is found to be

$$2\pi f_a = \omega_a = \sqrt{\frac{(FD - A) \pm \sqrt{(FD - A)^2 - (AE - BD)(B - FE)}}{AE - BD}}$$

Obtaining the second derivative and substituting the value of ω_a in this expression gives the sign of the second derivative. It is thus found that it has the same sign as that used with the inner radical in the expression for ω_a . That is, when the negative sign is used with the inner radical the impedance is a maximum, and when the positive sign is used with the inner radical the impedance is a minimum. This still leaves to be investigated the possibility of having both a maximum and a minimum in a given circuit, and the critical value of the resistances for which it changes from one to the other.

By substituting $R_C = a\sqrt{L/C}$ and $R_L = b\sqrt{L/C}$ in the equation for the frequency of antiresonance it reduces to the following form

$$\omega_a = \frac{1}{\sqrt{LC}} \sqrt{\frac{(b^2 - a^2) \pm \sqrt{(a^4 + 2a^3b - 2a^2 - 1)(b^4 + 2b^3a - 2b^2 - 1) + (b^2 - a^2)^2}}{a^4 + 2a^3b - 2a^2 - 1}}$$

From this equation $(a^4 + 2a^3b - 2a^2 - 1)$ and $(b^4 + 2b^3a - 2b^2 - 1)$ are equated to zero and plotted in Fig. 2. There are found to be four regions bounded by these curves and the axes. In the first of these

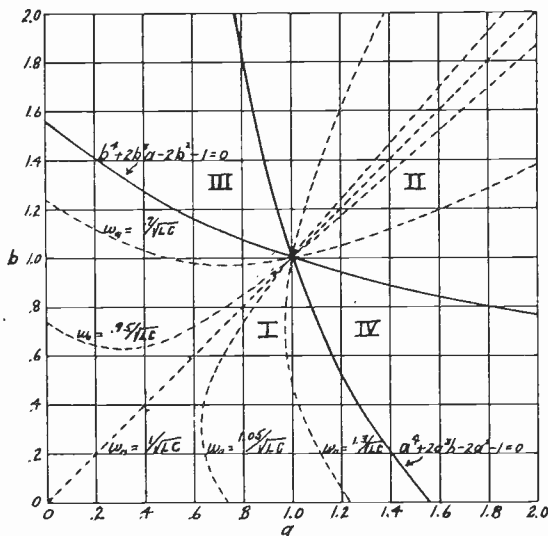

Fig. 2

regions both of these expressions above are found to be negative. Reference to the equation for antiresonance shows that in this region the denominator is negative and the negative sign must be used with the inner radical to give a real frequency. Thus for all values of a and b in this region the impedance is a maximum. In the second region, where both these expressions are positive, it is found that only the positive sign with the inner radical gives a real frequency. For all values of a and b in this region the impedance is a minimum. For the other two regions where one expression is negative and the other is positive it is seen (taking into account that a is always greater than b or vice versa) that neither sign with the inner radical gives a real frequency. This means that the impedance either increases or decreases continually from zero frequency on.

It should be noticed that if a equals b the expression for anti-resonance becomes $\omega_a = 1/\sqrt{LC}$. In Fig. 2 there have been plotted the loci of the values of a and b for both 5 per cent and 30 per cent increase and decrease in frequency from this value. Also it is found that this value of ω_a is the geometric mean of the two values of ω_a one for a and b interchanged from their values for the other. The boundary lines as plotted become the loci of points for which the frequency of antireso-

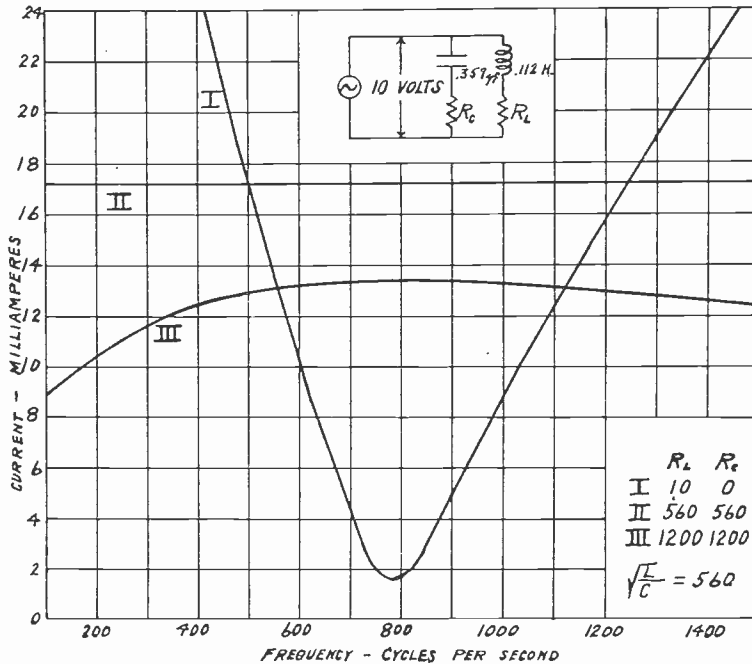

Fig. 3

nance has moved either to zero or to infinity. For the point $a = b = 1$ these two boundary lines cross, and for this point the impedance is constant for all frequencies. This has been pointed out by various authors, e.g., Morecroft, "Principles of Radio Communication," p. 92. In Fig. 3 there have been plotted actual experimental values of current from the generator for a circuit at various frequencies and for various resistances. It is noticed that in the case of minimum impedance the resonance curve is not sharp and so would not be useful in the same sense as a series resonant circuit.



NORTH ATLANTIC SHIP-SHORE RADIOTELEPHONE TRANSMISSION DURING 1932-1933*

BY

CLIFFORD N. ANDERSON

(Bell Telephone Laboratories, Inc., New York City.)

Summary—This paper extends the analysis of ship-shore radio transmission data for an additional two-year period beyond that reported on in a previous paper. Contour diagrams show the variation of signal field with time of day and distance for the winter, summer, spring, and fall seasons and for the approximate frequencies 4, 8, and 13 megacycles.

A comparison is made with the data obtained during 1930 and 1931. In general transmission during 1932-1933 tends to be somewhat better on frequencies below about 9 megacycles and somewhat poorer on frequencies above 9 megacycles. At 4 megacycles the increase is of the order of 10 decibels, and for 13 and 17 megacycles, the decreases are about 6 and 10 decibels, respectively.

A PREVIOUS paper presented¹ an analysis of ship-to-shore radiotelephone transmission over the North Atlantic during 1930 and 1931. The present paper extends that analysis to include field strength data for 1932 and 1933. These data represent transmission from the ships to shore and have been obtained incidental to the operation of a marine radiotelephone service between ships in the North Atlantic shipping lanes and the American Telephone and Telegraph Company's coastal stations at Ocean Gate and Forked River, N. J. Although frequencies in the four mobile bands 4, 8, 13, and 17 megacycles are employed, transmission results on 17 megacycles the past two years have been so inferior that this frequency has been used only infrequently.

Field Strength Contours

The method of analysis is the same as that discussed in greater detail in the previous paper. In general, a mass plot for each hour is made of fields vs. distance and an approximate envelope of the maximum fields drawn in. From these hourly curves of maximum fields, a surface is constructed and represented by a contour diagram similar to those given in Figs. 1 to 9, inclusive. These contour diagrams show the

* Decimal classification: R113×R270. Original manuscript received by the Institute, May 25, 1934. Presented before Ninth Annual Convention, Philadelphia, Pennsylvania, May 29, 1934.

¹ C. N. Anderson, "North Atlantic radiotelephone transmission during 1930 and 1931," *Proc. I. R. E.*, vol. 21, pp. 81-101; January, (1933). It is to be noted that the contour curves of Figs. 3 and 24 of this paper are interchanged, that is, the chart of Fig. 3 represents the 1930-1931 spring and fall data instead of winter.

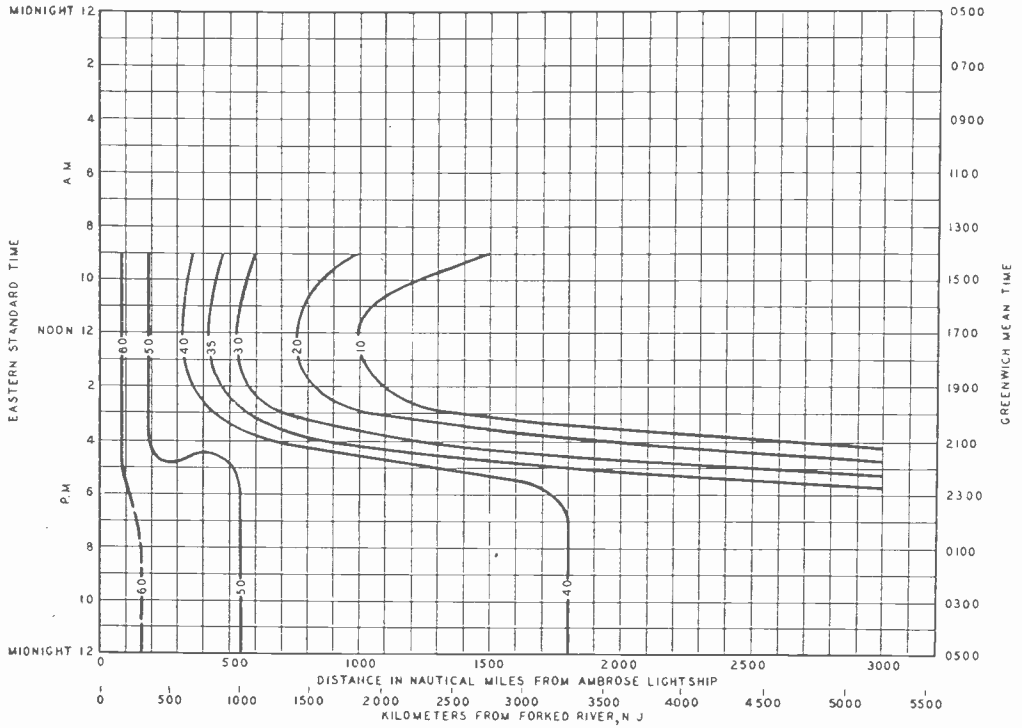

Fig. 1—Approximate variation of radio field strengths with distance and time of day. Contour lines indicate maximum expected field strengths in decibels above 1 microvolt per meter. Frequency 4.2 megacycles. Winter 1932 and 1933. Corrected to 1 kilowatt radiated power.

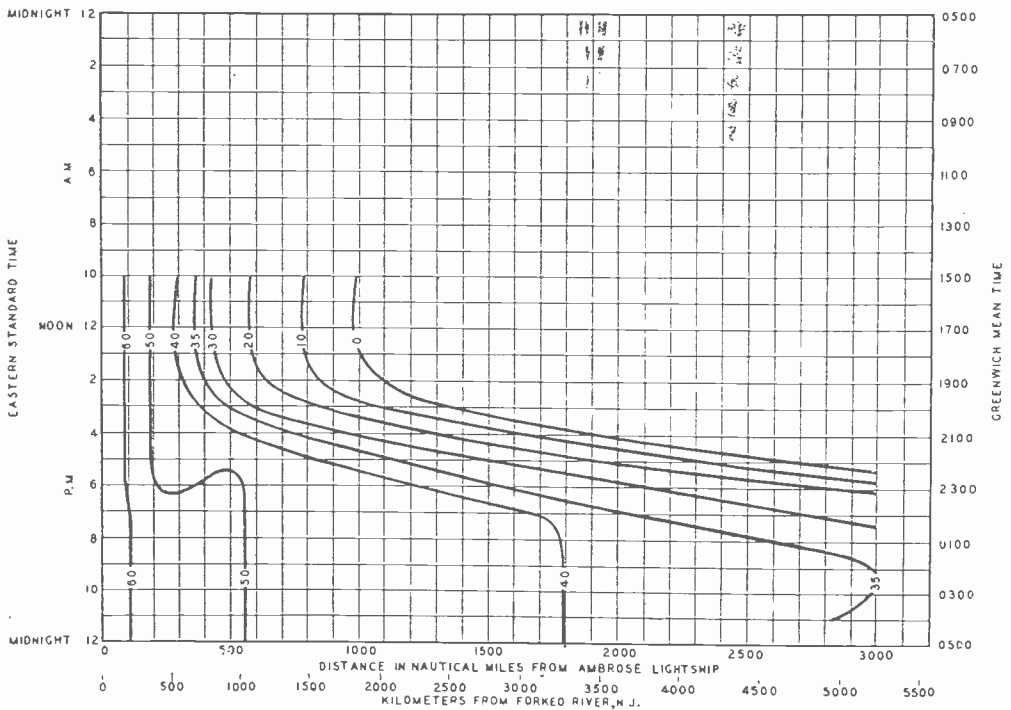

Fig. 2—Approximate variation of radio field strengths with distance and time of day. Contour lines indicate maximum expected field strengths in decibels above 1 microvolt per meter. Frequency 4.2 megacycles. Spring and fall 1932 and 1933. Corrected to 1 kilowatt radiated power.

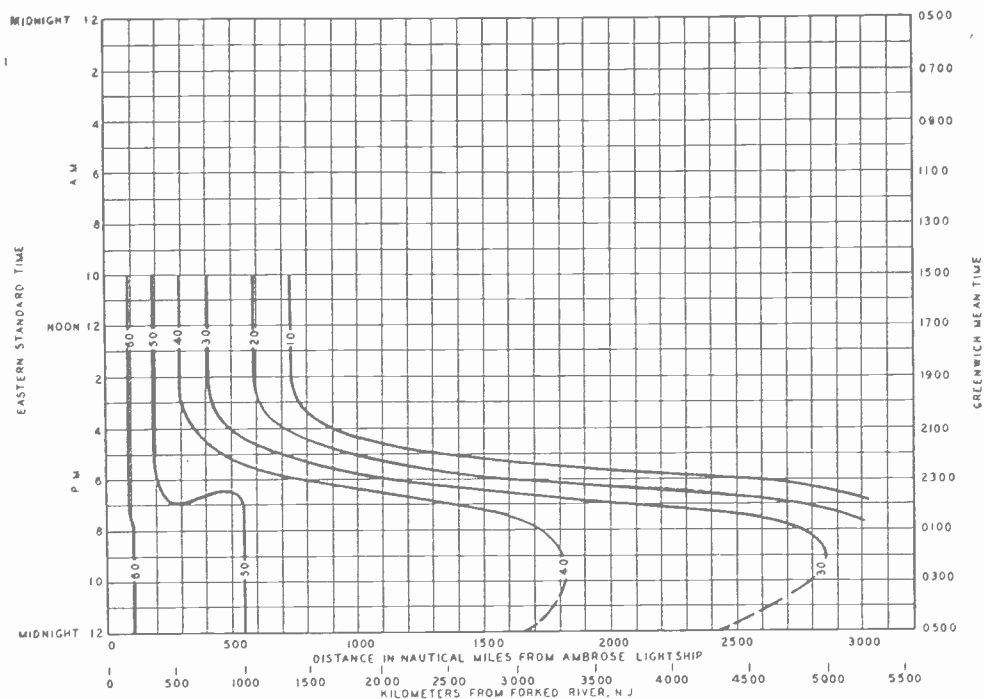

Fig. 3—Approximate variation of radio field strengths and distance and time of day. Contour lines indicate maximum expected field strengths in decibels above 1 microvolt per meter. Frequency 4.2 megacycles. Summer 1932 and 1933. Corrected to 1 kilowatt radiated power.

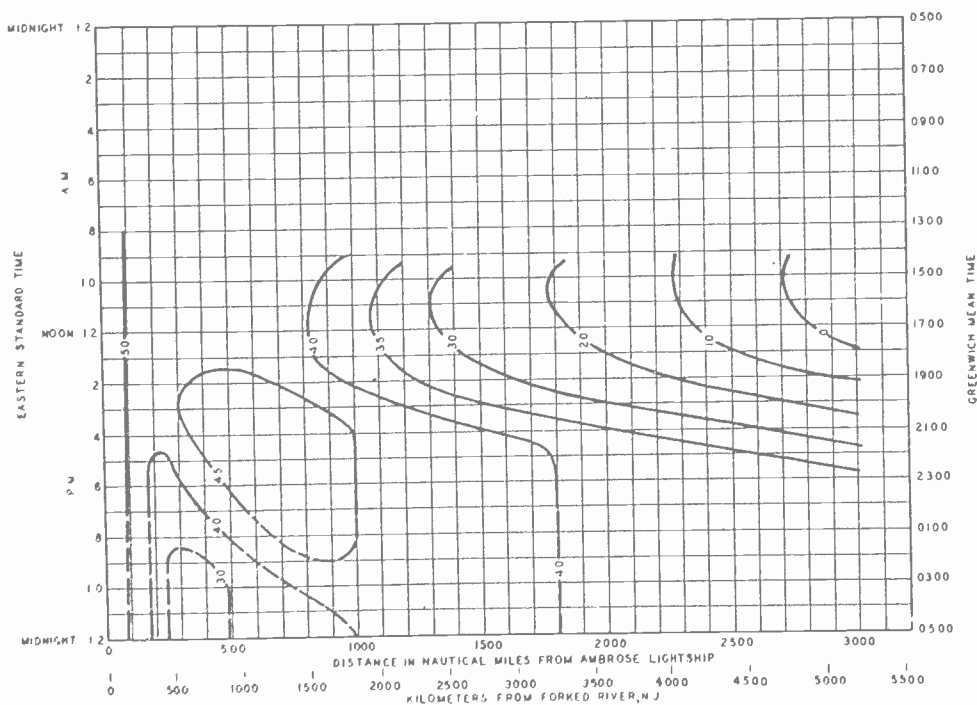

Fig. 4—Approximate variation of radio field strengths with distance and time of day. Contour lines indicate maximum expected field strengths in decibels above 1 microvolt per meter. Frequency 8.8 megacycles. Winter 1932 and 1933. Corrected to 1 kilowatt radiated power.

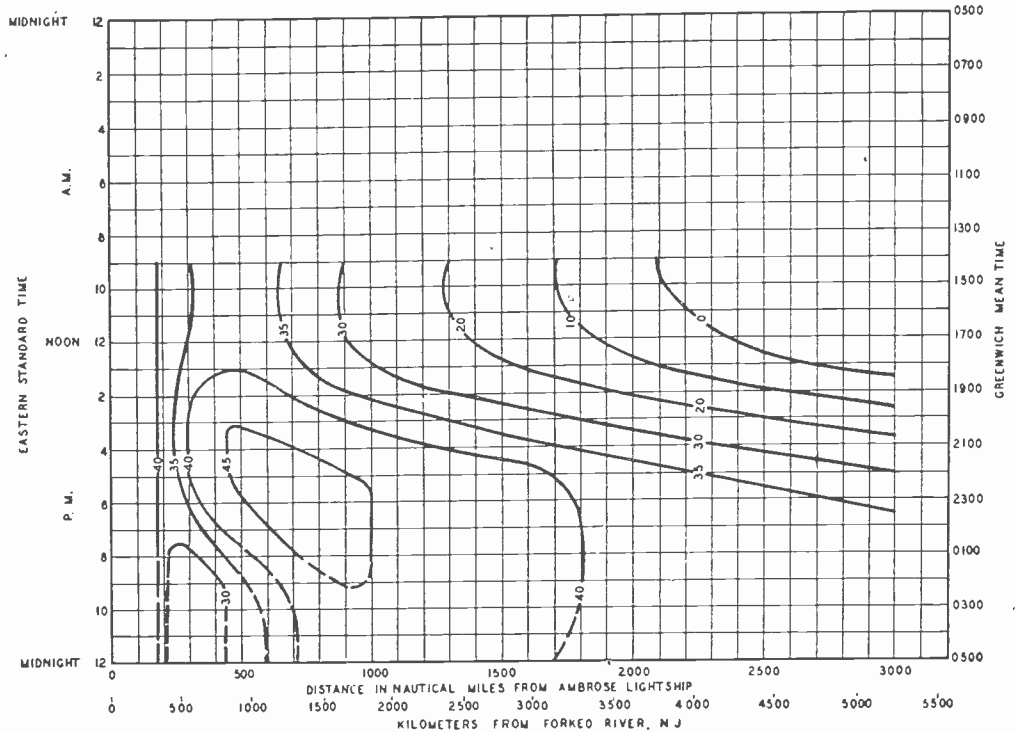

Fig. 5—Approximate variation of radio field strengths with distance and time of day. Contour lines indicate maximum expected field strengths in decibels above 1 microvolt per meter. Frequency 8.8 megacycles. Spring and fall 1932 and 1933. Corrected to 1 kilowatt radiated power.

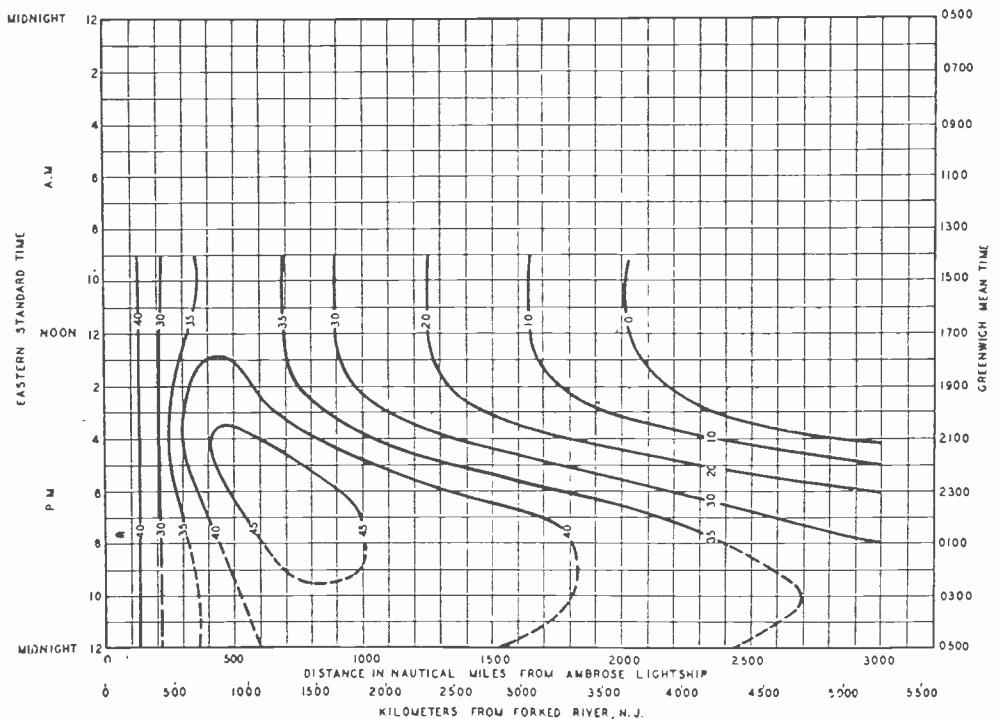

Fig. 6—Approximate variation of radio field strengths with distance and time of day. Contour lines indicate maximum expected field strengths in decibels above 1 microvolt per meter. Frequency 8.8 megacycles. Summer 1932 and 1933. Corrected to 1 kilowatt radiated power.

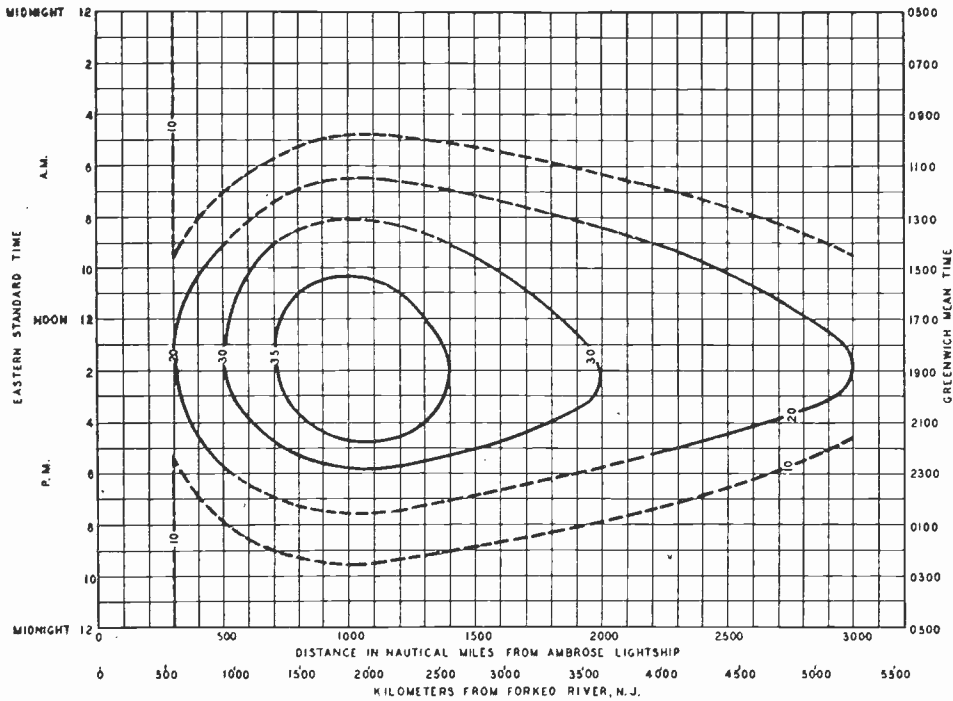

Fig. 7—Approximate variation of radio field strengths with distance and time of day. Contour lines indicate maximum expected field strengths in decibels above 1 microvolt per meter. Frequency 13.2 megacycles. Winter 1932 and 1933. Corrected to 1 kilowatt radiated power.

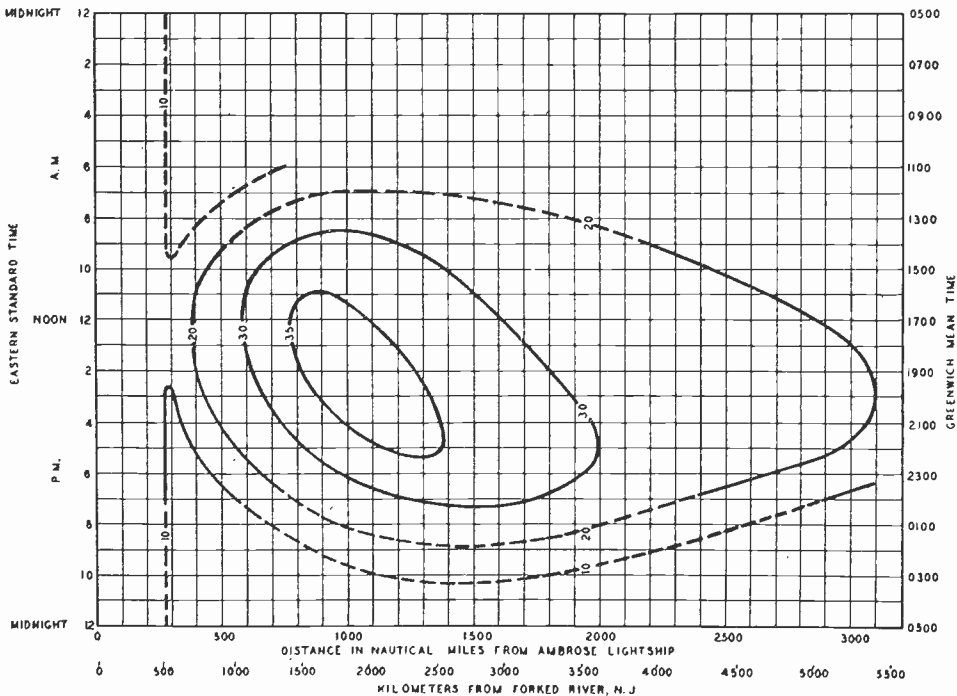

Fig. 8—Approximate variation of radio field strengths with distance and time of day. Contour lines indicate maximum expected field strengths in decibels above 1 microvolt per meter. Frequency 13.2 megacycles. Spring and fall 1932 and 1933. Corrected to 1 kilowatt radiated power.

variation of signal fields on 4, 8, and 13 megacycles with distance and time of day for winter, spring and fall, and summer seasons.

As noted, these contours represent the approximate envelope of the *maximum* values of signal field. The distribution of the observed values with respect to this envelope is shown in Fig. 10. From this figure it will be seen that the mean lies 7 decibels below the envelope for 4 megacycles and 10 below the envelope for 8 and 13 megacycles. The 4-megacycle distribution differs somewhat from that of the other two

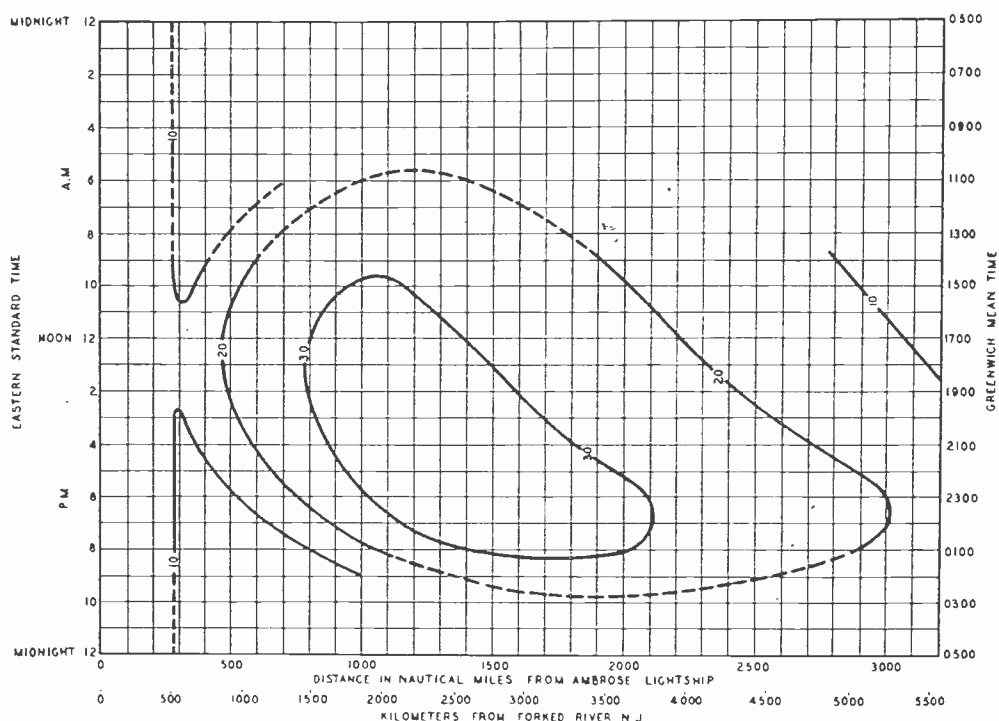

Fig. 9—Approximate variation of radio field strengths with distance and time of day. Contour lines indicate maximum expected field strengths in decibels above 1 microvolt per meter. Frequency 13.2 megacycles. Summer 1932 and 1933. Corrected to 1 kilowatt radiated power.

frequencies because an appreciable portion of the observations are for ground-wave transmission, resulting in considerably less variation.

This wide distribution of fields is, of course, primarily due to variations in the transmission medium. Minor deviations are due to variation in radiated power, type of antenna used, any errors in making the field strength measurements, errors in the determinations of the distances, and errors of analyses. Because simple antennas are generally used on shipboard, the antenna factor is less important than in the case of transmission from the highly directive antennas employed on land. With directive antennas, the diurnal characteristic may vary considerably from that indicated by the contour diagrams due to lower fields being received at certain times of the day.

1932-1933 Data Compared with 1930-1931 Data

A comparison of the contour diagrams for 1932-1933 with the corresponding curves for 1930-1931 shows, in general, very much the same type of curves, although there may be a tendency for the whole surface represented by the contours to be higher or lower in one set of data than the other. The increase in sky-wave fields is, however, limited by

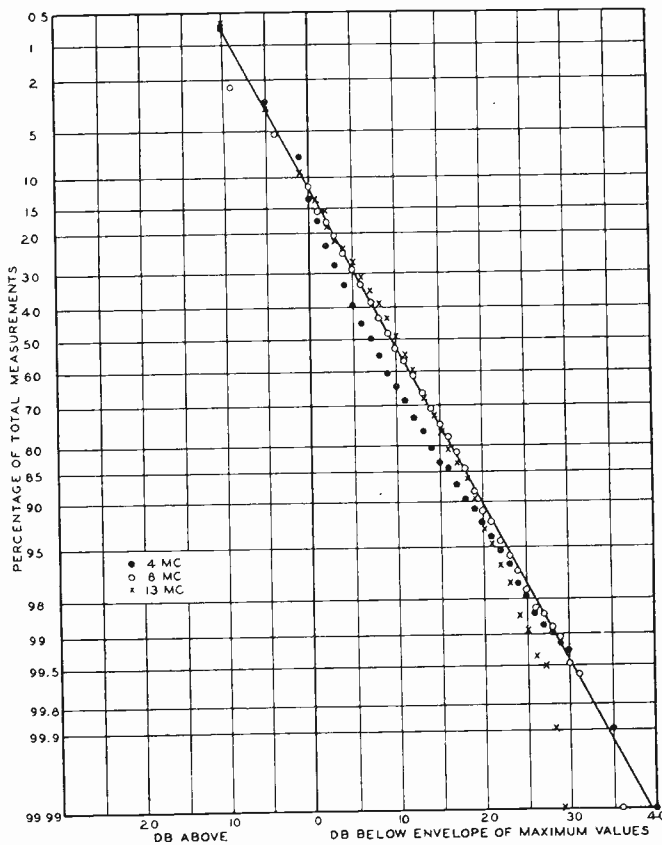

Fig. 10—Distribution of measured fields with respect to envelope of maximum values. 1932 and 1933.

the inverse distance values. For example, the 4-megacycle sky-wave fields in 1932-1933 tend to be about 10 decibels higher than in 1930-1931 except for those nighttime fields which were already represented by the inverse distance curve.

A somewhat better picture of the relative transmission on the various frequencies in 1932-1933 compared with that in 1930-1931 can be had from Figs. 11 and 12. These figures represent cross sections of the contour diagrams (for 250 watts, however, instead of 1000 watts) at 1000 miles and 3000 miles, respectively, the solid lines representing the envelope of maximum values in 1932-1933, and the dotted lines the

corresponding envelope for 1930-1931. In general, in 1932-1933 the 4.2-megacycle fields were about 10 decibels higher, the 8.8-megacycle fields 1 decibel higher, and the 13.2-megacycle fields 6 or 7 decibels lower than the 1930-1931 fields. These differentials are plotted in Fig. 13, together with the differential (decrease) of 10 decibels in 18-megacycle fields determined from transmission data obtained on the New York-London radiotelephone circuits.

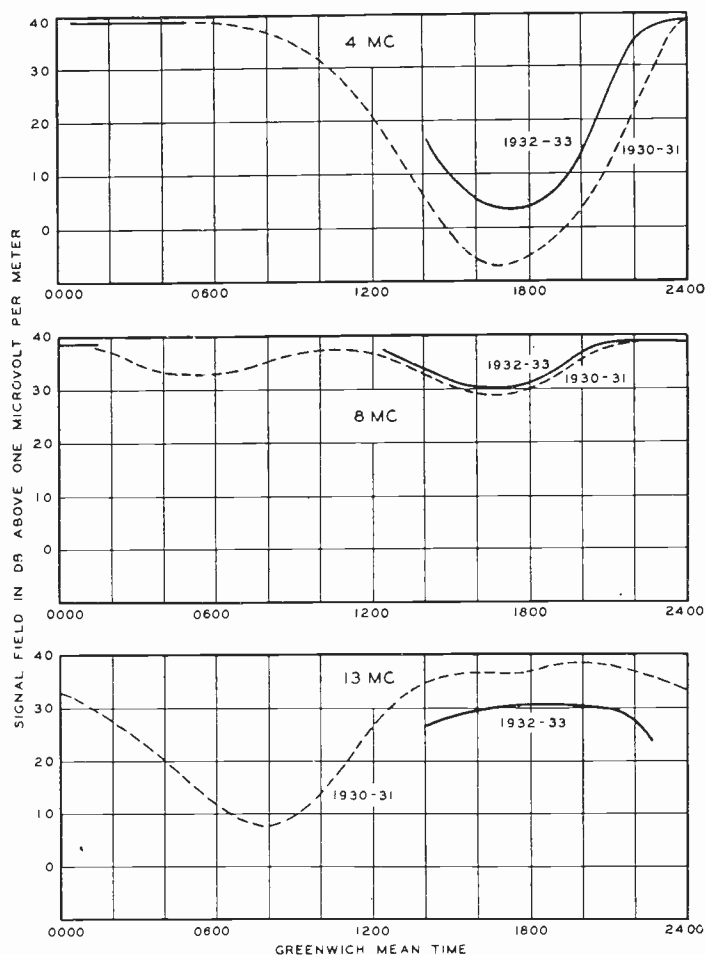

Fig. 11—Diurnal variation of maximum signal fields. Winter transmission from ships to Forked River, N. J. 250 watts radiated power. Distance 1000 nautical miles.

Radio Transmission and the Sun-Spot Cycle

A comparison of the transmission results obtained during the past four years with the sun-spot cycles as shown in Fig. 14 leads to interesting speculation. It will be noted that the 1930-1931 data were taken during a part of a sun-spot cycle marked by a rapid decrease in numbers. During 1932-1933, the sun-spot numbers were at about the bottom of the cycle. As it is expected that 1934 will also be near the minimum of the cycle, radio transmission will probably be similar to that experienced during the past two years.

In the application of short waves, we have long been accustomed to using different frequencies for daytime and nighttime transmission. In general, the transmission range on frequencies above 10 megacycles is greater during the daytime than at nighttime and on frequencies below 10 megacycles the reverse is true. We have appre-

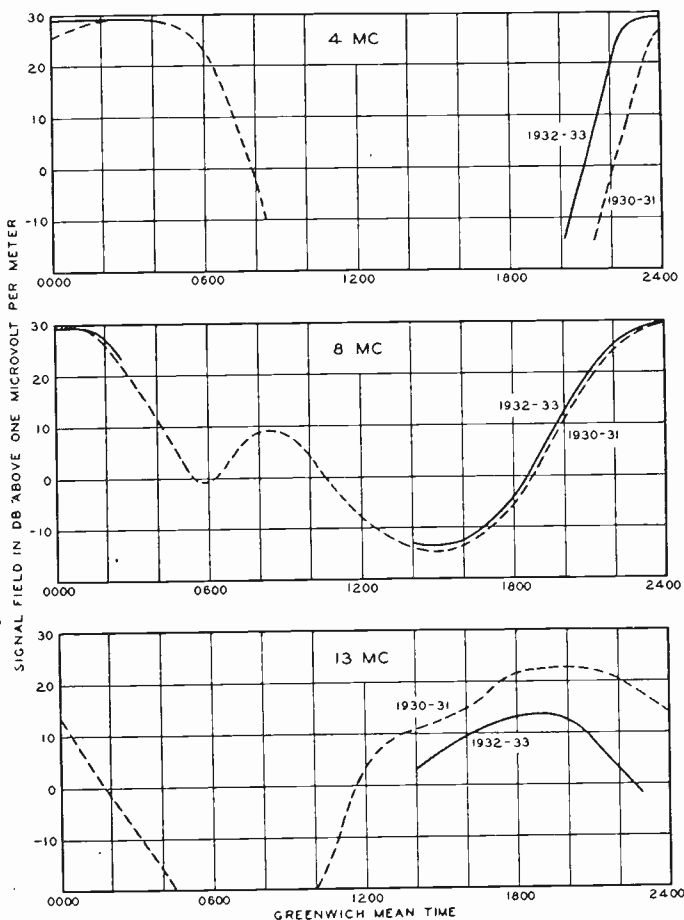

Fig. 12—Diurnal variation of maximum signal fields. Winter transmission from ships to Forked River, N. J. 250 watts radiated power. Distance 3000 nautical miles.

ciated from diurnal and seasonal changes in transmission conditions from the outset of the short-wave art that when transmission conditions are most favorable for one frequency, they are not necessarily most favorable for other frequencies. Such changing conditions as these are due primarily to varying exposures of the transmission path to sunlight.

Over a period of years, the general conditions of the transmitting medium are also changing but it is not entirely obvious that this should affect transmission on certain frequencies in the short-wave range differently than on others. Such, however, appears to be the case. During periods of minimum solar activity, the so-called "night" fre-

quencies (below 10 megacycles) are favored and during periods of increased solar activity, the "day" frequencies are favored. However, as is now well known, during individual solar storms of greatly increased activity, transmission on the higher frequencies is impaired as

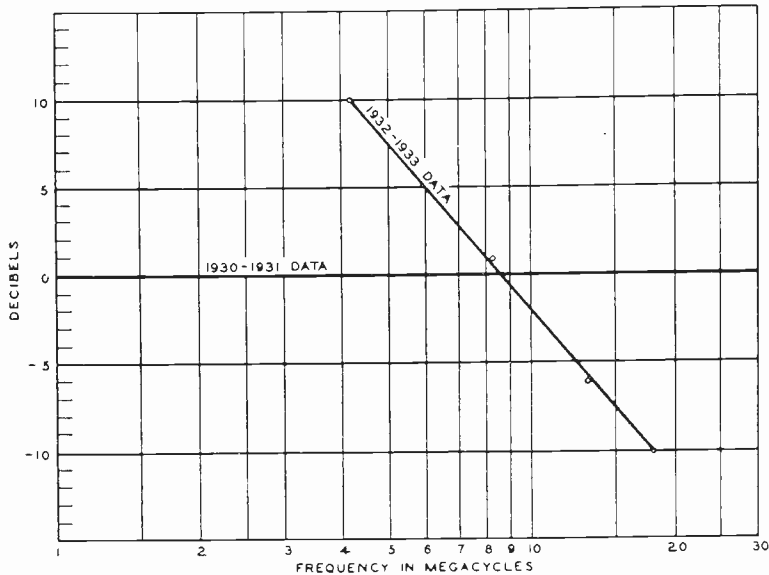

Fig. 13—Comparison of sky-wave transmission in 1932-33 with transmission in 1930-31. Transmission from ships in North Atlantic shipping lanes to Forked River, N. J.

well as transmission on the lower frequencies. There must, therefore, be some upper limit to the extent to which the transmitting medium can be affected by solar activity without having an adverse effect on transmission on these higher frequencies.

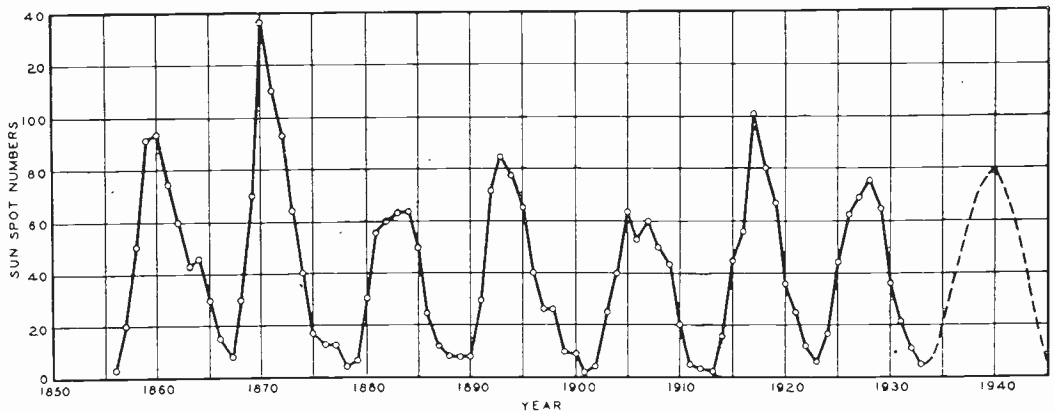

Fig. 14—Variation of sun spot numbers from year to year. Data obtained from Department of Terrestrial Magnetism, Carnegie Institution of Washington.

Present data are insufficient to determine whether this phenomenon is a function of the degree of ionization with its accompanying effect upon reflection and absorption, whether it is a function of layer heights, or of other factors resulting from solar activity.

BOOK REVIEWS

Loud Speakers (Theory, Performance, Testing and Design), by N. W. McLachlan. Published by Oxford University Press, New York City. 399 pages, 160 figures. Price \$13.50.

As the title implies, this book covers the subject of loud speakers very thoroughly. Discussions of numerous details which had appeared previously only in scattered publications have been included in this book.

Chapters I to XII, which treat such subjects as pressure on vibrators, vibrational modes, spatial distribution of sound from vibrating diaphragms, power radiation, theory of moving coil, electrostatic and horn speakers, sound waves of finite amplitude, and transients, require a good knowledge of calculus and, to a certain extent, Bessels functions for intelligent use. Under any conditions it does not seem that much important loud speaker development work can be done without such knowledge.

The remainder of the book Chapters XIII to XX dealing with driving mechanisms, magnets, efficiency, electrical impedance measurements, response curves, measurements of vibrational frequencies of conical shells and design of horn and hornless moving coil speakers, requires comparatively small mathematical ability.

The reviewer prefers to see references in the form of footnotes at the bottom of the page where the reference is made, rather than in the form of a collection at the end of the book as the author has arranged them. The former arrangement is much more convenient for their use.

This is undoubtedly a volume which can be a great aid to the engineers, both development and research, who are interested in learning how to improve loud speaker design.

*IRVING WOLFF

Broadcasting Abroad, Revised Edition. Published by the National Advisory Council on Radio in Education, Inc., 60 East 42 St., New York City. 104 pages.

This pamphlet is No. 7 in the series of information bulletins published by the National Advisory Council on Radio in Education. It has been compiled from material prepared for the Council by the International Broadcasting Union, Geneva, Switzerland. Use has also been made of a supplemental memorandum on Radio Broadcasting in the Far East and Southern Pacific, prepared by the American Council, Institute of Pacific Relations.

The bulletin summarizes for each of the principal countries of Europe and for some countries in other parts of the world the general organization of broadcasting in those countries. The names of the operating agencies are given, and lists of the broadcasting stations are included, together with their power ratings. No information is given with regard to the frequencies used by the stations. In most cases, reference is made to the extent to which the Government is responsi-

* RCA Victor Company, Camden, N. J.

ble for the preparation of programs. Facts regarding the final support of the broadcast organizations are given, it being indicated, for example, whether a tax is paid by the listeners or whether support is derived from advertising.

Special emphasis is placed on a review of the practice in each country with regard to the transmission of programs of an educational nature, and it is pointed out that in many cases programs are broadcast for reception in schools or by scholars outside of school hours.

This is the second edition of this bulletin and there is reprinted in it the preface to the first edition published in 1932. This preface, written by Dr. Irvin Stewart of Washington, D. C., concludes with the following paragraph:

"The subject of 'broadcasting abroad' is one upon which the facts are not readily available and upon which reports and opinions differ widely. The National Advisory Council on Radio in Education has performed a useful service in making accessible in a convenient form a large amount of factual information. While men hereafter will doubtless continue widely at variance in their interpretation of the facts, at least the Council has provided a point from which the variations in interpretation may start."

†L. E. WHITTEMORE

Present and Impending Applications to Education of Radio and Allied Arts-Information Series Number Five, by National Advisory Council on Radio in Education, Inc., New York. 83 pages.

This is the second edition of a bulletin giving authoritative information concerning radio. This second edition contains 83 pages. The subjects treated are: radiotelephone broadcasting, synchronization of broadcast stations, electrically transcribed programs and their syndication, facsimile broadcasting, television, short-wave and short-wave broadcasting, broadcasting over wires (including "wired radio"), and sound motion pictures in school and home: The Appendix covers the cost of broadcast stations and gives a definition of terms.

*R. R. RAMSEY

† American Telephone and Telegraph Company, 195 Broadway, New York, N. Y.

* Indiana University, Bloomington, Ind.



BOOKLETS, CATALOGS, AND PAMPHLETS RECEIVED

Copies of the publications listed on this page may be obtained without charge by addressing the publishers.

Alsimag is described in some technical leaflets issued by the American Lava Corporation of Chatanooga, Tenn.

The General Manufacturing Company of 8066 S. Chicago Avenue, Chicago, Ill., has issued several drawings showing dimensions and circuits for their multirange coils.

The Application of Monel Metal and Nickel to Industrial Processing Equipment is the name of a booklet issued by the International Nickel Company of 67 Wall Street, New York City, and gives in addition to data on the physical and mechanical properties of these materials, information on their fabrication.

The Type EB 50-watt police alarm transmitter manufactured by the Westinghouse Electric and Manufacturing Company, Radio Division at Chicopee Falls, Mass., is illustrated in a leaflet.

Catalog 10-A of the Roller-Smith Company of 233 Broadway, New York City describes their Kathetron Manual Regulator for alternating-current circuits.

Bulletin 320 of the Rubicon Company of 29 N. 6th Street, Philadelphia, Pa., describes various galvanometers produced by that company.

The Westinghouse Electric and Manufacturing Company of East Pittsburgh, Pa., has published a leaflet on their electronic contactor timers for spot welding.

Summerill seamless nickel and other tubing is described in a leaflet issued by the Summerill Tubing Company of Bridgeport, Pa.

Bulletin AVB-6 which describes the RCA Victor aviation radio general purpose receiver is available from the RCA Victor Company, Inc., at Camden, N. J.

Felt bonded metal is described in a booklet by the Felters Company, Inc., of 210 South Street, Boston, Mass.

Application Note No. 41 of the RCA Radiotron Company of Harrison, N. J. is devoted to the 1C6 and Note No. 42 covers a short-cut method for determining the operating conditions of power output triodes.

CONTRIBUTORS TO THIS ISSUE

Anderson, Clifford N.: Born September 22, 1895, at Scandinavia, Wisconsin. Received Ph.B. degree, University of Wisconsin, 1919; M.S. degree, 1920. Supervising principal of schools, Amery, Wisconsin, 1913-1917. Ensign, Aircraft Radio, U.S.N.R.F., 1917-1918. Instructor, engineering physics, University of Wisconsin, 1919-1920; standardizing laboratory, General Electric Company, Lynn, Massachusetts, 1920-1921; Fellow to Norway, American-Scandinavian Foundation, 1921-1922; department of development and research, American Telephone and Telegraph Company, 1922-1934; Bell Telephone Laboratories, 1934 to date. Associate member, Institute of Radio Engineers, 1919; Fellow, 1934.

Chambers, J. A.: Born August 21, 1903, at Union, South Carolina. Received B.S. degree, Clemson College, 1924. Radio engineering department, General Electric Company, 1924-1927; technical supervisor of stations WLW, WSAI, and W8XAL, Crosley Radio Corporation, 1927 to date. Member, Acoustical Society of America. Associate member, Institute of Radio Engineers, 1928; Member, 1930.

Craft, L. Morgan: Born January 16, 1908, at Scotland, Illinois. Received B.S. and M.S. degrees in electrical engineering, University of Illinois. Bell Telephone Laboratories, 1930-1932. Graduate assistant, Ohio State University, 1932 to date. Nonmember, Institute of Radio Engineers.

Ferrell, Enoch B.: Born January 1, 1898, at Sedam, Kansas. Received B. A. degree, 1920; B.S. degree in electrical engineering, 1921; M.A. degree, University of Oklahoma, 1924. Instructor in mathematics, University of Oklahoma, 1921-1924. Member, technical staff, Bell Telephone Laboratories, 1924 to date. Associate member, Institute of Radio Engineers, 1925; Member, 1929.

Fyler, George W.: Born September 3, 1906, at New Haven, Connecticut. Connecticut State College, 1924-1925; received B.S. degree in electrical engineering, Yale University, 1929; M.S. degree, Union College, 1932. Bell Telephone Laboratories, 1928; radio engineer, General Electric Company, 1929 to date. Installation engineer, General Electric Company, stations WTIC, WGY, KFI, WCAU, and WLW. Associate member, Institute of Radio Engineers, 1930.

Honnell, Pierre M.: Born January 28, 1908, at Paris, France. Received B.S. degree in electrical engineering, A. and M. College of Texas, 1930. Ship's radio operator, the Texas Company, 1926-1928; member, technical staff, Bell Telephone Laboratories, 1930-1933. Student, Technical Institute in Vienna, 1933 to date. Junior member, Institute of Radio Engineers, 1927; Associate member, 1929.

Hutcheson, J. A.: Born January 21, 1905, at Park River, North Dakota. Received B.S. degree, University of North Dakota, 1926. Radio engineering department, Westinghouse Electric and Manufacturing Company, 1926 to date; Member, Sigma Xi. Associate member, Institute of Radio Engineers, 1928; Member, 1930.

Jones, L. F.: Born July 4, 1905, at St. Louis, Missouri. Received B.S. degree, Washington University, 1926. Radio engineering department, General

Electric Company, 1926–1928. Graduate School of Business Administration, Stanford University, 1928–1929. Radio engineering department, General Electric Company, 1929–1930. Transmitter engineering department, RCA Victor Company, 1930 to date. Member, Sigma Xi. Junior member, Institute of Radio Engineers, 1926; Associate member, 1926.

Kreer, J. G.: Born March 25, 1903, at Chicago, Illinois. Received B.S. degree, University of Illinois, 1925; M.A. degree, Columbia University, 1928. Member, technical staff, Bell Telephone Laboratories, 1925 to date. Nonmember, Institute of Radio Engineers.

Leach, Edward A.: Born September 3, 1905, at Bridgehampton, New York. Received B.S. and M.S. degrees in electrical engineering, Massachusetts Institute of Technology, 1928. General Electric Test Course, 1925–1928 (intermittently); radio consulting laboratory, General Electric Company, 1928; radio engineering department, 1928 to date; installation engineer, station WLW. Nonmember, Institute of Radio Engineers.

Peterson, Eugene: Born August 26, 1894, at New York City. Cornell University, 1911–1914; Brooklyn Polytechnic Institute, 1917; received M.A. degree, Columbia University, 1923; Ph.D. degree, 1926. Electrical Testing Laboratories, 1915–1917; Signal Corps, U. S. Army, 1917–1919; member, technical staff, Western Electric Company, 1919–1925; Bell Telephone Laboratories, 1925 to date. Member, American Institute of Electrical Engineers and American Physical Society. Member, Institute of Radio Engineers, 1930.

Ware, L. A.: Born May 21, 1901, at Bonapart, Iowa. Received B.E. degree, University of Iowa, 1926; M.S. degree, 1927; Ph.D. degree, 1930. Instructor in physics, Blainstown, Iowa high school, 1923–1924. Commonwealth Edison Company, summers, 1925 and 1926. Instructor in physics, University of Iowa, 1926–1929. Member, technical staff, Bell Telephone Laboratories, 1929–1933. Nonmember, Institute of Radio Engineers.

Williamson, R. H.: Born April 6, 1907, at Eagle Grove, Iowa. Received B.S. degree in electrical engineering, Iowa State College, 1928. High power transmitter section, General Electric Company, 1928 to date. Associate member, Institute of Radio Engineers, 1931.



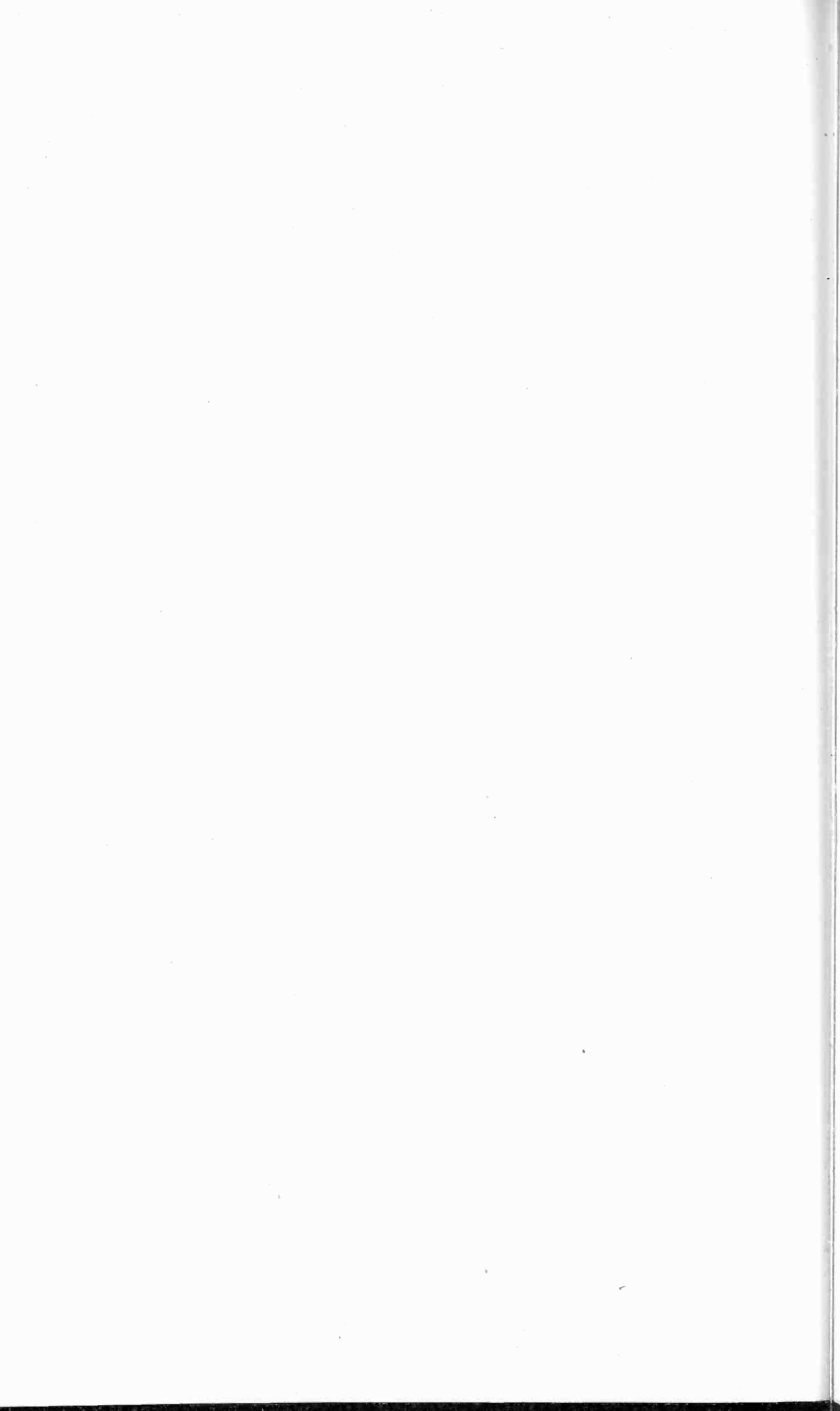

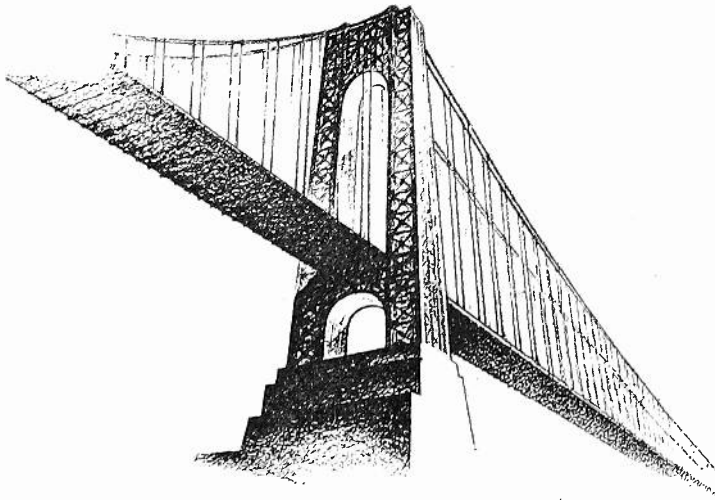

FIRM FOUNDATIONS

Even amid the shifting currents of recent years, Hygrade Sylvania Corporation has upheld its reputation as a stable organization. In fact during the depression period our financial strength increased consistently. The credit rating of this company has never varied from the highest attainable. .AaA1.

Firm Foundations!

There are no absentee owners in Hygrade Sylvania. It is owned by the men who manage the

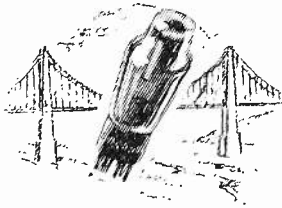

business.

They established research laboratories wherein Sylvania engineers pioneered the development of the 6.3 volt tube. Hygrade Sylvania is also contributing importantly to the development of radio transmission equipment!

Radio set manufacturers are invited to use Sylvania's facilities in solving circuit and design problems. No obligation incurred. Hygrade Sylvania Corporation, Emporium, Penna.

Sylvania

(Reg. U. S. Pat. Off.)



THE SET-TESTED RADIO TUBE

© 1933, H. S. C.

When writing to advertisers mention of the PROCEEDINGS will be mutually helpful

The Internationally - Accepted
STANDARDS of QUALITY:

C-D
condensers

For Radio Transmission

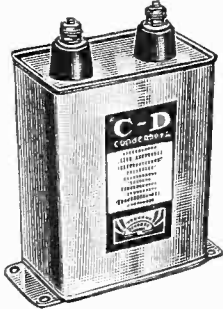

For Power Factor Work

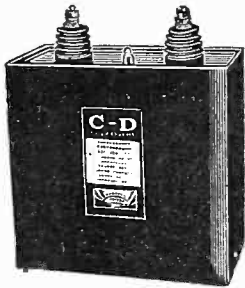

For X-Ray and High
Frequency Applications

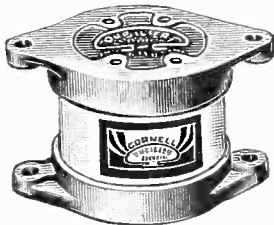

For Every Industrial
Requirement

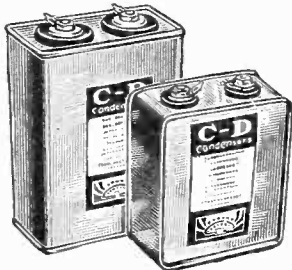

ENGINEERS—

WE OFFER YOU

24 years of

EXPERIENCE

SPECIALIZATION

LEADERSHIP

FAIR DEALING

*in the exclusive manufacture
of the world's finest condensers*

PAPER



MICA

OIL



ELECTROLYTIC

*In many thousands of types, sizes, styles,
capacities—from 12 volts to 100,000 volts—*

OUR ENGINEERING FACILITIES ARE AT
YOUR DISPOSAL, WRITE FOR CAT. #127

**CORNELL-DUBILIER
CORPORATION**

4379 Bronx Boulevard,

New York City



REG. U.S. PAT. OFF.

When writing to advertisers mention of the PROCEEDINGS will be mutually helpful

**GOOD
SERVICE
THROUGH
TRYING YEARS**

THROUGH recent trying years there has been no letting down in the quality of your Bell telephone service. On the contrary, improvement has gone steadily on.

On long distance and toll calls, the percentage of calls completed is now higher than ever before. The average time required for making these connections has been reduced from 2.8 minutes in 1929 to 1.5 minutes. Since 1929, mistakes by operators have been reduced one-third and more than 99% of all telephone calls are now handled without error.

The number of service complaints by customers is now the lowest on record and reports of trouble with instruments have decreased 17% since 1929.

Good times and bad have proved the wisdom of one policy, one system and universal service.



BELL TELEPHONE SYSTEM



When writing to advertisers mention of the PROCEEDINGS will be mutually helpful



**Reliable
INDICATORS
OF CAPACITY AND
RESISTANCE
VALUES**

Among radio engineers there is but one choice in the selection of an instrument for measuring radio fundamentals . . . it must have the dependability and long-life which only an instrument built by Weston provides.

For measuring capacity and resistance values Weston Models 663 and 664 are universally used. The Model 663 provides for the measurement of all values of resistance as well as all values of D.C. current and voltage encountered in radio servicing. Similarly, the Model 664 provides for the measurement of all capacity values, A.C. voltages and output readings ordinarily encountered.

Both instruments are built on rugged, enduring Bakelite panels . . . and will always be up-to-date because they indicate in fundamental units. A bulletin gives complete data. Fill in and mail the coupon . . . Weston Electrical Instrument Corp., 589 Frelinghuysen Ave., Newark, N. J.

WESTON 
Radio Instruments

WESTON ELECTRICAL INSTRUMENT CORPORATION
589 Frelinghuysen Ave., Newark, N. J.

Send bulletin on Weston Radio Instruments.

Name _____

Address _____

City and State _____

When writing to advertisers mention of the PROCEEDINGS will be mutually helpful

The Institute of Radio Engineers

Incorporated

330 West 42nd Street, New York, N.Y.

APPLICATION FOR ASSOCIATE MEMBERSHIP

(Application forms for other grades of membership are obtainable from the Institute)

To the Board of Directors
Gentlemen:

I hereby make application for Associate membership in the Institute of Radio Engineers on the basis of my training and professional experience given herewith, and refer to the members named below who are personally familiar with my work.

I certify that the statements made in the record of my training and professional experience are correct, and agree if elected, that I will be governed by the constitution of the Institute as long as I continue a member. Furthermore I agree to promote the objects of the Institute so far as shall be in my power, and if my membership shall be discontinued will return my membership badge.

(Sign with pen).

(Address for mail)

(Date)

(City and State)

Sponsors:

(Signature of references not required here)

Mr. ----- Mr. -----
Address ----- Address -----
City and State ----- City and State -----

Mr. -----

Address -----

City and State -----

The following extracts from the Constitution govern applications for admission to the Institute in the Associate grade:

ARTICLE II—MEMBERSHIP

Sec. 1: The membership of the Institute shall consist of: * * * (c) Associates, who shall be entitled to all the rights and privileges of the Institute except the right to hold any elective office specified in Article V. * * *

Sec. 4. An Associate shall be not less than twenty-one years of age and shall be a person who is interested in and connected with the study or application of radio science or the radio arts.

ARTICLE III—ADMISSION AND EXPULSIONS

Sec. 2: * * * Applicants shall give references to members of the Institute as follows: * * * for the grade of Associate, to three Fellows, Members, or Associates; * * * Each application for admission * * * shall embody a full record of the general technical education of the applicant and of his professional career.

ARTICLE IV—ENTRANCE FEE AND DUES

Sec. 1: * * * Entrance fee for the Associate grade of membership is \$3.00 and annual dues are \$6.00.

ENTRANCE FEE SHOULD ACCOMPANY APPLICATION

(Typewriting preferred in filling in this form) No.....

RECORD OF TRAINING AND PROFESSIONAL EXPERIENCE

Name
(Give full name, last name first)

Present Occupation
(Title and name of concern)

Business Address

Permanent Home Address

Place of Birth..... Date of Birth..... Age.....

Education

Degree (college) (Date received)

TRAINING AND PROFESSIONAL EXPERIENCE

DATES	

Record may be continued on other sheets of this size if space is insufficient.

Receipt Acknowledged..... Elected..... Deferred.....
Grade Advised of Election..... This Record Filed.....

Why Round-Can Electrolytics?

THERE'S a decided swing-back to round-can electrolytics. With *quality* rather than price the prime factor in this season's radio sets, there is ample reason for a greater demand than ever before for these tried and proven Aerovox products. For instance:

ECONOMY

Maximum capacity and working voltage, positive dependability and extreme life offered at lowest cost in Aerovox aluminum-can dry electrolytic condensers. Aerovox chemists as well as engineers have developed a superior product, efficiently and economically duplicated by a vast electrolytic condenser department that is a complete plant in itself.

COMPACTNESS

Units available for upright or inverted mounting. Convenient universal mounting ring bracket. Double and triple section units for use in small assemblies where space is at a premium.

RUGGEDNESS

Built to stand the gaff! Conservatively rated, thereby providing higher safety factor. Special method of hermetically sealing containers maintains original operating characteristics throughout long life. No evaporation or seepage. No absorption of excessive moisture from air. Sturdy aluminum cans. Lug terminals on molded bakelite top. Extensively used in small sets to replace paper box type units where high temperatures would limit life of latter.

LONG LIFE

Designed for long life and troubleproof service. Manufacturers are coming back to Aerovox round-can electrolytics because of the performance of these units in sets in everyday use. Simply install them and forget them!

Do You Get The RESEARCH WORKER?

A monthly publication containing the latest engineering practice in the condenser and resistor arts—the very cream of the crop of advanced radio technique. Sample copy sent on request. Also catalog on Aerovox electrolytic and other types of condensers, as well as resistors.

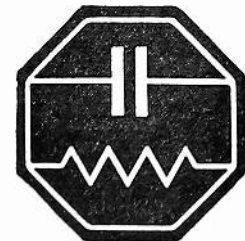

AEROVOX

C O R P O R A T I O N

71 Washington Street

Brooklyn, N.Y.

When writing to advertisers mention of the PROCEEDINGS will be mutually helpful

RADIO AND SCIENTIFIC LITERATURE

Rider's Manuals

THE "STANDARD" OF THE RADIO INDUSTRY

Engineers—Research Laboratories—
Technical Schools—Colleges—Broad-
casting Stations—all—who require in-
formation about the electrical struc-
ture and components of American
radio receivers produced during the
past 14 years, turn to Rider's Man-
uals.

The world's most complete compila-
tion of information pertaining to
American radio receivers. Absolutely
authentic.

Now available in four volumes totaling
more than 4000 pages. Up to date to
March 1934.

Write for descriptive literature

JOHN F. RIDER, Publisher
1440 Broadway New York City

PUBLISHERS

•
This Radio and Scientific
Literature page is run to help
you acquaint the readers of
the Proceedings with your
radio and technical publica-
tions.

For further information as
to rates, etc., address:—

•
Advertising Department
Institute of Radio Engineers
330 West 42nd Street
New York, N.Y.

Alphabetical Index to Advertisements

	A	
Aerovox Corp.		XVII
American Tel. & Tel. Co.		XIII
	C	
Central Radio Laboratories		XXII
Cornell-Dubilier Corp.		XII
	E	
Erie Resistor Corp.		XXI
	G	
General Radio Co.		Outside Back Cover
	H	
Hygrade Sylvania Corp.		XI
	I	
I.R.E.		XV, XVI, Inside Back Cover
	P	
Professional Eng. Directory		XIX
	R	
Radio and Scientific Literature		XVIII
	T	
Triplett Elec. Inst. Co.		XX
	W	
Weston Elec. Inst. Corp.		XIV

When writing to advertisers mention of the PROCEEDINGS will be mutually helpful

PROFESSIONAL ENGINEERING DIRECTORY

BLILEY ELECTRIC CO.

*Designers and Manufacturers
of*

QUARTZ CRYSTALS

for

Standard or Special Requirements

226A Union Station Bldg.
ERIE, PENNA.

PRACTICAL RADIO ENGINEERING

One year Residence Course
Advanced Home Study Course
Combined Home Study-Residence
Course

Write for details

Capitol Radio Engineering
Institute
Washington, D.C.

Cathode Ray Tubes and Associated Equipment For All Purposes

*Write for Complete
Technical Data*

ALLEN B. DUMONT
LABORATORIES
UPPER MONTCLAIR, N.J.

For the Engineering Consultant

who can handle a little extra business this year

For the designer

who can manage some additional work

For the Patent Attorney

who is anxious to develop a larger clientele

we suggest the Professional Engineering Directory of the PROCEEDINGS I.R.E. Manufacturers and organizations with special problems who need services such as yours come to the Professional Engineering Directory for information. Your name and special services announced here will tell them what you do and where to find you. Further information will be furnished on request. Special rates to members of the Institute.

When writing to advertisers mention of the PROCEEDINGS will be mutually helpful

TODAY'S
Most Modern
Precision
Measuring
Instruments

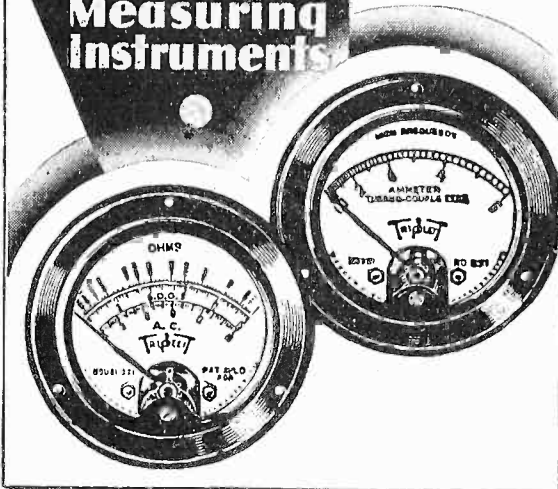

TRIPLET

THERE is a Triplet Precision Measuring instrument for every radio purpose. Their advanced design, precision construction and many exclusive features represent the master achievement of some of today's most prominent instrument engineers. Prove their greater worth by a competitive test . . . learn why, more and more, they are being regarded as the yardstick of fine instrument performance . . . as today's most modern precision measuring instruments.

Triplet makes a Precision Measuring Instrument for every radio purpose, including: Thermo-Couple Ammeters (High Frequency), Universal A.C.-D.C. Meters (Copper Oxide), Portable Instruments, A.C. and D.C. Panel Instruments. These instruments are made in several sizes: 2", 3 1/2", 5 1/8". They are obtainable in these types of cases: Wide flange, projection, portable—metal and Bakelite.

The metal dials of these meters are enameled permanently white with black figures. The contrast makes for easiest-reading scales. The finest sapphire jewel bearings are used. The aluminum needle and other parts are ribbed and made unusually strong throughout. The moving coil is light in weight. The scales are extra long, uniform and easy to read. All have zero adjustments.

**THE TRIPLET
 ELECTRICAL
 INSTRUMENT
 COMPANY**
 92 Main Street
 BLUFFTON, OHIO

MAIL TODAY FOR DETAILS !

Triplet Electrical Instrument Co.
 92 Main St., Bluffton, Ohio

Gentlemen:

Please send me information about Triplet meters. Also catalog on servicing instruments.

Name

Street Address

City State

When writing to advertisers mention of the PROCEEDINGS will be mutually helpful

JUDGE RESISTOR EFFICIENCY



by

ALL-ROUND PERFORMANCE

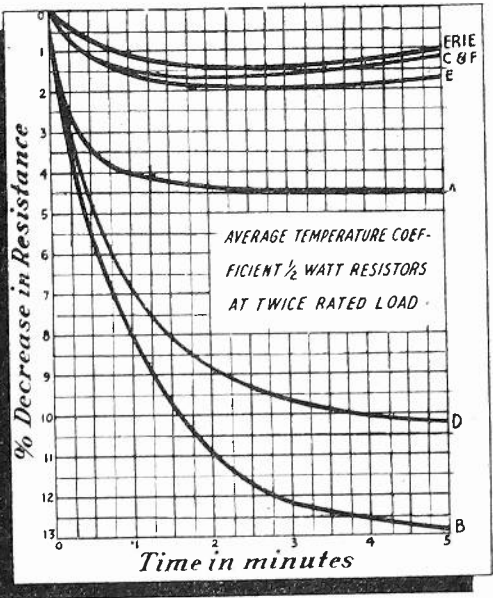
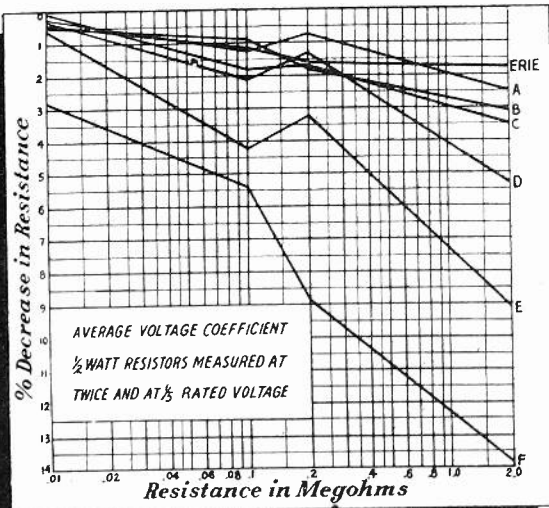

It is a comparatively easy matter to develop a carbon resistor that will surpass all other makes in some one electrical characteristic--at the expense of some other requirement.

But when it comes to actual performance in the set, the resistor that presents the best record in every characteristic is the one that will give the most satisfactory operation.

In the graphs of voltage coefficient and temperature coefficient of seven competitive makes of resistors this one fact stands out: That while they are not first in every result, ERIE RESISTORS ARE THE ONLY MAKE THAT STANDS HIGH IN BOTH TESTS.

It is this consistently high record in every standard measurement that accounts for the all-round efficiency of Erie Resistors.

Test conditions shown on the curves were used in obtaining these voltage and temperature coefficient data. The Erie Resistors tested are standard production units selected at random from several orders being prepared for shipment to well known radio manufacturers.

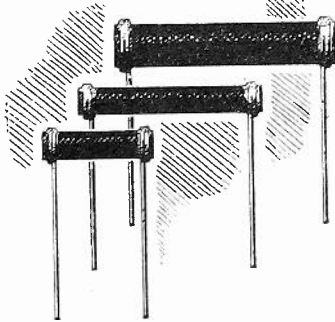

Only Erie Resistors are High in Both Tests!

	Voltage Coefficient	Temperature Coefficient
Erie	1.80%	1.10%
Resistor A	2.50%	4.55%
Resistor B	3.10%	12.90%
Resistor C	3.50%	1.20%
Resistor D	5.30%	10.25%
Resistor E	9.10%	1.75%
Resistor F	13.85%	1.20%

Above voltage coefficient readings taken at 2 megohms; temperature coefficient at 5 minutes.

ERIE RESISTOR CORPORATION

ERIE, PA.

Factories in ERIE, PA. - TORONTO, CANADA - LONDON, ENG.

When writing to advertisers mention of the PROCEEDINGS will be mutually helpful

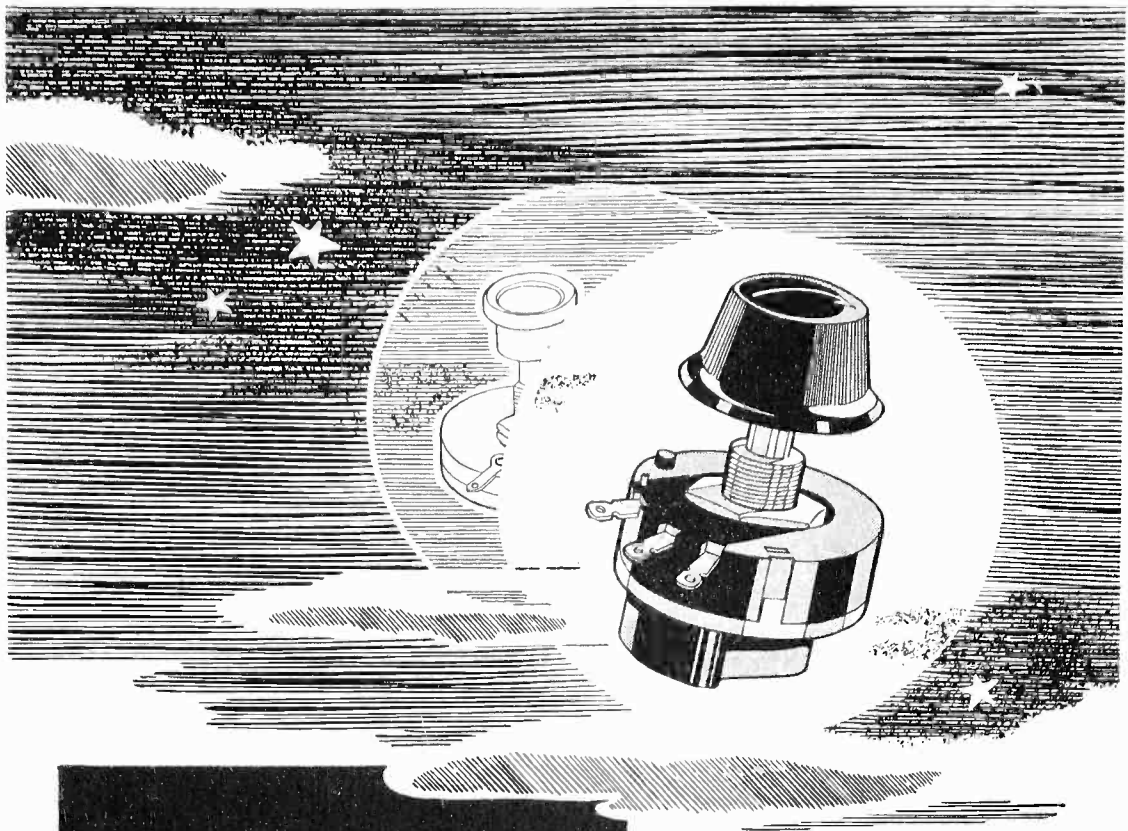

the "NEW"
Eclipses
the "OLD"

The NEW RADIOHM is no longer "NEW" for it is an accepted precision volume control in millions of new receivers.

The CENTRALAB patented non-rubbing contact eliminates wear and insures both mechanical and electrical smoothness of operation.

Where former CENTRALAB Controls have been doing a real job . . . the new RADIOHM reaches a NEW height of perfection.

Central Radio Laboratories, Milwaukee

Centralab
CRL
RADIOHM

When writing to advertisers mention of the PROCEEDINGS will be mutually helpful

INSTITUTE SUPPLIES

EMBLEMS



Three styles of emblems are available to members of the Institute only. They are all of 14k gold with gold lettering on an enameled background, the color of which indicates the grade of membership. The approximate size of each emblem is as illustrated.



The lapel button is supplied with a screw back having jaws which fasten it securely to the coat. The price is \$2.75, postpaid, for any grade.

The pin which is provided with a safety catch may be obtained for any grade for \$3.00, postpaid.



The watch charm is handsomely finished on both sides and is equipped with a suspension ring for attaching to a watch chain or fob. Price for any grade, \$5.00, postpaid.

BINDERS

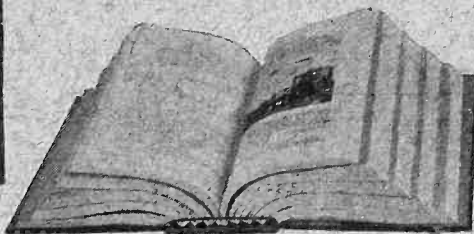

Binders are available for those who desire to protect their copies of the PROCEEDINGS with stiff covers. Each binder will accommodate the twelve monthly issues published during the year. These binders are of blue Spanish Grain Fabricoid with gold

lettering, and will serve either as temporary transfers or as permanent binders. They are so constructed that each individual copy of the

PROCEEDINGS will lie flat when the pages are turned. Copies can be removed from the binder in a few seconds and are not damaged by their insertion. They are priced at \$1.50 each, and the member's name or PROCEEDINGS Volume Number will be stamped upon the binder in gold for \$0.50 additional.

BACK ISSUES OF THE PROCEEDINGS

Complete volumes of back issues of the PROCEEDINGS are available in unbound form for the years 1918, 1920, 1921, 1922, 1923, and 1926 at \$6.75 per year (six issues). Also complete unbound for 1931, 1932, and 1933 at \$7.50 per year. A list of the available miscellaneous copies published from 1913 on may be obtained from the Secretary. Single copies published prior to 1927 are sold to members at \$1.13 each, and those issued during and after 1927 are \$0.75 each. Foreign postage on single copies is \$0.10 per copy, making \$0.60 on unbound volumes before 1927.

Issues for 1922 may be obtained bound in blue buckram at \$8.75 per volume. Similar bound volumes for 1930, 1931, 1932, and 1933 are priced at \$9.50 each. Foreign postage is \$1.00 additional per volume. Volumes for 1922 and 1926 bound in Morocco leather are available at \$10.25 each; volumes for 1930 and 1931 are \$11.00 each.

TWENTY-TWO-YEAR INDEX

An Index of the PROCEEDINGS for the years 1909-1930, inclusive, is available at \$1.00 per copy. It is extensively cross indexed. The earlier references are to the PROCEEDINGS of the Wireless Institute; the PROCEEDINGS of the Institute of Radio Engineers has been published since 1913.

When ordering any of the above, send remittance with order to the Secretary, Institute of Radio Engineers, 330 West 42nd Street, New York City.

BEYOND 20 MEGACYCLES

Television — police communication — hobby — whatever use the channels beyond 20 megacycles are destined for they are being put to increasing use.

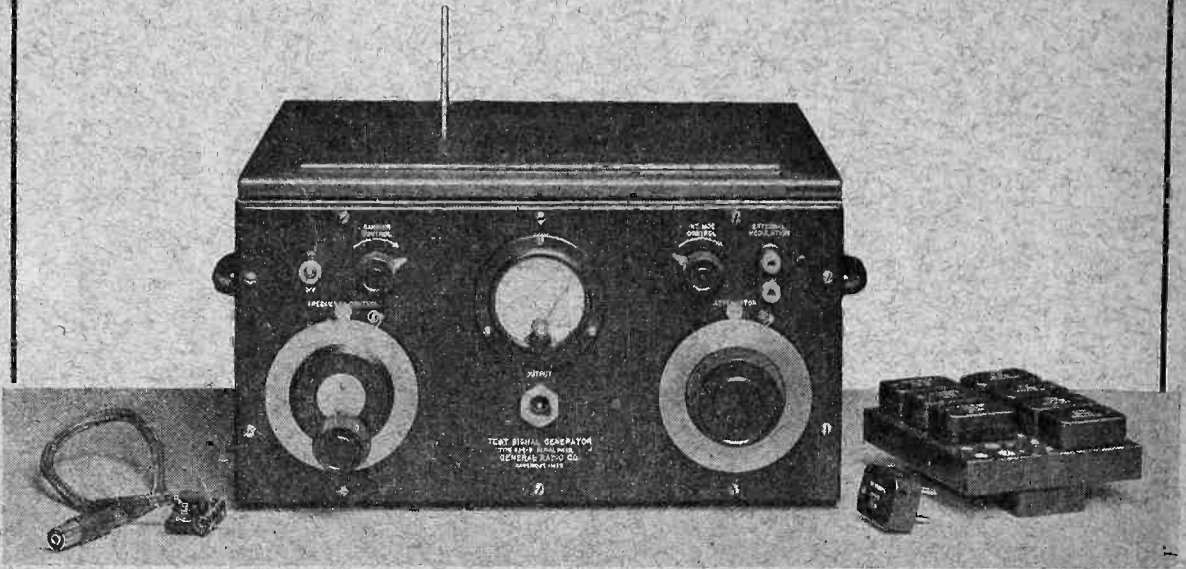

The Type 604-B Test-Signal Generator serves as a dependable measuring stick for receiver developments in this frequency range. A wide modulation frequency range provides for measurement of receivers intended for wide range television reception. Adaptability of output system, wide frequency and voltage ranges, and portability combine to make this generator a valuable addition to the receiver development laboratory.

SPECIFICATIONS:

Frequency range: 3 megacycles to 100 megacycles

Output voltage:

Attenuator: 5 microvolts to 10,000 microvolts

Antenna: 1 volt

Price: \$300.00.

Described in Bulletin 332-R

GENERAL RADIO COMPANY
CAMBRIDGE MASSACHUSETTS