

VOLUME 22

MARCH, 1934

NUMBER 3

PROCEEDINGS  
*of*  
**The Institute of Radio  
Engineers**



**Ninth  
Annual Convention  
Philadelphia, Pennsylvania  
May 28, 29, 30, 1934**

---

# Institute of Radio Engineers Forthcoming Meetings

---

## NINTH ANNUAL CONVENTION

Philadelphia, Pennsylvania

May 28, 29, and 30, 1934

---

## CINCINNATI SECTION

March 13, 1934

---

## LOS ANGELES SECTION

March 20, 1934

---

## NEW YORK MEETING

March 7, 1934

---

## PHILADELPHIA SECTION

April 5, 1934

---

## TORONTO SECTION

March 16, 1934

---

PROCEEDINGS OF  
**The Institute of Radio Engineers**

Volume 22

March, 1934

Number 3

Board of Editors

ALFRED N. GOLDSMITH, *Chairman*

R. R. BATCHER

K. S. VAN DYKE

H. H. BEVERAGE

L. P. WHEELER

F. W. GROVER

L. E. WHITTEMORE

G. W. PICKARD

WILLIAM WILSON

CONTENTS

PART I

Frontispiece, John Harold Morecroft.....	280
Institute News and Radio Notes.....	281
January 31 Meeting of the Board of Directors.....	281
Report of the Secretary for 1933.....	282
Joint Meeting of the Institute and the American Section U. R. S. I....	285
Institute Meetings.....	286

PART II

*Technical Papers*

Some Notes on Adjacent Channel Interference.....	I. J. KAAR	295
A New Type of Thyatron Relay.....	GEORGE BABAT	314
The Polarization of Sky Waves in the Southern Hemisphere..	A. L. GREEN	324
Phase Interference Phenomena in Low-Frequency Radio Transmission... .....	G. W. KENRICK AND G. W. PICKARD	344
The Calculation of Class C Amplifier and Harmonic Generator Perform- ance of Screen-Grid and Similar Tubes.....	F. E. TERMAN AND J. H. FERNS	359
Elimination of Phase Shifts Between the Currents in Two Antennas.... .....	HANS RODER	374
Inductance at High Frequencies and Its Relation to the Circuit Equation .....	J. G. BRAINERD	395
Radio Abstracts and References.....		402
Contributors to This Issue.....		409

# The Institute of Radio Engineers

---

## GENERAL INFORMATION

**INSTITUTE.** The Institute of Radio Engineers was formed in 1912 through the amalgamation of the Society of Wireless Telegraph Engineers and the Wireless Institute. Its headquarters were established in New York City and the membership has grown from less than fifty members at the start to several thousand.

**AIMS AND OBJECTS.** The Institute functions solely to advance the theory and practice of radio and allied branches of engineering and of the related arts and sciences, their application to human needs, and the maintenance of a high professional standing among its members. Among the methods of accomplishing this is the publication of papers, discussions, and communications of interest to the membership.

**PROCEEDINGS.** The PROCEEDINGS is the official publication of the Institute and in it are published all of the papers, discussions, and communications received from the membership which are accepted for publication by the Board of Editors. Copies are sent without additional charge to all members of the Institute. The subscription price to nonmembers is \$10.00 per year, with an additional charge for postage where such is necessary.

**RESPONSIBILITY.** It is understood that the statements and opinions given in the PROCEEDINGS are views of the individual members to whom they are credited, and are not binding on the membership of the Institute as a whole. Papers submitted to the Institute for publication shall be regarded as no longer confidential.

**REPRINTING PROCEEDINGS MATERIAL.** The right to reprint portions or abstracts of the papers, discussions, or editorial notes in the PROCEEDINGS is granted on the express condition that specific reference shall be made to the source of such material. Diagrams and photographs published in the PROCEEDINGS may not be reproduced without making specific arrangements with the Institute through the Secretary.

**MANUSCRIPTS.** All manuscripts should be addressed to the Institute of Radio Engineers, 33 West 39th Street, New York City. They will be examined by the Papers Committee and the Board of Editors to determine their suitability for publication in the PROCEEDINGS. Authors are advised as promptly as possible of the action taken, usually within two or three months. Manuscripts and illustrations will be destroyed immediately after publication of the paper unless the author requests their return. Information on the mechanical form in which manuscripts should be prepared may be obtained by addressing the secretary.

**MAILING.** Entered as second-class matter at the post office at Menasha, Wisconsin. Acceptance for mailing at special rate of postage is provided for in the act of February 28, 1925, embodied in Paragraph 4, Section 412, P. L. and R., and authorization was granted on October 26, 1927.

---

Published monthly by

**THE INSTITUTE OF RADIO ENGINEERS, INC.**

Publication office, 450-454 Ahnaip St., Menasha, Wis.

BUSINESS, EDITORIAL, AND ADVERTISING OFFICES

Harold P. Westman, *Secretary*

33 West 39th Street, New York, N. Y.

## INSTITUTE SECTIONS

- ATLANTA—Chairman, H. L. Wills; Secretary, Philip C. Bangs, 23 Kensington Road, Avondale Estates, Ga.
- BOSTON—Chairman, E. L. Chaffee; Secretary, G. W. Kenrick, Tufts College, Mass.
- BUFFALO-NIAGARA—Chairman, L. Grant Hector; Secretary, E. C. Waud, 235 Huntington Avenue, Buffalo, N. Y.
- CHICAGO—Chairman, Hugh S. Knowles; Secretary, John S. Meck, The Fensholdt Company, Washington St., Chicago, Ill.
- CINCINNATI—Chairman, W. C. Osterbrock; Secretary, Helen Klein, Crosley Radio Corporation, Cincinnati, Ohio.
- CLEVELAND—Chairman, F. G. Bowditch; Secretary, C. H. Shipman, 14805 Ardenall Ave., East Cleveland, Ohio.
- CONNECTICUT VALLEY—Chairman, K. S. Van Dyke; Secretary, C. B. De Soto American Radio Relay League, 38 La Salle Rd., W. Hartford, Conn.
- DETROIT—Chairman, Samuel Firestone; Secretary, E. C. Denstaedt, Detroit Police Department, Detroit, Mich.
- LOS ANGELES—Chairman, H. C. Silent; Secretary, N. B. Neely, 1569 Munson Ave., Los Angeles, Calif.
- NEW ORLEANS—Chairman, J. A. Courtenay; Secretary, C. B. Reynolds, Radiomarine Corporation, 512 St. Peter St., New Orleans, La.
- PHILADELPHIA—Chairman, W. F. Diehl; Secretary, G. C. Blackwood, 243 E. Upsal St., Mt. Airy, Philadelphia, Pa.
- PITTSBURGH—Chairman, Lee Sutherlin; Secretary, A. P. Sunnergren, West Penn Power Company, 14 Wood St., Pittsburgh, Pa.
- ROCHESTER—Chairman, Arthur L. Schoen; Secretary, Earl C. Karker, Mechanics Institute, 55 Plymouth Ave., Rochester, N. Y.
- SAN FRANCISCO—Chairman, G. T. Royden; Secretary, R. C. Shermund, 2300-16th Ave., San Francisco, Calif.
- SEATTLE—Chairman, Howard Mason; Secretary, Raymond C. Fisher, 602 N. C Street, Seattle, Wash.
- TORONTO—Chairman, W. F. Choat; Secretary, G. E. Pipe, Rogers-Majestic Corporation, Toronto, Ont., Canada.
- WASHINGTON—Chairman, T. McL. Davis; Secretary, C. L. Davis, Washington Building, 15th and G Sts., Washington, D. C.

# The Institute of Radio Engineers

## GENERAL INFORMATION

**INSTITUTE.** The Institute of Radio Engineers was formed in 1912 through the amalgamation of the Society of Wireless Telegraph Engineers and the Wireless Institute. Its headquarters were established in New York City and the membership has grown from less than fifty members at the start to several thousand.

**AIMS AND OBJECTS.** The Institute functions solely to advance the theory and practice of radio and allied branches of engineering and of the related arts and sciences, their application to human needs, and the maintenance of a high professional standing among its members. Among the methods of accomplishing this is the publication of papers, discussions, and communications of interest to the membership.

**PROCEEDINGS.** The *PROCEEDINGS* is the official publication of the Institute and in it are published all of the papers, discussions, and communications received from the membership which are accepted for publication by the Board of Editors. Copies are sent without additional charge to all members of the Institute. The subscription price to nonmembers is \$10.00 per year, with an additional charge for postage where such is necessary.

**RESPONSIBILITY.** It is understood that the statements and opinions given in the *PROCEEDINGS* are views of the individual members to whom they are credited, and are not binding on the membership of the Institute as a whole. Papers submitted to the Institute for publication shall be regarded as no longer confidential.

**REPRINTING PROCEEDINGS MATERIAL.** The right to reprint portions or abstracts of the papers, discussions, or editorial notes in the *PROCEEDINGS* is granted on the express condition that specific reference shall be made to the source of such material. Diagrams and photographs published in the *PROCEEDINGS* may not be reproduced without making specific arrangements with the Institute through the Secretary.

**MANUSCRIPTS.** All manuscripts should be addressed to the Institute of Radio Engineers, 33 West 39th Street, New York City. They will be examined by the Papers Committee and the Board of Editors to determine their suitability for publication in the *PROCEEDINGS*. Authors are advised as promptly as possible of the action taken, usually within two or three months. Manuscripts and illustrations will be destroyed immediately after publication of the paper unless the author requests their return. Information on the mechanical form in which manuscripts should be prepared may be obtained by addressing the secretary.

**MAILING.** Entered as second-class matter at the post office at Menasha, Wisconsin. Acceptance for mailing at special rate of postage is provided for in the act of February 28, 1925, embodied in Paragraph 4, Section 412, P. L. and C., and authorization was granted on October 26, 1927.

Published monthly by

**THE INSTITUTE OF RADIO ENGINEERS, INC.**

PUBLICATION OFFICE, 450-454 MAIN ST., MENASHA, WIS.

BUSINESS, EDITORIAL, AND ADMINISTRATIVE OFFICES

HAROLD F. WESTMAN, Secretary

33 West 39th Street, New York, N. Y.

## INSTITUTE SECTIONS

- ATLANTA—Chairman, H. L. Wills; Secretary, Philip C. Bangs, 23 Kensington Road, Avondale Estates, Ga.
- BOSTON—Chairman, E. L. Chaffee; Secretary, G. W. Kenrick, Tufts College, Mass.
- BUFFALO-NIAGARA—Chairman, L. Grant Hector; Secretary, E. C. Waud, 235 Huntington Avenue, Buffalo, N. Y.
- CHICAGO—Chairman, Hugh S. Knowles; Secretary, John S. Meck, The Fensholt Company, Washington St., Chicago, Ill.
- CINCINNATI—Chairman, W. C. Osterbrock; Secretary, Helen Klein, Crosley Radio Corporation, Cincinnati, Ohio.
- CLEVELAND—Chairman, F. G. Bowditch; Secretary, C. H. Shipman, 14805 Ardenall Ave., East Cleveland, Ohio.
- CONNECTICUT VALLEY—Chairman, K. S. Van Dyke; Secretary, C. B. De Soto American Radio Relay League, 38 La Salle Rd., W. Hartford, Conn.
- DETROIT—Chairman, Samuel Firestone; Secretary, E. C. Denstaedt, Detroit Police Department, Detroit, Mich.
- LOS ANGELES—Chairman, H. C. Silent; Secretary, N. B. Neely, 1569 Munson Ave., Los Angeles, Calif.
- NEW ORLEANS—Chairman, J. A. Courtenay; Secretary, C. B. Reynolds, Radiomarine Corporation, 512 St. Peter St., New Orleans, La.
- PHILADELPHIA—Chairman, W. F. Diehl; Secretary, G. C. Blackwood, 243 E. Upsal St., Mt. Airy, Philadelphia, Pa.
- PITTSBURGH—Chairman, Lee Sutherlin; Secretary, A. P. Sunnergren, West Penn Power Company, 14 Wood St., Pittsburgh, Pa.
- ROCHESTER—Chairman, Arthur L. Schoen; Secretary, Earl C. Karker, Mechanics Institute, 55 Plymouth Ave., Rochester, N. Y.
- SAN FRANCISCO—Chairman, G. T. Royden; Secretary, R. C. Shermund, 2300-16th Ave., San Francisco, Calif.
- SEATTLE—Chairman, Howard Mason; Secretary, Raymond C. Fisher, 602 N. C Street, Seattle, Wash.
- TORONTO—Chairman, W. F. Choat; Secretary, G. E. Pipe, Rogers-Majestic Corporation, Toronto, Ont., Canada.
- WASHINGTON—Chairman, T. McL. Davis; Secretary, C. L. Davis, Washington Building, 15th and G Sts., Washington, D. C.

## OFFICERS AND BOARD OF DIRECTORS, 1934

(Terms expire January 1, 1935, except as otherwise noted)

### *President*

C. M. JANSKY, JR.

### *Vice President*

BALTH. VAN DER POL, JR.

### *Treasurer*

MELVILLE EASTHAM

### *Secretary*

HAROLD P. WESTMAN

### *Editor*

ALFRED N. GOLDSMITH

### *Directors*

W. G. CADY, *Junior Past President*

O. H. CALDWELL

J. V. L. HOGAN

L. C. F. HORLE

C. W. HORN

E. L. NELSON

E. R. SHUTE

A. F. VAN DYCK

H. A. WHEELER

### Serving until January 1, 1936

R. A. HEISING

L. M. HULL, *Junior Past President*

F. A. KOLSTER

H. M. TURNER

### Serving until January 1, 1937

ARTHUR BATCHELLER

WILLIAM WILSON



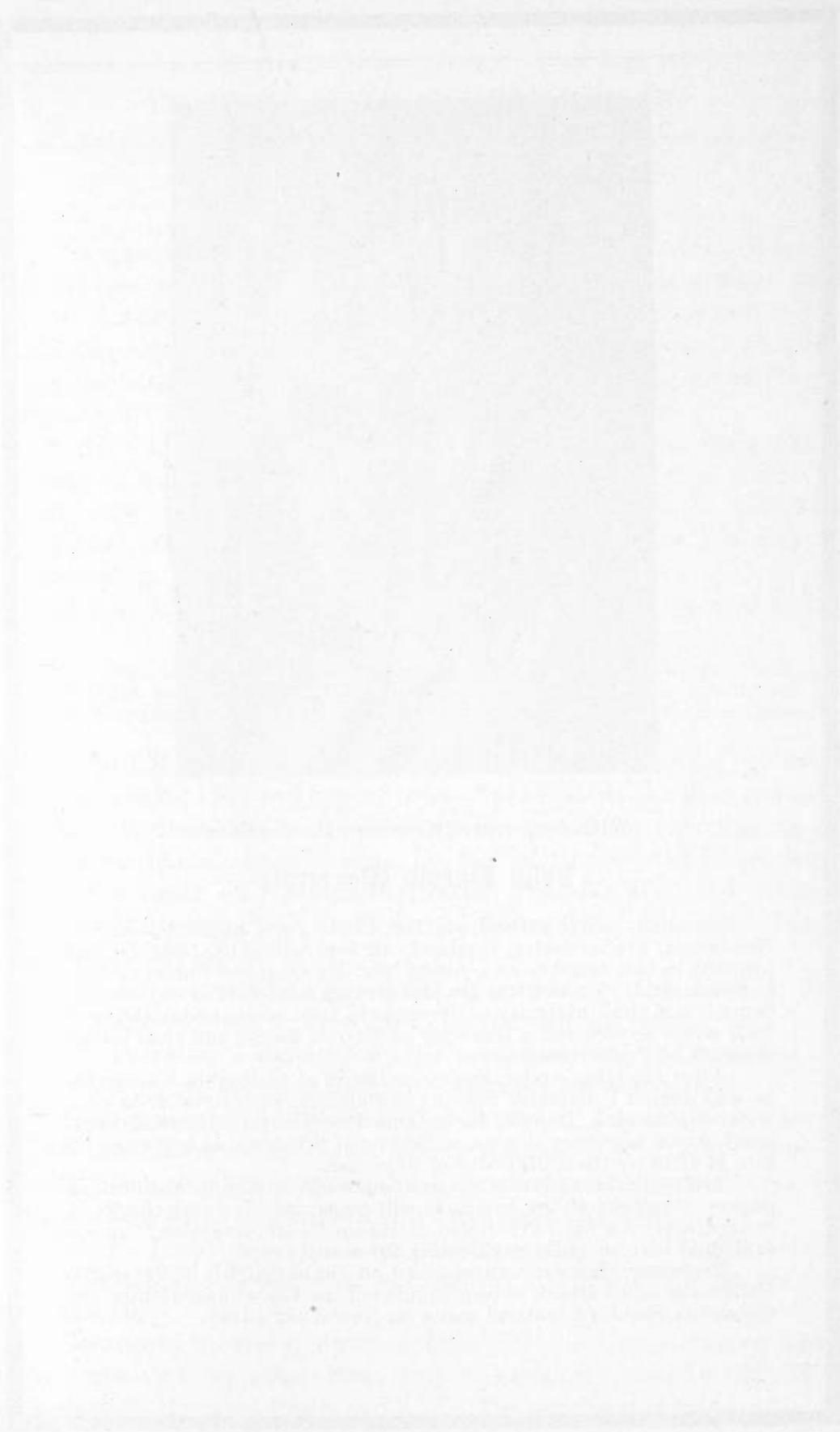

**REPORT OF THE SECRETARY  
INSTITUTE OF RADIO ENGINEERS  
1933**

**T**HIS report is published for the information of the membership, and its contents are indicative of the results of the efforts of over 150 members who have contributed their time and energy to Institute affairs by serving on the Board of Directors and the various committees which operate under it.

**General**

The membership at the end of 1933 totaled 5199 compared with 6403 for 1932, a reduction of nineteen per cent. Present business conditions are undoubtedly responsible for this condition.

Our seventeen sections have continued to operate satisfactorily. Forty-one meetings of the various Institute committees were held in addition to the extensive correspondence through which the Papers Committee and Board of Editors handle manuscripts submitted for publication in the PROCEEDINGS. A reduction of about nine per cent in the editorial portion of the PROCEEDINGS was due to financial limitations only.

The comparative balance sheet given at the end of this report shows a loss for the year's operation, cash for which has been obtained through the sale of securities which were part of the reserves built up during past years to guarantee operation during such contingencies as are evident now. It is felt that the use of reserve funds at this time is warranted in order that the Institute services to its members be not too drastically reduced.

**Board of Directors**

The Board of Directors, which is the governing body of the Institute, held twelve meetings. Two of these were special meetings to consider the relation of the engineer and his employer with respect to the National Industrial Recovery Act.

**Annual Convention**

At the annual convention held in Chicago, about two dozen technical papers were presented. No inspection trips of a technical nature were arranged, and the time normally given to such functions was occupied in visiting the Century of Progress Exposition. The registration was almost five hundred. J. Barton Hoag, chairman, and the Convention Committee deserve many thanks for their effective handling of this event.

### **Rochester Fall Meeting**

The Rochester Fall Meeting was held November 13th and 14th and was attended by approximately two hundred. Ten technical papers were presented and the component parts exhibition which was a part of the meeting included displays by approximately two dozen organizations. All arrangements were made by a Rochester Section Committee under the chairmanship of Virgil M. Graham.

### **Membership**

In spite of the election of over 500 new members during the year, the membership has dropped from 6403 at the end of 1932 to 5199, a loss of nineteen per cent. Resignations and delinquencies have been due almost entirely to strained financial conditions and changes in occupation.

Institute members are found throughout the world, and twenty-one per cent are located outside of the United States and its possessions.

### **Sections**

Although Institute sections have not been as active in 1933 as in the preceding year, they have fulfilled their purposes very well and have been responsible for some very fine meetings at which important engineering papers have been presented.

To maintain close contact with the national headquarters, the annual meeting of the Sections Committee is always held during the annual convention so as to permit as large an attendance of section representatives as possible. An additional meeting is held during the Rochester Fall Meeting for the same reason.

### **PROCEEDINGS**

One hundred thirty-four papers submitted for publication in the PROCEEDINGS were reviewed by the Papers Committee and Board of Editors. Of these, 100 were published, 27 were rejected as unsuitable, and in nine cases, papers were returned to the authors for revision. Seven discussions of papers were reviewed and accepted and 27 book reviews prepared and published. Finances required a reduction in expenditures for the PROCEEDINGS. However, reductions in print costs helped and the reduction in editorial pages was only nine per cent. By a more critical examination of papers, and their return to the authors for condensation when such was possible, there were published only three per cent fewer papers than appeared in the previous volume.

### Emergency Employment Service

In May, 1933, it being apparent that the unemployment situation was not to be of short duration but that the problem would confront us for many months, it was felt necessary to establish a more permanent structure looking toward the obtaining of positions for unemployed Institute members. Accordingly, the then existing committee was dissolved and the Emergency Employment Service organized for operation under the general supervision of the Secretary.

The active enrollment at the end of 1933 was 566 of whom 447 were members. Of those registered, 186 were employed either permanently or temporarily; 304 of the remaining unemployed were Institute members. During 1933, approximately 400 worked for one or more months while about 100 of these were employed for six months or longer. One hundred and sixty-nine had no employment whatsoever.

Jobs were obtained for 185 during the year and in addition 212 obtained work partially through our efforts. About fifteen jobs are being filled each month at the present time.

No charge is made either for enrollment or placement, and preference is given to Institute members. Those who have reported to us on the availability of jobs have rendered their fellow members a substantial service which will not soon be forgotten.

### Deaths

There is listed below the names of seven members whose membership has been terminated by death.

Jensen, S.	Noll, E. T.
Kortes, G. T.	Rae, W. T.
McFarland, W. F.	Reber, S.
Stephenson, R. J.	

### Acknowledgment

My appreciation and thanks are extended to the headquarters staff for their loyal efforts during these times when normal procedures are so unduly complicated by the existing troubled business conditions.

Respectfully submitted,

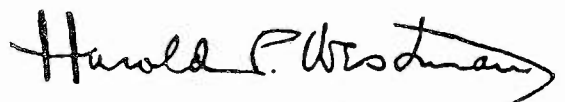

*Secretary*

Issued January 27, 1934.

EXHIBIT "A"

The Institute of Radio Engineers, Inc.  
 COMPARATIVE BALANCE SHEET  
 December 31, 1933 and 1932

ASSETS	Dec. 31, 1933	Dec. 31, 1932	INCREASE DECREASE
<b>CURRENT ASSETS</b>			
Cash.....	\$ 3,460.37	\$ 3,794.24	\$ 333.87
<b>ACCOUNTS RECEIVABLE—CURRENT</b>			
Dues.....	712.72	1,470.34	757.62
Advertising.....	589.20	1,327.77	738.57
Reprints.....	112.85	45.52	67.33
<b>INVENTORY</b> .....	6,962.54	5,125.97	1,836.57
<b>ACCRUED INTEREST ON INVESTMENTS</b> .....	529.97	1,050.76	520.79
<b>TOTAL CURRENT ASSETS</b> .....	12,367.65	12,814.60	446.95
<b>INVESTMENTS—AT COST (EXHIBIT "D")</b> .....	49,692.12	55,647.62	5,955.50
(Market Value 12/31/33 \$28,221.25)			
<b>ACCOUNTS RECEIVABLE DUES—COLLECTIONS DEFERRED</b> .....	5,344.36	4,715.34	629.02
<b>FURNITURE AND FIXTURES</b> .....	\$8,442.00		
Less—Reserve for Depreciation.....	5,183.98	3,258.02	4,019.99
<b>PREPAID EXPENSES</b>			
Unexpired Insurance Premiums.....	66.05	51.38	14.67
Stationery Inventory—Estimated.....	400.00	400.00	
Section Expense.....	81.50	41.81	39.69
Convention Expense.....		30.00	30.00
<b>TOTAL ASSETS</b> .....	\$71,209.70	\$77,720.74	\$6,511.04
LIABILITIES AND SURPLUS	Dec. 31, 1933	Dec. 31, 1932	INCREASE DECREASE
<b>ACCOUNTS PAYABLE</b> .....	\$ 3,132.55	\$ 2,012.68	\$ 1,119.87
<b>SUSPENSE</b> .....	105.95	133.95	28.00
<b>ADVANCE PAYMENTS</b>			
Dues.....	1,169.99	1,228.01	58.02
Subscriptions.....	3,025.18	3,510.80	485.62
Advertising.....		75.33	75.33
<b>DUE EMERGENCY EMPLOYMENT COMMITTEE</b> .....		647.96	647.96
<b>TOTAL LIABILITIES</b> .....	7,433.67	7,608.73	175.06
<b>FUNDS</b>			
Morris Liebmann Memorial Fund Principal and Unexpended Income.....	10,077.87	10,077.87	
Associated Radio Manufacturers Fund.....	1,997.80		1,997.80
<b>TOTAL FUNDS</b> .....	12,075.67	10,077.87	1,997.80
<b>SURPLUS</b>			
Balance, January 1.....	60,034.14	68,639.01	8,604.87
Deduct—Operating Loss for Year (Exhibit "B").....	8,333.78	8,604.87	271.09
<b>SURPLUS—DECEMBER 31</b> .....	51,700.36	60,034.14	8,333.78
<b>TOTAL LIABILITIES AND SURPLUS</b> .....	\$71,209.70	\$77,720.74	\$6,511.04

Patterson and Ridgeway, Certified Public Accountants  
 74 Trinity Place, New York City

## JOINT MEETING OF THE INSTITUTE AND THE AMERICAN SECTION U.R.S.I.

Arrangements have been made between the Executive Committee of the American Section of the International Scientific Radio Union and the Board of Directors of the Institute of Radio Engineers for a joint meeting of the two bodies in Washington, D. C., in the last week of April. It is hoped that this meeting may become an important annual feature of the week which attracts to Washington every year an increasingly large number of scientists and scientific societies.

For this first joint meeting a single day's session for the presentation of papers on the more fundamental aspects of radio problems has been planned. It is certain to be an interesting program, and the members of the Institute are urged to make a special effort to attend in order to ensure the success of this first coöperative venture.

Further details of the meeting will be given in next month's issue of the PROCEEDINGS.

---

### Institute Meetings

#### ATLANTA SECTION

A meeting of the Atlanta Section was held at the Atlanta Athletic Club on December 14th and was presided over by H. L. Wills, chairman.

No prepared paper was read and the eight members and three guests in attendance participated in a general discussion of radio subjects.

#### BUFFALO-NIAGARA SECTION

The Buffalo-Niagara Section met on January 24th at the University of Buffalo. L. Grant Hector, chairman, presided and a paper on "The Rôle of the Amateur in Radio Progress" was presented by B. T. Simpson, Director of the State Institute for the Study of Malignant Diseases.

The members and guests in attendance totaled fifty-four.

#### CHICAGO SECTION

A meeting of the Chicago Section was held on December 20th in the auditorium of the Western Society of Engineers. John W. Church, vice chairman, presided in the absence of the chairman and a paper on "Static vs. Radio" was presented by H. C. Tittle, Chief Engineer of the Radio Division of the Stewart-Warner Corporation. In it the author presented an historical review of the most noteworthy attempts at building devices or systems for reducing the effects of static inter-

ference in radio reception. The nature of simple static pulses was discussed from both physical and mathematical aspects.

In treating "static eliminator" systems, it was pointed out that many of them gave an improved ratio of signal to static over systems with which they were compared but that this improvement was due either to increased selectivity or directivity, or both.

This being the Annual Meeting of the Section, officers for 1934 were elected and are H. S. Knowles, Chief Engineer, Jensen Radio Manufacturing Company as chairman; Alfred Crossley, Consulting Engineer, vice chairman; and J. S. Meck, Fensholdt Company, secretary-treasurer. An Auditing Committee of K. H. Jarvis and J. W. Million was appointed.

#### CLEVELAND SECTION

The Case School of Applied Science was the place for the December 21st meeting of the Cleveland Section which was presided over by F. T. Bowditch, chairman.

"Frequency Multiplication in Vacuum Tube Circuits" was the subject of a paper by C. E. Smith of broadcast station WHK. The subject was treated chiefly in relation to its use in frequency comparing devices. Various circuits and types of amplifiers were compared and their effectiveness illustrated through the use of oscillograms. Methods of obtaining bias voltages and their effect upon circuit operation were compared. A system of obtaining crystal control of frequency which did not absorb power from the crystal circuit was illustrated. It was pointed out that for frequency multiplication a square-wave form was superior to a sinusoidal form since it is indicative of high harmonic content.

In the WHK frequency meter, a 10-kilocycle oscillator is multiplied in a number of steps to 1400 kilocycles which beats with the original 10 kilocycles and the difference frequency of 1390 kilocycles is obtained. This is compared directly with energy received from an antenna tuned to the transmitter which operates at 1390 kilocycles. Similarly, the original 10 kilocycles is stepped up to 5000 kilocycles and compared directly with WWV.

#### CINCINNATI SECTION

The annual meeting of the Cincinnati Section was held on December 12 at the University of Cincinnati. W. C. Osterbrock, chairman, presided and thirty members and guests were in attendance.

"Distortion in Speakers for High Quality Receivers" was the subject of a paper by H. S. Knowles, Jensen Manufacturing Company.

The author presented a brief discussion of distortion found in radio receivers and its control. This was followed by a description and compilation of details of present commercial loud speakers and the possibilities of adopting and improving them for use in high fidelity receivers. The paper was discussed by Messrs. Kilgour, Rockwell and others in attendance.

In the election of officers for 1934, R. E. Kolo of the Cincinnati and Suburban Bell Telephone Company was named chairman, and E. J. H. Bussard of the Crosley Radio Corporation vice chairman. Miss Helen Klein continues as secretary-treasurer.

The January meeting of the Cincinnati Section was held jointly with the local section of the American Institute of Electrical Engineers at the University of Cincinnati. It was presided over by L. C. Nowland, chairman of the A.I.E.E. section. The attendance was 850.

"Transoceanic Telephony" was the subject of a paper by J. O. Perrine of the Bell Telephone Laboratories. In it Dr. Perrine presented an interesting talk on transoceanic telephony. He outlined the history of the telephone and the difficulties encountered at various stages of its development, illustrating these with both slides and models of early equipment.

He then outlined the nature of sound and the need for transmitting certain ranges of frequency if satisfactory fidelity in speech and music is to be obtained. By means of talking pictures, the effect of filtering out various portions of the audio-frequency spectrum was shown.

Dr. Perrine then demonstrated the operation of the transatlantic system by speaking to Colonel Shreeve, the London representative of the American Telephone and Telegraph Company. The speech from London was amplified and distributed to the audience by means of loud speakers. In addition the speech currents were applied to an oscillograph so that the wave shapes could be seen. For a portion of the conversation, the speech was left scrambled so that this effect could be noted.

#### CONNECTICUT VALLEY SECTION

The Annual Meeting of the Connecticut Valley Section was held at the Hotel Charles, Springfield, on December 21st, the presiding officer being H. W. Holt, chairman.

A paper on "Radio Circuits Applied to New Uses" was presented by J. K. Henney, associate editor of *Electronics*. In it the author described a large number of industrial applications of radio devices. These devices were largely electronic in nature and were used for production testing, industrial control, and electrical and physical measure-



ments. Possibilities of further developments in this field were pointed out, and the part the radio engineer must necessarily play in such progress was emphasized. It was shown that while in some instances electronic devices were prohibitively complicated and expensive in themselves, their existence spurred workers in mechanical fields to overcome stagnancy of long duration to produce competitive mechanical devices.

Officers for the forthcoming year were elected and are: chairman, K. S. Van Dyke, Wesleyan University; vice chairman, M. E. Bond, United American Bosch Corporation; and secretary-treasurer, C. B. DeSoto, American Radio Relay League. Thirty-eight members and guests were in attendance at this meeting.

#### DETROIT SECTION

The January meeting of the Detroit Section was held on the 19th at the Detroit News Conference Room, Samuel Firestone, chairman, presiding.

F. A. Firestone of the University of Michigan presented a paper on "Acoustics." In it Professor Firestone pointed out that the acoustic quality of a room was dependent upon five principle features which are: noise level, reverberation time, echoes, distribution of intensity, and loudness level. He drew attention to the lack of acoustical perspective of the present single channel broadcast system and discussed the advantages of a two- or three-channel system. He then showed how the illusion of distance from a microphone could be caused by controlling the reverberation heard. This suggests a new constant, the liveness constant of the room, a relationship of the intensity of reverberant sound to that of the direct sound. This involves the directivity of the microphone used and of the source of sound. The speaker then discussed the properties of the pressure-operated microphone and the newer directional microphone. Troubles introduced by the acoustics of the listener's room and by the directional effects of the loud speaker were then outlined.

A number of the thirty-five members and guests in attendance participated in the discussion.

#### LOS ANGELES SECTION

J. K. Hilliard, chairman, presided at the December 19th meeting of the Los Angeles Section held in the Hotel Arcady.

This was the annual meeting and in the election of officers, H. C. Silent, of the Electrical Research Products, Inc., was named chairman; W. F. Ludlum, W. F. Ludlum Sound Equipment Co., vice

chairman; and Norman B. Neely, J. S. Cole—Radio Enterprises was reappointed secretary-treasurer.

After the election, D. T. Smith of the public relations department of the Southern California Telephone Company discussed the problems and the advisable extent of educating the general public concerning the technical aspects of the telephone company's activities, and then showed two reels of sound pictures entitled "New Voice Highways" and "The Family Album." The first was an inspection tour showing the various phases in the manufacture and testing of multiple-circuit telephone cables, while the second described as "by-products" of the telephone, radio broadcasting, public address systems, sound pictures, and the electrical stethoscope.

H. B. Axtell of the research department of the Southern California Telephone Company then discussed the fundamental theory and operation of cathode ray tubes and their uses. His paper was illustrated and a cathode ray oscilloscope was available for demonstration purposes.

The meeting was attended by one hundred and twenty-five members and guests.

#### NEW YORK MEETING

The regular February New York meeting was advanced one week to January 31st so as to permit our presenting, through the courtesy of Dr. Harvey Fletcher and the Bell Telephone Laboratories, a demonstration of "Transmission and Reproduction of Speech and Music in Auditory Perspective." President Jansky presided.

In a studio in the Engineering Societies Building, three microphones were set up, one on each side and the other in the center of the stage on which the performers appeared. The output of each microphone was amplified and fed to a bank of loud speakers located in a similar position on the stage of the main auditorium in the building. The effectiveness of the system in permitting the audience to locate the apparent source of the sound on the stage of the auditorium was strikingly exhibited.

The equipment was capable of rendering faithful reproduction of all frequencies from forty cycles to fifteen thousand cycles and had an intensity range of over one hundred decibels.

The audience was given the opportunity of testing its hearing by the transmission of a pure tone which was varied in frequency over the range of the equipment. The upper intensity limit was demonstrated by causing a low-frequency sound to rattle the windows in the auditorium, by the reproduction of the sound of an airplane motor at

the equivalent intensity heard by one standing within a few feet of it, and by the reproducing of the report of a pistol shot.

The attendance was about eight hundred and fifty, the capacity of the auditorium, and was limited by the requirement that tickets be obtained in advance of the meeting.

#### PHILADELPHIA SECTION

A meeting of the Philadelphia Section was held on January 4th at the Engineers Club. W. F. Diehl, chairman, presided and the attendance totaled ninety-two.

A. W. Hull, Assistant Director of the Research Laboratories of the General Electric Company presented a paper on the "Physics of the Thyatron." In it Dr. Hull discussed the effect of gas pressure upon the conductivity, glow potential, and other related characteristics of the Thyatron. Certain practical problems such as the disintegration of the anode by positive ion bombardment were treated. The paper was profusely illustrated, and many experimental types of tubes were available for examination and discussion.

#### SAN FRANCISCO SECTION

A meeting of the San Francisco Section was held at the Bellevue Hotel on January 17th and was presided over by G. T. Royden, chairman.

No regular paper was presented but the meeting known as "Old-Timers Night" was devoted to a general discussion of the development of radio on the Pacific Coast. B. H. Linden gave a chronological history of Pacific Coast radio and R. R. Beal, L. H. Fuller, W. W. Hanscome, R. M. Heintz, and A. R. Rice commented on and added to it. A resolution to elaborate the material presented by Mr. Linden was passed in order that an accurate and reasonably complete history might be prepared.

The original application and charter granted by the Commonwealth of Massachusetts to the Society of Wireless Telegraph Engineers was exhibited, and it was agreed that these documents be presented to the national headquarters of the Institute.

The attendance at the meeting was thirty-eight and twelve were present at the informal dinner which preceded it.

#### SEATTLE SECTION

A meeting of the Seattle Section was held on November 24th at the University of Washington. Raymond Fisher, vice chairman, presided, and the attendance was forty-four.

C. L. Utterbach of the University of Wisconsin presented a paper on "Atoms and Electrons." In introducing his subject Professor Utterbach stated that he would talk about the "on's" which he specified as being the ion, electron, proton, photon, magneton, neutron, deuteron, and positron. He then outlined the characteristics of each and the evidence gathered to date to show their existence. In closing he pointed out that the physicist discovers as much as possible about the structure and composition of the universe and it is then the problem of the engineer to apply these discoveries to the development of new and useful applications. The paper was discussed by Messrs. Fisher, Libby and Tolmie.

The Annual Meeting of the Seattle Section was held on December 22nd at the University of Washington and was presided over by H. H. Bouson, chairman. Twenty-nine members and guests were in attendance.

A paper on "Modern Broadcast Receivers and Their Circuits" was presented by L. C. Austin who traced the development of the receiver from the early tuned radio-frequency sets to the modern superheterodyne. Various details of modern receivers such as automatic volume control, intercarrier noise suppression, and methods for visual tuning were then discussed in detail. The paper was closed with a demonstration of some of these devices on an actual receiver.

This being the annual meeting officers were elected for 1934 and are Howard Mason, chairman; C. E. Williams, vice chairman; and R. C. Fisher, secretary-treasurer.

#### TORONTO SECTION

The University of Toronto was the place of the January 19th meeting of the Toronto Section. It was presided over by W. F. Choat, chairman, and fifty-seven members and guests were present.

"Radiation and Microphonics in Short-Wave Receivers" was the subject of a paper by David Grimes of the RCA License Laboratory.

It was pointed out that very few superheterodyne receivers manufactured years ago were guilty of radiation from the oscillators as the shielding was adequate and the circuit design fundamentally correct. However, many of the low-priced receivers of the present day radiate strongly and this radiation takes place through power lines, antenna, ground, tank circuit, condensers, or even unshielded tubes. Methods of preventing radiation were discussed. Its measurement was then outlined and is based on a standard method which prescribes that the maximum permissible radiation shall be 150 microvolts per meter at five feet. It was pointed out that even a cheaply made receiver could

be made to conform with this standard at a very low cost and unless precautions are taken, substantial trouble due to radiation is bound to eventuate.

The elimination of microphonic howls in short-wave superheterodyne receivers was discussed. The set is adjusted to howl while tuned to a signal from a signal generator. A headset, substituted for the loud speaker, invariably stops the howl and the set is then tapped at various places with a rubber mallet until the howl becomes audible in the head set. This locates the source of the microphonic conditions and steps may be taken to modify the design to avoid it.

#### WASHINGTON SECTION

The January 11th meeting of the Washington Section was held at the Kennedy-Warren Apartments and was presided over by T. McL. Davis, chairman.

A paper on "Some Recent Advances in Television" was presented by V. K. Zworykin of the RCA Victor Company. In it Dr. Zworykin outlined briefly the historical development of television systems of both the mechanical and electrical types, and consideration was given to three different possible methods of employing cathode rays.

A detailed discussion was given of the number of picture elements and lines required for obtaining acceptable detail and their relation to the transmission band required. Some of the experimental activities of the RCA Victor Company were described, mention being made of many difficulties encountered and the manner in which they were overcome. A description was given of the iconoscope used for pick-up at the transmitter. Methods of synchronizing the receiver with the transmitter were outlined.

A general discussion followed and was participated in by a number of the one hundred and thirty-four members and guests in attendance. Fifty-two were present at the informal dinner which preceded the meeting.



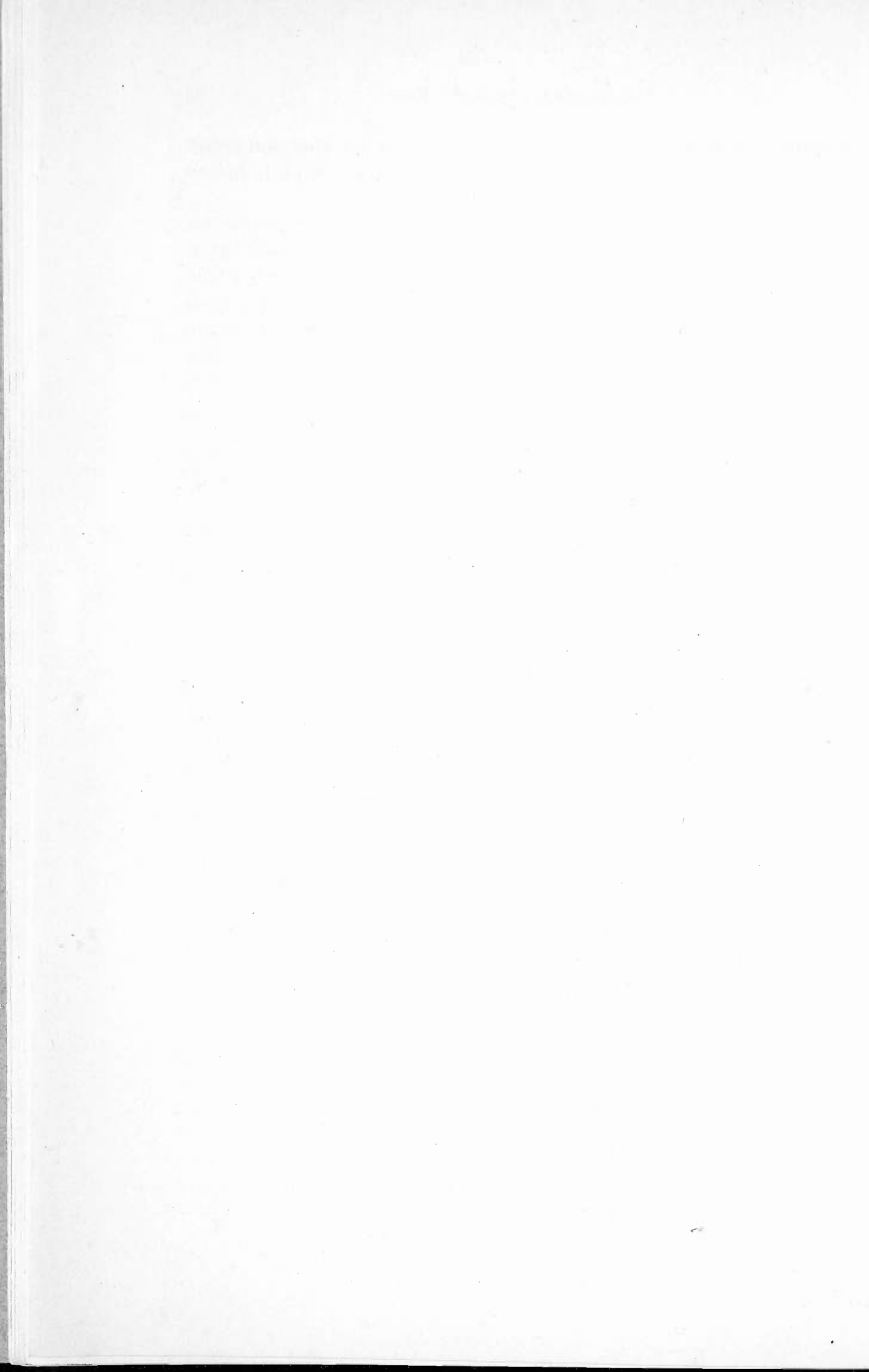

## TECHNICAL PAPERS

## SOME NOTES ON ADJACENT CHANNEL INTERFERENCE\*

By

I. J. KAAR

(General Electric Company, Schenectady, New York)

*Summary*—This paper deals with a form of adjacent channel broadcast interference brought about largely as a result of nonlinearity, misadjustment, misoperation, or improper design of the broadcast transmitter and associated equipment.

The nature and the significance of this particular form of interference was first pointed out by E. H. Armstrong and W. L. Carlson as restricting the further development of receiver selectivity and fidelity, and it was largely at their instigation that a study of the problem was made in Schenectady in cooperation with RCA Victor and Westinghouse engineers.

SINCE its earliest beginnings the broadcast art has known interference in some form or other. Many of the various forms of interference which have harassed the engineer from time to time are rapidly disappearing. We may be said to be approaching perfection in the ease with which we now select one signal to the exclusion of all others.

With such near perfection achieved there comes to light an additional trouble which may be termed adjacent channel interference. This term describes a form of interference noticeable when listening to a distant station while in the strong field of a local transmitter operating on an adjacent or near-by channel. The interference appears in the form of unpleasant rasps and growls, at times usually associated with peaks of modulation of the strong local transmitter. This form of interference is due, in the main, to one general deficiency of the transmitter equipment, namely, to nonlinearity in one or more of its many forms. A complete treatment of the causes and cures for all the manifold forms of nonlinearity in broadcast transmitters would be a lengthy treatise indeed, and is far beyond the scope of this paper. There are, however, certain outstanding factors in the cause and control of this type of interference which justify attention.

Adjacent channel interference first received consideration with the advent of high power broadcasting and increased in importance with the utilization of complete modulation and with the desire for increased

\* Decimal classification: R430×R550. Original manuscript received by the Institute, November 15, 1933. Presented before New York Meeting, February 8, 1933.

selectivity of receivers. There is a steady tendency toward higher fidelity in all audio equipment, meaning, among other things, a general broadening of the audio spectrum. The trend is especially apparent in regard to program wire lines. Naturally, the free transmission of higher audio frequencies results in wider side bands, but, what is more to the point, contributes to the radiation of modulation products outside the legitimate channel to an increased extent.

#### THE RECEIVER PROBLEM

It has only been within recent years that receivers have been selective enough to cut out the normal crosstalk existing between two adjacent channels, and, until this time, any adjacent channel interference present was largely submerged by crosstalk. Modern receivers, however, reduce crosstalk interference below the level of adjacent channel heterodyne interference and, consequently, any out-of-channel radiation from a transmitter is at once evident. It is impracticable to increase the selectivity of receivers until adjacent channel interference can be eliminated or very largely reduced inasmuch as the increased selectivity could not discriminate against adjacent channel interference appearing within the acceptance band.

In the United States, broadcast channels are designated as being 10 kilocycles wide. Physically, this limits side bands to a width of 5 kilocycles and yet there are many transmitters in service capable of being modulated to 10,000 cycles. It would be expected, therefore, that legitimate side bands from one transmitter would be found in the adjacent channel. This is indeed the case, but interference from this cause alone is not serious. In the first place the energy content of legitimate high audio frequencies is comparatively low, and second, modulation frequencies above, say, 7 kilocycles, seldom reach the transmitter. The steady trend toward a wider audio spectrum in wire lines and audio equipment may make this a matter of importance in the next few years. Diligence on the part of the Federal Radio Commission in providing geographic separation between adjacent channel transmitters has been a noticeable factor in minimizing crosstalk interference.

In 1930 receivers were produced having selectivity characteristics as shown by *a-b-c* of Fig. 1. Receivers could now be constructed having noticeably better selectivity and such receivers undoubtedly would be marketed if the increased selectivity were useable.

It is of interest to examine the requirements for "satisfactory" performance in regard to adjacent channel interference. No more could be desired than to be able to listen to a distant station whose field strength lay in the region of 10 microvolts per meter (probably the



minimum useable signal) while in the field of a 50-kilowatt local transmitter operating 10 kilocycles away and laying down a field of, say, 100 millivolts per meter. Such performance is several orders away from possible accomplishment with present-day art and "satisfactory" performance should be defined as something better than is achieved in the majority of cases but which is still within the limits of possibility.

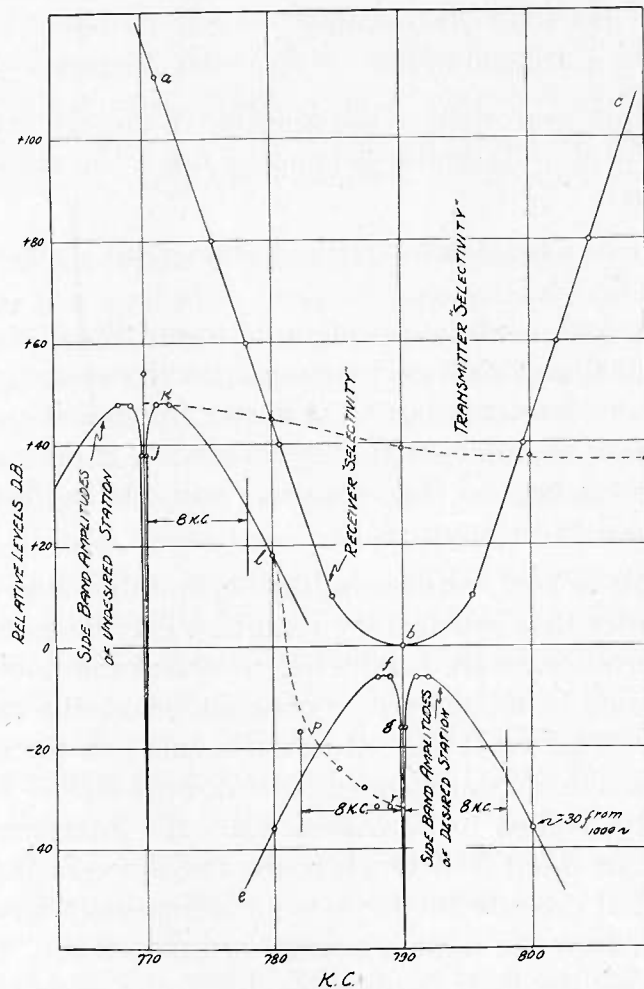

Fig. 1—Graphical interpretation of the adjacent channel interference problem.

As one example of "satisfactory" performance we may say that it should be possible to receive a signal of 100 microvolts through a strong local signal of 50 millivolts, 20 kilocycles removed. Such performance is shown graphically by Fig. 1. In this figure certain assumptions are made, some being justifiable, and others open to question. It is assumed that:

1. The desired transmitter has a carrier voltage of 100 microvolts

per meter on 790 kilocycles. This is taken as zero level for comparative purposes.

2. The side bands from either transmitter do not exceed in amplitude the boundaries as shown. These curves are based on the observation that, in average programs, relative modulations are approximately as given below:

at 50 cycles	- 10 decibels
at 1000-2000 cycles	- 0 decibel
at 10,000 cycles	- 30 decibels.

Closer definition of these relative levels cannot be made inasmuch as they vary over wide limits depending upon the class of music or speech involved.

3. The receiver has a selectivity characteristic as shown by curve *a-b-c* of Fig. 1.
4. 100 per cent modulation of both transmitters is assumed between 1000 and 2000 cycles modulation frequency with the possibility of occasional bursts at higher frequencies.
5. Legitimate modulation of the transmitter is desired only up to 8 kilocycles, beyond this frequency any side bands produced are considered to be spurious.

The question is now, what amplitude of spurious side bands can be tolerated in order that satisfactory reception may be assured?

Some experiments were conducted to determine how much interfering signal could be tolerated on a program before the results became unsatisfactory. The worst case observed seemed to be the superposition of an 800-cycle tone on speech or smooth, flowing music. The threshold of acceptability seemed to be passed when the interfering signal became higher than about 30 decibels below the desired signal. When the interfering signal exceeds 2000 cycles an increasingly stronger tone is required to produce the same sensation of interference. The radio receiver attenuates the high frequencies due to its selectivity and also attenuates interfering side bands which lie in the range of legitimate side bands of 5 kilocycles or more. The second of these facts permits a much higher amplitude of spurious side bands in this region inasmuch as the actual sound produced is very small compared to sounds in the region of one or two kilocycles which fully modulate the transmitter, suffer little attenuation in the receiver, and consequently produce high volumes of sound from the loud speaker. Compared to the amplitude of the legitimate side bands, then, and taking account of the selectivity of the receiver, we may say that the interfering signal must not exceed the following:

At all frequencies up to 2 kilocycles	-30 decibels
at 3 kilocycles	-25 decibels
at 5 kilocycles	-15 decibels
at 8 kilocycles	+ 5 decibels.

It will be obvious that a new tabulation could be made for almost every type of program. For instance, an interfering signal producing an 8-kilocycle sound having an amplitude of +5 decibels compared to an instantaneous legitimate signal representing, for instance, a low passage of violin music, would be very noticeable whereas the same signal would not be noticeable if the legitimate signal happened to be a brass band. In the latter case even higher interference could be permitted.

The table above is submitted as a starting point and probably represents close to the maximum level of permissible interference in the average case. Consideration of a stricter table, as will later be shown, would demand from the transmitter a degree of performance which is practically out of reason. The interfering signals may be compared to the signal produced by the two legitimate side bands of the transmitter. Referring to Fig. 1 a curve  $p-r$  may then be drawn under  $e-f-g$  (the upper limits of side bands from the desired station) by amounts as shown in the preceding table with a positive correction of roughly 4 decibels which is accounted for by the fact that only one side band is effective in producing the interference, whereas both legitimate side bands are effective in producing the desired signal. Signals other than the heterodyne difference between the desired carrier and the undesired side band are of course present if other than a square-law detector is used. For instance, the second harmonic of the beat frequency will reach 17 per cent if the side band and carrier amplitude are equal and a linear first detector is used. Two facts make these other frequencies of little importance: first, the spurious side band is usually very small compared to the desired carrier, and, second, actual detectors lie somewhere between square law and linear. Therefore, only the true difference frequencies need be considered.

An idea may now be had regarding the order of permissible transmitter distortion considering, in each case, that one harmonic alone is causing the interference. The level of the allowable harmonic is taken in comparison to the actual level of the side band of the legitimate signal as obtained from curve  $j-k-l$ .

It is thus observed that the amplitude of any single harmonic must not exceed a figure of approximately 0.03 per cent of the amplitude of its fundamental. This will be most difficult to meet when it

represents, say, the sixth harmonic of 2000 cycles since 2000 cycles is a frequency modulating the transmitter 100 per cent. Harmonics of higher modulating frequencies will be naturally lower since higher frequencies do not modulate the transmitter fully.

From the above it may be observed that, even to provide a lenient "satisfactory" condition, very high fidelity must be preserved in the transmitter. It may be safely said that no existing transmitters will meet these requirements but there is some hope that this degree of excellence can be achieved within the next few years. It is possible to build transmitters which will produce a total distortion of one per cent or less at 100 per cent modulation, which, considering conditions of a few years ago, is a noteworthy advance.

TABLE I

Modulation Frequency	Order of Harmonic	Maximum Level of Harmonic
6333	third	-67.5 decibels
6000	third	-68.5 decibels
5666	third	-66 decibels
5333	third	-66 decibels
5000	third	-65 decibels
4666	third	-64.2 decibels
4333	third	-64 decibels
8000	second	-54 decibels
7500	second	-54.4 decibels
6500	second	-56 decibels

Assume that the total root-mean-square distortion of 1 per cent includes a second harmonic of 0.5 per cent and, assume that a frequency of 6500 cycles occasionally modulates the transmitter to 100 per cent. Under these conditions there exists approximately sixteen times the amplitude of spurious side band as can be tolerated if the above described "satisfactory" condition is to be met. Further development along the line of reduced distortion will probably be retarded for economic reasons, for, aside from the matter of adjacent channel interference, there is no real need for greater fidelity than is now possible.

#### THE TRANSMITTER PROBLEM

Adjacent channel interference as defined above, is the result of any one or a combination of the following causes, all of which represent nonlinearity in one form or another.

1. Modulation in excess of 100 per cent.
2. Generation of spurious radio frequencies.
3. Improper adjustment of the transmitter.
4. Improper design of equipment.

## OVERMODULATION

In well-designed and properly adjusted transmitters, cause number 1 is undoubtedly of the greatest importance and is the most difficult with which to deal. Fortunately, or unfortunately, the broadcast art in so far as studios, wire lines, control equipment, etc., are concerned, has largely been an outgrowth of existing telephone practices. In such practices, there exists no well-defined physical barrier dictating allowable upper limits of level. Broadcasting however, by the double side band plus carrier method, dictates that the maximum level must never exceed that necessary to reduce the antenna current to zero unless distortion is to result and the distortion so caused is in no way associated with the excellence of the transmitter.

The broadcast engineer is faced with two problems which are somewhat at variance. He is obliged to maintain the average level of modulation as high as possible to permit full utilization of facilities and on the other hand he is reticent, or should be, to permit peaks of modulation to exceed 100 per cent. The result is usually a "compressing" of the program by the control room operator. Obviously, such action is to usurp the prerogatives of the director and this practice has been made the subject of much comment by prominent critics of music. Broadcast material varies in level probably in the order of 10,000,000 to 1 or more, and if levels were set so that no peak should ever exceed 100 per cent we would have the impracticable condition of average modulation being in the order of one per cent or so. From a strictly theoretical standpoint, there is no question but that the musicians are right, and theoretically correct technique would be to set the gain controls once and for all, at a point corresponding to 100 per cent modulation at the maximum sound level to be encountered.

If adjacent channel interference is to be reduced or eliminated, then, first of all, assurance must be had that modulation even for the shortest peaks must never exceed 100 per cent. It must be repeated that regardless of the excellence of the equipment up to 100 per cent modulation, distortion will immediately exist when that figure is exceeded and the rate of increase of distortion past this point is high indeed.

It is interesting to note the magnitude of the distortion caused by excessive modulation in the ideal case, that is, in the case of a transmitter having no distortion at all up to 100 per cent modulation. (Practical distortions will obviously exceed the values given.) A diagram, "a" of Fig. 2 was prepared wherein the zero line takes the successive positions as defined by the horizontal lines truncating the lower half

of the cycle. The full upper half cycle plus the section below the axis bounded by each horizontal line in turn was analyzed graphically to provide coefficients for the Fourier series. A graph of the resulting harmonics in percentage of the fundamental is given by "b" of Fig. 2. The Federal Radio Commission<sup>1</sup> limits the permissible harmonics, arithmetically added to 10 per cent at 75 per cent modulation.

If this limit of distortion is to be complied with, then overmodulation must not exceed 15 per cent even with an otherwise perfect transmitter. Actually, it must be somewhat less inasmuch as only the first seven harmonics are considered here and actual distortion will

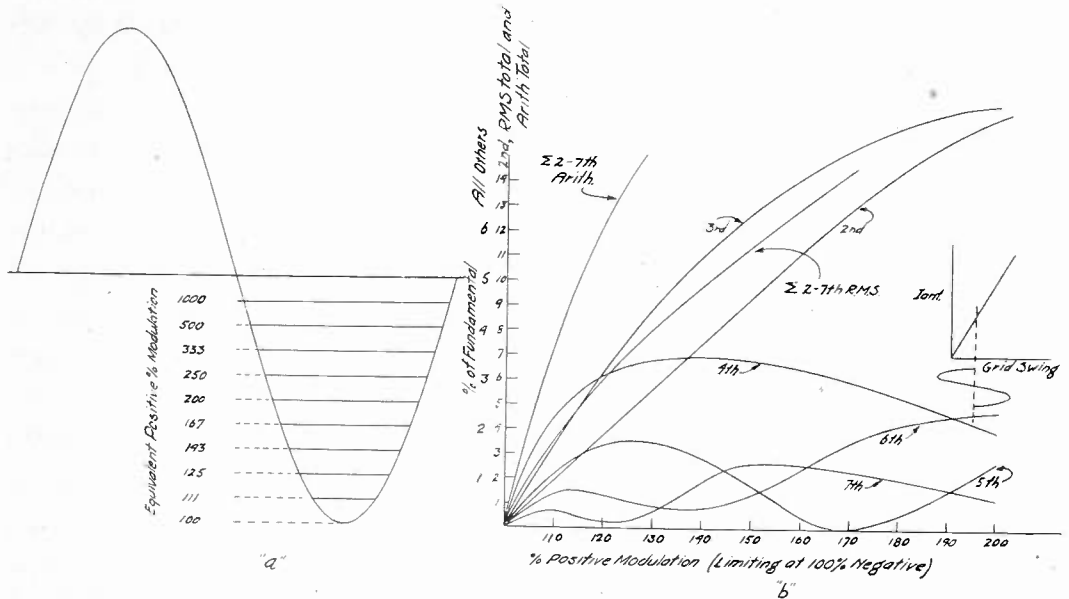

Fig. 2—Distortion of a perfect transmitter when overmodulated.

exceed the values given. It has been shown that a 10 per cent harmonic content arithmetically added is sufficient to produce very serious adjacent channel interference.

Distortion is usually not evident in the legitimate signal until the distortion has reached a value capable of producing objectionable adjacent channel interference. Because of the unnoticeable effect upon the legitimate signal, gain controls are often set at a point which permits frequent overmodulation of the transmitter. Such practice is resorted to in order to realize the utmost from the installed facilities but should be condemned from the interference standpoint. A solution would seem to be to prohibit side band frequencies lying outside the channel from reaching the antenna. This dictates the use of a radio-frequency filter which at the present time seems to be an impracticality if at all possible. This scheme is complicated for two main rea-

<sup>1</sup> Paragraph 139, page 40, "Rules and Regulations of the Federal Radio Commission."

sons, first, in contrast to receiver practice, each of the sections of any filter would be loaded by the antenna resistance whereas filter sections in receivers are unloaded and are carefully designed to reduce even the inherent decrements of the sections. Second, the filter would be terminated in a load having a variable phase angle, the load being real at only one frequency. An idea of the cut-off afforded, for instance, by the successive tuned circuits of a 50-kilowatt transmitter is given by Fig. 3 which is a composite graph of the accumulative selectivity as each tank is passed.

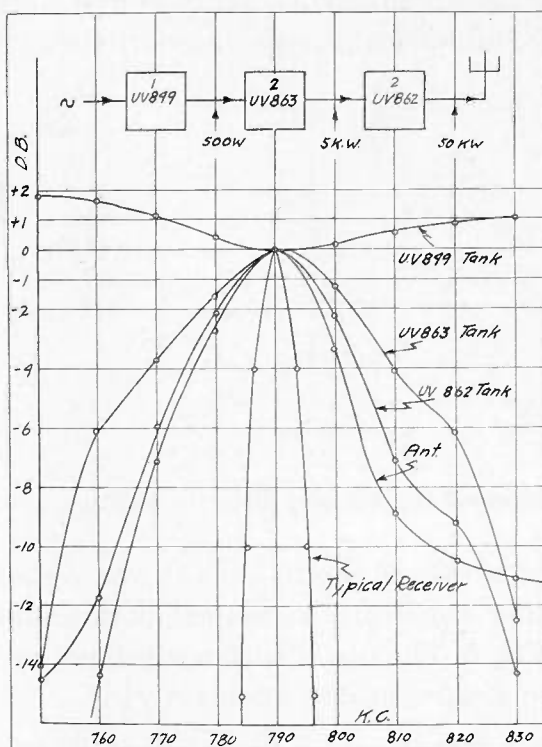

Fig. 3—Accumulative “selectivity” of a typical 50-kilowatt transmitter.

The solution of this filter problem would provide a definite solution to the problem of adjacent channel interference and, undoubtedly, future development will give consideration to this method of attack.

The limiting of the input audio frequencies is of course, of no avail as the modulation products are generated in the stages themselves. However, there are certain line noises and transients having equivalent frequencies above those desired to transmit which may be eliminated to advantage by means of a low pass filter in the input audio line. This latter, would, of course, be beneficial but would still provide no means of caring for the modulation products generated in the subsequent stages, and little improvement has been experienced in adjacent channel interference by this practice.

A filter cutting off at 8 kilocycles has been used in conjunction with a mercury vapor limiter in the audio input circuit as shown by Fig. 4. It is intended that the glow tube will limit the level of the audio input to a value resulting in not more than 100 per cent modulation of the carrier, the filter attenuating the frequencies, above its cut-off, generated as a result of the limiter action. Of course, the filter must not suppress frequencies lying within the desired transmitting band and the effects of overmodulation are still evident in the received signal although to a lesser degree than would be the case if the limiter were not used, for the reason that both positive and negative modulation peaks are limited symmetrically, whereas, only the negative peak suffers

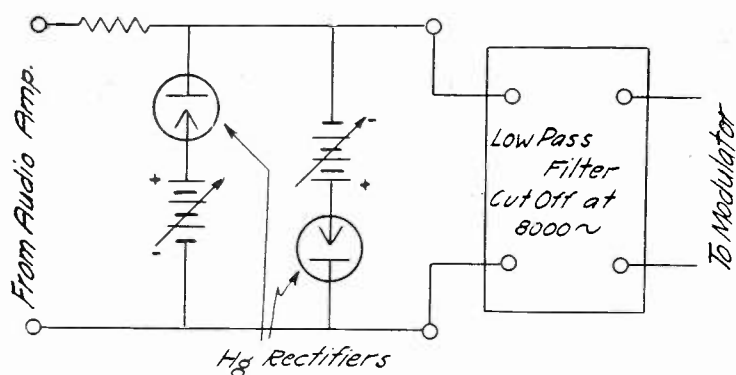

Fig. 4—Audio input limiter and filter for limiting overmodulation.

in the usual course of events (up to a point where positive limitation is occasioned by other causes). Theoretical performance of such a device is shown by Fig. 5. The use of such a combination still leaves much to be desired. The disadvantages are mainly:

1. Modulation products which occur below 100 per cent modulation are unaffected.
2. An infinite series of limiters and filters would be required in order to limit the modulating voltage to a value resulting in 100 per cent modulation.

An evident fallacy exists in the supposition that a limiter followed by a filter will limit output voltages to a value given by the breakdown voltage of the limiter. Consider Fig. 6 wherein "a" is the amplitude of the incoming voltage, at some frequency below the cut-off frequency of the filter, "b" is the shape of the voltage wave after limiting, while "c" is the amplitude of the fundamental component which passes the filter, obviously higher in peak amplitude than "b."

By far the most workable scheme yet devised for the reduction of adjacent channel interference as caused by overmodulation, is to pro-



vide a means of warning the control room operator whenever peaks of modulation exceed 100 per cent, regardless of the duration of such

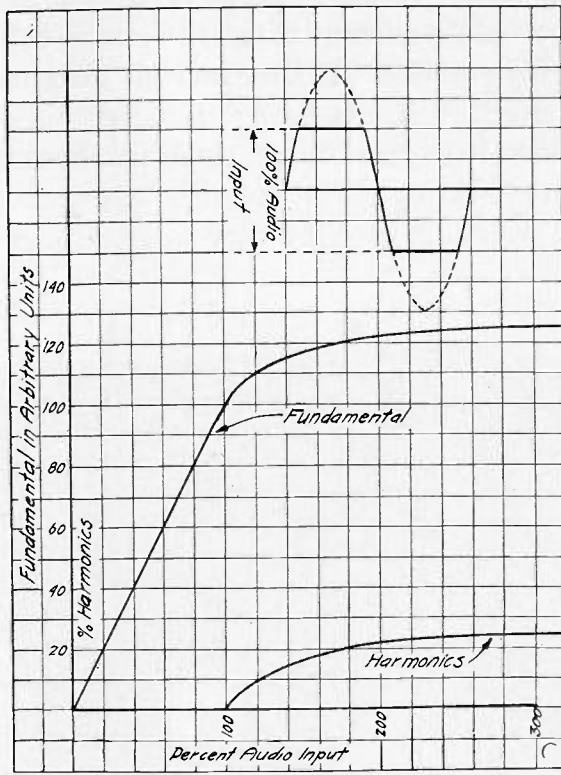

Fig. 5—Theoretical performance of limiter.

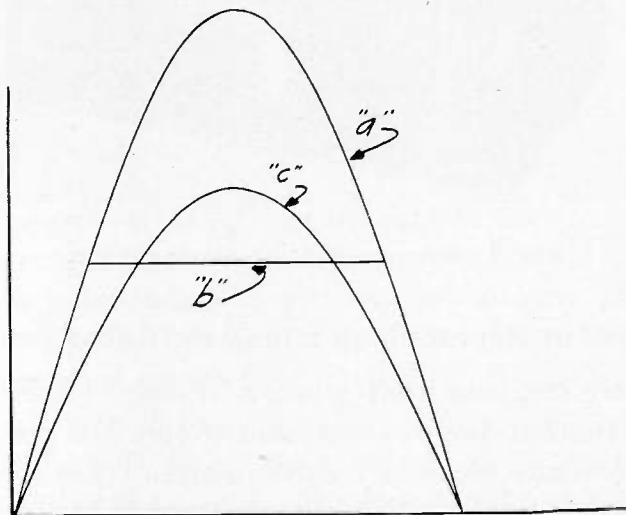

Fig. 6—The fallacy of the limiter and filter combination in limiting modulation.

peaks. An adaptation of the peak reading voltmeter together with a thyatron relay has been successfully used for this purpose. Such a device is shown by Fig. 7. As observed from Fig. 8, a thyatron is biased

in such a manner as to permit plate current to flow only if the grid voltage exceeds a predetermined value. The thyatron grid voltage is applied from the carrier through the medium of a high vacuum rectifier. The thyatron plate current is used to ring a bell or flash a lamp. Since the device is sensibly without inertia, instantaneous bursts of modulation are effective in operating the alarm. At WGY the order wire between transmitter and control room has been duplexed and the alarm impulses are fed back to the control room where gain settings are supervised. This system is working very satisfactorily.

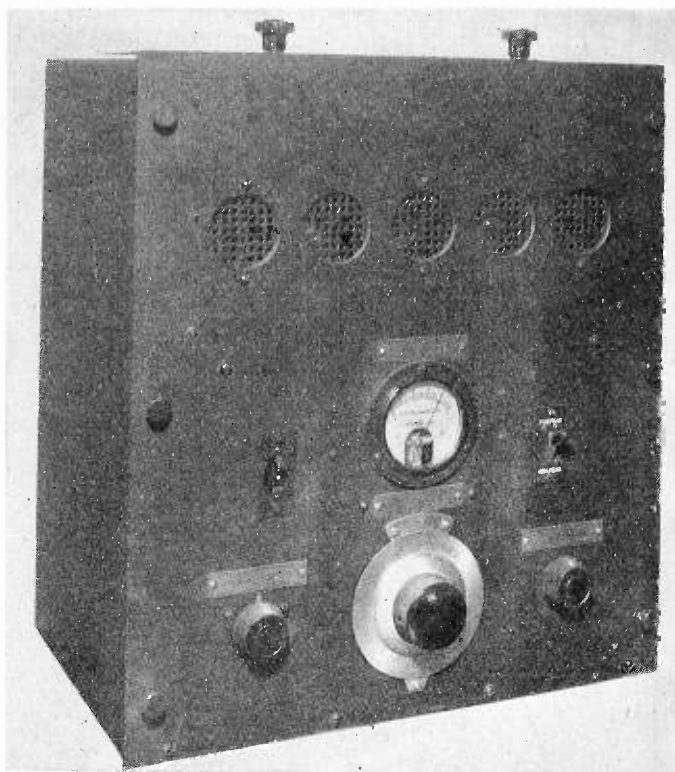

Fig. 7—Overmodulation alarm device.

#### GENERATION OF SPURIOUS OR PARASITIC RADIO FREQUENCIES

It frequently happens that when a transmitter is first installed trouble is experienced due to generation of spurious frequencies. Such frequencies constitute secondary carriers often lying at some distance from the legitimate carrier. Each of these carriers has its own family of side bands. Interference from this source is so pronounced and the cure is so obvious that the condition seldom lasts very long.

A particularly obnoxious form of this interference is caused by the periodic generation of spurious radio frequencies. In this case the radio frequency is generated in audio-frequency beats which occur only in

certain regions of grid voltage and the interference so caused may be mistaken for a defection in the linearity characteristics. Fortunately, trouble of this kind is usually accompanied by general instability of the transmitter, abnormal voltages in circuits which cannot be explained by normal operation, etc., and therefore, trouble of this nature is usually cleared up during the installation period.

### NONLINEARITY

Probably the second most important contributor to adjacent channel interference is misadjustment or misdesign of the transmitter

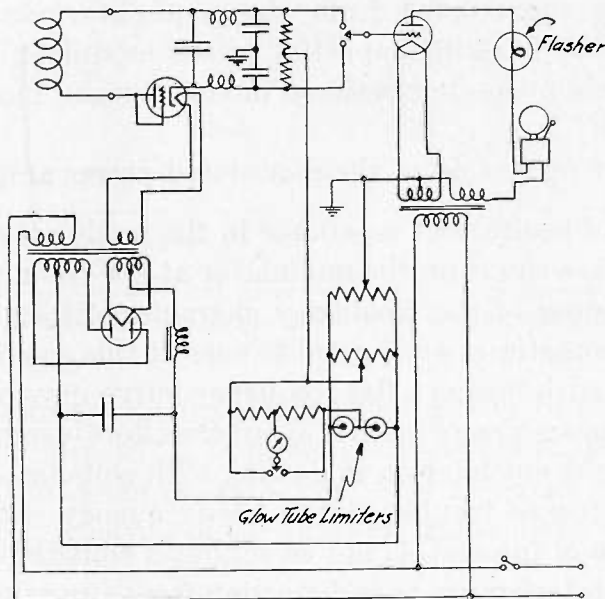

Fig. 8—Schematic of overmodulation alarm device.

equipment. The over-all effect is nonlinearity with its associated distortion. This cause is placed second in importance not because the distortion possible is secondary in degree, but because distortions from this source are usually less amenable to treatment. When a misadjusted or misdesigned transmitter is modulated past 100 per cent, or past its inherent modulation capability, there then occurs the most violent case of adjacent channel interference which can be experienced.

The nonlinearity of vacuum tubes is a subject about which a great deal has been written and it is only intended to cover outstanding cases herein, which from observation contribute most seriously to adjacent channel interference.

Linearity in low level audio amplifiers is in practice very closely achieved, it being possible and economical to construct amplifiers up to several hundred watts capacity with root-mean-square total dis-

tortions in the order of only one or two per cent and, compared to possible distortions in other parts of the equipment this value is of secondary concern.

#### THE MODULATOR AND THE MODULATED AMPLIFIER

The combination of modulator and the modulated stage provide a possible source of prolific distortion. The trouble is usually occasioned, directly or indirectly, by one or more of the following:

1. Insufficient reactance in the modulator reactor or hysteresis effects therein.
2. Shunting capacitance from the modulator plate to ground, notably the blocking capacitor of the modulated amplifier.
3. Impedance mismatch between modulator and modulated power amplifier.
4. Improper excitation of the modulated power amplifier.

The effect of insufficient reactance in the modulation reactor is to provide a reactive shunt on the modulator at low frequencies. This results in a drooping of the frequency characteristic at low audio frequencies. It is sometimes attempted to correct this condition by equalization and by such means a flat frequency curve may be produced (if taken by root-mean-square methods) but the effort is sometimes wasted as will be brought out later on in dealing with equalization.

Distortion due to trouble at the low-frequency end of the audio spectrum, while of interest, is not so serious a contributor toward adjacent channel interference as is distortion from any cause at the high-frequency end of the spectrum. The latter distortion is often caused, in an indirect manner, due to shunting capacitance from anode to ground along the audio amplifier chain. The effect of shunt capacitance is to cause the dynamic characteristic to depart from a straight line into an ellipse and to increase in general steepness. This condition is shown by Fig. 9, wherein "a" is the load line or dynamic characteristic for a typical transmitter tube working into its optimum resistance of 30,000 ohms, shunted by 0.001 microfarad. (This is a "reasonable" value for the blocking capacitor in the modulated stage), and at a frequency low enough to make the effect of the capacitor negligible. "b" is a similar curve except at 1000 cycles, "c" at 5000 cycles, and "d" at 10,000 cycles. It should be observed that plate-current cut-off will be experienced, if the grid excitation is held constant as the frequency is increased. Equalization attempts to do this very thing. It is indeed fortunate that the amplitude of high-frequency sounds is usually low and that plate-current cut-off due to legitimate signals is rarely met.

It is interesting to note the theoretical distortion resulting if the grid excitation is held constant by equalization at high frequencies.

Suppose the requirements of the transmitter demand full utilization of the above modulator tube. This requires a grid peak swing,

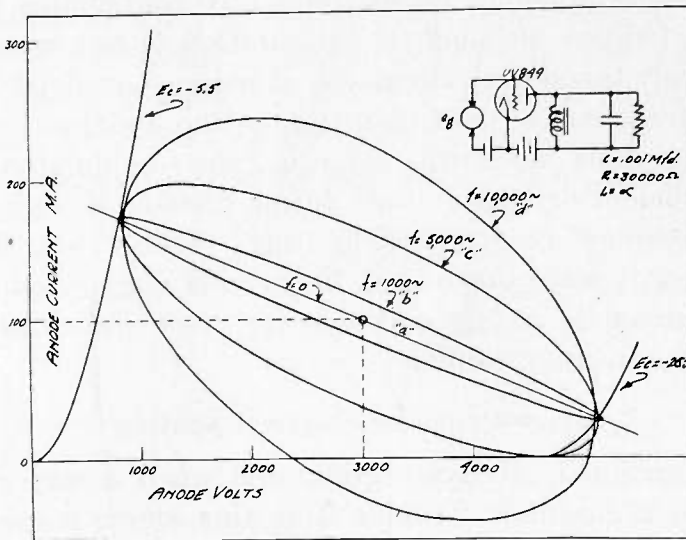

Fig. 9—Typical variation of dynamic characteristic of modulator supplying reactive load.

above and below bias, of 120 volts. At frequencies below 5000 cycles phase shift only occurs, which in broadcasting is not particularly detrimental. At frequencies above 5000 cycles anode current will cease over a part of the cycle. Analysis of the resulting curve as given by Fig. 10

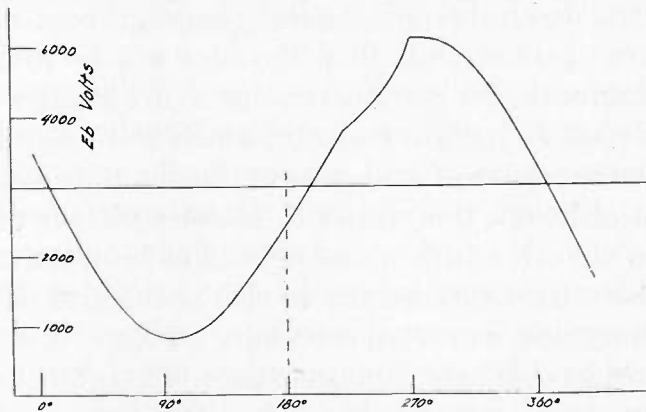

Fig. 10—Output wave shape of modulator with reactive load.

shows that at 10,000 cycles the harmonics have values as follows: second, 6.5 per cent; third, 2.5 per cent; fourth, 0.97 per cent; fifth, 1.48 per cent; compared to a total of 1.67 per cent in the case of, say, 100 cycles. This analysis does not include any transient effects due to cutting off of the anode current.

The use of high kilovolt amperes in the tank circuit of the modulated stage is detrimental due to its effect of reducing the amplitude of high-frequency side bands and promoting the temptation to equalize. Therefore, indirectly, at least, the use of high kilovolt-ampere tank circuits in radio-frequency stages frequently contributes to adjacent channel interference although if equalization is not attempted, the effect of sharply tuned tank circuits is, of course, beneficial.

Another frequent cause of distortion is the underexcitation of the modulated amplifier when this stage is "plate-modulated." This results in insufficient driving voltage during periods of high plate voltage with consequent peak output limiting. Trouble from this cause is usually secondary since the load on the driving stage is reduced during periods of high anode voltage on the driver stage, and an automatic increase of grid excitation results.

#### DISTORTION IN CLASS B STAGES

Some distortion is always encountered when a modulated stage drives a class B amplifier. Trouble from this source is one of the inherent weaknesses of the class B amplifier (whether audio or radio). Two main contributors exist: First, the grid-current—grid-voltage characteristic of triodes is far from linear which means that the driver is supplying a resistance load whose value varies over wide limits. A great deal is accomplished in practice by loading the driver with a fixed load so that the increase in driver load, when the driven grid goes positive, is a small fraction of the fixed load. Naturally, this system is wasteful and cuts down the power gain. Second, if regulation exists in the direct-current grid circuit, then the bias will be roughly proportional to the nonlinear grid current and distortion is aggravated. There is required for class B operation a tube which will pass full plate current without the necessity of grid current. Such a tube would probably have a low  $\mu$  although this, in itself, is not a serious disadvantage. The power gain of such a tube would be tremendous. An inherent tube weakness has been used successfully in combating grid distortion. Because of secondary grid emission, especially on high voltage tubes, the grid derives considerable help from the anode circuit during its positive swing. This dynatron tendency is a form of regeneration, and if too severe results in self-oscillation of the stage, usually at a frequency determined by the grid filter circuit. A controllable amount of secondary emission is advantageous and is permitted in practice.

#### EXCITATION—LOAD RATIO

A very common source of distortion in class B radio amplifiers is due to an improper ratio between excitation and loading. A certain

predetermined carrier level may be obtained with high excitation and low loading or vice versa. The efficiency, however, is generally best at high excitation. It has become an accepted practice<sup>2</sup> to adjust grid excitation (half maximum) to produce the desired output at approximately 33 per cent efficiency. There are two main considerations to be borne in mind when making this adjustment and these are somewhat at variance. First, the efficiency should be high for reasons of economy, and second, the distortion should be low over the entire output range. It so happens that, in general, as the fidelity increases the efficiency decreases, but some latitude exists as to the optimum adjustment. How-

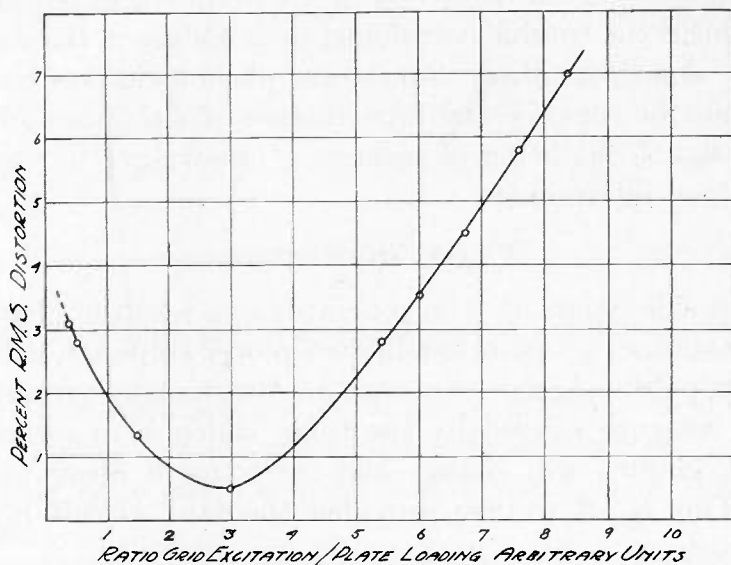

Fig. 11—The effect upon distortion of varying the excitation-to-load ratio of a class B radio-frequency amplifier.

ever, it has been ruled<sup>1</sup> that the arithmetical sum of the audio harmonics must not exceed 10 per cent at 75 per cent modulation. This restricts the latitude of adjustment considerably, especially so, since a further ruling<sup>2</sup> limits the input allowed by defining the efficiency at which the equipment shall operate.

In practice it has been shown that a material reduction in distortion and a like reduction in adjacent channel interference can be accomplished by reducing the grid excitation, reducing the grid bias and increasing the anode loading beyond the typical adjustments necessary to give 33 per cent efficiency. Fig. 11 is a typical example of the effect, for instance, of changing the excitation—loading ratio at constant bias, anode voltage, and output as obtained on the output stage of a typical 5-kilowatt transmitter.

<sup>2</sup> Paragraphs 135 to 136, page 39, "Rules and Regulations of Federal Radio Commission."

Summarizing this matter, it appears that with the available methods and apparatus, a reduction in distortion of a class B amplifier must be accompanied by a reduction of efficiency. The importance of audio harmonic reduction by this method should not be underestimated as very material gains may be accomplished. It is also possible by careful adjustment to cancel, by a succeeding stage, a great deal of the distortion produced by the driver.

Serious distortion due to plate-current saturation is not frequently encountered since trouble due to this source represents a misapplication of equipment.

A frequent source of distortion at low frequencies is interesting in passing. This is the trouble occasioned by economy in the design of the main filter capacitor. Many interesting phenomena are encountered, the net result however, is the introduction of distortion affecting the legitimate signal but being of secondary importance in regard to adjacent channel interference.

#### PHASE MODULATION

Spurious side bands may be generated as a result of phase modulation. For instance in a plate-modulated power amplifier, if the plate is driven to a point wherein the average direct plate current changes, then the resistance offered by the tube, which is in series with the tuned tank circuit, will change and introduce a phase shift in the carrier.<sup>3,4</sup> This is, of course, provided the tank circuit itself is not exactly tuned.

#### EQUALIZATION

In general, all manners of distortion except phase distortion may be said to be of two types: (1) Absence of something in the received signal which was present in the original; (2) presence in the received signal of something which was lacking in the original. Of the two types, the second is probably the most important, most especially of course, in connection with the production of adjacent channel interference. However, a great deal of importance has been attached to the linear frequency response of transmitters. This characteristic has to do with the first class of distortion mentioned above. It is not intended to minimize the desirability of linear frequency response. However, great care should be taken in the means by which this condition is achieved, otherwise, a gain in fidelity of the first classification will result in a loss of fidelity due to the second and will result in adjacent channel interference.

<sup>3</sup> W. Fitch, *Proc. I.R.E.*, vol. 20, p. 863; May, (1932).

<sup>4</sup> Hans Roder, *Proc. I.R.E.*, vol. 19, p. 2145; December, (1931).



Consider Fig. 12, of which "a" is a typical frequency characteristic of a broadcast transmitter. Equalization may be affected by attenuating frequencies in the middle range resulting in curve "b." This step is permissible and results in increased fidelity accompanied by a reduction in modulation capabilities. Usually though, the next step is to increase the gain over the whole range supposedly resulting in a characteristic such as "c" and indeed such a characteristic is often approached by root-mean-square measurement methods. It should be borne in mind that the failure of the transmitter to produce a linear

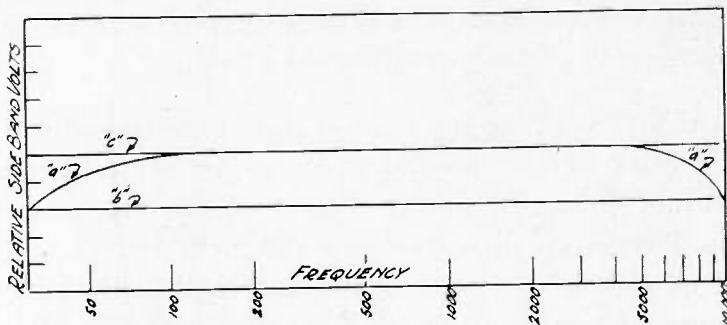

Fig. 12—Over-all equalization to improve transmission characteristics.

frequency characteristic was due to some inherent fault of the equipment and "forcing," which while it may result in greater power output, can certainly have but one effect, the production of spurious audio frequencies.

Of prime importance in the production of adjacent channel interference is the distortion produced by the equalization for high audio frequencies inasmuch as their harmonics lie in adjacent channels. High-frequency distortion is largely due to a condition previously mentioned, i.e., shunting capacitances along the audio channel. It may be argued that high-frequency inputs are usually of low amplitude and it is probably due to this fact that adjacent channel interference is not worse than it is. In any event, the correct procedure is to remove the cause rather than to alleviate the effect.



## A NEW TYPE OF THYRATRON RELAY\*

By

GEORGE BABAT

(Research Laboratory, "Svetlana" Works, Leningrad, U. S. S. R.)

*Summary*—This paper describes a new type of Thyatron relay and circuit which are novel from the viewpoint that continuous current flows through the load for half-wave rectification. A Thyatron tube of novel design is described which in addition to the usual electrodes includes an auxiliary anode which functions as a rectifier during the negative half cycle of the main anode. Formulas for the circuit are included together with oscillograms showing experimental results.

THYRATRON tubes have been applied successfully as relays. Such a relay arrangement has a number of distinct advantages over other forms of relays. Fig. 1 shows the usual schematic diagram of a Thyatron tube used as a relay.

The use of alternating current in such applications for supplying the anode current results from the fact that in a Thyatron the grid

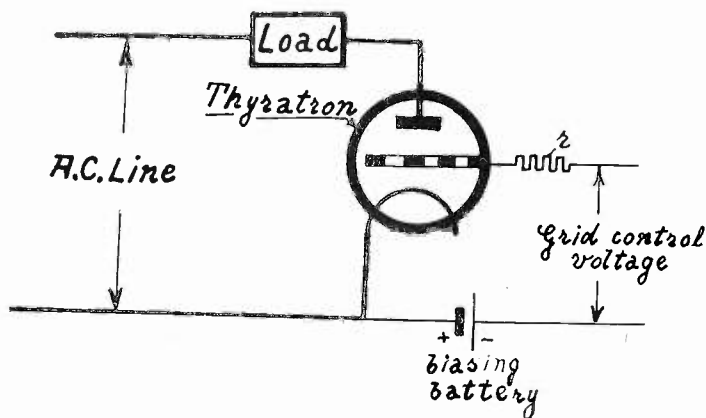

Fig. 1—Usual form of half-wave Thyatron circuit.

as commonly designed can normally control only the time of starting of the anode current and cannot stop the discharge once it has started. For the case of direct-current anode supply, either a special design of Thyatron or special circuit arrangements must be employed. Actually the great majority of control circuits are most conveniently operated from an alternating-current supply and thus this feature is of no disadvantage in most cases.

In the so-called half-wave circuit of Fig. 1, however, it is obvious that the current flowing through the anode circuit and relay coil is

\* Decimal classification: R339. Original manuscript received by the Institute, June 26, 1933.

not continuous but consists of a series of impulses.<sup>1</sup> This characteristic of intermittent current through the tube and relay coil is in many cases quite objectionable due to noise and mechanical and contact difficulties in the latter.

Also in cases where a single Thyatron rectifier tube is used in a half-wave circuit to supply power for generator or motor field windings or other power purposes, the pulsating nature of the current is often undesirable. Therefore, the use of a series inductance is expensive and, at best, is not a complete solution of the problem.

This paper describes a new type of Thyatron tube and circuit which is capable of delivering a direct current without interruption

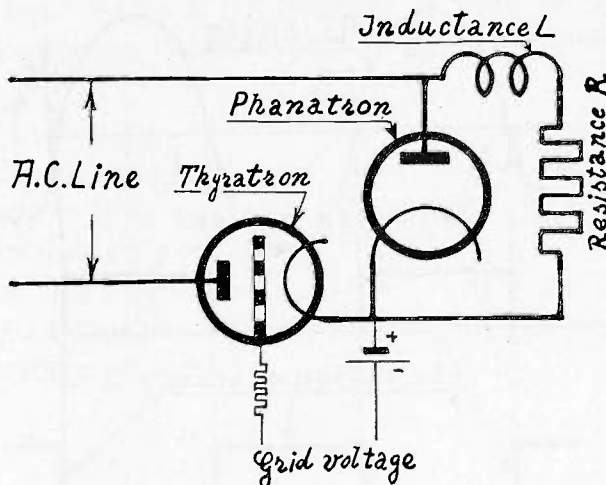

Fig. 2—Schematic diagram of the circuit principle described by the author.

from an alternating-current supply, at the same time involving little additional complications over the simplicity of the half-wave rectifier circuit. For this new arrangement, however, it is necessary that the load possess a certain amount of inductance. Before describing the new type of tube that can be used to advantage, the principle of the circuit will be described.

Fig. 2 is a schematic diagram of this new circuit. It will be noted that without the addition of the Phanatron or two-element rectifier tube it is the same circuit as has been described in Fig. 1. However, with the addition of this rectifier tube the load current will continue

<sup>1</sup> This is true even for the case of a very highly inductive load circuit. Thus, the addition of a large series inductance, as in the circuit of Fig. 1, does not eliminate the feature of interrupted current flow but only decreases the average value. See N. Papalex, *Ann. Phys.*, no. 39, p. 976, (1912).

*Editorial Note:* It is of interest to note that this circuit arrangement incorporating a discharge tube across a reactive load to smooth the load current has been in common use in this country for some time. The illumination control circuits used in the large theater at Radio City have this feature.

to flow after the plate potential has reversed and become negative. This is due to the fact that the discharge current from the inductance  $L$  now passes through the rectifier tube. It is obvious that this current results from the stored electromagnetic energy in the inductance.

When, with the next half cycle, the plate current again flows in the positive direction, the current through the rectifier tube will cease, and normal half-wave rectifier operation will be resumed. Thus, current will flow through the load on both half waves of the alternating-current supply frequency. As has been noted, the current flowing through the load circuit will not be continuous except in the case of a load inductance greater than some definite value.

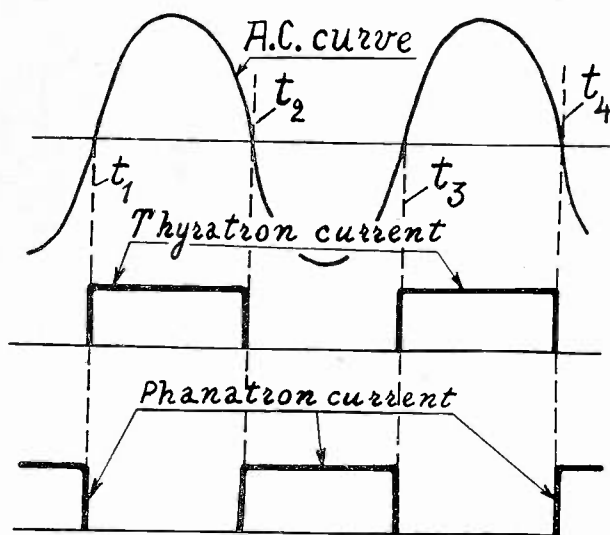

Fig. 3—Wave form of currents for circuit of Fig. 2 for the case of a very large load inductance  $L$ .

This minimum value of load inductance to insure a continuous flow of load current can be calculated approximately. For such a calculation, let us refer to Fig. 3. At the period of the cycle marked  $t_1$  current begins to pass through the Thyatron tube. The following equation is the expression for the load current:<sup>2</sup>

$$i = \frac{E_m}{Z} [\sin (\omega t - \phi) + \sin \phi e^{-Rt/L}] \quad (1)$$

where  $t$  lies between  $t_1$  and  $t_2$  and where  $E_m$  is the amplitude of the alternating-current voltage feeding the relay,  $\omega$  = its angular frequency,

$$\phi = \tan^{-1} \frac{\omega L}{R} \quad \text{and} \quad Z = \sqrt{R^2 + \omega^2 L^2}.$$

<sup>2</sup> In order to simplify these equations, the voltage drop in the tube has been ignored. For most cases, such an assumption does not result in a serious error.

At the point  $t_2$  of the cycle the Thyatron tube ceases to pass current and the load current begins to flow through the rectifier tube. The magnitude of this current flowing to the load at the time  $t_2$  may be calculated by replacing  $t$  in (1) by  $T/2$ , where  $T/2 = \pi/\omega$ , as follows:

$$i_{t_2} = \frac{E_m}{Z} [\sin \phi + \sin \phi \cdot e^{-\pi R/L\omega}] = \frac{\sin \phi \cdot E_m}{Z} [1 + e^{-\pi R/L\omega}]. \quad (2)$$

Following the point  $t_2$  in the cycle there is a process of discharge of the inductance through the rectifier tube.

If the current carrying characteristic of the rectifier tube were similar to a resistance, there would be an exponentially decreasing current through the load, and any appreciable amount of inductance in the circuit would result in a definite final value of current at the end of the half cycle.

However, in the case of the Phanotron rectifier tube under consideration here, the voltage drop has a nearly constant value. Therefore, this characteristic is equivalent to inserting in this circuit a constant counter electromotive force of equal amount.

Expressing this Phanotron tube drop by  $\Delta V$ , the following expression gives the current through the load during the negative portion of the supply voltage cycle:<sup>3</sup>

$$i = A e^{-Rt/L} - \frac{\Delta V}{R}, \quad (3)$$

where  $t$  lies between  $t_2$  and  $t_3$ .

For  $t = t_2$ ,  $i$  is given by (2) and also by the relation derived from (3) by putting  $t = 0$ . Hence the constant  $A$  is given by the relation,

$$A - \frac{\Delta V}{R} = \frac{E_m \sin \phi}{Z} [1 + e^{-\pi R/L\omega}]$$

and (3) becomes

$$i = \left\{ \frac{E_m \sin \phi}{Z} [1 + e^{-\pi R/L\omega}] + \frac{\Delta V}{R} \right\} e^{-Rt/L} - \frac{\Delta V}{R} \quad (4)$$

where  $t$  lies between  $t_2$  and  $t_3$ .

If we substitute  $T/2$  for  $t$  in (4), we obtain an expression for the current flowing through the load circuit just before the Thyatron tube starts to pass current. The result is

<sup>3</sup> Equation (3) is true only when  $i \geq 0$ . It must be remembered that  $\Delta V$  is not a real electromotive force. When  $i = 0$  then  $\Delta V$  also equals 0. There cannot be a negative value for current in this case.

$$i_{t_3} = \left\{ \frac{E_m \sin \phi}{Z} [1 + e^{-\pi R/L\omega}] + \frac{\Delta V}{R} \right\} e^{-\pi R/L\omega} - \frac{\Delta V}{R} \quad (5)$$

The limiting value for  $i_{t_3}$ , just as the current begins to transfer or commutate, will be zero. Therefore, the problem is to find a relation between the values of  $E_m$ ,  $R$ ,  $\Delta V$ , and  $L$  which will reduce (5) to zero. Denoting  $\pi R/L\omega$  by  $x$  and  $E_m/\Delta V$  by  $a$  and substituting these values in (5) and equating it to zero, there is obtained, after a series of transformations, a solution which reduces  $i_{t_3}$  to zero as follows:

$$a = \frac{(e^x - 1) \left( \frac{x}{\pi} + \frac{\pi}{x} \right)}{1 + e^{-x}} \quad (6)$$

From (6) the curve of Fig. 4 is calculated and plotted. For this curve  $R/L\omega$  is shown as a function of  $E_m/\Delta V$ . If the components  $E_m$ ,  $\Delta V$ ,  $\omega$ ,  $R$ , and  $L$  of the circuit arrangement are such that operation is

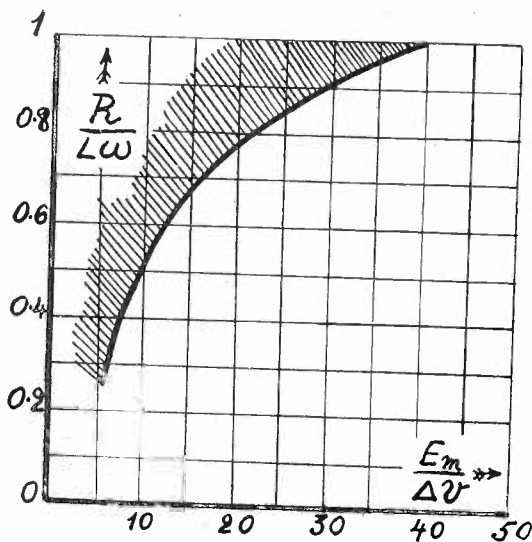

Fig. 4 —  $\frac{R}{L\omega}$  as a function of  $\frac{E_m}{\Delta V}$ .

in the shaded part of the curve, there will be interruptions in the load current. However, for conditions on the right side of the curve when  $R/L\omega = f(E_m)/\Delta V$  there will be no interruptions in the load current.

Therefore, to secure satisfactory relay operation, it is suggested that for given values of  $\Delta V$ ,  $E_m$ , and  $\omega$ , the quantities  $R$  and  $L$  be chosen so that the result will be to the right of the curve of Fig. 4.

In most cases the ratio  $E_m/\Delta V$  is of the order of 20 to 30. ( $E_m = 150$  to 350 volts and  $\Delta V = 8$  to 12 volts.) Therefore, to secure an uninterrupted flow of load current, it is sufficient to have  $L\omega$  approximately

equal to  $R$ . As a practical example, if the current supply to the relay has a frequency of 60 cycles and  $\omega$  equals 377, the critical value of  $L$  will be  $0.003 R$ . In actual load devices the  $L/R$  ratio is usually many times greater than this critical value which has been found necessary for a continuous flow of load current. For example, a typical electro-magnetic relay winding has an  $L/R$  ratio of the order of 0.01 to 0.1. It is apparent, therefore, that a continuous flow of load current is usually obtainable.

The average value of the load current may be calculated from the formula

$$I_o = \frac{E_m - \pi \Delta V}{\pi R} \quad (7)$$

The value of  $L$  does not influence the value of  $I_o$ .

#### DESCRIPTION OF A NEW FORM OF RECTIFIER TUBE

By reference to Fig. 2 it is noted that the Thyatron and Phanotron tube cathodes are common electrically. This fact, therefore, gives the possibility of combining these two devices inside one bulb in such a

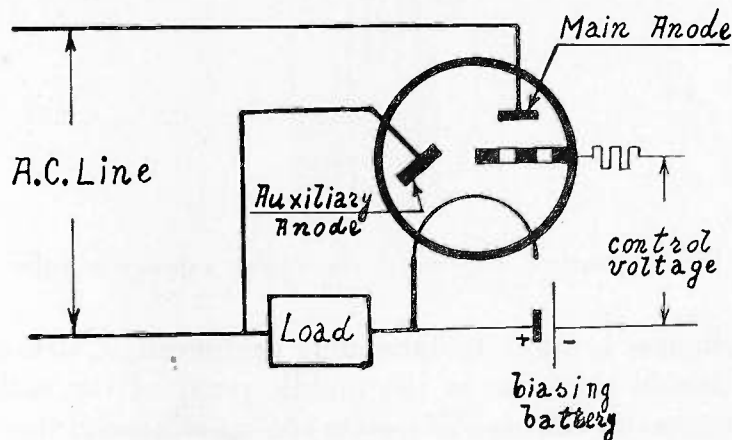

Fig. 5—Schematic diagram of the circuit and special design of tube described.

way that one cathode functions in common for two separate anodes. A grid is used in connection with one of these anodes. The schematic arrangement of such a tube is shown in Fig. 5.

In the design of such a tube there are certain points which must be taken into consideration. The Thyatron portion of the tube must be designed in such a way that the ionization between the common cathode and the added auxiliary rectifying anode (shown at the side of the bulb) will not result in a loss of control for the grid in relation to the other main anode. This, of course, is an important factor for satisfac-

tory operation of the Thyatron tube, a certain amount of deionization time being essential. To accomplish this, considerable care is necessary in the design of the electrode structure.

An outline drawing of a design of tube to accomplish this result in a satisfactory manner is shown in Fig. 6. A photograph of such a tube is shown in Fig. 7.

In this design the ionization between the cathode and the auxiliary anode has been localized by the use of a screen. This screen consists of

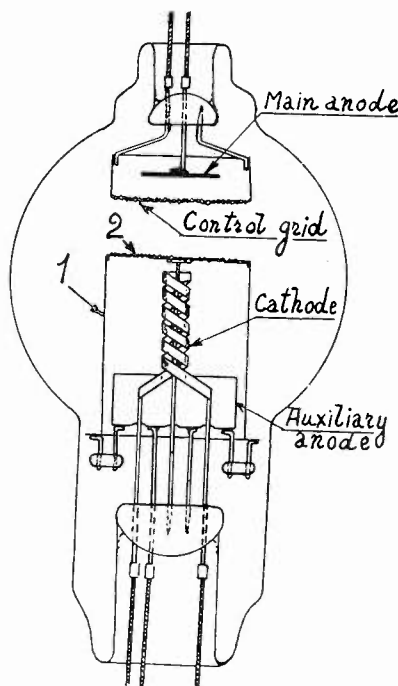

Fig. 6—Outline drawing of the author's design of tube.

a nickel cylinder, 1, and a molybdenum grid mesh, 2. It is electrically connected inside the tube to the middle point of the cathode. This screen prevents the diffusion of ions in the space around the cathode to the vicinity of the Thyatron control grid.

The essential electrical characteristics of the tube shown in Fig. 7 are as follows:

Filament voltage	2.5
Filament current	5-6 amperes
Maximum peak plate current	2 amperes
Average plate current	1 ampere
Voltage drop to main anode	8-14
Maximum peak plate voltage (Inverse)	1000

The voltage drop to the auxiliary anode is usually somewhat lower than the voltage drop to the main anode.



In Fig. 8 there are shown characteristic curves for this tube. The curve *A-B* gives the grid voltage recommended to insure satisfactory

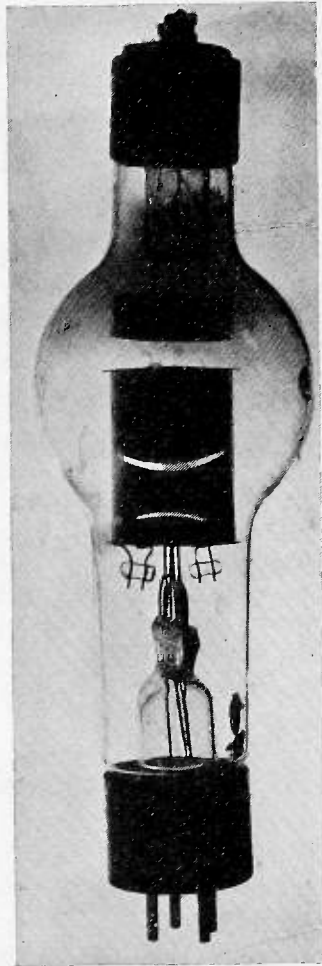

Fig. 7—Photograph of the author's design of tube.

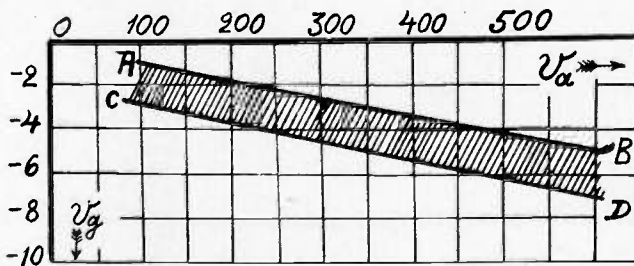

Fig. 8—Control characteristic of the author's design of tube shown in Figs. 6 and 7.

starting while the curve *C-D* gives the voltage required to prevent starting. These curves change with the temperature of the tube.

Oscillograms of the operation of this tube are given in Figs. 9 and

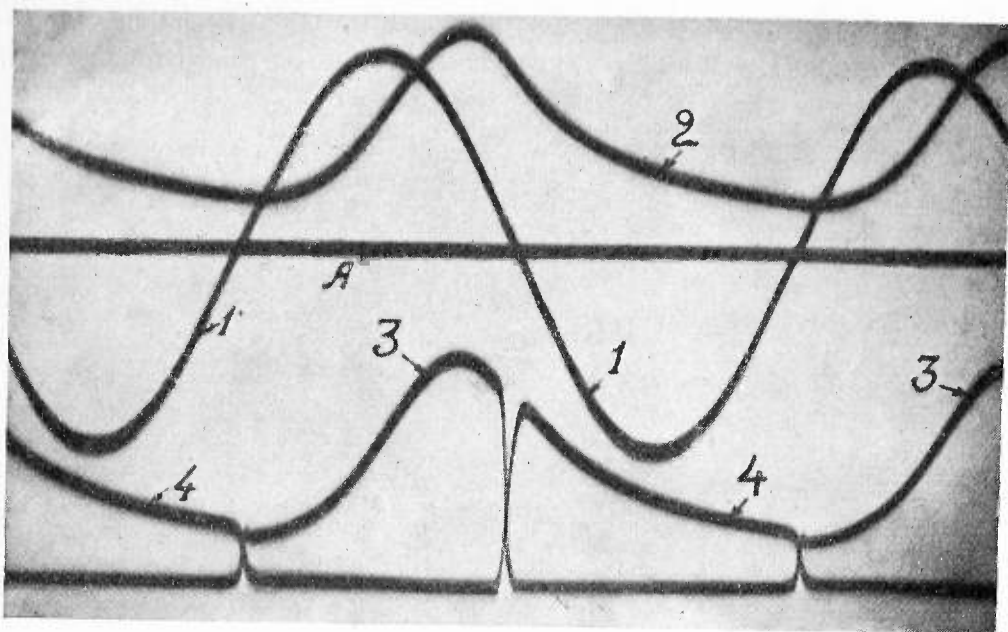

Fig. 9—Oscillogram of the operation of the circuit shown in Fig. 5.

Curve No. 1—Alternating-current supply voltage.

Curve No. 2—Direct-current load current (average of 1.6 amperes).

Curve No. 3—Main anode current.

Curve No. 4—Auxiliary anode current.

Line A is axis for curves No. 1 and 2.

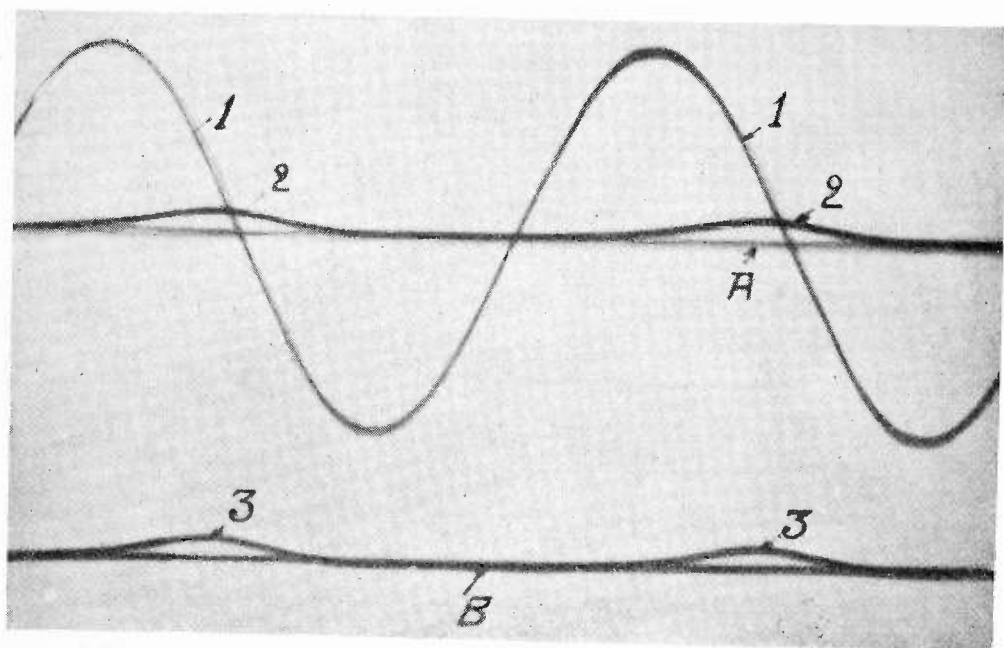

Fig. 10—Oscillogram of the operation of the circuit shown in Fig. 1.

Curve No. 1—Alternating-current supply voltage.

Curve No. 2—Direct-current load current (average of 0.08 ampere).

Curve No. 3—Main anode current.

Line A is axis for curves No. 1 and 2.

Line B is axis for curve No. 3.

10. A study of the wave form of Fig. 9 confirms the relationship illustrated in Fig. 5. In taking the oscillogram shown in Fig. 10, no change in the resistance or inductance value of the load was made. It also involves the same value of alternating supply voltage. In other words, only the auxiliary anode has been eliminated which results in a change from the circuit shown in Fig. 5 to the circuit shown in Fig. 1. A sudden drop in the average current from 1.6 amperes to 80 milliamperes is noted, accompanied by an interruption for a definite period of time in each cycle.

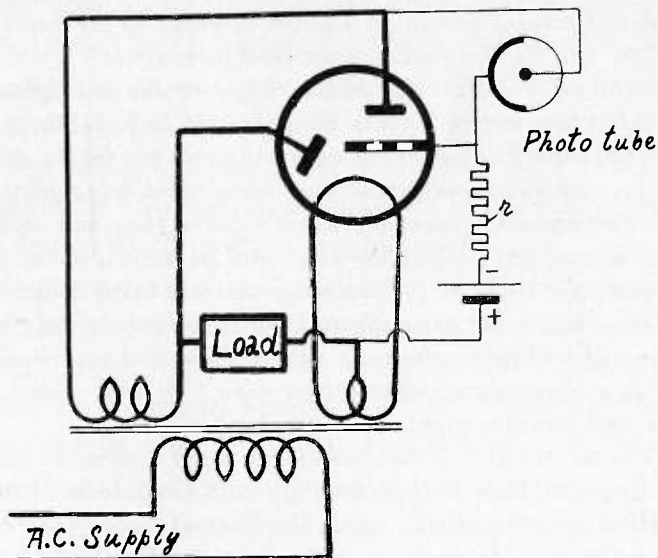
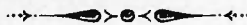

Fig. 11—Schematic diagram for a circuit combining a phototube.

No attempt will be made in this paper to discuss at length application details. It is interesting to note, however, that by the use of an arrangement, such as shown in Fig. 11, with the addition of a phototube in the control grid circuit, very successful operation has been obtained. In such a case, as soon as light falls on the phototube, current will flow through the resistance  $r$ , the grid potential will then become more positive, and current will be established in the load circuit.



## THE POLARIZATION OF SKY WAVES IN THE SOUTHERN HEMISPHERE\*

BY

A. L. GREEN

(Radio Research Board, Australian Commonwealth Council for Scientific  
and Industrial Research, Sydney, Australia)

*Summary.*—In the Southern Hemisphere, and for directions of propagation of downcoming waves very nearly parallel to the lines of force of the earth's magnetic field, the constants of polarization of sky waves deviated by the ionosphere at heights ranging between 94 and 262 kilometers have been measured.

At all times the polarization was very nearly circular and right-handed. During the sunrise period, when measurements were thought to be liable to least error, the average value of the ratio of component alternating forces in the downcoming wave was found to be 1.4, the abnormally polarized component being greater than the normally polarized. The angular phase difference between the components was  $-84$  degrees, the normal component leading the abnormal in time, and the sense of rotation of the resultant magnetic vector in the downcoming wave being clockwise.

At other times, when the experimental conditions were not quite so suitable, due to the presence of multiple reflections and to phase and amplitude changes of the sky waves, the mean constants of polarization were 1.08 and  $-89.6$  degrees, respectively, again showing circular right-handed polarization.

The experimental conditions were carefully made similar to those of Appleton and Ratcliffe in England, these authors having found circular and left-handed polarization for directions of transmission along the lines of force of the earth's magnetic field. Their prediction that observations in the Southern Hemisphere for propagation against the lines of force of the earth's field should show circular polarization with a right-handed sense of rotation, has therefore been verified.

As a consequence of this direct test of the influence of the earth's field in the production of magneto-ionic phenomena, including the differential absorption in the ionosphere of the right-handed and left-handed components of an incident plane polarized wave, with the return to the earth of only one component in each hemisphere, it may now definitely be stated that the origin of abnormal polarization in sky waves is to be linked up with the earth's magnetic field.

The practical application is to radio direction finding, where it has been found that night errors are due to the abnormally polarized component of magnetic force in downcoming waves. It is therefore to be expected that night errors in bearing should be great for directions of propagation parallel to the lines of force of the earth's field, and less for directions perpendicular to them.

### I. INTRODUCTION

THIS paper describes the results of the first of a series of investigations in Australia of the influence of the ionized regions of the upper atmosphere on the reception of downcoming wireless waves.

\* Decimal classification: R113.6. Original manuscript received by the Institute, June 22, 1933.

In the main the Australian experiments were purposely carried out in such a way that comparisons could be made between them and the results of similar experiments in the Northern Hemisphere, and it is chiefly with this comparative aspect that the present paper is concerned.

In 1928 Appleton and Ratcliffe published their measurements of the state of polarization of downcoming waves<sup>1</sup> for which they found a predominant left-handed circular rotation of the magnetic vector. The conditions of their experiments in England were such that downcoming waves traveled along paths which were only slightly inclined to the lines of force of the earth's magnetic field, and it was pointed out that differential absorption, in the ionosphere, of the two circularly polarized components which had originally left the transmitting aerial in the form of an equivalent plane polarized wave, was sufficient to explain the elimination of the right-handed component and the reception of the left-handed in the Northern Hemisphere.

In the discussion of this hypothesis, they stated that the most direct test<sup>2</sup> of the action of the earth's magnetic field in the production of differential absorption of the two circularly polarized component waves, would be found in a repetition of their experiments at corresponding points in the Southern Hemisphere, where the measured polarization should be circular but right-handed.

The formation of the Australian Radio Research Board in 1929 presented an opportunity for this test to be made, and since it was realized that the magneto-ionic theory of wave propagation in the Kennelly-Heaviside layer has an important bearing on the cause of night errors in wireless direction finding, it was decided to proceed with the polarization experiments without delay. In carrying out the test, the greatest care was taken to operate under conditions which would allow of a strict comparison being made between the results of the experiments in the two hemispheres, and, with this purpose in view, the experimental technique developed by Appleton and his assistants in the course of their "frequency-change" measurements was adhered to rigidly.

## II. DEFINITIONS

The experimental method of determining the constants of polarization is that described by Appleton and Ratcliffe.<sup>3</sup>

<sup>1</sup> "Proc. Roy. Soc.," A, vol. 117, p. 576, (1928).

<sup>2</sup> W. G. Baker and the author have recently pointed out, Proc. I.R.E., vol. 21, no. 8, pp. 1103-1131; August, (1933), that, for short distances between sender and receiver, the complete reversal between left-handed and right-handed circular polarization is only to be expected in the cases of propagation in the two hemispheres from stations transmitting towards the corresponding magnetic poles.

Fig. 1. It is assumed that the downcoming wave, which arrives at receiver  $R$  at an angle of incidence  $i$ , has a magnetic force which can be resolved into two components. The abnormally polarized component,  $H_1'$ , is in the plane of propagation, i.e., the vertical plane containing the sender and receiver. Both the normally polarized component,  $H_1$ , in the atmospheric wave, and the magnetic force,  $H_0$ , in the ground wave, are perpendicular to the plane of propagation, so that in Fig. 1 they would be directed out of the paper and towards the reader.

The phase difference between the ground wave and the normal component in the downcoming wave is  $\theta$ , while the corresponding quantity for the abnormal component is  $\theta'$ .

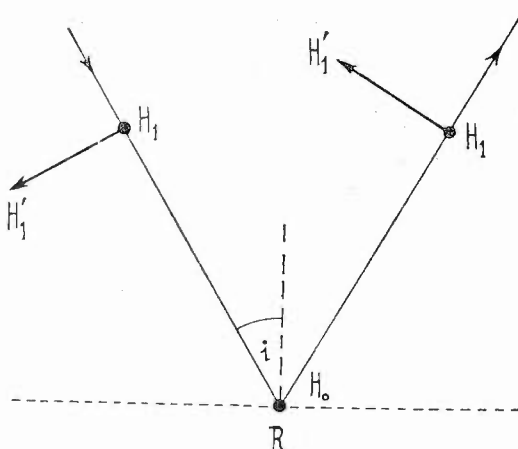

Fig. 1—Downcoming wave reflected at the ground. Both the normally polarized component  $H_1$  of the sky wave and the magnetic force  $H_0$  in the ground wave are directed out of the paper and towards the reader. Note the reversal in phase of the abnormally polarized component  $H_1'$  of the downcoming wave after reflection.

The state of polarization is then completely determined when one can measure the quantities, (a) the ratio of components,  $H_1'/H_1$ , and (b) the magnitude and the sign of the angular phase difference between  $H_1'$  and  $H_1$ , this being denoted by  $x = \theta' - \theta$ .

If, for the moment, we dissociate the downcoming wave from its orientation with the ground and consider Fig. 2, we see that  $OX$  is the normally polarized component of magnetic force of value  $H_1 \cdot \sin(pt + \theta)$ , and  $OY$  is the abnormal component equal to  $H_1' \cdot \sin(pt + \theta')$ , where  $p$  is the angular frequency of the wave. In this figure the direction of propagation is assumed to be at right angles to the plane of the paper, and away from the reader.

Looking, therefore, from the transmitter to the receiver, with  $OX$

<sup>3</sup> For a number of reasons it has proved desirable to reproduce a summary of the theory of their method.

pointing to the right, and for increasing values of the time  $t$ , the definition of the sense of rotation of  $OH$ , the resultant magnetic force in the downcoming wave, is as follows:

If the angle  $\alpha$  lies in the first or second quadrants, then the rotation is left-handed; on the other hand, if  $\alpha$  lies between 0 and  $-180$  degrees, then the rotation is right-handed.

### III. CONDITIONS AT THE GROUND

For the conditions of these experiments where we are concerned with waves of broadcast frequency approaching ground of high conductivity at steep angles of incidence, a downcoming wave will be reflected at the surface of the earth with negligible change of amplitude.<sup>4</sup>

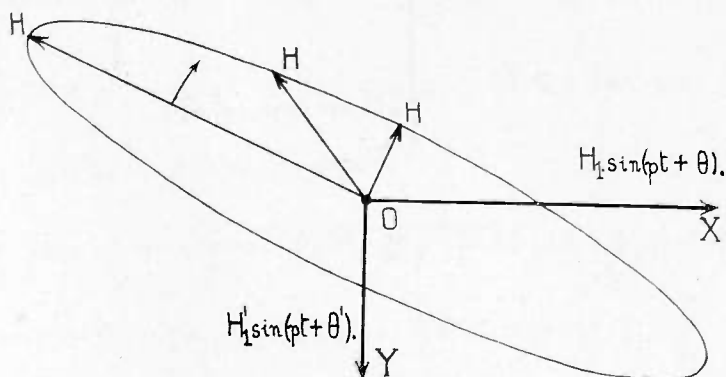

Fig. 2—Magnetic forces in the sky wave, pictured as traveling away from the reader and at right angles to the plane of the diagram.  $OX$  and  $OY$  are the alternating components of the rotating vector  $OH$ . The sense of rotation of  $OH$  within the ellipse of polarization is clockwise, or right-handed, if the angle  $\theta' - \theta$  lies between 0 and  $-180^\circ$ . The shape of the ellipse is determined by measuring the ratio of components,  $OY/OX$ , and the angular phase difference,  $\theta' - \theta$ . The sense of rotation of  $OH$  is determined by the sign of the angle  $\theta' - \theta$ .

Now, in the method due to Appleton and Ratcliffe, use is made of three receiving loop aerials whose planes are vertical, so that the magnetic forces in the incident and reflected waves must be resolved horizontally. This is done in Figs. 3(a) and 3(b), which are ground plans of the magnetic forces. The point  $R$  represents the receiving station,  $RA$  and  $RB$  are both horizontal,  $AR$  is the direction of propaga-

<sup>4</sup> For the same conditions, the reversal in phase of the abnormally polarized component of the downcoming wave is very nearly complete, so that, to an observer traveling with the wave, the sense of rotation would seem to change, say from right-handed to left-handed, at the earth's surface. Thus, in the case of an atmospheric wave originally leaving the transmitting aerial as plane polarized, the downcoming wave after the first reflection by the layer may be circularly polarized with a right-handed sense of rotation, but the wave approaching the layer for a second reflection would be left-handed circularly polarized. This fact may be of importance in the interpretation of multiple reflections.

tion and  $RB$  points to the right for an observer standing at the receiver and looking away from the transmitter.

On resolving magnetic forces horizontally, the vectors represented by  $RB$  and  $RA$  are,

$$H_0 \cdot \sin pt + 2H_1 \cdot \sin (pt + \theta)$$

and,

$$2H_1' \cdot \cos i \cdot \sin (pt + \theta'), \text{ respectively.}$$

The three receiving loops are marked I, II, and III. Loop II is in the plane of propagation, loops I and III make angles of 45 degrees

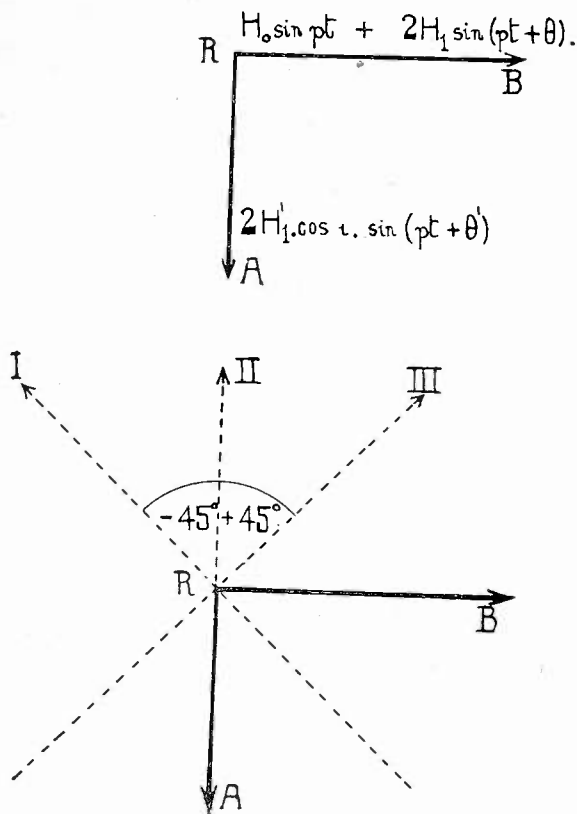

Fig. 3—Ground plans of the magnetic forces in relation to the three receiving loop aerials I, II, III.  $R$  is the receiver and  $AR$  is the direction of propagation.

with the direction of propagation. In some later experiments a fourth loop was added, this being perpendicular to loop II and being designated loop IV.

The magnetic forces linked with the three loops are,

$$\text{I. } \frac{1}{\sqrt{2}} \cdot [H_0 \cdot \sin pt + 2H_1 \cdot \sin (pt + \theta) - 2H_1' \cdot \cos i \cdot \sin (pt + \theta')] \quad (1)$$

$$\text{II. } H_0 \cdot \sin pt + 2H_1 \cdot \sin (pt + \theta) \quad (2)$$



$$\text{III. } \frac{1}{\sqrt{2}} \cdot [H_0 \cdot \sin pt + 2H_1 \cdot \sin (pt + \theta) + 2H_1' \cdot \cos i \cdot \sin (pt + \theta')]. \quad (3)$$

Now, although there are six unknowns in these three expressions, it is possible to reduce the number to four if some simplifying assumptions are made, these being,

- (a) that the magnitude of the ground wave is sensibly constant, at any rate during the period of a few seconds covered by the tests, and  
 (b) that the same is true of the angle of incidence of the downcoming wave, so that  $\cos i$  may be taken to be a constant factor during the same period of time.

We may now use as variables the quantities  $2H_1/H_0$  and  $2(H_1' \cdot \cos i)/H_0$ , and these will be called  $a$  and  $b$ , respectively. Using the new variables and collecting terms, (1), (2), and (3) may be reduced to

$$\text{I. } \frac{H_0}{\sqrt{2}} \cdot [\sin pt + \sqrt{a^2 - 2ab \cdot \cos x + b^2} \cdot \sin (pt + \theta + \zeta)] \quad (4)$$

$$\text{II. } H_0 \cdot [\sin pt + a \cdot \sin (pt + \theta)] \quad (5)$$

$$\text{III. } \frac{H_0}{\sqrt{2}} \cdot [\sin pt + \sqrt{a^2 + 2ab \cdot \cos x + b^2} \cdot \sin (pt + \theta + \eta)], \quad (6)$$

where,  $x = (\theta' - \theta)$ ,  $a = 2H_1/H_0$ ,  $b = 2(H_1' \cdot \cos i)/H_0$ ,

$$\tan \zeta = -\sin x / (-\cos x + a/b) \text{ and } \tan \eta = \sin x / (\cos x + a/b). \quad (8)$$

It follows that the ratio of components is given by  $b \cdot \sec i/a$ .

#### IV. DETERMINATION OF THE RATIO OF COMPONENTS AND THE MAGNITUDE OF THE ANGULAR PHASE DIFFERENCE

The effect of a small change of frequency at the transmitter is to alter the phase difference between the ground wave and the downcoming wave in such a way that alternately the received signal passes through a succession of maxima and minima. For instance, in the case of reception with loop II, the signal  $H_0 \cdot \sin pt + 2H_1 \cdot \sin (pt + \theta)$  may also be written in the form  $H_0 \cdot \sin pt + 2H_1 \cdot \sin p(t - D/c)$ , where  $D$  is the path difference between the ground and atmospheric waves, and  $c$  is the velocity of light. From these two expressions it is seen that

$$\theta = -pD/c \quad (9)$$

so that a variation in the angular frequency  $p$  will alter  $\theta$ , giving for the maximum and minimum signals received in this loop,

$$H_0 \sin pt \pm 2H_1 \sin pt.$$

Similar variations in received signals hold for the other two loops, and if we denote a maximum by  $M$  and a minimum by  $m$ , it follows that,

$$\frac{M - m}{M + m_{(I)}} = \sqrt{a^2 - 2ab \cdot \cos x + b^2} \quad (10)$$

$$\frac{M - m}{M + m_{(II)}} = a \quad (11)$$

$$\frac{M - m}{M + m_{(III)}} = \sqrt{a^2 + 2ab \cdot \cos x + b^2} \quad (12)$$

where the subscripts I, II, and III refer to the particular loop concerned.

Hence, by making three frequency changes at the transmitter, and receiving on each one of the three loops in turn it is possible, from an

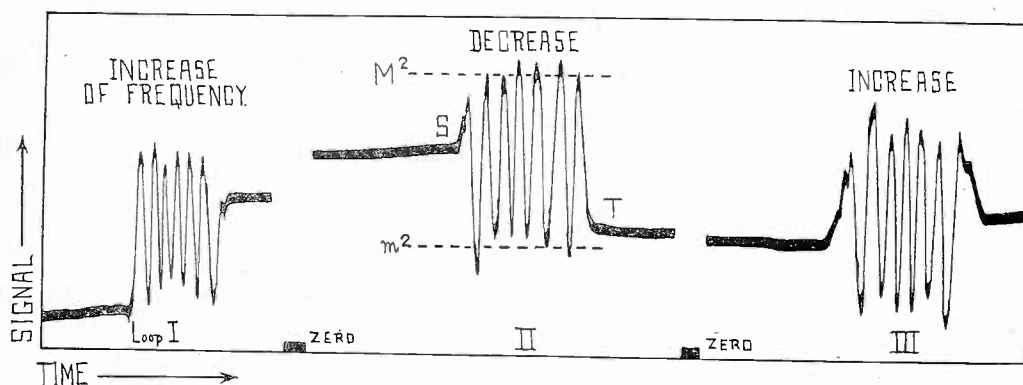

Fig. 4—A drawing from one of the photographic records showing three sets of interference fringes produced by three frequency changes of the transmitter, received in turn on loops I, II, and III. The beginning and end of the second frequency change are marked at  $S$  and  $T$ . The thick traces during the intervals between frequency changes should be horizontal unless natural fading is occurring. The 6.5 fringes per frequency change indicate a Kennelly-Heaviside layer height of 109 kilometers.

examination of the photographic records, to read off the amplitude of the interference fringes, and from them to calculate the quantities in (10), (11), and (12), due care being observed to allow for the response law of the amplifier and detector. Reference to Fig. 4, which is a drawing from one of the photographs, will make the procedure clear.

In the case of the frequency change recorded with loop II, the beginning and the end are marked at  $S$  and  $T$ . During the interval between two changes, the transmitted frequency being then steady, the switchover is made between one loop and the next. Usually the fringes are not quite of constant amplitude throughout a change of frequency,

for a number of reasons, so that it is necessary to strike an average value for  $M^2$  and  $m^2$ .

Having solved (10), (11), and (12), we know the values of  $a$ ,  $b$ , and  $\cos x$ , from which can be estimated the magnitude of the angle  $x$  and the value of  $(H_1' \cos i)/H_1$ , the latter being the ratio  $b/a$ .

Now, by counting the average number of fringes and knowing the amount of the frequency change which produced them, it is an easy matter to calculate the height of the deviating layer or the angle of incidence of the downcoming wave at the ground, since we have

$$\frac{\Delta n}{\Delta f} = \frac{D}{c} \quad \text{and} \quad \sin i = G/(G + D), \quad (13)$$

where  $\Delta n$  is the number of fringes produced by a change of frequency  $\Delta f$ ,  $f$  being the mean frequency of transmission,  $G$  the length of the ground wave path and  $D$ , as before, the difference in the paths of the ground and sky waves.<sup>5</sup> From these two expressions there may be calculated the value of  $\cos i$ , and hence the ratio of components,  $H_1'/H_1$ , may be determined from  $b/a$ .

It will be remembered that there is still an ambiguity as to the sense of rotation, since, although we know the magnitude of  $(\theta' - \theta)$ , we do not know its sign. The determination of  $\sin x$  in the next section resolves the difficulty.

## V. THE SENSE OF ROTATION

Whereas the ratio of components and the magnitude of the angular phase difference have been found by examining the amplitudes and the numbers of fringes, as recorded by three loops, the sense of rotation is determined from the same photographic record by noting the relative phases of the ground and sky waves as shown either at the beginning or at the end of a frequency change. Going back, for a moment, to Fig. 4 and looking at the interference fringes for loop II, it is seen that the phase between the ground and atmospheric waves amounts to zero whenever there is a maximum of signal. The relative phases at an intermediate point, such as  $S$  or  $T$ , however, will depend on whether the frequency of the sending station was being increased or decreased during that particular frequency change.

In equation (9),  $\theta = -pD/c$ , so that when  $p$  is increasing,  $\theta$  is also increasing, but in a negative direction, while for a decreasing frequency change, the phase increases in a positive direction. For the

<sup>5</sup> See Appleton, *Proc. Roy. Soc., A*, vol. 126, p. 542, (1930), and earlier publications. Actually, the quantity measured is not the optical path difference  $D$ , but the equivalent path difference  $D'$ .

point *S*, therefore, in Fig. 4, since we know that the frequency of the transmitter was just beginning to decrease at that moment,  $\theta$  would be about  $+330$  degrees, while for the point *T*, the phase difference would be  $+150$  degrees.

In order to find the corresponding phases for the other two loops, we must go back to (4) and (6), in which it is seen that the loop I phase is  $(\theta + \zeta)$ , and the loop III phase is  $(\theta + \eta)$ . Now, in Fig. 4, the changes received on both of these loops were increases of frequency, so that we can tabulate the following results:

End of loop I change,  $\theta + \zeta = -340^\circ$   
 Beginning of loop II change,  $\theta = +330^\circ$   
 from which  $\zeta$  is approximately  $+50^\circ$ ,  
 and hence  $\tan \zeta = +1.2$   
 End of loop II change,  $\theta = +150^\circ$   
 Beginning of loop III change,  $\theta + \eta = -260^\circ$   
 from which  $\eta$  is about  $-50^\circ$   
 and hence  $\tan \eta = -1.2$

The next change of frequency, not shown in the figure, was again with loop I, so that from the beginning of the change on this loop and from the end of the change on loop III which preceded it, we can get a check calculation, for instance:

Beginning of the next loop I change,  $\theta + \zeta = +20^\circ$   
 End of the preceding loop III change,  $\theta + \eta = -70^\circ$   
 from which  $\zeta - \eta$  is about  $+90$  degrees, which checks well enough with the figures given above for  $\zeta$  and  $\eta$ .

Now, from (8), we see that

$$\sin x = \tan \zeta (\cos x - a/b) \quad \text{or} \quad \tan \eta (\cos x + a/b).$$

Usually  $\cos x$  is approximately zero, and  $a/b$  unity, as shown by the calculations of the previous section, so that  $\sin x$  must be approximately  $-1$  in both cases. This immediately settles the sense of rotation since the angle  $x$  is approximately  $-90$  degrees, indicating right-handed or clockwise rotation of the resultant magnetic vector in the sky wave.

We get, also from  $\sin x$ , a check on the magnitude of the phase difference  $x$  as calculated in the previous section.

## VI. EXPERIMENTAL DETAILS

The station from which the frequency changes were made was 2BL, situated at Coogee, Sydney, New South Wales, its mean frequency being 855 kilocycles, and the amount of the frequency change 16,650 cycles.

The ground wave path, of length 143 kilometers, was mainly over sea water, since the coast line dips in somewhat between Sydney and Jervis Bay, where the receiver was located. The map in Fig. 5 shows the location of transmitter and receiver. The bearing of Coogee from the receiving site is about 15 degrees east of magnetic north, the magnetic field dip is  $62^{\circ}30'$  South, and the angle of incidence of a downcoming

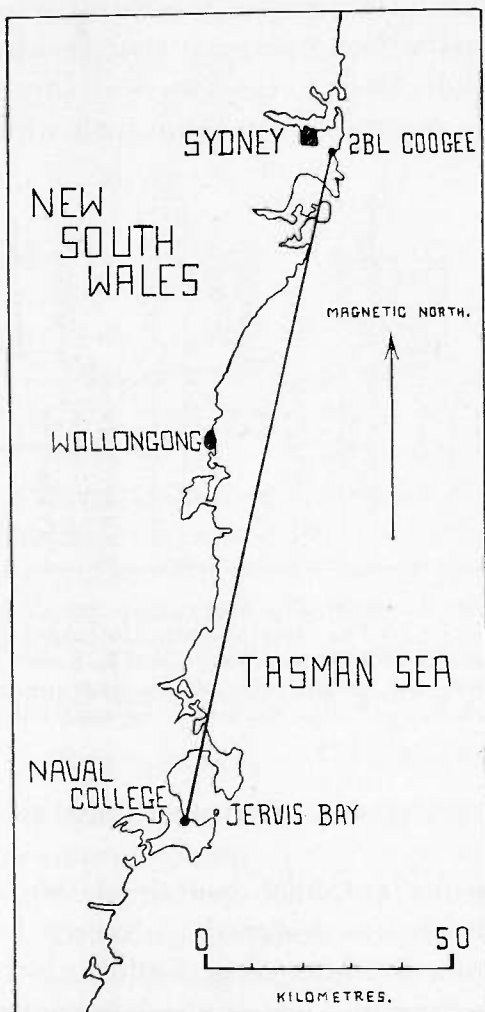

Fig. 5—The location of the transmitter 2BL at Coogee is  $151^{\circ}15' E, 33^{\circ}55' S$  and of the receiver at Jervis Bay,  $150^{\circ}43' E, 35^{\circ}09' S$ . Owing to the midpoint of the path being off the coast, multiple reflections of sky waves were unusually troublesome.

wave at the ground, after deviation by a layer at a height of 100 kilometers, is  $35^{\circ}30'$ , so that the angle between the direction of propagation of the downcoming wave and the lines of force of the earth's magnetic field must have been small. Moreover, the receiver being south of the transmitter, downcoming waves, after leaving the ionosphere, must have traveled against the lines of force.

These experimental conditions were selected as being close to those required for a strict comparison between the English and the Australian polarization tests. In the former, transmission was from south to north, the distance between sender and receiver being 131 kilometers. The mean frequency of transmission for most of the English tests<sup>6</sup> was 750 kilocycles.

The main features of the receiving apparatus are shown in Fig. 6. The three loop aerials were equilateral triangles of wire having a common vertex of altitude 45 feet, the two leads from each loop being taken to double-pole switches arranged in such a way that each one of

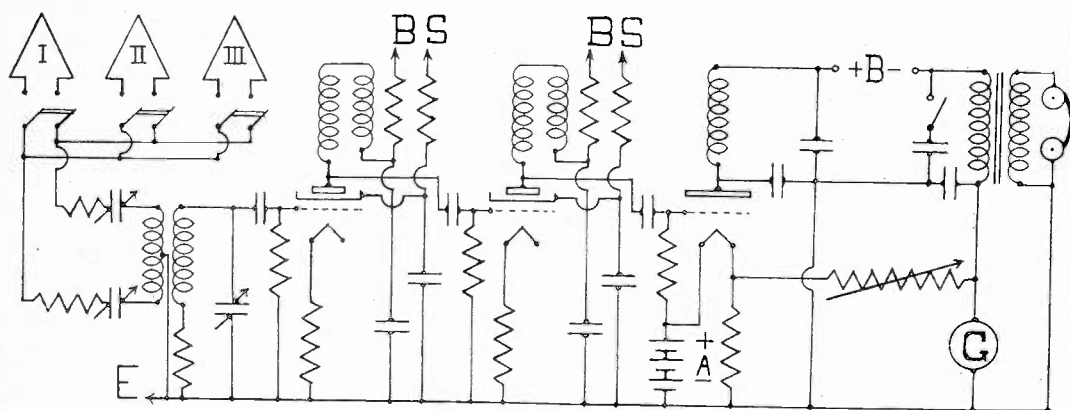

Fig. 6—Diagram of the receiver. The three loop aerials can be switched into the tuned circuit in turn. The resistances in the tuned circuits, and the astatic chokes in the amplifying stages were used in order to obtain broad tuning. The valve voltmeter, on the right of the diagram, was specially designed for the "frequency-change" experiments to be used with an Einthoven string galvanometer.

the loops could be connected in turn into a tuned circuit coupled to the amplifier.

The radio-frequency amplifier contained two screen-grid tubes, coupled with astatic chokes designed to have a broad maximum of amplification at about 855 kilocycles. Following the amplifier was a valve voltmeter,<sup>7</sup> the response law of which is known to be square-law when used with an Einthoven galvanometer, so long as the input grid swings are small. In the anode circuit of the voltmeter there were two filter systems, the first to reduce radio-frequency feed-back from the

<sup>6</sup> I am indebted to W. G. Baker for pointing out that the critical wavelength, corresponding to the frequency with which electrons in the Kennelly-Heaviside layer spiral around the lines of force of the earth's magnetic field is, for Sydney conditions, about 180 meters. For a smaller value of the total component of the earth's field in England, the critical wavelength is 212 meters, so that the choice of a transmitter for the Australian tests with a wavelength of 351 meters enabled these tests to be carried out at a wavelength very nearly double that of the critical, just as in the case of the 400-meter English tests.

<sup>7</sup> See Appleton and Green, *Proc. Roy. Soc., A*, vol. 128, p. 159, (1930).

detector into the amplifier, and the second an optional noise filter, the choke of which was the primary of the telephone transformer. Usually there was no reason for listening while the galvanometer was working, and it was only then that the filter was required in order to clear the photographs from transmitter carrier-wave hum and from background static. This loss of generality in the receiver was more than balanced by the increase in voltmeter efficiency as a consequence of the use of the telephone transformer as a double-purpose device.

The galvanometer was a standard Cambridge Einthoven string instrument, with camera; the frequency response was effectively reduced by the filter circuit already mentioned, which had a low admittance to any current variations much higher in frequency than about 50 cycles.

Frequency changes at the transmitting station were simply arranged by having a variable condenser of small capacity shunted across the main tuning circuit of the master oscillator. The amount of the frequency change was measured at the receiving station at least once in each group of tests, the method consisting in matching the change with a variable tone produced by a low-frequency oscillator.

The tests were given in two series, the first taking place during the three hours of the sunrise period on Friday mornings between June and the end of November, 1930. The second series were on four evenings per week during the same months, beginning at 10:30 P.M. A single frequency change was made in about three seconds, there being a two-second pause between an increasing and a decreasing change.

## VII. RESULTS OF THE EXPERIMENTS

During the course of the polarization experiments some 800 triplets of frequency changes were recorded using loops I, II, and III, but of these, barely 100 could be used in a complete determination of the constants of ellipticity, including the sense of rotation. Of the rest, the great majority are capable of analysis for the ratio of components and for the magnitude of the phase difference, and each record, whether suitable for polarization calculations or not, has been inspected for Kennelly-Heaviside layer height measurements, an account of which will be given later. Usually, however, variations in the height of the layer, in the amplitude of the downcoming wave, and in its phase relative to the ground wave, as well as the presence of multiple reflections, all tended to make the calculations of the sense of rotation in these cases very hazardous.

Accordingly, in presenting the results in this paper, care has been taken to mention only those records which give unequivocal values to

the polarization. It often happened that small defects were present, but where these were not sufficient to render the results unintelligible, the calculations have been made, and a suitable note added to describe the particular fault which was apparent.

The first table gives some specimen results from records that are believed to be quite free from error. It will be noticed that, in all cases, they were taken during the early morning very near to the time of sunrise at ground level, the reason being that this was the period when smooth primary fringes were most often recorded free from multiple reflections and from phase and amplitude changes in the downcoming wave. The duration of this period on any one morning might only be a few minutes, so that the constants of polarization were not necessarily representative of the conditions at other times during the dark hours.

TABLE I

Date	Time	Angle $x^\circ$	$H_1'/H_1$	$h$	Remarks
29- 8-30	6:20 A.M.	-94	1.03	104	Right-handed
		-80	1.66	104	" "
		-66	1.42	104	" "
20-10-30	5:10 A.M.	-79	1.82	105	" "
26- 8-30	6:30 A.M.	-92	0.81	106	" "
		-57	1.80	106	" "
21-10-30	5:20 A.M.	-100	1.80	104	" "
		-66	1.83	104	" "
		-97	1.35	104	" "
5- 9-30	6:10 A.M.	-98	0.94	105	" "
		-91	1.07	105	" "
		-84	1.41	105	" "
Mean values					

However, they are strictly comparable with the English results since measurements there were subject to similar restrictions as to the time of day.

It is seen that the angular phase difference is very nearly  $-90$  degrees and that the ratio of components is a little greater than unity, so that the polarization would be not very far from circular with a right-handed sense of rotation. In the column in Table I under  $h$  are written the ionosphere heights at the time that these records were taken, the figures being in kilometers.

In Table II are shown specimen calculations from records which had in a slight degree one or more defects. In the remarks column, R.H. represents right-handed rotation, A. means that there were variations in amplitude of the downcoming wave, P. variations in its phase relative to the ground wave, and S. the presence of subsidiary fringes in addition to the primaries showed that multiple reflections were taking place.

The mean value of the angular phase difference  $x$  in Table II is  $-89.6$  degrees, and the mean value of the ratio of components is 1.08, so that the polarization was always right-handed, and remarkably



TABLE II

Date	Time	Angle $x^\circ$	$H_1'/H_1$	$h$	Remarks
2-10-30	10:50 P.M.	-83	1.18	94	R.H., A., S.
		-82	1.11	94	R.H., A., S.
23-10-30	5:00 A.M.	-78	2.32	97	R.H., A., P.
3-10-30	5:40 A.M.	-38	0.51	100	R.H., A., P.
		-67	0.87	100	R.H., A., P.
26- 8-30	6:20 A.M.	-99	0.55	104	R.H., A., P., S.
26- 9-30	10:45 P.M.	-84	1.28	109	R.H., S.
5- 9-30	10:50 P.M.	-92	0.62	111	R.H., S.
2- 9-30	10:50 P.M.	-106	0.73	111	R.H., A., S.
23- 9-30	10:55 P.M.	-113	1.23	120	R.H., A., P.
		-99	1.26	120	R.H., A., P.
22-10-30	4:20 A.M.	-73	1.33	151	R.H., A., P.
22-10-30	4:40 A.M.	-114	1.84	158	R.H., A., S.
19- 9-30	4:40 A.M.	-94	0.61	205	R.H., A.
11- 9-30	10:55 P.M.	-103	1.02	237	R.H., A., P.
23- 9-30	10:40 P.M.	-109	0.81	262	R.H., A., P.
Mean values		-89.6°	1.08		Right-handed

close, on the average, to circular. It should further be noted that the records were selected for inclusion in this table in such a way as to represent heights of the ionosphere ranging from 94 to 262 kilometers.

The sense of rotation has never been found to reverse to left-handed in the Jervis Bay experiments, even in very abnormal cases. On five or six isolated occasions it was noticed that the amplitude of the interference fringes recorded with one of the loop aerials was very much less than that with either of the other two loops, the effect persisting throughout the ten frequency changes comprising one minute's test. For instance, at 5:10 A.M. on September 5, 1930, the average amplitude of the fringes recorded with loop I was between one quarter and one sixth of that with either loops II or III. Three of the abnormal records are quoted in Table III, and it is to be understood that they represent what were found to be the extremes in the polarization constants.

It is interesting to notice that, when the angular phase difference was at the extremes of  $-30$  and  $-134$  degrees, the ratio of components was almost normal, at approximately unity.

During the latter part of the time devoted to the polarization tests at Jervis Bay, some of the runs in the evening series were utilized for the purpose of examining the relative paths of the normally and of the

TABLE III

Date	Time	Angle $x^\circ$	$H_1'/H_1$	$h$	Remarks
5- 9-30	5:10 A.M.	- 30	1.11	107	Fringe amplitude smallest with loop I. R.H.
24- 9-30	11:00 P.M.	-114	4.13	111	Fringe amplitude smallest with loop II. R.H.
26- 9-30	10:50 P.M.	-134	1.03	109	Fringe amplitude smallest with loop III. R.H.

abnormally polarized components in the sky wave. In these experiments, only two loops were used, II and IV, these being in and perpendicular to the plane of propagation. Loop II received a ground wave and the normal component of the downcoming wave, while loop IV was only affected by the abnormal component. However, there was always a little leakage into the amplifier, so that sufficient of the ground wave was present, when loop IV was being used, in order to produce interference fringes, from which the equivalent path of the abnormal component could be calculated.

The method consisted in recording two frequency changes with loop II, an increase and a decrease, and then a similar procedure for loop IV. In this way there was avoided the effect<sup>8</sup> often noticed at times when the layer was moving rapidly, of an increasing frequency change producing a different number of fringes from a decreasing frequency change.

The results of these experiments indicated that usually no difference could be detected between the number of fringes recorded with the two loops, but that occasionally there were slight differences. For instance, at 10:50 P.M. on October 10, 1930, see Fig. 12, there were 6.5 fringes with loop II and 6.7 fringes with loop IV, showing that the abnormally polarized component had an equivalent path some 3.6 kilometers longer than the normal component's path of 260 kilometers. This is a small percentage difference, and on the record there appeared subsidiary fringes of large amplitude, so that the fringe counts could not be made altogether with certainty.

It is concluded, therefore, that the downcoming wave was, on the whole, coherent, and that the quantities measured as the normal and the abnormal components were actually parts of the same wave and not two downcoming waves traveling along different paths.

### VIII. SOME TYPICAL RECORDS

The following diagrams are some drawings from the photographic records in which the ordinates are proportional to the square of the incoming signal, and the abscissas represent time increasing from left to right. In Figs. 7 to 11, interpretation is on the same lines as for Fig. 4; there are three sets of fringes for three frequency changes recorded successively on loops I, II, and III. The zero marks between consecutive groups of fringes were made in the process of switching the amplifier from one loop aerial to the next.

<sup>8</sup> For this phase fading see Appleton, *Proc. Phys. Soc.*, vol. 42, p. 321, (1930).

Fig. 7. This is part of a record showing very nearly perfect conditions for the polarization experiments, there being no subsidiary fringes and negligible changes in amplitude and phase of the downcoming wave. There are six fringes per frequency change, for an equivalent height of the layer of 104 kilometers. The first and third frequency changes, re-

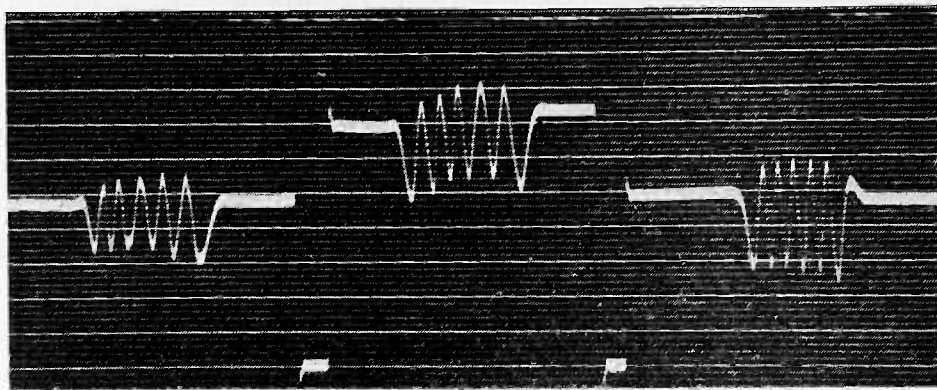

Fig. 7

ceived with loops I and III, respectively, were increases of frequency, and the photograph was taken just one minute after the time of sunrise at ground level.

Fig. 8. The changes in amplitude and phase were small when this record was taken, but the subsidiary fringes were thought to be too

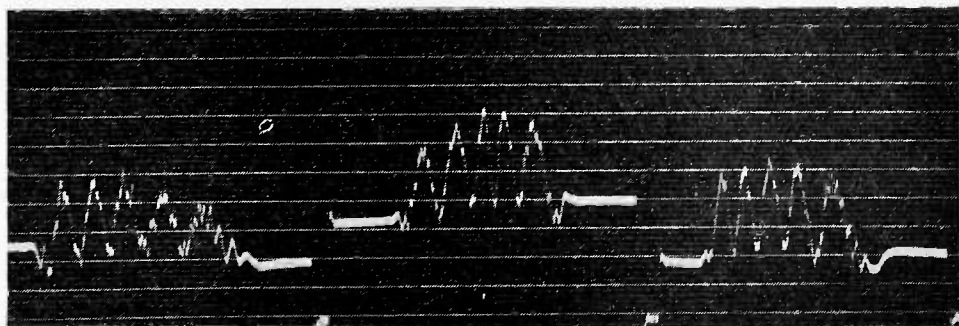

Fig. 8

large to allow of an accurate estimation of the sense of rotation. The main fringes, of number 5.2, indicate an equivalent height of the Kennelly-Heaviside layer of 94 kilometers, and there appear to be about 45 subsidiary fringes for a height of the Appleton layer of 470 kilometers. It is interesting to notice that the subsidiary fringes are more pronounced on the primary fringe corresponding to the higher frequency of the transmitted signal. Records such as these were rejected.

Fig. 9. This record is one of those obtained when the deviating layer was the F region, the 22.4 fringes per frequency change indicating a height of 262 kilometers. Here the changes in amplitude of the fringes are sometimes very marked, but the absence of subsidiary fringes and of serious phase changes enabled the polarization calculations to be made with fair accuracy. This record has been reproduced in order to

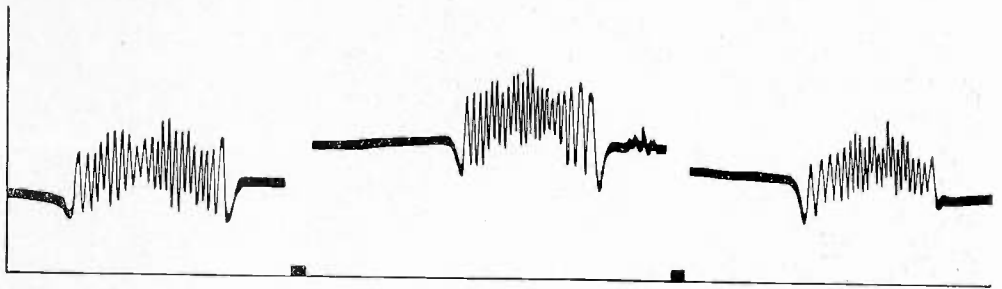

Fig. 9

make the point that estimates of the constants of ellipticity are always difficult when the sky wave has been returned from the upper layer. The three frequency changes were recorded on loops I, II, and III in order, the second change being an increase of frequency. The disturbance in the trace immediately following the second set of fringes was due to static.

Fig. 10. This is an early morning record taken when the layer was known to be moving rapidly. The numbers of fringes recorded with

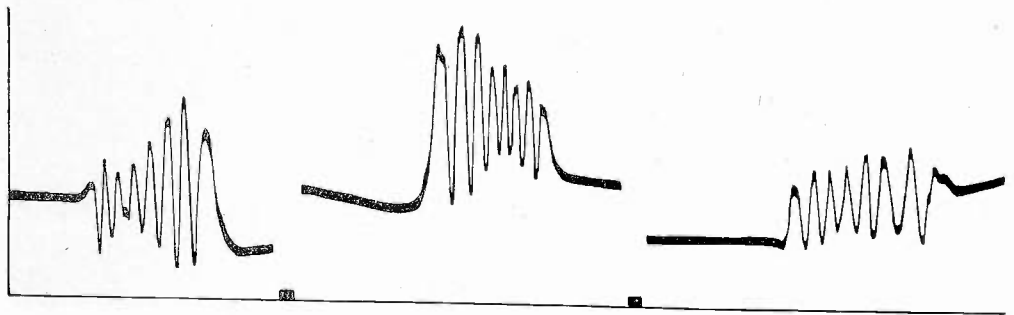

Fig. 10

loops I and III are 7.6, these being due to increasing frequency changes in both cases, while the decrease of frequency recorded with loop II produced 8 fringes, this effect indicating a downward movement of the layer. As well, there were marked changes in the amplitude of the fringes and some phase variations between the ground and sky waves, the latter being shown, for example, by the decrease in signal immediately preceding the second frequency change at the time when the transmitted signal was steady in frequency. Record rejected.

Fig. 11. This is one of the very abnormal records, specimens of which were quoted in Table III. The amplitude of the fringes received by loop I was very much less than that for either of the other two loops, and the angular phase difference between the normal and the abnormal components of the sky wave was calculated to be  $-30$  degrees. In the

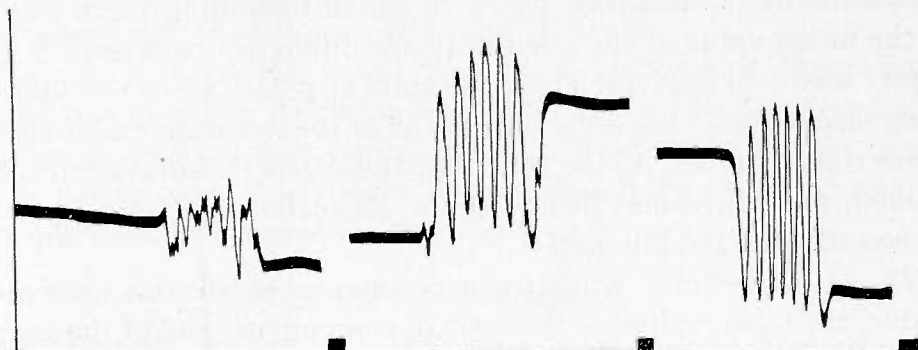

Fig. 11

case of loop I, the main fringes are broken up by subsidiaries, but the peculiar features of marked ellipticity are quite evident. The height of the layer at this time was 107 kilometers.

Fig. 12. Here are seen two sets of fringes, the first being taken with loop II and the second with loop IV. The fringe numbers are 6.5 and

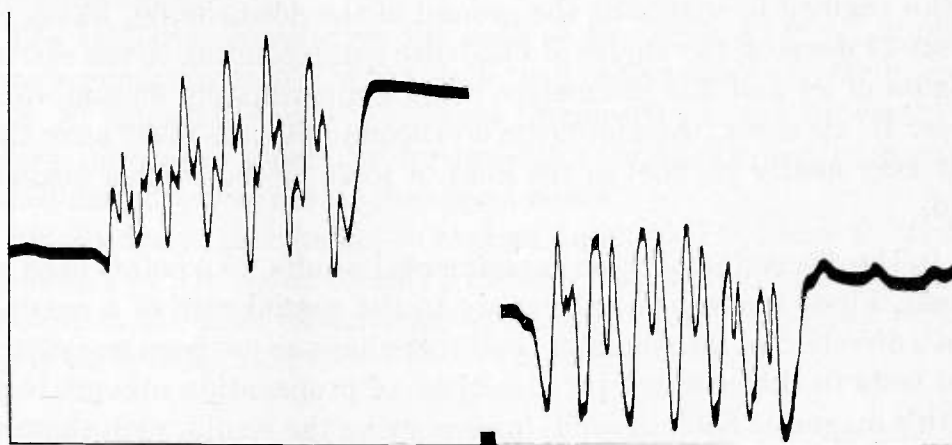

Fig. 12

6.7, showing a small difference in the equivalent paths of the normal and of the abnormal components of the sky wave. The mean layer height was 110 kilometers, and the 19.5 subsidiaries probably indicated a double reflection at that height. It should be noted that, on this record, the sensitivity of the loop-IV circuit was increased relatively to loop II, so that the fringe amplitudes are not directly comparable.

## IX. CONCLUSION

Briefly the results of the tests of polarization at Jervis Bay were as follows:

(1). During the steady sunrise period, when the polarization calculations were liable to least error, the mean value found for the ratio of components of the rotating vector in the downcoming wave was 1.4, and the mean value of the angular phase difference between the components was  $-84$  degrees. Thus, the state of polarization was approximately circular, and the sense of rotation of the resultant magnetic vector was right-handed. At the time that these experimental results were obtained, the equivalent height of the Kennelly-Heaviside layer was between 104 and 106 kilometers.

(2). At other times, when the experimental conditions were not so suitable, the mean values of the ratio of components and of the angular phase difference between them were 1.08 and  $-89.6$  degrees, respectively, so that the polarization was very close to circular and right-handed. Equivalent heights of the deviating layers at these times ranged from 94 to 262 kilometers, and it was possible to infer that there was no apparent tendency for the measured constants of polarization to depend, in any marked degree, on the height of the region responsible for the return to the earth of the sky waves.

This is what might be expected, since the total range of variation in the angle of incidence at the ground of the downcoming waves was about 21 degrees, the angles of incidence corresponding to the extreme heights of 94 and 262 kilometers being approximately 36 and 15 degrees. In all cases, therefore, the downcoming waves must have traveled very nearly parallel to the lines of force of the earth's magnetic field.

In the discussion of these experimental results, two points need emphasis. First, the results only apply to the special case of a north-to-south direction of transmission, and there have as yet been no polarization tests in this country for directions of propagation oblique to the earth's magnetic field. Second, in comparing the results with those obtained in England, it will be remembered that care has been taken to operate under conditions which would allow of a strict comparison being made between the results of the two series of experiments.

Hence, the fact that the polarization was found to be circular and left-handed for a south-to-north direction of transmission in England, and approximately circular and right-handed for north-to-south propagation in New South Wales, can be taken to mean that the action of the earth's magnetic field is such as to produce magneto-optical effects.

The two series of experiments therefore form complementary parts of the proof that, due to the earth's field, an initially plane polarized wave is resolved in the ionosphere into two circularly polarized component waves; differential absorption of the two component waves is then responsible for the return to the earth of only one of them in each hemisphere, the right-handed one being absorbed in the Northern Hemisphere, and the left-handed in the Southern.

Finally, it should be noted that the evidence of a characteristic polarization found by Appleton and Ratcliffe was the first proof of the existence of negative electrons in the Kennelly-Heaviside layer, in addition to heavy ions. The present experiments have demonstrated that there must also be electrons in the Appleton layer.

#### X. ACKNOWLEDGMENT

The work described was carried out on behalf of the Radio Research Board of the Australian Commonwealth Council for Scientific and Industrial Research, to whom the author is indebted for permission to publish these results.

Thanks are due to the Postmaster General's Department for the special frequency change transmissions from station 2BL Sydney; also to the Defence Department for the provision of a receiving site at the Royal Australian Naval College, Jervis Bay, and for the loan of personnel and equipment.

The author acknowledges the help of Professor J. P. V. Madsen in the preliminary stages of the work, and in obtaining the facilities at the P. N. Russell School of Electrical Engineering at the University of Sydney, but more especially for his valuable advice and encouragement during the progress of the experiments

Finally the author wishes to express a debt to Professor E. V. Appleton and to Mr. J. A. Ratcliffe in that they were originally his instructors in the basic experimental principles of the frequency change type of measurement.



## PHASE INTERFERENCE PHENOMENA IN LOW-FREQUENCY RADIO TRANSMISSION\*

BY

G. W. KENRICK

(Electrical Engineering Department, Tufts College, Massachusetts)

AND

G. W. PICKARD

(General Radio Company, Cambridge, Massachusetts)

*Summary*—The importance of phase interference phenomena in low-frequency radio transmission (as well as in the high-frequency regions) is emphasized. In the case considered (i.e., reception of WCI near Boston, Massachusetts) these phenomena are shown to exhibit periodicities coincident with cosmical phenomena, i.e., the solar and lunar periods and their harmonics. Strong evidence for the existence of these periods in long-distance low-frequency transmission data and in field intensity data for transmission in the broadcast band is also demonstrated.

An automatic field intensity recorder constructed particularly for use in extending the low-frequency observations in progress at Tufts College (and made possible by grants from the National Research Council) is also described, and field intensity records obtained by its use are shown. These records also exhibit phenomena which are probably due at least in part to phase interferences. The effects of magnetic storm phenomena are also displayed.

THE importance of multipath transmission phenomena such as phase interferences has been generally recognized in the intermediate- and high-frequency regions of the radio spectrum. In the case of low-frequency transmission, frequently, it has been assumed that these phenomena were only of very secondary importance and the so-called ground wave was primarily responsible for the results observed over short or moderate distances, while a single sky wave governed the field intensity at great distances from the transmitter.

It is the purpose of this paper not only to present convincing evidence for the existence of phase interference phenomena in both cases, but also to show that these phenomena are sufficiently intimately related to those existing at higher frequencies (such as the American broadcast region) to permit a number of interesting and significant correlations to be established.

\* Decimal classification: R113 × R270. Original manuscript received by the Institute, June 23, 1933. Revised manuscript received by the Institute, August 4, 1933.



## SHORT-DISTANCE LOW-FREQUENCY TRANSMISSION PHENOMENA

Some of the salient characteristics of the reception from Station WCI (18.4 kilocycles) at Tuckerton N. J., when received in the vicinity of Boston and how these characteristics vary with magnetic disturbances have already been described in a previous paper.<sup>1</sup> It will be recalled that on a magnetically quiet day the transmission usually assumes the characteristics shown in Fig. 1; i.e., the day field is moderately constant and much higher than that existing during the night, while there is a marked increase in intensity during the sunrise and sunset periods.

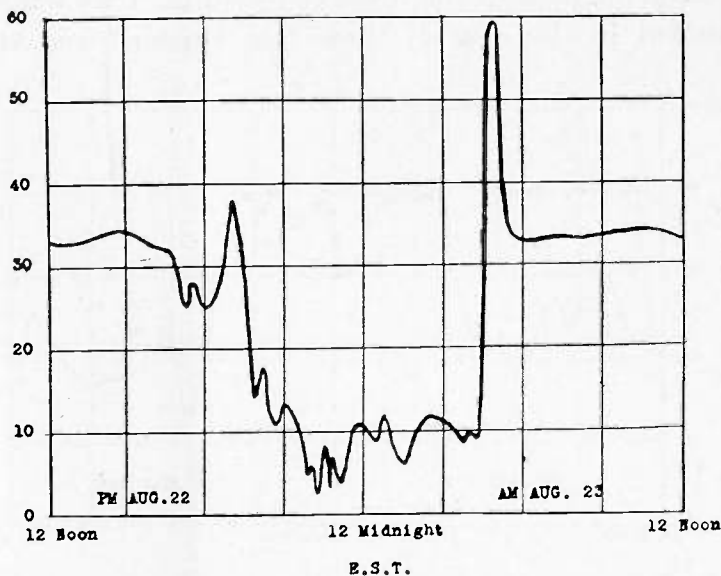

Fig. 1—WCI as received at Newton Center, Mass., August 22–23, 1929.

During a period of magnetic disturbance, however, a marked reversal occurs and the night field rises to much higher values than the day field (see Fig. 2). We attribute these observations largely to phase interference phenomena and believe the changes observed accompany the well-known changes in the Kennelly-Heaviside layer during periods of magnetic disturbance. It is of interest to note that, due no doubt to the very long wavelength, the major characteristics of the interference phenomena are rather persistent over a considerable region in the vicinity of Boston, (i.e., Newton Center and Medford) over a number of years. It should not be inferred, however, that they represent any inherent characteristics common to all low-frequency transmission or to all transmission paths, for simultaneous observations at other points have disclosed marked differences in the characteristics

<sup>1</sup> deMars, Kenrick, Pickard, "Low-frequency radio transmission," *Proc. I.R.E.*, vol. 18, no. 9, pp. 1488–1501; September, 1930.

of the transmission from the same station,<sup>2</sup> and observations at Boston on nearly the same frequency but different transmission paths clearly show that quite different characteristics may be obtained on the same frequency over slightly different distances. In this connection Fig. 3 is of particular interest. This figure shows simultaneous records of the reception from WCI (18.4 kilocycles) at Tuckerton, N. J., and WQK (18.2 kilocycles) at Rocky Point, L. I., as received at Tufts College on December 9-10, 1931. It will be noted that this record shows a striking tendency to inversion of the fading patterns during the night, and hence represents a strong confirmation of the importance of phase interference phenomena in the observed results. This tendency seems fairly persistent in the case of these two stations and transmission

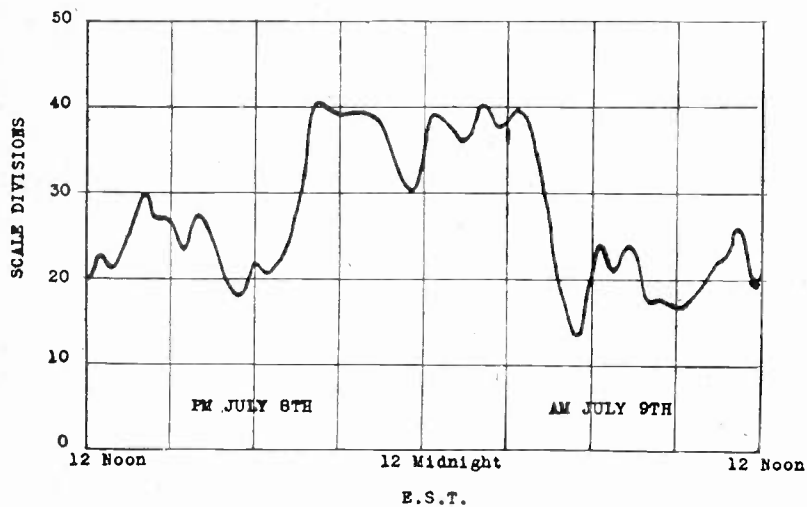

Fig. 2—WCI as received at Newton Center, Mass., July 8-9, 1928.

paths, although the degree of inverse correspondence (indicating about 180 degrees phase difference in interference paths) is by no means constantly observable, due perhaps to the existence of a number of paths of importance in determining the resulting field. The nearly unbroken series of observations on the field intensity from WCI which extends back to 1928 is now beginning to furnish sufficient data to permit more quantitative treatment than has heretofore been possible.

The nature of the phenomena as described above, however, is not such as to render a general average of the field intensity over a twenty-four-hour period particularly significant, and a more useful index has been found to be the ratio of the average day to the average night field

<sup>2</sup> Kenrick and Jen, "Further observations of radio transmission and height of the Kennelly-Heaviside layer," *Proc. I.R.E.*, vol. 17, no. 11, pp. 2034-2052; November, (1929). See also Fig. 1, Austin's "Long-wave radio receiving measurements at the Bureau of Standards in 1930," *Proc. I.R.E.*, vol. 19, no. 10, p. 1768, October, (1931).



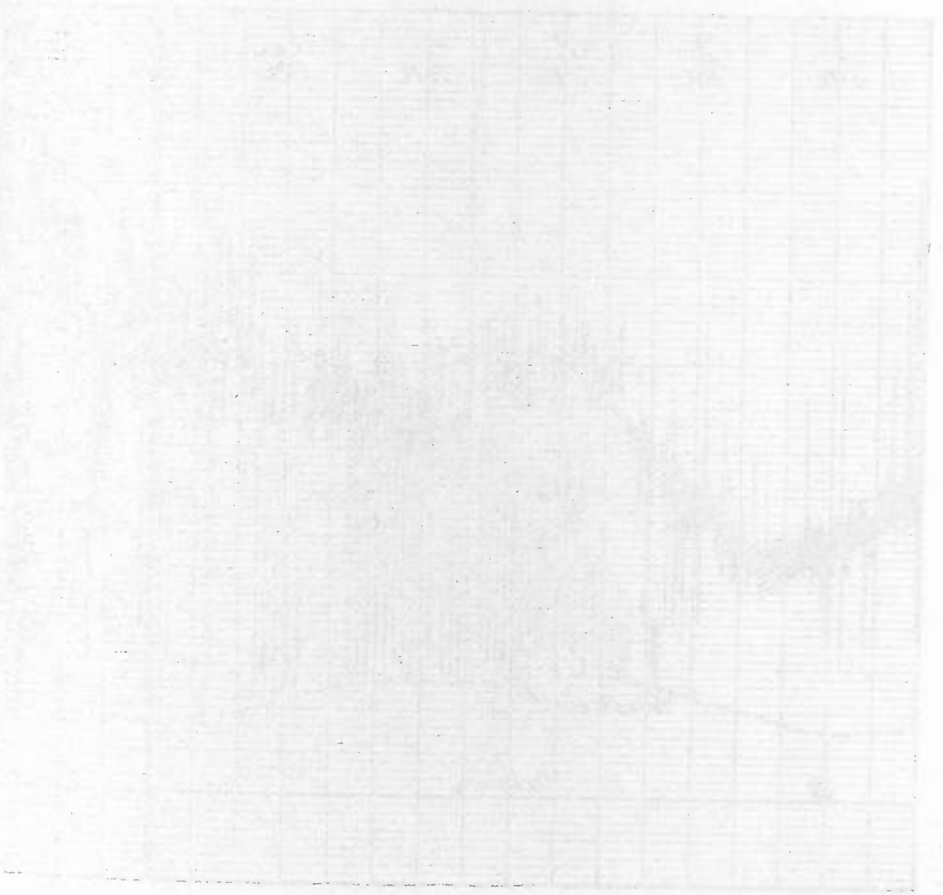
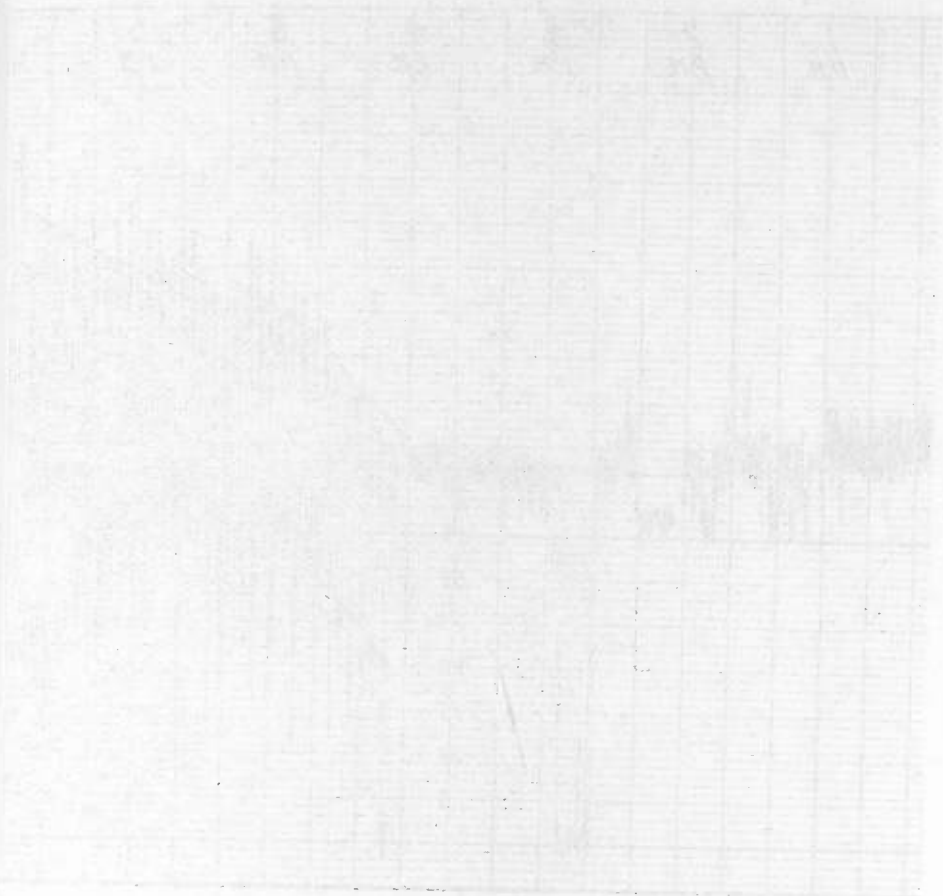

Station  
 clearly  
 a series  
 viz 3  
 of the  
 work  
 age on  
 striking  
 A, and  
 phase  
 minor  
 in direction

about  
 greater  
 that of  
 which  
 which  
 to per-  
 side  
 V 101  
 source  
 ex has  
 which  
 high  
 which  
 source  
 10, 11

intensities. In computing this index we exclude hours near sunset and sunrise to eliminate the sunrise and sunset peaks (see Fig. 1) which otherwise perturb the ratios. We shall now consider the correlation of the ratios thus obtained with other radio transmission and cosmical phenomena.

Several methods of harmonic analysis suggest themselves for this investigation. These include the classical methods of Balfour Stewart and Schuster and the more recent modifications devised by Clayton.<sup>3,4</sup> It is beyond the scope of this paper to enter into a detailed discussion of these methods and only a few of the salient results will be mentioned here. A more detailed discussion of their application to several important series of radio transmission data is, however, presented in another paper.<sup>5</sup> It is perhaps sufficient to note that Clayton's methods are well adapted to provide a rather high degree of resolution between several nearly equal periods. Using this method, one investigates the precession of phase between the periodicities in the series under investigation, and a trial period of nearly equal length. The available data are divided into a number of intervals equal in length to the trial period, and the amplitude of the frequency under investigation is then derived for each successive period, using sine and cosine products and a method closely analogous to that used in the ordinary Fourier series analysis to compute amplitudes. If prominent periods near but not exactly equal to the trial period are present in the data, the amplitude of the Fourier coefficients of the trial period given by successive trial period intervals will vary at a beat frequency and the phase of the periods of maximum amplitude will precess regularly. When applied to the available WCI data extending from 1928 to date, this leads to a plot of the form shown in Fig. 4. The amplitudes for the successive thirty-day intervals in the plot chosen for Fig. 4 have coefficients for successive thirty-day intervals as shown in the lower plot called the ampligram. The precession of phase for these major amplitudes is investigated in the upper plot called the phaseogram. The rate of precession of the phases of the thirty-day fundamental component for the periods corresponding to maxima in the ampligram should lie on straight lines if marked and persistent periodicities exist, and the slope of these phase angle lines, together with the known length of the trial period, determines the true period. The amplitudes of these periods may be investigated subsequently by dividing the data into the intervals indicated for the true periods and then computing the

<sup>3</sup> H. H. Clayton, "World Weather," page 372.

<sup>4</sup> A. Schuster, *Proc. Roy. Soc. A.*, vol. 87, pp. 136-140, (1906).

<sup>5</sup> Kenrick-Pickard: "Some common periodicities in radio transmission phenomena." *Trans. Amer. Geophysical Union*, (1932).

amplitudes of the coefficients by Fourier series methods. (This latter process is essentially the method of Schuster, except that his periods are chosen successively, without criteria like those established by Clayton's method.)

Clayton's methods also have an advantage in indicating abrupt changes of phase in a periodicity such as frequently occur in periodicities related to sun-spot phenomena (because of the limited duration of particular active areas). These phase shifts introduce breaks in the

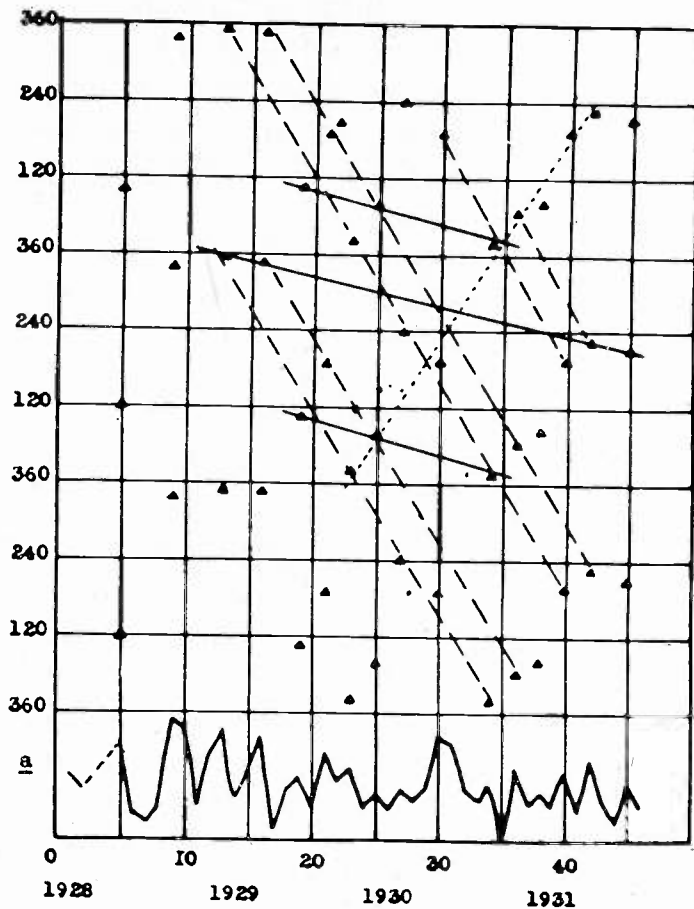

Fig. 4—WCI in thirty-day trial period.

continuity of the lines in the phaseograms without, however, changing their slope.

The WCI datum does not in itself represent a sufficiently long series to establish conclusively the existence of periodicities of the order of thirty days and several other longer series were also investigated. These series included the 10 A.M. observations on European stations resulting from Austin's measurements from 1925 to date, and the night field intensity data in the broadcast band as determined by the WBBM observations started at Newton Center in 1925 and still being continued at Tufts College.

TABLE I

Nominal length of period	WCI Series		WBBM Series		Pasadena* Series		Austin's Nauen Series		Probable origin of period
	Indicated length	Indicated amplitude	Indicated length	Indicated amplitude	Indicated length	Indicated amplitude	Indicated length	Indicated amplitude	
29.5 days	29.62	3.1%	29.42	5.9%	29.46	2.0%	29.52	0.3%	Lunar Solar Second Harmonic Lunar Second Harmonic Solar Third Harmonic Solar
27.5 days	27.50	4.3%	27.53	15.2%	27.52	3.0%	27.53	1.5%	
14.75 days		5.6%	14.78	7.5%					
13.8 days		7.1%	13.92	15.0%					
9.2 days			9.2	17.7%					

\* This series represents transmission from Station KPO, in San Francisco, as recorded by Howell C. Brown at Pasadena, and extends from 1928 to date.

The major periodicities deduced from these series by an application of Clayton's methods are given in Table I. The closeness of agreement between the major periodicities indicated is so strong as to be hardly imputable to chance, and the diversity of the series chosen is so considerable as to indicate that the periodicities found are more or less inherent to a large group of radio phenomena. The surprisingly close agreement of the periodicities computed from the diverse series with each other and with known cosmical periodicities suggests the reality not only of the familiar period of solar rotation and its prominent third harmonic, but also of the lunar period as has already been suggested by Stetson from a study of WBBM data.<sup>6</sup> The second har-

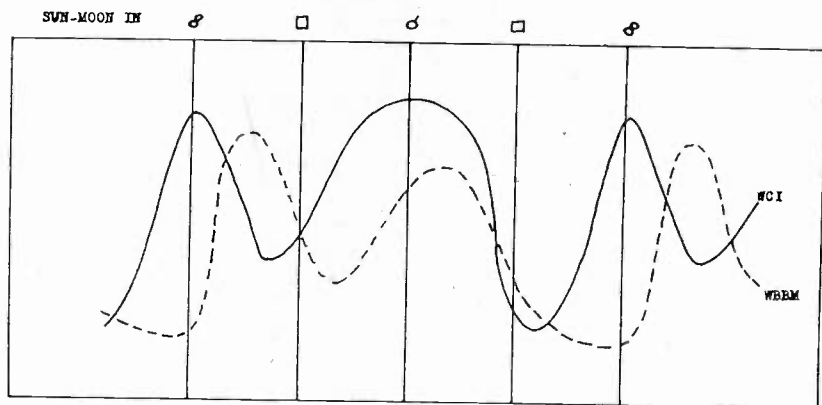

Fig. 5—WCI D/N and WBBM field averaged in trial period of a lunar month.

monic of the lunar period is further suggestive of a tidal phenomenon in connection with this effect. The nature of the periodicity is clearly indicated in Fig. 5. In comparing the data in Table I it should be noted that the percentage variations are in per cent of total fields (or ratios) and that the total percentage change from all causes is least for low-frequency fields, so that the importance of the indicated periodicities is not much less when compared with the total variation for the low-frequency data than in the case of the higher frequency field intensities. It is of particular interest to note that as arbitrary a parameter as the WCI night-to-day ratio at Boston (which is known to present quite different properties at different distances from the transmitter) shows clearly the same periodicities as are indicated from mean field intensities from distant stations in the low-frequency and broadcast frequency regions.

<sup>6</sup> H. T. Stetson, "Investigations at the Perkins Observatory of the changes in the Kennelly-Heaviside layer as a function of lunar altitudes," *Trans. Amer. Geophysical Union*, (1931).



## LONG-DISTANCE LOW-FREQUENCY TRANSMISSION

In view of the strong evidence for low-frequency phase interference phenomena it is of particular interest to consider the degree of coherence in the changes observable in low-frequency transmission over longer transmission paths. As in the case of long-distance broadcast transmission, it seems probable that (due to the larger number of paths existing in long-distance transmission) the character of the fading to be expected from a given transmitter would be less consistent from day to day at a given point of observation, but also a certain degree of smoothing of the variability might be expected by virtue of the statistical combination of the transmission over a large number of paths of nearly equal importance.

A long series of observations made at particular times each day at the Bureau of Standards by L. W. Austin and his coworkers are in accord with these conclusions; i.e., the average results on a large number of stations have disclosed interesting and important average variabilities, which as the previous section once again demonstrates, are susceptible of correlations with magnetic and other cosmical phenomena. However, a detailed examination of the data taken daily discloses considerable departures of the individual stations from the mean.

With the aid of a grant from the National Research Council it has been possible during the past two years to extend the scope of the low-frequency observations in progress at Tufts College to include similar daily observations on a number of low-frequency stations. One of the purposes of these observations was to establish the degree of correspondence between such simultaneous or nearly simultaneous observations made at different points and the degree of variability encountered between two points of observation thus separated. The research was not confined to this phase of the problem alone, however, but it has also been our purpose to examine so far as possible in greater detail the nature of transmission from low-frequency European stations. These records are used to compare differences in the reception from different low-frequency transmitters operating on nearly the same frequency, as received at Boston, and also the departures in the form of the curve of signal intensity from the same station when simultaneously received in Washington and Boston. It is evident that if these curves are markedly different, observations on a given station taken at some particular hour cannot be expected to correspond closely at the two points. The use of continuous records for the study of the nature of the variabilities encountered, therefore, appears to have

great difficulties. Thus, the noise level in the low-frequency channels is so high as to render consistent and reliable field intensity records on the European low-frequency group of stations particularly difficult, and every expedient is necessary if an extended series of reliable observations are to be obtained.

A low-frequency recorder which has been found eminently satisfactory for recording the field intensity from American stations has already been described in a previous paper,<sup>1</sup> but some important modifications in design were desirable in the development of a recorder

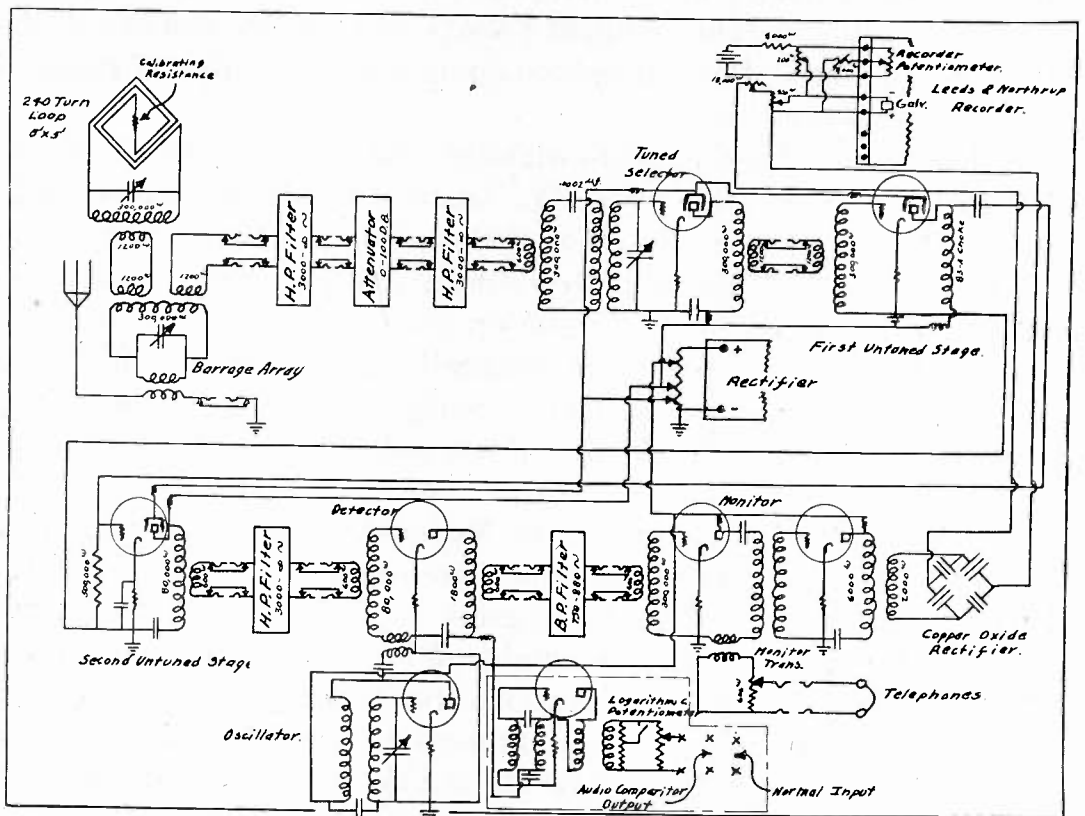

Fig. 6—Schematic diagram of low-frequency recorder constructed under grant from National Research Council.

to provide the added facilities essential to the recording program outlined above.

A schematic figure of the new recorder, showing the salient design features, is indicated in Fig. 6.

In developing a low-frequency recorder for the automatic recording of stations, it is of course a primary necessity that the device be as nearly as possible of constant, metrically controllable, gain, and if the signals are faint, as in the case of the European recording, it is also essential that the device have adequate amplification and sufficient selectivity to secure as favorable as possible signal-to-noise ratio. It is also convenient if the calibration of the recorder can be main-

tained as nearly as possible constant over the frequency range through which it is desired to operate it, as this considerably simplifies calibrations, particularly if observations are to be made on a number of stations by an audio comparator method.

In the low-frequency recorder, designed for the recording of rather powerful signals, and already described in a previous publication,<sup>1</sup> no particular attention to signal-to-noise ratio was necessary, because of the high field intensities which were being recorded. It was hence possible to design a practically flat high-frequency amplifier without selectivity other than that obtained in the audio band-pass filter following the detector stage. This arrangement readily provided for the frequency linearity in recording, mentioned above as a desirable feature; but when the gain of this device was raised to provide sufficient sensitivity for the recording of the European stations, considerable difficulty was experienced from noise, due to the lack of selectivity before amplification, which resulted in a large increase in the static level at the detector, and troublesome cross-modulation products. Considerable difficulty was also experienced with cross-modulation between powerful American stations operating with a frequency separation of 400 cycles, as these products readily passed through the 400-cycle band-pass filter. This was particularly notable in the case of WSS (18.0 kilocycles) and WCI (18.4 kilocycles). In order that work on continuous recording could be started as early as possible, some modifications in the design of this equipment were carried out which permitted this recorder to operate fairly satisfactorily on the more favorable European stations (as, for instance, GBR). These modifications provided for a tuned link circuit, between the attenuator and the detector, and during periods of heavy static, the loop input provided a means of further selectivity. These expedients have provided a set-up capable of making records under favorable conditions for comparison with those obtained with the new recorder, but do not permit of as favorable signal-to-noise ratio as that obtainable with the new equipment involving more elaborate design features, which we shall now further consider.

In Fig. 6 it will be noted that a considerable gain in selectivity and signal-to-noise ratio is obtainable at the input to the new set-up by the barrage array which permits a directional characteristic having a null at 180 degrees to the direction of the signal to be obtained. Inasmuch as the major source of atmospherics is roughly at 180 degrees from the northeast bearing of the European stations being recorded, this is a considerable assistance in increasing the signal-to-noise ratio, and it is estimated from observations thus far conducted that a gain of from

6 to 10 decibels is obtained in many cases. The gain is further accentuated, of course, by the sharply tuned input circuits and transformers coupling the array to the first tube. At the frequencies employed, the so-called barrage or unidirectional system seemed to provide the best means of obtaining directional selectivity available, inasmuch as wave antennas or other expedients familiar to the high-frequency art are of quite unwieldy dimensions for wavelengths of the order of 20,000 meters. The advance of the radio art since the installation of the first

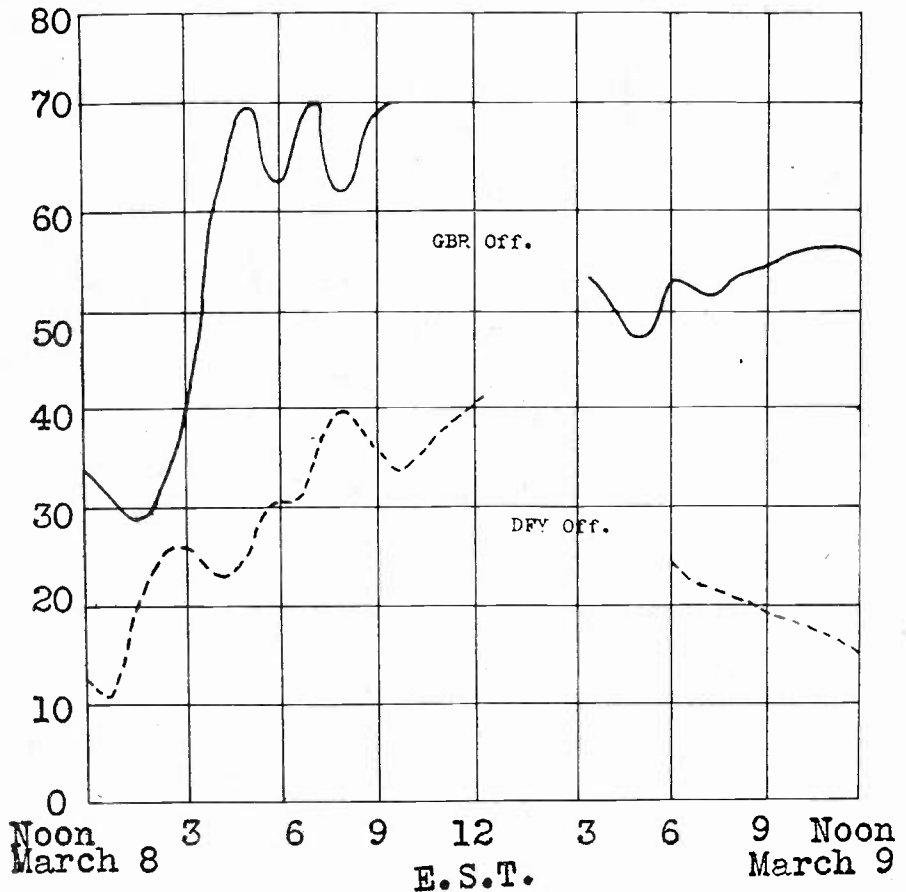

Fig. 7—Reception from March 8-9, 1932.

— GBR at Tufts.  
 - - - DFY at Tufts.

recorder has also made possible the utilization of alternating-current operated tubes, having a high gain per stage, and a considerably higher amplification permitting full-scale deflection of the recorder on as little as a 10-microvolt-per-meter signal, has thus been made possible. This gain is, of course, not in general useful, because of the noise level existing at the low frequencies, but the input is readily adjusted to a convenient scale by means of the metrical attenuator indicated between the antenna array and the first tuned circuit. The results obtained by these expedients have been rather gratifying, and it is esti-

mated that a gain of from 10 to 15 decibels in signal-to-noise ratio has frequently been secured by the arrangements indicated over that obtainable by the low-frequency recorder set-up designed without reference to the requirements of long-distance recording.

It appears that considerable day-to-day departures are to be found both in the daily observations and in continuous records of the same station at different points of observation and in different stations operating on nearly the same frequency at the same point of observation.

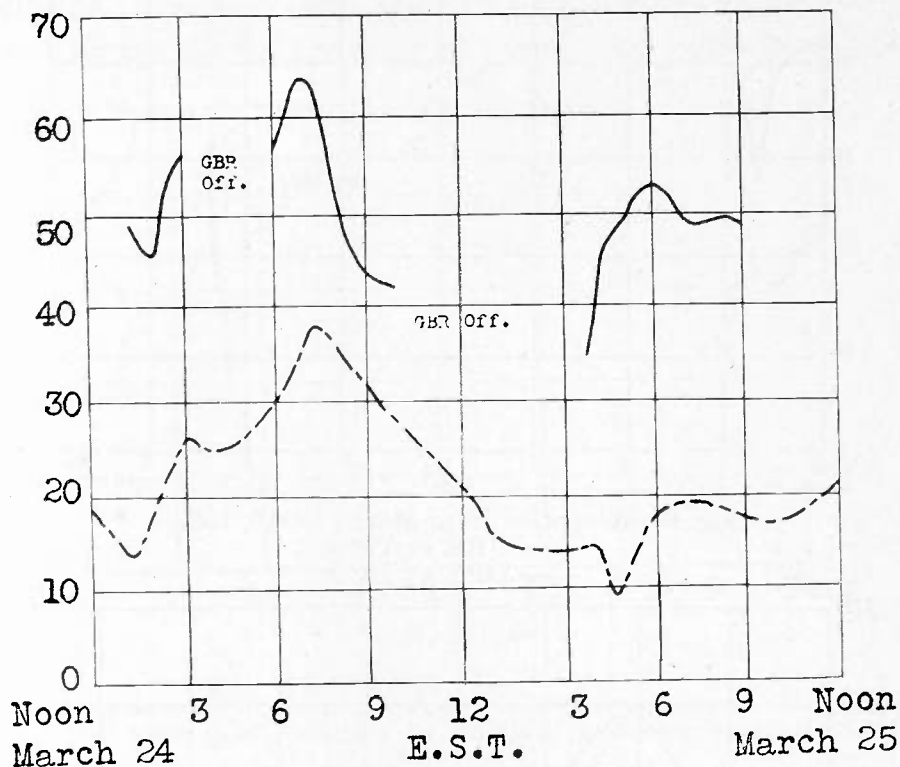

Fig. 8—Reception at Tufts College, March 24–25, 1932.

— GBR at Tufts.  
 - - - DFY at Tufts.

A marked example of the incoherence of these fading phenomena over short paths has already been shown in Fig. 3. Reliable consistent comparisons of fading detail are more difficult in the case of the longer low-frequency paths because of the higher noise level which frequently obtains, but Figs. 7, 8, and 9 show examples comparing the fading obtained on two low-frequency channels. It will be noted that the characteristic dips near midday E.S.T. (corresponding to sunset at the transmitter) are rather consistently displayed, and occur later in the case of GBR than DFY, as would be expected, due to the more eastern location of Rugby.

It will be noted that while the rate of rise and other details of the

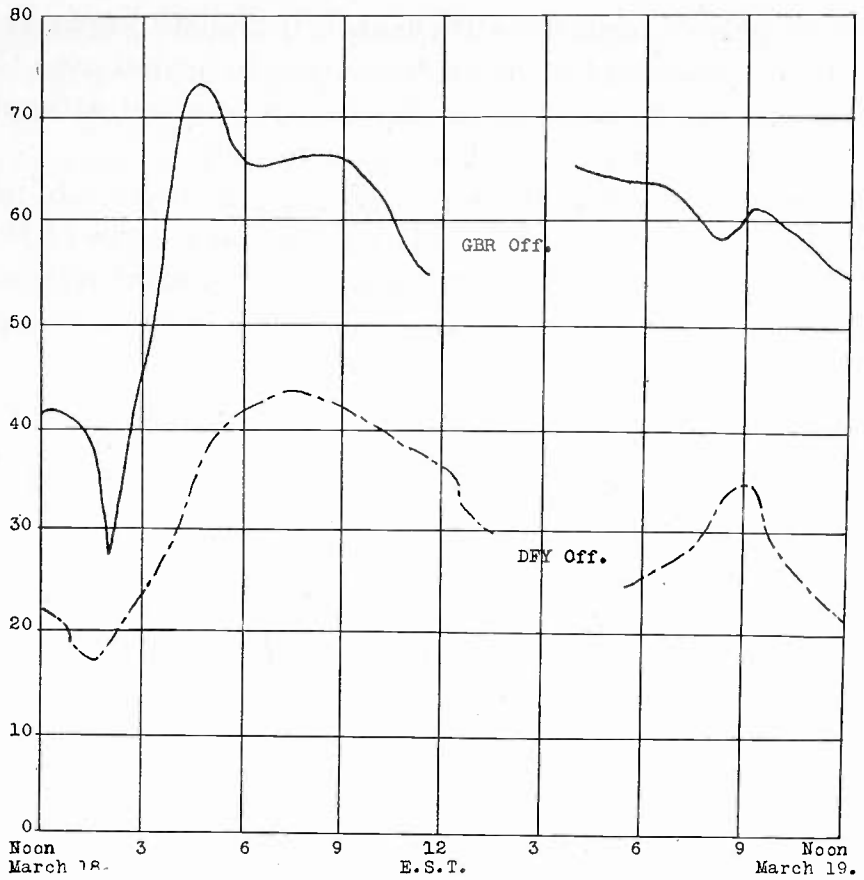

Fig. 9—Reception from March 18-19, 1932.

— GBR at Tufts.  
 - - - DFY at Tufts.

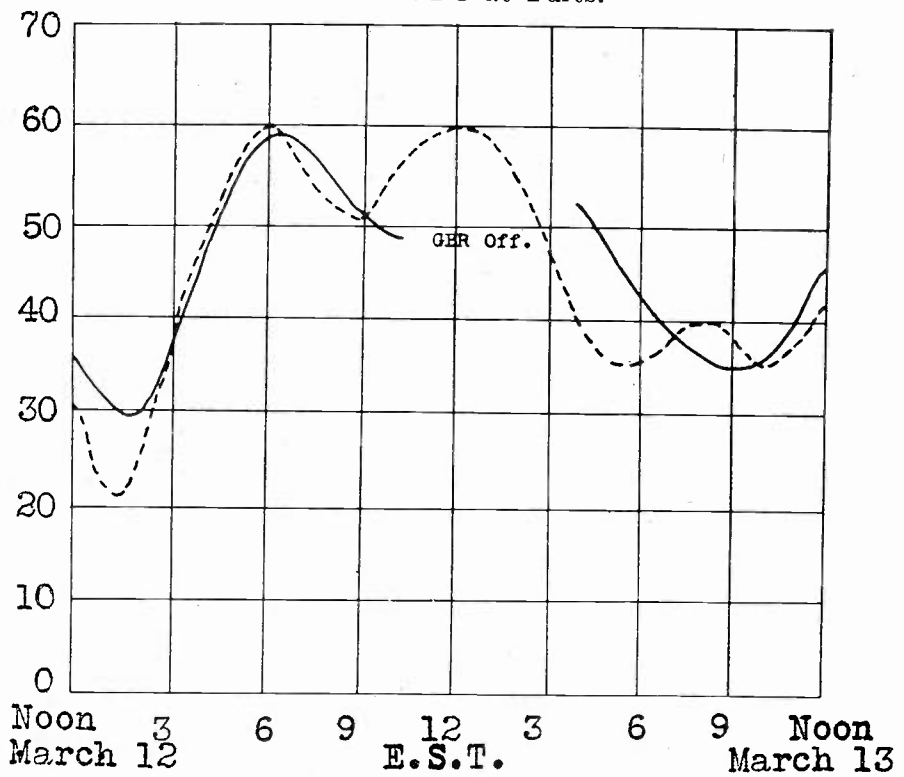

Fig. 10—Reception from March 12-13, 1932.

— GBR at Tufts.  
 - - - DFY at Tufts.

fading curves are by no means identical in most cases, on certain occasions the curves are of nearly the same form—a good example of closely coherent fading is shown in Fig. 10. It will be noted, however, that even in this case incoherent morning fading amounting to 20 per cent of the observed fields is to be noted.

However, in a normally undisturbed period, the DFY curve of March 24–25, 1932, which was taken under very favorable conditions of static, may be taken as fairly typical of the diurnal change of signal intensity; i.e., a normal early afternoon dip, followed by a rise to a maximum during the early evening and a decline to a minimum at sun-

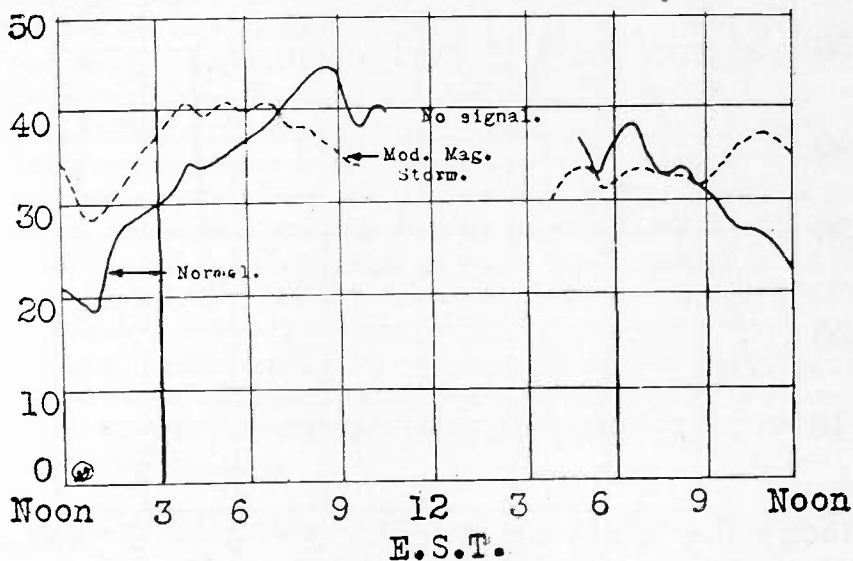

Fig. 12

— GBR average of February 11–18, 1933 (normal week).  
 - - - GBR average of February 19–26, 1933 (moderate magnetic storms).

rise (E.S.T.) followed by a rise during the morning (E.S.T.). The original record for this period is shown in Fig. 11. Due to short sending and a rather high night noise level, it is frequently difficult to follow these night variations with accuracy, but for a number of days, including the date shown, the transmitting station kindly modified their schedule so as to transmit two minutes of solid "V's" and calls followed by two minutes of silence during periods when the channel was not used for traffic. This permitted the noise level and time signal level to be accurately recorded and gave a record of the type shown. It will be noted that during this test a very satisfactory signal-to-noise level was secured.

It is interesting to compare the "normal" form of curve thus obtained with that following a magnetic storm. Comparative mean curves showing these effects are shown in Fig. 12, which shows the re-

sults of observations on GBR in February, 1933. It will be noted that a rise in day fields accompanies the storm, but that the night fields are in general depressed. This leads to a considerably modified diurnal characteristic, which is in general much flatter than the normal undis-

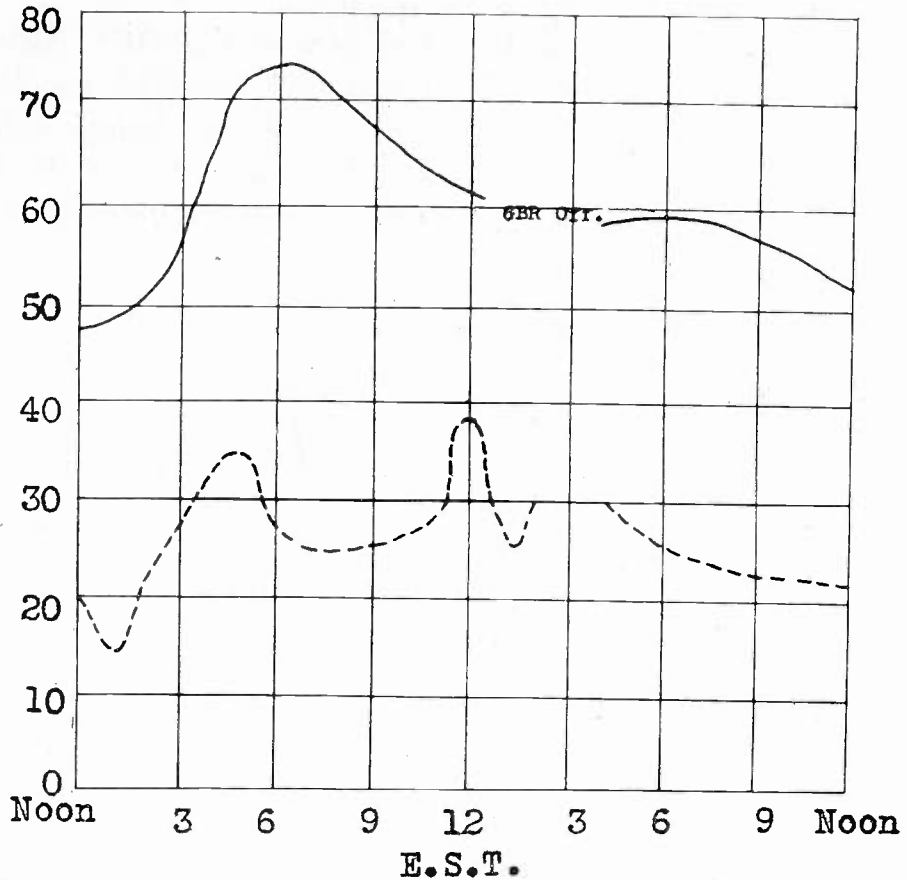
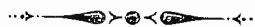

Fig. 13—Average reception from March 8-9, to March 15-16, 1932.  
 — GBR at Tufts.  
 - - - DFY at Tufts.

turbed records; i.e., the day fields are raised and the night fields depressed.

Another example of the form of the transmission characteristic for a period of normal reception is shown in Fig. 13. The variation of the form of the transmission characteristics for two stations operating on nearly the same frequency during this period is shown in this figure.





## THE CALCULATION OF CLASS C AMPLIFIER AND HARMONIC GENERATOR PERFORMANCE OF SCREEN-GRID AND SIMILAR TUBES\*

BY

FREDERICK EMMONS TERMAN AND JOHN H. FERNS

(Stanford University, Stanford, California)

*Summary*—In this paper it is shown how to predetermine the performance of harmonic generators and class C amplifiers which employ screen-grid and similar tubes in which the plate current is substantially independent of plate voltage over the working part of the characteristic. The sum of the plate and grid currents in such tubes is very nearly proportional to  $(E_g + E_{sg}/\mu_{sg})^\alpha$ , where  $\alpha$  is usually very close to  $3/2$ , and is always between 1 and 2 in practical tubes. The resulting current impulses are analyzed by the Fourier method for  $\alpha = 1$  and  $\alpha = 2$ , and are presented in curves which give the various frequency components in terms of the number of electrical degrees during which current flows, and the peak value of  $(I_p + I_g)$ . In the case of the alternating components it is shown that to a good approximation the effect of the grid current is to reduce the current component in the plate circuit below the value that would be obtained if there were no grid current by an amount twice the direct grid current.

It is shown how the results of the above analysis may be applied in a straightforward manner to lay out class C amplifiers and harmonic generators on paper, and to predict the voltage and power output, power input, plate loss, etc., for any particular set of operating conditions.

SCREEN-GRID tubes, pentodes, and high- $\mu$  triodes (such as those designed for class B audio service) are characterized by having a plate current that is substantially independent of plate voltage unless the plate voltage is so low that other positive electrodes rob the plate of a disproportionate fraction of the total space current. Since practical class C amplifiers and harmonic generators are operated so that the plate potential never becomes as low as this, one can always assume that the plate current is substantially independent of plate voltage and hence of load impedance. This makes the analysis of class C amplifiers and harmonic generators using these tubes entirely practicable.

### ANALYSIS OF THE PLATE-CURRENT WAVE

The total space current in any vacuum tube is determined by the electrostatic field in the immediate vicinity of the cathode. In screen-grid and pentode tubes this field is to a high degree of accuracy proportional to the quantity  $(E_g + E_{sg}/\mu_{sg})$ , where  $E_g$  and  $E_{sg}$  are the con-

\* Decimal classification: R132. Original manuscript received by the Institute, October 30, 1933.

trol-grid and screen-grid potentials, respectively, and  $\mu_{sg}$  is the amplification factor of the control grid against an anode represented by the screen grid. Triodes with very high amplification factors may be thought of as a special case where  $\mu_{sg}$  approaches infinity.

If the tube employs a heater-type cathode, is perfectly symmetrical, and if there is a full space charge in the vicinity of the cathode, the total space current will be proportional to  $(E_g + E_{sg}/\mu_{sg})^{3/2}$ . Actually the exponent is never exactly 3/2 because the ideal conditions are never realized, but experience shows that in commercial transmitting tubes the exponent is usually very close to 3/2 over the main part of the characteristic, and always lies between the limits of 1 and 2.

When tubes of the type being considered are operated so that the plate current is substantially independent of the plate voltage, the plate current will always be a substantially constant fraction of the total space current *provided the control-grid current is negligible*. Hence under this assumption one can write

$$I_p = k(E_g + E_{sg}/\mu_{sg})^\alpha \quad (1)$$

where  $k$  is a constant of the tube,  $\alpha$  is a constant commonly between 1 and 2, and the remaining notation is as explained above. The modifying influence which grid current has is taken up in a later section. For the present it will be sufficient to carry out the analysis for the ideal conditions of zero grid current.

In amplifiers and harmonic generators the voltage applied to the grid of the tube consists of a constant negative bias voltage  $E_c$  plus an alternating potential of crest amplitude  $E_s$  and angular velocity  $\omega$  so that (1) becomes

$$I_p = k(E_c + E_s \cos \omega t + E_{sg}/\mu_{sg})^\alpha. \quad (2)$$

The determination of the frequency components of the plate current is essentially a Fourier analysis of (2). This analysis has been carried out in Appendix I for the cases where the exponent  $\alpha$  has the values 1 and 2, and the results are presented in Fig. 1. The term "angle of current flow" used in this figure represents the number of electrical degrees measured in terms of the grid exciting voltage during which the plate current flows. The ratio  $I_n/I_m$  represents the ratio of the crest amplitude of the component of frequency  $n$ , to the peak amplitude of the plate-current impulse. This notation can be further visualized with the aid of Fig. 2, which illustrates the relation of  $I_m$  and the angle of current flow to the plate-current impulse. As an illustration of the use of the curves of Fig. 1 we note that if a tube has a square-law characteristic the third harmonic has a maximum ratio  $I_3/I_m$  of 0.177, and

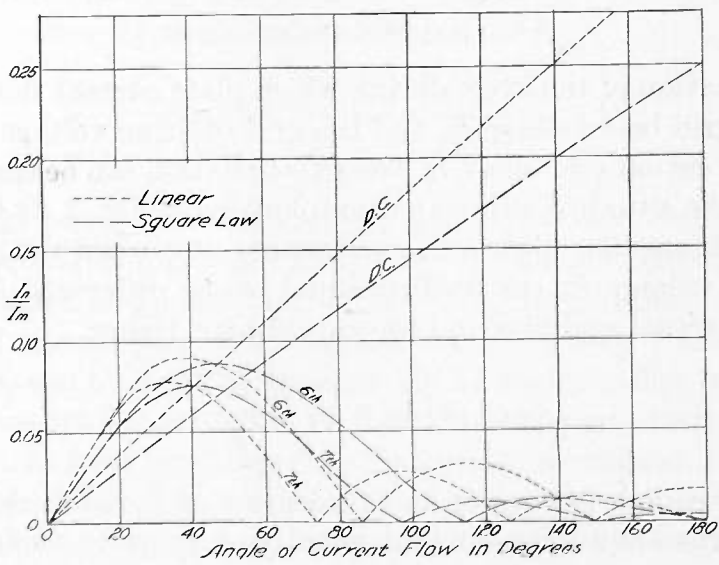
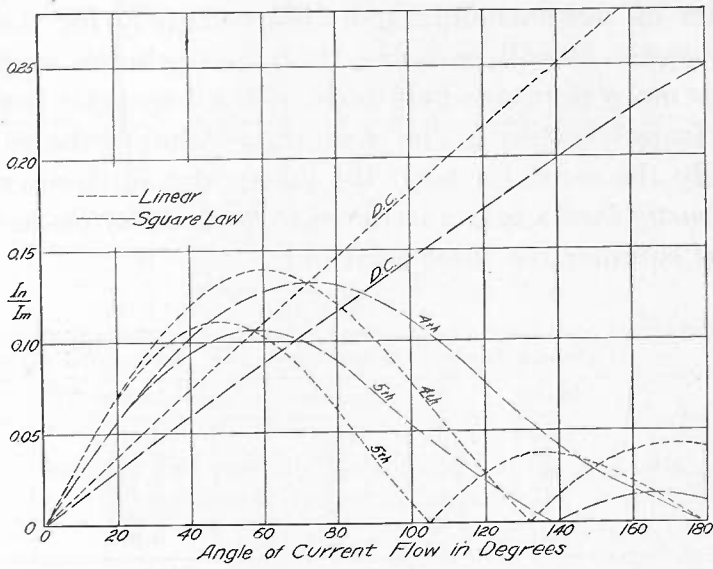
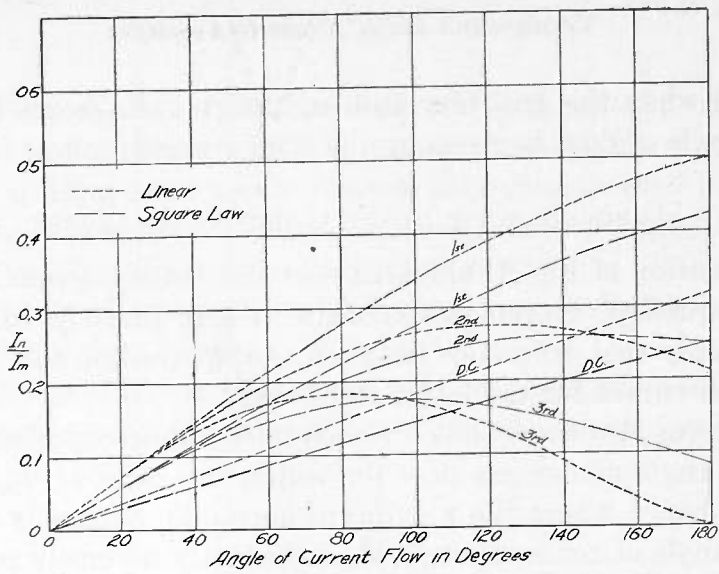

Fig. 1—Analysis of space-current impulses for linear and square-law tube characteristics.

this occurs when the grid bias and excitation voltage are so adjusted that the angle of flow as given by (3) is 95 degrees.

### DISCUSSION OF PLATE CURRENT ANALYSIS

Examination of Fig. 1 indicates that the direct-current and fundamental frequency components increase nearly linearly with angle of flow. The only real difference between the square-law and linear cases is that both curves for the latter rise faster.

The curves also show that for each harmonic component there is a particular angle of current flow for which the ratio  $I_n/I_m$  is a maximum, and hence where the maximum harmonic output is obtainable. This best angle of current flow is almost exactly inversely proportional to the order of the harmonic and differs slightly for the linear and square-law cases. It will be noted that the optimum angle of flow is appreciably more than one-half cycle of the harmonic frequency, but is not particularly critical. The maximum value of the ratio  $I_n/I_m$  is substantially the same for both the linear and square-law cases, and is almost exactly inversely proportional to the order of the harmonic. The table below summarizes these relations.

TABLE I

Harmonic	Optimum Angle of Current Flow		Ratio $I_n/I_m$ at Optimum Angle	
	Linear	Square-law	Linear	Square-law
2	130°	145°	0.275	0.260
3	80	95	0.185	0.180
4	60	73	0.140	0.133
5	47	57	0.122	0.117
6	40	47	0.091	0.088
7	33	40	0.078	0.076

### ANGLE OF CURRENT FLOW

The fraction of the cycle during which plate current flows depends upon the grid bias voltage  $E_c$  and the grid exciting voltage  $E_s$  in relation to the cut-off grid bias  $E_{c0}$ . The exact relation can be easily worked out from the situation illustrated graphically in Fig. 2. It is apparent from this figure that plate current starts to flow when the instantaneous signal voltage  $E_s \cos (\theta/2)$  is equal to the difference  $E_c - E_{c0}$  between the actual grid bias and the cut-off bias. Hence,

$$\cos (\theta/2) = - \frac{E_c - E_{c0}}{E_s} \quad (3)$$

Here  $\theta$  is the angle of current flow in degrees of the exciting frequency and the signs are so chosen that negative bias voltages are negative numbers.

The grid bias  $E_{c0}$  to be used in (3) should be a sort of projected cut-off which continues the trend of the main part of the  $E_g - I_p$  curve and ignores the trailing-out tendency commonly encountered in all tubes near cut-off. This is illustrated in Fig. 2 and means that the bias  $E_{c0}$  substituted in (3) will permit a very small amount of plate current to flow. In the case of triodes with high amplification factors the cut-off grid bias is very close to zero.

The actual grid bias and exciting voltages required in any particular case depends upon the extent that the grid is driven positive. De-

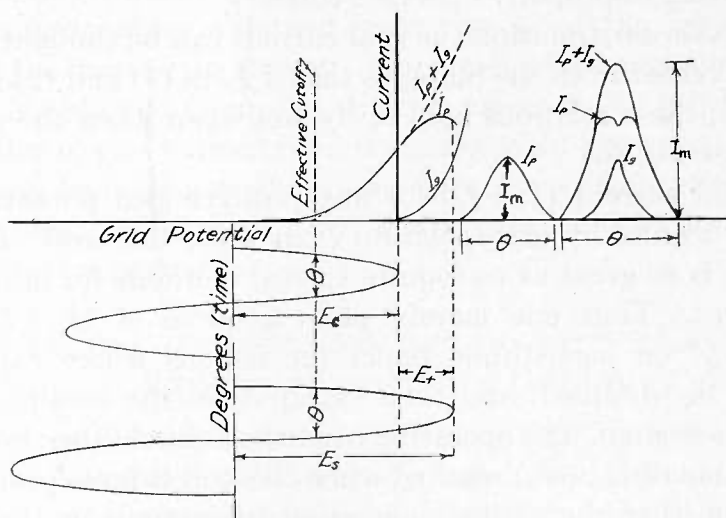

Fig. 2—Voltage and current relations in a tube used as a class C amplifier or harmonic generator.

noting this most positive grid potential by  $E_+$  then the exciting voltage required is  $-E_c + E_+$ , and (3) becomes

$$\cos (\theta / 2) = - \frac{E_c - E_{c0}}{-E_c + E_+} \tag{4}$$

After  $E_+$  has been determined as outlined in the next section, the required  $E_c$  and  $E_s$  for any desired angle of flow can be readily calculated.

Examination of (3) and (4) indicates that the grid bias required for an angle of current flow of 90 degrees or more is only a few times the cut-off bias, and so is entirely reasonable. If angles of flow in the order of 60 degrees are desired it will be found that the grid bias required is rather high, at least ten times cut-off, but can be realized if necessary. On the other hand, small angles such as 30 degrees require such enormous grid-bias voltages as to be virtually impossible to obtain, even when  $\mu_{sg}$  is high.

THE PEAK PLATE CURRENT  $I_m$  AND THE MODIFICATIONS REQUIRED  
TO TAKE INTO ACCOUNT GRID CURRENT

The analysis that has been given so far has assumed that the grid current is negligible. The effect of driving the grid appreciably positive is to cause the grid to rob the plate of current, resulting in a distorted wave of plate current which does not follow the law given in (1). Inasmuch as the grid is always driven positive in practical operation it is always necessary to apply corrections to allow for the effect of grid current. Fortunately this is relatively easy to do under the conditions existing in properly operated tubes.

To a first approximation the grid current can be thought of as having been diverted from the plate, so that if  $I_p$  in (1) and (2) is replaced by  $(I_p + I_g)$ , these relations hold fairly well even when the grid draws current. (See Fig. 2.)

The total current  $(I_p + I_g)$  for any positive grid potential is relatively easy to find by extrapolation even when the power dissipation in the tube is so great as to require special methods for obtaining the static curves.<sup>1</sup> Thus one merely plots a curve of  $(I_p + I_g)$  against  $(E_g + E_{sg}/\mu_{sg})$  on logarithmic paper for regions where experimental points can be obtained, and then extrapolates the resulting straight line as far as desired. The operating conditions should then be so chosen that the value of  $(I_p + I_g)$  reached when the grid is most positive is the largest value that the cathode emission will permit, or that will not make the tube losses excessive, whichever comes first. It is to be noted here that in fixing a value of  $(I_p + I_g)$  at which to operate, one is in effect selecting the maximum positive potential to be reached by the grid, and is also selecting the screen-grid potential for pentodes and screen-grid tubes, or the minimum potential reached by the plate in the case of triodes. This is because the best adjustment is always when maximum positive potential reached by the grid is nearly but not quite the potential of the next outer electrode at the same instant.

The effect which the current that the grid takes from the plate has upon the alternating-current components of the plate current can be readily approximated. This is because in practical tubes the adjustment is such that the grid current flows in a very sharp impulse that can be considered as taking place at almost the exact crest of the space-current impulse. If it is assumed that all of the grid current flows at exactly the crest of the cycle then Appendix II shows that the effect of a grid-current impulse having a direct-current value of  $I_{g0}$  is to re-

<sup>1</sup> For such a method see H. N. Kozanowski and I. F. Mouromtseff, "Vacuum tube characteristics in the positive grid region by an oscillographic method," *Proc. I.R.E.*, vol. 21, p. 1082; August, (1933).

duce the value of  $I_n$  given by Fig. 1 by an amount  $2I_{g0}$ . That is to say

$$\text{Actual alternating-current component} = I_n' = I_n - 2I_{g0}. \quad (5)$$

The grid current obviously reduces the direct plate current below the value obtained from Fig. 1 by the amount  $I_{g0}$ .

The procedure to follow in applying Fig. 1 to the case where grid current is present can therefore be summarized as follows: The symbol  $I_m$  appearing in Fig. 1 should be interpreted to mean  $(I_p + I_g)$ , and can be obtained by extrapolation as outlined above. The actual output of the alternating-current component  $I_n'$  is  $(I_n - 2I_{g0})$ , where  $I_n$  is the desired component as obtained from Fig. 1 for the appropriate  $I_m$ , and  $I_{g0}$  is the direct grid current. The direct plate current is  $(I_0 - I_{g0})$ , where  $I_0$  is obtained from Fig. 1. It is necessary to estimate the expected value of grid current in order to make the necessary corrections, but this can be satisfactorily done on the basis of experience because the grid current is after all a secondary effect and so need be known with only fair accuracy.

#### THE PLATE LOAD IMPEDANCE AND THE POWER RELATIONS EXISTING IN THE PLATE CIRCUIT

It is desirable to operate the tube at or near its rated direct plate voltage  $E_b$ . Inasmuch as there is a minimum instantaneous plate voltage  $E_{\min}$  that can be permitted without causing other electrodes to rob the plate of space current,<sup>2</sup> the alternating voltage that can be developed across the plate load impedance is fixed, and has the value  $E_b - E_{\min}$ . The load resistance that should be inserted in the plate circuit must therefore satisfy the equation

$$\text{Proper load resistance} = R_L = \frac{E_b - E_{\min}}{I_n'}. \quad (6)$$

A load resistance that is too high will make the minimum plate voltage too low, which causes other electrodes to rob the plate of current. On the other hand a load resistance smaller than the proper value increases the plate losses, since the input to the plate is just the same as with the proper load resistance but the output is less. If the maximum value of load resistance that it is practicable to obtain is less than the

<sup>2</sup> In the case of screen-grid tubes this minimum allowable instantaneous plate potential is a voltage slightly (perhaps 15 to 25 per cent) more positive than the screen grid. In the case of high- $\mu$  triodes it is likewise slightly more positive than the most positive potential reached by control grid. With pentodes the situation is not as simple, but with the small tubes now on the market the plate begins to be robbed of current when its potential is 15 to 25 per cent of rated value.

proper value, it is then desirable to lower the plate voltage correspondingly in order to save the tube unnecessary heating.

The power output which a class C amplifier or harmonic generator delivers to a load impedance  $R_L$  is obviously

$$\text{Power output} = \frac{I_n'^2 R_L}{2} = I_n' \frac{(E_b - E_{\min})}{2} \quad (7)$$

The power input to the plate is likewise

$$\text{Power input} = E_b I_0 \quad (8)$$

where  $I_0'$  is the direct plate current as obtained from Fig. 1, and corrected for grid current. The plate efficiency of the tube is then the ratio of output to input, while the plate loss is the difference between the two.

#### DESIGN AND ADJUSTMENT OF CLASS C AMPLIFIERS

The procedure to follow in laying out a class C amplifier of the type being considered here is as follows: One first decides upon the peak current  $I_m = (I_p + I_g)$  which the tube will be called upon to deliver, and then selects  $E_+$  and  $E_{sg}$  (or in the case of high- $\mu$  triodes, the minimum  $E_p$ , by extrapolating the  $(I_p + I_g)$  curve as plotted against the  $(E_g + E_{sg}/\mu_{sg})$  on logarithmic paper. The cut-off grid bias for the resulting value of  $E_{sg}$  should also be determined by extending the straight line part of the  $(I_p + I_g)$  curve toward very low plate currents.

The next step is to decide upon the angle of current flow which is to be employed. This is a compromise between a number of conflicting factors, since a small angle of flow gives a high plate efficiency, but has the disadvantages of requiring a large grid bias and a correspondingly large excitation voltage, and of developing relatively little output even though the power obtained is developed at a high efficiency. After the angle of flow has been selected, the operating grid bias is obtained from (4), and the required exciting voltage calculated. One can now determine  $I_n$  and  $I_0$  from Fig. 1, and by estimating the expected grid current as a reasonable percentage of  $I_0$ , it is possible to correct for the effect of this grid current, and determine  $I_n'$  and  $I_0'$  by the methods that are outlined above. In using Fig. 1 one can interpolate between the square-law and linear characteristics according to the exponent of the tube characteristic given by the slope of the  $(I_g + I_p)$  vs.  $(E_g + E_{sg}/\mu_{sg})$  characteristic as plotted on logarithmic paper. With transmitting tubes this exponent is usually very close to 3/2.

It is now possible to determine the proper load impedance, the expected power output, power input, and plate loss. If these results are



not satisfactory, it will of course be necessary to modify  $I_m$  and/or the angle of flow and go through the calculations again.

With the required excitation voltage determined as above and the direct grid current estimated, it is possible to estimate the exciting power that will be required. This is<sup>3</sup>  $I_0' \times E_s$ .

The above procedure will make it possible to determine within fairly close limits the best operating conditions and the results to be expected. In setting up class C amplifiers which have been laid out in this manner the only difficulties that may be encountered are in determining when the proper exciting voltage and load impedance are obtained.

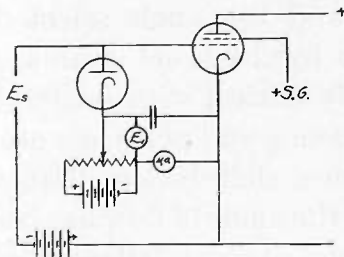

Fig. 3—Method of measuring the amount the grid is driven positive.

The exciting voltage must be known rather accurately since the amount that the grid is driven positive is ordinarily only a small fraction of the total exciting voltage and is accordingly very critical with respect to  $E_s$ . The best way of determining the excitation which the tube is receiving is illustrated in Fig. 3, which shows a method of measuring directly the most positive potential to which the grid is driven. The procedure is to vary the voltage  $E_1$  until the microammeter just begins to show current. Under this condition the maximum positive potential of the grid with respect to the cathode is obviously  $E_1$ , and is therefore read directly upon the direct-current voltmeter.

When the bias is obtained from a grid leak it may be necessary to experiment with different leak resistances until the value giving the required bias with the proper excitation is found.

The coupling of the load to the tank circuit required to give the proper load impedance can be best selected experimentally. The procedure is to start with a reasonable coupling, which is then decreased until just before the plate current begins to drop rapidly. If this operating point cannot be reached with the lowest coupling that will transfer

<sup>3</sup> This is because to a first approximation the grid current can be assumed to flow when the grid exciting voltage is at its crest. See F. E. Terman, *Radio Engineering*, p. 234. Recent experimental work indicates that power calculated in this way is in the order of 5 to 10 per cent high. See H. P. Thomas, "Determination of grid driving power in radio-frequency power amplifiers," *Proc. I.R.E.*, vol. 21, p. 1134; August, (1933).

a reasonable output to the load, it is then desirable to reduce the direct plate voltage in order to avoid excessive tube losses. In tuning up the amplifier it is to be noted that tank circuit resonance cannot be checked by the variation in direct plate current since this current is substantially constant irrespective of the tuning. The proper way is to note the alternating load current, which will be greatest at resonance.

#### DESIGN AND ADJUSTMENT OF HARMONIC GENERATORS

The procedure to follow in designing and adjusting harmonic generators is as follows: The first step is to determine the proper angle of current flow for the harmonic desired. This can be done with the assistance of Table I, and the angle selected should be either the optimum angle as given by the table or an angle somewhat less. The output is not particularly critical with moderate changes in the angle of flow. When plate efficiency and plate loss are points to consider, the best angle of flow is hence slightly less than the optimum angle for maximum output. After the angle of flow has been selected, the remaining steps are just the same as those followed in the case of the class C amplifier. About the only difference is that the plate load impedance will be tuned to a different frequency, and that in some cases, particularly when high order harmonics are desired, the highest practicable load impedance may not develop sufficient output voltage to make it desirable to operate the tube at its rated plate potential.

Examination of Table I shows that it is possible, at least theoretically, to obtain relatively large output power and voltage on very high, high-order harmonics. Practically, however, these higher order harmonics require that the angle of flow be relatively short, and this means an extremely high grid bias voltage and correspondingly large excitation. If on the other hand, one attempts to obtain high-order harmonics with an angle of flow appreciably greater than the optimum value as given by Table I, the output is greatly reduced while at the same time the direct-current input is high, resulting in low efficiency and high plate loss together with very small output.

#### PRACTICAL LIMITATIONS TO THE ACCURACY OF ANALYSIS

The entire method of analysis that has been outlined is based upon the assumption that (1) holds and that  $\mu_{sg}$  is a constant. Tests with characteristics of a number of tubes indicate that these requirements are very closely met in ordinary tubes when the space current exceeds 5 to 20 per cent of  $I_m$ . For smaller space currents  $\mu_{sg}$  tends to fall off, giving an incipient variable-mu characteristic that varies in degree with different tube types, and is generally less pronounced in large

tubes. The proper procedure is to use the value of  $\mu_{sg}$  that holds with relatively large plate currents, and then take the cut-off grid bias as the value computed from this  $\mu_{sg}$ . When this is done the effect of the variable-mu tendency will be to make values of  $I_n$  (except  $I_o$ ) as obtained from Fig. 1 slightly low when the angle of flow is very small, has little effect when the angle of flow is  $180^\circ/n$ , and makes the results obtained from Fig. 1 high when the angle of flow is in the order of  $360^\circ/n$ ,

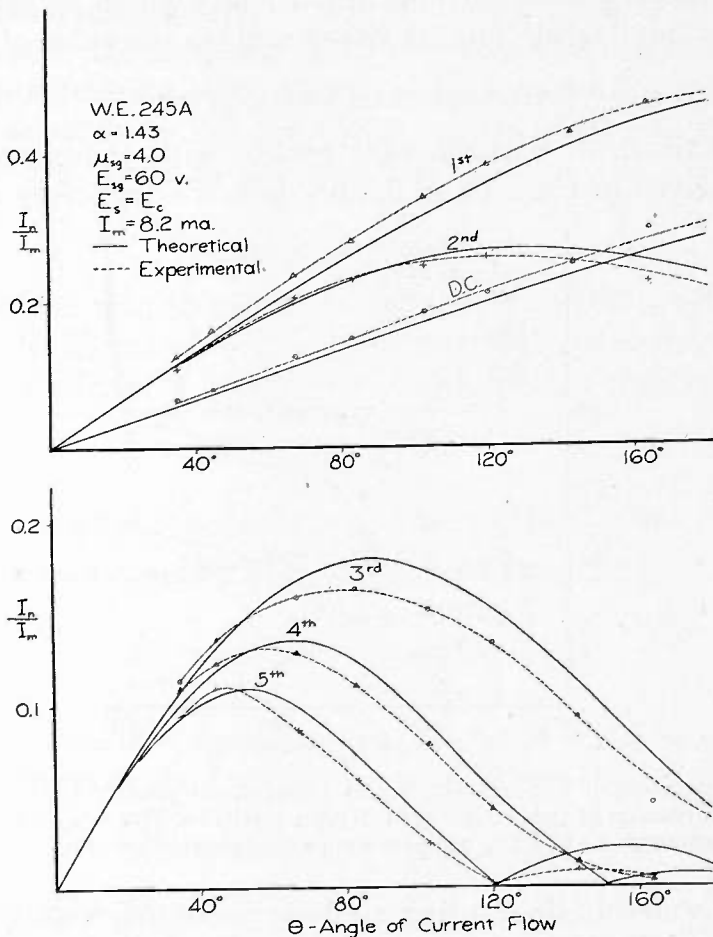

Fig. 4—Comparison of experimental and theoretical results for a small screen-grid tube where the grid was just driven to zero potential. Note that those discrepancies which appear are largely caused by the variable-mu tendency near cut-off.

where  $n$  is the order of the harmonic. This error introduced by the variable-mu tendency is greater the larger the angle of current flow. These consequences of a gradual cut-off are the result of the way in which the extra plate current contributes to the value of the Fourier integral. The effect on the direct space current  $I_o$  is always to increase it slightly above the calculated value.

The weakest link in the entire analysis is that one must estimate the

grid current, as secondary emission effects are so variable that prediction of control-grid current is a practical impossibility at the present time. The uncertainty that arises from guessing at the control-grid current is, however, not as bad as might be thought at first glance. This is because the control-grid current is usually only a small fraction of the total space current, particularly in large tubes where the high operating potentials give secondary emission at the grid. Hence a large percentage error in estimating the control-grid current, such as 50 per cent, will make only a small error (such as 10 per cent) in the value of  $I_n'$ .

#### EXPERIMENTAL VERIFICATION

A comparison of experimental results with those predicted by theory are given in Figs. 4 and 5, and show a satisfactory agreement.

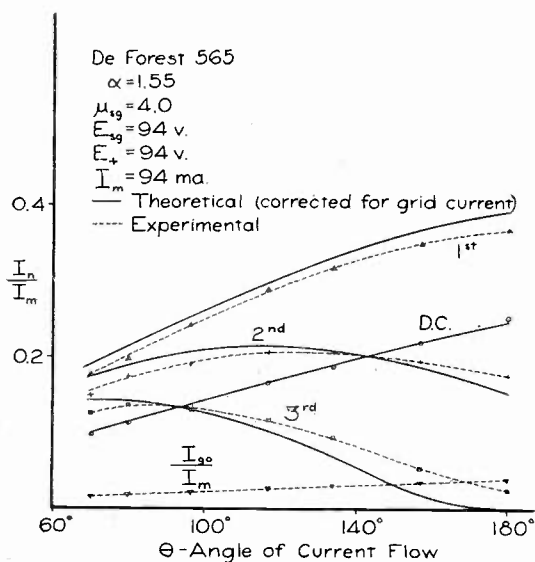

Fig. 5—Comparison of experimental and theoretical results for a small transmitting screen-grid tube with grid driven positive. Note that the correction for grid current makes the agreement entirely satisfactory.

The results were obtained using a 60-cycle exciting voltage, and the output was analyzed by means of a tuned circuit type of harmonic analyzer developed by the Bell System.

The results in Fig. 4 are for a receiving screen-grid tube operated so that the grid was almost but not quite driven positive. This tube had an exponent  $\alpha$  of 1.43, and the theoretical curve is for this exponent as interpolated between the linear and square cases of Fig. 1. The tube had a moderate variable-mu tendency near cut-off, and it will be noted that if this is allowed for, the agreement with theory is almost perfect. Thus in every case the agreement is excellent when the angle of flow is  $180^\circ/n$ , since here the variable-mu tendency has little effect, while the observed  $I_n/I_m$  is high for smaller angles of flow and low for larger

angles. The observed direct-current component on the other hand is always high, as theory would predict.

The results of Fig. 5 are for a  $7\frac{1}{2}$ -watt screen-grid tube where the grid is driven positive. It will be observed that the observed values  $I_n/I_m$  agree very satisfactorily with the theoretical results corrected for grid current. The only significant discrepancy is at the higher harmonics when the angle of current flow is large, since here the grid current flows during an appreciable part of the cycle of the harmonic voltage instead of mainly at or near the crest. Under these conditions the correction for grid current is too large, and the theoretical results can be expected to be low, as is strikingly brought out for the third harmonic of Fig. 5 at large angles of flow.

#### ACKNOWLEDGMENT

The authors wish to express their appreciation of the assistance of Mr. Philip E. Ekstrand, who checked the calculations leading to Fig. 1, and to Mr. James M. Sharp, who made the final experimental measurements.

#### APPENDIX I

##### ANALYSIS OF PLATE-CURRENT IMPULSES

*Linear case:* From (2), we have for the linear case:

$$I_p = k \left( E_c + \frac{E_{sg}}{\mu_{sg}} + E_s \cos \omega t \right).$$

This can be simplified by noting that  $E_{sg}/\mu_{sg} = -E_{c0}$ , so that by utilizing the relation of (3), namely,  $E_s \cos (\theta/2) = -(E_c - E_{c0})$ , gives

$$I_p = kE_s [\cos \omega t - \cos (\theta/2)]. \quad (8)$$

By the usual Fourier theorem we now have

$$I_0 = \frac{kE_s}{\pi} \int_0^{\omega t = \theta/2} [\cos \omega t - \cos (\theta/2)] d(\omega t) \quad (9a)$$

$$I_n = \frac{2kE_s}{\pi} \int_0^{\omega t = \theta/2} [\cos \omega t - \cos (\theta/2)] \cos (n\omega t) d(\omega t). \quad (9b)$$

The maximum current  $I_m$  is when  $t=0$ , so that

$$I_m = kE_s(1 - \cos (\theta/2)). \quad (10)$$

Carrying out the integrations indicated in (9a) and (9b), and then dividing the results by (10) gives

$$\frac{I_0}{I_m} = \frac{1}{\pi} \frac{\sin(\theta/2) - (\theta/2) \cos(\theta/2)}{1 - \cos(\theta/2)} \quad (11a)$$

$$\frac{I_1}{I_m} = \frac{2}{\pi} \frac{-\sin(\theta/2) \cos(\theta/2) + \frac{\theta + \sin \theta}{4}}{1 - \cos(\theta/2)} \quad (11b)$$

For  $n > 1$

$$\frac{I_n}{I_m} = \frac{2}{\pi} \frac{\frac{\sin(n\theta/2) \cos(\theta/2)}{n} + \frac{\sin(n+1)(\theta/2)}{2(n+1)} + \frac{\sin(n-1)(\theta/2)}{2(n-1)}}{1 - \cos(\theta/2)} \quad (11c)$$

These results have been plotted in Fig. 1 as a function of  $\theta$ .

*Square-law case.* Here the equation of current is

$$\begin{aligned} I_p &= k \left( E_c + \frac{E_{sg}}{\mu_{sg}} + E_s \cos \omega t \right)^2 \\ &= k E_s^2 [\cos \omega t - \cos(\theta/2)]^2. \end{aligned} \quad (12)$$

By the usual Fourier theorem we have

$$I_0 = \frac{k E_s^2}{\pi} \int_0^{\omega t = \theta/2} [\cos \omega t - \cos(\theta/2)]^2 d(\omega t) \quad (13a)$$

$$I_n = \frac{2k E_s^2}{\pi} \int_0^{\omega t = \theta/2} [(\cos \omega t - \cos(\theta/2))]^2 \cos n\omega t d(\omega t). \quad (13b)$$

The maximum current  $I_m$  is when  $t=0$ , so that

$$I_m = k E_s^2 [1 - \cos(\theta/2)]^2.$$

Carrying out the integrations indicated in (13a) and (13b) and then dividing by (14) gives

$$\frac{I_0}{I_m} = \frac{1}{\pi} \frac{(\theta/2) [\cos^2(\theta/2) + 1/2] - (3/2) \sin(\theta/2) \cos(\theta/2)}{[1 - \cos(\theta/2)]^2} \quad (15a)$$

$$\frac{I_1}{I_m} = \frac{2}{\pi} \frac{\sin(\theta/2) - (1/3) \sin^3(\theta/2) - (\theta/2) \cos(\theta/2)}{[1 - \cos(\theta/2)]^2} \quad (15b)$$

$$\frac{I_2}{I_m} = \frac{2}{\pi} \frac{\sin \theta \left[ \frac{\frac{1}{2} + 3 \cos^2 (\theta/2)}{4} \right] - \cos (\theta/2) \left[ \sin (\theta/2) + \frac{\sin (3\theta/2)}{3} \right]}{[1 - \cos (\theta/2)]^2} - \frac{(\theta/2) \cos (\theta/2)}{4 [1 - \cos (\theta/2)]^2} \quad (15c)$$

For  $n > 2$

$$\frac{I_n}{I_m} = \frac{2}{\pi} \frac{\frac{\sin (n\theta/2)}{n(n+2)} [1 + 2(n+1) \cos^2 (\theta/2)] - \frac{\cos (\theta/2) \sin (n-1)(\theta/2)}{n-1}}{[1 - \cos (\theta/2)]^2} - \frac{\cos (\theta/2) \sin (n+1)(\theta/2)}{n+1} + \frac{\sin (n-2)(\theta/2)}{n^2-4} \dots \dots (15d)$$

These results have been plotted in Fig. 1 as a function of  $\theta$ .

APPENDIX II

CORRECTION OF  $I_n$  FOR GRID CURRENT

The reduction in  $I_n$  caused by the current which the grid diverts from the plate is:

$$\text{Loss in } I_n = \frac{1}{\pi} \int_0^{2\pi} i_g \cos n\omega t \, d(\omega t).$$

The integration is here carried out over the interval for which grid current flows. If this is so short a time about the crest of the cycle that  $\cos n\omega t$  can be considered as sensibly constant at a value of unity, then

$$\text{Loss in } I_n = \frac{1}{\pi} \int_0^{2\pi} i_g \, d(\omega t).$$

But by the Fourier theorem,  $I_{g0} = (1/2\pi) \int_0^{2\pi} i_g \, d(\omega t)$ . Hence

$$\text{Loss in } I_n = 2 I_{g0},$$

where  $I_{g0}$  is the direct grid current.



## ELIMINATION OF PHASE SHIFTS BETWEEN THE CURRENTS IN TWO ANTENNAS\*

BY

HANS RODER

(General Engineering Laboratory, General Electric Company, Schenectady, N. Y.)

**Summary**—If two antennas (vertical radiators) are fed through transmission lines from a common radio-frequency supply, then phase shifts between the currents in these antennas will occur if one antenna varies in capacity or resistance. This will result in a change of the horizontal radiation pattern.

As shown in the following paper these phase shifts can be eliminated by a certain method of tuning the antenna circuits. The degree of phase compensation attainable, however, depends on the attenuation of the transmission line. Compensation of phase shifts is also possible if an artificial line is inserted at the sending end for reasons of making the effective electrical length of the transmission line any value desired.

The results of the experimental investigation were found to be in good agreement with the theoretical analysis.

### I. INTRODUCTION

**A**N investigation of the following problem is to be made. Two antennas are fed through transmission lines from a common voltage,  $E_1$  (Fig. 1). Depending on the tuning of the antennas and the lengths of the transmission lines the phase displacement be-

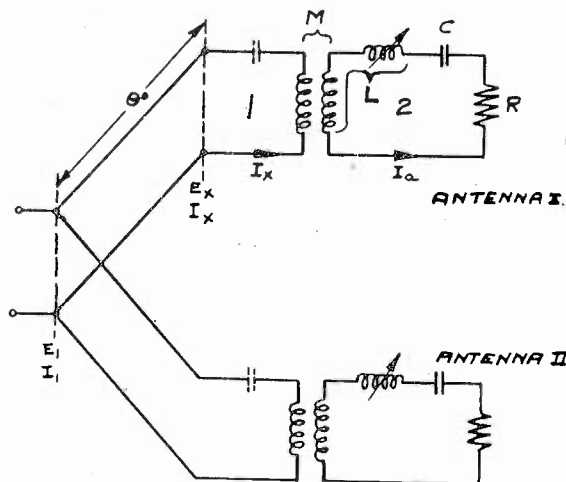

Fig. 1

tween both antenna currents will have a certain value,  $\phi$ . The angle  $\phi$  will be 0 or 180 degrees in case the antennas and transmission lines are exactly alike. It is obvious that  $\phi$  will change if the capacity of one

\* Decimal classification: R120. Original manuscript received by the Institute, June 30, 1933.



antenna varies due to some external influence, for instance, weather conditions. The *problem* is to find that tuning of the antenna and of the line terminating equipment which provides a *minimum of phase shift* for a given percentage change in antenna capacity.

This problem is applicable to several practical cases.

In radio range beacon transmitters two vertical loop antennas are used which are placed 90 degrees with respect to each other. The radiation pattern of each loop is a figure eight. Four courses thus result, each course being at an angle of 45 degrees with respect to the loops. However, it was found some time ago that frequently considerable shifts in course took place, especially during the night. The reason was obviously that the plane of polarization of horizontal field components which were due to the horizontal parts in the loop antenna was shifted during the night on account of reflections from ionized layers in the atmosphere. It was, therefore, proposed to modify the antenna systems in order to eliminate fully the radiation of horizontal field components. In the new systems, four antennas are to be used. The antennas consist of steel towers which are located on the corners of a square and serve as vertical radiators. They are fed through underground transmission lines from the transmitter house located in the center of the square.<sup>1</sup> The new type antenna system resulted in a practically complete elimination of night effects.<sup>2</sup> The importance of maintaining a fixed phase relation between the two antenna currents is obvious, since any phase change causes the course to shift. The schematic diagram for feeding both antennas I and II from a common source is shown in Fig. 1.

Another application is found in the case of directional broadcasting, the term "directional" referring to both the horizontal and the vertical field pattern. Horizontal directivity is obtained by placing two or more vertical radiators at a proper distance and feeding them in proper phase.<sup>3</sup> For the suppression of high angle radiation certain arrays of vertical radiators can be used which are fed in phase through transmission lines.<sup>4</sup>

<sup>1</sup> "New type of transmitting antenna developed for radio range beacons," *Air Commerce Bulletin*, U. S. Dept. of Commerce, Aeronautics Branch, vol. 4, p. 33; July 15, (1932).

<sup>2</sup> H. Diamond; "The cause and elimination of night effects in radio range beacon reception," Bureau of Standards Journal of Research, vol. 10, p. 7, (1933).

<sup>3</sup> R. M. Wilmotte, "Directive antennas for broadcast station WFLA," *Electronics*, vol. 5, p. 362; December, (1932).

<sup>4</sup> O. Boehm, "Broadcast antennas with suppression of high angle radiation," *Telefunken-Zeitung*, no. 60, p. 21; March, (1932); H. Harbich and W. Hahne-mann, "Fading reduction in broadcasting by means of special arrays," *Elek. Nach. Tech.*, vol. 9, no. 10; p. 361, (1932).

## II. THEORETICAL INVESTIGATION

The tuning and detuning procedure of the circuit is as follows: First, the antenna and the line terminating equipment are tuned in a certain manner. We call this status "normal conditions." Then, later, due to some weather influences, the antenna capacity is supposed to change, thus leading to "not normal conditions." We put

$C_0$  = antenna capacity under normal conditions

$C = C_0 + dC$  = antenna capacity under not normal conditions.

$$\frac{dC}{C_0} = z = \text{percentage change in antenna capacity.}$$

Other abbreviations we shall use are (with reference to Fig. 1)

$$X_m = \omega M$$

$X_1(X_2)$  = reactance of circuit 1 (circuit 2) = reactance which is found in path of current  $I_x$  (current  $I_a$ ) if circuit 2 (circuit 1) is removed

$R$  = total resistance in antenna circuit

$R_{21}$  = resistance reflected from circuit 2 into circuit 1

$X_{21}$  = reactance reflected from circuit 2 into circuit 1

$Z_0$  = surge impedance of the transmission line

$\theta$  = electrical length of the line in degrees =  $x\omega\sqrt{L'C'}$  ( $L'$  and  $C'$  inductance and capacity, respectively, per unit length;  $x$  length of line).

$X_{c0}$  = reactance of  $C$  under normal conditions.

$X_c$  = reactance of  $C$  under not normal conditions.

$X_L$  = reactance of  $L$ .

$X_{20} = X_L - X_{c0}$  = resulting secondary reactance under normal conditions.

$$\frac{X_{20}}{R} = \tan \psi$$

$\psi$  = angle between  $I_a$  and electromotive force induced by  $I_x$  into the antenna circuit (under normal conditions).

## 1. COMPENSATION OF UNDESIRE PHASE CHANGES

Tuning of the antenna circuit and of the line terminating circuit is done under *normal conditions*.

It is not probable that the optimum tuning of the antenna circuit will always be unity power factor; i.e.,  $\psi = 0$ , where  $\psi$  is the angle between induced voltage and  $I_a$ . In general, it may be better to operate

the antenna circuit off-tune with  $\psi \neq 0$  and  $X_{20} \neq 0$ . The components of the impedance reflected from the antenna into the line terminating circuit are (Fig. 1)

$$R_{210} = \frac{X_m^2}{R^2 + X_{20}^2} \quad R = \frac{X_m^2}{R} \cos^2 \psi$$

$$X_{210} = \frac{-X_m^2}{R^2 + X_{20}^2} \quad X_{20} = \frac{X_m^2}{X_{20}} \sin^2 \psi.$$

It is desired to have no standing waves on the line in order to keep line losses and line radiation at a minimum. We thus have to terminate the line by a load equal to its surge impedance. On account of the high frequency, however, the surge impedance can be considered to be a pure resistance. It thus follows that under normal conditions the coupling between line terminating circuit and antenna circuit must be such as to be in accordance with the relation

$$R_{210} = Z_0 = \frac{X_m^2}{R^2 + X_{20}^2} R. \quad (1)$$

The reactive component of the impedance, into which the transmission line is looking, must be zero:

$$X_{210} + X_1 = X_1 - \frac{X_m^2}{R^2 + X_{20}^2} X_{20} = 0. \quad (2)$$

*a. Analytical Computation of the Phase Change due to Capacity Variation*

We have now to investigate what value of  $\psi$  will result in smaller phase shifts if the antenna capacity slightly varies. Since the voltage  $E_1$  (Fig. 1) is the common feed voltage in both antenna circuit I and antenna circuit II, it is essential to know the phase shift between  $E_1$  and  $I_a$  for small changes in  $C$ . We write

$$X_2 = X_L - X_c = X_L - \frac{1}{\omega(C_0 + dC)} = X_L - \frac{X_{c0}}{1+z} = X_L y \quad (3)$$

where,

$$y = \frac{\frac{X_{20}}{X_L} + z}{1+z}. \quad (4)$$

For the currents  $I_z$  and  $I_a$  we have the following expressions which can be easily derived:

$$I_x = \frac{E_x}{jX_1 + \frac{X_m^2}{R + jX_2}} \quad (5)$$

$$I_x = I_x \frac{-jX_m}{R + jX_2} \quad (6)$$

The following relations are well known from the theory of transmission lines, whereby  $E_1$  and  $I_1$  are measured at the sending end and  $E_x$  and  $I_x$  at the receiving end.

$$\left. \begin{aligned} E_1 &= E_x \cos \theta + j I_x Z_0 \sin \theta \\ I_1 &= I_x \cos \theta + j (E_x / Z_0) \sin \theta \end{aligned} \right\} \quad (7)$$

These equations refer to a transmission line without attenuation. (The effect of attenuation will be considered in Part II, Section 3.) If the line is properly terminated, then  $I_x Z_0 = E_x$ , with  $\theta$  being the phase displacement measured from  $E_x$  to  $E_1$ .

With regard to (1) and (2), the original tuning is to be performed such that

$$X_m^2 = \frac{Z_0}{R} (R^2 + X_{20}^2) = \frac{Z_0 R}{\cos^2 \psi} \quad (8)$$

$$X_1 = X_{20} \frac{Z_0}{R} = Z_0 \tan \psi \quad (9)$$

With these expressions, after some transformations, (5) and (6) can be brought into the following forms:

$$j \dot{I}_x = \dot{I}_x \sqrt{\frac{Z_0}{R}} \frac{1}{\cos \psi} \frac{1}{1 + j \frac{X_L}{R} y} \quad (10)$$

$$\dot{E}_x = \dot{I}_x Z_0 \left( j \tan \psi + \frac{1}{\cos^2 \psi} \frac{1}{1 + j \frac{X_L}{R} y} \right) \quad (11)$$

Equation (11) when substituted into (7) yields

$$\dot{E}_1 = \dot{I}_x Z_0 \frac{\cos \theta}{\cos^2 \psi} \left[ j \cos^2 \psi (\tan \psi + \tan \theta) + \frac{1}{1 + j \frac{X_L}{R} y} \right] \quad (12)$$

In (10), (11), and (12),  $y$  is the only variable. It measures the detuning of the antenna circuit by an undesired change in antenna capacity (equation (4)). Equations (10) and (12) refer the current  $j\dot{I}_a$  and the voltage  $\dot{E}_1$ , respectively, to the current  $\dot{I}_x$  in both phase and amplitude.

b. Circle Diagram for Finding the Phase Change

Equations (10) and (12) lend themselves very conveniently for graphical solution. The complex function

$$W = \frac{1}{1 + j \frac{X_L}{R} y}$$

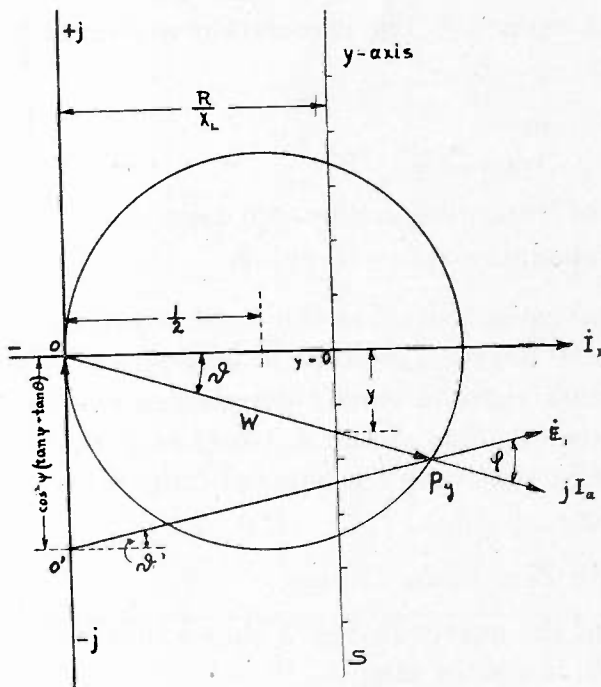

Fig. 2

if plotted for all values of  $y$  from  $-\infty$  and  $+\infty$  yields a circle (Fig. 2). The diameter of this circle equals 1. Its center is located on the real axis at a distance of  $+0.5$  from the origin. In order to find the value of  $W$  for a given  $y$  we have to know that  $W$  includes with the real axis an angle  $\vartheta$  for which

$$\tan \vartheta = \frac{-y}{R/X_L} = - \frac{\tan \psi + \frac{X_L}{R} z}{1 + z} \tag{13}$$

Thus, by drawing the "scale"  $S$  parallel to the vertical axis at a distance of  $R/X_L$ , and dividing this scale in linear fashion in terms of  $y$

(or in nonlinear fashion in terms of  $z$  by means of (4)) we can find  $W$  for any value of  $y$ .

With reference to (10) we see that the angle  $\vartheta$  represents the angle between  $j\dot{I}_a$  and  $\dot{I}_x$ .

According to (12) we obtain the angle between  $\dot{E}_1$  and  $\dot{I}_x$  if we add

$$j \cos^2 \psi (\tan \psi + \tan \theta) + W. \quad (14)$$

This yields the vector  $O'P_y$ . Then, as Fig. 2 shows,  $\vartheta'$  is the phase angle between  $\dot{E}_1$  and  $\dot{I}_x$ , while  $\varphi$  is the wanted phase angle between  $j\dot{I}_a$  and  $\dot{E}_1$ . The true phase angle  $\dot{I}_a, \dot{E}_1$  is simply  $(\varphi + 90$  degrees).

In the manner as described the phase angle  $\varphi$  was found by the graphical method under various conditions for a change of  $\pm 1$  per cent in antenna capacity. The calculation was made under the following assumptions:

$$R = 6 \text{ ohms}$$

$$X_L = X_{c0} = 1000 \text{ ohms}$$

$$\text{Length of transmission line} = 60 \text{ degrees}$$

$$\text{Surge impedance} = Z_0 = 80 \text{ ohms.}$$

The cases investigated cover the total possible interval from  $-80$  degrees  $< \psi < +80$  degrees, in steps of 20 degrees. The results—phase shift and antenna current versus percentage change in antenna capacity—are shown in Figs. 3 and 4. Cases of  $\psi > \pm 80$  degrees are impractical, since in that case the mutual inductance,  $M$ , becomes unreasonably large.

### c. Adjustment for Zero Phase Change.

Inspection of the curves in Fig. 3 shows that the phase change between  $j\dot{I}_a$  and  $\dot{E}_1$  is zero in case

$$\psi = -\theta.$$

This is not accidental, but holds in general, as one can easily see when referring to (10), (11), and (12). If, in (12), the term

$$j \cos^2 \psi (\tan \psi + \tan \theta)$$

is made zero, then the voltage  $\dot{E}_1$  and the current  $j\dot{I}_a$  are in phase, regardless of the value of  $y$ , whereby  $y$  measures the undesired capacity variation of the antenna. This requires making the original tuning of each antenna such that

$$\tan \psi = \frac{X_{20}}{R} = -\tan \theta. \quad (15)$$

This is also checked if we refer to Fig. 2. If the vector

$$j \cos^2 \psi (\tan \psi + \tan \theta)$$

becomes zero, then the vectors  $\vec{E}_1$  and  $j\vec{I}_a$  are always in phase regardless of the value of  $y$ . Since the voltage  $\vec{E}_1$  is common to both antennas the phase of the individual antenna currents becomes independent of variations in antenna capacity.

If (15) holds, then another feature of this particular tuning becomes obvious: we get from (10) and (12)

$$I_a = -jE_1 \frac{1}{\sqrt{Z_0 R}}. \quad (16)$$

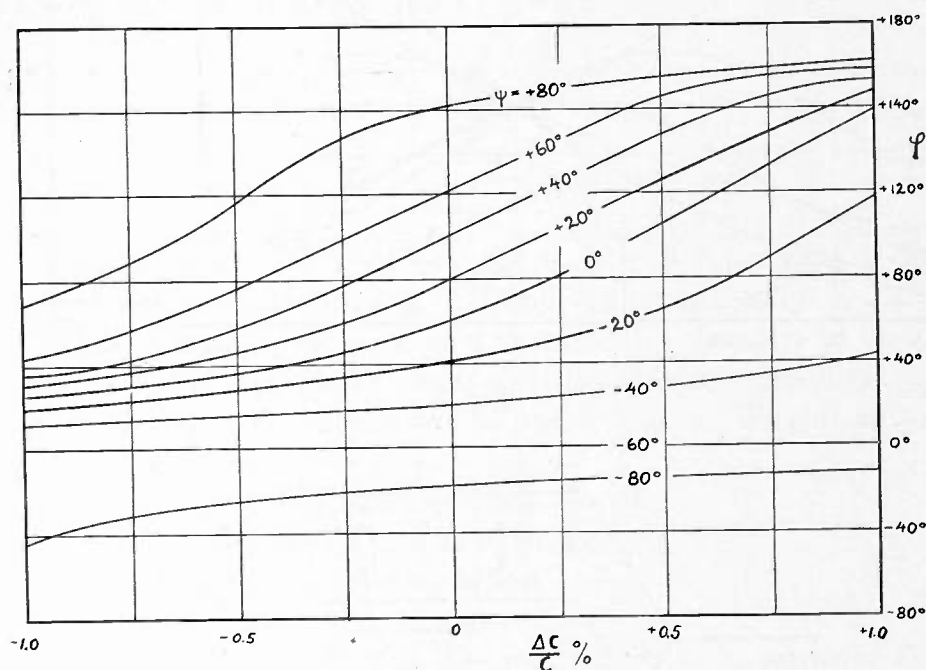

Fig. 3

This means that not only the phase between  $E_1$  and the current in antenna I is independent of variations in antenna capacity but also the relative magnitude of the currents in the antennas I and II is independent of capacity variations. (Fig. 4.) In the case of the radio range beacon system, shifting of the course will result from variations in relative phase and magnitude of the currents in two opposite antennas. However, by tuning according to (15) we can eliminate both variations.

We thus obtain the following simple rule for making the phase displacement between both antenna currents independent of capacity variations:

1. Find the electrical length of the transmission line.
2. Tune antenna circuit such that  $\tan \psi = -\tan \theta$ .
3. Adjust coupling and primary tuning such that the transmission line is looking into a pure resistance of magnitude  $Z_0$ .

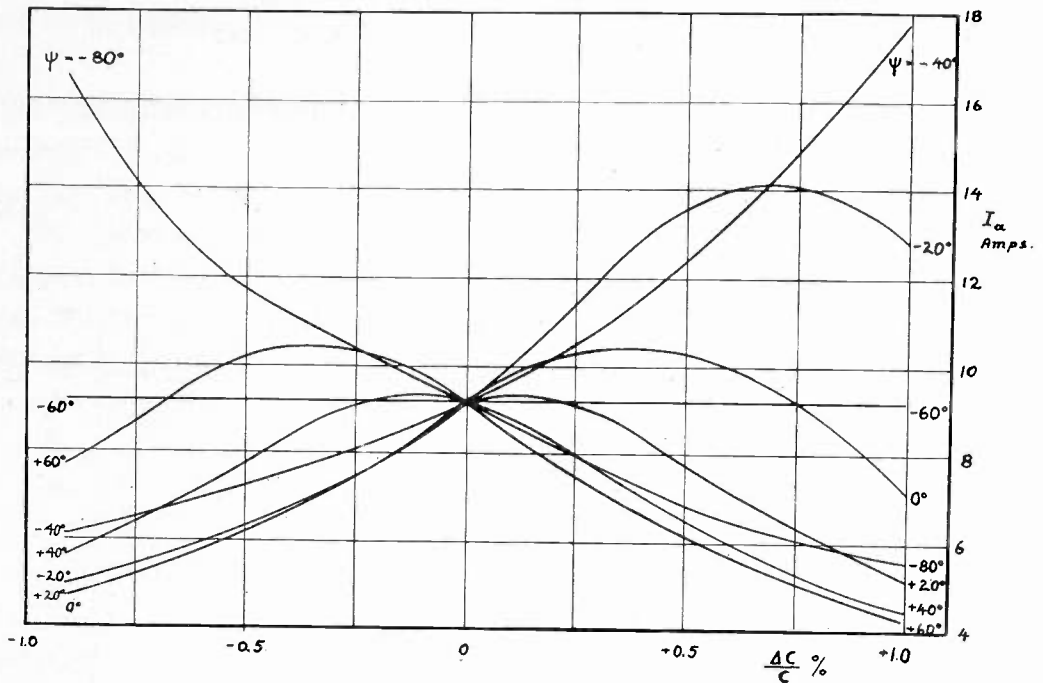

Fig. 4

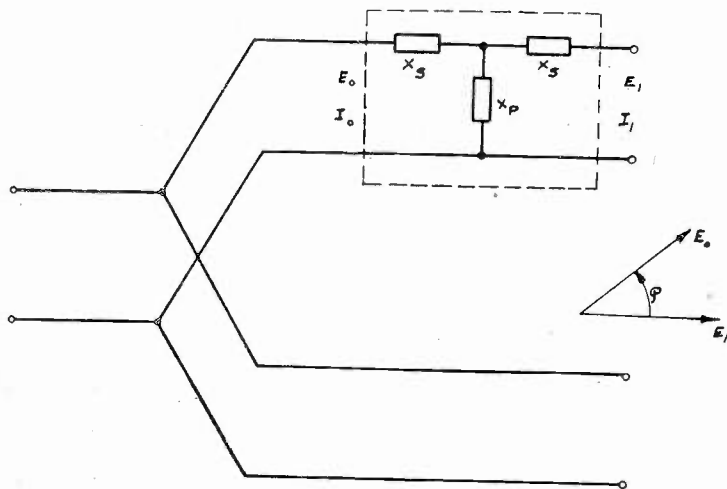

Fig. 5

## 2. USE OF AN ARTIFICIAL TRANSMISSION LINE.

If the antennas are alike and if they are fed through transmission lines of equal characteristic constants and of equal lengths, then the phase displacement between the antenna currents is either zero or 180 degrees. In case the above conditions are not given or in case any



other angle of phase displacement is desired, it becomes necessary to insert a phase shifting network into one or both of the transmission lines.

The phase shifting network is best built in the form of an artificial line, i.e., as a filter T-section. It must be designed to meet the following requirements (Fig. 5):

1.  $E_0$  and  $E_1$  must be of equal magnitude
2. The phase angle between  $E_1$  and  $E_0$  must equal a specified value. We call this angle  $\rho$ .
3. Input and output impedance must be equal, such that  $E_1/I_1 = E_0/I_0 = Z_0$ .

It is known from filter theory that a network with

$$X_p = - Z_0 \frac{1}{\sin \rho} \tag{17}$$

$$X_s = Z_0 \frac{1 - \cos \rho}{\sin \rho} = Z_0 \tan \frac{1}{2}\rho \tag{18}$$

will have the properties specified above. Fig. 6 represents a design chart for that network showing (17) and (18) graphically.

We have now to investigate how the antenna circuit is to be tuned in order to have zero phase change if the antenna capacity varies. The same method will be followed as in Section 1a. We put as previously

- $E_0, I_0$ —at input of phase shifting network
- $E_1, I_1$ —at beginning of transmission line
- $E_x, I_x$ —at end of transmission line
- $I_a$ , —current in antenna circuit.

Utilizing the relations (17) and (18) we find for  $E_0$  in terms of  $E_1$  and  $I_1$ ,

$$E_0 = + \cos \rho E_1 + j \sin \rho Z_0 I_1. \tag{19}$$

By means of (7) we can eliminate  $E_1$  and  $I_1$  and get

$$E_0 = E_x \cos (\rho + \theta) + j I_x Z_0 \sin (\rho + \theta). \tag{20}$$

Except that  $E_0$  is replacing  $E_1$  and  $(\rho = \theta)$  is replacing  $\theta$ , this equation is equivalent to the upper equation in (7). As in (Section 1a) we find:

$$\dot{E}_0 = I_x X_0 \frac{\cos (\theta + \rho)}{\cos^2 \psi} \left[ j \cos^2 \psi (\tan \psi + \tan (\theta + \rho)) + \frac{1}{1 + j \frac{X_L}{R} y} \right] \tag{21}$$

This expression is the equivalent of (12). We see from (10) and (21) that the phase relation between  $E_0$  and  $I_a$  is independent of  $y$  (which is a measure for the capacity variation in the antenna circuit), if we make

$$\tan(\theta + \rho) + \tan \psi = 0 \quad (22)$$

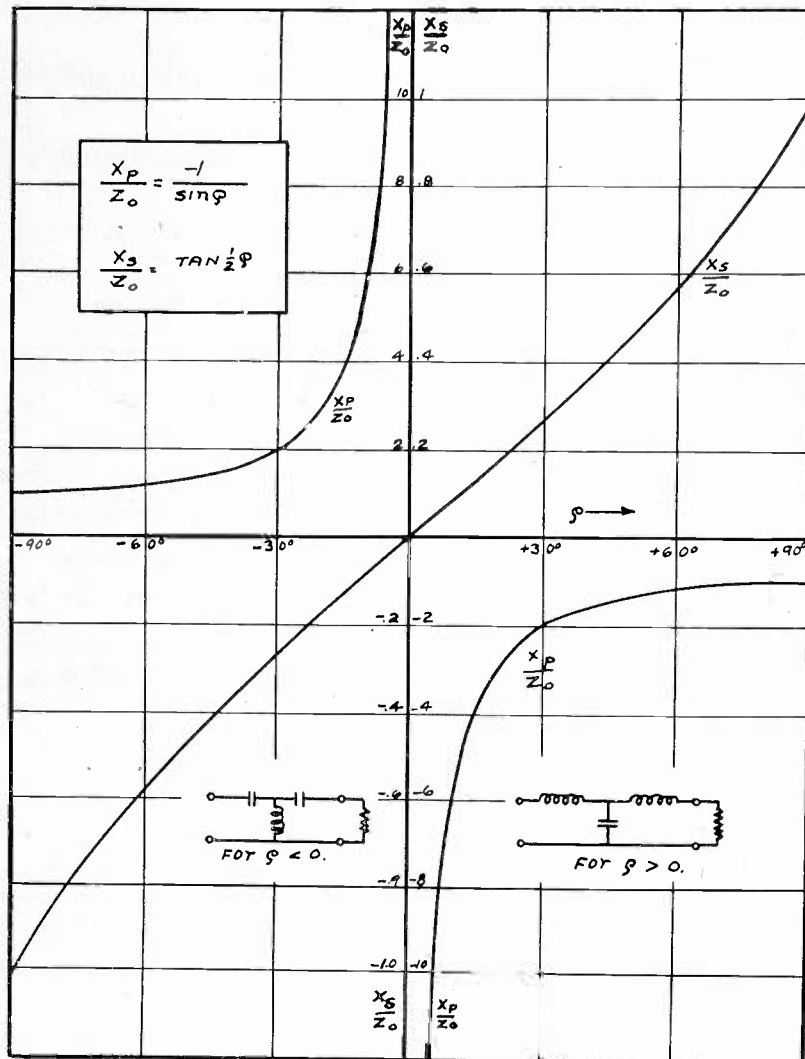

Fig. 6

or, if  $(\theta + \rho) < 90$  degrees

$$\psi = -(\theta + \rho).$$

Thus, in order to eliminate phase changes, we have to tune the antenna such that under normal conditions in the antenna circuit the phase angle between induced voltage and current is equal and opposite to the phase angle between  $E_x$  and  $E_0$ . This will also result in elimination of variations in relative magnitude of the currents in two opposite antennas.

If  $\theta + \rho$  is greater than 90 degrees, one can find the proper values of  $\psi$  from the following table:

$\theta + \rho$	$\psi$
From 0 to 90°	From 0 to -90°
From 90° to 180°	From +90° to 0°
From 180° to 270°	From 0 to -90°
From 270° to 360°	From +90° to 0°

### 3. EFFECT OF LINE ATTENUATION UPON PHASE COMPENSATION

The equations (7)

$$E_1 = E_x \cos \theta + jI_x Z_0 \sin \theta$$

$$I_1 = I_x \cos \theta + (jE_x / Z_0) \sin \theta$$

refer to a line without attenuation; i.e. a line in which resistance and leakage conductance are zero. However, this is not true for practical transmission lines. In case of a *line with attenuation*, (7) becomes

$$\left. \begin{aligned} E_1 &= E_x \cosh ax + I_x Z_0 \sinh ax \\ I_1 &= I_x \cosh ax + (E_x / Z_0) \sinh ax \end{aligned} \right\} \quad (23)$$

where,

$$a = \alpha + j\beta$$

$\alpha$  = attenuation constant } of the cable.

$\beta$  = wavelength constant }

$x$  = physical length of line

$\alpha x$  = attenuation of the line, measured in nepers

$\beta x = \theta$  = electrical length of line in degrees.

If we substitute (23) into (10) and (11) we obtain

$$E_1 = I_x Z_0 \frac{\cosh ax}{\cos^2 \psi} \left[ \cos^2 \psi (j \tan \psi + \tanh ax) + \frac{1}{1 + j \frac{X_L}{R} y} \right] \quad (24)$$

which is equivalent to (12). For  $\tanh ax$  we have<sup>5</sup>

$$\tanh ax = \tanh (\alpha + j\beta)x = \frac{\sinh 2\alpha x + j \sin 2\beta x}{\cosh 2\alpha x + \cos 2\beta x}$$

while,

$$\cosh ax = \cosh \alpha x \cos \beta x + j \sinh \alpha x \sin \beta x.$$

Since  $\alpha x$  is small we can replace the hyperbolic sine and cosine by the first members of their respective power series. This yields:

<sup>5</sup> Jahnke-Emde, "Funktionentafeln," p. 11.

$$\tanh ax = \frac{2\alpha x}{1 + \cos 2\theta} + j \tan \theta$$

and,

$$\cosh ax = \cos \theta + j\alpha x \sin \theta = \cos \theta (1 + j\alpha x \tan \theta) = \frac{\cos \theta}{\cos \sigma} \epsilon^{j\sigma},$$

where,

$$\tan \sigma = \alpha x \tan \theta.$$

$\sigma$  is a constant, but normally very small angle, depending only upon line length and line attenuation. Substituting in (24) we obtain

$$\begin{aligned} E_1' &= E_1 \cos \sigma \epsilon^{-j\sigma} \\ &= I_x Z_0 \frac{\cos \theta}{\cos^2 \psi} \left[ \cos^2 \psi \left( j \tan \psi + j \tan \theta + \frac{2\alpha x}{1 + \cos 2\theta} \right) \right. \\ &\quad \left. + \frac{1}{1 + j \frac{X_L}{R} y} \right]. \end{aligned} \tag{25}$$

This expression can also be represented graphically by a circle diagram (Fig. 7). However, in this diagram, the point  $O'$  (origin of  $E_1'$ ) is not located on the  $j$ -axis any more as was the case in Fig. 2. The true phase angle between  $E_a$  and  $E_1'$  is  $(\sigma + \varphi + \pi/2)$ .

If we now put as previously

$$\tan \psi = - \tan \theta$$

$O'$  will coincide with  $O''$ . The distance  $O O''$  then equals  $\alpha x$ . In this case, the phase change becomes a minimum if the antenna capacity varies. However, a perfect zero phase compensation is impossible, because  $O''$  and  $O$  will not coincide on account of the real term  $2\alpha x/(1 + \cos 2\theta)$  being present (equation (25)).

Hence it follows: Perfect phase compensation is only possible if the transmission line between antenna and transmitter house has a very low attenuation. This can probably best be obtained by using a concentric transmission line.

To give an idea of the magnitude of  $\alpha x$  it may be said that in average installations  $\alpha x$  will be in the order of from 0.01 to 0.10 nepers.<sup>6</sup>

<sup>6</sup> One neper = 8.686 decibels. The neper is the natural unit of attenuation. In (23), (24), and (25),  $\alpha x$  is to be substituted in nepers.

#### 4. EFFECT OF RESISTANCE OF THE COUPLING TRANSFORMER

The energy transfer from the line terminating circuit into the antenna circuit is obtained by a coupling transformer. The resistance in the secondary of this transformer simply adds to the total antenna resistance, while the effect of resistance in the primary is to be found. We put (Fig. 1)

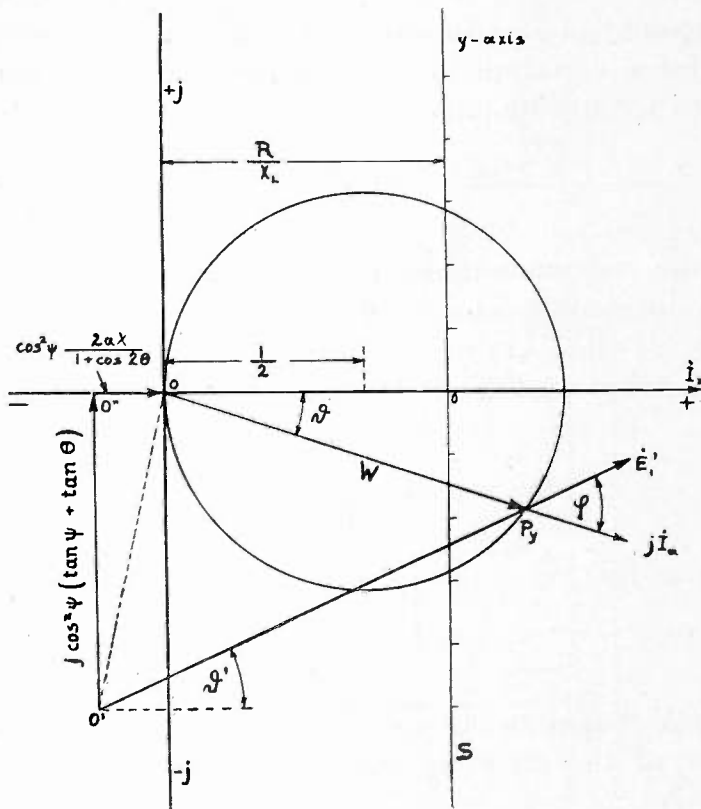

Fig. 7

$Z_1 =$  impedance of line terminating circuit.

$$= R_1 + jX_{L1} - jX_{c1}$$

$$= jZ_0 \tan \psi \left( 1 - j \frac{R_1}{Z_0 \tan \psi} \right).$$

The above relation holds only if  $R_1$  is sufficiently small compared with  $Z_0$ . Now when substituting into (5), (6), and (7) we get

$$E_1 = I_x Z_0 \frac{\cos \theta}{\cos^2 \psi} \left( \cos^2 \psi \left( j \tan \theta + j \tan \psi + \frac{R_1}{Z_0} \right) + \frac{1}{1 + j \frac{X_L}{R} \psi} \right) \quad (26)$$

Comparing this with (25) we find both expressions of identically the same form, the term  $R_1/Z_0$  having the same effect as the term due to the line attenuation in (25). Numerically, however, the term  $R_1/Z_0$  is usually much smaller than the corresponding term in (25) except in the case when  $\psi$  approaches 90 degrees.

### 5. EFFECT OF VARIATIONS IN ANTENNA RESISTANCE

If the capacity of an antenna varies this will in most cases be accompanied by a variation in antenna resistance. We can take this variation into account by putting

$$R = R_0 + dR = R_0 (1 + v) \quad (27)$$

where,

$R_0$  = antenna resistance under normal conditions

$v = dR/R_0$  = percentage change of resistance.

Substituting (27) into (1) to (12), (21) and (24) we obtain for (10), (11), (12), and (21) identically the same expressions, except that the term

$$1 + j \frac{X_L}{R} y$$

is to be replaced by

$$(1 + v) + j \frac{X_L}{R_0} y. \quad (28)$$

The same circle diagrams as those in Fig. 2 and Fig. 7 may be used if the diameter of the circle is made equal to  $1/1+v$  and  $\tan \vartheta = -X_L y/R_0(1+v)$ .

It is evident that also in this case the relations

$$\tan \theta = - \tan \psi$$

and,

$$\tan (\theta + \rho) = - \tan \psi$$

result in zero phase change or minimum phase change, respectively. If they are fulfilled the result of changes in both antenna capacity and antenna resistance is eliminated thus resulting into constant phase and constant (relative) amplitude of the antenna current.

### III. EXPERIMENTAL INVESTIGATION

For the experimental investigation of the theory outlined in the foregoing sections an arrangement was used which is shown schematically in Fig. 8. The capacity in the dummy antenna I consisted of three

capacitors; a fixed capacitor,  $C$ , of about 500 micromicrofarads; a variable capacitor,  $C_1$ , of about 300 micromicrofarads and a small vernier capacitor,  $C_2$ , of about 100 micromicrofarads. The tuning of the circuit for "normal conditions" was performed by variation of  $C_1$  (with  $C_2$  set at 50 degrees), while "not normal conditions" were produced by variation of  $C_2$ . Electrical length and surge impedance of the transmission line was measured. Tuning of antenna circuit and line terminating circuit was done according to the requirements outlined

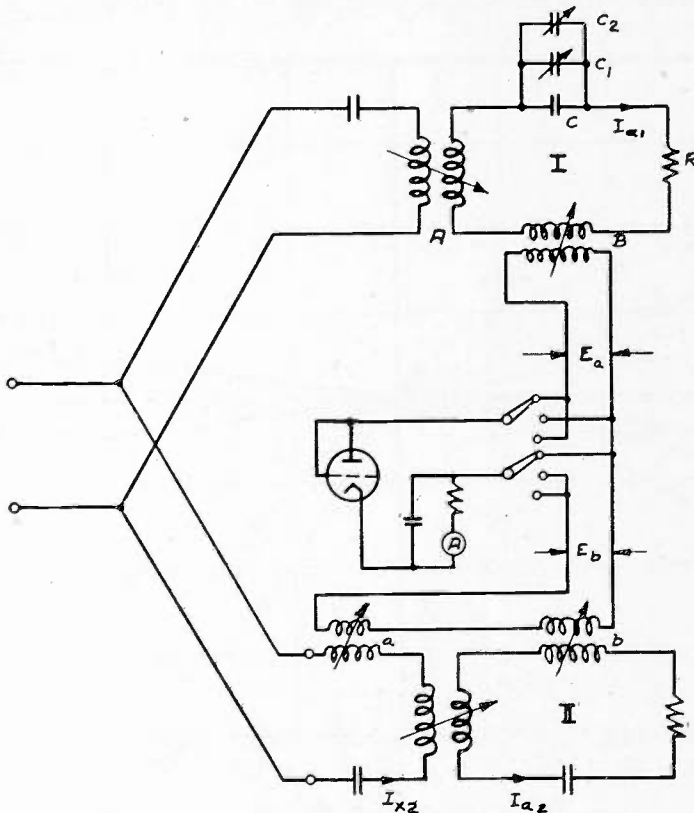

Fig. 8

in Part II, Section 1. Antenna circuit II was used to supply a voltage of fixed phase against which the phase of current I could be compared.

The frequency used was 221 kilocycles.

For measuring the phase the well-known three-voltmeter method was used (Fig. 8). The voltage  $E_a$  (coupled off from circuit I), the voltage  $E_b$  (coupled off from circuit II) and the voltage  $E_a + E_b$  were measured separately. A calibrated rectifier was used as a voltmeter. In order to have the most accuracy obtainable it was necessary to adjust  $E_a$  and  $E_b$  equal in amplitude and opposite in phase if circuit I was set to "normal conditions." This necessitated making the phase

and amplitude of  $E_b$  adjustable. The arrangement shown in Fig. 8 was found to be the most convenient. Antenna circuit II was tuned for series resonance ( $X_L = X_c$ ). This results in making a 90-degree phase displacement between  $I_{x2}$  and  $I_{a2}$ . Then by properly setting the couplings  $a$  and  $b$ , Fig. 8, the phase and amplitude of  $E_b$  can be made any value desired. This arrangement worked very satisfactorily.

Great care had to be taken for eliminating the effects of distributed capacities in the transformers  $A$  and  $B$  and  $a$  and  $b$ . The accuracy of phase measurements was approximately  $\pm 3$  degrees.

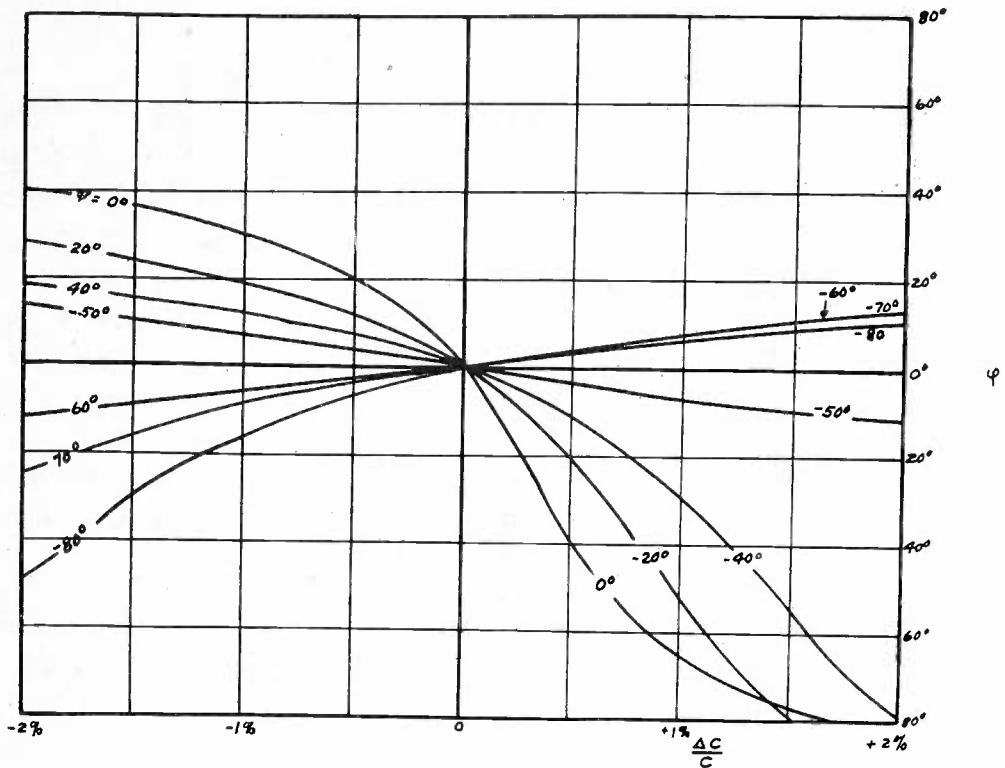

Fig. 9

The transmission lines used consisted of a lead cable No. 14 AWG, 600 volts (No. 14 wire varnished cambric insulation, inner diameter of lead sheath 0.191 inches).

The following measurements were made:

- A. 250-foot line consisting of two lead cables No. 14 AWG bound together. Copper wires used as conductors, lead sheath grounded.

$$Z_0 = 62 \text{ ohms (measured)}$$

$$\theta = 50 \text{ degrees (measured)}$$

The variation in phase between  $I_{a1}$  and  $I_{a2}$  versus  $dC/C$  is shown in Fig. 9.  $\psi$  is parameter ( $\psi$  being the phase angle between  $E_1$  and  $I_{a1}$  under "normal conditions"). The smallest phase change is obtained for a value of  $\psi$  of about  $-50$  or  $-60$  degrees.



B. 175-foot line consisting of one lead cable No. 14 AWG. Lead sheath used as return conductor.

$$Z_0 = 28.6 \text{ ohms (calculated and measured)}$$

$$\theta = 36 \text{ degrees (measured)}$$

The phase variation is shown in Fig. 10. The optimum adjustment for  $\psi$  is about  $-35$  to  $-45$  degrees. Fig. 11 shows the corresponding variation of the current ratio  $I_{a1}/I_{a2}$ , whereby for "normal conditions" this ratio is always put equal to unity.

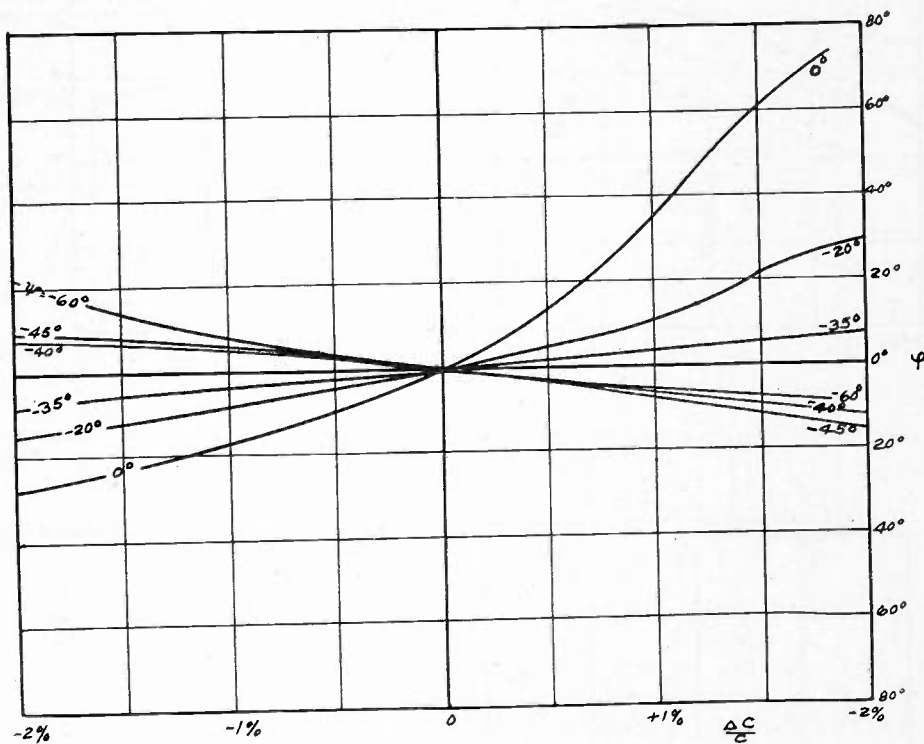

FIG. 10

C. Same line as in B, but with phase shifting network having  $\rho = -36$  degrees. This network is designed according to Part II, Section 2b. with

$$C_s = 77,500 \text{ micromicrofarads}$$

$$L_p = 35 \text{ microhenries}$$

$$Z_0 = 28.6 \text{ ohms (measured)}$$

$$\theta = 36 \text{ degrees (measured)}$$

$$\rho = -36$$

$$\theta + \rho = 0$$

The phase variation is shown in Fig. 12. The optimum adjustment for  $\psi$  is about 0.

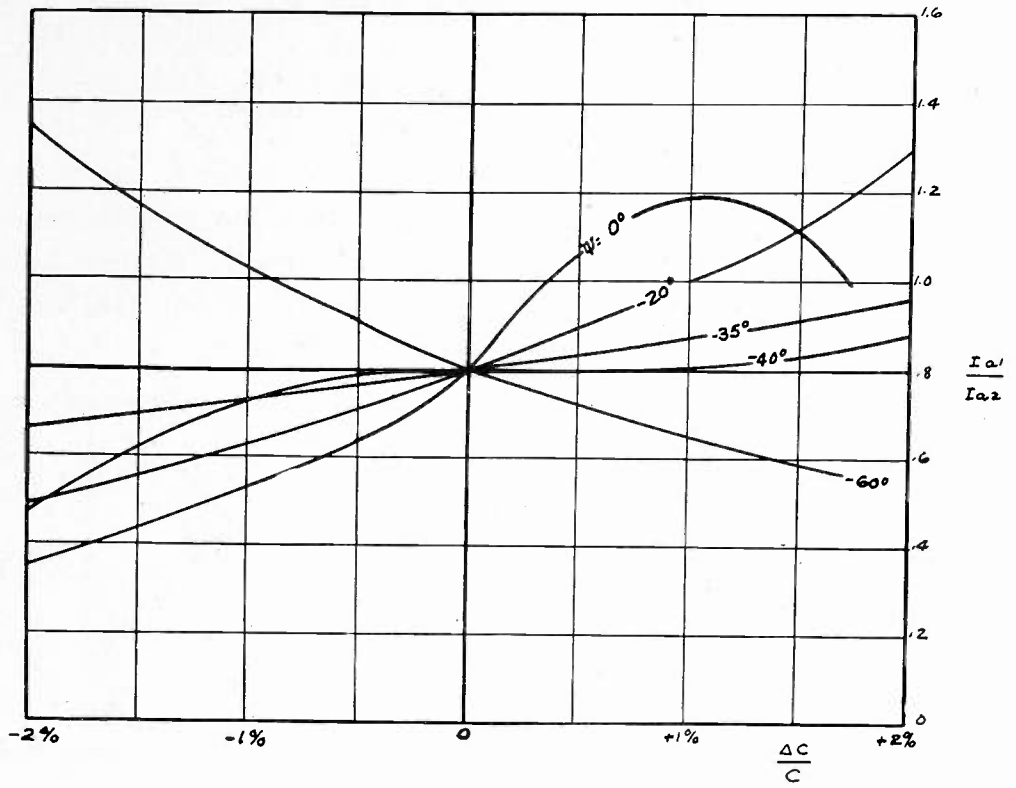

FIG. 11

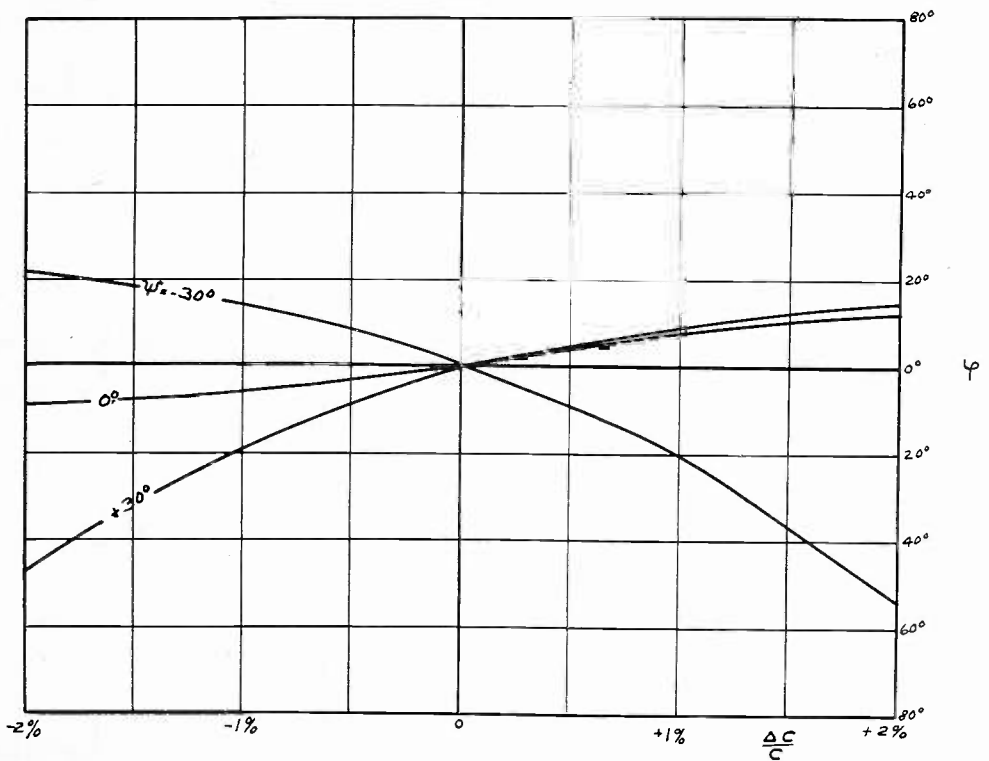

FIG. 12

D. Very short transmission line (high voltage lead cable about 10 feet in length), thus  $\theta$  is approximately zero. The phase variation is shown in Fig. 13. The optimum adjustment is obtained for

$$\psi = 0.$$

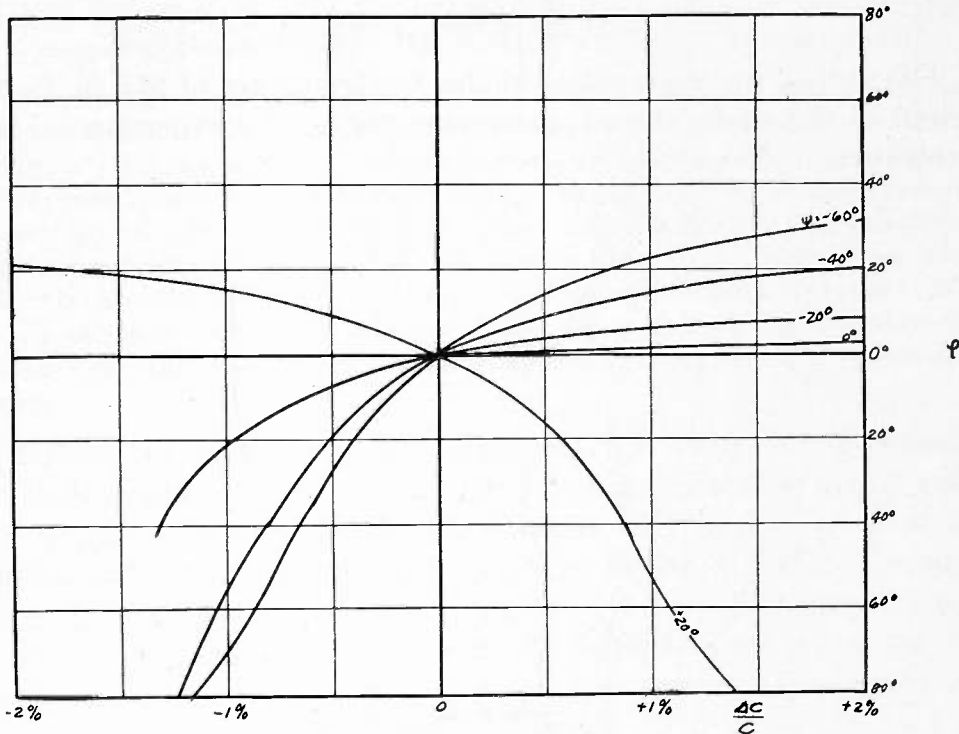

FIG. 13

### III. CONCLUSIONS

1. The above measurements check the theory by which it was requested to make

$$\psi = -\theta$$

or,

$$\psi = -(\theta + \rho).$$

2. The measurement under  $C$  checks the theory of the phase shifting network as made in Part II, Section 2.

3. Case  $B$  (Graph Fig. 11) checks that for  $\psi = -\theta$  the variation in the current ratio  $I_{a1}/I_{a2}$  becomes a minimum.

4. In cases  $A$ ,  $B$ , and  $C$  a perfect zero adjustment of the phase shift was not obtainable. We have, for instance, in measurement  $A$  (Fig. 9) also tried various other values of  $\psi$  from  $-45$  to  $-65$  degrees with results being approximately the same as those shown for  $\psi = -50$  and

-60 degrees. This is probably due to the nonuniformity of the transmission line used and to its attenuation. Also, no special attention had been given to load both conductors of the transmission line equally, a fact which also contributes to the phase stability obtainable. In case *D*, however, a perfect adjustment for zero phase shift could be made.

#### ACKNOWLEDGMENT

The author wishes to acknowledge the assistance of Mr. E. B. McDowell of the Radio Test Department during the experimental part of this investigation.



## INDUCTANCE AT HIGH FREQUENCIES AND ITS RELATION TO THE CIRCUIT EQUATIONS\*

BY  
J. G. BRAINERD

(Moore School of Electrical Engineering, University of Pennsylvania, Philadelphia Pa.)

**Summary**—Inductance is essentially a low-frequency concept. On the other hand, transmission line analysis based on low-frequency circuit equations can be applied to lines and even antennas carrying high-frequency currents, with approximately correct results in many cases. The problem here attacked is that of determining in what manner the term  $-LdI/dt$ , representing the self-induced electromotive force, must be modified when low-frequency circuit theory is applied to high-frequency wire circuits. The results indicate that in addition to a change in  $L$ , an entirely new term  $Nd^2I/dt^2$  must be introduced. The quantity  $\omega^2N$ , here called radiactance, has units of ohms and is intimately related to the so-called radiation resistance.

INDUCTANCE, as usually understood, is a low-frequency concept. Self-inductance is often computed in a given case with the aid of Ampere's formula, which itself holds only at low frequencies.<sup>1</sup> Mutual inductance is assumed to be given by a formula such as  $M_{ab} = \int (ds_a \cdot ds_b) / r$  where  $ds_a$  and  $ds_b$  are (vector) elements of length of two wire circuits,  $r$  is the (scalar) distance between them and  $ds_a \cdot ds_b$  denotes the dot product of the two vectors. This again is a formula which holds only at low frequencies.

At high frequencies it is desirable to deal with electric and magnetic fields, as is usually done. However, in the case of simple wire circuits and transmission lines the low-frequency analysis which deals directly with currents and electromotive forces is often applied to high-frequency problems. Carson<sup>2</sup> has emphasized the need for more rigorous analysis, and in general the direct application of the low-frequency circuit theory to high-frequency problems should be made only with extreme caution.

The particular problem considered here is the change in inductance with increasing frequency; at least so the problem may be considered initially. Actually the change in inductance will prove less important than the need for a new parameter not of the same nature as inductance.

\* Decimal classification R145.3 × R140. Original manuscript received by the Institute, November 20, 1933.

<sup>1</sup> See, for example, Rosa and Grover, "Formulas and tables for the calculation of mutual and self-inductance," *Bulletin Bureau of Standards*, vol. 8, p. 1, (1912), and references there cited.

<sup>2</sup> Carson, "Electromagnetic theory and the foundations of electric circuit theory," *Bell Sys. Tech. Jour.*, vol. 6, p. 1; January, (1927).

In Heaviside-Lorentz units Maxwell's equations are<sup>3</sup>

$$\begin{aligned} \frac{1}{c} \left( \mathbf{J} + \frac{\partial \mathbf{D}}{\partial t} \right) &= \nabla \times \mathbf{H} \\ \nabla \cdot \mathbf{D} &= \rho \\ -\frac{1}{c} \frac{\partial \mathbf{B}}{\partial t} &= \nabla \times \mathbf{E} \\ \nabla \cdot \mathbf{B} &= 0 \end{aligned} \quad (1)$$

where  $\mathbf{J}$  is the vector conduction current density,  $\mathbf{D}$  the vector electric flux density,  $\mathbf{H}$  the vector magnetic field strength,  $\mathbf{B}$  the vector magnetic flux density,  $\mathbf{E}$  the vector electric field strength,  $\rho$  the electric charge density, and  $c$  a constant ( $3 \times 10^{10}$  cm per sec).

The solutions of equations (1) for  $\mathbf{B}$  and  $\mathbf{D}$  are<sup>4</sup>

$$\begin{aligned} \mathbf{B} &= \mu \mathbf{H} = \nabla \times \mathbf{U} \\ \mathbf{D}/k &= \mathbf{E} = -\frac{1}{c} \frac{\partial \mathbf{U}}{\partial t} - \nabla \Phi \end{aligned} \quad (2)$$

where  $\mu$  and  $k$  are the magnetic and dielectric permeabilities respectively,

$$\mathbf{U} = \frac{\mu}{4\pi c} \int \frac{\mathbf{J}(t - r/c)}{r} dV \quad (3)$$

and,

$$\Phi = \frac{1}{4\pi k} \int \frac{\rho(t - r/c)}{r} dV.$$

Here  $dV$  is an element of volume,  $r$  the distance from  $dV$  to the point at which  $\mathbf{U}$  or  $\Phi$  is being evaluated at time  $t$ ,  $\mathbf{J}(t - r/c)$  is the value of  $\mathbf{J}$  at a time  $r/c$  earlier than  $t$ ,  $\rho(t - r/c)$  is similar, and the integrals are to be taken throughout all space.

Equations (2) and (3) lead to

$$\mathbf{B} = -\frac{\mu}{4\pi c} \int (\mathbf{r}_1 \times \mathbf{J}_1) \left[ \frac{\mathbf{J}(t - r/c)}{r^2} + \frac{J'(t - r/c)}{rc} \right] dV \quad (4)$$

where  $\mathbf{J}_1$  is a unit vector in the direction of  $\mathbf{J}$ , and  $J'$  is the derivative of  $J$  with respect to  $(t - r/c)$ .

<sup>3</sup> For vector notation see Appendix A.

<sup>4</sup> The given solutions have a few minor restrictions of no consequence in the applications made here.

Equation (4) is fundamental to a study of inductance, or, more generally, to a study of the magnetic field. It shows, for example, that the lines of force about a section of a straight cylindrical conductor far removed from all other conductors, including the return portion of its own circuit, are circles concentric with the cylinder and lying in planes normal to the cylinder. This assumes that the current density  $J$  in the conductor is symmetrically distributed about the center line. The result holds at all frequencies.

At low frequencies (wavelength  $\lambda \gg 2\pi r$ ) the idea of inductance may be introduced from (4) in the following manner. For frequency  $f \ll c/2\pi r$ , the term  $J'/rc$  is negligible and  $J(t-r/c)$  may be written  $J(t)$  without appreciable error. Then

$$\mathbf{B} = -\frac{\mu}{4\pi c} \int (\mathbf{r}_1 \times \mathbf{J}_1) \frac{J(t)}{r^2} dV.$$

For a circuit or a portion of a circuit the linear length of which is small,  $J(t)$  is substantially the same at any instant over every normal cross section of a given uniform conductor. Hence the flux density at a point due to any such circuit or portion of a circuit is<sup>5</sup>

$$\mathbf{B} = -\frac{\mu I(t)}{4\pi c} \int \frac{\mathbf{r}_1 \times \mathbf{J}_1}{r^2} ds \quad (5)$$

where  $ds$  is an element of length of the conductor and  $I(t)$  the current passing through normal cross section of the conductor. Equation (5) is Ampere's law, the differential form of which follows by considering the contribution to  $\mathbf{B}$  due to the current in a differential length  $ds$  of the conductor.

From  $(-1/c)\partial\mathbf{B}/\partial t = \nabla \times \mathbf{E}$  it follows that

$$-\frac{1}{c} \frac{\partial}{\partial t} \int_S \mathbf{B} \cdot d\mathbf{S} = \int_0 \mathbf{E} \cdot d\mathbf{s} = E_{mf} \quad (6)$$

where  $d\mathbf{S}$  is an element of a surface  $S$ ,  $ds$  an element of length of the circuit forming the periphery of  $S$ , and the integrals are to be taken over the entire surface  $S$  and around the entire periphery respectively. But (5) shows that  $I(t)$  is the only time function in the surface integral. Hence,

$$-L \frac{\partial I}{\partial t} = E_{mf} \quad (7)$$

<sup>5</sup> A slight approximation is introduced here.

where  $L$  is a quantity, called the self-inductance of the circuit, which is dependent on the geometry of the circuit and  $\mu$  only. Equation (7) states that the magnetic field due to the current in a circuit "induces" in that circuit an electromotive force. In circuits of simple geometrical form and in those possessing geometrical symmetry of a kind it is frequently possible to assign inductance to portions of the circuit, and the concept of inductance per unit length of conductor is thus formed. Hence at low frequencies there is an electromotive force  $-LdI/dt$  which appears in the circuit equations of fixed circuits of small linear dimensions ( $I$  assumed same at each cross section of a given conductor) and equally in the equations for *differential* lengths of conductors in a circuit of large linear dimensions (transmission line) in which  $I$  cannot be assumed the same at each cross section of a given conductor. In this manner phase propagation can be inferred from the circuit equations in the case of a transmission line, and is independent of the term neglected in the right-hand side of (4), which is the radiation term.

In the case of high frequencies ( $\lambda \ll 2\pi r; f \gg c/2\pi r$ ) the neglect of the  $J'$  term and of the retardation in (4) is not justified. The magnetic flux density  $\mathbf{B}$  at any point will now be a function of  $t$  due to both the  $J$  and the  $J'$  terms. Equation (6) is general and holds at all frequencies. Hence, instead of getting (7) as the expression for the electromotive force in a circuit due to the magnetic field set up by the current in that circuit, two terms are obtained upon substituting  $\mathbf{B}$  as given by (4) in (6); one of these terms contains  $J(t-r/c)$  and the other  $J'(t-r/c)$  under integral signs:

$$E_{mf} = - \frac{\mu}{4\pi c^2} \frac{\partial}{\partial t} \int \left\{ \int (\mathbf{r}_1 \times \mathbf{J}_1) \left[ \frac{J(t-r/c)}{r^2} + \frac{J'(t-r/c)}{rc} \right] dV \right\} \cdot d\mathbf{S}. \quad (8)$$

Now if an equation for electromotive force in a short fixed section of a conductor is to be written in a form similar to that which would be written for the low-frequency case, then the electromotive force due to the magnetic field set up by the currents in the circuit itself, that is, the electromotive force which corresponds to the negative of the self-inductive drop at low frequencies, will be of the form

$$-L \frac{dI}{dt} + N \frac{d^2I}{dt^2} = E_{mf} \quad (9)$$

where  $N$  is a parameter of dimensions<sup>6</sup>  $\mu TL$  whereas inductance has dimensions  $\mu L$  and resistance has dimensions  $\mu LT^{-1}$ .



A more or less rigorous deduction of the expression (9), which is intended to be an approximation of (8) in circuit analysis, is given in Appendix B. It may be justified roughly by several considerations:

(1) Equation (8) indicates an equation of the type of (9) as a possible equivalent.

(2) If the circuit equations of a short length of conductor carrying a high-frequency current are to be written in a form analogous to those for the low-frequency case, then (8) indicates that (9) will at least be a better approximation than  $-LdI/dt$  alone.

(3) A partial justification of (8) can be made a posteriori. It is known that in some cases the low-frequency analysis holds to a certain degree for currents varying so rapidly that radiation of energy is appreciable. Transmission lines used at radio frequencies and antennas, to which transmission-line theory is applied, are examples. We will show immediately that the low-frequency analysis (without the  $Nd^2I/dt^2$  term) is consistent with (9).

Consider a circuit or portion of a circuit for which

$$rI + L \frac{dI}{dt} - N \frac{d^2I}{dt^2} \quad (10)$$

gives the resistance and the two-part "inductive" drop. The linearity of the usual circuit equations is not disturbed by the introduction of the  $Nd^2I/dt^2$  term. Hence, using complex numbers, (10) corresponds to

$$(r + j\omega L + \omega^2 N)I \quad \text{or} \quad (r + \omega^2 N)I + j\omega LI \quad (11)$$

where  $I$  is the complex equivalent of  $I$ ,  $\omega$  is  $2\pi$  times the frequency, and  $j \equiv \sqrt{-1}$ . Thus it is seen that the  $\omega^2 N$  term may be included in the "effective" resistance. This is entirely a practicable device and explains why the low-frequency analysis of a transmission line applies as well as it does to a line or antenna carrying high-frequency currents.

Fundamentally,  $r$ ,  $\omega L$ , and  $\omega^2 N$  all differ. Each has the ohm for a unit, but just as reactance  $\omega L$  and resistance  $r$  are distinguished, so should  $\omega^2 N$  be identified as a quantity separate from  $r$  and  $\omega L$ . It might indeed be given a distinctive name, *radiactance*, for example.

<sup>6</sup>  $T$  = time,  $L$  = length,  $\mu$  = magnetic permeability in this sentence. It will be noticed that in going from (8) to (9) both inductance and  $N$  are defined very loosely. In the case of sinusoidally varying current densities much more exact definitions are given in Appendix B, and in this important case both the inductance and  $N$  will be real only to a first approximation; in general, each will be complex.

It should also be emphasized that the current  $I$  in (9) is the current at some particular point. In the integral of (8) this means that the currents at other points must be expressed in terms of the current at a particular point. The variations of the currents from point to point must be included within the integrals.

Practically, the fact that  $rI$  and  $\omega^2NI$  are in phase [equation (11)] has led to the inclusion of  $\omega^2N$  with  $r$  in an "effective" resistance. For  $\omega^2N$  is simply the so-called *radiation resistance*,<sup>7</sup> which as pointed out above might be named radiactance. The radiactance multiplied by  $I^2$  represents rate of energy radiation. It does not represent rate of energy dissipation as heat and it is just as much, and no more, a factor by which  $I$  is to be multiplied to give a drop as is  $j\omega L$  [equation (10)] while equation (10) shows that  $r$  and  $N$  are fundamentally different. The term "radiation resistance" is thus unjustified from any except a strictly practical point of view and the coincidence that  $rI$  and  $\omega^2NI$  are in phase [equation (11)]. It may be noted here, incidentally, that from the practical point of view, radiation resistance is the factor by which  $I^2$  must be multiplied to give rate of energy radiation; by a similar argument  $\omega L$  is a resistance since it is the factor by which  $I^2$  must be multiplied to give the average rate of energy storage in the magnetic field.

#### APPENDIX A

*Vector Notation.* The Gibbs' notation is used. Bold-faced symbols denote vectors, the same symbol in italics and not bold-faced denotes the magnitude of the vector. Except in (11) all vectors are space vectors, not vectors representing the complex numbers of alternating-current circuit theory. The dot product  $\mathbf{a} \cdot \mathbf{b}$  is the same as the scalar or inner product of  $\mathbf{a}$  and  $\mathbf{b}$ ; the cross product  $\mathbf{a}\mathbf{b}$ , is the same as the vector or outer product of  $\mathbf{a}$  and  $\mathbf{b}$ . The quantity

$$\nabla \equiv \mathbf{i} \frac{\partial}{\partial x} + \mathbf{j} \frac{\partial}{\partial y} + \mathbf{k} \frac{\partial}{\partial z}$$

( $\mathbf{i}, \mathbf{j}, \mathbf{k}$ , unit vectors parallel to the axes  $XYZ$  of a rectangular coordinate system) is both a vector and a differential operator.  $\nabla \times \mathbf{H}$  is the cross product of  $\nabla$  and  $\mathbf{H}$ , sometimes called the curl of  $\mathbf{H}$ ;  $\nabla \cdot \mathbf{D}$  is the dot product of  $\nabla$  and  $\mathbf{D}$ , sometimes called the divergence of  $\mathbf{D}$ ;  $\nabla \Phi$  where  $\Phi$  is a scalar function of  $x, y, z; t$  is sometimes called the gradient of  $\Phi$ .

#### APPENDIX B

*Derivation of Equation (9).* In view of the essential linearity of the fundamental equations (1), the current density  $J(x, y, z, t)$  can be expanded in a Fourier series and each component treated separately. Let

$$\mathbf{J}(x, y, z, t) = \mathbf{J}_1 J(x, y, z) e^{j\omega t}$$

<sup>7</sup> For a derivation of radiation resistance from the fundamental equations (1) to (4) see Stuart Ballantine, "On the radiation resistance of a simple antenna at wave lengths below the fundamental," Proc. I.R.E., vol. 12, p. 823; December, (1924).

where  $\omega$  is a constant and  $\epsilon$  the base of the natural logs. Then,

$$J(x, y, z, t - r/c) = J_1 J(x, y, z) \epsilon^{i\omega(t-r/c)}.$$

Substituting in (8) and writing  $J$  for  $J(x, y, z)$

$$E_{mf} = (j\omega\epsilon^{i\omega t})A \int \left\{ \int (\mathbf{r}_1 \times \mathbf{J}_1) \frac{J}{r^2} \epsilon^{-i(\omega r/c)} dV \right\} \cdot d\mathbf{S} \\ + (-\omega^2\epsilon^{i\omega t})A \int \left\{ \int (\mathbf{r}_1 \times \mathbf{J}_1) \frac{J}{rc} \epsilon^{-i(\omega r/c)} dV \right\} \cdot d\mathbf{S} \quad (12)$$

( $A \equiv -\mu/4\pi c^2$ ). From this it at once follows that

$$E_{mf} = j\omega LI\epsilon^{i\omega t} - \omega^2 NI\epsilon^{i\omega t} \quad (13)$$

where  $I\epsilon^{i\omega t}$  represents the total current passing any cross section of a conductor, and  $L$  and  $N$  are parameters which for a given frequency, fixed circuit, and fixed distribution of the current over every cross section of the conductors of the circuit will be constants. Since (13) is exactly equivalent to (11), it has been shown that the latter applies in the steady (alternating) state. Furthermore, the argument used in deducing (12) shows that (10) holds to a certain approximation.

It may be noted in (12) that both  $L$  and  $N$  are functions of the frequency in general, and that either or both may be complex, a fact disregarded in discussing (11) but which does not change the final results qualitatively since it is possible to resolve the complex  $L$  and  $N$  in two components, one in the real and one in the  $j$  direction.



## RADIO ABSTRACTS AND REFERENCES

THIS is prepared monthly by the Bureau of Standards,\* and is intended to cover the more important papers of interest to the professional radio engineer which have recently appeared in periodicals, books, etc. The number at the left of each reference classifies the references by subject, in accordance with the "Classification of Radio Subjects: An Extension of the Dewey Decimal system," Bureau of Standards Circular No. 385, obtainable from the Superintendent of Documents, Government Printing Office, Washington, D. C., for 10 cents a copy. The classification also appeared in full on pp. 1433-1456 of the August, 1930, issue of the PROCEEDINGS of the Institute of Radio Engineers.

The articles listed are not obtainable from the Government or the Institute of Radio Engineers, except when publications thereof. The various periodicals can be secured from their publishers and can be consulted at large public libraries.

### R000. RADIO (GENERAL)

- R004 F. Cutting and H. A. Gates. Some of the problems of motor-car  
×R360 radio design. *Radio Engineering*, vol. 14, pp. 16-17, 22; January, (1934).

The following problems of motor-car radio design are discussed: Those occasioned by the necessarily small antenna and consequent small signal pick-up; those due to ignition; interference; acoustic problems and satisfactory power supply; those resulting from the severe mechanical and physical requirements and limitations.

- R009 Lt. Col. Chetwoode Crawley. Twelve months of progress—Com-  
×R090 mercial achievements in 1933. *Wireless World* (London), vol. 33, pp. 494-496; December 29, (1933).

Outline of salient features of progress in radio for the year 1933.

- R051 R. C. Walker and T. M. C. Lance. Photo-electric cell applications  
×R535.3 (book). Sir Isaac Pitman, London, England, 1933. Price 8 shillings, 6 pence.

Practical applications of the photo-electric cells are dealt with. Applications to photo-telegraphy, television, and scientific instruments are described.

- R051 L. R. Koller. The physics of electron tubes (book). McGraw-Hill  
×R130 Book Co., Inc., New York, N. Y., 1933. Price \$3.00.

The book presents the fundamental physical phenomena involved in the operation of electron tubes in a thorough yet not ultra-technical treatment. Emphasis is placed on what takes place inside the tube rather than the circuits in which the tubes operate or the applications of the tubes. It covers recent advances in the field and brings together in one volume much material which has heretofore been available only in scattered publications.

- R070 What radio engineers are thinking and talking about. *Radio Engin-  
×R360 neering*, vol. 14, p. 15; January, (1934).

A report of an informal discussion at a meeting of the Institute of Radio Engineers in New York of qualifications of radio engineers and the merits of present-day radio receivers.

- R084 C. A. Mizen. Visualizing the formula. *Radio Engineering*, vol. 14,  
pp. 6-8; January, (1934).

Some well-known radio formulas are presented in a graphical manner. It is shown how certain routine computations may be made in one tenth the usual time by the use of such charts.

\* This list compiled principally by Miss E. M. Zandonini and Mr. E. L. Hall.

## R100. RADIO PRINCIPLES

- R113 Sir F. E. Smith. The Twenty-fourth Kelvin Lecture—"The travel of wireless waves." *Jour. I.E.E.* (London), vol. 73, pp. 574-590; December, (1933).  
The author discusses the development of the practice and theory of propagation of wireless waves over the surface of the earth and in the ionosphere. The discussion considers the viewpoints of the radiotelegraphist and that of the geophysicist independently. The result obtained when the two viewpoints are combined is then discussed.
- R113 D. R. Hartree. The dispersion formula for an ionized medium (letter). *Nature* (London), vol. 132, pp. 929-930; December 16, (1933).  
An answer to previous letters in which Dr. L. Tonks criticizes the use by the author of an expression relating the ionization density, the refractive index, and the frequency of waves in an ionized medium.
- R113 R. L. Smith-Rose and J. S. McPetrie. Ultra-short radio waves—Refraction in the lower atmosphere. *Wireless Engineer & Experimental Wireless* (London), vol. 11, pp. 3-11; January, (1934).  
Some aspects of the problem of the refraction of electric waves in the lower atmosphere due to the variation of density of the air with altitude are considered. A summary of previous work is given and particular attention is drawn to the experimental evidence on the ultra-high frequencies (0.5 to 8 meters) indicating possible communication ranges of nearly fifty per cent in excess of those determined by the rectilinear or optical path. On the basis of the calculation made in this paper, it appears that the curvature of the waves by refraction is not sufficient to explain some of the experimental results.
- R113 H. T. Friis, C. B. Feldman, and W. M. Sharpless. The determination of the direction of arrival of short radio waves. *Proc. I.R.E.*, vol. 22, pp. 47-78; January, (1934).  
×R115
- R113.55 S. S. Kirby, L. V. Berkner, T. R. Gilliland, and K. A. Norton. Radio observations of the Bureau of Standards during the solar eclipse of August 31, 1932. *Bureau of Standards Journal Research*, vol. 11, pp. 829-845; December, (1933). Research Paper No. 629.  
Radio observations of the heights of the several layers of the ionosphere were made at Washington, D. C. and Sydney, Nova Scotia, by the pulse method during the afternoon of the solar eclipse of August 31, 1932 and during the afternoons of several days preceding and following. It was found that the ionization for the E layer decreased to about 30 per cent of normal and that for the F<sub>1</sub> region it decreased to about 40 per cent of normal very nearly in phase with the optical eclipse. No unusual change was evident in the F<sub>2</sub> critical frequency. No evidence of a corpuscular eclipse was found at either Washington or Sydney.
- R113.61 J. A. Ratcliffe and E. L. C. White. Some automatic records of wireless waves reflected from the ionosphere. *Proc. Phys. Soc.* (London), vol. 46, pp. 107-115; January 1, (1934).  
Some automatic records of wireless waves reflected from the ionosphere are discussed. The records extend over a period of fourteen months. A statistical investigation is made to see whether the occurrence of the nocturnal ionization in region *e* is associated with the occurrence of magnetic disturbances or of thunderstorms. It is shown that if the nocturnal ionization was unrelated to magnetic disturbances the probability of the observed coincidences between the occurrence of the two phenomena would be 0.01 and if the thunderstorms and the nocturnal ionization were unrelated the corresponding probability would be 0.0015.
- R113.61 F. W. G. White. The diurnal variation of the intensity of wireless waves reflected from the ionosphere. *Proc. Phys. Soc.* (London), vol. 46, pp. 91-106; January 1, (1934).  
An account is given of the diurnal variation of the relative intensity of waves returned from the ionized regions of the upper atmosphere as observed over the early morning period from about 2 A.M. until about 9 A.M. The relative intensity is taken as the ratio of the intensity of the downcoming wave to that of the ground wave. Experimental observations described show that the magneto-ionic doubling of the echo, which has been observed by Appleton and Builder for the F region, occurs also for the E region. The doublet echo for this region is observed only for a short period of the morning, owing to the fact that the extraordinary ray is very soon totally absorbed.

- R120  
×R084 C. E. Rickard. Graphical method for determining fundamental wavelength of a broadcast aerial. *Marconi Review*, no. 45, pp. 3-7; November-December, (1933).

Graphical methods adopted for practical filter and transmission line calculation are brought to bear on the design of antennas, and an abac has been developed which gives the frequency of a broadcast antenna as a function of its dimensions.

- R120  
×R320 E. F. Johnson and R. P. Glover. A practical transmission-line system for the doublet system. *QST*, vol. 18, pp. 17-21; January, (1934).

Means of impedance matching to a transmitting antenna utilizing a quarter-wave section transformer fed from a main transmission line are discussed. A simple theoretical explanation and some mechanical construction ideas of such a system are given.

- R130 B. C. Sil. On the variation of the interelectrode capacity of a triode at high frequencies. *Phil. Mag.* (London), vol. 16, pp. 1114-1128; December, (1933).

A study of the conditions under which the dielectric constant of the plate-grid space of a triode vacuum tube increases or decreases.

- R135 S. Bagno and S. S. Egert. Linear modulation by a 55-tube. *Electronics*, vol. 7, pp. 16-17; January, (1934).

The possibilities of full-wave rectification by a 55-type tube with various biases on the diode plates for linear modulation in signal generators is investigated.

- R144  
×R382 B. B. Austin. The effective resistance of inductance coils at radio frequency. *Wireless Engineer & Experimental Wireless* (London), vol. 11, pp. 12-16; January, (1934).

This is an abstract of a paper by S. Butterworth published in 1926 which gave formulas for the calculation of high-frequency coils. The following subjects are treated: Influence of coil shape and wire diameter on high-frequency resistance, calculation of inductance, best wire diameter (solid and stranded), high-frequency resistance (solid and stranded wire), and high-frequency resistance of straight wire.

- R191  
×537.65 H. Straubel. Schwingungsformen piezo-elektrische Kristalle. (Modes of vibration of piezoelectric crystals.) *Phys. Zeit.*, vol. 34, pp. 894-896; December 15, (1933).

Modes of vibration of quartz and tourmaline plates are studied by the interferometer method. The frequencies of the quartz plates were 555 and 750 kilocycles and of the tourmaline plate, 750 kilocycles.

## R200. RADIO MEASUREMENTS AND STANDARDIZATION

- R243.1 F. V. Hunt. A vacuum-tube voltmeter with logarithmic response. *Rev. Sci. Instr.*, vol. 4, pp. 672-675; December, (1933).

A new vacuum-tube voltmeter which has a response proportional to the logarithm of the input voltage is described.

- R262.4  
×R132 O. H. A. Schmitt. Method for realizing the full amplification factor of high- $\mu$  tubes. *Rev. Sci. Instr.*, vol. 4, pp. 661-664; December, (1933).

Description of a method to attain full amplification of 1500-2500 per stage for the "57" type of vacuum tube using only 300-600 volts plate supply.

- R282.1 R. G. Zender. Characteristics of insulated wires used in radio set production. *Electronics*, vol. 7, pp. 18-19; January, (1934).

Data on the voltage breakdown, moisture absorption and capacitance of textile insulated hook-up wire used in radio receiving sets are given.

## R300. RADIO APPARATUS AND EQUIPMENT

- R325.3 L. S. Palmer and D. Taylor. The action of a tuned rectangular frame aerial when transmitting short waves. *Proc. Phys. Soc.* (London), vol. 46, pp. 62-75; January 1, (1934).  
Experiments are described which show that a variation of the coil-dimensions affects both the coil current and radiation and that these quantities only attain their maximum values if the coil-dimensions are suitably adjusted.
- R325.3 L. S. Palmer, D. Taylor, and R. Witty. The current-distribution round a short-wave frame aerial. *Proc. Phys. Soc.* (London), vol. 46, pp. 76-90; January 1, (1934).  
Experimental results are described which verify the conclusions concerning the positions of the antinodes and the effects produced by a revolving coil antenna.
- R325.3 L. S. Palmer and D. Taylor. Rectangular short-wave frame aeri-als for reception and transmission. *Proc. I.R.E.*, vol. 22, pp. 93-114; January, (1934).
- R355 R. B. Parmenter. A convertible push-pull oscillator or amplifier. *QST*, vol. 18, pp. 22-24; January, (1934).  
Constructional details of a simple, inexpensive, medium power unit.
- R355.4 L. C. Waller. An efficient CW and 'phone transmitter using the new tubes and circuits. *QST*, vol. 17, pp. 13-17; December, (1933); vol. 18, pp. 11-16, January, (1934).  
Multifrequency operation in the amateur bands, quartz plate control, use of the type 800 vacuum tube, speech amplifier and a class B modulator unit are discussed in this paper.
- R355.5 F. Hamburger, Jr. Electron oscillations with a triple-grid tube. *Proc. I.R.E.*, vol. 22, pp. 79-88; January, (1934).
- R355.7 G. Grammar. Improving the performance of the neutralized power amplifier. *QST*, vol. 18, pp. 27-31; January, (1934).  
Permanent neutralization, higher efficiency, and harmonic suppression in the power amplifier are discussed.
- R355.8 W. T. Ditcham. A note on tests of the "Floating carrier" method applied to a broadcasting transmitter. *Marconi Review*, no. 45, pp. 1-2; November-December, (1933).  
An improved method of modified amplitude modulation in which the carrier power is automatically adjusted to suit the modulation is described and results of some tests which have been carried out to determine its practical value are given.
- R356.3 S. R. Durand. Metal-clad grid-controlled mercury rectifiers for  
×621.313.7 radio stations. *Electronics*, vol. 7, pp. 4-6; January, (1934).  
Description of metal-clad grid-controlled mercury rectifiers for use in high power broadcast stations. These rectifiers have six main anodes so as to provide six-phase rectification. The total power required by the vacuum pumps and excitation circuits is about the same as that required by the filaments of rectifier tubes, so that the metal-clad rectifier is equivalent in operating characteristics to a vacuum tube rectifier employing six three-element mercury vapor tubes with the exception that the life of the metal-clad unit is unlimited.
- R361 A. N. Goldsmith. Conditions necessary for an increase in usable receiver fidelity. *Proc. I.R.E.*, vol. 22, pp. 9-15; January, (1934).
- R363 L. A. Turner. On balanced d.c. amplifying circuits. *Rev. Sci. Instr.*, vol. 4, pp. 665-671; December, (1933).  
Three different circuit arrangements are described for use with a single vacuum tube in order to balance out effects of fluctuations of the electromotive force of the plate battery.

- R363 W. L. Watton. The reduction of filament battery coupling in amplifiers. *Wireless Engineer & Experimental Wireless* (London), vol. 11, pp. 17-21; January, (1934).  
A frequently unsuspected source of coupling between different stages of vacuum tube amplifiers is described. Its nature is investigated and methods are suggested for reducing the amount of coupling from this cause. Curves are given showing the amount of reduction to be expected from any given arrangement.
- R363.1 Correlation of theoretical and experimental data on class C operation of radio-frequency amplifiers. *Radio Engineering*, vol. 13, pp. 12-14; December, (1933).  
The question of tube and circuit efficiency is considered with respect to class C operation of radio-frequency amplifiers with very high positive grid swings.
- R363.2 W. S. Mortley. The design of low-frequency transformer-coupled amplifiers. *Marconi Review*, no. 45, pp. 25-30; November-December, (1933).  
The design of audio-frequency transformer-coupled amplifiers is examined from the viewpoint of wave filter theory in such a manner as to insure linear response over a wide range of frequencies. The effects resulting from component imperfections are treated in this manner, and an example is given of the performance obtained from an amplifier designed from such considerations.
- R363.2 E. O. Scriven. Auditory perspective—Amplifiers. *Electrical Engineering*, vol. 53, pp. 25-28; January, (1934).  
Some problems are discussed in the design of a system of amplifiers which must amplify with great fidelity practically the whole range of audible frequencies and be capable of delivering a high level while at the same time providing a wide volume range.
- R363.2 H. S. Black. Stabilized feed-back amplifiers. *Electrical Engineering*, vol. 53, pp. 114-120; January, (1934).  
Describes and explains theory of the feed-back principle and demonstrates how stability of amplification, reduction of modulation products and certain other advantages follow when stabilized feed-back is applied to an amplifier. The principle of design by means of which "singing" is avoided is also set forth. Results obtained on amplifiers which have been built employing this new principle are given.
- R365.2 H. F. Olson. A cone loud speaker for high fidelity sound reproduction. *Proc. I.R.E.*, vol. 22, pp. 33-46; January, (1934).
- R365.2 E. C. Wentz and A. L. Thuras. Auditory perspective—Loud speakers and microphones. *Electrical Engineering*, vol. 53, pp. 17-24; January, (1934).  
Principles of design of the loud speakers and microphones used in the Philadelphia-Washington experiment are treated at length in this paper.
- R365.2 The piezo-electric loud speaker. *Wireless World* (London), vol. 34, pp. 5-6; January 5, (1934).  
Describes a unit now available in England using sections of Rochelle salt crystals for the piezo-electric loud speaker.
- R382 W. J. Polydoroff. Further notes on iron-core coils for use at r.f. and i.f. *Electronics*, vol. 7, p. 13; January, (1934).  
A discussion of iron-cored coils for use in radio receiving sets.
- R383 L. F. Curtiss. Lacquer-coated resistors. *Rev. Sci. Instr.*, vol. 4, pp. 679-680; December, (1933).  
Description of a compact form of resistor of high resistance, consisting of graphite on Pyrex, sealed in glyptal lacquer which has been found very satisfactory. Resistors of this type with a resistance of  $10^8$  to  $10^{12}$  ohms may be made with comparative ease. They are not affected by changes of temperature or humidity and their small size renders them useful where economy of space is essential.



- R386 J. S. Meck. Filter systems for use with auto radio power supplies.  
 ×R366.1 *Radio Engineering*, vol. 14, pp. 19-20; January, (1934).  
 An engineering comparison of the motor-generator and vibrator systems of providing plate voltages for vacuum tubes in automobile receiving sets with respect to filter systems.
- R386 W. T. Cocking. Adjusting band-pass filters. *Wireless World* (London), vol. 34, pp. 11-12; January 5, (1934).  
 A simple and accurate method of adjusting closely coupled coils is described.
- R386 Ultra selectivity with crystal filters. *Radio News*, vol. 15, pp. 477, 505; February, (1934).  
 Description of a piezo-electric quartz plate filter unit used in the superheterodyne receiving set.
- R388 A. B. DuMont. Recording of patterns and waves applied to cathode-ray tube by camera. *Radio Engineering*, vol. 13, p. 15; December, (1933).  
 A method of recording wave forms or patterns occurring on the fluorescent screen of a cathode-ray tube by means of a camera is given. This method has been made possible by the increased intensity of the fluorescent screen of the cathode-ray tube and the increased sensitivity of the photographic film available.
- R388 J. M. Hollywood and M. P. Wilder. Laboratory applications of cathode-ray tubes. *Radio News*, vol. 15, pp. 464-465, 508; February, (1934).  
 Applications are given of the cathode-ray tube in electrical and radio measurements
- R390 J. H. Miller. Radio testing instruments from the engineering viewpoint. *Radio Engineering*, vol. 13, pp. 19-22; December, (1933).  
 The problem of adequate servicing on broadcast receiving sets is demanding the development of test equipment panels which perform several functions. Several of these panels are described.

## R500. APPLICATIONS OF RADIO

- R521.1 R. D. Washburne and N. H. Lessem. An airplane dual-range receiver and 5 meter transreceiver. *Radio-Craft*, vol. 5, pp. 464-465; February, (1934).  
 ×R522.1 Constructional details.
- R526.2 W. S. Hinman, Jr. A radio direction finder for use on aircraft. *Bureau of Standards Journal Research*, vol. 11, pp. 733-741; December, (1933). Research Paper No. 621. *Proc. I.R.E.*, vol. 22, pp. 117-118; January, (1934).  
 A new type of radio direction finder is described which eliminates phasing difficulties by using a single loop antenna having a field pattern modified by dissymmetry in the loop-antenna circuit. Visual indication of the "course" is given and the direction finder is bilateral and unidirectional. This direction finder may be added as a unit to any radio receiving set. It operates on any received signal with modulated or unmodulated waves. Flight tests were made using broadcasting stations of Washington, D. C., and Baltimore, Md.
- R528 E. Kramer. Ein Beitrag zur Gleitwegblindlandung von Flugzeugen. (A contribution on blind landing gliding path for aircraft.) *Elek. Nach. Tech.*, vol. 10, pp. 451-453; November, (1933).  
 The device, originally developed by the U. S. Bureau of Standards in which the flier guides himself to the ground by receiving a beam of ultra-short waves with constant intensity is changed so as more nearly to yield a landing path of different shape. As soon as the flier decides to land, he starts a timed attenuating device which gradually reduces the sensitivity of the receiver. By varying the rate of changing the sensitivity any landing curve may be obtained.

- R538 R. S. Kruse. The amateur and police radio. *QST*, vol. 18, pp. 34-37; January, (1934).  
Description of the Detroit Police Department radio station WCK.
- R538 Police radio service. *Radio Engineering*, vol. 13, pp. 16-18; December, (1933).  
Information is given which is of value to municipalities operating police radio systems and those contemplating such a service.
- R550 Common frequency broadcasting—Stations which share time may by synchronizing operate simultaneously. *Radio Engineering*, vol. 14, pp. 21-22; January, (1934).  
Description of Western Electric Company equipment for common frequency broadcasting.
- R570 J. A. Code, Jr. Remote controlled transmissions. *Radio News*, vol. 15, pp. 459, 499; February, (1934).  
Describing use of ultra-high-frequency signals for automatically controlling a radio transmitter on a distant island site.
- R583 I. G. Maloff. Problems of cathode-ray television. *Electronics*, vol. 7, pp. 10-12, 19; January, (1934).  
Several of the new engineering problems of television by means of cathode rays are discussed.

## R600. RADIO STATIONS

- R612.1 Five hundred kilowatts at WLW. *Radio Engineering*, vol. 14, p. 10; January, (1934).  
A brief description of the new high powered broadcast transmitting equipment of WLW.
- R612.1 O. B. Hanson. National Broadcasting Company's new studios in Radio City, New York. *Radio Engineering*, vol. 13, pp. 8-10; December, (1933).  
Plans and facilities of the broadcast studios are given.

## R800. NONRADIO SUBJECTS

- 535.38 V. K. Zworykin. The iconoscope—A modern version of the electric eye. *Proc. I.R.E.*, vol. 22, pp. 16-32; January, (1934).
- 537.7 G. Ulbricht. Visual test device. *Proc. I.R.E.*, vol. 22, pp. 89-92; January, (1934).
- 621.374.3 A. T. Starr. The rectifying peak voltmeter as a standard instrument. *Proc. Phys. Soc. (London)*, vol. 46, pp. 35-46; January 1, (1934).  
The paper describes a peak voltmeter using overbiased rectifying vacuum tubes. Various errors are discussed and calculated.
- 621.375.1 H. W. Lord and O. W. Livingston. An electronic multiplier for high speed counting. *Electronics*, vol. 7, pp. 7-9; January, (1934).  
A multiplier circuit is described which relies for its operation on the fundamentals of the single tube inverter described in April, 1933, issue of *Electronics*. The device is used in counting the output of automatic machines in manufacturing plants.

CONTRIBUTORS TO THIS ISSUE

**Brainerd, John Grist:** Born 1904. Police reporter, The Philadelphia North American, 1923-1925. Instructor and assistant professor, Moore School of Electrical Engineering, University of Pennsylvania, 1925 to date. Received B.S. degree, 1925; Sc.D. degree, University of Pennsylvania, 1934. Associate member, Institute of Radio Engineers, 1933.

**Babat, George:** Born January, 1911, at Gitomir, Russia. Radio amateur, 1925 to date. Graduated radio engineering department, Kiev Polytechnic Institute, 1932. Research laboratory, Svetlana Works, Leningrad, U. S. S. R. Nonmember, Institute of Radio Engineers.

**Ferns, John H.:** Born July 2, 1908, at San Francisco, California. Received A.B. degree, Stanford University, 1932. California State Highway Commission, 1932 to date. Member, A.I.E.E. Nonmember, Institute of Radio Engineers.

**Green, Alfred Leonard:** Born February 3, 1905, at London, England. Educated at King's College, London University; received B.S. degree, 1925; M.S. degree, 1929. Investigator to Radio Research Boards, Councils for Scientific and Industrial Research, Great Britain and Australia, 1927 to date. Associate member, Institute of Radio Engineers, 1928.

**Kaar, I. J.:** Born October 17, 1902, at Dunsmuir, California. Federal Telegraph Company, at sea, 1920; Department of Commerce, radio communication development, Forest Service, 1921; design and construction of KDYL, 1922; acoustic development, Nathaniel Baldwin, Inc., 1923; received B.S. degree in electrical engineering, University of Utah, 1924; in charge of transmitter development, General Electric Company, 1924 to date. Junior member, Institute of Radio Engineers, 1922, Associate, 1924; Member, 1929.

**Kenrick, G. W.:** Born May 25, 1901, at Brockton, Massachusetts. Received B.S. degree in physics, 1922; M.S. in physics, 1922; Sc.D. in mathematics, Massachusetts Institute of Technology, 1927. Department of Physics, Massachusetts Institute of Technology, 1920-1922; department of development and research, American Telephone and Telegraph Company, 1922-1923; instructor in electrical engineering, Massachusetts Institute of Technology, 1923-1927; Moore School of Electrical Engineering, University of Pennsylvania, 1927-1929; assistant professor of electrical engineering, Tufts College, 1929 to date; consulting radio engineer, Bureau of Standards, 1930 to date. Associate member, Institute of Radio Engineers, 1923; Member, 1929; Fellow, 1933.

**Pickard, Greenleaf Whittier:** Born February 14, 1877, at Portland, Maine. Educated at Westbrook Seminary, Westbrook, Maine; Lawrence Scientific School, Harvard University; and Massachusetts Institute of Technology. Experimental radio work with Blue Hill Observatory, 1898-1899. Research engineer for and director of the Wireless Specialty Apparatus Company of Boston, 1907-1930; RCA Victor of Massachusetts, 1930-1931; consulting engineer, Newton

Center, Massachusetts, 1931–1933; General Radio Company, 1933 to date. Received Medal of Honor, 1926. Member, Institute of Radio Engineers, 1912; Fellow, 1915.

**Roder, Hans:** Born September 27, 1899, at Mengersrenth, Bavaria, Germany. Institute of Technology, Munich, 1919–1923. Received M.S. degree in electrical engineering, 1923. Radio transmitter laboratory, Telefunken Gesellschaft für Drahtlose Telegraphie, Berlin, 1923–1929. Radio engineering department, General Electric Company, 1930–1933. General engineering laboratory, General Electric Company, 1933 to date. Member, Institute of Radio Engineers, 1929.

**Terman, Frederick Emmons:** Born June 7, 1900, at English, Indiana. Received A.B. degree, 1920; E.E. degree, Stanford University, 1922; D.Sc. degree, Massachusetts Institute of Technology, 1924. Associate professor of electrical engineering, in charge of communication, Stanford University. Associate member, Institute of Radio Engineers, 1925.



# Quality

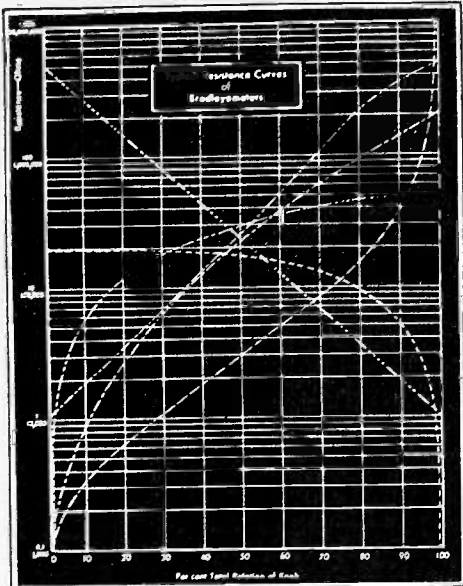

## • in Flexibility

The Bradleyometer, by virtue of its unique resistor element which is not obtainable in any other control, can be supplied with practically any resistance-rotation curve for over 100 different connection combinations.

## • in Performance

The design of the resistor element together with the precision manufacturing methods used in its construction result in an output of Bradleyometers of unequalled uniformity. This, in turn, assures a continuous output of radio receivers of optimum performance.

## • in Workmanship

Carefully selected raw materials, precision manufacturing methods, and continuous checking of production processes guarantee long life and de luxe performance for all Bradleyometers.

## Volume Control De Luxe



### A Quiet A. C. Relay for Remote Control

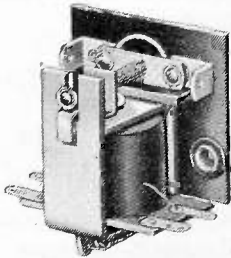

Allen-Bradley scores another triumph in this new quiet A. C. remote control relay for radio receivers. When operated by remote control, this relay connects or disconnects the main power pack circuit of the receiver. Send for specifications and prices today.

The Bradleyometer, now available in over 100 circuit combinations, represents the highest attainment in variable resistors for volume control, tone control, and automatic tone correction with volume control. Allen-Bradley engineers, foremost in the field of radio resistor design, have pioneered in the development of this volume control de luxe.

The slight extra cost of the Bradleyometer adds immeasurably to the quality of the receiver. Make your receivers outstanding in performance by using the Bradleyometer—the Volume Control De Luxe. Let Allen-Bradley engineers send you performance data, today.

Allen-Bradley Co.  
116 W. Greenfield Ave., Milwaukee, Wis.

## Bradleyometer

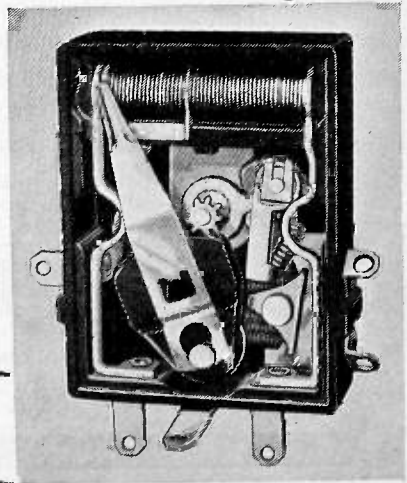

When writing to advertisers mention of the PROCEEDINGS will be mutually helpful.

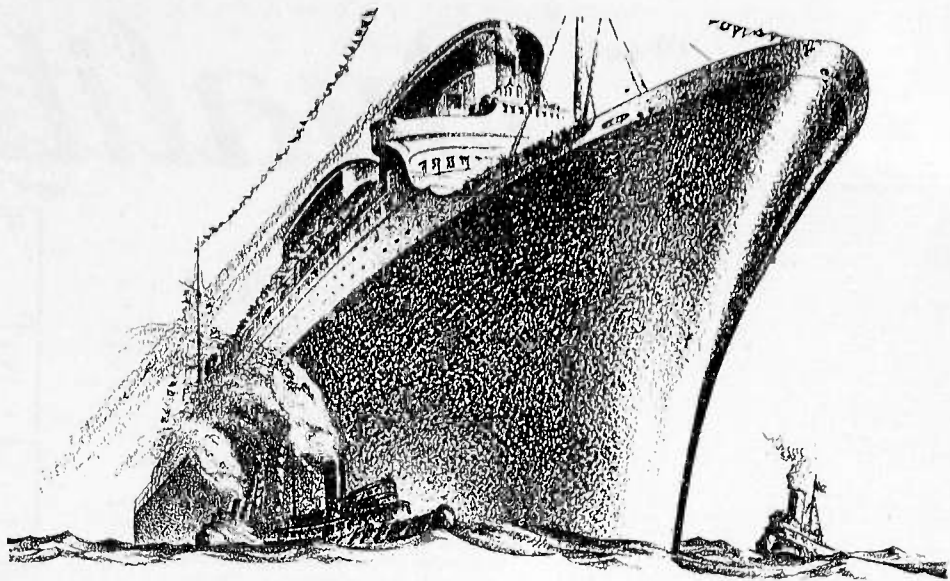

# MAIDEN VOYAGE

A new ship's reputation for comfort . . . speed . . . performance . . . is either made or broken on her trial run.

Radio sets face a similar critical trial whenever they are demonstrated.

That is why leading set manufacturers install tubes manufactured by Sylvania as original equipment. They know their sets will perform best with tubes that have been tested and proved for their own circuits!

Sylvania Tubes are built by one of the world's largest companies specializing in electric vacuum tubes. Hygrade Sylvania pioneered in the development of the efficient 6.3 volt tubes for automobile radios, and later, for all general use.

Set manufacturers are invited to consult Sylvania engineers and avail themselves of Sylvania's complete Circuit Laboratory in solving their circuit and design problems. No obligation incurred. Write: Hygrade Sylvania Corporation, Emporium, Pa.

# Sylvania

(Reg. U. S. Pat. Off.)

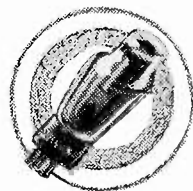

THE SET-TESTED RADIO TUBE

When writing to advertisers mention of the PROCEEDINGS will be mutually helpful.

© 1933, H. S. C.



## *A Swift Messenger in Time of Need*

TO EVERYBODY there comes, suddenly, the great emergency — the occasion when, regardless of all else, the desperate human need stands first and alone.

To find somebody, to get somebody's advice, to learn somebody's final answer is for the moment the one, all-important purpose.

Have you ever stopped to consider how great a part the telephone plays in the meeting of such emergencies?

Even our daily routine is a succession of lesser emergencies. Satisfactory living consists largely in

grasping situations as they arise — solving each promptly, finally, and getting on to the next.

It is because of all this that the telephone is so essential and helpful in the daily life of so many people. To millions of homes it brings security, happiness and the opportunity for larger achievement.

---

*Your home is safer—life moves more smoothly — when you have extension telephones in the rooms you use most. The cost is small, especially when you consider the time and steps saved, the increased comfort and privacy. Installation can be made quickly, at the time you set. Just call the Business Office of your local Bell Telephone Company.*

BELL TELEPHONE SYSTEM



*When writing to advertisers mention of the PROCEEDINGS will be mutually helpful.*

# Inside Information

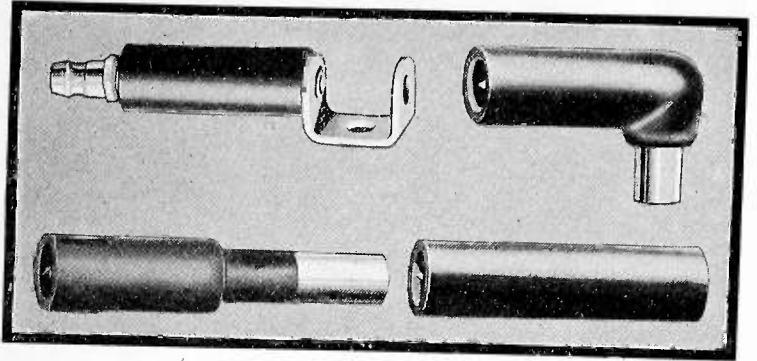

## about ERIE SUPPRESSORS

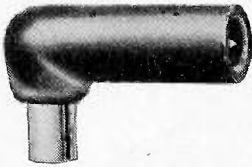

Durable Bakelite covering protects the resistance unit from the extreme conditions of heat, moisture, dust and oil encountered near an automobile engine.



Here is the heart of the suppressor—only  $\frac{3}{4}$ " in length. In spite of its unusual compactness, laboratory and road tests show that its resistance changes less than 5% in 50,000 miles of use.

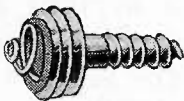

This rugged screw recessed in the socket of the bakelite case and cemented to it, makes a positive connection to the high tension cable under all conditions of use. Vibration proof contact from the screw to the end of the resistance unit is maintained by a strong, heavily plated steel spring. High frequency interference due to poor connections is impossible.

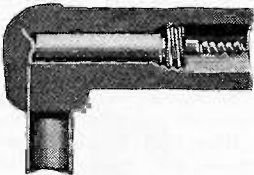

The compactness of Erie Suppressors is evident in this cross section view. Extremely low distributed capacity is made possible by the small size and effective spacing of metallic terminals. The full length of the resistance unit is utilized by avoiding the use of metal caps over its ends.

## ERIE RESISTOR CORPORATION

ERIE, PA.

Factories In ERIE, PA. - TORONTO, CANADA - LONDON, ENG.

*When writing to advertisers mention of the PROCEEDINGS will be mutually helpful.*



# The Institute of Radio Engineers Incorporated

33 West 39th Street, New York, N. Y.

## APPLICATION FOR ASSOCIATE MEMBERSHIP

(Application forms for other grades of membership are obtainable from the Institute)

To the Board of Directors  
Gentlemen:

I hereby make application for Associate membership in the Institute of Radio Engineers on the basis of my training and professional experience given herewith, and refer to the members named below who are personally familiar with my work.

I certify that the statements made in the record of my training and professional experience are correct, and agree if elected, that I will be governed by the constitution of the Institute as long as I continue a member. Furthermore I agree to promote the objects of the Institute so far as shall be in my power, and if my membership shall be discontinued will return my membership badge.

.....  
(Sign with pen)

.....  
(Address for mail)

.....  
(Date)

.....  
(City and State)

### Sponsors:

(Signature of references not required here)

Mr. .... Mr. ....

Address ..... Address .....

City and State ..... City and State .....

Mr. ....

Address .....

City and State .....

The following extracts from the Constitution govern applications for admission to the Institute in the Associate grade:

#### ARTICLE II—MEMBERSHIP

Sec. 1: The membership of the Institute shall consist of: \* \* \* (c) Associates, who shall be entitled to all the rights and privileges of the Institute except the right to hold any elective office specified in Article V. \* \* \*

Sec. 4. An Associate shall be not less than twenty-one years of age and shall be a person who is interested in and connected with the study or application of radio science or the radio arts.

#### ARTICLE III—ADMISSION AND EXPULSIONS

Sec. 2: \* \* \* Applicants shall give references to members of the Institute as follows: \* \* \* for the grade of Associate, to three Fellows, Members, or Associates; \* \* \* Each application for admission \* \* \* shall embody a full record of the general technical education of the applicant and of his professional career.

#### ARTICLE IV—ENTRANCE FEE AND DUES

Sec. 1: \* \* \* Entrance fee for the Associate grade of membership is \$3.00 and annual dues are \$6.00.

**ENTRANCE FEE SHOULD ACCOMPANY APPLICATION**



# New

Heavy-Duty

## TRANSMITTER CHOKE

With Peak  
Impedance  
At the Popular  
Amateur  
Bands

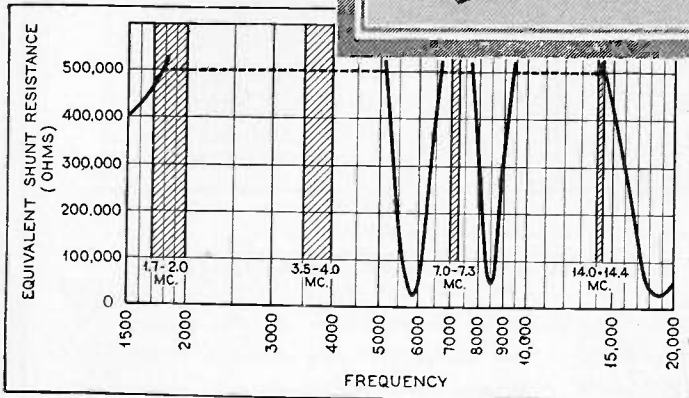
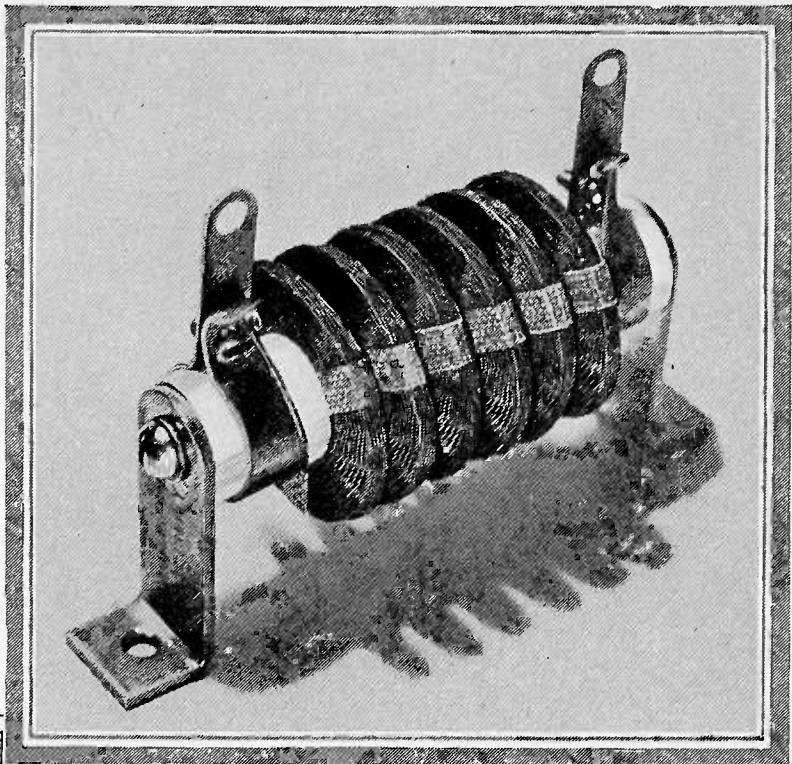

## New MIDGET R. F. CHOKE

Invaluable for small space.  
Inexpensive for generous use.

**T**HE only available choke, for parallel feed in high-power transmitters, in which the highest useful impedance is effective precisely where it is wanted—at the 20, 40, 80 and 160-meter amateur bands.

Throughout these bands, as the diagram shows, this new Hammarlund Choke has the exceptionally high impedance of more than 500,000 ohms and, consequently, introduces negligible losses. It is also effective from 1500 to 15,000 kc. with the exception of frequencies between 5300 and 6400 and between 8000 and 9000 kc. Its use at these frequencies is not recommended.

Inductance 2.5 mh. Distributed capacity less than 1.5 mmf. DC resistance 8 ohms. Maximum recommended DC (continuous) 500 milliamperes.

Six thin universal-wound pies on Isolantite core. Insulated mounting brackets secured by short machine screws. No metal passes through core. With brackets removed, may be mounted with single machine screw. Choke size:  $1\frac{1}{8}$  in. x  $2\frac{3}{8}$  in.

Mail Coupon for Details



HAMMARLUND MANUFACTURING CO.  
424 W. 33rd St., New York

—Check here for new booklet describing the  
COMET "PRO" Professional Superheterodyne.  
—Check here for New General Catalog of Radio  
Parts.

Name .....

Address .....

PE-3



When writing to advertisers mention of the PROCEEDINGS will be mutually helpful.

# PROFESSIONAL ENGINEERING DIRECTORY

## BLILEY PIEZO-ELECTRIC CO.

*Designers and Manufacturers  
of  
QUARTZ CRYSTALS  
for  
Standard or Special Requirements*  
226A Union Station Bldg.  
ERIE, PENNA.

## Cathode Ray Tubes and Associated Equipment For All Purposes

*Write for Complete  
Technical Data*  
ALLEN B. DUMONT  
LABORATORIES  
UPPER MONTCLAIR, N.J.

## PRACTICAL RADIO ENGINEERING

One year Residence Course  
Advanced Home Study Course  
Combined Home Study-Residence  
Course

*Write for details*  
Capitol Radio Engineering  
Institute  
Washington, D.C.

## FOR MANY YEARS

the Professional Engineering Directory  
has helped consulting engineers, design-  
ers, and laboratory men make the right  
contacts in the radio industry. Perhaps we  
can help you with your problems too. For  
further information write to

*Advertising Department*  
INSTITUTE OF RADIO  
ENGINEERS  
33 West 39th St.  
NEW YORK CITY, N.Y.

## Alphabetical Index to Advertisements

	A	
Allen-Bradley Company .....		VII
American Tel. & Tel. Co. ....		IX
	C	
Central Radio Laboratories .....		XVIII
Cornell-Dubilier Corp. ....		XVII
	E	
Erie Resistor Corp. ....		X
	G	
General Radio Co. ....		Outside Back Cover
	H	
Hammarlund Manufacturing Company .....		XIII
Hygrade Sylvania Corp. ....		VIII
	I	
Isolantite, Inc. ....		XVI
I.R.E. ....		XI, XII, Inside Back Cover
	P	
Professional Eng. Directory .....		XIV
	R	
Rola Company, The .....		XV

**ROLA'S  
NEW  
PM**  
*permanent magnet*  
**DYNAMIC  
SPEAKERS**

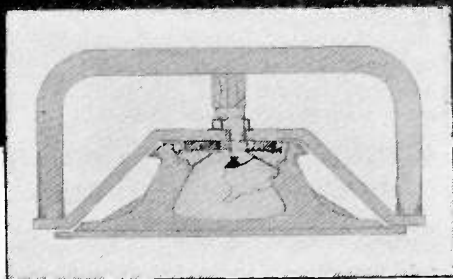
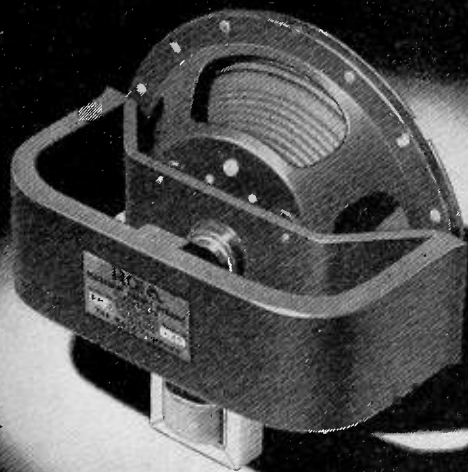

**W**ITH a domed center cap that completely shields the air-gap and voice-coil, and a radically new corrugated diaphragm type centering member, and acoustic filter assembly, Rola's new PM DYNAMIC speakers attest the skill of Rola technicians in pioneering new fields of loudspeaker engineering.

For the first time metallic particles and dust are permanently excluded from entrance to the magnetic air-gap . . . the vital part of the loudspeaker. The voice-coil is fully protected. Its free movement is unrestricted. Greatly increased flux density is secured by a new and novel magnet-core construction, and new fea-

tures of assembly. Service troubles are entirely eliminated. New high standards of efficiency are secured. New markets . . . new sales opportunities are made available to radio manufacturers.

Brilliant in performance, these new high efficiency PM dynamic speakers are adapted for use in hotels, schools, hospitals, theatres, restaurants and clubs. They bring previously unknown performance to battery-energized radio sets where it is impractical to apply energy for the field coil. Featuring new, exclusive vital parts, these Rola speakers are worthy of your closest consideration. Write today for a sample unit, sizes and dimensions. Full details on request.

## THE ROLA COMPANY

2530 SUPERIOR AVENUE, CLEVELAND, OHIO, U. S. A

*Manufacturers of all types of speakers for automobile, portable and console Radio sets . . . and high power speakers for public address systems.*

*When writing to advertisers mention of the PROCEEDINGS will be mutually helpful.*

**MINIMIZE  
HIGH FREQUENCY LOSSES**

**WITH**

**Isolantite**

**CERAMIC INSULATION**

**APPROVED FOR A DECADE  
BY LEADING ENGINEERS**

<b>Electrical Characteristics</b>	<b>Mechanical Properties</b>
Dielectric Constant . . . . . 6.1	Tensile Strength . . . 5,000 lbs. Per Sq. In.
Power Factor . . . . . .00185	Compressive Strength . . . . . 100,000 lbs. Per Sq. In.
Loss Factor . . . . . 1.13	Modulus of Rupture . . . . . 17,000 lbs. Per Sq. In.
Volume Resistivity . $2.75 \times 10^{14}$ ohms per CC	Thermal Expansion . . .000007 Per degree C at 20°C
Surface Leakage Resistivity . . . . . $10^{15}$ ohms per C Sq.	

**WRITE FOR BULLETIN 100F**

**Isolantite Inc.**

BELLEVILLE, NEW JERSEY

NEW YORK SALES OFFICE: 75 VARICK STREET

*When writing to advertisers mention of the PROCEEDINGS will be mutually helpful.*



# High-Frequency

# Capacitors

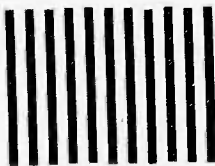
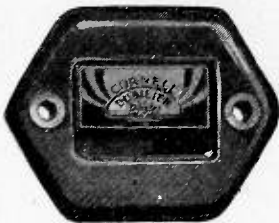

Higher and higher frequencies in 1934. Heretofore virgin ultra-short-wave bands will soon be on a practical, commercial basis. So once more Cornell-Dubilier engineers offer their contribution, this time capacitors particularly designed for ultra high frequency operation.

## MICA TRANSMITTING UNITS

Type 9, a heavy-duty low r.f. loss molded bakelite capacitor for transmitting circuits. Ideal as high current blocking (plate to grid) unit. Also as by-pass for r.f. around any device or D.C. meter. Short-path connections for h.f. work. Available in standard bakelite or in special low-loss bakelite for ultra h.f. work. Voltages up to 2000 D.C. Capacities, .00005 to .015 mfd. and higher at lower voltages.

## MICA RECEIVING UNITS

Tiny molded bakelite units, Types 2 and 3, in wide range of capacities for low-current, low-voltage by-pass functions up to 400 volts D.C. Designed primarily for low-loss receiving circuits but also applicable to transmitting circuits.

## SULFINITE CAPACITORS

Because of compact design, extremely low loss at higher frequencies, and ease of stacking, C-D sulfinite ultra-short-wave transmitting capacitors are highly popular. Connected in series, parallel or series-parallel. Available in 10 to 200 mmf. capacities.

## —and for Every Need

Cornell-Dubilier, the complete condenser line, provides capacitors for every transmitting and receiving function, always keeping abreast of radio progress since 1910.

Write for latest 1934 catalog covering entire line of C-D capacitors. And do not hesitate to consult our engineers regarding your capacitor problems.

## CORNELL-DUBILIER CORPORATION

4377 Bronx Boulevard - - - New York City

When writing to advertisers mention of the PROCEEDINGS will be mutually helpful.

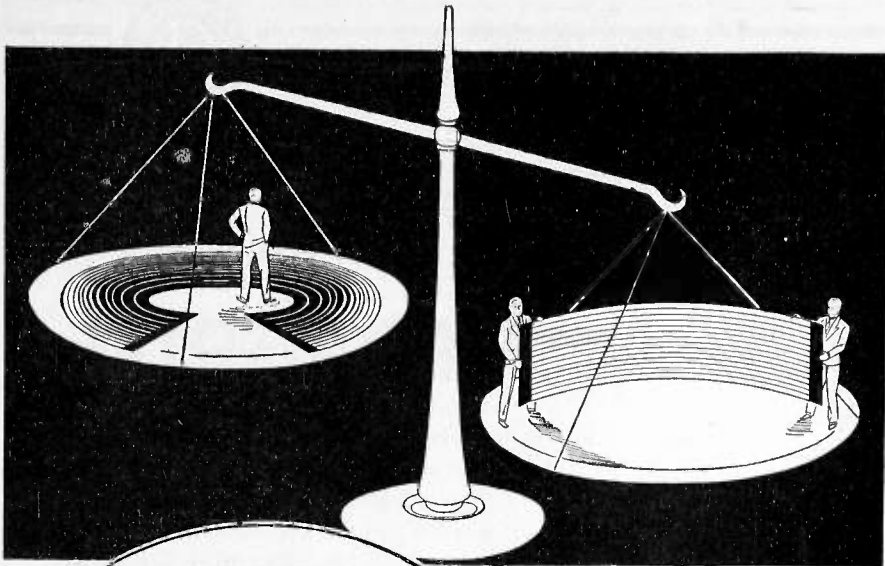

**THE**  
*new*  
**OUTWEIGHS**  
**THE OLD**

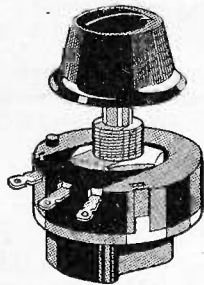

**T**HE new Centralab Radiohm permits smoother attenuation because of the greater effective length of the resistance strip employed.

The current path in the new Radiohm is more than twice as long as that in an old-style annular control of equal outside diameter. Current short cuts that might cause jumpy control

are eliminated in the new Radiohm.

Since smooth control depends upon gradual resistance change the "doubled" length of current path in the new RADIOHM offers a still finer performance . . . again demonstrating Centralab superiority and reliability.

## Central Radio Laboratories

Milwaukee, Wisconsin

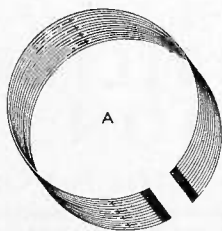

Resistor A used in the new Radiohm, has the same length path across its entire width, giving greater effective area for good volume control.

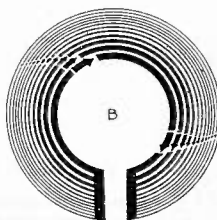

Resistor B of annular shape, has long been the standard type. Current concentrates around the INNER edge, i.e., the shortest path.

*When writing to advertisers mention of the PROCEEDINGS will be mutually helpful.*



# Take Your Choice

Every member of the Institute of Radio Engineers will want to wear one of these three attractive emblems. All of these emblems are appropriately colored to indicate the various grades of membership and each emblem is approximately the size of the following illustrations.



The Lapel Button is of 14k gold, with background enameled in the membership color, and with the lettering in gold. The screw-back on the back of this button fastens it securely to your coat.

\$2.75 postpaid—any grade.



The Pin is also of 14k gold. It is provided with a safety catch and is appropriately colored for the various grades of membership.

\$3.00 postpaid—any grade.



The Watch Charm, handsomely finished on both sides, is also of 14k gold. This charm is equipped with a suspension ring for attaching to a watch fob or chain.

\$5.00 postpaid—any grade.

*Orders, accompanied by checks made payable to the Institute of Radio Engineers, should be addressed to*

**THE INSTITUTE OF RADIO ENGINEERS**

33 West 39th Street  
NEW YORK CITY, N.Y.

*Send in your order now!*

# ALWAYS READY

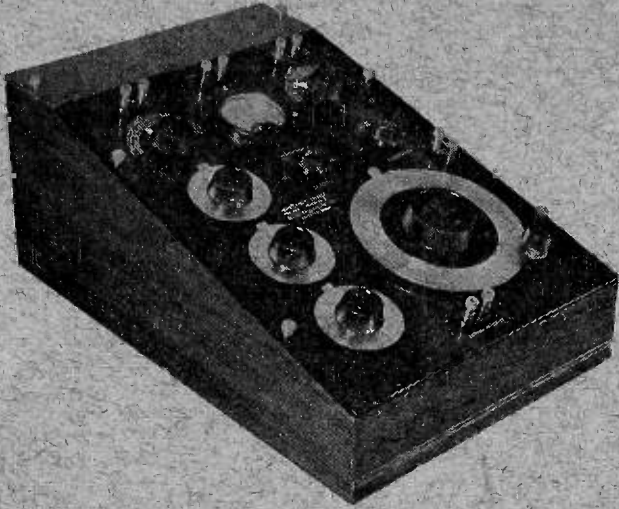

## RANGE:

Capacity: 0.000008  $\mu$ f  
—10  $\mu$ f

Resistance: 0.01 ohm  
—1 megohm

Inductance: 5 micro-  
henrys—100 henrys

PRICE \$175.00

Whatever the unit, resistor, capacitor, inductor, within the very wide limits listed above, the Type 650 Bridge is always set up and ready. Standards and power source are self-contained—no external connections except to the unit to be measured and the telephones.

Direct reading—in resistance—inductance—capacitance— $Q$  ( $=\frac{\omega L}{R}$ ) of coils— $D$  ( $=R\omega C$ ) of capacitors. An invaluable time-saver in any electrical laboratory.

Described in Bulletin EX-3304-R. Write to General Radio Company, 30 State Street, Cambridge, Massachusetts.

# GENERAL RADIO