

VOLUME 22

JANUARY, 1934

NUMBER 1

PROCEEDINGS  
*of*  
**The Institute of Radio  
Engineers**



Form for Change of Mailing or Business Title on Page XIV

---

# Institute of Radio Engineers Forthcoming Meetings

---

**DETROIT SECTION**  
January 19, 1934

---

**NEW YORK MEETING**  
January 3, 1934  
January 31, 1934

---

**PHILADELPHIA SECTION**  
January 4, 1934

---

**SAN FRANCISCO SECTION**  
January 17, 1934

---

**WASHINGTON SECTION**  
January 11, 1934

---

PROCEEDINGS OF

# The Institute of Radio Engineers

Volume 22

January, 1934

Number 1

Board of Editors

ALFRED N. GOLDSMITH, *Chairman*

R. R. BATCHER  
 H. H. BEVERAGE  
 F. W. GROVER  
 G. W. PICKARD

K. S. VAN DYKE  
 L. P. WHEELER  
 L. E. WHITTEMORE  
 WILLIAM WILSON

## CONTENTS

### PART I

Institute News and Radio Notes.....	1
December Meeting of the Board of Directors.....	1
Rochester Fall Meeting, 1933.....	1
Committee Work.....	2
Institute Meetings.....	3
Personal Mention.....	8

### PART II

#### *Technical Papers*

Conditions Necessary for an Increase in Usable Receiver Fidelity.....	9
..... ALFRED N. GOLDSMITH	
The Iconoscope—A Modern Version of the Electric Eye. V. K. ZWORYKIN	16
A New Cone Loud Speaker for High Fidelity Sound Reproduction.....	
..... HARRY F. OLSON	33
The Determination of the Direction of Arrival of Short Radio Waves....	
..... H. T. FRIIS, C. B. FELDMAN, AND W. M. SHARPLESS	47
Electron Oscillations with a Triple-Grid Tube.....	
..... FERDINAND HAMBURGER, JR.	79
Visual Test Device.....	
..... GUNTHER ULBRICHT	89
Rectangular Short-Wave Frame Aerials for Reception and Transmission	
..... L. S. PALMER AND D. TAYLOR	93
A 200-Kilocycle Piezo Oscillator (abstract).....	115
..... E. G. LAPHAM	
Phase Synchronization in Directive Antenna Arrays with Particular Appli- cation to the Radio Range Beacon (abstract).....	116
..... F. G. KEAR	
A Radio Direction Finder for Use on Aircraft (abstract).....	
..... W. S. HINMAN, JR.	117
A Method of Providing Course and Quadrant Identification with the Radio Range Beacon System (abstract).....	119
..... F. W. DUNMORE	
Performance Tests of Radio System of Landing Aids (abstract).....	
..... H. DIAMOND	120
Book Reviews: "Electron Tubes and Their Applications," by J. H. More- croft.....	122
..... B. E. SHACKELFORD	
"Sub-Harmonics in Forced Oscillations in Dissipative Systems," by P. O. Pedersen.....	122
..... J. K. CLAPP	
"The Inductance Authority," by E. M. Sheipe.....	124
..... H. A. WHEELER	
"Handbook of Chemistry and Physics (18th Edition)," by C. D. Hodgman.....	124
..... R. R. RAMSEY	
Booklets, Catalogs, and Pamphlets Received.....	125
Radio Abstracts and References.....	126
Contributors to This Issue.....	131

*Copyright, 1934, by the Institute of Radio Engineers*

# The Institute of Radio Engineers

---

## GENERAL INFORMATION

**INSTITUTE.** The Institute of Radio Engineers was formed in 1912 through the amalgamation of the Society of Wireless Telegraph Engineers and the Wireless Institute. Its headquarters were established in New York City and the membership has grown from less than fifty members at the start to several thousand.

**AIMS AND OBJECTS.** The Institute functions solely to advance the theory and practice of radio and allied branches of engineering and of the related arts and sciences, their application to human needs, and the maintenance of a high professional standing among its members. Among the methods of accomplishing this need is the publication of papers, discussions, and communications of interest to the membership.

**PROCEEDINGS.** The PROCEEDINGS is the official publication of the Institute and in it are published all of the papers, discussions, and communications received from the membership which are accepted for publication by the Board of Editors. Copies are sent without additional charge to all members of the Institute. The subscription price to nonmembers is \$10.00 per year, with an additional charge for postage where such is necessary.

**RESPONSIBILITY.** It is understood that the statements and opinions given in the PROCEEDINGS are views of the individual members to whom they are credited, and are not binding on the membership of the Institute as a whole. Papers submitted to the Institute for publication shall be regarded as no longer confidential.

**REPRINTING PROCEEDINGS MATERIAL.** The right to reprint portions or abstracts of the papers, discussions, or editorial notes in the PROCEEDINGS is granted on the express condition that specific reference shall be made to the source of such material. Diagrams and photographs published in the PROCEEDINGS may not be reproduced without making specific arrangements with the Institute through the Secretary.

**MANUSCRIPTS.** All manuscripts should be addressed to the Institute of Radio Engineers, 33 West 39th Street, New York City. They will be examined by the Papers Committee and the Board of Editors to determine their suitability for publication in the PROCEEDINGS. Authors are advised as promptly as possible of the action taken, usually within two or three months. Manuscripts and illustrations will be destroyed immediately after publication of the paper unless the author requests their return. Information on the mechanical form in which manuscripts should be prepared may be obtained by addressing the secretary.

**MAILING.** Entered as second-class matter at the post office at Menasha, Wisconsin. Acceptance for mailing at special rate of postage is provided for in the act of February 28, 1925, embodied in Paragraph 4, Section 412, P. L. and R., and authorization was granted on October 26, 1927.

---

Published monthly by

**THE INSTITUTE OF RADIO ENGINEERS, INC.**

Publication office, 450-454 Ahnaip St., Menasha, Wis.

BUSINESS, EDITORIAL, AND ADVERTISING OFFICES

Harold P. Westman, *Secretary*

33 West 39th Street, New York, N. Y.



## INSTITUTE SECTIONS

- ATLANTA—Chairman, H. L. Wills; Secretary, Philip C. Bangs, 23 Kensington Road, Avondale Estates, Ga.
- BOSTON—Chairman, E. L. Chaffee; Secretary, G. W. Kenrick, Tufts College, Mass.
- BUFFALO-NIAGARA—Chairman, L. Grant Hector; Secretary, E. C. Waud, 235 Huntington Avenue, Buffalo, N. Y.
- CHICAGO—Chairman, R. M. Arnold; Secretary, Donald H. Miller, McGraw-Hill Publishing Company, 520 N. Michigan Ave., Chicago, Ill.
- CINCINNATI—Chairman, W. C. Osterbrock; Secretary, Helen Klein, Crosley Radio Corporation, Cincinnati, Ohio.
- CLEVELAND—Chairman, P. A. Marsal; Secretary, R. P. Worden, 1629 Cordova Ave., Lakewood, Ohio.
- CONNECTICUT VALLEY—Chairman, H. W. Holt; Secretary, C. B. De Soto American Radio Relay League, 38 La Salle Rd., W. Hartford, Conn.
- DETROIT—Chairman, G. W. Carter; Secretary, E. C. Denstaedt, Detroit Police Department, Detroit, Mich.
- LOS ANGELES—Chairman, J. K. Hilliard; Secretary, N. B. Neely, 1569 Munson Ave., Los Angeles, Calif.
- NEW ORLEANS—Chairman, J. A. Courtenay; Secretary, C. B. Reynolds, Radiomarine Corporation, 512 St. Peter St., New Orleans, La.
- PHILADELPHIA—Chairman, W. F. Diehl; Secretary, G. C. Blackwood, 243 E. Upsal St., Mt. Airy, Philadelphia, Pa.
- PITTSBURGH—Chairman, Lee Sutherlin; Secretary, A. P. Sunnergren, West Penn Power Company, 14 Wood St., Pittsburgh, Pa.
- ROCHESTER—Chairman, Arthur L. Schoen; Secretary, Earl C. Karker, Mechanics Institute, 55 Plymouth Avenue, Rochester, N. Y.
- SAN FRANCISCO—Chairman, G. T. Royden; Secretary, R. C. Shermund, 2300-16th Ave., San Francisco, Calif.
- SEATTLE—Chairman, H. H. Bouson; Secretary, Howard Mason, 2709-4th West, Seattle, Wash.
- TORONTO—Chairman, W. F. Choat; Secretary, G. E. Pipe, Rogers-Majestic Corporation, Toronto, Ont., Canada.
- WASHINGTON—Chairman, T. McL. Davis; Secretary, C. L. Davis, Washington Building, 15th and G Sts., Washington, D. C.

## GEOGRAPHICAL LOCATION OF MEMBERS ELECTED DECEMBER 6, 1933

### Elected to the Associate Grade

Connecticut	New Haven, 291 Lexington Ave. ....	Keeler, C. E.
	New Haven, 893 Elm St. ....	Suloway, F. L.
Massachusetts	Cambridge, 4:230, Mass. Inst. of Tech. ....	Hall, W. M.
Michigan	Bay City, WBCM, Tuscola Rd. ....	Boshaw, M. L.
New Jersey	Camden, RCA Victor Co., Inc. ....	Eaton, T. T.
	Salem, 190 E. Broadway ....	Morton, R. S.
New York	Brooklyn, 535-55th St. ....	Anderson, W.
	New York City, 19 W. 69th St. ....	Lendvai, D.
Ohio	Berlin Heights. ....	Kenyon, H. S.
Australia	Melbourne Cl., Victoria, 407-409 Swanston St. ....	Evans, E. E.
	Melbourne Cl., Victoria, 407-409 Swanston St. ....	Soloman, C. H.
	St. Kilda S2, Victoria, 231 Glen Eira Rd. ....	Clyne, E. M.
Canada	London, Ont., 30 Carfrae Cres. ....	Foster, G. L.
China	Chungking, West China Dev. Corp., Tao Meng Kow. ....	King, G.
	Shanghai, c/o Wireless Dept., Butterfield & Swire. ....	Venn, W. M.
England	Chelmsford, Essex, 47 Arbour Lane. ....	Borgars, S. J.
	Croch Hill N. 4, London, "Fairwood," Holly Park. ....	Rolfe, R. G.

### Elected to the Junior Grade

California	Sacramento, 1315-41st St. ....	Jeffers, L. M., Jr.
Iowa	Waterloo, 422 Randall St. ....	Ebel, A. J.
New York	Evergreen, 1705 Norman St. ....	Lewbel, S.
	New York City, 5 W. 63rd St. ....	Ryan, E. G.

### Elected to the Student Grade

New York	Yonkers, 40 Caryl Ave. ....	Lieb, J. S.
----------	-----------------------------	-------------



APPLICATIONS FOR MEMBERSHIP

Applications for transfer or election to the various grades of membership have been received from the persons listed below, and have been approved by the Admissions Committee. Members objecting to transfer or election of any of these applicants should communicate with the Secretary on or before January 31, 1934. These applications will be considered by the Board of Directors at its meeting on February 7, 1934.

For Transfer to the Fellow Grade

New Jersey	Englewood, 279 Audubon Rd.	Gillett, G. D.
New York	New York City, 195 Broadway	Anderson, C. N.

For Transfer to the Member Grade

Massachusetts	Cambridge, General Radio Co., 30 State St.	Worthen, C. E.
---------------	--	----------------

For Election to the Member Grade

Illinois	Chicago, 4450 Ravenswood Ave.	Scott, E. H.
New York	New York City, 800 West End Ave.	Saxl, I. J.

For Election to the Associate Grade

Arkansas	Hot Springs, National Park, Radio Station KTTHS	McDonald, J. M.
California	Pasadena, 265 Bellfontaine St., San Francisco, c/o Underwriters' Labs., 615 Commercial St.	Hopkins, R. E. Monti, L. P.
Indiana	Marion, 215 N. Washington St.	Winfield, W. S.
Louisiana	New Orleans, 5718 St. Charles Ave.	Bloom, J. D., Jr.
Massachusetts	Cambridge, 18a Shaler Lane	Lyman, F., Jr.
New Jersey	Arlington, 88 Quincy Ave.	Sumpter, P. B.
New York	Brooklyn, 1467-53rd St. Kenmore, 83 Legion Dr. New York City, 540 Fort Washington Ave.	Stillman, H. L. Korts, H. G. Kahn, R.
	Niagara Falls, 220-47th St.	Bovee, B. A.
	Pelham, 59 Chestnut Ave.	Looney, H. C.
Pennsylvania	Emporium, 410 W. 4th St. Jenkintown, 201 Greenwood Ave. Philadelphia, University of Pennsylvania Philadelphia, 2319 S. 10th St. Pittsburgh, 327 Craft Ave.	Knouse, J. J. Miller, A. C. Razek, J. Serotta, G. G. Kuhlman, P. W.
Texas	Houston, 106 S. Wayside Dr.	Guyann, C. A.
Washington	Seattle, 2319-2nd Ave.	James, R. C., Jr.
Canada	Edmundston, N. B., Box 310	Laporte, J. M.
England	Bingley, Yorkshire, 16 Heath St. Bromley, Kent, "Tresco," 71 Nightingale Lane. Hayes, Middlesex, c/o 50 Clayton Rd. Kenton, Middlesex, 5 Woodhill Cres. London W., c/o Grindlay & Co., Ltd., 54 Parliament St. London S. W. 12, 1 Baltic House, Balham Hill. London E. C. 4, Totalisators Ltd., 3 Thames House, Queen St. Pl. London N. 11, 47 Highfield Gardens London, 2 Melbourne Way, Bush Hill Park, Enfield London W. 4, 45 Fairfax Rd., Bedford Park Seven Kings, Essex, "Vronloce" 464 Green Lane, St. Albans, Hertfordshire, 43 Alma Rd.	Flett, J. Seabourne, E. W. Williams, N. G. Tuchfeld, E. Adams, L. E. Challans, B. W. S. Dawes, T. J. Gootnick, S. Perch, H. A. Walters, D. Ranson, H. L. Findell, A. H. Green, W. S.
New Zealand	Wellington, 35 Lower Taranaki St.	Patrick, P. E.
South Africa	Cape Town, African Broadcasting Co.	Sutter, H. T.
Switzerland	Basel, 6 Lenzgasse	Schaffner, C. L.
Uruguay	Montevideo, Minas 1566	

For Election to the Junior Grade

Maryland	Mt. Rainier, 3319 Bunker Hill Rd.	Bless, R.
New York	Buffalo, 484 Minnesota Ave. Rome, 913 N. George St.	Lillycrop, H. Suba, L. H.

For Election to the Student Grade

California	Hollywood, 1418 N. Spaulding Ave. Pasadena, 64 Ricketts House, Calif. Inst. of Tech.	Moore, M. E. Stevenson, L.
Maryland	Baltimore, 2220 Linden Ave.	Ember, T.
Massachusetts	Cambridge, Morris Hall D-39, Harvard Univ.	Borsarelli, C.
Minnesota	Minneapolis, 1904 James Ave. S.	Findley, L. K.
New York	Briarcliff Manor, Oak Rd. Richmond Hill, 112-14 Liberty Ave.	Wilde, A. E., Jr. Lasky, L.
Pennsylvania	Bethlehem, Chi Psi Lodge Bethlehem, A Taylor Hall, Lehigh Univ. Bethlehem, 414 Pawnee St.	Bartlett, C. O. Stupp, R. W. Wall, A. S.
Utah	Germantown, Phila., 153 W. Washington Lane.	Cooper, D. T.
China	Salt Lake City, 1369 Kensington Ave. Wusih Kiangsu, 25 Tao Chang Lane.	Wright, P. B. Yew, C.

## OFFICERS AND BOARD OF DIRECTORS, 1933

(Terms expire January 1, 1934, except as otherwise noted)

*President*

L. M. HULL

*Vice President*

JONATHAN ZENNECK

*Treasurer*

MELVILLE EASTHAM

*Secretary*

HAROLD P. WESTMAN

*Editor*

ALFRED N. GOLDSMITH

*Directors*

M. C. BATSEL  
J. V. L. HOGAN  
C. M. JANSKY, JR.

R. H. MANSON, *Junior Past President*  
E. R. SHUTE  
A. F. VAN DYCK  
WILLIAM WILSON

Serving until January 1, 1935

W. G. CADY, *Junior Past President*  
O. H. CALDWELL

C. W. HORN  
E. L. NELSON

Serving until January 1, 1936

R. A. HEISING  
H. M. TURNER

F. A. KOLSTER



## INSTITUTE NEWS AND RADIO NOTES

### December Meeting of the Board of Directors

The December meeting of the Board of Directors was held on the 6th at the Institute office and was attended by L. M. Hull, president; Melville Eastham, treasurer; O. H. Caldwell, Alfred N. Goldsmith, R. A. Heising, J. V. L. Hogan, C. W. Horn, C. M. Jansky, Jr., E. L. Nelson, E. R. Shute, William Wilson, and H. P. Westman, secretary.

Twenty-three applications for Associate membership, four for Junior, and one for Student were approved.

The gift of approximately \$2,000 received from Associated Manufacturers was ordered placed in a special fund pending future disposition when a suitable use becomes apparent.

The Standards Committee presented its report which this year was not a technical one but an analysis of past procedure and recommendations on future operation. These recommendations which concern such matters as methods of choosing the personnel of the Standards Committee, procedure of operation of it and its technical committees, the frequency of publishing reports, the mechanical arrangements of reports, and similar matters were approved.

The Emergency Employment Service placed fifteen men in jobs during November. Its registration to date totals 690, approximately three quarters of whom are unemployed. Those who anticipate hiring engineers or other technical employees are urged to bring their requirements to the attention of the Emergency Employment Service thus giving preference to Institute members.

### Rochester Fall Meeting

The 1933 Rochester Fall Meeting was held on November 13, 14, and 15 at the Sagamore Hotel in Rochester. The first two days were devoted to the presentation of a number of technical papers, the titles of which were listed in the November issue of the PROCEEDINGS.

Two papers were scheduled for presentation at the informal stag banquet which was held on the evening of the second day and were "Art in Radio Cabinet Design" by W. K. Stone, professor of art at Cornell University and "Push-Pull in Music" by David Grimes of the RCA License Laboratory. Although showing profound knowledge of the fields, the authors were prevailed upon to be not too serious and their intrusion was not only excused but applauded by those present.

Almost two dozen organizations exhibited their products, thus permitting an effective survey to be made of the field of component parts,

testing and measuring equipment, and manufacturing aids which would be of importance to engineers handling manufacturing and design problems.

It is interesting to note that the attendance showed over one hundred and twenty five from out of town and a total of approximately two hundred which compares very favorably with attendance at other past meetings of this nature.

---

### Committee Work

#### ADMISSIONS COMMITTEE

The Admissions Committee met on December 6. Those present were A. F. Van Dyck, chairman; H. C. Gawler, C. M. Jansky, Jr., E. R. Shute, and H. P. Westman, secretary.

Two applications for transfer to the grade of Fellow were approved, together with one of two applications for transfer to the grade of Member and two applications for admission to the grade of Member.

#### MEMBERSHIP COMMITTEE

A meeting of the Membership Committee was held on the evening of December 6 and was attended by H. C. Gawler, chairman; J. E. Smith and Jack Yolles (representing David Grimes). The committee prepared some material for use in circularizing the membership to stimulate and increase membership activities.

#### SECTIONS COMMITTEE

A meeting of the Sections Committee was held at the Sagamore Hotel in Rochester on November 13 which was during the Rochester Fall Meeting. Those in attendance were R. M. Arnold, Chicago; W. F. Choat, Toronto; L. F. Curtis, Connecticut Valley; W. F. Diehl, Philadelphia; R. A. Hackbusch, Toronto; L. G. Hector, Buffalo-Niagara; H. J. Klumb, Rochester; R. H. Langley, New York; A. L. Schoen, Rochester; Lee Sutherland, Pittsburgh, and H. P. Westman, secretary.

Because the time was limited, only a short discussion was held on the results of a questionnaire circulated to Institute sections concerning the desirability of establishing a standard system of bookkeeping and methods employed in handling section funds.

#### STANDARDS COMMITTEE

A meeting of the Standards Committee was held on December 6 and was attended by William Wilson, chairman; Alfred N. Goldsmith, A. F. Van Dyck, and H. P. Westman, secretary.

The committee put in final form a preliminary draft of its report to the Board of Directors. These recommendations cover the procedure of operation for future standards committees with the objective of eliminating as much waste motion as possible and the obtaining of a maximum of authoritative opinions on subjects treated. The procedure for issuing future reports, their form, and frequency of issuance were also treated.

---

## Institute Meetings

### BOSTON SECTION

A meeting of the Boston Section was held on October 20 at Harvard University. E. L. Chaffee, chairman, presided, and the attendance totaled 100.

The paper on "Determination of the Direction of Arrival of Short Radio Waves" which is published elsewhere in this issue was presented by Mr. Sharpless.

Membership and Papers Committees were appointed.

The November meeting was held on the 17th day at Harvard University. The attendance was 120 and the meeting was presided over by E. L. Chaffee, chairman.

"Construction of Cathode Ray Tubes" was the subject of a paper by O. H. Biggs of the Hygrade Sylvania Corporation. The paper was devoted chiefly to a discussion of methods of focusing the cathode ray beam and included the utilization of gaseous ionization characteristic of earlier tubes, electrostatic focusing, and electromagnetic focusing. The constructional features peculiar to each of these methods were briefly outlined and their advantages and limitations described.

A second paper presented by Eduard Karplus of the General Radio Company was on "Applications of Cathode Ray Tubes." This paper emphasized the wide variety of applications of these tubes. It was pointed out that the choice of the tube in preference to other methods of measurement frequently was determined by economic considerations and convenience. The limitations of tubes for many laboratory applications due to their relatively low voltage sensitivity was considered, and the difficulties in obtaining satisfactory frequency characteristics in associated amplifiers was indicated as being a limitation in the over-all performance of such devices. An experimental illustration of a self-synchronizing circuit for the study of voice variations and other quasi-periodic phenomena was demonstrated. Other classical operations of cathode ray tubes including frequency matching and phase difference determinations were also illustrated.

## BUFFALO-NIAGARA SECTION

A meeting of the Buffalo-Niagara Section was held on November 22 at the University of Buffalo with L. G. Hector, chairman, presiding. Forty-six members and visitors were in attendance.

A paper on "Design Problems in Radio Receiving Sets" was presented by V. C. MacNabb of the Rudolph Wurlitzer Manufacturing Company. The paper was confined to the design of broadcast receivers of superheterodyne type using intermediate-frequency amplifiers in the range from 175 to 485 kilocycles. Many circuit arrangements suitable for such receivers were described and their practical advantages and disadvantages compared as factors influencing their selection for specific design. They included schemes for image rejection, antenna coupling circuits, oscillators having suitable characteristics, problems in the arrangement of tracking condensers to stabilize the intermediate frequency, the confining of leakage flux in audio-frequency transformers, and many other items. A general discussion followed its presentation.

Additional business handled at this meeting concerned the election of officers for the following year. It was felt that it would be inadvisable to make a change at the present time and those in office will continue until June, 1934.

## CHICAGO SECTION

On November 27 a meeting of the Chicago Section was held in the auditorium of the Western Society of Engineers. R. M. Arnold, chairman, presided, and the attendance was 150.

A paper on "Probable Developments in Radio Receiving Sets" was presented by K. W. Jarvis, Director of Engineering, Zenith Radio Corporation.

The speaker introduced his subject by outlining past developments in radio receivers and using these data as the basis for anticipating advances in the field. He showed that under present considerations sensitivity and selectivity were limited by noise and fidelity considerations. Indications of improvement in quality which may be expected shortly were given with special emphasis on the amplitude type of distortion now common. The use of a dynamic detector system to prevent the effects of fading on quality and other high modulation distortion problems was given. Several novel features in tuning and quality control systems were outlined. The meaning of selectivity and how far toward an ideal we might expect to approach were discussed. With the probable improvement in selective systems, it was shown to be possible to improve both sensitivity and static reduction. In closing the paper



the speaker pointed out the desirability of recognizing all problems as soluable rather than accepting as finalities what are apparently insurmountable obstacles.

#### DETROIT SECTION

A meeting of the Detroit Section was held in the Detroit News Conference Room on November 17. G. W. Carter, chairman, presided, and the attendance totaled fifty-five.

A paper on "The Electron, The Nature of Matter and Photo-Electric Effect" was presented by E. L. Barker. The subject was introduced with a discussion of the physical and electrical constants of the electron and the various methods employed to obtain information of this nature. An interesting group of analogies and comparisons helped in visualizing the characteristics of the electron.

Professor Barker described an arrangement due to Hull and Williams using a screen-grid tube to measure the charge of the electron. He then outlined the method of Dunnington for measuring its mass. In this procedure the weight was calculated from the bending of the electron path due to a magnetic field. The discussion of electron constants was concluded with a description of the Kaufman experiment which subjected the electron to the effect of magnetic and electric fields. The structure of copper and the flow of the electrons along a wire was then considered and the spinning wire experiment of Professor Tolman was explained. A general discussion followed.

#### NEW YORK MEETING

The regular monthly New York meeting of the Institute was held in the Engineering Societies Building on December 6. The meeting was opened by Dr. Hull who introduced the speaker, H. F. Olson of the RCA Victor Company, who presented a paper on "A New Cone Loud Speaker for High Fidelity Sound Reproduction."

In his paper, Dr. Olson pointed out that the economic conditions which are involved in every product designed for wide use have prevented the adoption of elaborate types of equipment. This has been true of wide range or high fidelity sound reproducers. It is evident that the loud speaker has been one of the component parts of the reproducing systems which has limited the frequency range of the equipment. He then described a speaker capable of covering wide acoustic range, the delivery of large acoustic outputs, at the same time retaining a system free from the highly complex construction usually associated with such devices. This reproducer consists of a voice coil and the coil cylinder segregated into masses and compliances and connected to a

cone suitably corrugated to present an impedance to the driven system such as will yield a uniform response from 80 to 10,000 cycles.

A group of these loud speakers was demonstrated and compared with a similar number of speakers which had previously been considered as satisfactory. Comparisons of reproduction on these two types of speakers were made on the acoustical effects of tearing paper and cellophane, the jingling of chains and keys, and several types of bells and sirens.

A lengthy discussion based to a large extent upon the demonstration of the equipment as well as the broader aspects of high quality reproduction was guided by J. V. L. Hogan as Dr. Hull was unable to remain throughout the meeting. The attendance was 575.

#### PHILADELPHIA SECTION

A meeting of the Philadelphia Section was held on October 5 at the Engineers Club with W. H. Diehl, chairman, presiding.

The speaker was E. W. Kellog of the Research Division of the RCA Victor Company who discussed "Sound Recording on Sixteen-Millimeter Film," and treated in detail numerous improvements which had been made recently in that field. Seventy-eight members and guests were in attendance.

The November meeting of the section was held on the 2nd at the Engineers Club with W. H. Diehl, chairman, presiding. The attendance totaled 148.

A paper on "The Loudness of Sound" was presented by Harvey Fletcher, physical research director of Bell Telephone Laboratories. In it Dr. Fletcher dealt with the terms and scales for measuring the loudness of sound and described a method of calculating loudness from the measured intensities of individual components of the sound. Experiments from which the constants entering into such calculations have been determined were outlined. A general discussion followed the presentation of the paper.

#### SAN FRANCISCO SECTION

The November meeting of the San Francisco Section was held on the 15th at the Bellevue Hotel. The meeting was presided over by A. H. Brolly in the absence of the chairman.

A paper on the "San Francisco-Oakland Bay Bridge Construction Radio Equipment" was presented by Reginald Tibbits and was followed by a general discussion.

The attendance at the meeting totaled seventy and sixteen were present at the informal dinner which preceded it.

## TORONTO SECTION

W. F. Choat presided at the October 18 meeting of the Toronto Section held at the University of Toronto.

"Design and Constructional Details of Modern Broadcast Transmitters" was the subject of a paper by H. W. Parker of the Rogers Radio Company. The subject was introduced with an outline of the early history of Station CFRB. The fundamental design characteristics of energy radiators were then reviewed and their efficiencies compared with initial cost. The laws governing transmitter line design for antenna feeders were also presented and typical examples worked out which included wire spacings and impedance matching calculations. The balanced transmission line circuits used in the new equipment at CFRB were described and the outstanding considerations governing the design of broadcast transmitters were discussed in general. Frequency stability, harmonic suppression, filtering of power supplies, and parallel tube operation were a few of the items covered. Among others, the general discussion was participated in by Messrs. C. Bowers, F. Fox, and A. B. Oxley.

## WASHINGTON SECTION

The November meeting of the Washington Section was held on the ninth at the Kennedy-Warren Apartments. H. G. Dorsey presided and the attendance was thirty-six. Ten were present at the informal dinner which preceded the meeting.

T. R. Gilliland of the Radio Section of the Bureau of Standards presented a paper on "Radio Methods of Studying the Ionized Upper Atmosphere." A brief outline was presented of the experimental and theoretical development of the study of the ionized upper atmosphere from the first suggestions of Kennelly and Heaviside in 1902 to the present. The pulse method of Breit and Tuve for measuring the virtual heights of the various regions of the ionosphere and a modification of this method permitting continuous automatic records on a fixed frequency were discussed. Sample records show changes that occur and the variability from day to day was pointed out. The results of manual measurements made on various frequencies since 1930 were shown.

A more recent development giving an automatic record of virtual height and frequency was described. Sample records were shown and the method for using these to determine the density of ionization in the various layers was discussed. Records were presented showing sporadic changes indicating sudden shifts in gradient or density of ionization. The frequencies with which these changes occur make it difficult to

connect them definitely with other observed terrestrial or cosmic phenomena.

---

### Personal Mention

J. S. Anderson has been transferred to the Lincoln, Nebraska, station of United Air Lines.

J. R. Bird has left the Rola Company to join the Shelbourne Manufacturing Company of Cleveland, Ohio.

W. T. Born has been made director of the laboratory of the Geophysical Research Corporation of Tulsa, Okla.

L. R. Brady of the Federal Radio Commission Inspection Service has been transferred from New York City to Washington, D. C.

Lowell Cooper, Lieutenant, USN, has been transferred from Bremerton, Washington to San Diego, California.

Formerly with RCA Communications, L. D. Culley has joined the studio engineering staff of National Broadcasting Company in San Francisco.

E. D. A. Geoghegan previously with Sprague Specialties has entered the employ of Polymet Manufacturing Company of New York City.

J. C. Hromada, a radio engineer for the Airways Division of the Department of Commerce, has been transferred from Washington, D. C. to Chicago, Ill.

Previously with the Electric Corporation, C. W. Larsen is now a transmission engineer for United Artists Studio Corporation, Los Angeles, Calif.

W. W. Lindsey, Jr. has severed his connection with the Fox Film Corporation and is now engaged in consulting work with headquarters in Los Angeles.

Formerly with Century Radio Products Company, C. A. L. Mitchell has joined the laboratory staff of General Manufacturing Company, Chicago, Ill.

H. L. Pitts, Lieutenant, USN, has been transferred from the USS Wright to Fallbrook, Calif.

Frank Ralph has joined the staff of Standard Telephones and Cables, Ltd., London, England. He was formerly connected with the International Telephone and Telegraph Company.

Previously with the Electronic Engineering Corporation, Morris Rappaport is now development engineer for Cambridge Instrument Company of Ossining, N. Y.



TECHNICAL PAPERS

CONDITIONS NECESSARY FOR AN INCREASE  
IN USABLE RECEIVER FIDELITY\*

By

ALFRED N. GOLDSMITH  
(Consulting Engineer, New York City)

IT IS incontestable that the broadcast listeners, given satisfactory programs, derive great pleasure from the entertainment material which reaches them through the air. It should also be emphasized that the tone quality of both speech and music produced by the better radio receivers at this time is far in advance of that in the earlier stages of the art. However, the reproduction of the program in the home has not as yet approached the ideal of transplanting the listener in fancy to the broadcast studio. Few radio listeners, shutting their eyes, can bring themselves to imagine that they are actually present at the original performance. Since every effort to enhance the enjoyment of the listener through an increase in the naturalness of reproduction of the radio programs is justified, there can be no doubt that consistent and vigorous efforts should be made to increase the over-all fidelity of reproduction of the broadcast system.

In his laudable attempts to improve the fidelity of broadcast receivers, the experimenter has occasionally concentrated on the thought that the best possible receiver was that having the highest over-all fidelity. On this theory the wider the band of audio frequencies accurately reproduced, the better the receiver and, as a result, the more pleased would be the listener. It is taken for granted in this discussion that what may be crudely termed the "goodness" of a receiver is measured by the satisfaction which it will give to the listener, acceptable programs being assumed. In the strictly scientific sense the best receiver is that approaching the scientific ideal of perfect fidelity; but under existing conditions the "goodness" of a receiver must be judged by the engineer as being a measure of the adaptation of the receiver to the conditions encountered, using as a criterion the production of the greatest possible listener satisfaction. More specifically, the engi-

\* Decimal classification: R361. Original manuscript received by the Institute, October 4, 1933. Presented before Rochester Fall Meeting of The Institute of Radio Engineers, November 13, 1933.

neer cannot accept in advance the viewpoint that the best receiver under all conditions is the receiver having maximum fidelity.

To cover the question more definitely, there will be outlined in the following a number of conditions precedent to the successful utilization of receivers of high fidelity. As a result of this discussion it will become evident that nothing less than an orderly and progressive campaign, over a considerable period of time, would enable the conditions in question to be met. To simplify the problem let us assume that we desire to reproduce in the home, or rather in the mind of the listener, precisely the impression which would be created were the listener actually present in the studio or concert hall. In other words, there is sought the "illusion of reality." Among the necessary conditions for the attainment of this illusion are the following:

(1) The pick-up of the program in the studio and the subsequent amplification of the corresponding audio-frequency currents must be handled on a critical and precision basis. High fidelity reception clearly discloses poor microphone placement, orchestral unbalance, incidental studio noises, incorrect studio acoustics, inartistic performances, and other deficiencies in the program pick-up.

Allowance should be made in the design of the amplifying system or otherwise for the increase in high audio-frequency response of microphones resulting from their physical effect on the incident sound wave when the microphone dimensions become comparable with the wavelength of the corresponding sounds.

The amplifiers and the circuits associated with them must be kept free from avoidable noises and must be designed to have flat audio-frequency response, ample dynamic range, and greatly reduced harmonic distortion as compared with some present practice.

It is worthy of note that the pick-up of programs in the studio is an art as well as a science; that this art is only partly understood as yet (and particularly with reference to the securing of "auditory perspective" in the resulting performance); and that high fidelity reception will impose higher standards of artistic manipulation and technical perfection if satisfaction for the more critical listeners is to be attained.

Parenthetically it may be stated that the type of microphone required, the placing of the microphone or microphones in the studio, and the audio characteristics of the studio itself cannot at this time be quantitatively and exactly defined for maximum fidelity of pick-up and the best "illusion of reality" to the listener in the home.

(2) The wire lines linking the studio and the transmitting stations (as well as the wire lines constituting the broadcast network) must be on a parity with the remainder of the system for high fidelity reproduc-

tion. Accordingly the noise level on such lines should be low; their audio-frequency characteristic should be flat; and the amplifiers along the line (line repeaters) should have ample capacity in terms of distortion-free output to carry the programs without harmonic production of an objectionable amount. Residual hum on such lines will become noticeable with high fidelity reception.

(3) The transmitter should be free from obviously objectionable and eliminable results of incorrect design or unsatisfactory operation. For example, there must not be present in the modulation of the transmitting station hum of an amount either audible at the receiving station or capable of modifying injuriously the quality of the received music. Noise modulation, resulting from circuit conditions should be avoided.

(4) The over-all audio-frequency characteristic of the transmitting station should be flat over the entire range of audible frequencies to within the minimum noticeable deviation (say 1db). That is, the envelope of the modulated carrier wave should be identical, so far as frequency response is concerned, with the wave form of the sound impinging on the studio microphone. The capability of the antenna system of radiating the carrier and the full side bands without noticeable attenuation of the edges of the latter is involved in meeting accurately the condition in question. As intimated, the audio-frequency characteristics of the transmitter should be measured "in the air."

(5) The transmitter must not introduce objectionable amounts of harmonic components into the audio-frequency modulation. That is, if a fundamentally pure tone excites the microphone, the envelope of the radiated wave should contain only this tone or, at worst, harmonic components of only negligible amplitude. As a general rule, in terms of good current practice, harmonic distortion (expressed in terms of the total harmonics spuriously produced) should be limited to a few per cent.

(6) It should also be remembered that a transmitter may initially meet the preceding requirements and yet, after a period of time, no longer deliver an identically high fidelity output. Various circuit elements, such as transformer cores, grid leak resistors, vacuum tubes and the like are not necessarily permanent and invariable devices. Accordingly, transmitters must be not only adjusted to high fidelity initially but, if high fidelity receivers are to be advantageously used, transmitters must also be systematically and rigidly maintained in their optimum operating condition.

(7) Phenomena are encountered in the propagation of the radiated wave which affect the quality of the received signal. For best reception

the transmitted wave should reach the receiving antenna over a *single* path having *constant* attenuation over a band of frequencies covered by the carrier frequency and the frequencies comprised in the side bands. Paths in which the attenuations are both high and noticeably variable within the 20-kilocycle or wider band required for high fidelity transmission deviate from the ideal requirement. Multiple-path transmission is even worse, and particularly if the distribution of the wave energy between the various paths fluctuates rapidly. In this last case, there will be rapid fading of the carrier frequency and of various frequency components in the side bands. The carrier or these other frequencies may even disappear for noticeable periods. Under such circumstances, intolerable distortion of tone quality will be noticed even on medium fidelity receivers, and it would be even less desirable to use high fidelity receivers under such conditions.

It is therefore necessary to minimize selective fading when using high fidelity reception. The available measures include suitable design of the antenna at the transmitting station; proper location of the transmitting station relative to its service area; the judiciously restricted use of synchronized transmission of the same program on a given carrier frequency; and, more rarely, the installation of specially designed receiving antennas. This last measure is more suitable on commercial circuits, in general, than in the case of the average listener although there is a noticeable tendency toward better receiving antennas and "centralized radio-frequency distribution systems" in multiple-apartment dwellings or hotels.

(8) In view of the inevitable presence of receiver noise, arising from such causes as irregular leakage currents, and the "shot effect" or the discontinuous nature of an electric current (which, strictly speaking, is an electron current), it is found that the field strength of the signal, the antenna dimensions, the coupling of the antenna to the receiver, and the amount of radio-frequency amplification must all be so related that no audible background noise exists when the unmodulated carrier is radiated and received (assuming the absence of any audible amount of static). Quantitatively this requirement does not necessitate as high field strengths as are required in view of the next considerations to be mentioned.

(9) Natural and man-made disturbances of reception should be absent. The greater the fidelity of the receiving set, the more rigorously must this requirement be fulfilled. It is well-known that the acoustic spectrum of music or speech shows relatively little energy radiated in the higher audio frequencies. On the other hand, the abrupt disturbances corresponding to static of most types have a relatively high per-

centage of their energy in the upper regions of the audio spectrum. Accordingly it is quite possible in the presence of static to receive a more pleasurable though less accurate signal from weak or distant stations if the receiver is arranged to be relatively insensitive to the higher audio frequencies. Conversely a high fidelity receiver tuned to such stations under the mentioned conditions produces a more accurate but relatively unpleasant effect. We thus encounter a natural limitation to the utility of a high fidelity receiver based on the ratio of the field strength of the received signal to the field strength of the random atmospheric disturbances, and dependent upon the acoustic quality of each of these.

This apparent anomaly produces confusing effects in connection with casual tests of high fidelity receivers. Unless the fidelity of the transmitter is known, as well as the ratio of the signal field strength to the disturbance field strength, no valid analysis can be made of the reason for the apparent quality of the signal, nor can any convincing explanation be offered for the utility or lack of usefulness of a given type of high fidelity receiver under the specific receiving conditions in question.

(10) It is common practice to space telephone broadcast stations on channels separated by 10,000 cycles. This separation is obviously inconsistent with the requirements of high fidelity transmission and reception. Assuming the radiation of 15-kilocycle side bands from a high fidelity transmitter and the provision of a 5-kilocycle guard band between the outer edge of each side band of a given station and the outer edge of each side band of the nearest adjacent stations on higher and lower frequencies, a channel separation of 35 kilocycles or even more is required. Unless the listener is so situated that a given and desired station has a field strength far greater than the field strength of the stations on the adjacent channels, there is little possibility of successful reception of frequencies above 4500 cycles approximately, on the basis of the present 10-kilocycle channel separation. As a practical conclusion, if stations become capable of modulating their carriers accurately up to 10,000 or 15,000 cycles, with all that this implies in the way of improvement of equipment and methods of operation, (and on the assumption that the Governmental authorities will permit such high fidelity radiation on the present broadcast wavelengths) it would even then be necessary to confine the use of high fidelity receivers to a region not too remote from the station, and wherein the field strength of the desired station signal would far override that of the stations on adjacent channels. Otherwise stated, universal high fidelity reception is incompatible with 10-kilocycle channel separation. "Side band col-

lision" cannot coexist with the satisfying use of high fidelity in a receiver.

(11) The requirement of over-all high fidelity in the receiver is of course necessary for accurate audio-frequency reproduction. This implies either that every element in the receiver shall leave unchanged the envelope form of the received wave or alternatively that mutually compensatory effects shall be introduced in the receiver system so that any excessive response toward certain audio frequencies in one part of the receiver shall be balanced by a correspondingly deficient response to the same audio frequencies in another part of the receiver. The term "receiver" in this connection includes the loud speaker system.

(12) The receiver should similarly be free from harmonic distortion due to overloading and nonlinear characteristics of the tube circuits. It is to be noted in this connection that the harmonic distortion introduced in the receiver is roughly speaking additive to that produced in the transmitter, thus increasing the undesired effect.

(13) When we enter the realm of sound reproduction through the use of loud speakers, it is found that a number of outstanding problems remain unsolved. If a single loud speaker is used in a receiving set, and if the directional characteristics of the loud speaker for various audio frequencies are not identical, the quality of the reproduction heard by the listener (in the open air) will depend upon his position. In a room the results will be complicated by wall reflections which, in turn, may be selectively favorable toward certain ranges of audio frequencies. A person listening to a loud speaker which has an exaggeratedly narrow or concentrated directional characteristic for the higher audio frequencies will experience an unpleasantly sharp effect when he sits in the "beam" of the speaker, particularly in a room which has hard walls capable of reflecting to advantage the high audio frequencies in question. It has been mentioned by numerous listeners that they cannot enjoy radio music of the same loudness as that which they would cheerfully accept from a symphony orchestra in a concert hall. One of the reasons for this discrimination is the nature of loud speaker radiation into a living room of average acoustic characteristics.

(14) Receivers of high fidelity should be periodically checked to make sure that their fidelity has not been reduced by change in the circuit elements and tubes. They will require more thoughtful and individualized installation. Their servicing should be conducted far more systematically and thoroughly than is the present practice.

(15) We are thus led to a consideration of the acoustics of the room in which the broadcast listener receives his programs. In the absence of published data covering exhaustively the optimum living room



conditions for most natural reproduction of sound, there is little that can be done beyond pointing out the existence of a problem and the desirability of a systematic investigation aimed at its solution.

There have been described above some of the requirements for what might be termed ideal reception. Practically none of these conditions exist at the present time, and it is impracticable to go far ahead on some factor without making corresponding progress in most of the others because the net improvement resulting from a change in one factor may be slight, or in some cases even negative. In practice, marked improvement of receivers under existing receiving conditions would merely persuade the average listener that high fidelity receivers were high in cost but not in performance. This undesirable impression must be guarded against. Just as it is unsafe for individual soldiers to advance too far ahead of their regiment, so the practical method of meeting this situation is to outline a progressive plan whereby steps of proper magnitude for every factor are taken in correct order and at suitable intervals. One of the first steps, and a highly desirable one from numerous viewpoints, is the systematic increase in the power of transmitting stations. Another early step, to which no valid exception can be taken, is the reduction of the harmonic distortion of transmitting stations. Since the task of improving receiver fidelity falls within the domain of a somewhat different group from that controlling radio transmission, it is logical that any plan for the general improvement of the quality of reception should be handled by a coördinating committee containing representatives of all groups involved. Such, for example, is the Joint Committee of The Institute of Radio Engineers, the Radio Manufacturers Association, and the National Association of Broadcasters. Probably as useful a contribution to the advancement of broadcasting in the United States as any that could be made by this logically constituted group would be the development, on a flexibly scheduled basis, of a plan of the type described for rendering high fidelity reception useful and satisfying to American radio listeners.

Radio broadcasting cannot stand still, for a static art is drifting backwards in relation to its competitors and cannot hold the interest and approval of the public. Broadcasting has done well in many respects but cannot afford to rest on its laurels. It will be alike to the benefit of the listeners and the radio industry to carry forward a consistent and active campaign for the improvement of fidelity of the entire broadcast system along thoughtful lines worked out in accordance with some such plan as has been here proposed.



## THE ICONOSCOPE—A MODERN VERSION OF THE ELECTRIC EYE\*

BY

V. K. ZWORYKIN

(RCA Victor Company, Inc., Camden, New Jersey)

*Summary*—This paper gives a preliminary outline of work with a device which is truly an electric eye, the iconoscope, as a means of viewing a scene for television transmission and similar applications. It required ten years to bring the original idea to its present state of perfection.

The iconoscope is a vacuum device with a photo-sensitive surface of a unique type. This photo-sensitive surface is scanned by a cathode ray beam which serves as a type of inertialess commutator. A new principle of operation permits very high output from the device.

The sensitivity of the iconoscope, at present, is approximately equal to that of photographic film operating at the speed of a motion picture camera. The resolution of the iconoscope is high, fully adequate for television.

The paper describes the theory of the device, its characteristics and mode of operation.

In its application to television the iconoscope replaces mechanical scanning equipment and several stages of amplification. The whole system is entirely electrical without a single mechanically moving part.

The reception of the image is accomplished by a kinescope or cathode ray receiving tube described in an earlier paper.

The tube opens wide possibilities for applications in many fields as an electric eye, which is sensitive not only to the visible spectrum but also to the infra-red and ultra-violet region.

THE idea of being able to observe far-away events is a fascinating one. A device which will enable a person to do so has been for centuries the dream of inventors and for decades the goal of earnest scientific workers.

The goal of television is to make this dream a reality. The problem, however, is a difficult one and requires for its solution a great many component elements, most of them unknown up to quite recent years.

The meaning of seeing over a great distance can be interpreted as sending instantaneously a picture through this distance. This requires means of communication extremely rapid and free from inertia. The discovery of electricity and the development of electrical communication, therefore, laid the foundations for the future realization of television.

The first step which enabled the conversion of the picture into elec-

\* Decimal classification: 535.38. Original manuscript received by the Institute, June 14, 1933. Presented before Eighth Annual Convention, Chicago, Illinois, June 26, 1933.

trical energy was taken by May in 1873 through the discovery of the photo-resistive property of selenium. Further advance came from Hertz fifteen years later by the discovery of the photo-electric effect. The succeeding years witnessed rapid progress in this line from the study of the effect by Hallwachs, Elster, Geitel, and others.

How eagerly the experimenters were taking advantage of these new tools placed at their disposal is illustrated by the fact that the first proposal of a solution of the television problem by means of the selenium cell was made by Carey in 1875, or only two years after its discovery. Carey proposed to imitate the human eye by a mosaic consisting of great numbers of minute selenium cells. The second attempt to construct a mosaic of this kind with a small number of elements was made by Ayrton and Perry in 1877. Later in 1906 Rignoux and Fournier actually used a mosaic of this type to transmit simple patterns and letters. Their transmitter consisted of a checkerboard of sixty-four selenium cells. Each cell was connected by two wires to a corresponding shutter in a similar checkerboard comprising a receiver. The picture was projected on selenium cells, creating in them electric currents which, in turn, operated the shutters. The light from behind the shutters reproduced the picture.

The idea of separating the picture into small elements, converting the illumination of each element into electrical current, and sending each through a separate wire is a good one, but leads to a very elaborate system. To transmit a picture of good quality, a great many pairs of separate wires would be required, which, of course, is impracticable. To simplify the problem, Nipkow in 1884 proposed, that instead of sending all the elements of the picture at once, to transmit the picture point by point, or to scan the picture. This proposal simplified the problem considerably, since it enabled the transmission of the picture over a single wire or even a single communication channel.

The means by which this simplification was achieved was the scanning disk. The introduction of the scanning disk alone, however, did not bring the solution of the problem, due to the lack of some more essential elements. Almost forty years later, through the development of the thermionic amplifier for radio purposes and gas-discharge tubes, television became possible, and various inventors demonstrated television images transmitted by radio.

In the next few years progress was rapid and remarkable results were obtained, considering the difficulties encountered during this period of development. Practically all the work was done with mechanical methods of scanning, using either Nipkow disks, polygonal mirrors, mirrored screws, etc. This involved purely mechanical complica-

lision" cannot coexist with the satisfying use of high fidelity in a receiver.

(11) The requirement of over-all high fidelity in the receiver is of course necessary for accurate audio-frequency reproduction. This implies either that every element in the receiver shall leave unchanged the envelope form of the received wave or alternatively that mutually compensatory effects shall be introduced in the receiver system so that any excessive response toward certain audio frequencies in one part of the receiver shall be balanced by a correspondingly deficient response to the same audio frequencies in another part of the receiver. The term "receiver" in this connection includes the loud speaker system.

(12) The receiver should similarly be free from harmonic distortion due to overloading and nonlinear characteristics of the tube circuits. It is to be noted in this connection that the harmonic distortion introduced in the receiver is roughly speaking additive to that produced in the transmitter, thus increasing the undesired effect.

(13) When we enter the realm of sound reproduction through the use of loud speakers, it is found that a number of outstanding problems remain unsolved. If a single loud speaker is used in a receiving set, and if the directional characteristics of the loud speaker for various audio frequencies are not identical, the quality of the reproduction heard by the listener (in the open air) will depend upon his position. In a room the results will be complicated by wall reflections which, in turn, may be selectively favorable toward certain ranges of audio frequencies. A person listening to a loud speaker which has an exaggeratedly narrow or concentrated directional characteristic for the higher audio frequencies will experience an unpleasantly sharp effect when he sits in the "beam" of the speaker, particularly in a room which has hard walls capable of reflecting to advantage the high audio frequencies in question. It has been mentioned by numerous listeners that they cannot enjoy radio music of the same loudness as that which they would cheerfully accept from a symphony orchestra in a concert hall. One of the reasons for this discrimination is the nature of loud speaker radiation into a living room of average acoustic characteristics.

(14) Receivers of high fidelity should be periodically checked to make sure that their fidelity has not been reduced by change in the circuit elements and tubes. They will require more thoughtful and individualized installation. Their servicing should be conducted far more systematically and thoroughly than is the present practice.

(15) We are thus led to a consideration of the acoustics of the room in which the broadcast listener receives his programs. In the absence of published data covering exhaustively the optimum living room

conditions for most natural reproduction of sound, there is little that can be done beyond pointing out the existence of a problem and the desirability of a systematic investigation aimed at its solution.

There have been described above some of the requirements for what might be termed ideal reception. Practically none of these conditions exist at the present time, and it is impracticable to go far ahead on some factor without making corresponding progress in most of the others because the net improvement resulting from a change in one factor may be slight, or in some cases even negative. In practice, marked improvement of receivers under existing receiving conditions would merely persuade the average listener that high fidelity receivers were high in cost but not in performance. This undesirable impression must be guarded against. Just as it is unsafe for individual soldiers to advance too far ahead of their regiment, so the practical method of meeting this situation is to outline a progressive plan whereby steps of proper magnitude for every factor are taken in correct order and at suitable intervals. One of the first steps, and a highly desirable one from numerous viewpoints, is the systematic increase in the power of transmitting stations. Another early step, to which no valid exception can be taken, is the reduction of the harmonic distortion of transmitting stations. Since the task of improving receiver fidelity falls within the domain of a somewhat different group from that controlling radio transmission, it is logical that any plan for the general improvement of the quality of reception should be handled by a coördinating committee containing representatives of all groups involved. Such, for example, is the Joint Committee of The Institute of Radio Engineers, the Radio Manufacturers Association, and the National Association of Broadcasters. Probably as useful a contribution to the advancement of broadcasting in the United States as any that could be made by this logically constituted group would be the development, on a flexibly scheduled basis, of a plan of the type described for rendering high fidelity reception useful and satisfying to American radio listeners.

Radio broadcasting cannot stand still, for a static art is drifting backwards in relation to its competitors and cannot hold the interest and approval of the public. Broadcasting has done well in many respects but cannot afford to rest on its laurels. It will be alike to the benefit of the listeners and the radio industry to carry forward a consistent and active campaign for the improvement of fidelity of the entire broadcast system along thoughtful lines worked out in accordance with some such plan as has been here proposed.



## THE ICONOSCOPE—A MODERN VERSION OF THE ELECTRIC EYE\*

BY

V. K. ZWORYKIN

(RCA Victor Company, Inc., Camden, New Jersey)

*Summary*—This paper gives a preliminary outline of work with a device which is truly an electric eye, the iconoscope, as a means of viewing a scene for television transmission and similar applications. It required ten years to bring the original idea to its present state of perfection.

The iconoscope is a vacuum device with a photo-sensitive surface of a unique type. This photo-sensitive surface is scanned by a cathode ray beam which serves as a type of inertialess commutator. A new principle of operation permits very high output from the device.

The sensitivity of the iconoscope, at present, is approximately equal to that of photographic film operating at the speed of a motion picture camera. The resolution of the iconoscope is high, fully adequate for television.

The paper describes the theory of the device, its characteristics and mode of operation.

In its application to television the iconoscope replaces mechanical scanning equipment and several stages of amplification. The whole system is entirely electrical without a single mechanically moving part.

The reception of the image is accomplished by a kinescope or cathode ray receiving tube described in an earlier paper.

The tube opens wide possibilities for applications in many fields as an electric eye, which is sensitive not only to the visible spectrum but also to the infra-red and ultra-violet region.

THE idea of being able to observe far-away events is a fascinating one. A device which will enable a person to do so has been for centuries the dream of inventors and for decades the goal of earnest scientific workers.

The goal of television is to make this dream a reality. The problem, however, is a difficult one and requires for its solution a great many component elements, most of them unknown up to quite recent years.

The meaning of seeing over a great distance can be interpreted as sending instantaneously a picture through this distance. This requires means of communication extremely rapid and free from inertia. The discovery of electricity and the development of electrical communication, therefore, laid the foundations for the future realization of television.

The first step which enabled the conversion of the picture into elec-

\* Decimal classification: 535.38. Original manuscript received by the Institute, June 14, 1933. Presented before Eighth Annual Convention, Chicago, Illinois, June 26, 1933.

trical energy was taken by May in 1873 through the discovery of the photo-resistive property of selenium. Further advance came from Hertz fifteen years later by the discovery of the photo-electric effect. The succeeding years witnessed rapid progress in this line from the study of the effect by Hallwachs, Elster, Geitel, and others.

How eagerly the experimenters were taking advantage of these new tools placed at their disposal is illustrated by the fact that the first proposal of a solution of the television problem by means of the selenium cell was made by Carey in 1875, or only two years after its discovery. Carey proposed to imitate the human eye by a mosaic consisting of great numbers of minute selenium cells. The second attempt to construct a mosaic of this kind with a small number of elements was made by Ayrton and Perry in 1877. Later in 1906 Rignoux and Fournier actually used a mosaic of this type to transmit simple patterns and letters. Their transmitter consisted of a checkerboard of sixty-four selenium cells. Each cell was connected by two wires to a corresponding shutter in a similar checkerboard comprising a receiver. The picture was projected on selenium cells, creating in them electric currents which, in turn, operated the shutters. The light from behind the shutters reproduced the picture.

The idea of separating the picture into small elements, converting the illumination of each element into electrical current, and sending each through a separate wire is a good one, but leads to a very elaborate system. To transmit a picture of good quality, a great many pairs of separate wires would be required, which, of course, is impracticable. To simplify the problem, Nipkow in 1884 proposed, that instead of sending all the elements of the picture at once, to transmit the picture point by point, or to scan the picture. This proposal simplified the problem considerably, since it enabled the transmission of the picture over a single wire or over a single communication channel.

The means by which this simplification was achieved was the scanning disk. The introduction of the scanning disk alone, however, did not bring the solution of the problem, due to the lack of some more essential elements. Almost forty years later, through the development of the thermionic amplifier for radio purposes and gas-discharge tubes, television became possible, and various inventors demonstrated television images transmitted by radio.

In the next few years progress was rapid and remarkable results were obtained, considering the difficulties encountered during this period of development. Practically all the work was done with mechanical methods of scanning, using either Nipkow disks, polygonal mirrors, mirrored screws, etc. This involved purely mechanical complica-



tions in construction of sufficiently precise scanners, difficulties in increasing the number of picture elements and particularly in obtaining sufficient light. This last limitation actually introduced a stone wall which prevented the increase of the resolution of the transmitted picture to obtain the necessary quality and practically excluded all hope of transmitting an outdoor picture—the real goal of television.

In order fully to understand the reasons for this difficulty we should remember that the picture in all conventional systems of television is scanned point by point and therefore the photosensitive element is affected by the light from a given point only for a very short interval of time corresponding to the time of illumination of one picture element. Assume for a picture of good quality, we desire 70,000 picture elements. For twenty repetitions per second, this means that the time of transmission of one picture element is  $1/1,400,000$  of a second. On the other hand, the output of the photocell, which goes into the amplifier is proportional to the intensity of the light and time during which the light is acting on the photocell. A brief computation shows how microscopic will be the output of the photocell for this number of picture elements. If we take an average photographic camera with a lens  $F-4.5$ , the total light flux falling on the plate from a bright outdoor picture is of the order of  $1/10$ th of a lumen. Substituting a scanning disk for the plate suitable for 70,000 picture elements and placing a photocell of 10 microamperes per lumen sensitivity, we will have a photo current from a single picture element

$$I_e = \frac{1 \times 10^{-5}}{10 \times 70,000} = 1.43 \times 10^{-11} \text{ amperes.}$$

The charge resulting from this current in the time of one picture element is

$$Q = I_e \times t = \frac{1.43 \times 10^{-11}}{1.4 \times 10^6} = 1 \times 10^{-17} \text{ coulombs.}$$

Comparing that with a charge of one electron,  $e = 1.59 \times 10^{-19}$  coulombs, we see that only 63 electrons are collected during the scanning of one element. The amplification of such small amounts of energy involves practically insurmountable difficulties. If we now compare this condition with that of a photographic plate during exposure, we shall see that the latter operates under much more favorable conditions since all its points are affected by the light during the whole time of exposure. This time for studio exposure is several seconds, and of the order of one hundredth of a second for outdoor exposures, or many thousand

times greater than in the case of the scanned televised picture. The human eye, which we regard as an ideal of sensitivity, operates also under the same favorable condition.

If a television system could be devised which would operate on the same principle as the eye, all the points of the picture would affect the photosensitive element all the time. Then in our example of a picture with 70,000 elements the photo-electric output for each point would be 70,000 times greater than in the conventional system. Since scanning is

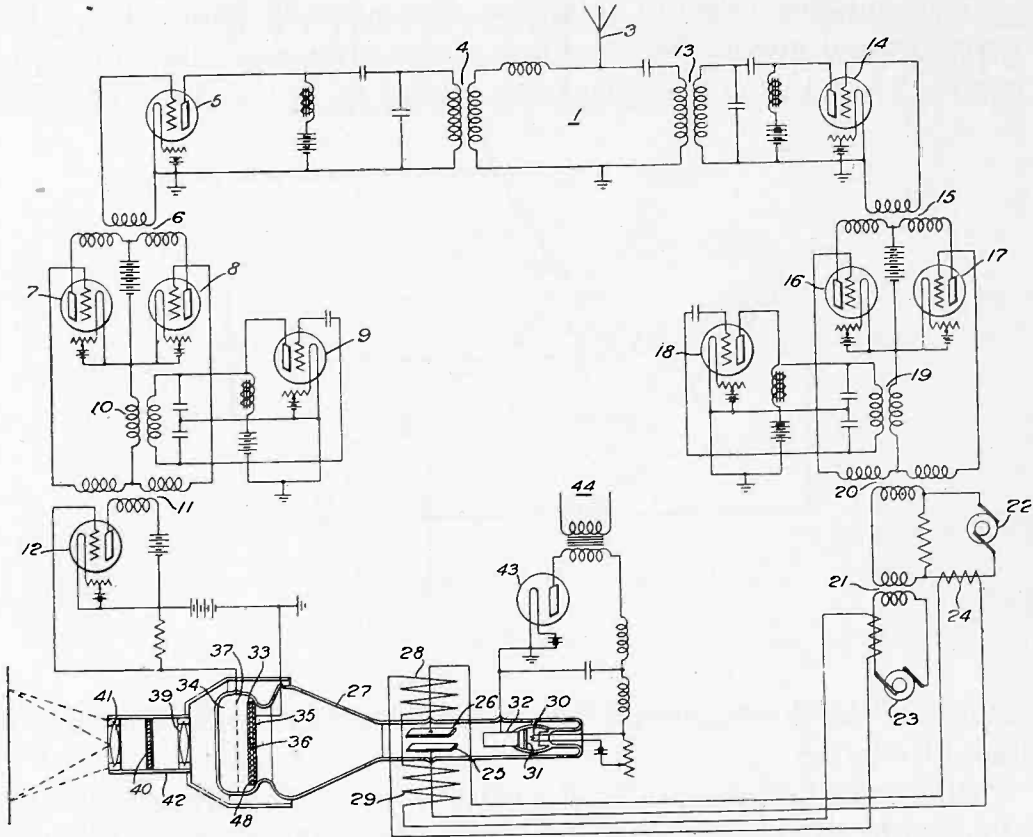

Fig. 1

still necessary in order to use only one communication channel, we should have some means for storing the energy of the picture between two successive scanings of each point.

The writer began to work on the realization of this idea years ago, and devised various solutions of the problem. One of the solutions of this problem involved the use of a special cathode ray tube with a photosensitive mosaic structure applied on an insulated metallic plate, as shown in Fig. 1. This represents a picture from one of the patents already issued upon one form of the development.<sup>1</sup> Each element of

<sup>1</sup> U. S. Patent No. 1,691,324. Issued November 13, 1928. Filed July 13, 1925.

the mosaic is a miniature photo-electric cell. The picture is projected on this mosaic, resulting in continuous emission of photo-electrons according to the distribution of light of the picture. The charge acquired by each element of the mosaic is released by the cathode ray beam once in each repetition of the picture. The resulting impulses were amplified and used to modulate the intensity of the cathode ray beam in the receiving tube, in which the picture was reproduced on a fluorescent screen.

Transmitting tubes of this type were actually built quite a few years ago and proved the soundness of the basic idea. During the succeeding years this development was carried on in the Research Labo-

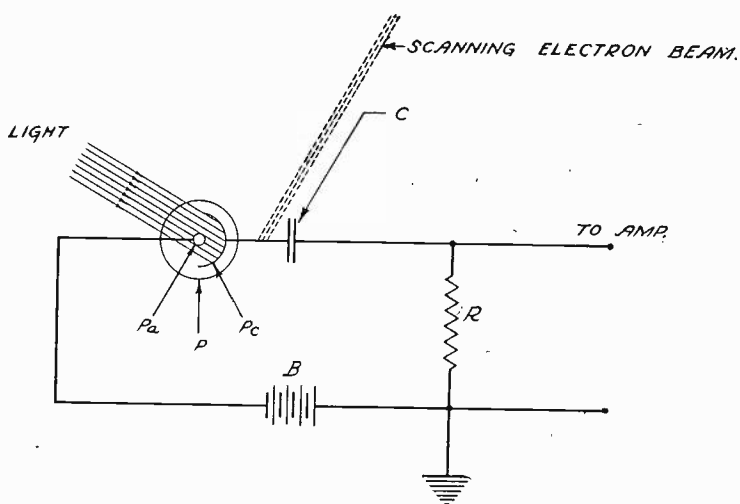

Fig. 2

ratories of the Westinghouse Electric and Manufacturing Company in East Pittsburgh.

One of the first receptions of a picture with a cathode ray tube was achieved in 1929, using a mechanical galvanometer for transmitter.<sup>2</sup> This was reported at the Rochester meeting of the I.R.E. in November, 1929. The next year the work was moved to the laboratories of RCA Victor Co., in Camden, where development of the cathode ray receiving system was continued, the pick-up being obtained with a scanning disk. This has been described in a series of papers in the PROCEEDINGS of the I.R.E.

In the meantime, the development of the pick-up tube was pushed on and the results obtained from it soon surpassed the results of mechanical scanning and eventually completely replaced it. The tube itself is called the "iconoscope" from the Greek word "icon" meaning an image and "scope" signifying observation.

<sup>2</sup> V. K. Zworykin, *Radio Engineering*, December, (1929).

To understand fully the operation of the iconoscope, it is best to consider the circuit of a single photo-electric element in the mosaic, as shown in Fig. 2. Here  $P$  represents such an element and  $C$  its capacity to a plate common to all elements, which hereafter will be called the "signal plate." The complete electrical circuit can be traced starting from the cathode  $P_c$  to  $C$ , then to resistance  $R$ , source of electromotive force  $B$  and back to the anode  $P_a$ . When light from the projected picture falls on the mosaic each element  $P_c$  emits electrons, and thus the condenser element  $C$  is positively charged by the light. The magnitude of this charge is a function of the light intensity. When the electron beam which scans the mosaic strikes this particular element  $P_cC$  that

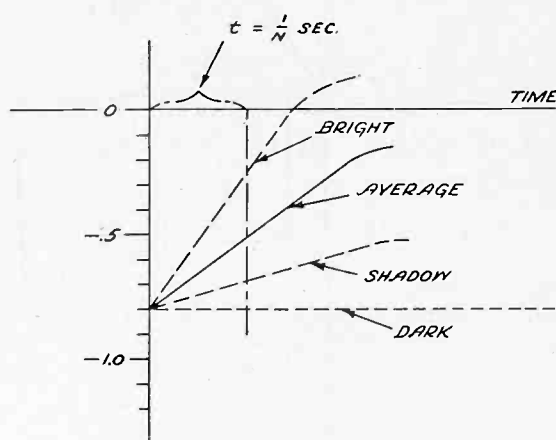

Fig. 3

element receives electrons from the beam and may be said to have become discharged.

This discharge current from each element will be proportional to the positive charge upon the element and, hence, the discharged current will be proportional to the light intensity at the particular element under question. The electrical circuit then transforms this discharge current into a voltage signal across the output resistor  $R$ .

If we plot the rise of charge of the element  $P_cC$  with respect to time, as shown on Fig. 3, the potential will continuously increase due to the light of the picture. The slope of this increase or  $dv/dt$  will depend only on the brightness of the particular point of the picture shining on this element. This linearity will be preserved until the saturation of the capacity  $C$ , which is so chosen as never to be reached at a given frequency  $N$  of repetition of the discharge. Since the scanning is constant, the interval of time,  $t$ , which is equal to  $1/N$  is also constant and therefore the value of charge depends only on the brightness of this particular point of the picture. With constant intensity of the scanning

beam, the impulse through  $R$  and consequently the voltage drop  $V_I$  across  $R$  is also proportional to the brightness of a given point of the picture. This potential  $V_I$  is the output of each single photo element of the iconoscope, and is applied to an amplifier.

The above explanation is actually somewhat complicated by the fact that this discharging beam not only neutralizes the positive charge of the photo-element, but charges it negatively. The equilibrium potential of the element is defined by the velocity of the beam and the secondary emission from the photo-emitting substance due to bom-

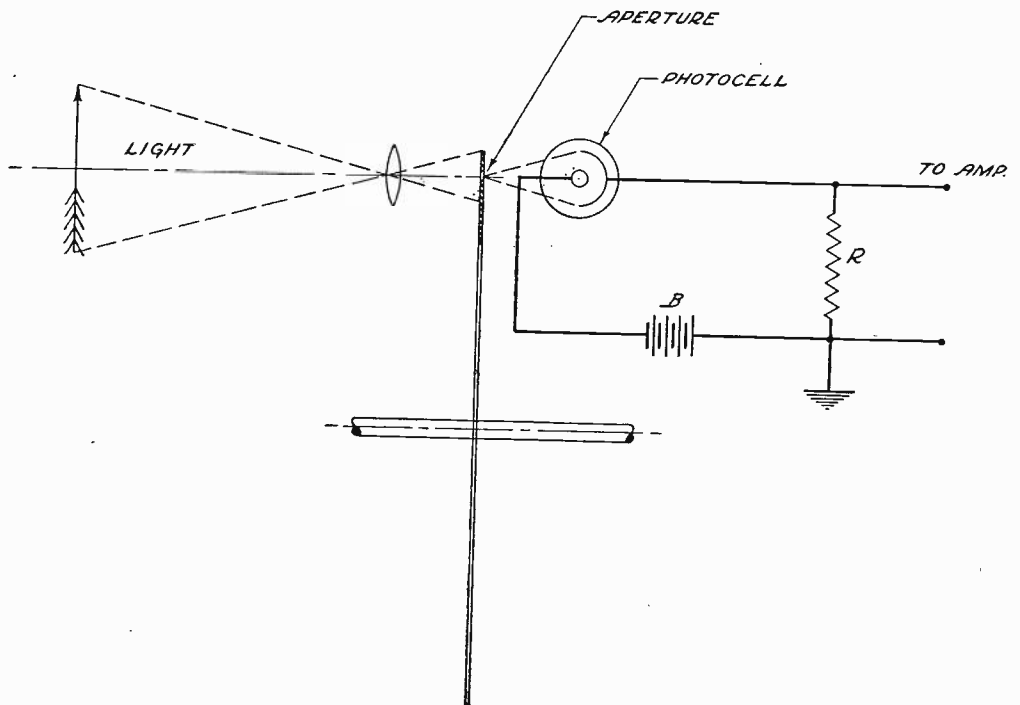

Fig. 4

bardment by the electrons of this velocity. This equilibrium condition in the dark, for a normal iconoscope, is of the order of 0.5 to 1.0 volt negative. The light causes the element to gain a positive charge, thus decreasing the normal negative charge, and the scanning beam brings it back again to the equilibrium potential.

Another complication is due to the existence, besides the discharge impulses, of a charging current of the entire mosaic due to light. This current is constant for the stationary picture and varies when the picture, or part of it, begins to move across the mosaic. This variation, however, is very slow and does not affect the amplifier which has a cut-off below 20 cycles.

In order to compare the magnitude of this output with that of the conventional television system, using a perforated disk, under identi-

cal conditions, we shall write down the value of the output for the iconoscope and for the usual mechanical method. A typical circuit for mechanical scanning is shown in Fig. 4.

The output of the photo-electric cell measured across the resistance,  $R$ , from the disk scanner is

$$V_d = R \times \frac{L}{n} \times S$$

$L$  = light flux corresponding to the total image,

$S$  = sensitivity of the photo element,

$n$  = number of picture elements,

$R$  = input resistance.

Considering the time necessary to build up the picture signal, we have to satisfy the condition that the time constant  $CR$  of the input circuit ( $C$  being the capacity of the photo element and associated circuits to ground) should be at least equal to or less than the time of scanning of a picture element,

$$\frac{1}{Nn} \text{ where } N = \text{number of picture frames per second.}$$

or,

$$CR = \frac{1}{Nn}$$

from which,

$$R = \frac{1}{NnC}$$

Introducing this in the expression of output of the photo-electric cell, we have

$$V_d = \frac{L}{n} \times S \times \frac{1}{NnC}$$

which shows that the output decreases as the square of the number of picture elements.

For the charge on one picture element of the iconoscope, we can write approximately

$$q = \frac{L}{n} \times S \times t$$

where  $t$  is the time during which the light shines on the element and which roughly equals

$$t = \frac{1}{N}.$$

The output voltage from the iconoscope will be

$$V_I = \frac{q}{C_I} \quad \text{where } C_I \text{ is the total input capacity of iconoscope and associated circuits to the ground.}$$

or,

$$V_I = \frac{L \times S}{n \times N \times C_I}.$$

The ratio between outputs from the iconoscope and disk scanner will be

$$\eta = \frac{\frac{L \times S}{n \times N \times C_I}}{\frac{L \times S}{n^2 \times N \times C}} = n \frac{C_I}{C}$$

or for equal output capacity

$$\eta = n \text{ (the number of picture elements).}$$

If we take the previously given number of picture elements  $n = 70,000$ , the net theoretical gain of the mosaic system against the conventional system of television is equal to 70,000 times. It should be noted, however, that 100 per cent efficiency can hardly ever be attained for various reasons, but we have already achieved approximately 10 per cent efficiency which gives us a net gain of several thousand times. These several thousand times increase of picture signal output do not serve merely to decrease the necessary amplification. In the conventional television system, we have already pushed the amplification as far as it is possible from the point of view of permissible noise to picture signal ratio. This gain, therefore, is the only factor whereby real television can be achieved, if we understand by this term not only the transmission of a picture of limited definition under artificial conditions but the actual transmission of a picture of high resolution under reasonable or natural conditions of illumination.

The scanning of an object with the flying spot is not considered in this computation, because it represents an entirely artificial condition and cannot be used for television pictures of distant objects.

The schematic diagram of a complete electrical circuit for the iconoscope is shown in Fig. 5. Here the two parts of the photo element  $P$ , shown on Fig. 2, are entirely separated. The cathodes are in



the shape of a photosensitive mosaic on the surface of the signal plate and isolated from it, the anode is common and consists of a silvered portion on the inside of the glass bulb.

The capacity  $C$  of each individual element with respect to the signal plate is determined by the thickness and dielectric constant of the insulating layer between the elements and the signal plate. The discharge of the positive charge of the individual elements is accomplished by an electron beam originating from the electron gun located opposite the mosaic and inclined at 30 degrees to the normal passing through the middle of the mosaic. Both mosaic and electron gun are enclosed in the same highly evacuated glass bulb. The inclined position

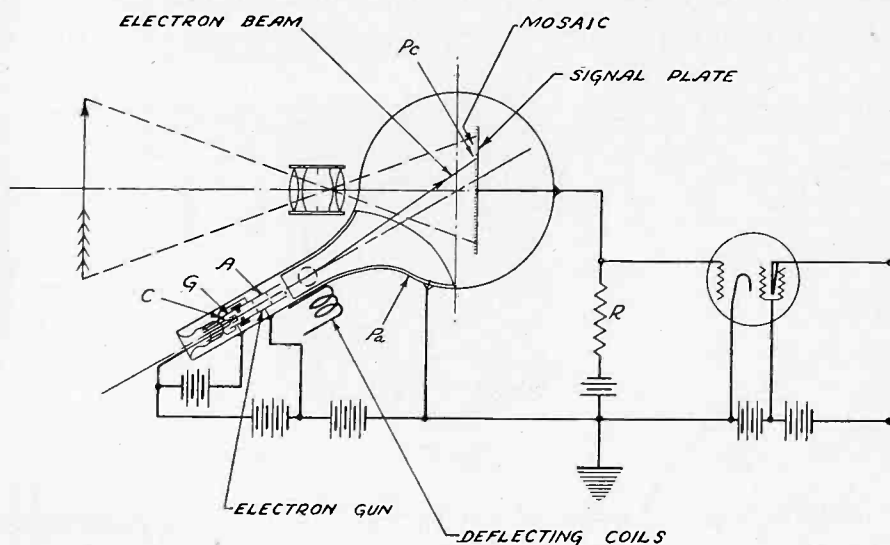

Fig. 5

of the gun is merely a compromise in the construction in order to allow the projection of the picture on the surface of the mosaic.

The resolution of the iconoscope is determined by both size and number of picture elements in the mosaic and size of the scanning electron beam. In practice, however, the number of individual photo elements in the mosaic is many times greater than the number of picture elements, which is determined entirely by the size of the scanning spot. This is shown diagrammatically on Fig. 6. From the initial assumptions formulated in the analysis of the ideal circuit for individual elements, as shown on Fig. 2, we find the qualifications which should satisfy the mosaic for the iconoscope. These assumptions required that all the elements be of equal size and photosensitivity and equal capacity in respect to the signal plate. The fact that the exploring spot is much larger than the element modifies and simplifies this requirement so that the average distribution, surface sensitivity, and capacity of ele-

ments over an area of the mosaic corresponding to the size of the scanning spot should be uniform. This allows considerable tolerance in the dimensions of individual elements.

The requirement of uniformity, which at first glance is quite difficult to accomplish, is solved by the help of natural phenomena. It is known that such a common material as mica can be selected in a thin sheet of practically ideal uniform thickness, and it therefore serves as a perfect insulating material for the mosaic. The signal plate is formed by a metallic coating on one side of the mica sheet. The mosaic itself can be produced by a multitude of methods, the simplest of which is a direct evaporation of the photo-electric metal on to the mica in a vacuum. When the evaporated film is very thin it is not continuous but consists of a conglomeration of minute spots or globules quite uni-

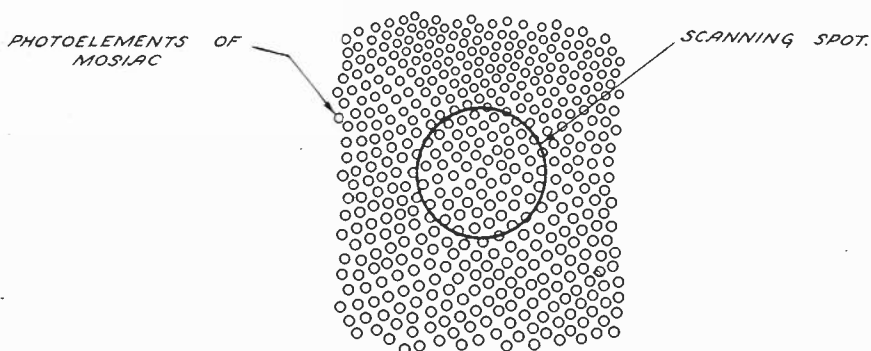

Fig. 6

formly distributed and isolated each from the other. Another possible method is that of ruling the mosaic from a continuous metallic film by a ruling machine.

Although the initial method of formation of the photosensitive mosaic was the deposition of a thin film of alkali metal directly on an insulating plate, subsequent developments in the photocell art resulted in changes in the methods of formation of the mosaic.

The mosaic which is used at present is composed of a very large number of minute silver globules, each of which is photosensitized by caesium through utilization of a special process.

Since the charges are very minute the insulating property and dielectric losses should be as small as possible. Mica of good quality satisfies this requirement admirably. However, other insulators can also be used and thin films made of vitreous enamels have proved to be entirely satisfactory. The insulation is made as thin as it can be made conveniently.

The sensitivity is of the same order as that of corresponding high vacuum caesium oxide photocells. The same is true also of the color

response. The spectral characteristic is shown on Fig. 7. The cut-off in the blue part of the spectrum is due to the absorption of the glass. The actual color sensitivity of the photo elements themselves is shown as a dotted curve.

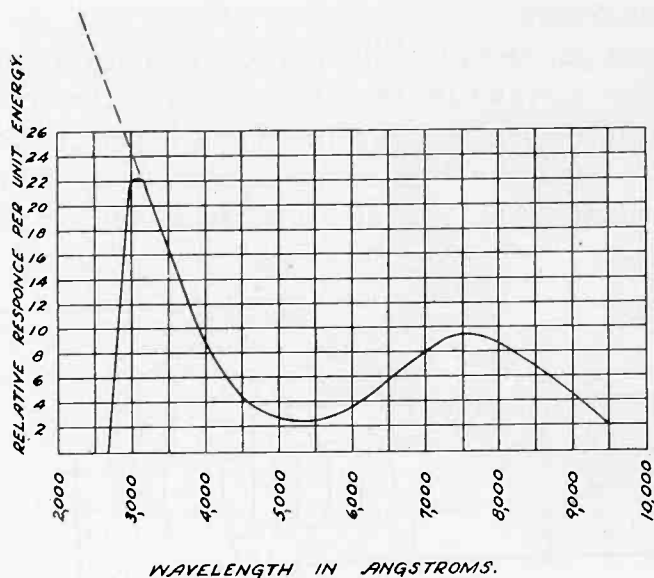

Fig. 7

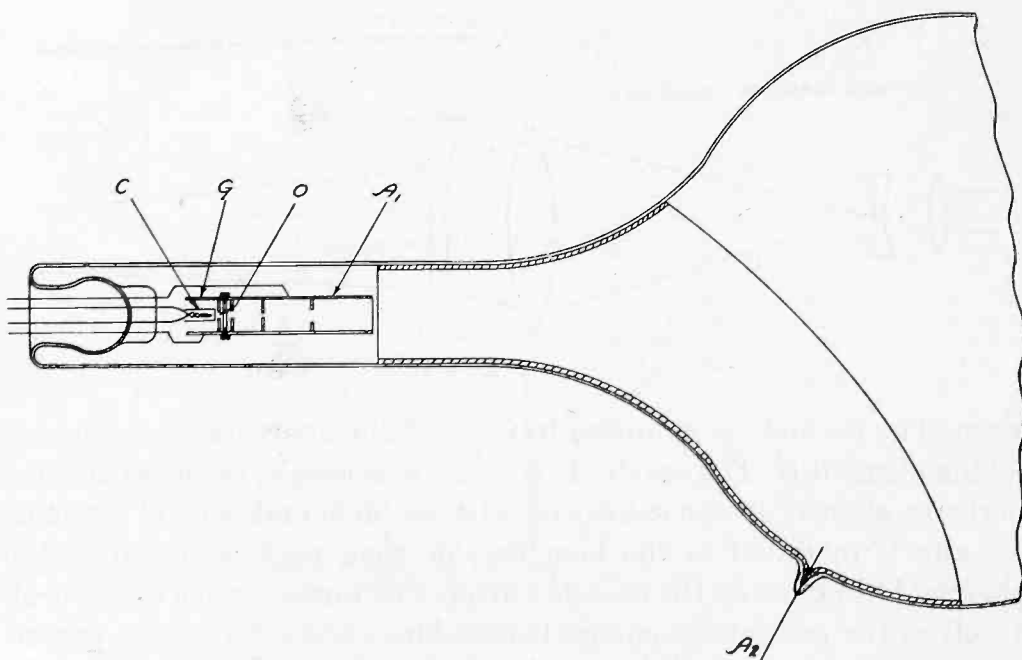

Fig. 8

The electron gun producing the beam is quite an important factor in the performance of the iconoscope. Since the resolution is defined by the size of the spot, the gun should be designed to supply exactly the size of spot corresponding to the number of picture elements for which

the iconoscope is designed. For the given example of 70,000 picture elements and a mosaic plate about 4 inches high, the distance between two successive lines is about 0.016 inch and the diameter of the cathode ray spot approximately half of this size. This imposes quite a serious problem in gun design.

The electron gun used for this purpose is quite similar to the one used for the cathode ray tube for television reception or the kinescope, which has already been described in several papers.<sup>2</sup> The components of the gun are shown in Fig. 8. It consists of an indirectly heated cathode, *C*, with the emitting area located at the tip of the cathode

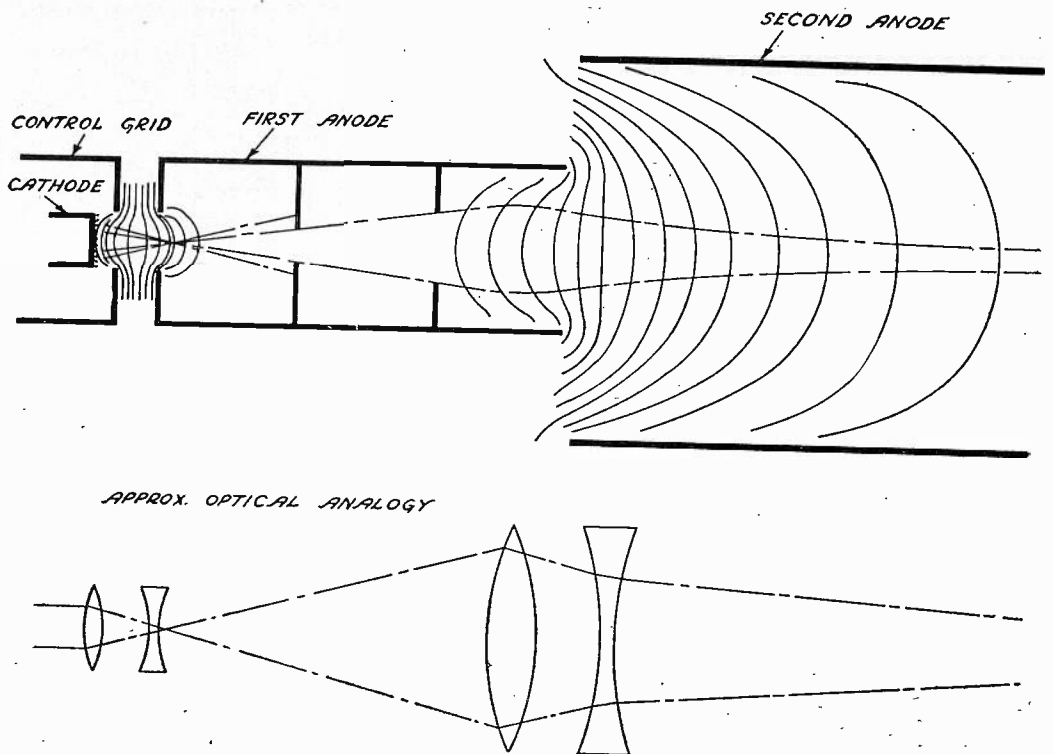

Fig. 9

sleeve. The cathode is mounted in front of the aperture *O* of the controlling element *G*. The anode *A*<sub>1</sub> consists of a long cylinder with three apertures aligned on the same axis with cathode and control element. The gun is mounted in the long narrow glass neck attached to the spherical bulb housing the mosaic screen. The inner surface of the neck as well as the part of the sphere is metallized and serves as the second anode for the gun and also as collector for photo electrons from the mosaic. The first anode usually operates at a fraction of the voltage applied to the second anode, which is approximately 1000 volts.

The focusing of the electron beam is accomplished by the electrostatic field between elements of the gun and between the gun itself and the second anode. The distribution of equipotential lines of the

electrostatic field is shown on Fig. 9. The theory of electrostatic focusing for this type of gun has already been published by the writer.<sup>3</sup> Briefly summarized, it amounts to the fact that a properly shaped elec-

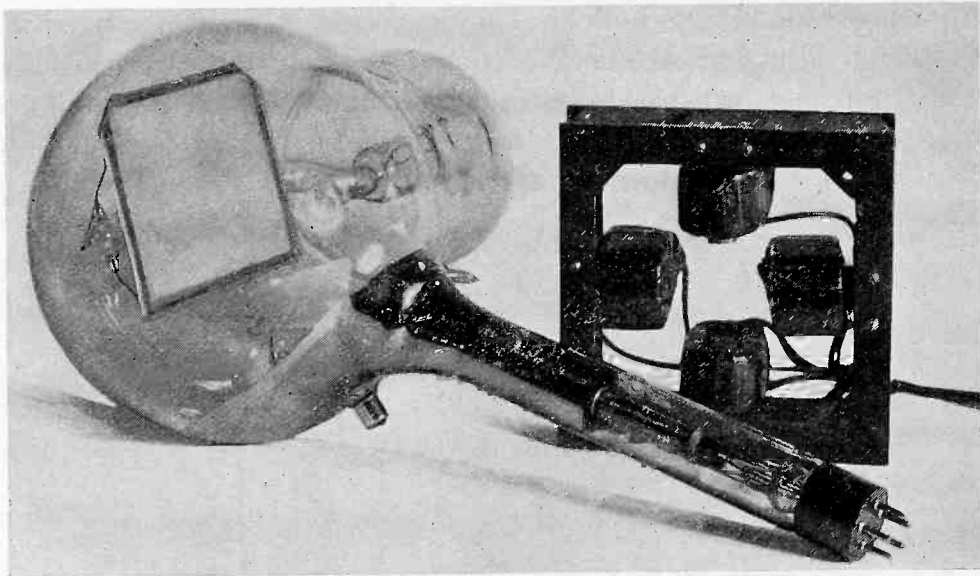

Fig. 10

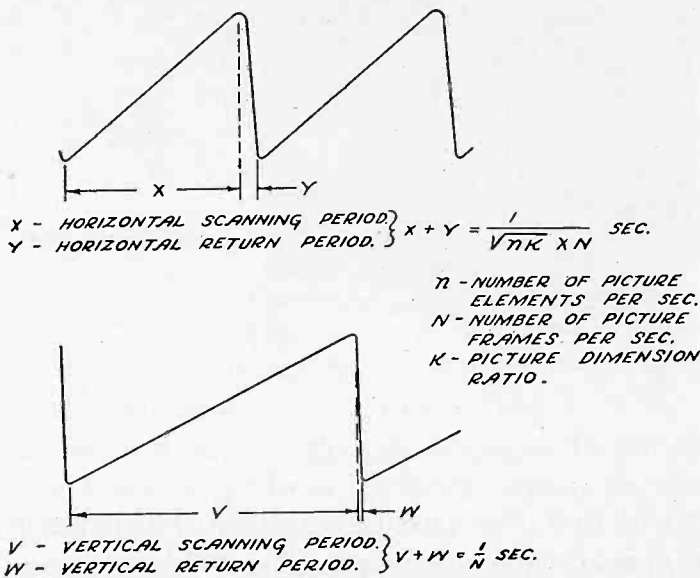

Fig. 11

trostatic field acts on moving electrons in the manner as a lens on a beam of light. The action of the field in the iconoscope gun is roughly equivalent to a composite lens consisting of four glasses, two positive and two negative. The optical analogy is shown on the same figure.

<sup>3</sup> V. K. Zworykin, *Jour. Frank. Inst.*, May, (1933).

The actual appearance of the iconoscope is shown on Fig. 10. Its over-all length on this particular model is 18 inches and diameter of the sphere 8 inches.

The deflection of the electron beam for scanning the mosaic is accomplished by a magnetic field. The deflection coils are arranged in a yoke which slips over the neck of the iconoscope. The assembled deflecting unit is shown besides that of the tube. The scanning is linear in both vertical and horizontal directions and is caused by saw-tooth-

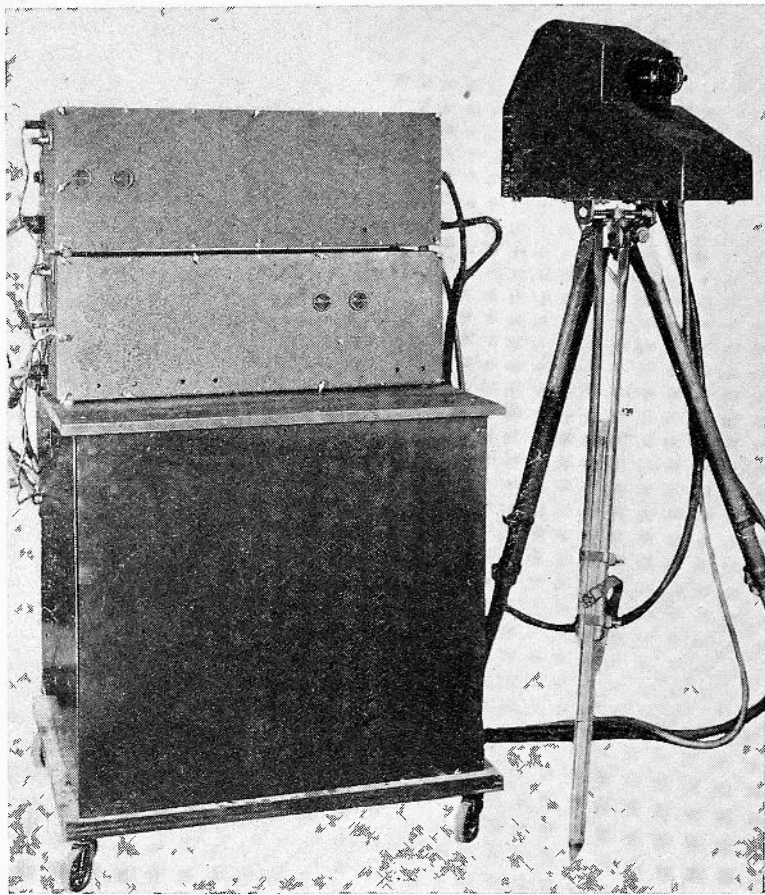

Fig. 12

shaped electrical impulses passing through the deflecting coils and generated by special tube generators. The resultant path of the scanning cathode ray spot plotted with respect of time is shown on Fig. 11. The circuits for those generators as well as methods of synchronizing were given in a previous series of papers in the PROCEEDINGS.<sup>4</sup>

Since the iconoscope is practically a self-contained pick-up unit, it is possible to design a very compact camera containing the iconoscope and a pair of amplifier stages connected with the main amplifier and

<sup>4</sup> Proc. I.R.E., vol. 21, pp. 1631-1706; December, 1933

deflecting units by means of a long cable. Since the camera is portable, it can be taken to any point of interest for the transmission of a television picture. The photograph of such a unit is shown on Fig. 12.

The reception of images transmitted by the iconoscope is accomplished by means of the cathode ray receiving tube or kinescope. This tube was described in the writer's earlier papers.<sup>2,3</sup> The picture of the tube is shown in Fig. 13.

The complete block diagram of the circuit associated with the transmitting and receiving ends of the whole system is shown on Fig. 14.

The main feature of this scheme, as seen from this diagram, is that

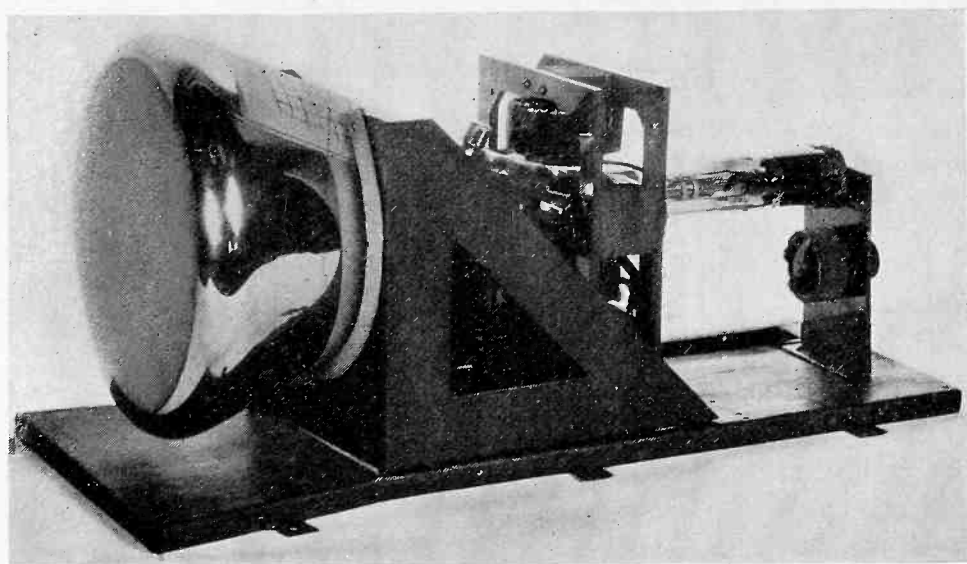

Fig. 13

in the whole system there are no mechanically moving parts and the transmission of the picture is accomplished entirely by electrical means.

From the color response curve shown on Fig. 7, it is clear that the iconoscope can be used not only for transmission of pictures in visual light but also pictures invisible to the eye in which the illumination is either by ultra-violet or infra-red light.

The present sensitivity of the iconoscope is approximately equal to that of a photographic film operating at the speed of a motion picture camera, with the same optical system. The inherent resolution of the device is higher than required for 70,000 picture element transmission. Some of the actually constructed tubes are good up to 500 lines with a good margin for future improvement.

With the advent of an instrument of these capabilities, new prospects are opened for high grade television transmission. In addition,



wide possibilities appear in the application of such tubes in many fields as a substitute for the human eye, or for the observation of phenomena at present completely hidden from the eye, as in the case of the ultra-violet microscope.

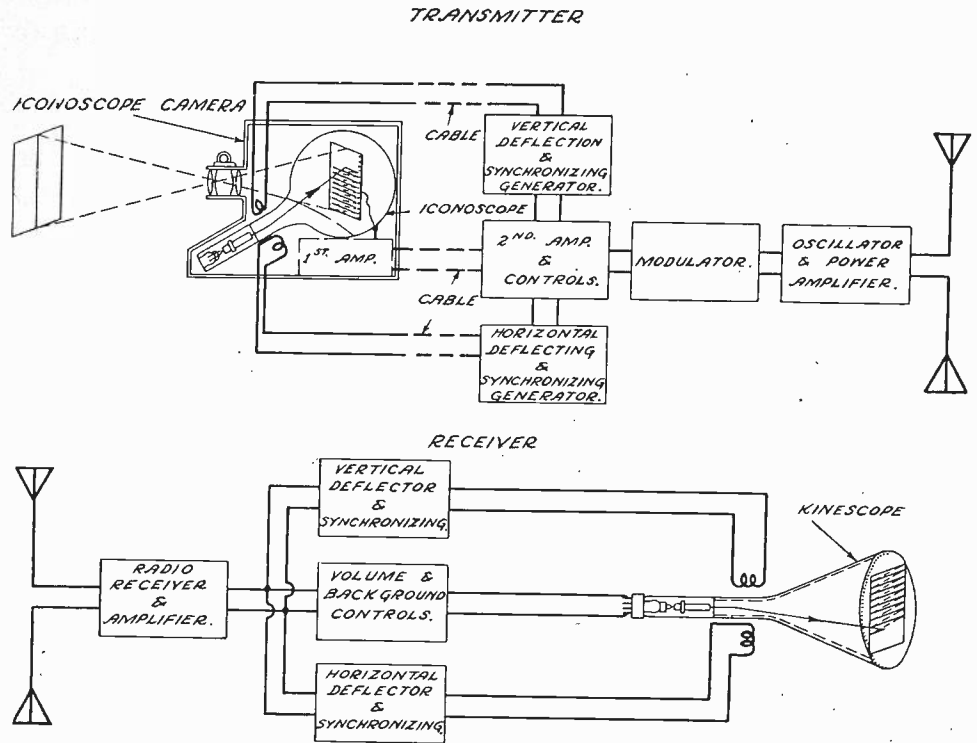

Fig. 14

## ACKNOWLEDGMENT

The writer wishes gratefully to acknowledge the untiring and conscientious assistance of Messrs. G. N. Ogloblinsky, S. F. Essig, H. Iams, and L. E. Flory, who carried on much of the theoretical and experimental work connected with the development which has been described in the foregoing, and whose ability was the major factor in the successful solution of the many problems arising in the course of this work.



## A NEW CONE LOUD SPEAKER FOR HIGH FIDELITY SOUND REPRODUCTION\*

BY

HARRY F. OLSON

(RCA Victor Company, Inc., Camden, New Jersey)

*Summary*—Economic conditions which are involved in every product designed for the multitudes have prevented the adoption of the various elaborate types of wide range sound reproducers. A consideration of this problem shows that the loud speaker is one of the component parts which has limited the range of radio and phonograph reproduction. This paper describes the result of a program of development on the production of a wide range cone loud speaker capable of delivering large acoustic outputs and at the same time retaining a system free from the complexities of construction usually associated with wide range electro-acoustic transducers. The wide range cone loud speaker consists of a voice coil and coil cylinder segregated into masses and compliances and connected to a cone suitably corrugated to present an impedance to the driving system which would yield uniform response from 80 to 10,000 cycles. Objective and subjective performance tests indicate that this loud speaker is suitable for high fidelity sound reproduction and substantiates the theoretical analysis.

### INTRODUCTION

A SOUND transmitting system to yield faithful reproduction should transmit all the audible frequencies of the sound in the ratio of their original intensities. The range which it is necessary to reproduce with fidelity depends upon the frequency-amplitude characteristics of the sound and the hearing characteristics of the ear. Sound transmitting systems capable of reproducing the entire audible spectrum have been available in the laboratories for some time. Economic conditions which are involved in every product designed for the multitudes have prevented the widespread use of such elaborate apparatus. However, data have been assembled employing this laboratory equipment to establish the range necessary to reproduce with good fidelity the average sounds of speech and music. These data show that the amplitude-frequency characteristics of the high grade broadcast stations will render faithful reproduction for most sounds of speech and music. However, an examination of the amplitude-frequency characteristics of the average radio receiver shows that the range is not commensurate with the remainder of the transmission system, and the result is that most sounds are not faithfully reproduced. At the present time, broadcast stations are separated by 10 kilocycles, which means

\* Decimal classification: R365.2. Original manuscript received by the Institute, September 21, 1933. Presented before Eighth Annual Convention, Chicago, Illinois, June 28, 1933; presented before New York Meeting, December 6, 1933.

that the amplitude-frequency characteristic must be confined to slightly less than this range. Male and female speech is reproducible with excellent fidelity by transmission of frequencies up to 8000 cycles and 10,000 cycles, respectively. In the case of orchestral music a comparison between reproduction up to 10,000 cycles and the entire audible spectrum shows that there is no appreciable impairment of the tone quality; however, a 5000-cycle cut-off shows considerable impairment. A 10,000-cycle cut-off does affect the naturalness of noises, but does not preclude recognition of the noise.<sup>1</sup>

Therefore, in view of these facts, the logical procedure towards higher fidelity is an improvement in the over-all amplitude-frequency characteristic of the radio receiver, including the final sound output. A consideration of this problem shows that the loud speaker is one of the component parts which has limited the range of radio receivers. As a consequence, a program of development was instituted, concentrating on the production of a wide range loud speaker capable of delivering large acoustic outputs and at the same time retaining a system free from the complexities of construction usually associated with wide range electro-acoustic transducers.

It is the purpose of the paper which follows to describe a cone loud speaker which covers the band from 60 to 10,000 cycles.

#### THE DYNAMIC CONE LOUD SPEAKER

In this section, we shall outline briefly the action of the conventional dynamic loud speaker and the inherent response limitations of this system. This vibrating system consists of mass, stiffness, and resistance, and the velocity of the cone in terms of these quantities is given by the expression,

$$\dot{X} = \frac{Bli}{r_A + j\omega m - \frac{j}{\omega c}} \quad (1)$$

where,

$B$  = flux density of the magnetic field.

$i$  = current in voice coil,

$l$  = length of the conductor,

$m$  = mass of cone, voice coil, and the air load associated with the cone,

$c$  = compliance of the suspension and centering device,

$r_A$  = resistance due to air load,

$\omega = 2\pi f$ ,

$f$  = frequency.

<sup>1</sup> W. B. Snow, *Jour. Acous. Soc. Amer.*, July (1931).

In the case of an eight-inch cone, which is employed in this system, all parts of the cone and driving coil move in the same phase up to about 1000 cycles. Also, in this range the radiation is essentially the same as that of a vibrating piston. The impedance<sup>2</sup> due to air presented to a vibrating piston in an infinite plane is given by

$$Z_A = \left\{ \left[ 1 - \frac{J_1(2kR)}{kR} \right] + j \left[ \frac{K(2kR)}{2k^2R^2} \right] \right\} \pi R^2 \rho v \quad (2)$$

where,

$$\begin{aligned} J_1 &= \text{Bessel function}^3 \text{ of order 1,} \\ k &= 2\pi/\lambda, \\ \lambda &= \text{wavelength,} \\ R &= \text{radius of piston.} \\ K(2kR) &= 2kRH_1(2kR). \end{aligned}$$

The resistive and reactive components for an eight-inch cone in an infinite baffle are shown in Fig. 1. The condition of an infinite baffle is not satisfied under actual conditions; the expressions for these com-

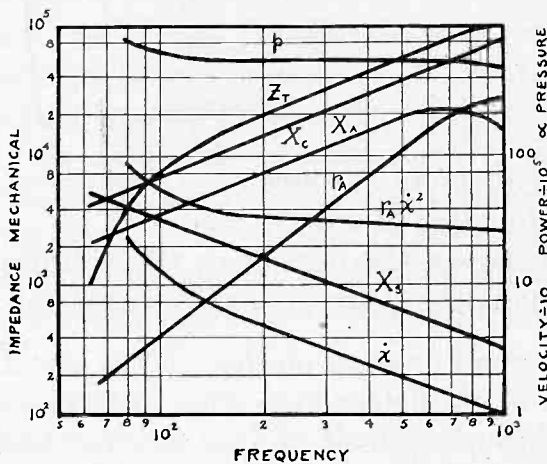

Fig. 1—Characteristics of a cone loud speaker.

- $r_A$  = radiation resistance
- $X_A$  = air load reactance
- $X_c$  = cone reactance
- $X_s$  = suspension reactance
- $Z_T$  = total impedance of the system
- $\dot{x}$  = velocity of the cone
- $r_A \dot{x}^2$  = power output
- $p$  = sound pressure on the axis

ponents must be modified to suit the particular system in question. In the case of most well-designed radio cabinets, the operation differs from that in an infinite baffle only at very low frequencies. It is beyond the scope of this analysis to outline the operation at these frequencies;

<sup>2</sup> Rayleigh, "Theory of Sound", vol. II, pp. 278 and 302.

<sup>3</sup> Watson, "Theory of Bessel Functions."

however, in general the operation and conclusions will not be materially changed by the assumption of an infinite baffle. The acoustic output is the product of the resistive component of the air load and the square of the velocity of the system, and may be expressed by

$$r_A \dot{X}^2 = \left[ 1 - \frac{J_1(2kR)}{kR} \right] \pi R^2 42 \dot{X}^2. \quad (3)$$

In the range considered above, it will be seen that the velocity as given by (1) and shown graphically in Fig. 1 is inversely proportional to the frequency.

The resistive component of the air load for the same range is practically proportional to the square of the frequency. Therefore, the acoustic output as given by (3) should be independent of the frequency. The slight attenuation in the power output as the frequency increases is compensated for by the directional characteristics.

The directional characteristics<sup>4</sup> of a vibrating piston are a function of the frequency and may be expressed by the ratio of radiation for angle  $\alpha$  to  $\alpha = 0$ .

$$D = \frac{2J_1(kR \sin \alpha)}{kR \sin \alpha} \quad (4)$$

where,

$D$  = ratio of pressure at angle  $\alpha$  to pressure at angle  $\alpha = 0$ ,

$J_1$  = Bessel function of order 1, and

$\alpha$  = angle between the normal to the vibrating plane and the line joining the source and the observation point.

Knowing the sound pressure on the axis the sound pressure for any point in space can be determined from (4). From these data the acoustic power output of a loud speaker may be obtained by integrating the sound energy flux over a sphere with the loud speaker as the center. Conversely using (4) and the total sound energy radiated, the sound pressure on the axis may be determined. The results are shown in Fig. 1 and indicate that the sound pressure on the axis is practically independent of the frequency up to 1000 cycles. Due to the large angular distribution of sound in this range, the slight change in directional characteristics does not result in noticeable frequency discrimination for points removed from the axis.

Up to the present we have been discussing the behavior of an eight-inch cone loud speaker in the frequency range below approximately 1000 cycles (that is, the range where piston action may be expected).

<sup>4</sup> H. Stenzel, *Elek. Nach. Tech.*, June, (1927); I. Wolff and L. Malter, *Jour. Acous. Soc. Amer.*, vol. II, no. 2, p. 201; I. Wolff, *Electronics*, February, (1932).

In order to determine the performance at the higher frequencies, let us consider the mechanical elements of a cone with its driving system, as shown in Fig. 2. This consists of a voice coil,  $m$ , a compliance  $c$  at the junction between the coil cylinder and the cone and the impedance of the cone  $Z_c$ . As we pointed out above, if the cone is assumed to be rigid, the impedance  $Z_c$  will be a mass reactance, and  $c$  will be zero, and since the force available for driving the system is constant, the velocity of the system will be inversely proportional to the frequency. The radiation resistance is constant above 1000 cycles for an eight-inch cone; therefore, the sound power radiated will be inversely proportional to the square of the frequency. Even if it were physically possible, there would be two fundamental reasons which would make it undesirable to maintain piston action in a cone loud speaker above 1000 cycles. First, the directional characteristic of such a radiator, as given by (4), shows that at the very high frequencies the sound would be radiated in a very narrow beam, with the result that there would be considerable frequency discrimination for points removed from the axis. Second, the power output would decrease rapidly at higher frequencies, as pointed out above, because the mass reactance of such a system is proportional to the frequency, and as a consequence, the velocity for constant applied force is inversely proportional to the frequency, with the result that above the frequency of ultimate acoustic resistance the radiated energy would fall off rapidly with increase of frequency. It is quite evident then that to maintain constant acoustic output above the frequency of ultimate resistance, the velocity of the cone must be independent of the frequency for constant applied force.

In the design of electrical networks for the transmission of wide frequency bands the end is attained by the use of multiple resonant circuits. The same procedure has been followed in this vibrating system. To reduce the effective impedance  $Z_c$  the cone is divided into sections of masses  $m_1$ ,  $m_2$ , and  $m_3$ , etc., separated by compliances introduced by suitable corrugations.

To maintain constant sound power output, the sum of the outputs of the elements  $m_1$ ,  $m_2$ ,  $m_3$  . . . which is determined by the product of the radiation resistance of each element and the square of the velocity of that element must be independent of the frequency. The radiation resistance of each element is a function of the configuration of the element and the phase relation between the elements. Furthermore, the directional characteristic of the entire system is determined by the phase relations between the elements. The problem then is to design a mechanical system of masses and compliances so that the

acoustic power output for constant applied force will be practically independent of the frequency, together with reasonably uniform directional characteristics.

When a suitable system has been found, we shall obtain a certain impedance  $Z_c$  at the point designated on Fig. 2. It has been found experimentally that by applying constant force at this point to a cone

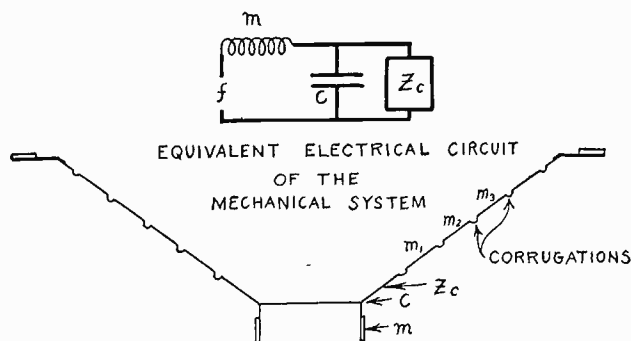

Fig. 2—Mechanical system consisting of a voice coil of mass  $m$ , compliance  $c$ , and cone impedance  $Z_c$ .

having the impedance characteristic of Fig. 3 that the sound output is practically independent of the frequency. It is beyond the scope of this paper to outline in detail the action of the corrugated cone which consists of masses and compliances distributed so that the response of the resulting system for constant applied force is independent of the fre-

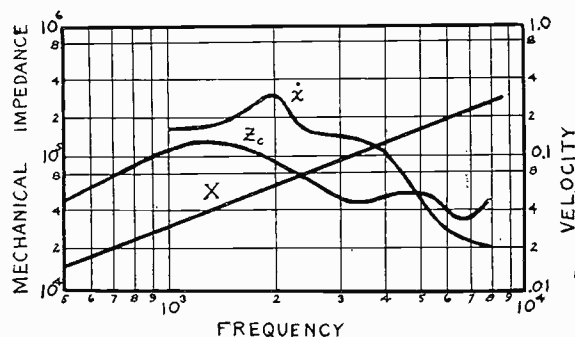

Fig. 3—Characteristics of a cone and a simple driving system.

$Z_c$  = impedance of cone

$X$  = reactance of voice coil

$x$  = velocity of  $Z_c$

quency. The values of  $Z_c$  for a particular cone are shown in Fig. 3. The mass reactance of an ordinary driving system, which results in good low-frequency response, is shown in Fig. 3. Used in conjunction with this driving system, the output will be independent of the frequency until the mass reactance due to the coil is comparable to the impedance presented to the driving system. In the ordinary type of cone and



driving system used in the past, this occurs at about 2500 cycles, as shown in Fig. 3. Beyond this point, the velocity of  $Z_c$ , as shown in Fig. 3, will begin to fall off. For this reason, the radiation from the cone loud speaker with a simple driving system is attenuated above 2500 cycles. To maintain unattenuated response above 2500 cycles requires a reduction in the effective mass of the voice coil. This may be accomplished by using an auxiliary high-frequency loud speaker with a light coil, or a single loud speaker for the entire range with a voice coil consisting of multiple resonant mechanical systems. It is the purpose of the section which follows to outline the relative merits of one- and two-unit loud speakers for wide range reproduction of sound.

#### SINGLE AND MULTIPLE UNIT DYNAMIC CONE LOUD SPEAKERS FOR WIDE RANGE REPRODUCTION OF SOUND

A loud speaker having response above 3000 cycles commensurate with the low-frequency response of the loud speaker described in the preceding section must have a driving system of small mass. Such a system will of necessity have a large ratio of ampere turns to mass, which means that the voice coil will have a small total number of ampere turns. Such a system will not be efficient at low frequencies where large forces, as obtained from a voice coil comparable with the static mass of the system are necessary to overcome the combined mass reactance of the cone and air load. One solution to the problem of maintaining unattenuated sound radiation up to 10,000 cycles is the use of two loud speakers, one of the type described in the preceding section covering the range to 3000 cycles, and the other covering the band above this frequency.

The disadvantages of the multiple unit system will now be outlined. The radiating surfaces must be separated by a finite distance, with the result that this system will exhibit peculiar directional characteristics in the overlap region where the sound radiation issues from both sources. To reduce this effect to a minimum, the overlap region must be confined to a very small range which requires an elaborate electric filter system for allocating the frequency bands of the units. The greater space required for the two loud speakers is another important factor. The cost of two separate field structures and vibrating systems will be considerably greater than that of a single unit. The additional power required for energizing the field in the case of two systems will result in increased cost of the field supply system. It is evident that the single unit type of wide range reproducer has certain inherent advantages as compared with the multiple system. For this reason, the development of a wide range reproducer in this laboratory has been

primarily concerned with the single unit type. It is the purpose of the section which follows to describe a wide range reproducer in which the voice coil consists of a special type of mechanical system.

### THE WIDE RANGE CONE LOUD SPEAKER

The wide range cone loud speaker consists of a voice coil and coil cylinder mechanically segregated into masses and compliances and connected to a cone suitably corrugated to present an impedance to the driving system which will yield uniform response from 60 to 10,000 cycles.

To reduce the impedance, the driving system is sectionalized with compliances separating the individual masses. The voice coil is divided mechanically into two parts,  $m_1$  and  $m_2$ , separated by a compliance,  $c_1$  (Fig. 5). The electrical network used to allocate the current, with respect to frequency, in the driving system is shown in Fig. 4. At low

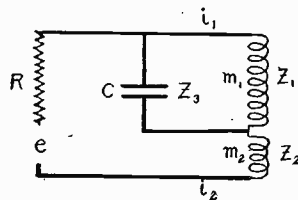

Fig. 4—Electrical circuit of the voice coil system.

frequencies the current flows through both portions of the coil and the cone is driven by forces generated in  $m_1$  and  $m_2$ ; at high frequencies, the major portion of the current in the circuit flows in  $m_2$  and the cone is driven by the forces generated in  $m_2$ . The current in the portion of the coil designated  $m_1$  is given by the expression,

$$i_1 = \frac{e(Z_3)}{(R + Z_2)Z_3 + (Z_2 + R)Z_1 + Z_1Z_3}, \quad (5)$$

where,

$Z_1$  = impedance of  $m_1$  portion of the voice coil,

$Z_2$  = impedance of  $m_2$  portion of the voice coil,

$R$  = resistance of the generator,

$$Z_3 = \frac{j}{\omega C_3}.$$

The current in the portion of the coil designated  $m_2$  is given by,

$$i_2 = \frac{e(Z_1 + Z_3)}{(R + Z_2)Z_3 + (Z_2 + R)Z_1 + Z_1Z_3}. \quad (6)$$

The driving system and cone and the equivalent electrical circuit of the mechanical system is shown in Fig. 5. The forces  $f_1$  and  $f_2$  are the product of the current, length of the conductor, and flux density in the portions of the coil  $m_1$  and  $m_2$ . The force  $f_1$  is given by,

$$f_1 = Bl_1 i_1 \tag{7}$$

where,

- $B$  = flux density,
- $l_1$  = length of wire in  $m_1$ ,
- $i_1$  = current given by (5).

The force  $f_2$  is given by,

$$f_2 = Bl_2 i_2 \tag{8}$$

where,

- $l_2$  = length of wire in  $m_2$ ,
- $i_2$  = current given by (6).

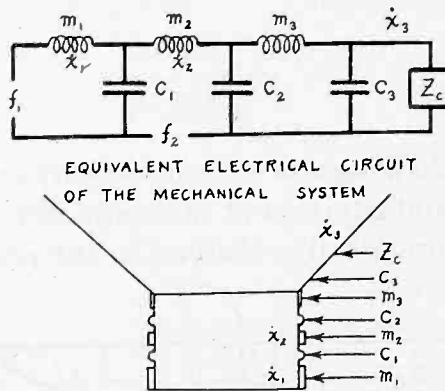

Fig. 5—Mechanical system consisting of voice coil masses  $m_1$  and  $m_2$ , coil cylinder mass  $m_3$ , compliances  $c_1$ ,  $c_2$ , and  $c_3$  and cone impedance  $Z_c$ .

The currents in the  $m_1$  and  $m_2$  portions of the voice coil circuit are shown in Fig. 6. The phase angle between the current is important in the region where the drive is derived from both coils. The optimum angle must be determined from a consideration of the mechanical system.

In the mechanical system, Fig. 5, we are interested in the velocity  $\dot{X}_3$  of the cone represented by  $Z_c$ . The velocity,  $\dot{X}_3$ , is given by the expression,

$$\dot{X}_3 = \frac{f_1 Z_2 Z_4 Z_6}{\{Z_6 + Z_c\} \{Z_1(Z_2 + Z_3)(Z_4 + Z_5) + Z_2 Z_3(Z_4 + Z_5) + Z_4 Z_5(Z_1 + Z_2)\} + Z_6 Z_c \{(Z_1 + Z_2)(Z_3 + Z_4) + Z_1 Z_2\}} + \frac{f_2 Z_4 Z_6}{(Z_3 + Z_1')(Z_4 + Z_5)(Z_6 + Z_c) + Z_6 Z_c(Z_1' + Z_3 + Z_4) + Z_4 Z_5(Z_6 + Z_c)} \tag{9}$$

where,

- $m_1$  = mass of the larger portion of the voice coil,
- $m_2$  = mass of the smaller portion of the voice coil,
- $m_3$  = mass of the neck and coil leads,
- $c_1$  = compliance separating  $m_1$  and  $m_2$ ,
- $c_2$  = compliance separating  $m_2$  and  $m_3$ ,
- $c_3$  = compliance of junction between coil cylinder and cone,
- $Z_c$  = impedance of cone.

$$Z_1 = j\omega m_1$$

$$Z_2 = 1/j\omega c_1$$

$$Z_3 = j\omega m_2$$

$$Z_4 = 1/j\omega c_2$$

$$Z_5 = j\omega m_3$$

$$Z_6 = 1/j\omega c_3$$

$$Z_1' = \frac{Z_1 Z_2}{Z_1 + Z_2}$$

At this point we shall digress to discuss compliances as used in this system. Due to the configuration of magnetic structure and voice coil which is regarded as practically standard at the present time, the par-

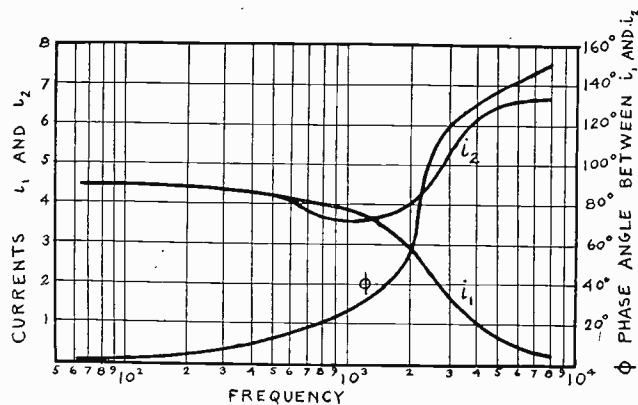

Fig. 6—Graph showing the magnitude and phase of the currents in the  $m_1$  and  $m_2$  portions of the voice coil.

ticular kind of compliance most readily adapted is a bead pressed into the material connecting the coils. A cross section of a simple compliance which has been successfully employed as a link dividing the masses in the vibrating system is shown in Fig. 7. Save for second order effects, we can consider a single compliance to be made of four separate cantilever beams, namely, AB, BC, CD, and DE, Fig. 7. The stiffness of each of these beams may be calculated and their compliances added.

If the shape of each section is similar to the quadrant of a circle the formula for the stiffness is given by,

$$\text{Stiffness} = \frac{F}{d} = \frac{4EI}{\pi R^3} \quad (10)$$

$E$  = Young's modulus,

$I = \frac{bh^3}{12}$  = moment of inertia of the cross section of material,

$b$  = peripheral length of cylinder,

$h$  = thickness of material,

$R$  = radius of curvature of bend in bead.

If the bead were made narrower in comparison with its depth, each section would approach the shape of a straight beam with a sharp bend

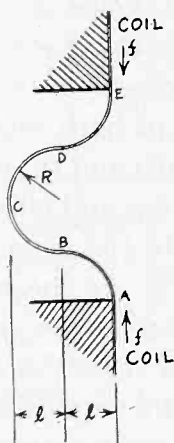

Fig. 7—Enlarged cross section of compliances shown in Fig. 5.

at the anchored end. The bend could then be neglected and we would use the formula for a straight beam.

$$\text{Stiffness} = \frac{F}{d} = \frac{3EI}{l^3} \quad (11)$$

where  $l$  = length of each beam, which is half the total height of the bead.

The radius  $R$  in (10) is identical to the beam length  $l$  of (11).

Experimental models have had a stiffness midway between these two values tending toward (10) for a wide bead and (11) for a narrow one. An empirical formula used in design follows:

$$\text{Stiffness} = \frac{UEI}{l^3}; \quad (12)$$

$U = \text{constant}$  involving the configuration of the compliance.

In these discussions we have neglected the peripheral stresses which are set up when the pressure is applied to the compliance. In general, this can be taken care of in the constant of the empirical formula.

In the range below 1000 cycles the impedance of the capacitor  $C$ , Fig. 4, is high and the currents in the two portions of the voice coil are equal in magnitude and phase. Furthermore, the mechanical impedance of the compliance,  $c_1$ , Fig. 5, which separates the two sections  $m_1$  and  $m_2$  of the voice coil is large compared to the mechanical impedance of the masses  $m_1$ ,  $m_2$ ,  $m_3$ , and  $Z_c$  and the two parts of the coil act as a unit. The physical characteristics of the two sections of the voice coil taken together are the same as those of the conventional loud speaker system described in a preceding section. Therefore, the action below 1000 cycles is the same as that of a cone loud speaker with a simple driving system.

In the region between 1000 cycles and 4000 cycles, the phase difference between the velocities  $\dot{X}_1$  and  $\dot{X}_2$  of the mechanical system, Fig. 5, increases with the frequency. It is in this region that we wish to transfer the driving power from both sections of the voice coil to the  $m_3$  section. A consideration of (5) and (6) expressing the magnitude and phase of the currents in the voice coil circuit shows that the phase difference between the currents in the  $m_1$  and  $m_2$  portion increases with frequency as depicted in Fig. 6. As the resulting phase difference between the forces  $f_1$  and  $f_2$  is thus made commensurate with the phase difference existing between the velocities  $\dot{X}_1$  and  $\dot{X}_2$ , a maximum combined force will be obtained for driving the cone  $Z_c$ . It will be seen that the current in the  $m_1$  portion of the circuit decreases with frequency, while the current in the  $m_2$  portion increases with frequency. Furthermore, in the mid-part of this region the impedance of the compliance  $c_1$  is equal to the mass reactance of the  $m_1$  portion of the voice coil. Above 4000 cycles, the force generated in the  $m_1$  portion of the voice coil becomes small compared with the force in the  $m_2$  portion. At the same time, the impedance of the compliance  $c_1$  becomes small compared to the impedance of the mass,  $m_1$ . Therefore, above this frequency, the system is driven by the force,  $f_2$ . The mass of the  $m_2$  portion of the voice coil is 0.9 gram. The mass of the cylinder between the coil and the cone plus the cone leads is 0.9 gram. The combined mass reactance of the coil and cylinder is sufficiently large to limit the velocities in these sections above 6000 cycles. To obviate this, a compliance  $c_2$  is placed between these two sections. The combined mass of the cylinder and the portion of the cone near the cylinder is also of sufficient magnitude to cause a reduction in the velocity of the cone  $Z_c$ . A further sectionaliza-

tion is accomplished by placing a compliance at the junction between the coil cylinder and cone designated as  $c_3$ . Considering the entire structure physically, we have a mechanically resonant system for transferring the force generated in  $m_2$  to the cone.

We are now prepared to determine the performance of the driving system with a cone of the type shown in Fig. 2. The impedance  $Z_c$  of the cone as a function of the frequency is shown in Fig. 8. The velocity imparted to  $Z_c$  by the driving system can be computed from (9). The result is depicted on Fig. 8 and indicates that the velocity remains nearly constant with increase of the frequency. Therefore, the force applied to the impedance  $Z_c$  falls very gradually with increase in frequency. As stated in a previous section, if the force were constant, the

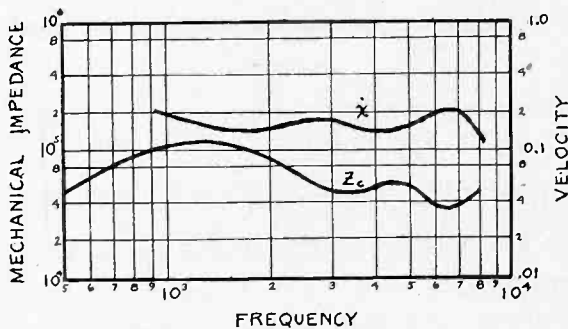

Fig. 8—Characteristics of a cone and a sectionalized driving system.

$Z_c$  = impedance of cone

$\dot{x}$  = velocity of  $Z_c$

sound output would be practically independent of the frequency, and hence the sound pressure on the axis would rise at the higher frequencies because of the sharpening of the directional characteristic. The slight fall in the driving force is, however, sufficient to overcome the gain due to sharpening of the directional characteristic, and hence the sound pressure on the axis remains substantially uniform as the frequency increases.

The experimentally obtained outdoor response-frequency characteristic of the loud speaker in a 3-foot irregular baffle at a distance of 10 feet is shown in Fig. 9. It will be seen that the response is practically independent of the frequency from 80 to 10,000 cycles and substantiates the theoretical analysis. The gradual attenuation in response below 100 cycles is due to the size of the baffle. The primary purpose of a free space curve of a cone loud speaker in a flat baffle is to dissociate the system from intangible factors, such as room and cabinet effects, which would influence the performance and render the data valueless for design purposes or for comparison with other loud



speakers. In a cabinet housing this loud speaker the response may be maintained to well below 60 cycles by a suitable design of acoustic networks associated with a properly designed cabinet. Listening tests are the ultimate criteria of the performance of any sound reproducing system. Comparison listening tests of this loud speaker with a master reference system capable of reproducing the range from 35 to 16,000

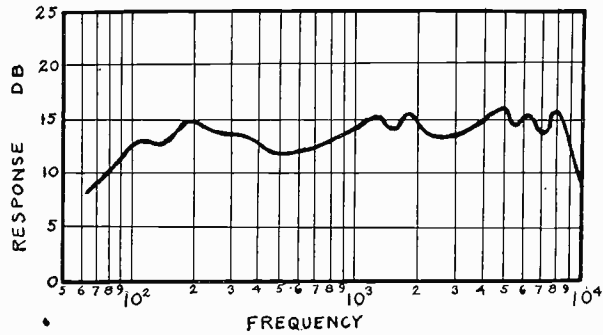

Fig. 9—Response frequency characteristic of the wide range loud speaker sound pressure on the axis of the cone at 10 feet in free space.

cycles indicates that the reproduction of speech and music employing this loud speaker compares favorably for all practical purposes with the master system.

#### ACKNOWLEDGMENT

In conclusion, the author wishes to express his appreciation to Mr. J. Weinberger, under whose direction the work on this loud speaker was done, and to Mr. R. W. Carlisle who contributed certain elements in the driving system as finally developed as well as considerable of the experimental and mechanical design work.



## THE DETERMINATION OF THE DIRECTION OF ARRIVAL OF SHORT RADIO WAVES\*

By

H. T. FRIIS, C. B. FELDMAN, AND W. M. SHARPLESS

(Bell Telephone Laboratories, Inc., New York City)

*Summary*—In this paper are described methods and technique of measuring the direction with which short waves arrive at a receiving site. Data on transatlantic stations are presented to illustrate the use of the methods. The methods described include those in which the phase difference between two points constitutes the criterion of direction, and those in which the difference in output of two antennas having contrasting directional patterns determines the direction. The methods are discussed first as applied to the measurement of a single plane wave. Application to the general case in which several fading waves of different directions occur then follows and the difficulties attending this case are discussed.

Measurements made with equipment responsive to either the horizontal or the vertical component of electric field are found to agree.

The transmission of short pulses instead of a steady carrier wave is discussed as a means of resolving the composite wave into components separated in time. More detailed and significant information can be obtained by this resolving method. The use of pulses indicates that (1) the direction of arrival of the components does not change rapidly, and (2) the components of greater delay arrive at the higher angle above the horizontal. The components are confined mainly to the plane of the great circle path containing the transmitting and receiving stations.

A method is described in which the angular spread occupied by the several component waves may be measured without the use of pulses.

Application of highly directional receiving antennas to the problem of improving the quality of radiotelephone circuits is discussed.

### INTRODUCTION

SHORT waves propagated via the Kennelly-Heaviside layer may arrive at the receiving site from various directions. Knowledge concerning these directions is important, not only for the scientific deductions which may be made concerning the structure of the layer, but also in the design of directional antennas. Selective fading, believed to be due principally to the existence of several waves having different delays, can be reduced by directional antennas which receive only one wave. Bruce<sup>1</sup> has indicated this possibility. Potter<sup>2</sup> has de-

\* Decimal classification: R113×R115. Original manuscript received by the Institute, September 8, 1933. Presented before Eighth Annual Convention, Chicago, Illinois, June 27, 1933; presented before Boston Section, October 20, 1933.

<sup>1</sup> E. Bruce, "Developments in short-wave directive antennas," PROC. I.R.E., vol. 19, no. 8, (pp. 1406-1433; August, (1931).

<sup>2</sup> R. K. Potter, "Transmission characteristics of a short-wave telephone circuit," PROC. I.R.E., vol. 18, no. 4, pp. 581-648; April, (1930).

scribed the selective fading occurring on the North Atlantic short-wave circuits to England. Receiving antenna design is, therefore, particularly dependent upon such knowledge of wave directions. To a lesser degree, probably, transmitting antenna design may be aided by such knowledge, in point-to-point communication.

Short-wave energy does not usually arrive in the form of an approximately plane transverse wave, and the meaning of wave direction associated with such a wave cannot be strictly applied. It is convenient, however, to regard the complicated wave as consisting of a number of essentially plane waves. That this may legitimately be done depends upon the great distance to the Kennelly-Heaviside layer. That it is convenient to do so depends upon how few plane waves are required to describe the complicated wave.

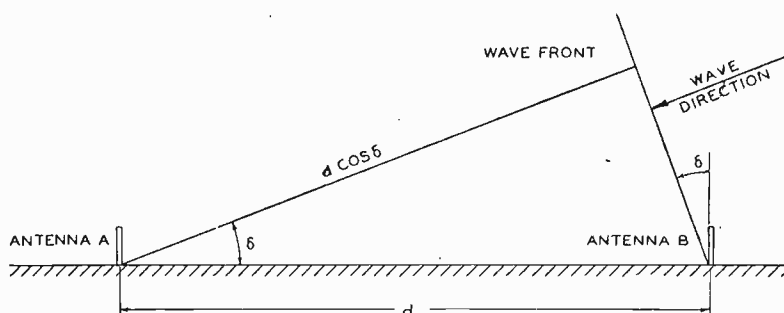

Fig. 1—Principle of the phase method. The phase difference between A and B is  $2\pi d/\lambda \cos \delta$ .

The methods of measuring wave directions will accordingly be treated from the point of view of plane waves. All of the methods to be described are applicable to short waves (15 to 60 meters) and have been employed at Holmdel, N. J., chiefly for measuring on transatlantic and other long-distance circuits. The data presented in this paper will be confined to illustrations of the use of the methods.

Methods for measuring wave directions may be classified as:

- A. Phase methods.
- B. Differential output methods.

The principle of the phase methods is illustrated in Fig. 1. The phase difference in the outputs of the antennas is measured and the angle  $\delta$  is computed. Identical antennas located similarly with respect to the ground are employed to insure that the variation of phase difference follows the relation indicated in Fig. 1. Considerable departures from this elementary picture occur in some of the phase methods. In some cases the distinction between classes becomes obscure.

To the phase method class may be assigned the loop antenna, the Adcock antenna,<sup>3</sup> large rotatable directional antennas, such as the one

<sup>3</sup> F. Adcock, British Patent 130490, 1919.

described by Jansky,<sup>4</sup> and the cathode ray oscillograph as employed by one of the authors<sup>5</sup> for the measurement of phase difference. We have used a modification of the latter method extensively, in which a calibrated variable phase changer is employed to replace the oscillographic phase determination.

The differential output method consists essentially in employing two antennas of contrasting directional patterns. Fig. 2 shows, in polar coordinates, the vertical directional patterns of two antennas we have used for this purpose. The ratio of the outputs of the antennas determines the vertical angle. Another combination suitable for vertical angle measurements utilizes two horizontal doublet antennas at different heights above the ground.

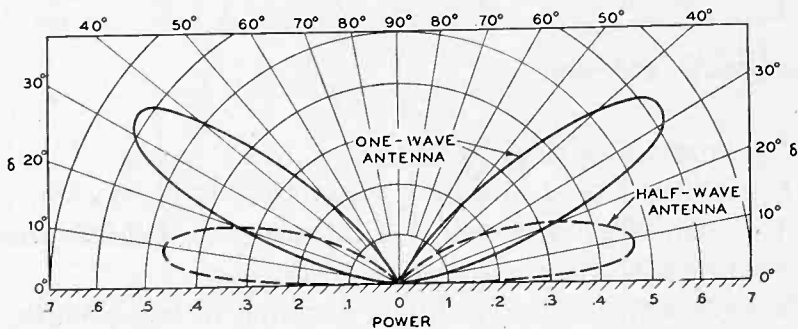

Fig. 2—Principle of the differential output method. These curves are the solid curves of Fig. 4A redrawn in polar coordinates. The ratio of outputs determines the angle.

## II. DIFFERENTIAL OUTPUT METHODS. VERTICAL ANGLES

The power output of an antenna may be expressed as a function of incident field intensity and angle of arrival. Not knowing the field intensity makes it impossible to determine the angle from the received power. By using two antennas whose outputs are different functions of angle of arrival, the unknown field intensity is eliminated and the angle can be obtained. Obviously, the output must be expressed in terms of power inasmuch as current and voltage are subject to change with impedance transformation. The calculation of directional patterns in terms of power follows the method outlined in a previous paper by one of the authors.<sup>6</sup> The equations employed for the vertical half-wave and one-wave antennas are

<sup>4</sup> K. G. Jansky, "Directional studies of atmospherics at high frequencies," *Proc. I.R.E.*, vol. 20, no. 12, pp. 1920-1932; December, (1932).

<sup>5</sup> H. T. Friis, "Oscillographic observations on the direction of propagation and fading of short waves," *Proc. I.R.E.*, vol. 16, no. 5, pp. 658-665; May, (1928).

<sup>6</sup> C. B. Feldman, "The optical behavior of the ground for short radio waves," *Proc. I.R.E.*, vol. 21, no. 6, pp. 764-801; June, (1933).

$$P = |I|^2 R = \frac{E^2 \lambda^2}{2\pi^2} \frac{R}{(R + R_A)^2} \sec^2 \delta [1 + \cos(\pi \sin \delta)] \left[ 1 + A^2 + 2A \cos\left(\frac{4\pi H \sin \delta}{\lambda} + \theta\right) \right] \text{ micromicrowatts} \quad (1)$$

for the half-wave antenna, and

$$P = |I|^2 R = \frac{E^2 \lambda^2}{2\pi^2} \frac{R}{(R + R_A)^2} \sec^2 \delta [1 - \cos(2\pi \sin \delta)] \left[ 1 + A^2 - 2A \cos\left(\frac{4\pi H \sin \delta}{\lambda} + \theta\right) \right] \text{ micromicrowatts} \quad (2)$$

for the one-wave antenna.

where,

$P$  = power absorbed by  $R$ .

$E$  = incident field intensity in microvolts per meter.

$A$  = ratio of ground reflected intensity to incident intensity.

$\theta$  = phase shift accompanying reflection.

$H/\lambda$  = elevation of mid-point of antenna in wavelengths.

$\delta$  = angle of incidence measured from the ground. This is the complement of the angle usually referred to in optical literature.

$\lambda$  = wavelength in meters.

$R$  = load resistance in ohms.

$R_A$  = radiation resistance of antenna in ohms.

Maximum power is obtained when  $R$  is made equal to  $R_A$ .

These equations imply that the power is extracted from the antenna at a current antinode. In practice, power is taken from a vertical antenna, whose lower end is near ground, by matching the impedance between the antenna and a "counterpoise" ground plate. The power is equal to that obtainable at a current antinode.

The corresponding equation for a half-wave horizontal antenna is

$$P = |I|^2 R = \frac{E^2 \lambda^2}{\pi^2} \frac{R}{(R + R_A)^2} \left[ 1 - 2A \cos\left(\frac{4\pi H}{\lambda} \sin \delta + \theta\right) + A^2 \right] \text{ micromicrowatts} \quad (3)$$

Here  $H/\lambda$  is the elevation of the antenna in wavelengths.

The radiation resistance of half-wave and one-wave antennas may be readily calculated, assuming a perfectly conducting earth.<sup>7</sup> Experience has shown that the conductivity of ordinary earth is sufficient, in the case of half-wave and one-wave vertical antennas at short waves, to simulate infinite conductivity. The upper curve of Fig. 3 shows the calculated variation, with height, of the radiation resistance of a vertical half-wave antenna. The points represent measurements made over two different kinds of ground. With horizontal antennas the

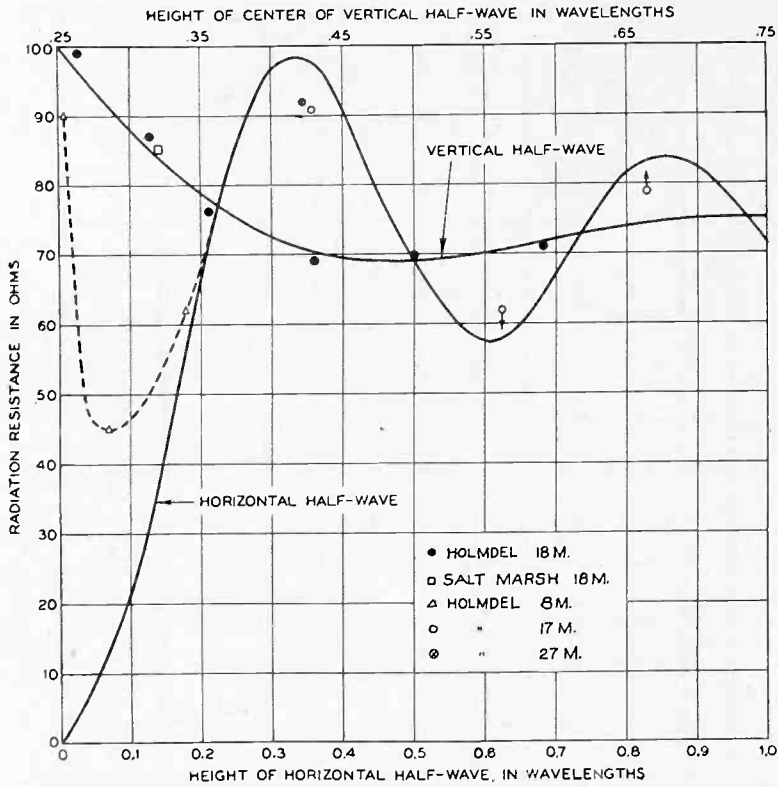

Fig. 3—Radiation resistance versus height. The solid curves are calculated for perfectly conducting ground. The points denote measurements made at wavelengths from 8 to 27 meters.

effect of imperfect conductivity is more pronounced. The lower curve of Fig. 3 is calculated for infinite conductivity. Some measured values are shown. As might be expected, the contrast between minimum and maximum values is less than for infinite conductivity. The degree of divergence between measured and calculated values at elevations less

<sup>7</sup> A. A. Pistolokors, "The radiation resistance of beam antennas," Proc. I.R.E., vol. 17, no. 3, pp. 562-628; March, (1929).

Levin and Young, "Field distribution and radiation resistance of a straight vertical unloaded antenna radiating at one of its harmonics," Proc. I.R.E., vol. 14, no. 5, pp. 675-689; October, (1926).

P. S. Carter, "Circuit relations in radiating systems and applications to antenna problems," Proc. I.R.E., vol. 20, no. 6, pp. 1004-1041; June, (1932).

than about 0.2 wavelength depends considerably on the wavelength and the ground constants.

In Fig. 4A are shown the power directional patterns of a half-wave and a one-wave antenna plotted in rectangular coordinates. Thus for the case of Holmdel ground, if the power supplied by the signal to the two receivers is equal, the angle  $\delta$  is 19 degrees. With receivers whose gains are measured in decibels the curves of Fig. 4B are convenient for

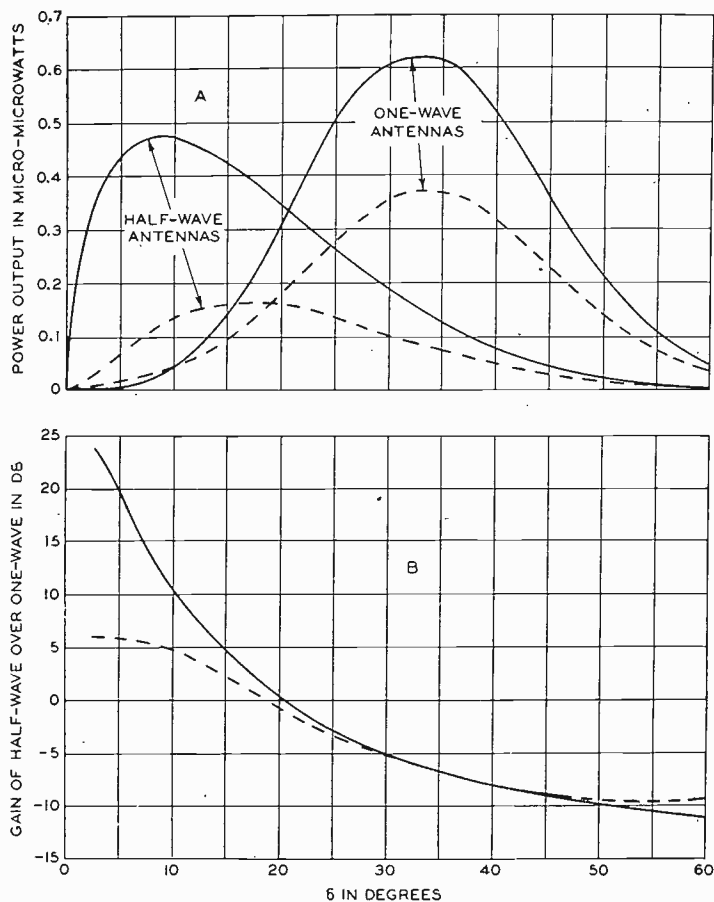

Fig. 4—A shows vertical directional patterns of half-wave and one-wave vertical antennas. The solid curves are for ocean water (dielectric constant = 80, conductivity =  $4 \times 10^{-11}$  e.m.u.). The broken curves are for Holmdel ground (dielectric constant = 25, conductivity =  $1.3 \times 10^{-13}$  e.m.u.). The wavelength is assumed to be 25 meters and the incident field intensity one microvolt per meter. In B the ratio of power expressed as a gain is plotted for the two types of ground. The angle  $\delta$  is measured from the horizontal. The lower ends of the antennas are assumed to be in close proximity to the ground.

determining the angle. The relative gains of the receivers must be known and correction must be made for any difference in losses occurring between the antennas and receivers.

Fig. 4B shows that, with Holmdel ground, angles less than about ten degrees cannot be measured owing to the flatness of the curve in that region. This effect is due to the imperfect conductivity of the



ground. If these antennas are used on a salt marsh site or directly at the seashore, the curves show that the greater conductivity results in increased contrast at low angles. Angles as low as a few degrees may be determined with considerable accuracy. A steeper curve at low angles may also be obtained at an earth site by tilting the one-wave antenna backward from the arriving wave by a few degrees.

The use of two horizontal half-wave antennas at different distances above the ground has the advantage that the electrical constants of the

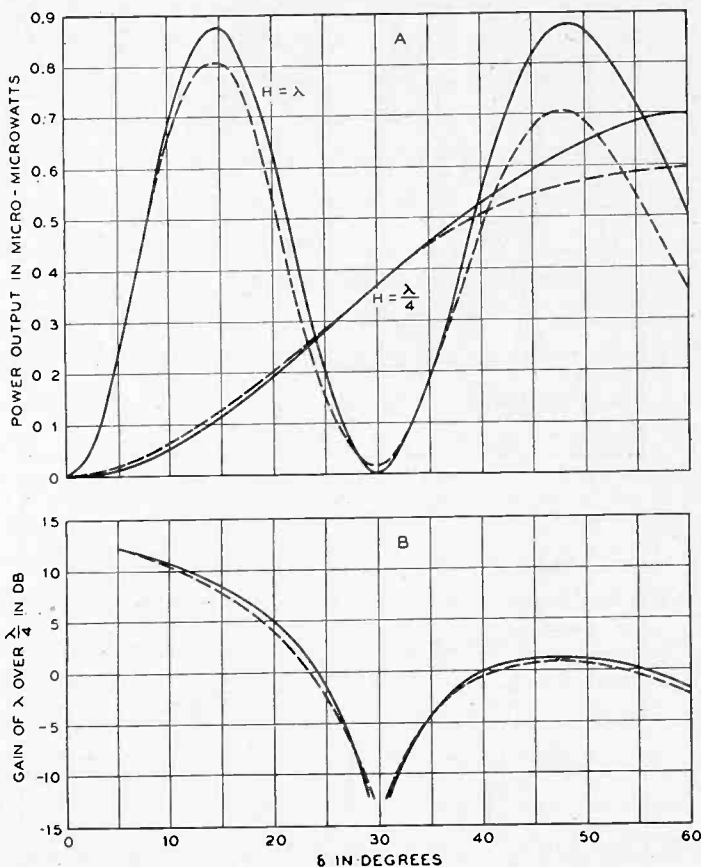

Fig. 5—A shows vertical directional patterns in the median plane of horizontal antennas.  $H$  denotes the height above ground. The solid curves are calculated for perfectly conducting ground, the broken curves for Homidel ground (dielectric constant = 25, conductivity =  $1.3 \times 10^{-13}$  e.m.u., wavelength 25 meters, and the incident field intensity one microvolt per meter). B shows the corresponding gain curves.

ground may vary widely without appreciable effect on the gain angle curve. In fact, the latter curve may be calculated on the basis of perfectly conducting ground and used without serious error for usual earth sites. The most important feature of the horizontal antenna combination is, however, the facility with which the gain measurements or calibrations may be made. This feature will be discussed later. In practice, the antennas are contained in a plane perpendicular to the great

circle path and are placed at different heights along two vertical lines spaced two or three wavelengths.

Directional patterns and gain angle curves for horizontal antennas at various heights are shown in Figs. 5 and 6. The use of a quarter-wavelength height gives nearly the maximum degree of contrast with the higher elevations. Some slight improvement could be obtained by

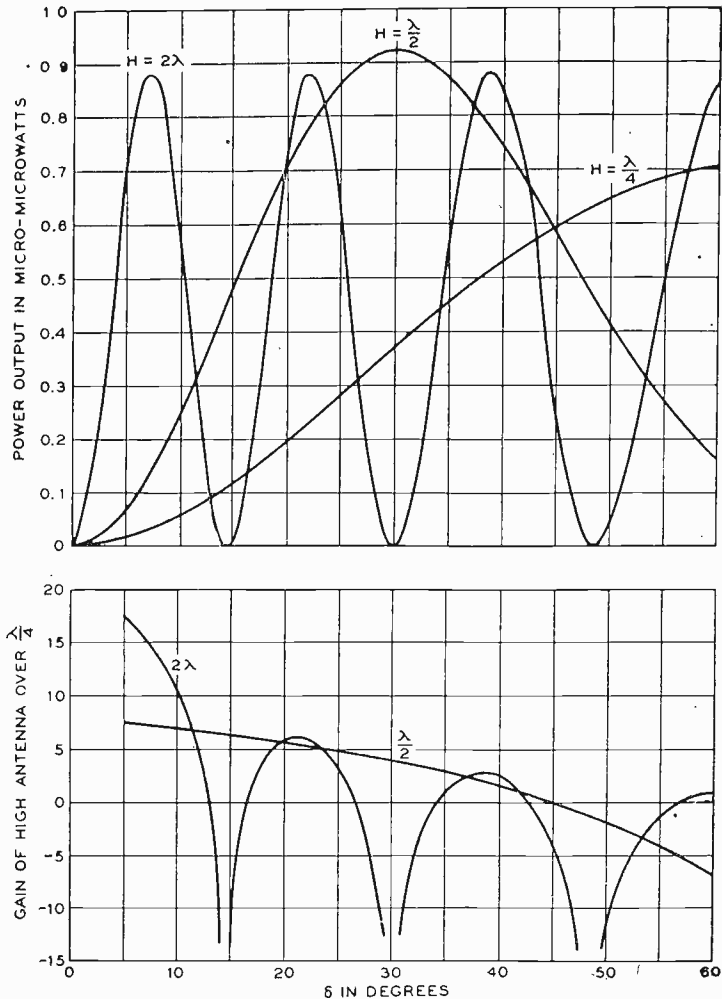

Fig. 6—Vertical directional patterns of horizontal antennas calculated for perfectly conducting ground. The wavelength is assumed to be 25 meters and the incident field intensity one microvolt per meter.

using a lower height than a quarter-wavelength but the output would be reduced and, perhaps more important, the resistance of the antenna would, as shown in Fig. 3, depend too greatly on the ground constants. The ambiguity in the angle gain curves due to the multiple lobed patterns of the high antennas is objectionable but may be avoided by first using a low height such as a half wavelength. The high elevations are necessary only in determining low angles.

Two important problems arise in the application of the differential

output method. First, the method must be applied to the general case in which several waves exist having slightly different angles of arrival. The average angle, weighted, perhaps, according to the relative amplitude of the several waves is all that could be expected from such a measurement method. Second, practical means must be devised for determining the relative gains of the receivers and the losses in the coupling circuits and transmission lines associated with the antennas.

If one observes the instantaneous outputs of two antennas receiving a carrier signal they will not, in general, fade similarly or synchronously. If these two antennas are the pair used for angle determination, the instantaneous outputs would indicate violent and rapid fluctuations of angle. Such an interpretation would not be justified, however. The existence of two or more waves of unvarying angle but of varying relative phase causes such results. This will be discussed at greater length in connection with pulse reception.

If, instead of making instantaneous comparisons, an integrating recorder system is used<sup>8</sup> and the integration time is long enough to include several fading periods, the integrated outputs yield approximately the average value of the several angles involved. Due to the shapes of the individual directional patterns a somewhat different weight is given in each antenna to components of different angles. This results in an apparent angle somewhat different from the mean angle of energy flow. The significance of the result of measurements made with the differential output method scarcely justifies any attempt to correct for such angle distortion, however.

Integrating recorders of the automatic type having an integrating time of nine seconds have been used extensively in our work. Manual observations, if carefully made, may replace automatic recording. If the peak values of the fading signal indicated by a meter in each receiver are observed and their respective averages over several minute periods are compared, the angle may be obtained with considerable accuracy. Instead of using two receivers one may be connected alternately to both antennas for periods of several minutes and a fairly good estimate of the angle may be obtained.

Since the desired accuracy of angle measurements depends on knowing the relative outputs to within a few decibels or less, receiver gains and transmission losses must be carefully accounted for. Several means for measuring the relative gains of the equipment between the antenna terminals and the final indicating meter (or recorder pen) have been employed. The horizontal antenna system previously discussed

<sup>8</sup> W. W. Mutch, "A note on an automatic field strength and static recorder," *Proc. I.R.E.*, vol. 20, no. 12, pp. 1914-1919; December, (1932).

was designed to facilitate the direct determination of relative gains. One antenna of the pair is depicted in Fig. 7. The higher antenna is lowered to the same elevation as the lower one and the difference in output is observed or the gains adjusted to make the outputs alike. This is done while receiving the distant signal. Some variation of radi-

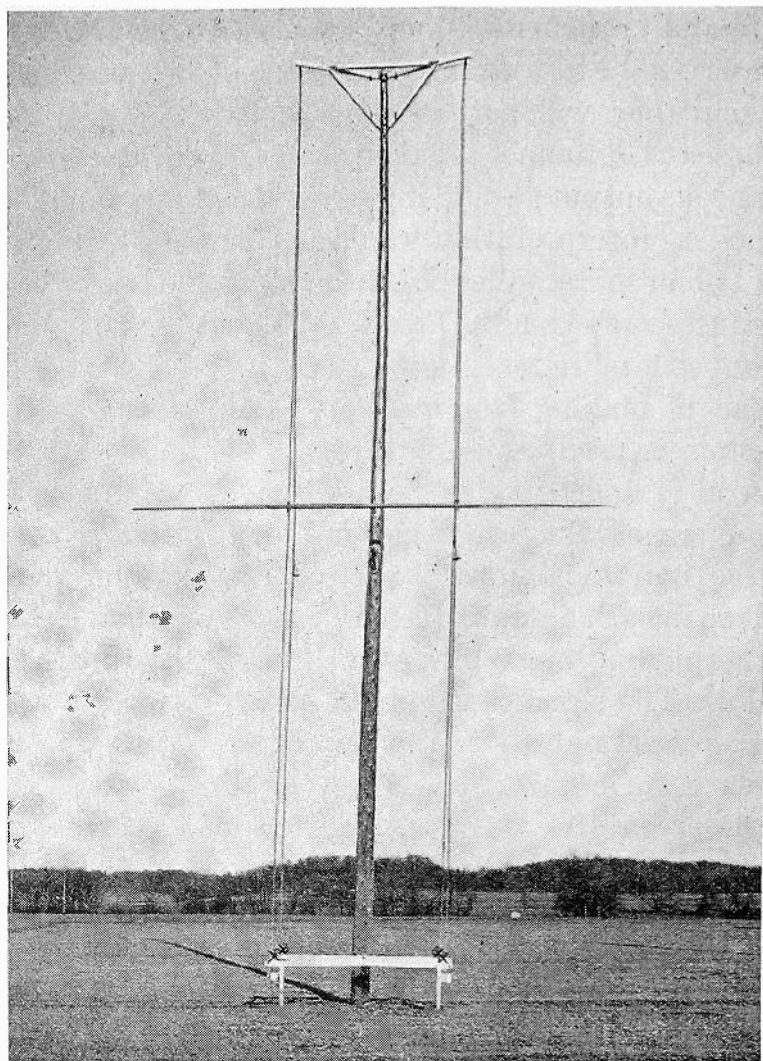

Fig. 7—Horizontal antenna with tackle for varying the height, mounted on a pole 92 feet high. The antenna is attached to the counterweighted boom which is suspended from an endless rope. The structure permits the use of an antenna 20 meters long.

ation resistance occurs when the antenna is raised. This was included in the calculation of the curves of Figs. 5 and 6. No rematching is necessary inasmuch as such a procedure yields only a few tenths of a decibel for the variation in resistance involved. Apart from the variation of resistance with height the horizontal antenna combination may be said to involve only the *shapes* of the directional patterns. Antennas

considerably shorter than a half wavelength may be used without knowing their gains but loading coils are then required. The calibration with the antennas at the same height is made every hour or so during a measurement period. The relative outputs are believed to be reliable within 0.5 decibel. The two receivers and recorders used with this system are shown in Fig. 8.

With the vertical half-wave and one-wave combination two gain calibration methods have been used. In one, the one-wave antenna is replaced by a half-wave antenna periodically during a several hour

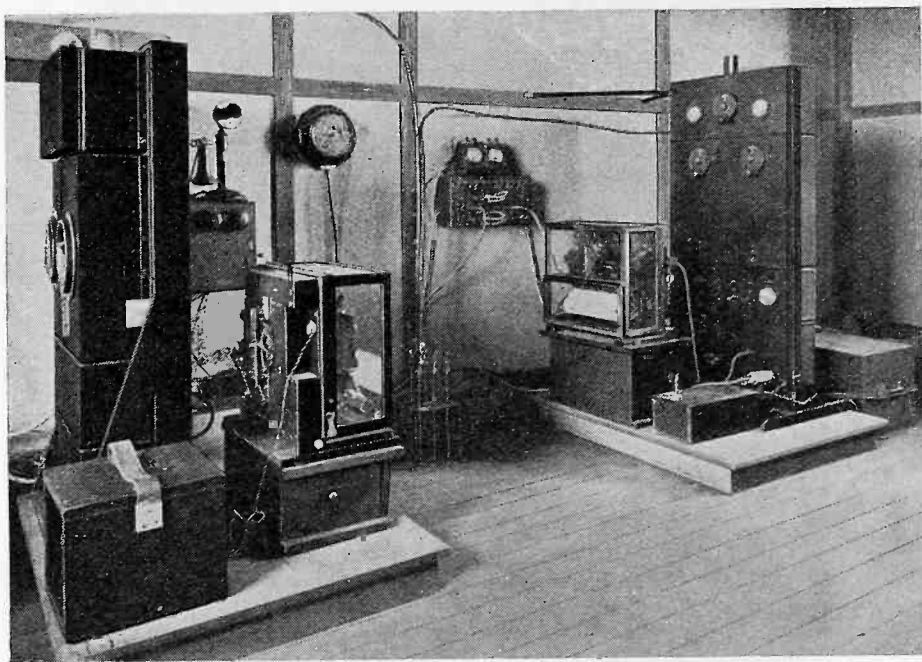

Fig. 8—The two receivers and integrating recorders used in the horizontal antenna differential output method. The recorder automatically adjusts the receiver gain to keep the output constant and records the gain variation. Adjustments are made at 10-second intervals.

measuring period, and the relative outputs noted or equalized as in the horizontal antenna method. A thirty per cent increase in radiation resistance occurs in changing from the half-wave to the one-wave lengths. If power is taken from the base of the antenna the impedance involved is the radiation resistance multiplied by the "step-up factor" of the antenna. By using, for instance, No. 14 B & S wire for the one-wave antenna and 3/8-inch tubing for the half-wave antenna the "step-up factor" is different for the two antennas and compensates for the change in radiation resistance. The impedance of either antenna is then about 1700 ohms. This compensation is hardly justified, however; the 30 per cent mismatch results in only a small fraction of a decibel error.

More important, however, is the requirement that the two antennas involved in the substitution have no reactance (or the same reactance). Cutting the antennas to 47.5 per cent and 97.5 per cent of the wavelength instead of the nominal values insures substantially resistive impedances.

In the other calibration method which is applicable to either the horizontal or the vertical half-wave and one-wave antenna combinations, the receivers are interchanged periodically. Such an exchange

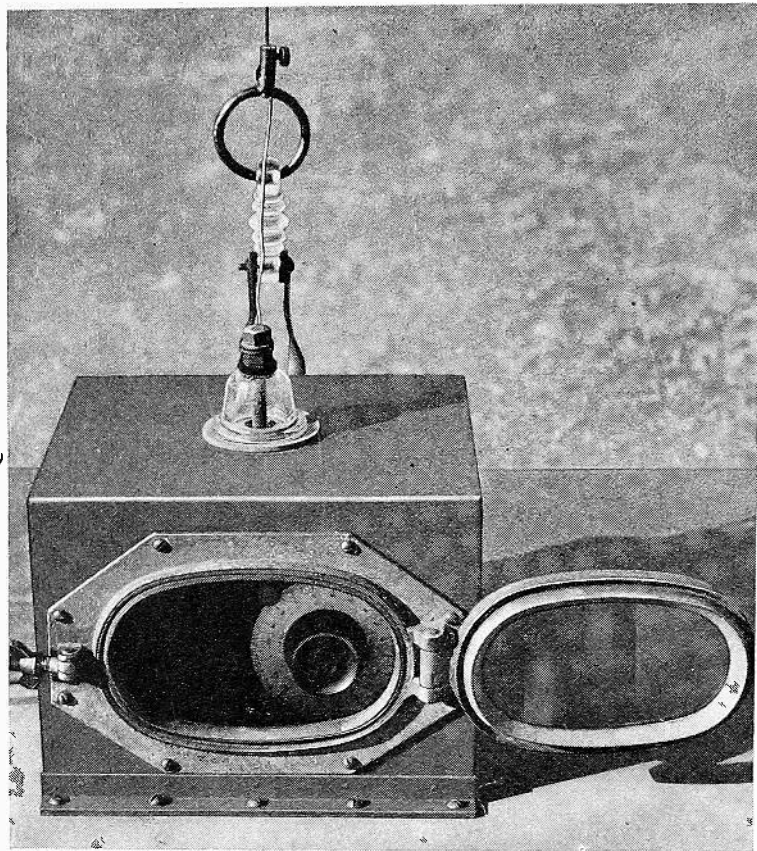

Fig. 9—Terminating equipment used to connect a vertical antenna to the buried concentric transmission line.

permits one to calculate the ratio of receiver gains but does not determine the relative losses in the equipment preceding the receivers.

It may be in place here to point out that measurements of angles made with antennas for which the directional patterns may be calculated in terms of watts permit the absolute determination of the intensity of the incident wave. Other field intensity measurements, made without regard for angle of arrival, determine the resultant of the incident and ground reflected waves which may differ greatly from the value of the incident field intensity.

Before describing phase methods in the next section, certain prac-



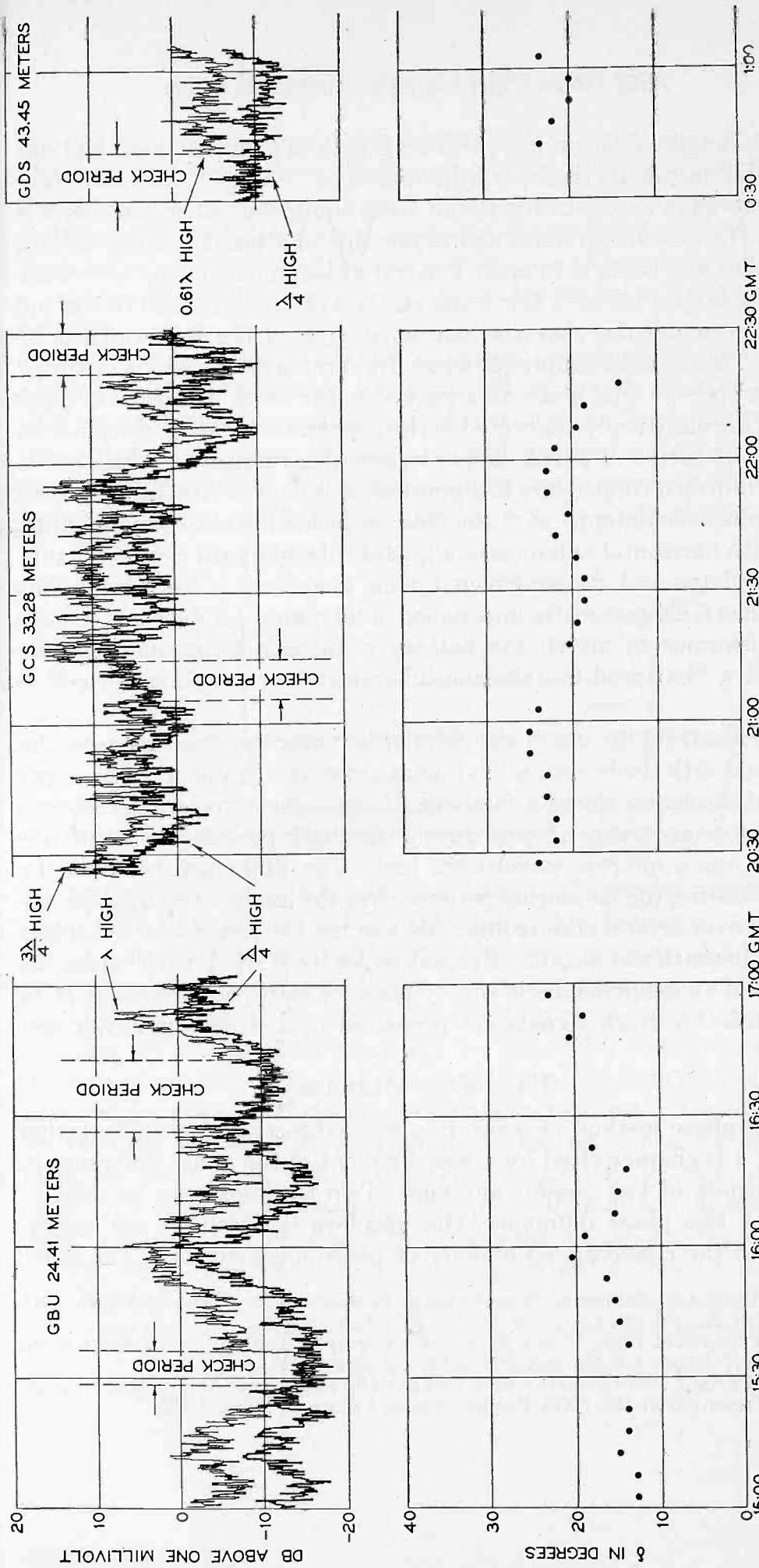

Fig. 10—Automatic recorder record for February 1, 1933, of outputs of horizontal antennas. During the check periods the high antenna is lowered to a height of one-quarter wavelength. The angles are obtained by referring to curves such as are shown in Fig. 6. The stations GBU, GCS, and GDS are British Post Office stations located at Rugby, England.



ticable details of technique, pertaining to both phase methods and differential output methods, will be described. With vertical half-wave and one-wave antennas the terminating equipment shown in Fig. 9 is used. The antenna is connected to one side of a parallel tuned circuit, the other side being grounded. The transmission line, of the concentric type, is tapped across a few turns on the low potential end of the coil so as to match the characteristic impedance of the line which is 65 ohms. The circuit is amply protected from the weather and is mounted on a copper-covered platform anchored in the earth by means of pipes which are electrically connected to the copper. Concentric transmission lines constructed of  $\frac{3}{8}$ -inch copper refrigerator tubing,<sup>9</sup> in which a No. 12 hard-drawn copper wire is supported on isolantite insulators, is used to connect the antenna with the receiver located in a near-by building.

With horizontal antennas of adjustable height twin conductor rubber insulated and rubber-covered cable is used as a down-lead. This cable has a characteristic impedance of 90 ohms and does not require a transformer to match the half-wave antenna impedance. At the ground a "balanced-to-unbalanced" transformer coupling device<sup>10</sup> is used.

To illustrate the use of the differential output method some results obtained with the horizontal antennas are shown in Fig. 10. The upper part of the figure shows a facsimile of the recorder records. They are redrawn so as to superimpose during the check periods when both antennas are a quarter wavelength high. The difference between the curves during the measuring periods gives the angles. The average difference over several minute intervals was used to determine the angles shown beneath the records. A recent paper by R. K. Potter<sup>11</sup> gives the results of an extended angle survey made of transpacific signals. Data on South American signals are presented in a paper by Potter and Friis.<sup>10</sup>

### III. PHASE METHODS

The phase method of measuring wave direction angles illustrated in Fig. 1 is characterized by a measurement of the phase difference in the outputs of two *similar* antennas. Two methods may be used to measure this phase difference. One employs the cathode ray oscillograph in the conventional manner of phase measurement. The other

<sup>9</sup> Sterba and Feldman, "Transmission lines for short-wave radio systems," Proc. I.R.E., vol. 20, no. 7, pp. 1163-1202; July, (1932).

<sup>10</sup> Potter and Friis, "Some effects of topography and ground on short-wave reception," Proc. I.R.E., vol. 20, no. 4, pp. 699-721; April, (1932).

<sup>11</sup> "Certain characteristics of a transpacific short-wave radiotelephone circuit." Presented at the Fifth Pacific Science Congress, June, 1933.

aims to balance the two outputs against each other by making known phase adjustments. These adjustments may be made by changing the relative position of the antennas as in the case of the rotatable Adcock system or the rotatable loop antenna. In the system described in this section the antennas are fixed and a balance is obtained by adjusting a variable phase changer inserted in the transmission line from one antenna.

Two similar antennas are located several wavelengths apart on the ground. In the transmission line from one antenna is inserted a continuously variable phase changer. The output of the other antenna and the output of the phase changer are combined and a receiver is connected at the junction. If a single plane wave arrives along some arbitrary direction in space it is possible to vary the phase changer until

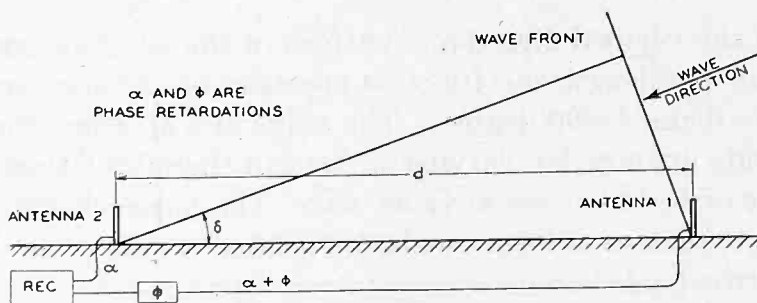

Fig. 11—Similarly spaced antennas used in the phase method. The phase shift  $\phi$  is obtained with a variable phase changer.

the two antenna outputs cancel each other in the receiver input. The phase shift, referred to a certain calibration value, necessary to accomplish this is the criterion of direction: Two such systems with the two pairs of antennas located on the ground, at right angles to each other would be necessary to determine the direction of the wave in space. In practice, we use this method mainly for measuring the vertical angle in cases where the horizontal direction is known approximately and, accordingly, the second system may be dispensed with. The antennas are then, for vertical angle measurements, spaced several wavelengths along the great circle path joining the transmitting and receiving stations. The small deviations from the great circle direction, known to occur, do not seriously invalidate the measurements of vertical angle.

Fig. 11 shows two identical antennas spaced a distance  $d$  in the plane of incidence. The phase shifts between the antennas and the receiver are the retardations  $\alpha$  and  $\alpha + \phi$  where  $\phi$  is variable. Taking the phase of the output of antenna 1 as a reference, the input to the receiver is proportional to

$$\begin{aligned}
 & B \cos [\omega t - (\alpha + \phi)] + B \cos \left[ \omega t - \alpha - \frac{2\pi d}{\lambda} \cos \delta \right] \\
 &= 2B \cos \left[ \frac{\pi d}{\lambda} \cos \delta - \frac{\phi}{2} \right] \cos \left[ \omega t - \alpha - \left( \frac{\pi d}{\lambda} \cos \delta + \frac{\phi}{2} \right) \right] \quad (4)
 \end{aligned}$$

where,

$B$  represents the vertical directional pattern of each antenna

$\omega$  is  $2\pi$  times the frequency

$\lambda$  is the wavelength in the same units as  $d$

$\delta$  is the angle of incidence.

The quantity

$$\left| B \cos \left[ \frac{\pi d}{\lambda} \cos \delta - \frac{\phi}{2} \right] \right|$$

represents the vertical directional pattern of the antenna system. If  $d$  exceeds one wavelength this function possesses one or more zero values between  $\delta=0$  and  $\delta=90$  degrees. The value of  $\delta$  at which the zero occurs depends upon  $\phi$ . By varying  $\phi$  one can therefore "steer" a blind spot at the direction of the arriving wave. The phase changer may be calibrated by means of local oscillators located on the ground and the angle of arrival calculated.

In Fig. 12 are shown two directional patterns with values of  $\phi$  so chosen as to locate null points at 20 degrees and 10 degrees, respectively. A change in  $\phi$  equal to 66 degrees of phase accomplishes this amount of steering. A change of 180 degrees replaces a null by a maximum.<sup>12</sup>

The ambiguity due to the several nulls can easily be avoided by employing several different spacings of antennas. Only the correct one of the ambiguous values is likely to repeat with all spacings.

If this method is applied when more than one wave exists, a null or deep minimum cannot be obtained. The depth of the minimum referred to the maximum obtained by reversing the phase shift 180 degrees is then a measure of the angular spread of the waves. In practice one determines the phase changer adjustment which gives the greatest reduction of the fading signal. It is important to observe that the manipulation does not seek continuously to keep the output at a minimum. When a minimum setting is obtained several fading cycles must be observed and the fading maxima are taken as a measure of the output. To illustrate, suppose that several waves occur with angles in the vicinity of 20 degrees and that a minimum of 15 decibels could be ob-

<sup>12</sup> Strictly speaking, the maximum will not occur at precisely the position of the minimum. The factor  $B$  influences the angle at which the maximum occurs.

tained with the antenna whose pattern is shown in Fig. 12A. The angular spread then would be of the order of five degrees. If there were only two waves of equal amplitude the angle between them would be five degrees. In the general case in which many waves are present, the indicated angular spread (five degrees in the above example) may be somewhat greater or less than the true difference between extreme angles. This method inherently tends to exaggerate the importance of

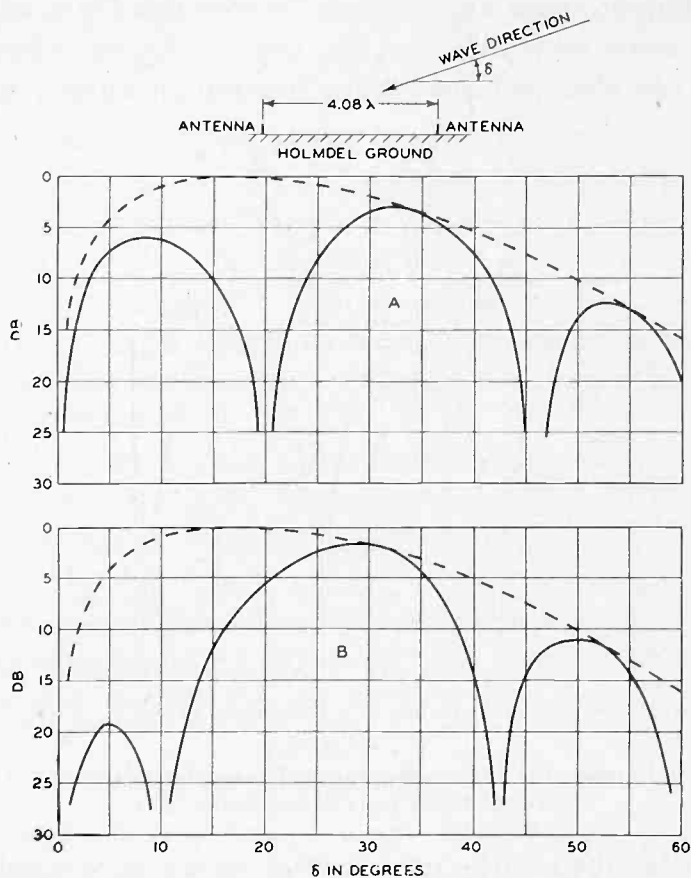

Fig. 12—Vertical directional patterns of the antenna combination shown above, drawn for two different values of  $\phi$ . The broken curve is the envelope of the maxima produced by varying  $\phi$ . It is the vertical pattern of the individual half-wave antennas.

weak components having angles outside the main group of waves. It nevertheless gives valuable information.

If the angular spread is nearly as large as (or larger than) the aperture of the null (some 15 degrees in Fig. 12A) no minimum is detectible and the method is unworkable. In such cases a closer spacing of antennas is required. A choice of spacings is desirable such that the minimum lies between 6 and 20 decibels.

Considering the performance of this system when a deep minimum is unobtainable<sup>13</sup> it does not logically follow that several waves of dif-

ferent angles are simultaneously present. A failure to obtain a deep minimum could occur if only one wave of fluctuating angle were present. In the latter case, however, fading observed on each antenna separately would necessarily be similar and synchronous. Considerable attention was given to this and it was found that failure to obtain a deep minimum was invariably accompanied by unlike fading observed on the two antennas separately, thus indicating that two or more waves of different angle were present. It was also found that when the fading was essentially alike on the two antennas a deep minimum could always be obtained thus indicating a single unvarying angle. The

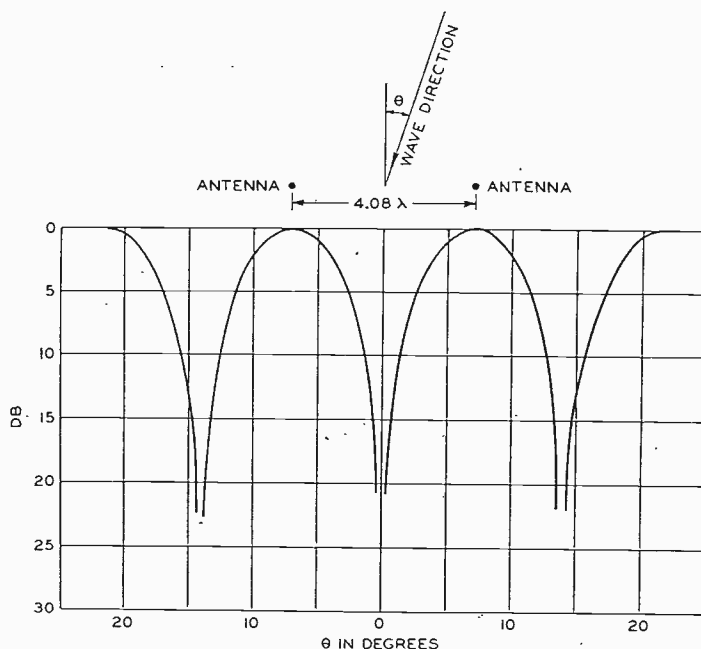

Fig. 13—Horizontal plane characteristic of the antennas of Fig. 12 drawn for a particular value of  $\phi$ .

pulse work described in the next section shows more conclusively that the angles of the individual waves remain substantially fixed.

Three half-wave vertical antennas are used at the Holmdel laboratory for the vertical angle measurements. These can be combined in pairs spaced 330 feet, 590 feet, and 920 feet and are located on the great circle path to Rugby, England. Three other similar antennas used for horizontal angles are arranged on a line perpendicular to the great circle path and yield spacings of 150 feet, 350 feet, and 500 feet.

The horizontal plane directional pattern of spaced antennas may be obtained from (4) by replacing  $B$  by a function representing the horizontal plane directional pattern of each antenna. The angle  $\delta$  is then measured from the line of the antennas in the horizontal plane.

<sup>13</sup> It is assumed, of course, that the losses between the antennas and receiver are equalized so that a deep minimum is possible.

Fig. 13 depicts the horizontal directional pattern corresponding to the vertical pattern shown in Fig. 12. The effect of varying the phase changer, i.e., varying  $\phi$ , is mainly to shift the curve along the  $\theta$ -axis. The shape of the curve remains practically unaltered, over the range of angles shown in Fig. 13.

The phase changer is an important part of the foregoing equipment. It comprises an arrangement of circuits which establishes a rotating field in which a rotatable pick-up coil is located. An input amplifier feeds two tuned circuits with coils at right angles, one of which is excited in quadrature with the other by means of inductive coupling. A rotating magnetic field exists when the circuits are properly adjusted. The pick-up coil feeds an output amplifier of adjustable gain. Since this equipment operates at the signal frequency (9 to 15 megacycles) considerable care had to be exercised in its construction. Symmetry and balance had to be rigidly maintained. In addition, several of the tuned circuits had to be loaded with resistance in order that the reactions accompanying the rotation of the pick-up coil did not vary the amplitude excessively.

Vertical angles lower than eight degrees and as high as 38 degrees have been measured with the spaced antenna phase method. Angular spreads smaller than one degree and as large as 20 degrees have been observed.

In the horizontal plane only slight deviations of the order of a few degrees from the great circle direction have been found for the mean angle. Horizontal angular spreads of three or four degrees have been observed.

#### IV. USE OF SHORT CARRIER PULSES<sup>14</sup>

From theoretical considerations, the time of propagation for the waves of different angles might be expected to be different. If under such conditions, instead of transmitting a steady carrier wave, a sufficiently short pulse of carrier frequency is transmitted it would arrive as a succession of pulses each having traveled over paths of different delay. The result would be a resolution of the waves in terms of time.

The British Post Office has cooperated with us by providing such pulses. They are transmitted at the rate of 50 per second each occupying about 0.0002 second. These are received with wide band receivers of the double-detection type, and the envelope of the rectified output is displayed on a cathode ray oscillograph tube provided with a synchronized linear time axis. The linear time axis is obtained with a time

<sup>14</sup> Pulses have been employed by many experimenters since the work of Breit and Tuve in 1926 but the writers know of no publications pertaining to the use of pulses in angle measurement.

constant sweep circuit of the conventional type employing a saturated diode as a resistance and a gas-filled tube as a condenser discharger. Synchronization of the sweep with the transmitted pulse is accomplished by utilizing the frequency stability of the British and American power systems. The transmitted pulses are synchronized with the 50-cycle power system supplying Rugby. At Holmdel a 60-cycle synchronous motor is geared down in a 6-to-5 ratio and a "magnetic switch" operated from the resulting 1500 revolutions per minute shaft is used to control the sweep circuit by introducing, twice per revolution, a

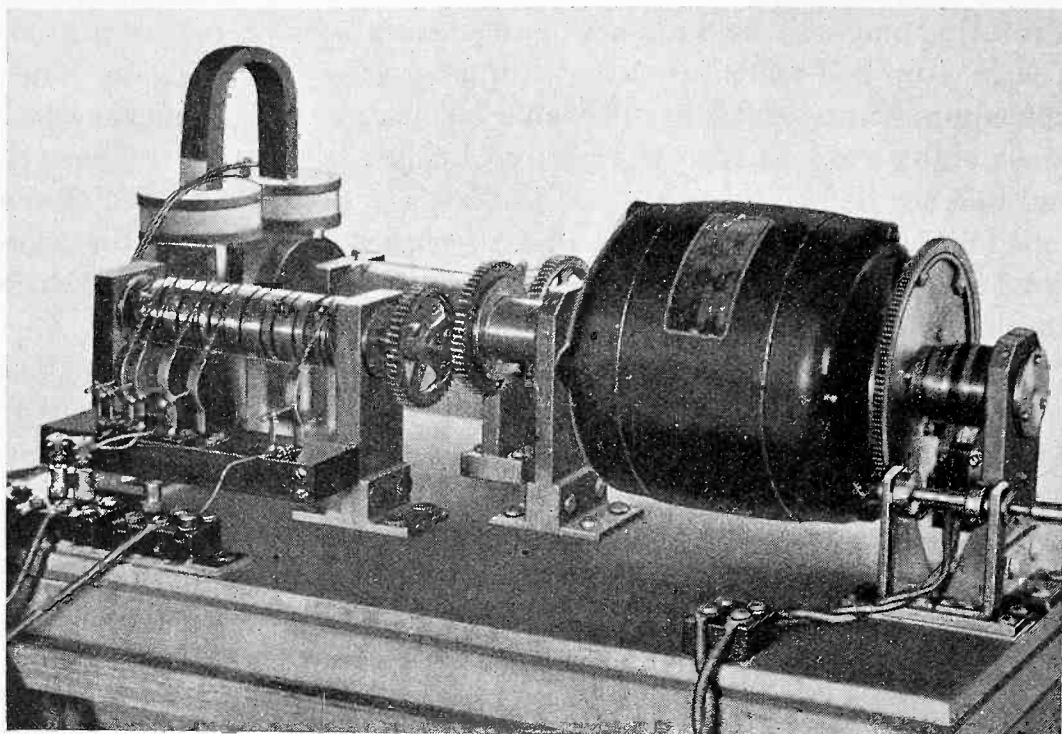

Fig. 14—The synchronizing-commutating unit used in pulse reception. Synchronization is accomplished manually by turning the synchronous motor frame. The sweep circuit is controlled by the "magnetic switch." The outputs from two or three receivers are switched by the drum type commutator.

small induced voltage into the grid circuit of the gas-filled tube. The motor is mounted on bearings and a crank handle is geared to the frame. Turning this crank manually provides the phase adjustment and slight frequency compensation necessary to maintain the pulse pattern fairly steady on the time axis. The rotating shaft has, in addition, the important function of commutating the outputs of three receivers (or two) so that successive sweeps may display, at displaced positions on the cathode ray tube screen, the pulse patterns from three antennas. The synchronizing-commutating unit is shown in Fig. 14. A sixteen-millimeter motion picture camera is used to record, for later study,



samples of the patterns exhibited by the cathode ray tube. A von Ardenne tube operated at 2000 volts was used for the most of the work. A photograph of the phase changer, the three receivers, and the oscillographic equipment appears in Fig. 15.

This equipment has been used extensively in connection with the differential output method employing vertical half-wave and one-wave

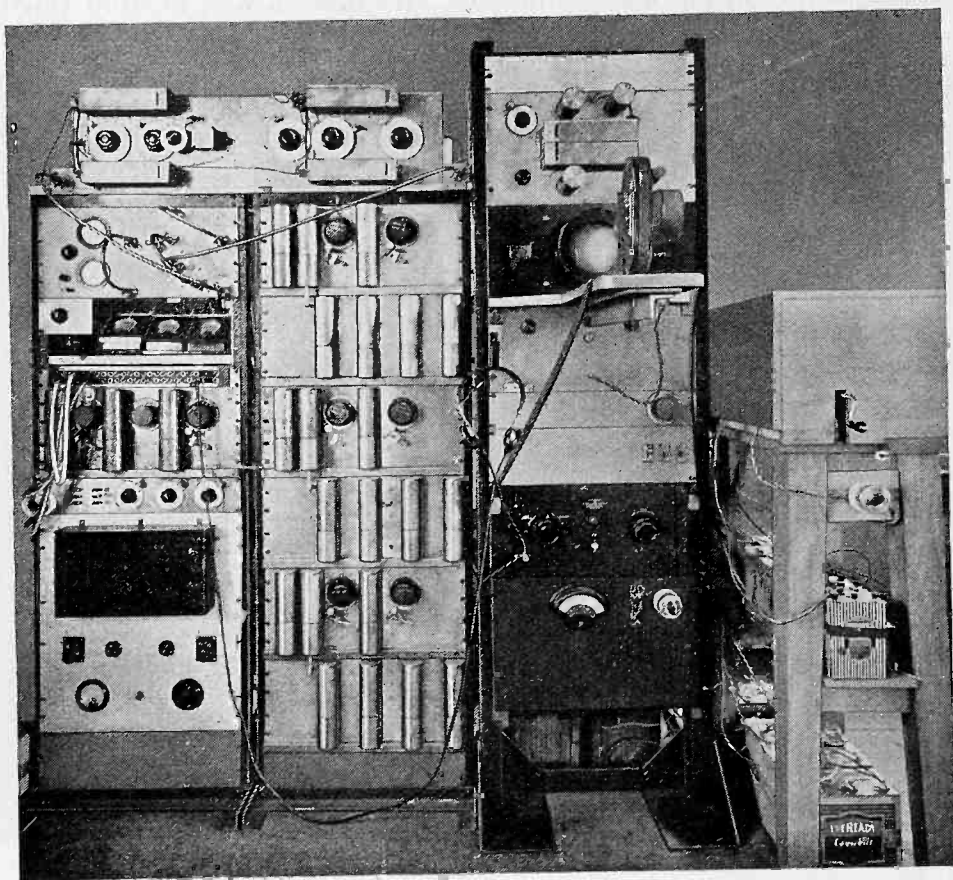

Fig. 15—Receivers, high-frequency phase changer, cathode ray oscillograph, and motion picture camera. Three double detection receivers employing a common beating oscillator occupy the center bay. The phase changer appears above the receivers. The adjustment crank of the synchronizing-commutating unit appears at the extreme right. The high-frequency jackboard at the left enables various antennas to be connected. The patch cords consist of short lengths of concentric transmission line.

antennas, and with the phase method employing spaced vertical half-wave antennas. It is not the purpose here to go into detail concerning pulse propagation and the interpretation of pulse patterns but some details of technique and some results will be described.

If the resolution afforded by pulses were perfect, so that all waves were completely separated in time thus appearing on the cathode ray oscillograph as a succession of pulses, these could be treated as speci-

mens of single plane waves. Such resolution does not occur, usually, in transatlantic propagation and the difficulties of the nonresolving carrier signal are only reduced manifold by employing pulse transmission. Pulse patterns are sometimes found to fade differently on similar spaced antennas, and the instantaneous outputs of two arbitrarily located antennas of a *differential* output system are not instantaneously comparable for angle determination. Because it was desired particu-

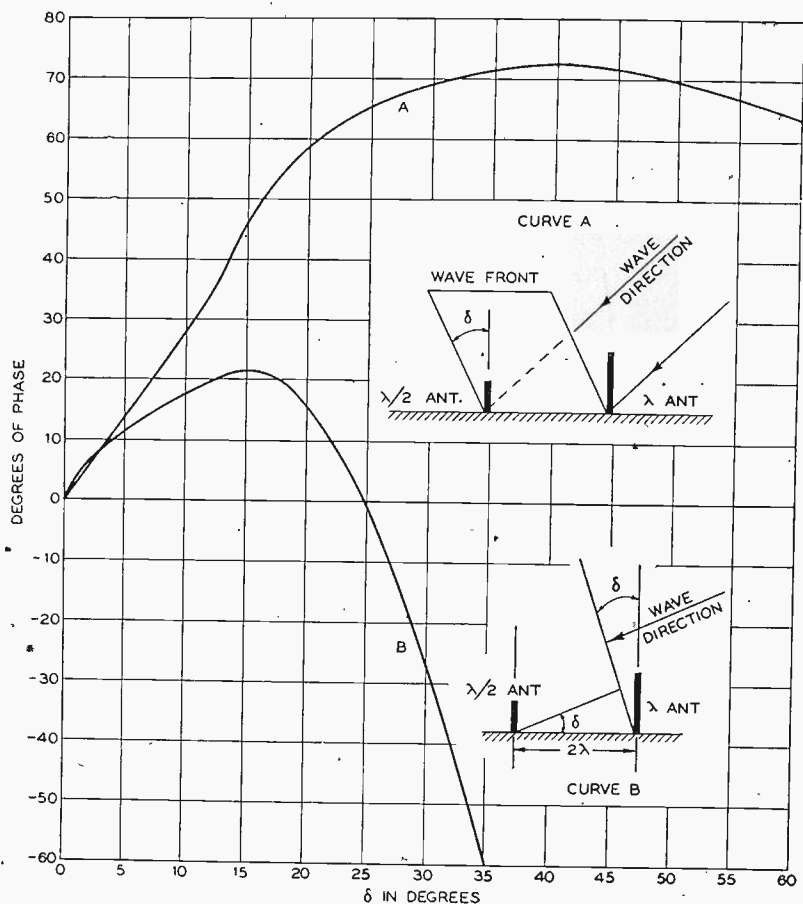

Fig. 16—Phase characteristics of half-wave and one-wave antennas calculated for Holmdel ground. The phase angles represent the difference in phase of the outputs of the two antennas. (The origin on the phase axis is without significance.)

larly to determine the stability of the angles efforts were made to reduce the effect of imperfect resolution so that instantaneous observations would indicate more nearly the true angles. The difficulty was recognized to reside mainly in the fact that imperfectly separated pulses combine differently in their overlapping portions in the outputs of the two antennas. Consider, for example, two similar antennas as shown in Fig. 11, but not combined. Two waves having angles  $\delta_1$  and  $\delta_2$  will interfere in antenna 1 according to their phase difference at antenna 1. At the same time they will interfere in antenna 2 according to

a phase difference which is different by  $2\pi d/\lambda (\cos \delta_1 - \cos \delta_2)$ . Since antennas must be separated several wavelengths to prevent excessive reaction, an effect of this kind is necessarily involved.<sup>15</sup> In the system finally adopted advantage is taken of the fact that the phase characteristics of a half-wave vertical and a one-wave vertical antenna are different. By placing the one-wave antenna several wavelengths ahead of the half-wave antenna the difference in the individual characteristics

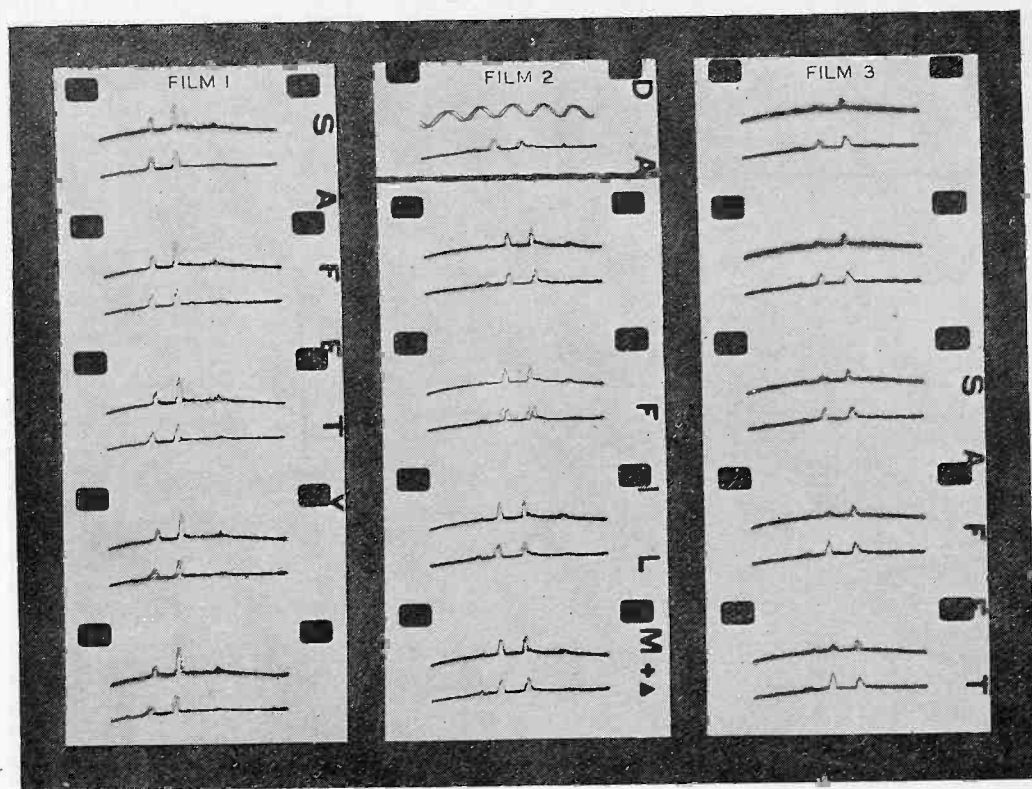

Fig. 17—Motion picture oscillograms of pulse reception. Time progresses from left to right and is measured by the 1000-cycle timing wave shown in Film 2. The upper trace on each frame of Films 1 and 2 shows the output of a one-wave vertical antenna; the lower trace shows the output of a half-wave vertical antenna. In Film 3 both antennas are half-wave verticals spaced 8.4 wavelengths on the great circle path. GCS, 33.28 meters (Rugby, England) March 13, 1933, about 2015 G.M.T.

tends to counteract the effect of spacing. Curve A of Fig. 16 shows the phase disparity between the outputs of a half-wave and a one-wave antenna placed broadside to an arriving wave front. Two waves not completely resolved on the time axis, arriving at ten and fifteen degrees respectively, would differ in degree of interference by  $(46 - 27) = 19$

<sup>15</sup> Placing the antennas perpendicular to the great circle path removes the vertical angle effect but substitutes an equally serious effect due to horizontal plane angular spread. While horizontal spread is much smaller than vertical spread the effect is manifold greater.

degrees of phase. Very much greater disparity is introduced, however, if the two waves have slightly different horizontal angles as is commonly the case. Locating the antennas along the great circle path reduces the effect of horizontal spread to a negligible amount. By placing the one-wave antenna ahead of the half-wave antenna the rising characteristic of curve *A* can be overcome, resulting in a fairly flat portion in the most common range of angles shown in curve *B*. Curve *A* is cal-

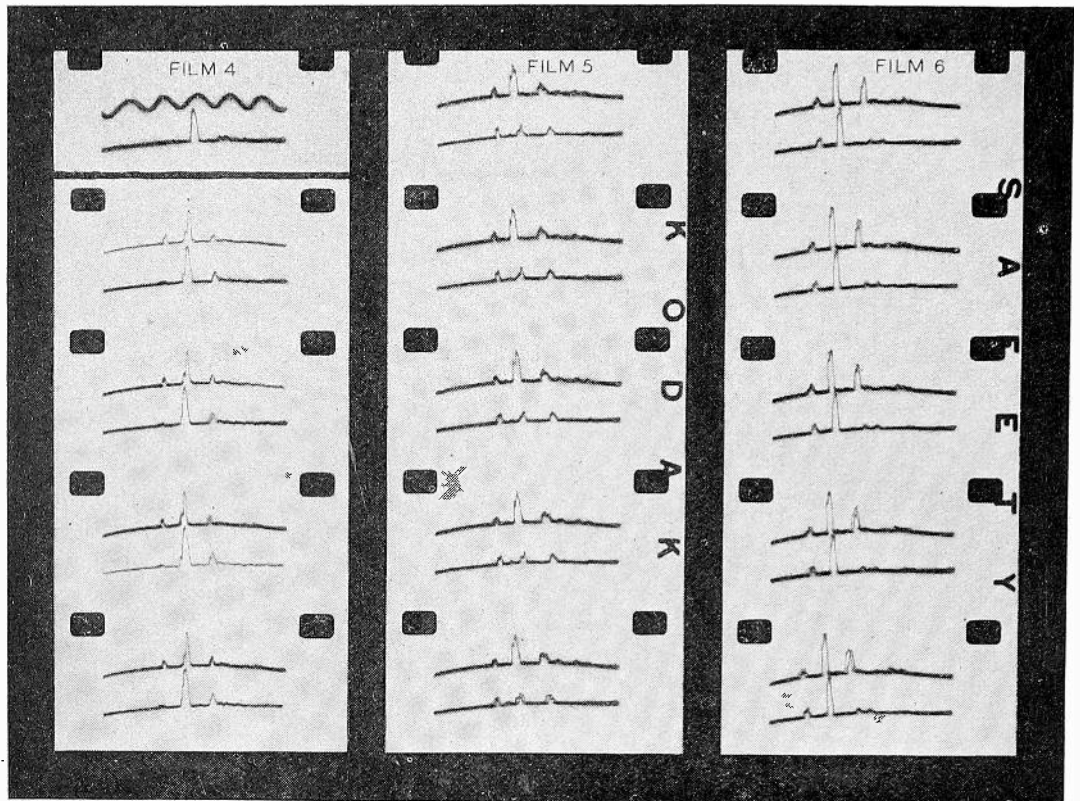

Fig. 18—Motion picture oscillograms of pulse reception. Time progresses from left to right and is measured by the 1000-cycle timing wave in Film 4. The lower trace on each frame shows the combined output of two half-wave vertical antennas spaced 8.4 wavelengths on the great circle path. The upper trace shows for comparison the output of a near-by one-wave vertical antenna. In Films 4, 5, and 6 a null is steered at each of the pulses successively. GCS, 33:28 meters (Rugby, England) March 13, 1933, 2000 G.M.T.

culated by methods suggested in a paper by one of the authors<sup>6</sup> for Holmdel ground.<sup>16</sup>

Fig. 17 shows three sections of motion picture film cut from a record made in the afternoon of March 13, 1933. Film Nos. 1 and 2 show the pulse patterns as received on a half-wave and a one-wave antenna located as in Fig. 16*B*. Film No. 1 is a representative sample of the record and indicates angles of 18 and 23 degrees, obtained by referring to

<sup>16</sup> For perfectly conducting ground curve *A* is flat.

Fig. 4B, for the early and late pulses, respectively. Occasionally, however, a short section of film shows false angles such as Film No. 2. Here the indicated angles are 20 and 20 degrees. The third sample, Film No. 3, is intended to explain the occasional false indications of angles. This sample, cut from a record taken a few minutes later, shows the pulse patterns observed on two similar antennas (half-wave verticals) spaced 8.4 wavelengths on the great circle path. The fact that the two patterns on each frame are not alike indicates that the pulses do not represent single angles. Thus, the occurrence of false angle indications may be explained in view of the imperfect phase compensation

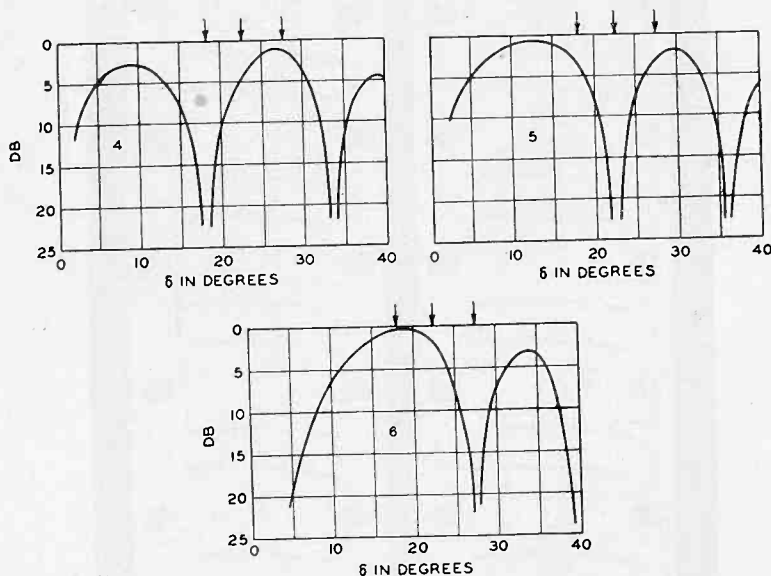

Fig. 19—Vertical directional patterns corresponding to the pulse patterns shown in Fig. 18. The numbers 4, 5, and 6 refer to the correspondingly numbered films. The arrows denote the angles of the pulses.

in curve *B* of Fig. 16. While errors still occur with the antenna located as in curve *B* of Fig. 16 they are greatly reduced in number and magnitude compared with the broadside arrangement corresponding to curve *A*.

The application of the phase method in which spaced antennas are combined in variable phase has proved very valuable in pulse work. In cases where the propagation results in a number of clear-cut, separated pulses it is possible to measure the angles accurately by steering a null at each of them successively. Fig. 18 shows three samples of a record in which this was done. The calculated directional patterns of the combined antennas are shown in Fig. 19. The ambiguity as to whether the angles are 18, 22.5, and 27.5 degrees or 33.5, 36, and 40 degrees was settled by using other spacings of antennas which determined that the angles were in the 25-degree region. The first two



angles agree with those of Fig. 17. The third wave of 27.5 degrees appeared during the 15-minute interval which elapsed between Figs. 17 and 18.

Figs. 20 and 21 illustrate the manner in which the ambiguity of the widely spaced antennas, such as that of Fig. 19, may be avoided. An-

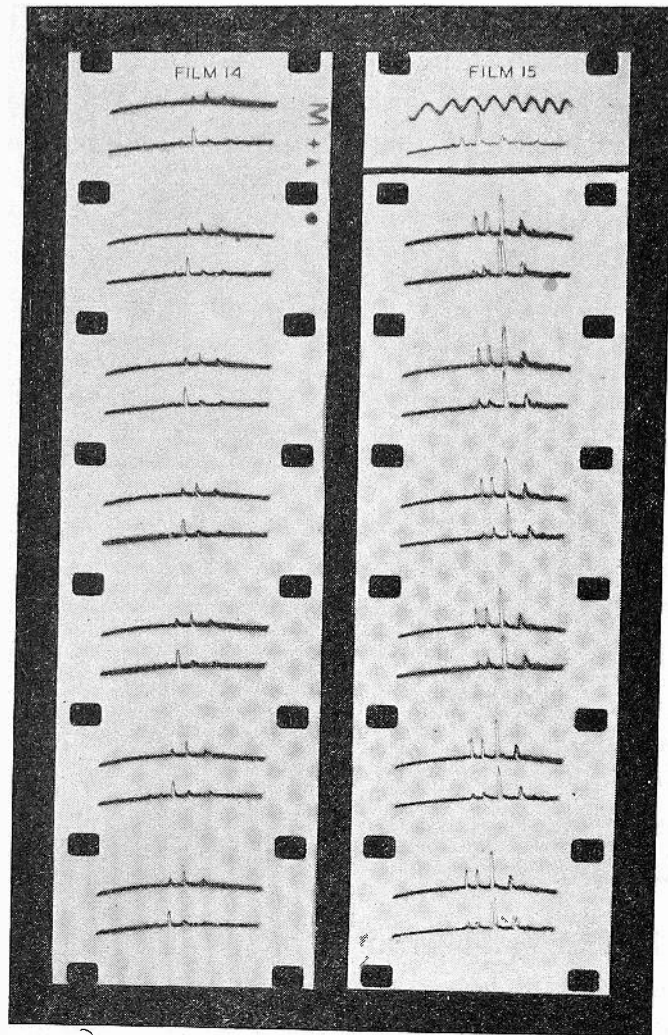

Fig. 20—Example of steering with antennas spaced three wavelengths along the great circle path. Time progresses from left to right and is measured by the 1000-cycle timing wave. The lower trace on each frame shows the combined output of two antennas spaced three wavelengths on the great circle path. The upper trace shows the output of a one-wave vertical antenna. In Film 15 the directional pattern is steered so as to discriminate against the early portion of the pulse. In Film 14 the steering discriminates against the latter portion. GCS, 33.28 meters (Rugby, England) March 6, 1933, 2030 G.M.T.

tennas spaced three wavelengths were used for Figs. 20 and 21 and show that the angular spread extends roughly from 17 to 32 degrees.

Whenever the resolution has been sufficient to permit accurate measurements to be made, the angles of the separate component waves have

been found to be very stable. Constant angles have been observed for periods as long as an hour and have sometimes been found to recur day after day. Variations of two degrees could have been detected had they occurred. Pulses of these constant angles are highly variable in amplitude, however, and often pulses of different angles appear and disappear within the course of a few minutes. These comparatively fast changes in energy-angle distribution may account for the somewhat scattered angle values obtained with the differential output method such as shown in Fig. 10.

In cases where the propagation results in a more complicated pulse pattern so poorly resolved that the two previously described methods

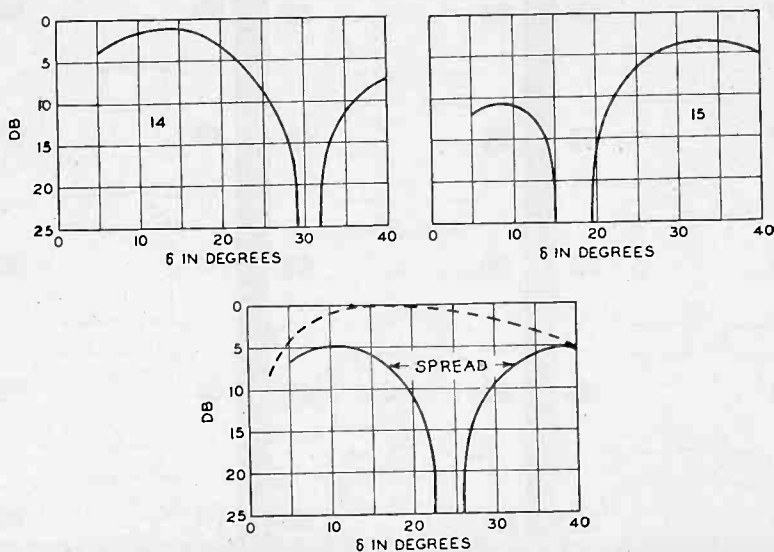

Fig. 21—Vertical directional patterns corresponding to the pulse patterns of Fig. 20. The numbers 14 and 15 refer to the correspondingly numbered films. The lower curve shows the directional pattern corresponding to the minimum output on carrier transmission immediately following. The minimum was found to be 6 to 8 decibels below the maximum, indicating an angular spread of the order of 15 degrees. The broken curve is the envelope of the maxima.

become unworkable, a different application of the phase method has been found very valuable. A spacing of antennas is chosen which gives an aperture wide enough to permit all of the angles to fit well down into the null. Then the phase changer adjustment knob is rapidly moved back and forth so as to provide a directional pattern suppressing the low angles and the high angles alternately. Such a procedure invariably causes the general pulse pattern to rock in step with the rotation of the phase adjustment knob. The sense of this correlation is always such as to indicate that the early part of the pulse pattern is due to lower angle contributions than the later part. Instantaneous pictures, examined in detail, show apparent discrepancies explainable again by



imperfect resolution. To one viewing the rocking phenomenon the correlation is striking. Fig. 22 is a sample of film showing poor resolution and the rocking phenomenon so useful in such cases. Compared with the broad reference antenna (the upper trace on each frame) the steerable antenna shows in Film 11 discrimination against the late part of the pulse pattern while in Film 12 the effect is reversed. Film 13 is included to show that the angular spread of the entire pulse pat-

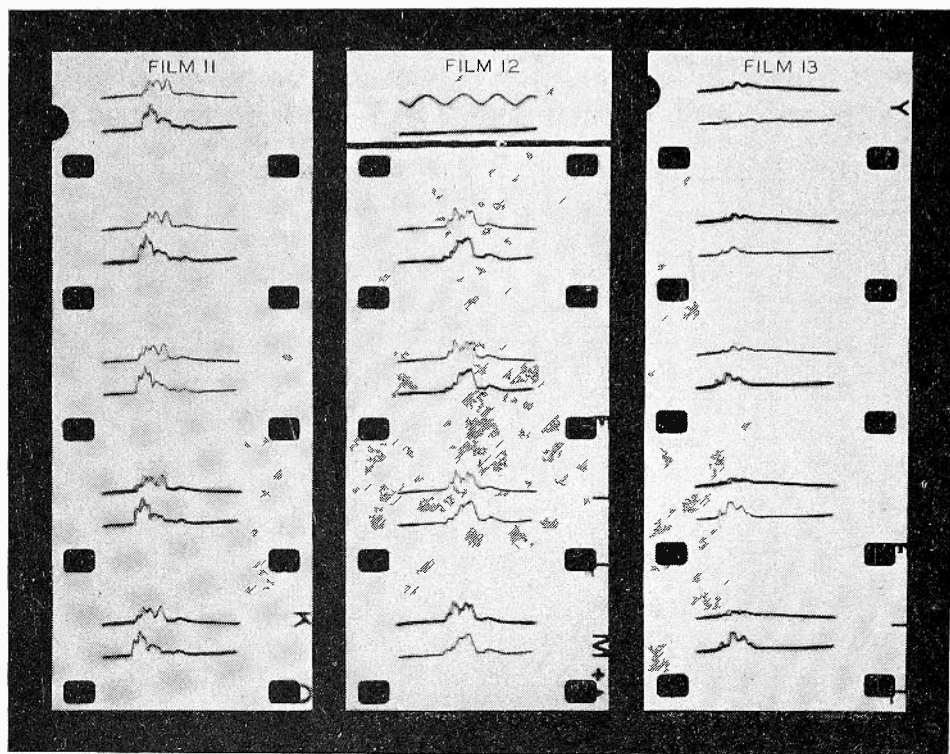

Fig. 22—Example of “rocking” the pulse pattern. Time progresses from left to right and is measured by the 1000-cycle timing wave. The lower trace on each frame shows the combined output of two antennas spaced 13.5 wavelengths on the great circle path. The upper trace shows the output of a one-wave vertical antenna. In Film 11 the steering discriminates against the late part of the pulse pattern. In Film 12 the steering discriminates against the early portion. During the time (about 0.8 second) in which the sequence in Film 13 was recorded the phase was rapidly changed 180 degrees from the value which gave the maximum reduction of the entire pattern. GBW, 20.78 meters (Rugby, England) April 8, 1933, 1715 G.M.T.

tern is sufficiently small to fit well into a null of the vertical plane directional pattern. The directional patterns corresponding to the films of Fig. 22 are shown in Fig. 23.

Agreement between angles measured by the vertical antenna differential method and the vertical antenna phase method is to be expected. Such agreement has been illustrated in the foregoing.

On several occasions, simultaneous measurements have been made with the spaced vertical antenna phase method, and the horizontal

antenna differential method. Measurements of the mean angle usually agree within a few degrees. While pulses are being transmitted the differential method described in Section I is unworkable, but pulse transmission is usually preceded and followed by carrier transmission. Thus, on February 28, 1933, the following data were obtained on reception from GCS 33.28 meters (Rugby, England): Between 1930 and 1950 G.M.T. the horizontal antenna differential output method gave mean angle values from 25 to 28 degrees. At 2000 G.M.T. pulse transmission showed four pulses of 17.5, 20, 26, and 34 degrees. Following the pulse

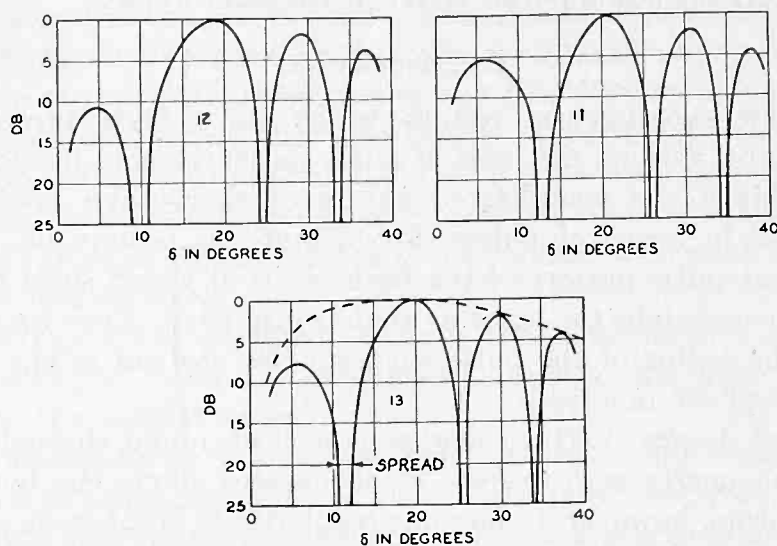

Fig. 23—Vertical directional patterns corresponding to the pulse patterns of Fig. 22. The numbers 11, 12, and 13 refer to the correspondingly numbered films. No 13 shows the directional pattern corresponding to the minimum portion of Film 13. The broken curve is the envelope of the maxima.

transmission the differential method gave a mean angle of 25 degrees. At 2030 G.M.T. pulse transmission showed the presence of three angles of 19.5, 24.5, and 30 degrees. From 2100 to 2130 G.M.T. the differential method gave angles ranging from 23 to 25 degrees.

The agreement is more significant when the angular spread is small. Thus, the horizontal antenna differential method yielded angles of 12 to 12.5 degrees preceding and following the pulse period in which Fig. 23 was obtained. Later in the day (near 2000 G.M.T.) higher angle waves replaced those of 12 degrees and the differential method yielded angles of 17 to 19 degrees. The phase method indicated an angle of 18 to 20 degrees. It appears, therefore, that the angle of the horizontally polarized waves and that of the vertically polarized<sup>17</sup> waves are essentially the same. Further evidence of this is found in a paper by Potter

<sup>17</sup> By "vertically polarized" we mean here "polarized in the plane of incidence."

and Friis.<sup>10</sup> The method described in that paper may be considered as a differential output method depending on this similarity.

Pulse patterns received simultaneously on vertical and horizontal antennas having somewhat similar directional patterns show that, for each of the several components of various delays observed on one antenna, a corresponding one occurs on the other. Corresponding pulses fade in an apparently unrelated manner, however. Horizontal antennas have not been employed thus far in a quantitative angle measuring system equipped for pulse reception, so we are unable to state definitely that the corresponding pulses arrive at the same angle.

## V. DISCUSSION

The few experimental results which have been presented to illustrate the various methods of angle measurements illustrate also the variability and complicated nature of short-wave propagation. Interpreted in terms of pulses, for instance, it is only on rare occasions that pulse patterns have been received which show only one pulse approximately the same as that transmitted. Even on such occasions, the fading of the pulse suggests that instead of one discrete wave several are involved.

*Vertical Angles.* Vertical angles have been found throughout the range from nearly zero degrees to 40 degrees above the horizontal. There appears, however, to be some regularity in short-wave propagation.

The following points, pertinent to the subject of this paper, have been tentatively established by the results of wave angle studies:

1. To the extent that we have been able to resolve the propagation into separate angles, the separate angles are found not to be erratic; they vary slowly.

2. There appears to be at least a qualitative relation between angle and delay; the greater the delay the greater the angle above the horizontal.

3. The horizontal and vertical components of the entire group of waves have the same mean angle and *probably* the horizontal and vertical components of each separate wave arrive at substantially the same angle.

These points suggest that a multiple reflection phenomenon is involved in the propagation. Undoubtedly this is so but quantitatively the picture of multiple reflection from a single ionized layer of uniform virtual height explains only a small fraction of the results in transatlantic propagation.

Simple equipment could hardly be expected to analyze completely such complex phenomena. Pulse signals were required, and both the differential output and the phase methods were valuable in establishing points 1 and 2 above. In particular, the phase method employing the steering feature to "rock" the pulse pattern gave the most reliable and significant data in cases of poor resolution. In order to compete with the steering method, a differential output method would require antennas having much more contrast and more suitable phase characteristics than the half-wave and one-wave vertical antennas.

The use of short pulses has a fundamental disadvantage in that wide band receivers are required. Under poor transmission conditions, which are of especial interest, noise and interference become serious obstacles on account of the wide bands. Nevertheless, considerably shorter pulses may be required to obtain more definite and detailed information. On the other hand, carrier signals permit highly selective filters and allow limited information to be obtained on weak fields with high interference levels.

With only a carrier signal available the phase method employing spaced antennas yields the most information, giving both the mean angle and the angular spread.

The measurement of very low angles imposes requirements not encountered in measuring high angles. Expensive pole structure is required to obtain the necessary height in a horizontal antenna differential output system. In the spaced antenna phase method great spacings are required. In both systems the ground must be flat well ahead of the optical point of incidence, which for low angles, requires a rather extensive tract. The use of a half-wave and one-wave vertical antenna combination on a salt marsh site, or directly at the seashore, so that the waves are reflected from a highly conducting surface, is perhaps ideal for a low angle differential method.

The variable character of short-wave transmission requires a somewhat statistical approach to the problem of obtaining a comprehensive picture of the propagation. The automatic recorder is here a valuable tool and occupies an important place in the differential output system. The data give no indication of angular spread but, taken in conjunction with field intensity measurements, form a valuable background for the design of a short-wave radio circuit.

For the purpose of making a less pretentious angle survey a manual technique may be sufficient. A phase method employing the cathode ray oscillograph for phase determination<sup>5</sup> has certain advantages for this purpose. It is simple to install, is flexible in operation, and is independent of ground constants.

*Horizontal Angles, Direction Finding.* Investigations of horizontal angles, made with the steering equipment described in Section III, showed that the horizontal angle spread is comparatively small and that the mean angle coincides within a few degrees with the great circle path containing the transmitting and receiving stations. Some unpublished researches made by K. G. Jansky of these laboratories using a rotatable antenna array<sup>4</sup> also found departures of only a few degrees in the case of reception from LSN at Buenos Aires.

Horizontal direction finding, involving as it does only small angular spreads, is comparatively simple. Small compact equipment suffices to measure horizontal directions with significant accuracy. A rotatable "Adcock" antenna system or the cathode ray phase method<sup>5</sup> is suitable.

*Improvement of Radiotelephone Quality.* The existence of the many waves of different delay, which is known to make fading selective with respect to frequency, greatly impairs the quality of a short-wave radiotelephone circuit. The principal object of the detailed wave angle studies employing pulses, briefly outlined in this paper, has been to evaluate the problem of improving quality by the use of receiving antennas which by directional discrimination reduce the number of waves. The experimental facts, tentatively established, that individual wave angles are fairly stable and that waves of different delay invariably possess different vertical angles make this problem hold considerable promise.

The simple antennas described in Section II of this paper are suitable for angle determination because of their ability to reject a single wave but they are not in general suitable for quality improvement. For such studies it would be preferable to construct a more elaborate antenna whose directional pattern has a single major lobe which is steerable in the vertical plane. Such an antenna would aim to select a narrow range of angles in which occur waves of substantially the same delay. It would also, because of its higher gain, permit wave angle studies under conditions of weak fields when the simple antennas used in our work fail.

#### ACKNOWLEDGMENT

In conclusion the authors wish to express their appreciation to the British Post Office for its kind coöperation; to Mr. T. Walmsley of the British Post Office for providing suitable test schedules and for his coöperation and interest; to their many associates who have coöperated in this work; and to Mr. L. R. Lowry whose engineering and testing was of great value. They are particularly indebted to Mr. R. K. Potter of the American Telephone and Telegraph Co. who not only facilitated the arranging of test schedules, but who contributed much through his interest.

## ELECTRON OSCILLATIONS WITH A TRIPLE-GRID TUBE\*

BY

FERDINAND HAMBURGER, JR.

(School of Engineering, Johns Hopkins University, Baltimore, Maryland)

*Summary*—An arrangement is described for producing ultra-short waves with a triple-grid tube. The data show that a type'89 triple-grid tube is a most satisfactory oscillator at a wavelength of about one and one-half meters. Experimental and theoretical considerations show that the oscillation produced by the triple-grid tube is of the well-known Barkhausen-Kurz and Gill-Morrell type.

## INTRODUCTION

ELECTROMAGNETIC waves of the order of one meter and less have been produced by various experimenters making use of the Barkhausen-Kurz and Gill-Morrell effects. Briefly stated these oscillations are produced with a triode by a departure from the conventional oscillator connection. This departure takes the form of a high positive potential on the grid of the triode and a small negative or zero potential on the plate.

Oscillators of this character have been studied by various experimenters. Among these Hollman's studies are quite complete and a brief résumé of some of his conclusions are of interest and should be borne in mind when considering the subject of this paper. According to Hollman<sup>1</sup> the general explanation of the Barkhausen-Kurz oscillations is simply that electrons emitted from the cathode are rapidly accelerated by the high positive potential of the grid. Some strike the grid wires, others pass through the grid mesh. Those electrons passing through the grid mesh come into a decelerating field and finally reverse and move back towards the grid. Once again some of these reversed electrons strike the grid wires and some pass through the grid mesh into the grid-cathode space. Here again deceleration of these electrons takes place and they finally join electrons freshly emitted from the cathode and the process described continues. Thus there is an oscillation of electrons about the grid—the period of the oscillation being principally controlled by the potential distribution within the tube. These oscillations are found to be entirely independent of the dimensions of the external circuit and are the well-known Barkhausen-Kurz oscillations.

\* Decimal classification: R355.5. Original manuscript received by the Institute, October 19, 1933.

<sup>1</sup> Numbers refer to bibliography.



Gill and Morrell<sup>7</sup> showed that by the use of an external tuned circuit oscillations of greater intensity and shorter wavelength were produced, these oscillations being initiated by the Barkhausen-Kurz oscillation described above but differing from them in that the Gill-Morrell oscillations are dependent upon the dimensions of the external circuit in the usual  $LC$  relation. For a more complete résumé of the Barkhausen-Kurz and Gill-Morrell oscillations the paper by Hollman as well as the bibliography accompanying it should be consulted.

Hollman further showed that other oscillations of similar nature to those above discussed could be produced with a triode, and he listed four types as follows:

- (1). Oscillations within the cathode-anode space whose wavelength was independent of the dimensions of the external circuit.
- (2). Oscillations similar to (1) but whose wavelength was determined by external circuit dimensions.
- (3). Oscillations within the grid-anode space whose wavelength was independent of the external circuit dimensions.
- (4). Oscillations similar to (3) but whose wavelength was determined by external circuit dimensions.

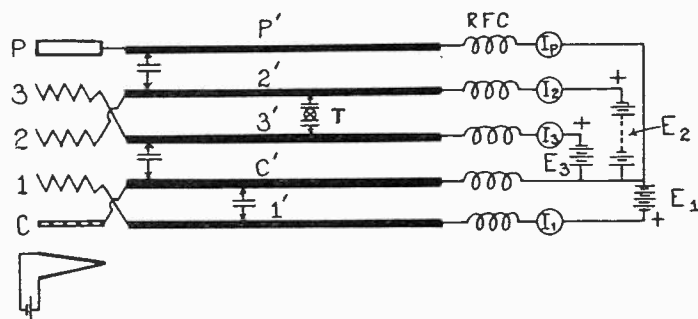

Fig. 1—Diagram of connections.

These conclusions of Hollman led the present investigator to believe that if other possible oscillation paths were introduced within a tube results of interest might be found. In other words, if oscillations, as found by Hollman, occurred not only in the cathode-anode space but also in the grid-anode space it seemed likely that the presence of additional electrodes would add other possible oscillation spaces.

#### EXPERIMENTAL WORK

The following report gives the results of an investigation of the production of oscillations of character similar to the Barkhausen-Kurz and Gill-Morrell oscillations but produced with a triple-grid tube rather than with a triode. Preliminary experiments with a type '89 tube indicated that this tube would produce short-wave electronic os-



illations, and since its three grids offered the multiplicity of paths desired for these experiments this tube was used throughout the investigation to be described. In order to facilitate reference to the tube electrodes in the following discussion these abbreviations will be used: Cathode, *C*; Grid closest to the cathode, Grid 1 or 1; the middle grid, Grid 2 or 2; Grid closest to the plate, Grid 3 or 3; and the plate, *P*.

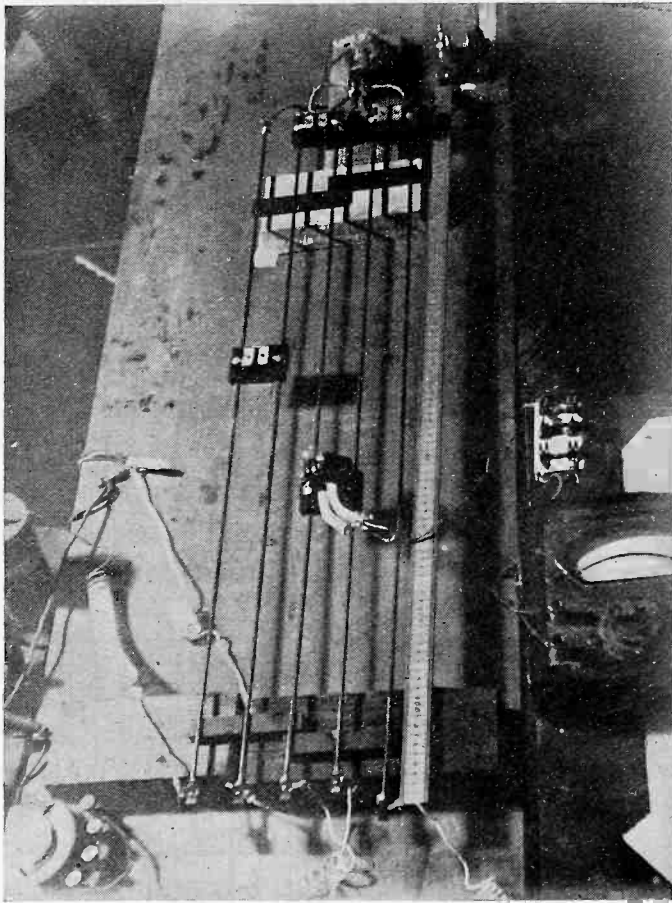

Fig. 2—Photograph of experimental equipment.

Several methods of connecting the tube are of course possible but after several trials the tube set-up used for the experiments here described was that shown in Fig. 1. The conductors indicated between the tube terminals and the radio-frequency chokes were brass rods 0.479 centimeter (0.1885 inch) in diameter and 93.35 centimeters (36.75 inches) long. These brass rods were supported by small bakelite strips so that they were spaced on 4.685-centimeter (1.844-inch) centers. The arrangement shown in Fig. 1 indicates that there are several pairs of adjacent rods which will be referred to as rods  $P'-2'$ ,  $2'-3'$ ,  $3'-C'$ , and  $C'-1'$ , respectively. In order to tune the circuits formed by these

rods sliding bridges were arranged, each bridge carried a small 0.002-microfarad condenser to form a short circuit for radio-frequency currents without shorting the direct-current potentials supplied to the tube elements. In addition to these shorting bridges one bridge was

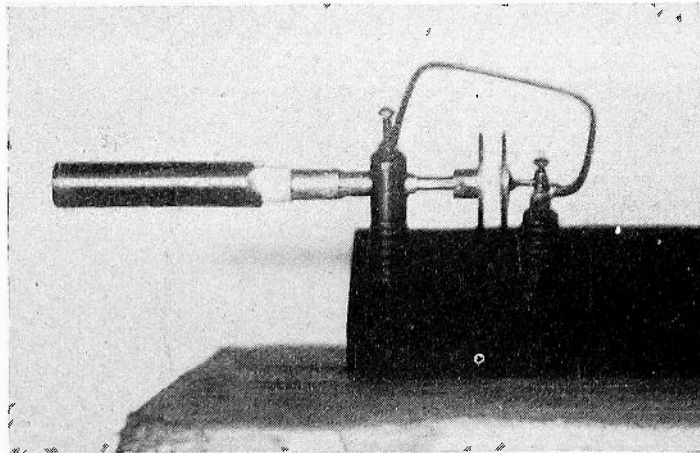

Fig. 3—Photograph of microwave meter.

arranged with two condensers and a thermocouple so that radio-frequency currents across any pair of rods could be measured. This bridge will be referred to as the "thermocouple bridge" in order to distinguish

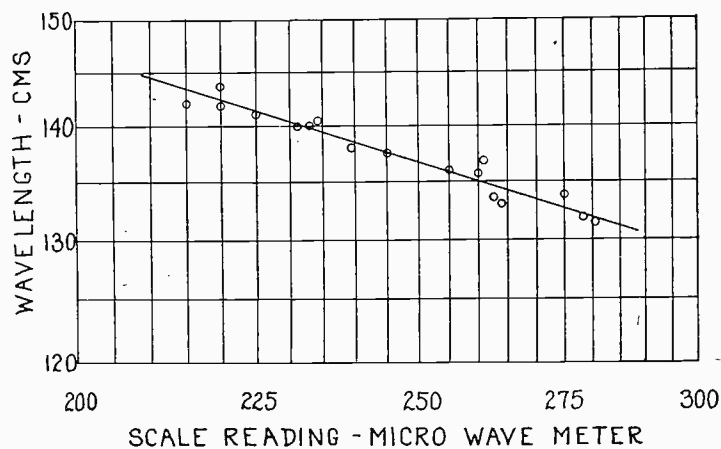

Fig. 4—Calibration curve of microwave meter.

it from the other "shorting bridges." A photograph of the set-up of the tube and circuits is shown in Fig. 2.

In the preliminary experiments the wavelength of the oscillations produced by the triple-grid tube was measured by a Lecher wavemeter. This method proved to be so slow that a more rapid means of wavelength measurement had to be devised. A wavemeter was there-

fore constructed using a small fixed loop and a variable condenser, the condenser being constructed with the use of a micrometer head for close adjustments. A photograph of this micro wavemeter is shown in Fig. 3. This wavemeter is similar to the short wavemeter described by Helmholtz.<sup>2</sup> All measurements were made using this micro wavemeter and it was calibrated periodically against the Lecher wavemeter. A typical calibration curve is shown in Fig. 4.

By placing a shorting bridge on one pair of rods at a time it was found that oscillations of low intensity were produced when the electrode potentials were properly adjusted. The manner in which the wavelength varied with the position of the shorting bridge as it was moved along one pair of rods at a time is shown in Fig. 5. It was noted

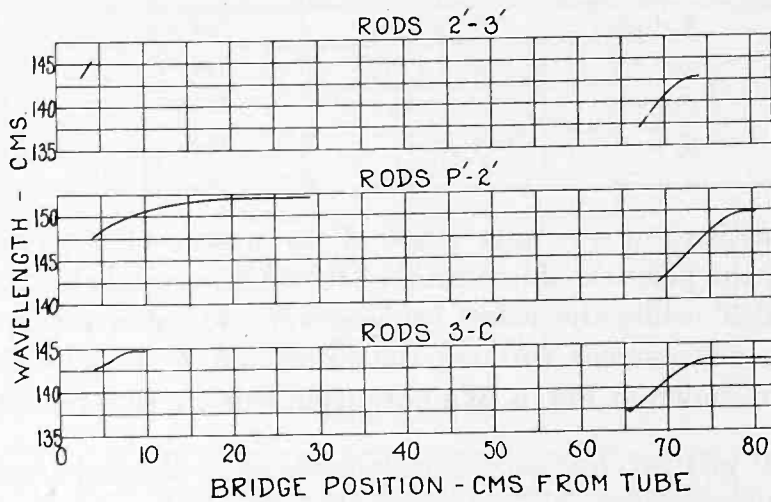

Fig. 5—Variation of wavelength with bridge position for individual bridges.

that for the conditions shown the order of magnitude of the wavelength of the oscillation produced was independent of the pair of rods upon which the shorting bridge was placed. This suggested that the intensity of oscillation might be increased by placing shorting bridges on more than one pair of rods at a time. Experiment proved this to be the case as shown by Table I. Table I gives the results of three similar tests. In Case A the thermocouple bridge was placed across rods 2'-3' and was left in a fixed position. The table shows the way in which the intensity of the radio-frequency current across rods 2'-3' increases as successive rods are tuned. The table also shows that the wavelength was independent of the number of rods tuned. Case B and Case C are similar to Case A except that different electrode potentials were used and in Case B the thermocouple bridge was placed across rods 3'-C' and in Case C across rods P'-2'.

TABLE I  
 VARIATION OF THE INTENSITY OF OSCILLATION WITH THE NUMBER OF TUNED CIRCUITS

Case	Potentials Volts	Bridge on Rods	Wavelength Cms	Intensity of Oscilla- tion Milliampers Radio-Frequency
A	$E_1 = +4.5$	2'-3' Only	141.0	6.4
	$E_2 = +78$	2'-3' & P'-2'	141.5	10.75
	$E_3 = +43$	2'-3', P'-2', 3'-C'	140.5	16.4
	$E_p = +0$	2'-3', P'-2' 3'-C', C'-1'	141.0	22.4
B	$E_1 = +4.5$	3'-C' Only	141.8	10.6
	$E_2 = +73$	3'-C' & 2'-3'	141.5	13.6
	$E_3 = +34$	3'-C', 2'-3', P'-2'	141.4	15.2
	$E_p = +0$	3'-C', 2'-3' P'-2', C'-1'	141.0	18.1
C	$E_1 = +4.5$	P'-2' Only	138.0	5.0
	$E_2 = +85$	P'-2' & 2'-3'	138.0	9.6
	$E_3 = +48$	P'-2', 2'-3', 3'-C'	138.0	12.4
	$E_p = +0$	P'-2', 2'-3' 3'-C', C'-1'	138.0	21.7

An investigation was next made of the nature of the oscillations by varying the position of one bridge (the thermocouple bridge) along the rods 2'-3' while the other bridges were adjusted for maximum radio-frequency current through the bridge on 2'-3'. The results of this run are shown in Fig. 6. We note from this curve a region of con-

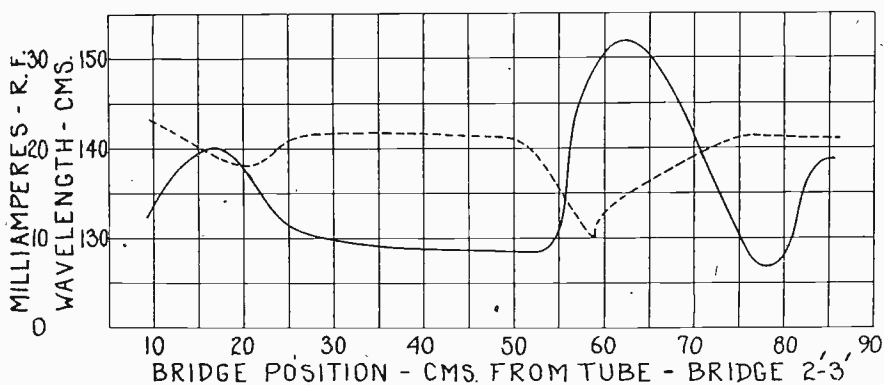

Fig. 6—Variation of wavelength and intensity of oscillation with position of bridge 2'-3'.

----- Wavelength  
 ————— Intensity

stant wavelength for a range of bridge positions followed by a decrease in wavelength accompanied by an increase in intensity of oscillation. Subsequently there is an increase of wavelength as the bridge is moved further away from the tube. This is typical of the Barkhausen-Kurz and Gill-Morrell oscillations as shown by Hollman.

Only a few tests have thus far been carried out with varying potentials. Those that have been made show a variation in wavelength with a variation of the potentials of grids 2 and 3. This wavelength variation appears to follow the results of other investigators of the Barkhausen-Kurz and Gill Morrell oscillations. There is one striking difference in the behavior of the triple-grid tube, the wavelength is independent of the potential of grid 1 and at the same time the intensity of oscillation is a function of this same potential. This is shown for one test in Fig. 7.

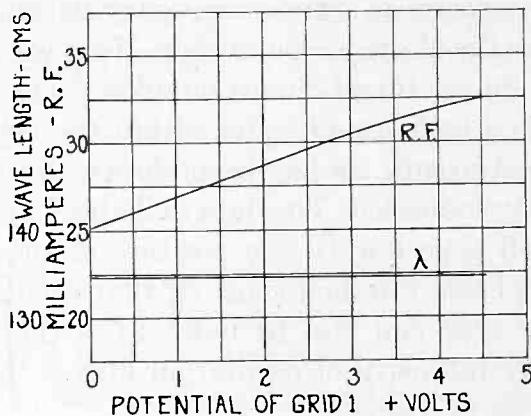

Fig. 7—Variation of wavelength and intensity of oscillation with potential of Grid 1.

#### DISCUSSION

In the usual case of electronic oscillations we consider that the oscillation consists of a to-and-fro motion of electrons about the grid of the triode. If such be the case it is obvious that there must be some sort of synchronizing action within the tube in order that an oscillation of definite period be observed. This means that the random velocities with which the electrons are emitted from the cathode must by some sort of action within the tube be brought into a concentrated motion in order to produce oscillations of a particular frequency and of sufficiently great intensity to be observed. Further, the intensity of the oscillation is greatly increased when the external circuit's natural period approaches the period of the electronic oscillation thus producing the Gill-Morrell oscillations, as explained by Hollman.

There are two possible explanations of the results in Fig. 5. First, it is possible that through the proper selection of tube dimensions and electrode potentials there exists within the tube several electron paths about which oscillation of a given frequency may take place. By simultaneous tuning of all these paths as indicated in Table I oscillations are produced of relatively large magnitudes as compared to a single

path. This might be looked upon as a building up of the intensity of oscillation by a combination of several circuits all adjusted to the same frequency or simply a pulling into step at one frequency of more and more of the electrons emitted from the cathode. The second and more plausible explanation concludes that all of the electron oscillation consists of electron travel over a path approximately twice as long as the distance from cathode to anode. That is, the path of travel of an electron for one complete oscillation is from the cathode to the anode and back again. Thus we may think of the cathode-anode space as a reservoir of oscillation energy at a fixed frequency determined by the tube dimensions and by the electrode potentials. Next we may consider each pair of rods as a simple tuned circuit coupled to an oscillator; the oscillator being the cathode-anode space within the tube. Hence by coupling several tuned circuits as has been shown the total energy available may be greatly increased. The data in Table I apply to oscillations of the Gill-Morrell type due to the position of the shorting bridges. Similar data have been obtained showing that oscillations of the pure Barkhausen-Kurz type can also be built up in the same manner. In this case the lower intensity of oscillation makes the data less clear-cut than that given in Table I.

It is of passing interest to note that when an effort is made to produce oscillations, of the character discussed above, by means of any of the standard triodes of the receiving type it is usually done at the expense of overloading the tube.<sup>4,5,6</sup> With the triple-grid tube used in these experiments such is not the case. The oscillations are readily produced without excessive electron emission from the cathode and without overheating any of the electrodes of the tube. This is probably due to the fact that in a triode all of the accelerating force acting on an electron is produced by a single grid and hence relatively high potentials must be used whereas in the triple-grid tube the work of acceleration is divided between three grids and hence only moderate potentials are necessary. This means fewer electrons actually striking the grid wires and hence lower operating temperature of the grid. A study should be made of the effect of various grid spacings and grid and plate diameters in the triple-grid electronic oscillator to determine wavelength and intensity limitations. Such a study is being contemplated.

That the oscillations produced by the triple-grid tube are truly of an electronic nature and of the Barkhausen-Kurz and Gill-Morrell types is proved by the exact similarity of the results here obtained and the results of Hollman. This is readily seen by comparing Hollman's curves with Fig. 6 of this paper. Further, it is possible by cal-

culations similar to those made by Barkhausen and Kurz<sup>3</sup> to estimate the wavelength of the oscillations produced by the triple-grid tube.

The computation of the wavelength is based on the velocity of and distance traversed by electrons after emission from the cathode. In order to make this calculation a number of assumptions are necessary. These assumptions involve the following points;

- (a). The electrons are assumed to leave the cathode with zero velocity.
- (b). The average velocity of an electron as it passes through the space between the cathode and the plate must be estimated for each portion of its journey, that is, for the cathode-grid space, the grid 1-grid 2 space, etc.
- (c). The complete path of an electron in performing one complete oscillation is taken to be twice the distance from cathode to plate.

Using these assumptions a calculation for the tube used shows that the period of oscillation should yield a wavelength of approximately 120 centimeters, which is of the same order of magnitude and in fairly good agreement with the wavelength found by experiment.

#### CONCLUSIONS

1. It is possible to produce short-wave electronic oscillations by means of a triple-grid tube.
2. Oscillations so produced are similar to the Barkhausen-Kurz and Gill-Morrell oscillations produced with a triode.
3. The data have indicated that the frequency of oscillation produced is independent of the potential of one of the grids while the intensity of oscillation is practically proportional to this same potential. This should be of value in using the triple-grid oscillator for communication of intelligence.
4. The full possibilities of the triple-grid tube as an ultra-short-wave oscillator can only be brought out by further investigation. Such an investigation is to be carried out.

#### ACKNOWLEDGMENT

This work was carried out in the Electrical Engineering Laboratories of the School of Engineering of the Johns Hopkins University.

#### Bibliography

<sup>1</sup> H. E. Hollman, "On the mechanism of electron oscillations in a triode," *Proc. I. R. E.*, vol. 17, no. 2, p. 229; February, (1929).

<sup>2</sup> E. W. Helmholtz, "Experimentelle Prufung der Theorie der Barkhausen-Kurz Schwingungen," *Elek. Nach. Tech.*, vol. 10, no. 4, p. 181, (1933).



<sup>3</sup> H. Barkhausen and K. Kurz, "Die kurzessten, mit Vakuumrohren herstellbaren Wellen," *Phys. Zeit.*, vol. 21, no. 1, p. 1, (1920).

<sup>4</sup> J. J. Lamb, "Developments in ultra-high-frequency oscillators," *Q. S. T.*, vol. 15, no. 7, p. 9, (1931).

<sup>5</sup> S. Uda, "Radiotelegraphy and radiotelephony on half-meter waves," *Proc. I. R. E.*, vol. 18, no. 6, p. 1047; June, (1930).

<sup>6</sup> J. N. Dyer, "Practical electron transmitters and receivers," *Q. S. T.*, vol. 15, no. 9, p. 21, (1931).

<sup>7</sup> E. W. B. Gill, and J. H. Morrell, "Short electric waves obtained by valves" *Phil. Mag.*, vol. 44, p. 161, (1922).



## VISUAL TEST DEVICE\*

BY

GUENTHER ULBRICHT

(Institute for High-Frequency Physics of the Hannover Technical High School, Hannover, Germany)

**Summary**—In this paper there is described a test device for showing frequency response curves visually wherein the recording apparatus is a cathode ray tube. In this method a sine voltage is used for the deflection of the beam, and the capacity of the rotating condenser is varied sinusoidally. The form of the plates of this rotary condenser is described, and several examples of resonance curves photographed on the screen of the cathode ray tube are given.

### I. METHOD

DEVICES for the visual delineation of frequency or resonance curves have been described on numerous occasions, and several methods are in common use. In the equipment described by Schuck<sup>1</sup> a mechanical arrangement involving a rotating mirror was utilized to obtain the horizontal time base, the distances along which were calibrated according to the corresponding frequency.

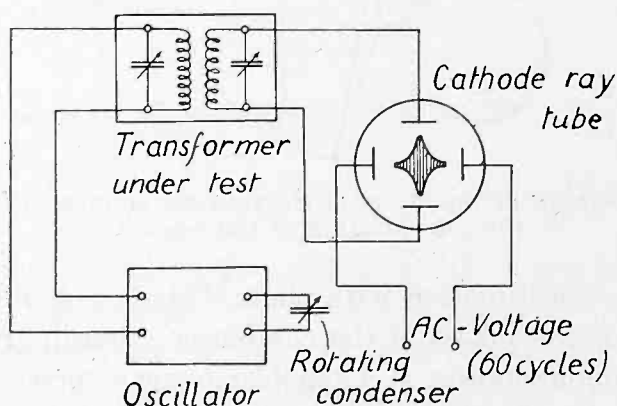

Fig. 1—Device for showing resonance curves with the cathode ray tube.

The arrangement to be described is particularly adapted to the cathode ray type of oscillograph and overcomes some of the disadvantages of the Banneitz and Marx method which utilized a continuously rotating potentiometer.<sup>2</sup>

The basic principle used by many of these test devices is to apply a continuously varying oscillator of suitable range to the frequency

\* Decimal classification: 537.7. Original manuscript received by the Institute, June 14, 1933.

<sup>1</sup> O. H. Schuck, *Proc. I. R. E.*, vol. 20, no. 10, p. 1580; October, (1932).

<sup>2</sup> E. Marx and F. Banneitz, *Jahr. der draht. Teleg. und Teleph.*, vol. 6, p. 146, (1912).

responsive device under test. The output is applied to the visual indicator as in Fig. 1.

Each individual frequency of the band covered must be assigned to a definite location on the screen so that successive diagrams, covering a series of revolutions, appear at the same position. Therefore if the frequency of the variable oscillator is varied linearly with time the mechanism whereby the horizontal deflection is obtained must be varied linearly at the same rate. Or if the oscillator frequency is varied in a sinusoidal manner a sine wave of the same frequency can be applied as the time base.

This latter suggests a simple method of obtaining a suitable time base, *i.e.* from the 60-cycle lighting line. A means will now be disclosed whereby the frequency of the variable oscillator can be controlled in a sinusoidal manner. It is necessary to vary the capacity of the oscillator

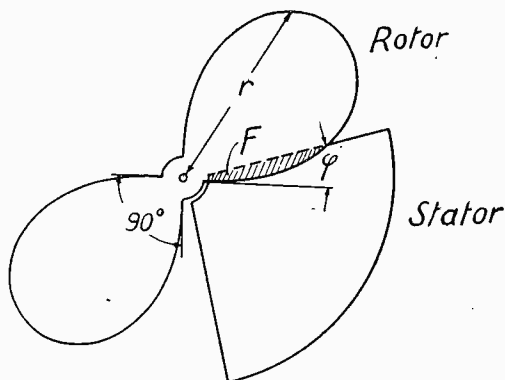

Fig. 2—Shape of the plates of the rotating condenser for sine-shaped variation of the capacity.

according to a sine function with time. This is not difficult; one has merely to shape the plates of the condenser accordingly and to drive it by a synchronous motor. If a synchronous converter is at one's disposal, one may put the plates of the "sine shape" of the condenser upon the shaft of this converter driven by direct current, and utilize the produced sine voltage for the deflection.

## II. THE ROTATING CONDENSER

In Fig 2 is shown an example for the form of the plates of the rotating condenser. In order to balance the rotating masses two exactly similar plates diametrically opposite one another are placed upon the shaft of the motor. The stator plate has the form of a quarter circle. The capacity is proportional to the surface  $F$  of the rotor plate covered by the stator plate. With a turn of the rotor around the angle  $d\phi$  the covered surface changes by the value  $dF$ . It is

$$dF = \frac{r^2}{2} \cdot d\varphi, \quad r = \text{radius vector.}$$

It is evident from Fig. 3 that the capacity of the condenser and with it the surface  $F$  must be varied according to a cosine function, so that

$$F = 1 - \cos \varphi$$

and, therefore,

$$r^2 = 2 \frac{dF}{d\varphi} = 2 \sin \varphi$$

and,

$$r = \text{const.} \sqrt{\sin \varphi}.$$

After a turn around the angle  $\varphi_0$  the capacity is restored to the original

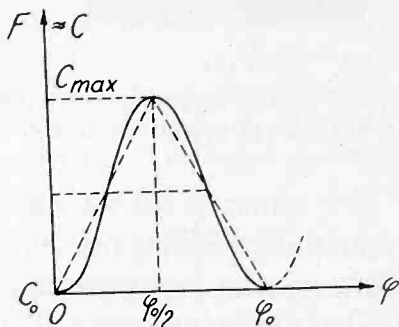

Fig. 3

value  $C_0$ . In our case with two plates standing opposite one another  $\varphi_0$  amounts to 180 degrees. With a turn of the rotor spindle the resonance curve is thus described four times, whereas it is described only twice by a single period of the deflecting network voltage. Therefore, the synchronous motor only needs half the number of revolutions corresponding to the network frequency, at 60 cycles, 1800 revolutions. Both the rotor plates must exactly correspond in form and position relatively to the stator plates,<sup>3</sup> otherwise the picture of the resonance curve on the fluorescent screen is not sharp. For the same reason they must be also absolutely symmetrical.

The horizontally deflecting voltage must have a phase displacement of 90 degrees with respect to the variable sine-shaped capacity which is most simply obtained by turning the rotor plate upon the shaft.

<sup>3</sup> The influence of an unequal space of the plates can be eliminated by using two stator plates, between which the rotor plate is running.

## III. APPLICATION

With the described device one receives the double picture of the resonance curve on the fluorescent screen. The reversing points of the cathode beam at the maximum and minimum values of the high-frequency voltage form the line of the resonance curve, because the beam slows down during the reversal. Fig. 4 shows the response curve of a resonant circuit coupled with the high-frequency oscillator *a* with

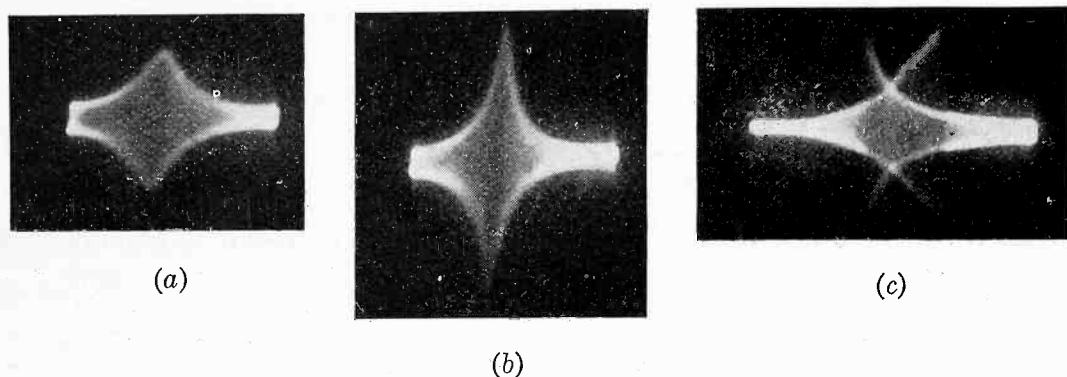

Fig. 4—Resonance curves on the screen of the cathode ray tube with different damping and coupling.

*a* a damping resistance of 7 ohms, *b* without damping resistance, *c* at more than critical coupling. By enlarging the horizontally deflecting voltage the resonance curve may be drawn apart and with it the accuracy of the resonance tuning is increased. Thus in Fig. 4*c* this voltage is increased by about 50 per cent compared to Fig. 4, *a* and *b*, in order to show this effect. In these pictures made with a wavelength of 200 meters the horizontal deflection corresponds to a variation of the capacity of 55 micromicrofarads (=capacity of the rotating condenser).



## RECTANGULAR SHORT-WAVE FRAME AERIALS FOR RECEPTION AND TRANSMISSION \*

BY

L. S. PALMER and D. TAYLOR

(The University College, Hull, England)

*Summary*—Previous work on the optimum dimensions of tuned rectangular frame aerials for the reception of short waves has been continued, and the theory has been extended to include an additional condition, the fulfillment of which results in a large frame current.

The analogous problem of the optimum dimensions of a tuned rectangular transmitting frame actuated by a local oscillator has also been investigated, and the critical dimensions for maximum frame current have been deduced from the theory, and tested experimentally.

The critical dimensions of the frame for maximum radiation in a given direction are not necessarily the same as those for maximum frame current. From the theory developed it is concluded that, for maximum radiation perpendicular to the sides and in the plane of the frame, the height and width of the frame should be  $0.40\lambda$  and  $1.0\lambda$ , respectively, and for no other dimensions (less than one wavelength) will the radiation be as great for the same applied electromotive force.

### I. INTRODUCTION

WHEN a frame or loop aerial is tuned, the current produced in it by a passing wireless wave will be increased many hundred-fold compared with the current produced in an untuned frame of the same dimensions. With wavelengths which are long in comparison with the dimensions of the frame the only other method of increasing the current is to increase the area of the frame. The increase in current by the usual theory is then proportional to the increase of the frame area. If the length of the wave is of the same order as the dimensions of the frame then it is found that the current, even in a tuned frame, may be still further increased many hundredfold not by increasing the area of the frame, but by critically adjusting the ratio of the frame dimensions to the wavelength. In a previous communication<sup>1</sup> this process was described and a theory outlined which accounted for the experimental values of the critical ratios frame height/wavelength ( $H/\lambda$ ) and frame width/wavelength ( $W/\lambda$ ) for which the received current became abnormally large. The process of adjusting the frame di-

\* Decimal classification: R325.3. Original manuscript received by the Institute, May 16, 1933. Revised manuscript received by the Institute, September 8, 1933.

<sup>1</sup> Palmer and Honeyball, Proc. I.R.E. vol. 20, pp. 1345-1367; August, (1932).

mensions was tentatively called "formatising." Since that time (August, 1932) the work has been continued and a further formatising condition has been determined, whilst the investigation has also been extended to transmitting frames.

The objectives of the present paper are to give the complete formatising conditions for tuned receiving frames and to determine the corresponding conditions for transmitting frames. Furthermore, the conditions for a large current in a transmitting frame are not necessarily the same as those for maximum radiation from the transmitting frame. Hence the final portions of the theoretical and experimental sections will deal with the question of the best conditions for maximum radiation from a tuned rectangular transmitting frame.

## II. THEORY

### 1. Reception

The current which circulates in a receiving frame is due to the electromotive force in the frame which is a consequence of the incident wireless wave, whilst the magnitude of the current depends necessarily on the magnitude of the electromotive force and on the value of the impedance of the frame. In order to simplify the present problem a tuned frame will be considered. The impedance of the frame will then be equal to the ohmic resistance and, compared with the variations discussed below, may be assumed to be reasonably constant with frequency, whilst the current will be in phase with the electromotive force produced by the passing wave.

If the wave only acted directly on the several wires of the tuned frame producing a current in phase with the electromotive force the problem would be comparatively simple, but at any point in the frame the effective electromotive force is not only that due to the direct action of the passing wave because the wave is indirectly effective in two other ways as well. For convenience these two additional indirect effects or electromotive forces may be considered separately.

#### (a) *Effect of Incident Wave*

Let us consider first the direct action of the wave. This was discussed in the previous communication where it was shown that, for a tuned frame oriented in the plane of wave propagation and for an angle of incidence  $\gamma$  between the wave front and the vertical wires of the frame,<sup>2</sup> the currents produced in the horizontal wires distant  $H$  apart would tend to differ in phase by  $a' \sin \gamma$ , and the currents pro-

<sup>2</sup> See Fig. 1 of the previous paper.



duced in the vertical wires distant  $W$  apart would tend to differ in phase by  $a \cos \gamma$ , where  $a' = 2\pi H/\lambda$  and  $a = 2\pi W/\lambda$ ,  $\lambda$  being the wavelength. If the several wires of the frame were tuned and independent of each other then these would be the actual phase differences between the several currents. The amplitudes of the currents in similar parallel wires would be approximately the same so long as the wires were many wavelengths distant from the transmitter.

Let us now suppose that the wave has produced a current in the near limb of the frame and then, for the sake of discussion, ceases to be propagated and does not affect the other limbs. In spite of this, currents would be produced in the other limbs because the current already produced by the wave would itself affect the other wires of the frame. Thus, *indirectly*, the wave would cause currents to flow in all the wires, even though its direct effect was limited to the one wire. The indirect action of the wave takes place in two different and independent ways. The first is due to the fact that the field of the initial current may cut the other wires and so induce currents in them. In the previous paper such currents were termed the "indirect" currents to distinguish them from the "direct" currents produced by the wave itself. To distinguish these indirect currents, due to the field, from the second indirect currents mentioned below, they will here be called the "first indirect" currents.

If we now make a further supposition and imagine the wires of the frame to be effectively screened from each other, then, even though the wave itself and the field of the initial current be both inoperative on the other wires of the frame, there will still be a current in these wires because they are metallically connected in the form of a frame. We shall distinguish this indirect current from the "first indirect" current by calling it the "second indirect" current.

#### (b) *First Formatising Conditions*

The previous communication dealt with the former or "first indirect" current. It was there shown that the amplitude of this component was sensibly independent of the frame dimensions as long as the parallel wires were not closer than about  $0.2\lambda$ , and furthermore, the phase difference between the initial current in one limb and that induced in a parallel wire a distance  $H$  or  $W$  away was  $-(a' - \phi' + \pi/2)$  or  $-(a - \phi + \pi/2)$ , respectively, where  $\phi' = \tan^{-1} a'/(1 - a'^2)$  and  $\phi = \tan^{-1} a/(1 - a^2)$ .

If the two effects, that is the direct action of the wave and this indirect action of the current in any particular limb of the frame, tend to produce currents in a neighboring wire in the same phase, then the resultant current will be a maximum because the amplitudes are sen-

sibly independent of  $a$  and  $a'$ . This condition, namely,  $a \cos \gamma = -(a - \phi + \pi/2)$ , or  $a' \sin \gamma = -(a' - \phi' + \pi/2)$  was developed and led finally to the equations

$$\tan [a(1 + \cos \gamma) - \psi] = (a'^2 - 1)/a \quad (1a)$$

and,

$$\tan [a'(1 + \sin \gamma) + \psi] = (a'^2 - 1)/a' \quad (1b)$$

in which  $\psi$  is any arbitrary phase angle. The solutions of these equations give respectively the critical ratios  $W/\lambda$  and  $H/\lambda$  for which the frame current will be a maximum. For convenience these conditions will, in the present paper, be termed the first formatising conditions.

### (c) *Second Formatising Conditions*

The phase relations of the "second indirect" current lead to a second formatising condition. This was not discussed in the previous paper and will therefore be considered more fully here. The initial current produced directly by the wave at any part of the frame may be represented by  $I_0 \sin \omega t$  where  $\omega = 2\pi c/\lambda$ ,  $c$  being the velocity of the wave. This disturbance travels round the frame (of perimeter  $2H + 2W$ ) with negligible loss of amplitude so long as radiation is negligible<sup>3</sup> and with a velocity approximately equal to  $c$  or that of the wave in the surrounding medium. Consequently, the disturbance returns to the point under consideration lagging behind the initial disturbance by an amount equal to the time taken to travel round the frame. This "second indirect" current, to use the expression suggested above, will be represented by

$$I_0 \sin \left[ \omega t - \frac{4\pi(H + W)}{\lambda} \right].$$

Using the previous argument, the initial direct and this indirect component will combine to give a resultant current which will be a maximum when the components are in phase, that is when

$$\frac{4\pi(H + W)}{\lambda} = 0 \text{ or } 2n\pi$$

where  $n$  is an integer.

If as before we put  $2\pi H/\lambda = a'$  and  $2\pi W/\lambda = a$  this equation reduces to

$$a + a' = n\pi. \quad (2)$$

<sup>3</sup> The justification for this assumption is given in Sections II (3) and III (2) below.

Thus we conclude that when this condition is fulfilled, the frame current will tend to be a maximum. Since (2) may be written in the form

$$2(H + W) = n\lambda$$

it follows that the frame perimeter must be an integral number of wavelengths. This is also the necessary condition for the establishment of permanent stationary waves round the frame. Equation (2) gives the second formatising conditions, but whereas the first formatising conditions depend on the two ratios  $H/\lambda$  and  $W/\lambda$  separately and therefore on the shape of the frame, the second formatising conditions depend only on the ratio of the perimeter to the wavelength and are therefore independent of the shape of the frame.

Furthermore, the second formatising conditions are independent of the nature of the initial direct electromotive force and will apply equally well whether the original disturbance was produced by an incident wave or by a local valve oscillator, but this does not apply to the assumptions underlying (1). In other words, (2), but not (1) will apply equally well to a frame aerial whether it is used as a receiving frame and actuated by an electromagnetic wave, or as a transmitting frame and actuated by a local oscillator. This point is referred to again in the following subsection on transmission.

The first formatising conditions for a receiving frame have already been tested experimentally and discussed in the previous communication. The experimental verification of the second formatising conditions was carried out on a transmitting frame (to which this condition also applies) and is described below in Section III.

## 2. Transmission

Corresponding to the two formatising conditions for a receiving frame there are two formatising conditions for a transmitting frame, the fulfillment of which will ensure maximum frame current.

### (a) First Formatising Conditions

Consider the first formatising conditions. The direct current will be that due to the local oscillator coupled to (say) the lower horizontal limb of the frame, and may be written  $I_0 \sin wt$ . The "first indirect" current component in the upper horizontal limb will, as before, be sensibly independent of the frame height and will differ in phase from the "direct" current in the lower limb by an amount  $-(a' - \phi' + \pi/2)$  where  $a' = 2\pi H/\lambda$ ,  $H$  being the distance between the horizontal wires of the frame. The "first indirect" current in the lower limb will result

from reradiation from the upper limb, and the consequent phase difference between the two component currents in the lower limb will be  $-2(a' - \phi' + \pi/2)$ . For these two currents to reinforce with a maximum resultant current, their amplitudes must be independent of  $a'$ , and their phases must be the same, i.e.

$$-2(a' - \phi' + \pi/2) = 0 \text{ or } 2n\pi.$$

Similarly, for the "direct" and "first indirect" currents in the vertical wires of the frame to be in phase, we have

$$-2(a - \phi + \pi/2) = 0 \text{ or } 2n\pi.$$

These equations lead to the transcendental equations

$$\tan a' = (a'^2 - 1)/a'$$

giving the critical values of  $H/\lambda$  for the first formatising condition in a transmitting frame; and

$$\tan a = (a^2 - 1)/a$$

giving the corresponding critical values of  $W/\lambda$ . The solutions of these equations are

$$a = a' = 4.45, 7.7, \text{ etc.}$$

or,

$$W/\lambda = H/\lambda = 0.71, 1.2, \text{ etc.}$$

As was pointed out in the case of a receiving frame, these last equations give both maximum and minimum conditions. Experiments show, however, that the odd solutions give the conditions for maximum transmitting frame current. Thus it is concluded that a square frame for which

$$H = W = 0.71\lambda$$

will have a large current circulating in it when directly coupled to a local oscillator. This result may be compared with the corresponding conditions for a receiving frame, namely when

$$H = 0.71\lambda, W = 0.33\lambda \text{ or } 0.85\lambda$$

and the frame was not square for a direction of wave propagation parallel to the horizontal wires [i.e.  $\gamma = \psi = 0^\circ$  in (1)].

Now the early experiments showed that if the critical widths be altered, then a large current would still be maintained by suitably varying the height. This can be explained, as in the previous paper, by extending the above reasoning as follows:

Suppose the frame width be increased so that the phase angle between the current components be not  $2n\pi$  but  $(2n\pi - 2\psi)$  say, then

$$-(a - \phi + \pi/2) = n\pi - \psi. \quad (3)$$

The new width may be considered to act as an added inductance producing the undesirable phase lag  $\psi$ . If now the height be decreased just sufficiently to produce a phase lead of  $2n\pi + 2\psi$  in the currents in the horizontal wires of the frame, then the effect on the frame current is similar to that of introducing a capacity of sufficient magnitude to compensate for the inductive effect of increasing the frame width. Thus,

$$-(a' - \phi' + \pi/2) = n\pi + \psi. \quad (4)$$

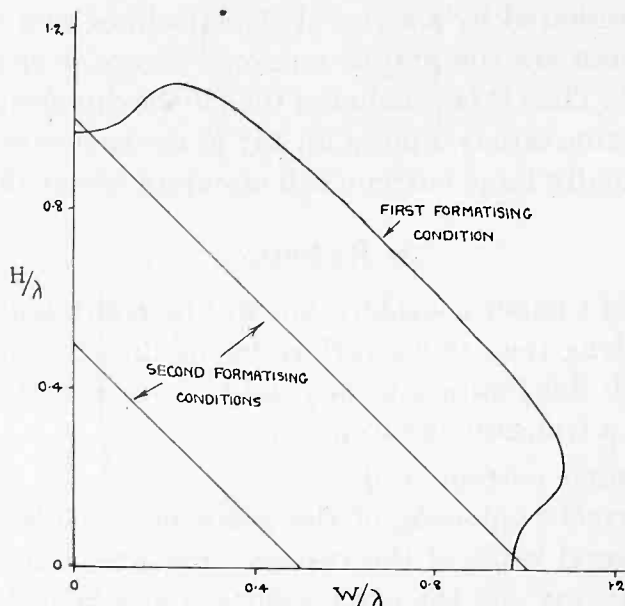

Fig. 1—Graph showing the theoretical dimensions of a transmitting frame for maximum current.

Equations (3) and (4) reduce to

$$(a^2 - 1)/a = \tan(2n\pi + a - \psi) = \tan(a - \psi) \quad (5a)$$

and,

$$(a'^2 - 1)/a' = \tan(2n\pi + a' + \psi) = \tan(a' + \psi). \quad (5b)$$

The frame dimensions (that is the values of  $H/\lambda$  and  $W/\lambda$ ) for different values of  $\psi$  can be calculated from the above transcendental equations. This has been done by a graphical method and the relation between  $H/\lambda$  and  $W/\lambda$  is shown by the graph marked "first formatising condition" in Fig. 1.

Thus any point on this graph gives the frame dimensions in terms of  $H/\lambda$  and  $W/\lambda$  for which the initial "direct" current will be in phase with the "first indirect" current and the resultant current will therefore be a maximum.

(b) *Second formatising conditions*

It has already been shown that the second formatising conditions for a receiving frame will also apply to a transmitting frame. Consequently we have the second set of critical frame dimensions for maximum current given by

$$a + a' = n\pi. \quad (2)$$

If, as before, we take  $W/\lambda$  to be abscissas and  $H/\lambda$  to be ordinates, then (2) is represented by a series of straight lines cutting the axes at 45 degrees. These are the graphs marked "second formatising conditions" in Fig. 1. Thus it is concluded that if the dimensions of a tuned transmitting frame satisfy a point on any of the curves drawn in Fig. 1, then an abnormally large current will circulate round the frame.

## 3. Radiation

In the present paper consideration will be restricted to the case of transmission along the earth's surface in the direction of the plane of the frame. With this limitation the conditions necessary for maximum radiation from a transmitting frame are

- (i) large frame current, and
- (ii) the correct cophasing of the component fields radiated from the several wires of the transmitting frame at the particular point  $P$  (say) on the earth's surface at which the radiation is being received.

Conversely, the radiation to  $P$  will be small if either the frame current be small or the fields at  $P$  due to the currents in the several wires of the frame be not in phase.

Equations (5) and (2) give the conditions for maximum frame current, whilst (1) (with  $\gamma = 0^\circ$  since  $P$  is on the earth's surface) by the reciprocity theorem, gives the conditions for the component fields at  $P$  to be in phase. The graphs of all these equations are shown in Fig. 2 which may be compared with Fig. 1. From Fig. 2 it is apparent that within the range  $0.2\lambda$  to  $1.2\lambda$ , (5) and (1) are simultaneously satisfied only at the point of intersection  $X$ . Consequently, only for a transmitting frame of these particular dimensions (namely,  $H/\lambda = 0.40$  and  $W/\lambda = 1.00$ ) will the radiation be good. For other frame dimensions given by (5) the current will be large but the fields due to the currents in the parallel limbs will not completely reinforce at  $P$ , and hence the received radiation at  $P$  will be less.

Turning now to (2) giving the second formatising conditions; the graph of this equation has also solutions in common with those of (1),

but in this case radiation is not to be expected as a result of the fulfillment of the stipulated conditions. The reason for this is that, with free permanent stationary waves, that is for frames the perimeters of which are integral numbers of wavelengths, the whole of the energy is dissipated in the frame and not in external radiation whether the conditions given by (1) are fulfilled or not.<sup>4</sup>

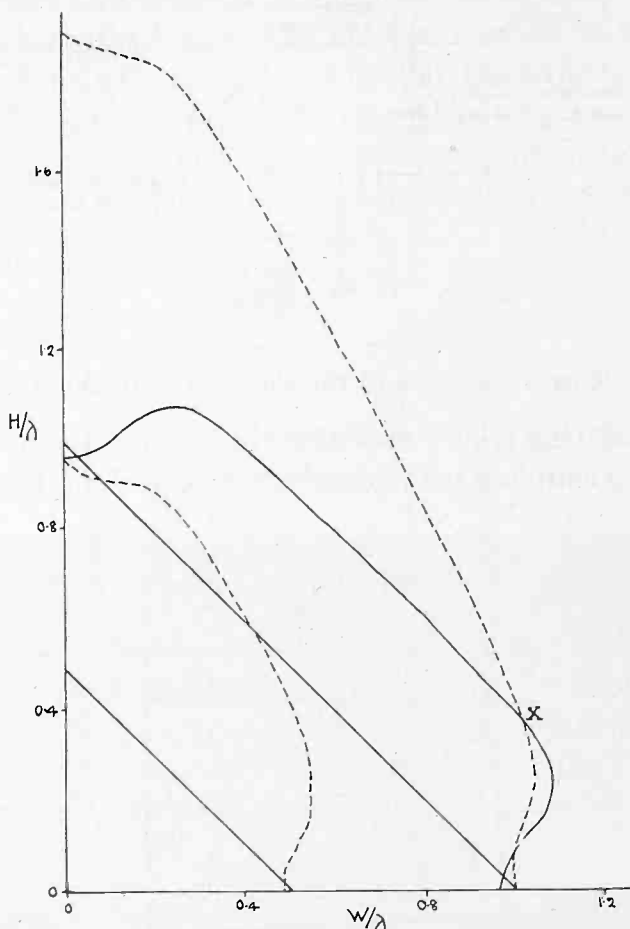

Fig. 2—Graph showing the theoretical dimensions of a transmitting frame for maximum radiation.

### III. EXPERIMENTAL INVESTIGATION

#### 1. Transmitting Frame

##### (a) Apparatus

As in the previous work on reception, ultra-short waves were used in order that the dimensions of the frame could be kept within reasonable limits. For various reasons the valve oscillator described in the previous communication was unsuitable for the transmitting experi-

<sup>4</sup> See, for example, Macdonald's "Electric Waves," Cambridge University Press, p. 62 et seq.



ments and a new oscillator was therefore utilized. Fig. 3 shows the circuit employed. By using a single turn inductance coil and a condenser of capacity 0.0001 microfarad in the tuned circuit a wavelength range from 5.5 to 11.4 meters was obtained. An L.S.6.A. Osram valve with about 400 volts on the plate gave adequate power for transmission over a distance of several wavelengths.

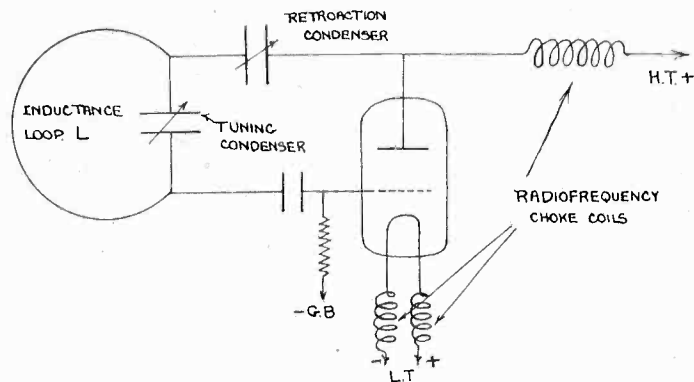

Fig. 3—Circuit diagram of the short-wave transmitter used.

The transmitting frame was directly coupled to the inductance  $L$  (see Fig. 3), the coupling being carefully screened. With this particular

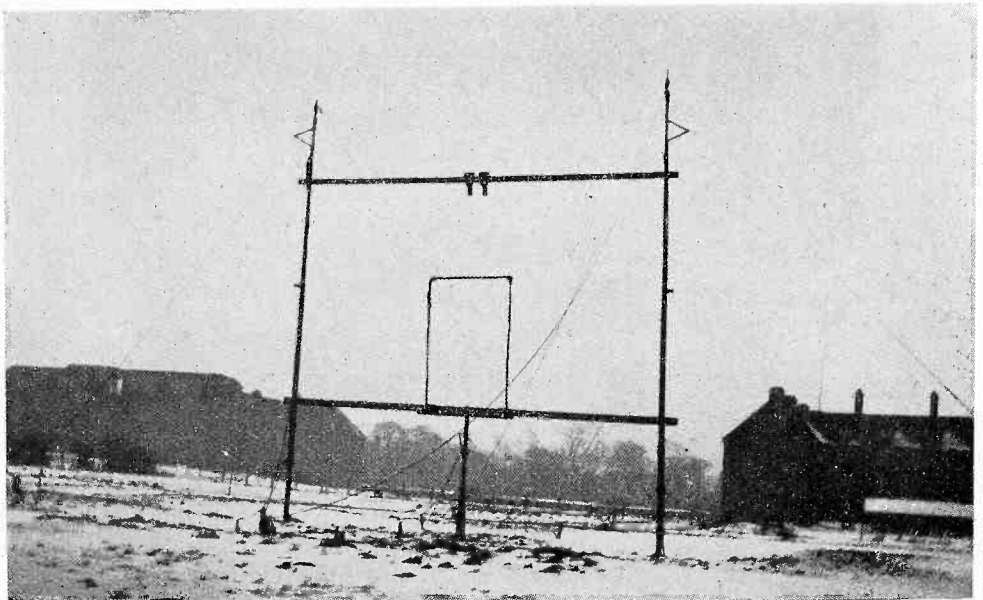

Fig. 4—View of adjustable frame aerial.

type of coupling (see Fig. 5) the change in the radiated wavelength as the frame dimensions were varied was very small, provided the minimum inductance of the frame was very much larger than that of the inductance  $L$ . This was so in the present experiments, and hence the radiated wavelength remained appreciably constant whilst the dimensions of the frame were varied.

The frame was capable of expanding and contracting in either or both dimensions. This was effected in the preliminary measurements in the manner described by Palmer and Honeyball in the previous communication. That method, however, suffers from a number of disadvantages which, whilst of little consequence in the reception experiments, were conducive to important errors when used for transmission. The actual arrangement of the new frame used in the later experiments is shown in Fig. 4. The chief advantage of this frame over that used previously for reception is that all the adjustments necessary for varying the dimensions can be carried out by an observer standing some distance from the frame. This is very important because any one standing near the apparatus may introduce several spurious effects.

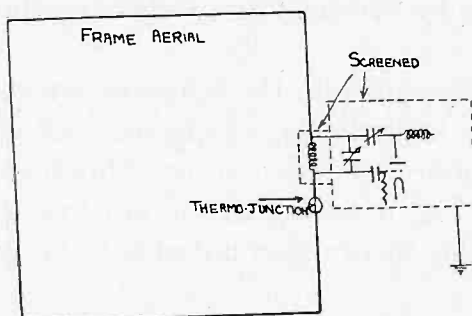

Fig. 5—The coupling of the frame to the oscillator.

The frame current was measured by a thermojunction and a microammeter, the thermojunction being inserted in the frame where shown in Fig. 5. Since observers moving near the frame may seriously distort the radiation characteristics, all the measurements were carried out from a distance using a telescope and a periscopic arrangement of mirrors.

### (b) Current Measurements

As in the previous work two main experimental methods were used. In the first method the width of the frame was varied whilst the height of the frame was kept constant. For each value of the frame width the corresponding variation in the frame current was measured for a constant input electromotive force and constant wavelength. In the second method the height of the frame was varied and the width maintained constant. Occasionally also a third method was employed. With this method the dimensions of the frame were kept constant and the radiated wavelength was varied by changing the capacity of the oscillatory circuit of the transmitter. With this method, however, the observer had to be continually near the apparatus and therefore the results obtained were not so reliable as those obtained by using the first two

methods. In view of this fact, only the experiments obtained by varying the frame dimensions will be described here.

The general procedure adopted in the first method was to arrange a frame one meter in height (say) and then gradually vary the width, taking readings of the frame current for each value of the width. The experiment was repeated for frames of various heights varying from 1 to 6 meters. Fig. 6 shows some results obtained by this method, whilst Fig. 7 shows a set of curves obtained by the second method.

It is apparent from these two figures that a variation of the frame dimensions affects the frame current to a very marked degree, and that the current for a given input electromotive force can be adjusted to a maximum value by correctly proportioning the dimensions of the frame.

Some of the curves shown in these figures are very irregular and in every case where an irregularity was found, the curve had to be resolved into two or more smooth curves. This has been done for example in curve 2 of Fig. 6, and it was found that within the errors of the measurements the theory accounted for the positions of the resolved peaks.

In order to compare the dimensions of the frames with maximum currents with the dimensions predicted in the theoretical section, it was necessary to calculate the values of  $H/\lambda$  and  $W/\lambda$  for all the current peaks. This has been done and the results are shown in Fig. 8. For comparison the theoretical curves of Fig. 1 are included on the same graph, and it is apparent from this that the theoretical conditions developed in Section II account for the majority of the experimental results. It is also apparent, however, that certain experimental points (those marked  $\times$ ) are not accounted for by the theory. An explanation of these points will now be considered.

### (c) *Reflection Effects*

In the above experimental work the frame was quite close to the ground, whereas in the theoretical discussion it was assumed that the frame was well removed from the influence of all other bodies, and it is therefore necessary to consider what modification (if any) must be made to the theory given in Section II, Part 2.

If the frame be near to the ground, the waves radiated from the frame may be reflected back at the earth's surface and then possibly received again by the frame. Under these circumstances the waves reflected back to the frame will be incident at an angle  $\gamma=90$  degrees (using the nomenclature of the previous paper). Consequently the

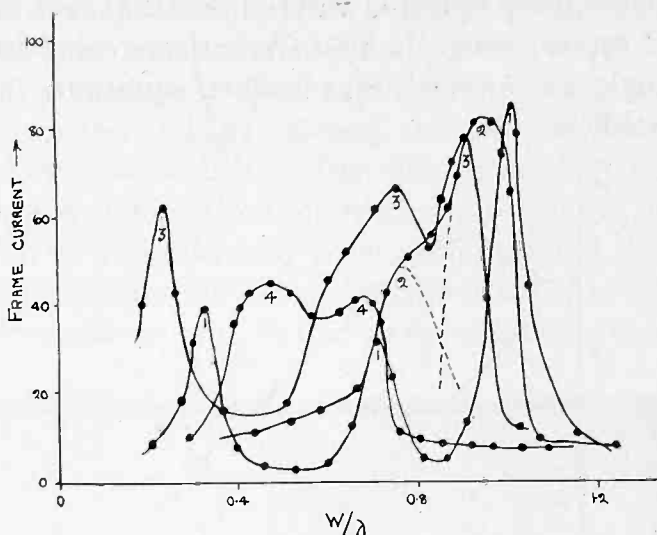

Fig. 6—Variation of the frame current with the width of the frame (height constant).

$\lambda = 5.85$  meters

For the curve marked

1.  $H/\lambda = 0.14$

2.  $H/\lambda = 0.35$

3.  $H/\lambda = 0.52$

4.  $H/\lambda = 0.72$

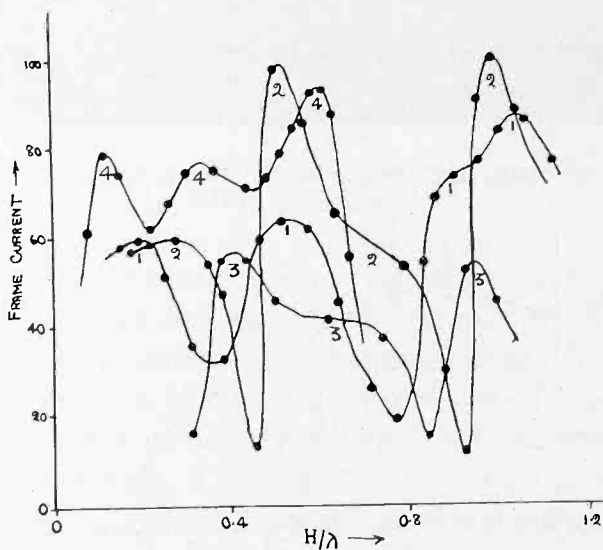

Fig. 7—Variation of the frame current with the height of the frame (width constant).

$\lambda = 5.9$  meters

For the curve marked

1.  $W/\lambda = 0.17$

2.  $W/\lambda = 0.36$

3.  $W/\lambda = 0.51$

4.  $W/\lambda = 0.83$

frame will receive these reflected waves best (that is it will be formatised for these waves) when the first fromatising conditions for reception at this angle are satisfied, that is when equations (1) with  $\gamma = 90$  degrees are satisfied.

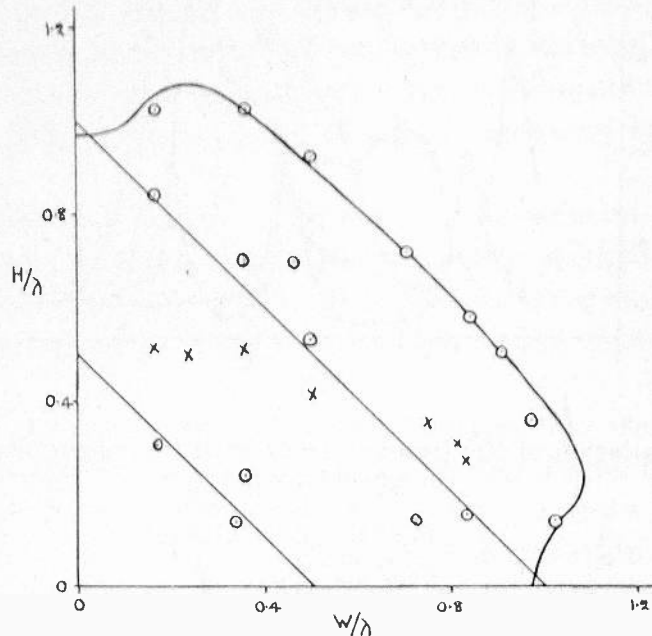

Fig. 8—Comparison of the experimental results with the theoretical curves of Fig. 1.

With this condition, equations (1) reduce to

$$\tan(a - \psi) = (a^2 - 1)/a \quad (6a)$$

and

$$\tan(2a' + \psi) = (a'^2 - 1)/a'. \quad (6b)$$

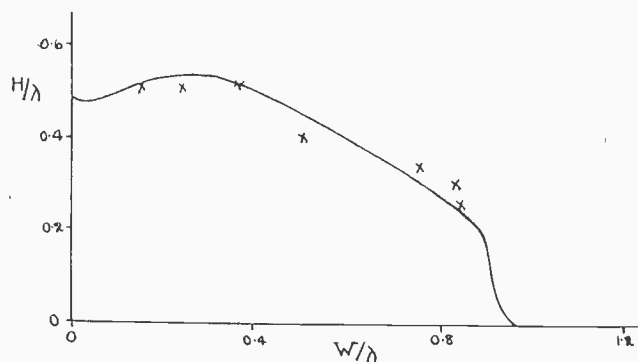

Fig. 9—Graph showing the theoretical dimensions of a frame for the reception of waves reflected from the ground.

The solutions of these equations in terms of  $H/\lambda$  and  $W/\lambda$  are shown in Fig. 9 together with the unexplained experimental points of Fig. 8, and it would seem from this graph that these experimental points are due to the effect of the reflected waves. A more conclusive

test of this, however, was obtained by carrying out some additional experiments with the use of a modified apparatus shown in Fig. 10.

The general procedure in these experiments was to use a frame of height (say) one meter and then to vary the width in exactly the same manner as in the first method.<sup>5</sup> After this experiment had been performed, the whole frame, together with the oscillator, was elevated through a given distance (usually about a meter) and the experiment repeated. This procedure was then carried out with the frame at various distances from the ground. In this way a series of current variations

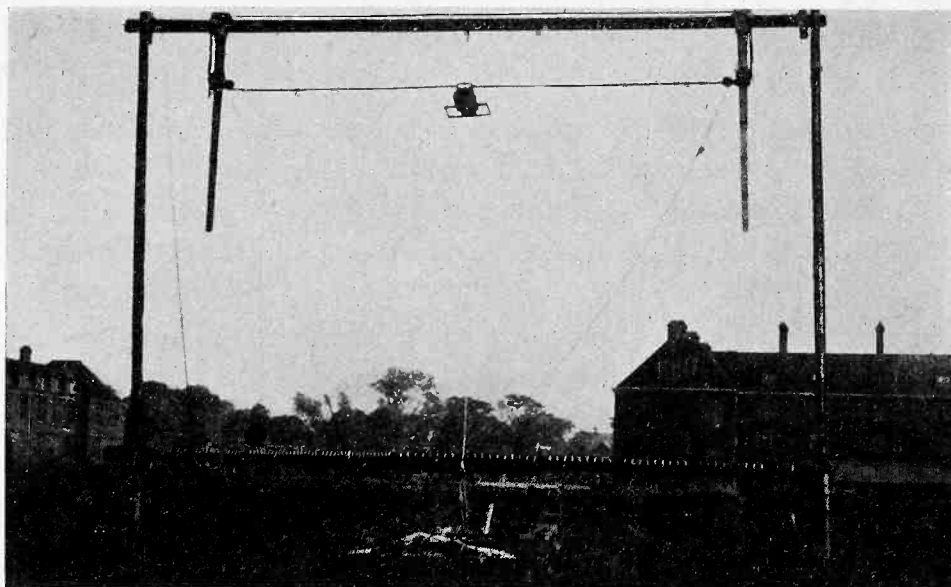

Fig. 10—View of the adjustable frame aerial used for the reflection experiments.

were obtained in which the effect of the reflected waves became of less and less consequence, whilst the normal formatising effects remained unaltered. This method enabled the current variations due to the reflected waves to be identified. In actual practice, if the frame be elevated sufficiently, the current variations due to the reflected waves may be eliminated entirely. This is shown in Fig. 11 in which the full-line curve represents the current variations when a frame (of height 3 meters) was near to the ground and the dotted curve represents the current variations when the frame was well removed from the ground. A peak at about  $W/\lambda = 0.23$  completely disappeared when the frame was elevated. On reference to Fig. 9 it will be seen that the peak in question is represented by the second cross from the left for which  $H/\lambda = 0.51$  and  $W/\lambda = 0.23$ . In a similar manner the other peaks

<sup>5</sup> Cf. *Current Measurements* on page 103.

marked by crosses in Figs. 8 and 9 were found to disappear or were reduced in value when the frame was removed from the neighborhood of the ground, whilst the peaks which remained unaffected by the elevation of the oscillator and frame were those predicted by the forming conditions. Actually it was found possible to eliminate these spurious effects entirely only when the ground was fairly dry. If the ground was moist then the current variations due to the reflected waves became more pronounced. This was evidently due to the increase in the electrical conductivity of the ground consequent upon the increase in the moisture content of the surface layers. The peaks could be artificially reproduced by drenching the ground with a hose.

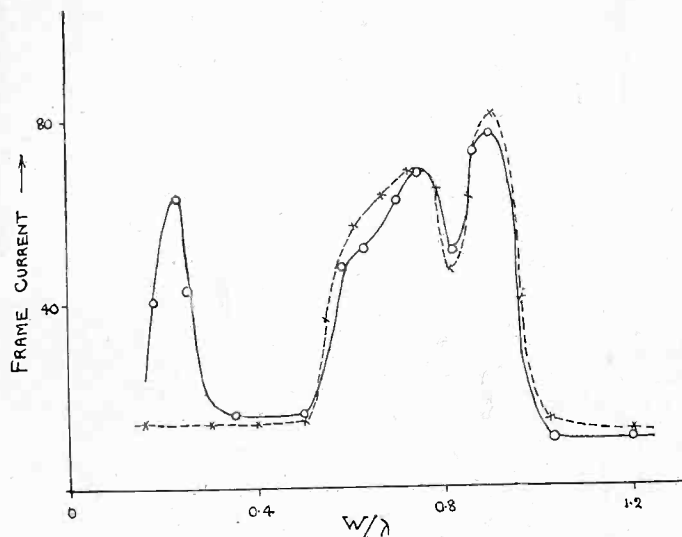

Fig. 11—Variation of the frame current with the width of the frame (height constant).

$\lambda = 5.85$  meters; height  $H = 0.51\lambda$

————— frame near to the ground.

----- frame elevated a considerable distance above the ground.

From these experiments it is concluded that the unexplained experimental points of Fig. 8 (i.e., the points marked  $\times$ ) are due to those waves which are transmitted downwards, and reflected by the ground back to the transmitting frame.

## 2. Radiation Measurements

For the purpose of testing the conditions for maximum radiation, a Hertzian dipole receiver was erected several wavelengths from the transmitting frame. Measurements were taken with the receiver in the same vertical plane as the frame. A complete description of the Hertzian dipole receiver has already been given in a previous paper.<sup>6</sup>

<sup>6</sup> *Jour. I.E.E.* (London), vol. 67, p. 1045; August, (1929).



The procedure usually adopted in these experiments was to take simultaneously readings of the frame current and the current received by the Hertzian rod as the dimensions of the frame varied. The frame current measurements have already been described, and Fig. 12 shows a set of curves obtained from observations of the Hertzian rod currents. In Fig. 13 the values of the critical frame dimensions (that is, the values of  $W/\lambda$  and  $H/\lambda$ ) for the Hertzian rod peak currents have been calculated and compared with the theoretical curves obtained in Section II. For convenience, the experimental points in Fig. 13 are lettered to correspond with the curves of Fig. 12. The chief points arising from a consideration of these figures will now be summarized and discussed.

1. There are, in general, for each value of the transmitting frame width  $W$ , two critical values of the frame height  $H$  less than one wavelength for which the radiation is a maximum. Corresponding pairs of points are marked with the same letter in Figs. 12 and 13.
2. The value of the width of the transmitting frame, for which the radiation is a maximum, decreases as the height of the frame increases, and vice versa.
3. Of the experimental points shown in Fig. 13 some of them lie approximately on the graph given by the first formatising condition, whilst the remainder of the experimental points (those marked  $\times$ ) are not accounted for by the foregoing theory. None of the experimental points lie on the graphs given by the second formatising conditions.
4. The two frames indicated by points  $F$  and  $D'$  in Figs. 12 and 13 radiate more effectively than frames of any other dimensions.

The general variations in frame dimensions indicated by points  $A$  to  $G$  are those predicted by the theory of Section II, whilst their quantitative agreement with the theory is shown by the distribution of the points along the first formatising graph of Fig. 13.

The positions of the points marked  $\times$  may be explained as follows. In subsection III, 1, (c) it was shown that, due to the effect of the reflected waves, the transmitting frame current would be large when its dimensions satisfied (1) in which  $\gamma=90$  degrees. This is also the graph upon which the unexplained points  $\times$  in Fig. 13 lie. Hence it may be concluded that the radiation from frames of these particular dimensions is due to the fact that the frame is so shaped that it was capable of receiving waves reflected from the ground and

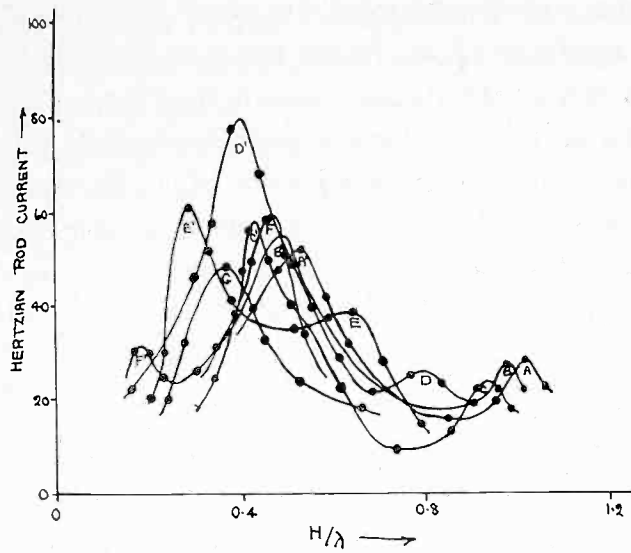

Fig. 12—Radiation measurements.

Variation of the Hertzian rod current with variation in the height of the transmitting frame of constant width.

$\lambda = 5.9$  meters

For the curve marked

- A  $W/\lambda = 0.17$
- B  $W/\lambda = 0.36$
- C  $W/\lambda = 0.497$
- D  $W/\lambda = 0.52$
- E  $W/\lambda = 0.66$
- F  $W/\lambda = 0.88$
- G  $W/\lambda = 1.04$

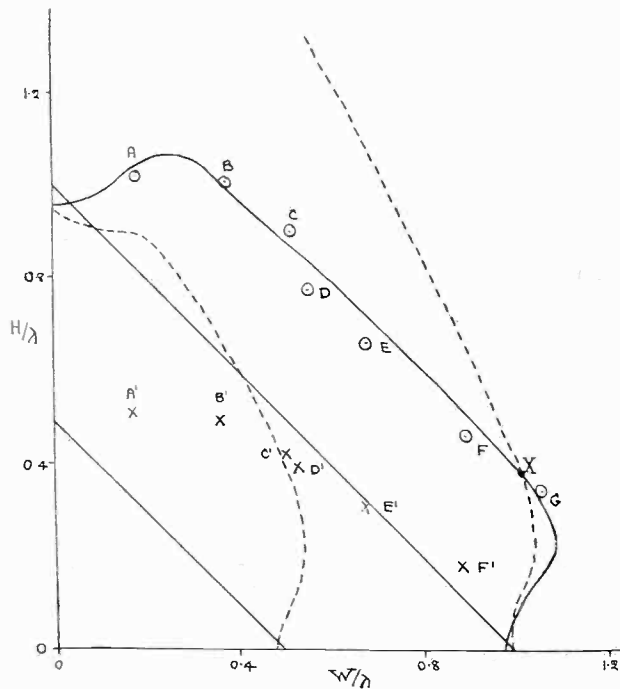

Fig. 13—Comparison of the experimental results shown in Fig. 12 with the theoretical curves of Fig. 2.

this energy was reradiated more or less efficiently to the Hertzian rod receiver. In this way, the positions of the points  $\times$  may be explained and are, in fact, a natural consequence of the points  $\times$  in Fig. 8.

The absence of points in Fig. 13 on the graphs of the second forming equation shows that there is no radiation from the frame when its dimensions satisfy these particular conditions, that is, when such free stationary waves occur round the frame, in spite of the large currents present. This point can be seen more clearly from Fig. 14 in which both the transmitting frame currents and the Hertzian rod currents

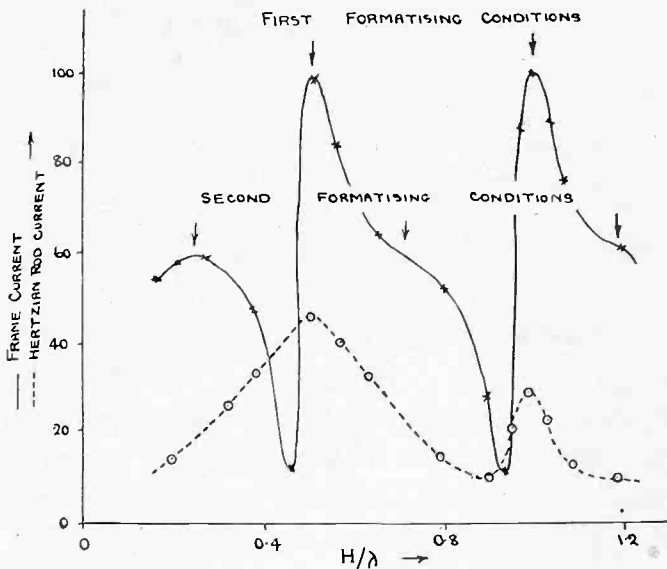

Fig. 14—Variation of the transmitting frame current and the Hertzian rod current with the height of the transmitting frame (width constant).  
 $\lambda$  5.5 meters;  $W/\lambda = 0.36$

are plotted on the same graph. This is an interesting confirmation of the conclusion on page 101 that there is no effective radiation when the length of wire is an integral number of wavelengths.

Turning now to the fourth and last of the points arising from Figs. 12 and 13, namely, the abnormal radiation from frames the dimensions of which are indicated by points  $D'$  and  $F$ ; on reference to Fig. 13 the peak  $F$  is seen to correspond to the frame, the dimensions of which approximate the theoretical dimensions of the frame indicated by the point  $X$  in Fig. 2. On page 100 it was concluded that abnormal radiation might be expected from a frame of these dimensions. This conclusion followed from the facts that the frame was so proportioned that not only would large currents circulate round it, but the currents in its vertical limbs would propagate fields which would reinforce each other at points on the earth's surface which lie in the plane of the frame. The simultaneous fulfillment of these two conditions will re-

sult in a larger radiation field than when only one of the conditions is satisfied. This is perhaps the most crucial test of the foregoing theory. Actually the point  $G$  (Fig. 13) is slightly closer to  $X$  than point  $F$ , but it is thought this discrepancy is due to the experimental errors caused by the difficulties inherent in these short-wave measurements.

Concerning the abnormal radiation from the frame indicated by the point  $D'$  in Figs. 12 and 13, it has already been shown above that for a frame of these dimensions there will be a large frame current due to the efficient reception of reflected waves for which the frame is form-

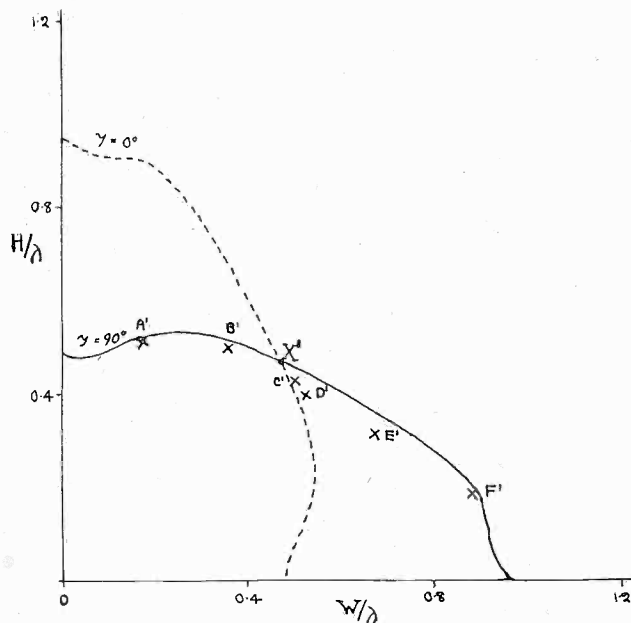

Fig. 15—Graphs showing the theoretical dimensions of a frame for the reception and reradiation of waves reflected off the ground.

alized. But these conditions, namely those given by putting  $\gamma = 90$  degrees in (1), are not necessarily the same conditions as those for effective radiation across the earth's surface. These latter conditions are given by putting  $\gamma = 0$  degrees in (1). If now the graphs of these two conditions be plotted on the same figure it will be seen that they intersect at the point  $X'$  (Fig. 15) and hence for a frame of these particular dimensions, namely  $H = W = 0.47\lambda$ , both conditions will be satisfied simultaneously and an abnormally large radiation field may be expected.

On reference to Fig. 15 it will be seen that point  $D'$  lies very close to the point  $X'$ . Hence we may explain the abnormally large radiation from the frame indicated by the point  $D'$  by realizing that it is not only formatized for the reception of reflected waves from the ground, but is also formatized for reradiation across the earth's sur-

face, and for no other of the frames under consideration are both these conditions simultaneously satisfied.

#### IV. CONCLUSIONS

The results of the foregoing investigation may be summarized as follows:

1. When an electromagnetic field is incident on a tuned rectangular frame aerial, the current produced in the frame will be a maximum when the ratios of the frame dimensions to the wavelength fulfill either of the conditions given by

$$\text{and, } \left. \begin{aligned} \tan [a(1 + \cos \gamma) - \psi] &= (a^2 - 1)/a \\ \tan [a'(1 + \sin \gamma) + \psi] &= (a'^2 - 1)/a' \end{aligned} \right\} \quad (1)$$

or,

$$a + a' = n\pi. \quad (2)$$

These have been called respectively the first and second formatising conditions for reception.

2. When the current in a tuned rectangular frame is produced by a local oscillator, then the current is a maximum (for a given input electromotive force) when the ratios of the frame dimensions to the radiated wavelength fulfill either of the conditions given by

$$\text{and, } \left. \begin{aligned} \tan (a - \psi) &= (a^2 - 1)/a \\ \tan (a' + \psi) &= (a'^2 - 1)/a' \end{aligned} \right\} \quad (5)$$

or,

$$a + a' = n\pi. \quad (2)$$

These have been called, respectively, the first and second formatising conditions for transmission.

3. Radiation will occur when the conditions given by (5) are fulfilled, but not when the conditions given by (2) are fulfilled. Furthermore, the radiation will be a maximum in a given direction when the dimensions of the frame satisfy (1) and (5) simultaneously. For the particular case of radiation along the earth's surface in the plane of the frame [ $\gamma = 0$  degrees in (1)], both equations are satisfied simultaneously only by a frame of dimensions

$$H = 0.40\lambda \text{ and } W = 1.0\lambda.$$

4. If the transmitting frame receives reflected waves from the ground there will be another set of critical dimensions, namely  $H = W = 0.47\lambda$  for which the radiation (reradiation in this case) will be a maximum.

#### ACKNOWLEDGMENT

We should like to take this opportunity of thanking Mr. R. A. Watson-Watt, Superintendent of the Slough Radio Research Station, England, for the loan of the short-wave oscillator used in this work.

We are also pleased to acknowledge gratefully much material assistance from Mr. R. Curry and Mr. Roy Witty.



## A 200-KILOCYCLE PIEZO OSCILLATOR\*

BY

E. G. LAPHAM

(Bureau of Standards, Washington, D. C.)

### ABSTRACT

The paper describes a piezo oscillator which is used to control the frequency of the standard frequency transmitter of the Bureau of Standards. The piezo-electric element is a Curie or zero-cut quartz plate having a fundamental frequency of 200 kilocycles. The mounting is a clamped type which maintains the quartz plate in a fixed position between the electrodes without introducing an excessive amount of damping.

The oscillator circuit arrangement is the conventional type in which the quartz plate is connected between the grid and filament of a UX112A tube. An untuned inductance load is connected in the plate circuit. There are two coupling amplifiers which are connected in cascade. The first is a UX222 tube which is connected to the oscillator plate impedance through a small condenser and a voltage divider arrangement. The second amplifier is a UX112A tube.

The temperature control consists of two thermostatically-controlled compartments, one within the other. The quartz plate has a double temperature control, while the oscillator and amplifier circuit arrangements are within the outer control only.

The piezo oscillator described has been in use for a year. During this time its frequency in terms of the primary frequency standard has changed only about one part in a million. The frequency is constant within a few parts in a hundred million for several hours.

\* Published in full in *Bureau of Standards Journal of Research*, vol. 11, pp. 59-64; July, (1933). Research Paper No. 576.





## PHASE SYNCHRONIZATION IN DIRECTIVE ANTENNA ARRAYS WITH PARTICULAR APPLICATION TO THE RADIO RANGE BEACON\*

By

F. G. KEAR

(Bureau of Standards, Washington, D. C.)

### ABSTRACT

In the radio range beacons located along the airways of the United States the course indication is secured by the intersection of two space patterns produced by properly excited antenna structures. In the T-L antenna system recently developed for these stations to eliminate night effect there are four towers employed to secure the desired space pattern. In order that this pattern remain fixed in space, the relations between the currents in the various structures must be maintained constant, both as to phase and magnitude, to a high degree of accuracy.

To accomplish this there has been developed an excitation system which automatically maintains this condition even during adverse conditions of antenna tuning. This synchronizing action is secured in one of two ways, first by the use of transmission lines 90 electrical degrees in length connected in parallel to the power amplifiers, and second by lines 180 degrees long connected in series.

The operation of the parallel connected lines is dependent upon the fact that the relation between sending voltage and receiving end current for a line 90 degrees in length is independent of the impedance of the load. The series connection is based upon the condition that a 180-degree line acts as a simple series circuit and consequently the current is continuous throughout the system. Both of these are dependent upon the fact that the attenuation of the line is negligible.

Tests of the system show it to perform very satisfactorily and it has been adopted as the standard method of installation on the airways.

\* Published in full in *Bureau of Standards Journal of Research*, vol. 11, pp. 123-140; July, (1933). Research Paper No. 581.



## A RADIO DIRECTION FINDER FOR USE ON AIRCRAFT\*

BY

W. S. HINMAN, JR.

(Bureau of Standards, Washington, D. C.)

### ABSTRACT

The need for an accurate marking of the principal air routes of the country has been well met by the installation of radio range beacons. Their operation over a number of years shows quite definitely that they are satisfactorily devised for guiding aircraft. The limitation, however, is that they may only be used on the particular air routes for which they were installed. The itinerant pilot cannot always use them. Thus there is the need for a direction finder operating as a radio compass with which airplane pilots may guide themselves to a point where radio range beacons are not available.

A new type of radio direction finder is described which operates with a single small loop antenna, no vertical antenna being necessary. Bilateral indication of the "course," together with directive sense, is automatically given by a pointer instrument. The direction finder may be added as a unit to any radio receiver, and operates equally well on modulated or unmodulated waves. The indicator is of the usual zero-center type, and the course sharpness is readily controllable. When "on-course" indications are received the signals are quite intelligible, allowing reception of voice while the direction finder is operating. An audio tone of increasing intensity is heard as the loop antenna is turned away from the "on-course" position. The "course" is not distorted at any volume level.

The direction finder depends for its operation upon the production of two modified figure-of-eight field patterns from one loop antenna. For a given position of the loop antenna, the course indicator is made to deflect to the right in proportion to one field pattern and to the left in proportion to the other field pattern. Since these two field patterns approach a cardioid in form, one the reverse of the other, the two points of equal signal, or "course," are at 90 degrees to the plane of the loop antenna.

The two field patterns are produced by grounding the ends of the loop antenna through two rectifiers which pass current alternately. When one rectifier passes current, its resistance is low and the loop is effectively grounded at that end. Equal alternating voltages, opposite in phase, operate the rectifiers so that when one rectifier passes current, the other is cut off, and vice versa. Grounding the loop antenna at one end produces dissymmetry in the loop antenna circuit, and vertical antenna effect is thereby introduced which modifies the normal figure-of-eight field pattern into an approach to a cardioid type of pattern. While current due to the vertical effect is not accurately phased with the loop antenna current, this vertical effect is made partially aperiodic by the resistance of the rectifiers. Partial phasing is sufficient for proper operation.

The rectifier tubes used for grounding the antenna are also used to operate the zero-center course indicator. The currents of the two rectifier tubes due to the alternating voltages impressed on them, pass through the course indicator in opposite directions, and since they are equal, they cancel. The audio output of

\* Published in full in *Bureau of Standards Journal of Research*, December, (1933). Research Paper No. 621.

the direction finder is also applied to these rectifier tubes, and is proportional to the field pattern for a given position of the loop antenna with respect to the incoming radio wave. Since when one rectifier passes current the audio output voltage is proportional to the field pattern for that condition, and when the other rectifier passes current the audio output is proportional to the other field pattern, the current deflecting the course indicator right or left is equal to the difference in the currents due to the two output voltages, or is proportional to the difference of the field patterns.

Two courses are given by the direction finder, but directive sense is assured by the reversal of the action of the course indicator on one course with respect to the other.

On flight tests of the direction finder in which it was used as a homing device, the accuracy was of the order of one degree, and positive localizing action was given by the reversal of the course indicator on passing over the transmitter. Broadcast stations were used for these tests, indications being very constant under all conditions. Data are given on triangulation work with the direction finder, as well as a graph showing the direction shift introduced by the airplane structure.



## A METHOD OF PROVIDING COURSE AND QUADRANT IDENTIFICATION WITH THE RADIO RANGE BEACON SYSTEM\*

BY

F. W. DUNMORE

(Bureau of Standards, Washington, D. C.)

### ABSTRACT

Certain circumstances may arise, especially when near the radio beacon, when an airplane pilot may pass from one course or quadrant to another without his knowledge of it. When once so lost he may wander many miles in an attempt to reorient himself, since the four courses are all practically identical and two of the four quadrants between the courses give identical indications. A method has been developed which obviates this difficulty. It consists of transmitting a directive signal composed of one dot in a westerly direction, a similar signal of two dots in an easterly direction, three dots north, and four dots south; depending upon which set of these signals is the loudest, a pilot may determine his general direction from the beacon. Methods have been devised for transmitting these signals with practically no interruption to the visual beacon signals and during the station identification interruption of the aural beacon.

The change from the figure-of-eight transmission for the courses to the unidirectional cardioid transmission may be accomplished either by changing the point of coupling into suitable phasing sections in the transmission line feeding the antenna or by superimposing on a figure-of-eight radiation through a suitable hybrid coil two inphase radiations 90 degrees out of phase with the figure-of-eight radiations. Standard relays operated by a motor-driven dot-sending device serve to make these changes. In the latter method a simple reversing relay serves to reverse the direction of transmission of the cardioid signals from a given set of antennas.

These identification signals may be easily applied to existing radio range-beacon stations of either the aural or visual type with the T-L antenna system, as the only additions necessary are phasing sections and relays in the transmission line circuit inside the beacon station.

In the case of the visual beacon system, the double-modulation course signals are interrupted only for the period of each quick dot of the identification signal. This interruption is so short that the reeds in the reed indicator do not have time to drop except to about two thirds their normal amplitude and as they are equally damped the course indications do not change during this instant of decreased amplitude. It requires about ten seconds to send a series of identification signals twice and they need be sent only once every three minutes.

\* Published in full in *Bureau of Standards Journal of Research*, Vol. 11, No 3; September, (1933). Research Paper No. 593.



## PERFORMANCE TESTS OF RADIO SYSTEM OF LANDING AIDS\*

By

H. DIAMOND

(Bureau of Standards, Washington, D. C.)

### ABSTRACT

Tests and demonstrations carried on at the Newark Municipal Airport, Newark, N. J., during March and April, 1933, indicated the complete practicality of the Bureau of Standards radio landing system developed to assist airplanes in making safe landings under conditions of zero visibility. The work on this system was conducted by the Research Division, Aeronautics Branch, Department of Commerce, organized at the Bureau of Standards. The system employs three elements, a runway beacon, marker beacons, and a landing beam, to provide continuous and accurate information on the position of the airplane in three dimensions as it approaches and reaches the instant of landing. The first stage of development of the system has been previously described.<sup>1</sup> The present paper gives details of the final stage of the development work which comprised the engineering redesign of the system to meet the requirements of practical use.

The runway beacon gives indications of the directional position of the aircraft with respect to the airport and permits keeping the aircraft directed to and over the desired landing runway. A 200-watt transmitting set of the visual beacon type, operating on 278 kilocycles, and feeding small, multiturn loop transmitting antennas, is employed. At the Newark airport the wind, under conditions of low visibility, is usually from the northeasterly quadrant. The runway beacon accordingly is located at the northeast end of the field. With the aid of a goniometer to swing the course anywhere between the two hangar lines, it is possible to accommodate practically all wind conditions during low visibility. On the aircraft, the same receiving set used by air transport operators for the reception of radio range beacon signals and airways weather broadcasts is employed for receiving the runway beacon signals. This set is augmented by an automatic volume-control unit and by a reed converter to convert the beacon signals to pointer type course indications, given by the vertical pointer of a combined instrument. A vertical index line across the face of the combined instrument represents the desired landing runway while the position of the pointer corresponds to the relative position of the aircraft with respect to the runway.

Longitudinal position of the aircraft as it approaches the airport is given by the combination of a distance indicator on the aircraft with the aural signals received from two marker beacons. The distance indicator, operating from the beacon receiver, reads field intensity of the runway beacon and may be calibrated approximately in miles from the beacon (say, 0 to 5 miles). Absolute indication of the longitudinal position of the aircraft when near the airport is given by aural signals from two 5-watt, marker beacon transmitters. One signal, a high pitched

\* Published in full in *Bureau of Standards Journal of Research*, October, (1933). Research Paper No. 602.

<sup>1</sup> *Bureau of Standards Journal of Research*, October, (1930), (RP238); *Proc. I.R.E.*, vol. 19, p. 585; April, (1931).

note, is heard, when within 2000 feet of the southwest end of the airport. The second signal, a low pitched note, is received when over the field boundary. The marker beacon transmitting antennas, two to six feet high, are stretched transversely across the line of flight of the aircraft, to provide signals for all orientations of the runway beacon course.

Vertical guidance is given by a horizontally polarized ultra-high-frequency landing beam (90,800 kilocycles). The landing beam transmitter feeds a directive transmitting antenna array which gives the necessary directivity of beam in the vertical plane while spreading the beam out in the horizontal plane to afford service in the 40-degree sector. On the aircraft, a simple ultra-high-frequency receiver is used, fed by a transmission line from a horizontal half-wave receiving antenna which is located in the wing slightly ahead of the leading edge. The rectified output from this set operates the horizontal pointer of the combined instrument. The receiver sensitivity is so adjusted that the line of constant received signal below the inclined axis of the beam, corresponding to half-scale deflection of the horizontal pointer, marks out a landing path which is suitable for the aircraft and airport considered. The horizontal index line across the face of the combined instrument represents the half-scale deflection and corresponds to the proper landing path. The horizontal pointer represents the position of the aircraft relative to this path.

The vertical and horizontal index lines of the combined instrument intersect in the center of the instrument dial. The point of intersection, indicated by a small circle, represents the proper spatial landing path. The point of intersection of the horizontal and vertical pointers of the combined instrument represents the position of the aircraft relative to the desired landing runway and the proper landing path. The course indications are therefore instinctive and deviations from both courses may be corrected simultaneously. By keeping the pointers crossed over the small circle on the instrument face, a suitable spatial landing path is followed down to the point of landing. The system requires a minimum of manipulation on the part of the pilot. Once the beacon receiver is tuned to the frequency of the runway beacon, no further adjustments of tuning or sensitivity of any of the receiving equipment is required.

The demonstrations at Newark were preceded by an extensive series of tests at College Park, Md., where the practicability of the system was studied through the medium of flights and landings in an airplane equipped with a canvas hood over the pilot's cockpit. Over a hundred hooded landings were made during these tests. A check pilot was used in the front cockpit to take care of faulty landings or other emergencies. The installation at Newark was then made to determine the operation of the system under the conditions obtaining at a commercial airport. During the two months of tests, besides making a large number of hooded landings, it was possible to fly at all times when the scheduled air mail and passenger airplanes were on the ground because of fog. The operation of the system was demonstrated in the air to many engineers and officials as well as to nearly one hundred air transport pilots. Perhaps the most striking demonstration was a completely blind flight from College Park, Md., to the Newark Airport on March 20, during which radio was the sole means used for navigation and for landing.

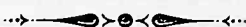

## BOOK REVIEWS

**Electron Tubes and Their Applications**, by John H. Morecroft, Columbia University. Published by John Wiley & Sons, Inc., New York, 458 pages. Price \$4.50.

The scope of Professor Morecroft's new book is suggested by the title. Nearly half of it is given to the consideration of thermal and photo-electric emission and of the more fundamental phenomena occurring in vacuum and gas-filled tubes. Subsequent chapters deal with various uses of "valves" or two-electrode devices and with a rather full study of the triode and its different functions. The final chapters deal with special uses of tubes and other electron devices.

Because of the separation of the discussions on tubes and on applications, information on specific subjects is at times scattered throughout the book. References are given in footnotes. In view of the scope of the book and the briefness of many of the discussions, the inclusion of a bibliography would have been of material assistance to the student. Various topics of considerable interest, such as pentodes and screen-grid tubes are either only mentioned or treated in brief fashion. The book is stimulating, particularly for the nonmathematical reader, as it brings together considerable general information. Comparatively little mathematical treatment is given; the book has many excellent diagrams and other illustrations.

The book is not as free from inaccuracies and questionable statements, such as the three ton anode discussed on page 84 and the discussion on thermionic emission from coated filaments, as it might be.

\*B. E. SHACKELFORD

**Sub-Harmonics in Forced Oscillations in Dissipative Systems**, by P. O. Pedersen Ingeniorvidenskabelige Skrifter Series A No. 35. Published by Danmarks Naturvidens Kabelige Sanfund, Copenhagen, Denmark, 1933, pp. 86. Price 8.00 Kr.

The paper opens with a statement covering the observation of sub-harmonics in a loud-speaker, the second sub-harmonic (a tone of one half the driving frequency) being present for a number of frequencies between 490 and 1800 cycles. The sub-harmonic tone did not appear unless the driving voltage exceeded a critical or threshold value. In some cases the fourth sub-harmonic was observed.

The author then gives a concise review of the literature, finding that the question of sub-harmonics has not been taken up, except in those cases where the systems contained sources of energy, arranged to act as oscillators with the frequency of the sub-harmonic. In such cases, the impressed voltage acts to control the low-frequency generator. This group of circuits, termed variously as relaxation oscillators, multivibrators, submultiple generators and frequency-dividing oscillators is now well-known and widely utilized. The paper deals with the production of sub-harmonics in systems which are not oscillators or generators.

\* RCA Radiotron Company, Inc., Harrison, New Jersey.



Quoting from the paper: "Most authors pass over this question in silence as they take it for granted that the occurrence of sub-harmonics is an impossibility. An interesting example will be found in an instruction book issued by a leading firm abroad from which the following is a quotation: 'It is common knowledge that sub-harmonics do not exist'."

In attempting the approximate solution of the equations of motion of a system, to indicate the possibility of the production of sub-harmonics, the author finds that Rayleigh's solution fails to produce a usable approximation. He then points out that similar objections apply to the results obtained by Helmholtz and Schafer; Duffing takes it for granted that sub-harmonics cannot appear, while Rudenberg openly denies the existence of sub-harmonics.

The author then turns to an analysis of mechanical or electrical systems of a finite number of degrees of freedom, considering *only* the forced oscillations, in an effort to determine the conditions under which sub-harmonics are produced. Several cases are considered, in which the system parameters, or the driving force, or both, are considered as dependent on displacement. In a system tuned to the sub-harmonic frequency (one half the driving frequency) it is shown that if one of the circuit parameters, or the driving force, is linearly dependent on displacement, the sub-harmonic may be produced, provided the driving force be sufficiently great.

Having proved the possibility of the occurrence of sub-harmonics under particular conditions, the author proceeds to an experimental verification of the theoretical conclusions. A tuned mechanical system is described in which the driving force is linearly dependent on displacement. It was found that the second sub-harmonic could be produced, provided the driving force were sufficiently large. A modification of this system, in which the damping was made dependent on displacement, gave qualitative confirmation of the theory, the second sub-harmonic being brought out when the driving force was sufficiently large.

Turning to electrical systems, it was found that a tuning fork driven by a telephone receiver (without diaphragm) would oscillate strongly when the receiver was excited by a tube generator having a frequency equal to twice the fork frequency. It is essential that the driving voltage be sufficiently great.

Vacuum tube circuits, tuned to one half the frequency of the driving voltage, may be caused to oscillate at this sub-harmonic frequency when the tube functions as a variable capacitance, or as a modulator of the driving voltage. In both cases an analysis is given indicating very satisfactory agreement with the theory.

Some further theoretical consideration is given to the question of points of stable and unstable equilibrium, and some general considerations regarding the occurrence of sub-harmonics are given. Attention is also given to sub-harmonics in two coupled circuits with variable capacity (stiffness).

In conclusion, it is stated that while in systems with but one degree of freedom *only* second sub-harmonics can occur, in systems with two degrees of freedom a fourth sub-harmonic *may* occur under certain conditions. The fourth sub-harmonic cannot be brought out by itself; a second sub-harmonic must always first be present. While the fourth sub-harmonic has been observed in loudspeakers, this has only occurred under extremely critical conditions.

\*J. K. CLAPP

**The Inductance Authority**, by Edward M. Sheipe. Published by Herman Bernard, 135 Liberty Street, New York. Price \$2.00. Looseleaf binder, paper cover, 50 pages, 9-1/2 × 12 inches.

This volume is a useful compilation of thirty-eight full-page inductance charts for close-wound single-layer coils of various wire sizes and insulations. Each chart is drawn for a given wire size, in terms of inductance (abscissas), number of turns (ordinates), and coil diameter (parameter). The length of the coil is not indicated. The charts are less useful for space-wound coils of even pitch. They are of odd size and do not fit in 8-1/2 × 11 inches looseleaf notebooks. There are twelve pages of related information and directions.

\* HAROLD A. WHEELER

**Handbook of Chemistry and Physics (Eighteenth Edition)**, Chemical Rubber Publishing Co., Cleveland, Ohio, 1818 pages, 4 1/4 inches x 6 1/2 inches. Price \$6.00.

*The Handbook of Chemistry and Physics* is a compilation of mathematical formulas and tables and of chemical and physical constants and laws. It is the purpose of the authors to include material on all branches of chemistry and physics and closely allied sciences which would be likely to find extended use. The edition of 1933 differs from that of 1932 by about 100 pages. Among the new tables included are a table giving the speed of photographic plates and films, and a table of transmission of colored glasses. Much of the data in previous editions has been corrected and brought up to date. The table giving the characteristics of thermionic vacuum tubes consists of twelve pages. This includes receiving tubes, transmitting tubes and commercial tubes; in fact, practically all tubes in use up to date of going to press, in July, 1933.

†R. R. RAMSEY

\* Hazeltine Corporation, Bayside, L. I., New York.

† Indiana University, Bloomington, Indiana.



**BOOKLETS, CATALOGS, AND PAMPHLETS RECEIVED**

Copies of the publications listed on this page may be obtained gratis by addressing the manufacturer or publisher.

Three bulletins in English have been issued by the Laboratorium Manfred von Ardenne of Berlin, Lichterfelde-Ost, Jungfernstieg 19. They cover electrostatic microphones for transmitting and measuring purposes, accessory photographic apparatus for the registration of oscillograms, and a highly sensitive two-stage valve voltmeter operated from alternating current.

Premier Crystal Laboratories, Inc., of 53 Park Row, New York City, in their Bulletin No. 100 discuss a new technic for rapid inductance and capacity measurements. Constant frequency control equipment is discussed in another leaflet issued by that organization.

The E. F. Johnson Company of Waseca, Minn., have issued a leaflet describing their transmitting equipment.

"Uniform Cost Activities in Trade and Industry" is the title of a booklet issued by the Policy Holder Service Bureau of the Metropolitan Life Insurance Company, 1 Madison Avenue, New York City.

General Plastics, Inc. of North Tonawanda, N. Y. have issued a booklet on "Case Histories in Product Design."

Westinghouse miniature panel instruments are covered in catalog Section 43-340 which is obtainable from that organization at 30 Rockefeller Plaza, New York City.

The Acheson Oildag Company of Port Huron, Mich., has available for distribution technical bulletin R113, dealing with "The Importance of Colloidal-Graphited Lubricants in Running-In Operations."

"Elastic Stop" is the name of a technical data booklet on the use of elastic stop nuts manufactured by the Elastic Stop Division of the A.G.A. Company of Elizabeth, N. J.

Transformers for audio- and power-frequency purposes used in radio transmitters and receivers are covered in bulletin U1000A issued by the United Transformer Corporation of 264 Canal Street, New York City.

Hygrade Sylvania Corporation of Emporium, Pa., has issued a leaflet giving average characteristics of their radio tubes and a tube base chart showing connections of the elements of tubes to the terminals. They have also compiled a booklet of miscellaneous information on the servicing of broadcast receivers under the title of "Service Hints."

The International Resistance Company of 2100 Arch Street, Philadelphia, Pa., describes a new volt-ohmmeter recently placed on the market.

A thermo regulator and a mechanical relay for controlling heating loads up to 1000 watts and other purposes is described in bulletin 932 of the American Instrument Company of 774 Girard Street, N.W., Washington, D. C.

Technical data on Raytheon tubes are given in a leaflet published by that organization which may be addressed at 30 East 42nd Street, New York City.

Modern circuit selector switches and their radio application is an engineering report on that subject issued by the Yaxley Manufacturing Company Division of P. R. Mallory and Company of Indianapolis, Ind.

## RADIO ABSTRACTS AND REFERENCES

THIS is prepared monthly by the Bureau of Standards,\* and is intended to cover the more important papers of interest to the professional radio engineer which have recently appeared in periodicals, books, etc. The number at the left of each reference classifies the reference by subject, in accordance with the "Classification of Radio Subjects: An Extension of the Dewey Decimal System," Bureau of Standards Circular No. 385, obtainable from the Superintendent of Documents, Government Printing Office, Washington, D. C., for 10 cents a copy. The classification also appeared in full on pp. 1433-1456 of the August, 1930, issue of the PROCEEDINGS of the Institute of Radio Engineers.

The articles listed are not obtainable from the Government or the Institute of Radio Engineers, except when publications thereof. The various periodicals can be secured from their publishers and can be consulted at large public libraries.

### R000. RADIO (GENERAL)

R007 J. W. Wright. Some aspects of radio law. *PROC. I.R.E.*, vol. 21, pp. 1574-1585; November, (1933).

R007.9 K. B. Warner. The American Regional Conference. *QST*, vol. 17, pp. 19-46; November, (1933).

An account of the radio conference held in Mexico City, July 10-August 9 with particular emphasis on the status of the amateur operators.

### R100. RADIO PRINCIPLES

R111 R. R. Ramsey. Radiation and induction. *PROC. I.R.E.*, vol. 21, pp. 1586-1589; November, (1933).

R113 C. R. Englund. Ultra-short-wave transmission. *Bell. Lab. Record*, vol. 12, pp. 66-71; November, (1933).

Experiments conducted by the Bell Laboratories to determine the transmission characteristics of the 3-5 meter band are described. Phenomena of air refraction and radiation diffraction are used to explain reception after passing grazing incidence.

R113.5 The Polar Year—Solution of two radio problems obtained—Influence of sunspots. *Electrician* (London), vol. 111, p. 553; November 3, (1933).

Prof. Appleton presents a summary of results obtained by the British Radio Expedition to the Arctic Circle carried out under the auspices of the Department of Scientific and Industrial Research as part of the International Polar Year program.

R113.61 H. E. Hollmann and K. Kreielsheimer. Selbststatige Registrierung der Heaviside-schicht. (Automatic recording of the Heaviside layer.) *Elek. Nach. Tech.*, vol. 10, pp. 392-396; October, (1933).

A Braun tube employing a linear time axis is used for continuous automatic recording of the heights of the reflecting layers. The apparatus described was established in Norway for the International Polar Year work. A record strip for a period of ten hours, which is of interest, is shown.

R113.61 E. V. Appleton. On two methods of ionospheric investigation. *Proc. Phys. Soc.* (London), vol. 45, pp. 673-688; September, (1933).

Two radio methods of measuring upper-atmospheric ionization, both of which involve measurements of the equivalent height of reflection for a number of electric

\* This list compiled principally by Miss E. M. Zandonini and Mr. E. G. Lapham.

wave frequencies are discussed. The desirability of equipment which will give an automatic registration of equivalent height as a function of frequency is pointed out.

- R113.63 G. W. O. Howe. The tilt of radio waves and their penetration into the earth (editorial). *Wireless Engineer & Experimental Wireless* (London), vol. 10, pp. 387-391; November, (1933).

Telephone transmission formulas are applied to the problem of propagation of electromagnetic waves over the surface of the earth and results are obtained which agree with those obtained from the analysis based on Maxwell's electromagnetic equations. It is pointed out that the method may prove of value in calculation of the variation with depth of the conductivity and permittivity of the soil.

- R114 E. T. Burton and E. M. Boardman. Audio-frequency atmospheric. *Proc. I.R.E.*, vol. 21, pp. 1476-1494; October, (1933). *Bell Sys. Tech. Jour.*, vol. 12, pp. 498-516; October, (1933).

Musical and nonmusical atmospheric occurring within the frequency range lying between 150 and 4000 cycles have been studied. Attention is directed to two types of the former, one a short damped oscillation, apparently a multiple reflection phenomenon, and the other a varying tone of comparatively long duration. Dependence of atmospheric variations on diurnal, seasonal and meteorological effects is discussed. Characteristics of audio-frequency atmospheric are shown in oscillograms and graphs.

- R130 F. B. Llewellyn. Vacuum tube electronics at ultra-high frequencies. *Proc. I.R.E.*, vol. 21, pp. 1532-1573; November, (1933).

- R133 Production and utilization of microrays. *Electrical Eng.*, vol. 52, pp. 739-740; November, (1933).  
×R355.5

Some facts concerning the methods of producing oscillations of ultra-high frequencies (20 cms) are given.

- R133 K. Okabe. On the production of ultra-short-wave oscillations with cold-cathode discharge tubes. *Proc. I.R.E.*, vol. 21, pp. 1593-1598; November, (1933).

- R140 W. B. Kouwenhoven and M. W. Pullen. A new method of calculating circuits. *Electrical Eng.*, vol. 52, pp. 776-779; November, (1933).

A "short circuit current solution" for calculating the currents and voltages in an electrical network has recently been discovered. It is applicable to both direct- and alternating-current circuits, and reduces the labor of calculations considerably.

- R143 L. B. Hallman, Jr. A note on the simple two-element low-pass filter of two and three sections. *Proc. I.R.E.*, vol. 21, pp. 1603-1608; November, (1933).

- R161 E. Messing. Notes on dual-band receiver design. *Electronics*, vol. 6, pp. 300-301; November, (1933).

The problems to be considered in the design of dual-band receiving sets for the bands 1500-540 and 340-140 kilocycles are discussed.

- R191 K. Heegner. Über den Kristalloszillator nach Pierce. (On a crystal oscillator by Pierce.) *Elek. Nach. Tech.*, vol. 9, pp. 357-371; September, (1933).

A discussion of a theory of the operation of the quartz plate oscillator circuit arrangement developed by Pierce.

## R200. RADIO MEASUREMENTS AND STANDARDIZATION

- R214 R. Bechmann. Über neue temperaturgeregelte Quarz-oszillatoren. (On new temperature-controlled quartz oscillators.) *Elek. Nach. Tech.*, vol. 9, pp. 371-376; September, (1933).

A description is given of a temperature-controlled quartz plate oscillator whose frequency is said not to be affected by the capacity of the exciting electrodes or the circuit. The mounting of the quartz plate which is clamped in position, is also described in detail.

- R230 C. L. Fortescue. The measurement of very small inductances. *Jour. Sci. Instr.* (London), vol. 10, pp. 301-305; October, (1933).

A method of measuring inductances of the order of 0.1 microhenry at 25,000 kilocycles with an inaccuracy not exceeding  $\frac{1}{2}$  per cent in spite of the presence of resistances as high as 4 or 5 ohms, is described.

- R230 A study of Litz wire coils for intermediate- and radio-frequency  
×R382 transformers. *Electronics*, vol. 6, pp. 303; November, (1933).

Results of a study made to determine the most suitable sizes of Litz wire coils for intermediate- and radio-frequency transformers are given. The frequencies at which the measurements on the Litz wire coils were made are: 175, 260, 450, 550, 1000, and 1500 kilocycles.

- R230 T. Slonczewski. Measuring inductance with a resistor. *Bell Lab. Record*, vol. 12, pp. 77-80; November, (1933).

A method is described of measuring inductance by comparison with a standard resistance rather than the usual method of comparing with a standard inductance.

- R240 A. T. Starr. Modifications in the new impedance measuring set. *Wireless Engineer & Experimental Wireless* (London), vol. 10, pp. 609-610; November, (1933).

This paper gives wiring diagrams of two impedance measuring sets. A set is also described for use at very high frequencies.

- R290 F. Klutke. Der Blindwiderstand von Rundfunk-Empfangs-antennen und sein Einfluss auf die Funktion von Saug- und Sperrkreisen. (The reactance of broadcast receiving antennas and its influence on shunt and resonance circuits.) *Hochfrequenz. und Elektroakustik*, vol. 42, pp. 99-105; September, (1933).

Qualitative conceptions of the reactance of antenna-ground systems are evolved. Measurements of the reactance of this antenna-ground system were carried out at 545 and 1250 kilocycles.

### R300. RADIO APPARATUS AND EQUIPMENT

- R325.31 D. Belcher. Radio acoustic ranging. *Electronics*, vol. 6, pp. 308-309;  
×R617 November, (1933).

Description of the work done by the Coast & Geodetic Survey on radio acoustic ranging is given. In this system the ship's location is determined by the time required for the sound from a bomb released near the ship to travel through the water to three separate points. The time of arrival of the sound at these points is determined at the ship by a radio signal which the arrival of the sound causes to be sent out.

- R330 H. E. Hollmann. Der Empfang ultrakurzer Wellen mit dem Bremsaudion. (The reception of ultra-short waves with the Bremsaudion.)  
×R361 *Hochfrequenz. und Elektroakustik*, vol. 42, pp. 89-99; September, (1933).

A new type of vacuum tube, the "Bremsaudion" for the reception of decimeter waves is described, and a special type of circuit arrangement for use with this vacuum tube is given.

- R330 J. L. Reinartz. Putting the type 800 transmitting tube to work.  
×R355.7 *QST*, vol. 17, pp. 27-30; November, (1933).

The uses of this vacuum tube in radio frequency and class-B audio-frequency amplifiers are given.

- R330 A. D. Muldoon. Speech-amplifier economy with a 2A5. *QST*, vol.  
×R363.2 17, p. 18; November, (1933).

It is demonstrated how the 2A5 vacuum tube can be used to simplify the audio-frequency system preceding the class-B modulator.

- R330 J. van Linden. Technical data and characteristics on eleven new tubes. *Radio News*, vol. 15, pp. 334-335; December, (1933).  
The types of vacuum tubes described are: the duplex-diode-triodes (-55, -85, -75, -2A6), the multipurpose output tubes (-59, -89), the twin class B amplifiers (-79, -19), the pentodes (-77, -78, -57), and the tetrode (-48).
- R339 W. E. Kock. The effect of inductance on the intermittent glow discharge. *Physics*, vol. 4, pp. 359-361; October, (1933).  
×R355.9 The insertion of an inductance in the condenser arm of an intermittent glow discharge circuit was found to affect the characteristics of the oscillations. For alternating-current bridge measurements and other experiments where harmonics in the voltage wave are objectionable, the inductive glow discharge tube oscillator offers a convenient and simple sine wave generator of practically constant frequency.
- R355.5 G. Grammar. A simplified five-meter exciter unit. *QST*, vol. 17, pp. 10-14; November, (1933).  
Description of the 5-band exciter unit covering the amateur frequencies.
- R361.2 McMurdo Silver. The newest design in all-wave superheterodyne receivers. *Radio-Craft*, vol. 5, pp. 276-277; November; pp. 346, 362, December, (1933).  
The constructional details are given for an all-wave superheterodyne receiving set developed by the author.
- R361.2 H. J. Benner. Progress in automotive radio design. *Radio Eng.*, vol. 13, pp. 8-9; October, (1933).  
The various circuit arrangements used in the superheterodyne receiving sets designed for automobile installation are given and merits discussed.
- R362.2 R. Hilferty. A new regenerative detector circuit for ultra-short waves. *QST*, vol. 17, pp. 15-17; November, (1933).  
Description of a stable regenerative detector circuit arrangement that is peculiarly adapted to ultra-high-frequency operation.
- R363.2 D. R. Freeling. A wired-radio public address system. *Radio-Craft*,  
×R590 vol. 5, pp. 272-273; November, (1933).  
An entirely new system of public address operation is described using the electric light wiring of a building to convey the address to radio receivers located anywhere in the building.
- R365.2 W. G. Ellis. New electrophones for high-fidelity sound reproduction. *Radio Eng.*, vol. 13, pp. 18-19; October, (1933).  
A summary of recent developments in the design of piezo-electric loud speakers.
- R365.2 P. Hermardinquer. The new "resonator" loudspeaker. *Radio-Craft*,  
vol. 5, p. 269; November, (1933).  
"The author describes the use of a system of tubes, resonant at one or more points in the audio scale, for reënforcing the output of a dynamic reproducer."
- R382 E. M. Shiepe. The inductance authority (book). Published by H.  
×R051 Bernard, 135 Liberty St., New York, N. Y. 1933. Price \$2.00.  
Graph sheets are given with curves for single-layer coils of diameters between  $\frac{1}{4}$  and 3 inches for wire between No. 14 and No. 32 B. & S. gauge and for all insulations. The text shows by examples how coils with spaced windings may be designed by means of the curve sheets.
- R382.1 A. Crossley. Iron core intermediate-frequency transformers. *Electronics*, vol. 6, pp. 298-299; November, (1933).  
Certain phases of the application of the special iron developed by Polydoroff to intermediate-frequency transformer design, are described. Data on the relative merits of air core and iron core transformers as to gain and selectivity are given.
- R384 H. Ataka. Superregenerative wave meter for ultra-short waves.  
×R211.1 Proc. I.R.E., vol. 21, pp. 1590-1592; November, (1933).
- R385.5 A. Barbieri. The velocity microphone. *Radio Eng.*, vol. 13, pp. 14-16; October, (1933).  
Theory and construction of a velocity microphone.



- R386 J. J. Lamb. Developments in crystal filters for SS superhets. *QST*, vol. 17, pp. 21-24; November, (1933).  
Description of the operation of crystal filters for single-signal superheterodyne receiving sets.
- R388 M. von Ardenne. A new high efficiency cathode ray tube—Applications as a projecting oscillograph. *Wireless Engineer & Experimental Wireless* (London), vol. 10, pp. 592-595; November, (1933).  
×621.374.7 A new cathode ray tube is described which has a brighter spot so that the projection of fluorescent-screen pictures for television purposes and lecture demonstrations are made possible.

## R500. APPLICATIONS OF RADIO

- R520 N. F. S. Hecht and H. L. Crowther. Civil aviation signal services—Considerations affecting the choice of wavelength. *Wireless Engineer & Experimental Wireless* (London), vol. 10, pp. 596-605; November, (1933).  
The present paper has for its object the determining of a scale of frequencies which are applicable to the particular technique of civil aviation services. Practical considerations, technical requirements, and peculiar limitations are given.
- R526.1 E. Kramar. A new field of application for ultra-short waves. *Proc. I.R.E.*, vol. 21, pp. 1519-1531; November, (1933).
- R526.2 Radio direction finder for use on airplanes. *Electrical Eng.*, vol. 52, pp. 779-780; November, (1933).  
Description of radio direction finder developed by the Bureau of Standards and adapted to take bearings on broadcast stations. Bearings are taken by observing a zero center indicating instrument. Sense indication is also given simultaneously with bearing indications. The direction finder unit may be adapted to operate from the output of the standard receiving set with slight modifications in some cases.
- R583 E. B. Kurtz and J. L. Potter. A projector type light flux generator for testing light sensitive devices. *Proc. I.R.E.*, vol. 21, pp. 1599-1602; November, (1933).  
×535.3

## R800. NONRADIO SUBJECTS

- 621.314.3 L. H. Carr. How to make your own transformers and chokes—Part I.  
×621.314.6 *Radio-Craft*, vol. 5, pp. 280-281; November, (1933).  
The theoretical and practical viewpoints in the design and construction of units in power and alternating-frequency circuits are given.
- 621.374.2 J. G. Ferguson. Classification of bridge methods of measuring impedances. *Bell Sys. Tech. Jour.*, vol. 12, pp. 452-468; October, (1933).  
An analysis is made of the requirements for satisfactory operation of the simple four-arm bridge when used for impedance measurements. Eight practical forms of bridges are given. These bridges together allow the measurement of any type of impedance in terms of practically any type of adjustable standard.
- 621.375.1 L. B. Snoddy. Ionization time of thyratrons. *Physics*, vol. 4, pp. 366-371; October, (1933).  
The ionization times for four types of commercial thyratrons tubes are given for the following cases: (1) impulse voltage applied to the anode with the grid biased positively or negatively, (2) impulse voltage applied to the grid with the anode potential constant and (3) impulsive voltage applied to grid and anode simultaneously.
- 621.375.1 E. D. McArthur. Electronics and electron tubes—Part VIII: Gas- or vapor-filled tubes. *General Electric Rev.*, vol. 36, pp. 501-505; November, (1933).  
Thyratron tubes are discussed. They are divided into two classes as to their use for direct and indirect control. Circuit arrangements are given for the FG-33, FG-57 and FG-95 thyratron tubes both as "thyratron timers" and for the continuous control from maximum to zero of large amounts of power.

CONTRIBUTORS TO THIS ISSUE

**Feldman, Carl B.:** Born March 26, 1902, at St. Peter, Minnesota. Received B.S. degree, 1926; M.S. degree, 1928, University of Minnesota. Bell Telephone Laboratories, Inc., 1928 to date. Associate member, Institute of Radio Engineers, 1926.

**Friis, H. T.:** Educated at Royal Technical College in Copenhagen, 1916; Columbia University, 1919-1920. Research department, Western Electric Company, 1920-1924; Bell Telephone Laboratories, Inc., 1925 to date. Associate member, Institute of Radio Engineers, 1918; Member, 1926; Fellow, 1929.

**Goldsmith, Alfred N.:** Born September 15, 1887, at New York City. Received B.S. degree, College of the City of New York, 1907; Ph.D. degree, Columbia University, 1911. Associate professor and professor, College of the City of New York for a number of years; consulting radio engineer, U. S. Department of Commerce, Atlantic Communication Company, and General Electric Company; director of research, Marconi Wireless Telegraph Company of America. Appointed director of research upon formation of Radio Corporation of America; chief broadcast engineer, RCA, 1923; vice president, RCA Photophone, Inc., 1928; vice president and general engineer, RCA, 1929 to 1933; Consulting Engineer, 1933 to date. President, Institute of Radio Engineers, 1928; director, 1913-1928; 1930 to date. Member, Institute of Radio Engineers, 1912; Fellow, 1915.

**Hamburger, Ferdinand, Jr.:** Born July 5, 1904, at Baltimore, Maryland. Received B.E. degree in electrical engineering, 1924; Dr. Eng., Johns Hopkins University, 1931. Electric testman, Consolidated Gas, Electric Light and Power Company, 1924-1925; research associate, Johns Hopkins University for Underground Systems Committee, N.E.L.A., 1925-1929. Graduate student, 1929-1930; Charles A. Coffin Fellow, 1930-1931; instructor in electrical engineering, 1931 to date, Johns Hopkins University Member, Sigma Xi; Member, A.I.E.E.; Associate member, Institute of Radio Engineers, 1932.

**\*Kramer, Ernst A. Ludwig:** Technical High School, Prague, 1919-1925; Technical High School, Dresden, laboratories of Professor Barckhausen, 1925-1927; received Dr. Ing. degree, 1927. Radio laboratories, C. Lorenz Aktiengesellschaft, Berlin-Tempelhof, 1927 to date. Member W. G. L. Nonmember, Institute of Radio Engineers.

**Olson, Harry F.:** Born December 28, 1902, at Mount Pleasant, Iowa. Received B.E. degree, 1924; M.S. degree, 1925; Ph.D. degree, 1928, University of Iowa. Engineering department, Illinois Bell Telephone Company, 1924; research assistant, University of Iowa, 1925-1928; research department, Radio Corporation of America, 1928-1930; engineering department, RCA Photophone, 1930-1932; research division, RCA Victor Company, 1932 to date. Nonmember, Institute of Radio Engineers.

\* Paper published in November, 1933, PROCEEDINGS.

**Palmer, Lionel S.:** Born August 2, 1891, at London, England. Graduate, Bristol University, 1913. Captain, British Army, 1914-1918. Received Ph. D. and D. Sc. degrees, 1920. Radio research engineer, H. M. Navy, 1920-1922. Lecturer in radio engineering, 1922-1924; head of physics department, Manchester College of Technology, 1924-1926; professor of physics, University College of Hull, 1927 to date. Member, I.E.E.; Fellow, Institute of Physics. Non-member, Institute of Radio Engineers.

**Sharpless, W. M.:** Born September 4, 1904, at Minneapolis, Minnesota. Received B.S. degree, University of Minnesota, 1928. Bell Telephone Laboratories, Inc., 1928 to date. Associate member, Institute of Radio Engineers, 1928.

**Taylor, Denis:** Born May 15, 1910, at Hull, Yorkshire, England. Demonstrator and lecturer in physics and electrical engineering, Hull Municipal Technical College. Received B. Sc. degree, University of London, 1931; M. Sc. degree, 1933. Engaged in wireless research, University College, Hull, 1931, 1933. Non-member, Institute of Radio Engineers.

**Ulbricht, Guenther:** Born, May, 1905, at Leipzig, Germany. Graduated from Staats-Gymnasium, 1924. Studied electrotechnics, Technical High School, Dresden. Received Dipl.-Ing. degree, 1929; Dr. Ing. degree, 1930, Technical High School, Dresden. Assistant, Institute for High-Frequency Physics, Technical High School, Hannover, 1929 to date. Nonmember, Institute of Radio Engineers.

**Zworykin, Vladimir K.:** Born 1889 in Russia. Received E.E. degree, Petrograd Institute of Technology. In 1912 entered laboratory, College de France, Paris, research in X-rays, working under Professor P. Langevin. During World War served in Russian Army as officer in Radio Corps. Research laboratory, Westinghouse Electric and Manufacturing Company, 1920 to date. Received Ph.D. degree, University of Pittsburgh, 1926. Since 1929 connected with research laboratory, RCA Victor Company, working on television, electron optics, photo-electric cells, and allied problems. Member, Institute of Radio Engineers, 1930.



# Quality

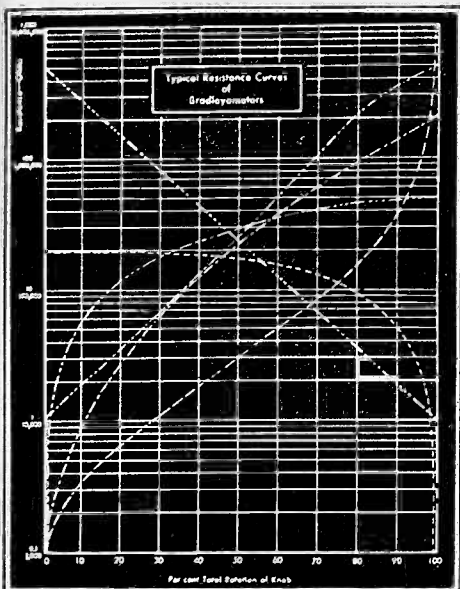

## • in Flexibility

The Bradleyometer, by virtue of its unique resistor element which is not obtainable in any other control, can be supplied with practically any resistance-rotation curve for over 100 different connection combinations.

## • in Performance

The design of the resistor element together with the precision manufacturing methods used in its construction result in an output of Bradleyometers of unequalled uniformity. This, in turn, assures a continuous output of radio receivers of optimum performance.

## • in Workmanship

Carefully selected raw materials, precision manufacturing methods, and continuous checking of production processes guarantee long life and de luxe performance for all Bradleyometers.

## Volume Control De Luxe



### A Quiet A. C. Relay for Remote Control

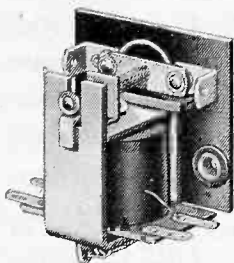

Allen-Bradley scores another triumph in this new quiet A. C. remote control relay for radio receivers. When operated by remote control, this relay connects or disconnects the main power pack circuit of the receiver. Send for specifications and prices today.

The Bradleyometer, now available in over 100 circuit combinations, represents the highest attainment in variable resistors for volume control, tone control, and automatic tone correction with volume control. Allen-Bradley engineers, foremost in the field of radio resistor design, have pioneered in the development of this volume control de luxe.

The slight extra cost of the Bradleyometer adds immeasurably to the quality of the receiver. Make your receivers outstanding in performance by using the Bradleyometer—the Volume Control De Luxe. Let Allen-Bradley engineers send you performance data, today.

Allen-Bradley Co.  
116 W. Greenfield Ave., Milwaukee, Wis.

## Bradleyometer

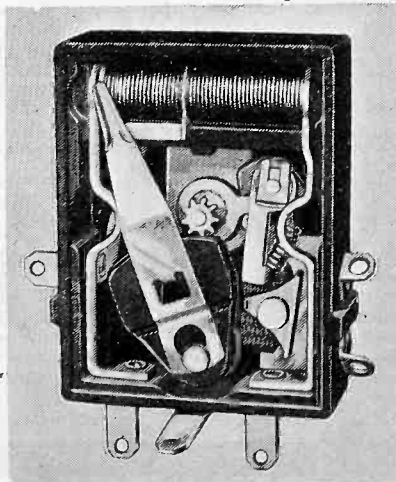

When writing to advertisers mention of the PROCEEDINGS will be mutually helpful.

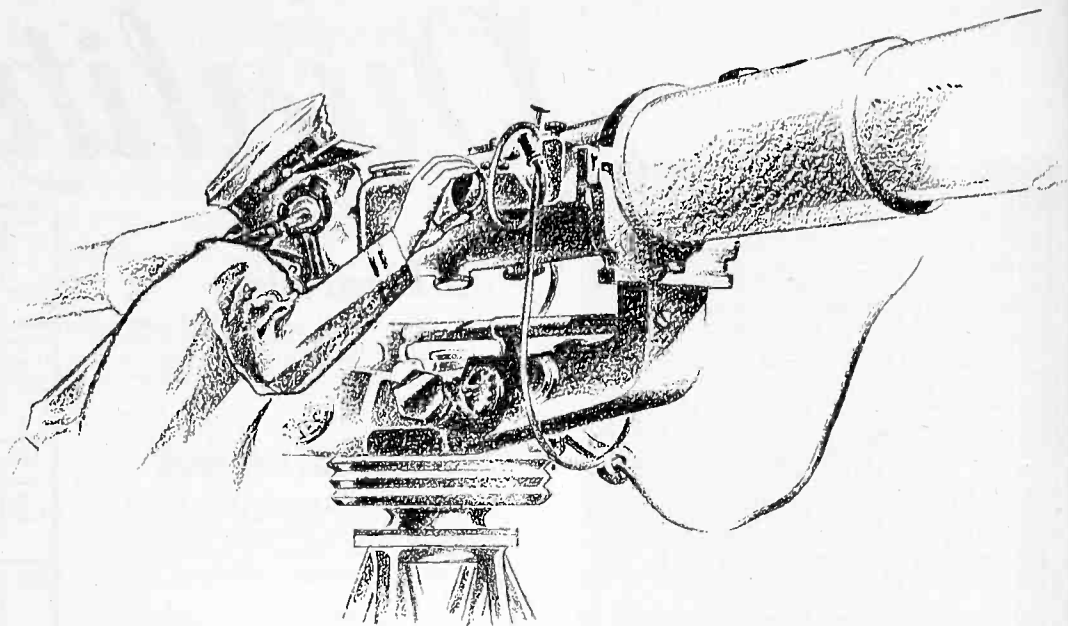

# MATHEMATICALLY ACCURATE

☐ Before the big guns of a battleship hurl their giant missiles, every detail of the range and aim must be calculated with mathematical exactness!

Equal precision governs the making of Sylvania Radio Tubes! Sylvania engineers put the same care into the designing, manufacturing and inspecting of radio tubes that goes into the construction and operation of the finest engineering instruments.

There is a reason why these standards can be maintained. The Hygrade Sylvania Corporation is management owned. The men who control its destinies have only one loyalty . . . to the success of their business and of their customers.

Set manufacturers are invited to avail themselves of Hygrade Sylvania's engineering facilities in solving their circuit and design problems. No obligation incurred. Hygrade Sylvania Corporation, Emporium, Pa.

# Sylvania

(Reg. U S. Pat. Off.)

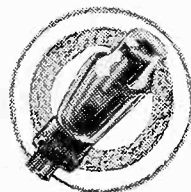

THE SET-TESTED RADIO TUBE

When writing to advertisers mention of the PROCEEDINGS will be mutually helpful.

© 1933, H. S. C.

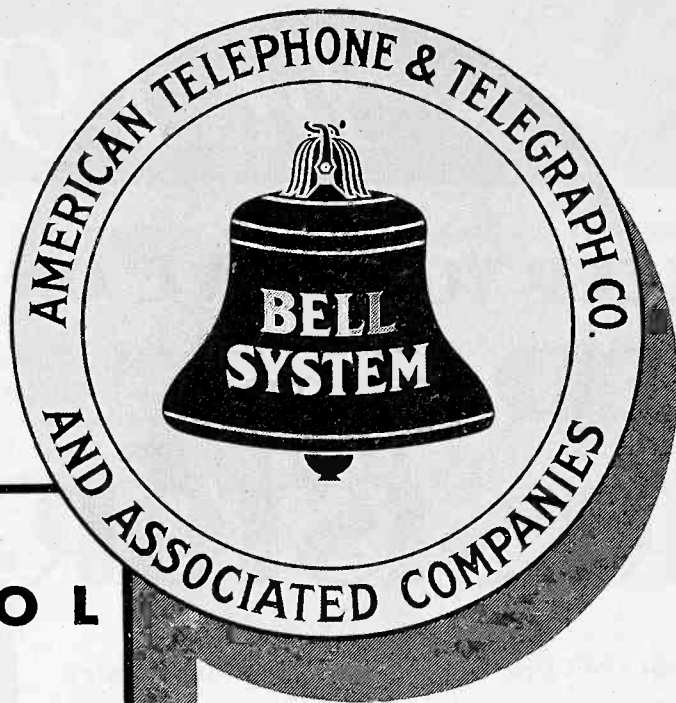

THE  
SYMBOL  
OF  
SERVICE

WELL-KNOWN to millions of telephone users is the circular emblem of the Bell System. Back of it is the far-flung organization that enables you to talk to almost any one, at any time. It is the mark of a friendly service.

The Bell System consists of twenty-four regional companies, each attuned to the needs of the territory it serves. There is also the Bell Telephone Laboratories, working ceaselessly and scientifically to improve the scope and value of your telephone. There is the Western Electric Company, specializing in the economical production of telephone equipment of the highest quality. Co-ordinating and assisting the work of the operating companies, Bell

Laboratories and Western Electric, is the American Telephone and Telegraph Company. It is owned largely by the people it serves and there are nearly 700,000 stockholders. They represent a cross-section of the American people; they come from every walk of life and live in every state of the Union. No one owns as much as one per cent of its stock.

Everything has been planned and organized for one specific purpose — to give you the best possible telephone service at the lowest possible cost.

---

*A telephone serves you in many ways each day. It runs your errands; takes you to friends and brings them to you; speeds aid in sickness or emergency. It does these things and many more—for a few cents a day. The Business Office of your local Bell Telephone Company, or any employee, will gladly take your order.*

## BELL TELEPHONE SYSTEM

*When writing to advertisers mention of the PROCEEDINGS will be mutually helpful.*





# In 1934

## KEEP YOUR EYE ON ERIE RESISTOR

In 1933 Erie again led the resistor industry with these major improvements:

1. Installation of automatic testing and manufacturing equipment of our own design that assures new standards of uniformity and precision of Erie Resistors.
2. Perfection of a compact elbow type Erie suppressor resistor that will stand up satisfactorily under the extremely high voltage encountered.
3. Development of a radically new combination of raw materials that improves the voltage coefficient of Erie Resistors 50% and more.

Erie engineers are now working on many problems of decided importance to the industry. During this year research and experiment will continue to keep our products more than abreast of radio manufacturers' requirements.

So we say . . . KEEP YOUR EYE ON ERIE RESISTOR IN 1934.

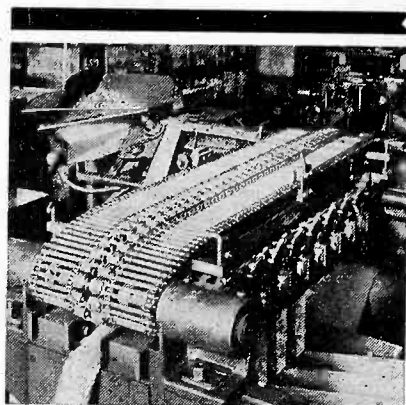

New automatic testing equipment.

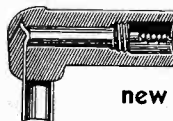

Cross section of new elbow suppressor.

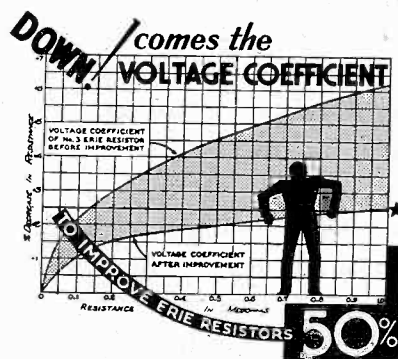

Improved raw materials.

## ERIE RESISTOR CORPORATION

ERIE, PA.

Factories in ERIE, PA. - TORONTO, CANADA - LONDON, ENG.

When writing to advertisers mention of the PROCEEDINGS will be mutually helpful.



# The Institute of Radio Engineers

Incorporated

33 West 39th Street, New York, N. Y.

## APPLICATION FOR ASSOCIATE MEMBERSHIP

(Application forms for other grades of membership are obtainable from the Institute)

To the Board of Directors  
Gentlemen:

I hereby make application for Associate membership in the Institute of Radio Engineers on the basis of my training and professional experience given herewith, and refer to the members named below who are personally familiar with my work.

I certify that the statements made in the record of my training and professional experience are correct, and agree if elected, that I will be governed by the constitution of the Institute as long as I continue a member. Furthermore I agree to promote the objects of the Institute so far as shall be in my power, and if my membership shall be discontinued will return my membership badge.

.....  
(Sign with pen)

.....  
(Address for mail)

.....  
(Date)

.....  
(City and State)

### Sponsors:

(Signature of references not required here)

Mr. .... Mr. ....

Address ..... Address .....

City and State ..... City and State .....

Mr. ....

Address .....

City and State .....

The following extracts from the Constitution govern applications for admission to the Institute in the Associate grade:

#### ARTICLE II—MEMBERSHIP

Sec. 1: The membership of the Institute shall consist of: \* \* \* (c) Associates, who shall be entitled to all the rights and privileges of the Institute except the right to hold any elective office specified in Article V. \* \* \*

Sec. 4. An Associate shall be not less than twenty-one years of age and shall be a person who is interested in and connected with the study or application of radio science or the radio arts.

#### ARTICLE III—ADMISSION AND EXPULSIONS

Sec. 2: \* \* \* Applicants shall give references to members of the Institute as follows: \* \* \* for the grade of Associate, to three Fellows, Members, or Associates; \* \* \* Each application for admission \* \* \* shall embody a full record of the general technical education of the applicant and of his professional career.

#### ARTICLE IV—ENTRANCE FEE AND DUES

Sec. 1: \* \* \* Entrance fee for the Associate grade of membership is \$3.00 and annual dues are \$6.00.

**ENTRANCE FEE SHOULD ACCOMPANY APPLICATION**

(Typewriting preferred in filling in this form) No.....

## RECORD OF TRAINING AND PROFESSIONAL EXPERIENCE

Name .....  
(Give full name, last name first)

Present Occupation .....  
(Title and name of concern)

Business Address .....

Permanent Home Address .....

Place of Birth..... Date of Birth..... Age.....

Education .....

Degree .....  
(college) (Date received)

### TRAINING AND PROFESSIONAL EXPERIENCE

DATES	
_____	_____
_____	_____
_____	_____
_____	_____
_____	_____
_____	_____
_____	_____
_____	_____
_____	_____
_____	_____
_____	_____
_____	_____
_____	_____
_____	_____
_____	_____
_____	_____
_____	_____
_____	_____
_____	_____
_____	_____
_____	_____
_____	_____
_____	_____

Record may be continued on other sheets of this size if space is insufficient.

Receipt Acknowledged..... Elected..... Deferred.....  
Grade ..... Advised of Election..... This Record Filed.....

# A NEW CRYSTAL FILTER

Further Improves  
The

# COMET "PRO" RECEIVER

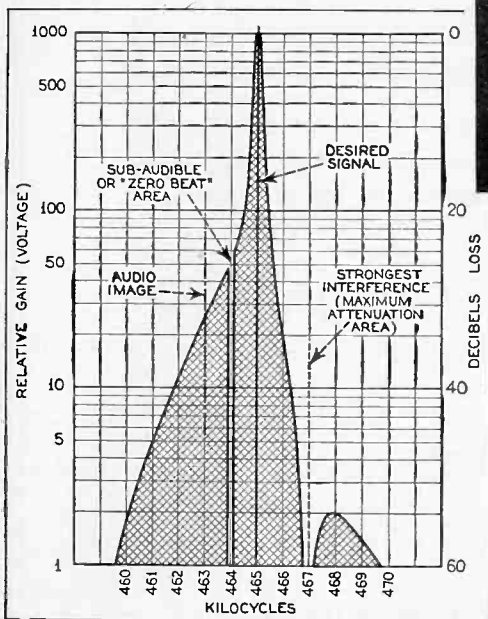
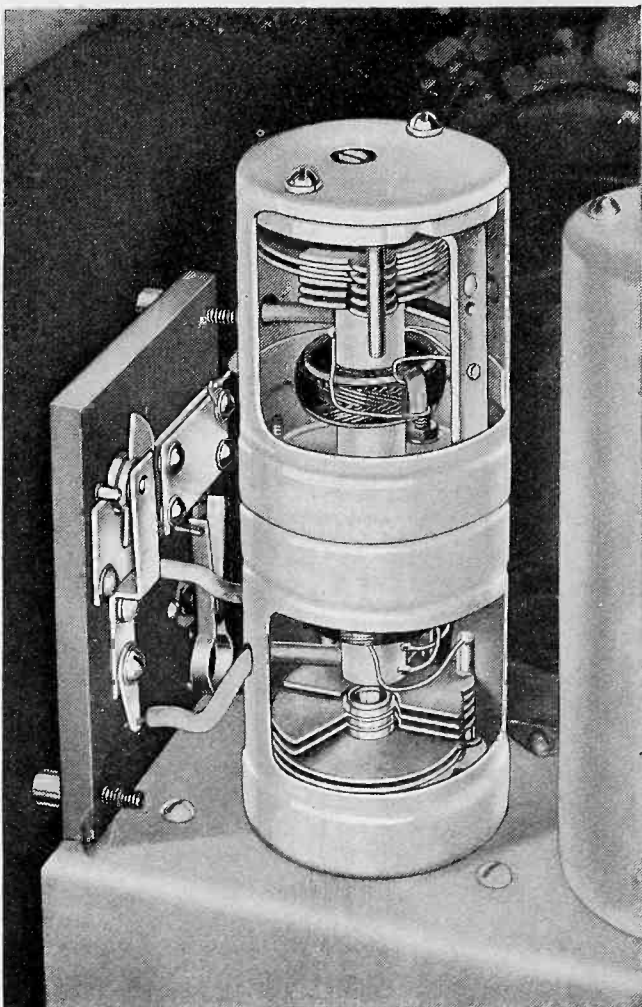

The diagram illustrates the elimination of a strong heterodyne while still maintaining the "single-signal" peak of the Quartz Crystal Filter.

By means of a panel control, this "elimination notch" may be shifted to either side of the main peak to greatly attenuate exceptionally troublesome interference.

The Crystal Filter, also Automatic Volume Control, may be added at moderate cost to the Standard Model "PRO."

Mail Coupon for Details



HAMMARLUND MANUFACTURING CO.  
424 W. 33rd St., New York

—Check here for new booklet describing the COMET "PRO" and information about adding Crystal Filter or Automatic Volume Control to the Standard "PRO."—Check here for New General Catalog of Radio Parts.

Name .....

Address .....

PE-1



When writing to advertisers mention of the PROCEEDINGS will be mutually helpful.

# CHANGE IN MAILING ADDRESS OR BUSINESS TITLE

Members of the Institute are asked to use this form for notifying the Institute office of a change in their mailing address or the listing of their company affiliation or title in the Year Book.

The Secretary,  
THE INSTITUTE OF RADIO ENGINEERS,  
33 West 39th Street,  
New York, N.Y.

Dear Sir:

Effective ..... please note change in my address  
(date)  
for mail as follows:

FROM

.....  
(Name)

.....  
(Street Address)

.....  
(City and State)

TO NEW ADDRESS

.....  
(Street Address)

.....  
(City and State)

Please note following change in my Year Book listing.

.....  
(Title)

.....  
(Company Name)

.....  
(Company Address)

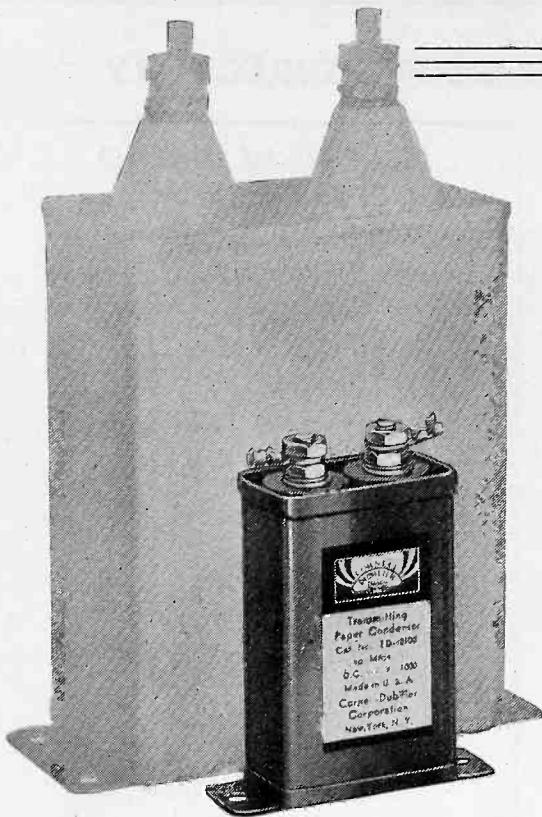

# 1/6<sup>th</sup> Size

with better

Operating

## Characteristics!

Here are two 1 mfd. units rated at 1000 volts D.C.—the usual standard paper unit and the new Cornell-Dubilier *special impregnation* unit.

Note the comparative sizes. The new unit measures only 1 3/4 x 1 x 2 1/2 inches! But that is only the story of size. There is an even better story to tell regarding the superior characteristics of the new

## C-D Specially Impregnated Units

- Compactness and reliability made possible by special impregnating compound as well as careful selection of paper dielectric.
- Conservative working voltage ratings, based on numerous life tests.
- Superior operating characteristics and longer life.

Available in capacities of from 5 mfd. at 600 volts D.C., to 1 mfd. at 2,000 volts.

Width and depth dimensions fixed—1 3/4 x 1 inch; height varies from 2 1/8 to 4 3/4 inches depending on rating.

**Write** for further data on these new space-saving and money-saving capacitors, as well as our new 1934 catalog covering the C-D complete line of condensers.



# CORNELL-DUBILIER CORPORATION

4377 Bronx Boulevard - - - New York City

When writing to advertisers mention of the PROCEEDINGS will be mutually helpful.

# PROFESSIONAL ENGINEERING DIRECTORY

TO

CONSULTANTS

DESIGNERS

PATENT

ATTORNEYS

Cathode Ray Tubes  
and Associated  
Equipment For All  
Purposes

*Write for Complete  
Technical Data*

ALLEN B. DUMONT  
LABORATORIES  
UPPER MONTCLAIR, N.J.

## PRACTICAL RADIO ENGINEERING

One year Residence Course  
Advanced Home Study Course  
Combined Home Study-Residence  
Course

*Write for details*

Capitol Radio Engineering  
Institute  
Washington, D.C.

We

suggest

the use

of the

Professional

Engineering Directory

## *Alphabetical Index to Advertisements*

A	
Allen-Bradley Co. ....	VII
American Tel. & Tel. Co. ....	IX
C	
Central Radio Laboratories .....	XVIII
Cornell-Dubilier Corp. ....	XV
E	
Erie Resistor Corp. ....	X
G	
General Radio Co. ....	Outside Back Cover
H	
Hammarlund Mfg. Co. ....	XIII
Hygrade Sylvania Corp. ....	VIII
I	
Isolantite, Inc. ....	XVII
I.R.E. ....	XI, XII, XIV, Inside Back Cover
P	
Professional Eng. Directory .....	XVI

# Isolantite

APPROVED FOR A DECADE

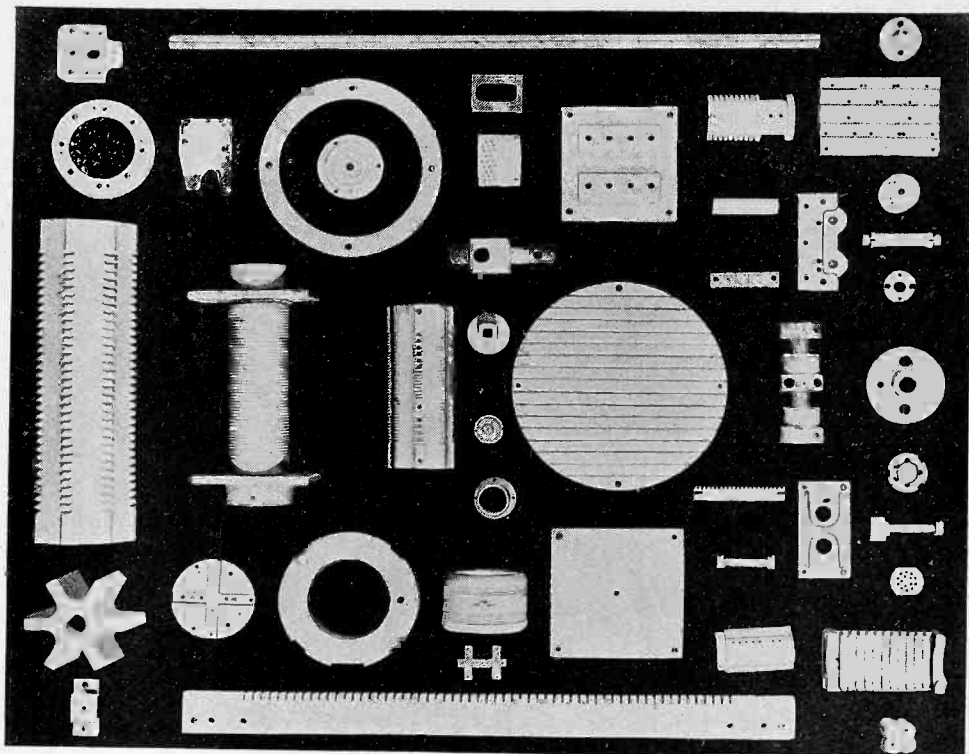

ISOLANTITE possesses unusual properties, desirable in a ceramic, making it applicable to many electrical and mechanical uses. One of these outstanding properties is the manner in which it can be *machined* before firing.

## ISOLANTITE IS

DRILLED  
BROACHED

THREADED  
TAPPED

COUNTER BORED  
MILLED

TURNED IN HAND OR AUTOMATIC LATHES

This singularly valuable property of Isolantite affords the user a precision of dimension in the finished product attainable in few ceramic materials. It makes possible the fabrication of small quantity orders *without die costs*. Isolantite manufacturing processes, however, are flexible and with the advantageous use of dies large quantity production is also accomplished economically.

Isolantite Sales and Engineering personnel will gladly assist you with your insulation problems large or small. A copy of bulletin 100-F illustrating standard designs, typical applications and complete properties of Isolantite is available on request.

Factory  
343 Cortlandt St.,  
BELLEVILLE, N.J.

## Isolantite Inc.

Sales Office  
75 Varick St.  
NEW YORK CITY

*When writing to advertisers mention of the PROCEEDINGS will be mutually helpful.*



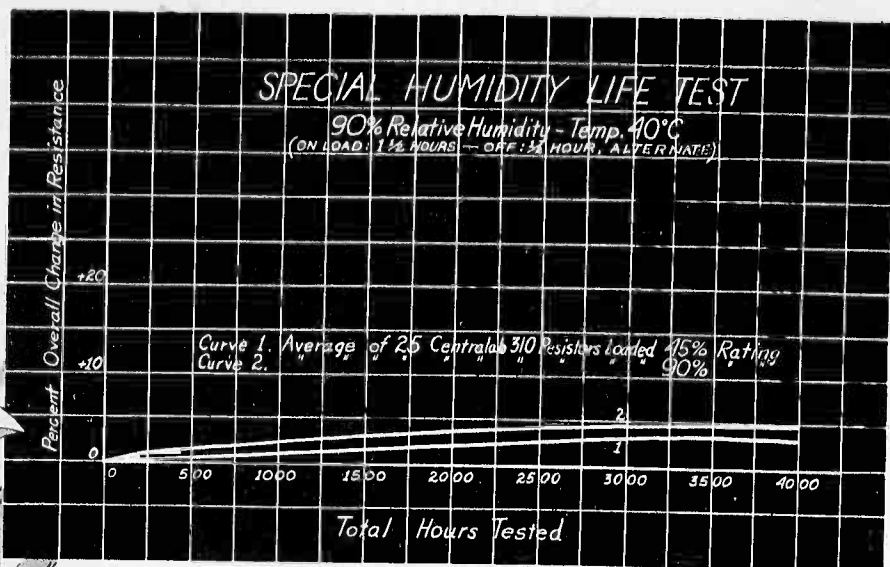

# Little DROPS OF WATER

in the atmosphere, torrential rain storms, heavy fogs —none of these can affect the performance of a radio that is Centralab equipped. Many radio resistors fail in damp climates because the alternate heating and cooling, as the set is turned on and off, promotes moisture penetration. As a proof that Centralab Resistors are impervious to moisture under all conditions, a humidity chamber was equipped with a clock mechanism applying an intermittent load to a large number of resistors. After 4,000 hours, the equivalent of many years of radio service, the average change under this severest test of all was less than 5%.

Centralab Resistors surpass all others in performance because they are the only resistor made with solid core and integral ceramic jacket, all Baptized in Fire at 2,700° F.

Use Centralab for unfailing performance.

**CENTRALAB RADIO LABORATORIES  
 MILWAUKEE**

# Centralab FIXED RESISTORS

*When writing to advertisers mention of the PROCEEDINGS will be mutually helpful.*

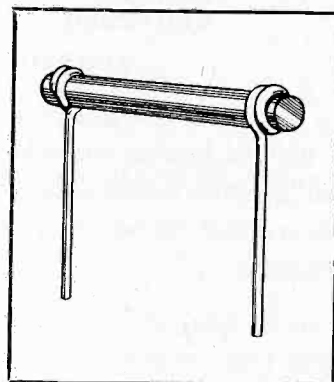

# Take Your Choice

Every member of the Institute of Radio Engineers will want to wear one of these three attractive emblems. All of these emblems are appropriately colored to indicate the various grades of membership and each emblem is approximately the size of the following illustrations.



The **Lapel Button** is of 14k gold, with background enameled in the membership color, and with the lettering in gold. The screw-back on the back of this button fastens it securely to your coat.

\$2.75 postpaid—any grade.



The **Pin** is also of 14k gold. It is provided with a safety catch and is appropriately colored for the various grades of membership.

\$3.00 postpaid—any grade.



The **Watch Charm**, handsomely finished on both sides, is also of 14k gold. This charm is equipped with a suspension ring for attaching to a watch fob or chain.

\$5.00 postpaid—any grade.

*Orders, accompanied by checks made payable to the Institute of Radio Engineers, should be addressed to*

**THE INSTITUTE OF RADIO ENGINEERS**

33 West 39th Street

NEW YORK CITY, N.Y.

*Send in your order now!*

---

# MEGOHM METER

---



*Measures  
Any  
Passive  
Resistance  
from  
10,000 ohms  
to 10,000  
Megohms*



*Direct-  
Reading*



**TOTAL  
SCALE  
LENGTH  
44 INCHES**

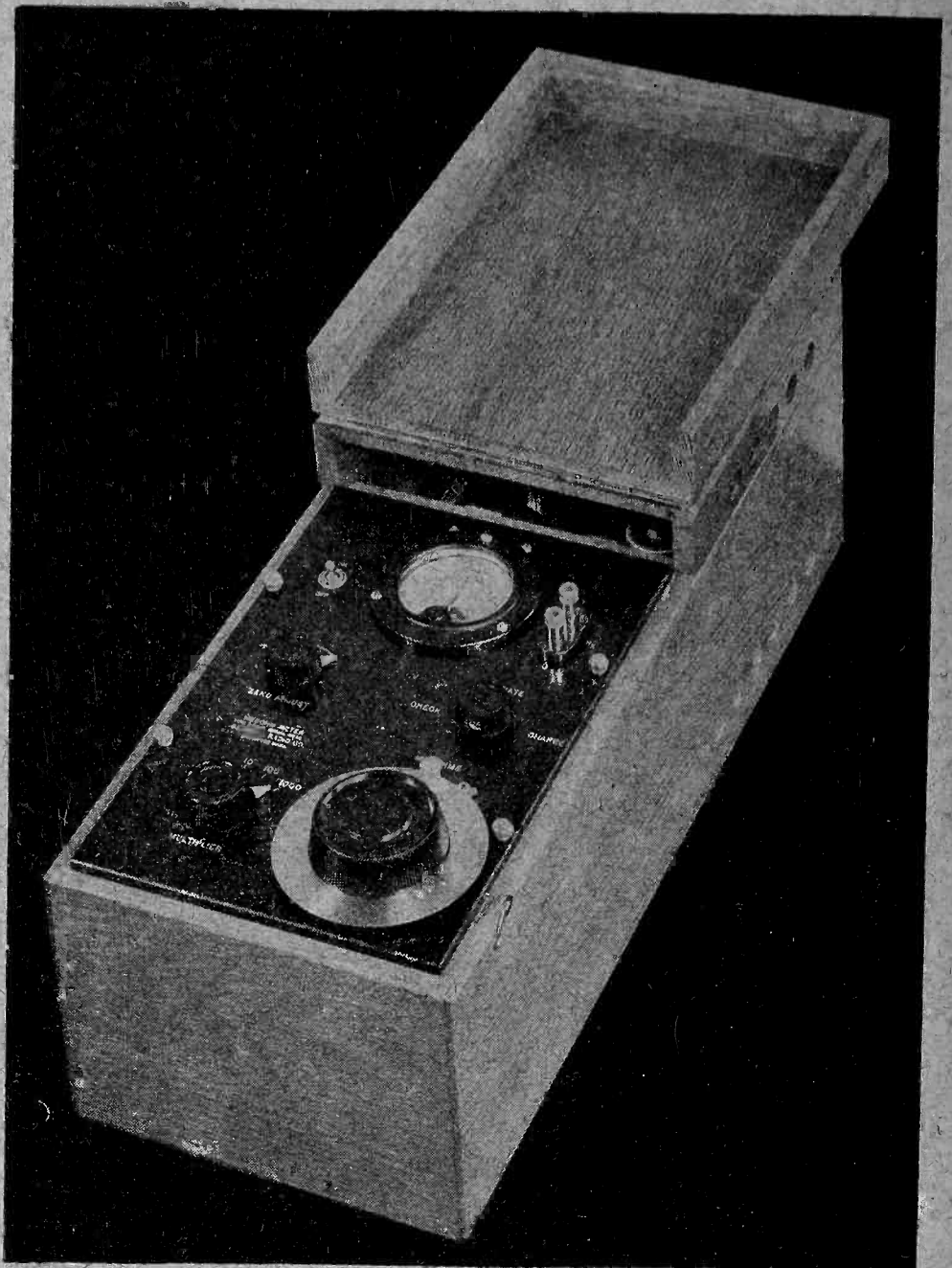

**A**CCURATE, reliable measurements of the very high values of resistance were difficult to make before the General Radio Megohm Meter became available. Its extremely wide range brings within its scope, all kinds of resistance measurements: insulation resistance of cables and low-voltage equipment of all kinds, resistivity tests on slabs of most insulating materials, etc. The long scale means that such tests can be made to show the effects of humidity, temperature, etc. on samples. Price: \$165.00

## SEND FOR BULLETIN

A complete description of the Megohm Meters is yours for the asking. Address a request for Bulletin EX-3306R to the General Radio Company, Cambridge, Massachusetts.

---

# GENERAL RADIO

---