

VOLUME 21

NOVEMBER, 1933

NUMBER 11

PROCEEDINGS  
*of*  
The Institute of Radio  
Engineers



Form for Change of Mailing or Business Title on Page X

---

# Institute of Radio Engineers Forthcoming Meetings

---

**ROCHESTER FALL MEETING**  
November 13, 14, and 15, 1933

---

**NEW YORK MEETING**  
December 6, 1933  
January 3, 1934

---

**WASHINGTON SECTION**  
November 9, 1933

---

PROCEEDINGS OF  
**The Institute of Radio Engineers**

Volume 21

November, 1933

Number 11

Board of Editors

ALFRED N. GOLDSMITH, *Chairman*

R. R. BATCHER  
H. H. BEVERAGE  
F. W. GROVER  
G. W. PICKARD

L. P. WHEELER  
L. E. WHITTEMORE  
WILLIAM WILSON  
K. S. VAN DYKE

CONTENTS

PART I

Institute News and Radio Notes.....	1513
Rochester Fall Meeting.....	1513
Committee Work.....	1514
Institute Meetings.....	1515

PART II

*Technical Papers*

A New Field of Application for Ultra-Short Waves.....	ERNST KRAMAR	1519
Vacuum Tube Electronics at Ultra-High Frequencies.....	F. B. LLEWELLYN	1532
Some Aspects of Radio Law.....	J. WARREN WRIGHT	1574
Radiation and Induction.....	R. R. RAMSEY	1586
Superregenerative Wave Meter for Ultra-Short Waves.....	H. ATAKA	1590
On the Production of Ultra-Short-Wave Oscillations with Cold-Cathode Discharge Tubes.....	KINJIRO OKABE	1593
A Projector Type Light Flux Generator for Testing Light Sensitive De- vices.....	E. B. KURTZ AND J. L. POTTER	1599
A Note on the Simple Two-Element Low-Pass Filter of Two and Three Sections.....	L. B. HALLMAN, JR.	1603
Discussion on "Linearly Tapered Loaded Transmission Lines," by J. W. Arnold and R. C. Taylor.....	A. T. STARR	1609
Radio Abstracts and References.....		1610
Contributors to This Issue.....		1619

*Copyright, 1933, by the Institute of Radio Engineers*

# The Institute of Radio Engineers

---

## GENERAL INFORMATION

**INSTITUTE.** The Institute of Radio Engineers was formed in 1912 through the amalgamation of the Society of Wireless Telegraph Engineers and the Wireless Institute. Its headquarters were established in New York City and the membership has grown from less than fifty members at the start to several thousand.

**AIMS AND OBJECTS.** The Institute functions solely to advance the theory and practice of radio and allied branches of engineering and of the related arts and sciences, their application to human needs, and the maintenance of a high professional standing among its members. Among the methods of accomplishing this need is the publication of papers, discussions, and communications of interest to the membership.

**PROCEEDINGS.** The PROCEEDINGS is the official publication of the Institute and in it are published all of the papers, discussions, and communications received from the membership which are accepted for publication by the Board of Editors. Copies are sent without additional charge to all members of the Institute. The subscription price to nonmembers is \$10.00 per year, with an additional charge for postage where such is necessary.

**RESPONSIBILITY.** It is understood that the statements and opinions given in the PROCEEDINGS are views of the individual members to whom they are credited, and are not binding on the membership of the Institute as a whole. Papers submitted to the Institute for publication shall be regarded as no longer confidential.

**REPRINTING PROCEEDINGS MATERIAL.** The right to reprint portions or abstracts of the papers, discussions, or editorial notes in the PROCEEDINGS is granted on the express condition that specific reference shall be made to the source of such material. Diagrams and photographs published in the PROCEEDINGS may not be reproduced without making specific arrangements with the Institute through the Secretary.

**MANUSCRIPTS.** All manuscripts should be addressed to the Institute of Radio Engineers, 33 West 39th Street, New York City. They will be examined by the Papers Committee and the Board of Editors to determine their suitability for publication in the PROCEEDINGS. Authors are advised as promptly as possible of the action taken, usually within two or three months. Manuscripts and illustrations will be destroyed immediately after publication of the paper unless the author requests their return. Information on the mechanical form in which manuscripts should be prepared may be obtained by addressing the secretary.

**MAILING.** Entered as second-class matter at the post office at Menasha, Wisconsin. Acceptance for mailing at special rate of postage is provided for in the act of February 28, 1925, embodied in Paragraph 4, Section 412, P. L. and R., and authorization was granted on October 26, 1927.

---

Published monthly by

**THE INSTITUTE OF RADIO ENGINEERS, INC.**

Publication office, 450-454 Ahnaip St., Menasha, Wis.

BUSINESS, EDITORIAL, AND ADVERTISING OFFICES

Harold P. Westman, *Secretary*

33 West 39th Street, New York, N. Y.

## INSTITUTE SECTIONS

- ATLANTA—Chairman, H. L. Wills; Secretary, Philip C. Bangs, 23 Kensington Road, Avondale Estates, Ga.
- BOSTON—Chairman, E. L. Chaffee; Secretary, G. W. Kenrick, Tufts College, Mass.
- BUFFALO-NIAGARA—Chairman, L. Grant Hector; Secretary, E. C. Waud, 235 Huntington Avenue, Buffalo, N. Y.
- CHICAGO—Chairman, R. M. Arnold; Secretary, Donald H. Miller, McGraw-Hill Publishing Company, 520 N. Michigan Ave., Chicago, Ill.
- CINCINNATI—Chairman, W. C. Osterbrock; Secretary, Helen Klein, Crosley Radio Corporation, Cincinnati, Ohio.
- CLEVELAND—Chairman, P. A. Marsal; Secretary, R. P. Worden, 1629 Cordova Ave., Lakewood, Ohio.
- CONNECTICUT VALLEY—Chairman, H. W. Holt; Secretary, C. B. De Soto American Radio Relay League, 38 La Salle Rd., W. Hartford, Conn.
- DETROIT—Chairman, G. W. Carter; Secretary, E. C. Denstaedt, Detroit Police Department, Detroit, Mich.
- LOS ANGELES—Chairman, J. K. Hilliard; Secretary, N. B. Neely, 1569 Munson Ave., Los Angeles, Calif.
- NEW ORLEANS—Chairman, J. A. Courtenay; Secretary, C. B. Reynolds, Radiomarine Corporation, 512 St. Peter St., New Orleans, La.
- PHILADELPHIA—Chairman, W. F. Diehl; Secretary, G. C. Blackwood, 243 E. Upsal St., Mt. Airy, Philadelphia, Pa.
- PITTSBURGH—Chairman, Lee Sutherlin; Secretary, A. P. Sunnergren, West Penn Power Company, 14 Wood St., Pittsburgh, Pa.
- ROCHESTER—Chairman, A. E. Soderholm; Secretary, John J. Long, Radio Station WHAM, Sagamore Hotel, Rochester, N. Y.
- SAN FRANCISCO—Chairman, G. T. Royden; Secretary, R. C. Shermund, 2300-16th Ave., San Francisco, Calif.
- SEATTLE—Chairman, H. H. Bouson; Secretary, Howard Mason, 2709-4th West, Seattle, Wash.
- TORONTO—Chairman, W. F. Choat; Secretary, G. E. Pipe, Rogers-Majestic Corporation, Toronto, Ont., Canada.
- WASHINGTON—Chairman, H. G. Dorsey; Secretary, C. L. Davis, Washington Building, 15th and G Sts., Washington, D. C.

## GEOGRAPHICAL LOCATION OF MEMBERS ELECTED OCTOBER 4, 1933

### Transferred to the Fellow Grade

Massachusetts	Tufts College.....	Kenrick, G. W.
New Jersey	Harrison, RCA Radiotron Co.....	Warner, J. C.

### Transferred to the Member Grade

Nebraska	Lincoln, University of Nebraska.....	Norris, F. W.
New Jersey	Newark, 200 Mt. Pleasant Ave.....	Ports, E. G.
England	Farnborough, Hants, 99 Highgate Lane.....	Ogg, J. G.

### Elected to the Member Grade

New York	New York City, 533 W. 112th St.....	Arnson, L.
	New York City, 420 Lexington Ave.....	Eaves, A. J.
England	Monton, Manchester, 12 Highfield Dr.....	Baxter, C.

### Elected to the Associate Grade

California	Los Angeles, 3360 Durango St., Palms Station.....	Paul, A., Jr.
	Rockwell Field, 19th Bomb. Grp. Hqrs.....	Ivie, E. S.
Connecticut	Westport, P. O. Box 595.....	Fay, R. H.
Illinois	Joliet, 2100 E. Washington St.....	Dyer, W. E.
Kansas	Kansas City, 32 North Valley.....	Smith, W. C.
Louisiana	New Orleans, 5835 Magazine St.....	Bowles, H. B.
	New Orleans, 820 Pine St.....	Graham, H. U.
Massachusetts	Hingham, Tropical Radio Tel. Co., Box 584.....	Fisher, A. B.
New Hampshire	Manchester, Rm. 106, Carpenter Hotel.....	Chandler, V. H.
New York	Little Neck, L. I., c/o Press Wireless, Inc., Box 25.....	Nichols, L. E.
	New York City, 356 W. 34th St.....	DeBaun, J. R.
Ohio	Lebanon, Roanoke Apts.....	Leydorf, G. F.
Brazil	Rio de Janeiro, Rua Ibituruna 81.....	Cavalcanti, A. P.
	Rio de Janeiro, Caixa Postal 126.....	Schulman, L.
Canada	Beaumaris Muskoka, Ont.....	Anderson, J. W.
	Fort William, Ont., 210 Victoria Ave.....	Brewer, H. L.
China	Chungking, Szechuen, The Chungking Central Radio Station, Shih Pang Chieh.....	Soei-Feng, L.
England	Calstock, Cornwall.....	Hopwood, C. H.
	Filton, Bristol, "Eden House," 64 Eden Grove.....	Smith, H. M.
	Wallingford, Berkshire, High St.....	Hoddinott, J. K.
	West Hartlepool, 46 Tristram Ave.....	Snowball, J.
	Wisbech, Cambs., 22 Cordon St.....	Barker, G. C.
Italy	Turin, Via Ospedale 14.....	Strada, F.
South Africa	Johannesburg, 7 Mersey St., Kensington.....	Abbott, C. E.

### Elected to the Junior Grade

California	Amador City.....	Hornberger, W. N.
Ohio	Cheviot, 3504 Bruestle Ave.....	Weiskittel, N. R.

### Elected to the Student Grade

California	El Monte, 421 Lexington St.....	Keeley, K. V.
Kansas	Manhattan, 805 Poyntz Ave.....	Peery, W. E.
Massachusetts	Cambridge, B-12 Adams House.....	Penn, W. D.



## APPLICATIONS FOR MEMBERSHIP

Applications for transfer or election to the various grades of membership have been received from the persons listed below, and have been approved by the Committee on Admissions. Members objecting to transfer or election of any of these applicants should communicate with the Secretary on or before November 30, 1933. These applications will be considered by the Board of Directors at its meeting on December 6, 1933.

### For Election to the Associate Grade

Connecticut	New Haven, 291 Lexington Ave.	Keeler, C. E.
	New Haven, 893 Elm St.	Sulloway, F. L.
Massachusetts	Cambridge, 4:230, Mass. Inst. of Tech.	Hall, W. M.
Michigan	Bay City, WBCM, Tuscola Rd.	Boshaw, M. L.
New Jersey	Bloomfield, 198 Washington St.	Marsh, J. P.
	Camden, RCA Victor Co., Inc.	Eaton, T. T.
	Harrison, RCA Radiotron Co., Inc.	Burnett, C. E.
	Harrison, RCA Radiotron Co., Inc.	Nesslage, C. F.
	Livingston, 20 Amherst Pl.	Charnley, R.
	Plainfield, 1441 Evergreen Ave.	Bucklin, K. G.
	Salem, 190 E. Broadway	Morton, R. S.
	Weehawken, 48 Hauxhurst Ave.	Dreyer, K.
New York	Brooklyn, 535-55th St.	Anderson, W.
	New York City, 19 W. 69th St.	Lendvai, D.
Ohio	Berlin Heights	Kenyon, H. S.
Australia	Melbourne Cl., Victoria, 407-409 Swanston St.	Evans, E. E.
	Melbourne Cl., Victoria, 407-409 Swanston St.	Soloman, C. H.
	St. Kilda S2, Victoria, 231 Glen Eira Rd.	Clyne, E. M.
Canada	London, Ont., 30 Carfrae Cres.	Foster, G. L.
China	Chungking, West China Dev. Corp., Tao Meng Kow	King, G.
	Shanghai, c/o Wireless Dept., Butterfield & Swire	Venn, W. M.
England	Chelmsford, Essex, 47 Arbour Lane	Borgars, S. J.
	Crouch Hill N. 4, London, "Fairwood," Holly Park	Rolfe, R. G.

### For Election to the Junior Grade

California	Sacramento, 1315-41st St.	Jeffers, L. M., Jr.
Iowa	Waterloo, 422 Randall St.	Ebel, A. J.
New York	Evergreen, 1705 Norman St.	Lewbel, S.
	New York City, 5 W. 63rd St.	Ryan, E. G.

### For Election to the Student Grade

New York	Yonkers, 40 Caryl Ave.	Lieb, J. S.
----------	------------------------	-------------



## OFFICERS AND BOARD OF DIRECTORS, 1933

(Terms expire January 1, 1934, except as otherwise noted)

### *President*

L. M. HULL

### *Vice President*

JONATHAN ZENNECK

### *Treasurer*

MELVILLE EASTHAM

### *Secretary*

HAROLD P. WESTMAN

### *Editor*

ALFRED N. GOLDSMITH

### *Directors*

M. C. BATSEL

J. V. L. HOGAN

C. M. JANSKY, JR.

R. H. MANSON, *Junior Past President*

E. R. SHUTE

A. F. VAN DYCK

WILLIAM WILSON

### Serving until January 1, 1935

W. G. CADY, *Junior Past President*

O. H. CALDWELL

C. W. HORN

E. L. NELSON

### Serving until January 1, 1936

R. A. HEISING

H. M. TURNER

F. A. KOLSTER



## INSTITUTE NEWS AND RADIO NOTES

### October Meeting of the Board of Directors

In the absence of Dr. Hull, Dr. Goldsmith was requested to take the chair at the October 4 meeting of the Board of Directors which was attended by Melville Eastham, treasurer; O. H. Caldwell, R. A. Heising, J. V. L. Hogan, F. A. Kolster, E. L. Nelson, E. R. Shute, H. M. Turner, A. F. Van Dyck, William Wilson, and H. P. Westman, secretary.

G. W. Kenrick and J. C. Warner were transferred to the grade of Fellow; F. W. Norris, J. G. Ogg, and E. G. Ports were transferred to the grade of Member; and Ludwig Arnson, Charles Baxter, and A. J. Eaves were admitted directly to the grade of Member. Twenty-four Associates, two Juniors, and three Students were elected to membership.

Approximately fifteen Institute members have been placed in positions during each of the last four months by the Emergency Employment Service which continues in operation.

Because of his candidacy, A. F. Van Dyck resigned as a member of the Tellers Committee.

The Constitution and Laws Committee presented a number of recommended changes in the Institute Constitution. These were given detailed consideration and the secretary was instructed to submit the proposed revisions to the membership for letter ballot.

### Rochester Fall Meeting

For the past several years special district meetings have been held in Rochester and have become known as the Rochester Fall Meetings. They have always been held in November and this year the dates are 13, 14, and 15. The Hotel Sagamore will be the headquarters for the meeting and the three days will be devoted to the presentation of papers on technical problems of particular interest to the broadcast receiver engineer.

All papers will be presented in the informal manner which has characterized these meetings in the past and while attempts will be made to secure the manuscripts for publication, it is highly probable that extremely few will have been prepared and released for that purpose. Consequently, there is no assurance that these papers will appear in the PROCEEDINGS at a later date. A tentative list of the papers follows:

“Development of Cathode Ray Tubes for Oscillograph Purposes,”

by H. B. Headrick, R. T. Orth, and C. W. Taylor, RCA Radiotron Company.

"Dynamic Detection," by K. W. Jarvis, Zenith Radio Corporation.

"Some Television Problems and Their Solutions," by I. G. Maloff, RCA Victor Company.

"Superregeneration as Applied to Ultra-High-Frequency Reception," by David Grimes and W. S. Barden, RCA License Laboratory.

"Losses in Electrolytic Capacitors," by P. Robinson, Sprague Specialties Company.

"Speaker Problems in High Fidelity Receivers," by Hugh S. Knowles, Jensen Radio Manufacturing Company.

"Conditions Necessary for an Increase in Usable Receiver Fidelity," by Alfred N. Goldsmith, Consulting Engineer.

"Problems in Ignition Interference Suppression," by L. F. Curtis, United American Bosch Corporation.

"New Tube Design Problems," by Roger M. Wise, Hygrade-Sylvania Corporation.

"Vibrating Rectifiers for B Power Supplies," by C. T. Wallis, Delco Appliance Corporation.

A technical exhibition will be held and will offer the engineer an opportunity of examining and discussing with the producer an extensive array of components for broadcast receivers, measuring equipment, and manufacturing aids.

Reservations should be made in advance for hotel accommodations as during past meetings it has been impossible for all to obtain accommodations at the Sagamore. Consequently, those placing early reservations will find it to their advantage.

---

## Committee Work

### CONSTITUTION AND LAWS COMMITTEE

A meeting of the Constitution and Laws Committee was held on October 3 at the Institute office. Those in attendance were J. V. L. Hogan, chairman; Austin Baily, Arthur Batcheller, R. A. Heising, A. F. Van Dyck and H. P. Westman, secretary.

The committee completed its examination of the Institute constitution and prepared for submission to the Board of Directors its recommendations on proposed changes in that document.

### American Standards Association

The American Standards Association has announced a recently adopted standard for Inch-Millimeter Conversion for Industrial Uses. The standard is based upon 1 inch = 25.4 millimeters and gives several conversion tables which will prove of convenience to those making such computations. Copies of the standard may be obtained at 20 cents each from the American Standards Association, 29 West 39th Street, New York City.

---

### Proceedings Binders

Binders for the PROCEEDINGS, which may be used as permanent covers or for temporary transfer purposes, are available from the Institute office. These binders are of handsome Spanish grain fabrikoid, in blue and gold. Wire fasteners hold each copy in place, and permit removal of any issue from the binder in a few seconds. All issues lie flat when the binder is open. Each binder will accommodate a full year's supply of the PROCEEDINGS, and they are available at one dollar and seventy five cents (\$1.75) each. Your name, or PROCEEDINGS volume number, will be stamped in gold for fifty cents (50c) additional.

---

### Institute Meetings

#### ATLANTA SECTION

A meeting of the Atlanta Section was held on May 11 at the Atlanta Athletic Club. Henry Reid, vice chairman, presided in the absence of Chairman Wills.

A discussion on "Carrier Current Telephony" was the subject of a paper by E. Y. Webb, an engineer for the American Telephone and Telegraph Company. His treatment of the subject was interesting and instructive and was illustrated by means of various graphs and circuit diagrams.

The paper was discussed by Messrs. Bangs, Daugherty, Gardberg, Gerks, and Wills. Seven were present at the informal dinner which preceded the meeting, and sixteen attended the meeting.

The July meeting of the section was held on the 20th at the Atlanta Athletic Club and was attended by eighteen. Eight were present at the informal dinner which preceded it.

H. L. Wills, chairman, presided and presented J. W. Spratlin of the Radio Department of Eastern Air Transport who presented a paper on "Aircraft Radio." The speaker described the various transmitting

and receiving equipment used in the communication system of Eastern Air Transport, and illustrated his paper with various pieces of equipment which were available for inspection at the meeting.

A general discussion followed which was entered into by Messrs. Bangs, Daugherty, Gardberg, Smith, and Wills.

The August 10 meeting was held at the Atlantan Hotel. Chairman H. L. Wills presided and the attendance totaled thirteen of whom seven were present at the informal dinner held before the meeting.

"High Fidelity Theater Sound Equipment" was the subject of a paper by Harry Leighley, sales representative of the RCA Victor Company. The speaker presented a detailed discussion of the methods and equipment used for theater projection of sound films.

The paper was discussed by Messrs. Bangs, Gardberg, Gearhart, Holliday, and Wills. At the conclusion of the discussion, the meeting adjourned to the home of J. B. Dumestre where a demonstration was given of the equipment.

#### CHICAGO SECTION

The Chicago Section held its September 22 meeting in the auditorium of the Western Society of Engineers. R. M. Arnold, chairman, presided and the attendance totaled 100.

A paper on "Performance of Various Coils and Types of Wire in Superheterodyne Receivers" was the subject of a paper by David Grimes and W. S. Barden of the Radio Corporation of America License Laboratory. Mr. Barden presented the paper.

Several sizes of Litzendraht wire were tested in various coil formations typical of present-day broadcast receiver design to determine their merits and effects on both selectivity and gain in intermediate-frequency amplifiers for superheterodyne receivers. It was not found to be important to make an extensive study at 175 kilocycles as Litz wire becomes definitely worth while only at the higher intermediate frequencies. Measurements may indicate the desirability of standardizing on 3/40, 7/41, and 10/41 Litz for broadcast receiver work. These sizes are, respectively, desirable for very small, medium, and large intermediate-frequency transformer coils. The effect of a broken strand is unimportant in the two larger sizes and not serious in the smallest size specified. A broken strand is not the equivalent of its removal and despite the break, the strand will assist in the process of conduction.

While some improvement over solid wire is shown in the larger sizes at 550 kilocycles, none tested at 1500 kilocycles showed a worthwhile advantage.

The paper was discussed by Messrs. Arnold, Jacobs, Jarvis, Knowles, Marco, Million, and Wunderlich.

#### DETROIT SECTION

The September 15 meeting of the Detroit Section was held in the Detroit News Conference Room. G. W. Carter, chairman, presided and thirty-eight members and guests were in attendance.

W. R. Hoffman, chief engineer of WWJ, Detroit News Broadcasting Station, presented a "Discussion of Present-Day Broadcast Methods." In it, he presented a general description of the equipment used at WWJ including the frequency control and monitoring equipment, transmitter proper, and studio designs. He then discussed in detail the audio input system used and the switching arrangements provided to insure flexibility and continuity of operation. The paper was concluded with a report of the arrangements made for broadcasting the Harmsworth races including some incidents which had not been included in the original schedule and which threatened ineffectively to interfere with the successful broadcast of the event.

A number of those present participated in the general discussion which followed the paper. In closing the meeting some new extension radio courses offered by the University of Michigan and the Detroit City College were discussed.

#### NEW YORK MEETING

A meeting of the Institute was held in New York on October 4 in the Engineering Societies Building. Donald McNicol presided in the absence of Dr. Hull.

The paper of the evening "Vacuum Tubes of Small Dimensions for Use at Extremely High Frequencies" by B. J. Thompson and G. M. Rose, Jr., of the RCA Radiotron Company was presented by Mr. Thompson. This paper was previously presented in Chicago during the Eighth Annual Convention of the Institute and is summarized in the June, 1933, issue of the PROCEEDINGS. A demonstration of these tubes was given by Mr. Rose.

An interesting discussion was participated in by a number of the 500 members and guests in attendance.

#### SAN FRANCISCO SECTION

A meeting of the San Francisco Section was held on September 20 at the Bellevue Hotel. G. T. Royden, chairman, presided and the attendance totaled fifty-eight. Sixteen were present at the dinner which preceded the meeting.

A paper on "Electrical Recording" was presented by S. A. Sollie of McGregor and Sollie. The author presented a description of the methods used in electrically recording sound on disks and discussed various important factors which must be given careful consideration in order to obtain high fidelity reproduction.

At the conclusion of the paper, the meeting adjourned to visit the laboratories of McGregor and Sollie to witness the complete cycle of recording and processing records.

#### WASHINGTON SECTION

A meeting of the Washington Section was held on September 14 at the Kennedy-Warren Apartments with H. G. Dorsey, chairman, presiding.

"Compact Direction Finders for Atmospheric Disturbances" was the subject of a paper by W. B. Burgess of the U. S. Naval Research Laboratories. The author presented first a summary of methods previously used in the directional study of atmospherics emphasizing that when multiple sources are involved, integrating devices are less satisfactory than taking bearings on the individual static crashes.

A compact direction finder was described. It employs a cathode ray tube and a receiver unit having fixed loops of small dimensions. It is operated on a fixed frequency of twelve kilocycles and requires a field intensity of eight microvolts per meter per centimeter of deflection of the cathode ray at maximum intensity. By comparison with the output of a local calibrated oscillator and attenuator, field strengths are readily computable up to about one volt per meter. Bearings uncalibrated with respect to intensity may be taken on atmospherics of much greater field strength. Tests indicate an inherent instrumental accuracy of direction of two degrees.

The problems of shielding of circuits and the substantial elimination of regenerative effects were discussed. Iron shields were found necessary and the voltage gain of the amplifier was approximately nine million. The apparatus is being used by the U. S. Navy in the study of atmospherics and meteorological conditions.

A number of the forty-five members and guests present participated in the discussion of the paper. Seventeen attended the informal dinner which preceded the meeting.



TECHNICAL PAPERS

A NEW FIELD OF APPLICATION FOR  
ULTRA-SHORT WAVES\*

BY

ERNST KRAMAR

(Laboratories of C. Lorenz Aktiengesellschaft, Berlin-Tempelhof, Germany)

*Summary*—In a previous issue of the PROCEEDINGS<sup>1</sup> A. Esau and W. M. Hahnemann referred to the applications of ultra-short waves and to their being suitable for a precise bundling of radiation. In the meantime, other authors have discussed the same subject. The present paper describes the use of this kind of waves in connection with radio beacons. A new method of forming a guide ray by keying the reflectors is stated. The dependence of the guide ray upon size, spacing, and number of reflectors is measured. There is no distortion due to reflections. A description is given of the use of the radio range beacon for blind landing of airplanes in thick weather. Simultaneous visual and aural reception in the airplane is possible without changing the method of keying the transmitter.

THE extremely rapid oscillations ( $10^8$  cycles per second and over) corresponding to wavelengths below ten meters in their very nature are similar to the oscillations of the visible light spectrum. Exactly as in the case of these their range is limited to the straight visibility between transmitter and receiver when the influence of diffraction, etc., is disregarded. Their penetration qualities, however, are considerably stronger than those of the visible rays, for they penetrate fogs or clouds unweakened. Due to their limited range, these waves can be used for telegraph communication only in exceptional cases. They may be used, however, to great advantage wherever the known optical signaling means, such as lighthouses and normal beacons, fail due to poor visibility.

One requirement is imposed on all such optical signals, viz., to cover only a strictly limited angle of the compass card, for example, in order to indicate harbor entrances or to warn of dangerous zones. This necessity, so easily to be complied with in the case of optical lights with the help of reflectors and lens systems, can be met with difficulty only—at least as far as waves longer than one meter are concerned—because of the large dimensions of the required mirrors or reflectors. Not

\* Decimal classification: R526.1. Original manuscript received by the Institute, July 26, 1933.

<sup>1</sup> Numbers refer to bibliography.

A paper on "Electrical Recording" was presented by S. A. Sollie of McGregor and Sollie. The author presented a description of the methods used in electrically recording sound on disks and discussed various important factors which must be given careful consideration in order to obtain high fidelity reproduction.

At the conclusion of the paper, the meeting adjourned to visit the laboratories of McGregor and Sollie to witness the complete cycle of recording and processing records.

#### WASHINGTON SECTION

A meeting of the Washington Section was held on September 14 at the Kennedy-Warren Apartments with H. G. Dorsey, chairman, presiding.

"Compact Direction Finders for Atmospheric Disturbances" was the subject of a paper by W. B. Burgess of the U. S. Naval Research Laboratories. The author presented first a summary of methods previously used in the directional study of atmospherics emphasizing that when multiple sources are involved, integrating devices are less satisfactory than taking bearings on the individual static crashes.

A compact direction finder was described. It employs a cathode ray tube and a receiver unit having fixed loops of small dimensions. It is operated on a fixed frequency of twelve kilocycles and requires a field intensity of eight microvolts per meter per centimeter of deflection of the cathode ray at maximum intensity. By comparison with the output of a local calibrated oscillator and attenuator, field strengths are readily computable up to about one volt per meter. Bearings uncalibrated with respect to intensity may be taken on atmospherics of much greater field strength. Tests indicate an inherent instrumental accuracy of direction of two degrees.

The problems of shielding of circuits and the substantial elimination of regenerative effects were discussed. Iron shields were found necessary and the voltage gain of the amplifier was approximately nine million. The apparatus is being used by the U. S. Navy in the study of atmospherics and meteorological conditions.

A number of the forty-five members and guests present participated in the discussion of the paper. Seventeen attended the informal dinner which preceded the meeting.





TECHNICAL PAPERS

A NEW FIELD OF APPLICATION FOR  
ULTRA-SHORT WAVES\*

By

ERNST KRAMAR

(Laboratories of C. Lorenz Aktiengesellschaft, Berlin-Tempelhof, Germany)

*Summary*—In a previous issue of the PROCEEDINGS<sup>1</sup> A. Esau and W. M. Hahnemann referred to the applications of ultra-short waves and to their being suitable for a precise bundling of radiation. In the meantime, other authors have discussed the same subject. The present paper describes the use of this kind of waves in connection with radio beacons. A new method of forming a guide ray by keying the reflectors is stated. The dependence of the guide ray upon size, spacing, and number of reflectors is measured. There is no distortion due to reflections. A description is given of the use of the radio range beacon for blind landing of airplanes in thick weather. Simultaneous visual and aural reception in the airplane is possible without changing the method of keying the transmitter.

THE extremely rapid oscillations ( $10^8$  cycles per second and over) corresponding to wavelengths below ten meters in their very nature are similar to the oscillations of the visible light spectrum. Exactly as in the case of these their range is limited to the straight visibility between transmitter and receiver when the influence of diffraction, etc., is disregarded. Their penetration qualities, however, are considerably stronger than those of the visible rays, for they penetrate fogs or clouds unweakened. Due to their limited range, these waves can be used for telegraph communication only in exceptional cases. They may be used, however, to great advantage wherever the known optical signaling means, such as lighthouses and normal beacons, fail due to poor visibility.

One requirement is imposed on all such optical signals, viz., to cover only a strictly limited angle of the compass card, for example, in order to indicate harbor entrances or to warn of dangerous zones. This necessity, so easily to be complied with in the case of optical lights with the help of reflectors and lens systems, can be met with difficulty only—at least as far as waves longer than one meter are concerned—because of the large dimensions of the required mirrors or reflectors. Not

\* Decimal classification: R526.1. Original manuscript received by the Institute, July 26, 1933.

<sup>1</sup> Numbers refer to bibliography.

until the advent of the so-called radio beacons has it been possible to transmit sufficiently concentrated beams of electric wave energy—especially in times of bad visibility—to make possible a welcome supplement to purely optical signaling systems. It is the object of this paper to show that these radio beacons for short and ultra-short waves can be very simply and efficiently designed, so that an extensive use of this approved system can be foreseen.

The idea of using a comparison of field strengths for the indication of a guiding line was first expressed by Scheller in 1907, and a patent was granted.<sup>2</sup> It is probably due to the stage then arrived at in the radio art that this new method of direction finding was not adopted for general use. Only individual trials, carried out with more or less success, showed that engineers became interested now and then in this sort of equipment.<sup>3</sup> The experiments of Kiebitz are especially worth mentioning. It was not until aviation with its long straight routes became a common means of traffic that the simplicity and usefulness of the guide ray system was again recognized, and credit is due to the U. S. Department of Commerce, the U. S. Army, and the Bureau of Standards that the radio beacon for *long waves* has been developed to its present state in the art.<sup>4</sup>

Although this system is well known, a short description will be given here. If two directional radiators are arranged in vertical direction with respect to each other and transmit complementary signals (for instance  $a = \cdot -$  and  $n = - \cdot$ ) in such a way that these signals are combined into a uniform permanent signal, they will produce the so-called guide ray or equal-signal zone defined by the line connecting the places where both signals are received with equal intensity. An airplane or boat moving on such a line will receive a permanent signal in its radio receiver, but when deviating from that line, it will receive the signal (either  $a$  or  $n$ ) with the greater intensity which is assigned to that side by the directional ray system. A variation of this idea is the modulation of the two directional transmitters with different tone frequencies, and the comparison of the intensities of these two sounds by means of a reed frequency meter or of a rectifier with milliammeter, respectively.<sup>5</sup>

At first sight, it seems natural to use crossed horizontal dipoles as directive antennas when applying this idea to the short-wave field. Such an arrangement will, however, be liable to cause considerable misdirections because then a horizontal dipole is also necessary for the receiving station, and because such a receiving antenna will have its own directional characteristics. Consequently, and in conformity with the relative position of the receiving with respect to the transmitting

aerial one or the other of the two complementary signals will be preferred in the equal-signal zone.

It results therefore that only vertical polarization is admissible. On this basis it has been found possible to develop a simple method of keying antenna reflectors which is especially adapted to the principle of radio beacons.

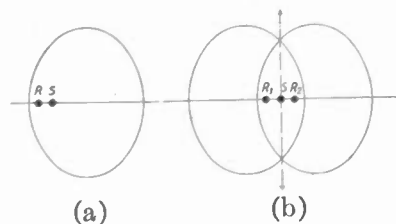

Fig. 1—(a) Propagation of transmitting dipole  $S$  and reflector  $R$ .  
(b) Propagation diagram of transmitting dipole  $S$  with two reflectors.

With the help of a reflector dipole coupled by radiation and arranged in parallel with the vertical transmitter dipole, it is possible to establish a great variety of field distortions depending on the lengths of the reflectors and their distance from each other. Length and spacing of the reflectors may be chosen in such a manner that the propagation diagram given in Fig. 1 (a) will result. If a second reflector of equal characteristics is mounted on the other side of the transmitting dipole,

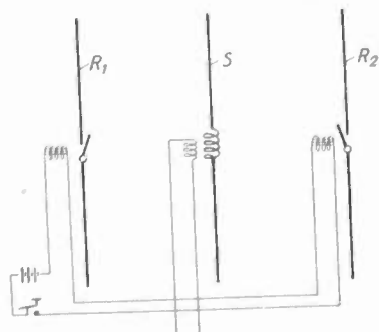

Fig. 2—Circuit of keying equipment for ultra-short-wave beacon.  
 $S$  = transmitter dipole.  
 $R_1$  and  $R_2$  = reflector dipoles.

alternating in operation with the first reflector, as shown in Fig. 1 (b), the pilot ray is formed along the line connecting the points of equal field strength. The keying is simply effected by relays interrupting the reflector wires in their current antinodes (centers). This can be done with advantage by designing one of the relays with make contacts and the other with break contacts, so that only one kind of signal has to be keyed. The load on the transmitter itself remains uniform. Fig. 2 shows

the fundamental circuit of this equipment. The transmitter feeds the center dipole uniformly. Merely by keying the reflectors the radiation is directed once to the one side and again to the other side. Fig. 3 shows the construction of the antenna equipment for an 8-meter wavelength which has been in use since last year. Fig. 4 is a view of the 4-stage tourmaline controlled experimental transmitter for 70 watts modulated output, and of the keying motor for the relays.<sup>6</sup>



Fig. 3—Ultra-short-wave beacon, Berlin-Tempelhof airport.

In conformity with the nature of the method of its production the pilot ray is independent of interference due to undesired reflections except very close to the beacon. In the case of short waves, simple direction finding by means of a loop antenna is disturbed by any incidentally existing reflector, even if this reflector may be tuned only approximately to the proper wavelength of the beacon. This leads to great deviations in practice. On the contrary, the pilot ray of this short-

wave radio beacon is absolutely rectilinear, as may be seen from Fig. 5. Here are shown measurements made on a beacon (2 watts output, 7 meters wavelength) over unsuitable ground. Neither the telephone line on the main road (see point 1 in Fig. 5), nor the railway line (point 3), nor the canal (points I and II), nor the forest (points III and IV) cause the least deviations.<sup>7</sup>

An undesired reflector fed from the field of the beacon has no great influence at places far distant from the transmitter or from the zone of equal intensity. It cannot cause a disturbance unless its lateral dis-

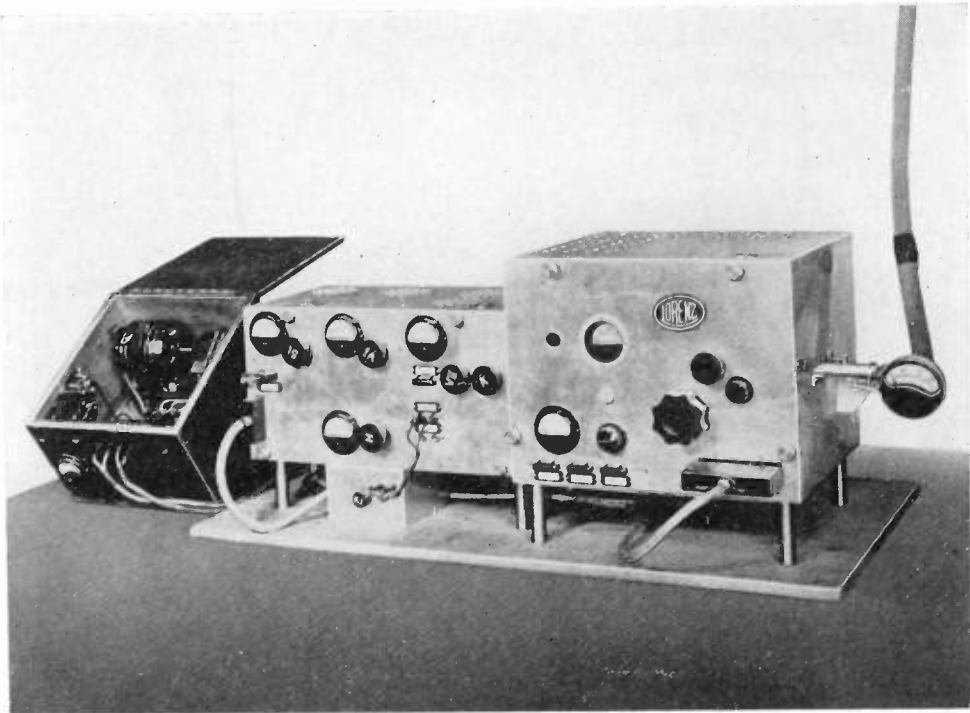

Fig. 4—Experimental transmitter for ultra-short-wave beacon, tourmaline controlled. Keying motor on the left.

tance from the pilot ray amounts to only a few wavelengths and is located in a place where the two field strengths are essentially different. This, however, is the case only in the close vicinity of the beacon. At all the other places the undesired reflector changes only the field strength in the equal-signal zone, but causes no distortion because it reflects only the desired signal and cannot reflect the signal from the other side of the course. The measurements given in the following table confirm these considerations.

For a discussion of the possibilities of using ultra-short-wave beacons, especially for harbor entrances and for similar safeguarding by means of pilot rays, it is necessary to know the precision of the guide

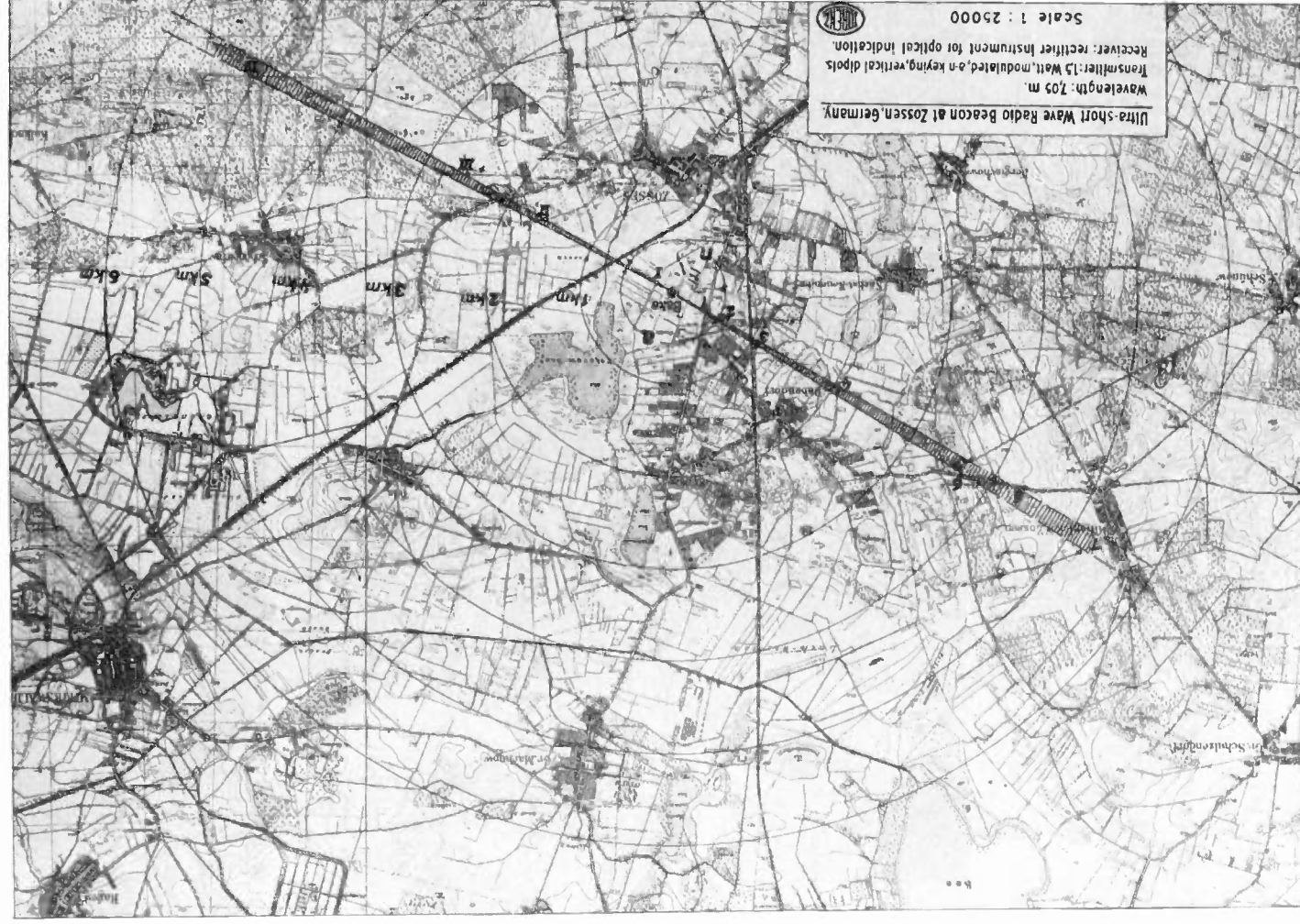

Fig. 5—Measured precision of equal-signal zone. Ultra-short-wave beacon at Zossen, Germany.

TABLE I  
 $\lambda = 7$  meters

Distance of Reflector from the Zone of Permanent Dash	$\lambda/2$	$\lambda$	$3/2\lambda$	$2\lambda$	$\lambda/2$	$\lambda$	$2\lambda$
Percentage of Energy Alteration by Reflector	+53	-35		-23	+50	-32	-20
Prevailing Signal	<i>n</i>	<i>a</i>	<i>n</i>	<i>a</i>	<i>n</i>	<i>a</i>	<i>a</i>
Corresponding Deviation of Guide Line (by degrees)	1.5	4	1	2	0.5	0.75	1
Distance from the Transmitter	80 meters				200 meters		

line actually obtainable. Assuming that a difference of 5 per cent between the two field strengths will suffice for securing distinctly perceptible indication, the width of the guiding beam will be about  $\pm 1$  degree in the case of a long-wave four-ray beacon which originates two lemniscate diagrams normal to each other.<sup>8</sup> If the directional diagrams are produced by reflectors coupled by radiation, as described above, the sectional angle of the curves of equal field strengths is subject to the influence of both the distance of the reflectors from each other and to

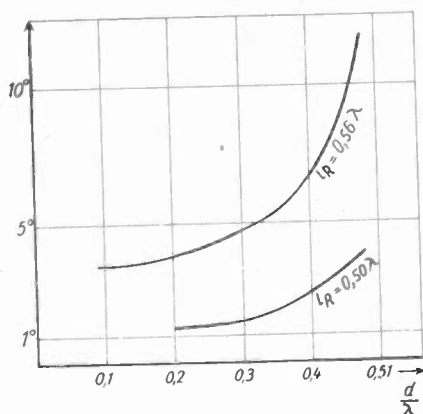

Fig. 6—Width of equal-signal zone, (field strengths differing 5 per cent or less), as a function of reflector distance and reflector length.

the length of the reflectors. The separation controls the phase of the exciting field relative to the oscillator itself; the length of the reflectors controls phase and amplitude of the counteracting field. Fig. 6 shows two curves which have been found experimentally for the field strength ratio (5 per cent) mentioned above using the 7-meter wave. The diagrams, however, can be essentially altered according to the method by which they are produced. It is possible to obtain different characteristics all having the same sectional angles. Fig. 7 shows a variety of curves for constant distance between the reflectors and variable lengths of reflectors. Fig. 8 illustrates the influence of reflector distance for constant length of the reflectors.

The latter two figures show that there exist a great variety of possibilities. By adding a third reflector for example the reverse part of the guide beam can be nearly completely eliminated so that only one pilot ray (Fig. 9) results. With this arrangement a certain section can be marked also simply by simultaneously connecting and disconnecting

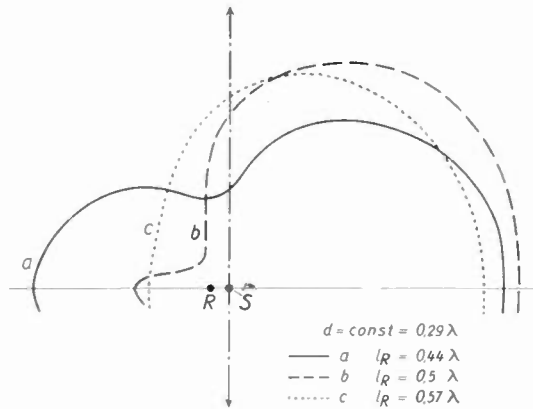

Fig. 7—Different field characteristics for constant distance and varied length of the reflector. The dash-dotted line indicates the course when a second reflector is mounted symmetrically to  $R$ .

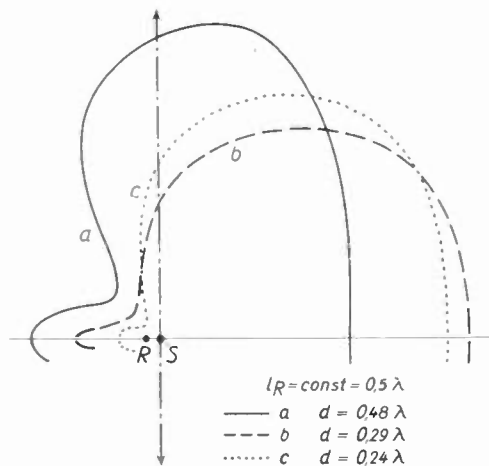

Fig. 8—Different field characteristics for constant lengths and varied distance of the reflector. The dash-dotted line indicates the course when a second reflector is mounted symmetrically to  $R$ .

two of the three reflectors (see  $R_1$  and  $R_2$  in Fig. 10). The desired combination may be chosen in accordance with the special conditions to be met with.

In the following an especially important application of the radio range beacon principle is described, viz., its use in connection with thick weather flying and blind landing of airplanes. Experience has shown that, when clouds are about 40–50 meters above ground, it is



sufficient if the pilot receives the direction of the airport approaches and a signal at the spot where he can safely penetrate the clouds in order to arrange for his landing ("thick weather landing"). The arrangement described before is especially suited for this purpose. The direction is indicated by the beacon; the signal for penetrating the

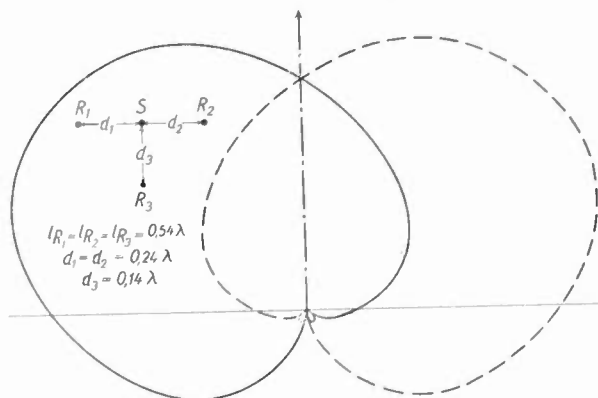

Fig. 9—Pilot ray in *one* direction obtained with three reflectors.  $R_1$  and  $R_2$  are keyed alternately.  $l_R$  refers to reflector length,  $d$  to reflector distance.

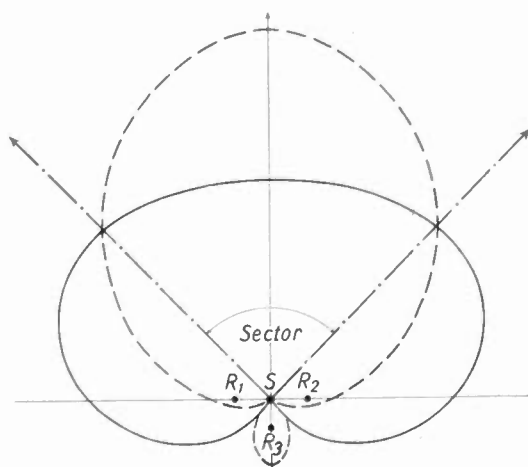

Fig. 10—Same beacon as in Fig. 9. Reflectors  $R_1$  and  $R_2$  keyed simultaneously for marking a sector.

clouds is given when the plane is just vertically above the beacon by an interruption of the reception, since in the case of vertical polarization no radiation takes place within a cone of a certain angle above the transmitting dipole.<sup>9</sup> It is therefore useful to erect the beacon a few hundred meters before the airport's boundary in the direction of the approach.

A wavelength below 10 meters proves to be extremely useful for this particular purpose. The range of these waves being limited, all airports can work with the same landing wave, without causing any mutual

interference. This simplifies further the apparatus necessary in the airplane as well as its maintenance. Inasmuch as radiation into the open atmosphere is concerned, the range, on the other hand, is so large as to allow a sufficient field strength for reliable reception at 23–30 kilometers if the airplanes are flying at a height of 300–400 meters. Moreover, as experience shows, these waves are not subject to fading and the receivers operate uninfluenced by atmospheric noises. Finally, the antennas have rather small dimensions even with a most favorable radiation efficiency and, therefore, the whole transmitter including the antenna can be established as a truck station, in order to be located in accordance with the actual wind conditions.

Last winter such an equipment was tested at the instigation of the Deutsches Reichsamt für Flugsicherung (German Board for the Protection of Aircraft) and in close cooperation with the Deutsche Luft-hansa and the Deutsche Versuchsanstalt für Luftfahrt (German Research Institute for Aviation) at the airport of Berlin-Tempelhof. The apparatus was supplied by C. Lorenz Aktiengesellschaft (see Figs. 3 and 4). The receiver used was a 4-valve audion detector set, and the receiving antenna in the airplane was a vertical rod about 60 centimeters in length.

The flight tests proved that the equipment complied with the requirements set forth. The direction transmitted by the beacon was distinctly noticeable when approaching the airport. It was found advantageous to work with a relatively great width of the course indicating ray (3 degrees). Smaller width can be easily established as shown in Fig. 6. The increasing volume of sound, when approaching, permits rough estimation of the distance from the airport. The cone within which no reception above the transmitter is possible, had an angle of about 60 degree; i.e., when passing the transmitter equipment at a height of about 200 meters there is no reception for a duration of about 4–5 seconds. This zero zone is also perceptible when the airplane passes the transmitter laterally outside of the pilot ray, and it is of such a characteristic nature that it is easily distinguished from temporary or casual failure of the receiver.

The question of where to install the radio beacon on the line of approach is determined by the size of the landing field and by the angle in which the airplane glides when landing. This is due to the fact that the nonreception of the guide signal indicates to the pilot that he is to start landing. The use of the radio beacon for blind landing solely with the aid of measuring instruments will be dealt with in a special paper as soon as certain experiments undertaken in cooperation with the Deutsche Versuchsanstalt für Luftfahrt have been completed.

According to experience gathered by numerous flight tests, it can be assumed that in certain cases visual indication is an advantage for the control of the course deviation and of the guide signal. While a number of pilots were of the opinion that the eye of the pilot, especially at blind flight, is already overloaded by the number of instruments to be watched, and that an audible signal should indicate the direction, there were others who expressed the idea that it is impossible to see

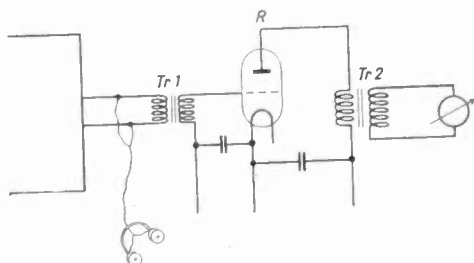

Fig. 11—Circuit of simultaneous acoustic and visual indication.

and hear, to watch and listen with full attention because the ear ought to be free for controlling the motor. Therefore, a method has been developed which with the same keying of the transmitter allowed simultaneous visual and aural operation.

The keying signals employed for this simultaneous indication are short dots and long dashes, respectively, transmitted in the time ratio of 1:8 or 1:10. This method of signaling has been found especially clear

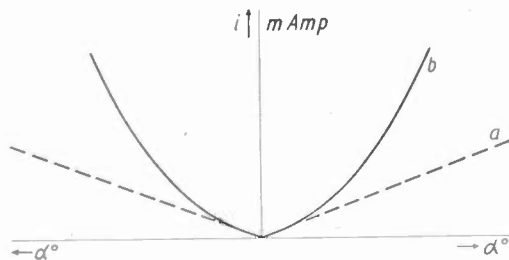

Fig. 12—Sensitivity of indicating instrument (a) for a normal direct-current ammeter, (b) for new type of decreasing sensitivity.

also from the acoustic and physiological point of view, because these signals can be distinguished more easily than  $a$  or  $n$  even by an unexperienced ear. The simultaneous visual indication is obtained by the deflection of an instrument pointer in accordance with the course deviation. In order to have the two kinds of signals cause a deflection of the pointer to two different sides, the following solution was arrived at: If the rectified signals are transmitted via a transformer ( $Tr2$  in Fig. 11), only the beginning and the end of the signals will become effec-

tive at the secondary side of the transformer. Therefore, the impulse starting a dot, for instance, will deflect the pointer of a direct-current instrument to the left and at the end of the dot will deflect it to the right, whereas at the end of a dash the pointer is deflected in the reverse, i.e., first to the right and then to the left. If the instrument is of a suitable slow-acting type and provided with means to minimize its sensitivity with increasing deflection (see Fig. 12), the pointer will respond only to the first impulse deflecting it from the zero position. The instrument will, however, not be sensitive enough to react on the immediately succeeding reverse impulse as this impulse finds the instrument still in a position of reduced sensitivity. The pointer then reaches the zero position in the long interval between the dots or in the interval

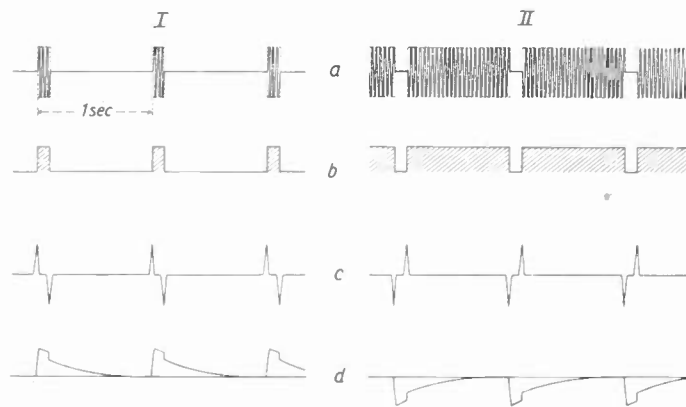

Fig. 13—Method of visual indication.

I = signal in dot zone. II = signal in dash zone.

(a) = low-frequency currents in headphones at receiver output for acoustic indication.

(b) = anode current of rectifier.

(c) = secondary voltage of transformer *Tr 2*.

(d) = movement of instrument pointer.

indicated by the dashes. Fig. 13 (a-d) explains this method by which the pointer of the instrument is deflected in one direction by any dot radiated from the transmitter, and after having slowly returned to zero is deflected in the opposite sense by any dash. The required sensitivity characteristic of the instrument can easily be attained by suitably shaping the pole pieces of the magnet.

By biasing the rectifier (Fig. 11) and increasing the transformation ratio (of *Tr1*) it is possible to obtain a considerable sensitivity so that the width of the ray found by comparison of the acoustic signals may forthwith also be measured by visual signals.

A second instrument which is connected to a copper-oxide rectifier and to the output terminals of the receiving set indicates the distance from the transmitter of the beacon and the cessation of reception above the beacon. In the case of an approach on the proper course the pointer

of the direction finding instrument will maintain its center position, while the deflection of the instrument measuring the intensity will increase more and more as the airplane approaches the beacon.

Tests with a radio beacon of a similar type were made last summer on the beach of the Baltic near Swinemünde for harbor approaches. Also in this case the results obtained are very satisfactory although the precision of the ray has to be increased for some purposes. These tests will be continued this summer.

Summarizing, one can conclude that for ranges of about 30 kilometers† ultra-short-wave beacons form a simple and consequently safe means for securing guide lines by pilot rays. Their special advantages are their limited range, their freedom from atmospheric interference, the absence of fading phenomena, and the small dimensions of the necessary antennas.

† H. A. Chinn observed ranges greatly in excess of this distance. The author regrets very much that his report in these PROCEEDINGS, June, (1933), was not published before the present paper was completed.

#### Bibliography\*

- <sup>1</sup> A. Esau and W. M. Hahnemann, "Report on experiments with electric waves of about 3 meters: Their propagation and use," Proc. I.R.E., vol. 18, no. 3, p. 471; March, (1930).
- W. Hahnemann, "Die Wellengruppen der Radiotechnik," *Radiowelt* (Vienna), February, (1929).
- <sup>2</sup> Lorenz-Scheller, D.R.P., 201496, 1907.
- <sup>3</sup> Lorenz-Scheller, D.R.P., 299753, 1916 (Goniometer).
- F. Kiebitz, *Jahr. der Draht. Teleg.*, vol. 15, p. 299, (1919).
- F. Kiebitz, *Telegraphen- und Fernsprechtechnik*, vol. 9, p. 46, (1920).
- <sup>4</sup> F. H. Engel and F. W. Dunmore, Bureau of Standards Scientific Paper No. 480, (1923).
- W. H. Murphy and L. M. Wolfe, *Jour. Soc. Automotive Eng.*, vol. 19, p. 209; September, (1926).
- J. H. Dellinger, *Engineers and Engineering*, vol. 43, p. 301; November, (1926).
- <sup>5</sup> J. H. Dellinger and H. Pratt, Proc. I.R.E., vol. 16, p. 890; July, (1928).
- <sup>6</sup> E. Kramer, *Hochfrequenz. und Elektroakustik*, vol. 40, no. 3, p. 88, (1932).
- <sup>7</sup> E. Kramer, *Elek. Nach.*, vol. 9, no. 12, p. 469, (1932).
- <sup>8</sup> P. Besson, *L'Onde Électrique*, vol. 10, p. 369; September, (1931).
- <sup>9</sup> H. Jacobshagen and E. Kramar, *Funkbastler*, vol. 19, p. 298, (1933).

\* Further literature references may be found in the papers mentioned and in an essay of H. Fassbender, *Hochfrequenztechnik in der Luftfahrt*, page 492, (1932).



## VACUUM TUBE ELECTRONICS AT ULTRA-HIGH FREQUENCIES\*

BY

F. B. LLEWELLYN

(Bell Telephone Laboratories, Inc., New York City)

*Summary*—Vacuum tube electronics are analyzed when the time of flight of the electrons is taken into account. The analysis starts with a known current, which in general consists of direct-current value plus a number of alternating-current components. The velocities of the electrons are associated with corresponding current components, and from these velocities the potential differences are computed, so that the final result may be expressed in the form of an impedance.

Applications of the general analysis are made to diodes, triodes with negative grid, and to triodes with positive grid and either negative or positive plate which constitute the Barkhausen type of ultra-high-frequency oscillator. A wavelength range extending from infinity down to only a few centimeters is considered, and it is shown that even in the low-frequency range certain slight modifications should be made in our usual analysis of the negative grid triode.

Oscillation conditions for positive grid triodes are indicated, and a brief discussion of the general assumptions made in the theory is appended.

### I. FOREWORD

THE art of producing, detecting, and modulating ultra-high-frequency electric oscillations has reached the same state of development which was attained in early work on lower frequency oscillations when experiment had outstripped theory. The experimenters were able to produce oscillations by using vacuum tubes, but were not able to explain why. They were able to make improvements by the long and tedious process of cut and try, but did not have the powerful tools of theoretical analysis at their command. In particular, the advantage of the theoretical attack may be illustrated by the rapid advance in technique which followed the theoretical concept of the internal cathode-plate impedance of three-element vacuum tubes. The work of van der Bijl and Nichols showed that for purposes of circuit analysis this path could be replaced by a fictitious generator of voltage,  $\mu e_p$ , having an internal impedance whose magnitude is given by the reciprocal of the slope of the static  $V_p - I_p$  characteristic. Development of commercially reliable vacuum tube circuits began forthwith. In a similar, yet less complicated manner, the internal network of two-element tubes may be replaced by an equivalent resistance when relatively low frequencies only are considered.

In these concepts where the vacuum tube is replaced by its equivalent

\* Decimal classification: R130. Original manuscript received by the Institute, August 2, 1933. Presented in brief summary before U.R.S.I., Washington, D.C., April, 1932.

lent network impedance, one outstanding feature is exemplified; namely, the separation of the alternating- and direct-current components. The equivalent networks are applicable to the alternating-current fundamental component of the current and differ widely from the direct-current characteristics. A complete realization of the importance of this separation will be of advantage in the later steps where extension of the classical theory to the case of ultra-high-frequency currents is described.

For a short time after the original introduction of the equivalent network of the tube, affairs progressed smoothly. Soon, however, frequencies were increased and a new complication arose. The difficulty was attributable to the interelectrode capacities existing between the various elements of the vacuum tube. The original attempts to take this into account were based on the viewpoint that the tube network should be complete in itself and separate from the external circuit network to which it was attached. Correct results, of course, were obtained by this method but later developments showed the advantage of considering the equivalent network of the complete circuit, including both tube and external impedances in a single network. For instance, by grouping the combination of grid-cathode capacity with whatever external impedance was connected between these two electrodes, a great simplification occurred. This step also has its analogy in the development of ultra-high-frequency relations.

As time went on, higher and higher frequencies were desired, and they were produced by the same kind of vacuum tubes operating in the same kind of circuits, although refinements in circuit and tube design allowed the technique to be improved to the point where oscillations of the order of 70 to 80 megacycles were obtainable with fair efficiency. When the frequency was increased still further, it was found that extension of the same kind of refinements was unavailing in maintaining the efficiency and mode of operation of the higher frequency oscillations at the level which had previously been secured. Ultimately, the three-electrode tube regenerative oscillator ceases to function as a power generator in the neighborhood of 100 megacycles for the more usual types of transmitting tubes. When this point was reached, the external circuit had not yet shrunk up to zero proportions and neither had its losses become sufficiently high to account altogether for the failure of the tube to produce oscillations. From this point on, the old-time cut-and-try methods were employed and marked improvements were secured. In fact, low power tubes have been made which operate at wavelengths of the order of 50 to 100 centimeters with fair stability, although quite low efficiency.

In the meantime, the production of ultra-high-frequency oscillations had been progressing in a somewhat different direction. The discovery, about 1920, by Barkhausen that oscillations of less than 100 centimeters wavelength could be secured in a tube having a symmetrical structure, when the grid was operated at a fairly high positive potential, while the plate was approximately at the cathode potential, started experiments on what was thought to be an altogether different mode of oscillation. Workers by the score have extended both the experimental technique and the theory of production of this newer type of oscillation. However, one of the results which an analysis of ultra-high-frequency electronics illustrates is that the electron type of oscillator is merely another example of the same kind of oscillation which was produced in the old-time so-called regenerative circuits.

For the purpose of extending the theory of electronics within vacuum tubes to frequencies where the time of transit of the electrons becomes comparable with the oscillation period, it is important at the outset to select an idealized picture which is simple enough to allow exact mathematical relations to be written. At the same time, the picture must be capable of adaptation to practical circuits without undue violence to the mathematics. An example of this kind of adaptation is illustrated by the classical calculation of the amplification factor  $\mu$ , which was accomplished by consideration of the force of the electrostatic field existing near the cathode in the absence of space charge even though tubes were never operated under this condition. In a like manner, such violations of the ideal must, of necessity, be made in ultra-high-frequency analysis but their practical validity lies in so choosing them that the quantitative error introduced is less than the expected precision of measurement. It becomes, therefore, of the utmost importance to state clearly the transitions which occur between results obtained for the idealized case to which the mathematics is strictly applicable and the practical circuits where the assumptions and approximations are made to conform with operating conditions.

A start has already been made on the problem of developing such a generally valid system of electronics. This was done by Benham<sup>1</sup> who considers a special case comprising two parallel-plane electrodes, one of which is an emitter and the other a collector, when conditions at the emitter are restricted by the assumption that the electrons are emitted with neither initial velocity nor acceleration. This work of Benham's has the utmost importance in a general electronic theory

<sup>1</sup> W. E. Benham, "Theory of the internal action of thermionic systems at moderately high frequencies," Part I, *Phil. Mag.*, p. 641; March, (1928); Part II, *Phil. Mag.*, vol. 11, p. 457; February, (1931).



and, in fact, the means of extending his theory exists primarily in the selection of much more general boundary conditions than were assumed by him. It will, therefore, result that some repetition of Benham's work will appear in the following pages. However, in view of the new state of the theory and the importance of accurate foundations for it, this repetition is advantageous rather than otherwise.

With these preliminary remarks in mind, the next step is the selection of the idealized starting point for a mathematical analysis. Exactly as was done by Benham we take two parallel planes of infinite extent, one of which is held at a positive potential  $V$  with respect to the other, and between the two electrons are free to move under the influence of the existing fields. The next step in the idealization constitutes the separation of alternating- and direct-current components, not only of current and potential, but also of electron velocity, charge density, and electric intensity. With this separation, the restriction that the direct-current component of the electron velocity and acceleration is zero at the negative plane may be made while leaving us free to select much more general boundary conditions for the alternating-current component. It is true that the more general conditions now proposed will not fit the original physical picture where the negative plane consists of a thermionic emitter. Nevertheless the extension is of importance since it allows application to be made to the wide number of physical cases where "virtual cathodes" are formed. One such example is the convergence of electrons toward a plate maintained at cathode potential while a grid operating at a high positive potential with respect to both is interposed between them. In a stricter mathematical sense, the broader boundary conditions come about because of the fact that the general equations containing all components are separable into a system of equations, one for each component, and that the boundary conditions for the different equations of the system are independent of each other.

The concept of an alternating-current velocity component requires a few words of explanation. In the absence of all alternating-current components, electrons leave the cathode with zero velocity and acceleration and move across to the anode with constantly increasing velocity under the well-known classical laws. This velocity constitutes the direct-current velocity component. When the alternating-current components are introduced, there will be a fluctuation in velocity superposed on the direct-current value, and the alternating-current component need not be zero at a virtual cathode. This separation of components will come about naturally in the course of the mathematical analysis which follows, but since the interpretation of the equations is

of paramount importance, a few words of explanation and repetition will be necessary.

## II. FUNDAMENTAL RELATIONS

For the development of the fundamental relations existing between the two parallel planes, we have the classical equations of the electromagnetic theory which may be set down in the following form:

$$\left. \begin{aligned} E &= -\frac{\partial V}{\partial x} \\ \frac{\partial E}{\partial x} &= 4\pi P \\ J &= PU + \frac{1}{4\pi} \frac{\partial E}{\partial t} \end{aligned} \right\} \quad (1)$$

where  $E$  is the electric intensity,  $V$  the potential,  $P$  the charge density,  $J$  the total current density consisting of conduction and displacement components, and  $U$  is the charge velocity. These equations apply to frequencies such that the time which would be taken by an electromagnetic wave in traveling between the two planes is inappreciable when compared with the period of any alternating-current frequency considered. Ordinarily this limitation will become of importance only at frequencies higher even than those in the centimeter wavelength range where the time of electron transit is of great importance, although the time of passage of an electromagnetic wave is still negligibly small.

An electron situated between the two parallel plates will be acted upon by a force which determines its acceleration. The resulting velocity is a function both of the distance,  $x$ , from the cathode and the time,  $t$ , so that in terms of partial derivatives, the equation expressing the relation between the force and acceleration is,

$$\frac{\partial U}{\partial t} + U \frac{\partial U}{\partial x} = \frac{e}{m} E. \quad (2)$$

From (1) and (2) may readily be obtained

$$\left( \frac{\partial}{\partial t} + U \frac{\partial}{\partial x} \right)^2 U = 4\pi \frac{e}{m} J. \quad (3)$$

In this equation we have a relation between the velocity and the total current density. The advantage of this form of equation for a starting point lies in the fact that the total current density  $J$  is not a function of  $x$ . This comes about because of the plane shape and parallel dis-

position of the electrodes, and the fact that current always flows in closed paths. Thus, while the current between the two planes may be a function of time, it is not a function of  $x$ .

The separation of alternating- and direct-current components may now be made. We write,

$$J = J_0 + J_1 + J_2 + \dots \quad (4)$$

with corresponding

$$\left. \begin{aligned} U &= U_0 + U_1 + U_2 + \dots \\ V &= V_0 + V_1 + V_2 + \dots \end{aligned} \right\} \quad (5)$$

where the quantities with the zero subscript are independent of time, those with subscript 1 are dependent to first order upon time, those with subscript 2 are dependent to second order, and so forth. As a result of this separation in accord with the order of dependence upon time, (3) may be split up into a system of equations, the first of which expresses the relation between  $U_0$ ,  $J_0$ , and  $x$  and does not involve time. This is the relation governing the direct-current components. The second equation of the system involves the relation between  $U_1$ ,  $J_1$ ,  $x$ , and time, and contains  $U_0$  which was determined by the first equation. Likewise, the third equation contains  $U_2$ ,  $U_1$ ,  $J_2$ ,  $x$ , and  $t$ . Since the series given by (4) and (5) are convergent so that, in general, the terms with higher order subscripts are smaller than those with lower subscripts, we may consider that, at least for small values of alternating-current components, the total fundamental frequency component is given by the terms with unity subscript.

The first two equations of the system are as follows:

$$U_0 \frac{\partial}{\partial x} \left( U_0 \frac{\partial U_0}{\partial x} \right) = 4\pi \frac{e}{m} J_0 \quad (6)$$

$$\begin{aligned} &\left( \frac{\partial}{\partial t} + U_0 \frac{\partial}{\partial x} \right) \left( \frac{\partial U_1}{\partial t} + U_0 \frac{\partial U_1}{\partial x} + U_1 \frac{\partial U_0}{\partial x} \right) \\ &+ U_1 \frac{\partial}{\partial x} \left( U_0 \frac{\partial U_0}{\partial x} \right) = 4\pi \frac{e}{m} J_1. \end{aligned} \quad (7)$$

In the solution of (6), the boundary conditions are restricted so that when  $x$  is zero, the velocity and acceleration both are zero. These restrictions mean that initial velocities are neglected, and that complete space charge is assumed. Thus the solution for  $U_0$  is

$$U_0 = \alpha x^{2/3} \quad (8)$$

where,

$$\alpha = \left( 18\pi \frac{e}{m} J_0 \right)^{1/3}. \quad (9)$$

The solution of (7) is more complicated. We assign a particular value to  $J_1$ , namely,  $J_1 = A \sin pt$  and find the corresponding value of  $U_1$ . To do this, it is convenient to change the variable  $x$  to a new variable  $\xi$ , which will be called the transit angle. This new variable is equal to the product of the angular frequency  $p$  and the time  $\tau$  which it would take an electron moving with velocity  $U_0$  to reach the point  $x$  and is given as follows:

$$\xi = p\tau = \frac{3p}{\alpha} x^{1/3}. \quad (10)$$

Upon changing the dependent variable from  $U_1$  to  $\omega$ , where  $U_1 = \omega/\xi$ , we find from (7)

$$\left( \frac{\partial}{\partial t} + p \frac{\partial}{\partial \xi} \right)^2 \omega = \xi \beta \sin pt \quad (11)$$

where,

$$\beta = 4\pi \frac{e}{m} A.$$

This has the solution

$$U_1 = -\frac{\beta}{p^2} \left[ \sin pt + \frac{2}{\xi} \cos pt + F_1(\xi - pt) + \frac{1}{\xi} F_2(\xi - pt) \right]. \quad (12)$$

This equation contains two arbitrary functions of  $(\xi - pt)$  which must be evaluated by the boundary conditions selected for  $U_1$ . Thus the boundary conditions for the alternating-current component make their first appearance.

From the form of (7) which is linear in  $U_1$ , it is evident that  $U_1$  must be a sinusoidal function of time having an angular frequency  $p$  in order to correspond with the form of  $J_1$ . It follows, then, that the most general form which can be assumed for the steady state functions  $F_1$  and  $F_2$  is as follows:

$$\left. \begin{aligned} F_1(\xi - pt) &= a \sin(\xi - pt) + b \cos(\xi - pt) \\ F_2(\xi - pt) &= c \sin(\xi - pt) + d \cos(\xi - pt) \end{aligned} \right\} \quad (13)$$

Now for the boundary conditions. As pointed out, there is no mathematical necessity for the boundary conditions imposed upon  $U_1$  to correspond with those which were imposed upon  $U_0$ . At an actual

cathode consisting of an electron emitting surface it would be appropriate to assume that the initial velocities are in no way dependent upon the current, but we shall have to deal not only with actual cathodes, but also with virtual<sup>2</sup> cathodes where the assumption of zero alternating-current velocity and acceleration is unwarranted. Such a virtual cathode might occur, for instance, between a grid operated at a positive direct-current potential and a plate nearly at cathode potential. If enough electrons came through the mesh of the grid to depress the potential until it became practically zero at some point in the space between grid and plate, the direct-current boundary conditions of zero velocity and acceleration of electrons would be fulfilled at that point. The general equations for the alternating current will therefore apply when the origin is taken at the point of direct-current potential minimum which forms the virtual cathode, and when all of the electrons which are emitted by the actual cathode pass by the virtual cathode and reach the plate. In the event that some of the electrons are turned back at the virtual cathode and move again toward the grid, as indeed they all do when the plate is at a negative potential, a change in the form of the general equation is necessary, and will be described in the sections dealing particularly with positive grid triodes. This change, however, affects merely the form of the equations and not the physical arguments underlying the selection of boundary conditions, which are the same whether all the electrons reach the plate or whether some or all of them turn back toward the grid.

If the alternating-current velocity is determined by small variations in grid potential, let us say, it is evident that no additional assumptions save the requirement that the velocity must not become infinite, may be made concerning its value at the virtual cathode. Consequently, a quite general set of boundary conditions will suffice to determine the quantities,  $a, b, c, d$ , which appear in (13) and thus completely determine  $U_1$ .

Since there are two arbitrary functions in (12), two boundary conditions will be needed. Further inspection shows that the stipulation that the alternating-current velocity be finite at the origin is sufficient to furnish one of these boundary conditions. For the other, a knowledge of the value of the alternating-current velocity at any point between the two reference planes is sufficient. Thus, if at a particular value of  $\xi$ , say  $\xi_1$ , we know that  $U_1$  is equal to  $M \sin pt + N \cos pt$ , we have enough information to calculate its value at all other points between the two planes. For example, the two reference planes might be the grid and plate of a positive grid triode. In this event, the alternating-current

<sup>2</sup> E. W. B. Gill, "A space-charge effect," *Phil. Mag.*, vol. 49, p. 933, (1925).

velocity at the grid could be calculated at the grid plane by means of conditions between there and the cathode.

In mathematical form the two boundary conditions may be set forth as follows:

when,

$$\xi = 0, \quad U_1 \text{ must be finite} \quad (14)$$

$$\xi = \xi_1 \quad U_1 = M \sin pt + N \cos pt. \quad (15)$$

From (12) and (13) these result in the values:

$$c = 0 \quad d = -2$$

$$a = \frac{p^2}{\beta} (M \cos \xi_1 - N \sin \xi_1) + \cos \xi_1 - \frac{2}{\xi_1} \sin \xi_1 \quad (16)$$

$$b = \frac{2}{\xi_1} (1 - \cos \xi_1) - \sin \xi_1 - \frac{p^2}{\beta} (M \sin \xi_1 + N \cos \xi_1). \quad (17)$$

Thence from (12) we have for the alternating-current velocity, in general

$$\begin{aligned} U_1 = & (M + iN)(\cos \xi_1 + i \sin \xi_1)(\cos \xi - i \sin \xi) \\ & + \frac{\beta}{p^2} \left[ \left\{ \left( \cos \xi_1 - \frac{2}{\xi_1} \sin \xi_1 \right) - i \left( \frac{2}{\xi_1} - \frac{2}{\xi_1} \cos \xi_1 - \sin \xi_1 \right) \right\} \right. \\ & \left. (\cos \xi - i \sin \xi) - \left( 1 - \frac{2}{\xi} \sin \xi \right) - i \frac{2}{\xi} (1 - \cos \xi) \right] \quad (18) \end{aligned}$$

where, in accord with engineering practice, complex notation is employed, so that  $\sin pt$  has been replaced by  $e^{ipt}$  and  $\cos pt$  has been replaced by  $ie^{ipt}$ , where  $i = \sqrt{-1}$ .

The first step in the derivation of fundamental relations has now been achieved. The alternating-current velocity at any point between the two planes has been expressed in terms of the alternating-current velocity,  $M + iN$ , existing at a definite value of  $x$ , say  $x_1$ , corresponding to the transit angle  $\xi_1$ .

The next step is a determination of the potentials corresponding to the velocities  $U_0$  and  $U_1$ , respectively. Thus from (1) and (2)

$$-\frac{e}{m} \frac{\partial V}{\partial x} = \frac{\partial U}{\partial t} + U \frac{\partial U}{\partial x} \quad (19)$$

and then with the separation of components as given by (5)

$$-\frac{e}{m} \frac{\partial V_0}{\partial x} = U_0 \frac{\partial U_0}{\partial x} \quad (20)$$

$$-\frac{e}{m} \frac{\partial V_1}{\partial x} = \frac{\partial U_1}{\partial t} + \frac{\partial}{\partial x} (U_0 U_1). \quad (21)$$

The solution of (20) is

$$V_0 = -\frac{m}{2e} U_0^2 = -\frac{m}{2e} \alpha^2 x^{4/3} \quad (22)$$

which is the well-known classical relation between the potential, the current, and the position between two parallel planes where complete space charge exists. The complete space-charge condition is postulated by the boundary conditions selected for  $U_0$  and the implications involved are discussed by I. Langmuir and Karl T. Compton.<sup>3</sup>

The alternating-current component of the potential is obtained by integration of (21) as follows:

$$-\frac{e}{m} V_1 = \frac{\partial}{\partial t} \int U_1 dx + U_0 U_1 + f(t) \quad (23)$$

whence, from (18), and in complex notation

$$\begin{aligned} V_1 = & -\frac{2m}{e} \frac{\alpha^3}{9p^2} (M + iN) (\cos \xi_1 + i \sin \xi_1) [(\xi \sin \xi + \cos \xi) \\ & + i(\xi \cos \xi - \sin \xi)] \\ & - \frac{2m\alpha^3\beta}{e9p^4} \left[ \left\{ \left( \cos \xi_1 - \frac{2}{\xi_1} \sin \xi_1 \right) - i \left( \frac{2}{\xi_1} - \frac{2}{\xi_1} \cos \xi_1 - \sin \xi_1 \right) \right\} \right. \\ & \left. [(\xi \sin \xi + \cos \xi) + i(\xi \cos \xi - \sin \xi)] \right. \\ & \left. - \cos \xi - i \left( \xi + \frac{1}{6}\xi^3 - \sin \xi \right) \right] + \text{constant}. \quad (24) \end{aligned}$$

With the attainment of (24), the fundamental relation between the alternating-current component  $J_1$  and the alternating-current potential  $V_1$  in the idealized parallel plate diode has been secured. In a more general sense the equation is applicable between any two fictitious parallel planes where one is located at an origin where the boundary conditions for  $U_0$  are satisfied; namely, that the direct-current components of the velocity and acceleration are zero, and the value of the alternating-current velocity at a point,  $x_1$ , corresponding to the transit angle,  $\xi_1$ , is given by  $M \sin pt + N \cos pt$ , or by  $M + iN$  in complex notation.

<sup>3</sup> I. Langmuir and Karl T. Compton, "Electrical discharges in gases—Part II," *Rev. Mod. Phys.*, vol. 3, p. 191; April, (1931).

Equation (24) contains an additive constant which always appears in potential calculations. This constant disappears when the potential difference is computed. For instance, suppose the potential difference between planes where  $\xi$  has the values  $\xi$  and  $\xi'$ , respectively, is desired. We have

$$V_1 = f(\xi) + \text{constant}$$

$$V_1' = f(\xi') + \text{constant}$$

so that,

$$V_1 - V_1' = f(\xi) - f(\xi'). \quad (24-a)$$

Since the potential difference is always required rather than the absolute potential, (24-a) gives the means for applying (24) to actual problems.

### III. APPLICATION TO DIODES

In the application of the fundamental relations to diodes where the thermionic emitter forms the plane located at the origin and the anode coincides with the other plane, the boundary condition is that  $U_1$  shall be zero at the cathode. This means that both  $M$  and  $N$  are zero and that  $\xi_1$  is also zero. The resulting forms taken by (18) and (24-a), respectively, are as follows:

$$U_1 = -\frac{\beta}{p^2} \left[ \left( 1 + \cos \xi - \frac{2}{\xi} \sin \xi \right) + i \left( \frac{2}{\xi} - \sin \xi - \frac{2}{\xi} \cos \xi \right) \right] \quad (25)$$

$$V_1 - V_1' = \frac{2m\alpha^3\beta}{e9p^4} \left[ (2 \cos \xi + \xi \sin \xi - 2) + i(\xi + \frac{1}{6}\xi^3 - 2 \sin \xi + \xi \cos \xi) \right]. \quad (26)$$

These two equations are identical with those obtained by Benham,<sup>1</sup> and graphs are given in Figs. 1 and 2 showing their variation as a function of the transit angle  $\xi$ . In particular, the equivalent impedance between unit areas of the two parallel planes may be found from (26). It must be remembered that the current,  $A$ , was assumed positive when directed away from the origin. Hence, we may write

$$Z = -\frac{V_1 - V_1'}{A}. \quad (27)$$

Moreover, the coefficient outside the square brackets in the equation may be expressed more simply when it is realized that the low-frequency internal resistance of a diode is given by the expression

$$r_0 = -\frac{\partial V_0}{\partial J_0}, \quad (28)$$



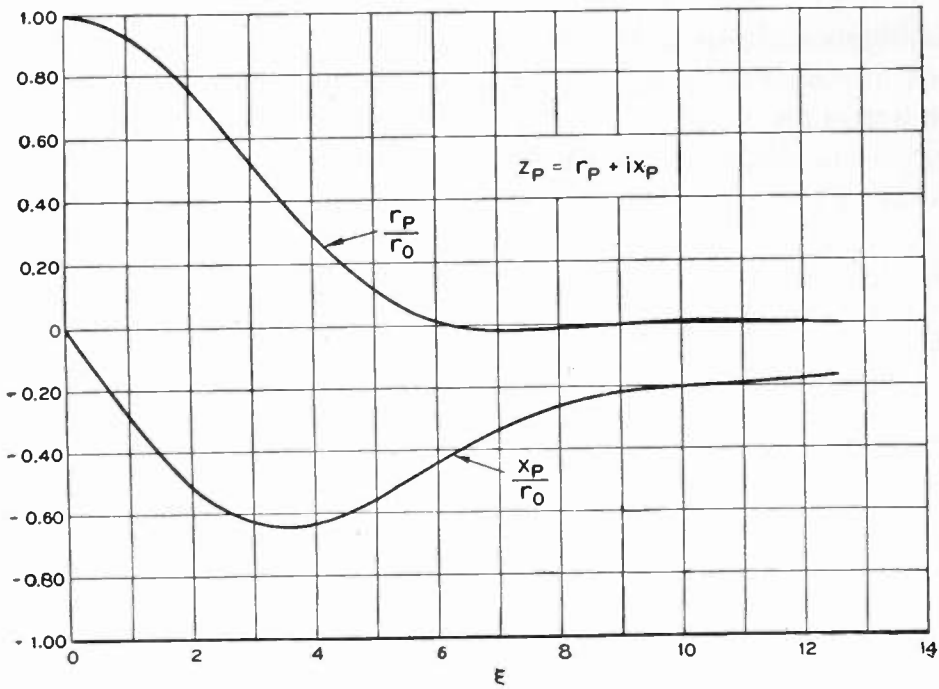

Fig. 1—Plate impedance of diodes or of negative grid triodes as a function of electron transit angle.

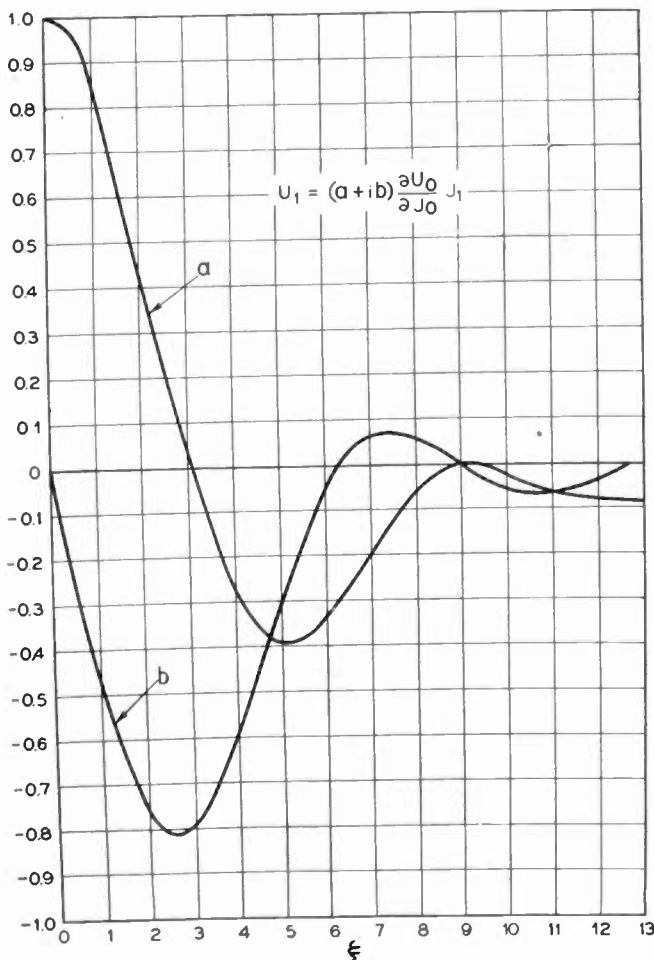

Fig. 2—Electron velocity fluctuation in diodes versus transit angle.

the minus sign again appearing because of the assumed current direction. Consequently, under the condition of complete space charge, we have from (22)

$$\frac{2m\alpha^3\beta}{e9p^4} = \frac{12r_0A}{\xi^4} \quad (29)$$

In addition to the graphs in Figs. 1 and 2 showing the real and imaginary components of impedance and velocity, the graphs shown in Figs. 3 and 4 give their respective magnitudes and phase angles.

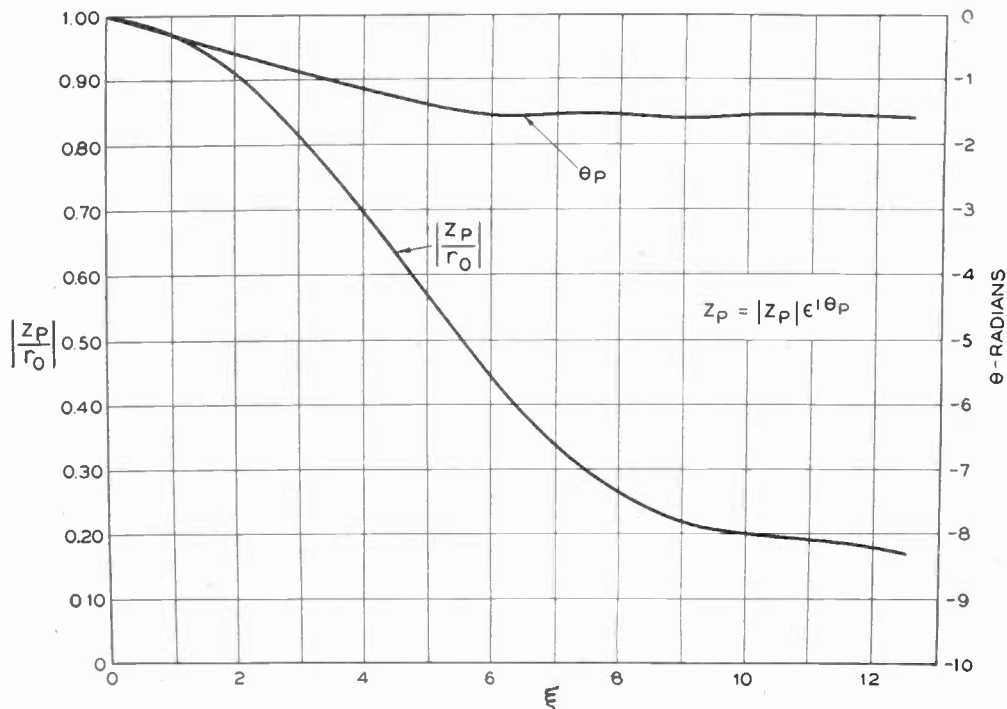

Fig. 3—Magnitude and phase angle of plate impedance of diodes or of negative grid triodes versus transit angle.

The impedance charts show a negative resistance for diodes in the neighborhood of a transit angle,  $\xi$ , of 7 radians. The possibility of securing oscillations in this region has been discussed by Benham, so that only a few additional remarks will be made here.

The magnitude of the ratio of reactance to resistance is about 15 when the transit angle is 7 radians. This means that oscillation conditions require an external circuit having a larger ratio of reactance to resistance. On account of the high value of reactance required, a tuned circuit or Lecher-wire system is needed, which would have to operate near an antiresonance point in order to supply the high reactance value. But the resistance component of the external circuit impedance is large at frequencies in the neighborhood of the tuning point, so that the ratio of reactance to resistance is small. Calculations show that

the possibility of securing external circuits having low enough losses to meet the oscillation requirements of most of the diodes which are at present available is not very favorable. The large radio-frequency loss in the filamentary cathodes with which many tubes are supplied is an additional obstacle to be overcome before satisfactory ultra-high-frequency operation of diodes can be expected.

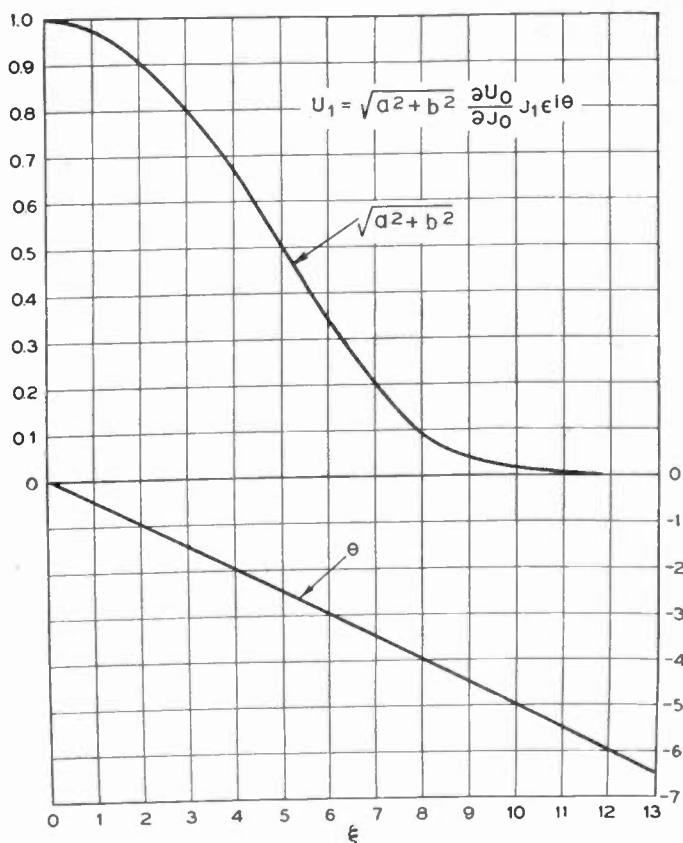

Fig. 4—Magnitude and phase angle of electron velocity fluctuation in diodes versus transit angle.

#### IV. TRIODES WITH NEGATIVE GRID AND POSITIVE PLATE

In the application of the fundamental relations to triodes operating with the grid at a negative potential, the problem becomes more complicated because of the several current paths which exist within the tube. Moreover, the direct-current potential distribution is disturbed in a radical way by the presence of the negative grid. In fact, the negative grid triode in some respects offers greater theoretical difficulty than does the positive grid triode, which is treated in the next section. However, because of the greater ease in the interpretation of the results in terms which have become familiar through years of use, the negative grid triode is treated first.

In the analysis recourse must be had to approximations and idealizations which allow the theory to fit the practical conditions. In the selection of these, the first thing to notice is that no electrons reach the grid, so that most of the electrostatic force from the grid acts on electrons quite near the cathode, where the charge density is very great. The most prominent effect of a change in grid potential will thus be a change in the velocity of electrons at a point quite near the cathode. It will thus be appropriate to assume as a starting point that the alternating-current velocity at a point  $x_1$ , located quite near the cathode is directly proportional to the alternating-current grid potential,  $V_g$ , so that we may write

$$\begin{aligned} \xi &= \xi_1, \\ \text{when,} \quad U_1 &= (M + iN) = kV_g. \end{aligned} \quad (30)$$

In any event, this relation may be justified if the factor of proportionality,  $k$ , be allowed to assume complex values, and  $\xi_1$  is not taken too near the origin. Actually, the electron-free space surrounding the grid wires, and the fact that the electric intensity at a point midway between any two of the wires is directed perpendicularly to the plane of the grid, gives us more confidence in extending the approximation, so that  $k$  will be regarded as real, and  $\xi_1$  will be taken very small.

Equation (24) may, therefore, be applied under the conditions that  $\xi_1 \rightarrow 0$ , and gives the following for the potential difference between plate and cathode:

$$\begin{aligned} V_p = -\frac{12r_0A}{\xi^4} & \left[ (\xi \sin \xi + 2 \cos \xi - 2) + i(\xi + \frac{1}{6}\xi^3 - 2 \sin \xi + \xi \cos \xi) \right. \\ & \left. - (M + iN) \frac{p^2}{\beta} [(\xi \sin \xi + \cos \xi - 1) - i(\sin \xi - \xi \cos \xi)] \right]. \end{aligned} \quad (31)$$

This equation may be written in condensed form with the aid of (30)

$$V_p = J_1(r + ix) - V_g(\mu + i\nu) \quad (32)$$

where,

$$\left. \begin{aligned} r &= -\frac{12r_0}{\xi^4} (\xi \sin \xi + 2 \cos \xi - 2) \\ x &= -\frac{12r_0}{\xi^4} (\xi + \frac{1}{6}\xi^3 - 2 \sin \xi + \xi \cos \xi) \\ \mu &= \frac{2\mu_0}{\xi^2} (\xi \sin \xi + \cos \xi - 1) \\ \nu &= \frac{2\mu_0}{\xi^2} (\xi \cos \xi - \sin \xi) \end{aligned} \right\} \quad (33)$$

The significance of (32) is at once apparent when it is compared with the classical form of the equation representing the alternating-current plate voltage, namely,

$$V_p = I_p r_0 - \mu V_g.$$

The plate resistance  $r_0$  has now become complex as likewise has the amplification factor  $\mu$ . Values of the plate impedance

$$z_p = r + ix$$

are the same as those obtained for the diode and are plotted in Figs. 1 and 3. Values of the amplification factor

$$\sigma = \mu + iv ]$$

are shown in Figs. 5 and 6.

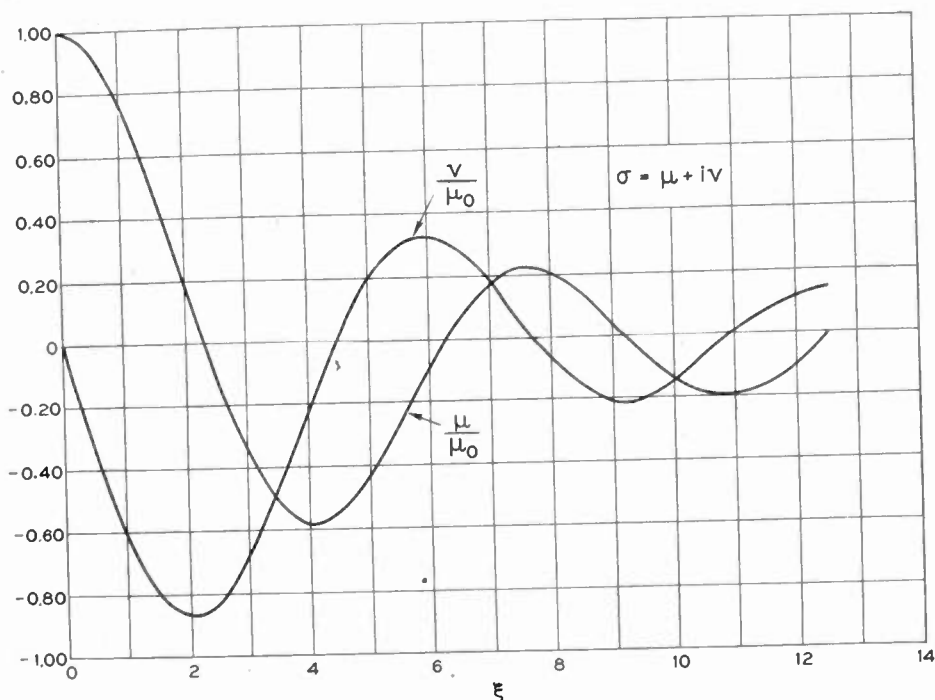

Fig. 5—Real and imaginary components of complex amplification factor of negative grid triodes versus transit angle.

It is evident that radical changes in the phase angles existing between the grid voltage and plate current are present when the transit time becomes appreciable in comparison with the period of the applied electromotive force. The plate impedance decreases in magnitude as also does the magnitude of the amplification factor. However, the ratio of the two, namely,  $\sigma/z$ , maintains a fairly constant magnitude as shown in Fig. 7, whose phase angle nevertheless rotates continually in a negative direction becoming equal to 3 radians when  $\xi$  is  $2\pi$ .

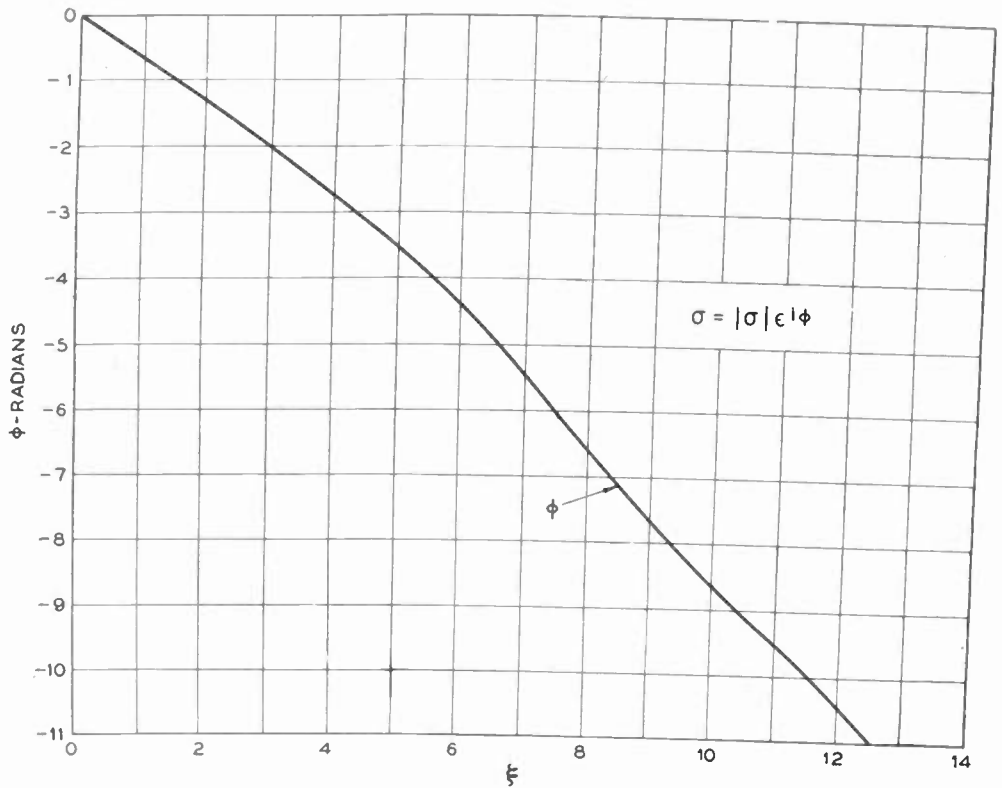

Fig. 6—Phase angle of amplification factor of negative grid triodes versus transit angle.

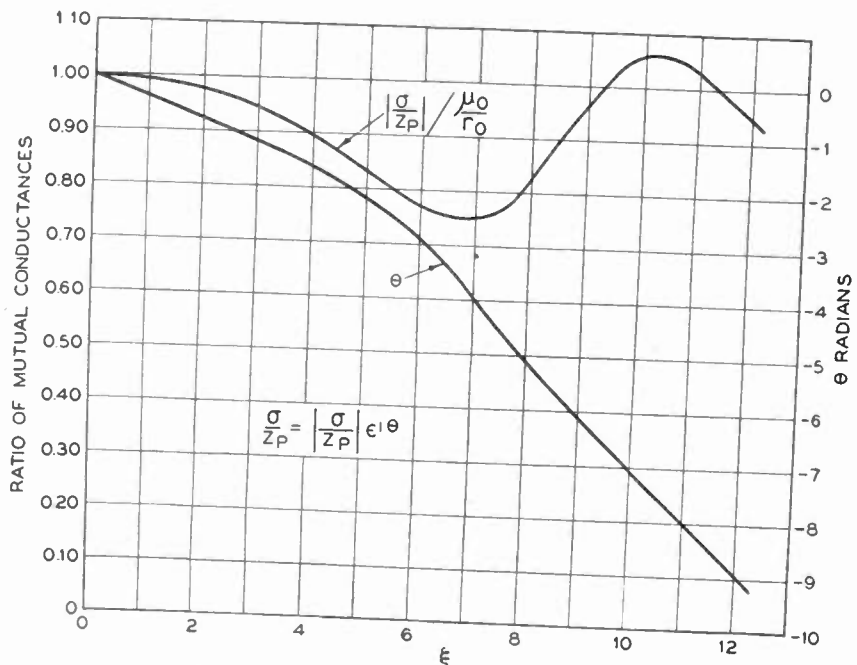

Fig. 7—Magnitude of complex mutual conductance of negative grid triodes versus transit angle.

The interelectrode capacity between cathode and plate is included in the fundamental relations here employed. This inclusion exhibits one important difference between (29) and the classical case. At low frequencies, the equivalent circuit represented by (32) degenerates into that shown on Fig. 8. The capacity branch exists in parallel with the resistive branch and they are both in series with the effective generator  $\sigma e_g$ , whereas in the classical picture the capacity branch shunts the effective generator and plate resistance which are in series with each other. Practically the difference between the two equivalent circuits is negligible except at extremely high frequencies. The following physical viewpoint supports the newer picture.

As pointed out, the action of the grid is exerted mostly on the region of dense space charge existing very near the cathode and variations in the grid potential act on the velocities of the emerging elec-

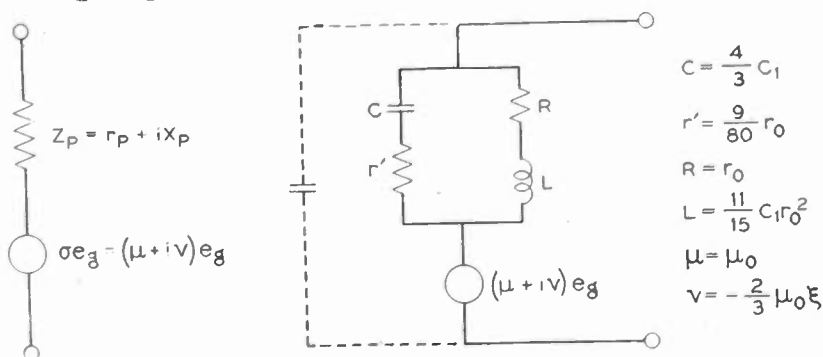

Fig. 8—Equivalent network of plate-cathode path of negative grid triodes for transit angles less than 0.3 radian.

trons, thus producing the equivalent generator of the plate circuit. The plate current consists of conduction and displacement components whose sum is the same at all points in the cathode-plate path. Near the cathode, the conduction component comprises the whole current because of the high charge density and the effective generator acts in series with this current and hence in series with the path of the displacement current into which the character of the total current gradually changes as the plate is approached.

Strictly speaking, the equivalent circuit corresponding to (32) exists, not between the plate and cathode, but between the plate and the potential minimum near the cathode which is caused by the finite velocities with which electrons are emitted from the cathode. Practically, the difference is negligible except at extremely high frequencies. Since the impedance between the cathode and potential minimum is small compared to the plate impedance, its effect is merely to add a loss to the system which increases with frequency since the plate impedance approaches a capacity as the frequency approaches infinity.

The grid cathode path presents less difficulty, although a somewhat less rigorous treatment is given here. As pointed out, the force from the grid acts on the high charge density region existing near the potential minimum. The impedance between cathode and grid, therefore, consists of two parts in series; namely, capacity between grid and potential minimum and impedance between potential minimum and cathode, the latter part of this impedance being common both to plate- and grid-current paths.

If we were to connect the grid and cathode terminals of such a triode to a capacity bridge and measure the capacity existing there when the tube was cold and when the cathode was heated, we should find that the capacity would exhibit a slight increase in the latter case. The reason for this increase may best be explained by noting that in the cold condition the electrostatic force from the grid is exerted on the cathode itself, whereas in the heated state, the force acts on the electrons near the potential minimum, thus resulting in an increased capacity in series with a resistive component.

In some measurements of the losses in coils which were made at a frequency of 18 megacycles, J. G. Chaffee of these Laboratories has found that a loss existed between grid and cathode of vacuum tubes which was much greater than can be accounted for by any of the dielectrics used and which was present only when the tube filament was hot. This loss increased with frequency in the manner characteristic of that of the capacity-resistance combination between cathode and grid which was described above. Present indications are that, at least in part, the loss may be ascribed to the resistance existing between the cathode and the region of potential minimum.

Of the three current paths through the tube, one more still remains to be considered. This is the grid-plate path. The relations involved here are more readily seen by considering first a low-frequency example. Here the electron stream passes through the spaces between grid wires, afterward diverging as the plate is approached. Electrostatic force from the grid acts not only on the plate but also on the electrons in the space between. It is evident, then, that the path which, when the cathode was cold, constituted a pure capacity changes into an effective capacity different from the original in combination with a resistive component. The losses would be expected to increase with frequency just as they did in the grid-cathode type. The change in grid-plate impedance is particularly noticeable when it is attempted to adjust balanced or neutralized amplifier circuits with the filament cold, in which case the balance is disturbed when the cathode is heated.

As yet, no accurate expression for this grid-plate impedance has



been obtained, either at the low frequencies where transit times are negligible or at the higher frequencies now particularly under investigation. The reason for this lies in the repelling force on the electron stream of the negative grid so that the assumption of current flow in straight parallel lines is not valid in so far as current from the grid to the plate is involved.

It has been shown that both the cathode-grid path and the grid-plate path contain resistive components with corresponding losses which increase with increase of frequency. This loss may be cited as a reason why triodes with negative grids cease to oscillate at the higher frequencies. If it were not for these losses, external circuits could be attached to the tube having such phase relations as to satisfy oscillation conditions, so that the negative grid triode could be utilized in the range which is now covered by the triode with positive grid.

#### V. TRIODES WITH POSITIVE GRID AND SLIGHTLY POSITIVE PLATE

When the grid of a three-element tube is operated at a high positive potential with respect both to cathode and plate, electrons are attracted toward the grid, and the majority of them are captured on their first transit. Those which pass through the mesh and journey toward the plate will be captured by the plate if its potential is sufficiently positive with respect to the cathode.

In general, space-charge conditions existing between grid and plate are quite complicated. An analysis has been made by Tonks<sup>4</sup> which indicates several distinct classes of space-charge distribution which are possible. In the first place so few electrons may pass the grid mesh that no appreciable space charge is set up between there and the plate. In this instance a positive plate will trap them all, whereas a negative plate will return them all toward the grid. Second, with a fixed positive plate potential an increase in the number of electrons which pass the grid mesh will result in a depression of the potential distribution as illustrated at (a) by the curves in Fig. 9. This depression will continue to increase until a potential minimum is formed. When this potential minimum becomes nearly the same as that of the cathode, either of several things may occur. If the minimum is just above the cathode potential, all electrons will pass that point and eventually reach the plate. However, an extremely small increase in the number of electrons will cause the potential minimum to become equal to the cathode potential. When this happens some of the electrons will be turned back and travel again toward the grid. These will increase the charge den-

<sup>4</sup> L. Tonks, "Space charge as a cause of negative resistance in a triode and its bearing on short-wave generation," *Phys. Rev.*, vol. 30, p. 501; October, (1927).

sity existing and, therefore, cause a further depression in the potential resulting in a mathematical discontinuity so that the curve of the potential suddenly changes its shape with a resulting change in plate current. Again, the plate may be operated at a negative potential. In this case, none of the electrons will reach it and the potential distribution curves have the character illustrated at (c) and (d) in Fig. 9.

In attempting to apply the fundamental relations to this grid-plate region, we must choose our origin at a point where the potential distribution curve touches the zero axis and is tangent to it. Whenever such a point exists, the relations may be applied as described below. Even when this condition does not exist inside the vacuum tube, there may be a virtual cathode existing outside of the plate.

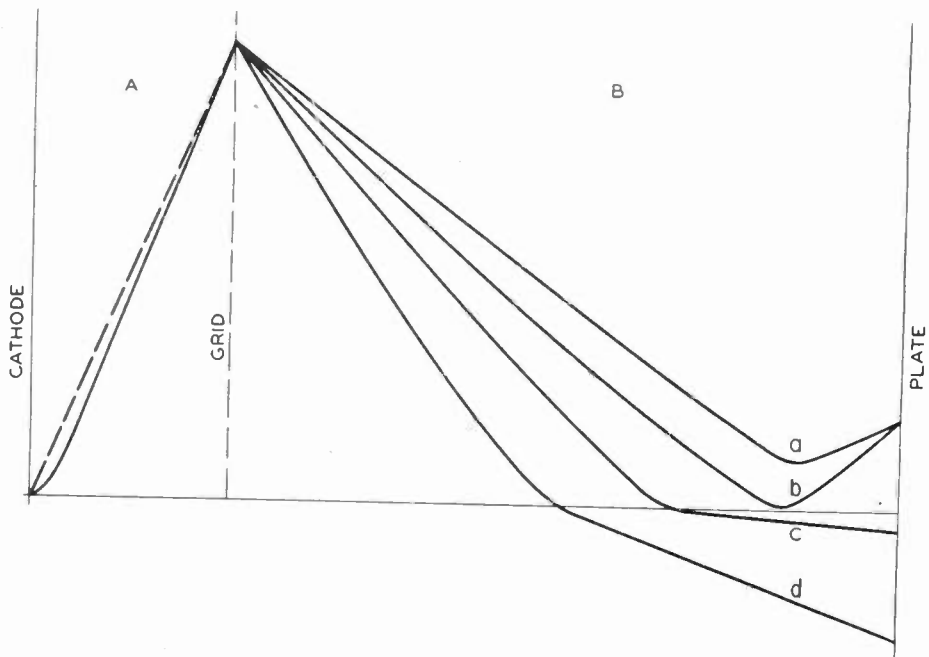

Fig. 9—Potential distributions in positive grid triodes.

Whenever all of the electrons passing the grid reach the plate the general equations may be applied in a straightforward manner with the origin taken at the virtual cathode. Whenever some of the electrons are turned back toward the grid, slightly different equations are required, although they may be applied in the same manner. These modified equations will be derived and discussed after the application of the equations already derived has been made to the case where all of the electrons reach the plate.

Choosing the origin for this latter case at the point of zero potential or virtual cathode, we can compute the impedance between the grid-plane and the virtual cathode when we know the alternating-current velocities with which the electrons pass through the grid-plane. This

has been found for the condition of complete space charge between cathode and grid and was given by (25). Likewise, it can be found on the supposition that no space charge exists in the cathode-grid region and the result will be calculated later. Thus, two limiting cases are available for numerical application.

In order to prevent confusion for the grid—virtual-cathode region where the electron flow is toward the origin rather than away from it, as was assumed in the derivation of the fundamental relations, it will be convenient to change the symbol for transit angle from  $\xi$  to  $\zeta$ . This will automatically take care of all algebraic signs, currents and velocities now being considered positive when directed towards the origin.

Since we are computing the impedance between an origin at the virtual cathode and the grid plane we may apply (24) to find the potential difference, getting

$$V_1 - V_1' = \left( \frac{2m}{e} \frac{\alpha^3}{9p^2} \right) (M + iN) [(1 - \cos \zeta) + i(\zeta - \sin \zeta)] \\ - i \left( \frac{2m}{e} \frac{\alpha^3 \beta}{9p^4} \right) \left( \frac{1}{6} \zeta^3 - \frac{4}{\zeta} (1 - \cos \zeta) + 2 \sin \zeta \right) \quad (34)$$

where  $V_1'$  is the potential at the virtual cathode.

This relation is of the form

$$V_o - V_p = (M + iN) \left( \frac{2m}{e} \frac{\alpha^3}{9p^2} \right) [(1 - \cos \zeta) + i(\zeta - \sin \zeta)] + J_p Z_p \quad (35)$$

where  $J_p$  is the plate current, and  $Z_p$  is the effective impedance:

$$Z_p = -i \left( \frac{2m}{e} \frac{\alpha^3 \beta}{9p^4 A} \right) \left( \frac{1}{6} \zeta^3 - \frac{4}{\zeta} (1 - \cos \zeta) + 2 \sin \zeta \right). \quad (36)$$

In terms of the cold capacity  $C_1$  between plate and grid plane this becomes

$$Z_p = -\frac{i}{pC_1} \frac{6}{\zeta^3} \left[ \frac{1}{6} \zeta^3 - \frac{4}{\zeta} (1 - \cos \zeta) + 2 \sin \zeta \right]$$

which is plotted in Fig. 10.

The form of (35) shows that the equivalent network between the plane of the grid and the plate may be represented by an equivalent generator acting in series with the impedance,  $Z_p$ . This is evidenced by the fact that the velocity  $M + iN$  with which the electrons pass the grid, may be expressed in terms of the grid potential  $V_o$  by means of conditions between the grid and cathode. When complete space

charge exists near the cathode, these conditions are expressed by (25) and (26). On the other hand, tubes with positive grid are sometimes operated with inappreciable space charge between grid and cathode. In this event, a similar analysis leads to values for the alternating-current velocity and potential at the grid as follows:

$$U_1 = M + iN = -\frac{\beta}{p^2} \left[ \left( \frac{\eta - \sin \eta}{\eta} \right) + i \left( \frac{1 - \cos \eta}{\eta} \right) \right] \quad (37)$$

$$V_o = i \frac{4\pi x}{p} A = \frac{iA}{pC} \quad (38)$$

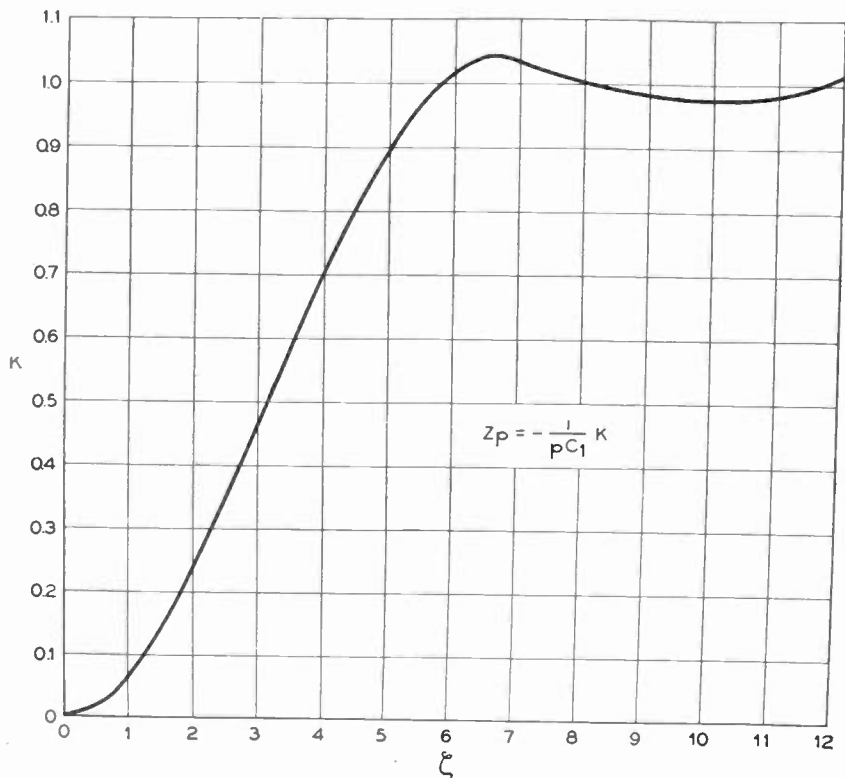

Fig. 10—Plate impedance of positive grid triodes with slightly positive plate.

where  $\eta$  is the transit angle in the absence of space charge, and  $C$  is the electrostatic capacity between unit area of cathode and of grid plane. The right-hand side of (38) does not contain a minus sign because of the assumed current direction which is away from the cathode, as is also the convention employed in (25) and (26) where the electron charge  $e$  is a positive number.

The relations given by (35) allow the potential difference between grid and plate to be determined in terms of the total current flowing to the plate, and the total current flowing from the cathode, which appears in the velocity factor  $M + iN$ . In the usual case some of the alter-

nating current flows to the grid wires and is returned through an external circuit connected to the grid. If the impedance between grid and plate is desired it is necessary to find the relation which this grid current bears to the total cathode and plate currents and to the alternating-current potentials. The calculations involved are extremely complicated because the assumption of current flow in straight lines between parallel planes is far from representing the actual conditions in the immediate neighborhood of the grid wires. Rather than attempting an analysis of these conditions at the present time, we shall content ourselves with results already obtained, since they are applicable to the special case, which can be realized approximately in experiment, where the grid is connected to a radio-frequency choke coil of sufficiently good characteristics to prevent it from carrying away any alternating current. For this special case the current  $J_1$  is the same both in the cathode region and in the plate region, and all encumbering assumptions involving different paths for the conduction and displacement components of the current in the neighborhood of the grid wires have been done away with.

The application of the equations to this special case is dealt with in the section of this paper devoted to positive grid oscillators. Before these oscillators can be treated comprehensively, a further extension of fundamental theory is necessary. This extension comes about because positive grid oscillators are often operated with a slightly negative potential applied to the plate.

## VI. TRIODES WITH POSITIVE GRID AND NEGATIVE PLATE

When consideration is directed to tubes operating with positive grid but negative plate, the fundamental underlying theory must again be investigated. The reason for this lies in the fact that all electrons which penetrate through the meshes of the grid are turned back before they reach the plate, so that in the grid-plate space there are two streams of electrons moving in opposite directions. The effect of this double value for the velocity may readily be calculated in so far as direct-current components, only, are concerned. We have merely to note that the charge density is double the value which it would have in the presence of those electrons which are moving in one direction, only, so that the correct relations are obtained from the equations already derived by taking twice the value of direct current in one direction.

When alternating-current components are considered, however, matters are more complicated, but not difficult. To see what the actual relations are, let there be two possible values at any point for the in-

stantaneous velocity, and call these two values  $U_a$  and  $U_b$ , respectively. Then the relation between force and acceleration becomes

$$\frac{eE}{m} = \frac{dU_a}{dt} = \frac{dU_b}{dt} \quad (39)$$

Hence, at a given value of  $x$  we have by integration

$$U_a = U_b + \text{constant.}$$

But, when both values of velocity are separated into their components according to (5) we have from (39)

$$U_{a0} + U_{a1} + \dots = U_{b0} + U_{b1} + \dots + \text{constant.}$$

By equating corresponding terms, we find

$$\left. \begin{aligned} U_{a0} &= U_{b0} + \text{constant} \\ U_{a1} &= U_{b1} \\ U_{a2} &= U_{b2}, \text{ etc.} \end{aligned} \right\} \quad (40)$$

The first of these equations is trivial when the boundary conditions are inserted, for then it appears that  $U_{a0} = -U_{b0}$  and the equation merely states that at a given value of  $x$  the direct-current velocity component is not a function of time.

The second equation is much more enlightening and tells us that although two values of the direct-current velocity may be present, nevertheless there is only a single value for the alternating-current component. The same conclusion holds for the higher order velocity components. This conclusion supplies the key for the solution of the general equations when applied to the stream of electrons moving in both directions between the grid and plate of the tube.

In general, the total current may be written

$$J = P_a U_a + P_b U_b + \frac{1}{4\pi} \frac{\partial E}{\partial t} \quad (41)$$

If  $\Sigma$  is the total area of each of the electrode planes and

$$\Sigma = a + b$$

where  $a$  and  $b$  are constants to be defined later, (41) may be written as follows

$$J\Sigma = \left( P_a U_a \frac{\Sigma}{a} + \frac{1}{4\pi} \frac{\partial E}{\partial t} \right) a + \left( P_b U_b \frac{\Sigma}{b} + \frac{1}{4\pi} \frac{\partial E}{\partial t} \right) b. \quad (42)$$

In this expression, the two streams of current are clearly separated if

$a$  and  $b$  are taken so that<sup>5</sup>

$$P_a \frac{\Sigma}{a} = P \text{ and } P_b \frac{\Sigma}{b} = P \quad (43)$$

where  $P$  is the total charge density, equal to the sum of  $P_a$  and  $P_b$ .

The total current may now be expressed in terms of velocities, only, giving similarly to the transition from (1) to (3),

$$4\pi \frac{e}{m} J\Sigma = a \left( U_a \frac{\partial}{\partial x} + \frac{\partial}{\partial t} \right)^2 U_a + b \left( U_b \frac{\partial}{\partial x} + \frac{\partial}{\partial t} \right)^2 U_b. \quad (44)$$

When  $U_a$  and  $U_b$  are each separated into their components according to (5), so that (44) may be resolved into a system of equations, we have for the first two equations, analogous to (6) and (7),

$$4\pi \frac{e}{m} J_0 \Sigma = (a - b) \left[ U_0 \frac{\partial}{\partial x} \left( U_0 \frac{\partial U_0}{\partial x} \right) \right] \quad (45)$$

and,

$$\begin{aligned} \beta \Sigma = & (a+b) \left[ U_0 \frac{\partial}{\partial x} \left( U_0 \frac{\partial U_1}{\partial x} + U_1 \frac{\partial U_0}{\partial x} \right) + \frac{\partial^2 U_1}{\partial t^2} + U_1 \frac{\partial}{\partial x} \left( U_0 \frac{\partial U_0}{\partial x} \right) \right] \\ & + (a-b) \left[ U_0 \frac{\partial}{\partial x} \left( \frac{\partial U_1}{\partial t} \right) + \frac{\partial}{\partial t} \left( U_0 \frac{\partial U_1}{\partial x} + U_1 \frac{\partial U_0}{\partial x} \right) \right] \end{aligned} \quad (46)$$

where the components of  $U_b$  have been expressed in terms of those of  $U_a$  by means of (40) and the relation that  $U_{b0} = -U_{a0}$ .

The solution of (45) is, as before,

$$U_0 = \alpha x^{2/3} \quad (47)$$

where,

$$\alpha = \left( 18\pi \frac{e}{m} J_{0a} \frac{\Sigma}{a} \right)^{1/3}.$$

Before attempting to solve (46) we make a change of variable as in (10), writing

$$\xi = \frac{3p}{\alpha} x^{1/3} \text{ and } U_1 = \frac{\omega}{\xi}.$$

This gives from (46)

$$\beta \Sigma = \left[ \frac{p^2}{\xi} \frac{\partial^2 \omega}{\partial \xi^2} + \frac{1}{\xi} \frac{\partial^2 \omega}{\partial t^2} \right] \Sigma + (a - b) \left( \frac{2p}{\xi} \frac{\partial^2 \omega}{\partial \xi \partial t} \right). \quad (48)$$

<sup>5</sup> A more rigorous analysis, involving mean values of the motions of individual electrons, leads to the same result.

In finding a solution for this, we shall restrict ourselves to the case where all of the electrons turn back at the virtual cathode, so that  $a=b$  and therefore the last term of (48) vanishes. The solution of the remaining equation is then,

$$U_1 = -\frac{\beta}{p^2} \left[ \sin pt + \frac{1}{\xi} F_1(i\xi + pt) + \frac{1}{\xi} F_2(i\xi - pt) \right] \quad (49)$$

which is analogous to (12).

Again, assuming the two arbitrary functions to have the form,

$$\left. \begin{aligned} F_1(i\xi + pt) &= a \sin(i\xi + pt) + b \cos(i\xi + pt) \\ F_2(i\xi - pt) &= c \sin(i\xi - pt) + d \cos(i\xi - pt) \end{aligned} \right\} \quad (50)$$

and inserting the boundary conditions, (14) and (15), we have, in complex form,

$$U_1 = (M + iN) \frac{\xi_1}{\xi} \frac{\sinh \xi}{\sinh \xi_1} - \frac{\beta}{p^2} \left( 1 - \frac{\xi_1}{\xi} \frac{\sinh \xi}{\sinh \xi_1} \right) \quad (51)$$

which is a simpler equation than its analogue (18). The potential is obtained as in (24) giving,

$$\begin{aligned} V_1 = & - \left( \frac{\alpha^3 m}{9p^2 e} \right) (M + iN) \frac{\xi_1}{\sinh \xi_1} \left[ \xi \sinh \xi + i(\xi \cosh \xi - \sinh \xi) \right] \\ & + \frac{\alpha^3 m \beta}{9p^4 e} \left[ \left( \xi^2 - \frac{\xi_1 \xi \sinh \xi}{\sinh \xi_1} \right) \right. \\ & \left. + i \left( \frac{\xi^3}{3} - \frac{\xi_1}{\sinh \xi_1} (\xi \cosh \xi - \sinh \xi) \right) \right] + \text{constant.} \quad (52) \end{aligned}$$

The alternating-current potential difference between the grid and the virtual cathode where all of the electrons are turned back may be obtained immediately from (52). As before, the variable  $\zeta$  will be substituted for  $\xi$  to show that the grid-plate region is considered, and currents and velocities will be considered positive when directed towards the origin at the virtual cathode. Thus, from (52)

$$\begin{aligned} V_g - V_p = & - \frac{\alpha^3 m}{9p^2 e} (M + iN) \left[ \zeta^2 + i(\zeta^2 \coth \zeta - \zeta) \right] \\ & + \frac{\alpha^3 m \beta}{9p^4 e} i \left[ \frac{\zeta^3}{3} - \zeta^2 \coth \zeta + \zeta \right]. \quad (53) \end{aligned}$$

The velocity,  $(M + iN)$  may be expressed in terms of the alternating-current grid potential,  $V_g$ , so that the path between grid plane and



virtual cathode may be represented by an effective generator in series with an impedance, as was done in (34), (35), and (36).

## VII. OSCILLATION PROPERTIES OF POSITIVE GRID TRIODES

The oscillation properties of the positive grid triode are next to be investigated. In the usual experimental procedure, an external high-frequency circuit is connected between the grid and the plate of the tube. It is unfortunate that this particular arrangement greatly complicates the theoretical relations. Accordingly, a slightly modified experimental set-up will be considered. This modification consists in connecting the external circuit between the cathode and plate of the tube, rather than between grid and plate. Experimental tests have shown that the modified circuit exhibits the same general phenomena as the more usual one, the difference being mainly one of mechanical convenience in securing low-loss leads between the tube and the external circuit.

The modified circuit, then, will be employed for analysis, and the assumption will be made that the necessary direct-current connections are made through chokes which are sufficiently good so that it may be considered that no external high-frequency impedance is connected between either the grid and the plate, or between the cathode and the grid.

It is easy to see that under these conditions there can be no high-frequency current carried away by the grid. It follows that for plane-parallel structures, the alternating-current density,  $J_1$ , will be the same both in the cathode-grid region and in the grid-plate region. The arrangement thus reduces the problem to the consideration of the single current,  $J_1$ , and the resulting potential difference between cathode and plate.

There are several possible combinations of direct-current biasing potentials. For the first of these, the plate will be supposed to be biased at a potential sufficiently positive to collect all electrons which are not captured by the grid on their first transit. Complete space charge will be assumed both in the cathode region and in the plate region.

Under these conditions, we have the grid-cathode potential difference given by (26) and the grid-plate potential difference given by (35), where the velocity,  $M + iN$ , is given by (25). We can write,

$$\begin{aligned} V_p - V_c &= (V_p - V_o) + (V_o - V_c) \\ &= - [\text{Eq. 35}] + [\text{Eq. 26}]. \end{aligned} \tag{55}$$

It will be remembered that the current was assumed to be positive in (26) when directed away from the origin, and positive in (35) when

directed toward the origin. Therefore, since the same current exists in both regions, and they are joined together at the grid, the sign of the current  $J_1$  remains the same in both (35) and (26), its direction being from cathode to plate. The impedance looking into the cathode-plate terminals may be obtained from (55) by dividing by the amplitude  $A$  of  $J_1$  and reversing the sign of the result to correspond to a current from plate to cathode. Letting

$$Z_0 = R_0 + iX_0 \quad (56)$$

represent the impedance looking into the cathode-plate terminals, we can write the result as follows

$$\begin{aligned} R_0 = & -\frac{12r_0}{\zeta^4} \left[ \left( 1 + \cos \eta - \frac{2}{\eta} \sin \eta \right) (1 - \cos \zeta) \right. \\ & - \left( \frac{2}{\eta} - \sin \eta - \frac{2}{\eta} \cos \eta \right) (\zeta - \sin \zeta) \\ & \left. + (2 \cos \eta + \eta \sin \eta - 2) \right] \quad (57) \end{aligned}$$

$$\begin{aligned} X_0 = & -\frac{12r_0}{\zeta^4} \left\{ \left( 1 + \cos \eta - \frac{2}{\eta} \sin \eta \right) (\zeta - \sin \zeta) \right. \\ & + \left( \frac{2}{\eta} - \sin \eta - \frac{2}{\eta} \cos \eta \right) (1 - \cos \zeta) \\ & + \left[ \frac{1}{6}\zeta^3 - \frac{4}{\zeta} (1 - \cos \zeta) + 2 \sin \zeta \right] \\ & \left. + \left[ \eta + \frac{1}{6}\eta^3 - 2 \sin \eta + \eta \cos \eta \right] \right\} \quad (58) \end{aligned}$$

where  $\eta$  is the transit angle from cathode to grid,  $\zeta$  is the transit angle from grid to virtual cathode at the plate, and  $r_0$  is the zero-frequency resistance which would be present in a diode having the grid-plate dimensions, and the same operating direct-current voltages and current densities which occur in the grid-plate region of the triode under consideration.

Fig. 11 shows graphically the relation between  $R_0$  and  $X_0$  for a wide frequency range, in terms of the reference resistance,  $r_0$ . Curve  $A$  is drawn for the hypothetical condition that  $\eta = \zeta$ , so that the tube is exactly symmetrical about the grid. Actually such a condition could not be attained, since the grid captures some of the electrons, leaving

fewer for producing space charge near the plate. The grid-plate dimension would accordingly have to be increased in order to secure the space charge, but this would cause the transit angle  $\zeta$  to become larger than  $\eta$ . However, despite the fact that it does not correspond to a physically realizable condition, curve *A* is nevertheless of use in indicating the limit which is approached as the grid capture fraction is made smaller and smaller.

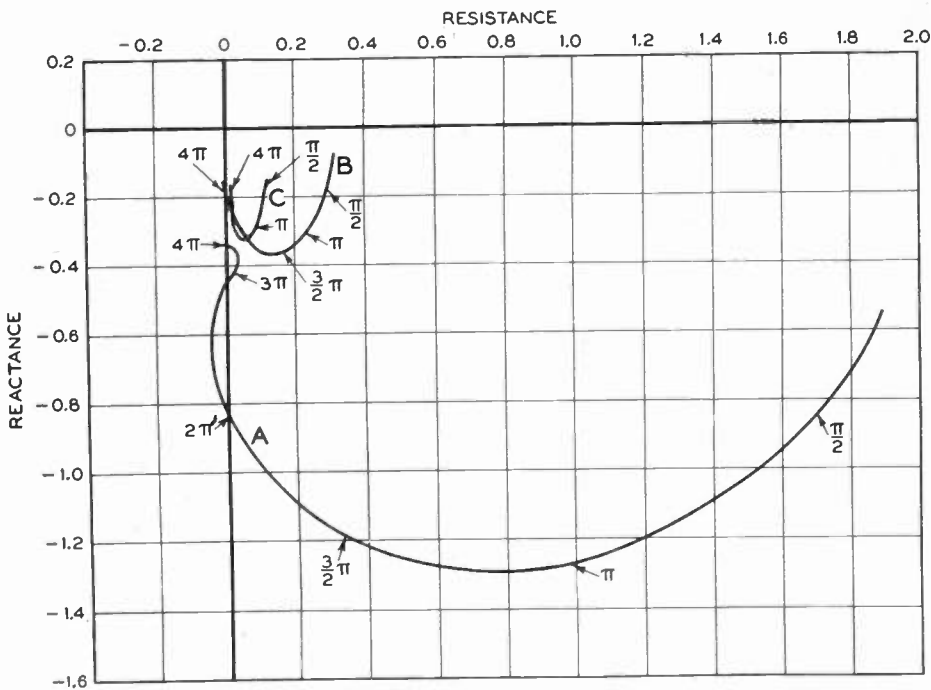

Fig. 11— $R_0$ — $X_0$  diagram for positive grid, slightly positive plate triode with cathode space charge.

Curve *A*,  $\eta = \zeta$   
 Curve *B*,  $\eta = 1/2\zeta$   
 Curve *C*,  $\eta = 1/3\zeta$

Curves *B* and *C* correspond to values of grid-plate transit angle equal respectively to two and three times the cathode-grid transit angle. Both these curves represent conditions which may readily be obtained experimentally, and indeed, curves lying much closer to *A* than does the curve *B* may be secured. For example, the general relation for the ratio of the transit angles in terms of the direct currents  $J_a$  and  $J_b$  in the cathode and in the plate region, respectively, when complete space charge exists in both regions, is,

$$\frac{\zeta}{\eta} = \sqrt{\frac{J_a}{J_b}}$$

Suppose that the grid captured half of the electrons. Then the ratio of transit angles would be 1.41. This would result in a curve lying between *A* and *B* in Fig. 11.

The numbers,  $\pi/2$ ,  $\pi$ , and so forth, which are attached to the curves in Fig. 11 show the values of the grid-plate transit angle,  $\zeta$ , which correspond to the points indicated.

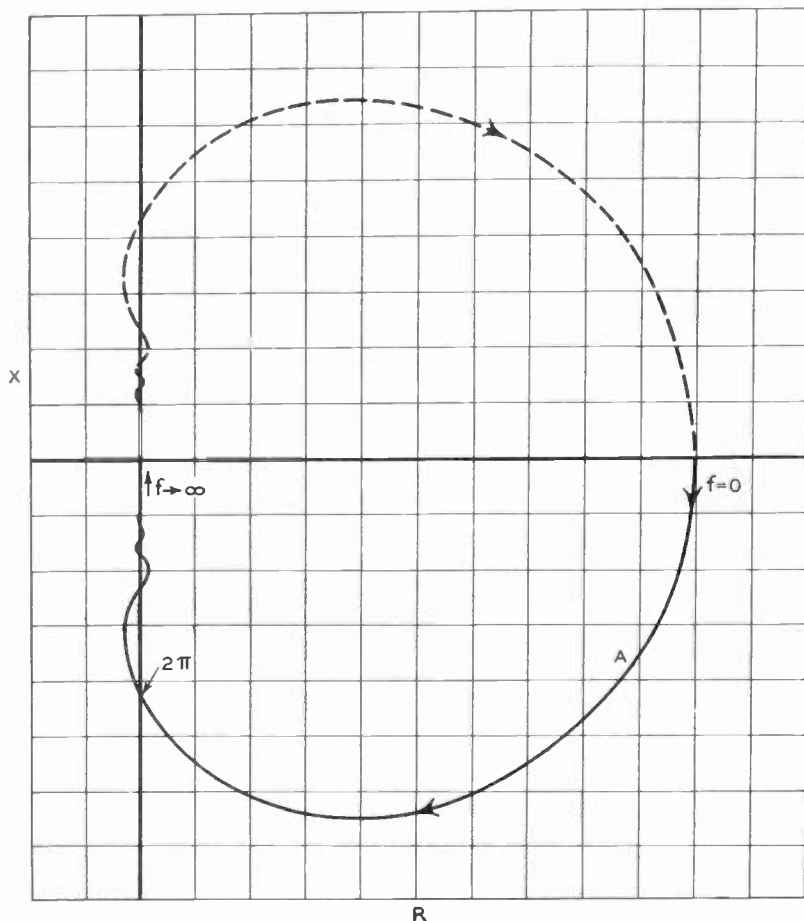

Fig. 12—Curve *A* of Fig. 11 together with the image corresponding to negative frequencies.

We now come to the problem of obtaining information about the oscillation properties of a tube from a set of curves such as those shown in Fig. 11. In a very loose way, and without proof we may state the results of an extension of Nyquist's<sup>6</sup> rule as follows:

If an  $R-X$  diagram, which in general may include negative as well as positive frequencies, encircles the origin in a clockwise direction, then the system represented by the diagram will oscillate when the terminals between which the impedance was measured are connected together.

<sup>6</sup> H. Nyquist, "Regeneration theory," *Bell Sys. Tech. Jour.*, vol. 11, p. 126; January, (1932).

Verification of this rule, together with further extension to more general cases are expected to be discussed in a subsequent paper. For the present, its validity will have to be accepted on faith, but with the assurance that the applications employed in this discussion are readily capable of demonstration.

Returning to consideration of the positive grid triode with complete space charge on both sides of the grid, and a slightly positive plate, whose  $R-X$  diagram is given in Fig. 11, we see at once that the diagram does not encircle the origin as it stands. Of course only positive

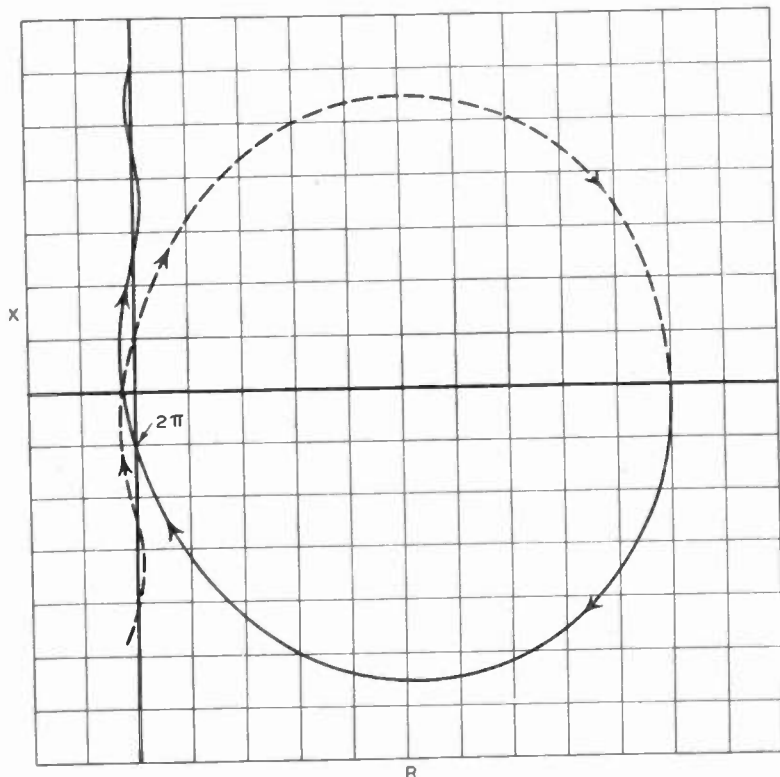

Fig. 13—Modification of Fig. 12 produced by added inductance.

values of frequency are included in the curves as they are shown. The inclusion of negative frequencies (never mind their physical meaning) would produce a curve which would be the image of the curve shown, a reflecting mirror being regarded as a plane perpendicular to the paper, and containing the  $R$ -axis. The curve  $A$ , for instance, would have its part corresponding to negative frequencies lying above the  $R$ -axis and forming an image of the part lying below. This is shown by the dotted curve in Fig. 12.

It is obvious that the curve of Fig. 12 will encircle the origin or not depending on what happens at infinite frequencies. However, the slightest amount of resistance in the leads to the tube will be sufficient to move the curve to the right and thus exclude the origin. This means

that no oscillations would be obtained if an alternating-current short were placed between plate and cathode. The result, although in accord with experiment, is not particularly useful. The important thing is to find whether the curve can be modified by the addition of a simple electrical circuit in such a way that the origin of the resulting  $R-X$  diagram for the combination of tube and circuit is encircled in a clockwise direction.

Suppose that a simple inductance is connected in series with the plate lead, and the impedance diagram of the series combination of tube and inductance is plotted. For this arrangement, the  $R-X$  diagram of Fig. 12 would be modified as shown in Fig. 13. Here the part of the curve corresponding to negative values of resistance has been pushed upward until the origin is enclosed within a loop which encircles it in a clockwise direction. It is therefore to be expected that oscillations will result. As to their frequency, we can say that the grid-plate transit angle must be at least as great as  $2\pi$  for this particular example. This follows by supposing a certain amount of resistance to be added in series with the circuit. The effect of this resistance will be to move the curves on Fig. 13 bodily to the right. The lowest frequency which will just allow the origin to be included within the loop when the series resistance is reduced to zero and the inductance is adjusted, corresponds to a grid-plate transit angle of  $2\pi$ .

It must be remembered that the foregoing details apply only to curve *A* of Fig. 11, and it has already been pointed out that curve *A* represents a limit which can be approached in practice, only as the grid capture fraction is made smaller and smaller. Curve *B* can well be duplicated in experiment. For this case, the lowest frequency at which oscillations may be expected is much higher than before, since the transit angle must be equal to  $4\pi$  before the resistance becomes negative. Actually, conditions intermediate between the two curves may be realized, so that from a practical standpoint the transit angle must be in the neighborhood of  $3\pi$  before we may expect to secure oscillations.

This would correspond to a frequency somewhat higher than is often associated with this type of oscillation. It must be remembered however, that the particular case considered was that of a tube with its plate at a slightly positive potential, whereas the majority of the experimental frequency observations were made with the plate either slightly negative, or, if positive, adjusted so that a virtual cathode was formed inside the tube, and many of the electrons were turned back before they reached the plate. The curves of Fig. 11 do not apply to these cases.

Therefore, let us see what happens when the plate is operated at a negative potential so that all of the electrons are turned back before they reach it. At the outset, it should be remarked that this condition does not prohibit the presence of direct-current plate current *after the oscillations have built up to a finite amplitude*. The analysis applies to the requirements for the starting of the oscillations, only, so that if the plate fluctuates in potential by a very small amount, as it does for incipient oscillations, and hence does not become positive during

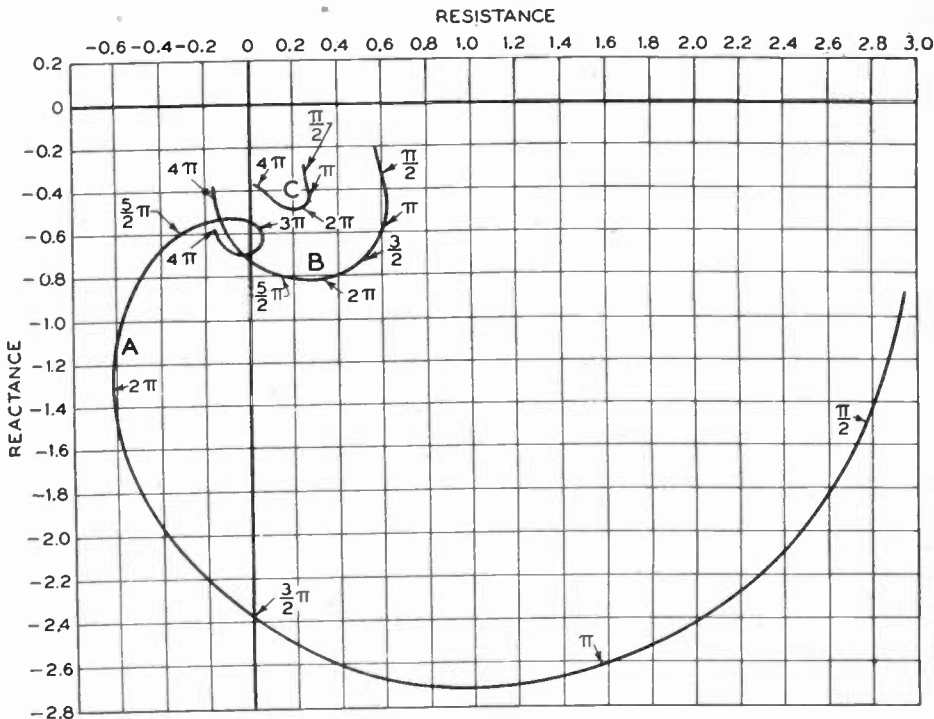

Fig. 14— $R_0 - X_0$  diagram for positive grid, slightly negative plate triode with cathode space charge.

Curve A,  $\eta = \zeta$

Curve B,  $\eta = 1/2\zeta$

Curve C,  $\eta = 1/3\zeta$

the alternating-current alternation, then no direct-current plate current can occur when the plate is biased negatively. After oscillations have built up to an appreciable amplitude, the presence of plate current is not only possible, but is in fact to be expected.

We have at hand the mathematical tools with which to compute our  $R - X$  diagram for the negative plate triode with complete space charge near the cathode. Thus, instead of substituting (35) in (55) we must substitute (53). Since complete space charge is still postulated near the cathode, (26) and (25) are still applicable. The result is:

$$\begin{aligned}
 R_0 = & -\frac{12r_0}{\zeta^4} \left[ \left( 1 + \cos \eta - \frac{2}{\eta} \sin \eta \right) \zeta^2 \right. \\
 & - \left( \frac{2}{\eta} - \sin \eta - \frac{2}{\eta} \cos \eta \right) (\zeta^2 \coth \zeta - \zeta) \\
 & \left. + (2 \cos \eta + \eta \sin \eta - 2) \right] \quad (59)
 \end{aligned}$$

$$\begin{aligned}
 X_0 = & -\frac{12r_0}{\zeta^4} \left[ \left( \frac{2}{\eta} - \sin \eta - \frac{2}{\eta} \cos \eta \right) \zeta^2 \right. \\
 & + \left( 1 + \cos \eta - \frac{2}{\eta} \sin \eta \right) (\zeta^2 \coth \zeta - \zeta) \\
 & \left. + \left( \frac{1}{3} \zeta^3 - \zeta^2 \coth \zeta + \zeta \right) + \left( \eta + \frac{1}{6} \eta^3 - 2 \sin \eta + \eta \cos \eta \right) \right] \quad (60)
 \end{aligned}$$

and the corresponding diagram is shown in Fig. 14. Here the curve *A* shows oscillation possibilities for transit angles as small as  $3/2\pi$ , while a much greater amount of resistance would have to be added to the circuit in order to eliminate the negative resistance and so stop the oscillations. In all, then, this method appears to be a better way of operating the system than with the positive plate, and this conclusion is substantiated by experimental observations.

As before, an increase in the grid capture fraction moves the oscillation region up to higher frequencies.

In both of the examples cited above, and represented by Figs. 11 and 14, respectively, complete space charge was assumed near the cathode. The effect of decreasing the cathode heating current so that this charge becomes negligible may be computed by employing (37) in place of (25), and (38) in place of (26).

The resulting equations for a slightly positive plate are,

$$R_0 = -\frac{12r_0}{\zeta^4} \left[ \left( \frac{\eta - \sin \eta}{\eta} \right) (1 - \cos \zeta) - \left( \frac{1 - \cos \eta}{\eta} \right) (\zeta - \sin \zeta) \right] \quad (61)$$

$$\begin{aligned}
 X_0 = & -\frac{12r_0}{\zeta^4} \left\{ \left( \frac{\eta - \sin \eta}{\eta} \right) (\zeta - \sin \zeta) + \left( \frac{1 - \cos \eta}{\eta} \right) (1 - \cos \zeta) \right. \\
 & \left. + \left[ \frac{1}{6} \zeta^3 - \frac{4}{\zeta} (1 - \cos \zeta) + 2 \sin \zeta \right] + \frac{1}{4} \eta \zeta^2 \right\}. \quad (62)
 \end{aligned}$$

The corresponding *R*-*X* diagram is given in Fig. 15.



Again, the equations for a negative plate and no cathode space charge are,

$$R_0 = -\frac{12r_0}{\zeta^4} \left[ \left( \frac{\eta - \sin \eta}{\eta} \right) \zeta^2 - \left( \frac{1 - \cos \eta}{\eta} \right) (\zeta^2 \coth \zeta - \zeta) \right] \quad (63)$$

$$X_0 = -\frac{12r_0}{\zeta^4} \left[ \left( \frac{1 - \cos \eta}{\eta} \right) \zeta^2 + \left( \frac{\eta - \sin \eta}{\eta} \right) (\zeta^2 \coth \zeta - \zeta) + \left( \frac{1}{3}\zeta^3 - \zeta^2 \coth \zeta + \zeta \right) + \frac{1}{4}\eta\zeta^2 \right] \quad (64)$$

and the  $R - X$  diagram is shown in Fig. 16.

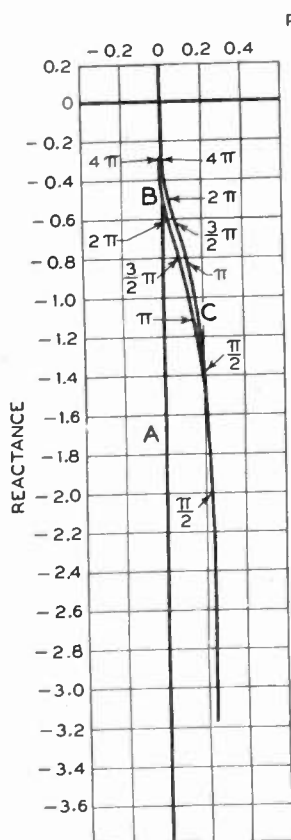

Fig. 15— $R_0 - X_0$  diagram for positive grid, slightly positive plate triode, without cathode space charge.

Curve A,  $\eta = \zeta$   
 Curve B,  $\eta = 1/2\zeta$   
 Curve C,  $\eta = 1/3\zeta$

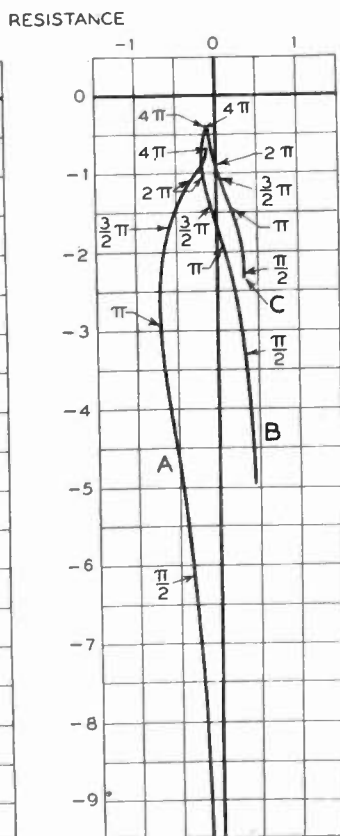

Fig. 16— $R_0 - X_0$  diagram for positive grid, slightly negative plate triode, without cathode space charge.

Curve A,  $\eta = \zeta$   
 Curve B,  $\eta = 1/2\zeta$   
 Curve C,  $\eta = 1/3\zeta$

Inspection of Figs. 15 and 16 shows that the negative plate condition is greatly to be preferred when there is no cathode space charge. In fact, when account is taken of the difference in the scales for which

Fig. 16 and the other three figures, 11, 14, and 15, are plotted, it is evident that the negative plate without space charge offers the greatest latitude in the adjustment of circuit conditions. As in all of the cases, except Fig. 15, a small grid capture fraction is to be desired. If curve *A* in Fig. 16 could be attained practically, it would be possible to secure oscillations even at low frequencies by connecting an inductance between the plate and cathode terminals. Curve *B* shows a low-frequency limit of a little less than  $3/4(\pi)$  for the grid-plate transit angle.

One of the more important observations to be drawn from the curves of Figs. 11, 14, 15, and 16 is that if the inductance between plate and cathode is obtained by means of a tuned antiresonant circuit, then the circuit must be tuned to a frequency somewhat higher than the oscillation frequency. This is in order that it may effectively present an inductive impedance to the oscillating tube, so that the extended curves in the figures may encircle the origin in a clockwise direction.

Another conclusion is that there are so many different permutations and combinations of the operating conditions that it is small wonder that there have been a great many different "theories" and empirical frequency formulas advocated. For instance, operation under conditions giving an  $R-X$  diagram which shows negative resistance over a small frequency range, only, such as *A* in Fig. 11, or *B* in Fig. 15, would give oscillations whose frequency would be much more nearly independent of the tuning of the external circuit than would conditions which resulted in a negative resistance over a wide frequency range, as at *A* in Fig. 16. In this latter case the external circuit exerts a large influence upon the frequency.

The data from which Figs. 11 to 16 were plotted are given in the appended tables. The final step in the calculation of these data was a multiplication by 12 which was performed on a slide rule. For all previous steps seven-place tables were employed because of the frequent occurrence of differences of numbers of comparable magnitude.

The effect on the frequency of a change in the operating voltages can be deduced inferentially from the curves. Thus, in general, the formulas for the transit angle have the form,

$$\xi = \frac{Kx}{\lambda\sqrt{V_0}} \quad (65)$$

where,

$x$  is the grid-origin distance

$\lambda$  is the wavelength

$V_0$  is the grid potential

$K$  is a constant which depends on the mode of operation.

When the plate potential is changed by a relatively large amount the operation undergoes a transition from a limiting mode illustrated by one of the figures to another limiting mode shown on some other one of the figures.

On the other hand, a change in grid potential will act to change the transit angles on the two sides of the grid in the same proportion. A modification of this generality occurs because the value of  $x$  in (65) will shift as the effective position of the virtual cathode moves about. Also, the complete space-charge condition near the plate becomes modified, and so the general relations become extremely variable. The partial space charge that exists with very negative values of plate potential, or with very high values of grid potential does not lend itself readily to mathematical treatment, so that intermediate conditions between complete and negligible space charge can be treated only by inference as to what happens between the two limiting conditions.

With inappreciable space charge on both the plate and the cathode sides of the grid, there can be no oscillations at all, since all impedances then approach pure capacities, with no negative resistance components.

A word concerning the so-called "dwarf" waves is in order before this general theoretical discussion is completed. In the curves, Fig. 14 distinctly shows this possibility in curve *A*, since the resistance reaches a large negative value at  $2\pi$  and again at  $4\pi$ . Likewise Fig. 11 shows the same possibility. On account of the resulting confusion in the figures, the higher frequency portions have not been drawn in the figures, but from (57), (59), (61), and (63) we can see what happens. Thus, for very high frequencies,  $\eta$  is large compared with unity, so that the formulas may be written,

$$R_0 = - \frac{12r_0}{\zeta^4} (\eta + \zeta) \sin \eta \quad (57-a)$$

$$\begin{aligned} R_0 &= - \frac{12r_0}{\zeta^2} (1 + \cos \eta + \sin \eta) \\ &= - \frac{12r_0}{\zeta^2} \left[ 1 + \sqrt{2} \sin \left( \eta + \frac{\pi}{4} \right) \right] \end{aligned} \quad (59-a)$$

$$R_0 = - \frac{12r_0}{\xi^4} \left[ 1 - \frac{\xi}{\eta} \cos \xi + \frac{\xi}{\eta} \cos \eta \right] \quad (61-a)$$

$$R_0 = - \frac{12r_0}{\xi^2} \quad (63-a)$$

It is noteworthy that all of these exhibit the possibility of "dwarf" waves separated by discrete frequency intervals except (63-a). On the

other hand, (63-a) gives possible conditions for operation at all high frequencies provided that the proper external circuit may be secured.

### VIII. POSTSCRIPT

The extension of the electronics of vacuum tubes which was described in the preceding pages must be regarded in the light of a tentative starting point rather than as a completed structure. Of the fundamental correctness of the method of attack there can be little doubt. The various simplifying assumptions, however, require careful scrutiny and doubtless some of them will be revised as time goes on and additional experience is acquired. Experimental guidance will be invaluable, and indeed certain data already have been obtained which are helpful in analysis of the assumptions. Although these data are in general qualitative agreement with the theory as outlined, the experimental technique must be refined before quantitative comparison can be made. It is hoped that the results can be made available at an early date.

Among the various assumptions which were made in the development of the theory, there are three which lead particularly to far-reaching consequences. These three may be enumerated as follows:

1. Plane-parallel tube structures
2. Current flow in straight lines
3. Small alternating-current amplitudes.

There are grounds for the belief that the assumption of plane-parallel tube structures does not exclude the application of the alternating-current results to cylindrical structures as completely as might be supposed. In the first place, the approximation of cylindrical arrangements to the plane-parallel structure becomes better as the cathode diameter is made large. Many tubes contain special cathode structures where this is the case. Furthermore, Benham<sup>1</sup> has obtained an approximate solution for the alternating-current velocity in cylindrical diodes where the cathode diameter is vanishingly small, and the transit angle is less than 5 radians. The resulting curves of alternating-current velocity versus transit angle have the same shape as the curves for the planar structures, and when the cylindrical transit angle is arbitrarily increased by about 20 per cent, the quantitative agreement is fair for transit angles less than 4 radians. It follows that until accurate solutions for cylindrical triodes can be obtained, the planar solutions may be expected to give correct qualitative results, and fair quantitative results when appropriate modifications of the transit angle are made. In fact, good agreement is obtained if calculations of the cylindrical transit angle are made as though the structure were planar.

The assumption of current flow in straight lines is open to some question when a grid mesh is interposed in the current path. For the positive grid triode, the objection to the assumption has been overcome by postulating a special case where an ideal choke coil prevents the grid from carrying away any of the alternating current. Benham<sup>1</sup> has suggested an alternative which seems to work fairly well when the grid-cathode path of a negative grid tube is considered, but which offers grave difficulties when the grid-plate path is included. A still different alternative was employed in the present paper in connection with negative grid triodes, and successfully indicates phase angles for the mutual conductance of the tube which are qualitatively logical. The grid-plate path is still without adequate treatment, however.

As to the third general assumption; that of relatively small alternating-current amplitudes, there can be no objection from a strictly mathematical point of view, and for a very large proportion of the physical applications the assumption is thoroughly justified. Indeed, it is the only one which is successful in giving *starting* conditions for oscillators. However, when questions as to the power efficiency of oscillators or amplifiers arise, then the "small signal" theory is inadequate, and should be supplanted by an approximate theory. The form which this approximate theory should take is indicated by the standard methods of dealing with the efficiencies of low-frequency power amplifiers and oscillators where the wave shape of the plate current is assumed to be given. The application of the same kind of approximation to ultra-high-frequency circuits may eventually prove to be a simpler matter than the "small signal" theory set forth in these pages.

Besides the three main assumptions discussed above, there was a fourth assumption which, although of lesser importance, deserves some comment. This fourth assumption involves the neglect of initial velocities at a hot cathode. If all electrons were emitted with the same velocity, the theory is adequate, and may be applied as indicated by Langmuir and Compton.<sup>3</sup> When the distribution of velocities according to Maxwellian, or Fermi-Dirac, laws is considered, some modifications may be necessary. In general, a kind of blurring of the clear-cut results of the univelocity theory may be expected, which will be expected to result in an increase in the resistive components of the various impedances at the expense of the reactive components. Again, lack of symmetry in the geometry of the tube structure may be expected to do the same thing, since the transit angles are then different in the different directions.

Finally, however, and with all its encumbering assumptions, it is hoped that the excursion back to fundamentals which was made in

this paper, has resulted in a method of visualizing the motions of the condensations and rarefactions of the electron densities inside of vacuum tubes operating at high frequencies and has shown their relation to the conduction and displacement components of the total current.

DATA FOR FIG. 11

$\zeta$	$\eta = \zeta$		$\eta = \frac{1}{2}\zeta$		$\eta = \frac{1}{3}\zeta$		$\eta = \frac{1}{4}\zeta$	
	$R_0$	$X_0$	$R_0$	$X_0$	$R_0$	$X_0$	$R_0$	$X_0$
1.0	1.87	-0.577	0.302	-0.119			0.0633	
1.4	1.75	-0.777	0.292	-0.164			0.0604	-0.160
1.57	1.69	-0.855	0.288	-0.182	0.112	-0.172		
1.8	1.60	-0.949	0.280	-0.204	0.108	-0.193	0.0568	-0.200
2.356	1.36	-1.13	0.260	-0.241	0.0987	-0.240		
2.8	1.15	-1.23	0.241	-0.289			0.0458	-0.278
3.14	0.986	-1.27	0.226	-0.311	0.0838	-0.289	0.0418	-0.297
3.6	0.769	-1.29	0.204	-0.335	0.0748	-0.308	0.0364	-0.316
4.0	0.593	-1.27	0.186	-0.350	0.0673	-0.320	0.0320	-0.327
4.71	0.326	-1.18	0.153	-0.366	0.0457	-0.329		
5.2	0.186	-1.08	0.132	-0.368			0.0216	-0.330
5.6	0.0972	-0.987	0.116	-0.368			0.0193	-0.324
6.28	0	-0.830	0.0923	-0.358	0.0365	-0.309	0.0165	-0.306
6.8	-0.0348	-0.719	0.0767	-0.346			0.0153	-0.291
7.2	-0.0440	-0.644	0.0662	-0.337	0.0308	-0.284	0.0148	-0.278
7.85	-0.0369	-0.546	0.0515	-0.318	0.0284	-0.264		
8.4	-0.0199	-0.487	0.0414	-0.302	0.0268	-0.248	0.0144	-0.238
9.0	+0.000414	-0.444	0.0320	-0.284	0.0254	-0.233	0.0144	-0.222
9.42	0.0125	-0.424	0.0262	-0.272	0.0244	-0.222	0.0143	-0.235
10.0	0.0218	-0.407	0.0194	-0.256			0.0138	-0.198
10.99	0.0213	-0.385	0.0101	-0.232	0.0192	-0.193		
12.57	0	-0.342	0	-0.197	0.0128	-0.172	0.00962	-0.162

DATA FOR FIG. 14

$\zeta$	$\eta = \zeta$		$\eta = \frac{1}{2}\zeta$		$\eta = \frac{1}{3}\zeta$		$\eta = \frac{1}{4}\zeta$	
	$R_0$	$X_0$	$R_0$	$X_0$	$R_0$	$X_0$	$R_0$	$X_0$
1.0	2.94	-0.932	0.581	-0.225			0.133	-0.221
1.4	2.84	-1.33	0.595	-0.304			0.136	-0.286
1.57	2.78	-1.49	0.601	-0.336	0.252	-0.302		
1.8	2.67	-1.71	0.606	-0.377	0.255	-0.330	0.139	-0.336
2.356	2.30	-2.19	0.618	-0.465	0.264	-0.381		
2.8	1.90	-2.48	0.619	-0.528			0.147	-0.401
3.14	1.56	-2.63	0.613	-0.571	0.272	-0.424	0.150	-0.410
3.6	1.06	-2.71	0.598	-0.625	0.276	-0.438	0.153	-0.416
4.0	0.645	-2.67	0.577	-0.665	0.277	-0.448	0.155	-0.417
4.71	0.00015	-2.38	0.525	-0.728	0.275	-0.460	0.157	-0.412
5.2	-0.319	-2.08	0.479	-0.762			0.158	-0.407
5.6	-0.494	-1.80	0.436	-0.784			0.158	-0.404
6.28	-0.608	-1.31	0.356	-0.807	0.253	-0.476	0.156	-0.396
6.8	-0.565	-0.990	0.292	-0.814			0.154	-0.390
7.2	-0.480	-0.796	0.241	-0.803	0.232	-0.483	0.152	-0.386
7.85	-0.290	-0.594	0.160	-0.797	0.213	-0.485		
8.4	-0.111	-0.528	0.0957	-0.773	0.196	-0.486	0.144	-0.376
9.0	+0.00226	-0.536	0.0308	-0.735	0.175	-0.485	0.138	-0.372
9.42	0.0574	-0.574	-0.0102	-0.705	0.160	-0.484	0.133	-0.369
10.0	0.077	-0.634	-0.0581	-0.666			0.127	-0.365
10.99	0	-0.690	-0.118	-0.564	0.101	-0.436		
12.57	-0.152	-0.560	-0.152	-0.414	0.0445	-0.383	0.0938	-0.348

DATA FOR FIG. 15

$\zeta$	$\eta = \zeta$		$\eta = \frac{1}{2}\zeta$		$\eta = \frac{1}{3}\zeta$		$\eta = \frac{1}{4}\zeta$	
	$R_o$	$X_o$	$R_o$	$X_o$	$R_o$	$X_o$	$R_o$	$X_o$
1.0			0.239	-3.06			0.179	-1.58
1.4			0.228	-2.22			0.172	-1.19
1.57			0.223	-2.00	0.199	-1.39		
1.8			0.215	-1.76	0.192	-1.24	0.162	-0.979
2.356			0.193	-1.39	0.173	-1.01		
2.8			0.173	-1.21			0.131	-0.737
3.14			0.157	-1.10	0.130	-0.825	0.120	-0.693
3.6			0.135	-0.983	0.123	-0.756	0.104	-0.645
4.0			0.116	-0.903			0.0902	-0.610
4.71			0.0837	-0.788	0.0796	-0.633		
5.2			0.0643	-0.724			0.0540	-0.524
5.6			0.0503	-0.677				
6.28			0.0308	-0.605	0.0346	-0.506	0.0308	-0.455
6.8			0.0197	-0.558			0.0232	-0.425
7.2			0.0131	-0.525	0.0194	-0.444	0.0187	-0.402
7.85			0.00568	-0.477	0.0126	-0.406		
8.4			0.00203	-0.442	0.00939	-0.378	0.109	-0.343
9.0			-0.0000284	-0.409	0.00710	-0.351	0.00908	-0.318
9.42			-0.000646	-0.388	0.00608	-0.333	0.00826	-0.290
10.0			-0.000817	-0.363			0.00744	-0.284
10.99			-0.000402	-0.327	0.00408	-0.282		
12.57			0	-0.285	0.00216	-0.246	0.00385	-0.227

DATA FOR FIG. 16

$\zeta$	$\eta = \zeta$		$\eta = \frac{1}{2}\zeta$		$\eta = \frac{1}{3}\zeta$		$\eta = \frac{1}{4}\zeta$	
	$R_o$	$X_o$	$R_o$	$X_o$	$R_o$	$X_o$	$R_o$	$X_o$
1.0	-0.176	-9.35	0.426	-4.84			0.342	-2.52
1.4	-0.306	-6.84	0.366	-3.64			0.316	-1.96
1.57	-0.363	-6.15	0.338	-3.33	0.345	-2.32		
1.8	-0.436	-5.41	0.299	-3.00	0.321	-2.11	0.287	-1.67
2.356	-0.584	-4.15	0.206	-2.46	0.263	-1.77		
2.8	-0.658	-3.44	0.137	-2.17			0.212	-1.29
3.14	-0.685	-3.00	0.0888	-1.99	0.188	-1.48	0.190	-1.21
3.6	-0.685	-2.52	0.0318	-1.80	0.149	-1.36	0.162	-1.12
4.0	-0.661	-2.17	-0.0104	-1.65	0.120	-1.27	0.140	-1.06
4.71	-0.565	-1.69	-0.0698	-1.43	0.0747	-1.13	0.108	-0.957
5.2	-0.482	-1.45	-0.0998	-1.30			0.0871	-0.898
5.6	-0.413	-1.30	-0.119	-1.21			0.0730	-0.853
6.28	-0.304	-1.11	-0.141	-1.07	0.0478	-0.907	0.0523	-0.787
6.8	-0.236	-1.02	-0.151	-0.975			0.0389	-0.742
7.2	-0.195	-0.963	-0.155	-0.910	-0.0220	-0.805	0.0296	-0.709
7.85	-0.148	-0.894	-0.156	-0.815	-0.0364	-0.743		
8.4	-0.126	-0.848	-0.152	-0.747	-0.0458	-0.695	+0.0072	-0.625
9.0	-0.113	-0.803	-0.145	-0.680	-0.0538	-0.647	-0.00162	-0.589
9.42	-0.109	-0.771	-0.138	-0.638	-0.0582	-0.615	-0.00706	-0.565
10.0	-0.107	-0.727	-0.128	-0.588			-0.0135	-0.535
10.99	-0.101	-0.653	-0.107	-0.518	-0.0668	-0.517		
12.57	-0.0760	-0.556	-0.0760	-0.439	-0.0667	-0.439	-0.0314	-0.426



## SOME ASPECTS OF RADIO LAW\*

BY

J. WARREN WRIGHT

(Radio Division, Navy Department, Washington, D. C.)

*Summary*—The Radio Act of 1927 provides a basis for the regulation of interstate radio communication and of transmission of electrical energy without wires. The scope of the Act has been clarified by decisions which have been rendered by the courts in cases which have arisen from time to time since its enactment.

This paper describes a number of the cases which have arisen and discusses the theory that radio transmission is interstate commerce within the meaning of the Constitution. Comparison is made from a legal standpoint between radio broadcasting and advertising by billboard.

The present tendency to regard the public reception of material broadcast by radio as coming within the terms of the copyright act is discussed.

The power of the several states to regulate certain phases of radio under regulations pursuant to their police powers is brought out.

It is also shown that the courts do not regard a license to broadcast as granting immunity to a broadcast station from liability for damages for libel published over the station.

Few new legal principles seem to be involved but engineers and lawyers should cooperate so that radio law may develop in accordance with fact situations.

THE Radio Act of 1927, entitled "An Act for the Regulation of Radio Communications and for Other Purposes" was "intended to regulate all forms of interstate and foreign radio transmissions and communications"<sup>1</sup> therein defined as "any intelligence, message, signal, power, pictures, or communications of any nature transferred by electrical energy from one point to another without the aid of any wire connecting the points from and at which the electrical energy is sent or received and any system by means of which such transfer of energy is effected."<sup>2</sup> It further specifically prohibits any "person, firm, company, or corporation" from using or operating "any apparatus for the transmission of energy or communications or signal by radio—" when the effects thereof extend beyond the borders of any state or

\* Decimal classification: R007. Original manuscript received by the Institute, April 14, 1933. Revised manuscript received July 14, 1933.

*Author's Note*—Opinions and assertions contained herein are the private ones of the writer and are not to be construed as official or reflecting the views of the Navy Department.

*Editorial Note*—Readers of this paper may be interested also in papers which have appeared in *Air Law Review*, published by American Academy of Air Law, Washington Square East, New York, N. Y., and in *Journal of Radio Law*, published by Northwestern University Press, 357 East Chicago Avenue, Chicago, Ill.

<sup>1</sup> Figures refer to Annotations at end of paper.



interfere with interstate or international transmissions or the reception of such transmissions, unless the operator and apparatus are licensed under the provision of this Act.

The broad language of this statute has been extended even further by the case of *Whitehurst v. Grimes*,<sup>3</sup> which case was heard on motion to dismiss for want of equity and involved the question of the right of a municipality to require the payment of a license tax for the privilege of engaging in the "business" of amateur or commercial radio. It did not raise the problem of taxing the tangible property of such individual, company, or corporation; but in deciding the case the Court proceeded on the theory that all radio communications are interstate in character. In effect the Court considered that all radio transmissions are interstate commerce, within the meaning of the Constitution,<sup>4</sup> and that as Congress had sole power to regulate such matters, the municipal ordinance was void.

The term electrical energy used in the above definition of radio communication must refer to the transfer of intelligence by means of electromagnetic waves<sup>5</sup> since this is the only known means of effecting such transmission without the use of wires. The difficulty with this definition for our purpose lies in its application to the actual facts unless electromagnetic waves in only the radio portion of the spectrum, and used only for communication purposes, are considered. The reason for considering the purpose of transmission is to distinguish radio emissions from disturbances caused by automobile ignition systems,<sup>6</sup> medical equipment, etc.<sup>7</sup> Such obviously was the intent of the Congress.

While all electromagnetic waves exhibit certain characteristics in common,<sup>8</sup> their behavior is different. For example the extreme shortness of X-rays makes penetration possible,<sup>9</sup> since the spaces in most materials are comparable with the wavelength, while waves of somewhat longer length are more subject to reflection. Similarly in the band 10 to 500,000 kilocycles, which composes the present radio spectrum,<sup>10</sup> the range of transmission at frequencies from 10 to 550 kilocycles is considered to depend largely on ground wave propagation although the effect of the sky wave is noticeable at night and the same is true for frequencies in the broadcast band, although here the effect of the sky wave is more pronounced.<sup>11</sup> As the frequency of transmission is increased the absorption of the ground wave also increases so that for frequencies above about 3000 kilocycles greater ranges are obtainable than would be expected from an inspection of empirical transmission formulas<sup>12</sup> adapted for use at the lower frequencies. Above about 6000 kilocycles skips<sup>13</sup> are noticeable and long range transmission using the

sky wave is possible with only moderate power in comparison with that required at the low frequencies. As the transmitting frequency is still further increased the skip distance also increases up to about 1800 miles at 40,000 kilocycles but this appears to be about the highest frequency at which the sky wave will be refracted back to earth by the Heaviside layer. The transmitting range for frequencies above this value approaches the optical path as the upper limit of the radio spectrum is reached.<sup>14</sup> Actually this path will only be reached for waves of  $4 \times 10^{11}$  kilocycles (red light).

Thus X-ray photographs are made possible by using one type of electromagnetic wave while the colors of a painting or an advertisement on a billboard become evident and appreciable because of the selective absorption and reflection of somewhat longer waves and the effect of such waves on the human eye.<sup>15</sup> There are similar differences in the behavior of the longer waves which form a part of the radio spectrum. Thus waves in the neighborhood of 500,000 kilocycles can be reflected by means of metallic reflectors and refracted by paraffine prisms, lenses, etc., and behave in general more like light waves than do the commonly used electromagnetic waves of the radio spectrum.<sup>16</sup>

It becomes apparent that if waves in a portion of the radio spectrum behave more like light than radio, it is possible in point of fact to have purely intrastate transmission. Such may be possible from a practical viewpoint also at frequencies below the point where skip distance effects are noticeable, particularly below 3000 kilocycles, if very low powers are employed. However, the doctrine of *Whitehurst v. Grimes* can be applied practically to extend judicially the operation of the Radio Act on the basis of a presumption of law that all radio transmission is *per se* interstate commerce or a burden thereon, so that the desirable end is attained wherein the Federal Government has the sole right to regulate all radio transmission. Such an extension follows the principle enunciated by the Supreme Court in an analogous situation involving the authority of the Interstate Commerce Commission to regulate railroad rates wherein the Court said:<sup>17</sup> “. . . Wherever the interstate and intrastate transactions of carriers are so related that the government of one involves the control of the other, it is Congress, and not the State, that is entitled to prescribe the final and dominant rule, for otherwise Congress would be denied the exercise of its constitutional authority, and the State, and not the Nation would be supreme within the national field. . . .”

As previously indicated the right of Federal regulation probably does not extend to the regulation of the use of medical equipment, automobiles, street cars, elevators, X-rays, and electrical equipment

not used for communication purposes simply because the operation of such equipment causes interference to radio signals.<sup>18</sup> In such situations the general doctrine pertaining to the abatement of nuisances is deemed applicable but should be applied with caution to assure equity to all.<sup>19</sup> It is possible that Federal regulation might be extended to limit the use of radiating receivers under the present Radio Act as extended by judicial decisions.

It is evident that the use of the ether is a question involving public policy<sup>20</sup> and except where treaties, statutes, or regulations have intervened every individual has a right to the free use of the ether for transmitting and receiving. Such appears to have been the case in the early days of radio prior to the enactment of a statute in 1913 designed to carry the 1912 International Radiotelegraph Convention into effect.<sup>21</sup> Under this statute the issuance of a station license was not a discretionary act except as to choice of frequency.<sup>22</sup> Such a situation could not continue, and the Act of 1927 was passed to remedy a situation which was rapidly becoming chaotic and the subject of international agreements; so that at the present time there does not appear to be any right to engage in radio transmission unless pursuant to a license and even then there does not seem to be any assurance that the license will be continued unless it is shown to be in the interest of the public.<sup>23</sup>

The discussion so far assumes that Congress has the sole power to regulate radio transmission based on its Constitutional power over interstate commerce.<sup>24</sup> So far the radio cases indicate that this is the correct view on the theory that an analogy exists between the radio and the wire telephone and telegraph cases<sup>25</sup> but the Supreme Court has not passed on the question. It is considered important to discuss the commerce or "business" phase of the subject in order to determine what if any valid legislation can be enacted by the several states with regard to radio stations and their operation. In order to do so it is desirable to classify radio communications roughly as follows:

- (1) Commercial point-to-point, shore-to-ship, and ship-to-ship.
- (2) Amateur.
- (3) Broadcast.

In the first class there is no question but that all such communications are commerce, within the meaning of Article I, Sections 8-3 and 8-18 of the Constitution of the United States, regardless of whether the transmission crosses state lines, since the nature of the transaction rather than the means employed is the determining factor. The telephone and telegraph cases<sup>26</sup> are therefore directly in point as is the 1902 opinion of the Attorney General which applies to this class of communications.<sup>27</sup>

Amateur communications raise the question as to whether non-commercial intercourse is commerce within the meaning of the Constitution<sup>28</sup> although unregulated communications of this character would unquestionably impose a serious burden on interstate traffic regardless of the actual transmission range.<sup>29</sup> State regulations over such transmission would probably be held to be unconstitutional.

Most of the legal problems arising in connection with the above two situations occur and are more troublesome in connection with broadcasting. Hence they will be discussed in that connection, although the application to other services will be evident from the context.

One difficulty in considering broadcasting to be commerce within the meaning of the Constitution is that it is difficult to see the necessary relation between broadcaster and listener required for strict compliance with even such a modern definition of interstate commerce as cited by Chief Justice Hughes in the recent case of *Furst v. Brewster*<sup>30</sup> wherein it was quoted that:

All interstate commerce is not sales of goods. Importation into one state from another is the indispensable element, the test of interstate commerce; and every negotiation,<sup>31</sup> contract,<sup>32</sup> trade, and dealing between citizens of different states, which contemplates and causes such importation, whether it be of goods,<sup>33</sup> persons,<sup>34</sup> or information, is a transaction of interstate commerce.

In broadcasting the importer is absent in the same degree as if a large billboard were placed adjacent to a state line and read in another state by chance observers. The message placed on the billboard is conveyed by means of the effect of electromagnetic waves, in the frequency band  $4 \times 10^{11}$  to  $7.5 \times 10^{11}$  kilocycles,<sup>35</sup> upon the eyes of the observers whereas radio broadcasts must be selected by the observer using a suitable receiver and accessories to make the aural, visual, or combination broadcast utilizing modulated electromagnetic waves of much lower frequency, evident.

The courts have indicated that a billboard may be in interstate commerce during physical transit but after erection the interstate commerce feature has ended and the state where it is placed has the power to regulate it.<sup>36</sup> In both the radio and billboard situations that which is transmitted across state lines is in the form of minute amounts of electromagnetic wave energy which obeys natural laws and may be received by any one properly equipped and located. It is thus difficult to see any element of property in the waves after transmission and prior to chance reception.<sup>37</sup> Furthermore, the usual communication system wherein a message is transmitted via the system to a named addressee does not exist unless it be inferred from very remote circum-

stances. Certainly the listeners are unknown and in no sense in direct contractual relation with the broadcaster under the system in use in the United States; so that there is a marked difference in this respect with the factual background of the cases involving the transfer of electrical energy or communications over wire circuits.

The radio situation seems to be one where electrical energy is transmitted in such manner that title to the emission is lost on transmission, except in so far as copyrights may be involved; and as natural laws make it probable that any radio transmission may cause international difficulties or burdens on *prima facie* interstate and foreign communications unless all radio emissions are properly controlled, Congress unquestionably should have sole power to regulate such transmissions. Such Congressional authority can be found in the ancillary powers to carry valid treaties into effect even if it were to be held that such transmissions are not interstate commerce. Under both theories the States would seem to lack authority to regulate directly such transmissions.<sup>38</sup>

The broadcasting of copyrighted material raises the problem as to whether the reception of such a program constitutes a performance within the meaning of the copyright laws.<sup>39</sup> This has been answered in the affirmative by the case of *Buck v. Jewell-La Salle Co.*<sup>40</sup> where the Court held that the reception of copyrighted material by a hotel proprietor and the furnishing of such a program to guests constituted an infringement of the copyright on the theory that it was a public performance for profit. The noncommercial reception of the same program in a private home would not violate this law. Such a decision is hard to justify, since in reception the field laid down by the transmitter is used to control the receiver output, and if damage to the copyright owner results the proximate cause of such injury is the unauthorized use of the copyrighted material by the broadcaster. This view is supported by the definition of broadcasting as emissions intended for public reception.<sup>41</sup> The result should be the same regardless of whether the broadcaster was licensed under the copyright or not.

It is probable that certain types of state regulations and taxes will be held valid under the doctrine of *Utah Power and Light Co. v. Pfof*<sup>42</sup> which case involved the right of a state to tax electrical power generated within the state and transmitted in interstate commerce. The court held that the conversion of mechanical into electrical energy during the process of generation was a sufficient manufacture to sustain the validity of the particular tax since manufacture comes before the transmission in interstate commerce. By analogy it would appear that the conversion of electrical or mechanical and sound energy to

modulated radio-frequency energy would likewise be such a manufacture as would justify certain forms of taxes, and regulations under the police powers of the several states, particularly in case of broadcasting. The idea of manufacture as applied to radio transmission distinguishes it from the billboard cases except where news flashers are involved. The latter can be distinguished from radio only on the basis of the use of different frequency waves which necessitates the employment of different means for transmission and reception.

State regulation of broadcasting under the police power will likely prove troublesome as such regulations will doubtless tend toward prohibiting certain forms of advertising in addition to the usual regulations governing manufacturing. Yet if the billboard or manufacturing analogies are applied to radio and the limited service areas of modern broadcasting supports the former, a state could doubtless pass certain laws, valid under its police powers, and proceed against station and operators in the event of violations. Similar situations arose prior to the passage of the 18th Amendment in connection with the manufacture of liquor in dry states and the Supreme Court in *Mugler v. Kansas*<sup>43</sup> held that the State of Kansas having authority to prohibit the manufacture and sale of intoxicating liquor had the power to declare any place maintained for such purpose a public nuisance and to proceed in abatement against the property as well as punish the offenders.

Of course a state could not prevent undesired transmission, originating in other states, from entering its borders.<sup>44</sup> The state could and probably would in the hypothetical case proceed against anyone within its jurisdiction who "tuned in" on an obnoxious program and thereby created a nuisance. State courts have already taken the stand that the manner of operating a radio receiver determines whether it is a nuisance or not.<sup>45</sup>

The Constitutional right of free speech would probably not invalidate a proper State statute because of the right of every State to pass laws regulating safety, health, morals, and public welfare under the guise of police powers and practice has shown that such laws are generally sustained by the courts.<sup>46</sup>

The Nebraska case of *Sorenson v. Wood*<sup>47</sup> indicates that a Federal license to broadcast does not relieve a broadcaster from liability in the event that a libel is published over his station. The Court considered that broadcasters are engaged in commercial advertising for pay and may be compared with newspapers and magazines rather than with common carriers.

Since it is probable that State regulation as indicated above would

be held valid regardless of whether the commerce idea was retained or not, it is interesting to examine the doctrine of Federal regulation under ancillary powers. If the latter theory is adopted the possible objection that State taxes<sup>48</sup> or regulations<sup>49</sup> are invalid as affecting instrumentalities of interstate commerce would be avoided. Furthermore, property rights in radio transmission as such, do not exist any more than property rights in uncaptured migratory birds so that similarly permission from the Federal Government to transmit may be revoked at will on the theory that the right is that of a mere licensee. The power to regulate is justified because of the necessity for international and national regulation if any one is to utilize radio successfully as a means for long-distance communication or broadcasting.

Anyone engaging in any business affected by public interest must expect the imposition of reasonable regulations, and having accepted licenses under such regulations it appears that there is no longer any question as to the right of the regulating power to revoke a license without liability on the theory of confiscation of property.<sup>50</sup> However, some decisions indicate that the regulating power may be estopped to deny a license under certain conditions where a station has been erected in good faith under a construction permit and no new facts have been found to justify the refusal of a station license.<sup>51</sup>

If the manufacturing doctrine of interstate commerce and the theory of regulations passed pursuant to ancillary powers do not exempt stations and operators from the operation of certain state laws, it is submitted that neither should bar civil suits even in cases when the licensed transmission is itself the cause of damage as where adjacent property is set on fire.

It is clear from the foregoing that while the introduction of radio into everyday use has added problems peculiar to the new means; that few new legal theories are involved. It is simply a question of the engineers and lawyers coördinating their efforts to the end that legal principles will follow and be correctly applied to the fact situations of radio.

#### Annotations

1. Title 47 U.S.C.A. Chapter 4. For complete statement of intent of Act see 47 U.S.C.A. 81.
2. 47 U.S.C.A. 111.
3. Reported in 21 Fed. (2d) 787. From the 1927 Government Amateur Call Book it is noted that the power of the defendant's amateur station was listed as 15 watts and it is probable that the transmitting frequency was in the neighborhood of 8000 kilocycles.
4. Article 1, Sections 8-3 and 8-18 of Constitution of the United States.

5. The waves were predicted by Maxwell from theoretical considerations but it remained for Hertz actually to generate them and demonstrate that they were a part of the electromagnetic spectrum. It appears that Hertz actually made his discovery while giving a lecture demonstration by noting that a coil of insulated wire energized by a spark coil through a gap induced similar though weaker currents in another like coil. Investigation of this phenomena in the light of Maxwell's theory resulted in Hertz' laying the foundation of present-day wireless telegraphy and telephony although we are indebted to Marconi for utilizing the new discovery for practical communication purposes. See for example Fahie "History of Wireless Telegraphy," Blackwood and Sons, London, 2nd edition, (1901), or Fleming "Principles of Electric Wave Telegraphy and Telephony" Longmans and Co., 4th edition, (1919), particularly chapter V.
6. Curtis "Electrical interference in motor car receivers," PROC. I.R.E. vol. 20, p. 674; April, (1932), states that the radio disturbances from Model T Fords is a maximum at about 60,000 kilocycles.
7. Such equipment is used for various purposes as in diathermy, to produce artificial fevers and to energize the radio knife. Diathermy and electric knife equipments usually use frequencies between 300 and 2000 kilocycles, but avoiding frequencies in the broadcast band which is from 550 to 1500 kilocycles. Fever equipments use frequencies of about 50,000 kilocycles. Underhill "The radio knife," *Electronics*, October, (1930), discusses the subject equipment and cites references to medical literature. Carpenter and Page "Producing artificial fevers by short radio waves," *Electronics*, May, (1930), and Page "Very short radio waves," *Electronics*, July, (1930), discuss some of the uses of high-frequency radio waves for other than communication purposes. The equipment described uses the same types of vacuum tubes as used for communication purposes and closely follows radio practice.
8. For example see Palmer "Wireless Principles and Practice," chapter 1, Longmans Green, London, (1928); page 272 Reese "Light," Missouri Book Co., (1921).
9. Chapter 1 Bragg and Bragg "X-Rays and Crystal Structure," G. Bell and Sons, 5th edition, (1925).
10. Federal Radio Commission Regulation No. 185.
11. The absorption of the ground wave appears to increase with frequency whereas the absorption of the sky wave seems to reach a maximum in the present broadcast band. See *Electronics*, May, (1932), for certain transmitting range data compiled by the United States Bureau of Standards.
12. Calculations of the field laid down at a distance by a given transmission by the various available formulas do not agree very well as will be noted by referring to pages 37, 38, and 39 of the "Fifth Annual Report of the Federal Radio Commission" where results obtained using eleven such formulas are plotted for a frequency of 1000 kilocycles and a radiated power of 1000 watts and compared with actual measurements made by the Radio Inspection Service.
13. The article by Taylor and Hulburt, *Physical Review*, February, (1926), is one of the first on this subject and discusses the theory of the propagation of high-frequency radio waves.
14. Beverage, Peterson, and Hansell, "Application of frequencies above 30,000 kilocycles to communication problems," PROC. I.R.E., vol. 19, p. 1313;



August, (1931), states that frequencies as high as 43,000 kilocycles have been observed at infrequent intervals beyond the ground wave range while frequencies of 300,000 kilocycles and above behave essentially like light. This article also discusses the Hawaiian Island high-frequency radio-telephone system. Also see Proc. I.R.E., vol. 21, no. 3; March, (1933). Entire number is devoted to ultra-high-frequency problem.

15. Page 21 Reese "Light," Missouri Book Co., (1921).
16. Fleming "Principles of Electric Wave Telegraphy and Telephony," 4th edition, (1919), Longmans and Co. Chapter V describes experiments showing that very short radio waves behave similarly to light as regards reflection and refraction.
17. *Houston & Texas Ry. v. United States*, 234 U. S. 342.
18. Public interest would seem to demand that reasonable precautions and efforts be made to eliminate such radiations and to place the burden of due care upon the power companies or users of interfering equipment. For analogous situations see Clark "Principles of Equity" published by Johnson and Hardin, (1919), particularly sections 205 and 223.
19. Analogous situations appear in the oft-cited cases of *Fletcher v. Rylands*, L.R. 3H.L. 330, Wilson's "Cases on Torts" page 659 and *Hoare & Co. v. McAlpin & Sons*, (1923), 1 Ch. 167, Wilson's "Cases on Torts" page 699. The first dealt with the escape of water from a reservoir constructed on the defendant's land and the court held that as this was an unnatural use of the land that the defendant was liable. In the second case the driving of piles set up vibrations in the earth which shook the plaintiff's building so as to cause great damage and the court held the defendant liable citing *Fletcher v. Rylands*. In *Hoare v. McAlpin* the vibrations were set up in the earth and transmitted by earth waves to a near-by building setting up destructive disturbances therein. The ether vibrations set up by near-by radio or electrical equipment may cause damage. The case of *Fletcher v. Rylands* was decided in 1868 by the House of Lords, and the situations now encountered in modern cities and in radio transmission were not contemplated. It is not believed to be applicable to cases of mechanical vibrations or to radio. It is submitted that reasonableness should be the test and if unreasonable vibrations of earth or ether are set up those responsible for their generation should be held accountable. This view is in accord with *Hennesay v. Carmony*, 50 N.J. Reports, Equity, Ames, "Cases in Equity Jurisdiction," (vol. 1, p. 578) where injunctive relief was granted against the generation of unreasonable vibrations by laundry dryers which vibrations constituted a private nuisance. Note 1, p. 585 of Ames Cases is also significant in this connection as indicating that actual damage is not a condition precedent to obtaining relief.
20. The purpose of radio legislation is to prevent chaos by properly regulating the use of the ether, *Journal Co. v. Federal Radio Commission* 48 Fed. (2d) 461.
21. Historical Note 47 U.S.C.A. 51.
22. *Hoover v. Intercity Radio Co.* 286 Fed. 1003.
23. But facts known at time of granting a construction permit should not be urged against granting a license if the applicant has acted bona fide and erected his station. *Richmond Development Co. v. Federal Radio Commission* 35 Fed. (2d) 883. However, the Federal Radio Commission appears to have the right to refuse to grant or continue a license for cause. 47 U.S. C.A. 91.

24. *Brown v. Houston*, 114 U.S. 622.
25. For example see *Duncan v. U.S.* 48 Fed. (2d) 128, *Whitehurst v. Grimes loc. cit.*, and *Mich. Law Rev.*, note 26, p. 919, remembering that sound and electromagnetic waves are different.
26. For example see *Pensacola Tel. Co. v. Western Union*, 96 U.S. 1; *Western Union Tel. Co. v. Speight*, 245 U.S. 17; *Western Union Tel. Co. v. Missouri*, 190 U.S. 412, and *Western Union Tel. Co. v. Pendleton*, 122 U.S. 347.
27. 24 Op. Atty. Gen'l. 100.
28. For an old though oft-repeated definition of interstate commerce see *Gibbons v. Ogden*, 9 Wheaton 1.
29. Certainly a more direct burden than where diseased cattle strayed across a state line which was held to be a burden on interstate commerce in *Thorn-ton v. U.S.* 271 U.S. 414.
30. 282 U.S. 493 quoting from *Butler Bros. Shoe Co. v. U.S. Rubber Co.* 156 Fed. 17.
31. The sale of negotiable paper has been held not to be interstate commerce. See note 67, p. 741, Willoughby "Constitutional Law," 3-volume edition.
32. Insurance contracts are not interstate commerce. *N.Y. Life Ins. Co. v. Deer Lodge Co.*, 231 U.S. 495.
33. See *Hammer v. Dagenhart*, 247 U.S. 251. Case involved question of Federal authority to prevent shipment of products of child labor in interstate commerce.
34. White slave cases are generally argued on basis that women are being used as subjects of barter and gain. See *Hope v. U.S.*, 227 U.S. 308.
35. The visual spectrum.
36. See *Packer Corp. v. Utah* 285 U.S. 105 which held State law prohibiting advertising on billboards valid and not a burden on interstate commerce.
37. *Am. Bond and Mortgage Co. v. U.S.*, 52 Fed. (2d) 318 held right to use ether permissive not vested.
38. The case of *Missouri v. Holland*, 252 U.S. 416 held Congress had ancillary power for execution of treaties affecting migratory birds.
39. See Title 17 U.S. C.A.
40. 283. U.S. 191.
41. Regulation 71 of Federal Radio Commission.
42. 286 U.S. 165 (1932 case). Also consider the striking analogy to the "Original Package Cases." See for example *Austin v. Tennessee*, 179 U.S. 343. The transmission of a broadcast program over an interstate wire circuit can be likened to shipment in an original package while the broadcasting of the program by the station is similar to breaking the package and retailing its contents. The program after broadcasting is again interstate in character but at some point, say the input to the transmitter, the "original package" may be considered to be broken.
43. 123 U.S. 623.
44. The power to regulate such emission is in the Congress. Compare with *Brooks v. U.S.*, 267, U.S. 432, which case upheld National Motor Vehicle Theft Act on theory of federal police power in field of interstate commerce.
45. *Weber v. Mann*, 42 S.W. (2d) 492. Similar reasoning appears applicable to auto radio cases.
46. *Adair v. U.S.*, 208 U.S. 161.
47. 243 N.W. 82, Nebraska Supreme Court, 1932.

48. A state property tax is not invalid if it taxes property used in interstate commerce as it taxes other similar property and is not levied against the commerce, *C. & C. Bridge Co. v. Kentucky*, 154 U.S. 204.
49. *Champlin Refining Co. v. Corp. Commission* 286 U.S. 210 held a state could regulate production of petroleum when same is immediately shipped in interstate commerce.
50. See for example *G. E. Co. v. Fed. Radio Commission*, 31 Fed. (2d) 630; *Technical Radio Lab. v. F.R.C.*, 36 Fed. (2d) 112; *City of New York v. F.R.C.*, 36 Fed. (2d) 115; and *Munn v. Illinois* 94 U.S. 113.
51. See Note 23 *supra* and *F.R.C. v. Nelson Bros. Bond & Mortgage Co.* decided May 8, 1933, by U.S. Supreme Court (Cases Nos. 657, 658, 659, and 660).



## RADIATION AND INDUCTION\*

BY

R. R. RAMSEY

(Department of Physics, Indiana University, Bloomington, Indiana)

IN A paper entitled "Radiation and Induction"<sup>1</sup> by the author and Robert Driesback in 1928, the fields about coils and aerials were developed. The development of the radiation field was the same as that given by Dellinger.<sup>2</sup> On pages 1122 and 1123 of the first paper it is pointed out that the vector potential (i)  $h/x$ , used by Dellinger, has the same form as the scalar potential of a magnet. Although it is pointed out that the field due to an aerial is perpendicular to the direction  $x$  the similarity of the two equations seems to have led to confusion. Since some of the late textbooks have pointed out the similarity<sup>3</sup> without calling attention to the difference, and others have referred to the paper in the PROCEEDINGS for an elementary explanation,<sup>4</sup> the author thinks that perhaps a more detailed development might be advantageous. It might be said that the similarity is more apparent than real, and perhaps the confusion would be less if there had been less similarity.

We can produce a magnetic field in two ways: first, by means of a magnet or magnetic pole; second, by means of a current of electricity. The field due to a magnetic pole is  $H = m/r$ ,<sup>2</sup> due to the pole of strength,  $m$ . The field at any point,  $P$ , is the vector sum of all such expressions. It is much more convenient to obtain  $H$  from the space derivative of a scalar potential or  $H = \partial \left( \frac{m}{r} \right) / \partial S$ , where  $m/r$  can be understood to be the algebraic sum or the scalar sum of all expressions,  $m/r$ . This has been illustrated in several cases in the original paper.

In the case of the magnetic field due to a current we have the fundamental equation  $H = (Idl/r^2) \cos \theta$  where  $Idl$  is an element of current,  $r$  is the distance of the point  $P$  from the element,  $Idl$ , and  $\theta$  is the angle made between  $r$  and the perpendicular drawn to the element,  $Idl$ . We can assume that the element of current  $Idl$  at the origin, Fig. 1, has the components,  $I dX$ ,  $I dY$ ,  $I dZ$ . It will be apparent that a current

\* Decimal classification: R111. Original manuscript received by the Institute, May 8, 1933.

<sup>1</sup> Proc. I.R.E., vol. 16, p. 1118, (1928).

<sup>2</sup> Scientific Papers of the Bureau of Standards, No. 354.

<sup>3</sup> Everitt, "Communication Engineering," p. 506.

<sup>4</sup> Terman, "Radio Engineering," p. 494.

flowing in any direction will produce no magnetic field in that direction, since the lines of force are circles about the current.

Let us determine the field in the  $Z$  direction at the point  $P$  in the figure. The field due to  $I dZ$  will be zero. The field due to  $I dY$ , according to the equation is

$$- (IdY/r^2)(\sqrt{x^2 + z^2}/r)(x/\sqrt{x^2 + z^2})$$

where,

$$\cos \theta = \sqrt{x^2 + z^2}/r$$

and where,

$$x/\sqrt{x^2 + z^2}$$

is the cosine of the angle between the direction of the field at  $P$  and the  $Z$  direction. This when simplified is  $H_z = - (I dY)(x/r^3)$ . The minus sign is given since the field is perpendicular and into the plane of the paper.

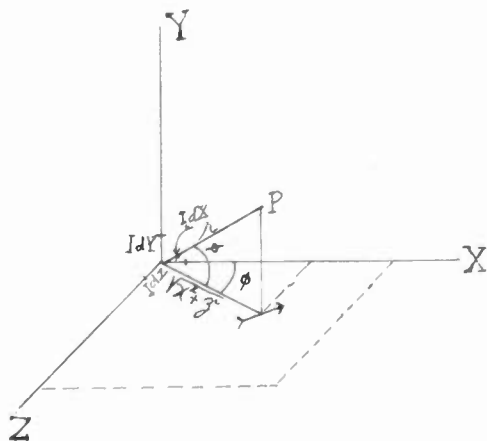

Fig. 1

This is seen to be the derivative of  $I dY/r$  with respect to  $x$ .

$$\begin{aligned} H_z &= \frac{\partial}{\partial x} (IdY)(x^2 + y^2 + z^2)^{-1/2} = (IdY)(-1/2)(x^2 + y^2 + z^2)^{-3/2}(2x) \\ &= - (IdY)x/r^3. \end{aligned}$$

This is the field in the  $Z$  direction due to the component of current  $I dY$ . There also will be a component field in the  $Z$  direction due to the current  $I dX$ . This will be seen to be

$$H_z = (IdX)(y/r^3) = - \frac{\partial}{\partial y} (IdX/r).$$

Thus the total field in the  $Z$  direction is

$$H_z = \frac{\partial}{\partial x} (IdY/r) - \frac{\partial}{\partial y} (IdX/r).$$

This will be recognized as the  $Z$  component of a curl equation. The complete equation is

$$\left. \begin{aligned} H_x &= \frac{\partial}{\partial y} (IdZ/r) - \frac{\partial}{\partial z} (IdY/r) \\ H_y &= \frac{\partial}{\partial z} (IdX/r) - \frac{\partial}{\partial x} (IdZ/r) \\ H_z &= \frac{\partial}{\partial x} (IdY/r) - \frac{\partial}{\partial y} (IdX/r) \end{aligned} \right\} = \text{curl } (Idl/r).$$

In the case of an aerial the current is all in the  $Y$  direction and we can assume  $(I dY/r) = Ih/r$  where  $h$  is the equivalent height of the aerial and  $r$  is great compared to  $h$ . Since there is no current in the  $X$  and  $Z$  directions our fields simplify to

$$\begin{aligned} H_x &= \frac{\partial}{\partial z} (Ih/r) = (Ih)(z/r^3) \\ H_y &= 0 \\ H_z &= \frac{\partial}{\partial x} (Ih/r). \end{aligned}$$

Since the point,  $P$ , is usually assumed to be on the surface of the earth in the  $XY$  plane, we have  $z=0$  and  $H_x=0$ , and since  $r=x$  our field becomes

$$H_z = \frac{\partial}{\partial x} (Ih/x).$$

The field due to a current is the curl of a vector potential,  $I dl/r$ . This when simplified becomes the derivative with respect to  $x$  of the vector potential  $Ih/x$  which is Dellinger's equation.

The complete equation for the magnetic field is,

$$H = - \frac{\partial}{\partial s} (m/r) + \text{curl } (Idl/r).$$

The field is the negative derivative with respect to space of a scalar potential,  $m/r$ , due to magnets, plus the curl of a vector potential due to currents. To quote A. G. Webster,<sup>5</sup> "The vector potential belonging to the magnetic force is the vector potential of the current density."

<sup>5</sup> Webster, "The Theory of Electricity and Magnetism," p. 436.

In radiation from an aerial we are interested in the fields produced by the current. This field in any direction,  $Z$ , is the derivative with respect to space in a second direction,  $X$ , say, of a vector potential,  $I dY/r$  in the third or  $Y$  direction. When dealing with fields produced by magnets it is often convenient to use the negative space derivative of a scalar potential,  $m/r$ . Likewise when dealing with fields produced by a current it is at times convenient to use the curl of a vector potential,  $I dl/r$ .



## SUPERREGENERATIVE WAVE METER FOR ULTRA-SHORT WAVES\*

BY

H. ATAKA

(Meidi College of Technology, Tobata, Japan)

**Summary**—In order to determine the wavelength of ultra-short-wave oscillators with insufficient output, a simple generating wavemeter based on superregeneration is developed, and some descriptions are given of its construction, manipulation, and accuracy.

THE Lecher-wire system is widely used for wavelength determination of ultra-short waves. As it is a kind of absorption method, it is very troublesome for calibrating the wavelength of an oscillator with insufficient output, one of the chief examples of which is the receiver for use on ultra-short waves. For such a purpose, one might naturally turn to a wave meter based on the heterodyne principle. The beat notes, however, are usually very unstable for these waves, and the

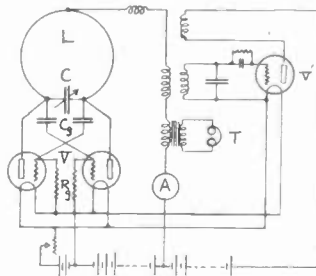

Fig. 1—Circuit of superregenerative wave meter.  
 $C_0 = 0.0001$  microfarad,  $R_0 = 1$  megohm.

wave meter on this principle will not be so useful as for longer waves. To overcome these difficulties we have constructed a wave meter employing superregeneration.

Fig. 1 represents a circuit of the superregenerative wave meter diagrammatically. The resonant circuit consists of a single-turn circular coil  $L$  and a variable condenser  $C$ .  $C$  is a midget condenser of 13 plates and  $L$  a set of coils of the following dimensions:

Coil  $A$ , diameter 14 cm,

Coil  $B$ , diameter 7 cm,

Coil  $C$ , diameter 3.2 cm,

\* Decimal classification: R384×R211.1. Original manuscript received by the Institute, June 26, 1933.



each coil being made of copper wire B & S No. 6. The frequency of quenching oscillator  $V'$  is 77.8 kilocycles.

In the first place, the wavelength of the oscillator  $V$  is carefully calibrated by means of a Lecher-wire system. The calibration curves are shown in Fig. 2. The range of wavelength from 4 to 10 meters is

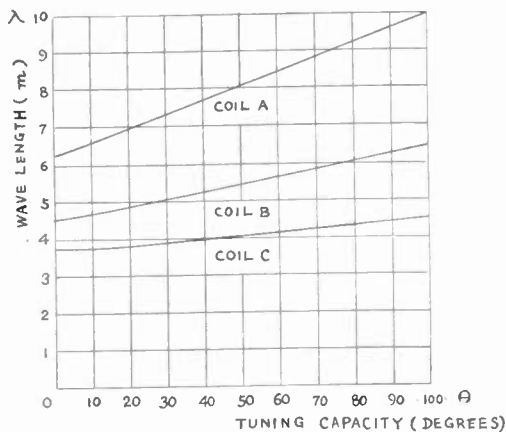

Fig. 2—Calibration curve of wave meter.

covered with these coils. In order to extend this range to shorter wavelengths, it would be necessary to decrease the capacity of the condenser. The variations of wavelength with the operating plate voltage and

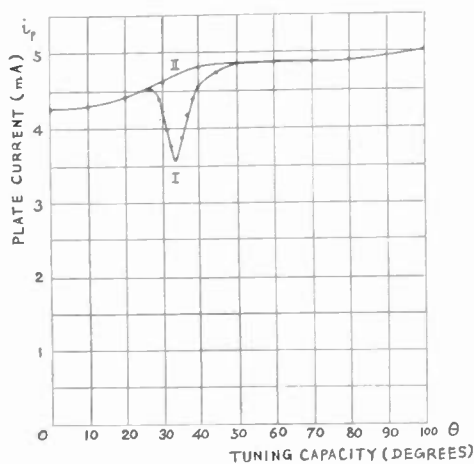

Fig. 3—Resonance curve of wave meter.

filament current have been found to be within an error of one per cent or less.

If the wave meter is put into operation, a characteristic noise will be caused by the quenching action of superregeneration and a reading will be observed on the milliammeter  $A$ . When a wave is incident upon the wave meter and the resonant circuit is tuned to the wave, both the

noise in the telephone receiver  $T$  and the reading on the ammeter  $A$  will show sudden decreases simultaneously, and the more perfect the resonance is, the more they decrease. By observing these variations and referring to the calibration curves, we can find the unknown wavelength of incoming wave. It is preferable to take plate current as the indicator of resonance, owing to its sharp variation.

Now let us illustrate by an example: It is required to determine the wavelength of a receiver. The wave meter is placed near the receiver at a distance two meters or so. Using a suitable coil ( $B$ , in this case), the tuning capacity is, as usual, varied gradually. Then for plate current as a function of capacity, we obtain curve I, as shown in Fig. 3, on which curve II is for the case without incoming wave. From these curves it is easily found that resonance occurs at the point  $\theta = 33.0$ . Hence from Fig. 2 the wavelength of the receiver is found to be 5.12 meters. A direct determination by means of the Lecher-wire system gives a wavelength of 5.10 meters. In practice it is not necessary to plot a resonance curve as the value of  $\theta$  corresponding to minimum reading of the meter  $A$  can be used without any loss in accuracy.



## ON THE PRODUCTION OF ULTRA-SHORT-WAVE OSCILLATIONS WITH COLD-CATHODE DISCHARGE TUBES\*

BY

KINJIRO OKABE

(Nagoya Higher Technical College, Nagoya, Japan)

**Summary**—In this paper it is pointed out that the ultra-short-wave oscillation whose wavelength depends on the external circuit can be successfully produced with a cold-cathode discharge tube of special construction by applying a strong magnetic field. The oscillation whose wavelength is below one meter could be obtained by this method.

Theoretical discussion of the present oscillation is also given in connection with one of the magnetron oscillations.

### INTRODUCTION

IN A previous communication<sup>1</sup> the author pointed out that he could produce high-frequency oscillations of two different types with a cold-cathode discharge tube of special construction (Fig. 1) by applying a strong magnetic field. These two types are: (A) the oscillation in which its frequency is approximately independent of properties of external circuit, and (B) the oscillation in which its frequency is determined by the external circuit.

The oscillation of type (A) is similar in its characteristics to those obtained by Fox,<sup>2</sup> Pardue and Webb,<sup>3</sup> and others.

The oscillation of type (B) seems to occur by the same cause as the magnetron oscillation of type (B),<sup>4</sup> and it appears to the author that a negative resistance of special type which differs from those shown by Habann<sup>5</sup> and others must be taken into consideration in the explanation of the oscillation of this type. In this paper experimental results and theoretical considerations of this oscillation will be dealt with.

### EXPERIMENTAL RESULTS

Fig. 1 shows the construction of the discharge tube (residual gas: nitrogen) used in the present experiment. The terminal lead  $T_3$  was utilized in the course of evacuation, but it was not used during the experiment.

\* Decimal classification: R133. Original manuscript received by the Institute, July 5, 1923.

<sup>1</sup> K. Okabe, Reports of the Institute of Science in Japan, vol. 8, (1932).

<sup>2</sup> G. W. Fox, *Phys. Rev.*, vol. 35, p. 1066 (1930); vol. 37, p. 821, (1931).

<sup>3</sup> L. A. Pardue and J. S. Webb, *Phys. Rev.*, vol. 32, p. 946, (1928).

<sup>4</sup> K. Okabe, *Proc. I.R.E.*, vol. 18, p. 1748, (1930).

<sup>5</sup> E. Habann, *Zeit. für Hochfrequenz*, vol. 24, p. 115 and p. 135, (1924).

It has been found that the most necessary requirement for the production of the oscillation of type (B) is to keep the proper degree of vacuum. The author has obtained satisfactory results in the case where a gaseous discharge begins to occur under a strong magnetic field, a high voltage being applied to the anode.

Fig. 2 shows the circuit used in the present experiment. The wavelengths, etc., were measured by a Lecher-wire system placed near this circuit.

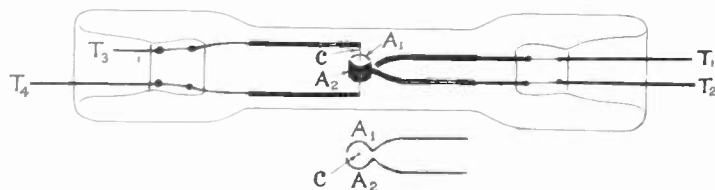

Fig. 1

One of the experimental results, which was obtained with a properly evacuated discharge tube (the diameter of the anode: 3 millimeters, the diameter of the cathode: 0.09 millimeter) is shown in Fig. 3. In the figure  $\lambda$  and  $H$  represent the measured wavelength and the intensity of the applied magnetic field, respectively. The other sym-

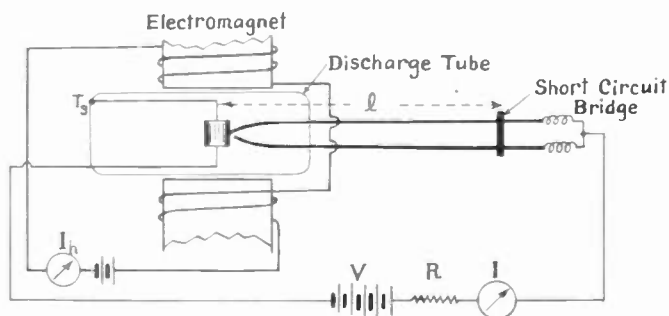

Fig. 2

bols correspond with those of Fig. 2. In this case the author could detect the ultra-short-wave oscillation down to 76 centimeters in wavelength.

Fig. 4 shows the change of anode current and detector current when the intensity of magnetic field was varied. The detector current is represented by  $I_d$  in the figure, and it becomes the measure of the intensity of oscillation. This result was obtained with the same tube as the above, when the length of  $l$  was so adjusted as to produce the most intense oscillation under the given values of  $V$  and  $R$ .

In general the oscillation was strongest at a proper value of  $l$ , and a falling static characteristic in either of the anode circuits of a tube was not a necessary factor for the production of the present oscillation.

THEORETICAL CONSIDERATION IN CONNECTION WITH  
MAGNETRON OSCILLATION OF TYPE (B)

It seems to the author that the present oscillation may be caused in the same way as that of the magnetron oscillation of type (B), as

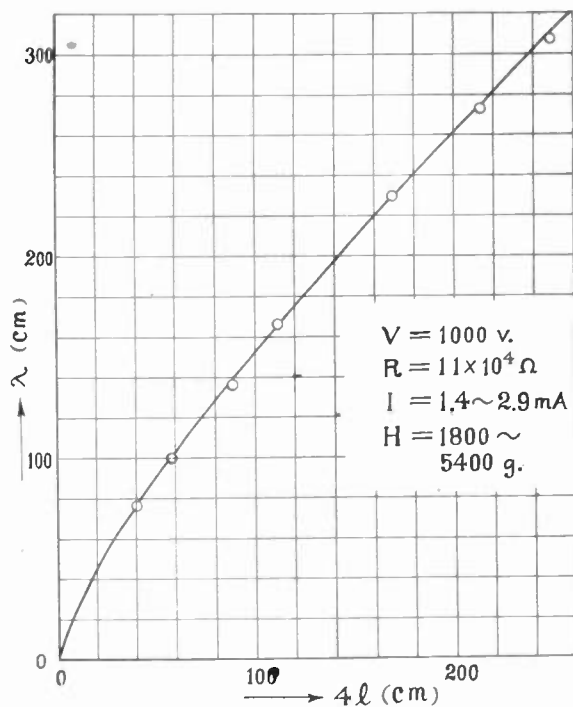

Fig. 3

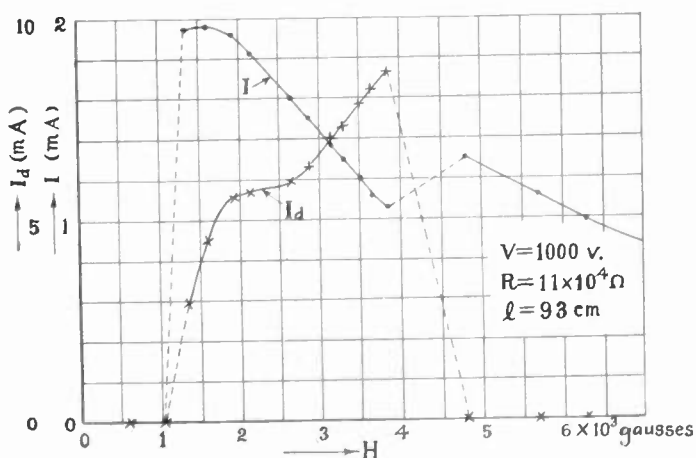

Fig. 4

the degree of vacuum had to be kept comparatively high and the oscillations were too short in wavelength to be caused by some ionic phenomenon. Furthermore, the fact that the characteristics are very closely

similar in both cases may support the above hypothesis, so the cause of the magnetron oscillation of type (B) will be discussed in the following.

The author could successfully produce the magnetron oscillation of type (B) with the unsplit-anode magnetron and the split-anode magnetron whose two anode segments were connected together at the anode side, connecting the oscillation circuit between the terminals of the

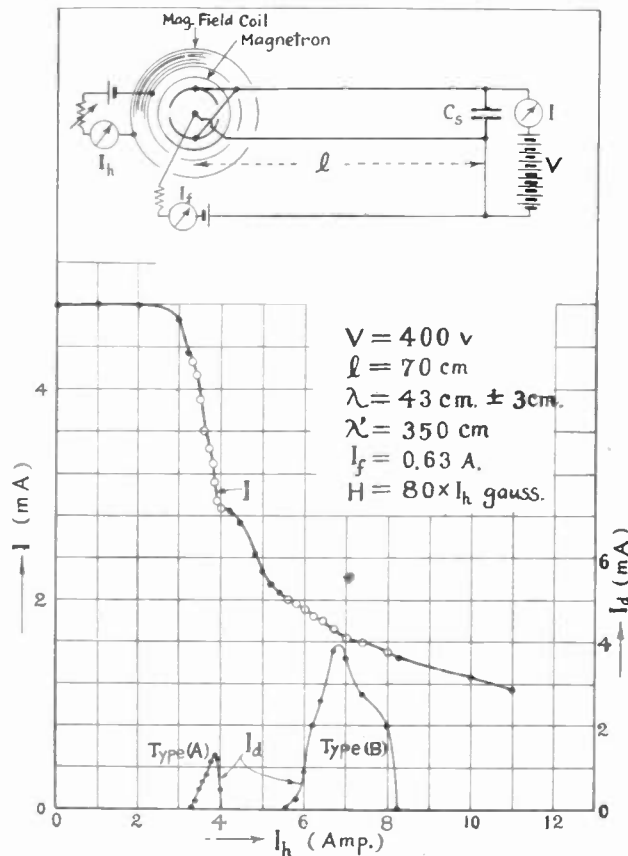

Fig. 5

anode and the cathode.<sup>6</sup> Also the author could produce it with a split-anode magnetron which showed no prominent falling characteristic in each anode circuit.<sup>6</sup>

Figs. 5 and 6 illustrate the above-mentioned results. In both figures  $\lambda$  and  $\lambda'$  represent the wavelengths of the magnetron oscillations of types (A) and (B), respectively, and  $I_d$  represents the detector current which becomes the measure of the intensity of oscillation. Other symbols are diagrammatically illustrated in the figures. The diameter and length of the anode of the tube used in the present experiments are 1.8

<sup>6</sup> K. Okabe, M. Ishida, and M. Hishida, *Jour. I.E.E. (Japan)*, vol. 152, p. 478, (1932).

centimeters and 2.5 centimeters, respectively. In Fig. 6 the curve II was obtained when the various quantities had been so adjusted as to make the oscillation start at a proper value of  $V_1 - V_2$ , and the curve I was obtained under the same condition except that the short-circuit condenser  $C_s$  (0.1 microfarad) had been removed in order to stop the oscillation.

McArthur and Spitzer,<sup>7</sup> Megaw<sup>8</sup> and others reported valuable results regarding the magnetron oscillation which seems to belong to the

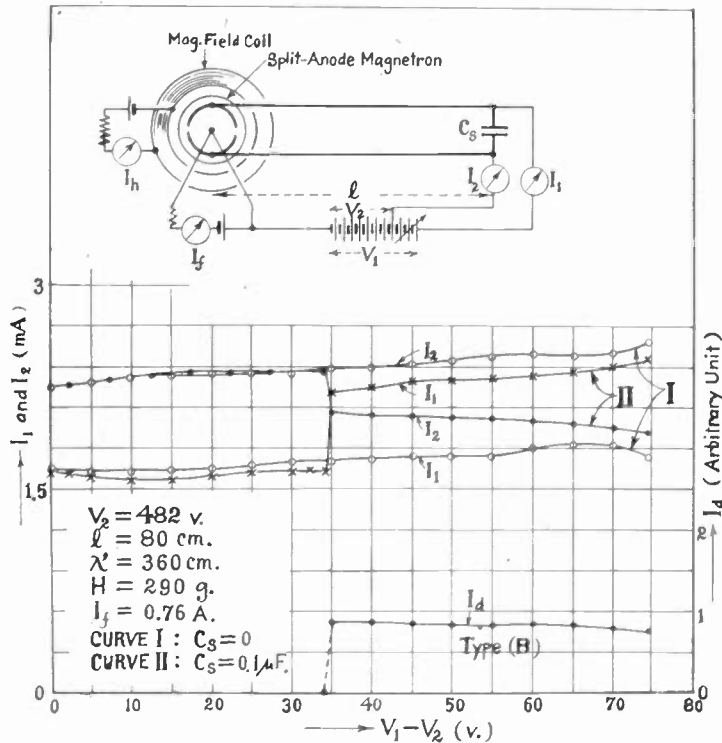

Fig. 6

magnetron oscillation of type (B), and tried to explain this oscillation by a negative resistance of the dynatron type (which appears only by the change of electron path) just in the same way as the case of Habann oscillation. The author, however, thinks that in the explanation of this oscillation it may be necessary to take the experimental results shown in Figs. 5 and 6 into consideration, and also thinks that in this case the negative resistance, which probably exists in consequence of the abnormal accumulation of electronic space charge near the anode,<sup>9,10</sup>

<sup>7</sup> E. D. Mc Arthur and E. E. Spitzer, Proc. I.R.E., vol. 19, no. 11, p. 1971-1982; November, (1931).

<sup>8</sup> E. C. S. Megaw, Jour. I.E.E., vol. 72, p. 326, (1933).

<sup>9</sup> L. Tonks, Phys. Rev., vol. 30, p. 501, (1927).

<sup>10</sup> K. Okabe, Tech. Rep. Tohoku Imp. Univ., vol. 7, p. 241, (1928).

or some other similar distribution<sup>11</sup> is to be taken into consideration, the effect of the external circuit also being taken into account.

In short the author is of opinion that the oscillation of type (B) obtained with cold-cathode discharge tube may be the same as the magnetron oscillation of type (B), and most of the oscillation of this type may not be due to the same cause as those of the Habann type.

<sup>11</sup> K. Kohl, *Ergebnisse der exakten Naturwissenschaften*, vol. 9, p. 275, (1930).





## A PROJECTOR TYPE LIGHT FLUX GENERATOR FOR TESTING LIGHT SENSITIVE DEVICES\*

By

E. B. KURTZ

(Professor and Head Electrical Engineering Department, University of Iowa, Iowa City, Iowa)

AND

J. L. POTTER

(Instructor in Electrical Communication, University of Iowa, Iowa City, Iowa)

*Summary*—A novel light flux generator is described which is capable of giving a sinusoidal light flux for frequencies up to 100,000 cycles or higher per second, for use in the testing of television equipment or other equipment using photo-electric cells.

An experimental and calculated curve is shown to verify the accuracy of the apparatus.

IN THE study of the frequency characteristics of photo-electric cells and neon lamps such as are used in television, it is necessary to employ some type of light flux generator which will give a variable light flux, comparatively free from harmonics. Various types of light flux generators have been developed, but the one in most general use seems to be a disk with holes arranged in a circle around the circumference, which are so masked as to give a sine wave of light flux.<sup>1</sup> This scheme works fairly well up to frequencies as high as 15,000 cycles per second or possibly higher. If the disk contained 100 holes and could be rotated 6000 revolutions per minute, a maximum frequency of 10,000 cycles would be generated. If higher frequencies are to be obtained, either the disk speed must be raised or the number of holes in the disk must be increased. Both of these expedients have limitations.

It is the purpose here to describe briefly a new sinusoidal light flux generator capable of generating a light flux frequency of 100,000 cycles or higher. A frequency of 100,000 cycles is high enough for most of the television equipment in use at the present time.

The light flux generator itself consists of a variable area recorded frequency film placed on a rotating drum with the edge containing the frequency recording projecting over the edge of the drum. In order to obtain the proper light source, the same lamp and optical system as is

\* Decimal classification: R583 × 535.3. Original manuscript received by the Institute, June 21, 1933.

<sup>1</sup> Zworykin and Wilson, "Photocells and Their Applications," 2nd edition, page 208; YEAR BOOK, I.R.E., pp. 174-175, (1931).

found in the standard movie sound head is used. This consists of an  $8\frac{1}{2}$ -volt, 4-ampere exciter lamp, and a Bausch and Lomb lens tube assembly, which contains the slit and the proper lens system for focusing. The beam of light leaving the film is given a right-angle turn and projected on to the photo-electric cell. A photograph of the light flux generator is shown in Fig. 1.

In placing the film around the drum it is necessary to splice the film so that it contains an integral number of waves. This reduces the effect of the splice in the film.

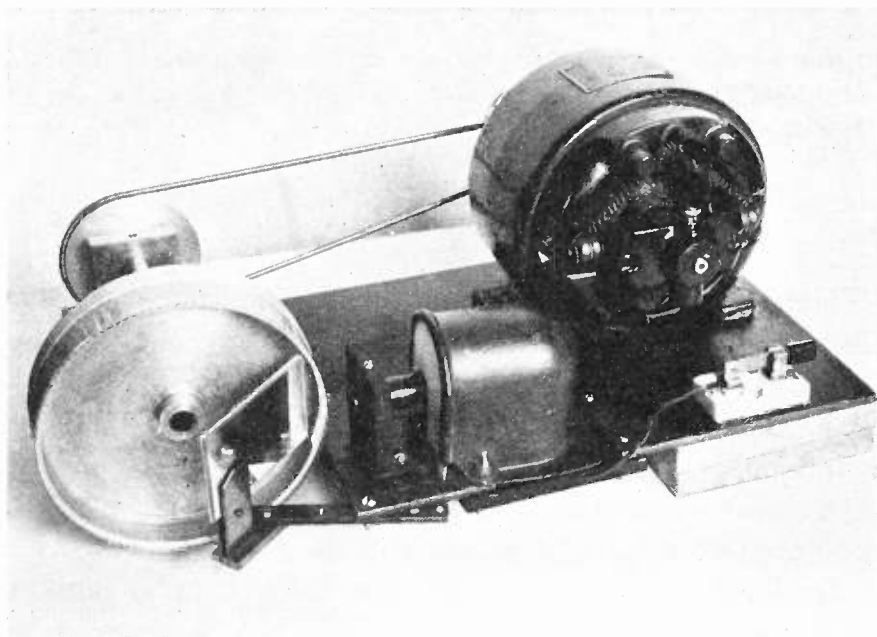

Fig. 1

These frequency film bands are eighteen inches in length, and if a 1000-cycle recording is used, 1000 waves will be generated for each revolution of the drum. If the maximum speed of the drum is 3000 revolutions per minute or 50 revolutions per second, a frequency of 50,000 cycles will be generated. This is not the limit of the generator as more waves can be recorded per inch of film length and the speed of the drum can be increased.

After the light flux generator was constructed it was used to test photocells up to frequencies of sixty thousand cycles per second.

In order to test the accuracy of the equipment, a vacuum photocell was used with a good resistance-capacitance coupled amplifier, and the output was put into an oscillograph and adjustments made on the light source until a sinusoidal wave form was obtained. Fig. 2 shows the wave obtained (a) and a section of the variable area recorded frequency film (b).

The load resistance on the photocell was 30,000 ohms and the amplifier response curve was practically flat up to 50,000 cycles. This combination of both photocell and amplifier also produced a practically flat response curve up to 50,000 cycles. (See Fig. 3, curve 1.) A 274-micromicrofarad fixed capacitance was then placed across the 30,000-

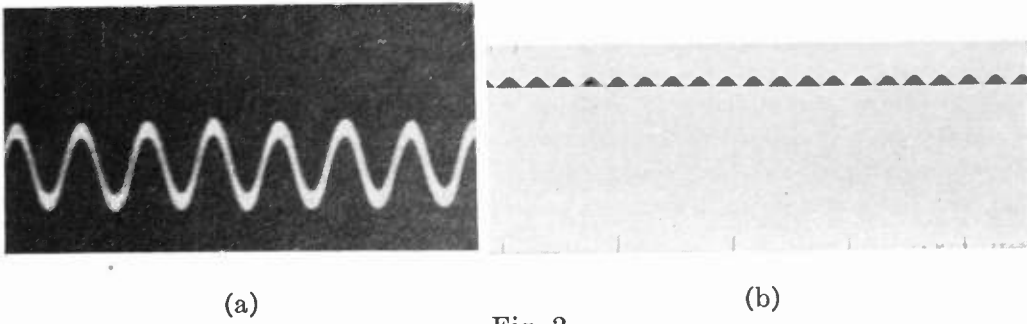

Fig. 2

ohm load resistance of the photocell. Curve 2 shows the calculated relative input impedance for this combination, and the points marked (x) are the points obtained experimentally with the apparatus. The coincidence is sufficient to bring out the accuracy of the equipment.

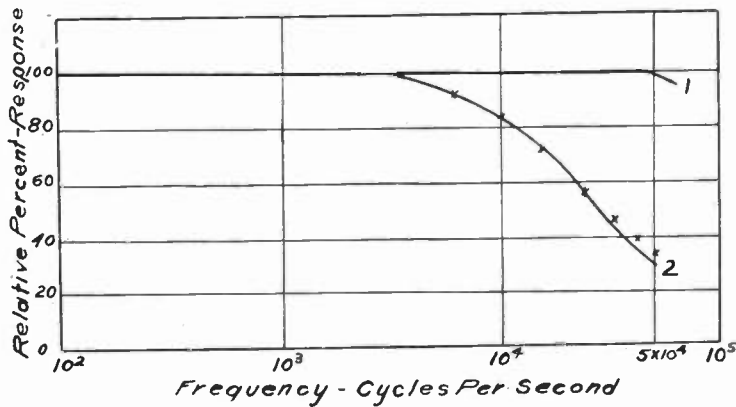

Fig. 3—1. Vacuum photocell and amplifier.  
 2. Calculated relative input impedance when total shunt capacitance is 274 micromicrofarads.  
 x. Experimental check, same capacitance.

The light flux generator with photocell and amplifier may also be used as an audio-frequency generator for making frequency runs on various types of radio and television equipment. The frequency can be varied smoothly and quickly, thereby fulfilling the requirements of a beat frequency oscillator and at the same time having a wider range of frequency.

This apparatus, therefore, provides an excellent method for obtaining dynamic characteristics of photocells at the higher frequencies

and should also prove valuable from a research standpoint for other applications.

#### ACKNOWLEDGMENT

The writers wish to express their appreciation to Mr. Harold A. Peterson, graduate student in Electrical Engineering, for carrying out the construction of the apparatus, and to the Eastman Kodak Company for their kindness in supplying the frequency film.



## A NOTE ON THE SIMPLE TWO-ELEMENT LOW-PASS FILTER OF TWO AND THREE SECTIONS\*

BY

L. B. HALLMAN, JR.

(Montgomery Broadcasting Co., Inc., Montgomery, Alabama)

**Summary**—An analytical study of the simple two-element low-pass filter of two and three sections is presented. Making certain approximations, applicable to the majority of such structures, the most economical distribution of a given sum total capacity and inductance between the various sections of the filter is determined. The advantage of the third section is shown by obtaining a simple expression for the filtering ratio of the three-section filter in terms of the ratio of the first two sections, taken alone, and the parameters of the last section.

### INTRODUCTION

BECAUSE of its almost universal use in connection with all manner of power supply circuits, the two-element low-pass filter of two and three sections warrants individual consideration. The usual purpose of the filter is to reduce the effectiveness of the alternating components in the power source. Since the direct-current component is desired, it should not be greatly affected. It is the purpose of this note to determine, analytically, the most economical distribution of inductance and capacity when designing this type of filter.

Any source of electromotive force that requires filtering may be replaced by an infinite number of generators, each having a sinusoidal output and an internal impedance  $Z_n$ . The root-mean-square voltage of each may be represented by  $e_n$  and may be derived by a Fourier expansion of the wave form to be filtered. The output of these  $n$  generators is superimposed on a purely constant electromotive force.

It will, doubtless, be desirable to make the calculations at the lowest frequency existing in the power supply wave form. This is true in most practical cases for two reasons: First, the lowest frequency or fundamental component is the most difficult to filter, and second, the amplitudes of the higher frequency components or harmonics are smaller than the fundamental.

### TWO-SECTION FILTER

The two-section structure is shown schematically in Fig. 1(a), with the equivalent circuit and applied alternating-current component,  $e_n$ , in 1(b). It is known<sup>1</sup> that the current flowing through  $Z_L$  in such a

\* Decimal classification: R143. Original manuscript received by the Institute, May 1, 1933.

<sup>1</sup> K. S. Johnson, "Transmission Circuits for Telephonic Communication," Appendix E, page 283.

structure is:

$$i_L = \frac{e_n Z_{c1} Z_{c2}}{(Z_n + Z_1)(Z_{c1} + Z_2)(Z_{c2} + Z_L) + Z_{c2} Z_L (Z_n + Z_1 + Z_{c1}) + Z_{c1} Z_2 (Z_{c2} + Z_L)}$$

Before the filter was inserted the current flowing through  $Z_L$  was:

$$i_{L0} = \frac{e_n}{Z_n + Z_L}$$

The effectiveness of the filter is best measured in terms of the ratio of these two currents. Thus,

$$i_{L0}/i_L = R_2 \tag{1}$$

$$= \left| \frac{(Z_n + Z_1)(Z_{c1} + Z_2)(Z_{c2} + Z_L) + Z_{c2} Z_L (Z_n + Z_1 + Z_{c1}) + Z_{c1} Z_2 (Z_{c2} + Z_L)}{(Z_n + Z_L) Z_{c1} Z_{c2}} \right|$$

$R_2$  may be expressed in decibels, napiers or any other convenient form. It is the interpretation of (1), applicable to the two-section filter, with which we are concerned.

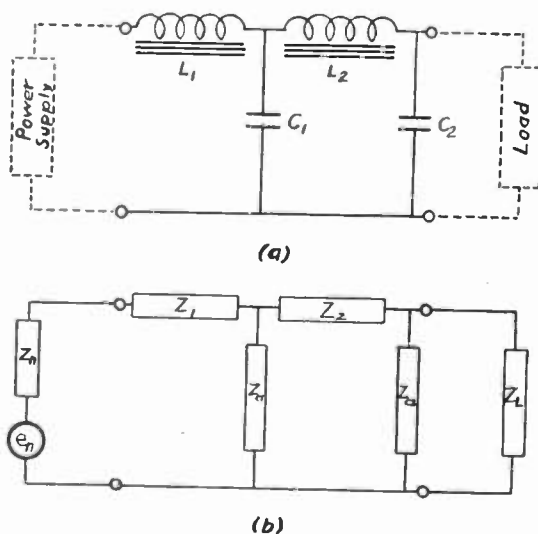

Fig. 1

For any frequency at which the filter is reasonably effective

$$\begin{aligned} |Z_{c1}| &\ll |Z_2|, \\ |Z_{c1}| &\ll |Z_1|, \\ |Z_{c2}| &\ll |Z_L|. \end{aligned}$$

This assumes reasonably large condensers and chokes, which is correct for the usual filter. With these assumptions (1) becomes

$$R_2 \doteq \left| \frac{Z_L Z_2 (Z_n + Z_1)}{Z_{c1} Z_{c2} (Z_n + Z_L)} \right|.$$

With a given load and source of power,  $Z_L/(Z_n + Z_L)$  is constant, and we may write

$$R_2 \doteq \left| K \frac{Z_2}{Z_{c1} Z_{c2}} (Z_1 + Z_n) \right|. \quad (2)$$

Therefore, if  $C_1$  and  $C_2$  are large enough to make (2) justifiable, the effectiveness of the filter depends on the product of  $C_1$  and  $C_2$ . As long as this product is constant, and the above approximations are correct, the effectiveness of the filter will remain the same. If  $C_1 + C_2$  remains constant, as  $C_1$  and  $C_2$  are varied, then, applying the differential calculus, it is found that  $C_1 C_2$  is a maximum when  $C_1 = C_2$ . This is the most economical distribution of capacity under these conditions.

Turning now to the inductance we find that, providing the structural parameters are so adjusted as to make (2) correct,  $R_2$  will depend on the product  $Z_2(Z_1 + Z_n)$ . If  $Z_1 + Z_2$  is held constant, as  $Z_1$  and  $Z_2$  are varied, the product will be a maximum when  $Z_2 = Z_1 + Z_n$ . This is the most economical distribution of inductance. Hence, the two inductances  $L_1$  and  $L_2$  are of different sizes, for the most economical design, with  $L_1$  the smaller.

$L_1$  is useful particularly in connection with thermionic rectifiers, where it reduces appreciably the harmonic currents flowing through the tubes, thereby making higher efficiencies possible.

### THREE-SECTION FILTER

The three-section two-element low-pass filter is shown schematically in Fig. 2(a) with the equivalent circuit in 2(b). It is used in preference to the two-section filter when sufficient filtering cannot be obtained with chokes and condensers of reasonable size arranged in two sections. It is obvious that greater filtering can be obtained with smaller individual units arranged in three sections.

The current flowing in the load of the structure of Fig. 2(b) is known to be<sup>1</sup>

$$i_L = \frac{e_n Z_{c1} Z_{c2} Z_{c3}}{(Z_{c3} + Z_L) [(Z_1 + Z_n)(Z_{c1} + Z_2)(Z_{c2} + Z_3) + Z_{c1} Z_2 (Z_{c2} + Z_3) + Z_{c2} Z_3 (Z_n + Z_1 + Z_{c1})] + Z_{c3} Z_L [(Z_n + Z_1 + Z_{c1})(Z_2 + Z_{c2}) + Z_{c1} (Z_1 + Z_n)]}$$

Proceeding as for the two-section filter we find

$$R_3 = \frac{(Z_{c3} + Z_L)[(Z_1 + Z_n)(Z_{c1} + Z_2)(Z_{c2} + Z_3) + Z_{c1}Z_2(Z_{c2} + Z_3) + Z_{c2}Z_3(Z_n + Z_1 + Z_{c1})] + Z_{c3}Z_L[(Z_n + Z_1 + Z_{c1})(Z_2 + Z_{c2}) + Z_{c1}(Z_1 + Z_n)]}{Z_{c1}Z_{c2}Z_{c3}(Z_n + Z_L)} \quad (3)$$

Assuming reasonably large chokes, let us begin increasing the size of the condensers. A point will be reached where

$$\begin{aligned} |Z_{c3}| &\ll |Z_L|, \\ \text{Also, } |Z_{c1}| &\ll |Z_2|, \\ |Z_{c2}| &\ll |Z_3|; \end{aligned}$$

and consequently

$$\left| [Z_{c1}Z_2(Z_{c2} + Z_3) + Z_{c2}Z_3(Z_n + Z_1 + Z_{c1})] \right| \ll \left| (Z_1 + Z_n)(Z_{c1} + Z_2)(Z_{c2} + Z_3) \right|.$$

When this is true, we may write

$$R_3 \doteq \left| \frac{Z_L Z_2 Z_3 (Z_1 + Z_n)}{Z_{c1} Z_{c2} Z_{c3} (Z_n + Z_L)} \right| \equiv \left| K \frac{Z_2 Z_3}{Z_{c1} Z_{c2} Z_{c3}} (Z_1 + Z_n) \right|.$$

It follows, then, that if the parameters of the first two sections of the three-section filter be equal to the corresponding sections of the two-section filter, we have

$$R_3 \doteq \left| R_2 \frac{Z_3}{Z_{c3}} \right| \doteq \left| R_2 \omega^2 L_3 C_3 \right|. \quad (4)$$

It should be noted that this is the same result as would be obtained by treating the last section as an unloaded voltage divider and assuming  $|Z_{c3}| \ll |Z_3|$ .

Consequently, if we choose  $L_3$  and  $C_3$  so as to make  $|Z_{c3}| \ll |Z_L|$  and  $|Z_{c2}| \ll |Z_3|$ , we can calculate the advantage of the third section over the two sections by (4). From this it is possible to determine, for any particular case, whether it is more economical to increase the parameters of an existing two-section filter or add another section to it.

If the two-section filter was designed making  $C_1 = C_2$ , it is seen that for a certain constant value of the sum  $C_1 + C_2 + C_3$ , the product  $C_1 C_2 C_3$  is a maximum when

$$C_1 = C_2 = C_3.$$



This is the most economical distribution of capacity in the three-section filter.

Proceeding in the same manner we determine the most economical distribution of inductance to be that which makes:

$$Z_3 = Z_2 = (Z_1 + Z_n).$$

Obviously, this treatment could be extended to any number of sections. It is rare, however, that more than three sections are necessary in a filter of this type.

The possibility of series resonance in the circuits containing  $L_1, C_1, L_2, C_2$  and  $L_3, C_3$ , has not been considered. Clearly this condition is

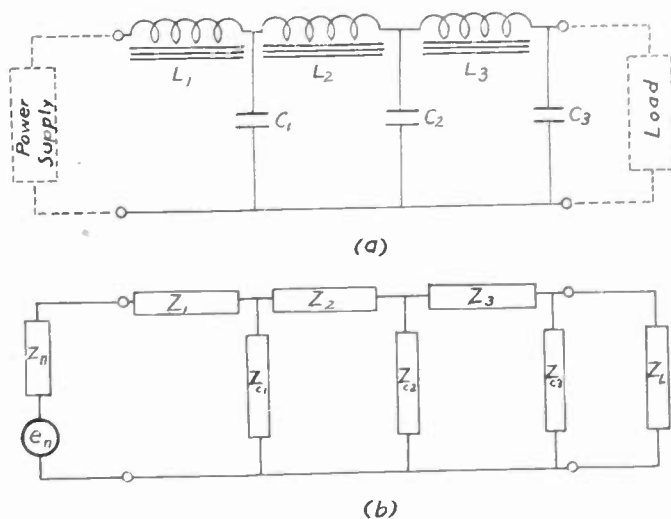

Fig. 2

detrimental and should be avoided. This causes no serious difficulty, however, as it is practically always possible to adjust the circuit to avoid this condition and, at the same time, obtain the desired relations.

There is also a possibility of parallel resonance, at harmonic frequencies, between the distributed capacity and inductance of large chokes. This condition is desirable because it tends toward elimination of the resonant frequency.

#### CONCLUSION

We may conclude, then, that if the structural parameters, of the two-section filter are so adjusted as to make

$$\begin{aligned} |Z_{c1}| &\ll |Z_2|, \\ |Z_{c1}| &\ll |Z_1|, \\ |Z_{c2}| &\ll |Z_L|, \end{aligned}$$

the filtering ratio,  $R_2$ , is given by

$$\left| K \frac{Z_2}{Z_{c1}Z_{c2}}(Z_1 + Z_2) \right|.$$

A given sum total capacity is most effective when so distributed as to make

$$C_1 = C_2.$$

A certain sum total of inductance is most effective when

$$Z_2 = Z_1 + Z_n.$$

If a third section is added, making  $|Z_{c3}| \ll |Z_L|$  and  $|Z_{c2}| \ll |Z_3|$ , we find that the filtering ratio,  $R_3$ , for all three sections is given by

$$| R_2 \omega^2 L_3 C_3 | .$$

The most economical distribution of capacity is that which makes

$$C_1 = C_2 = C_3.$$

The most economical distribution of inductance is that which makes

$$Z_3 = Z_2 = Z_1 + Z_n.$$



DISCUSSION ON "LINEARLY TAPERED LOADED  
TRANSMISSION LINES"\*

J. W. ARNOLD AND R. C. TAYLOR

A. T. Starr:<sup>1</sup> I wish to correct a misapprehension which occurs in the admirable paper by Messrs. Arnold and Taylor on the linearly tapered loaded transmission lines in the November issue. It is there stated that my solution of the problem [Proc. I.R.E., June, (1932)] suffers from the restriction  $k_R/R_A = k_L/L_A$ . It is seen from my first application (tapered submarine cable) that this is not the case, for there  $k_R = 0$  and  $k_L \neq 0$ . The misapprehension is probably due to the fact that it was not noticed by the authors, that  $x$  may be the actual length plus a complex constant. In my first application only the inductance was considered as varying, but this was merely because the complete and detailed solution was being reserved for a later paper. The extension to the case of the tapered, loaded line is simple, and follows in this way. The series impedance per unit length is

$$\begin{aligned} Z &= (R_0 + k_R l) + j\omega(L_0 + k_L l) \\ &= (R_0 + j\omega L_0) + l(k_R + j\omega K_L) \\ &= (k_R + j\omega k_L) [l + (R_0 + j\omega L_0)/(k_R + j\omega K_L)] \\ &= zx, \end{aligned}$$

where,

$$z = k_R + j\omega k_L$$

and,

$$x = l + (R_0 + j\omega L_0)/(k_R + j\omega k_L).$$

Incidentally, I have arrived at equations (28) and (29) of the authors by the methods indicated in my paper. The detailed solution is being published in the Philosophical Magazine and a worked example is given.

\* Proc. I.R.E., vol. 20, pp. 1811-1817; November, (1932).

<sup>1</sup> 73 Lansdowne Road, London, W. 11, England.



## RADIO ABSTRACTS AND REFERENCES

THIS is prepared monthly by the Bureau of Standards,\* and is intended to cover the more important papers of interest to the professional radio engineer which have recently appeared in periodicals, books, etc. The number at the left of each reference classifies the reference by subject, in accordance with the "Classification of Radio Subjects: An Extension of the Dewey Decimal System," Bureau of Standards Circular No. 385, obtainable from the Superintendent of Documents, Government Printing Office, Washington, D.C., for 10 cents a copy. The classification also appeared in full on pp. 1433-1456 of the August, 1930, issue of the PROCEEDINGS of the Institute of Radio Engineers.

The articles listed are not obtainable from the Government or the Institute of Radio Engineers, except when publications thereof. The various periodicals can be secured from their publishers and can be consulted at large public libraries.

### R000. RADIO (GENERAL)

- R004      Progress in receiver design. *Wireless World* (London), vol. 33, pp. 121-  
×R361      128; August 18, (1933).  
            Outstanding features of new sets on display at Olympia.
- R007      K. B. Warner. Our regulations are revised. *QST* vol. 17, pp. 19-25;  
            September, (1933).  
            The regulations of the Federal Radio Commission, governing amateur radio effective  
            October 1, 1933, are given.
- R007      Code of fair competition for the radio manufacturing industry. *Radio*  
            *Eng.*, vol. 13, pp. 13-19; August, (1933).  
            A code of fair practice as submitted by the Radio Manufacturers Association to the  
            National Recovery Administration on July 29, 1933.
- R070      E. H. Reitzke. Practical radio engineering. *Radio Eng.*, vol. 13, pp.  
            9-10; August, (1933).  
            A brief statement concerning the courses of study for use in teaching practical radio.

### R100. RADIO PRINCIPLES

- R111      G. Beauvais. Recherches expérimentales sur la réflexion totale des  
            ondes hertziennes. (Experimental investigations of total reflection of  
            ultra-high frequencies.) *L'Onde Electrique*, vol. 12, pp. 273-294; June,  
            (1933).  
            This is a continuation of the articles appearing in previous reference lists: Evanescent  
            waves having the electric vector, (1) perpendicular to the plane of incidence, (2) in the  
            plane of incidence are studied.
- R113      G. H. Munro and A. L. Green. Measurements of attenuation, fading  
            and interference in South-Eastern Australia, at 200 kilocycles per  
            second. Reprint, *Jour. I.E.E.* (Australia), vol. 5, pp. 1-8; June,  
            (1933).  
            \*This paper describes the experimental measurement, in South-Eastern Australia,  
            at a transmission frequency of 200 kilocycles per second, of (a) direct ray attenuation for

\* This list compiled by Mr. A. H. Hodge and Miss E. M. Zandonini.

both inland and coastal districts, (b) severity of fading at distances up to 750 kilometers from the transmitter, (c) intensity of the direct ray, and (d) amount of interference by atmospherics." The ground conductivity over various types of terrain are given. It is found that the general noise level, due to indirect ray propagation of atmospherics from great distances, does not exceed 0.015 millivolt per meter. "A broadcasting service, at 200 kilocycles per second of 1.5 millivolts per meter will be entirely free from atmospheric interference, it being understood that purely local thunderstorms are excepted."

- R113.61 I. Ranzi. Recording wireless echoes at the transmitting station. *Nature* (London), vol. 132, p. 174; July 29, (1933).

The author states that he has successfully used a pulse transmitter and receiver in the same room in studying the ionosphere. A brief description of the apparatus used is given.

- R113.61 I. J. Saxl. Radio echoes from space. *Radio News*, vol. 15, pp. 135-137, 182; September, (1933).

The author reviews some of the current theories of the reflections or echoes of radio signals from outside space, linking transmitters, and receivers at great distances apart.

- R125 W. Ochmann and M. Rein. Theorie und praktische Anwendung der gerichteten Strahlung—Zusammenfassender Bericht. (The theory and practical use of directed radiators—Review.) *Hochfrequenz. und Elektroakustik*, vol. 42, pp. 27-32; July, (1933).

A very brief presentation of the fundamental principles of directional radiation is given. A bibliography of 53 references is included.

- R133 J. S. McPetrie. A graphical method for determining the transit times of electrons in a three-electrode valve under conditions of space-charge limitation. *Phil. Mag.* (London), vol. 16, pp. 284-293; August, (1933).

When a thermionic vacuum tube is used to produce electronic oscillations, the frequency of these is dependent upon the transit times of the electrons between the tube electrodes. In this paper, a graphical method is described by which these transit times may be determined for electrons under conditions in which the current is limited by the space charge.

- R133 C. E. Cleeton and N. H. Williams. A magnetostatic oscillator for the generation of 1 to 3 centimeter waves. *Phys. Rev.*, vol. 44, p. 421; September 1, (1933).

Continuous waves have been produced by tubes, of the split-anode type, of very small dimensions. A simple grating spectrometer consisting of two parabolic brass mirrors about one meter in diameter, and an echelette grating was used to measure the wavelength.

- R138 A. J. Ahearn. The effect of temperature on the emission of electron field currents from tungsten and molybdenum. *Phys. Rev.*, vol. 44, pp. 277-286; August 15, (1933).

Electron field currents from the central portion of long molybdenum and tungsten filaments about  $2.7 \times 10^{-3}$  centimeters in diameter were studied. Thermionic emission measurements gave the values 4.32 and 4.58 volts for the work function of the molybdenum and tungsten respectively. Emission measurements were made at fields varying from about  $5 \times 10^5$  volts per centimeter to about  $1 \times 10^6$  volts per centimeter and at temperatures varying from 300 to about 2000 degrees Kelvin.

- R140 H. G. Baerwald. Der Einfluss der Anpassung auf Verstärkung und Selektivität in abgestimmten Hochfrequenzverstärkern. (The influence of matching on amplification and selectivity in tuned radio-frequency amplifiers.) *Elek. Nach. Tech.*, vol. 10, pp. 258-276; June, (1933).

The author examines the subject of matching the oscillatory circuits with the vacuum tubes in order to bring out clearly and quantitatively the effect of such matching on the amplification and selectivity. As an example, a two-tube receiver with a screen-grid radio-frequency stage followed by a detector with retroactive coupling is treated. He then investigates the rôle played by matching in the design of multicircuit radio-frequency amplifiers.

- R148 M. V. Callendar. A note on demodulation under practical conditions. *Wireless Engineer & Experimental Wireless* (London), vol. 10, pp. 480-483; September, (1933).

An experimental study has been made of demodulation under practical conditions. Two tables of data show demodulation ratio for power grid detector and for a diode detector respectively. In practice the demodulation ratio is found to have any value between half the theoretical and unity.

- R148 G. Fayard. Théorie élémentaire du système de modulation multiple d'une oscillation a haute fréquence. (Elementary theory of a system of multiple modulation of an oscillation at high frequency.) *L'Onde Electrique*, vol. 12, pp. 295-325; June, (1933).

The author briefly recalls the efficiency characteristics which one obtains theoretically with triode amplifiers. The reasons for obtaining low efficiency, and poor modulation in practice are pointed out. After explaining the general principles of the system of multiple modulation, the author describes some applications which permit one to obtain much higher efficiency in the power stages and give very little distortion.

- R149 F. Siemens. An analysis of linear rectification. *Radio News*, vol. 15, p. 145; September, (1933).

A simplified analysis of linear rectification.

- R161  
×R361 E. B. Moullin. An outline of the action of a tone corrected highly selective receiver. *PROC. I.R.E.*, vol. 21, pp. 1252-1264; September, (1933).

The action of a highly selective simple tuned circuit located between a source of radio-frequency energy and the terminals of a detector is discussed. Next, the effect of linear and of square-law detection together with an audio-frequency tone correction system is described. Various interference conditions are analyzed with the aid of graphical construction.

## R200. RADIO MEASUREMENTS AND STANDARDIZATION

- R214 I. Koga. Vibrations of piezoelectric oscillating crystal. *Phil. Mag.* (London), vol. 16, pp. 275-283; August, (1933).

"Normal modes and frequency of thickness vibration are given in the mathematical expressions, and the special problems about the quartz plates are dealt with. In quartz, the X-cut plate is the only one that can realize the longitudinal thickness vibration. Plates cut parallel to the electrical axis vibrate always in the pure shear mode."

- R220.1  
×R240 J. R. Tolmie. Note on a modified reactance-frequency chart. *PROC. I.R.E.*, vol. 21, pp. 1364-1366; September, (1933).

An inverted scale of ordinates graduated in micromhos has been added to the "Bell Laboratories Reactance-Frequency Graph Sheets." This modification makes it possible to read directly the susceptances and reactances of any coil or condenser falling within the range of the chart. The chart is included.

- R225 M. G. Scroggie. A method of measuring the self-capacitance of coils. *Wireless Engineer & Experimental Wireless* (London), vol. 10, pp. 477-479; September, (1933).

The limitations of existing methods of measuring the self-capacitance of coils are explained, and a new method described in which the only reading required is that of a difference in capacitance three times as great as that being measured. The apparatus may be used for measurement of inductance also.

- R242.13 L. B. Hilton. A current transformer for low radio frequencies. *Bell Lab. Record*, vol. 12, pp. 24-26; September, (1933).

A transformer is described which is designed for measurements at radio frequencies of the order of 60 kilocycles. Its current range is from 10 to 500 amperes. It may be used to measure current in conductors whose potential is 10,000 volts above ground.

- R261.3 E. E. Free. Is good quality worth while? *Radio News*, vol. 15, pp. 140-141, 161; September, (1933).

A report of a psychological test at New York University on individual preferences of ten groups of university students.

- R270 H. Muyskens and J. D. Kraus. Some characteristics of ultra-high-frequency transmission. *Proc. I.R.E.*, vol. 21, pp. 1302-1316; September, (1933).

A receiving equipment and calibration method is described for the measurement in absolute units of 5.1-meter (58.8 megacycles) field strengths. A transmitter of low power is used. The attenuation of the waves is discussed, and a field strength contour map of Ann Arbor, Michigan and vicinity is presented. The attenuation constant is found to be 0.36. Experiments on receiving antenna lengths show the importance of a properly resonant receiving antenna. The field distribution around the transmitting antenna is investigated by rotations of the antenna with the receiver at a fixed location. The polarization of the waves is studied, and results indicate that horizontally polarized radiation is more rapidly attenuated than is the vertically polarized.

- R270 A. L. Green and H. B. Wood. A field intensity set. Reprint, *Jour. I.E.E.* (Australia), pp. 1-8, (1933).

This paper describes a field intensity set for both ground and sky waves. The development of a vacuum tube millivoltmeter enables the components of the artificial signal injection apparatus to be calibrated directly; the accuracy of the complete assembly therefore depends only on the precise measurement of the geometrical dimensions of the loop aerial, and on the calibration of the millivoltmeter. Results are given of practical tests with the apparatus in measuring field intensities of both ground and sky waves. It is concluded that a distance of 25 kilometers, and a transmission frequency of 1500 kilocycles constitute suitable conditions for the study of the Kennelly-Heaviside layer.

- R270 E. B. Judson. Low-frequency radio receiving measurements at the Bureau of Standards in 1931 and 1932. *Proc. I.R.E.*, vol. 21, pp. 1354-1363; September, (1933).

This report gives the monthly and annual averages of field intensities of ten European and three American low-frequency transatlantic radio stations, between frequencies of 16 and 24 kilocycles, and the field intensity averages of atmospherics on 15 and 23 kilocycles, observed at the Bureau of Standards, for the years 1931 and 1932. Annual average curves of daylight field intensities of European signals and afternoon atmospherics on 23 kilocycles are shown with the corresponding yearly averages of sun spot numbers.

- R281 W. W. Brown. Properties of Mycalex. *Proc. I.R.E.*, vol. 21, pp. 1339-1342; September, (1933).

This paper presents data recently obtained on physical and electrical properties of Mycalex, a material having extensive and growing applications in the design of radio apparatus. The electrical data relate to the frequency range to 100,000 kilocycles.

### R300. RADIO APPARATUS AND EQUIPMENT

- R320 H. J. Adler. How to build your own shielded lead-in system. *Radio News*, vol. 15, pp. 148-149, 185; September, (1933).

Constructional details for a shielded lead-in system.

- R320 H. F. Smith. Aerials up to date. *Wireless World* (London), vol. 33, pp. 118-119; August 18, (1933).

This article deals with the use of screened antenna down-leads as a palliative to man-made static.

- R322 R. Whitmer. Radiation resistance of concentric conductor transmission lines. *Proc. I.R.E.*, vol. 21, pp. 1343-1353; September, (1933).

An expression for the radiation resistance of a cylinder is derived, following the "tangential field" or "induced electromotive force" method as adapted by Pistolcors. The result is used to determine the radiation resistance of a segment of a concentric cylinder transmission line, as used in ultra-high-frequency oscillator circuits. A comparison is made with the more conventional parallel-wire line segments.

- R330 C. F. Stromeyer. Audio system with the new 2B6 tube. *Radio Eng.*, vol. 13, pp. 11-12, 20; August, (1933).

An audio system is described that employs the new double triode vacuum tube. A standard single tube circuit and a push-pull circuit are shown. The advantages of this tube are its power handling capacity and its quality characteristics which resemble those of the triode.

- R330 M. G. Scroggie. Pentode or triode? *Wireless World* (London), vol. 33, pp. 129-130; August 19, (1933).

The author compares the two tubes from the standpoints of sensitivity and efficiency.

- R330 G. Grammar. New intermediate power transmitting tubes. *QST*, vol. 17, pp. 33-34, 68; September, (1933).  
Information is given on types RK-18, 800 and 830 vacuum tubes.
- R330 E. D. McArthur. Electronics and electron tubes. *Gen. Elec. Rev.*, vol. 36, pp. 404-406; September, (1933).  
This article gives a discussion of the method of operation and characteristics of gas or vapor-filled electron tubes.
- R330 The new class "B" output valve. *Wireless World* (London), vol. 33, pp. 198; September 1, (1933).  
Operating data and curves for the Marconi and Osram B.21.
- R330 W. C. White. The selection of types of vacuum tubes as sources of high-frequency power. *Gen. Elec. Rev.*, vol. 36, pp. 394-397; September, (1933).  
The purpose of this article and its accompanying chart is to answer in part the question as to the type of vacuum tube desirable for different combinations of frequency and output.
- R330 And now—The "shoe-button" tube. *Radio-Craft*, vol. 5, p. 205; October, (1933).  
This new tube, only half an inch high is made for use at ultra-high frequencies. It is still in the experimental stage, and is not, as yet, on the market.
- R331 I. J. Saxl. Putting "empty space" in vacuum tubes. *Radio News*, vol. 15, pp. 220-222, 243; October, (1933).  
The author explains what is meant by the general term "vacuum" and how radio tubes are evacuated.
- R355.4 R. Romander. The inverted ultraudion amplifier. *QST*, vol. 17, pp. 14-18; September, (1933).  
"Working the triode as a screen-grid transmitting amplifier."
- R355.5 R. A. Hull. Feather weight sets for ultra-high frequencies. *QST*, vol. 17, pp. 27-31; September, (1933).  
Circuits and constructional data for ultra-high frequency receivers and transmitters of very light weight.
- R355.9 G. B. Baker. The inter-electrode capacitance of the dynatron, with special reference to the frequency stability of the dynatron generator. *Jour. I.E.E.*, (London), vol. 73, pp. 196-203; August, (1933).  
The changes of frequency are such as to indicate that the anode-grid capacitance is a function of the anode potential and is independent of the parameters of the oscillating circuit. The same changes of capacitance are found to occur when the circuit is not oscillating and the valve is used to reduce the power factor of the circuit. The dependence of capacitance on space charge is discussed briefly and outlined analytically. The dynatron characteristic is then analyzed.
- R355.9 M. F. Cooper and L. G. Page. Beat frequency oscillator—A mains-operated instrument primarily designed for testing talking picture recording apparatus and commercial amplifier equipment. *Wireless Engineer & Experimental Wireless* (London), vol. 10, pp. 469-476; September, (1933).  
Constructional details are given of a beat frequency oscillator having a range of 50-10,000 cycles. A bibliography of 14 references is given.
- R355.9 C. H. W. Brookes. A new mains-operated audio-frequency oscillator. *Jour. Sci. Instr.* (London), vol. 10, pp. 251-255; August, (1933).  
Details are given of an audio-frequency oscillator having a frequency range from 20 to 10,000 cycles which is manufactured by Standard Telephones and Cables, Ltd., of Hendon.



- R355.9 E. B. Moullin. The effect of the curvature of the characteristic on the frequency of the dynatron generator. *Jour. I.E.E.* (London), vol. 73, pp. 186-195; August, (1933).  
This paper develops a method of calculating the effect which the curvature of the characteristic has on the frequency of the dynatron generator. The analysis shows that the fundamental frequency is affected by the phase of the higher-harmonic components of anode potential and that the effect would be zero if the impedance of the circuit could be made purely resistive to all the higher-harmonic currents. A network is described which fulfils closely the required conditions.
- R355.9 Modulated pentode oscillator. *Wireless World* (London), vol. 33, p. 183; August 25, (1933).  
A pentode oscillator having its output modulated by periodic charging and discharging of the grid condenser is described.
- R356 G. Grammar. Plate supplies to conform to the new regulations. *QST*, vol. 17, pp. 11-13; September, (1933).  
Practical data for designing power supplies for small transmitting sets.
- R361 S. W. Page. Stability problems of tuned r-f and superheterodyne receivers. *Radio Eng.* vol. 13, pp. 8, 20; August, (1933).  
The necessity of electrostatic and electromagnetic shielding is emphasized. A brief discussion of filtering is given.
- R361 E. Messing and M. Cohen. A review of developments in broadcast receivers of 1933. *Radio Eng.*, vol. 13, pp. 6-7, 20; August, (1933).  
The development of the universal receiver is given in a technical presentation. The tubes used and the circuit arrangement are described.
- R361 W. T. Cocking. Modern battery four. *Wireless World* (London), vol. 33, pp. 86-89, August 11; pp. 153-155, August 25, (1933).  
"Iron-core tuning coils and class "B" amplification represent the chief developments in recent months." In the receiver described in these articles, they are utilized and as "regards selectivity, volume, and quality, the performance is greatly superior to that of any simple battery receiver more than six months old."
- R361 S. O. Pearson. Simple measurements on receivers and components. *Wireless World* (London), vol. 33, pp. 193-194; September 1, (1933).  
Many uses of an inexpensive meter are given.
- R361 S. O. Pearson. Simple measurements on receivers and components. *Wireless World* (London), vol. 33, pp. 211-213; September 8, (1933).  
Many practical tests on receivers are suggested in this article.
- R361 G. Day. How to make an all-current ultra-midget receiver. *Radio-Craft*, vol. 5, pp. 210-211, 234; October, (1933).  
Constructional details are given.
- R361 One month's tests on a new seven tube short-wave super—The National FB-7. *Radio News*, vol. 15, pp. 211-212, 215; October, (1933).  
Results obtained with this new receiver are given, based on tests made by the *Radio News* staff, under the supervision of L. M. Cockaday and S. G. Taylor
- R361.2 W. T. Cocking. Notes on the new monodial super. *Wireless World* (London), vol. 33, pp. 135-136; August 18, (1933).  
Hints are given on choosing a loud speaker for a new receiving set and on installing it to the best advantage.
- R361.2 F. H. Jones. A crystal controlled short-wave super. *Radio News*, vol. 15, pp. 204-205, 248; October, (1933).  
"This article introduces a new series which will include a description with constructional data, of an unusual type of short-wave receiver designed by the author and employed by him to pick up foreign programs for rebroadcast over his 790-kilocycle broadcast station CMJK, Camaguey, Cuba."

- R361.3 W. Kautter. Über die Wirkung der Entdämpfung in Rundfunkempfängern. (On the effect of regeneration in broadcast receivers.) *Elek.-Nach. Tech.*, vol. 10, pp. 287-302; July, (1933).  
The effect of regeneration in circuits on selectivity, voltage amplification, the "Klirrfaktor" and similar secondary phenomena are investigated.
- R361.5 G. W. Ray. How to build a five-meter receiver. *Radio News*, vol. 15, pp. 206-207; October, (1933).  
Constructional data on a five-meter receiver which has demonstrated its effectiveness in suburban, rural, and city locations during tests by the *Radio News* staff.
- R363 A. Pen-Tung Sah. The performance characteristics of linear triode amplifiers. Reprinted from *Science Reports of National Tsinghua University*, vol. 2, pp. 83-103; July, (1933).  
The conclusion of a theoretical treatment of linear triode amplifiers. The author states that since, under certain conditions the best load resistance depends on the "utilization factor  $n$ " manufacturers should give  $n$  and also  $I_p$ , the emission current, in stating triode constants. For a linear triode, there is a definite relation between triode internal resistance  $\rho$  and load resistance for maximum output, provided the excitation  $E$  is such that the  $i_p$  wave form does not vary as  $R$  is changed. At maximum power output, the efficiency of linear triode amplifiers varies from 25 to 78.6 per cent depending on the type of operation and the imposed limitation.
- R363.2 S. L. Baraf and I. A. Mitchell. A three-stage high-quality push-pull amplifier. *Radio News*, vol. 15, pp. 146-147, 180; September, (1933).  
Constructional data for a push-pull amplifier.
- R363.2 W. Baggally. On grid current compensation. *Proc. Inst. Wireless Technology* (London), vol. 2, pp. 12-21; May-June, (1933).  
In a previous paper [*Wireless World*, February, (1933)] the writer described a method of obtaining increased output from an audio-frequency amplifier in which the grid swing on the output tube is so great that the grid potential takes positive values during part of the cycle, the voltage drop in the input circuit due to the ensuing grid current being compensated by means of an additional drop. It is assumed that chokes and condensers are infinitely large. The resistance of chokes is neglected. It has been found that overemphasis is placed on the very low frequencies in certain amplifiers. This article is a theoretical investigation "taking into consideration all the principal circuit elements".
- R363.2 F. Lester. How to make four new amplifiers. *Radio-Craft*, vol. 5, pp. 214-215, 236; October, (1933).  
Constructional data for power amplifiers.
- R363.2 L. Gancher. Constructing a complete 26-watt, dual-channel P. A. system. *Radio-Craft*, vol. 5, pp. 216-217, 245; October, (1933).  
Construction details for a "superheterodyne tuner" to be used with the 26-watt amplifier described in the previous issue of *Radio-Craft*.
- R365.21 W. T. Cocking. Delayed diode A.V.C. *Wireless World* (London), vol. 33, pp. 208-210; September 8, (1933).  
The method of operation and conditions for best results with delayed diode automatic volume control are discussed.
- R365.22 G. Priechenfried. Tone correcting amplifiers. *Wireless Engineer & Experimental Wireless* (London), vol. 10, pp. 487-490; September, (1933).  
The fundamental principles in tone correcting amplifiers are described. The advantages of tone correction and several methods of obtaining tone correction are discussed.
- R380 F. Fausett. Practical pointers on utilizing meter rectifiers. *Radio News*, vol. 15, pp. 150-151, 177; September, (1933).  
A comprehensive discussion on the characteristics of meter rectifiers, and methods employed by one instrument manufacturer in overcoming some of their complications.
- R382 Iron-powder cores. *Wireless Engineer & Experimental Wireless* (London), vol. 10, pp. 467-468; September, (1933).  
A discussion of the electrical properties of iron-powder cores. The term "capacitive resistance" and dielectric losses are briefly discussed.

- R382.1 Push-pull output transformer. *Wireless World* (London), vol. 33, pp. 218-219; September 8, (1933).  
Constructional details are given of a push-pull component designed especially for the "monodial superheterodyne" receiving set.
- R384 Lampkin station frequency meter. *Radio Eng.*, vol. 13, p. 24; August, (1933).  
The meter is essentially an instrument for transferring the Bureau of Standards 5000-kilocycles transmission directly to the station frequency. Features of the instrument are: A direct dial reading in cycles deviation from the assigned frequency, plus or minus and a guaranteed accuracy of 0.003 per cent.
- R386 C. A. Johnson. Electric filter design. *Radio News*, vol. 15, pp. 216-217, 247; October, (1933).  
This article, the fifth of a series of articles on filters, discusses the design of high-pass filters, and describes the design of a useful high-pass filter with an effective cut-off at approximately 110 cycles.
- R386 H. H. Hall. A magnetostriction filter. *Proc. I.R.E.*, vol. 21, pp. 1328-  
×538.11 1338; September, (1933).  
A rod of monel metal supported at its mid-point and fitted with two coils, one on each end, shielded from each other, and supplied with a polarizing magnetic field, resonates sharply at its natural longitudinal frequency to a voltage impressed on one coil, and induces a voltage in the other only while vibrating. It is thus a very selective band-pass filter. The band is about seventy cycles wide, thirty decibels up from the minimum, when the resonant frequency is 20,000 cycles.
- R387.1 J. L. Hurff. Why tin cans in a radio set? *Electric Jour.*, vol. 30, pp. 364-365, 368; September, (1933).  
The author explains why shielding is necessary.
- R387.7 H. H. Brown. New pin insulators free from radio interference. *Elec. Eng.*, vol. 52, pp. 608-613; September, (1933).  
In this article comparative tests on some of the newer type insulators, that are claimed to be free from interference at their rated operating voltages, are described and the relative merits of the different designs are pointed out.
- R388 von J. Dantscher. Ein neuer Elektronenstrahloszillograph. (A new cathode-ray oscillograph.) *Zeits. für tech. Physik*, vol. 14, pp. 337-341; No. 9, (1933).  
The "AEG-Elektronenstrahloszillograph" consisting of a cathode-ray tube and auxiliary device for generating the time axis, is described. A relaxation oscillator is used to provide the time scale.
- R388 H. E. Hollmann. The use of the cathode-ray oscillograph at ultra-high frequencies. *Wireless Engineer & Experimental Wireless* (London), vol. 10, pp. 484-486; September, (1933).  
The phase displacement between the coordinates, and gas concentration at very high recording speeds are discussed.

## R400. RADIO COMMUNICATION SYSTEMS

- R423.4 A. J. Green. Getting the most out of the short waves. *Radio News*, vol. 15, pp. 142-143, 186; September, (1933).  
This article is a discussion of methods for obtaining best results in high-frequency radio communication. Particular attention is given to the receiver used, the accessories (such as antenna and ground system), the location, and the skill of the operator.
- R423.4 C. W. Palmer and G. W. Shuart. How to make and operate an experimental radiophone. *Radio-Craft*, vol. 5, pp. 200-201, 232; October, (1933).  
Constructional data and use of a small portable, modulated oscillator and a single-tube portable receiver are given.
- R423.5 H. P. Roberts. Amateur radio on the short waves. *Radio News*, vol. 15, pp. 201-203; October, (1933).

This article gives a historical account of the growth of the amateur station KA1HR in the Philippine Islands. "This station has contacted every known country in the world where there are amateur radio stations."

- R430 A. Morris. Problems of electrical interference. *Wireless World* (London), vol. 33, p. 144; August 19, (1933).

It is pointed out that although a good deal may be done to assist in suppressing electrical interference at the receiver, there is a definite limit beyond which the radio engineer cannot progress and the real solution rests with the suppression of electrical interference at the source.

#### R500. APPLICATIONS OF RADIO

- R526.3 Fog landing by wireless.—Ultra-short waves at the Aerodrome. *Wireless World* (London), vol. 33, pp. 151–152; August 25, (1933).

A brief description is given of the installation for blind landing of airplanes at Newark, N. J.

- R550 C. B. Aiken. A study of reception from synchronized broadcast stations. *PROC. I.R.E.*, vol. 21, pp. 1265–1301; September, (1933).

The present paper gives the practical results of an extensive analysis of the detection of two modulated waves of identical carrier frequency. It is shown that the total effects of time delay in the program distribution circuits, differences in circuit elements in the two transmitters, and differences in path lengths of the two signals in traveling from their respective transmitters to the receiving point, may be all expressed in terms of two fundamental angles. It is shown that if two synchronized broadcast stations are far enough apart and are of such powers that there are places where the signals from the two stations are of approximately the same strength and have traversed paths differing in length by more than about ten miles then distortion is at times bound to occur at these points. At places where the path difference is greatly in excess of ten miles, very serious distortions may occur. On the other hand, it is shown that if the two broadcast stations with synchronized carriers are fairly close together, that is, within about twenty-five miles of each other, there is no distortion in the middle zone between them if the modulated waves radiated from the two stations are identical. The results of the analysis suggest an interesting possibility for supplying service to urban areas.

- R566 F. W. Cunningham and T. W. Rochester. The radio patrol system of the city of New York. *PROC. I.R.E.*, vol. 21, pp. 1239–1251; September, (1933).

The application of radiotelephony to municipal police work in New York City is described from the organization viewpoint. Brief references are made to historical backgrounds and description of apparatus, and the steps taken to select a receiver suitable for local conditions are outlined. The method of controlling the patrol force by radio is described, and a summary of results during the first year is given to show the value of this means of communication to police work.

- R583 W. H. Wenstrom. Notes on television definition. *PROC. I.R.E.*, vol. 21, pp. 1317–1327; September, (1933).

This paper describes a qualitative study of the degrees of television definition required for the adequate portrayal of various scenes under various conditions. Still photographs transmitted by telephoto are examined. It is found that 60-line, 120-line and higher orders of television definition may be suitable for certain missions conditioned by general factors such as the comprehensiveness of the scene to be portrayed.

#### R800. NONRADIO SUBJECTS

- 535.38 The iconoscope. *Wireless World* (London), vol. 33, p. 197; September 1, (1933).

A discussion of the iconoscope, consisting of cathode-ray tube containing the mosaic screen, and the external deflecting coils.

- 537.4 J. F. Herd. Thunder and lightning—How wireless aerials are affected.  
×R120 *Wireless World* (London), vol. 33, pp. 190–191; September 1, (1933).

Experience shows that antennas are rarely struck during the thunder season in comparison with the number of lightning discharges that take place.

## CONTRIBUTORS TO THIS ISSUE

**Ataka, Hikosaburo:** Born August 6, 1904, at Kanazawa, Japan. Graduated, electrical engineering department, Tokyo Imperial University, 1927. Instructor in electrical engineering, Meidi College of Technology, 1927 to date. Associate Member, Institute of Radio Engineers, 1933.

**Hallman, L. B., Jr.:** Born July 21, 1907, at Sneads, Florida. Received B.S. degree in electrical engineering, Alabama Polytechnic Institute, 1929. Engineer, WAPI, 1926-1929; instructor in radio, Alabama Polytechnic Institute, 1927-1928; chief engineer, Montgomery Broadcasting Company, 1930 to date. Junior member, Institute of Radio Engineers, 1927; Associate member, 1929.

**Llewellyn, Frederick Britton:** Born September 16, 1897, at New Orleans, Louisiana. Received M.E. degree, Stevens Institute of Technology, 1922; Ph.D. degree, Columbia University, 1928. Ship and shore operator: American Marconi Company, 1915-1916; U. S. Navy, 1917-1919. With Vreeland Laboratory, 1922-1923; member technical staff, Western Electric Company, 1923-1925; Bell Telephone Laboratories, 1925 to date. Associate member, Institute of Radio Engineers, 1923.

**Kurtz, Edwin B.:** Born December 10, 1894, at Cedarburg, Wisconsin. Received B.S. degree, University of Wisconsin, 1917; M.S. degree, Union University, 1919; E.E. degree, 1925; Ph.D. degree, 1932, Iowa State College. Assistant professor of electrical engineering, Iowa State College, 1919-1924; associate professor, 1924-1925; professor and head of electrical engineering department, Oklahoma A. & M. College, 1925-1929; acting dean of engineering, 1928-1929; professor and head of electrical engineering department, University of Iowa, 1929 to date. Engineer, General Electric Company, 1917-1919; Milwaukee Electric Railway and Light Company, summers, 1916-1920-1921. Director of rural electrification, State of Oklahoma, 1925-1929. In charge of television station W9XK, 1931 to date. Fellow, American Institute of Electrical Engineers, 1929; Fellow, American Association for the Advancement of Science, 1924. Nonmember, Institute of Radio Engineers.

**Okabe, Kinjiro:** Born March 27, 1896, at Nagoya, Japan. Graduated, Nagoya Higher Technical College, 1916. Received degree from Tohoku Imperial University, 1922. Assistant professor, Tohoku Imperial University, 1925-1929; professor, Nagoya Higher Technical College, 1929 to date. Nonmember, Institute of Radio Engineers.

**Potter, J. L.:** Born December 4, 1905, at Carthage, Missouri. Received B.S. degree in electrical engineering, 1928; M.S. degree, 1930, Kansas State College. Research assistant, Kansas State College, 1929-1930. Western Electric Company, 1928-1929, summer, 1927. Instructor, department of electrical engineering, State University of Iowa, 1930 to date. Associate member, Institute of Radio Engineers, 1931.

**Ramsey, R. R.:** Born April 11, 1872, at Morning Sun, Ohio. Received B.A. degree, 1895; M.A. degree, 1898, Indiana University; Ph.D. degree, 1901 Cornell University. Instructor, University of Missouri, 1901-1903; assistant professor, associate professor, and professor, Indiana University, 1903 to date. Author of a number of papers relating to electrolytic conduction, radio-activity, and radiotelegraphy. Author of "Experimental Radio." Fellow, American Physical Society. Member, Institute of Radio Engineers, 1926.

**Wright, James Warren:** Born 1899 at Springfield, Ohio. Received B.A. degree, Ohio Wesleyan; M.A. degree, Ohio State; L.L.B. degree, George Washington University. Member of the Bar, District of Columbia. Taught in Physics Department, Ohio State, Ohio Wesleyan, and Syracuse Universities; member, technical staff, Radio Division, Naval Research Laboratory; Radio Division, Bureau of Engineering, Navy Department, 1928 to date. Nonmember, Institute of Radio Engineers.



# ALLEN-BRADLEY

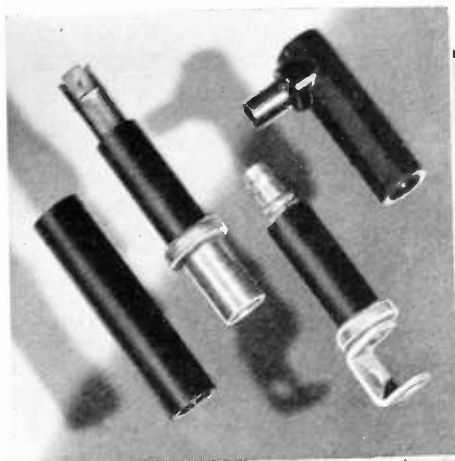

When you specify  
Allen-Bradley  
Spark Plug Resistors  
you get the benefit of the  
pioneer experience of Allen-  
Bradley engineers who are  
foremost in the field of radio  
resistor design. Allen-Brad-  
ley spark plug resistors are  
covered by U. S. patents  
1878014-1927185—other pat-  
ents pending.

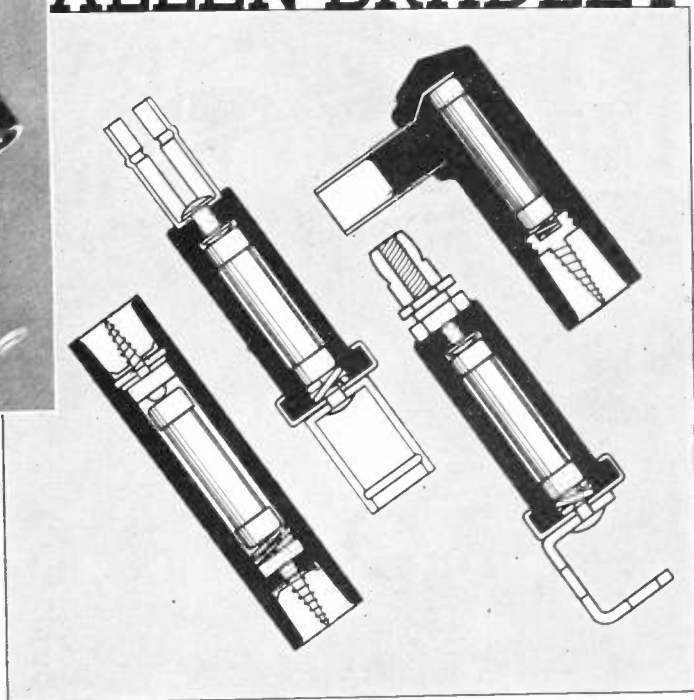

## Bradleyunits

Bradleyunits are solid  
molded resistors unaffected  
by temperature, moisture or  
age. All units are color-coded.

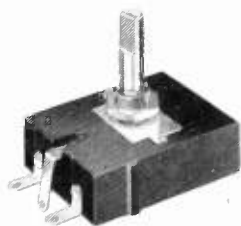

## Bradleyometers

The Bradleyometer is a  
potentiometer with approxi-  
mately fifty solid resistance  
discs interleaved between  
metal discs.

The total number of discs  
can be arranged in accord-  
ance with any resistance-  
rotation curve.

## LONG-LIVED—PERMANENT—RUGGED

—three essential qualities that are  
built into Allen-Bradley Suppressors

Allen-Bradley Suppressors are long-lived. They remain per-  
manent in resistance values even after thousands of miles of  
abusive automotive service.

They do not "open circuit" in service and thereby cripple  
the engine.

They do not "drop" in resistance and therefore fail as  
suppressors.

They do not have a "high voltage characteristic" which  
sharply decreases the suppressor resistance during each spark  
discharge and thus defeats the purpose of the suppressor.

They do not fail from exposure to oil and water.

They do not break due to car or engine vibration. Careless  
mechanics are no terror to Allen-Bradley Suppressors, because  
the resistors are enclosed in rugged, non-arcing bakelite cas-  
ings—not in brittle ceramic material.

The superiority of Allen-Bradley Suppressors can be easily  
demonstrated. Our engineers will gladly supply data and per-  
formance curves on resistors for your requirements. Write us  
today.

**ALLEN-BRADLEY COMPANY, 116 W. Greenfield Ave., Milwaukee, Wisconsin**  
Manufacturers of Bradleyunits, Bradley Suppressors,  
and a complete line of industrial control apparatus

*When writing to advertisers mention of the PROCEEDINGS will be mutually helpful.*

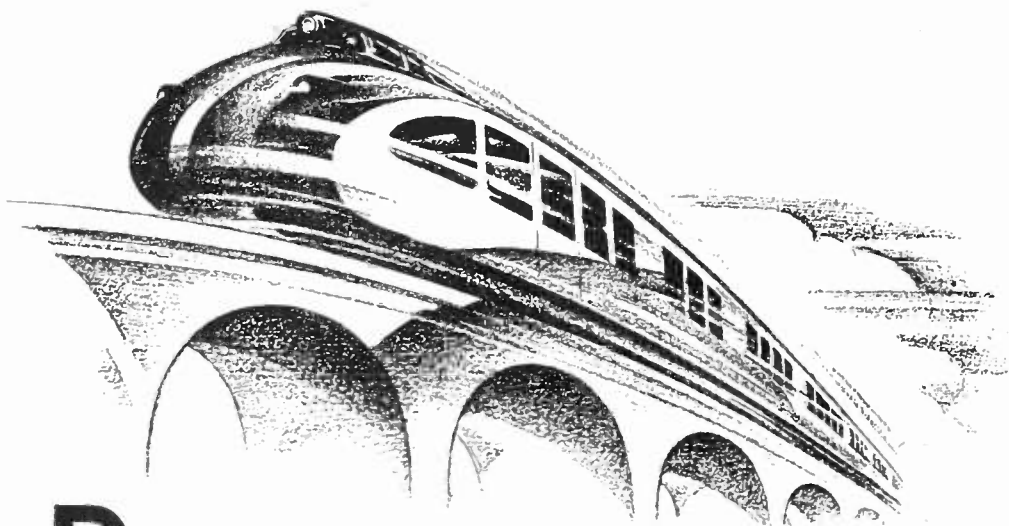

# PROGRESSIVE

as the new streamlined trains!

Engineering science now places in operation the radically new and more efficient streamlined railway trains.

With equal progressiveness Hygrade Sylvania pushes research and development in the radio tube field. Hygrade Sylvania pioneered in the development of the new 6.3 volt tubes for automobile radios . . . and later, the complete 6.3 volt group of tubes!

By cooperating with leading set manufacturers in solving circuit and design problems, also, Hygrade Sylvania has been enabled to make many other contributions to radio. Requests for service of this type are welcome. Our engineers will work with manufacturers in their own plants or in Hygrade Sylvania's modern laboratories. Write for consultation . . . no obligation incurred. Hygrade Sylvania Corporation, Emporium, Pa.



*Sylvania*  
(Reg. U. S. Pat. Off.)  
THE SET-TESTED RADIO TUBE

---

*When writing to advertisers mention of the PROCEEDINGS will be mutually helpful.*



# “WHERE TO, PLEASE?”



SCARCELY a day passes—sometimes scarcely an hour in the day—that you do not go visiting by telephone. It is truly the magic carpet that transports you, quickly and easily, to places you would like to be and people you would like to see.

Who can estimate the value of the telephone in the daily lives of millions of men and women . . . in time and money saved, in increased efficiency, in security and priceless help in time of need!

Contact, communication, swift interchange of ideas—these benefits the modern

world offers you. The telephone is one of the chief instruments by which you can seize them. With it you are ready for what may come—for opportunity, for emergency, for the brief word that may open a fresh chapter in your life.

Within the next twenty-four hours, sixty million telephone calls will be made over Bell System wires—each a separate, individual transaction, complete in itself. Yet your own calls will go through as quickly and efficiently as if the entire system had been built especially for you.



**AMERICAN TELEPHONE AND TELEGRAPH COMPANY**

*When writing to advertisers mention of the PROCEEDINGS will be mutually helpful.*

# CHANGE IN MAILING ADDRESS OR BUSINESS TITLE

Members of the Institute are asked to use this form for notifying the Institute office of a change in their mailing address or the listing of their company affiliation or title in the Year Book.

The Secretary,  
THE INSTITUTE OF RADIO ENGINEERS,  
33 West 39th Street,  
New York, N.Y.

Dear Sir:

Effective ..... (date) ..... please note change in my address  
for mail as follows:

FROM

.....  
(Name)

.....  
(Street Address)

.....  
(City and State)

TO NEW ADDRESS

.....  
(Street Address)

.....  
(City and State)

Please note following change in my Year Book listing.

.....  
(Title)

.....  
(Company Name)

.....  
(Company Address)

# The Institute of Radio Engineers

Incorporated

33 West 39th Street, New York, N. Y.

## APPLICATION FOR ASSOCIATE MEMBERSHIP

(Application forms for other grades of membership are obtainable from the Institute)

To the Board of Direction

Gentlemen:

I hereby make application for Associate membership in the Institute of Radio Engineers on the basis of my training and professional experience given herewith, and refer to the members named below who are personally familiar with my work.

I certify that the statements made in the record of my training and professional experience are correct, and agree if elected, that I will be governed by the constitution of the Institute as long as I continue a member. Furthermore I agree to promote the objects of the Institute so far as shall be in my power, and if my membership shall be discontinued will return my membership badge.

.....  
(Sign with pen)

.....  
(Address for mail)

.....  
(Date)

.....  
(City and State)

### References:

(Signature of references not required here)

Mr. .... Mr. ....  
Address ..... Address .....  
City and State ..... City and State .....

Mr. ....  
Address .....  
City and State .....

The following extracts from the Constitution govern applications for admission to the Institute in the Associate grade:

### ARTICLE II—MEMBERSHIP

- Sec. 1: The membership of the Institute shall consist of: \* \* \* (c) Associates, who shall be entitled to all the rights and privileges of the Institute except the right to hold any elective office specified in Article V. \* \* \*
- Sec. 4: An Associate shall be not less than twenty-one years of age and shall be a person who is interested in and connected with the study or application of radio science or the radio arts.

### ARTICLE III—ADMISSION AND EXPULSIONS

- Sec. 2: \* \* \* Applicants shall give references to members of the Institute as follows: \* \* \* for the grade of Associate, to three Fellows, Members, or Associates; \* \* \* Each application for admission \* \* \* shall embody a full record of the general technical education of the applicant and of his professional career.

*ENTRANCE FEE SHOULD ACCOMPANY APPLICATION*

### RECORD OF TRAINING AND PROFESSIONAL EXPERIENCE

Name .....  
(Give full name, last name first)

Present Occupation .....  
(Title and name of concern)

Business Address .....

Permanent Home Address .....

Place of Birth ..... Date of Birth ..... Age .....

Education .....

Degree .....  
(college) (Date received)

### TRAINING AND PROFESSIONAL EXPERIENCE

DATES	

Record may be continued on other sheets of this size if space is insufficient.

Receipt Acknowledged ..... Elected ..... Deferred .....

Grade ..... Advised of Election ..... This Record Filed .....

# DOWN! / comes the VOLTAGE COEFFICIENT

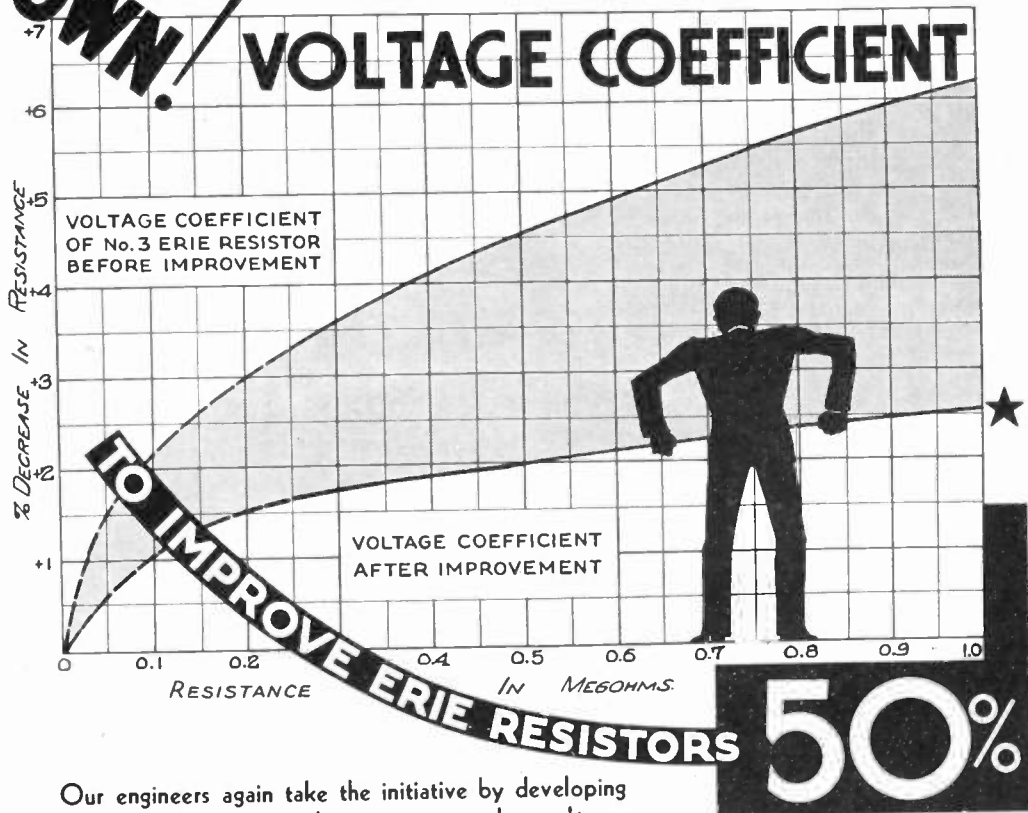

Our engineers again take the initiative by developing a vastly superior mix that improves the voltage characteristics of Erie Resistors 50% and more.

In the above graph of the No. 3, 1/2 watt Erie Resistor the improvement between the former and present types is indicated by the area between the two voltage coefficient lines. For example, on the 1.0 megohm resistor the voltage coefficient at 350 volts has been reduced from 6.25% to 2.55% -- a gain of over 59%. On higher resistance values the improvement is correspondingly greater.

Find out for yourself how much better these new Erie Resistors really are. A letter to us will bring you a complete set of samples to test in your own laboratory.

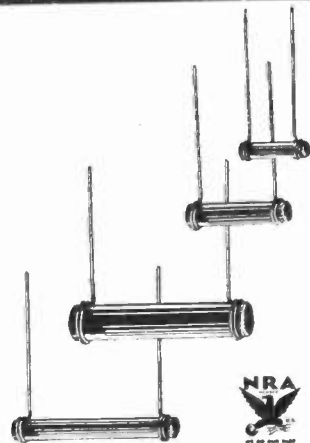

## ERIE RESISTOR CORPORATION

ERIE, PA.

Factories in ERIE, PA. - TORONTO, CANADA - LONDON, ENG.

When writing to advertisers mention of the PROCEEDINGS will be mutually helpful.



# Bombarder Capacitors

Cornell-Dubilier announces a new line of Bombarder Capacitors for use with radio-frequency induction heaters. Specifically designed to withstand the severe service encountered in bombarder equipment used in vacuum tube plants, these units feature:

- One standard type of casing for all capacities.
- Standard units offered in capacities of .004 to .05 mfd.
- Rugged mechanical and electrical construction throughout.
- Better cooling and improved internal design, with even distribution of

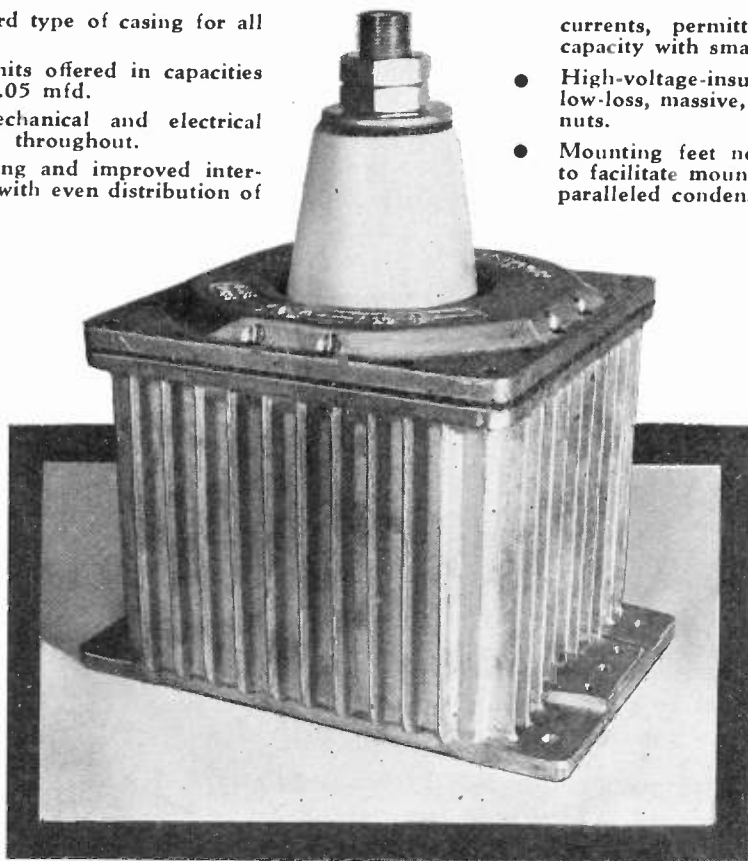

- currents, permitting greater KVA capacity with smaller space.
- High-voltage-insulated terminal with low-loss, massive, threaded stud and nuts.
- Mounting feet now placed at base to facilitate mounting and wiring of paralleled condensers.

C-D BOMBARDER CAPACITOR TYPE 75A

Cap.	500 KC	Current at 300 KC	200 KC	Test A.C. Volts
.004	60	50	40	20,000
.005	70	55	45	20,000
.0066	83	66	53	15,000
.008	90	70	60	15,000
.01	100	75	65	12,000
.02	120	110	90	12,000
.03	125	120	105	10,000
.04	125	125	115	10,000
.05	125	125	125	10,000

Overall Dimensions:  $10\frac{1}{2} \times 8\frac{5}{8} \times 12\frac{5}{8}$  inches high, including terminal.

**WRITE** for technical data on these new C-D Bombarder Capacitors, as well as for data on any other types of capacitors in which you may be interested. The complete Cornell-Dubilier line of condensers is described in our new 1933 catalog sent on request.



## CORNELL-DUBILIER CORPORATION

4377 Bronx Boulevard - - - New York City

When writing to advertisers mention of the PROCEEDINGS will be mutually helpful.

*Now* **EQUIPPED** *with*

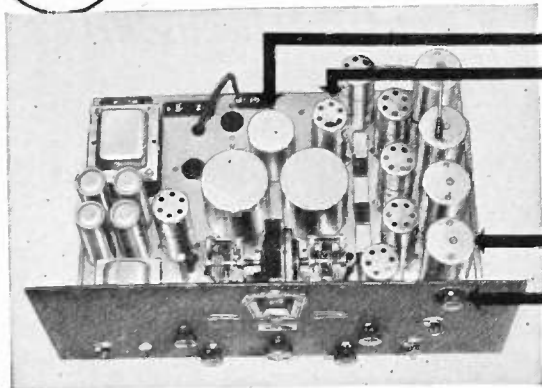

**AUTOMATIC  
VOLUME CONTROL**

*and*

**CRYSTAL  
FILTER**

# COMET "PRO"

*The Most Modern*

## RECEIVER

( 8 to 550 Meters )

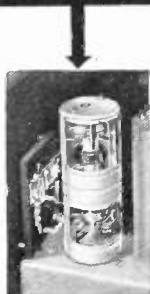

**H**AMMARLUND ever advances! More than 33 years of engineering progress is expressed in the four COMET "PRO" Receiver models.

First, the *Standard* "PRO"—the most complete, sensitive and selective standard short-wave receiver ever devised

Second, the inclusion of an improved panel - controlled Quartz Crystal Filter effects a remarkable reduction in high-frequency noise and increases selectivity amazingly—all without sacrifice of a single feature for which the *Standard* "PRO" has won international fame.

And now, Automatic Volume Control is available in either the *Standard* "PRO" or *Crystal* "PRO." This device may be used or not, at will, merely by operating

a front-panel switch. It is a useful improvement for maintaining more stable volume on fading signals.

All "PRO" models are *complete*, with built-in power pack, band-spread tuning on all waves, and four sets of coils covering 15 to 250 meters. *Extra coils for the 8 to 16 or 250 to 550 meter bands may be had for \$5.00 a pair.*

You will be as proud to own a COMET "PRO" as we are to produce it—because it is the *most modern receiver*, embodying all of the knowledge that radio engineering has mastered up to this time.

The Hammarlund Crystal Filter and Automatic Volume Control may be added, at moderate cost, to any *Standard* "PRO" Receiver.

*Mail Coupon for Details*



HAMMARLUND MANUFACTURING CO.,  
424-438 W. 33rd Street, New York, N. Y.

Check here for detailed description of the COMET "PRO".  Check here for information about adding Crystal Filter or automatic volume control to the Standard "PRO".  Check here for General Catalog of radio parts.

Name .....

Address .....

PE-11



*When writing to advertisers mention of the PROCEEDINGS will be mutually helpful.*

---

## Alphabetical Index to Advertisements

### A

Allen-Bradley Co. .... VII  
American Tel. & Tel. Co. .... IX

### C

Central Radio Laboratories. .... XXII  
Cornell-Dubilier Corp. .... XIV

### E

Employment Page. .... XX  
Erie Resistor Corp. .... XIII

### G

General Radio Co. Outside Back Cover

### H

Hygrade Sylvania Corp. .... VIII

### I

I.R.E. ... X, XI, XII, Inside Back Cover

### P

Professional Eng. Directory. .... XXI

### R

RCA Victor Company, Inc. .... XVII

### S

Stackpole Carbon Co. .... XIX

### W

Weston Elect. Inst. Corp. .... XVIII

---

## PROCEEDINGS BOUND VOLUMES



Volume 20 (1932) of the Proceedings is now available in bound form to members of the Institute. It may be obtained in Buckram or Morocco leather for \$9.50 and \$11.00 respectively.

Bound copies of volumes 18 and 19 (1930 and 1931) are also available at the same price.

*When writing to advertisers mention of the PROCEEDINGS will be mutually helpful.*



# For YOUR *Production*

## RCA VICTOR LABORATORY TEST EQUIPMENT



RCA Victor Beat  
Frequency Oscillator  
Type TMV-52-E



Are you losing valuable time and spending money on the development and production of these details?

Remove the guesswork from your test work—use genuine RCA Victor Laboratory Test Equipment. We can save time and money for you—if you will give us the opportunity.



RCA Victor  
Signal Generator  
Type TMV-18-D



*Faradon*



The design and manufacture of capacitors is a highly specialized branch of the industry. Faradon capacitors have a world-wide reputation for efficiency, economy and reliability. Specify Faradon condensers in your new equipment. A size and type is available for your particular requirements. Send for the complete catalog covering this line.



*Take advantage of the experience and the efficiency offered by this great radio research and manufacturing institution.*



Industrial Products Section  
**RCA VICTOR CO., INC.**

(A Radio Corporation of America Subsidiary)  
CAMDEN, N. J.

*When writing to advertisers mention of the PROCEEDINGS will be mutually helpful.*

# STANDARDS of SERVICE

There is no logical reason for using test equipment below proved Weston standards — since the long, dependable service which these thoroughly engineered test units give makes them cost far less in the end. Bulletin RA tells the whole story. Send for a copy . . . Weston Electrical Instrument Corporation, Newark, N. J.



## WESTON *Radio Instruments*

WESTON ELECTRICAL INSTRUMENT CORPORATION  
589 Frelinghuysen Avenue, Newark, New Jersey  
Send Bulletin RA on Weston Radio Instruments.

Name

Address

*When writing to advertisers mention of the PROCEEDINGS will be mutually helpful.*

# MOLDED CARBON VOLUME CONTROL

by

## STACKPOLE - - -

*Keeps pace with  
Radio Progress*

# 9

## FEATURES

*of design which  
promote performance*

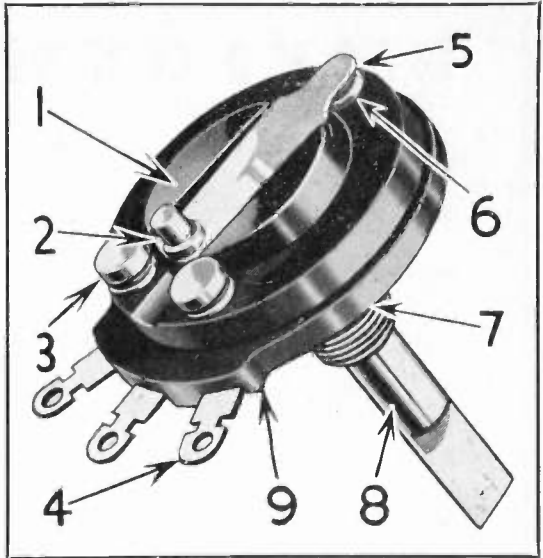

**1** Protection offered in fully insulated bushing and shaft  
A bakelite hub carries the spring arm and the contact for the moving element. The shaft is molded into the other end of this bakelite hub. Mounting bushing and shaft are thus fully insulated from entire Control Resistor.

**2** Accurate switch operation  
The cam dog which operates the A.C. switch on switch type variable resistors, is assembled as a composite part of the moving arm member. Accurate switch operation in respect to the resistance curve or hop-off value is assured.

**3** Stable and solid assembly  
Rugged stop pins are accurately located through the resistor element and the bakelite frame and hold the entire assembly into one solid form.

**4** Easy assembly  
The lugs of the resistor as well as those on the AC

Switch are tin dipped to facilitate the soldering of connecting wires.

**5** Smooth action and noiseless operation

**6** A one-piece special tempered spring arm maintains constant spring tension against a nickel chrome, highly polished, non-corrosive sliding shoe. Smooth and easy rotation of the variable resistor arm is assured.

**7** Simple mounting  
A standard brass bushing for one-hole mounting is fully insulated from the arm and resistor element.

**8** Quiet, easy operation  
The shaft is of non-rusting cadmium plated steel, perfectly fitted in the bore of the brass bushing to provide smooth and quiet operation.

## And 9 A New, Permanent, Molded Carbon RESISTOR ELEMENT

Stackpole offers the first control of its type and the first compact variable resistor which is permanent and unaffected by humidity.

The thick molded carbon resistor element, mounted on bakelite frame, is made in much the same way as permanent carbon resistors. Its hard glasslike surface is the result of firing at high temperatures and assures imperviousness to humidity—hard usage and varying

temperatures. Stackpole Molded Carbon Volume Controls will carry considerable current, are free from capacity effect, and have low heat and voltage coefficient. They are smooth and quiet in any circuit.

Made in any value from a few hundred ohms to a couple of megohms with any desired resistance taper and any hop off or fixed value of resistance at either or both ends.

**STACKPOLE CARBON CO.**  
ST. MARYS, PA.



Manufacturers  
of  
Quality  
Resistors  
and  
Suppressors



*When writing to advertisers mention of the PROCEEDINGS will be mutually helpful.*

# EMPLOYMENT PAGE

Advertisements on this page are available to members of the Institute of Radio Engineers and to manufacturing concerns who wish to secure trained men for positions. All material for publication on this page is subject to editing from the Institute office and must be sent in by the 15th of the month previous to the month of publication. (November 15th for December PROCEEDINGS IRE, etc.) Employment blanks and rates will be supplied by the Institute Office. Address requests for such forms to the Institute of Radio Engineers, 33 West 39th Street, New York City, N.Y.

**MANUFACTURERS** and others seeking radio engineers are invited to address replies to these advertisements at the Box Number indicated, care the Institute of Radio Engineers. All replies will be forwarded direct to the advertiser.

---

**RADIO ENGINEER** with B.S. in Electrical Engineering has had four years' experience in short wave and broadcast transmitter design, construction, and operation in powers up to 50 kilowatts. Six months in carrier current design and experiment. Fifteen years amateur and experimental experience. Has radio telephone first class license. Desires employment in development, design, construction, or operation of radio transmitting equipment. Age 27. Married. Will travel. Box 150.

# PROFESSIONAL ENGINEERING DIRECTORY

For Consultants in Radio and Allied Engineering Fields

## FOR ADVANCED TRAINING

in:

Practical Radio Engineering  
Practical Television Engineering

write to

### CAPITOL RADIO ENGI- NEERING INSTITUTE

Riggs Bank Bldg.  
Washington, D.C.

## Cathode Ray Tubes and Associated Equipment For All Purposes

Write for Complete  
Technical Data

ALLEN B. DUMONT  
LABORATORIES  
UPPER MONTCLAIR, N.J.

## CONSULTANT ON EXPORT OF SPECIAL RADIO EQUIPMENT AND ELECTRONIC APPARATUS

G. M. GIANNINI—304 East 45th Street,  
New York, N.Y., U.S.A.

## LITTELFUSE LABORATORIES

Specialists in

**Delicate Equipment Protection**  
INSTRUMENTS and METERS  
RADIO RECEIVERS  
RADIO AMPLIFIERS  
RADIO TRANSMITTERS

Write for new Technical Bulletin No. 5  
1764 Wilson Ave., Chicago, Ill.

*For the Engineering Consultant*

*who can handle a little extra business this year*

*For the designer*

*who can manage some additional work*

*For the Patent Attorney*

*who is anxious to develop a larger clientele*

we suggest the Professional Engineering Directory of the PROCEEDINGS I.R.E. Manufacturers and organizations with special problems who need services such as yours come to the Professional Engineering Directory for information. Your name and special services announced here will tell them what you do and where to find you. Further information will be furnished on request. Special rates to members of the Institute.

*When writing to advertisers mention of the PROCEEDINGS will be mutually helpful.*

# "Carrying ON"

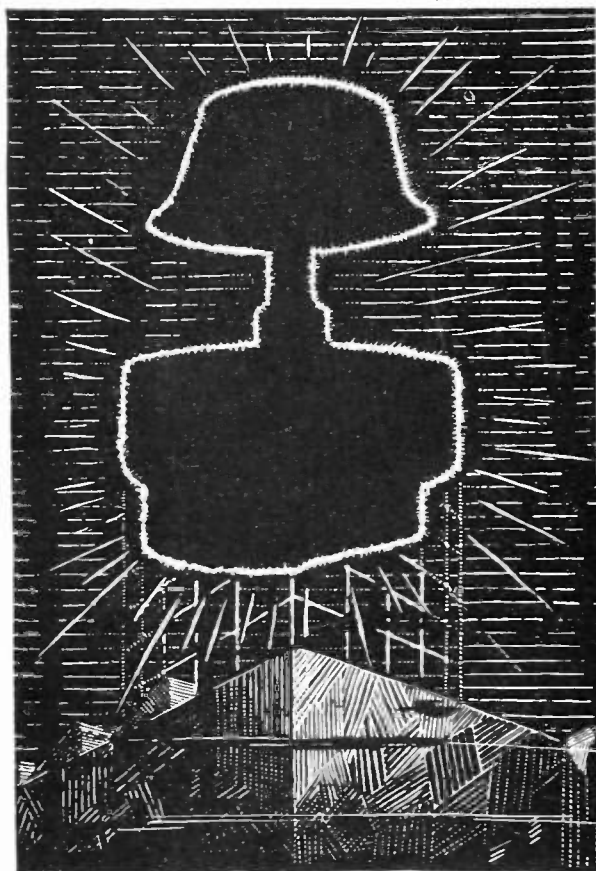

Day and night, nimble fingers and almost-human machines turn out thousands of Radiohms, each an exact duplicate of the other, each as near perfect as human ingenuity and supersensitive instruments can make them.

Centralab is CARRYING ON under the new deal, bringing a new light into the homes of hundreds of our co-workers, and continuing our standard of quality in the industry.

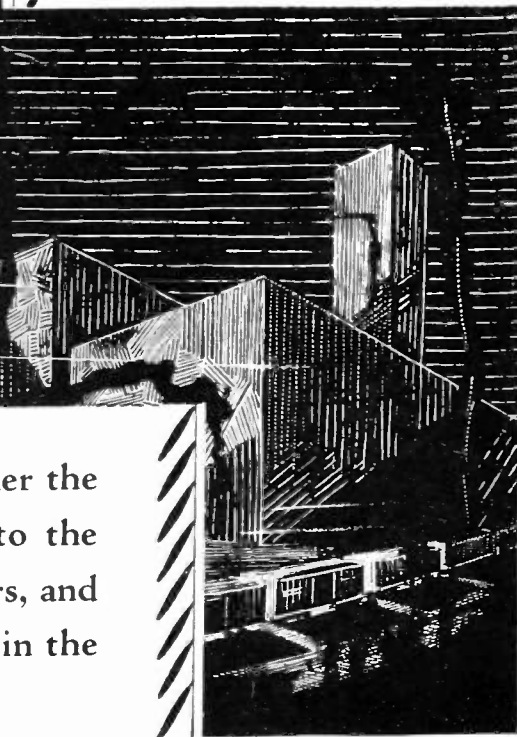

CENTRAL RADIO LABORATORIES ♦ MILWAUKEE, WISCONSIN

## Centralab RADIOHM

*When writing to advertisers mention of the PROCEEDINGS will be mutually helpful.*

# Don't Take Chances on Destroying Valuable Information!

Protect your back issues of the PROCEEDINGS with a binder that will stand abuse; a binder that will hold twelve issues and keep them all together for easy reference.

We can, to be sure, usually fill orders for back issues, but occasionally we may not have the one necessary to complete your reference work—this means unnecessary delay and delay means dollars.

Be sure—get a binder now and protect those back issues.

## PROCEEDINGS BINDER

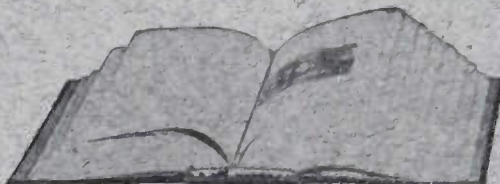
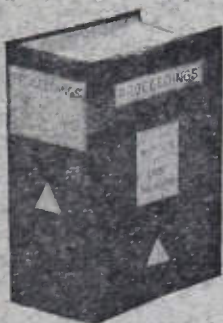

Binder of handsome Spanish Grain Fabrikoid in blue and gold. Can be used as temporary transfer binder or as a permanent cover. Wire fasteners hold each copy in place and permit removal of any issue from binder in a few seconds. All issues lie flat when binder is opened.

BINDER (holds complete 1932 or 1933 copies) .....\$1.75

*(Name stamped on volume for \$.50 additional)*

*Send orders for binders, accompanied by remittance, to*

**INSTITUTE OF RADIO ENGINEERS**

33 West 39th Street

New York City, New York

# A PRACTICAL WAVE ANALYZER AT A PRICE YOU CAN AFFORD

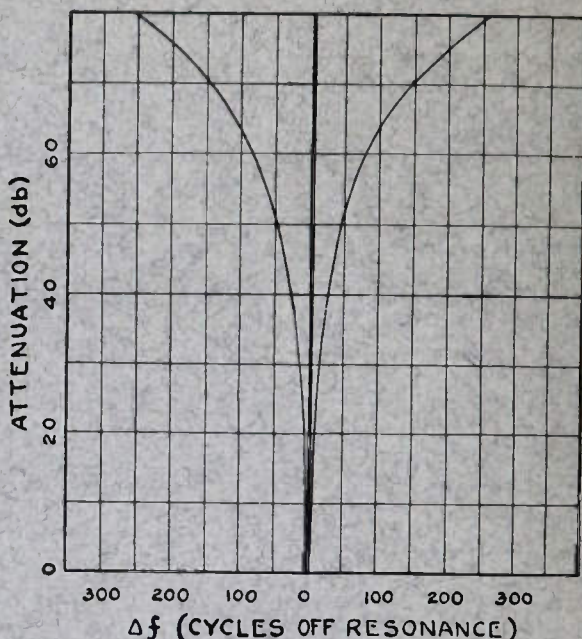
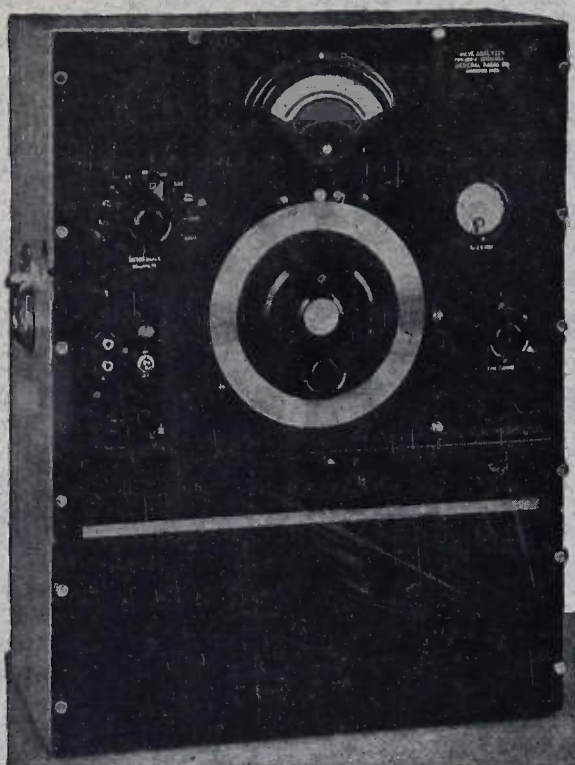

*The Type 636-A Wave Analyzer  
has a discrimination of 62 decibels  
for a separation of 100 cycles.*

Think of this wave analyzer as a sensitive voltmeter with a frequency discrimination sharp enough to resolve the 60-cycle sidebands on a 7000-cycle carrier. It will measure the amplitude of any audio component between 20 and 15,000 cycles.

As a voltmeter its range is from less than one millivolt up to 200 volts with an internal input impedance of 100,000 ohms or 10 megohms when using the external multiplier supplied with the instrument.

The Type 636-A Wave Analyzer is a heterodyne-type instrument with a 2-section quartz-crystal filter.

PRICE: \$475.00, COMPLETE

Write for Bulletin EX-3307

Address the General Radio Company  
Cambridge, Massachusetts

## GENERAL RADIO

GEORGE BANTA PUBLISHING COMPANY, MENASHA, WISCONSIN