

VOLUME 21

MAY, 1933

NUMBER 5

PROCEEDINGS  
*of*  
**The Institute of Radio  
Engineers**



**Eighth  
Annual Convention  
Chicago, Illinois  
June 26, 27, 28, 1933**

**Form for Change of Mailing Address or Business Title on Page XIX**



---

# Institute of Radio Engineers Forthcoming Meetings

---

## **EIGHTH ANNUAL CONVENTION**

Chicago, Illinois

June 26, 27 and 28, 1933

---

## **CONNECTICUT VALLEY SECTION**

May 25, 1933

---

## **DETROIT SECTION**

May 19, 1933

---

## **NEW YORK MEETING**

May 3, 1933

---

## **PHILADELPHIA SECTION**

May 4, 1933

---

## **SAN FRANCISCO SECTION**

May 17, 1933

---

## **WASHINGTON SECTION**

May 11, 1933

---

PROCEEDINGS OF  
**The Institute of Radio Engineers**

Volume 21

May, 1933

Number 5

Board of Editors

ALFRED N. GOLDSMITH, *Chairman*

R. R. BATCHER  
H. H. BEVERAGE  
F. W. GROVER  
G. W. PICKARD

L. P. WHEELER  
L. E. WHITTEMORE  
WILLIAM WILSON  
K. S. VAN DYKE

CONTENTS

PART I

Frontispiece, Electrical Group at Chicago Exposition.....	644
Institute News and Radio Notes.....	645
April Meeting of the Board of Directors.....	645
1933 Standards Report Notice.....	645
Committee Work.....	645
Institute Meetings.....	646
Personal Mention.....	653

PART II

*Technical Papers*

On the Collection of Sound in Reverberant Rooms, with Special Reference to the Application of the Ribbon Microphone..... HARRY F. OLSON	655
A High-Quality Ribbon Receiver... HARRY F. OLSON AND FRANK MASSA	673
Permissible Amplitude Distortion of Speech in an Audio Reproducing System..... FRANK MASSA	682
Ferro-Inductors and Permeability Tuning..... W. J. POLYDOROFF	690
The Spray Shield Tube..... H. W. PARKER AND F. J. FOX	710
Cyclones, Anticyclones, and the Kennelly-Heaviside Layer..... ROBERT CAMERON COLWELL	721
Discussion on "A Fourier Analysis of Radio-Frequency Power Amplifier Wave Forms," by L. B. Hallman, Jr..... F. E. TERMAN AND L. B. HALLMAN, JR.	726
Booklets, Catalogs, and Pamphlets Received.....	732
Radio Abstracts and References.....	733
Contributors to this Issue.....	740

*Copyright, 1933, by the Institute of Radio Engineers*

# The Institute of Radio Engineers

---

## GENERAL INFORMATION

**INSTITUTE.** The Institute of Radio Engineers was formed in 1912 through the amalgamation of the Society of Wireless Telegraph Engineers and the Wireless Institute. Its headquarters were established in New York City and the membership has grown from less than fifty members at the start to almost six thousand by the end of 1932.

**AIMS AND OBJECTS.** The Institute functions solely to advance the theory and practice of radio and allied branches of engineering and of the related arts and sciences, their application to human needs, and the maintenance of a high professional standing among its members. Among the methods of accomplishing this need is the publication of papers, discussions, and communications of interest to the membership.

**PROCEEDINGS.** The PROCEEDINGS is the official publication of the Institute and in it are published all of the papers, discussions, and communications received from the membership which are accepted for publication by the Board of Editors. Copies are sent without additional charge to all members of the Institute. The subscription price to nonmembers is \$10.00 per year, with an additional charge for postage where such is necessary.

**RESPONSIBILITY.** It is understood that the statements and opinions given in the PROCEEDINGS are views of the individual members to whom they are credited, and are not binding on the membership of the Institute as a whole. Papers submitted to the Institute for publication shall be regarded as no longer confidential.

**REPRINTING PROCEEDINGS MATERIAL.** The right to reprint portions or abstracts of the papers, discussions, or editorial notes in the PROCEEDINGS is granted on the express condition that specific reference shall be made to the source of such material. Diagrams and photographs published in the PROCEEDINGS may not be reproduced without making specific arrangements with the Institute through the Secretary.

**MANUSCRIPTS.** All manuscripts should be addressed to the Institute of Radio Engineers, 33 West 39th Street, New York City. They will be examined by the Papers Committee and the Board of Editors to determine their suitability for publication in the PROCEEDINGS. Authors are advised as promptly as possible of the action taken, usually within two or three months. Manuscripts and illustrations will be destroyed immediately after publication of the paper unless the author requests their return. Information on the mechanical form in which manuscripts should be prepared may be obtained by addressing the secretary.

**MAILING.** Entered as second-class matter at the post office at Menasha, Wisconsin. Acceptance for mailing at special rate of postage is provided for in the act of February 28, 1925, embodied in Paragraph 4, Section 412, P. L. and R., and authorization was granted on October 26, 1927.

---

Published monthly by

**THE INSTITUTE OF RADIO ENGINEERS, INC.**

Publication office, 450-454 Ahnaip St., Menasha, Wis.

BUSINESS, EDITORIAL, AND ADVERTISING OFFICES

Harold P. Westman, *Secretary*

33 West 39th Street, New York, N. Y.

## INSTITUTE SECTIONS

- ATLANTA—Chairman, H. L. Wills; Secretary, Philip C. Bangs, 23 Kensington Road, Avondale Estates, Ga.
- BOSTON—Chairman, E. L. Chaffee; Secretary, G. W. Kenrick, Tufts College, Mass.
- BUFFALO-NIAGARA—Chairman, L. Grant Hector; Secretary, E. C. Waud, 235 Huntington Avenue, Buffalo, N. Y.
- CHICAGO—Chairman, R. M. Arnold; Secretary, Donald H. Miller, McGraw-Hill Publishing Company, 520 N. Michigan Ave., Chicago, Ill.
- CINCINNATI—Chairman, W. C. Osterbrock; Secretary, Helen Klein, Crosley Radio Corporation, Cincinnati, Ohio.
- CLEVELAND—Chairman, P. A. Marsal; Secretary, R. P. Worden, 1629 Cordova Ave., Cleveland, Ohio.
- CONNECTICUT VALLEY—Chairman, H. W. Holt; Secretary, C. B. De Soto, American Radio Relay League, 38 La Salle Rd., W. Hartford, Conn.
- DETROIT—Chairman, G. W. Carter; Secretary, E. C. Denstaedt, Detroit Police Department, Detroit, Mich.
- LOS ANGELES—Chairman, J. K. Hilliard; Secretary, N. B. Neely, 1569 Munson Ave., Los Angeles, Calif.
- NEW ORLEANS—Chairman, Pendleton E. Lehde; Secretary, Anton A. Schiele, 1812 Masonic Temple, New Orleans, La.
- PHILADELPHIA—Chairman, H. W. Byler; Secretary, G. C. Blackwood, 243 E. Upsal St., Mt. Airy, Philadelphia, Pa.
- PITTSBURGH—Chairman, R. T. Griffith; Secretary, C. K. Krause, 1541 Princess Ave., Pittsburgh, Pa.
- ROCHESTER—Chairman, A. E. Soderholm; Secretary, John J. Long, Radio Station WHAM, Sagamore Hotel, Rochester, N. Y.
- SAN FRANCISCO—Chairman, A. R. Rice; Secretary, K. G. Clark, Department of Commerce, 328 Custom House, San Francisco, Calif.
- SEATTLE—Chairman, H. H. Bouson; Secretary, Howard Mason, 2709-4th West, Seattle, Wash.
- TORONTO—Chairman, R. A. Hackbusch; Secretary, G. E. Pipe, Rogers-Majestic Corporation, Toronto, Ont., Canada.
- WASHINGTON—Chairman, H. G. Dorsey; Secretary, C. L. Davis, Patent Department, Radio Corporation of America, 1227-1233 National Press Building, Washington, D.C.

**GEOGRAPHICAL LOCATION OF MEMBERS  
ELECTED APRIL 5, 1933**

**Transferred to the Member Grade**

Michigan	Detroit, 2041 McDougall Ave.....	Denstaedt, E. C.
New Jersey	Whippany, c/o Bell Tel. Labs., Inc.....	Stansel, F. R.
Spain	Madrid, Avenida Pi y Margall, 2.....	Wendell, E. N.

**Elected to the Member Grade**

New York	New Dorp, S.I., 612 Rockland Ave.....	Ligh, C.
Australia	Sydney, Supt. Engineers Branch, 219 Castlereagh St....	Weir, H.
New Zealand	Wanganui, Telegraph Engineer.....	Allan, D. T.

**Elected to the Associate Grade**

Alabama	Birmingham, 701 Protective Life Bldg.....	Middlebrooks, J.
California	San Francisco, 2100 Monterey Blvd.....	Fung, J. T. S.
	San Francisco, c/o Byington Elec. Corp., 808 Leavenworth St.....	Lewis, E. L.
	Whittier, R.R. 2, Box 376.....	Flutot, E.
Connecticut	Hamden, 75 Russel St.....	Kelly, F. G., Jr.
	Hamden, 37 Greenwood St.....	Sparhawk, G. H.
	New Haven, 2690 Yale Station.....	Gilly, T. A.
	New Haven, Box 1004-A Yale Station.....	Van Voorst, M.
	New Haven, Box 1004-A Yale Station.....	White, D. B.
Dist. of Columbia	Washington, c/o Adjutant General.....	Meade, F. C.
Florida	De Land, 518 E. New York Ave.....	Smith, G. E.
Illinois	Carthage, Superior Broadcasting Service, WCAZ.....	Filz, E. W.
	Chicago, 2510 N. Mango Ave.....	Grace, J. R.
	Chicago, 2935 Walnut St.....	Turnquist, L.
	Hinsdale, 110 N. Adams St.....	McGinley, J. C.
Indiana	Marion, 520 W. 10th St.....	Hilligoss, D. R.
Massachusetts	Harwich Port, Box 404.....	Fletcher, R. E.
	Wakefield, 13 Summer St.....	Cahoon, E. V.
Mississippi	Jackson, 141 Alta Woods.....	Davis, W. H.
Missouri	University City, 7126 Dartmouth.....	Racen, F.
New York	Brooklyn, 390 Parkside Ave.....	Bernstein, A. C.
	Flushing, 35-35-168th St.....	Lebert, A. W.
	Hicksville, c/o Press Wireless Inc., Box 292.....	De Neuf, D. K.
	New York City, 62 E. 90th St.....	Johnson, E. S.
	New York City, 395 Hudson St.....	Sharp, W. O.
	New York City, M/S Harboe Jensen, c/o Tropical Radio Tel. Co., Pier 3 N.R.....	Strommen, E.
	Woodside, L.I., 5854-43rd Ave.....	Thieblemont, A. H.
Ohio	Toronto, 1014 Franklin St.....	Smith, C. E.
Pennsylvania	New Castle, 509 Laurel Blvd.....	Jones, F. N.
Texas	San Angelo, Box 153.....	Price, S.
Utah	Salt Air, KSL Transmitter.....	Kimball, R.
Vermont	Bennington, 523 Main St.....	Mullen, W. C.
Virginia	Norfolk, VP-10 Squadron, Fleet Air Base.....	Johnston, R. A.
England	Dartford, Kent, 13 Carrington Rd.....	Summers, A. C.
	Horley, Surrey, Radio House, Victoria Rd.....	Coutts, S. A.
	Isleworth, Middlesex, Lissen, Ltd.....	Callendar, M. V.
	Leeds, 1, "The Leeds Mercury".....	Potter, M.
	London, S.W. 16, c/o E. J. Elford Esq., The Lawn Vicarage Rd., Eastsheen.....	Elford, E. N.
	London, S.W. 11, 11 Albany Mansions.....	Malkinson, W. D.
Japan	Fukuoka City, Fukuokahosokyoku.....	Hirayama, Y.
	Osaka, c/o Elec. Eng. Dept., Osaka Imperial University, 9-chome, Higasinoda, Kitaku.....	Aoyagi, K.
Mexico	Chihuahua, Chi., P.O.B. 157.....	Islas, F. L.
South Africa	Durban, Natal, Broadcasting Station.....	Dunning, C.

**Elected to the Junior Grade**

Georgia	Atlanta, 794 Springdale Rd.....	Rainwater, B. V.
Illinois	Chicago, 5920 S. Peoria St.....	Nelson, W. T.
New Zealand	Christchurch, Station 3YA, P.O. Box 219.....	Ryland, A.

**Elected to the Student Grade**

California	Berkeley, 1650 Oxford St.....	Creim, C.
New York	New York City, 1133 John Jay Hall, Columbia Univ....	Bose, J. H.
	Potsdam, 2 Lawrence Ave.....	Swain, E. W.
Pennsylvania	Media, R.D. No. 2.....	Harper, R. E.
Washington	Seattle, 7316 Jones Ave. N.W.....	Adams, A. W.
	Seattle, 5522-30th Ave. N.E.....	Harned, G. C.
	Seattle, 2321-14th Ave. S.....	McKinney, R. S.
	Seattle, 4023 Corliss Ave.....	Woodyard, H. R.

APPLICATIONS FOR MEMBERSHIP

Applications for transfer or election to the various grades of membership have been received from the persons listed below, and have been approved by the Committee on Admissions. Members objecting to transfer or election of any of these applicants should communicate with the Secretary on or before June 5, 1933. These applicants will be considered by the Board of Directors at its meeting on June 7, 1933.

For Transfer to the Member Grade

Georgia	Hapeville, 730 N. Central Ave.....	Gray, F. E.
Massachusetts	Hingham, c/o Tropical Radio Telegraph Co., P.O. Box 584.....	Williams, L. P.
New York	Brooklyn, 3518 Farragut Rd.....	Tuckerman, L. P.
Canada	Toronto, Ont., 245 Carlaw Ave.....	Ainsworth, A. L.
	Toronto, Ont., Philco Products Ltd. of Canada, 1244 Dufferin St.....	Oxley, A. B.
France	Paris (16e), 10 Rue Pergolese.....	Wallace, M.

For Election to the Associate Grade

Alabama	Mobile, U. S. Airways Radio Station.....	Shinn, E. K.
California	San Francisco, 515 Pierce St.....	Lowe, C.
	San Pedro, U.S.S. Texas, c/o Postmaster.....	Wayland, R. J.
Connecticut	New Haven, 289 Norton St.....	Michel, P. C.
Illinois	Chicago, 1751 N. Western Ave.....	Zender, R. G.
Iowa	Hartley.....	Grotewohl, H. D.
Massachusetts	Wellesley Hills, 75 Abbott Rd.....	Eager, M.
New Jersey	Kearny, 286 Chestnut St.....	Meier, W. L.
	Oceanport, Box 327.....	Harris, F. H.
	Passaic, 365 Main Ave.....	Post, G. W.
New York	Albany, 194 Clinton Ave.....	Vance, D. H.
	Brooklyn, 1539 E. 48th St.....	Bernstein, C. M.
	Brooklyn, 311-100th St.....	Milbourne, S. C.
	Brooklyn, Sperry Gyroscope Co., Manhattan Bridge Plaza.....	Moseley, F. L.
	Brooklyn, 242 Vernon Ave.....	Rothenberg, S. M.
	Grasmere, S. I., 2022 Clove Ave.....	Barden, W. S.
	West New Brighton, S.I., 220 Demarest Ave.....	Wilby, E. W.
Ohio	Cincinnati, c/o The Baldwin Co., Gilbert Ave. at Eden Park Entrance.....	Knoblauch, A. F.
Pennsylvania	Philadelphia, Moore School of Electrical Engineering University of Pennsylvania.....	Brainerd, J. G.
Alaska	St. Paul Island.....	Atkeson, A. A.
Canada	Quebec, P. Q., 680 St. Vallier St.....	Dion, A.
Cuba	Havana, Calle 25, No. 339, Vedado.....	Chisholm, E. E.
England	Croydon, Surrey, 53 Epsom Rd.....	Graef, P.
	Huddersfield, Yorkshire, 7 Celandine Ave., Selandine Nook.....	Moules, J. W.
	Kingsdown, Bristol, "The Bungalow," Henrietta St.....	Hind, W. T.
	London, N.W. 6, 50 Harvard Ct., West Hampstead.....	Gibson, J.
	Northwood, Middlesex, "Trewyth", Kewferry Hill.....	Phillips, C. G.
	West Hartlepool, 21 Leyburn St.....	Okey, H.
French Somaliland	Djibouti, Station F.Z.E.....	Franchette, F.
Scotland	Glasgow, 57 Trinley Rd., Knightswood.....	Johnstone, W. M.
Spain	Madrid, Avenida Pi y Margall, 2.....	Armstrong, L. H.

For Election to the Junior Grade

California	Oakland.....	Dittemore, J.
Ohio	Norwalk, 59 Foster Ave.....	Huth, E. J.

For Election to the Student Grade

California	Berkeley, 1924 Monterey Blvd.....	Tibbetts, D. R.
	Berkeley, 2505 Telegraph Ave.....	Wells, F. D.
	Oakland, 4144 Webster St.....	Cattolica, J. L.
	San Francisco, 1280 Florida St.....	Flynn, M. J.
Massachusetts	Cambridge, Technology Dormitories.....	Cimorelli, J. T.
Nebraska	Lincoln, 1503 H St.....	Bullock, M. W.
Oklahoma	Stillwater, 323 West St.....	Barlow, D. S.
Washington	Seattle, 4633-21st Ave. N.E.....	Coombs, W. C.
Canada	Edmonton, Alta., 10631-73rd Ave.....	Miller, G. A.
	Montreal, P. Q., 3592 University St.....	Wilson, W. R.
	Sherbrooke, P. Q., 100 Drummond St.....	Sangster, A. G.
Italy	Bologna, Via dei Mille 3.....	D'Agostino, A.
	Bologna, Via dei Mille 36.....	Fiegna, E.
	Bologna, Via dei Mille 36.....	Fiegna, G.
	Bologna, Via F. Albani 5.....	Ghermandi, M.
	Bologna, Via Orefici 2 presso Palmieri.....	Meloni, M.
	Bologna, Via Toscana 60.....	Visintini, E.

## OFFICERS AND BOARD OF DIRECTORS, 1933

(Terms expire January 1, 1934, except as otherwise noted)

### *President*

L. M. HULL

### *Vice President*

JONATHAN ZENNECK

### *Treasurer*

MELVILLE EASTHAM

### *Secretary*

HAROLD P. WESTMAN

### *Editor*

ALFRED N. GOLDSMITH

### *Directors*

M. C. BATSEL

J. V. L. HOGAN

C. M. JANSKY, JR.

R. H. MANSON, *Junior Past President*

E. R. SHUTE

A. F. VAN DYCK

WILLIAM WILSON

### Serving until January 1, 1935

W. G. CADY, *Junior Past President*

O. H. CALDWELL

C. W. HORN

E. L. NELSON

### Serving until January 1, 1936

R. A. HEISING

H. M. TURNER

F. A. KOLSTER



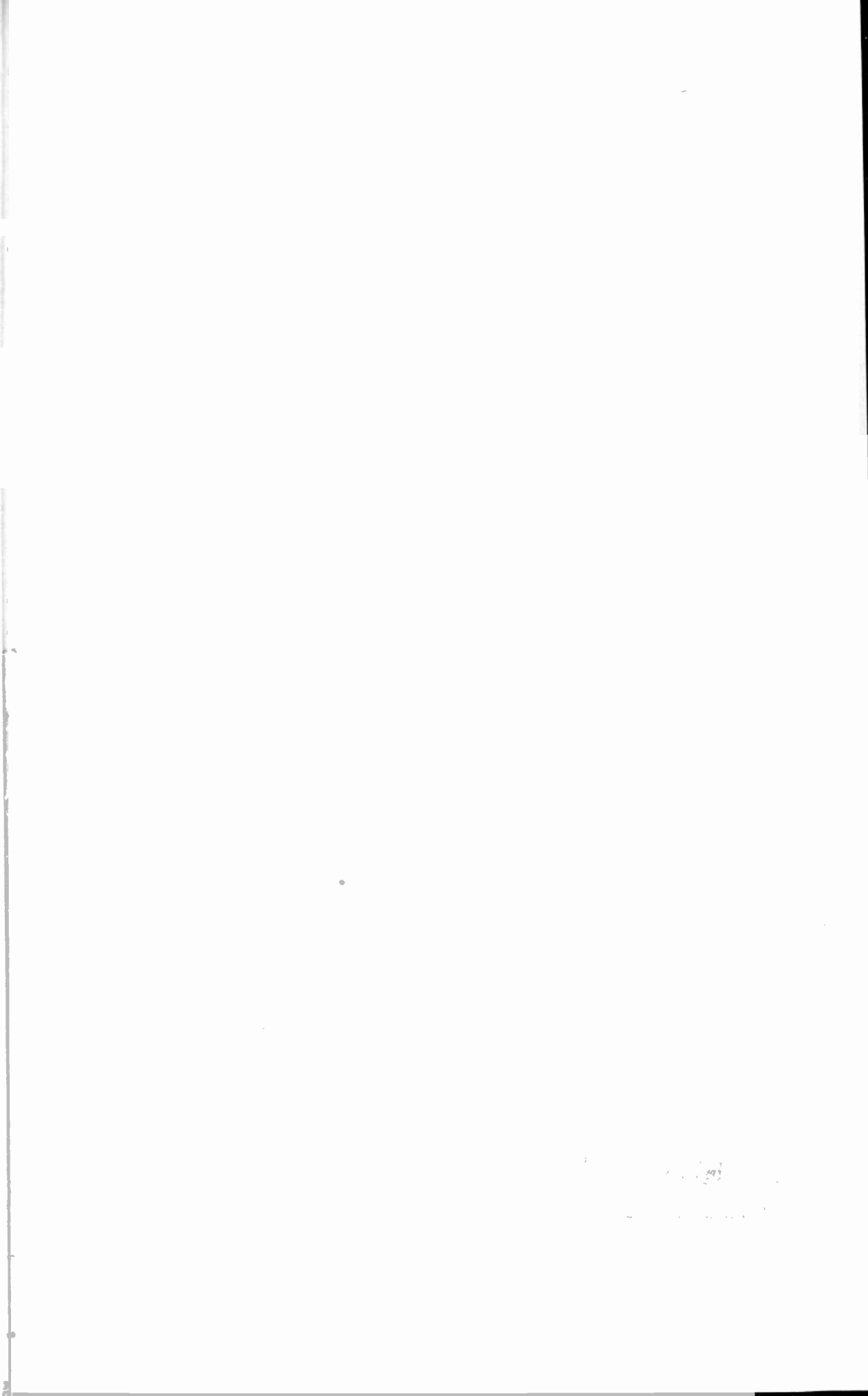

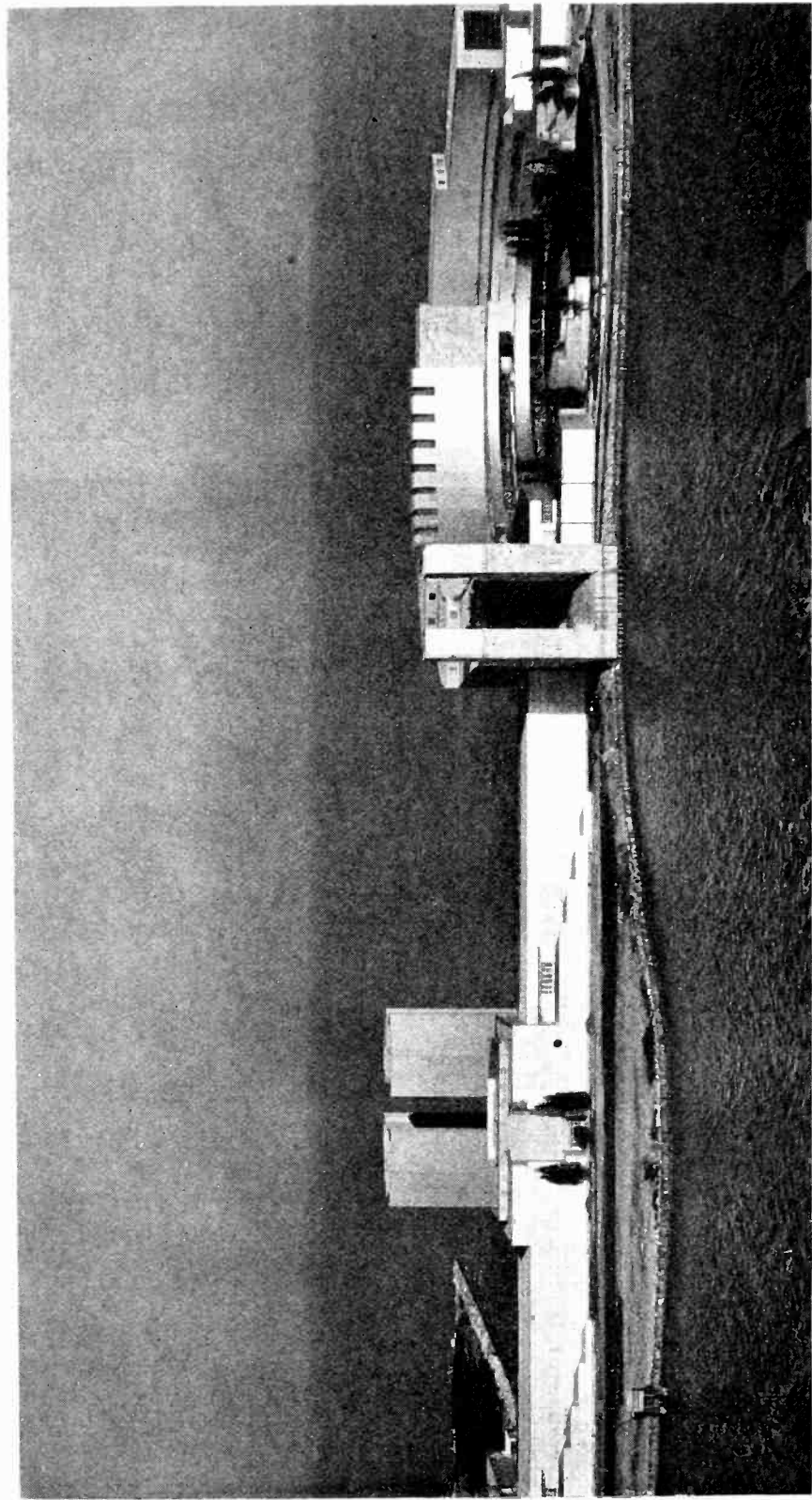

THE ELECTRICAL GROUP AT THE CHICAGO CENTURY OF PROGRESS EXPOSITION

The long low structure in the center is the Communications Building, while the circular structure at the right is the Electrical Building. Both will be visited during the Eighth Annual Convention of the Institute to be held in Chicago, June, 26, 27, and 28, 1933. Full details will appear in the June PROCEEDINGS.

## INSTITUTE NEWS AND RADIO NOTES

### April Meeting of the Board of Directors

The April meeting of the Board of Directors was held on April 5 at the Institute office. Those present were L. M. Hull, president; Melville Eastham, treasurer; M. C. Batsel, O. H. Caldwell, Alfred N. Goldsmith, R. A. Heising, J. V. L. Hogan, C. W. Horn, F. A. Kolster, E. L. Nelson, E. R. Shute, H. M. Turner, A. F. Van Dyck, William Wilson, and H. P. Westman, secretary.

Approval was granted of applications for transfer to the grade of Member in the names of E. C. Denstaedt, F. R. Stansel, and E. N. Wendell. D. T. Allen, Charles Ligh, and Harry Weir were elected to the grade of Member. Forty-three Associates, three Juniors, and eight Students were elected to membership.

At the request of the Constitution and Laws Committee for guidance in their work of revising the Institute By-Laws, it was directed that the By-Laws contain only matters pertinent to the establishment of administrative policies guiding the Board of Directors and its committees and not general matters merely of informative nature.

---

### 1933 Standards Report

The 1933 Standards Report will be available on June 1. Since there is to be no general distribution of this Report, copies will be sent to those who specifically request them of the Secretary.

---

### Committee Work

#### ADMISSIONS COMMITTEE

On April 5 a meeting of the Admissions Committee was held at which were present A. F. Van Dyck, chairman; Arthur Batchellor, O. H. Caldwell, C. W. Horn, E. R. Shute, and H. P. Westman, secretary.

Eight applications for transfer to the grade of Member were considered and six approved. One application was rejected and another tabled pending the obtaining of some additional data.

An application for admission to the Associate grade against which an objection had been lodged was considered and approved.

#### CONVENTION PAPERS COMMITTEE

At a meeting of the Convention Papers Committee, which was held on March 28 and attended by Alfred N. Goldsmith, E. L. Nelson,

William Wilson, and H. P. Westman, secretary, further consideration was given to the program of papers to be presented at the forthcoming convention.

#### CONSTITUTION AND LAWS COMMITTEE

The Constitution and Laws Committee met on March 28. Those in attendance were J. V. L. Hogan, chairman; Austin Bailey, R. A. Heising, A. F. Van Dyck, E. R. Shute, and H. P. Westman, secretary. The committee continued its consideration of the Institute Constitution and By-Laws and prepared a number of recommendations which will later be presented to the Board of Directors for action by that body.

#### STANDARDS COMMITTEE

The Standards Committee held a meeting on March 28 and those in attendance were William Wilson, chairman; P. G. Agnew, secretary of the American Standards Association, Alfred N. Goldsmith, J. W. McNair of the American Standards Association, H. M. Turner, A. F. Van Dyck, L. E. Whittemore, and H. P. Westman, secretary.

The committee considered a criticism of the 1931 Standards Report which had been submitted to the International Electrical Congress held in Paris in 1932. The report criticized the section on "Tests of Broadcast Radio Receivers," and will be brought to the attention of the proper technical committee when that body is reconstituted for formal standardization work.

Some suggestions regarding new terminology were discussed and will be referred to the proper technical committee at a later date.

The possibility of making some fundamental changes in the mechanical handling and publication of Institute standards was considered but no action taken.

In an endeavor to avoid any substantial duplication of effort, a thorough discussion of the relative positions of a number of bodies actively interested in standardization in the electrical field was made. Some valuable suggestions resulted from this investigation which it is anticipated will be of great assistance to the committee in formulating policies upon which the future operations of the Institute in the standardization field will be based.

---

### Institute Meetings

#### BUFFALO-NIAGARA SECTION

L. Grant Hector, chairman, presided at the March 29 meeting of the Buffalo-Niagara Section held at the University of Buffalo.

"A Standard Low-Frequency Oscillator" was the subject of a paper by Dr. Hector and F. J. Huntsinger of the Buffalo Evening News. The paper was presented by Mr. Huntsinger who showed a schematic diagram of the unit indicating the constants of the more important pieces of the equipment. The unit comprised a self-excited oscillator, and used two 56 and two 59 tubes. Approximately two watts of power were delivered over a frequency range from fifteen cycles to 75,000 cycles. The oscillator was operated, and by means of a loud speaker and a revolving mirror oscilloscope, the purity of the output wave was indicated. Lantern slides were projected to compare the output of the oscillator at 60 cycles with that of the standard 60-cycle power supply or at 400 cycles with a tuning fork.

The fifty-two members and guests in attendance participated in the discussion of the paper and their questions were answered by both Dr. Hector and Mr. Huntsinger.

#### CLEVELAND SECTION

P. A. Marsal, chairman, presided at a meeting of the Cleveland Section held at the Case School of Applied Science on March 24.

"Adventures in the Air" was the title of the paper by W. T. Van Orman who is one of the most consistent and successful of balloon pilots to use radio receivers for weather and other valuable information while participating in balloon races.

On one occasion, having started from Basle, Switzerland, he found himself drifting over Eastern Germany or Russia with visibility too poor for recognition of land marks and an obscured sky preventing determination of position by stars. A loop-operated radio receiver used as a direction finder gave information as to the location of Berlin and Bremen, Germany. The only station heard with sufficient strength to give a useful third reading was Madrid, Spain, which bearing checked closely with the others. The remainder of the trip planned on that basis was satisfactory.

He also told of drifting across Brest, France, and out to sea with a possibility that a shift in wind might occur at a practical altitude and carry them shoreward. Weather forecasts from London were tuned in and showed the wind carrying the balloon to sea might be expected to continue. On sighting a ship, the pilot signaled that he intended to land his balloon aboard the ship and was successful in doing this.

Other voyages in lighter-than-air craft were discussed and illustrated from photographs taken during them.

The attendance comprised ninety-nine members and guests.



## DETROIT SECTION

A meeting of the Detroit Section was held on March 17 at the Detroit News Conference Room, and was presided over by G. W. Carter, chairman.

A paper on "High Fidelity Sound Reproduction" was presented by H. L. Wilson who described equipment used for sound reproduction in the motion picture field and followed this with a discussion of the methods employed to obtain uniform response to the sense of hearing. A number of slides were shown to illustrate why amplifier characteristics must not be linear but must exaggerate both the low- and high-frequency ends of the audible spectrum to compensate for the deficiency of the ear and the acoustical properties of the average theater.

Dr. Wilson found that satisfactory quality could be had by using a main amplifier with reasonably uniform characteristics and then reënforcing the high-frequency notes with a separate high-frequency amplifier tapped into the second, third, or fourth stage of the main amplifier. The characteristics of the high-frequency amplifier are made variable and final adjustment is made after it has been installed for service. It was pointed out that a general method employed to date is to adjust the sound equipment and acoustical materials to give best results when the theater is from forty to sixty per cent filled.

A number of the eighty members and guests in attendance participated in the discussion.

## LOS ANGELES SECTION

On February 21, the Los Angeles Section held a meeting at the Westlake Park Pavilion in Los Angeles; J. K. Hilliard, chairman, presided. The meeting was in the nature of a seminar on "Radio Wave Propagation." The subject was divided into four sections, that on space variation being discussed by J. K. Hilliard; time variation, by J. J. Johnson; static and noise, by C. E. Weaver; and theories pertaining to the above, by J. F. Blackburn.

Mr. Hilliard explained the theory and application of the Austin-Cohen formula and presented a practical definition of ground waves. The attenuation factor for various localities and conditions were illustrated by several slides and it was pointed out that many considerations other than power determine the service area of a station. The effects and peculiarities of skip distance at various frequencies concluded his treatment of the subject.

Mr. Johnson presented data on fading, diurnal, lunar, and seasonal variations in transmission and the effects of the eleven-year cycle and fifteen-month variation of sun spot activity. A definition of fading was

presented and how it is affected by the frequency of transmission and other factors discussed. A comparison of the fading of radio waves with variations of other waves was made. The relative merits of various frequencies under certain assumed conditions were outlined. The effect of the Kennelly-Heaviside Layer upon signals and the behavior of the layer was then discussed.

Lieutenant Weaver pointed out that noise usually observed in broadcast reception could be classified as man-made or natural. He then listed various electrical and mechanical devices which are known to interfere with radio reception. A method for observing and comparing static crashes was described, and different types of static, their probable origin, and the localities affected discussed at some length.

Dr. Blackburn concluded the presentation with a summary and a general discussion and explanation of the various theories involved in the previous presentations. He compared briefly the behavior of radio and optical waves and discussed the behavior of ground waves under certain specified conditions. The Kennelly-Heaviside and other layers were described, and a graph presented showed the normal heights of these at various times of the day. Equipment to determine these heights was described in conclusion.

A substantial number of the thirty-six members and guests in attendance participated in the general discussion which followed these organized treatments of the subject.

#### NEW YORK MEETING

The April New York meeting of the Institute was held on the 5th in the Engineering Societies Building and in the absence of Dr. Hull was presided over by H. P. Westman, secretary.

"Image Suppression and Oscillator-Modulators in Superheterodyne Receivers" was the subject of a paper by H. A. Wheeler of the Hazeltine Corporation, Bayside Laboratory. In it the author pointed out that the principal problems peculiar to the superheterodyne receiver are, first, the selection of the desired signal and the suppression of interference at the intermediate frequency, the image frequency, and other spurious response frequencies and, second, the designing of oscillator and modulator circuits.

Image suppression and intermediate trap circuits which greatly improve the selectivity for a given number of circuits tuned to the signal frequency were described. Oscillator-modulator circuits using a single tetrode or pentode as a combined oscillator and modulator were discussed, and a further improvement in the development of the "emission valve modulator" employing a new hexode tube was de-

scribed. The theory of modulation which forms the basis of this arrangement was covered, and the advantages of the use of these improvements in commercial broadcast receivers outlined.

The paper was discussed by several of the 400 members and guests in attendance.

#### PHILADELPHIA SECTION

H. W. Byler, chairman, presided at the February 2 meeting of the Philadelphia Section held at the Engineers Club in Philadelphia.

At this meeting, Richard Kovacs, M.D., of the New York Polyclinic Medical School presented his paper on "Electricity in Medicine" which was previously given at the Atlantic City meeting during the sessions of the American Association for the Advancement of Science. In it the author dealt with the application of modern radio tubes and apparatus to the practice of medicine. Equipment and treatments were described and interesting side lines on the activities of pseudoscientific men and charlatans were given.

Among the seventy-nine members and guests present were several of the medical profession who expressed interest in the paper which was discussed generally.

The March meeting of the section was held on the 2nd at the Engineers Club with Chairman Byler presiding.

C. W. Hansell, a transmitter development engineer for R.C.A. Communications at Rocky Point, L.I., presented a paper entitled "The R.C.A. Communications Network." His paper dealt with the communications network developed by his organization and in it he presented many interesting details concerning antenna systems, transmitters, receivers, checking and measuring apparatus, and automatic recorders. Operating technique was discussed, and the material presented supplemented by phonograph records of the first transatlantic broadcast, the opening of the Vatican short-wave transmitter, and some comparative records illustrating the advance made in the reception and transmission of such programs.

An interesting discussion followed the presentation of the paper and it was participated in among others by H. H. Beverage under whose direction the work was accomplished.

The attendance totaled sixty-four.

#### PITTSBURGH SECTION

The Pittsburgh Section held a meeting on March 21 at the Fort Pitt Hotel with R. T. Griffith, chairman, presiding.

At this meeting, C. V. Aggers of the Westinghouse Electric and

Manufacturing Company presented a paper on "The Radio Interference Factor of Electrical Devices." In it the speaker outlined briefly the history of the various methods used to locate radio interference caused by electrical apparatus. With the aid of slides, he illustrated how the value of impedance at the interfering apparatus would, within limits, determine the voltage of the disturbance. Detailed consideration was given to capacitors used for the reduction of interference, and it was shown that the inductance of these units can materially affect their performance. The substantial effects which may be due to the inductance of only an inch or two of connecting leads was also covered.

An interesting discussion followed the presentation of the paper and was participated in by Messrs. Allen, Griffith, Krause, Magg, McKinley, Wyckoff and others of the thirty-two members and guests in attendance.

#### SAN FRANCISCO SECTION

On March 15 a meeting of the San Francisco Section was held at the Bellevue Hotel in San Francisco and was presided over by George Royden.

A paper was presented by D. M. Taylor, branch manager of the Postal Telegraph and Cable Company on "The Romance of Commercial Radio Communication." In it he outlined the growth of commercial radio communication from its early beginnings, and discussed in detail the various services which radio has now made available.

Forty members and guests attended the meeting.

Due to a protracted illness, Charles V. Litton, submitted a letter of resignation as chairman of the section. A meeting of the Executive Committee was held and Arthur R. Rice was selected as chairman and George T. Royden as vice chairman.

#### SEATTLE SECTION

A joint meeting of the Seattle Section of the Institute and the corresponding section of the American Institute of Electrical Engineers was held at the University of Washington on February 21, and was presided over by A. F. Darland, chairman of the American Institute of Electrical Engineers' section.

A paper by T. M. Libby and J. R. Tolmie was on the subject of "Resonance Phenomena on Power Transmission Lines." The speaker first explained from a telephone engineer's viewpoint the general theory of resonance phenomena on transmission lines from one-quarter to several wavelengths long. Numerous projected slides, blackboard sketches, and shadowgrams were shown. A transmission line three half

wavelengths long was operated on the stage by choosing a frequency of 75 megacycles. The current and voltage distribution along the line was indicated by flashlight lamps and neon lamps. Portions of the line consisted of a fine wire stretched within slender neon-filled glass tubes each a quarter wavelength long. These glowed with a tapered brilliancy according to the voltage gradient. The effect of shorting the line at various points and of adding half- and quarter-wave sections was shown in the shifting of the nodes.

The second portion of the paper dealt with the application of these resonance principles to commercial power transmission lines at 60 cycles. It was proposed to insert five equispaced loading coils along present power lines normally several hundred miles in length to load them to an electrical half wavelength. It was pointed out that except for line losses, this half wavelength circuit would, electrically, bring the generator up to the load. Vector diagrams for the normal line were compared with those of the proposed loaded line, the latter indicating a lower charging current, better voltage regulation, increased line capacity, and the possibility of greatly reducing the capacity of or entirely dispensing with the present synchronous converters employed at the load end. The cost and size of the loading coils were shown to be reasonable and benefits to be derived from building the line to slightly greater than a half wavelength were illustrated.

The paper was discussed by Dr. Magnusson, Professors Lowe and Eastman of the University of Washington, and also by Messrs. Miller, Darland and others. The attendance totaled 175.

#### TORONTO SECTION

A meeting of the Toronto Section was held at the University of Toronto on March 24, and was presided over by R. A. Hackbusch, chairman.

A paper on "Electrical Remote Control Radio Systems" was presented by Lee McCanne, manager of the Telektor Division of the Stromberg Carlson Telephone Manufacturing Company.

The speaker reviewed early stages in the development of both mechanical and electrical methods of tuning radio receivers from remote points. He described the various electrical systems that have been employed including those using the step motor, the selsyn motor, the thyatron bridge balance, and the reversible alternating-current induction motor. He also mentioned the attempts that have been made to use relay devices to obtain remote control. These, he said, possessed certain advantages but they limit the number of stations obtainable.

Mr. McCanne then discussed the problems involved in remote con-



trol of volume. The first attempts consisted merely of moving the volume control bodily to the remote control position. In modern remote control systems, however, the volume control is motor-operated.

He pointed out that the motor tuning control systems in use today possessed many decided advantages including ability to compensate for oscillator drift. With the aid of slides, Mr. McCanne illustrated a number of large remote control radio systems now in use, pointing out the interesting technical features in each case. In closing, he emphasized the tremendous possibilities of remote control, not only from an engineering point of view but also from a merchandising angle. He also spoke briefly of the future possibilities of electronic musical instruments.

Sixty-five members were present at the meeting.

#### WASHINGTON SECTION

The Washington Section held a meeting on March 9 at the Kennedy-Warren Apartments; H. G. Dorsey, chairman, presided.

A paper on "Recent Industrial Use of Photo-Electric Tubes" was presented by R. N. Stoddard of the tube apparatus section, Westinghouse Electric and Manufacturing Company, Pittsburgh, Pa. As indicated by the title, the author described numerous interesting and important applications of photo-electric control apparatus. The use of these devices in steel mills, line production, and testing in various industries, factory and office lighting regulation, and as circuit breaker control of dynamo-electric machinery during excessive arcing across commutator segments was treated.

Thirty-eight were in attendance at the meeting, and several participated in the discussion of the paper. Fourteen were present at the informal dinner preceding the meeting.

---

#### Personal Mention

F. X. J. Abraham of the British Broadcasting Corporation has been transferred from G5SW to the Empire short-wave station at Daventry.

Formerly with Telefunken-Versuchsplats in Berlin, Karl Baumann has joined the Department of Physics of the University of Basle in Basle, Switzerland.

Previously with the Jensen Radio Manufacturing Company, J. F. Church has joined the staff of Hawley Products Company, St. Charles, Ill.

Lieutenant H. N. Coulter, U.S.N. has been transferred from Lake-

hurst, N. J. to the Naval Air Station at Sunnyvale, Mountain View, Calif.

Professor J. R. Harrison of the Physics Department at Tufts College has recently been appointed assistant dean of engineering at that institution.

Previously with the Federal Telegraph Company, W. H. Hoffman has joined the radio engineering staff of RCA Victor of Camden.

F. J. Marco has reentered the consulting radio engineering field with headquarters at 2020 Farragut Avenue, Chicago, Ill.

G. S. Turner formerly assistant supervisor of radio in Chicago is now acting inspector in charge of the Atlanta office of the Federal Radio Commission.



TECHNICAL PAPERS

ON THE COLLECTION OF SOUND IN REVERBERANT ROOMS,  
WITH SPECIAL REFERENCE TO THE APPLICATION  
OF THE RIBBON MICROPHONE\*<sup>1</sup>

BY

HARRY F. OLSON

(Research Section, RCA Victor Company, Inc., Camden, N. J.)

*Summary*—The effective reverberation of collected sound may be expressed as the ratio of direct to generally reflected sound. Directional sound collectors discriminate against reverberation and other undesirable sounds by increasing the ratio of direct to generally reflected sound. The resultant is to reduce the effect of the acoustics of the studio, and in this manner to facilitate the problems of sound collection. One of the important requirements of a directional sound collector is a directional characteristic which is independent of the frequency. The ribbon microphone, consisting of a light metallic ribbon suspended in a magnetic field and freely accessible to air vibrations from both sides, exhibits directional characteristics which are independent of the frequency.

IN order that sound radiation might be projected from one point or area with a maximum of efficiency and a minimum of interference from reflecting surfaces, directional sound radiators have been almost exclusively employed for sound sources in large scale reproduction of sound. A similar directivity has been found to be desirable in the sound collecting systems to improve the ratio of direct to generally reflected sound and otherwise to discriminate against undesirable sounds.

Reproduced sound in general involves two rooms, the studio in which the microphone is placed and the auditorium or room in which the loud speaker is installed. There are a multitude of factors that govern the resultant sound in the auditorium. Aside from the frequency and linearity characteristics of the electrical system, the most important factor which governs the ultimate reproduction is the acoustic performance of the studio and auditorium. For example, suppose that the studio in which the microphone is placed exhibits optimum reverberation characteristics, as perceived by the auditor in the studio. If a conventional pressure-operated microphone is placed in the position

\* Decimal classification R385.5×534. Original manuscript received by the Institute, October 18, 1932.

<sup>1</sup> Ribbon microphone is synonymous with RCA Victor velocity microphone.

occupied by an auditor and the sound reproduced by means of a loud speaker, it is found that aside from other distinguishing characteristics the sound is, in general, highly reverberant.

In the case of radio reproduction, the acoustic conditions which exist at the reproducer must be accepted and an average value considered in arriving at the over-all result. In sound motion picture theaters the detrimental effects of excessive reverberation are reduced by means of materials used in the construction, together with directional sound radiators which increase the ratio of direct to generally reflected sound, and in this manner, reduce the effective reverberation of the reproduced sound. As in the case of radio, it is found that in addition to the reduction which is obtained by the above means, it is necessary to reduce the reverberation of the recording or broadcast studio below that which would obtain for optimum conditions for an auditor in the studio.

The amount of recorded reverberation can be controlled by the amount of absorption in the studio or by adjusting the distance between the source of sound and the microphone. However, unless considerable absorption is employed in the studio the distance between performers and the microphones must be reduced to such an extent that action becomes cramped and limited.

Excess reverberation resulting from long-distance reception in reverberant studios of motion picture sets is the primary limitation to sound collection over large distances. In the past, the excess reverberation often has been overcome by the use of highly damped rooms and sets. In general, it is extremely difficult and costly to build rooms with a low period of reverberation, together with an absorption characteristic which is independent of the frequency. However, the author has found that by employing directional pick-up systems, it is possible to reduce the effective or recorded reverberation without resorting to excessively damped rooms.

It is the purpose of this paper to discuss the merits of directional sound collecting systems from the standpoint of reduction in reverberation and in discrimination against undesirable sounds.

#### COLLECTION OF SOUND IN REVERBERANT ROOMS

In general, the growth and decay of sound in a room is a very complex phenomenon. This is particularly true of rooms having long periods of reverberation. Most broadcast and recording studios are rectangular parallelepipeds with small reverberation time. In cases like these, it is possible to apply the classical reverberation theory and arrive at a fairly good approximation of the actual conditions. When a

source of sound is started in a room the first sound which strikes a collecting system placed at a point in the room is that which comes directly from the source, without reflecting from the boundaries; following this comes the sound which has been reflected once, twice, and so on. This means that the sound energy density at the collecting system increases with time as the number of reflections increase. Ultimately, the absorption of energy by the boundaries equals the output of the source, and the energy density at the collecting system no longer increases; this is called the steady state condition. In most studios the reverberation time is very short, and the steady state conditions are established for most sounds of speech and music in which reverberation is a factor. Therefore, at a point in a room there are two distinct sources of sound, namely, the direct and generally reflected sound. For rooms which do not exhibit abnormal acoustic characteristics, we may assume that the ratio of generally reflected to direct sound represents the effective reverberation of the collected sound.

#### NONDIRECTIONAL SOUND COLLECTING SYSTEM

Consider a nondirectional collecting system which is characterized by the same efficiency of reception regardless of the direction of the incident sound with respect to some axis of the system. If the distance

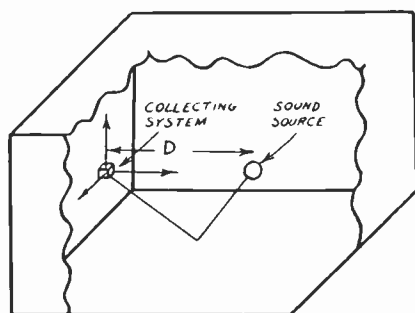

Fig. 1—Nondirectional sound collecting system.

between the source of sound and the collecting system is  $D$ , Fig. 1, the energy density due to the direct sound at the microphone is

$$E_D = \frac{E_0}{D^2 4\pi c} \quad (1)$$

where,

$E_0$  = power output of the sound source, and  
 $c$  = velocity of sound.

If this system is placed in a room of absorption,  $a$ , the energy density due to reflected sound after a time,  $t$ , is given by<sup>2</sup>

<sup>2</sup> C. F. Eyring, *Jour. Acous. Soc. Amer.*, vol. 1, p. 217, (1930).



$$E_R = \frac{4E_0}{caS} \left[ 1 - e^{-\frac{cS \log_e (1-a)t}{4V}} \right] (1-a) \quad (2)$$

where,

$a$  = absorption per unit area;  
 $S$  = area of absorbing material;  
 $V$  = volume of the room;  
 $t$  = time.

The ratio of generally reflected to direct sound is a measure of the received reverberation.

$$\frac{E_R}{E_D} = \frac{16\pi D^2 \left[ 1 - e^{-\frac{cS \log_e (1-a)t}{4V}} \right] (1-a)}{aS} \quad (3)$$

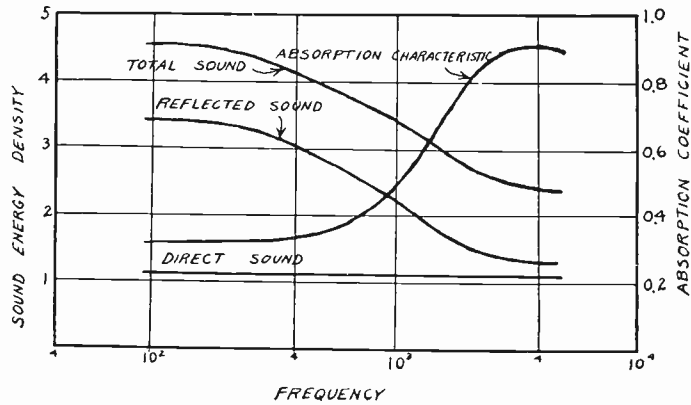

Fig. 2—Graphs showing the absorption characteristic of a room and the resultant direct, generally reflected, and total sound energy density at the collecting system.

If the sound continues until steady state conditions obtain, the equation above becomes,

$$\frac{E_R}{E_D} = \frac{16\pi D^2(1-a)}{aS} \quad (4)$$

From (3) and (4) we see that the received reverberation can be reduced by decreasing the distance between the source of sound and the collecting system. This, in many instances, crowds the performers to such an extent that this expedient becomes impracticable. The other alternative consists in increasing the acoustic absorption of the enclosure by increasing the amount of damping material. The absorption of most materials is a function of the frequency and may be expressed by

$$A = \sum aS = \sum Ku(f)S \quad (5)$$

where,

$f$  = frequency, and

$K$  = constant of the material.

Thus, we see that by increasing  $A$  we can increase the ratio of direct to generally reflected sound. This is the customary procedure in broadcast and sound motion picture studios. Considerable absorption must be used, which means that the material must have a high absorption coefficient. Materials having high absorption characteristics in general exhibit an absorption coefficient which increases with frequency. Fig. 2 shows a typical absorption characteristic. How this characteristic influences the generally reflected sound energy density is also shown in Fig. 2. The direct and generally reflected sounds are combined to

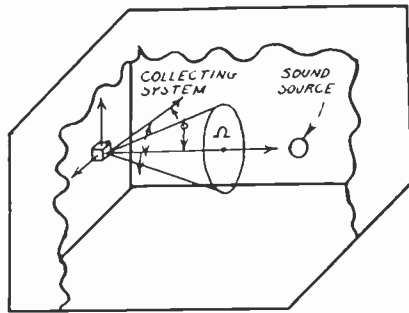

Fig. 3—Directional sound collecting system.

show the total sound energy at the collecting system. It will be seen that the ultimate result of employing sound absorbing material which does not have a constant value over the frequency range is frequency discrimination. In the particular example above the major portion of the reverberant sound is confined to the lower frequencies.

#### DIRECTIONAL SOUND COLLECTING SYSTEM

Consider next a directional sound collecting system, which is characterized by the efficiency of reception as a function of the direction with respect to some reference axis of the system. The output of the microphone may be expressed as

$$e = Qpf_1(\psi)f_2(\phi) \quad (6)$$

where,

$e$  = voltage output of the microphone;

$p$  = sound pressure in dynes;

$Q$  = sensitivity constant of the microphone;

$\psi$  and  $\phi$  are the angles shown in Fig. 3.

To simplify the discussion, assume that the response of the microphone is constant within the solid angle  $\Omega$ , Fig. 3, and zero for points outside. If the distance between sound source and the microphone is  $D$  and the source of sound is located within the solid angle  $\Omega$ , the energy response of this microphone to direct sound will be proportional to the energy density of the direct sound at the microphone. The direct sound to which the microphone is responsive (as in (1)) is given by

$$E_D = \frac{E_0}{4\pi D^2 c} \quad (7)$$

The energy density of the reflected sound in a room is given by (2). The direction and phase of the reflected sound is assumed to be random. Therefore, the reflected sounds available for actuating the directional microphone are the pencils of sound within the angle  $\Omega$ . The response of the directional microphone to generally reflected sound will be  $\Omega/4\pi$  that of a nondirectional microphone. The generally reflected sound to which the directional microphone is responsive is therefore given by

$$E_R = \frac{4E_0}{caS} \frac{\Omega}{4\pi} \left[ 1 - e^{-\frac{cS \log_e (1-a)t}{4V}} \right] (1-a) \quad (8)$$

The ratio of generally reflected to direct sound is a measure of the received reverberation.

$$\frac{E_R}{E_D} = \frac{4D^2 \Omega \left[ 1 - e^{-\frac{cS \log_e (1-a)t}{4V}} \right] (1-a)}{aS} \quad (9)$$

If the sound continues until steady state conditions obtain, the above equation becomes

$$\frac{E_R}{E_D} = \frac{4D^2}{aS} \Omega (1-a) \quad (10)$$

From (9) and (10) it will be seen that the *received reverberation can be reduced by decreasing the distance, by increasing the absorption  $aS$ , or by decreasing  $\Omega$* . The difficulties involved in changing the first two of these factors have been discussed in the preceding section. However, with a directional microphone, we can reduce the effective reverberation by decreasing the angle over which sound is received without attenuation. For the same room the amount of recorded reverberation will be  $\Omega/4\pi$  of that in the nondirectional system. In Fig. 4 is shown

the direct and generally reflected sound as received by a directional microphone in which  $\Omega = \pi$  and employing the same room as used for the nondirectional microphone, Fig. 2. *The combined sound energy output of microphone shows less frequency discrimination due to the larger ratio of direct to generally reflected sound.* If it is desired to have the same reverberation as in the case of the nondirectional system, we can employ a material with a smaller absorption coefficient. These materials in general exhibit coefficients which are less dependent upon the frequency. Thus, if the same distance of recording is used as in the nondirectional system, the conditions are more favorable for obtaining a uniform frequency characteristic.

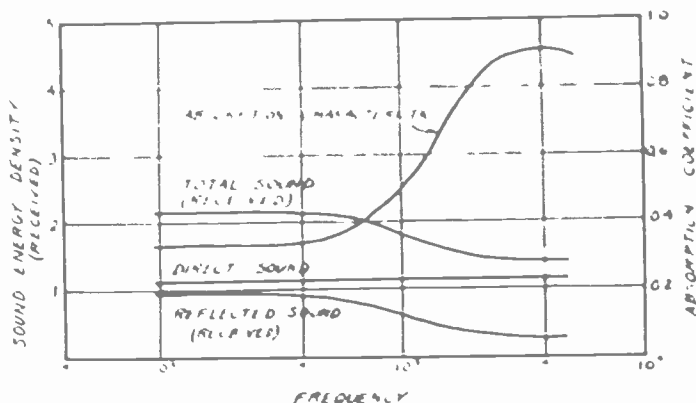

Fig. 4—Graphs showing the absorption characteristic of a room and the resultant direct, generally reflected, and total sound energy received by a directional sound collecting system.

In many instances, in sound motion picture recording, it is desirable to increase the distance of sound reception to facilitate the "range of action." For the same room the receiving distance can be increased  $\sqrt{4\pi/\Omega}$  times that in the nondirectional system, with the same reverberation in both systems.

Certain rooms and studios possess peculiar acoustic characteristics due primarily to the configuration of the boundaries. In these enclosures it is found that the reverberation possesses directional characteristics. That is, the rate of decay of sound depends upon the direction with respect to some reference axis in the room (or the sound decays at different rates in different directions). By employing a directional sound collecting system, the particular rate of decay which is recorded can be controlled by the orientation of the collecting system with respect to the room. Again, certain frequencies will be built up in intensity, by repeated reflections in a certain direction (as between two parallel walls). Here again the directional sound collector can be utilized to avoid the collection of such sounds by suitable orientation.

Noise and other undesirable sounds are other factors which oftentimes give rise to trouble in sound collection. If the sound comes from random directions the reduction of noise by the use of a directional as compared to a nondirectional microphone will be  $\Omega/4\pi$ . If the noise comes from a certain direction, the directional microphone can be oriented so that the zone of zero reception passes through the source of undesirable sound, in which case the noise can be practically eliminated.

The above discussion has been concerned with a few of the fundamental advantages of a directional sound collecting system. It is the purpose of the following section to discuss the important requisites of a directional sound collecting system.

#### REQUIREMENTS FOR A DIRECTIONAL SOUND COLLECTING SYSTEM

One of the important factors in a directive sound collecting system is the solid angle within which sound is received without appreciable attenuation. This must be sufficiently large to include the area occupied by the sources of sound to be received, but at the same time, the angle must be small enough so that an appreciable gain in discrimination against undesirable sounds is obtained.

*Another requirement is a directional characteristic which is independent of the frequency.* A system which does not possess this characteristic will introduce frequency discrimination. Due to the large frequency band of the audible spectrum, directional systems of the reflector type which depend upon interference become exceedingly cumbersome and complex if an attempt is made to obtain directional characteristics which are uniform at all frequencies.

In sound collection in motion picture studios, it is desirable and important that the dramatic action shall not be hampered or cramped by limitations of the sound collecting system. This implies that the microphone shall be small, light and easily movable, and capable of concealment within hanging lamps or similar objects when necessary. It should also have a comparatively low electrical impedance so that leads may be run from it to amplifiers a considerable distance away, in situations where an adjacent amplifier is not admissible.

The above discussion has been concerned with a generalized treatment of directional and nondirectional collecting systems. The requirements for a directional collecting system have been outlined. With these requirements in mind, work has been carried on to design a sound collecting system which incorporates these features. In the discussion which follows, a particular microphone will be described, namely, the ribbon microphone, which possesses directional characteristics which

have been found very useful in overcoming excessive reverberation and other undesirable sounds.

### THE RIBBON MICROPHONE

The ribbon microphone<sup>3</sup> consists of a light, corrugated, metallic ribbon suspended in a magnetic field and freely accessible to air vibra-

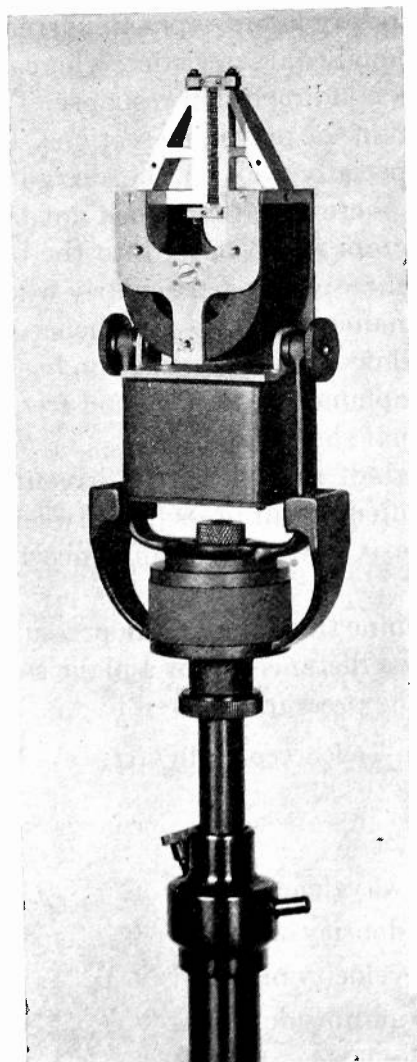

Fig. 5

tions from both sides, Fig. 5. The vibration of the ribbon due to an impressed sound wave leads to the induction of an electromotive force corresponding to the undulations of the incident sound wave. The

<sup>3</sup> H. F. Olson, *Jour. Acous. Soc. Amer.*, vol. 1, p. 56, (1931); *Soc. Motion Picture Eng.*, June, (1931).

ribbon is moved from its position of equilibrium by the difference in pressure existing between the two sides. In general, the ribbon is made light so that its motion corresponds to the motion of the air particles even at very high frequencies. This microphone can therefore very appropriately be termed a "pressure gradient" or "velocity" microphone. One of the important advantages of this type of microphone as compared with pressure-operated microphones (such as those of the condenser, carbon, and dynamic types in current use) is that it possesses marked directional characteristics, whereas a pressure-operated microphone possesses nondirectional response. The advantages of this have been pointed out in the preceding sections. The ribbon type of element lends itself especially well to the design of directional sound collectors. However, there apparently has not been any complete investigation of the factors which enter into the best utilization of this type of element in a microphone, particularly where velocity operation or directional performance is desired, and hence the author undertook the analysis which follows. This investigation has resulted in the design of a directional microphone which has good frequency characteristics and uniform directional characteristics.

As previously stated, the ribbon is driven from its position of equilibrium by the difference in pressure between the two sides. This difference in pressure is due to the difference in phase between the front and back.

We shall now examine the difference in pressure between two points in space separated by a distance  $2d$  for a plane sound field.

In a plane wave the pressure is given by

$$p = -\rho\Phi = k\rho H \sin k(ct - x)$$

where,

$$k = 2\pi/\lambda$$

$\lambda$  = wavelength;

$\rho$  = density of air;

$c$  = velocity of sound;

$H$  = amplitude of  $\Phi$ ;

$\Phi$  = velocity potential;

$x$  = coördinate of a particle in a medium.

Assume two points in space,  $A$  and  $B$ , separated by a distance  $2d$  in line with the direction of propagation. The difference in pressure between these two points is

$$\begin{aligned} \Delta p &= k\rho H [\sin k(ct + d) - \sin k(ct - d)] \\ &= 2k\rho H \cos (kct) \sin (kd). \end{aligned}$$

The instantaneous pressure available for driving the acoustic and mechanical systems of the microphone for a plane wave has been derived above. This difference in pressure, for a particular microphone, is shown in Fig. 6.

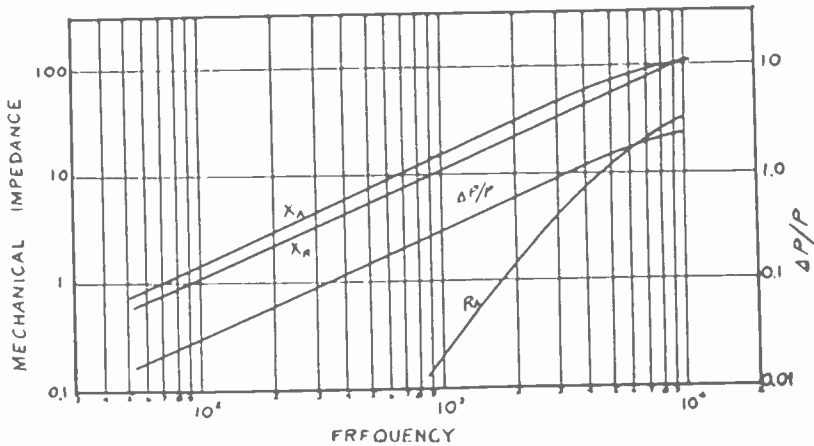

Fig. 6—Impedance characteristics of the components of the mechanical system.  
 $X_R$  = mechanical reactance of the ribbon  
 $X_A$  = mechanical reactance due to air  
 $R_A$  = mechanical resistance due to air  
 $\Delta p/p$  = ratio of the difference in pressure between the two sides of the ribbon to free space pressure.

The mechanical reactance due to the mass of the ribbon is given by

$$Z_R = X_R = 2\pi f m_R$$

where,

$$f = \text{frequency,}$$

and,

$$m_R = \text{mass of the ribbon.}$$

The reaction of the air upon the motion of the ribbon will now be considered.

The pressure at a distance,  $r$ , from an elementary source is

$$p = \frac{ds}{4\pi r} i p \xi e^{-i\omega t} e^{ikr}$$

$$\xi = \text{velocity of surface } ds.$$

The pressure at any point on the ribbon is

$$p = -\rho\Phi = \frac{i\rho\omega}{4\pi} \xi e^{i\omega t} \iint \frac{ds}{r_1} e^{-ikr_1}$$

where  $r_1$  is the radius vector having the shortest air distance from point  $l$  to the surface element  $ds$ . The integration extends over both sides of



the ribbon. To compute the force on the ribbon we must perform the above integration and then integrate the resulting pressure over the surface of the ribbon. Cognizance must be taken of the 180-degree difference in phase between front and back when integrating between these two surfaces. The total force is

$$\Psi = \frac{i\omega p \xi e^{i\omega t}}{4\pi} \iint ds' \iint \frac{ds}{r_1} e^{-ikr_1}.$$

The impedance is

$$Z_A = R_A + iX_A = \frac{\Psi}{\xi_0 e^{i\omega t}}.$$

The integral was evaluated for the particular ribbon by an approximation. The resistive and reactive components of the impedance presented to the ribbon by the air are given by the graphs in Fig. 6. For the size of ribbon and baffle employed it will be seen that both the reactive and resistive components of the system increase with frequency within the range indicated.

The ribbon is spaced by a few mils from the pole pieces of the magnetic structure. This aperture gives rise to a mechanical impedance which is given by the expression

$$Z_s = \rho\omega \frac{S}{C_0}$$

where,

$$S = \text{area of ribbon and aperture;} \\ C_0 = \text{conductivity of the aperture.}$$

This impedance is shunted by the mass reactance of the ribbon. In general the impedance due to the spacing is large compared with the mass reactance of the ribbon and may be neglected. It is important to note that in case this impedance is comparable to the mass reactance of the ribbon the net effect is a reduction in sensitivity of the microphone without discrimination against any frequency band.

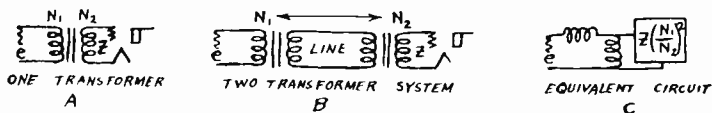

Fig. 7

The output of the ribbon is coupled to the grid of a vacuum tube by means of a step-up transformer as shown in Fig. 7A. In some cases where it is desirable to segregate the microphone and amplifier, two

transformers are employed, the first raising the impedance of the ribbon to that suitable for transmission over a line; the second raising this impedance to the input of a vacuum tube as shown in Fig. 7B. The equivalent circuit of these systems is shown in Fig. 7C. We shall now compute the effect of the electrical circuit upon the mechanical system. The electromotive force developed by the ribbon is

$$e = Bl\dot{x}$$

where,

$B$  = the flux density;

$l$  = the length of the ribbon; and

$\dot{x}$  = velocity of the ribbon.

The force required to generate a current  $i$  in the equivalent circuit Fig. 7C is

$$F = Bli.$$

The mechanical impedance due to the electrical circuit is

$$Z_R = \frac{F}{\dot{x}} = \frac{(Bl)^2}{Z_T}$$

where  $Z_T$  = total electrical impedance at the point  $e$ . The mechanical impedance due to the electrical circuit is in general negligible compared to the mechanical impedances considered above.

Expressions for the important mechanical impedances of the system have been derived and we are prepared to compute the motion of the ribbon. As was pointed out in the above derivation, the impedances due to electrical circuits and the aperture between the ribbon and the pole pieces may be neglected. The velocity of the ribbon is given by

$$\dot{x} = \frac{\Delta p}{Z_R + Z_A}.$$

It has been shown that the magnitude of  $Z_R$  and  $Z_A$  are practically proportional to the frequency. It has also been shown that  $\Delta p$  is proportional to the frequency. For this reason,  $\dot{x}$  remains practically constant throughout the frequency range. The generated voltage,  $e$ , is given by

$$e = Bl\dot{x} = \frac{\Delta p}{Z_R + Z_A} Bl.$$

This indicates that the generated voltage will be independent of frequency. The voltage presented to the grid of the vacuum tube may be computed from the electrical circuit shown in Fig. 7B.

A microphone of the type shown in Fig. 5 was calibrated by means of a Rayleigh disk. The millivolts per bar at the transmission line as a function of the frequency is shown in Fig. 8. It will be seen that the

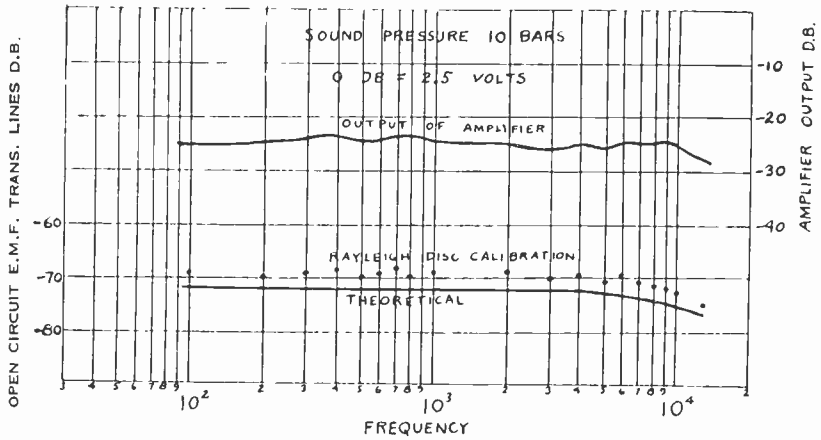

Fig. 8—Open-circuit voltage developed by the ribbon and the voltage output of the amplifier.

voltage output is practically independent of the frequency. It will be seen also that the theoretically predicted curve agrees with the experimental results and confirms the theory outlined above.

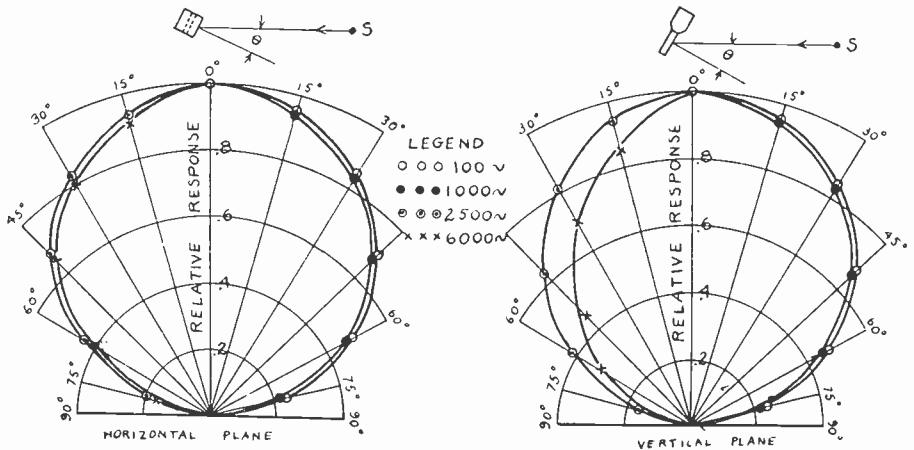

Fig. 9—Polar diagrams showing the directional characteristics of the ribbon microphone.

The uniform output over a wide frequency range indicates that this microphone is free from resonance systems. The natural period of the ribbon is located below the audible frequency range. In a condenser microphone at least two resonances occur within the audible range that influence the output, namely, the cavity resonance and the diaphragm resonances.

The above considerations have been concerned with the plane of the ribbon normal to the line of propagation of the sound. When the normal to the plane of the ribbon is inclined by the angle  $\theta$  to the line of propagation, the air distance from front to back is multiplied by the factor  $\cos \theta$ . When  $\theta$  is 90 degrees the pressure difference between front and back is zero for all frequencies and the ribbon remains stationary.

The observed directional characteristics of this microphone are shown in Fig. 9. It will be seen that the experimental results are in close agreement with the predicted performance. These results indicate that the directional characteristics of this microphone are practically independent of the frequency. For this reason this microphone does not produce frequency distortion due to its directional characteristics.

#### APPLICATION OF THE RIBBON MICROPHONE

The advantages of a directional sound pick-up system as compared to nondirectional from the standpoint of elimination of undesirable sounds have been brought out in a preceding section. It is the purpose of the discussion which follows to carry out a similar analysis for the specific case of the ribbon microphone.

The voltage output of the ribbon microphone for sound originating in the direction  $\theta$  is

$$e_R = p_0 Q_1 \cos \theta$$

where,

$e_R$  = the voltage output of the microphone;

$Q_1$  = a constant of the microphone expressing the relation between sound pressure and voltage output;

$p_0$  = the sound pressure at the microphone;

$\theta$  = angle between the direction of propagation and the normal to the face of the microphone.

The voltage output of a nondirectional microphone for sound originating in any direction can be expressed by

$$e_{ND} = Q_2 p_0$$

where,

$e_{ND}$  = voltage output of the microphone;

$Q_2$  = constant expressing the relation between sound pressure and voltage output.

Assume that  $Q_1 = Q_2$  which is equivalent to making the ribbon for sounds originating in a direction normal to the face equal to the sensitivity of a nondirectional microphone.

The efficiency of energy response of the ribbon microphone as compared to a nondirectional microphone for sounds originating in random directions, all directions being equally probable, is

$$\text{efficiency} = \frac{\sum_{\phi=0}^{\phi=4\pi} e_{R\phi}^2}{\sum_{\phi=0}^{\phi=4\pi} e_{ND\phi}^2} = \frac{4\pi K_1^2 p_o^2 \int_0^{\pi/2} \cos^2 \theta \sin \theta d\theta}{4\pi K_2^2 p_o^2} = \frac{1}{3}.$$

The following conclusion can be drawn:

*The energy response of the ribbon microphone to sound originating in random directions is one third that of a nondirectional microphone. For the same allowable recorded reverberation the ribbon microphone can be used at 1.7 the distance of a nondirectional microphone.*

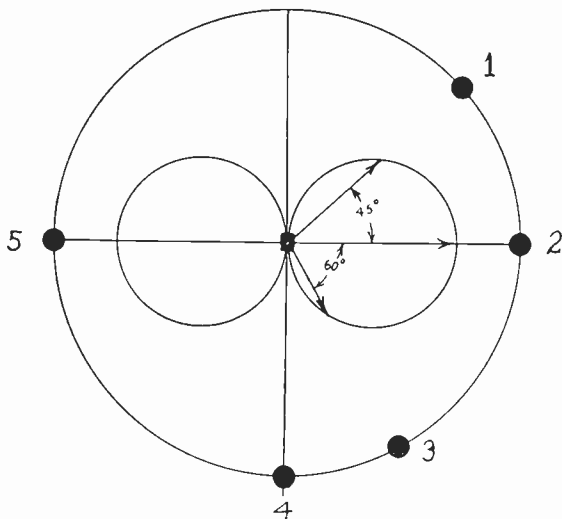

Fig. 10

The particular directional characteristics exhibited by the ribbon microphone have been found to be very convenient for arranging actors in dialog and for adjusting the relative loudness of a group of sounds, as for example, the instruments of an orchestra.

A plan view of a microphone and a number of sound sources is shown in Fig. 10. Suppose sources 2 and 5 represent two actors who are carrying on a dialog. In view of the fact that this microphone receives with the same efficiency in two directions, it is possible to have the actors face each other. In the case of a pressure-operated microphone, having a diameter of three inches, the response is nondirectional below 1500 cycles; above 2000 the angle of pick-up becomes smaller and smaller. To obtain pick-up without frequency discrimination with a

pressure-operated microphone of this size, in general, the source of sound must be confined within an angle of 40 degrees. That is, to obtain good results, the actors must speak at the microphone, which

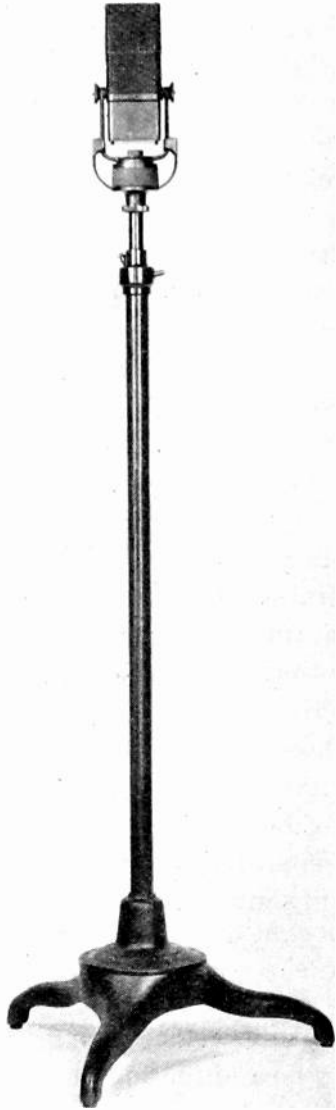

Fig. 11

means that the actors cannot conveniently face each other, as in the case of the ribbon microphone. Obviously, the directional characteristics of the ribbon microphone possess advantages from the dramatic standpoint.

Suppose that sources 1, 2, 3, and 5 represent the instruments of an orchestra. With this microphone the relative loudness of these sources can be adjusted by means of the angle between the normal to the plane of the ribbon and the line connecting the source and the microphone. In this diagram, all the sources are located at the same distance. This means that 1, which is located at 45 degrees, will give 0.7 as much voltage output as 2 for the same loudness of sound. In the same way, 3 will be 0.5 of 2. In the case of the pressure microphone, the relative loudness can only be adjusted by the distance from the microphone. However, in the case of the ribbon microphone, due to the directional characteristics, the relative loudness among sounds can be adjusted by means of the angle as well as distance. Obviously, this is a great advantage in balancing the instruments of an orchestra.

In Fig. 10 sound source 4 is considered as a source of objectionable sound and is placed in the zero reception zone of the microphone. It will therefore not actuate the microphone. Of course, the reflected sound will be received but this will in general be small.

The output of the ribbon is coupled to the grid of a vacuum tube by means of a transformer system. Where the microphone unit is located next to the amplifier, a single transformer is employed to raise the impedance from the ribbon to that suitable for the input of a vacuum tube. Where it is desirable to separate the microphone unit from the amplifier, a two-transformer system is employed, the first transformer raising the impedance to that suitable for transmission over a line, and the second transformer raising the impedance to that suitable for the input of a vacuum tube.

For broadcasting it is ordinarily required that stands for either floor or table mounting be supplied. For this work the amplifier and microphone unit are separated and the two-transformer system employed. The photograph shown in Fig. 11 shows the floor type of stand for the microphone.

#### ACKNOWLEDGMENT

In conclusion, the author wishes to express his appreciation to Mr. J. Weinberger, under whose direction the work on directional sound collecting systems has been done. The production designs of the ribbon microphone illustrated in this paper were made by Mr. L. J. Anderson.



## A HIGH-QUALITY RIBBON RECEIVER\*

BY

HARRY F. OLSON AND FRANK MASSA

(Research Division, RCA Victor Company, Inc., Camden, N. J.)

**Summary**—The ribbon receiver consists of a ribbon diaphragm in a magnetic field. In order that the ratio of pressure in the ear cavity to the applied voltage shall be independent of the frequency, the ratio of the amplitude of the ribbon to the applied voltage must be independent of the frequency. This is accomplished by employing an acoustic system consisting of two resonant circuits. The amplitude response of this receiver has a maximum variation of  $\pm 2\frac{1}{2}$  decibels in the range 30 to 10,000 cycles.

### INTRODUCTION

ONE of the fundamental advantages of ribbon diaphragms for use in electro-acoustic transducers resides in the fact that the entire vibrating system is used for the dual purpose of carrying the electric current, and generating the acoustic pressure. The ribbon diaphragm has been successfully employed for a high-quality microphone.<sup>1</sup> It will be shown that the ribbon diaphragm also can be used in a high-quality head receiver.

In the case of the microphone, the ratio of the velocity of the conductor to the pressure in the sound wave must be independent of frequency to obtain a system in which the sensitivity is independent of frequency. The mechanical system in the microphone is mass-controlled, that is, the mechanical impedance is proportional to the frequency. To maintain constant velocity of the ribbon, the acoustic system is designed so that the force available for actuating the ribbon is proportional to the frequency over the working range of the microphone. In the case of the receiver, we must supply constant sound pressure<sup>2</sup> to the ear cavity for constant voltage applied to the receiver. If we assume that the ear cavity presents a constant acoustic capaci-

\* Decimal classification: R360×R160. Original manuscript received by the Institute, October 18, 1932. Presented before the A.A.A.S. meeting, Atlantic City, N. J., December 29, 1932.

<sup>1</sup> H. F. Olson, *S.M.P.E.*, vol. 16, no. 6, pp. 695-708; *Jour. Acous. Soc. Amer.*, vol. 3, no. 1, pp. 56-68.

<sup>2</sup> When the head is immersed in plane wave sound field, the pressure at the surface of the head at the ears is a function of the azimuth of the head with respect to the direction of propagation of the sound. The pressure upon a rigid spherical surface has been investigated theoretically by Stewart, *Phys. Rev.*, vol. 14, p. 376, (1919); Ballantine, *Jour. Acous. Soc. Amer.*, vol. 3, no. 3, p. 319. Stewart has shown that these results can be applied to give the pressure at the surface of the head. These results show that the pressure at the surface of the head at the ears is essentially the same as that in free space. There is a variation in the ratio of the pressure at the ears to that in free space at the higher frequencies, but not of sufficient magnitude to be significant. If the head is turned so



tance to the receiver, the ratio of amplitude of the ribbon to the applied voltage should be independent of the frequency. It is well known that the impedance of the ear cavity presented to the receiver is not a pure capacitance, particularly at the higher frequencies, due to standing wave systems between the receiver and a portion of the ear cavity and also due to absorption which results in a resistive component. However, these factors vary from person to person. For this reason it seems that a receiver in which the ratio of amplitude to the applied voltage is independent of frequency meets the actual conditions about as accurately as one having any other characteristic.

The paper which follows describes the theory and construction of high-quality telephone receivers employing ribbon diaphragms.

### THEORY

In order that the pressure in the ear cavity shall be independent of the frequency for constant voltage applied to the receiver, the ratio

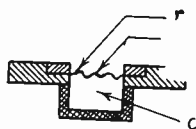

Fig. 1

of the amplitude of the ribbon diaphragm to the applied voltage must be independent of the frequency. This is equivalent to stating that the system must be *stiffness-controlled*. There are a multitude of ways

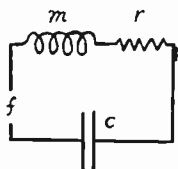

Fig. 2

in which this may be accomplished. In general, the possible systems employing a ribbon diaphragm will consist of one or more resonant

that one ear faces the source of sound, the pressure at this point at the higher frequencies is twice that in free space, while the shadow cast by the head results in a very small pressure upon the other ear. Of course, the normal listening position is that of facing the source of sound. In rooms in addition to the direct sound, there is also the generally reflected sound. If all directions of the reflected sound are assumed to be equally probable, there will be practically no frequency discrimination as regards any point on the surface of the head. It may be said, then, that under normal conditions the ratio of the pressure supplied at the surface of the head to the ear cavity to that in free space is independent of the frequency. Therefore, to simulate the normal listening condition the ratio of the sound pressure applied to the ear cavity to the voltage applied to the receiver must be independent of the frequency.

systems. The discussion which follows will describe two systems which satisfy these requirements; namely, one employing a single resonant system, and another employing two resonant systems.

A system employing a ribbon diaphragm and an acoustic capacitance is shown in Fig. 1. The equivalent circuit of this system is shown in Fig. 2. The velocity of the ribbon is given by the expression,

$$\dot{X} = \frac{F}{\sqrt{R^2 + (\omega M - 1/\omega C)^2}}$$

where,

$F_1$  = force per unit area of the ribbon,

$M$  = inertance of the ribbon,

$M = m/A^2$ ,

$m$  = mass of the ribbon,

$A$  = area of the ribbon,

$C$  = capacitance of the cavity enclosing the back of the ribbon,

$C = V/\rho s^2$ ,

$V$  = volume of the cavity,

$\rho$  = density of air,

$s$  = velocity of sound,

$R$  = acoustic resistance due to the damping material supporting the ribbon,

$\omega = 2\pi f$ ,

$f$  = frequency.

The amplitude in terms of the velocity is

$$x = \frac{\dot{X}}{\omega}$$

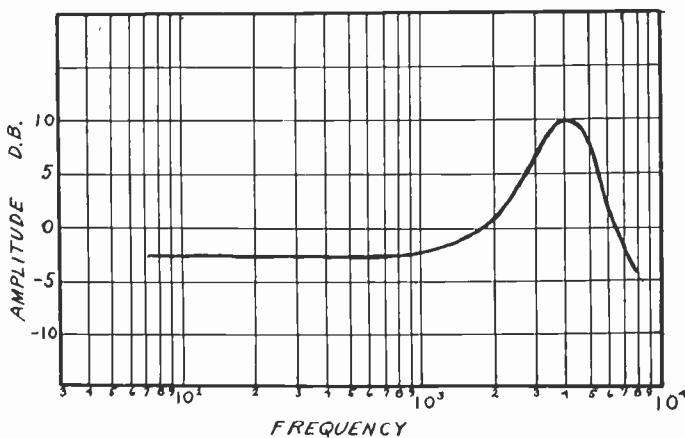

Fig. 3

The amplitude response of the system in Fig. 1 is shown in Fig. 3. It will be seen that the excessive response at the resonance frequency

is objectionable. To maintain constant amplitude in this system, either the resonant frequency must be located outside the operating range, or a large amount of resistance must be used and the resonant frequency placed near the upper limit of the operating range. The primary disadvantage of either of these expedients for obtaining uniform amplitude response lies in the relative insensitiveness of the resulting system.

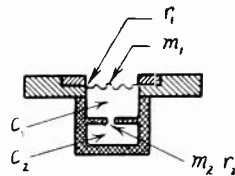

Fig. 4

In general, in any system designed to yield uniform response efficiently over a wide frequency band, it is necessary to resort to more than one resonant system. A system which consists of two resonant systems combining high sensitivity with uniform response over the

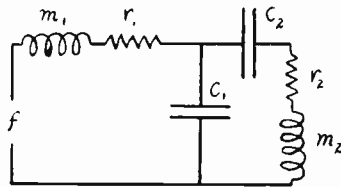

Fig 5

operating range is shown in Fig. 4. It is this system which has been adopted for the ribbon receiver. The equivalent circuit of this system is shown in Fig. 5. The velocity of the ribbon is given by

$$\dot{X} = \frac{F(Z_2 + Z_3)}{Z_1 Z_2 + Z_2 Z_3 + Z_1 Z_3}$$

where,

$$Z_1 = R_1 + i\omega M_1,$$

$$Z_2 = \frac{1}{i\omega C_1}$$

$$Z_3 = R_2 + i\omega M_2 + \frac{1}{i\omega C_2},$$

$M_1$  = inertance of the ribbon,

$R_1$  = acoustic damping resistance of the ribbon.

$$C_1 = \frac{V_1}{\rho s^2},$$

$$C_2 = \frac{V_2}{\rho s^2}$$

$V_1$  = volume of the cavity enclosing the back of the ribbon,  
 $V_2$  = volume of second cavity,  
 $R_2$  = acoustic resistance of the aperture connecting the two cavities,  
 $M_2$  = inertance of the aperture connecting the two cavities.  
 The amplitude in terms of the velocity is

$$x = \frac{\dot{X}}{\omega}.$$

We may adjust the constants of the system so that the amplitude per unit force will be practically independent of the frequency. The amplitude response for a certain set of constants is shown in Fig. 6.

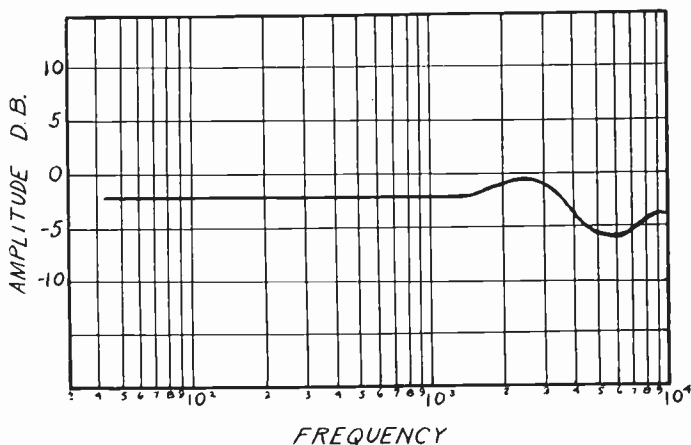

Fig. 6

## CONSTRUCTION

The construction of the ribbon receiver as finally developed is shown in Fig. 7. Essentially, the receiver is made up in three parts, the magnetizing unit, the ribbon mounting, and the ear cap. The magnetizing unit consists of three U-shaped cobalt steel magnets, molded into a bakelite shell which serves to keep the magnet structure as a rigid unit and also provides a suitable exterior surface for the main body of the receiver.

The pole pieces, made of Armco iron, also serve as the ribbon mounting. A brass clamp, insulated from the iron, is provided at each end of the air gap for making connection to the ribbon. The pole shoes are split along the center next to the air gap and means are provided for clamping the ribbon along its edges. A detailed view of the ribbon assembly is shown in Fig. 8.

It was found very important to prevent all leakage of air from the front to the back of the ribbon in order to preserve the low-frequency

sensitivity of the receiver. An effective seal along the ribbon edges was realized by cementing the ribbon to a strip of empire silk which was clamped between the split pole shoes. A window was cut out in the silk behind the ribbon in order to decrease the effective mass of the

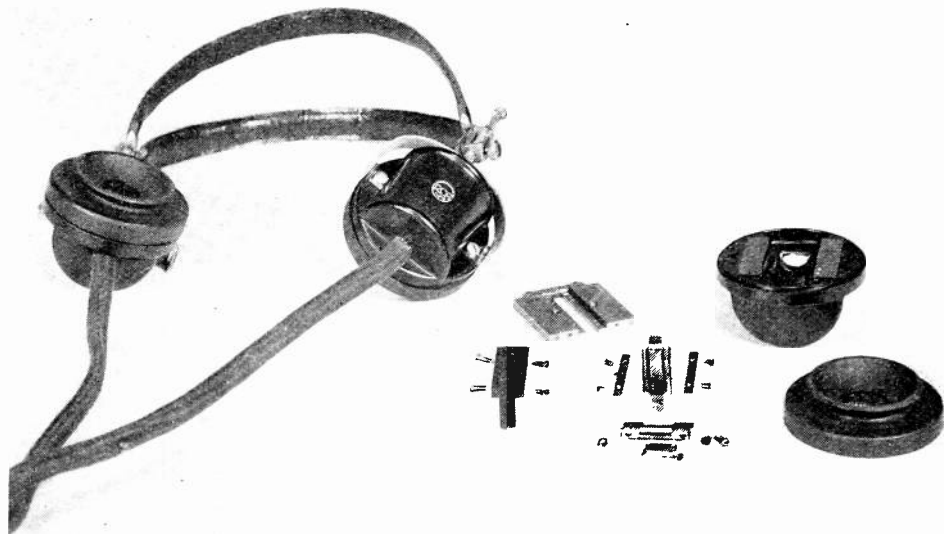

Fig. 7

diaphragm. The empire silk was found to be a very satisfactory mounting, for in addition to providing the desired seal, it offers sufficient damping to prevent diaphragm resonances at the higher frequencies which were encountered with other types of mounting. The ribbon was corrugated in order that its entire surface would vibrate in phase.

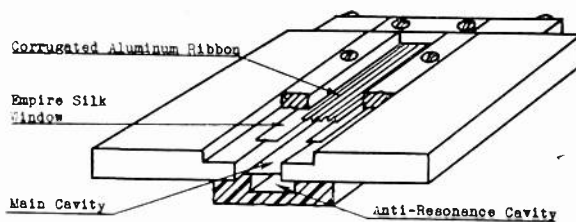

Fig. 8—Showing details of ribbon assembly.

When the ribbon is clamped in its mounting it is installed without stretching. The controlling stiffness of the system is obtained by the enclosed volume of air behind the ribbon. The size of cavity was designed so that the fundamental resonance of the system came at about 8000 cycles, which is within the frequency range of the response desired for the receivers. To remove the resonance to a frequency above 10,000 cycles would necessitate using a smaller cavity with a corre-

sponding decrease in sensitivity. In order to remove the 8000-cycle peak, a second cavity was coupled to the first by a series of small holes, which served to increase further the sensitivity of the receivers. The frequency-response characteristic of the receiver is shown in Fig. 9.

The necessity for preventing air leakage from the front to the back of the ribbon has already been mentioned. It is equally important that there be no air leakage from the ribbon to the atmosphere when it is placed against the ear. In order to have a good seal between the ear cap and the ear, the cap was made of rubber molded into the shape

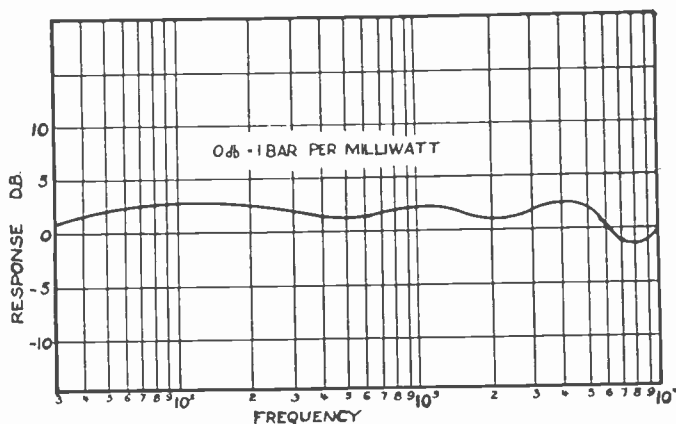

Fig. 9—Response-frequency characteristic of ribbon receiver.

shown in the photograph of Fig. 7. In assembling the ear cap to the receiver a layer of sealing compound composed of wax and oil was smeared over the pole pieces before fastening the cap, which prevents a leakage between the ear cap and pole shoes.

The two ribbons in the receivers making up the headset are connected in series and a transformer is provided for stepping up the impedance to 2000 ohms.

The absolute sensitivity of each receiver at 1000 cycles has been measured as 1.3 bars into a 4-cubic-centimeter cavity per milliwatt electrical input. The method of calibration of the receivers will be described below.

#### METHOD OF MEASUREMENT

In order to determine the frequency-response characteristic of the ear phones, a condenser microphone was arranged to approximate a human ear by inserting an adapter in the cavity which reduced it to 4 cubic centimeters. The receiver to be tested was placed over this. Extreme precautions were taken to prevent leakage between the phones and microphone. The seal was made perfect, since this is the condition realized by the ear cap design mentioned above. The pressure

developed at the microphone diaphragm was then measured at various frequencies for constant electrical input to the receivers. Hydrogen was introduced into the cavity in order to eliminate standing waves at the higher frequencies while testing the units. A schematic arrangement of the calibrating system is shown in Fig. 10. The presence of the hydrogen tubes leading from the microphone cavity caused a considerable reduction in the low-frequency response of the phones. In order to get a true indication of what the receivers were doing at low frequencies, the tubes were sealed and the low-frequency response recorded.

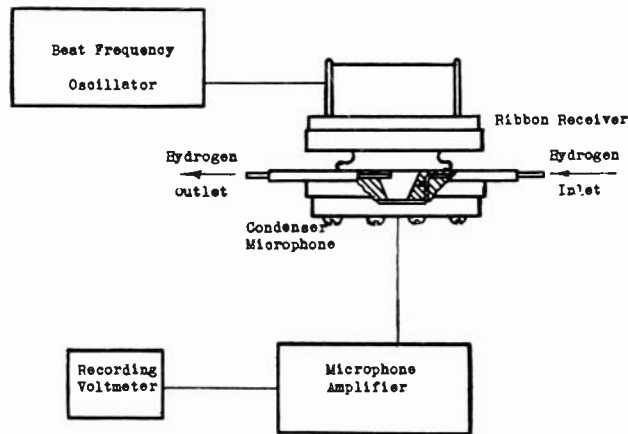

Fig. 10—Schematic arrangement of units involved in calibrating a receiver.

The receiver calibration shown in Fig. 9 is a composite curve in which the low-frequency end was taken with the hydrogen tubes sealed; and air in the cavity, while the high-frequency end was taken with hydrogen flowing through the cavity. The use of hydrogen increases the wavelength of sound sufficiently to prevent standing waves from occurring between the receiver and microphone within the desired range of measurement.

It must be remembered that when the receivers are placed against the ears, distortion is introduced due to standing waves set up in the ear itself. A peak appears in the neighborhood of 7500 cycles. This value of frequency is different for different ears, due to the impedance variations among different individuals, so that little can be done to compensate for its presence. Fortunately, the ear has a relatively high acoustical resistance at the high frequencies, so that the resonance peak is considerably attenuated and, therefore, gives less trouble. In addition, the characteristic of the receivers was made to dip slightly within the resonant frequency range of the ear, which further reduces the effect of the ear distortion.

To obtain the absolute sensitivity of the receiver, the sound pressure developed at the microphone diaphragm in the arrangement described above was measured for a known value of electrical input to the unit. The over-all frequency-response calibration of the measuring system was determined by using an electrostatic actuator placed near the microphone diaphragm and supplying voltage between the surfaces from the same oscillator used to supply power to the receivers.

ACKNOWLEDGMENT

In conclusion, the authors wish to express their appreciation to Mr. J. Weinberger, under whose direction this work was done.





## PERMISSIBLE AMPLITUDE DISTORTION OF SPEECH IN AN AUDIO REPRODUCING SYSTEM\*

BY

FRANK MASSA

(Research Division, RCA Victor Company, Inc., Camden, N. J.)

**Summary**—This paper gives the experimental results of a brief study of permissible amplitude distortion in an audio reproducing system having a relatively flat frequency-response characteristic, from 80 to 14,000 cycles. The effect of distortion on the character of reproduction was observed when the transmission band was cut off at 5000 cycles, 8000 cycles, and 14,000 cycles. Distortion was introduced by overloading an amplifier so calibrated that the amount of harmonic output being generated was known for various input intensities and attenuator settings. A cathode ray oscillograph was used across the input as a peak indicating voltmeter. It was found that the permissible amount of distortion is lower, the greater the frequency range of the reproducing system, and also that a certain amount of second harmonic is less objectionable than the same amount of third harmonic distortion.

### INTRODUCTION

IN AN audio reproducing system, three types of distortion may be encountered; namely, frequency distortion, which results from the nonuniform frequency-response characteristic of the system, phase distortion which results from certain frequency components being displaced in their phase relations with other components, and amplitude distortion which results from a nonlinear amplifying characteristic within the system.

The characteristics of frequency distortion are well known.<sup>1</sup> Many have judged the quality of reproduced sounds in which the reproducing system had known frequency characteristics, so that data are available which give some indication of the amount of frequency distortion that may be permissible without appreciably altering the quality of the original sound.

From the work that has been done on phase distortion, the consensus of opinion seems to be that this type of distortion of the amount usually found in reproducing equipment, does not materially affect the quality of reproduction.<sup>2</sup>

There seems to be little quantitative information available regarding the effect of amplitude distortion on the quality of reproduction. It is well known that overloaded amplifiers often introduce enough

\* Decimal classification: R148.1. Original manuscript received by the Institute, November 9, 1932.

<sup>1</sup> W. B. Snow, *Jour. Acous. Soc. Amer.*, p. 155, July, (1931).

<sup>2</sup> Balth. van der Pol. *Proc. I.R.E.*, p. 221, February, (1930).

harmonic content to make the quality of reproduction very bad. How much overloading can be permitted in an amplifier without materially affecting the quality is the purpose of the work described here.

Most of this experimental investigation was made on speech. An exhaustive study would have included various musical instruments in solo and in combinations, playing a large number of selections, but the time required for such an undertaking was not available.

#### DESCRIPTION OF APPARATUS

##### (a) High-Quality Reproducing System

For observing the effects of amplitude distortion on speech, a high-quality sound reproducing system was set up, consisting of a ribbon microphone with associated amplifier feeding into two power amplifiers in parallel; one supplying power to a dynamic cone speaker, and the other supplying power to a ribbon speaker.<sup>3</sup> A low-pass filter cutting off at 1500 cycles was used with the dynamic cone speaker, and a high-pass filter cutting off at 1500 cycles was used with the ribbon speaker. The over-all frequency characteristic of the microphone, amplifier, and loud speaker system was uniform from 80 to 14,000 cycles. The over-all distortion in the amplifying system was less than 2 per cent throughout the working range of the amplifier. This value was attained by using Thyrite<sup>4</sup> in the plate circuit of some of the tubes in order to keep the mutual characteristic linear over the desired range. Low-pass filters were provided for cutting off transmission through the system at 10,000, 8000 or 5000 cycles, as desired.

Between the microphone amplifier and the power amplifiers was inserted a circuit for introducing predetermined amounts of distortion. Across the input of the distortion circuit was connected an amplifier and cathode ray tube arranged to be used as a peak indicating voltmeter. A schematic arrangement of the parts is shown in Fig. 1.

##### (b) Distortion Circuit

The wiring diagram of the circuit designed for introducing distortion into the audio system is shown in Fig. 2. Switching facilities are provided for converting the push-pull output stage into a single tube stage, for the production of even harmonics. A calibrated potentiom-

<sup>3</sup> The ribbon speaker consisted of a light, corrugated aluminum ribbon coupled to a suitable exponential horn. Its frequency characteristic was uniform from 1500 to 14,000 cycles.

<sup>4</sup> Thyrite is a material developed by the General Electric Company for use as lightning arresters, and has the property of decreasing its resistance as the voltage across it is raised. For a complete discussion of its properties, see "Thyrite: a New Material for Lightning Arresters" by K. B. McEachron, *Gen. Elec. Rev.*, p. 92; February, (1930).

eter is provided at the input, the setting of which determines the amount of harmonic generated in the amplifier for a given input. A calibration showing the amount and order of harmonic appearing in the output as a function of the input potentiometer setting for both push-pull and single tube connections is shown in Figs. 3 and 4.

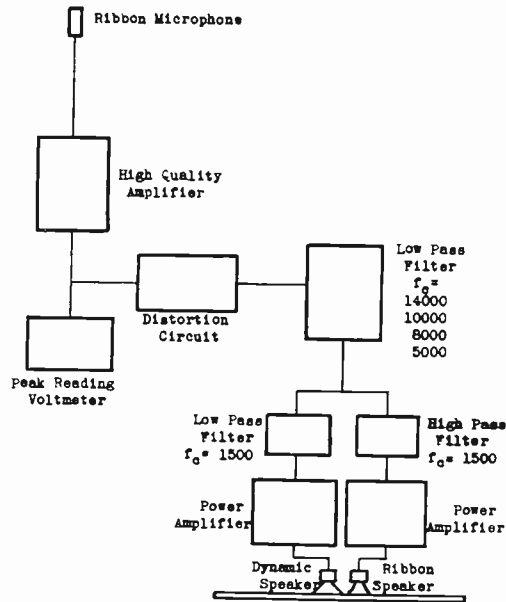

Fig. 1—Schematic arrangements of units involved in the experimental determination of allowable amplitude distortion in audio reproducing systems.

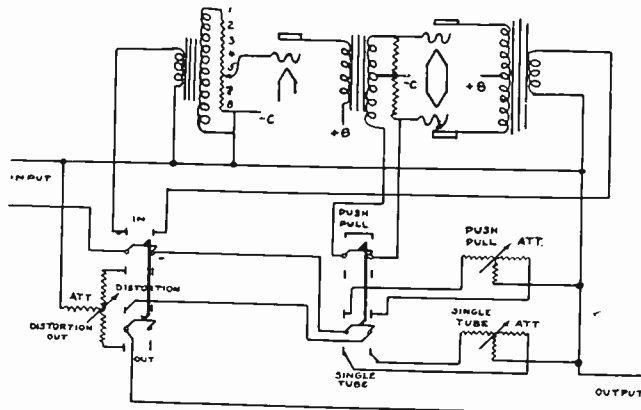

Fig. 2—Wiring diagram of circuit used for introducing distortion.

Switching arrangements are also provided whereby the distortion may be introduced or may be omitted, permitting a quick comparison of the quality of the distorted and undistorted sound. Suitable attenuators are placed in the circuit so that the intensity at the output end can be adjusted for both distorted and undistorted positions of the switches.

## (c) Peak Indicating Voltmeter

The peak reading voltmeter consisted of a cathode ray tube with a magnetic deflection circuit. To one set of deflection coils was connected a 60-cycle supply, which provided the power for the sweep circuit. The other set of coils was connected to the output of a resistance-coupled amplifier, the input of which was connected across the input of the distortion circuit, and the peak values of the voltage variations at that point could be easily read on the screen of the tube

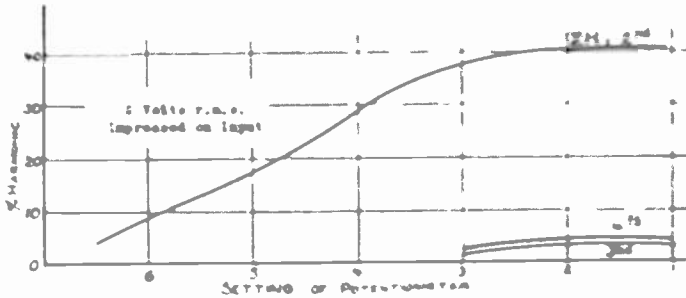

Fig. 3—Showing the harmonics introduced in the output of the distortion circuit for various potentiometer settings. Switch in Fig. 2 set to single-tube position.

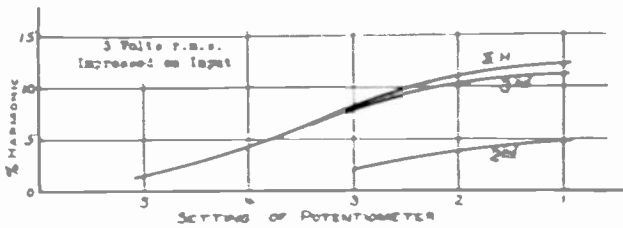

Fig. 4—Showing the harmonics introduced in the output of the distortion circuit for various potentiometer settings. Switch in Fig. 2 set to push-pull position.

## EXPERIMENTAL PROCEDURE

The microphone was placed in an acoustically-treated room, 20 feet  $\times$  20 feet  $\times$  8 feet with walls and ceiling covered with 4 inches of rockwool. Five persons, two women and three men, were placed, one at a time, before the microphone to speak during these experiments. The speech output from the microphone amplifier was transmitted to the listening room having normal living room acoustics, where the distorting circuit, peak voltmeter, and the high quality loud speaker combination were located.

The peak intensity of the incoming speech was adjusted to the desired value as read on the voltmeter. The amount of harmonic distortion was read from the calibrated potentiometer setting at the input of the distortion circuit. In obtaining the data, increasing amounts of

distortion, both with and without even harmonics, were introduced for each of the speakers. A group of listeners then voted, individually, on the quality of reproduction using the following system of rating:

*Barely noticeable.* The amount of distortion which just began to produce a detectable change in quality (by comparing the distorted output with the undistorted reproduction).

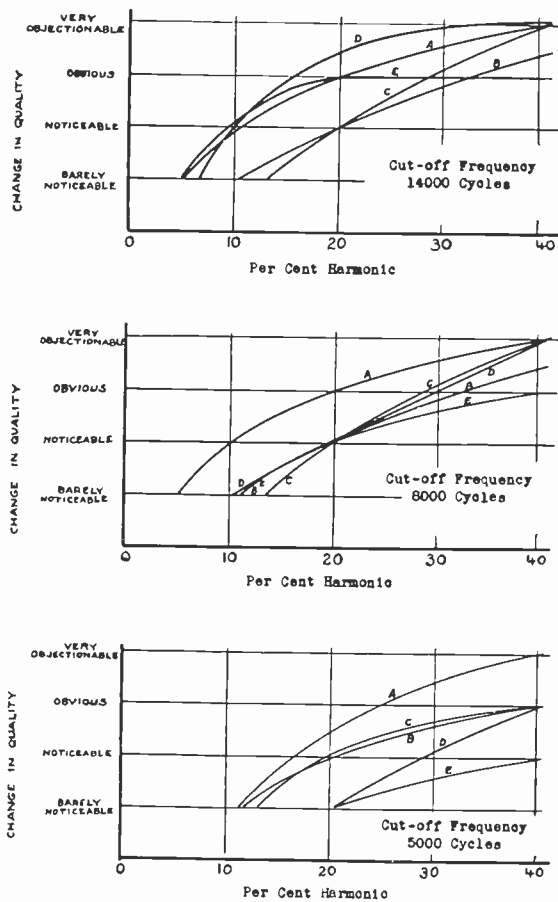

Fig. 5—Showing effect of harmonic distortion on the quality of reproduction of speech. (Single-tube overloading.)

*Noticeable.* The amount of distortion which produced a detectable change in the quality of reproduction without comparing with the undistorted reproduction.

*Obvious.* The amount of distortion which could be definitely identified as such in the output (the distortion just becoming objectionable).

*Very objectionable.* The amount of distortion which becomes very objectionable to the average listener.

With the cut-off frequency of the reproducing system set successively to 14,000 cycles, 8000 cycles, and 5000 cycles, distortion tests were made on speech, with each of the five persons coöperating in the experiment.

DEFINITION OF DISTORTION

In calibrating the distortion circuit, pure tones were used for the input, and the harmonic components in the output were measured with

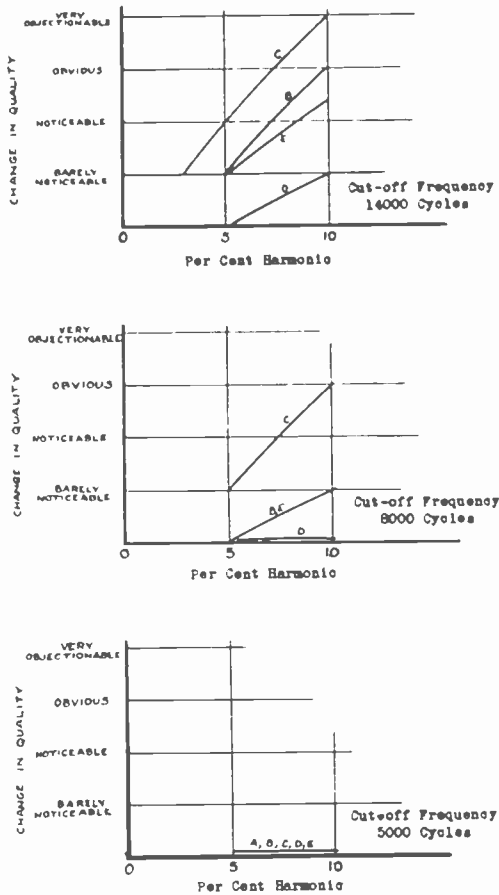

Fig. 6—Showing effect of harmonic distortion on the quality of reproduction of speech. (Push-pull overloading.)

various input voltages. The amount of total harmonic was defined as the ratio of the square root of the sum of the squares of the harmonic components to the fundamental.

In using the distortion circuit in connection with the complex audio signals (that is, speech) the per cent harmonic distortion in the system is defined as the amount of distortion produced by a pure tone having a peak value equal to the peak value of the complex wave.

## RESULTS OF INVESTIGATION

In Figs. 5 and 6 are shown a set of curves representing the opinion of a group of listeners regarding the quality of reproduction as a function of per cent harmonic introduced. Fig. 5 shows the effect of introducing mostly second harmonic distortion (single tube overloading (Fig. 3)) into a system reproducing all frequencies uniformly up to 14,000 cycles, 8000 cycles, and 5000 cycles.

Fig. 6 shows a set of curves similar to Fig. 5, except that the distortion is mostly third harmonic (push-pull overloading (Fig. 4)).

The curves in Figs. 5 and 6 show the most critical opinion among those of six observers for each of the individual tests. It is interesting to note that in all cases at least two observers voted similarly and independently, while in the majority of cases there were three and four independent agreements on the minimum amount of distortion to produce a change in the quality of reproduction. The observers were all skilled in acoustics and acted as very critical judges, so that in using the minimum values of Table I as the basis for the design of audio systems, there will be a reasonable factor of safety when using the system to satisfy the average listener.

In the above curves, persons *A*, *C*, and *D* are male; *B* and *E* are female.

It is apparent, from the above data, that the presence of amplitude distortion becomes more noticeable as the frequency range of the reproducing system is increased. Also, it is seen that the generation of third harmonic is more objectionable than the generation of second harmonic.

From Figs. 5 and 6 the minimum distortion required to produce a noticeable change in quality of speech is tabulated in Table I.

TABLE I  
PER CENT HARMONIC NECESSARY TO PRODUCE A DETECTABLE  
CHANGE IN THE QUALITY OF REPRODUCED SPEECH

Cut-off Frequency of System	Directly Comparing Distorted Reproduction with Undistorted Reproduction		Without Comparison Against Undistorted Reproduction	
	Single Tube Overloading (2nd Harmonic Predominant)	Push-Pull Overloading (3rd Harmonic Predominant)	Single Tube Overloading (2nd Harmonic Predominant)	Push-Pull Overloading (3rd Harmonic Predominant)
14,000	5 per cent	3 per cent	10 per cent	5 per cent
8,000	5 per cent	5 per cent	10 per cent	7 per cent
5,000	12 per cent	>10 per cent	17 per cent	>10 per cent

The per cent distortion given includes all persons who spoke during the test. Of course, as is to be expected, some voices can stand much more distortion than others before it is noticeable. This depends a

great deal upon the characteristics of the voice. A voice which is practically free from harmonics of a certain order, will be more susceptible to having its quality changed by the introduction of those missing harmonics than a voice already having the harmonics. It also depends a great deal on the frequency characteristics of the voice—whether or not the harmonics introduced come within a frequency region where the ear is more or less sensitive.

It must be remembered in interpreting the above results that the harmonic content is determined by the *peak values* of the complex audio signal; i.e., if the harmonic content is to be kept below 10 per cent, the peak values of the audio signal must be kept below the peak value of a sine wave that will cause 10 per cent harmonic production in the system.





## FERRO-INDUCTORS AND PERMEABILITY TUNING\*

BY

W. J. POLYDOROFF

(Johnson Laboratories, Chicago, Illinois)

*Summary*—Brief analysis indicates that tuning by variation of inductance in such a manner that  $L/R$  of the circuit is kept constant results in constant selectance and amplification throughout the tuning range.

Very finely divided and compressed magnetic-core material has been developed for this purpose. Between the prescribed limits of frequency range, iron cores can be so designed as to produce simultaneous inductance and resistance variations of the order of an air-core inductance. This material exhibits extremely low losses at broadcast frequencies and possesses exceptional magnetic stability, from which other than radio applications follow.

Constructional details of variable ferro-inductors are given, together with their behavior and application in radio circuits.

Because of inherent uniformity of the circuits, they are most applicable in tuned radio-frequency receivers, several forms of which are shown in their performance and construction.

### INTRODUCTION

TUNABLE resonant circuits are most commonly used in the radio art. Their ability to respond to desired signals in a relatively narrow band of frequencies, and to reject undesired signals having frequencies outside this band, is still the foundation of the process we call "selective tuning."

Any circuit consisting of inductance, capacity, and resistance is resonant or oscillatory, according to the formula,

$$\omega = 2\pi f = \sqrt{\frac{1}{LC} - \frac{R^2}{4L}},$$

provided that  $CR^2$  is less than  $4L$ , and provided the decay coefficient,  $R/2L$ , is sufficiently small. For all practical purposes this may be taken as

$$\omega = 2\pi f = \frac{1}{\sqrt{LC}}.$$

Circuits may be tuned to any desired frequency by adjusting either the inductance, the capacity, or both simultaneously. All three of these fundamental systems of tuning have been used, discussed, and fully

\* Decimal classification: R382. Original manuscript received by the Institute, May 9, 1931; revised manuscript received by the Institute, August 24, 1931; revised manuscript received by the Institute, December 5, 1932. Presented before New York meeting, February 1, 1933.

analyzed during the past decade, but mainly because of mechanical considerations, tuning by varying the capacity has been universally adopted.

Brief analysis of a circuit tunable over a fairly broad band of frequencies indicates that its electrical properties change materially with frequency. The decay coefficient for example,  $R/2L$ , changes if the capacity is varied for tuning, because the resistance increases with frequency. The ratio  $R/2L$ , however, can be kept constant if tuning by  $L$  or  $LC$  is applied in such manner that for every incremental increase of  $L$ ,  $R$  is correspondingly increased.

The decay coefficient is the direct measure of the selectivity of an isolated tuned circuit. Within close practical limits, it can be proved that the selectivity of a circuit, when measured from the resonance curve in *band width* between the maximum and that point on the slope where the amplitude is reduced to  $1/n$ th of the maximum, is numerically equal to<sup>1</sup>

$$\omega_0 - \omega_1 = n \frac{R}{2L}.$$

Expressed in terms of the conventional frequency scale, this measure of selectivity, hereafter called SELECTANCE is

$$S_n = f_0 - f_1 = \frac{n}{2\pi} \cdot \frac{R}{2L} = 0.08n \frac{R}{L}, \quad (1)$$

where  $f_0 - f_1$  is expressed in cycles per second,  $R$  in ohms, and  $L$  in henrys.

The calculated and observed values of  $S_n$  are in substantial agreement, if  $n$  is taken at a point on the slope of the selectivity curve where the sides are approximately straight lines.

No matter what arguments may be urged as to the validity of this analysis, or the usefulness of the approximations of the above formulas, the fact remains that for constant selectance the ratio  $R/L$  must be kept constant.<sup>2</sup>

A very important application of tuned circuits occurs in connec-

<sup>1</sup> The so-called "mathematical selectivity,"  $(\omega_1 - \omega_2)/\omega_0$ , can be obtained from this equation as follows:  $2(\omega_0 - \omega_1) = \omega_1 - \omega_2 = nR/L$ ; dividing both parts by  $\omega_0$  we get  $(\omega_1 - \omega_2)/\omega_0 = nR\sqrt{C/L}$  (Pearson, *Wireless World*, July 9, (1930)); compared with the logarithmic decrements,  $\delta = \pi R\sqrt{C/L}$ , it indicates the same quantity at  $n = \pi$ . Also  $\delta = \pi R/L\omega = \pi/Q$ ; hence the maze of analogous definitions.

<sup>2</sup> See R. H. Langley, "An examination of selectivity," Proc. I.R.E., vol. 20, pp. 665, 666; April, (1932).

tion with the thermionic amplifier, where the phenomenon known as parallel resonance is used to obtain selective voltage amplification.

In this case, a circuit tuned to resonance may be represented by a nonreactive load  $R_d = L/RC$  connected to a generator (the thermionic tube) having internal resistance of the value  $R_p$ .

When the inductance of such a circuit is varied for tuning, and if  $L/R$  is kept constant, then not only  $R_d$  but also the amplification,

$$A_s = \mu \frac{R_d}{R_p + R_d} \quad (2)$$

remains constant throughout the tuning range. Here  $\mu$  and  $R_p$  are the amplification factor and plate resistance of the tube, respectively.

It is interesting to note that the previous discussion of selectivity remains substantially the same when applied to a parallel resonant circuit. The internal resistance of the generator  $R_p$ , being parallel to  $R_d$ , increases the damping of the resonant circuit. If we denote the selectance of an isolated circuit by  $S_n$ , and the selectance of the same circuit in the plate of a thermionic amplifier by  $S_n'$ , simple algebra yields the expression,

$$S_n' = S_n \frac{R_d + R_p}{R_p} \quad (3)$$

From (1), knowing values of  $L$  and  $R$ , the selectance of the circuit by itself can easily be found. When such a circuit is connected between the plate and cathode of the tube, the selectance increases (that is, the selectivity becomes worse) in accordance with (3). The fact that  $R_p$  is substantially constant over a narrow band of frequencies will not destroy the constancy of the selectance,  $S_n'$ . For good selectivity, corresponding to small values of  $S_n'$ , the plate resistance,  $R_p$ , should be considerably greater than  $R_d$ . When  $R_p = R_d$ , which corresponds to maximum amplification, the selectance is *twice* its minimum value.

Thus in parallel resonant circuits, selectivity and amplification adversely affect each other, because the tuned circuit is a direct load on the plate of the thermionic tube. The solution lies in the design of the tube itself. Modern radio-frequency pentodes ('57 and '58 type), have a very high  $\mu$ , and produce considerable gain even with relatively small  $R_d$  in the tuned circuit. Their  $R_p$  in general is so high that the damping and its effect on selectivity are hardly noticeable.

To complete this brief analysis, we must also consider the circuit regularly used in reception, namely, the antenna. (Fig. 1.)

This is a series resonant circuit by virtue of the manner in which the electromotive force is applied. The output voltage is usually fed to the grid of a tube, and does not represent a load.

When such a circuit is tuned, the current is  $I = E/R$  and the voltage generated on the inductance, 90 degrees out of phase, is

$$V = E \frac{L}{R} \omega = E \frac{L}{R} 2\pi f. \quad (4)$$

If the inductance tuning, with constant  $L/R$ , is applied to such a circuit, we find that the voltage generated by the signals is directly proportional to frequency, that is  $V = Kf$ , but because both the propagation of the electromagnetic waves and the effective height of both the transmitting and receiving antennas vary with the frequency, the ultimate voltage  $V$  obtainable from two equally distant stations of equal power but of different frequency will vary considerably, and is quite beyond the control of the receiver designer.

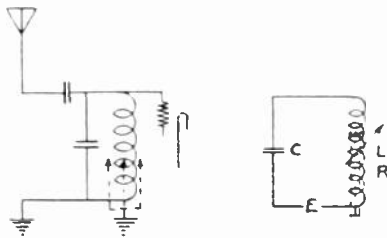

Fig. 1

It is evident from our discussion so far, that if inductive tuning be applied to resonant circuits in such a way that the ratio of  $L/R$  or  $R/L$  is maintained constant, the following advantages will be secured:

1. Uniform selectance throughout the tuning range of the circuit, whether isolated or associated with the amplifying tube.
2. Uniform gain in tuned radio-frequency amplifiers.
3. Favorable gain relation in a tuned antenna circuit throughout its tuning range.
4. Practical possibility of tuning the antenna circuit to obtain greater input gain and thus to increase signal-to-noise ratio.
5. Simplification of the circuits themselves since transformers are not required.

These highly desirable results may be conveniently accomplished by a new type of variable ferro-inductance. The coil itself is designed to have the desired performance at the highest frequency in the frequency band to be covered. The apparent inductance is increased to tune to lower frequencies by introducing a magnetic core into the

field of the coil. As the core is inserted into the coil, more lines of the magnetic field are intercepted by the core, and in effect, the average apparent permeability of the medium surrounding the coil increases from 1 (for air) to a certain maximum when the coil is entirely encased in the core. For this reason, and for other reasons described later in this paper, it is appropriate to describe this method as "Permeability Tuning."

#### IRON-CORE MATERIAL

Everyone can easily conceive the method of tuning by ferromagnetic cores. The idea has been frequently applied in the electrical art, to obtain resonant effects, by moving a core of laminated iron in and out of a solenoid. Several early attempts are recorded in patents in this country and abroad, in which the movement of laminated cores supposedly changes the period of the circuit.

When iron is applied at radio frequencies, the question arises whether there remains any period to change. The law of periodic circuits is such that the introduction of tremendous losses due to iron renders the circuits aperiodic. The circuit still may be "tunable" in a mechanical sense, because it has a handle to tune, and may give a weakly pronounced increase in response, due to a complicated combination of an increase of residual capacity and resistance, and *decrease* (not increase) of inductance, so as to provide an optimum load.

There is a distinct difference between periodic and aperiodic circuits, as shown in the fundamental equation. Only periodic circuits can be used for selective tuning. Thinly laminated (one-mil) iron was successfully used in the Alexanderson generator, but here outside power is abundantly supplied to overcome the losses in the generator. Telephone engineers long ago realized the importance of eliminating losses due to continuous conductive layers in laminations. As far back as 1890, Curie constructed what were probably the first iron-dust compressed cores (U. S. Patent 421,067). Since then continuous research in this direction has succeeded in producing scores of ferromagnetic cores made of finely divided particles using various highly permeable alloys to compensate for the tremendous loss in permeability resulting from the multiple air gaps between the particles. Good iron has a permeability of the order of 400, but the best alloys, whose solid permeability runs into thousands, will hardly reach 20 to 30 when finely divided.

Because of the relatively small permeability required for tuning through a practical range of radio frequencies, the permeability obtainable in finely divided pure iron is found to be adequate. But the

permissible losses, to maintain the selectance of the system at the desired values, are the chief difficulty.

We know that hysteresis losses are vanishingly small at radio frequencies. We also know that eddy-current losses, expressed in terms of resistance introduced, are roughly proportional to the square of the frequency, and to the length of the *circular* path around each minute particle. The "magnetic softness" of the material is of secondary importance, the grain size governing the losses. Other considerations in the choice of powdered material are its uniform purity, which materially affects permeability, and also its packing ability, or so-called "bulking factor." Of the different powdered materials obtainable in suitable grain size, preference should be given to iron reduced by hydrogen or obtained from carbonyl of iron. Both processes will produce reasonable uniformity of purity and grain size.

During the early stages of our investigation the only powdered iron available came from abroad, but during more recent years several American chemical concerns have closely cooperated with our research and have developed superior products which are now available in commercial quantities. Chiefly because of economical considerations, iron reduced by hydrogen has been chosen as the primary material for radio cores.

To meet the requirement which we have established for constant selectance, that is, to tune with constant  $L/R$ , the grain size must be properly chosen. Strictly speaking, different frequencies call for different grain size. It is possible, however, by special provisions in the core material, to construct cores capable of covering a wide band of frequencies without changing the value of  $L/R$ .

The present research was directed at the broadcast band (550–1500 kilocycles), and in this band the optimum grain size proves to be of the order of 5 microns. Powder of this grain size, and of the best commercial purity, when placed loosely inside and outside a solenoidal coil will exhibit an apparent permeability of only 5. The broadcast band, however, requires a variation of inductance of  $1500/550 = 2.727^2 = 7.45$  times, and because of the air gaps introduced an apparent permeability of about 10 seemed reasonable as the end to be sought.

Permeability of this order can be obtained by compression. This introduces the problem, however, of thorough insulation of each minute individual particle. The solution of this problem was the development of an entirely new insulating varnish, capable of extremely fine filming, and able to withstand pressures running as high as twenty-five tons per square inch. After the particles of iron are insulated with this varnish in loosely powdered form, an amount of phenol resin

powder just adequate for binding purposes is added and mixed, and this mixture is then pressed in heated molds of the desired shape.

The resultant material has the appearance of solid iron, exhibits fair mechanical strength and can be worked by usual mechanical methods. It has an iron content of 95 per cent, the remaining 5 per cent being "bakelite" and insulating varnish. Its specific density is 4.8 as against 7.0 for solid iron. Permeability, measured with toroidal coils, is of the order of 12; this figure does not account for leakage field, which is quite appreciable. The specific conductance is approximately 100 mhos per  $\text{cm}^3$ , as against  $10^{-5}$  for solid iron.

Perhaps the most unusual property of the material is its magnetic stability. Careful measurements indicate that its permeability remains constant throughout a range of frequencies from 50 to 2,000,000 cycles. This is probably due to the complete absence of any shielding effect.

Another striking property of the material is that variation of magnetic force from 0.01 to 10 gauss results in no appreciable change. This phenomenon may be explained by noting that the magnetic circuit has an extremely high reluctance, and that the iron is so finely divided that the point of saturation can never be reached.

In material intended for radio-frequency work we are chiefly interested in core losses, expressed in the reflected resistance of the circuit, not in ergs per cycle. It is appropriate, therefore, to introduce a new term to express the ratio of increase in inductance to increase in resistance at any specified frequency.

Calling  $\Delta l/\Delta r$  the factor of merit of the core, it is to be noted that this quantity remains substantially the same for different solenoids, toroids, etc., providing their original geometrical dimensions are similar or proportional. It is, therefore, convenient to state that for a given coil (without core) having a certain value of  $L/R$  at the high-frequency end of the range, the core material should have a factor of merit of the same value at the low-frequency end of the range, or  $\Delta l/\Delta r = L/R$ . This simplifies the nomenclature of various core materials for various initial values of  $L/R$  and for various ranges. Thus if  $L/R$  of the coil is very high (in a low-loss coil) the material must be correspondingly better in its  $\Delta l/\Delta r$ , and vice versa. It accomplishes nothing to produce a high-grade core material if it is to be used with a poor coil. As a general rule, the higher the permeability required, the more compression and the less insulation are used, and therefore  $\Delta l/\Delta r$  becomes lower.

Material intended for use in the broadcast frequency band has a factor of merit of the order of  $15 \times 10^{-6}$  ( $l$  and  $r$  stated in henrys and ohms). The core is designed to enclose almost completely the coil at 550 kilocycles.

At the lower frequencies the eddy-current losses rapidly diminish and are negligible at 50 kilocycles. Below this frequency hysteresis becomes more and more noticeable. At telephone frequencies (50–10,000 cycles) the hysteresis loss is considerably higher than in “soft” (heat-treated) alloys. However, the total losses are entirely permissible for successful operation in telephone circuits, loading coils, etc., where air-cored coils become bulky and impractical.

The following chart (Fig. 2) shows how the factor of merit of such a core changes with frequency.

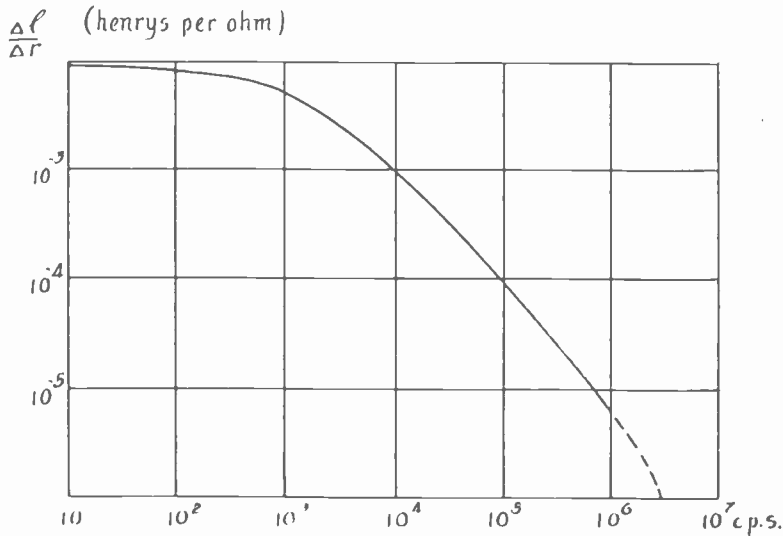

Fig. 2

$L/R$  or  $\Delta l/\Delta r$  is expressed in henrys/ohms, for convenience. This chart is a compilation of several series of measurements, taken with different methods. The slope of the curve, being plotted to a logarithmic scale, indicates an exponential relation of  $R$  to frequency.

So far we have been discussing movable cores to tune over a specified range of frequencies. We have started at the highest frequency with an air-core coil whose  $L/R$  had a certain desirable value, and we have gone to the lowest frequency, with  $L$  increased by an iron core whose  $\Delta l/\Delta r$  is of the same value, and thus gave a new  $L'/R'$  of the same magnitude. This, however, does not insure that at intermediate frequencies in the range  $L'/R'$  will be the same as its initial and final values. In fact, in a uniformly homogeneous core, at a point somewhere near the middle of the range  $L/R$  will drop to one half of its initial value. To compensate for this drop a new principle has been developed and employed in the construction of the core, which we call “variable magnetic density.” The requirement is that that portion of



the core which first enters the coil (at the high-frequency end of the tuning range) shall be of much lower permeability and resistance than the portion which enters the core last (at the low-frequency end). This result can easily be obtained by a suitable design of mold, by the assembly of additional pellets, or by various treatments after the cores are made. The first method has been found to be the simplest and has been adopted. The danger of nonuniformity in production runs is not serious. In the finished solenoidal shell-type core the ratio of permeability at the two ends may be as high as 1.6.

It is interesting to examine the behavior of a variable density core in the frequency range for which it was designed, also in neighboring ranges. (Fig. 3.)

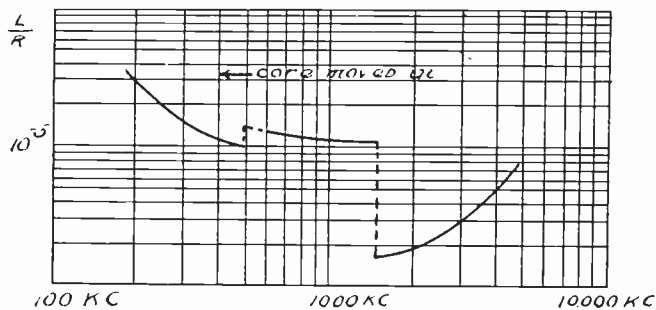

Fig. 3

Throughout the desired range  $L/R$  remains substantially constant, as indicated by the horizontal part of the curve. In the lower frequency ranges  $L/R$  gradually and then rapidly increases when the iron core is moved into the coil. Cores for these lower ranges are therefore preferably of coarser grain and higher compression (or less insulation) of the particles. In the higher frequency ranges  $L/R$  rapidly diminishes as the core is moved in. This indicates the use of smaller particles, better insulation, and loose compression. Particles of one micron size can easily be produced, and the flat portion of the range extended to about one megacycle.

The research in these regions is still in its infancy because of the lack of time and equipment. The above measurements were made with the same variable magnetic density core but with coils having different values of inductance (but of the same geometrical dimensions) and with different values of  $C$ .

Having now fully described the properties of this new radio-frequency core material we can proceed to the constructional details of the variable inductors and their application.

### THE VARIABLE FERRO-INDUCTOR AND ITS APPLICATION IN RADIO-FREQUENCY CIRCUITS

The design of the new variable inductor depends on the original value of  $L/R$  or  $Q$  of the coil itself at its "initial" frequency, for example 1500 kilocycles in the broadcast band.

Theory indicates that for the best value of  $Q$  the length of a solenoid should be one half of its diameter, but for maximum permeability variation the best relation is length twice the diameter. A ratio of 1.5 times, however, is generally adequate to obtain the desired range. Larger diameter coils, of course, produced better  $L/R$ . In the first designs, coils of one-inch diameter were wound with  $10 \times 38$  Litz, the value of  $L/R$  being  $15 \times 10^{-6}$ . These coils required a shell-type movable core weighing about 8 ounces. Further development produced a three-quarter-inch diameter coil wound with  $10 \times 41$  Litz, whose  $L/R$  is  $14 \times 10^{-6}$ . The core for this coil weighs only 4 ounces.

In the final design, the coil is slightly tapered and has a mean diameter of three-quarters of an inch, the total taper being one-sixteenth of an inch, as shown in Fig. 4.

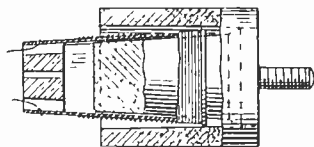

Fig. 4

It is also wound with  $10 \times 41$  Litz and its  $L/R$  is  $14.5 \times 10^{-6}$  ( $Q = \omega L/R = 140$ ). The core for this coil is made in two parts, an outer shell and a central plug, both tapered, the taper of the plug corresponding to the taper of the coil. This taper helps in securing the necessary variable magnetic density and also substantially approaches "straight-line-frequency" variation with linear movement. The total movement or "stroke" is one and three-eighth inches, and is usually arranged to actuate directly a dial indicator. The inductance of the coil is 65 microhenrys. This value was carefully chosen to satisfy average conditions of receiver design, both for radio stages and for the oscillator coil in superheterodynes. To resonate this coil at 1500 kilocycles, a fixed capacity of 160 micromicrofarads is required, and is easily obtainable in good mica condensers having an adjustable leaf. Note that this value of capacity is approximately three times as large as is normally used in condenser tuned systems at that frequency.

When several circuits are tracked together it is not necessary to have exactly the same values of inductance in each circuit. If two coils

of entirely different inductance are made geometrically alike, they will still track perfectly. This is because exactly the same permeability change is produced in both circuits, and they will therefore always be resonant to the same frequency, if initially synchronized. This is another reason for calling the system "permeability tuning." The iron core can easily be made to maintain  $L/R$  constant throughout the range.

The diagram (Fig. 5) indicates the performance of the variable ferro-inductor in the plate circuit of a '24 or '51 type tetrode and '58 type pentode, plotted in terms of gain, and the dotted curve shows the selectance in kilocycles at half amplitude,  $S_2$ . The band width at half amplitude is twice this value.

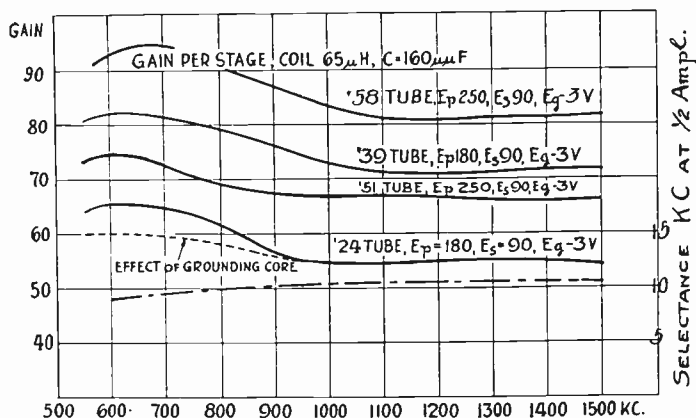

Fig. 5

Because the antenna gain varies roughly as 3:1, and for other reasons encountered in coupled circuits, it was found advantageous to increase  $L/R$  somewhat towards the lower frequency end (with the core well into the coil). This is accomplished by making the core factor of merit  $\Delta l/\Delta r$  slightly greater than the  $L/R$  of the coil.

In this latest design, the gain is higher at 550 kilocycles and the corresponding selectance is better. Thus the iron core can be made actually to improve the selectivity of the circuit as it is moved into the coil. This is strikingly illustrative of the extent to which the losses in the iron core material have been reduced.

The next chart (Fig. 6) shows the performance of this overcompensated type of core in the antenna circuit. Note that the antenna gain variation is reduced to 2:1 because of the higher value of  $\Delta l/\Delta r$ . It is reasonable to assume that the antenna stage will be followed by several stages of tuned radio frequency, each of which will further compensate in gain.

It is often desirable to include two tuned circuits between two thermionic tubes. The simplest and most economical way of coupling them is through a small capacity between high potential ends of the two tuned circuits. It is preferable, in order to get the best selectivity, to employ very loose coupling, and this reduces the gain per stage to about one third the maximum obtainable. The combination of a tuned antenna stage with either single or double interstage circuits is the basic arrangement of tuned-radio-frequency amplifiers as well as for the selector in a superheterodyne.

It remains to show how the variable ferro-inductor may be applied to the oscillator of a superheterodyne. This is accomplished by the use of the Colpitts oscillator. Three different methods may be used to secure tracking.

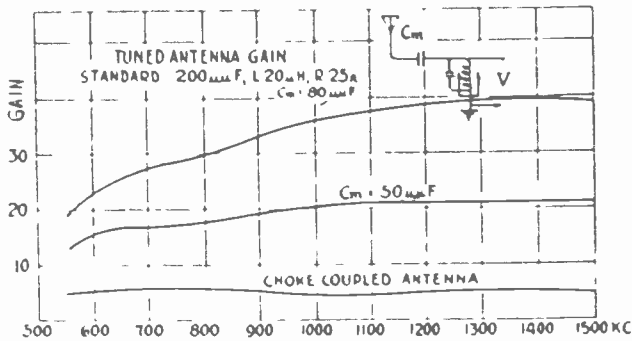

Fig. 6

In the first method, the coils and cores are exactly matched in the oscillator and the preselector. For an intermediate frequency of 175 kilocycles, five turns are removed from the small end of the coil, and a "padding" inductance is inserted in the circuit. The value of this padding inductance is  $L' = 0.408L$ , where  $L$  is the inductance of the coil after the turns have been removed. The capacity is readjusted. Such an oscillator, after adjustment, will track within 0.1 per cent in frequency with the other circuits.

In the second method, the coils and the outer shells of the cores are all identical, and there is no padding inductance. The inner plugs, however, are molded in a slightly different shape to produce the tracking.

In the third method, the coils and cores are matched throughout, but no outer shell is used in the oscillator. This open-type variometer produces a variation of the order of 4 times, and is correct for an intermediate frequency of 450-500 kilocycles.

The following diagram (Fig. 7) shows the output of one of these oscillators in milliamperes.

By adding resistance in the circuit the output current may be maintained substantially constant. This resistance may be made part of the bias resistance of the first demodulator, in which case the whole circuit is extremely stable and simple. Some engineers prefer to use inductive coupling from  $L_1$  applied to the grid circuit of the first detector.

In the majority of cases, when the ferro-inductor is used, the circuits must still be adequately shielded one from another. This can be accomplished by the use of round or square shield cans around the coil, with an opening for the core to pass through. A properly designed shield will slightly reduce the inductance of the coil, producing a corresponding decrease in the gain, without affecting the selectance of the circuit. For the coil described, the shield is preferably one and seven-eighth inches in diameter or one and three-quarter inches square.

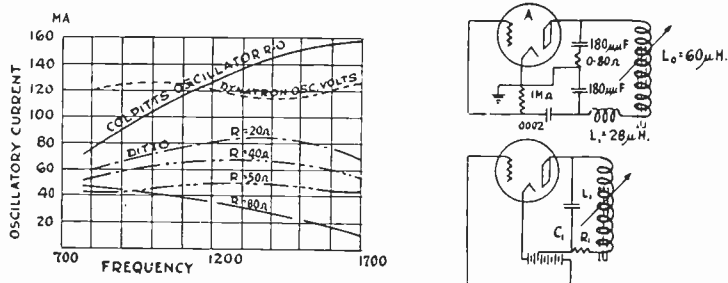

Fig. 7

Very fortunately, the shield around the coil *increases* the working frequency range of the instrument 10 to 15 per cent. The short-circuit action of the shield is materially reduced by the "shielding" effect of the core as it goes into the coil. Thus the core virtually "shields out" the shield. This is a very desirable phenomenon when a larger variation of  $L$  is required. In one case, in the design of an oscillator, the shield was reduced in diameter to just clear a core with the result that the total inductance variation was increased from 7.5 to 11.

#### APPLICATION TO BROADCAST RECEIVERS

The problem of operating several tuned circuits from a single control is materially simplified when variable ferro-inductors are used. Each tuned circuit consists of the variable inductor and a small mica condenser which, because of its small size, may be mounted inside the can that shields the inductor. Thus the complete tuned circuit is inside the shielding can. The connections between the inductor coil and the fixed condenser are also inside the can, and are very short. The number of leads emerging from the shields is reduced to a minimum.

The complete set of tuned circuits to be used in any receiver is grouped into a convenient and compact mechanical assembly, with provision for simultaneous linear movement of the cores. This we call the tuning unit. Because of the complete isolation of the tuned circuits the shielding is very effective, and the circuits may therefore be placed very close together.

Only two precautions are necessary in order to secure efficient tracking of the several circuits. The inductance variations with linear movement of the cores must be the same in all circuits, and the movement itself must be the same for all the cores. The first conditions require matching of the cores and coils, the second necessitates proper mechanical design of the mechanism for producing the movement. Variations in the accuracy of the tracking cause larger errors at the higher frequencies. In a system having inherently constant selectance, it is possible, and preferable, to set the limits of misalignment in kilocycles. Practical measurements have indicated that in systems of this kind the tolerance in frequency must be held below two kilocycles for each circuit and throughout the frequency range.

With the cores all the way out, the circuits are synchronized by adjustment of the small condensers at the initial frequency of 1500 kilocycles. As the cores are advanced into the coils, the inductance variation as between any two circuits is held below one-quarter per cent at 1000 kilocycles and one-half per cent at 500 kilocycles.

It has been found in laboratory "production runs" that with cores pressed from the same batch of powdered iron the limit of one-half per cent at 550 kilocycles is easily maintained. At the half position, corresponding to 1000 kilocycles, the variation is slightly greater than would be desirable, due to slight variations in the distribution of the iron particles in the core body. This slight variation may be corrected by the addition or subtraction of iron at the open end of the core, but it will probably be found more practicable in production to measure the cores at the half position, and to grade them into from three to five groups, so as not to exceed the prescribed limits. Equipment for grading the cores is very simple and the cost of grading will be very low.

Important mechanical considerations arise in the design of the tuning unit. Ganging of the cores must be such as to produce a high degree of uniformity of motion of the several cores. This is readily secured, however, by mounting the cores on a rigid bridle and arranging the mechanism to produce strictly linear movement of the bridle. A channel in the broadcast band corresponds to one hundredth of an inch of motion of the core, and it is therefore essential that cores move in

unison at least to within one-thousandth of an inch. In the designs shown in the illustrations this uniformity is easily obtained.

The separate shielding of the circuits, as we have already noted, is automatically secured, and a convenient arrangement of the separate shielded circuits, so as to obtain the shortest possible leads, is also a matter of no difficulty. A provision must be made to move each coil, or each core individually, in order to produce synchronization at a middle frequency, usually 1000 kilocycles. It is preferable to move the coils, so that the cores may be left rigidly mounted on the bridge. The required adjustment of the coils is less than one eighth of an inch, which not only insures the alignment but permits accurate setting of the dial, calibrated in kilocycles. Several mechanical designs for coils mounted so that they may be thus adjusted are available.

To summarize, there are only two synchronizing adjustments; first, with the cores withdrawn at 1500 kilocycles by adjusting the conden-

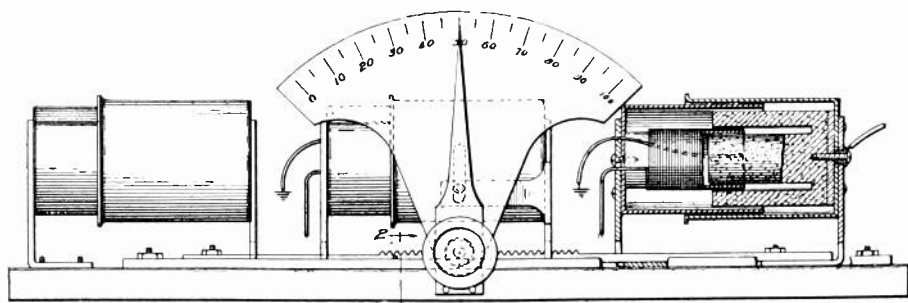

Fig. 8

sers, and second, with the cores halfway in at 1000 kilocycles by adjusting the positions of the coils. These adjustments are made in the completed receiver, so as to take care of variations in the wiring and accidental capacities.

The early experimental units shown were made along two different lines. In one, (Fig. 8), the three cores were mounted on a rigid rod.

This type is not suitable for multistage receivers because of the long leads and the lack of compactness. The preferable arrangement has the tuned circuits placed side by side with the cores mounted on a flat bridge plate. This form is shown in Fig. 9, which was the first of this type and was the basis for the perfected designs shown in later figures.

In a later type, 3-, 4-, 5-, and 6-circuit units are assembled on punched or die-cast plates with two guide posts rigidly secured to the plates. The plate includes provision for mounting the mica condensers and the square shield cans. The mica condensers are similar to those

used in superheterodyne receivers and include a spring plate for adjustment.

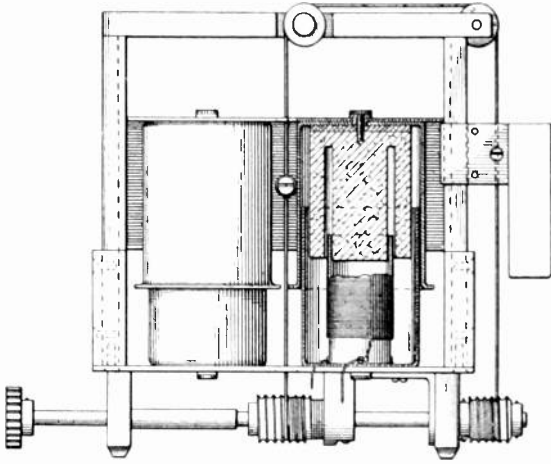

Fig. 9

In the 5-circuit unit shown in Fig. 10 as assembled in a radio chassis, the cores have been removed, and double condensers suggest simple construction of two-range receivers. The 4- and 6-circuit units are usually mounted above the chassis pan as shown in Figs. 11 and 12, their height being the same as that of the tubes, so that the grid leads are extremely short. The 3-circuit unit separately shown in Fig. 11 is intended for sub-base mounting.

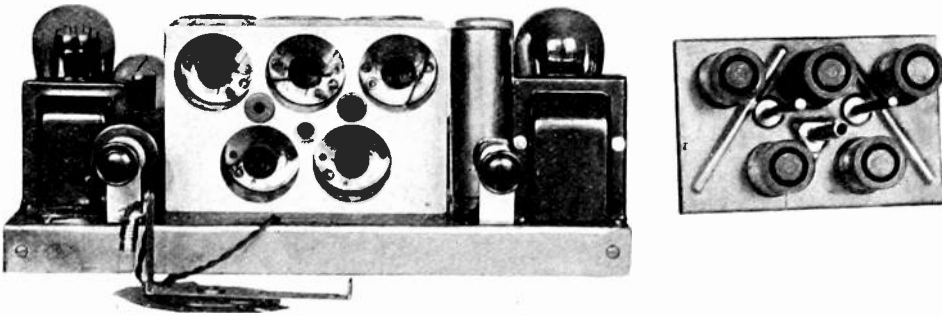

Fig. 10

Three different types of driving mechanisms have been used, as shown in the figures. They are based on the screw, the rack and pinion, and the cable drive, respectively. The screw movement is probably the most expensive, but may easily be arranged to provide any desired ratio of movement. The cable drive has the advantage that the control knob may be located at almost any point and with its axis in any desired direction, but the threading of the cable and the provision for



keeping it tight are disadvantages. Perhaps the best method is a blade wedged into a frictional pinion to eliminate backlash.

From the performance characteristics of single and double variable inductors already given, it is a simple matter to determine the number

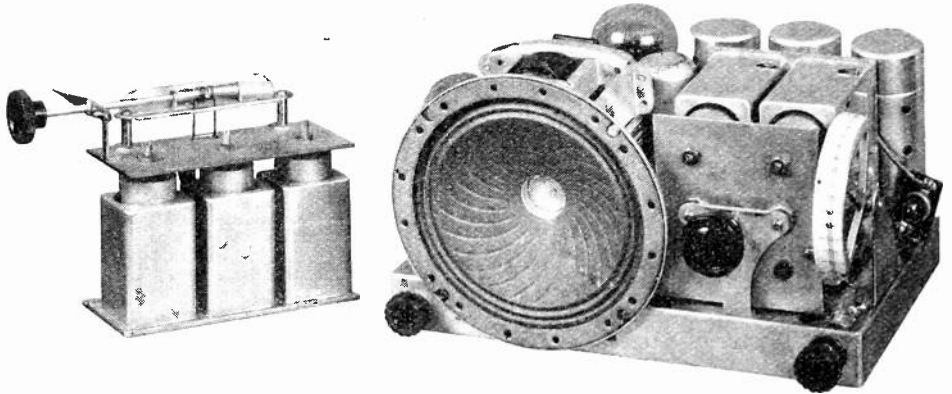

Fig. 11

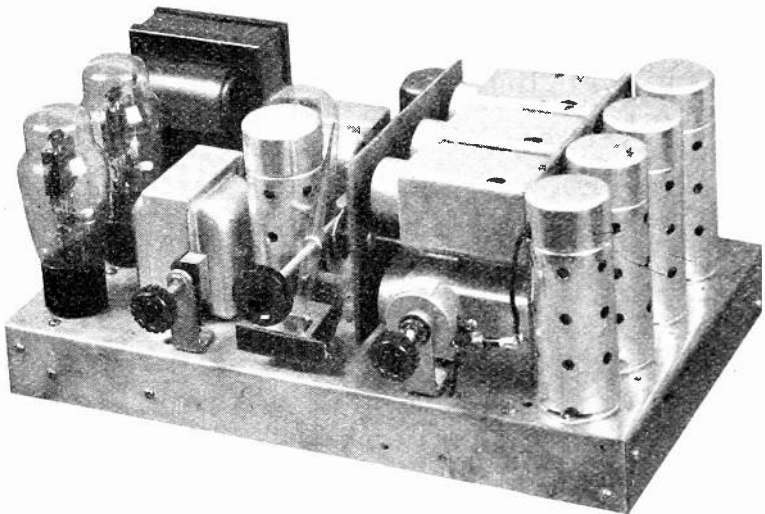

Fig. 12

of circuits necessary for any desired receiver performance. Superheterodyne designs usually employ three or four tuned circuits, one of which is the oscillator, which we have already discussed. The pre-selector may be arranged in accordance with one of the diagrams shown in Fig. 13.

Unlike condenser tuned systems, the image frequency response is quite uniform throughout the range. The measured ratio is from 2000 to 6000 times with two tuned circuits, and from 90,000 to 300,000 with three tuned circuits, the actual ratio depending on the values of coupling. The antenna coupling condenser will be between 10 and 50 micromicrofarads, depending upon the amount of gain and the desired signal-to-noise ratio.

Because of the uniform amplification and selectance of permeability tuned circuits, their real commercial possibility is probably in tuned radio-frequency systems rather than in superheterodynes. Receivers of this type have closely the same selectance as superheterodynes but have naturally better fidelity, and avoid the complications of an oscillator and two demodulators.

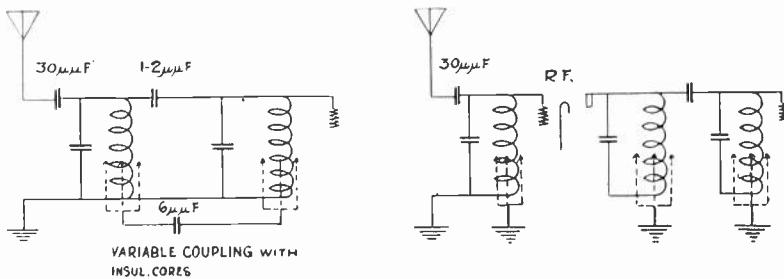

Fig. 13

Figs. 11 and 12 show two tuned radio-frequency receivers, one having four circuits with two radio-frequency tubes and the other six tuned circuits with three radio-frequency tubes. The receivers have automatic volume control; the second one also has interchannel suppression, and push-pull output. The 6-circuit design is particularly interesting because it shows the great saving of space offered by the new system of tuning as against a similar receiver employing a 6-gang variable condenser.

The actual circuits in tuned radio-frequency receivers are very simple.

With the new radio-frequency pentodes of the '58 type and a '55 detector feeding a power pentode, this receiver of Fig. 11 will give an average sensitivity of 50 microvolts with selectance as shown in Fig. 14.

The gain of the radio-frequency system, including the antenna, is of the order of 20,000, and is easily controlled. A diode type of detector of '55 type considerably reduced the sensitivity, which becomes of the order of 15 microvolts with diode-pentode, but regeneration can be employed to restore sensitivity and to improve selectance. Experiments indicate that steady regeneration may be maintained throughout the tuning range because of the constant dynamic resistance in the

plate circuits of the tubes. By this method the resistance of the circuits may be reduced to one tenth of its normal value, without danger of oscillation. It is also to be noted that the regeneration varies inversely with the strength of the incoming signal, and it is therefore possible to control the regenerative tube from the automatic volume control.

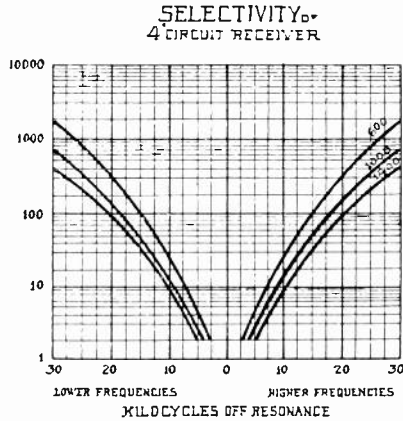

Fig. 14

Fig. 15 is a diagram for a receiver with six tuned circuits. The total radio-frequency gain is of the order of 500,000, which is just sufficient to swing the push-pull pentodes. The sensitivity is about five microvolts. The diode detector produces the necessary automatic volume

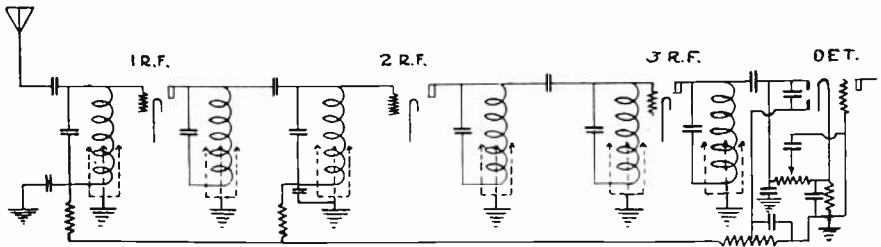

Fig. 15

control for the two '58 radio-frequency tubes. If a separate audio tube is used for suppressing interchannel noise, the output should be fed into push-pull triodes.

The selectance of this receiver is shown in Fig. 16.

The rejection on the second channel (20 kilocycles off) is well above 1000, and this proves to be entirely satisfactory, even under adverse conditions. The ability to reject powerful local signals on the adjacent channel was checked and logged on the outskirts of metropolitan New York one evening in November, 1932. It was noted that WBZ was received on the channel adjacent to WHN, that WJR, Detroit,

was received on the channel adjacent to WJZ, that WLW was received on the channel adjacent to WOR, and that WSM, Atlanta, was received on the channel adjacent to WEAF.

As matters stand at the time of writing, the research and the laboratory development of the variable ferro-inductors, and the complete mechanical units have been brought to a point where the only further changes will be to adapt the designs to the requirement of particular receivers and to the production facilities of particular plants. The production problems, so far as the cores and coils are concerned, have been

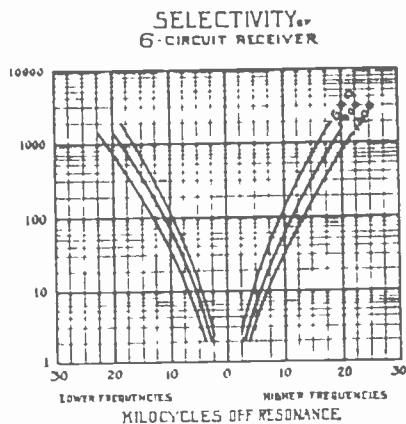

Fig. 16

studied by several well-known engineers and laboratories in this country, as well as by the staff which did the original research.

The new system has been favorably received in engineering circles, because of the inherent advantages. Uniformity of performance coupled with extreme simplicity of design and a much higher signal-to-noise ratio, naturally recommend themselves to those who have spent the last ten years trying to secure similar results with condenser tuned circuits. The revival of the tuned radio-frequency types, which in 1927 amounted to 95 per cent of all the models offered, becomes an attractive possibility. This is emphasized by the current demand for better fidelity and the more complete elimination of extraneous noises. Both of these ends are promoted by the use of permeability tuning.



## THE SPRAY SHIELD TUBE\*

BY

H. W. PARKER

(Engineer, Rogers Radio Tubes, Ltd., Toronto, Ontario, Canada)

AND

F. J. FOX

(Engineer, Rogers-Majestic Corp., Ltd., Toronto, Ontario, Canada)

*Summary*—A metal coating is applied to a vacuum tube covering the tube envelope and the shell of the base by successive operations of sand blasting and spraying metal from an oxyacetylene blow torch which produces a coating which is in intimate contact with the glass envelope.

A negative potential is applied to the metal spray shield when the tube is operated which prevents cathode rays, which are not intercepted by the anode, from reaching the interior surface of the glass envelope. Secondary emission of electrons from the glass wall is avoided. Localized heating of the glass is prevented and the fluctuation component of anode current is suppressed.

It is pointed out that a tube structure cooperating with the spray shield is more economical and the apparatus associated with the tube can be simplified in design.

### INTRODUCTION

THE use of a metallic envelope on the outer wall of the glass envelope of a vacuum tube is not new. The metallic envelope was used in the days of battery-operated receivers for electrostatically shielding the various stages of amplification. Shields of the form of deep drawn copper and of the wire wound type were not practical from the economic standpoint. The closest approach to the spray shield was the electrolytic deposit of copper which closely adhered to the glass wall. None of these shields exactly duplicated modern practice because the shielding was not in *intimate* contact with the glass wall envelope of the tube. The shielding methods of 1925 were replaced in 1928 by shielding cans which are extensively used at the present time. In 1929 a German firm manufactured a tube which was covered with a spray shield on the glass envelope only. This shield was contacted to the filament of the tube. In 1930 the idea of utilizing the spray shield to eliminate the shielding cans was imported and utilized by a few radio manufacturers in the United States and Canada. This tube had the spray shield connected to the cathode and was utilized for shielding tubes without any design changes in the internal structure. The purpose was to eliminate the shielding cans and no idea at that time was seriously concerned with utilizing the spray shield to permit internal structural design changes of the tube.

\* Decimal classification: R331. Original manuscript received by the Institute, November 28, 1932.

It is unfortunate that when the spray shield was first introduced into this country it was regarded as a sales feature only and not necessarily as an engineering advance.

Cost consideration in the fabrication of the vacuum tube opened the question regarding the utility of the outer screen in the old type 224 and an evolution took place in which the outer screen was eliminated in December, 1931. It was realized that the tube manufacturer as well as the set manufacturer could take advantage of the spray shield. Consequently a rapid evolution of the internal structure of the vacuum tube took place. Fig. 1 shows the first practical design utilizing the advantages of the spray shield.

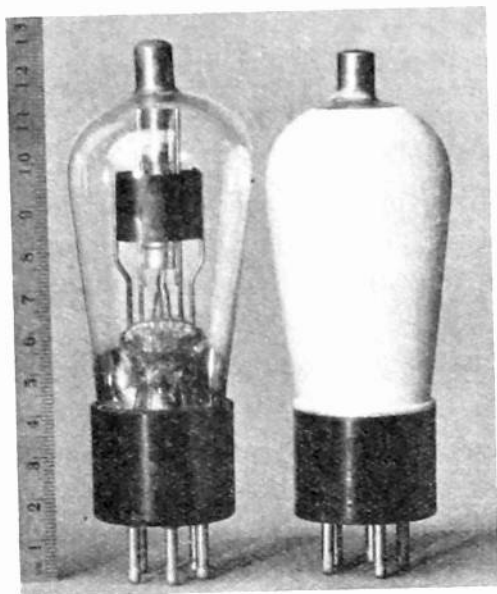

Fig. 1—Simplified tube structure cooperating with spray shield.

#### THEORY

Experiments with the cathode ray have shown that charges on the inner wall of the glass envelope may behave in a peculiar manner. If the impinging ray travels at a velocity greater than that due to a 25-volt acceleration, strong secondary emission of electrons will appear at the point of bombardment building up a positive charge which increases the velocity of the impinging electron beam liberating still more secondary electrons. This process is a vicious cycle and results in localized heating of the glass, which in the case of power tubes, may actually cause piercing of the envelope due to the melting of the glass wall. In receiving tubes where there exists uncontrolled plate current, cathode rays can impinge on the glass wall, and while no immediate

damage is done to the tube, considerable tube noise will exist on account of the random effect of these wall charges. The grid action of these wall charges is not important but the random characteristics of the secondary emission effect causes a fluctuation phenomena to occur in the plate circuit due to the fact that the secondary electrons flow to the plate.

In experiments on fluctuation phenomena this secondary emission of electrons from the inner wall of the glass envelope is often added to the fluctuation phenomena of the gas current to the control grid and the so-called "Schrott" effect of the plate current. It is unfair to consider tube noise as being entirely due to the gas current as sometimes it is mainly due to the wall charge effect.

#### THE SPRAY SHIELD

The purpose of spray shielding a triode or a power tube may be briefly summed up as follows:

1. The spray shield prevents the accumulation of charges on the inner wall of the glass envelope. This accomplishes two results in operation, the suppression of tube noise and the prevention of localized heating of the tube envelope.
2. The tube elements are electrostatically shielded from neighboring circuits.

The radio-frequency multiple-grid amplifier tube utilizes the full spray shield for the above reasons and in addition:

3. The coöperation of the internal tube structure with the full spray shield permits a very low value of direct feed-back capacitance.

Spray shielding can be utilized to minimize any wall charge effect by the conduction of currents through the glass to the *intimate* metallic coating. If this coating has a negative charge with respect to the cathode, it will serve to repel the cathode ray from the glass wall, and the glass wall is prevented from charging.

In the power class of tubes localized overheating of the glass envelope is prevented, and in the triode oscillator the fluctuation component of the carrier output is minimized and a quieter oscillator carrier is obtained.

In the multiple-grid radio-frequency amplifier the spray shield not only serves to diminish fluctuation phenomena in the plate circuit but it reduces the direct feed-back capacitance to such a degree that by coöperation of the internal structure with the outer envelope a very

effective reduction in feed-back capacitance is obtained, and by simplification of tube structure design a consequent lowering of the cost of the production of the tube is obtained as well. The main body of this paper concerns itself with this coöperation of the tube elements. The intimacy of the spray shield with the glass prevents conduction of electrostatic lines along the glass lamina of the tube envelope. This is an important consideration when it is desired to reduce coupling between the input and output elements of a multiple-grid radio-frequency amplifier with a minimum of internal metal shielding. Needless to say, if the spray shield were not grounded to the chassis, the feed-back capacitance would be much greater. It is necessary to provide clips to contact the full spray shield to the chassis.

A negligible impedance exists between the top of the spray shield and the chassis due to the large surface area of the conductor and the high conductivity of the metal coating.

The use of the cathode spray shield, that is, the spray shield connected to the cathode pin, was questioned on account of the fact that in the present-day circuit the cathode is used for very extraordinary purposes. It may be at a constant voltage or at a radio-frequency voltage above the potential of the chassis. The underwriters' code in some countries would regard the cathode spray as a hazard under these voltage conditions. It has even occurred that some early types of tubes utilizing the cathode spray shield had to be operated with a shielding can. The utilization of the full spray shield, which is a spray completely covering the glass envelope and the base, permitting a direct contact to the chassis, avoids all these difficulties and has produced a tube which, from the engineering standpoint, is quite universal, and is without any drawback.

#### METHOD OF MANUFACTURE

The machine (Fig. 2) was developed to permit low cost of production of the spray shield so that the tube could exist in a competitive market. The essential function of the machine is to sand-blast and coat the glass envelope and base, and the revolving table brings the tube into position for the successive operations of blasting and coating with metal from an oxyacetylene blowtorch. The mechanical necessities had to regard the abrasive action of the sand and the metal spray. A simplicity of design in this machine enables it to produce the spray shield rapidly with a minimum of initial cost and upkeep. The machine shown in the figure is capable of 200 to 400 tubes per hour with one operator.

The sand blasting permits the metal coat to form an intimate contact with the glass which is essential from the standpoint of adherence



of the coating to the wall of the glass and the use of the shield for suppressing noises due to wall charges. The coating will not scale off and can be scraped with a knife without causing it to peel. The coating is in a form of a semiporous metal coating. The metal used is a special zinc alloy.

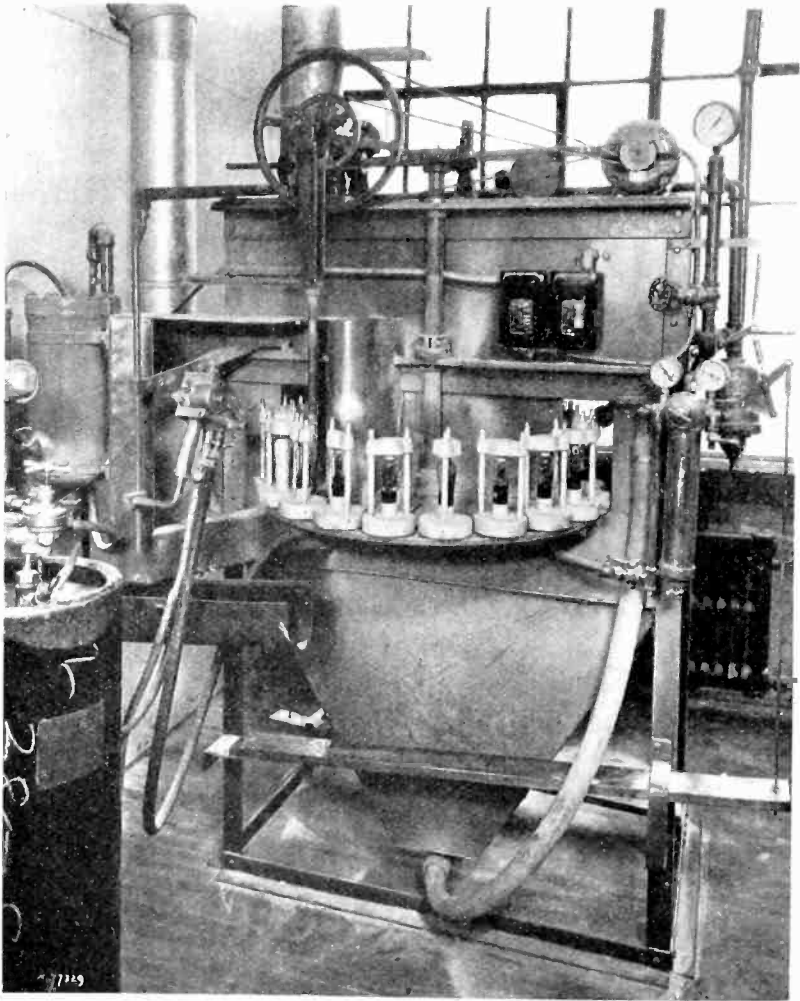

Fig. 2—Automatic machine for producing the spray shield.

#### STRUCTURAL DESIGN OF THE TUBE COÖPERATING WITH THE FULL SPRAY SHIELD

In Fig. 1 is shown a structure of the type 551 designed to coöperate with the spray shield. The structural simplicity is quite evident, and the materials used are considerably lessened. The simplification of the vacuum tube structure enables the manufacturer to lower the cost of production and to provide a higher quality of tube because of the fact

that the tube elements may be heated to a higher temperature by means of radio-frequency induction currents at the time when the tube is being exhausted. In Fig. 3 is shown a structure of the two and one-

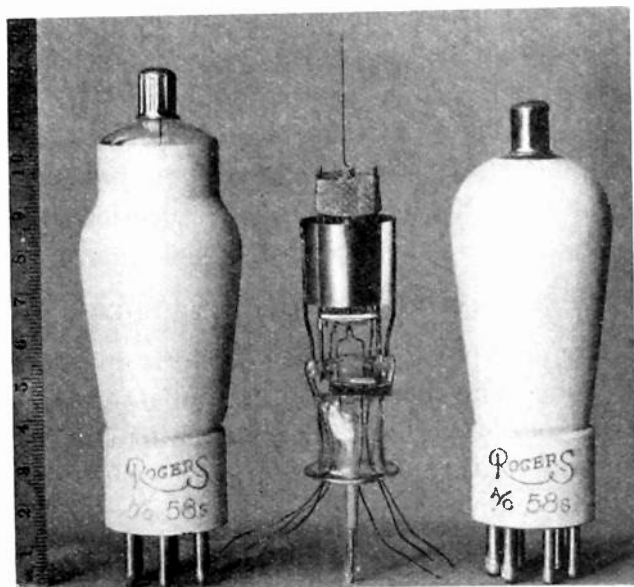

Fig. 3—Multiple-grid amplifier.

half watt cathode, radio-frequency amplifier tube having a triple-grid structure. The material used in the fabrication is of lower cost and the labor is reduced likewise. This triple-grid radio-frequency amplifier can be made in the type S12 or the type ST12 blank.

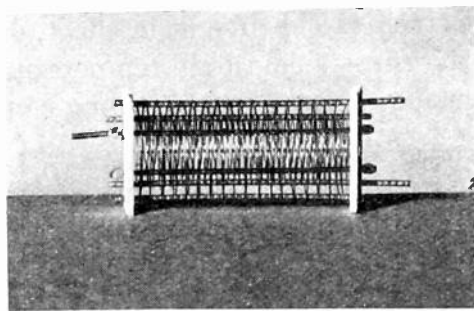

Fig. 4—Unitary subassembly of grid structure.

Tubes having the structure shown cannot be used without the cooperation of the spray shield. The use of shielding cans will not permit the desired low value of feed-back capacitance. We can regard this simplification of design as being possible only where full spray shielding is used.

Due to this simplification of design the tube elements are heated to a very high temperature during the exhaust operation. It is not possible to use mica in the structure on account of this temperature. The insulator used is a high temperature ceramic which permits the use of a very interesting subassembly in which the three grids are assembled and hydrogen-fired as a unit. Fig. 4 shows this structure.

The feed-back capacitance of the radio-frequency multiple-grid amplifier has the low value of  $0.0045 \mu\mu f$  and the input and output capacitances are increased by 20 per cent over that of a similar clear glass blank structure. This increase is not objectionable at broadcast frequencies.

#### TEMPERATURE OF THE SPRAY SHIELD

The thermal emissivity of the spray shield is approximately 30 per cent of a black body. The thermal conduction along the surface of the spray shielding is very low since it is a thin lamina and it does not serve to equalize the temperature distribution of the bulb to any great extent. At operating temperatures the normal component of radiation from the bulb is negligibly small compared with the dissipation of energy by convectional air currents. Spray shielding will allow a safe dissipation of 0.12 watt per square centimeter in free air.

The bulb temperature is increased a negligible amount over that of a clear glass blank up to the allowable dissipation stated. For bulb temperatures up to 100 degrees centigrade it cannot be said that the low thermal transmission of the spray shield is objectionable.

The shielding can, used at present with the clear glass tube, offers an impedance to air convection currents which are utilized to cool the glass envelope. The spray shield tube is, in effect, operated in free air. The result is that the spray shield bulb temperature is less than that of a clear glass envelope enclosed in a shielding can.

#### THE NATURE OF THE LEAKAGE CURRENTS TO THE SPRAY SHIELD

The curve shown in Fig. 5 was taken with the bulb at equilibrium temperature for normal operation of a representative power tube. It will be noticed that at negative values of potential on the spray shield with respect to the cathode as in region A, there is a small current of the order of one-tenth microampere. This current is a positive ion current. These positive ions originate in the space between the anode and the glass envelope due to the excursion of the electron stream past the upper and lower edge of the anode. The collisions with gas encountered in this excursion produces ionization and gives forth a consequent positive ion current which is accumulated by the inner

wall of the glass envelope. The specific resistance of glass is very high but at elevated temperatures soda lime glass will have a drop of only several volts through the thin lamina of the glass wall envelope.

On making the full spray shield positive with respect to the cathode, a change is observed where electrons start to flow through the glass to the spray shield as shown in region *B*. These electrons form a current of several microamperes up to potentials of the order of twenty volts. Then with increasing electron velocity a sudden change occurs as is shown by region *C* in the figure. This abrupt discontinuity is due to the threshold of velocity required to permit the inner wall of the glass envelope to emit secondary electrons. On going to higher and higher values of positive voltage with respect to the cathode there occurs a series of discontinuities showing that different levels of secondary electrons are emitted. The discontinuities of which five have been detected then settle out into a more continuous curve showing that a saturation has set in. Of the discontinuities the first is the most violent occurring at twenty-five volts. The question whether the secondary emission is emitted from an adsorbed gas layer on the glass or from the interior glass itself is a problem which requires further consideration.

On going to higher values of positive voltage on the spray shield the current increases to the region of maximum current marked *D* in the figure. The spray shield voltage is then approximately one half of the anode voltage, and space charge of secondary electrons sets in near the inner wall of the glass envelope. As we approach the anode voltage, 250 volts in this case, the secondary electron current is diminished on account of the space-charge effect so that in the region *E*, where the spray shield is at the anode potential the leakage current is zero. On going above 250 volts, primary electrons are drawn to the spray shield through the glass wall as is shown by the region *F* in Fig. 5.

The cathode in self-biased power tubes is generally at a positive potential with respect to the chassis. Thus we are able in all practical cases to have a negative potential applied to the spray shield. The use of a negative bias on the spray shield prevents entirely the secondary emission effect. The secondary emission is harmful in the operation of the set in creating a fluctuation noise in the receiver and also, more importantly, it shortens the tube life by the rapid evolution of gas from the glass wall when localized heating is obtained in the clear glass envelope. With spray shielding there can exist no localized heating due to bombardment of the cathode ray. In this way the spray shield may be regarded as providing a tube having a better life factor.

Objection may be made to the small current through the glass

which is of the order of one-tenth microampere in a new tube. After 100 hours life this current is reduced to a negligible amount so that glass electrolysis becomes a negligible factor when the tube is run under normal conditions. After 100 hours with one-tenth microampere positive ion leakage current, three micrograms of oxygen are transferred which would cause an increase of pressure of a little more than approximately five microns. However, the tube is capable of absorbing this amount of oxygen by physical adsorption and chemical combination so

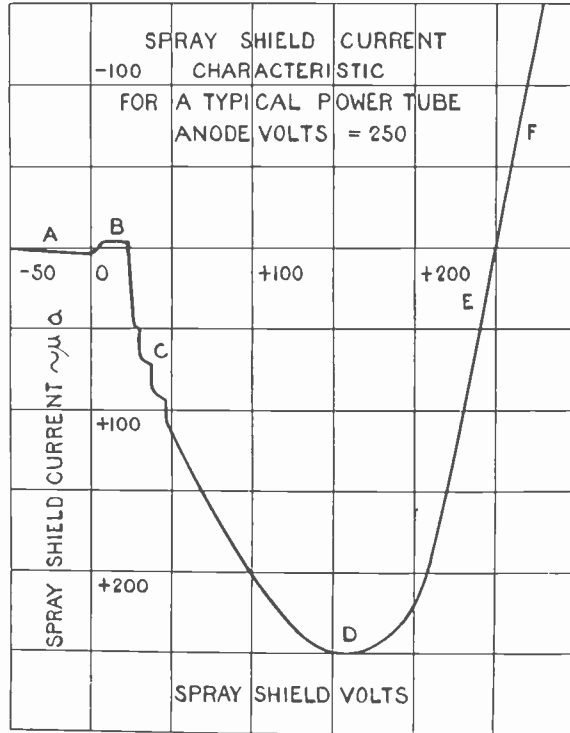

Fig. 5—Typical spray shield current characteristic.

that the gas pressure in a well-made tube remains unchanged by this small amount of glass electrolysis.

Spray shielding cannot be used on tubes of the gaseous conduction type. Rectifiers of the vapor or gaseous type would provide excessive positive ion current to the glass walls of the envelope and electrolysis would take place. In the hot cathode mercury vapor rectifier the cathode is several hundred volts above the potential of the chassis, and the potential of the ionized mercury vapor close to the inner wall of the glass envelope is practically the same as that of the cathode itself. We thus have glass acting as an electrolyte in which the solute is sodium oxide. Sodium oxide dissociates into sodium and oxygen. The oxygen will migrate to the inner wall and the sodium to the outer wall. The

sodium will become oxidized and return into the solvent and repeat the cycle. Thus it appears that oxygen is carried through the glass wall to the tube by this cyclic process. The presence of large amounts of oxygen in the tube serves to decrease the life of the active cathode. This electrolysis goes on so fast in the mercury vapor tube that it is not advisable to spray shield this type of tube. For this reason we do not spray shield the mercury rectifier but use a shielding can in the orthodox manner.

#### APPLICATION OF THE SPRAY SHIELD TUBE

In Fig. 6 is a photograph of an eleven-tube class B superheterodyne chassis utilizing the spray shield tube. It will be noted that the utiliza-

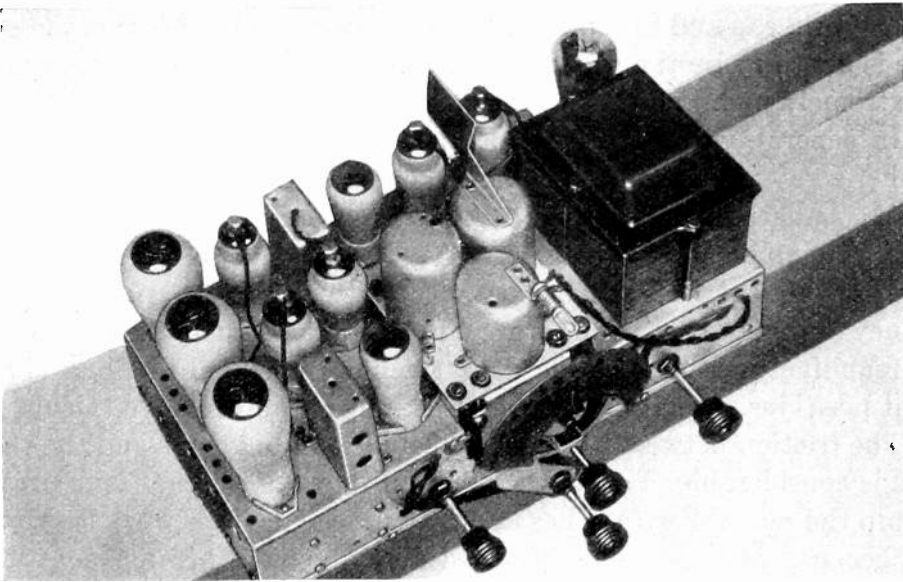

Fig. 6—Superheterodyne chassis.

tion of the space in the chassis is a maximum, and that the tubes are accessible and can readily be inserted in their sockets without the usual difficulties. The clips which contact the full spray shield are held by the rivets which hold the socket to the chassis. The cost of these clips is obviously negligible compared to the cost of a shield can. In the modern superheterodyne a baffle is provided only on occasion. In the chassis shown in the figure only one baffle is necessary which would be required anyway on account of the proximity of the input leads in the radio-frequency section of the circuit.

It will be noted that the power tubes are full spray shielded with a window at the top. The shielding is not only for the suppression of wall charges as described but also for the purpose of minimizing any cou-

pling which may exist with the rest of the circuit due to the presence of the intermediate frequency which may exist in a small amount in the plate circuit of the power tube. A more adequate suppression of intermediate-frequency harmonic responses is obtained thereby.

The spray shielding of power tubes is beneficial also where high gain audio resistance coupling is utilized. A more satisfactory audio circuit is obtained due to the elimination of capacitance coupling between the power tube and the input of the audio amplifier. Spray shielding in the case of some class B amplifiers is likewise beneficial in preventing propagation of radio-frequency disturbances which occur at large values of positive grid swing.

The possibility of a leakage path over the glass surface between the control-grid cap and the spray shielding is very remote because the surface is kept dry by the warmth of the glass bulb. The input resistance is extremely high and this leakage is entirely negligible.

In general, with spray shield tubes, the control-grid leads will be farther away from the shield than when shielding cans are used. As a result, changes in the position of the grid leads will have less effect on circuit alignment.

The input and output capacitance of the multiple-grid radio-frequency amplifier is very uniform and considerable time is saved by the set manufacturer's inspection department in the final test and alignment positions since it is not required to insert and remove shields.

The friction between the spray shield grounding clips and the tube base is considerable. This is very helpful in cases where it is desirable to ship the receiver with tubes in position. The dealer's work is simplified because with the conventional tube and shield arrangement it is generally necessary to remove packing.

#### CONCLUSION

The many desiderata, associated with the structure and use of the spray shield tube, can now be realized, on account of the improvement in tube design and the development of special machinery which permits economic production in a competitive market.

#### ACKNOWLEDGMENT

The writers wish to express their appreciation of the active participation of Mr. E. S. Rogers in the realization of this advance in the radio art.

## CYCLONES, ANTICYCLONES, AND THE KENNELLY- HEAVISIDE LAYER\*

BY

ROBERT CAMERON COLWELL

(Professor of Physics, West Virginia University, Morgantown, West Virginia)

*Summary*—Fading curves taken in Morgantown upon the signal of KDKA in Pittsburgh show an increase of intensity after nightfall provided a cyclonic area covers both cities or lies to the north of Morgantown. If a high pressure area covers both cities the night intensity does not increase above the day intensity and may even fall below it. These observations are explained by the theory that the Kennelly-Heaviside (E) layer is found at night in cyclonic regions but is not present in anti-cyclones. This theory is strongly supported by recent experiments of Ranzi on 100-meter waves.

FOR the last five years, regular observations have been made at Morgantown upon the signal from KDKA in Pittsburgh. The two cities are about sixty miles apart and on the same meridian. The received signal is passed through a superheterodyne, and the amplified carrier wave taken from the second detector is rectified in a diode; the rectified current actuates the galvanometer of a Shaw recorder. From several hundred fading curves taken on KDKA, it has been found that a high pressure area covering both Pittsburgh and Morgantown with its center north of Morgantown will cause the night intensity to fall slightly below that of the day; while a low pressure area covering both cities with its center to the north of Morgantown will cause a night intensity very much greater than that of the day. On the other hand a low pressure area south of Morgantown will cause a low intensity at night.

These phenomena are illustrated in the figures which were taken during the spring of 1930. In Fig. 1, Pittsburgh and Morgantown are on the edge of a low pressure area approaching from the west; the night intensity shown at the bottom of the figure is much above the day level. The night intensity of Fig. 2 is gradually falling below the day level as the high pressure area passes over the two cities. In Fig. 3 the intensity is dominated by the high pressure area shown, hence the night signal is equal to or below that of the day. On March 21st, the high pressure area was still exerting its influence and the signal intensity failed to rise at night. The next day, the high pressure was even more pronounced and the night signal was weaker than the day. On

\* Decimal classification: R113.61×R113.5. Original manuscript received by the Institute, November 25, 1932. Publication No. 87 of the Division of Industrial Sciences, West Virginia University.



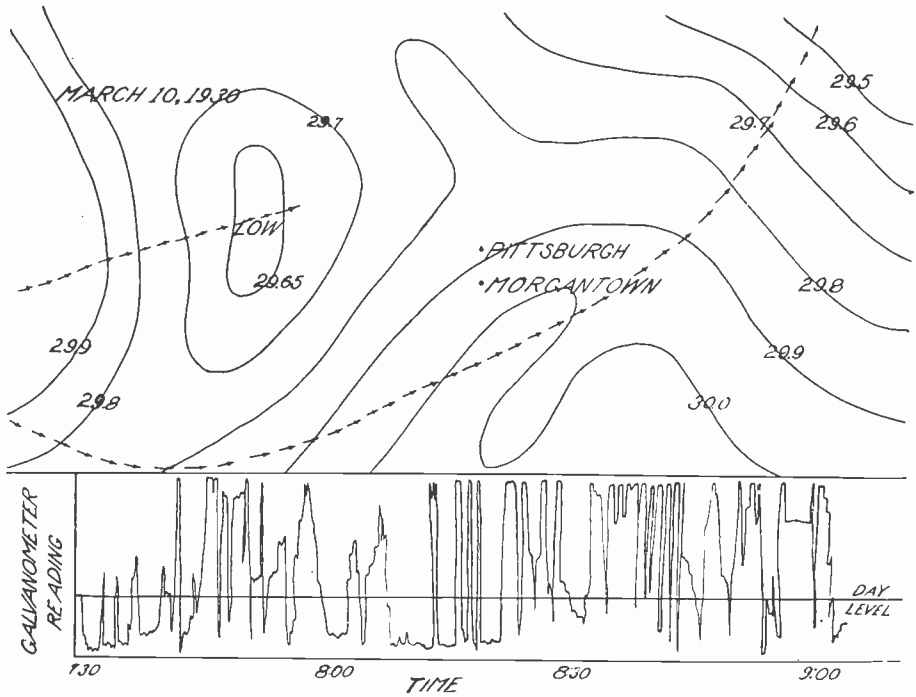

Fig. 1—March 10, 1930. Pittsburgh and Morgantown are on the edge of a low pressure area approaching from the west. The Kennelly-Heaviside layer gives strong reflection after sunset; hence the night signal is much stronger than the day signal.

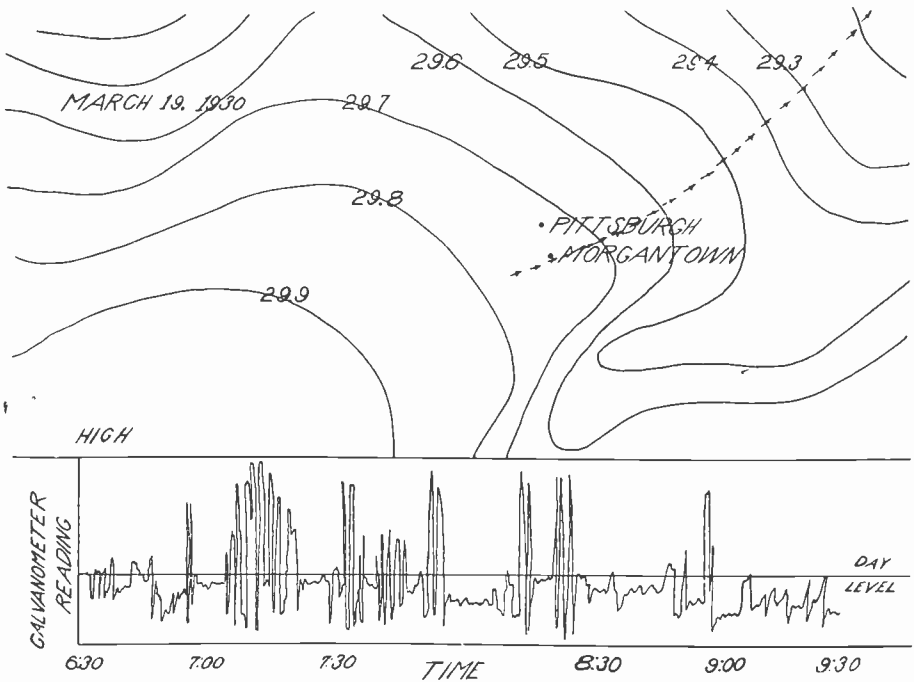

Fig. 2—March 19, 1930. A high pressure area is moving toward the sending and receiving stations. The Kennelly-Heaviside layer disappears after sunset, and toward the end the night signal is below the day level.

March 29th, there were two low pressure centers near the two cities but the effective one was the widespread area to the north; this caused the night intensity to rise very much above the day level.

This phenomenon can be satisfactorily explained on the assumption that the Kennelly-Heaviside region (E layer) is influenced by the presence of cyclones and anticyclones (low pressure and high pressure areas). The E layer is present to some extent during the day on account of the action of sunlight; at night it disappears entirely in an anticyclone area but becomes very much stronger in a cyclonic region.

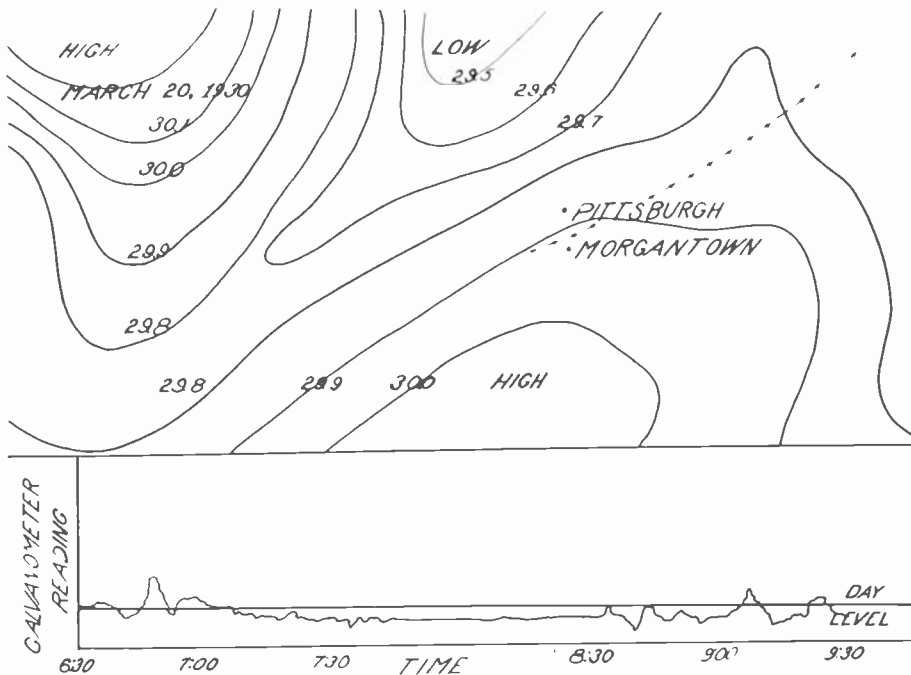

Fig. 3—March 20, 1930. Both stations are in a high pressure area. The Kennelly-Heaviside layer disappears rapidly after sunset. There is no reflection from the sky so that the night intensity is approximately the same as that of the day.

The signal from Pittsburgh reaches Morgantown along two paths, the sky wave and the ground wave. During the day, the ground wave is the stronger but a slight reflection from the E layer adds some strength to the received energy. At night in a high pressure area there is no E layer, hence no reflection, and the night signal drops a little below that obtained during the day; in a low pressure area, the E layer is very active at night, so that there is a large increase in intensity after sunset.

This theory is strongly supported by the recent experiments of Ranzi. He reflected 100-meter waves from the E layer during different conditions of barometric pressure. He found that "the abnormal increases of ionic density in the E region are accompanied by particular

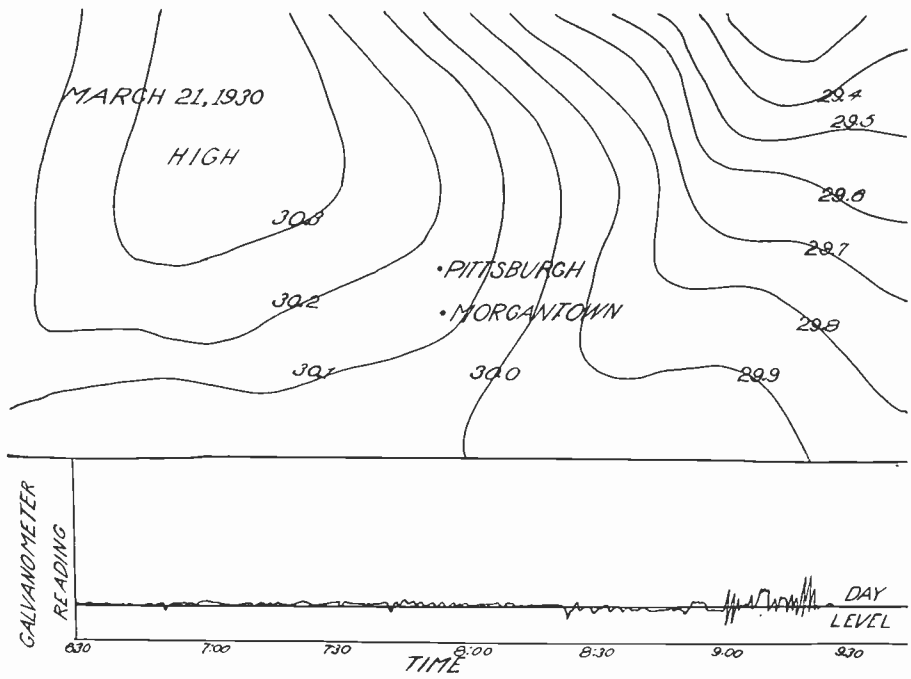

Fig. 4—March 21, 1930. Both stations are in an anticyclone area. There is no reflection from the sky. The night level is equal to that of the day.

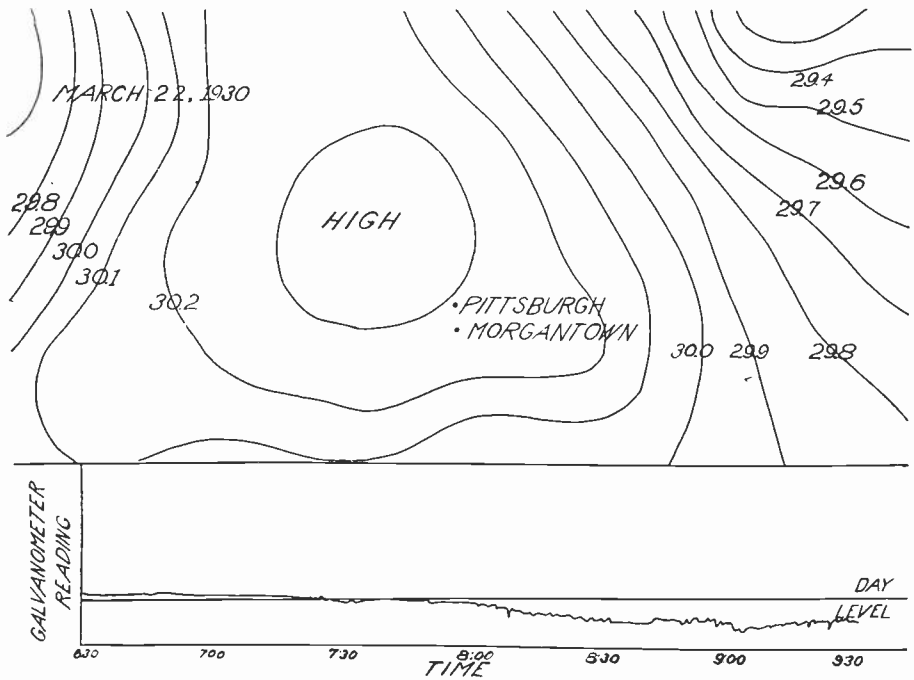

Fig. 5—March 22, 1930. A high pressure area covers both cities. The E region disappears at sunset. The sky wave is not reflected; the night intensity does not increase.

isobaric situations characterized by the presence of barometrical depressions at the place of observation or in the north of it. In anticyclonic conditions or conditions with depressions in the south, the reflection from the E region ceases in the shortest time."<sup>1</sup>

Under suitable conditions, the varying signal intensity of a radio station may be used to indicate the presence of cyclones and anticyclones, thus aiding in weather forecasts. The signal from KDKA has

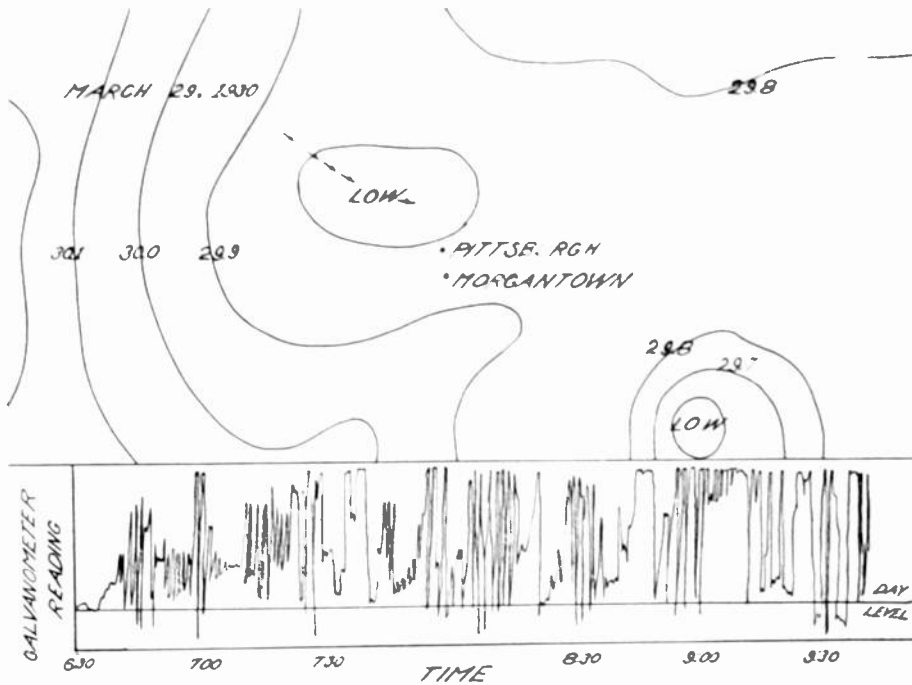

Fig. 6—March 29, 1930. A low pressure area has settled over both cities. The Kennelly-Heaviside region persists after sunset. There is a strong reflection of the sky wave and a corresponding increase in intensity after sunset.

been so used at West Virginia University. For the three years from 1927–1930, the forecasts were about ninety per cent correct. Since 1930, this section of the country has been visited by a drought, and although the radio signals still show the effect of cyclones and anticyclones, the mere presence of these areas does not indicate the weather probability.

<sup>1</sup> Ranzi, *Nature* (London), p. 368; September 3, (1932).

Note: The isobaric curves in the figures are taken from the daily charts of the U. S. Department of Agriculture Weather Bureau; they are adjusted to their position at 8 P.M.

DISCUSSION ON "A FOURIER ANALYSIS OF RADIO-FREQUENCY  
POWER AMPLIFIER WAVE FORMS"\*

L. B. Hallman, Jr.

**Frederick Emmons Terman:**<sup>1</sup> In Mr. Hallman's interesting and worthwhile paper I would like to call attention to the fact that the plate efficiency for the class C amplifier has not been correctly calculated. The efficiency is of course the fundamental frequency power delivered to the load impedance divided by the direct-current power which the plate supply voltage is required to furnish. The power output is half the product of the fundamental component of the alternating plate current and the fundamental component of the alternating plate voltage which this current develops across the plate load impedance. In the case of the square-top wave forms shown in Fig. 8 the alternating plate voltage developed across the load impedance can never exceed the battery voltage  $E_b$  since otherwise the plate would become negative, and no plate current would flow during the part of the cycle when the square wave of current is assumed to be present. In the case of Fig. 8(a) where the fundamental component of the plate current is  $0.636 I_s$  and the average plate current is  $0.5 I_s$ , the plate efficiency hence cannot exceed

$$\text{max. possible plate efficiency} = \frac{0.636 I_s E_b}{2 I_s E_b / 2} = 0.636.$$

Similarly in the case of Fig. 8(b) the plate efficiency has as its theoretical maximum the value

$$\text{max. possible efficiency} = \frac{0.45 I_s E_b}{2 I_s E_b / 4} = 0.90.$$

This revision in the plate efficiency will of course modify some of the conclusions. In particular, it shows the statement "that no increase in efficiency is to be expected from decreasing the portion of the half cycle during which saturation current flows" is not correct.

**L. B. Hallman, Jr.:**<sup>2</sup> Dr. Terman's discussion fails to take into consideration a characteristic of the parallel resonant circuit which must be considered when calculating the efficiencies of radio-frequency amplifiers. This characteristic is the property the circuit has of "amplifying," so to speak, the current flowing in the inductance leg. It will be noted from Dr. Terman's equations that he assumes the same current to be flowing through the power dissipative element of the circuit as flows in the plate circuit. This is not true. The power can be assumed dissipated in the resistance of the inductance leg of the circuit. This is very nearly true in all practical circuits where the tank circuit is coupled inductively to the load circuit. The circuit "amplifying factor" is denoted in my paper by the character  $A$ . That is, if  $I_1$  is the fundamental component of plate circuit current, the corresponding component,  $i_1$ , flowing in the inductance leg of the tank circuit (where the power is dissipated) is:

$$i_1 = A I_1.$$

\* Proc. I.R.E., vol. 20, pp. 1640-1659; October, (1932).

<sup>1</sup> Stanford University, California.

<sup>2</sup> Montgomery Broadcasting Co., Inc., Montgomery, Ala.

It would seem to me, then, that whether or not the method used in my paper is correct would depend upon whether or not  $A$  is a constant. To investigate this it will be convenient to utilize a method that, so far as I am aware, is due to E. B. Moullin.<sup>3</sup>

Referring to Fig. 1 and applying Kirchhoff's laws to this circuit we have for each component of the total plate current:

$$i_1 Z_1 = i_2 Z_2 = i Z_1 Z_2 / (Z_1 + Z_2)$$

and,

$$i_1/i = Z_2/(Z_1 + Z_2).$$

Substituting for  $Z_1$  and  $Z_2$

$$\begin{aligned} i_1/i &= \frac{R_2 + j(\omega L_2 - 1/\omega C)}{(R_1 + R_2) + j(\omega L_1 + \omega L_2 - 1/\omega C)} \\ &= \frac{R_2 + j\omega L_2(1 - 1/\omega^2 L_2 C')}{(R_1 + R_2) + j\omega(L_1 + L_2)(1 - 1/\omega^2 C'(L_1 + L_2))} \end{aligned}$$

where  $j$  is the rotating operator  $\sqrt{-1}$ .

If now  $\omega_0/2\pi$  is the frequency to which the circuit is tuned we may write

$$\omega_0^2(L_1 + L_2) = 1/C';$$

then,

$$1/\omega^2 L_2 C' = (\omega_0/\omega)^2((L_1 + L_2)/L_2)$$

and,

$$1/\omega^2 C'(L_1 + L_2) = (\omega_0/\omega)^2.$$

Therefore,

$$i_1/i = \frac{R_2 + j\omega L_2(1 - (L_1 + L_2)/n^2 L_2)}{(R_1 + R_2) + j\omega(L_1 + L_2)(1 - 1/n^2)}$$

where,

$$n^2 = (\omega/\omega_0)^2.$$

We are, however, interested particularly in the fundamental frequency component of the total plate current and for this component  $n$  is unity. We have then,

$$i_1/I_1 \doteq \omega L_1/(R_1 + R_2). \quad (1)$$

If, as was assumed in the paper under discussion, the resistance is concentrated in the inductance leg of the circuit and the capacity leg contains capacity only ( $L^2 = 0$ ), we have for (1)

$$i_1/I_1 \doteq \omega L_1/R_1.$$

This is closely the reciprocal of the power factor of the inductance leg and is the value of  $A$  used in my paper. The important thing that will be seen at a glance is that  $A$  is constant for a given circuit. It does not vary with the plate circuit wave form and the results obtained by using this quantity as a constant are correct.

Dr. Terman's statement that "the alternating plate voltage developed across the load impedance can never exceed the battery voltage  $E_b$ " is, of course, cor-

<sup>3</sup> E. B. Moullin, "The Theory and Practice of Radio-Frequency Measurements," Second Edition, pp. 111-112

rect. However, his assumption that the resultant impedance of the tank circuit is purely dissipative or that the same conditions would exist if it were is incorrect. The power output is dissipated in the resistance of the inductance leg of the tuned circuit and the current flowing in this branch must be known before the power output can be calculated. By basing the calculations on an assumed efficiency for the class A amplifier, the factor  $A$  is indirectly evaluated. It is then possible to calculate the efficiencies of other wave forms. The *fundamental* voltage component across the tank circuit is given by  $i_1(R_1 + j\omega L_1)$ . Of course  $i_1$  assumes a value that makes the *resultant* drop somewhat less than the battery voltage  $E_b$ . Clearly it must depend on  $R_1$  and  $\omega L_1$ , and this (1) shows to be true.

The value of 81 per cent given as the efficiency of the wave forms of Figs. 8(a) and 8(b) of my paper is the maximum possible efficiency for these wave forms. It is based on an assumed efficiency of 50 per cent for the class A amplifier which is, as is well known, the maximum possible efficiency for this amplifier. It will be noted that Dr. Terman's method gives correctly the maximum possible efficiency in the particular case of a class A amplifier. This is to be expected, however, because in this instance the same conditions exist whether or not the tank circuit is replaced by a pure resistance of suitable value. When dealing with class B or C radio-frequency amplifiers this method is likely to give erroneous results and is essentially incorrect.

A physical concept should help explain this apparent inconsistency. As is well known, the parallel resonant circuit acts as a pure resistance of value closely  $\omega^2 L^2 / R$  at the resonant frequency. That is, its power factor at parallel phase resonance is unity. We could not say, however, that it would be correct to make use of this hypothetical resistance in calculations involving the power output unless it were possible actually to replace the tuned circuit by a resistance of this value, and the same essential conditions still exist so far as the amplifier classification is concerned. If we are dealing with the class A amplifier and replace the tank circuit by a resistance of suitable value, we still have a class A amplifier operating at the same efficiency. The change here is justified and gives correct results. When the tank circuit of a class B or C radio-frequency amplifier is actually replaced by a resistance having the same value as its hypothetical resistance to the fundamental frequency, we cease to have a class B or C amplifier, as they have been defined. Efficiency calculations based on this transformation alone are therefore basically unsound.

**Frederick Emmons Terman:**<sup>1</sup> The basis of Mr. Hallman's objections to my efficiency calculations is given in the last paragraph of his discussion, and is incorporated in the contention that it is not permissible to calculate the power dissipated in a parallel resonant circuit at the resonant frequency by multiplying the square of the line current by the resistance which this circuit offers to the current. Instead, Mr. Hallman argues that it is necessary to make use of the series resistance of the tuned circuit and the current that circulates through this resistance.

It can be readily shown that these two methods of calculating the power lead to identical results. Referring to Fig. 1 of the discussion, if  $i$  is the effective value of the alternating current having the frequency to which the parallel circuit is tuned, then the power consumed in the circuit by my method of calculation is  $i^2 (\omega L_1)^2 / (R_1 + R_2)$ . According to the method of calculation which Mr. Hallman prefers, and assuming that  $i_1 = i_2$ , which is very nearly true at resonance, the ratio  $i_2/i$ , which is the resonance rise of current or the "amplifying"

effect, is equal to  $\omega L_1/(R_1 + R_2)$ . Making use of this relation to express  $i_2$  in terms of  $i_1$ , Mr. Hallman's expression leads to the same result which I have given above. The two methods of calculating power are thus demonstrated to be equivalent and it will be noted that I have in no way neglected the "amplifying" effect of the parallel circuit.

The fundamental trouble with Mr. Hallman's efficiency calculations lies in his attempt to express efficiency of class C amplifiers in terms of the efficiency for the class A amplifier. For example, in order for a class A amplifier to have an efficiency of 50 per cent, it is necessary that the load resistance be many times the plate resistance of the tube; i.e. that the load resistance approach infinity. On the other hand in class C amplification, the fraction of the cycle during which the plate current flows is very definitely affected by the load resistance, and it is impossible to obtain a current flow for a finite part of the cycle without having a finite load resistance. One therefore immediately runs into great difficulties in attempting to express the plate efficiency of a class C amplifier with a finite load resistance in terms of the plate efficiency of a class A amplifier with an infinite load impedance.

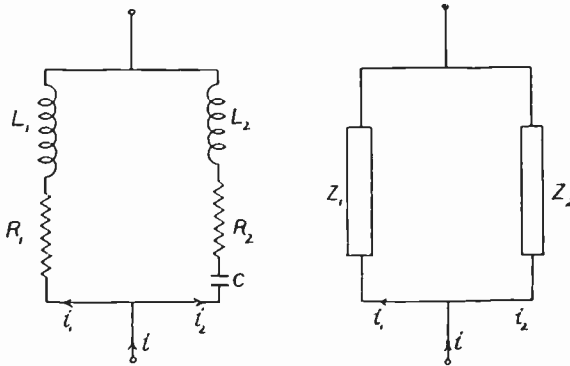

Fig. 1

L. B. Hallman, Jr.:<sup>2</sup> In the first part of Dr. Terman's discussion his efficiency calculations are based on the assumption that the maximum possible power output for the class C wave forms is given by  $E_b I_1/2$ . He states that this is true because the maximum voltage amplitude across the tank circuit can never exceed the battery voltage. It is also tacitly implied that this voltage amplitude is the  $(\omega^2 L^2/R)(I_1)$  drop across the tank circuit as otherwise the calculations would be meaningless. It was to this assumption that I objected. I am quite in accord with the fact that it is permissible to calculate the power dissipated in a parallel resonant circuit at the resonant frequency by multiplying the square of the line current by the resistance this circuit offers to the current. If the resistance of the circuit at the fundamental frequency is known, together with the resistance of the inductance and capacity legs, the current flowing in the inductance leg can be found. One implies the other.

In the portion of my discussion referred to by Dr. Terman I attempted to show that, practically, the harmonic content of the plate current wave forms prevented the resultant voltage across the tank circuit from being accounted for as caused by the fundamental current component alone. When harmonic components are present any statement as to the maximum possible amplitude of the resultant voltage cannot be applied to the fundamental without considering



the resultant harmonic component acting in phase or at 180 degrees with it. If the harmonic components are all zero the maximum amplitude of the fundamental voltage can obviously never exceed the battery voltage. In this event, the tank circuit can be replaced by a pure resistance of suitable value without any change in fundamental conditions. It was, doubtless, my discussion of this that was misunderstood.

It is interesting to consider this matter from another point of view. Let the root-mean-square value of the currents in the plate current wave form be  $i_1, i_2, i_3, \dots, i_n$ . The voltage drops caused by these currents as they flow through the tank circuit will be  $e_1, e_2, e_3, \dots, e_n$ . We can now write as the total power,  $P_0$ , dissipated in the tank circuit:

$$P_0 = \sum_{n=1}^{n=\infty} e_n i_n \cos \alpha_n.$$

Dr. Terman states that  $P_0$  can never exceed  $E_b I_1 / 2$ .  $P_0$  will equal  $E_b I_1 / 2$  when  $E_b / \sqrt{2} = e_1$  and  $I_1 / \sqrt{2} = i_1$ . He also assumes that the power output is  $E_b I_1 / 2$  and uses this value in his calculations of maximum efficiency. It is clear, however, that for this to be true,  $e_2 = e_3 = \dots = e_n = 0$ . This condition cannot be realized unless the resistance in both branches of the tank circuit is zero. If this is true the resistance offered to the resonant frequency, or fundamental, is infinity.

Dr. Terman objects to my calculations on the premise that they are based on an assumed tank circuit impedance approaching infinity. Certainly his method is subject to the same criticism.

Further consideration shows that this objection does not invalidate my results. It is not required that my calculations be based on a class A efficiency of 50 per cent alone. The basis could just as well be, say, 35 per cent. This would only alter the "A" of the tank circuit and certainly the objection to an infinite impedance is not justified in this case. The value of 50 per cent was chosen simply to indicate the maximum possible efficiencies obtainable with the various wave forms. It is in approaching the limiting conditions that Dr. Terman's method differs from mine. The limiting condition is, however, meaningless. Efficiency implies a ratio of power output and power input. Unless we assume it possible for a current to flow in an infinite resistance the power output, in the limit, is zero. The power input does not necessarily become zero because we may still have a direct plate current component flowing in the circuit. Hence, on this basis, the efficiency in the limit becomes zero. It is in approaching this obviously impossible condition that Dr. Terman obtains results differing from mine. My method allows this limit to be approached in an orthodox manner. For example, we can let the efficiency of the class A amplifier differ from 50 per cent by a small amount. The conditions now become compatible with reason. The impedance is finite, and consequently efficiency calculations have some meaning. Now, 50 per cent is the limiting value for the class A amplifier. Hence the efficiency for wave forms 8(a) and 8(b) becomes less than 81 per cent by a small amount depending on the class A efficiency. It is clear that, as the efficiency of the class A amplifier approaches 50 per cent, 81 per cent is approached as a limiting value for the efficiencies of wave forms 8(a) and 8(b).

Morecroft<sup>4</sup> measured the efficiency, experimentally, of several separately excited oscillators and found maximum values of 38 and 70 per cent. Using the method of my paper, this is seen to correspond to a maximum class A efficiency

<sup>4</sup> J. H. Morecroft, "Principles of Radio Communication," pp. 661-665, 1927 edition.

of from 42 to 43 per cent. From a practical point of view this value is not unreasonable. The plate current wave forms shown for these oscillators are comparable to those under discussion.

Many of these points were considered during the preparation of my paper and a discussion of them should probably have been included. The subject is a very interesting one, and I hope these remarks will serve to explain the reasoning upon which the calculations are based. I do not consider the method I used as flawless. For example, the feasibility of using the same tank circuit adjustment for class A, class B, and class C plate current wave forms is debatable. The calculations require that a sufficiently high plate voltage source be available to draw the full saturation current of the tube on peaks. For certain tank circuit adjustments this, of course, implies practical difficulties. It does not appear, however, that such assumptions are impossible. In fact, the results obtained are justifiable on the basis of such experimental data as have been checked.



**BOOKLETS, CATALOGS, AND PAMPHLETS RECEIVED**

Copies of the publications listed on this page may be obtained gratis by addressing the manufacturer or publisher.

Catalog No. 5 describing instrument-protecting fuses may be obtained from the Littlefuse Laboratories of 1772 Wilson Avenue, Chicago, Illinois.

A leaflet issued by the National Company of 61 Sherman Street, Malden, Mass., describes the National "AGS" short-wave receiver and some accessories.

Ceramic insulating pieces for extensive uses are described in a leaflet issued by the American Lava Corporation of 1431 William Street, Chattanooga, Tenn.

Continuous electric furnaces for heat treating ferrous and nonferrous strip metal and wire are described in Bulletin No. 280 published by H. O. Swoboda, Inc., of 3530 Forbes Street, Pittsburgh, Pa.

A leaflet of the Electromatic Record Changer Corporation of 203 N. Wabash Avenue, Chicago, Illinois, describes their electromatic record changer and cabinets.

Copies of Technical Bulletin No. 200.3 on "The Mechanics of Lubrication with Colloidal Graphite" are available from the Acheson Oildag Company of Port Huron, Mich.

A leaflet which describes a "Radio Modulator" designed to permit the use of any radio set as a public address system may be obtained from Shure Brothers Company of 337 W. Madison Street, Chicago, Ill.

Bulletin No. 5 of the Central Scientific Company of Chicago, Illinois, is devoted to relays, relay control units, and thermoregulators.

The Lightning Radio Calculator Company of Owensboro, Ky., has issued a leaflet describing their lightning radio calculator for computing values of inductance, capacity, frequency, wavelength, and various dimensions of coils.

Bulletin No. 26 describes a frequency converter manufactured by the International Broadcasting Equipment Company of 3112 W. 51st Street, Chicago, Ill.

Several technical bulletins have been issued jointly by RCA Radiotron Company and E. T. Cunningham of Harrison, N. J. Application Note No. 1 covers the use of the 77 as a biased detector, Note No. 2 treats the use of the 57 as a biased detector resistance coupled to a 2A5, Note No. 3 is on the use of the 2A7 and the 6A7 as pentagrid converters, and Note No. 4 discusses the 2B7, 6B7, 55, 75, 77, and 85 as resistance coupled audio-frequency amplifiers. Leaflets giving the operating characteristics of the 25Z5, 41, 48, 55, 59, 83, 85, and 89 are also available. A very limited number of the RCA Radiotron Manual R10 giving the characteristics of a substantial number of tubes for broadcast receivers is available without charge.

Meyer Koulisch Company of 64 Fulton Street, New York has issued a leaflet describing their sapphire needles and points for recording equipment.

Bulletin No. 26 covers paper dielectric condensers of assorted sizes and types and is issued by Wego Condensers, Inc., of 729-7th Avenue, New York City.

Triplett moving coil instruments are listed in a leaflet issued by the Triplett Electrical Instrument Company of Bluffton, Ohio.

RADIO ABSTRACTS AND REFERENCES

THIS is prepared monthly by the Bureau of Standards,\* and is intended to cover the more important papers of interest to the professional radio engineer which have recently appeared in periodicals, books, etc. The number at the left of each reference classifies the reference by subject, in accordance with the "Classification of Radio Subjects: An Extension of the Dewey Decimal System," Bureau of Standards Circular No. 385, obtainable from the Superintendent of Documents, Government Printing Office, Washington, D. C., for 10 cents a copy. The classification also appeared in full on pp. 1433-1456 of the August, 1930, issue of the PROCEEDINGS of the Institute of Radio Engineers.

The articles listed are not obtainable from the Government or the Institute of Radio Engineers, except when publications thereof. The various periodicals can be secured from their publishers and can be consulted at large public libraries.

R100. RADIO PRINCIPLES

R111 E. D. McArthur. Electronics and electron tubes—Part I—Electron and atomic theories. *Gen. Elec. Rev.*, vol. 36, pp. 136-138; March, (1933).

A simple treatment of the theories of the electron and molecule is given. The Bohr atom is described.

R113 A. W. Ladner and H. J. H. Wassell. The interference pattern of three carrier waves. *Marconi Rev.*, no. 39, pp. 19-29; November-December, (1932).

Results are given of an investigation which involved the simultaneous operation of three transmitters having a frequency separation of about 7 kilocycles.

R113 D. C. Rose. Radio observations on the upper ionized layer of the  
×R113.55 atmosphere at the time of the total solar eclipse of August 31, 1932. *Canadian Journal of Research*, pp. 15-28, (1933).

This report contains the results of one of the three stations set up by the National Research Council of Canada to take observations on radio reflections from the ionized layers in the upper atmosphere during the total solar eclipse of August 31, 1932. Results indicate that the ionization of the upper layer is caused by radiation from the sun. Whether or not this is the sole cause is uncertain because of the time lag in recombination of ions in the layer. A reduction in ionization of over 30 per cent was noted.

R113 F. C. Jones. Checking the behavior of ultra-high frequency waves.  
×R125 *QST*, vol. 17, pp. 14-17; March, (1933).

Describes transmission tests using directive antennas.

R113 L. F. Jones. A study of the propagation of wavelengths between three and eight meters. *Proc. I.R.E.*, vol. 21, pp. 349-386; March, (1933).

A description is given of the equipments used in an airplane, dirigible, automobile, and indoors to measure the propagation characteristics of wavelengths between about three and eight meters. The majority of observations were of television transmissions from the Empire State Building. The absorption of ultra-short waves traveling through or around large buildings is shown to be in terms of amplitude about 50 per cent every 500 feet for seven meters and 50 per cent every 200 feet for three meters. Various types of interference are mentioned. There are maps of the interference patterns measured in a typical residential room. It is shown that the service range of the Empire State transmitters includes most of the urban and suburban areas of New York, and that the interference range is approximately 100 miles.

This list compiled by Mr. A. H. Hodge and Miss E. M. Zandonini.

- R113 C. R. Englund, A. B. Crawford, and W. W. Mumford. Some results of a study of ultra-short-wave transmission phenomena. *Proc. I.R.E.*, vol. 21, pp. 464-492; March, (1933).

The results of a series of transmission experiments made in the range 3.7 to 4.7 meters and over distances up to 125 miles are reported. These observations were chiefly confined to the region reached by the directly transmitted radiation, and are found in good agreement with the assumption that such transmission consists mainly of a directly transmitted radiation plus the reflection components which would be expected from the earth's contour. Quantitative checks on hill-to-hill transmission have been obtained, and it has been found that a field intensity of 40 microvolts per meter gives very good transmission. Static is ordinarily entirely absent, and no Heaviside layer reflections have been observed.

- R113 Mary Taylor. The Appleton-Hartree formula and dispersion curves for the propagation of electromagnetic waves through an ionized medium in the presence of an external magnetic field. Part I—Curves for zero absorption. *Proc. Phys. Soc. (London)*, vol. 45, pp. 245-265; March, (1933).

This paper gives dispersion curves derived from the Appleton-Hartree formula in the case of zero absorption. The polarization corresponding to each dispersion curve is shown graphically, and the general properties of the polarization of the basic propagation modes are discussed.

- R113 J. C. Shelleng, C. R. Burrows, and E. B. Ferrell. Ultra-short-wave  
×R270 propagation. *Proc. I.R.E.*, vol. 21, pp. 427-463; March, (1933).

Part I of this paper first describes a method of measuring attenuation and field strength in the ultra-short-wave range. A résumé of some of the quantitative experiments carried out in the range between 17 megacycles (17 meters) and 80 megacycles (3.75 meters) and with distances up to 100 kilometers is then given. Part II gives a discussion of reflection, diffraction, and refraction as applied to ultra-short-wave transmission. Experiments over sea water are found to be consistent with the simple assumption of a direct and a reflected wave except for distances so great that the curvature of the earth requires a more fundamental solution. Several trends with respect to frequency are pointed out. The existence of optimum frequencies is pointed out, and it is emphasized that they depend on the topography of the particular paths, and that different paths may therefore have widely different optimum frequencies.

- R113 B. Trevor and P. S. Carter. Notes on propagation of waves below  
×R270 ten meters in length. *Proc. I.R.E.*, vol. 21, pp. 387-426; March, (1933).

The results of a number of measurements of field strength variation with distance from the transmitter and height above the ground for several wavelengths in the range below 10 meters are shown. Observations of the two transmitters on the Empire State Building in New York City, on 44 and 61 megacycles, were made in an airplane over Long Island. These tests show the nature of the interference patterns set up by the combination of the direct and reflected rays. Other similar tests are recorded. The experimental data are discussed in comparison with the theoretical curves determined from optical principles.

- R113 E. V. Appleton and G. Builder. The ionosphere as a doubly-refracting  
×R113.6 medium. *Proc. Phys. Soc. (London)*, vol. 45, pp. 208-220; March, (1933).

In previous communications the occurrence of wireless echo doublets was attributed to the influence of the earth's magnetic field on the dispersive properties of the ionosphere. A further study of the subject has confirmed this hypothesis. In southeast England, for ionospheric reflection at vertical incidence, the echo-component of lesser delay is, in general, of right-handed, and the component of greater delay of left-handed, circular polarization. This temporal sequence should be reversed in the Southern Hemisphere, and in certain special circumstances in the Northern Hemisphere.

- R113.1 J. T. Henderson and D. C. Rose. Fading and signal-strength meas-  
×R270 urements taken during the solar eclipse of August 31, 1932. *Canadian  
×R113.55 Journal of Research*, pp. 29-36, (1933).

This paper contains the results of observations on signal strength and fading, taken during the total solar eclipse of August 31, 1932, by the Canadian Marconi Company, the Northern Electric Company, the Marine Department of the Canadian Government, and l'Ecole Polytechnique of Montreal. Results of the observations on short waves indicate no effect at the time of the predicted corpuscular eclipse, but a definite night effect at the time of optical totality. Direction finding stations and observations on the broadcast band report no effect.

- R113.5 Changes in sun-spot numbers 1923-1932 give clue to radio vagaries. *Electronics*, vol. 6, p. 69; March, (1933).  
A chart showing the relation between sun-spot intensity and radio reception over the period 1923-1932 is given. Radio reception is shown to vary inversely as sun-spot intensity.
- R113.61 J. T. Henderson. Measurements of ionization in the Kennelly-  
×R113.55 Heaviside layer during the solar eclipse of 1932. *Canadian Journal of Research*, pp. 1-14, (1933).  
The ionization of the Kennelly-Heaviside layer was measured by Appleton's method during the total solar eclipse of August 31, 1932. In contrast to normal days, a sudden decrease of 58 per cent during the period of optical totality was found. It is shown that the cause of the lower layer ionization is ultra-violet light from the sun. Some measurements were made of the effective height of the "Appleton" layer. These are discussed. There was a marked effect at the time of optical totality on this layer also.
- R113.61 G. J. Elias and C. G. A. von Lindern. Messungen der Reflexion an der Heaviside-Schicht. (Measurements of reflection on the Heaviside layer.) *Elek. Nach. Tech.*, vol. 10, pp. 1-8; January, (1933).  
A research is described in which the amplitude of the electromagnetic field is determined by a simple reflection. The results are in good agreement with earlier published theoretical considerations.
- R113.61 R. Naismith. A comparison of the frequency-change and group retardation methods of measuring ionized-layer equivalent heights. *Proc. Phys. Soc. (London)*, vol. 45, pp. 235-244; March, (1933).  
The paper describes a number of experiments designed to test the measurement of the equivalent heights of the ionized layers by the frequency-change and group retardation methods. Measurements are conducted under varied conditions. The results appear to confirm the theoretical investigation recorded by Appleton in 1928. Apparatus is described.
- R113.61 J. F. Herd. The generation and reception of wireless signals of short duration. *Proc. Phys. Soc. (London)*, vol. 45, pp. 221-234; March, (1933).  
The paper describes methods of utilizing the common frequency of an alternating-current supply network to secure synchronization of transmitting and receiving time scales. The arrangement is first described in connection with ticking grid circuits at the transmitter and as a linear time base device at the receiver. Alternative linear time bases using mercury-vapor triodes are then discussed. A method of impulsing to the transmitter is described, involving the use of a thyatron as an abrupt switching device.
- R120 J. Labus. Rechnerische Ermittlung der Impedanz von Antennen. (Mathematical calculation of the impedance of antennas.) *Hochfrequenz. und Elektroakustik*, vol. 41, pp. 17-23; January, (1933).  
Using line integrals, the impedance of a centrally fed antenna is calculated. The vector and scalar potentials on the surface of the conductors are calculated. The impedance of the antenna at the feed point consists of a real and an imaginary part. Expressions for these are given.
- R120 S. Issakowitsch-Kosta. Anpassung von Speiseleitung an Kurzwellen-Sendeantennen. (The adjustment of transmission (feed) lines for high-frequency antennas.) *Elek. Nach. Tech.*, vol. 10, pp. 9-19; January, (1933).  
The total efficiency of a transmitting station with an energy conductor coupled to an antenna is analyzed in its components, from which the efficiency of the transducer and transmission line is treated. The general theory and experimental results for adjustment of one- and two-wire transmission lines are given.
- R140 M. G. Scroggie. Parallel feed precautions. *Wireless World (London)*, vol. 32, pp. 137-138; February 17, (1933).  
The author points out the difficulties which arise in autocoupled circuits and shows that in a mains set it is preferable to use the more conventional transformer coupling in which the primary and secondary are not directly connected.

- R140 M. Rousseau. Über die Theorie des freischwingenden Kreises. (On the theory of freely oscillating circuits.) *Hochfrequenz. und Elektroakustik*, vol. 41, pp. 27-28; January, (1933).

It is shown that the equation for the characteristic frequency of a freely oscillating circuit may assume different interesting mathematical forms.

- R140 E. A. Biedermann. Some notes on the use of a diode as a cumulative grid rectifier. *Wireless Engineer & Experimental Wireless* (London), vol. 10, pp. 123-133; March, (1933).

Operating conditions are considered for the purpose of determining the most efficient conditions for the rectifier and amplifier. The radio-frequency voltage applied to the vacuum tube is analyzed. Two methods of improving the radio-frequency filter are given. A method of coupling the rectifier and amplifier is considered. Use of the diode as a volume control tube is discussed.

- R152 J. Thomson. On the theory of oscillatory condenser discharges. *Phil. Mag.* (London), vol. 15, pp. 682-706; March, (1933).

The mechanism of the spark and of the oscillating arc are discussed.

- R163 W. T. Cocking. The evolution of the superhet. *Wireless World* (London), vol. 32, pp. 182-183; March 10, (1933).

The progress of the last decade is reviewed. Lines for future research are suggested.

## R200. RADIO MEASUREMENTS AND STANDARDIZATION

- R207 D. W. Dye and T. I. Jones. A radio-frequency bridge for impedance and power factor measurements. *Jour. I.E.E.* (London), vol. 72, pp. 169-181; February, (1933).

The paper deals with the problems which arose in the adaptation of the Schering bridge network for service at radio frequencies, and describes the final form taken by the arrangement of components, screened high-frequency sources, and screened detector-amplifier which has given a satisfactory performance at frequencies as high as one million cycles per second. The steps which had to be taken to insure a simultaneity of the main and auxiliary bridge balances and to expedite the convergence of the succession of balances upon the final simultaneous balance are explained.

- R212 O. Schmidt. Das Paralleldrahtsystem als Messinstrument in der Kurzwellentechnik. (The parallel wire system as an instrument of measurement in short-wave technique.) *Hochfrequenz. und Elektroakustik*, vol. 41, pp. 2-16; January, (1933).

The theory of the parallel wire system without natural damping is developed. It is shown that such a system can be considered as a non quasi stationary oscillating circuit. The use of the parallel wire system for the measurement of resistance, impedance, voltage, and current according to amplitude, phase and power is treated. A bibliography of 15 references on parallel wire methods is given.

- R214 F. R. Lack. Mounting quartz plates. *Bell Laboratories Record*, vol. 11, pp. 200-204; March, (1933).

×537.65

Some types of mountings for quartz plates are discussed. The advantages of the clamped plate holder are emphasized.

- R214 F. Hope-Jones. Time keeping—old and new. *Jour. Sci. Instr.* (London), vol. 10, pp. 43-49; February, (1933).

A discourse given at the Twenty-Third Annual Exhibition of the Physical Society. A historical survey of the development of time keeping devices is given. The important types of clocks are discussed. The accuracy and limitations of each are given.

- R243 P. Vigoureux and S. Watts. The temperature coefficient of the saturated Weston cell. *Proc. Phys. Soc.* (London), vol. 45, pp. 172-179; March, (1933).

The effect of temperature on the electromotive force and on the performance of acid Weston cells has been studied from -24 to +40 degrees C. The e.m.f. reached a maximum at about 3 degrees and at -20 degrees it was just over a millivolt less than the maximum. The cells behaved satisfactorily at -16 degrees, but at -18 degrees freezing took place gradually and was accompanied by a rapid decrease in e.m.f.

- R243.1 C. N. Smyth. A multi-range mains-operated valve voltmeter. *Wireless Engineer & Experimental Wireless* (London), vol. 10, pp. 134-137; March, (1933).

The design and behavior of a multi-range anode-bend vacuum tube voltmeter are described. The voltmeter derives its supplies from the alternating-current mains, covers a range of from 0.5 to 150 volts and, having a very high effective shunt impedance, is suitable for use up to radio frequencies.

- R256 A. Agricola. Messungen kleiner elektro-dynamischer Kräfte mit dem Kondensator-Mikrophon. (Measurements of small electrodynamic forces with the condenser microphone.) *Hochfrequenz. und Elektroakustik*, vol. 41, pp. 30-33; January, (1933).

The calibration of a condenser microphone for the measurement of small pressures is described.

### R300. RADIO APPARATUS AND EQUIPMENT

- R330 Ten more tubes. *QST*, vol. 17, pp. 23-26; March, (1933).

The types 19, 48, 79, ER1, 84(6Z4), 25Z5, 2A5, 2A3, 5Z3, are described.

- R330 L. Martin. Here are the new tubes. *RadioCraft*, vol. 4, pp. 586-588; April, (1933).

Data on the following vacuum tubes are given: 2A3, 5Z3, 2A5, 75, 12Z3, 25Z5, and 84.

- R330 M. Reiner. Constructing a simple, modern tube tester. *RadioCraft*, vol. 4, pp. 606-607; April, (1933).

Complete constructional details of a modern tube tester that tests the latest tubes without the use of adapters.

- R330 H. A. Wheeler. The emission valve modulator for superheterodynes. *Electronics*, vol. 6, pp. 76-77; March, (1933).

A multiple-grid vacuum tube is described, which is said to serve as; (1) combination oscillator-modulator, (2) high conversion gain, and (3) grid-bias volume control. The tube is called a hexode.

- R339 The Kathetron—A control tube with external grid. *Electronics*, vol. 6, pp. 70-72; March, (1933).

A mercury-vapor tube having an external grid is described.

- R339 A. W. Hull. Characteristics and functions of thyratrons. *Physics*, vol. 4, pp. 66-75; February, (1933).

A good description of the thyatron and its method of operation is given. The power rating, time lag of ionization and deionization, and applications are discussed. Several references are given.

- R339 A. C. Seletzky and S. T. Shevki. Plate and grid currents in a grid-controlled mercury-vapor tube. *Jour. Frank. Inst.*, vol. 215, pp. 299-326; March, (1933).

An oscillographic and quantitative investigation of the grid and plate currents of a grid-controlled mercury-vapor tube, operated in an alternating-current circuit, as functions of grid voltage and resistance, plate voltage, and phase displacement between grid and plate voltages.

- R339 C. Stansbury. A method of control for gas-filled tubes. *Electrical Eng.*, vol. 52, pp. 190-194; March, (1933).

Several methods of condenser discharge control for gas-filled electron tubes are described. The usual phase shift method is briefly mentioned.

- R360 C. F. Boeck. A radio distribution system for apartment buildings. *Bell Laboratories Record*, vol. 11, pp. 205-209; March, (1933).

The Western Electric 3A radio distribution system is described.



- R363 F. J. Moles. A supersensitive amplifier for measuring small currents. *Gen. Elec. Rev.*, vol. 36, pp. 156-158; March, (1933).  
An amplifier is described which uses two FP-54 vacuum tubes and is capable of measuring currents as small as  $10^{-17}$  amperes.
- R363 L. F. Curtiss. The elimination of background "noise" in sensitive pulse amplifiers. *Bureau of Standards Journal of Research*, vol. 10, pp. 151-154; February, (1933).  
A method of using several output tubes in parallel and selecting an operating point on the characteristic curve such that small fluctuations in the voltage applied to the control grids produce practically no change in the plate current, yet all pulses which exceed these fluctuations in the desired direction are reproduced in the plate current is described.
- R363 C. E. Kilgour. Push-pull amplifier graphics. *Electronics*, vol. 6, p. 73; March, (1933).  
A simple graphical method of solving problems of amplification is given.
- R365.21 C. N. Smith. Automatic volume control. *Wireless World* (London), vol. 32, pp. 134-137; February 17, (1933).  
The use of the double-diode-triode valve for quiet amplified and delayed automatic volume control. Four circuits are described.
- R365.3 T. H. Johnson and J. C. Street. A circuit for recording multiple-coincident discharges of Geiger-Mueller counters. *Jour. Frank. Inst.*, vol. 215, pp. 239-246; March, (1933).  
A circuit is described in which each of three Geiger-Mueller counters is connected to the grid of a tetrode, the negative pulse cutting off the plate current. The positive output pulse is inverted in a second tetrode stage and applied as a negative pulse to the grid of the third stage three-element low- $\mu$  tube. High sensitivity and elimination of false coincidences are claimed.
- R365.3 H. L. Bernarde. A new electronic recorder. *Electrical Eng.*, vol. 52, pp. 168-170; March, (1933).  
A recorder and amplifier are described which are suitable for measuring small thermal e.m.f.'s, vacuum tube voltages and currents, light intensities, and magnetic strain gage readings.
- R381 C. L. Dawes. Capacitance and potential gradients of eccentric cylindrical condensers. *Physics*, vol. 4, pp. 81-85; February, (1933).  
The method of inverse points and images is used to derive equations for the capacitance and potential gradient of eccentric cylindrical condensers.
- R382.1 A. J. Christopher. Tuned-transformer coupling circuits. *Bell Laboratories Record*, vol. 11, pp. 195-199; March, (1933).  
A type of low-loss air-core transformers which have both primary and secondary windings tuned with capacities is described. These transformers are of importance in carrier and radio development.
- R386 H. Piesch. Filter für Zwischenfrequenzverstärker. (Filter for intermediate-frequency amplifier.) *Hochfrequenz. und Elektroakustik*, vol. 41, pp. 23-26; January, (1933).  
The construction and method of operation of a new kind of filter chain is described which passes a broad frequency range without damping, and whose damping on the edges of this range rises very rapidly. As a special characteristic of this filter chain it is emphasized that within the transmission range the output voltage is higher than the input voltage, that the chain therefore possesses no damping loss, but acts as a voltage amplifier.
- R387.1 L. V. King. Electromagnetic shielding at radio frequencies. *Phil. Mag.* (London), vol. 15, pp. 201-223; February, (1933).  
The following subjects are treated mathematically. (1) Shielding ratio for a conducting spherical shell of finite thickness; (2) thin spherical shell, approximate formula for low frequencies; (3) thin spherical shell, asymptotic formula for radio frequencies; (4)

shielding ratio for a cylindrical shell of finite thickness in longitudinal magnetic field; (5) shielding ratio for a cylindrical shell of finite thickness in a transverse magnetic field; (6) thin cylindrical shell, approximate formula for low frequencies; (7) thin spherical shell, asymptotic formula for radio frequencies; (8) effect of magnetic permeability on shielding ratio of thin spherical shell, and on thin cylindrical shell. Some numerical examples are given.

- R388 L. F. Richardson. Time marking of a cathode-ray oscillogram. *Proc. Phys. Soc.* (London), vol. 45, pp. 135-141; March, (1933).

Time marks have been arranged as little blurs or gaps in the trace, by periodically defocusing the electron stream. The current in and voltage across a conductor can thus be recorded simultaneously with the time on a single oscillogram.

- R390 M. J. O. Strutt. Attenuation of transmission lines—Simple method of measuring. *Wireless Engineer & Experimental Wireless* (London), vol. 10, pp. 139-140; March, (1933).

On the input and output of the cable are placed voltmeters with internal impedance very large as compared to the wave impedance  $Z$ . The output is otherwise nonconnected. Then the frequency is varied, until the line is an entire number of half wavelengths long. When this condition is satisfied, the attenuation may be found by an equation which is given.

- R390 M. C. Gray. Mutual impedance of long grounded wires when the conductivity of the earth varies exponentially with depth. *Physics*, vol. 4, pp. 76-80; February, (1933).

A formula is presented for the mutual impedance of long grounded wires above the surface of the earth, on the assumption that the conductivity of the earth varies exponentially with the depth according to the formula  $\gamma = \gamma_0 e^{-bz}$ . For  $b=0$  the formula reduces to the result for a uniformly conducting earth, while if  $b$  is allowed to become negatively infinite it reduces to the result of an earth consisting of a conducting layer at the surface only. For small values of  $b$ , the first terms in the expansion of the impedance formula in powers of  $b$  are obtained, and curves are included of the real and imaginary parts of the coefficient of  $b$ .

- R390 C. M. Von Gewertz, Synthesis of a finite four-terminal network from its prescribed driving-point functions and transfer function. *Jour. Math. & Physics*, Massachusetts Institute of Technology, vol. 12, pp. 1-257; January, (1933).

A very complete and extensive treatment of the four-terminal network is given. A bibliography of 53 references is given. Following the theory of the network an appendix of numerical examples is included.

#### R400. RADIO COMMUNICATION SYSTEMS

- R423.5 Radio communication by very short electric waves. *Nature* (London), vol. 131, pp. 292-294; March 4, (1933).

The material used by Marchese Marconi in a lecture before the Royal Institution of Great Britain on December 2 is discussed. The development of the transmitting circuit, wavelength measurement, reflector arrangements, and ranges are discussed.

#### R500. APPLICATIONS OF RADIO

- R583 R. J. Kemp. Marconi television transmitter. Type TT5. *Marconi Rev.*, no. 39, pp. 7-18; November-December, (1932).

Description of transmitter.

#### R600. RADIO STATIONS

- R600 C. W. Horn. Proper sites for broadcast stations. *Electronics*, vol. 6, pp. 66-69; March, (1933).

It is proposed that due to the introduction of chain broadcast systems and the lack of interest of listeners in programs of distant stations, broadcast stations should be centrally located in the area that they are intended to serve—even in cities like New York.

CONTRIBUTORS TO THIS ISSUE

**Colwell, Robert C.:** Born October 14, 1884, at Fredericton, N. B., Canada. Received A.B. degree, Harvard University; M.A. degree, University of New Brunswick; Ph.D. degree, Princeton University. Professor of physics, Geneva College, 1913-1923; assistant director of radio laboratory, West Virginia University, 1924 to date. Member, American Physical Society, Franklin Institute, American Mathematical Society. Associate member, Institute of Radio Engineers, 1921; Member, 1929.

**Fox, Florian J.:** Born 1900. Graduated Yale, Sheffield Scientific School, electrical engineering, 1923. Development and research department, American Telephone and Telegraph Company, 1923-1924; Grimes Radio Engineering Company, 1924-1926; American Bosch Magneto Company, 1926-1928; Farrand Manufacturing Company, 1928-1929; Rogers-Majestic Corporation, Limited, 1929 to date. Associate member, Institute of Radio Engineers, 1927.

**Massa, Frank:** Born April 10, 1906, at Boston, Massachusetts. Received B.S. degree in electrical engineering, Massachusetts Institute of Technology, 1927; Swope Fellow, Massachusetts Institute of Technology, 1927-1928; M.S. degree in electrical engineering, Massachusetts Institute of Technology, 1928. Research engineer, Victor Talking Machine Company, 1928-1930; research engineer, RCA Victor Company, 1930 to date. Member, Acoustical Society of America. Associate member, Institute of Radio Engineers, 1930.

**Olson, Harry F.:** Born December 28, 1902, at Mount Pleasant, Iowa. Received B.E. degree, University of Iowa, 1924; M.S. degree, 1925, Ph.D. degree, 1928. Engineering department, Illinois Bell Telephone Company, 1924; research assistant, University of Iowa, 1925-1928; research department, Radio Corporation of America, 1928-1930; engineering department, RCA Photophone, 1930-1932; research division, RCA Victor Company, 1932 to date. Nonmember, Institute of Radio Engineers.

**Parker, Henry W.:** Born 1897 at New York City. Attended College of the City of New York, class of 1919. Research laboratory, General Electric Company, 1923-1929; manufacturing radio tubes, Rogers Radio Tubes, Limited, 1929 to date. Nonmember, Institute of Radio Engineers.

**Polydoroff, W. J.:** Born June, 1892, at St. Petersburg, Russia. Graduated Naval Academy with rank of Lieutenant of Navy, 1910; torpedo and wireless school, Kronstadt, 1913, wireless communication and experimental work for navy, 1914-1917; Centre d'Études et d'expériences de T.S.F. Mourillon, France, 1918; course in electrical engineering, Borough Polytechnic Institute, London. Consulting and industrial radio engineering, 1922-1923; radio research, Johnson Laboratories and consulting work, 1925 to date. Associate member, Institution of Electrical Engineers. Member, Institute of Radio Engineers, 1924.

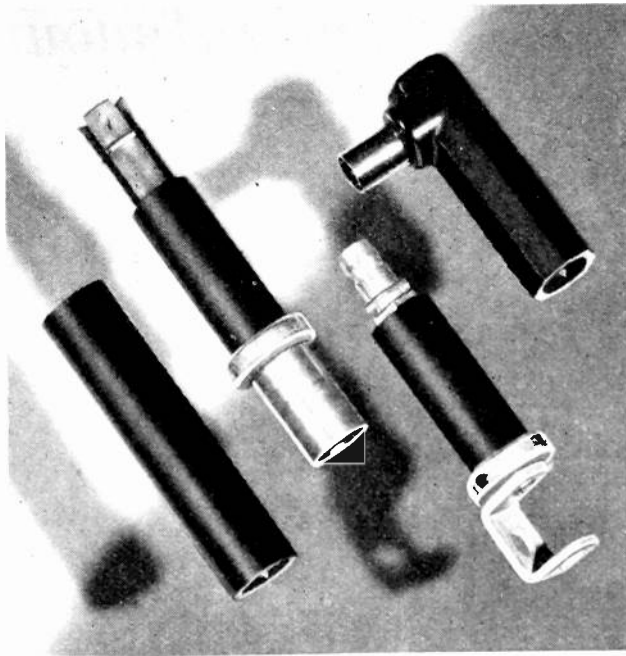

**When you specify  
Allen-Bradley  
Spark Plug Resistors**

you get the benefit of the pioneer experience of Allen-Bradley engineers who are foremost in the field of radio resistor design. In addition, their early work in the auto-radio field has made it possible for them to offer in Allen-Bradley Suppressors the finest spark plug resistors now available.



# Long Life

*that's the supreme criterion of spark plug resistors*

Allen-Bradley Suppressors are long lived. They remain permanent in resistance values even after thousands of miles of abusive automotive service.

They do not "open circuit" in service and thereby cripple the engine.

They do not "drop" in resistance and therefore fail as suppressors.

They do not have a "high voltage characteristic" which sharply decreases the suppressor resistance during each spark discharge and

thus defeats the purpose of the suppressor.

They do not fail from exposure to oil and water.

They do not break due to car or engine vibration. Careless mechanics are no terror to Allen-Bradley Suppressors, because the resistors are enclosed in rugged, non-arcing bakelite casings—not in brittle ceramic material.

The superiority of Allen-Bradley Suppressors can be easily demonstrated. Our engineers will gladly supply data and performance curves on resistors for your requirements. Write us today.

# Allen-Bradley

## FIXED AND VARIABLE RESISTORS

are the choice of the world's largest radio manufacturers. Bradleyometer volume control with tone compensation is an outstanding improvement in audio volume control. Write for complete information on low level tone compensation systems.

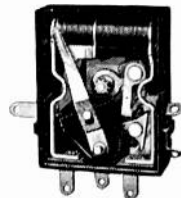

**ALLEN-BRADLEY CO., 116 W. Greenfield Ave., Milwaukee, Wisconsin**

*When writing to advertisers mention of the PROCEEDINGS will be mutually helpful.*

Now *Hygrade Sylvania* Announces

# A Complete Electronics Department

■ full production facilities

■ leading electronics engineers

WITH the formation of an extensive new Electronics Department, the Hygrade Sylvania Corporation now expands to meet all demands of the modern science of electronics!

In addition to quality lamp bulbs and radio set tubes, this company now produces radio transmitters, transmitter tubes, special receivers, industrial tubes and custom-built electronic devices of every specialized nature.

A technical staff composed of William J. Barkley, General Manager; D. E. Replogle, Chief Engineer; Victor O. Allen, Assistant Chief Engineer; and 22 other electronics engineers and executives, all formerly associated with the DeForest Radio Company; a complete research laboratory fully equipped for any purpose required in the electronic art; ample production facilities insured by a new fully equipped plant where all electronics work will be coordinated . . . all of these factors add to the Hygrade Sylvania resources the same skill and knowledge responsible for today's most important commercial applications of electronics.



The Hygrade Sylvania Corporation invites you to avail yourself of its technical experience, and vast production and research facilities. For consultations, write to:

**THE HYGRADE SYLVANIA CORP.**

*Electronics Division*

**64 Lakeview Avenue**

**Clifton, New Jersey**

*When writing to advertisers mention of the PROCEEDINGS will be mutually helpful.*

*"I'll call you up!"*



A HUSBAND bids his wife good-bye as he leaves in the morning. "I'll call you up," he says reassuringly. A guest leaves after a pleasant week-end. "I'll call you up," she tells her hostess. An executive sits at his desk. "I'll call you up," he answers many times a day.

"I'll call you up" is a phrase that has become part of our language and part of our modern security. It is a phrase of confidence and a phrase of friendship. Implied in it is a nearness to everything and everybody.

The familiar gesture of lifting the telephone receiver holds boundless possibilities. It may avert a danger, end an anxiety, insure an order. Or it may be for some trivial pleasant purpose—a jest to be shared, a greeting to be spoken.

Over the telephone speed the thoughts and ideas that change destiny, bring new hope to the wondering and greater achievement to the ambitious. Think what this world would be like if you could not telephone so easily to so many people. No friend or place is far away when you can say—"I'll call you up."



**AMERICAN TELEPHONE AND TELEGRAPH COMPANY**

*When writing to advertisers mention of the PROCEEDINGS will be mutually helpful.*

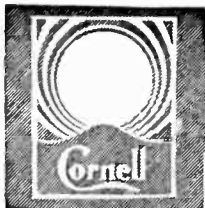

# Cornell

TRADE MARK REG.

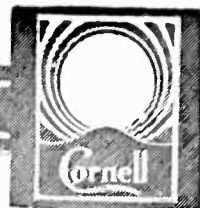

## For Radio and Industrial Use

# ELECTROLYTIC CONDENSERS

Every chemical and product that enters into a Cornell Dry Electrolytic condenser is tested and analyzed before use to prevent any possibility of variation from the strict Cornell standards that have been established.

Single and Dual Sections  
in Cardboard Boxes

Multiple Sections in  
Rectangular Metal Cans

By-Pass Dry Electrolytics

Cartridge Type Dry  
Electrolytics

Single, Dual and Multiple  
Sections  
in Round Metal Cans

High Capacity Dry A.C.  
Electrolytics

Paper and Dry Electrolytic  
Transmitting Condensers

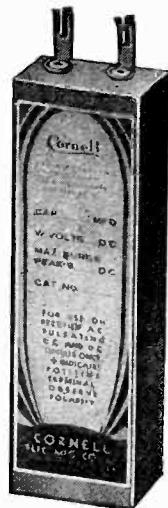

### WRITE FOR NEW CORNELL CATALOG

Our new catalog is just off the press. It illustrates and describes the complete Cornell line of Cub Condensers, Electrolytic Condensers, Paper Dielectric Capacitors for radio, television and ignition, and Resistors for radio and television.

## CORNELL ELECTRIC MFG. CO., Inc.

*Manufacturers of*

**CORNELL "CUB" CONDENSERS**

*Filter and By-Pass Condensers, Interference Filters and All Types of Paper Dielectric Capacitors and Resistors*

**LONG ISLAND CITY, NEW YORK**

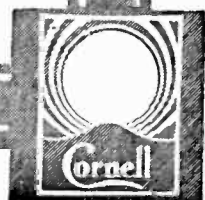
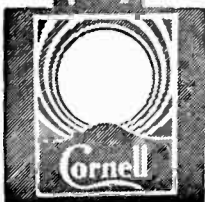

*When writing to advertisers mention of the PROCEEDINGS will be mutually helpful.*

# The Institute of Radio Engineers

Incorporated

33 West 39th Street, New York, N. Y.

## APPLICATION FOR ASSOCIATE MEMBERSHIP

(Application forms for other grades of membership are obtainable from the Institute)

To the Board of Direction

Gentlemen:

I hereby make application for Associate membership in the Institute of Radio Engineers on the basis of my training and professional experience given herewith, and refer to the members named below who are personally familiar with my work.

I certify that the statements made in the record of my training and professional experience are correct, and agree if elected, that I will be governed by the constitution of the Institute as long as I continue a member. Furthermore I agree to promote the objects of the Institute so far as shall be in my power, and if my membership shall be discontinued will return my membership badge.

.....  
(Sign with pen)

.....  
(Address for mail)

.....  
(Date)

.....  
(City and State)

### References:

(Signature of references not required here)

Mr. .... Mr. ....

Address ..... Address .....

City and State ..... City and State .....

Mr. ....

Address .....

City and State .....

The following extracts from the Constitution govern applications for admission to the Institute in the Associate grade:

### ARTICLE II—MEMBERSHIP

Sec. 1: The membership of the Institute shall consist of: \* \* \* (c) Associates, who shall be entitled to all the rights and privileges of the Institute except the right to hold any elective office specified in Article V. \* \* \*

Sec. 4: An Associate shall be not less than twenty-one years of age and shall be a person who is interested in and connected with the study or application of radio science or the radio arts.

### ARTICLE III—ADMISSION AND EXPULSIONS

Sec. 2: \* \* \* Applicants shall give references to members of the Institute as follows: \* \* \* for the grade of Associate, to three Fellows, Members, or Associates; \* \* \* Each application for admission \* \* \* shall embody a full record of the general technical education of the applicant and of his professional career.

*ENTRANCE FEE SHOULD ACCOMPANY APPLICATION*



(Typewriting preferred in filling in this form) No.....

# RECORD OF TRAINING AND PROFESSIONAL EXPERIENCE

Name .....  
(Give full name, last name first)

Present Occupation .....  
(Title and name of concern)

Business Address .....

Permanent Home Address .....

Place of Birth..... Date of Birth..... Age.....

Education .....

Degree ..... (college) ..... (Date received)

## TRAINING AND PROFESSIONAL EXPERIENCE

DATES	

Record may be continued on other sheets of this size if space is insufficient.

Receipt Acknowledged..... Elected..... Deferred.....  
Grade ..... Advised of Election..... This Record Filed.....

---

# Pacent *Carries On!*

**T**O SAFEGUARD and perpetuate one of the best known names in radio, Louis Gerard Pacent has personally purchased the principal assets of the Pacent Electric Company and Pacent Reproducer Corporation. His new organization, the Pacent Engineering Corporation, will manufacture and market the Pacent Essentials, as well as new products being developed by its research laboratory. A radically new merchandising policy insures

real profits to merchandisers, better products to engineers and manufacturers, and greater values and satisfaction to the public, because—

Just a few



## ESSENTIALS

Radioformers (Noiseless Reception)  
Line Filters (Line Silencer)  
Phonovoxes (Magnetic & Oil Damped)  
Recordovox (Home Recording Unit)  
Compensating Phonovox (A high quality Pickup with adjustable frequency characteristics)  
Phantom Antenna  
Transformers  
Talking Picture Sound Equipment  
Duo Lateral Coils, Rheostats, Plugs & Jacks  
PhonoMotors (Amplifiers)

**Research:** The organization maintains a fully equipped and manned research and development laboratory, from which new ideas and refinements of old ideas will come as the foundation for merchandising success.

**Production:** An efficient manufacturing plant of ample capacity at Seymour, Conn., assures the lowest production costs consistent with Pacent quality. A second plant at Ampere, N.J., will take care of the sound reproducing equipment and replacements.

**Merchandising:** Two decades of experience in the field of radio merchandising has served to point out the flaws of present-day radio marketing. A new merchandising policy has been evolved, assuring fresh opportunities to dealers and service men.

**Write** for details of the new and enlarged line of Pacent Essentials, as well as our "New Deal" Merchandising Plan.

## PACENT ENGINEERING CORPORATION

Louis Gerard Pacent, *Pres.*  
79 Madison Avenue, New York City

---

# PACENT

---

*When writing to advertisers mention of the PROCEEDINGS will be mutually helpful.*

# DEPENDABLE CONDENSERS

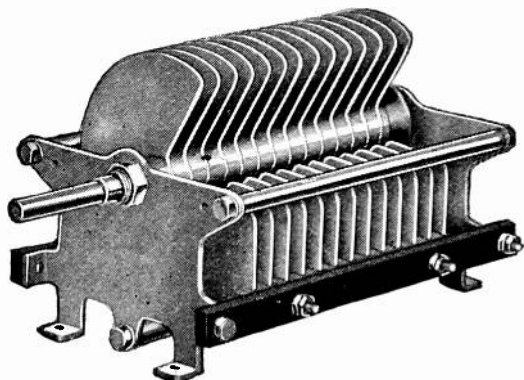

The CARDWELL line of condensers includes transmitting condensers for high, medium and low power, fixed oil dielectric condensers for induction furnaces and receiving condensers in infinite variety. The CARDWELL Midway Featherweight (all aluminum, none over 7 ounces in weight) for transmitting, receiving and neutralizing, is unequalled for aircraft and portable equipment.

•

CARDWELL made-to-order apparatus is well known for its excellence. We solicit your proposals. Our estimate on your requirements puts you under no obligations to us.

•

## CARDWELL CONDENSERS and MANUFACTURING SERVICE

The Allen D. Cardwell Mfg. Corp'n

93 Prospect Street, Brooklyn, N.Y.

---

**"THE STANDARD OF COMPARISON"**

---

*When writing to advertisers mention of the PROCEEDINGS will be mutually helpful.*

# PROFESSIONAL ENGINEERING DIRECTORY

For Consultants in Radio and Allied Engineering Fields

## FOR ADVANCED TRAINING

in:

Practical Radio Engineering  
Practical Television Engineering

write to

## CAPITOL RADIO ENGI- NEERING INSTITUTE

Riggs Bank Bldg.  
Washington, D.C.

## Cathode Ray Tubes and Associated Equipment For All Purposes

Write for Complete  
Technical Data

ALLEN B. DUMONT  
LABORATORIES  
UPPER MONTCLAIR, N.J.

## FOR MANY YEARS

the Professional Engineering Directory has helped consulting engineers, designers, and laboratory men make the right contacts in the radio industry. Perhaps we can help you with your problems too. For further information write to

*Advertising Department*

## INSTITUTE OF RADIO ENGINEERS

33 West 39th St.  
NEW YORK CITY, N.Y.

## LITTELFUSE LABORATORIES

*Specialists in*

Delicate Equipment Protection  
INSTRUMENTS and METERS  
RADIO RECEIVERS  
RADIO AMPLIFIERS  
RADIO TRANSMITTERS

Write for new Technical Bulletin No. 5  
1764 Wilson Ave., Chicago, Ill.

*For the Engineering Consultant*

*who can handle a little extra business this year*

*For the designer*

*who can manage some additional work*

*For the Patent Attorney*

*who is anxious to develop a larger clientele*

we suggest the Professional Engineering Directory of the PROCEEDINGS I.R.E. Manufacturers and organizations with special problems who need services such as yours come to the Professional Engineering Directory for information. Your name and special services announced here will tell them what you do and where to find you. Further information will be furnished on request. Special rates to members of the Institute.

*When writing to advertisers mention of the PROCEEDINGS will be mutually helpful.*

# EMPLOYMENT PAGE

Advertisements on this page are available to members of the Institute of Radio Engineers and to manufacturing concerns who wish to secure trained men for positions. All material for publication on this page is subject to editing from the Institute office and must be sent in by the 15th of the month previous to the month of publication. (May 15th for June PROCEEDINGS IRE, etc.) Employment blanks and rates will be supplied by the Institute office. Address requests for such forms to the Institute of Radio Engineers, 33 West 39th Street, New York City, N.Y.

**MANUFACTURERS** and others seeking radio engineers are invited to address replies to these advertisements at the Box Number indicated, care the Institute of Radio Engineers. All replies must be forwarded direct to the advertiser.

---

**COLLEGE GRADUATE**, Ph.D., has had four years as chief engineer in radio department of University of Wisconsin covering design construction and operation of all broadcast and experimental transmitters; instructor in radio engineering for two years. Two years research work in government department on radio frequency property of wood, then commercial connection on aircraft receiver and speech amplifier design. Three years chief transmission engineer for motion picture concern in charge of development of studio recording and re-recording channels and development of location transmission equipment. Desires research or development of transmission or receiving equipment, or supervision of transmission or research work. Age 28. Single. Will travel. Box 141.

---

**COLLEGE GRADUATE** with B.A. degree and two years post graduate work in physics and mathematics. Has had four years experience in large laboratory in radio research and engineering field, theoretical and experimental work with ultra-short wave transmitters and receivers. Nine months instructing in radio and assisting in physics laboratory. Has had thirteen years of active amateur experience. Desires work in ultra-short wave development. Age 24. Single. Will travel. Box 142.

---

**ASSOCIATE MEMBER** with three months experience in service and tube testing. One year, three months in interference elimination of man made static, two years as laboratory assistant in rail service and development concern. Desires work as broadcast operator, construction, maintenance or laboratory work on radio equipment. Age 25. Married. Will travel. Box 143.

---

**COLLEGE GRADUATE** with B.S. degree. Ten years experience in design and development of radio receivers, audio systems, loud speakers, and power supplies. Last four years in charge of receiver design for large radio manufacturer. Desires responsible position with manufacturer of sound equipment, vacuum tubes, electrical or laboratory apparatus or component parts. Age 33. Married. Will travel. Box 144.

*When writing to advertisers mention of the PROCEEDINGS will be mutually helpful.*

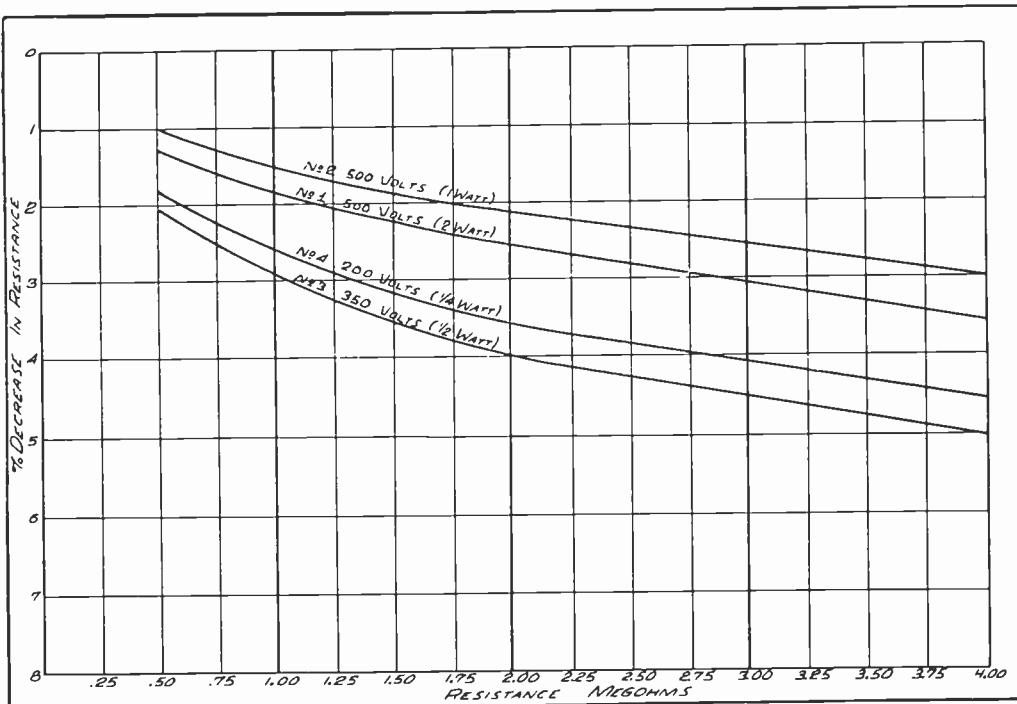

## IMPROVED VOLTAGE COEFFICIENT

Decided improvements in the voltage coefficient of ERIE RESISTORS have been made by our Engineering Department. On the higher resistance values the improvement reaches as high as 50% making those values far superior to any units previous offered.

For example on a No. 4 Resistor of 1 megohm resistance the drop from 20 to 200 volts averaged 5¼% and on the improved units (as shown on chart) is now about 2½%.

Again ERIE RESISTORS lead with an improved product.

# ERIE RESISTORS



ERIE RESISTOR CORPORATION, ERIE, PA.  
Factories in Erie, Pa., Toronto, Can., and London, Eng.

*When writing to advertisers mention of the PROCEEDINGS will be mutually helpful.*

# Take Your Choice

Every member of the Institute of Radio Engineers will want to wear one of these three attractive emblems. All of these emblems are appropriately colored to indicate the various grades of membership and each emblem is approximately the size of the following illustrations.



**The Lapel Button** is of 14k gold, with background enameled in the membership color, and with the lettering in gold. The screw-back on the back of this button fastens it securely to your coat.

\$2.75 postpaid—any grade.



**The Pin** is also of 14k gold. It is provided with a safety catch and is appropriately colored for the various grades of membership.

\$3.00 postpaid—any grade.



**The Watch Charm**, handsomely finished on both sides, is also of 14k gold. This charm is equipped with a suspension ring for attaching to a watch fob or chain.

\$5.00 postpaid—any grade.

*Orders, accompanied by checks made payable to the Institute of Radio Engineers, should be addressed to*

**THE INSTITUTE OF RADIO ENGINEERS**

33 West 39th Street  
NEW YORK CITY, N. Y.

*Send in your order now!*

*When writing to advertisers mention of the PROCEEDINGS will be mutually helpful.*

# CHANGE IN MAILING ADDRESS OR BUSINESS TITLE

Members of the Institute are asked to use this form for notifying the Institute office of a change in their mailing address or the listing of their company affiliation or title in the Year Book.

The Secretary,  
THE INSTITUTE OF RADIO ENGINEERS,  
33 West 39th Street,  
New York, N.Y.

Dear Sir:

Effective ..... please note change in my address  
(date)  
for mail as follows:

FROM

.....  
(Name)

.....  
(Street Address)

.....  
(City and State)

TO NEW ADDRESS

.....  
(Street Address)

.....  
(City and State)

Please note following change in my Year Book listing.

.....  
(Title)

.....  
(Company Name)

.....  
(Company Address)

*When writing to advertisers mention of the PROCEEDINGS will be mutually helpful.*



---

---

## Alphabetical Index to Advertisements

### A

American Tel. & Tel. Co. ....IX  
Allen-Bradley Co. ....VII

### C

Cardwell, Allen D., Mfg. Corp. ...XIV  
Central Radio Laboratories ....XXII  
Cornell Electric Mfg. Co. ....X

### E

Employment Page .....XVI  
Erie Resistor Corp. ....XVII

### G

General Radio Co. .Outside Back Cover

### H

Hygrade Sylvania Corp. ....VIII

### I

I.R.E. ....XI, XII, XVIII,  
XIX, Inside Back Cover

### P

Pacent Engineering Corp. ....XIII  
Professional Eng. Directory .....XV

### W

Weston Elec. Inst. Corp. ....XXI

---

---

## PROCEEDINGS BOUND VOLUMES



Volume 20 (1932) of the Proceedings is now available in bound form to members of the Institute. It may be obtained in Buckram or Morocco leather for \$9.50 and \$11.00 respectively.

Bound copies of volumes 18 and 19 (1930 and 1931) are also available at the same price.

*When writing to advertisers mention of the PROCEEDINGS will be mutually helpful.*



- Analyzer
- Volt-Ohmmeter
- Test Oscillator
- Tube Checker
- Capacity Meter

*Now—*  
**all 5 in one set**  
*to satisfy every service requirement*

COMPACTLY housed in a single carrying kit, Weston now offers the complete set of 5 Standardized Service Units: Analyzer, Volt-Ohmmeter, Test Oscillator, Tube Checker and Capacity Meter. The combination is a portable laboratory that makes intelligent servicing of any set easy and certain. It contains every instrument for making both Point-To-Point and Tube Checker-Analyzer tests as desired.

With the addition of this 5 unit set Weston has rounded out its line of Standardized Service Unit combinations. Those who prefer the Tube Checker-Analyzer

method will want the set containing the Test Oscillator, Tube Checker and Analyzer. For those who prefer the Point-To-Point method Weston offers the kit containing a Test Oscillator, Capacity Meter and Volt-Ohmmeter.

Bear in mind that each unit is entirely independent and can be bought and used separately. It can then be combined in the multiple unit case at some later date. We will be glad to furnish detailed description. Write to ..... Weston Electrical Instrument Corporation, 589 Frelinghuysen Avenue, Newark, New Jersey.

# WESTON·JEWELL

## *Radio Instruments*

Weston Electrical Instrument Corp.  
 589 Frelinghuysen Avenue  
 Newark, N. J.

Name.....

Please send me further  
 information on Weston-  
 Jewell Service Equipment.

Address.....

*When writing to advertisers mention of the PROCEEDINGS will be mutually helpful.*



» » » » Today, when complete sets list for what the tubes formerly cost . . . the consumer still expects **QUALITY**.

That is why wise manufacturers specify **CENTRALAB** Volume Controls and Centralab Fixed Resistors.

Centralab products still maintain their high standard of quality in spite of the

fact that they are priced to meet present-day price trends.

Write to our engineering department for samples built to your specifications.

**CENTRAL RADIO LABORATORIES · MILWAUKEE**

**Centralab**

**FIXED RESISTORS · VOLUME CONTROLS  
 MOTOR RADIO NOISE SUPPRESSORS**

*When writing to advertisers mention of the PROCEEDINGS will be mutually helpful.*

# Don't Take Chances on Destroying Valuable Information!

Protect your back issues of the PROCEEDINGS with a binder that will stand abuse; a binder that will hold twelve issues and keep them all together for easy reference.

We can, to be sure, usually fill orders for back issues, but occasionally we may not have the one necessary to complete your reference work—this means unnecessary delay and delay means dollars.

Be sure—get a binder now and protect those back issues.

## PROCEEDINGS BINDER

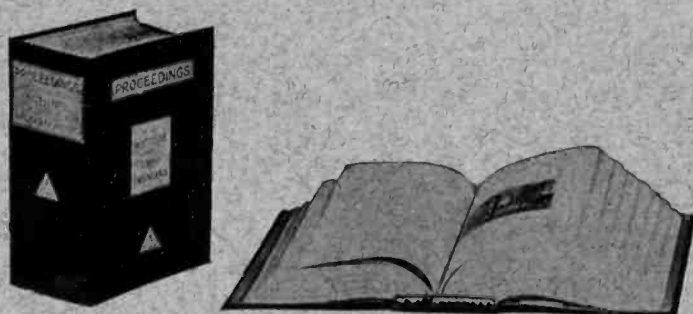

Binder of handsome Spanish Grain Fabrikoid in blue and gold. Can be used as temporary transfer binder or as a permanent cover. Wire fasteners hold each copy in place and permit removal of any issue from binder in a few seconds. All issues lie flat when binder is opened.

**BINDER (holds complete 1931 or 1932 copies) . . . . . \$1.75**

*(Name stamped on volume for \$.50 additional)*

*Send orders for binders, accompanied by remittance, to*

**INSTITUTE OF RADIO ENGINEERS**

33 West 39th Street

New York City, New York



*Announcing - - -*

## THE IDEAL MIXER CONTROL

### TYPE 653 VOLUME CONTROL

Type 653-MA: 50 ohms

Type 653-MB: 200 ohms

Type 653-MC: 500 ohms

All sizes, same price

**\$12.50**

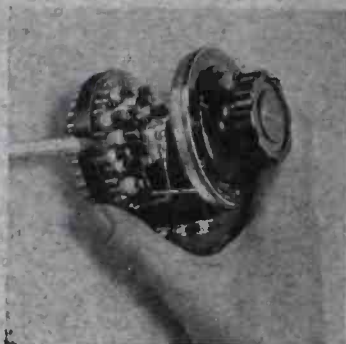

A new General Radio volume control is now available with all the desirable features that go to make for satisfactory mixer operation. It is mechanically rugged, free from noise in low-impedance circuits, and low in price. Nothing equals it in performance. Note these important features:

### FEATURES

Large number of steps, no sliding contacts on wire

Linear attenuation up to 45 db

Complete cutoff beyond the 45 db point

Frequency characteristic flat to 10,000 cycles, independent of setting

Stops work against the knob, not against the switch blade, thus eliminating "over riding"

Ladder-type network with only one sliding contact, constant impedance, and the complete cutoff feature

Easy mounting, two holes on the standard 1½ inch spacing

*Send Today for this Mixer Bulletin*

Ask us to send you Bulletin Ex-3303R which describes in detail many tested mixer circuits for practically all common installation problems. Address the General Radio Company, Cambridge, Massachusetts.

**GENERAL RADIO Co.**  
INSTRUMENTS OF PRECISION AND DEPENDABILITY

GEORGE BANTA PUBLISHING COMPANY, MENASHA, WISCONSIN