

VOLUME 19

MAY, 1931

NUMBER 5

PROCEEDINGS
of
The Institute of Radio
Engineers



1931 CONVENTION
Chicago, Illinois
June 4, 5, and 6

Form for Change of Mailing Address or Business Title on Page XLIII

TENTATIVE PROGRAM OF SIXTH ANNUAL CONVENTION INSTITUTE OF RADIO ENGINEERS
CHICAGO, ILLINOIS
JUNE 4, 5, AND 6, 1931

Wednesday—June 3

2:00 P.M.-8:00 P.M. Registration.

Thursday—June 4

- 8:00 A.M.-10:00 A.M. Registration and inspection of exhibits.
10:00 A.M.-12:00 Noon. Opening session. Addresses of welcome by Ray H. Manson, President of the Institute, and Byron B. Minnium, Chairman of the Chicago Section and Chairman of the Convention Committee. These addresses will be followed by a technical session.
12:00 Noon-1:30 P.M. Official luncheon. Address by Colonel Isham Randolph, President of the Association of Commerce of Chicago.
1:30 P.M.-2:00 P.M. Inspection of exhibits.
2:00 P.M.-5:00 P.M. Trip No. 1 to Grigsby-Grunow Company and Stewart-Warner Corporation.
2:00 P.M.-3:30 P.M. Technical Session.
2:00 P.M.-3:30 P.M. Trip No. 2, Shopping trip for ladies.
3:30 P.M.-5:00 P.M. Inspection of exhibits.
3:30 P.M.-5:00 P.M. Trip No. 3. Ladies tea and fashion promenade.
4:00 P.M.-5:30 P.M. Trip No. 4. American Telephone and Telegraph Company and Illinois Bell Telephone Company.
4:00 P.M.-5:30 P.M. Trip No. 5. National Broadcasting Company studios.
8:00 P.M. Lecture on "Modern Conceptions of the Electron" by Professor A. H. Compton of the University of Chicago.
8:15 P.M.-11:00 P.M. Theater party for ladies.
9:00 P.M. Inspection of Ryerson Laboratory of the University of Chicago.
9:00 P.M. Annual meeting of the Committee on Sections at the University of Chicago.

Friday—June 5

- 9:00 A.M.-10:00 A.M. Inspection of exhibits.
10:00 A.M.-12:00 Noon. Technical Session.
9:00 A.M.-12:00 Noon. Trip No. 6. Ladies sight-seeing tour.
12:00 Noon-1:00 P.M. Inspection of exhibits.
1:00 P.M.-5:00 P.M. Trip No. 7. Hawthorne Works of the Western Electric Company.
1:30 P.M.-4:30 P.M. Trip No. 8. Luncheon and bridge for ladies.
5:00 P.M.-7:00 P.M. Inspection of exhibits.
7:00 P.M. Banquet, entertainment, and dancing.

Saturday—June 6

- 9:30 A.M.-12:00 Noon. Trip No. 9. Ladies trip to Art Institute, Field Museum, or Aquarium.
10:30 A.M.-12:00 Noon. Technical Session.
12:00 Noon-1:00 P.M. Inspection of exhibits.
1:00 P.M. Trip No. 10. Riverbank Laboratories. (Ladies invited).

PROCEEDINGS OF

The Institute of Radio Engineers

Volume 19

May, 1931

Number 5

Board of Editors

ALFRED N. GOLDSMITH, <i>Chairman</i>	G. W. PICKARD
STUART BALLANTINE	L. E. WHITEMORE
RALPH BATCHER	
W. WILSON	

CONTENTS

PART I	PAGE
Condensed Program of Sixth Annual Convention.....	Inside front cover
Frontispiece, Arthur H. Compton.....	696
Institute News and Radio Notes.....	697
Chicago Convention of the Institute.....	697
April Meeting of the Board of Direction.....	709
Radio Signal Transmissions of Standard Frequency.....	710
Committee Work.....	712
Institute Meetings.....	713
PART II	
<i>Technical Papers</i>	
Output Networks for Radio-Frequency Power Amplifiers.. W. L. EVERITT	725
Theory and Operation of Tuned Radio-Frequency Coupling Systems.....	
..... H. A. WHEELER AND W. A. MAC DONALD	738
Discussion.....	804
..... L. A. HAZELTINE	
Test Procedure for Detectors with Resistance Coupled Output.....	
..... G. D. ROBINSON	806
Radiation Measurements of Short-Wave Beam Antenna at the Nauen High Power Radio Station.....	
..... M. BÄUMLER, K. KRÜGER, H. PLENDL, AND W. PFITZER	812
On the Amplitude of Driven Loud Speaker Cones.....	839
..... M. J. O. STRUTT	
Engineering Testimony Before Official Bodies.....	851
..... E. H. FELIX	
Oscillations in the Circuit of a Strongly Damped Triode... F. VECCHIACCI	856
Selectivity.....	873
..... B. DE F. BAYLY	
Effects of Sun Spots and Terrestrial Magnetism on Long-Distance Reception of Low-Frequency Waves.....	882
..... E. YOKOYAMA AND T. NAKAI	
Reflection of Electromagnetic Waves at Ionized Media with Variable Conductivity and Dielectric Constant.....	891
..... G. J. ELIAS	
Corrections.....	908
Book Review.....	909
Booklets, Catalogs, and Pamphlets Received.....	910
Monthly List of References to Current Radio Literature.....	911
Contributors to This Issue.....	916

Copyright, 1931, by the Institute of Radio Engineers

The Institute of Radio Engineers

GENERAL INFORMATION

The PROCEEDINGS of the Institute is published monthly and contains papers and discussions thereon submitted for publication or for presentation before meetings of the Institute or its Sections. Payment of the annual dues by a member entitles him to one copy of each number of the PROCEEDINGS issued during the period of his membership.

Subscription rates to the PROCEEDINGS for the current year are received from nonmembers at the rate of \$1.00 per copy or \$10.00 per year. To foreign countries the rates are \$1.10 per copy or \$11.00 per year.

Back issues are available in unbound form for the years 1918, 1920, 1921, 1922, 1923, and 1926 at \$9.00 per volume (six issues) or \$1.50 per single issue. For the years 1913, 1914, 1915, 1916, 1917, 1919, 1923, 1924, and 1925 miscellaneous copies (incomplete unbound volumes) can be purchased for \$1.50 each; for 1927, 1928, and 1929 at \$1.00 each. The Secretary of the Institute should be addressed for a list of these.

Discount of twenty-five per cent is allowed on all unbound volumes or copies to members of the Institute, libraries, booksellers, and subscription agencies.

Bound volumes are available as follows: for the years 1922 and 1926 to members of the Institute, libraries, booksellers, and subscription agencies at \$8.75 per volume in blue buckram binding and \$10.25 in morocco leather binding; to all others the prices are \$11.00 and \$12.50, respectively. For the year 1929 the bound volume prices are: to members of the Institute, libraries, booksellers, and subscription agencies, \$9.50 in blue buckram binding; to all others, \$12.00. Foreign postage on all bound volumes is one dollar, and on single copies is ten cents.

The 1931 Year Book, containing general information, the Constitution and By-Laws, Standards Report, Index to past issues of the PROCEEDINGS, catalog of membership, etc., is available to members at \$1.00; to nonmembers, \$1.50.

Contributors to the PROCEEDINGS are referred to the following page for suggestions as to approved methods of preparing manuscripts for publication in the PROCEEDINGS.

Advertising rates for the PROCEEDINGS will be supplied by the Institute's Advertising Department, Room 802, 33 West 39th Street, New York, N.Y.

Changes of address to affect a particular issue must be received at the Institute office not later than the 15th of the month preceding date of issue. That is, a change in mailing address to be effective with the October issue of the PROCEEDINGS must be received by not later than September 15th. Members of the Institute are requested to advise the Secretary of any change in their business connection or title irrespective of change in their mailing address, for the purpose of keeping the Year Book membership catalog up to date.

The right to reprint portions or abstracts of the papers, discussions, or editorial notes in the PROCEEDINGS is granted on the express condition that specific reference shall be made to the source of such material. Diagrams and photographs published in the PROCEEDINGS may not be reproduced without making special arrangements with the Institute through the Secretary.

It is understood that the statements and opinions given in the PROCEEDINGS are views of the individual members to whom they are credited, and are not binding on the membership of the Institute as a whole.

All correspondence should be addressed to the Institute of Radio Engineers, 33 West 39th Street, New York, N.Y., U.S.A.

Entered as second class matter at the Post Office at Menasha, Wisconsin.

Acceptance for mailing at special rate of postage provided for in the Act of February 28, 1925, embodied in paragraph 4, Section 412, P. L. and R. Authorized October 26, 1927.

Published monthly by

THE INSTITUTE OF RADIO ENGINEERS, INC.

Publication office, 450-454 Ahnaip Street, Menasha, Wis.

BUSINESS, EDITORIAL, AND ADVERTISING OFFICES,

Harold P. Westman, *Secretary*

33 West 39th St., New York, N.Y.

SUGGESTIONS FOR CONTRIBUTORS TO THE "PROCEEDINGS"

Preparation of Paper

Form—Manuscripts may be submitted by member and nonmember contributors from any country. To be acceptable for publication, manuscripts should be in English, in final form for publication, and accompanied by a summary of from 100 to 300 words. Papers should be typed double space with consecutive numbering of pages. Footnote references should be consecutively numbered and should appear at the foot of their respective pages. Each reference should contain author's name, title of article, name of journal, volume, page, month, and year. Generally, the sequence of presentation should be as follows: statement of problem; review of the subject in which the scope, object, and conclusions of previous investigations in the same field are covered; main body describing the apparatus, experiments, theoretical work, and results used in reaching the conclusions and their relation to present theory and practice; bibliography. The above pertains to the usual type of paper. To whatever type a contribution may belong, a close conformity to the spirit of these suggestions is recommended.

Illustrations—Use only jet black ink on white paper or tracing cloth. Cross-section paper used for graphs should not have more than four lines per inch. If finer ruled paper is used, the major division lines should be drawn in with black ink, omitting the finer divisions. In the latter case, only blue-lined paper can be accepted. Photographs must be very distinct, and must be printed on glossy white paper. Blueprinted illustrations of any kind cannot be used. All lettering should be 3/16 in. high for an 8 x 10 in. figure. Legends for figures should be tabulated on a separate sheet, not lettered on the illustrations.

Mathematics—Fractions should be indicated by a slanting line. Use standard symbols. Decimals not preceded by whole numbers should be preceded by zero, as 0.016. Equations may be written in ink with subscript numbers, radicals, etc., in the desired proportion.

Abbreviations—Write a.c. and d.c. (a-c and d-c as adjectives), kc, μ f, $\mu\mu$ f, e.m.f., mh, μ h henries, abscissas, antennas. Refer to figures as Fig. 1, Figs. 3 and 4, and to equations as (5). Number equations on the right in parentheses.

Summary—The summary should contain a statement of major conclusions reached, since summaries in many cases constitute the only source of information used in compiling scientific reference indexes. Abstracts printed in other journals, especially foreign, in most cases consist of summaries from published papers. The summary should explain as adequately as possible the major conclusions to a nonspecialist in the subject. The summary should contain from 100 to 300 words, depending on the length of the paper.

Publication of Paper

Disposition—All manuscripts should be addressed to the Institute of Radio Engineers, 33 West 39th Street, New York City. They will be examined by the Committee on Papers and by the Editor. Authors are advised as promptly as possible of the action taken, usually within one month.

Proofs—Galley proof is sent to the author. Only necessary corrections in typography should be made. *No new material is to be added.* Corrected proofs should be returned *promptly* to the Institute of Radio Engineers, 33 West 39th Street, New York City.

Reprints—With the galley proof a reprint order form is sent to the author. Orders for reprints must be forwarded promptly as type is not held after publication.

INSTITUTE SECTIONS

<i>Chairmen</i>	<i>Secretaries</i>
H. F. Dobbs	ATLANTA Philip C. Bangs, 23 Kensington Rd., Avondale Estates, Ga.
George W. Pierce	BOSTON Melville Eastham, 30 State St., Cambridge, Mass.
Stanley W. Brown	BUFFALO-NIAGARA E. C. Waud, 235 Huntington Ave., Buffalo, N. Y.
Byron B. Minnium	CHICAGO J. Barton Hoag, Ryerson Laboratory, University of Chicago, Chicago, Ill.
D. D. Israel	CINCINNATI Ralph P. Glover, 5737 Hamilton Ave., Cincinnati, Ohio.
G. B. Hammon	CLEVELAND P. A. Marsal, National Carbon Co., Inc., P.O. Box No. 400, Cleveland, Ohio.
R. S. Kruse	CONNECTICUT VALLEY George Grammer, 52 S. Beacon St., Hartford, Conn.
Lewis N. Holland	DETROIT Samuel Firestone, Room 615, 2000 Second Ave., Detroit, Mich.
T. E. Nikirk	LOS ANGELES L. Elden Smith, 340 N. Painter Ave., Whittier, Calif.
Pendleton E. Lehde	NEW ORLEANS Anton A. Schiele, 1812 Masonic Temple, New Orleans, La.
W. R. G. Baker	PHILADELPHIA G. C. Blackwood, 243 E. Upsal St., Mt. Airy, Philadelphia, Pa.
L. A. Terven	PITTSBURGH C. F. Donbar, 233 South Starr Ave., Bellevue, Pa.
Harry E. Gordon	ROCHESTER Howard A. Brown, Rochester G. & E. Co., 89 East Ave., Rochester, N. Y.
Walter D. Kellogg	SAN FRANCISCO Paul R. Fenner Custom House, San Francisco, Calif.,
Abner R. Willson	SEATTLE L. C. Austin, Woolley and Co., Inc., 1113 Third Ave., Seattle, Wash.
J. M. Leslie	TORONTO R. A. Hackbusch, Stromberg Carlson Tel. Mfg. Co., 211 Geary Ave., Toronto, Ont., Canada.
L. P. Wheeler	WASHINGTON Herbert G. Dorsey, U. S. Coast and Geodetic Survey, Washington, D. C.

GEOGRAPHICAL LOCATION OF MEMBERS ELECTED APRIL 1, 1931

Transferred to the Member grade		
New York	New York, c/o WRNY, 27 West 57th St.	Mc Laughlin, J. L.A.
Elected to the Member grade		
New Jersey	Mountain Lakes	Wilson, James R.
New York	New York, 60 Hudson St., Rm. 1724	Nelson, Crescent F.
Australia	Sydney, Amalgamated Wireless (A/sia) Ltd.	Hooke, L. A.
Elected to the Associate grade		
Arkansas	Dermott, Box 672	Fortune, W. F.
	Fayetteville, A. L. T. House	Albrecht, H. D.
	Texarkana, 404 State Line	Mims, M. P.
California	Los Angeles, 812 E. 28th St.	Boring, H. M.
	Los Angeles, 711 W. 2nd St.	Harris, Leland D.
	Palo Alto, c/o Mackay Radio & Tel. Co.	Wardlow, H. V.
	Pasadena, c/o Y.M.C.A.	Lindsay, W. F.
	San Francisco, c/o Radio KUP, 36 Annie St.	Paschal, W. P.
	San Francisco, 531 Call Building	Tobin, L. C.
Connecticut	Burnside, 48 Livingston Rd.	Gray, J. B.
Dist. of Columbia	Washington, National Press Bldg.	Lebowitz, S.
Florida	St. Petersburg, 725-15th St., No.	Lynn, W. L.
Idaho	Moscow, 904 Deakin St.	Kiebert, M. P.
Illinois	Chicago, 1907 Oakdale Ave.	Dillard, G. B.
	Chicago, 1804 W. Congress St.	Rice, Robert E.
	Chicago, 1647 Edgewater Ave.	Schuster, A. M.
	Chicago, c/o Automatic Electric, Inc.	Wu, S. W.
	Downers Grove, Great Lakes Broadcasting Co.	Mc Donnell, W. J.
Indiana	Angola, Box No. 164	Cooke, B. D.
	Fort Wayne, c/o Magnovox	Dempster, B.
Iowa	De Witt, 415-5th St.	Martin, Ray L.
	Iowa City, 225 Iowa Ave.	Potter, J. L.
Kansas	Sabetha, 53 Main St.	Baker, Fred L., Jr.
Maryland	Aberdeen, Broadway	Brown, W. C.
	Silver Spring, 8801 Georgia Ave.	Koehne, I. C.
Massachusetts	Brookline, 195 Davis Ave.	Sampson, G. L.
	Cambridge, 8 Maple Ave.	Horn, Tyree R.
	Cohasset	Gagnabin, William B.
	Newton, 67 Dalby St.	Sivigny, A. J.
	Springfield, 78 College St.	Cushing, T. F.
	Springfield, 51 Eureka St.	Ferguson, J. C.
Michigan	Ann Arbor, 1033 Packard St.	Nelson, W. H.
	Detroit, 19132 Greeley	Bradley, F. W.
Montana	Anaconda, 620 East Park Ave.	Antonich, P. L.
Nebraska	Rovenna, 323 Grand Ave.	Mc Connell, R. H.
New Jersey	Audubon, 227 Virginia Ave.	Creighton, R. R.
	Camden, R.C.A.-Victor Co., Eng. Dept.	Hughes, M. S.
	Camden, R.C.A.-Victor Co.	Lecchi, P. A.
	Merchantville, 123 S. Lexington Ave.	Emlein, Harold M.
	Newark, 74 S. 10th St.	Cartwright, R. V.
	Newark, 482 So. 19th St.	Macintosh, W.
New York	Rahway, R.F.D. No. 2, Box 107 D	Hubbard, C. W.
	Brooklyn, 6805 Baycliff Terrace	Buzalski, T. J.
	Brooklyn, 38 Slocum Place	Mc Cormick, H. L.
	Brooklyn, 679 Franklin Ave.	Mullen, J. F.
	Brooklyn, 7001-10th Ave.	Nardone, A. J.
	Flushing, L. I., Flushing Hospital	Feliciano, F. A.
	Jackson Heights, L. I., 37-20-81 St.	Swift, W. C. G.
	New York City, 711 Fifth Ave., Control Rm.	Grey, Charles C.
	New York City, 180 Varick St., Rm. 825	Jones, R. J.
	New York City, c/o Surprenant & Co., 350 Madison Ave.	Stanford, K. J.
	New York City, 27 East 30th St.	Terry, C. B.
	New York City, 463 West St.	Veazie, E. A.
	New York City, 127 West 96th St.	Wilson, D. B.
	Nyack, Grand View, 9 W. Highway	Stansbury, M. L.
	Richmond Hill, L. I., 9430-113th St.	Berry, F. L.
	Riverhead, 57 Moriches Road	Winans, Paul
	Schenectady, 1405 Grand Blvd.	Smith, H. A.
	Utica, 316 Cooper St.	Mallett, R. W.
	Waverly, 430 Cayuta Ave.	Sosnoski, W. J.
	West New Brighton, S. I., 191 Franklin St.	Langhammer, C. F.

Geographical Location of Members Elected April 1, 1931

Ohio	Blue Ash, Hunt Rd. & Conklin Ave.	Chapman, R. T.
	Cincinnati, 4133 Kirby Road	Robins, Daniel C.
	Cuyahoga Falls, 1539 Front St.	Makinson, G. E.
Pennsylvania	Mt. Gilead, 30 W. Center St.	Bush, Paul W.
	East Pittsburgh, Westinghouse Elec. & Mfg.	Plotts, Ellery L.
	Emporium, Warner House	Klinestiver, G. H.
	Philadelphia, 8419 Anderson St.	DaCosta, R. C.
	Philadelphia, 2303 W. Thompson St.	Guinan, John J.
	Philadelphia, H. H. Eby Mfg. Co.	Lodge, E. G.
	Philadelphia, H. H. Eby Mfg. Co.	White, C. D.
	Pittsburgh, 109 N. Graham St.	Templeman, David
	West Fairview, 508 Third St.	Ottery, Raymond B.
	Wilkinsburg, Penn Lincoln Hotel	Stoddard, Ralph N.
Rhode Island	Providence, 92 Early St.	Slocum, Walter E.
Tennessee	Jackson, 319 W. King St.	Dike, E. R.
Texas	Beaumont, 1645 Avenue G.	Murphree, H. L.
	Fort Worth, Airways Radio Station	Carpenter, C. I.
	Forth Worth, 4725 Birchman	Stinson, R. C.
Virginia	Quantico, Marine Corps Radio School, M.B.	Lockard, M. R.
	Quantico, 87th Co., Signal Bn.	Williams, Gerald R.
Washington	Everett, 2015 State St.	Eckstrom, H. E.
	Seattle, 1304 E. 62nd St.	Gleason, R. J.
	Seattle, 4042-51st Ave., S.W.	Lischke, Carl C.
Canada	Haileybury, Ont.	Thorpe, E. O.
	Hamilton, Ont., 7 Maine St.	Aiston, L.
	Toronto, Ont., 1792 Bloor St., W.	Choate, H. R.
	Toronto, Ont., 136 Chester Ave.	Gunn, Donald
	Toronto, Ont., 597 Bathurst St.	Hamilton, H. E. S.
	Toronto, Ont., 296 Garden Ave.	Ure, William C., Jr.
	Toronto, Ont., 48 Hiltz Ave.	Williams, H. S.
	Vancouver, Northern Electric Co.	Walker, E. N.
Central America	Nicaragua, Managua, All American Cables	Smith, T. R.
Egypt	Alexandria, Ras-el-Tin, 4 Magawry St.	Shiha, A. M.
China	Hangchow, University of Chekiang	Woung, S. S.
England	Birkenhead, Cheshire, 260 Conway St.	Thornton, J.
	Bradford, Yorkshire, 74 Morley St.	Ault, Harold B.
	Crosshills Keighley, 1 Newby St.	Smith, Harold
	Gt. Bookham, Surrey, "Byways" Sole Farm Rd.	Hesse, C. M.
	High Heaton, Newcastle-on-Tyne, 7 Horsley Rd.	Rush, James
	Hornsey, London, N. 8, 23 Ravenstone Rd.	Clark, R. G.
	Leicester, 5 Poplar Ave.	Charles, E. E.
	Moorgate, London, E. C. 2, I & I. C., Ltd.	Bruce, J. R.
	Rotherhithe, London, S.E. 16, 12 Henwood Rd.	Baxter, H. W.
	Southampton, Bellevue Terrace, 7 Glenloyn Terrace	Corney, W. D.
Italy	Genova, Via A. G. Barrili 1/26 A.	Buttolo, Romeo L.
Japan	Ishikawaken, Kanazawa City, Kanazawa Broadcasting Station JOJK	Nagamura, S.
New Zealand	Macandrew Bay, "Woodford"	Budd, L. W.
	Wellington, 183 Willis St.	Blackwell, W. J.
	Wellington, Box 605	McCutcheon, W. A.
Scotland	Edinburgh, 7, Mertoun Place	Miller, John C.
Elected to the Junior grade		
California	Los Angeles, 3501 Floral Dr.	Katzman, Louis
	San Francisco, 16 Avila St.	Letsinger, Paul R.
Dist. of Columbia	Washington, 2151 California St., N.W.	Dunne, William
Oklahoma	Tulsa, 2622 E. Archer	Roach, Harry J.
Oregon	Milwaukee, R. 10, Box 178	Perkins, O. D.
Utah	Salt Lake City, 632 Wilson Ave.	Peterson, H. C.
Australia	Melbourne, Vic., 55 Aintree Rd.	Lee-Archer, E.



APPLICATIONS FOR MEMBERSHIP

Applications for transfer or election to the various grades of membership have been received from the persons listed below, and have been approved by the Committee on Admissions. Members objecting to transfer or election of any of these applicants should communicate with the Secretary on or before May 29, 1931. Final action on these applications will be taken on June 1, 1931

For Election to the Associate grade

California	Berkeley, 2710 Hillegas Ave.	Power, L. T.
	Oakland, 1727 Centini Ave.	Stewart, J. A.
	Santa Monica, 1343 Chelsea St.	Slyfield, C. O.
	Vallejo, 1040 Georgia St.	Rice, A. R.
	Whittier, Route 3, Box No. 139	Wiggins, W. S.
Delaware	Wilmington, 1405 Delaware Ave.	Warfield, T. J.
	Bellevue-Anacostia, U. S. Naval Research Lab.	Trapeur, R. E.
Dist. of Columbia	Chicago, 50 N. Long Ave.	Kailus, P. C.
	Chicago, 21 W. Grand Ave.	Sanderson, G.
Illinois	Kokomo, 908 W. Taylor St.	Dawson, F. A.
	South Bend, 718 Sherman Ave.	Work, L. P.
Indiana	Diagonal	McCartney, M.
	Monroe, Box No. 893	Mask, W. B.
Louisiana	Salisbury, 613 Park Ave.	Perry, J. E.
	East Springfield, 577 Page Blvd.	Taylor, E. H.
Maryland	Pipestone, 103 E. French St.	Port, C. G.
	Minnesota	Saint Paul, 1941 James St.
Mississippi	Tupelo, Box No. 482	Stewart, E. B.
	Missouri	St. Louis, 6604 Tyler Ave.
New Jersey		Arlington, 412 Highland Ave.
	Audubon, 111 Chestnut St.	Feldman, N.
New York	Audubon, 105 Central Ave.	Pierson, I. S.
	Berkeley Heights, Box No. 26	Romano, M. A.
Ohio	Boonton, 113 Schultz St.	Barber, A. W.
	Camden, Plaza Club Hotel	Burnison, J. W.
Pennsylvania	Collingswood, 34 Woodlawn Ave.	Bov, R. F.
	Freehold, 25 Park Ave.	Hampton, E. C.
Rhode Island	Montclair, 104 Alexander Ave.	Jacobus, R. A.
	Newark, 250 S. 7th St.	Lampey, J. J.
Texas	Oaklyn, 125 E. Bettlewood Ave.	Byler, H. W.
	Binghamton, 3 Carlton St.	Craft, J. A.
Virginia	New York City, Trade Dept. British Consulate General, 44	Langley, H. E.
	Whitehall St.	Waring, J. T.
Alaska	New York City, Hotel Montclair, Rm. 1600	Bergere, S.
	Port Jefferson, 103 Myrtle Ave.	Wynne, W. A.
Bahama Islands	Cleveland, Hotel Belmont	Colvin, R. A.
	Dayton, 360 W. 1st St.	Mumma, R. E.
Canada	Dayton, 1615 Roosevelt St.	Peoples, A. G.
	Dayton, 3516 N. Main St.	Kilheffer, L. D.
Egypt	Osborn, R.D. No. 1	Smiley, W. A.
	Lemoyne, 440 Market St.	Bowers, F. L.
England	Philadelphia, 933 W. Somerset St.	Higgins, H. R.
	Philadelphia, 3714 N. Carlisle St.	Karker, A. S., Jr.
England	Philadelphia, 3834 N. 13th St.	Klingelhoeffer, R. H.
	Philadelphia, 1239 N. Hollywood St.	Eiler, D. L.
England	Schuylkill Haven, 336 Dock St.	Herr, B. R.
	York, R.D. No. 7	Heroux, G. A.
England	Woonsocket, 371 Nursery Ave.	Newton, W. W.
	Dallas, 1311 Republic Bank Bldg.	Henry, N. E.
England	Lynchburg, 1017 Knight St.	O'Loughlen, B. W.
	Juneau, Box No. 1498	Cruikshank, J. M.
England	Nassau, c/o British Government Hospital	Creswick, E. A.
	Toronto, Ont., 46 Spencer Ave.	Fichter, L.
England	Toronto, Ont., 322 Logan Ave.	Ford, F. W. R.
	Toronto, Ont., 433 Delaware Ave.	Geiger, D. G.
England	Toronto, Ont., Bell Telephone Co. of Canada	Girdler, H. J.
	Toronto, Ont., 95 Westwood Ave.	McIntyre, R. G.
England	Toronto, Ont., 1424 Queen St. W.	De Barro, F.
	Cairo, Marconi's Wireless Tel. Co. of Egypt	Horne, T.
England	Douglas, Manchester, 13 Park Rd.	Bate, J. R. T.
	Enfield, Middlesex, 8 St. Georges Rd. Forty Hill	Rapson, E. T. A.
England	Hull, Yorks, "Lynton," 17 Silverdale Rd.	Randall, M. C.
	Ilford, Essex, 351 Wanstead Park Rd.	Barnard, R. M.
England	London, N.W. 9, 259 The Broadway, West Hendon	Hawking, W.
	London, N.W. 2, Radio Section, P.O. Research Station, Dollis Hill	Starr, A. T.
England	London, 143 Sunny Gardens Rd., Hendon N.W. 4	

Applications for Membership

England (cont.)	Piccadilly, Manchester, Broadcasting House, British Broadcasting Corporation	Lycett, E. L.
	Portsmouth, Hampshire, 34 Mafeking Rd.	Wills, S.
	Rugby, 22 Holbrook Ave.	McDonald, D.
	Slough, Bucks, 12 First Crescent, Cloucester Ave.	Stoddart, J. A.
	Westcliff-on-Sea, 161 Hainault Ave.	Bradfield, G.
	Worksop, Notts, Launt House, Carlton Rd.	Webster, R.
	York, St. Sampson's Square	Shackleton, S. M.
Guam	Agana	Sutton, R. E.
Holland	Amsterdam, Riouwstraat 3	Bruchiss, L.
Philippine Islands	Cavite, 4 Cisneros St.	Minoza, I. P.
Scotland	Glasgow, Cathart, 48 Kingsacre Rd.	Barwise, H.
	Glasgow, E.1., 56 Drumover Dr.	Maceachern, H.
	Glasgow, S2, c/o Livingstone, 35 Langside Rd.	Wilson, T. A.
	Greenock, 25 Stront Crescent	Foster, H. W.
	Greenock, 20 Crawford St.	Young, A. D.
South Australia	Adelaide, 148 Watson Ave., Toorak	Baxter, E. W.

For Election to the Junior grade

Illinois	Chicago, 1055 N. Leamington Ave.	Liebhart, G. R.
New York	Ozone Park, L. I., 86-11 103rd Ave.	Bulzoni, A. L.
Canada	Toronto, Ont., 699 Sammon Ave.	Cooper, A. S.
England	London S.E. 10, 185 Trafalgar Rd., E. Greenwich	Drinkwater, E. W.
Scotland	Dumfries, Townhead Manse, 14 Moffat Rd.	Thomson, I. W. S.
	Gourock, 24 John St.	Balfour, W.
	Kion, Ailsa View, Stewart St.	Fraser, E. S.



OFFICERS AND BOARD OF DIRECTION, 1931

(Terms expire January 1, 1932, except as otherwise noted)

President

RAY H. MANSON

Vice President

C. P. EDWARDS

Treasurer

MELVILLE EASTHAM

Secretary

HAROLD P. WESTMAN

Editor

ALFRED N. GOLDSMITH

Managers

Arthur Batcheller

J. H. Dellinger

C. M. Jansky, Jr.

Lloyd Espenschied

Harry Houck

Serving until January 1, 1933

J. V. L. Hogan

R. H. Marriott

Serving until January 1, 1934

L. M. Hull

A. F. Van Dyck

Junior Past Presidents

A. HOYT TAYLOR

LEE DE FOREST

BOARD OF EDITORS

ALFRED N. GOLDSMITH, *Chairman*

STUART BALLANTINE

RALPH BATCHER

G. W. PICKARD

L. E. WHITEMORE

W. WILSON



ARTHUR H. COMPTON

Dr. Arthur H. Compton, Professor of Physics of the University of Chicago, will deliver a lecture on "Modern Conceptions of the Electron" during the Sixth Annual Convention of the Institute.

Princeton University granted Professor Compton his Ph.D. degree in 1916. After acting as an instructor in physics at the University of Minnesota during the following year, he became a research physicist for the Westinghouse Lamp Company at Pittsburgh from 1917 to 1919. As a National Research Fellow, he spent 1919-1920 at the Cavendish Laboratory of Cambridge University in England. He then, until 1923, became head of the Physics Department of Washington University in St. Louis, leaving to become Professor of Physics at the University of Chicago.

Professor Compton is considered the foremost authority on the nature of X-rays. His major projects have been the determination of the index of refraction of X-rays, the absolute measurement of wavelength by means of ruled gratings, the discovery of the complete polarization of X-rays, measurement of the intensity of X-rays reflected from crystals, the theory of the relation of scattered X-rays and recoil electrons to the quantum theory, and the discovery of the changed wavelength of scattered rays.

Dr. Compton is the youngest American to receive the Nobel Prize which was awarded to him for his investigations in the field of X-rays. He is one of the three Americans who have received this prize in the field of physics.

INSTITUTE NEWS AND RADIO NOTES

Sixth Annual Convention of the Institute

The Sixth Annual Convention of the Institute will be held in Chicago under the auspices of the Chicago Section. The convention is scheduled for June 4, 5, and 6 and the program will conform in general with those of previous Institute conventions. A number of technical sessions, trips to various radio and manufacturing organizations, and an exhibition of interest to engineers will comprise the three major technical portions of the program. For convenience there appears on the inside front cover of this issue a summary of the tentative program. A more complete program is listed below and is subject to minor revision.

WEDNESDAY, JUNE 3

2:00 P.M.—8:00 P.M.

Registration

THURSDAY, JUNE 4

8:00 A.M.—10:00 A.M.

Registration and inspection of exhibits.

10:00 A.M.—12:00 Noon

Opening session. Addresses of welcome by Ray H. Manson, President of the Institute, and Byron B. Minnium, Chairman of the Chicago Section and Chairman of the Convention Committee.

Technical Session

"The Spokesman for the Radio Engineer," by Captain S. C. Hooper, U. S. Navy.

"Thyratron," by J. C. Warner, General Electric Company.

"Music in Colors," by E. B. Patterson, RCA Radiotron.

"Amplitude, Phase and Frequency Modulation," by Hans Roder, General Electric Company.

12:00 Noon—1:30 P.M.

Official luncheon. Address by Colonel Isham Randolph, President of the Association of Commerce of Chicago.

1:30 P.M.—2:00 P.M.

Inspection of exhibits.

2:00 P.M.—5:00 P.M.

Trip No. 1 to Grigsby-Grunow Company and Stewart-Warner Corporation.

2:00 P.M.—3:30 P.M.

Technical session

"Developments in Common Frequency Broadcasting," by G. D. Gillett, Bell Telephone Laboratories.

"On the Use of Field Intensity Measurements for the Determination of Broadcast Station Coverage," by C. M. Jansky, Jr., and S. L. Bailey.

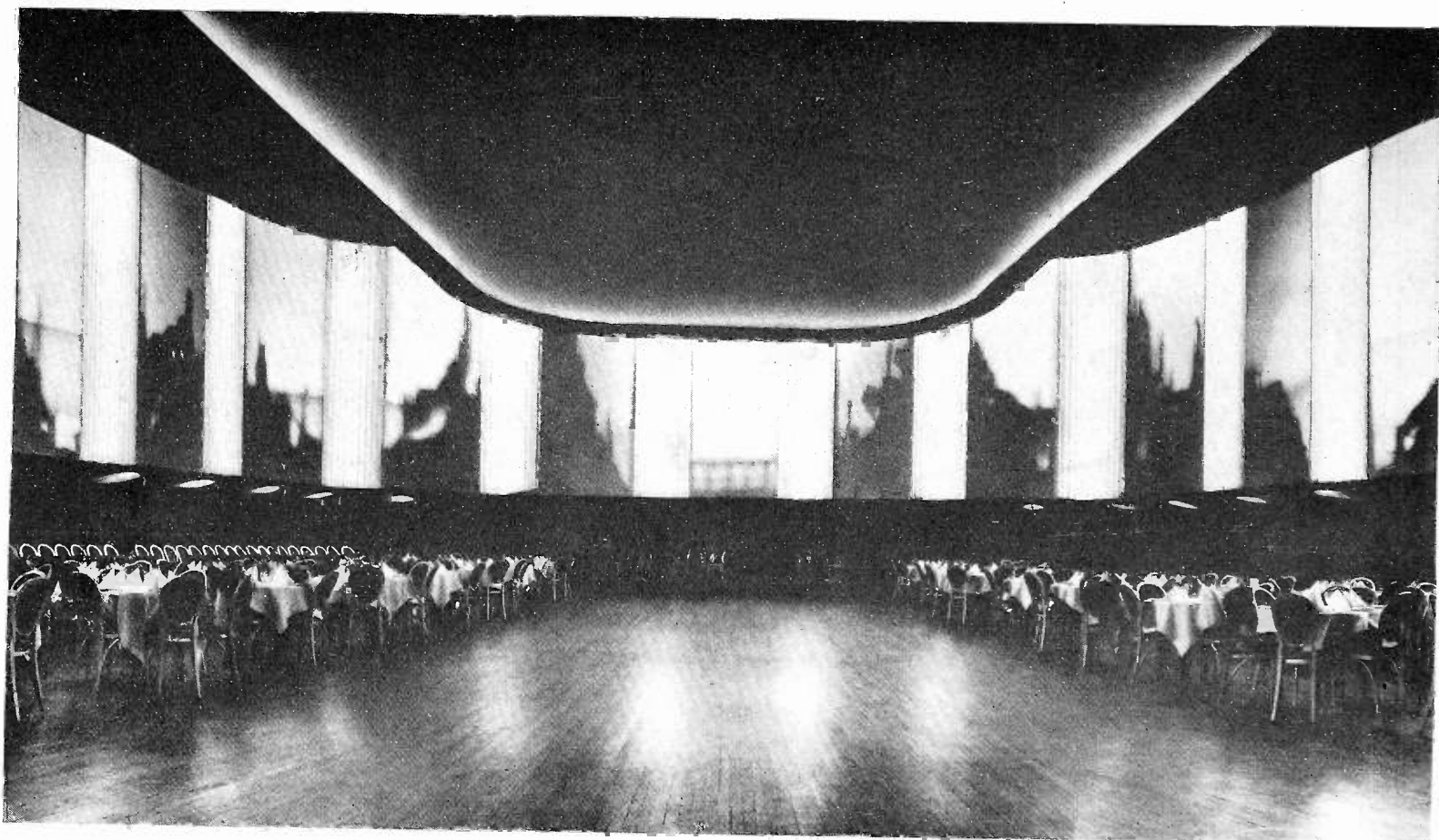

Kaufman-Fabry

The Bal Tabarin in which the banquet will be held. The decorations on the walls are due entirely to the use of polychrome light projected from the central balcony and other vantage points. Scenes are varied continuously and give an excellent example of the possibilities of painting with light.

"New Method of Frequency Control Employing a Long Line," by C. W. Hansell, J. L. Finch and J. W. Conklin, RCA Communications.

"Low Power High Frequency Aircraft Transmitter," by A. P. Bock, Westinghouse Electric and Manufacturing Company.

"Some Observations of the Behavior of Earth Currents and their Correlation with Magnetic Disturbances and Radio Transmissions," by Isabel S. Bemis, American Telephone and Telegraph Company.

2:00 P.M.-3:30 P.M.

Trip No. 2. Shopping trip for ladies.

3:30 P.M.-5:00 P.M.

Inspection of exhibits.

3:30 P.M.-5:00 P.M.

Trip No. 3. Ladies tea and fashion promenade.

4:00 P.M.-5:30 P.M.

Trip No. 4. American Telephone and Telegraph Company and Illinois Bell Telephone Company.

4:00 P.M.-5:30 P.M.

Trip No. 5. National Broadcasting Company studios.

8:00 P.M.

Lecture on "Modern Conceptions of the Electron" by Professor A. H. Compton of the University of Chicago.

8:15 P.M.-11:00 P.M.

Theater party for ladies.

9:00 P.M.

Inspection of Ryerson Laboratory of the University of Chicago.

9:00 P.M.

Annual meeting of the Committee on Sections at the University of Chicago.

FRIDAY, JUNE 5

9:00 A.M.-10:00 A.M.

Inspection of exhibits.

10:00 A.M.-12:00 Noon

Technical session.

"Technique of Loud Speaker Sound Measurements," by Stuart Ballantine, Boonton Research Corporation.

"Acoustic Problems of Sound Picture Engineering," by W. A. MacNair, Bell Telephone Laboratories.

"Rochelle Salt Crystals as Electrical Reproducers and Microphones," by C. B. Sawyer, Brush Laboratories.

"High Audio Output from Relatively Small Tubes," by L. E. Barton, RCA Radiotron.

9:00 A.M.-12:00 Noon

Trip No. 6. Ladies sight-seeing tour.

12:00 Noon-1:00 P.M.

Inspection of exhibits.

1:00 P.M.-5:00 P.M.

Trip No. 7. Hawthorne Works of the Western Electric Company.

1:30 P.M.-4:30 P.M.

Trip No. 8. Luncheon and bridge for ladies.

5:00 P.M.-7:00 P.M.

Inspection of exhibits.

7:00 P.M.

Banquet, entertainment, and dancing.

SATURDAY, JUNE 6

9:30 A.M.-12:00 Noon

Trip No. 9. Ladies trip to Art Institute, Field Museum, or Aquarium.

10:30 A.M.-12:00 Noon

Technical session

"Constant Frequency Oscillators," by F. B. Llewellyn, Bell Telephone Laboratories.



Kaufman-Fabry

The Merchandise Mart houses the Chicago studios of the National Broadcasting Company which will be visited on Trip No. 5.



A section of the Majestic plant in which power units are constructed is shown above. This factory will be visited as a part of Trip No. 1.

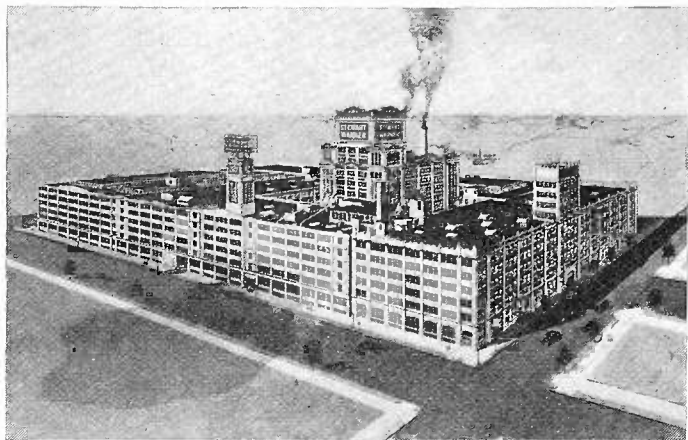

The Stewart-Warner plant on Diversey Parkway (Trip No. 1) manufactures Stewart-Warner radio receivers and accessories for automobile use.

"Electron Tubes as High-Frequency Alternators," by E. D. McArthur and E. E. Spitzer, General Electric Company.

"Development of Directive Transmitting Antennas for Short-Wave Transmission," by P. S. Carter, C. W. Hansell, and N. Lindenblad, RCA Communications.

"Development of Short-Wave Directive Antennas," by E. Bruce and H. T. Friis, Bell Telephone Laboratories.

12:00 Noon-1:00 P.M.

Inspection of exhibits.

1:00 P.M.

Trip No. 10. Riverbank Laboratories (ladies invited).

Technical Papers

In so far as is possible all technical papers will be prepared in preprint form for distribution at the registration desk upon registration. Preprints of the papers being presented at a technical session will also be available at that particular session.

Papers are to be presented in abstract form so that as much time as possible may be made available for the purpose of discussion. Delegates are requested to study carefully the preprints of the papers which they intend to discuss so that there shall be as little time wasted as possible in discussing items that have been covered in the preprint form of the paper. Because of the limited time available, all technical sessions will be started promptly on time, and in courtesy to the speakers it is anticipated that all those who intend being present at these sessions will be prompt in their attendance.

Inspection Trips

Because it is improbable that very many radio manufacturing plants will be in production so early in the season, the inspection trips are being confined largely to organizations other than those manufacturing broadcast radio receivers. In so far as it has been possible, a program of entertainment for the ladies has been provided which will keep them suitably occupied during those portions of the program which are of interest to the men only. Details of the organized trips which will be a part of the convention program follow.

Thursday, June 4, Trip No. 1

At 2:00 P.M., buses will leave the Hotel Sherman to visit the manufacturing plants of the Grigsby-Grunow Company, producers of Majestic radio receivers and Majestic refrigerators and the Stewart-War-



Torkel Korling

A view of part of Chicago's sky line showing some of the larger structures along the lake front. The strip of land in the foreground is a portion of Grant Park.

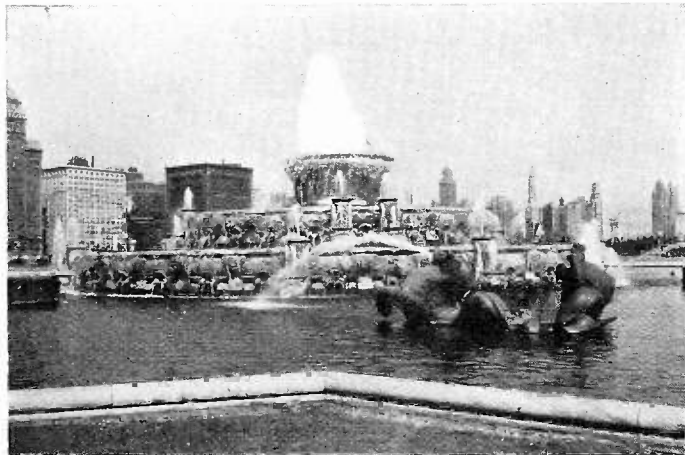

Kaufman-Fabry

Buckingham Memorial Fountain is another of the art objects which are to be found in Grant Park. During the evenings it is illuminated by colored lights.

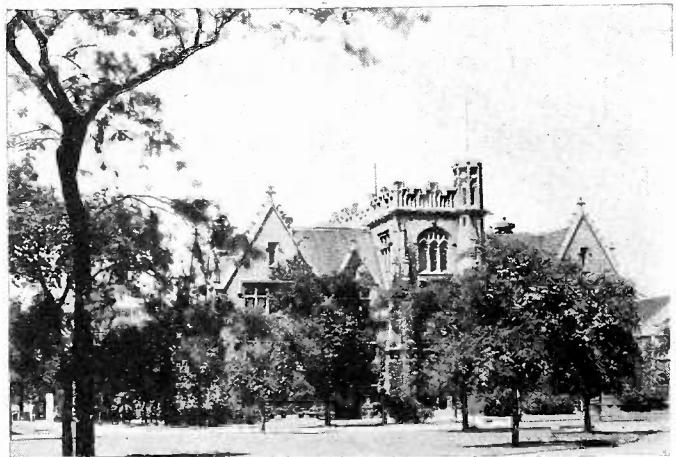

The Ryerson Laboratory is located in the beautiful structure shown above which is one of the many units comprising the University of Chicago.

ner Corporation manufacturers of Stewart-Warner radio receivers and automobile accessories. At the same time this trip is taken a technical session will be held.

Trip No. 2

While Trip No. 1 and the technical session are in progress, the ladies will be taken on a shopping tour through Chicago's leading stores. Arrangements will be made to comply with the desires of those in attendance, and one has the privilege of shopping individually or in small groups under competent direction.

Trip No. 3

At 3:30 P.M., the ladies will gather for tea at the Marshall Field Tea Room and following this will attend a fashion promenade arranged especially for the occasion.

Thursday Evening Lecture

At 8:00 P.M. a lecture will be delivered by Dr. Arthur H. Compton in the auditorium of the Bernard A. Eckhart Hall of the University of Chicago. The subject will be "Modern Conceptions of the Electron."

At the close of this lecture the Ryerson Laboratory, which is devoted to the subject of physics, will be open for inspection by those in attendance.

Theater Party

During the evening while the men are attending Professor Compton's lecture, a theater party is scheduled for the ladies. It will be possible to attend either a musical comedy or a play depending upon the taste of the individual. The Hotel Sherman is conveniently located right in the heart of the theater district.

Trip No. 4

At the conclusion of the technical session, a trip will be made to the long-lines department of the American Telephone and Telegraph Company. Inspection will be made of the "test room" in which all of the telephone and telegraph circuits are first terminated and tested regularly to insure satisfactory operation. The telephotographic equipment by which means photographs are transmitted over wires will be examined while in regular operation. Inspection of the telephone typewriter service and provisions for the handling of broadcast network long lines will also be included in the trip. For the benefit of those who may be interested in the problems of machine switching for telephone exchanges, the plant of the Illinois Bell Telephone Company which is

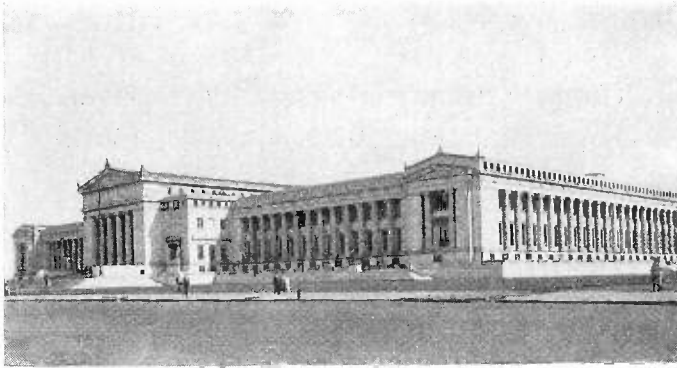

Kaufman-Fabry

The Field Museum may be visited by the ladies on Trip No. 9. Many famous collections of historical interest will be found within this structure.

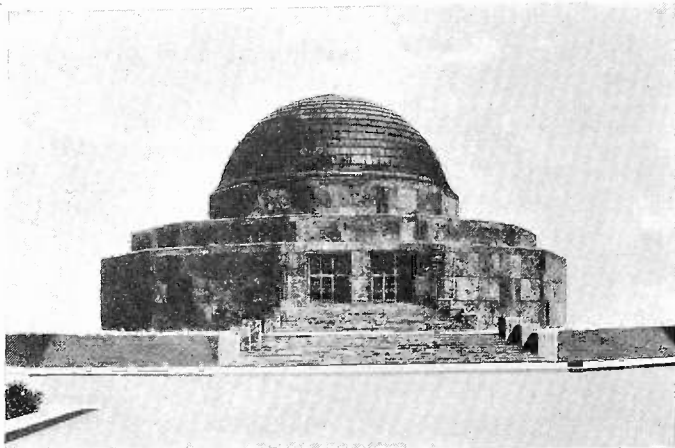

Kaufman-Fabry

The Adler Planetarium and Astronomical Museum is located in Grant Park just east of the Shedd Aquarium and Field Museum.

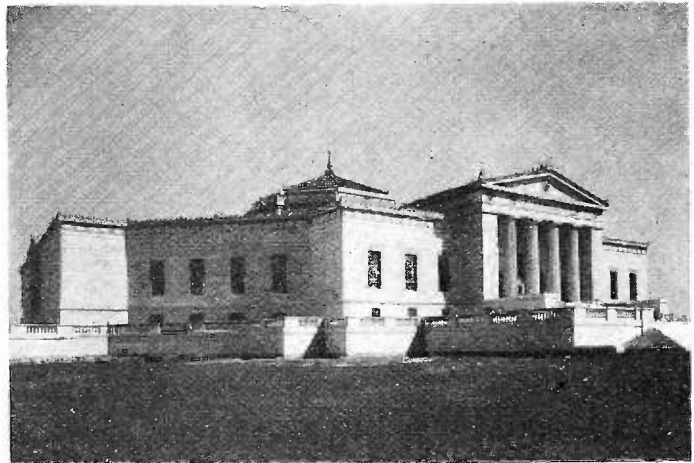

Kaufman-Fabry

The John C. Shedd Aquarium is located in Grant Park along the lake front. It may be visited on Trip No. 9 arranged for the ladies.

adjacent to the structure housing the long-lines department can be visited. Here one may see the equipment used to transfer a local telephone call from a machine switching exchange to a manually operated exchange. This is effected by a device known as a call indicator which flashes illuminated figures of the called subscriber's number to the operator who is to handle the call.

Trip No. 5

Coincidental with Trip No. 4, Trip No. 5 to the studios of the National Broadcasting Company will be made. These are the most modern and largest studios in the country and are located in the recently completed Merchandise Mart, a structure of enormous proportions which is illustrated elsewhere.

Friday, June 5, Trip No. 6

This trip will be a sight-seeing tour of Chicago and its environs, covering some forty-five miles in comfortable sight-seeing buses. Chicago is located on the western shore of the southern tip of Lake Michigan and extends over a territory of about thirty miles along the lake and approximately fifteen miles inland. It boasts of many beautiful parks among them being Jackson, Grant, and Lincoln Parks which are all found along the lake front. In Grant Park will be seen the Field Museum, Art Institute, Shedd Aquarium, Planetarium, Soldiers' Field, Buckingham Memorial Fountain, and the Chicago Yacht Club. A zoo, botanical gardens, public golf links, lakes and lagoon for boating, and bathing beach are a part of Lincoln Park.

Trip No. 7

The Hawthorne Works of the Western Electric Company will be visited on this trip. This manufacturing plant which covers an area of two hundred acres has built most of the telephone equipment now in use in the United States. Of the many interesting operations, the delegate can visit its copper rolling mill, and wire drawing plant as well as a copper reclamationary which produces secondary metal as pure as new copper.

Bakelite presses, die casting machines, and many other types of manufacturing equipment will be seen in operation. This plant presents examples of straight line production of equipment although it also produces some six billion parts a year on the vertical system of manufacture. The plant, is accordingly, not restricted to any one type of production and offers many interesting examples of manufacturing methods which are applicable to the radio industry.

Trip No. 8

After the sight-seeing tour, the ladies will gather at Maillards Tower Inn for luncheon and bridge. The Tower Inn is located in one of the taller buildings and permits a bird's eye view of the city.

Trip No. 9

The schedule for Trip No. 9 will permit the ladies to concentrate on those points of interest which were covered in a hasty fashion during the sight-seeing tour on Friday morning. They may visit places of interest to them either singly or in groups as preferred.

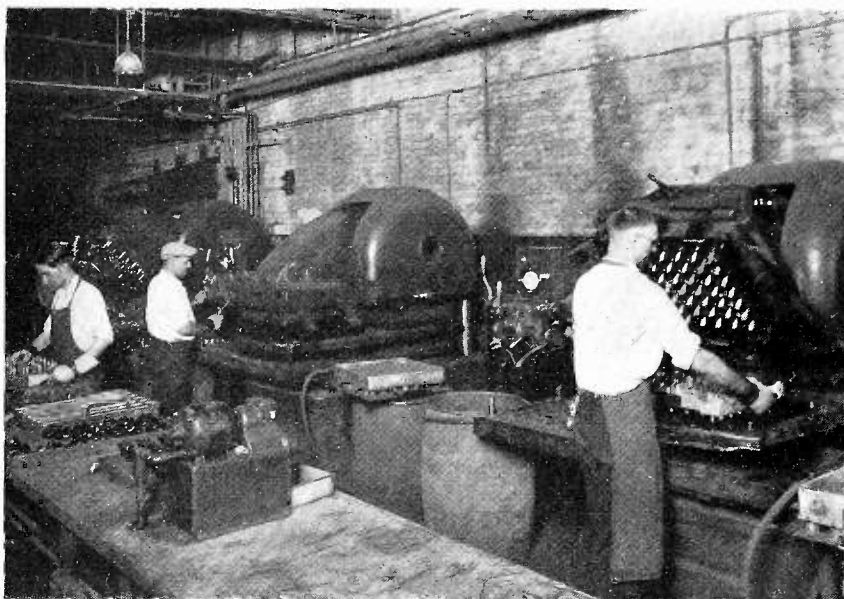

A view of some of the presses used in the molding of bakelite parts for telephone equipment. These are located at the Hawthorne Works of the Western Electric Company which will be visited on Trip No. 7.

Trip No. 10

The Riverbank Laboratories at Geneva, Illinois, will be the objective of trip No. 10. The entire afternoon will be devoted to this trip as Geneva is approximately thirty-five miles west of Chicago. The journey will be made by bus. The ladies are invited to come along and while the men are visiting the laboratories, they will have tea at an antique shop which is famous throughout the middle west. The buses will return to Chicago in time to permit those who are planning upon entraining to catch the evening trains.

Exhibition

The mezzanine floor of the Hotel Sherman, the headquarters for the convention, will be devoted to an exhibition of component parts employed in the manufacture of radio receivers, measuring and laboratory equipment, and such other items as will be of interest to engineers. There will be no displays of complete broadcast receivers. The booths will be in charge of manufacturers' representatives who are competent to discuss the products on display from an engineering viewpoint. At this time of the year when the newly designed receivers are being considered as production problems, it is anticipated that an exhibition of

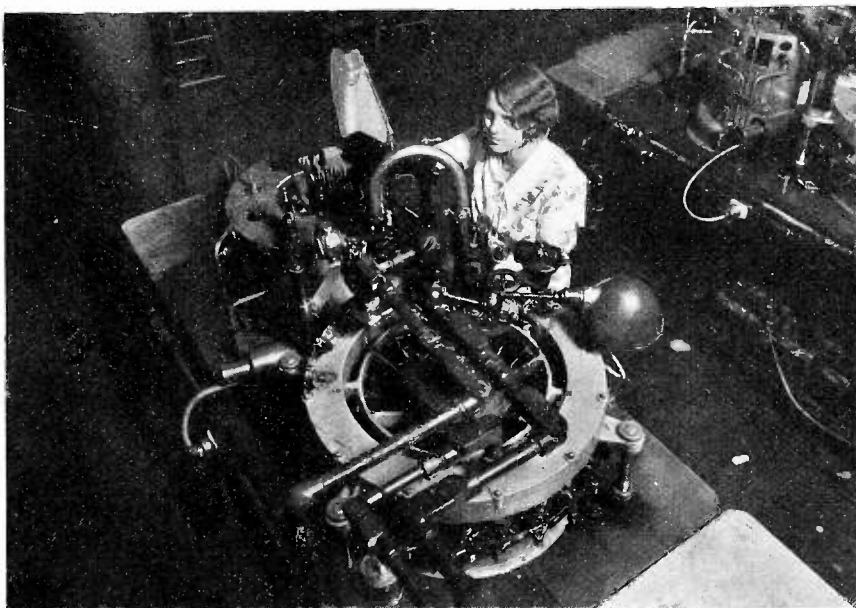

The above machine, which is a part of the equipment at the Hawthorne Works of the Western Electric Company, is used to exhaust and seal switchboard lamps. In addition it tests and automatically rejects any defective units.

this type will greatly assist the individual engineer in meeting the problems with which he is confronted. The possibility of discussing directly with the manufacturer's representative the problems involved in placing a new set in production will undoubtedly be of considerable value.

Luncheon

An official luncheon will be held at noon on Thursday, June 4, and will be addressed by Colonel Isham Randolph who is president of the Association of Commerce of the City of Chicago. Colonel Randolph will welcome the delegates on behalf of the City of Chicago.

Banquet

The informal banquet, which will be held at 7:00 P.M. on Friday, June 5, will be in the Bal Tabarin of the Hotel Sherman. The walls of this room are decorated exclusively by means of projected colored lights and unusually interesting color effects will be a part of the program.

As is customary, the Morris Liebmann Memorial Prize will be presented during the banquet. It will be awarded this year to Stuart Ballantine. The Institute Medal of Honor will not be awarded during the convention as the recipient, General Ferriè of France, will be unable to be present due to the necessity of his attending the Copenhagen meeting of the International Consulting Committee on Radio (C.C.I.R.) at about the same date.

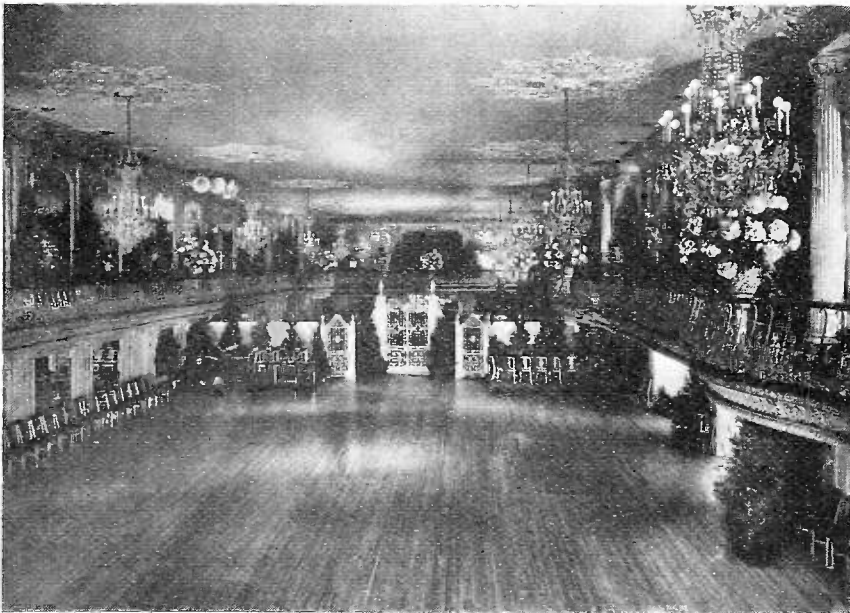

The grand ballroom of the Hotel Sherman, in which the technical sessions will be held, is capable of accommodating several hundred persons and is equipped with a public address system.

In addition to general entertainment, there will be dancing for those in attendance after the banquet.

Golf

For the benefit of those who may desire to play golf during the convention or on the Sunday following the convention, arrangements can be made for obtaining playing privileges at a number of the local clubs. The desire to play golf should be indicated on the advance registration card which will be forwarded to all members so that approximately the proper number of reservations can be made. It

should be kept in mind that reservations must be made in advance in order that time may be reserved at any of the golf courses particularly for Saturday and Sunday.

Radio Manufacturers' Association

The annual June show of the Radio Manufacturers Association will be held in Chicago from June 8 to 12 which is the week following the close of the Institute's convention. In addition to this well-known show, which will require no further explanation, meetings of the National Federation of Radio Associations and the Radio Wholesalers' Association will also be held. Arrangements have been made for reduced railroad fare on the certificate plan which will permit those in attendance at the Institute convention to stay over through the following week without invalidating their certificates. Further details regarding this will be mailed to all members of the Institute.

Committee on Sections Meeting

The Committee on Sections will hold its annual meeting at the University of Chicago at 9:00 P.M. on Thursday, June 4. This meeting will be held after the address by Professor Compton. All Sections of the Institute should be represented at this meeting by an officer or appointed delegate.

April Meeting of the Board of Direction

The April 1st meeting of the Board of Direction was attended by Ray H. Manson, president; Melville Eastham, treasurer; L. Espenschied, J. V. L. Hogan, H. Houck, C. M. Jansky, Jr., R. H. Marriott, A. F. Van Dyck, and H. P. Westman, secretary.

J. R. Wilson, C. F. Nelson, and L. A. Hooke were admitted to the grade of Member, and J. L. A. McLaughlin was transferred to the Member grade.

One hundred and twelve new Associate, and seven new Junior members were elected.

The advertising rates for insertions in the Professional Card Directory, as published in each issue of the Proceedings, were reduced. Three consecutive insertions under the name of a member of the Institute will now cost twelve (\$12.00) dollars, and twelve insertions may be had at the rate of forty (\$40.00) dollars. Insertions under the names of nonmembers of the Institute or organizations will be accepted at twice the above rates. A single insertion shall be at the rate of eight (\$8.00) dollars.

The "Engineers Available" page which is published in each copy

of the Proceedings will hereafter be known as the "Employment" page, and in addition to carrying advertisements by members of the Institute who desire positions, the page will be open to organizations desiring to hire engineers. The rates for either type of advertising will be two (\$2.00) dollars per insertion.

The Institute Medal of Honor which was voted to General Ferrié of Paris, France, will be presented to him in Copenhagen on or about the time of the meeting of the International Consulting Committee on Radio (C.C.I.R.) which is scheduled for late in May, 1931. The Morris Liebmann Memorial Prize will be awarded to Stuart Ballantine during the Sixth Annual Convention.

The continuation of the affiliation of the Rochester Section of the Institute with the Rochester Engineering Society was considered and approved.

Radio Transmissions of Standard Frequency, May and June, 1931

The Bureau of Standards announces a new and improved service of radio standard frequency transmissions. This service may be used by broadcast and other stations in adjusting their transmitters to exact frequency, and by the public in calibrating frequency standards and transmitting and receiving apparatus. The signals are transmitted from the Bureau's station, WWV, Washington, D.C. They can be heard and utilized by stations equipped for continuous-wave reception at distances up to about 1000 miles from Washington, and some of them at all points in the United States. This improved service is a step in the Bureau's program to provide eventually standard frequencies available at all times and at every place in the country.

Besides the usual monthly transmissions of specific frequencies, the Bureau will add another type of transmission which will be much more accurate than any previous transmissions by the Bureau. This transmission will be by continuous-wave radiotelegraphy on a frequency of 5000 kc, and will consist primarily of a series of very long dashes. The first five minutes of this transmission will consist of the general call (CQ de WWV) and announcement of the frequency. The frequency and the call letters of the station (WWV) will be given every ten minutes thereafter.

Besides this service, the Bureau will also continue the transmissions once a month on scheduled specific frequencies. These are also by continuous-wave radiotelegraphy. A complete frequency transmission includes a "general call," "standard frequency signal," and "announcements." The general call is given at the beginning of each 12-minute period and continues for about 2 minutes. This includes a statement of

the frequency. The standard frequency signal is a series of very long dashes with the call letters (WWV) intervening; this signal continues for about 4 minutes. The announcements follow, and contain a statement of the frequency being transmitted and of the next frequency to be transmitted. There is then a 4-minute interval while the transmitting set is adjusted for the next frequency.

Information on how to receive and utilize the signals is given in Bureau of Standards Letter Circular No. 280, which may be obtained by applying to the Bureau of Standards, Washington, D.C. Even though only a few frequencies are received (or even only a single one), persons can obtain as complete a frequency meter calibration as desired by the method of generator harmonics.

The 5000-kilocycle transmissions are from a transmitter of 150 watts power, which may be increased to 1 kilowatt early in the year; they occur every Tuesday except in those weeks in which the monthly transmissions are given. The monthly transmissions are from a transmitter of 1/2 to 1 kilowatt power; they are given on the 20th of every month (with one exception).

5000-Kilocycle Transmissions
1:30 to 3:30, and 8:00 to 10:00, P.M., Eastern Standard Time

	May	June
	5	2
	12	9
	26	16
		30

Monthly Transmissions, Eastern Standard Time	Eastern Standard Time	
	May 20	June 22
10:00 P.M.	4000	550
10:12	4400	600
10:24	4800	700
10:36	5200	800
10:48	5800	1000
11:00	6400	1200
11:12	7000	1400
11:24	7600	1500

The frequencies in the 5000-kilocycle transmission are piezo controlled, and are accurate to a few parts in ten million. The frequencies in the monthly transmissions are manually controlled, and are accurate to a few parts in a million.

In November, 1930, field intensity measurements were made of the 5000-kilocycle transmissions from (WWV) on 150 watts between Washington and Chicago. The daytime field intensity up to a distance of about 400 miles from Washington was about 100 microvolts per meter, with fading in the ratio 3 to 1. From this distance to Chicago the field intensity gradually decreased to about 10 microvolts per meter peak values with fading the same as above. The evening transmissions had

a field intensity of about 200 microvolts per meter with fading similar to that in the daytime. Around 8 p.m. the received intensity was sometimes too low to measure. This happened at distances of from 75 to 150 miles from Washington.

The Bureau of Standards would like to have detailed information on the reception of the 5000-kilocycle transmission, and will appreciate receiving reports from any observers on their reception of these transmissions. Phenomena of particular interest are approximate field intensity, and fading (whether slow or rapid, and approximate time between peaks of signal intensity). The Bureau would also like to receive comments on whether or not the transmissions are satisfactory for purposes of frequency measurement or control. Reports on the reception of the transmissions should be addressed to Bureau of Standards, Washington, D.C.

Committee Work

COMMITTEE ON ADMISSIONS

The regular meeting of the Committee on Admissions was held at the office of the Institute at 10:00 A.M. on Wednesday, April 1st, C. M. Jansky, Jr., chairman; E. R. Shute, and J. S. Smith being in attendance. One of two applications for transfer to the grade of Fellow was approved, three of six applications for transfer to the Member grade were approved, and three of five applications for admission to the Member grade were approved.

COMMITTEE ON BROADCASTING

A meeting of the Committee on Broadcasting was held at 7 p.m. at the office of the Institute, Tuesday, March 31, and was attended by C. M. Jansky, Jr., who acted as chairman in the absence of L. M. Hull; Raymond Guy, J. V. L. Hogan, C. W. Horn, R. H. Marriott, and E. L. Nelson.

COMMITTEE ON MEMBERSHIP

The regular monthly meeting of the Committee on Membership was held at the Institute office at 5:30 p.m. on Wednesday, April 1st. Those present were H. C. Gawler, chairman; Mr. Carr (representing W. W. Brown), Mr. Dettera (nonmember), M. B. Long, C. R. Rowe, J. E. Smith, and A. M. Trogner.

STANDARDIZATION

SUBCOMMITTEE ON HIGH-FREQUENCY RECEIVERS OF THE TECHNICAL COMMITTEE ON RADIO RECEIVERS—I.R.E.

A meeting of the Subcommittee on High-Frequency Receivers, operating under the Technical Committee on Radio Receivers of the

Institute, was held at 10:15 A.M. on Thursday, April 2nd, at the office of the Institute with C. M. Burrill, chairman; H. O. Peterson, F. A. Polkinghorn, S. E. Spittle, and B. Dudley, secretary, present.

The subcommittee carried on its discussion of various matters regarding the testing of high-frequency receivers. It is anticipated that it can complete its work at its next meeting and submit a report thereon.

TECHNICAL COMMITTEE ON VACUUM TUBES—A.S.A.

The Technical Committee on Vacuum Tubes, operating under the Sectional Committee on Radio of the American Standards Association, met at the office of the Institute at 10:00 A.M. Thursday, March 20th. Those present were J. C. Warner, chairman; N. P. Case, H. F. Dart (nonmember), J. B. Dow, A. B. DuMont, F. H. Engel, C. W. Hansell, M. J. Kelly, Ernest Kraus, R. E. A. Putnam, B. E. Shackelford, Dayton Ulrey, P. T. Weeks, and B. Dudley, secretary.

The Committee reviewed the 1931 Report of the Committee on Standardization of the Institute of Radio Engineers to determine which portions of it on the subject of vacuum tubes were suitable for recommendation to the Sectional Committee on Radio as American standards.

A subcommittee, composed of F. H. Engel as chairman, A. B. DuMont, M. J. Kelly, Ernest Kraus, B. E. Shackelford, and P. T. Weeks, was appointed to investigate the possibilities of standardizing the overall dimensions of vacuum tubes.

Institute Meetings . .

ATLANTA SECTION

Chairman Harry F. Dobbs presided at the February 9 meeting of the Atlanta Section held at the Atlanta Athletic Club.

The Section constitution approved by the Board of Direction was read and discussed. Upon vote it was unanimously accepted.

The meeting was then turned over to a general discussion on radio which was participated in by the ten members in attendance.

CHICAGO SECTION

B. B. Minnium, chairman, presided at the February 26 meeting of the Chicago Section held at the Hotel Sherman.

The paper of the evening on "A High Power Broadcast Transmitter" was presented by H. C. Vance.

The various details of transmitters from 1 to 50 kw showing the oscillators, power supply, control units, modulation, and amplification units were given and slides illustrating the various items were pro-

jected. Circuit details were also covered showing the various safety interlocking devices with particular emphasis placed upon those employed in the high power transmitters.

The discussion which followed the paper was entered into by Messrs. Adair, Armstrong, Arnold, Hoag, Minnium, and Wilcox.

The attendance at the meeting totaled eighty.

The March 27th meeting of the Chicago Section was held in the Engineering Building, Byron B. Minnium, chairman, presiding.

C. P. Beath of the Western Electric Company presented an illustrated paper on "Wire Drawing." The discussion which followed the presentation of the paper was entered into by Messrs. Armstrong, Minnium, Norris, and Stone. Sixty-four members and guests were in attendance.

CINCINNATI SECTION

The seventeenth meeting of the Cincinnati Section, held at the Chamber of Commerce on March 17, was presided over by H. J. Loftis, vice chairman.

The paper of the evening on "Sensitivity Controls—Manual and Automatic" was presented by D. D. Israel, chief development engineer of the Crosley Radio Corporation.

The speaker stated modern broadcast conditions require that the sensitivity control of a receiver be capable of introducing a total attenuation of approximately 160 db. The various problems encountered in the design of manual sensitivity controls were briefly reviewed and the more common methods as used with both triodes and tetrodes were described. Eight methods of automatic sensitivity control were also discussed with regard to the mode of operation and characteristics of each type. The characteristics of an arbitrarily chosen ideal automatic sensitivity control were compared with those displayed by a common type of manual control. The probable part to be played by the variable-mu or extended cut-off tubes in volume control design was also considered. The paper was illustrated by a number of slides.

The discussion which was held was participated in by Messrs. Boyle, Glover, Kilgour, Langley, and Nichols of the forty-three members and guests in attendance.

CLEVELAND SECTION

G. B. Herman, chairman of the Cleveland Section, presided at the February 27 meeting held at the Case School of Applied Science.

The speaker of the evening, C. B. Sawyer of the Brush Laboratories presented a paper on "The Use of Rochelle Salt Crystals for Electrical Reproducers and Microphones."

Dr. Sawyer presented the history of piezo-electricity going back to its discovery over a century ago.

In discussing the use of Rochelle crystals for piezo-electric purposes, it was pointed out that only clear crystals were suitable as they avoid rapid deterioration. A condition of saturation is possible in Rochelle crystals which is not true of quartz, and ways and means of avoiding saturation were explained.

The impedance of a typical Rochelle salt crystal loud speaker was given as 133,000 ohms at sixty cycles and 20,000 ohms at 500 cycles. It was stated that clear Rochelle salt crystals were nonhygroscopic and do not fail from fatigue. A sample crystal was subjected to 250 volts at 60 cycles for more than two years without failure.

Rochelle salt loud speakers, microphones, and phonograph pick-ups were demonstrated.

The attendance at the meeting totaled forty-eight.

CONNECTICUT VALLEY SECTION

The March meeting of the Connecticut Valley Section was held on the 12th of the month at the Hotel Charles in Springfield, Massachusetts, R. S. Kruse, chairman, presiding.

The paper on "Light Sensitive Devices" was presented by G. F. Metcalf of the Vacuum Tube Engineering Department, General Electric Company.

The paper covered the general subject of light sensitive devices with particular reference to the characteristics of the various types of photo-electric cells. Some commercial applications were discussed and two types of portable apparatus set-ups were demonstrated. Several different forms of photo-electric tubes were available for examination. A number of the sixty-two members and guests in attendance participated in the discussion which followed the presentation of the paper.

DETROIT SECTION

A joint meeting of the Detroit Section of the Institute of Radio Engineers and the Detroit-Ann Arbor Section of the American Institute of Electrical Engineers, was held in the Natural Science Auditorium, University of Michigan, on March 17th. Le Roy Braisted, Chairman of the Detroit-Ann Arbor Section of the A.I.E.E. presided.

The Chairman introduced John Bellamy Taylor, consulting engineer of the General Electric Company who gave an illustrated talk entitled "The Sound of a Shadow" which was enjoyed by the seven hundred and fifty members and guests in attendance. Preceding the meeting, a dinner at the University of Michigan Union was attended by one hundred and twenty-five members and guests.

LOS ANGELES SECTION

T. E. Nikirk, chairman of the Los Angeles Section, presided at the February 16 meeting of that Section held at the Rosslyn Hotel.

The paper of the evening on "Fundamental Requirements for Wide Band Transmission" was presented by John K. Hilliard, a research engineer of the United Artists Studios in Hollywood.

The paper was discussed by a number of the seventy-five members and guests in attendance at the meeting. The dinner which preceded the meeting was attended by thirty members and guests.

The March 16 meeting of the Los Angeles Section was held at the Rosslyn Hotel, chairman T. E. Nikirk presiding.

A paper on "Transoceanic Radiotelephony" was presented by H. C. Silent of the Electrical Research Products, Inc.

A film prepared by the American Telephone and Telegraph Company on the subject of transoceanic telephony was projected and was followed by the speaker who discussed the technical details of the work. The talk was further illustrated by slides.

A number of the sixty-five members and guests in attendance entered into the discussion which followed.

Prior to the meeting, an informal dinner was attended by twenty-five of those present.

NEW YORK MEETING

The regular April New York meeting of the Institute was held on the 1st in the Engineering Societies Building, 33 West 39th Street, New York City. The meeting was called to order by President Manson who introduced the speaker of the evening, Eduard Karplus, who presented a paper on "Communication with Quasi Optical Waves", which is summarized below.

"This paper deals with electromagnetic waves of about 1/1000 millimeter up to 10 meters, which are called quasi optical waves due to their performance being very similar to the performance of visual light.

"Theory and experiments show that only a very small part of the quasi optical range can be used for communication; that is, waves between 10 centimeters and 10 meters, and again 0.7 to 2.4 thousandths of a millimeter.

"Some of the characteristics of these high frequencies are straight-line propagation, the possibility to concentrate energy, and the apparent lack of all disturbances either atmospheric or man-made. On the other hand, the problems encountered in generating and detecting these high frequencies are rather complicated.

"The paper deals with advantages and disadvantages of these waves and discusses their application. Some of the applications are: Short-distance communication between portable stations; equipment for fog navigation of

ships and airplanes; communication lines for high modulating frequencies such as television; concealed communication for military purposes; and as one of the most important, short-wave broadcasting in big cities. The results obtained in recent tests in Berlin are considered.

"The possibilities for transmitters and receivers are discussed. In the first group are the tube oscillators with straight regenerative circuits, Barkhausen oscillators, spark oscillators, and the radiation of heat and infra-red from solid particles and electrically excited gases. In the second group are detectors, regenerative and superregenerative circuits, and photo-electric cells.

"Finally, some problems of the tube oscillators and receivers for 10-centimeter to 10-meter waves are discussed somewhat in detail, and examples of transmitters, including Barkhausen oscillators, receivers, and wave-meters are demonstrated in operation."

A lengthy discussion followed the presentation of the paper and was participated in by a number of the five hundred and twenty-five members and guests in attendance.

PHILADELPHIA SECTION

The March meeting of the Philadelphia Section was held on the 11th of the month at the Engineers Club, D. O. Whelan, vice chairman, presiding.

The paper of the evening was presented by J. W. Horton, chief engineer of the General Radio Company, who spoke on "What to Expect of Television."

The lecture proved of great popular interest and at the open forum, conducted at its close, brought forth a minute discussion of the points raised.

Two hundred and seventy-three members and guests were in attendance.

PITTSBURGH SECTION

The March 24th meeting of the Pittsburgh Section was held in the Tudor Room of the Fort Pitt Hotel, L. A. Terven, chairman, presiding.

The paper of the evening on "Radio Service Instruments—Design and Operation" was presented by L. D. Smith of the Weston Electrical Instrument Corporation.

The speaker discussed the construction and operation of various test equipment designed for use with radio receivers and other component parts. The copper-oxide rectifier type of meter was explained and its various adaptations to radio testing and measurement work were covered.

A number of the fifty members and guests present entered into the general discussion which followed the presentation of the paper.

ROCHESTER SECTION

A paper by Edwin H. Vedder, a design engineer for the Westinghouse Electric and Manufacturing Company at East Pittsburgh, Pa., on "Applications of the Light Sensitive Tube in Industry" was presented at the March 5 meeting of the Rochester Section. The meeting was presided over by H. J. Klumb and held at the Sagamore Hotel.

The speaker outlined briefly the possibilities of using vacuum tubes for various operations which are now being provided for by mechanical means. It was said that while it was possible in practically all cases to apply tubes to accomplish the work now done mechanically, the economics of each application was the principal matter to be considered. There are undoubtedly many uses to which the tube may be applied and it is the problem of the engineer to determine upon these applications and design tubes suitable for them.

The conventional type of photo-electric cell, its construction and characteristics were described and a diagrammatic circuit for the cell given. The grid glow tube was discussed and its use and the manner in which it differed from the photo to be were considered.

At the close of the paper, which was illustrated with numerous slides and several working models, a very lively discussion, which was entered into by many of the one hundred and eighty-five members and guests in attendance, ensued.

SAN FRANCISCO SECTION

A meeting of the San Francisco Section was held at the Bellevue Hotel on March 18, W. D. Kellogg, chairman, presiding.

The paper of the evening which was presented by Ralph R. Beal was on the subject "Radio Communications."

The author discussed the effect of radio communication on the national welfare, showing how our communication systems have opened up foreign trade. To illustrate some of the radio communication equipment, slides were projected to show portions of the apparatus installed by RCA Communications at their Bolinas and San Francisco stations.

The meeting was attended by seventy-one members and guests of whom forty-eight attended the informal dinner which preceded it.

SEATTLE SECTION

A meeting of the Seattle Section of the Institute was held on March 26th, at Guggenheim Hall, University of Washington, Abner R. Willson, chairman, presiding.

The paper of the evening on "The Development and Operation of Teletypewriter Systems" was presented by G. A. Miller.

The illustrated paper covered the development and operation of teletypewriter systems (the automatic printing telegraph) from the early telegraph systems to the present multiplex system. The type of driving motor with its torque control fly wheel, phasing, and synchronizing devices were outstanding points of interest.

Messrs. Fish, Pinkman, and Reid entered into the discussion. The attendance totaled forty-seven.

TORONTO SECTION

J. M. Leslie, chairman, presided at the February 18 meeting of the Toronto Section held in the Mining Building of the University of Toronto.

The speaker of the evening, D. E. Replogle, of the Jenkins Television Corporation presented a paper on "Television—How and When."

The speaker traced the early developments of television back to the work of Malus who discovered light polarization effects in 1808, the further work on this subject by Faraday around 1845, the discovery of the Kerr cell in 1875, and the Nipkow scanning disk in 1884.

Recent developments not only in the technical advances but in the establishment of regular television broadcasts were then covered.

Other problems were pointed out as requiring further development work. They included the necessity for phototubes of higher sensitivity having no lag or frequency restriction, more and higher power radio stations, suppression of sky wave to eliminated fading effects, rigorous economy of the channels available, better light sources and improved scanning methods and methods of synchronization which should be of an automatic nature. It was pointed out that the synchronization of sound with television broadcast should do a great deal in increasing interest.

The paper was discussed by Messrs, V. G. Smith, W. A. Shane, and F. J. Fox. The attendance at the meeting totaled one hundred and fifty.

The March meeting of the Toronto Section was held on the 11th in the Electrical Building of the University of Toronto, J. M. Leslie, chairman, presiding. Kendall Clough, chief engineer of the Silver Marshall Company, presented a paper on "Superheterodyne Design."

The author in reviewing the past history of the superheterodyne type of receiver pointed out that in many of the earlier types, repeat points, phantom stations, image effects, and selectivity made reception unenjoyable. Due to the intensive development during the past few

ROCHESTER SECTION

A paper by Edwin H. Vedder, a design engineer for the Westinghouse Electric and Manufacturing Company at East Pittsburgh, Pa., on "Applications of the Light Sensitive Tube in Industry" was presented at the March 5 meeting of the Rochester Section. The meeting was presided over by H. J. Klumb and held at the Sagamore Hotel.

The speaker outlined briefly the possibilities of using vacuum tubes for various operations which are now being provided for by mechanical means. It was said that while it was possible in practically all cases to apply tubes to accomplish the work now done mechanically, the economics of each application was the principal matter to be considered. There are undoubtedly many uses to which the tube may be applied and it is the problem of the engineer to determine upon these applications and design tubes suitable for them.

The conventional type of photo-electric cell, its construction and characteristics were described and a diagrammatic circuit for the cell given. The grid glow tube was discussed and its use and the manner in which it differed from the photo to be were considered.

At the close of the paper, which was illustrated with numerous slides and several working models, a very lively discussion, which was entered into by many of the one hundred and eighty-five members and guests in attendance, ensued.

SAN FRANCISCO SECTION

A meeting of the San Francisco Section was held at the Bellevue Hotel on March 18, W. D. Kellogg, chairman, presiding.

The paper of the evening which was presented by Ralph R. Beal was on the subject "Radio Communications."

The author discussed the effect of radio communication on the national welfare, showing how our communication systems have opened up foreign trade. To illustrate some of the radio communication equipment, slides were projected to show portions of the apparatus installed by RCA Communications at their Bolinas and San Francisco stations.

The meeting was attended by seventy-one members and guests of whom forty-eight attended the informal dinner which preceded it.

SEATTLE SECTION

A meeting of the Seattle Section of the Institute was held on March 26th, at Guggenheim Hall, University of Washington, Abner R. Willson, chairman, presiding.

The paper of the evening on "The Development and Operation of Teletypewriter Systems" was presented by G. A. Miller.

The illustrated paper covered the development and operation of teletypewriter systems (the automatic printing telegraph) from the early telegraph systems to the present multiplex system. The type of driving motor with its torque control fly wheel, phasing, and synchronizing devices were outstanding points of interest.

Messrs. Fish, Pinkman, and Reid entered into the discussion. The attendance totaled forty-seven.

TORONTO SECTION

J. M. Leslie, chairman, presided at the February 18 meeting of the Toronto Section held in the Mining Building of the University of Toronto.

The speaker of the evening, D. E. Replogle, of the Jenkins Television Corporation presented a paper on "Television—How and When."

The speaker traced the early developments of television back to the work of Malus who discovered light polarization effects in 1808, the further work on this subject by Faraday around 1845, the discovery of the Kerr cell in 1875, and the Nipkow scanning disk in 1884.

Recent developments not only in the technical advances but in the establishment of regular television broadcasts were then covered.

Other problems were pointed out as requiring further development work. They included the necessity for phototubes of higher sensitivity having no lag or frequency restriction, more and higher power radio stations, suppression of sky wave to eliminate fading effects, rigorous economy of the channels available, better light sources and improved scanning methods and methods of synchronization which should be of an automatic nature. It was pointed out that the synchronization of sound with television broadcast should do a great deal in increasing interest.

The paper was discussed by Messrs, V. G. Smith, W. A. Shane, and F. J. Fox. The attendance at the meeting totaled one hundred and fifty.

The March meeting of the Toronto Section was held on the 11th in the Electrical Building of the University of Toronto, J. M. Leslie, chairman, presiding. Kendall Clough, chief engineer of the Silver Marshall Company, presented a paper on "Superheterodyne Design."

The author in reviewing the past history of the superheterodyne type of receiver pointed out that in many of the earlier types, repeat points, phantom stations, image effects, and selectivity made reception unenjoyable. Due to the intensive development during the past few

years great headway has been made particularly on preselection, frequency conversion, single control operation, improved selectivity characteristics, and, by the use of screen-grid tubes, greater stability with higher amplification.

The problem of making the oscillator track with the balance of the circuit over the broadcast band was discussed and a mathematical method of properly designing the circuits was described together with laboratory methods of checking the results by means of a dynatron oscillator.

In the discussion which followed the problems of preventing radiation from the superheterodyne receiver was emphasized.

Some of the other problems made in the design, production and servicing of this type of receiver were considered.

The discussion was entered into by Messrs. F. J. Fox, J. M. Leslie, and C. A. Lowry of the one hundred and thirty-seven members and guests in attendance.

WASHINGTON SECTION

L. P. Wheeler, chairman of the Washington Section, presided at the February 12th meeting which was held at the Continental Hotel in Washington.

The paper of the evening on "The Radio Engineer and the Patent System" was presented by C. D. Backus, Primary Examiner in the U. S. Patent Office.

The speaker outlined the reason for the existence and the statutory origin of the patent system with special reference to the distinction between matter that may and may not be patented. The nature of the protection afforded a patentee was explained and emphasis laid on what constitutes an invention, because it is on this as a basis that the activity of the radio engineer in the patent field is to be measured.

The time period limits and wide scope of the subject matter of radio engineering were discussed and a basis indicated on which the work in this line is selectable from that in other electrical engineering lines. This work was stated also in terms of official classification, and expressed quantitatively as a total number of patents over the period in question. The very rapid rate of increase of radio patents was graphically compared to the rate of increase of all patents over the same period.

The status of the radio engineer in industry from the viewpoint of patents was considered, the position of the amateur outlined and some comments made, based on typical selection but on an incomplete survey of the patents, regarding their initial ownership and the parti-

icipation of the membership of the Institute of Radio Engineers in the acquisition of patents.

The meeting was attended by fifty-six members of whom twenty-nine were present at the informal dinner which preceded it.

The March meeting of the Washington Section was held on the 12th at the Continental Hotel, L. P. Wheeler, chairman, presiding.

V. Ford Greaves, assistant chief engineer to the Federal Radio Commission, presented a paper on "Some Observations on Radio Broadcast Allocation."

This paper was on the development and application of a quota-unit system for the distribution of radio broadcast facilities throughout the U. S. in accordance with the provisions of the Davis Amendment of the Radio Law which provides that the people are entitled to equality of radio broadcast facilities, both as to reception and transmission.

It was pointed out that the radio broadcast traffic problem in space is very similar to the automobile traffic problem in large cities, and in comparison to one class of boulevards for high speed through traffic, another of one-way streets and congested areas, we have in radio 40 high power clear channels with only one station per channel, and the other 50 channels divided among regional and local channels. No system can be absolutely perfect because of local and seasonable variations in the laws of propagation.

In order to test whether the present system approximates an equitable distribution of stations, measurements were made in different parts of the country to find areas which should receive fair day service of 400 microvolts or more from one or more stations.

Tables were shown giving the ratios of the percentage of population living within the 500 microvolt day service areas to the number of stations serving the same areas with this class of service or better. While the differences between actual allotments and quota are as great as—165 per cent and—100 per cent, when a distribution curve is plotted between percentage of quota for ordinates and percentage under and percentage over as abscissas, it was shown that on the average these differences amount to less than 5 per cent. The conclusions tend to show that in spite of certain apparent variations, the general allocation plan in effect at present is a substantial compliance within the law within practical limits.

The paper was discussed by Messrs. Burgess, Craven, Stewart, Professor Robinson, and Dr. Taylor.

Of the fifty-eight members and guests in attendance at the meeting, thirty-eight were present at the informal dinner which preceded it.

years great headway has been made particularly on preselection, frequency conversion, single control operation, improved selectivity characteristics, and, by the use of screen-grid tubes, greater stability with higher amplification.

The problem of making the oscillator track with the balance of the circuit over the broadcast band was discussed and a mathematical method of properly designing the circuits was described together with laboratory methods of checking the results by means of a dynatron oscillator.

In the discussion which followed the problems of preventing radiation from the superheterodyne receiver was emphasized.

Some of the other problems made in the design, production and servicing of this type of receiver were considered.

The discussion was entered into by Messrs. F. J. Fox, J. M. Leslie, and C. A. Lowry of the one hundred and thirty-seven members and guests in attendance.

WASHINGTON SECTION

L. P. Wheeler, chairman of the Washington Section, presided at the February 12th meeting which was held at the Continental Hotel in Washington.

The paper of the evening on "The Radio Engineer and the Patent System" was presented by C. D. Backus, Primary Examiner in the U. S. Patent Office.

The speaker outlined the reason for the existence and the statutory origin of the patent system with special reference to the distinction between matter that may and may not be patented. The nature of the protection afforded a patentee was explained and emphasis laid on what constitutes an invention, because it is on this as a basis that the activity of the radio engineer in the patent field is to be measured.

The time period limits and wide scope of the subject matter of radio engineering were discussed and a basis indicated on which the work in this line is selectable from that in other electrical engineering lines. This work was stated also in terms of official classification, and expressed quantitatively as a total number of patents over the period in question. The very rapid rate of increase of radio patents was graphically compared to the rate of increase of all patents over the same period.

The status of the radio engineer in industry from the viewpoint of patents was considered, the position of the amateur outlined and some comments made, based on typical selection but on an incomplete survey of the patents, regarding their initial ownership and the parti-

icipation of the membership of the Institute of Radio Engineers in the acquisition of patents.

The meeting was attended by fifty-six members of whom twenty-nine were present at the informal dinner which preceded it.

The March meeting of the Washington Section was held on the 12th at the Continental Hotel, L. P. Wheeler, chairman, presiding.

V. Ford Greaves, assistant chief engineer to the Federal Radio Commission, presented a paper on "Some Observations on Radio Broadcast Allocation."

This paper was on the development and application of a quota-unit system for the distribution of radio broadcast facilities throughout the U. S. in accordance with the provisions of the Davis Amendment of the Radio Law which provides that the people are entitled to equality of radio broadcast facilities, both as to reception and transmission.

It was pointed out that the radio broadcast traffic problem in space is very similar to the automobile traffic problem in large cities, and in comparison to one class of boulevards for high speed through traffic, another of one-way streets and congested areas, we have in radio 40 high power clear channels with only one station per channel, and the other 50 channels divided among regional and local channels. No system can be absolutely perfect because of local and seasonable variations in the laws of propagation.

In order to test whether the present system approximates an equable distribution of stations, measurements were made in different parts of the country to find areas which should receive fair day service of 400 microvolts or more from one or more stations.

Tables were shown giving the ratios of the percentage of population living within the 500 microvolt day service areas to the number of stations serving the same areas with this class of service or better. While the differences between actual allotments and quota are as great as—165 per cent and—100 per cent, when a distribution curve is plotted between percentage of quota for ordinates and percentage under and percentage over as abscissas, it was shown that on the average these differences amount to less than 5 per cent. The conclusions tend to show that in spite of certain apparent variations, the general allocation plan in effect at present is a substantial compliance within the law within practical limits.

The paper was discussed by Messrs. Burgess, Craven, Stewart, Professor Robinson, and Dr. Taylor.

Of the fifty-eight members and guests in attendance at the meeting, thirty-eight were present at the informal dinner which preceded it.



PART II
TECHNICAL PAPERS



OUTPUT NETWORKS FOR RADIO-FREQUENCY POWER AMPLIFIERS*

BY

W. L. EVERITT

(Ohio State University, Columbus, Ohio)

Summary—At high frequencies a transformer consisting of primary, secondary, and mutual inductances cannot be constructed to match a generator effectively to a resistive load. By introducing capacitative elements, such a match can be obtained.

The design of reactance networks to connect a resistive load efficiently to a source of power can be carried out most conveniently by the theory of image impedances. Such reactance networks can provide not only for high efficiency but can also attenuate undesired harmonics.

A variety of configurations can be designed to accomplish the desired result. The network can also be arranged to provide extremely high attenuation at designated frequencies.

The most efficient network is one designed for critical coupling, assuming a constant Q for the inductances. The efficiency also depends on the impedance ratio.

IN ORDER to extract the maximum power from a generator or supply network, it is a well-known fact that the external load should have a vector value which is the conjugate of the internal impedance of the source. Inasmuch as the useful load itself seldom meets this condition, it is usually necessary to use some impedance matching network which can modify the load as viewed from the generator.

At audio frequencies, the matching device is usually a transformer with a core of high permeability. Such a transformer can be designed to provide a good match over a wide range of frequencies.

At radio frequencies, a simple transformer cannot be designed which approximates the requirements of the ideal, viz.,

- (1) Mutual reactance much larger than the terminal loads, while primary and secondary resistances are negligible.
- (2) Coefficient of coupling nearly equal to unity.

Fortunately, at radio frequencies it is usually desirable to design the matching network for maximum power transfer over a range of frequencies which is a small fraction of an octave. It is possible, therefore, to use resonant combinations of inductance and capacitance to obtain an impedance matching network of as high an efficiency as is possible at lower frequencies with the standard type of transformers.

At radio frequencies, the most common type of supply network is the vacuum tube. In order to operate a vacuum tube amplifier at high efficiency, the output wave should have a large percentage of har-

* Decimal classification: R355.7×R390. Original manuscript received by the Institute, January 10, 1931.

monics. Such operation is permissible for most radio-frequency applications. Since the harmonics produced are usually undesired in the load itself, an output circuit which can also act as a filter to attenuate these harmonics is often desirable.

The inductively coupled resonant circuit has been extensively treated.¹ It is frequently more convenient to couple the final power stage of a radio transmitter to the antenna or transmission line by means of a π network of reactances. It is at this point that high efficiency is most important, and this article will be confined largely to this type of network. Exact design is now largely replacing cut-and-try methods in the determination of circuit constants in radio circuits.

GENERAL REQUIREMENTS OF IMPEDANCE MATCHING NETWORKS

If an unbalanced T or π network is terminated in an impedance, the impedance measured at the input terminals will, in general, be different from the terminating impedance. In Fig. 1 is a T network with three

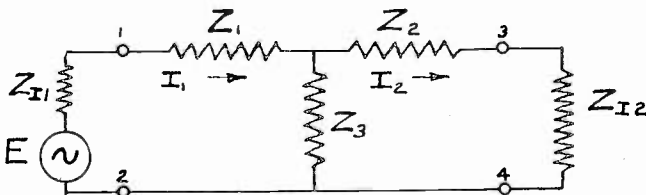

Fig. 1—General transmission system represented by equivalent T network.

arms, Z_1 , Z_2 , and Z_3 . If $Z_1 = Z_2$, and if it is terminated in an impedance equal to its characteristic impedance Z_0 , and the generator impedance is also equal to Z_0 , then the impedances looking both ways at the input terminals 1-2 will be equal, and a similar condition will exist at the output terminals 3-4.

If, on the other hand, Z_1 does not equal Z_2 , then a pair of impedances Z_{I1} and Z_{I2} may be found, such that if a generator of impedance Z_{I1} is connected between terminals 1-2, and an impedance Z_{I2} is connected between terminals 3-4, the impedances looking in both directions at the input terminals 1-2 will be equal, and the same will be true of the impedances in both directions at the terminals 3-4. These impedances Z_{I1} and Z_{I2} are called the image impedances of the network, and in the balanced section ($Z_1 = Z_2$) are both equal to Z_0 . From this definition, their value can be determined in terms of Z_1 , Z_2 , and Z_3 , and will be,²

¹ Pierce, *Electric Oscillations and Electric Waves*, McGraw-Hill, 1920.

² Johnson, *Transmission Circuits for Telephonic Communication*, D. Van Nostrand.

$$Z_{I1} = \sqrt{\frac{Z_1 + Z_3}{Z_2 + Z_3}}(Z_1Z_2 + Z_2Z_3 + Z_1Z_3) \quad (1)$$

$$Z_{I2} = \sqrt{\frac{Z_2 + Z_3}{Z_1 + Z_3}}(Z_1Z_2 + Z_2Z_3 + Z_1Z_3). \quad (2)$$

The image impedances can also be determined in terms of the open and short-circuited impedances.

Let Z_{01} = impedance at terminals 1-2 with 3-4 open
 Z_{02} = " " " 3-4 " 1-2 open
 Z_{s1} = " " " 1-2 " 3-4 shorted
 Z_{s2} = " " " 3-4 " 1-2 shorted

In Fig. 1

$$Z_{01} = Z_1 + Z_3$$

$$Z_{s1} = Z_1 + \frac{Z_2Z_3}{Z_2 + Z_3} = \frac{Z_1Z_2 + Z_2Z_3 + Z_1Z_3}{Z_2 + Z_3}$$

$$Z_{02} = Z_2 + Z_3$$

$$Z_{s2} = \frac{Z_1Z_2 + Z_2Z_3 + Z_1Z_3}{Z_1 + Z_3}$$

$$\therefore Z_{I1}^2 = Z_{01}Z_{s1} \quad (3)$$

$$Z_{I2}^2 = Z_{02}Z_{s2}. \quad (4)$$

Since a π network equivalent to the T network of Fig. 1 would have the same open- and short-circuited impedances (3) and (4) would also hold for such a π section.

By examining (1) and (2), it will be seen that a network of pure reactances may have image impedances which are either pure reactances or pure resistances. If the image impedances of such a network are pure resistances and it is connected between a generator and load whose impedances are equal to these image resistances, the impedances will match at both junctions. Under these conditions the maximum power will be absorbed from the generator and, since it has been assumed that the arms of the connecting network are pure reactances, no power will be dissipated in the transfer and so this maximum power will be delivered to the load.

Regardless of the generator impedance, any output load can be modified by a properly designed network so that the input impedance at the terminals 1-2 will be anything desired. In amplifiers which fall in classes B and C the output load is frequently not made equal to the effective impedance of the tube, and the design is made on the basis of an image impedance Z_{I1} equal to the load impedance required,

If the terminating impedances are not pure resistances, they can be made so at any single frequency by additional reactance in series with them.

Both T and π configurations of reactances can be used for matching networks. Actual networks have dissipation in their arms, but this should be made as small as is commercially feasible.

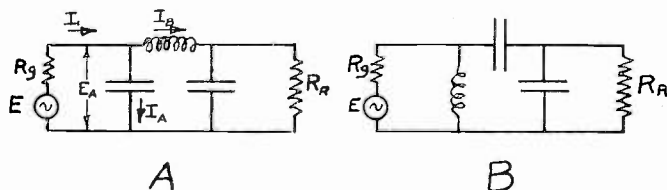

Fig. 2—Impedance matching networks.

Fig. 2 shows two types of π networks used to match impedances. Fig. 2A, in addition to being an impedance matching network, is also a low-pass filter and is, therefore, one of the best methods of coupling a radio-frequency power amplifier to its load.

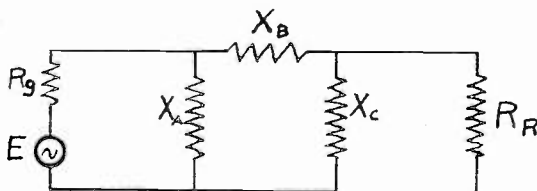

Fig. 3—General network for matching impedances.

To determine the image impedances of Fig. 3, the open- and short-circuited impedances will be computed, assuming each arm to be a pure reactance.

$$\begin{aligned}
 Z_{01} &= \frac{jX_A j(X_B + X_C)}{j(X_A + X_B + X_C)} \\
 Z_{s1} &= \frac{jX_A jX_B}{j(X_A + X_B)} \\
 Z_{02} &= \frac{jX_C j(X_A + X_B)}{j(X_A + X_B + X_C)} \\
 Z_{s2} &= \frac{jX_B jX_C}{j(X_B + X_C)} \\
 Z_{11}^2 = R_1^2 &= \frac{-X_A^2 X_B (X_B + X_C)}{(X_A + X_B + X_C)(X_A + X_B)} \quad (5)
 \end{aligned}$$

$$Z_{I_2}^2 = R_2^2 = \frac{-X_C^2 X_B (X_A + X_B)}{(X_A + X_B + X_C)(X_B + X_C)} \quad (6)$$

In order to make the image impedances resistive, it is apparent that one of the arms must be of an opposite type of reactance to the other two, so that the right-hand sides of (5) and (6) may be a positive number and its square root a pure resistance.

Multiplying (5) and (6) and extracting the square root:

$$R_1 R_2 = \frac{-X_A X_B X_C}{X_A + X_B + X_C} \quad (7)$$

Dividing (5) by (6) and extracting the square root:

$$\frac{R_1}{R_2} = \frac{X_A (X_B + X_C)}{X_C (X_A + X_B)} \quad (8)$$

From (8)

$$\begin{aligned} R_1 X_A X_C + R_1 X_B X_C &= R_2 X_A X_B + R_2 X_A X_C \\ X_A &= \frac{R_1 X_B X_C}{(R_2 - R_1) X_C + R_2 X_B} \end{aligned} \quad (8a)$$

From (7)

$$\begin{aligned} R_1 R_2 X_A + R_1 R_2 (X_B + X_C) + X_A X_B X_C &= 0 \\ X_A &= -\frac{R_1 R_2 (X_B + X_C)}{R_1 R_2 + X_B X_C} \end{aligned} \quad (7a)$$

Equate the right-hand sides of (7a) and (8a)

$$\frac{X_B X_C}{(R_2 - R_1) X_C + R_2 X_B} = -\frac{R_2 (X_B + X_C)}{R_1 R_2 + X_B X_C}$$

$$X_B^2 X_C^2 = -R_2^2 X_B X_C - R_2^2 X_C^2 + R_1 R_2 X_C^2 - R_2^2 X_B^2 - R_2^2 X_B X_C$$

$$X_B^2 X_C^2 = -R_2^2 (X_B + X_C)^2 + R_1 R_2 X_C^2$$

$$R_2 (X_B + X_C) = \pm X_C \sqrt{R_1 R_2 - X_B^2}$$

$$X_C = \frac{-R_2 X_B}{R_2 \pm \sqrt{R_1 R_2 - X_B^2}} \quad (9)$$

By the symmetry of the network the expression for X_A can be written immediately

$$X_A = \frac{-R_1 X_B}{R_1 \pm \sqrt{R_1 R_2 - X_B^2}} \quad (10)$$

When (9) and (10) are fulfilled, the case is one of optimum resonance. If the method of analysis just used is applied to the T section of pure reactances, the optimum resonance conditions given by Pierce¹ will be obtained.

X_B can be arbitrarily selected and may have a positive or negative value, except that the radical $\sqrt{R_1R_2 - X_B^2}$ must be a real number. Therefore the limitation on X_B is that

$$|X_B| < R_1R_2. \quad (11)$$

This limitation corresponds to the limitation on the *minimum* value which the shunt arm of a T network can have and maintain an impedance match. If $X_B^2 > R_1R_2$, therefore, the coupling is insufficient and an impedance match cannot be obtained no matter what the values of X_A and X_C .

There will be two pairs of values for X_A and X_C corresponding to the plus and minus signs in front of the radicals in (9) and (10). If the positive sign is selected in (9), then it must likewise be selected in (10) and vice versa.

As an example, take the case of a generator whose internal impedance is 2000 ohms (a vacuum tube perhaps), which is to be matched against a 500-ohm line. Then the maximum absolute value which X_B can have is

$$X_B = \sqrt{2000 \times 500} = 1000 \text{ ohms.}$$

Suppose an inductance whose reactance is 800 ohms is selected arbitrarily for X_B . Then

$$\sqrt{R_1R_2 - X_B^2} = 600.$$

Compute the pair of reactances X_A and X_C corresponding to the positive sign in front of the radical first.

$$X_C = \frac{-500 \times 800}{500 + 600} = -364 \text{ ohms}$$

$$X_A = \frac{-2000 \times 800}{2000 + 600} = -615 \text{ ohms.}$$

These values are shown in Fig. 4. If the values of reactance are known, the values of inductance and capacitance can be computed at any frequency.

¹ *Loc. cit.*

Next, compute the pair of reactances X_A and X_C corresponding to the negative sign in front of the radical.

$$X_C = \frac{-500 \times 800}{500 - 600} = +4000$$

$$X_A = \frac{-2000 \times 800}{2000 - 600} = -1142.$$

The values corresponding to this network are shown in Fig. 4 B.

If the input impedances of the networks with their 500-ohm terminations are computed, they will be found to be 2000 ohms and there-

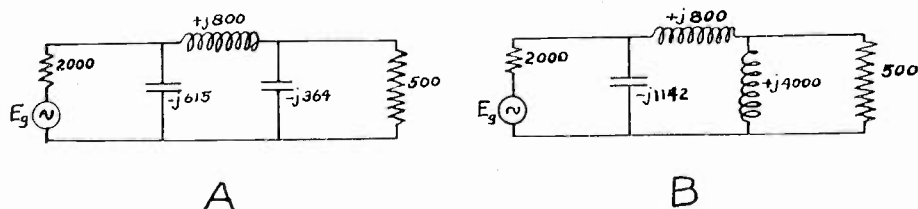

Fig. 4— π matching networks with inductive series element.

fore absorb maximum power from the generators. The network 4 A will also attenuate the harmonics, while 4 B will not, and therefore 4 A is usually the more desirable.

If X_B had been assumed as a negative reactance of 800 ohms, all the negative reactances of Fig. 4 would become positive reactances and vice versa. Two other types of networks would then be obtained, which are shown in Fig. 5.

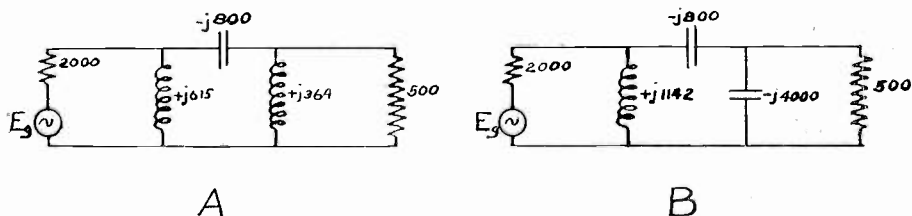

Fig. 5— π matching networks with capacitive series element.

The network of Fig. 5A has the configuration of a high-pass filter, and so may be useful in some special cases where it is desirable to eliminate frequencies lower than the one for which the network is designed, e.g., a frequency multiplier.

It is possible to accentuate the low-pass filter action of Fig. 4A. The capacitive reactance of X_A can be secured by an inductance in

series with a condenser as shown in Fig. 6A. The same may be said of X_C . Fig. 6B shows the reactance curve of the series combination. It is frequently desirable to eliminate the second or third harmonic. The frequency which is to be attenuated is the resonant frequency f_2 , while at the frequency f_1 at which the energy is to be transferred, the combination should have the reactance determined from (9) and (10).

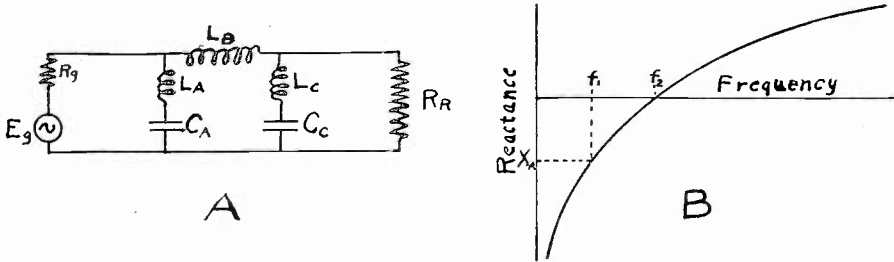

Fig. 6—Low-pass filter matching network for harmonic suppression.

Let ω_1 be the angular velocity at which the combination is to have a reactance X_A ,

ω_2 be the angular velocity at which the combination is to be resonant,

L_A be the inductance of the combination, and

C_A be the capacitance of the combination.

Then,

$$\omega_1 L_A - \frac{1}{\omega_1 C_A} = X_A \quad (12)$$

$$\omega_2 L_A - \frac{1}{\omega_2 C_A} = 0. \quad (13)$$

From (13)

$$\frac{1}{C_A} = \omega_2^2 L_A.$$

Substitute in (12)

$$\left(\omega_1 - \frac{\omega_2^2}{\omega_1} \right) L_A = X_A$$

$$L_A = \frac{\omega_1}{\omega_1^2 - \omega_2^2} X_A \quad (14)$$

$$C_A = \frac{\omega_1^2 - \omega_2^2}{\omega_1 \omega_2^2 X_A} \quad (15)$$

If the system is to attenuate a harmonic, let n be the number of the undesired harmonic. Then,

$$\omega_2 = n\omega_1$$

$$L_A = \frac{X_A}{(1 - n^2)\omega_1} \quad (14a)$$

$$C_A = \frac{(1 - n^2)}{n^2\omega_1 X_A} \quad (15a)$$

Equations (14) and (15) may be applied to determine the inductive and capacitive components for any arm to give resonance at one frequency and any desired reactance at another frequency.

As an example, let the computations of Fig. 4A be carried on to the values of Fig. 6A, such that X_A will attenuate the second harmonic and X_C will attenuate the third harmonic. Let the circuit be designed for maximum transfer of energy at 1,000,000 cycles.

$$\omega_1 = 6.28 \times 10^6$$

For X_A , $n=2$

$$L_A = \frac{-615}{(1 - 4)6.28} \times 10^{-6} = 32.6 \text{ microhenries}$$

$$C_A = \frac{(1 - 4) \times 10^{-6}}{4 \times 6.28 \times -615} = 194 \text{ micromicrofarads}$$

For X_C , $n=3$

$$L_C = \frac{-364}{(1 - 9)6.28} \times 10^{-6} = 7.24 \text{ microhenries}$$

$$C_C = \frac{1 - 9}{9 \times 6.28 \times -364} \times 10^{-6} = 389 \text{ micromicrofarads}$$

And

$$L_B = \frac{800}{6.28} \times 10^{-6} = 127.5 \text{ microhenries}$$

In a similar way it would be possible in the network of Fig. 5A to design the shunt reactances to be resonant at any frequency *below* the one for which the network is designed.

In Figs. 4A and 5A, if the reactances X_A and X_B are *small* in comparison with the resistances shunting them, it will be found that the matching network is essentially a parallel resonant circuit so that approximately,

$$X_A + X_B + X_C = 0$$

$$\text{Then} \quad X_B + X_C = -X_A$$

$$X_A + X_B = -X_C$$

and (8) becomes

$$\frac{R_1}{R_2} = \frac{X_A^2}{X_C^2} \quad (16)$$

This relation is frequently used to determine approximate values of X_A and X_C .

The network of physically realizable reactances will dissipate some energy in its elements. It is desirable to make this loss as small as

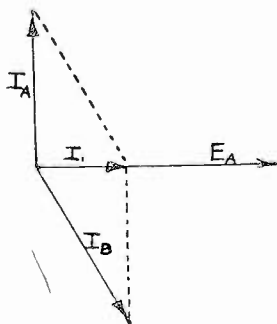

Fig. 7—Vector diagram of Fig. 2A.

possible. A vector diagram of the voltage and currents in Fig. 2A is shown in Fig. 7. If properly designed, I_1 will be in phase with E_A and $E_A/I_1 = R_1$

$$\begin{aligned} I_B^2 &= I_1^2 + I_A^2 \\ &= \frac{E_A^2}{R_1^2} + \frac{E_A^2}{X_A^2} \end{aligned}$$

If Q_B is equal to X_B/R_B for the coil, the power lost in the network is, neglecting condenser losses:

$$P_{\text{lost}} = I_B^2 \frac{X_B}{Q_B} = \frac{E_A^2 X_B}{Q_B} \left(\frac{1}{R_1^2} + \frac{1}{X_A^2} \right)$$

Substitute in the value of X_A^2 from (10)

$$\begin{aligned}
 P_{\text{lost}} &= \frac{E_A^2 X_B}{Q_B} \left[\frac{1}{R_1^2} + \frac{(R_1 + \sqrt{R_1 R_2 - X_B^2})^2}{R_1^2 X_B^2} \right] \\
 &= \frac{E_A^2 X_B}{Q_B} \left[\frac{X_B^2 + R_1^2 + 2R_1 \sqrt{R_1 R_2 - X_B^2} + R_1 R_2 - X_B^2}{R_1^2 X_B^2} \right] \\
 &= \frac{E_A^2}{R_1^2 X_B Q_B} [R_1^2 + R_1 R_2 + 2R_1 \sqrt{R_1 R_2 - X_B^2}]. \tag{17}
 \end{aligned}$$

The effect of increasing X_B is to increase the denominator and decrease the numerator, so the larger X_B is taken the less will be the loss.

The power delivered to the network is:

$$\begin{aligned}
 P_{\text{input}} &= \frac{E_A^2}{R_1} \\
 \text{Efficiency} &= \left(1 - \frac{P_{\text{lost}}}{P_{\text{input}}} \right) 100 \\
 &= \left[1 - \frac{1}{R_1 X_B Q_B} (R_1^2 + R_1 R_2 + 2R_1 \sqrt{R_1 R_2 - X_B^2}) \right] \times 100. \tag{18}
 \end{aligned}$$

The maximum value which X_B can have and still maintain an impedance match is:

$$X_B = \sqrt{R_1 R_2}.$$

The maximum efficiency has been shown to occur when X_B is a maximum,

$$\therefore \text{maximum efficiency} = \left[1 - \frac{R_1 + R_2}{Q_B \sqrt{R_1 R_2}} \right]. \tag{18a}$$

In addition to the Q of the coil, this maximum efficiency is a function of the ratio of resistances to be matched.

Let
$$a = \frac{R_1}{R_2}$$

$$\therefore \text{maximum efficiency} = \left[1 - \frac{a + 1}{Q \sqrt{a}} \right]. \tag{18b}$$

This efficiency decreases with increasing values of "a." It is interesting to note values which X_A and X_B have when X_B is equal to its maximum value $\sqrt{R_1 R_2}$.

From (9) and (10)

$$X_A = -X_B$$

$$X_C = -X_B.$$

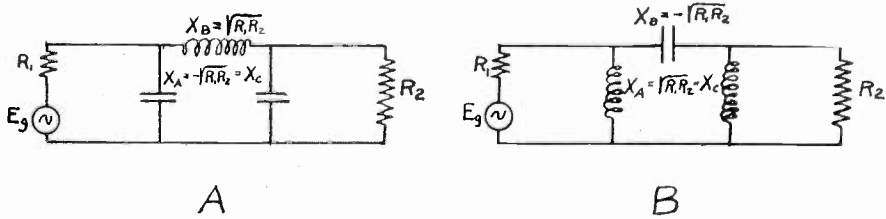

Fig. 8—Balanced π matching network.

The matching network then becomes the balanced π section of Fig. 8. The characteristic impedance of such a network is:

$$Z_{0\pi} = \sqrt{\frac{Z_1 Z_2}{Z_1 Z_2 + \frac{Z_1^2}{4}}}$$

Now, $Z_1 = \pm j\sqrt{R_1 R_2}$

$$Z_2 = \mp j\frac{\sqrt{R_1 R_2}}{2}$$

$$Z_{0\pi} = \frac{\frac{R_1 R_2}{2}}{\sqrt{\frac{R_1 R_2}{2} - \frac{R_1 R_2}{4}}} = \sqrt{R_1 R_2}. \quad (19)$$

The characteristic impedance of such a network is therefore the geometric mean of the terminating resistances. This is a special case of a line an odd number of quarter wavelengths long.

The input impedance of a line is, by long lines theory,

$$\frac{E_s}{I_s} = Z_0 \left(\frac{Z_0 \sinh \gamma l + Z_R \cosh \gamma l}{Z_0 \cosh \gamma l + Z_R \sinh \gamma l} \right)$$

If the attenuation is zero and if the line is an *odd* number of quarter wavelengths long, then

$$\begin{aligned} \cosh \gamma l &= \cosh \left[0 + j(2n - 1)\frac{\pi}{2} \right] \\ &= \cos (2n - 1)\frac{\pi}{2} = 0. \end{aligned}$$

Substitute this value in the long-lines equation

$$\frac{E_s}{I_s} = \frac{Z_0^2}{Z_R} \quad (20)$$

To show that the network of Fig. 8 is a quarter-wave section, use the well-known equation for balanced sections:

$$\cosh \gamma = 1 + \frac{Z_1}{2Z_2} \quad (21)$$

In Fig. 8,

$$\frac{Z_1}{2Z_2} = -1$$

$$\therefore \cosh \gamma = 0 \cosh (\alpha + j\beta) = \cosh \alpha \cos \beta + j \sinh \alpha \sin \beta = 0.$$

This can be true only if $\alpha = 0$ and $\beta = \pi/2$.

The open-circuited impedance of such a structure would be zero while the short-circuited impedance would be infinite, so that (3) and (4) become indeterminate. Under these conditions one image impedance may be assumed at will, but the other image impedance will be given by

$$Z_{11} = \frac{Z_0^2}{Z_{12}} \quad (22)$$

A radio-frequency transmission line has a small loss, and if its characteristic impedance can be made equal to the geometric mean of the terminating impedances, it can also be used to match two resistances when the line is an odd integral number of quarter wavelengths long. Usually, however, the range of permissible line impedances is limited.

From the discussion, it is apparent that there is a variety of configurations for matching networks which can be used to connect a generating system efficiently to its useful load, but in order to obtain high efficiency, any of these networks should be properly designed.



THEORY AND OPERATION OF TUNED RADIO-FREQUENCY COUPLING SYSTEMS*

BY

HAROLD A. WHEELER¹ AND W. A. MACDONALD²

(¹Engineer, ²Chief Engineer, Hazeltine Corporation, New York City)

Summary—The subject is the tuned r-f coupling systems commonly used in broadcast receivers, to couple the antenna to the grid of the first tube, and to couple the plate of each r-f amplifier tube to the grid of the following tube. The simple tuned r-f transformer used in the 1923 neutrodyne receiver has been improved by the coöperation of different kinds of impedances in the primary circuit. The "equivalent mutual inductance" is thereby caused to vary with frequency in a predetermined manner, without the use of any moving elements except the tuning condenser; this is also referred to as a varying "effective turns ratio." The gain of an amplifier can be held uniform or made to vary with frequency in any desired manner consistent with the amplifying ability of the tube and the tuned secondary circuit, and without appreciable loss of selectivity. A large variety of these improved coupling circuits is shown and classified in terms of the fixed and varying components of the equivalent mutual inductance. A large number of these coupling systems from commercial broadcast receivers are described in terms of coil structure, electrical constants, and performance. These include antenna and amplifier circuits dating from 1924 to date, and used in unneutralized, neutralized, and screen-grid receivers. Special attention is paid to antenna circuits for unicontrol receivers, whose tuning is substantially independent of antenna capacitance and of the adjustment of a shunt rheostat sometimes used as a volume control. The problems involved are treated mathematically with the aid of general theorems and specific examples.

PART I. HISTORICAL INTRODUCTION

THE SUBJECT of tuned radio-frequency transformers or coupling systems has received much attention since the spring of 1923, when non-oscillating broadcast receivers with tuned r-f amplifiers first appeared on the market and were widely accepted by the public. These receivers secured both high amplification and high selectivity without regeneration, by the use of low resistance helical coils tuned by variable air condensers. The elimination of regeneration as a controlling factor made the performance of these tuned r-f amplifiers entirely dependent on careful design and manufacture, which required much study and experimental work.

Tuned r-f coupling systems are most generally used in broadcast receivers for the purpose of coupling the antenna to the grid of the

* Decimal classification: R142. Original Manuscript received by the Institute, July 3, 1930. Presented before Fifth Annual Convention of the Institute, August 20, 1930.

first vacuum tube, and for the purpose of coupling the output or plate circuit of an r-f amplifier tube to the grid of the following tube.

A typical 1923 receiver used r-f transformers of the simple type which has become well known, and is shown in Fig. 1. C_n is the neutralizing capacitance of a plate-circuit neutralization arrangement for neutralizing the inherent grid-plate capacitive coupling of the tube and does not otherwise affect the action of the r-f transformers.¹

Primary coil L_1 is closely coupled to secondary coil L , and these two coils are tuned as a unit to the signal by means of a variable air condenser, C . The use of a condenser for the tuning means permits of a very low resistance fixed coil L and resulting high selectivity and amplification. For this reason this method of tuning has been generally adopted. In Fig. 1, an autotransformer is shown in the antenna circuit and an inductively coupled transformer in the amplifier circuit. The r-f action of these two is essentially the same.

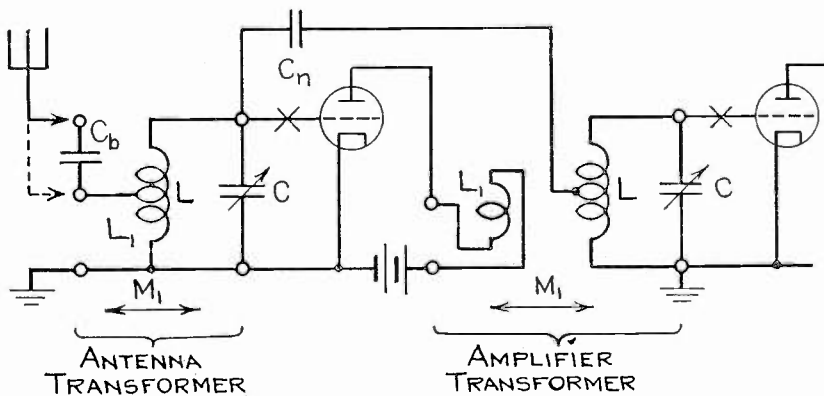

Fig. 1—Simple r-f transformers of neutrodyne receiver (I).

While condenser tuning is generally accepted as the best method, it has one serious weakness. When the tuned circuit is resonant at the various frequencies, the impedances across the secondary circuit are much higher at higher frequencies. Higher secondary circuit impedances promote higher amplification or gain, so that the gain using such transformers may be several times as great at the highest frequency as at the lowest frequency.

Various schemes have been used to make the gain of the simple transformer more uniform over the broadcast range. One of the most common employs a resistance in the grid leads at "X" in Fig. 1. Then an approach to uniform gain is secured only at a great loss of selectivity. Another of these schemes employs a mutual inductance,

¹ L. A. Hazeltine, *Proc. Radio Club of Amer.*, 2, No. 8, March, 1923. U. S. Patents 1,489,228, April, 1924, and 1,533,858, April, 1925.

M_1 , which is varied simultaneously with the tuning condenser. This variable element in addition to the tuning condenser is difficult to build in a radio receiver, especially in the recent receivers in which many parts are individually shielded.

The required scheme for securing uniform gain, therefore, has been an arrangement wherein the *effective* mutual inductance varies automatically with tuning frequency, without the use of any moving elements in addition to the tuning condenser.

The real solution of this problem was left to the late Carl E. Trube. A short time ago, he and the present writers planned to present this subject to the Institute in a joint paper. It is deeply regretted that he did not live to assist in this presentation of the developments which grew out of his inventions. The writers gratefully acknowledge the data furnished by him, which have contributed much to this paper.

Trube conceived that the characteristics of a tuned r-f coupling system could be determined within wide limits by effectively combining in the primary circuit, impedances of different kinds, instead of using only a closely-coupled primary coil, as in Fig. 1. By proper choice of these impedances, any desired results could be obtained within the amplifying ability of the tube and the tuned circuit. This would require no adjustable element except the tuning condenser.

In 1924-26, Trube was employed as consulting engineer by the Shepard-Potter Company of Plattsburg, New York, which was reorganized late in 1924 as the Thermiodyne Radio Corporation. This organization was then manufacturing radio receivers with tuned r-f amplifiers. Oscillations were prevented in these receivers by two coöperating means, without neutralization of the inherent grid-plate capacitive coupling of the tubes. First, the r-f amplifier plate circuits were provided with capacitive reactance so that the load in the plate circuits could not become so highly inductive while tuning the r-f transformers. This greatly reduced regeneration. Secondly, the gain was reduced sufficiently so that any remaining regeneration was insufficient to cause oscillations. Reduction of the gain too far below the oscillation threshold in any part of the broadcast band resulted in too poor sensitivity, and therefore it was necessary to predetermine the gain so that its value was sufficiently constant, or varied with frequency in the reverse manner, to fulfill these conditions. This second requirement was satisfied by the following developments.

The first Thermiodyne receiver was the model TF-6, which was manufactured beginning in August, 1924, and which employed three tuned r-f amplifier stages, each connected according to Fig. 2. Originally the choke coil, L_2 , was an iron-core coil, and later an air-core

coil of high inductance. Trube found that the gain at the lower frequencies could be greatly improved by making the air-core coil L_2 , together with primary condensers C_1 and C_2 , resonant at a frequency of 400 to 450 kc, slightly lower than the broadcast band.^{2,3} This feature was incorporated in the modified TF-6, first manufactured in

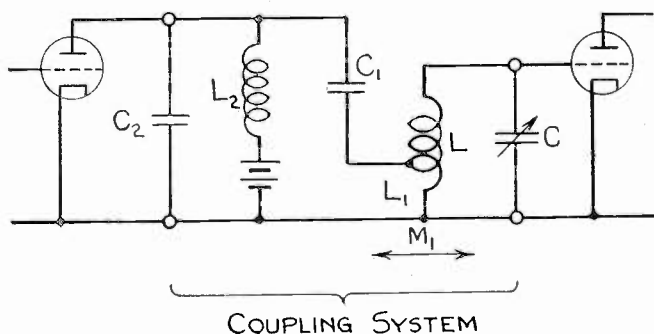

Fig. 2—Tuned r-f amplifier stage of modified TF-6 receiver (II).

December, 1924. This improvement was of such importance that service men were instructed how to modify the earlier receivers. The chassis of this model is shown in Fig. 3.

The action of Fig. 2 in the modified TF-6 is easily explained as follows. The amplified r-f plate current of the tube divides, one part

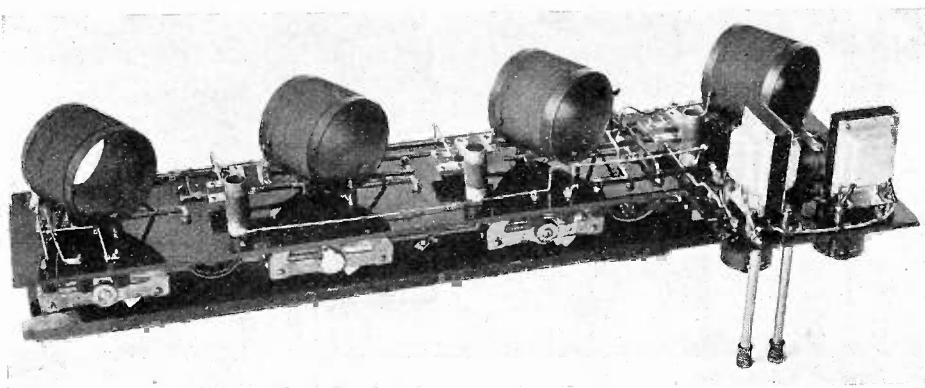

Fig. 3—Chassis of modified TF-6 receiver (II).

flowing through the parallel path, C_2 , L_2 , and the other part flowing through the series path, C_1 , L_1 . The "effective number of turns" of L_1 is therefore different from the actual number of turns. At the lower frequencies the effective capacitance of the parallel path is less because of the presence of L_2 . Therefore the effective number of turns of L is greater at lower frequencies. In other words, the "effective

² C. E. Trube, U. S. Patent 1,763,380, June, 1930.

³ C. E. Trube, British Patent 273,639, July, 1926.

step-up ratio" of the coupling system as a whole, is less at lower frequencies. This effect of varying primary turns is secured without actually changing any of the circuit elements. The resulting gain is predetermined merely by choice of the circuit constants.

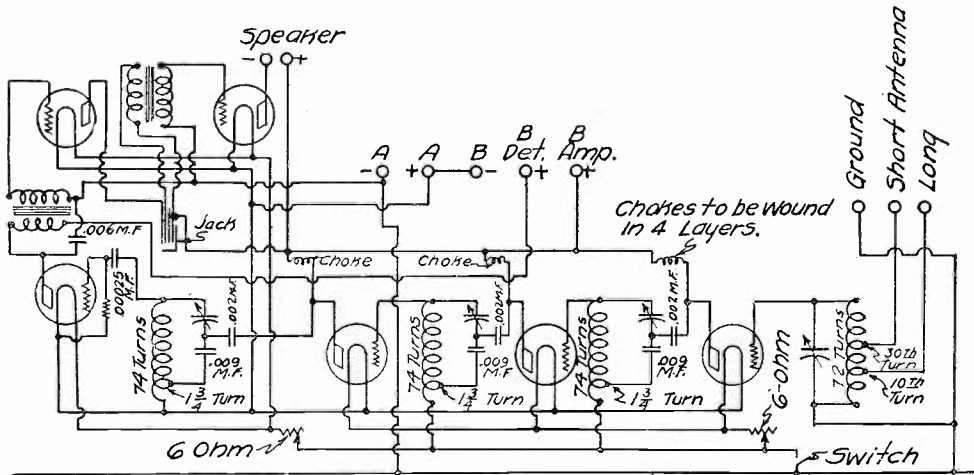

Fig. 4—Complete circuit of new TF-6 receiver (III).

The meritorious features of this and later Thermiodyne models were not generally appreciated by radio engineers until years later. In addition to the ingenious tuned r-f systems, these receiving sets employed tuning condensers operated simultaneously by a rack-and-pinion mechanism, and were probably the first manufactured receivers to use as many as four tuned circuits. Both of the latter features anticipated later practice.

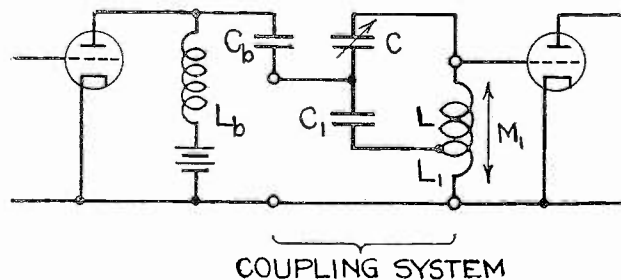

Fig. 5—Tuned r-f amplifier stage of new TF-6 and TF-5 receivers (III and IV).

A different r-f primary circuit was employed by Trube in a new TF-6 model, manufactured beginning in March, 1925. The chassis arrangement was not changed, but the circuit of the new model was according to Fig. 4, which is copied from a factory blueprint. A single r-f stage from this circuit is shown in Fig. 5.^{3,4}

⁴ Similar circuit described later by E. H. Loftin and S. Y. White, Proc. I.R.E., 14, 605; October, 1926.

The action of this circuit is somewhat different from that of Fig. 2, but achieves the same result. The choke coil, L_b , has a high r-f impedance and serves only to supply the direct plate current to the tube. The coupling condenser, C_b , contributes to the antiregenerative effect mentioned above, but does not affect the action of the r-f coupling system proper. The amplified r-f plate current divides between the tuning condenser, C , and the primary condenser, C_1 , only one part flowing through the tuned coil, L , but both parts flowing through the primary coil, L_1 . The effective number of primary turns is the sum of a fixed number depending on L_1 and a varying number depending on what part of the r-f plate current flows through L . At lower frequencies, the tuning condenser has more capacitance; therefore the total effective number of primary turns is greater at lower frequencies. In other words, the effective step-up ratio is less at lower frequencies, as in Fig. 2.

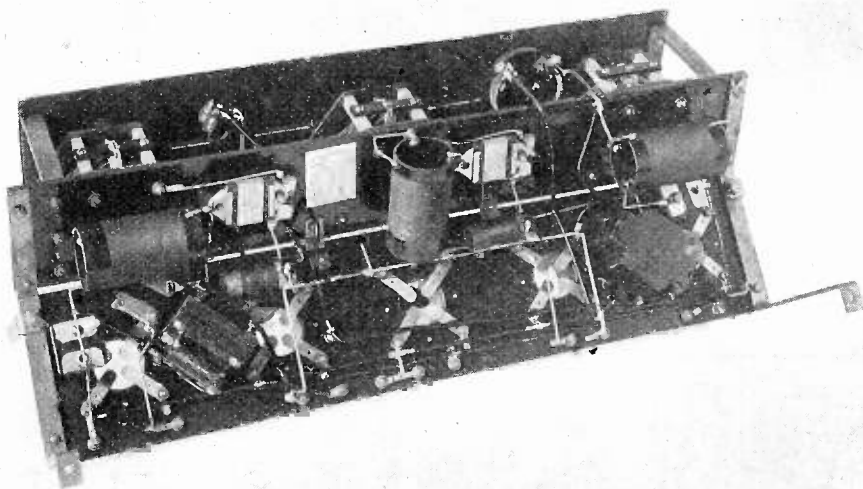

Fig. 6—Chassis of TF-5 receiver (IV).

The sensitivity of the new TF-6 model was very good and was much more uniform over the broadcast band than that of other contemporary receivers in its class. The gain in each of the three r-f stages was somewhat greater at lower frequencies, as limited by the oscillation criterion, but the gain of the antenna circuit was very much higher at higher frequencies, because the simple transformer was used in the antenna circuit.

Since the performance of the new TF-6 was better than required by many broadcast listeners, the TF-5 model was developed, having only two tuned r-f amplifier stages and a tuned antenna system. This model was first manufactured in April, 1925. Fig. 6 shows the chassis

arrangement. This model was made in two types which differed in only a few details; the circuit of the first TF-5 appears in Fig. 7, while that of the second TF-5 appears in Fig. 8. Both of these figures are copies of factory blueprints. The tuned r-f amplifier stages are like

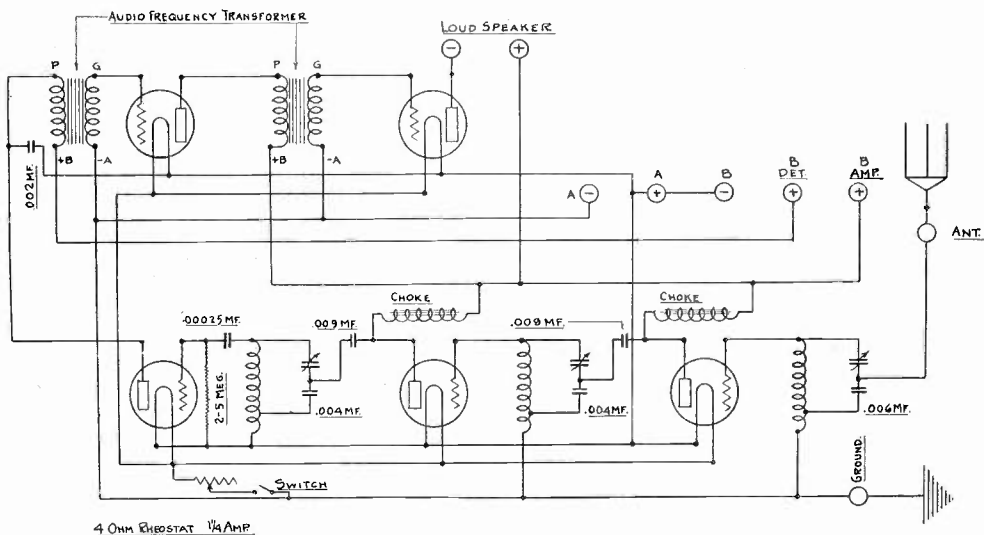

Fig. 7—Complete circuit of first TF-5 receiver (IV).

those of the new TF-6 but with changed electrical constants. In the TF-5, however, the antenna coupling system is made similar to the r-f amplifier coupling systems. This feature has the advantages that the

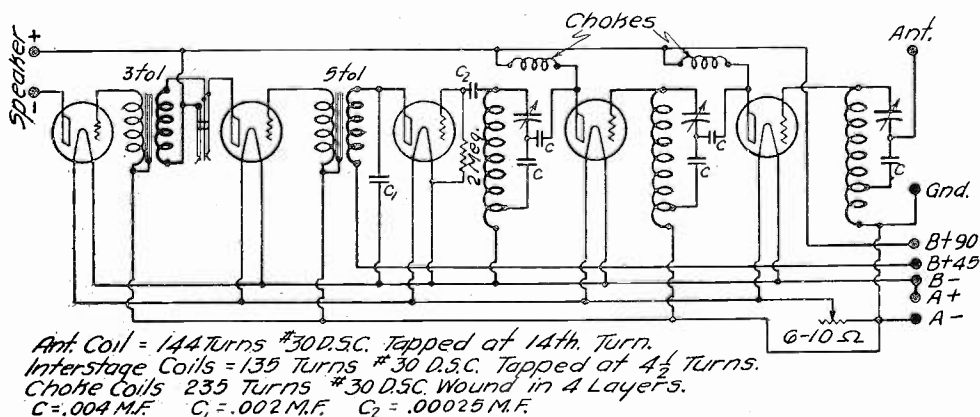

Fig. 8—Complete circuit of second TF-5 receiver (IV).

tuning of the antenna circuit is more like that of the r-f amplifier circuits, which facilitates unicontrol operation, and the gain of the antenna circuit is more nearly uniform.

During the 17 months from December 1924 to April 1926, more than 50,000 of the above receivers were manufactured and sold, mostly

of the new TF-6 model. This includes a chassis like the new TF-6, which was built into the Music Master model 175-G receiver.

Early in 1926, the Hazeltine Corporation secured the prospective patent rights of Trube, and subsequent developments have been carried on by this organization.

The Trube scheme was next employed in the chassis of Gilfillan receivers, models 30 and 40, manufactured beginning in December, 1926. Fig. 9 shows this chassis, with shielding boxes removed. The circuit is shown in Fig. 10, which is a copy of a factory blueprint. The

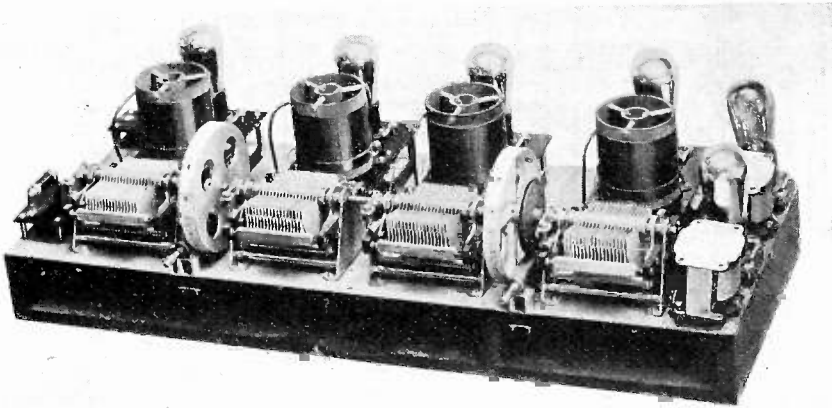

Fig. 9—Chassis of Gilfillan models 30 and 40 receiver (V).

antenna system and one tuned r-f amplifier stage are shown in the simplified diagram of Fig. 11.² This circuit was an adaptation of the Trube idea to the shielded neutrodyne receiver⁵ and oscillations were prevented by the so-called "plate-circuit neutralization" already in common use.

Referring to the antenna circuit in Fig. 11, there are two primary coils, L_1 and L_2 , connected in series in opposite directions. Then L_2 , together with C_1 and the antenna capacitance, is resonant at a frequency somewhat lower than the broadcast band. The result is equivalent to a simple transformer with varying number of primary turns, the sum of a fixed number depending on L_1 plus a varying number depending on L_2 and the frequency. The total effective number of turns is greater at lower frequencies since the current through L_2 is greater at frequencies nearer the natural frequency of the primary circuit.

The amplifier circuit of Fig. 11 is somewhat similar to the antenna circuit. In addition, each primary coil, L_1 , L_2 , has a neutralizing coil,

² *Loc. cit.*

⁵ J. F. Dreyer, Jr., and R. H. Manson, *PROC. I.R.E.*, 14, 217; April, 1926. L. A. Hazeltine (discussion), *PROC. I.R.E.*, 14, 395; June, 1926.

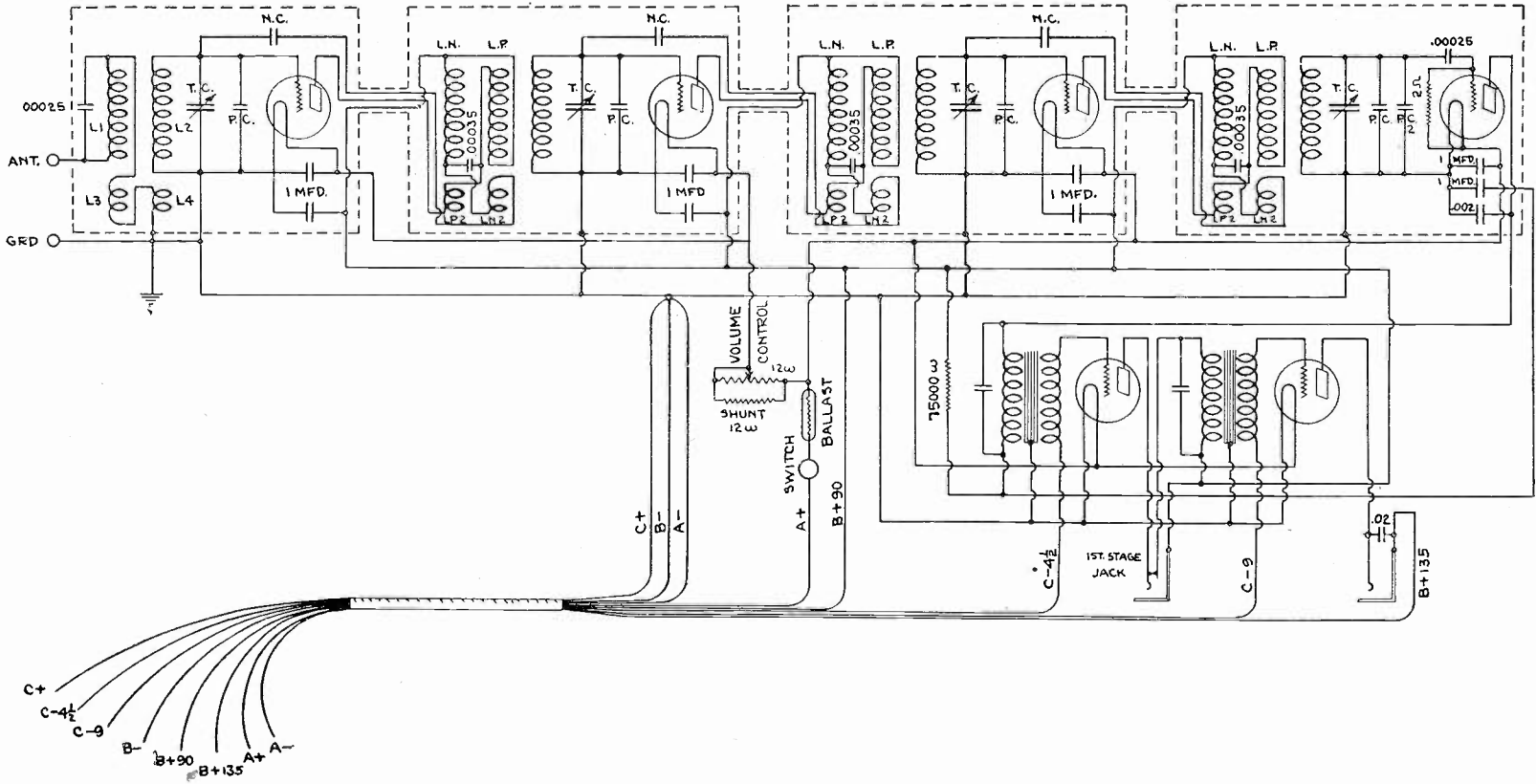

Fig. 10—Complete circuit of Gilfillan models 30 and 40 receiver (V).

L_1' , L_2' , wound interleaved therewith on the same cylindrical form. All coil forms are threaded to guide the windings. The neutralizing coils are thereby very closely coupled to the primary coils, which secures nearly perfect neutralization.⁵ Instead of connecting the primary condenser directly across L_2 , as in the antenna circuit, the condenser C_1' is connected across L_2 and L_2' in series. This gives more uniform current distribution in the windings of L_2 and L_2' , and thereby reduces the dissipation in these coils. Aside from this feature, the

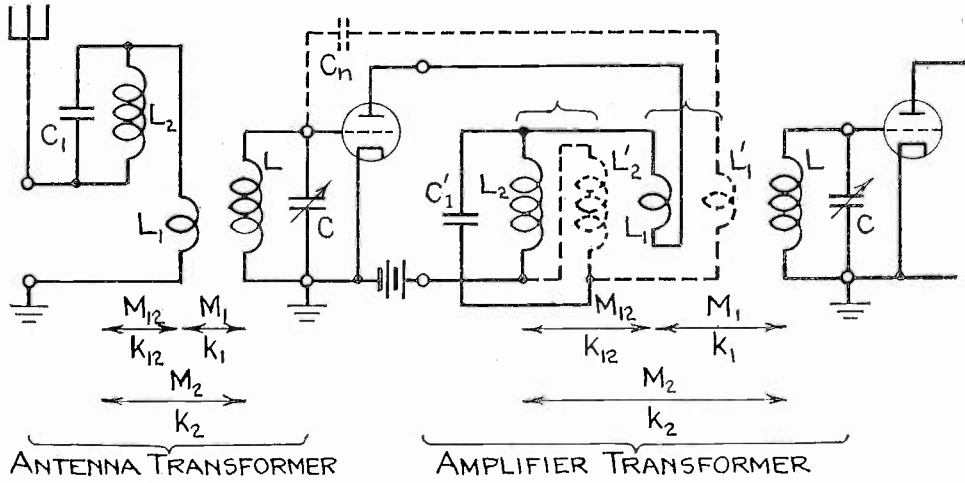

Fig. 11—Tuned r-f coupling systems of Gilfillan models 30 and 40 receiver (V).

neutralizing circuit, C_n, L_1', L_2' , makes no essential contribution to the action of the primary circuit.

This Gilfillan receiver gave excellent performance with these coupling systems, but the cost of manufacturing these coils was so great that this system was not used in other receivers. More recent developments have overcome such obstacles. The coils to be described later in this paper are representative of the commercial designs which have evolved out of the original work of Trube. Up to the present time, more than a dozen manufacturers have embodied these developments in their radio receivers, and more than 500,000 such sets have been marketed by this group. At the time of writing, there are at least eight large manufacturers producing receivers using circuits like those described herein.

PART II. THEORETICAL INTRODUCTION

This part of the paper will be devoted to a description of the theory of tuned r-f coupling systems, in so far as it is required to appreciate the essential subject matter. The detailed mathematical analyses,

⁵ *Loc. cit.*

on the other hand, will be relegated to the latter section of the paper, since they are not required for a general appreciation of the subject. This theoretical material, both descriptive and mathematical, is intended to convey a picture of the action of these coupling systems, together with a survey of the design problems met in practice.

Any coupling system must receive power from a source. The sources to be considered are the capacitive radio antenna and the amplifying vacuum tube. The vacuum tube will be treated as a unidirectional relay, without grid-plate capacitive coupling. In some examples to be described, this does not represent operating conditions; this fact has been pointed out in connection with the TF-5 and TF-6 receivers.

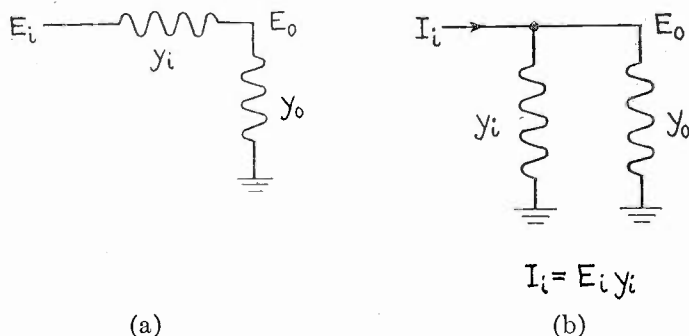

Fig. 12—Generalized source, (a) “constant voltage generator”, (b) equivalent “constant current generator” circuit.

In all other cases, this condition will be closely approximated either by the use of neutralization or by the use of screen-grid tubes.

It is customary to regard such a source as a fictitious generator having an internal e.m.f., E_i , and an internal admittance, y_i , as shown in Fig. 12 (a). The terminal voltage is indicated by E_o and the external or load admittance by y_o . This last quantity represents the input or primary circuit of the coupling system. This will be called the “constant voltage generator” concept, because the internal voltage, E_i , is considered to be independent of load characteristics. In Part VIII, this will be shown to be replaceable by a “constant current generator” concept, illustrated by Fig. 12(b). The same symbols appear in the latter figure, except the generator supplies a current I_i in place of a voltage E_i . The two sources supply the same load voltage and current when the equation of Fig. 12(b) is satisfied, so that the two concepts may be employed interchangeably.

In general, the nature of the internal admittance, y_i , affects the behavior of the coupling system connected thereto. It is therefore an advantage to have y_i appear in parallel with the load. In the analyses

to follow, y_i will be regarded as part of the coupling system wherever its presence affects the conclusions to be drawn.

The reduction of an antenna source to a "constant current generator" appears in Fig. 13, and that of a vacuum tube source appears in Fig. 14. In the former figure, c_a represents the apparent capacitance of the antenna at the signal frequency.

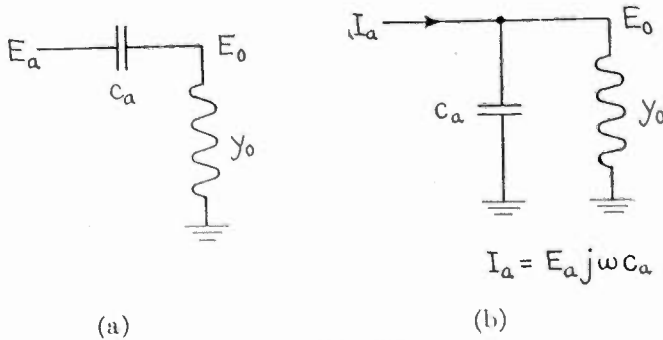

Fig. 13—Antenna source.

The tuned r-f coupling systems under study employ only fixed circuit elements, such as coils and condensers, in addition to a variable tuning condenser. Each system of coils and condensers, usually designated as an "r-f transformer," must not have any substantial coupling to any other such system in the same receiver, in order to avoid feed-back effects, regeneration or oscillations. Intertransformer coupling is now commonly prevented by the use of shielding cans around the individual coil systems. Such a shielding can constrains

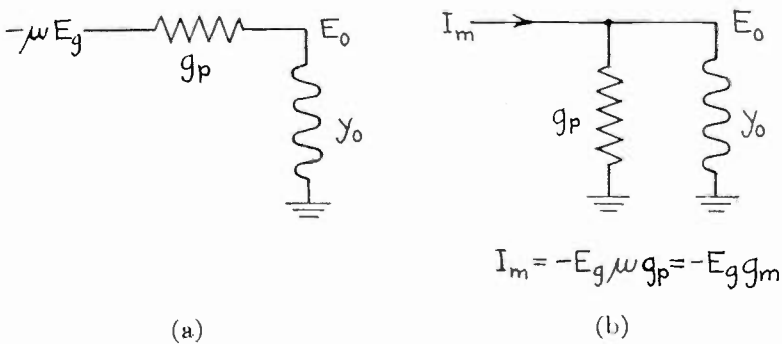

Fig. 14—Vacuum tube source.

the r-f alternating magnetic field of the coils and thereby reduces the self-inductance values for r-f currents. In the usual cases, the r-f mutual inductance values and the inductive coupling coefficients are also reduced.

The shielding action of the nonmagnetic cylindrical can used around coaxial r-f coils depends on induced currents around the can. A similar

effect is produced if the can is replaced by a short-circuited coil having the same diameter and very low resistance. In Part V, this effect is studied briefly and expressed by equations.

In order to avoid capacitive effects, the inductance of r-f coils is usually measured at a frequency of 1 kc. In the case of thin aluminum cans commonly used, the eddy currents at 1 kc are limited by resistance as well as by inductance. This differs from the conditions at radio frequencies; the magnetic field is only partially constrained and the observed inductance values are greater than for r-f currents. The inductance values given in this paper were measured at 1 kc, using 1/32-in. copper cans in place of the usual thin cans. These measurements indicate closely the inductance values effective for r-f currents. The proper cans were used, however, for r-f tests.

The simplest r-f transformers have been mentioned, and shown in Fig. 1. L. A. Hazeltine has described several interesting properties of this simple transformer.^{5,6} In general, the coefficient of coupling k_1 is appreciably less than unity, and therefore the actual turns ratio may have little significance. The coupling, however, is so close that both transformer circuits are tuned as a unit by the tuning condenser across the secondary coil. In this case the "effective turns ratio" is the ratio, L/M_1 , of secondary to mutual inductance, the transformer having this step-up ratio, plus a "leakage inductance" in series with the primary coil; this is treated in Part V. When this leakage reactance is much smaller than the impedance in parallel with the primary circuit, shown in Figs. 13(b) or 14(b), the former does not affect the operation of the tuned r-f coupling system.

The simple transformer has an optimum value of the effective turns ratio, which yields the highest gain at any given frequency to which the transformer is tuned. Hazeltine has shown the advantages of using an effective step-up ratio greater than the optimum value;⁶ by this means the selectivity is greatly improved, while lowering the gain by only a small amount. In this region of operation, increasing the effective step-up ratio departs further from the optimum value and results in decreasing the gain. In other words, the gain increases with greater mutual inductance. This relationship exists in most r-f amplifiers designed in the past few years, especially in those utilizing screen-grid tubes.

In the tuned r-f coupling systems described herein, the primary circuits are complicated by the cooperation of different kinds of coupling. A method has been devised whereby the sum of these various couplings can be identified with an equivalent mutual inductance which

⁶ L. A. Hazeltine, U. S. Patent 1,648,808, November, 1927.

varies with the frequency in a predetermined manner. This procedure is followed in Parts V and VI, in the latter section of this paper. First, the coil system in question is reduced to an equivalent unity-coupled transformer, with appropriate leakage inductances. Then the various parallel paths of the primary circuit, represented in Fig. 54, are reduced to an equivalent single path, as in Fig. 55. In the latter figure, m is the equivalent mutual inductance whose value was required.

The derivation of this equivalent mutual inductance brings into consideration another feature, the impedances reflected in the secondary circuit from the primary circuit. The nature of this phenomenon is well known, that the resistances and reactances in the primary circuit affect both the selectivity and the tuning of the secondary circuit, or of the coupling system as a unit. In the simple transformer,

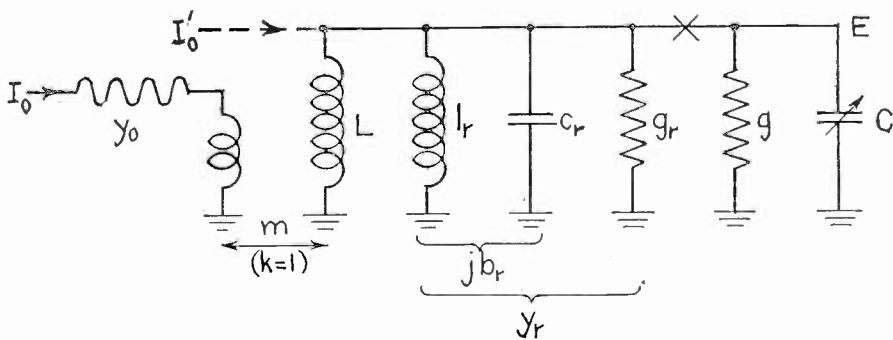

Fig. 15—Generalized tuned r-f coupling system.

these effects depend almost entirely on the antenna or vacuum tube connected to the primary coil, because otherwise the primary coil is practically an open circuit. In the more complicated primary circuits, this is no longer true; the impedances reflected in the secondary circuit depend also on the primary circuit of the coupling system proper.

Fig. 15 shows the analysis of a coupling system having various couplings combined in the primary circuit. These couplings are first reduced to the equivalent mutual inductance, m . Then the impedances reflected in the secondary circuit are reduced to their equivalent three parallel components (l_r, c_r, g_r). These components are uniquely determined within each narrow band of frequencies, as treated in Part VII. The respective inductance, capacitance and resistance values of these components may or may not be the same in different narrow frequency bands. Having reduced the coupling system to this form, the gain and selectivity can be computed at any resonant frequency by the same methods used for the simple transformer. This procedure is treated in Part VIII.

The problem of tuning several r-f coupling systems simultaneously in a unicontrol radio receiver, has risen to the same importance as the problems of gain and selectivity, since neither of the latter can be fully utilized without very closely tuning all of the coupling systems to the signal frequency. This third problem is simple only when all the systems are identical in all respects. This can be true only when the so-called "antenna coupling tube" is used; otherwise the antenna circuit is tuned and is necessarily different to some extent. The antenna coupling tube has proved deficient in that it permits cross-modulation of the various signals before any selection is effected. In fact, some receivers employ two or more tuned circuits between the antenna and the first tube, thereby increasing the number of dissimilar coupling systems which must be tuned at once.

The process of designing or adjusting a number of tuned circuits so that their natural frequencies are varied simultaneously by moving a single control, is referred to as "alignment." Correct alignment in the finished receiver can be secured by various methods. One method in wide use will be taken as standard in this paper. This method employs tuning condensers whose capacitance values are all equal at any position of the tuning control. Correct alignment then requires, in addition, that the inherent capacitance values be alike in all circuits, and that the effective inductance values of the secondary coils be alike in all circuits. The former requirement is met by careful design or more precisely by the final adjustment of a small condenser across each secondary coil. The latter requirement is met by careful design, and is discussed in Part X.

As already indicated, the alignment problem centers on the antenna circuits, which necessarily differ from the amplifier circuits. Those antenna coupling systems to be described which are used in unicontrol receivers are all of the type which requires no adjustment for different antennas. This is accomplished by the use of coupling between the primary and secondary circuits which is relatively small, but which is so proportioned that the gain is sufficient over the frequency range.⁷ This expedient also permits the use of a volume control attenuator in the antenna circuit without excessive detuning effects.

PART III. CLASSIFICATION OF CIRCUIT ARRANGEMENTS

There are a great many circuit arrangements which can be used to secure an equivalent mutual inductance which varies with frequency in a desired manner. A number of representative circuits will now be

⁷ W. A. MacDonald, *Radio Broadcast*, p. 235, August, 1929.

described and identified in terms of the respective fixed and varying components of the equivalent mutual inductance, m . These examples are shown in Figs. 16 to 22.

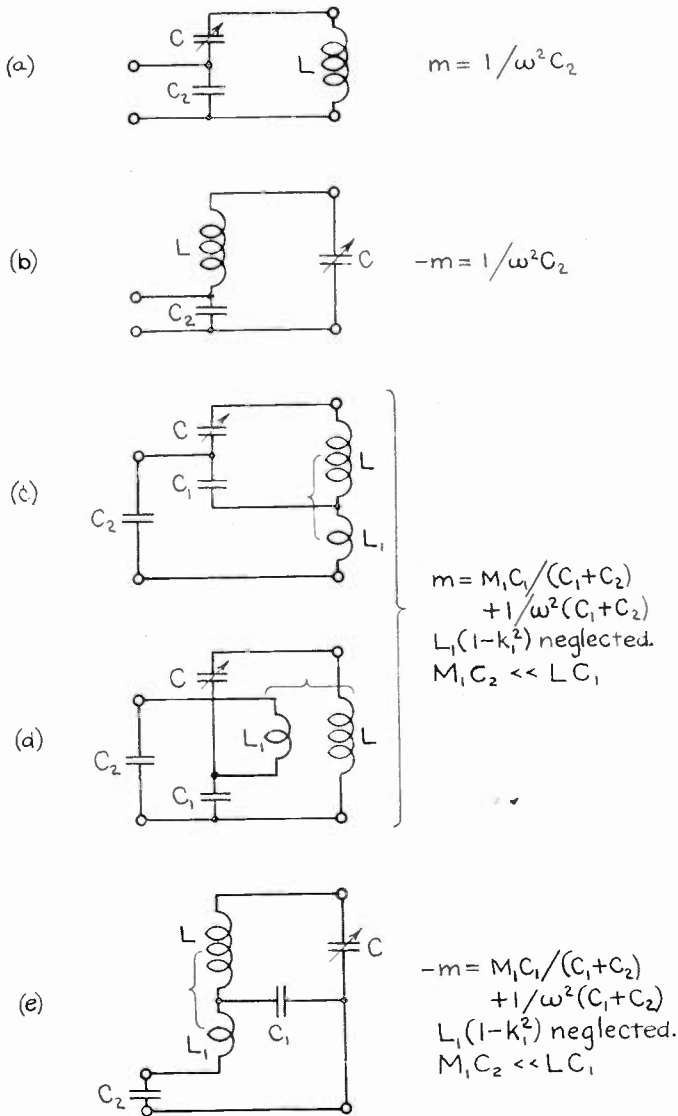

Fig. 16—Tuned r-f coupling systems having coupling condensers in series with tuning condensers.

In order to simplify the equations and reduce the number of examples, two rules are followed in these figures. First, any resistance effects in the primary circuit (including the "source") are omitted. These frequently do not affect the m values to an extent which is important, but would greatly complicate the equations. Secondly, in all cases a capacitance, C_2 , is shown across the input terminals of

the primary circuit. In the case of an antenna circuit, this includes the apparent capacitance of the antenna. In the case of screen-grid amplifiers, this includes the total plate capacitance, which is not usually negligible in these circuits. The presence of C_2 may otherwise be unessential, in which case it can be omitted.

A uniform nomenclature is used, in which the following are essential features. The tuning condenser and the tuned secondary coil are denoted by C and L , respectively. A primary coil of relatively

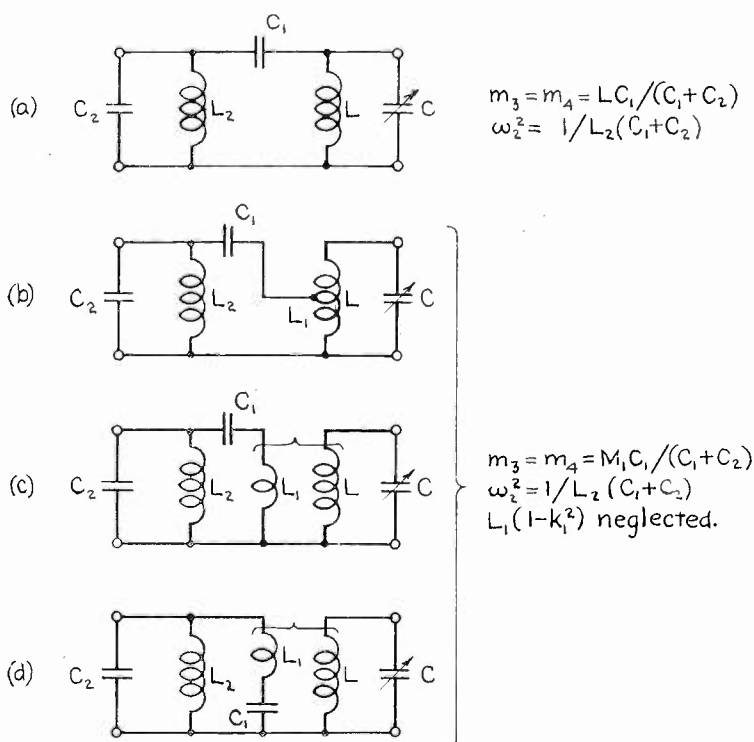

Fig. 17—Tuned r-f coupling systems having high inductance primaries not inductively coupled to secondaries.

low inductance, closely coupled to the secondary coil, is denoted L_1 , or referred to as a "low inductance primary." A primary coil of relatively high inductance, or which is not closely coupled to the secondary, is denoted by L_2 . M_1 , M_2 , and M_{12} are the respective mutual inductances between L_1 and L , L_2 and L , and between L_1 and L_2 . The corresponding coupling coefficients are k_1 , k_2 , and k_{12} . Magnetic coupling between coils is indicated by a brace, and is assumed zero if not indicated. Where coil symbols are drawn near each other and such coupling is indicated, the upper ends of these coil symbols indicate coil terminals having like a-c polarity in so far as direction of winding is concerned, and when the M values are taken as positive. The angular frequency to which the secondary circuit is tuned is denoted by ω .

Fig. 16^{3,4} shows a group of circuits, each of which has a relatively large condenser in series with the tuned circuit, L, C . In types (a) and (b), the value of m has no fixed component, but only a varying component which is much greater at lower frequencies. In the other

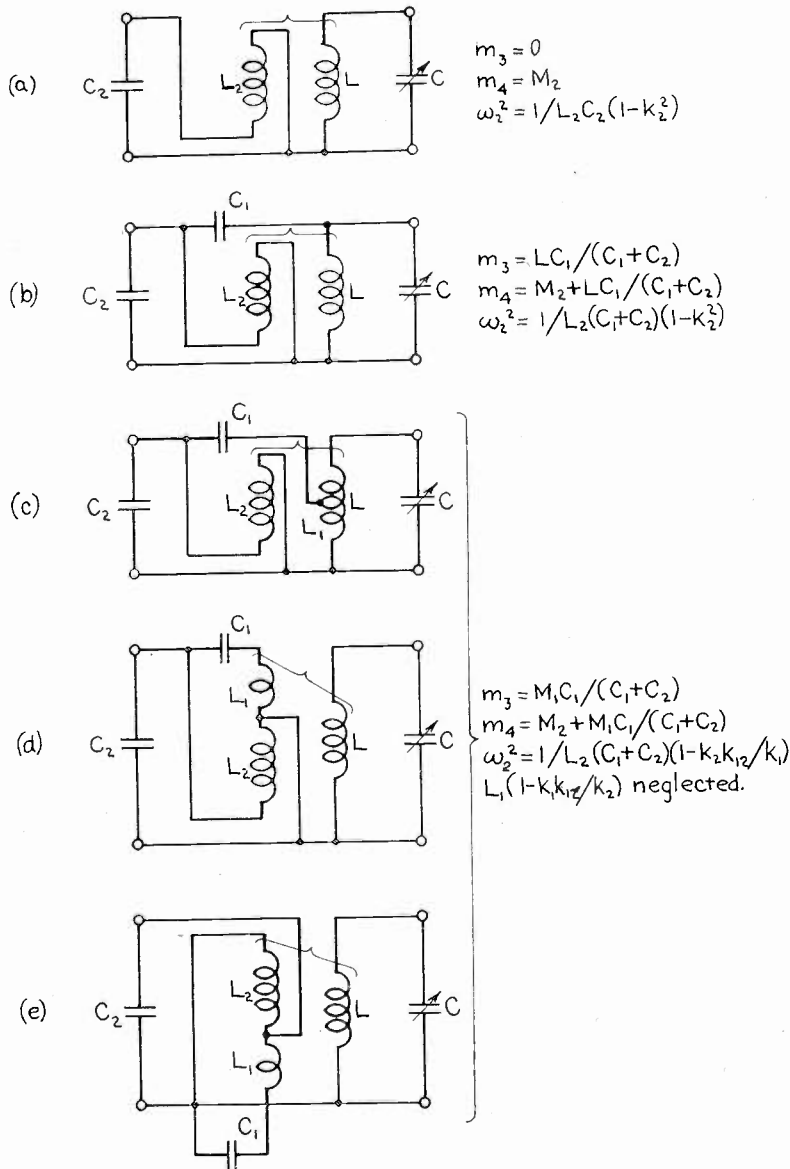

Fig. 18—Tuned r-f coupling systems having high inductance primaries inductively coupled to secondaries.

types, m has both fixed and varying parts, the former depending on M_1 and the latter depending only on the primary condensers, C_1 and C_2 . Type (c), without C_2 , was used in the new TF-6 and in the TF-5 receivers referred to above. Type (d) has been published be-

³ Loc. cit.

⁴ Loc. cit.

fore.⁴ Types (b) and (c) have the advantage that the tuning condenser rotor can conveniently be grounded if desired. This is not true of the other circuits of this group.

In Figs. 17 to 21, the fixed and varying components of m are denoted by the coefficients m_3 and m_4 , respectively, corresponding to Fig. 64 below. The natural frequency of the primary circuit, determined by L_2 , etc., is denoted by ω_2 and is lower than the range of tuning

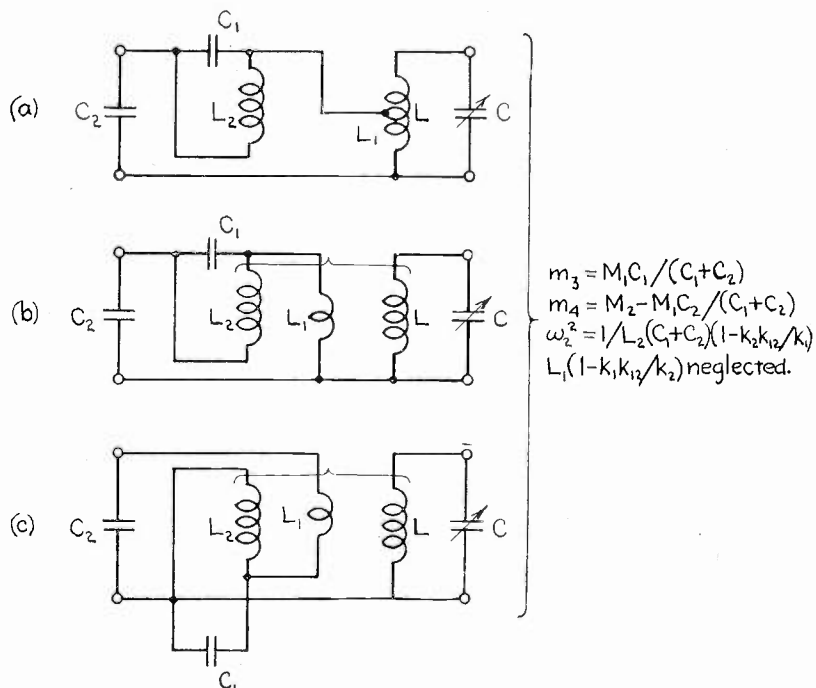

Fig. 19—Tuned r-f coupling systems having high inductance primaries inductively coupled to secondaries.

frequencies, ω . The resultant value of the equivalent mutual inductance is

$$m = m_3 + m_4 / (\omega^2 / \omega_2^2 - 1). \quad (1)$$

The m_3 component is fixed, while the m_4 component is much greater at lower frequencies than at higher frequencies.

The circuits shown in Fig. 17^{2,3} have in common the feature of a high inductance primary, L_2 , which is not inductively coupled to the secondary, L . In these circuits, the coil L_2 may be wound on a small bobbin, removed from the main coil assembly. Type (b) was used in the modified TF-6 model described above. Type (a) has recently been used in screen-grid receivers. In type (d) L_1 can be close to the lower part of L , and the inter-coil capacitance used as C_1 , in place of a separate condenser. These circuits have a slight disadvantage in that

⁴ *Loc. cit.*

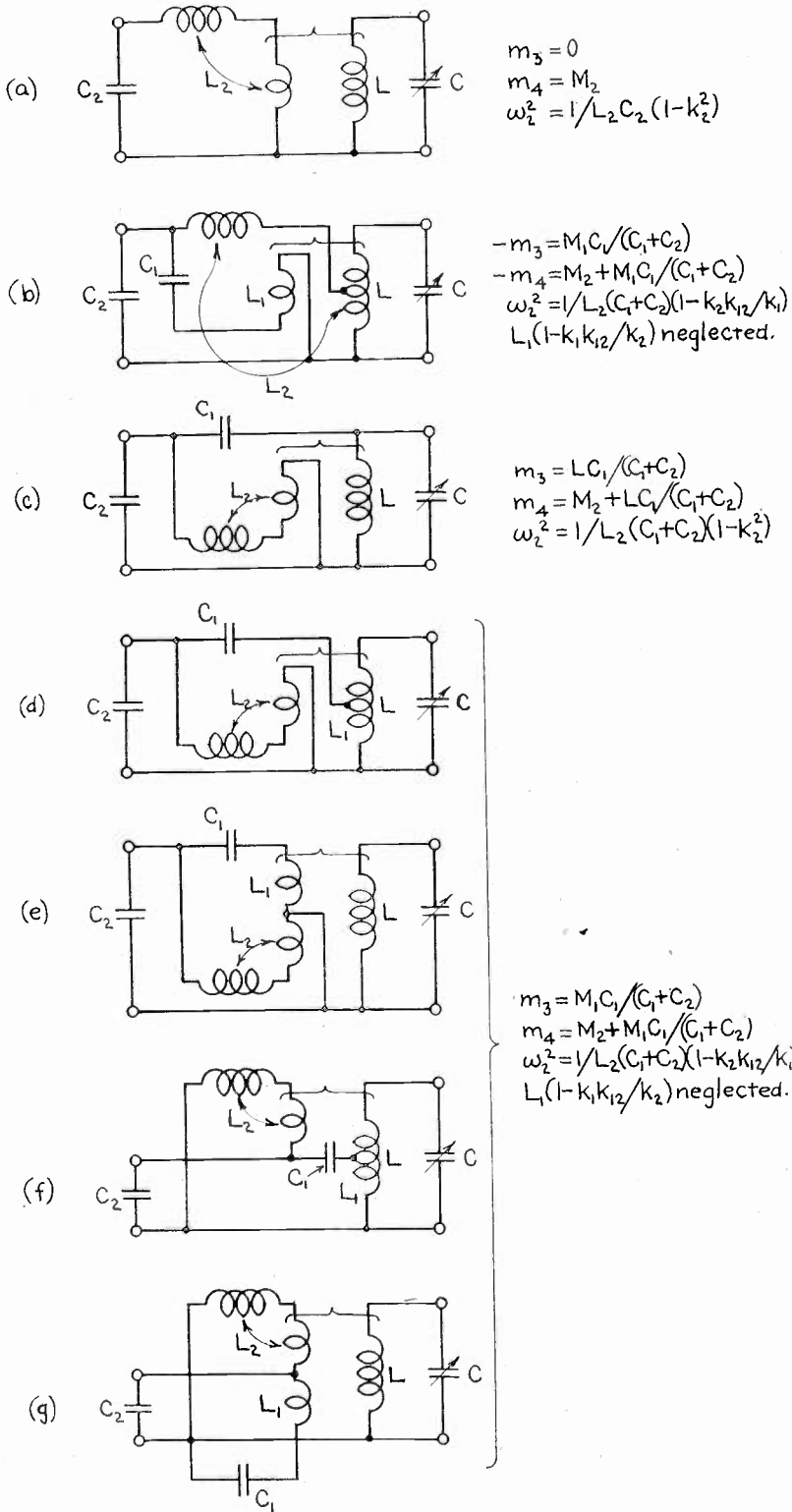

Fig. 20—Tuned r-f coupling systems having high inductance primaries coupled to secondaries by coupling coils.

m_3 and m_4 cannot have any ratio except unity; the relative magnitude of the two terms in equation (1) must therefore be determined entirely by the choice of ω_2 . This disadvantage is not present in the following examples, Figs. 18 to 21.

The circuits of Fig. 18^{2,3,7} are distinguished by the feature of a high-inductance primary, L_1 , connected directly between the primary terminals and inductively coupled to the secondary, L_2 . Type (b) is frequently used in both antenna and amplifier systems, with C_1 furnished by inter-coil capacitance, sometimes augmented by an additional small capacitive coupling. It is important in most cases that

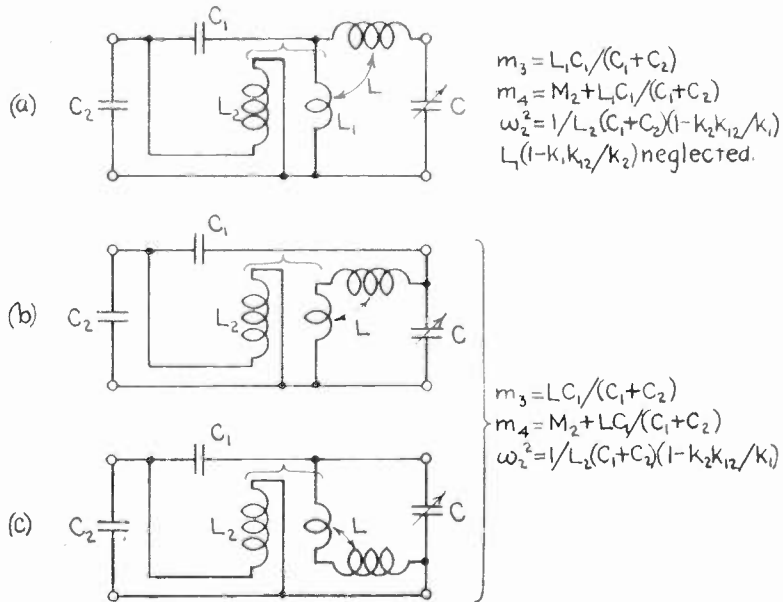

Fig. 21—Tuned r-f coupling systems having high inductance primaries coupled to coupling coils in secondary circuits.

the common connection between L_1 and L_2 be connected to coil ends of opposite polarity, as indicated, since that is the condition for additive relationship between capacitive and inductive coupling. In types (c) and (e) also, C_1 may be intercoil capacitance. In types (d) and (e), L_1 and L_2 may be wound on the same form, with a tap connection between the two coils.

The Fig. 19² circuits have the high-inductance primary, L_2 , in parallel with C_1 and inductively coupled to the secondary. In any of these three types, coil L_2 may be a multilayer coil, and its natural capacitance used as all or part of C_1 . In type (c), the intercoil capacitance between L_1 and L_2 may be used as C_1 . Type (b) has been extensively used in both neutralized and screen-grid receivers. In the

circuit of Fig. 11, described above, the antenna system is type (b), while the amplifier system is type (c), modified for the purpose of neutralization.

Fig. 20 shows a group of circuits in which part of L_2 is a separate coil, and the remainder is a coil inductively coupled to the secondary,

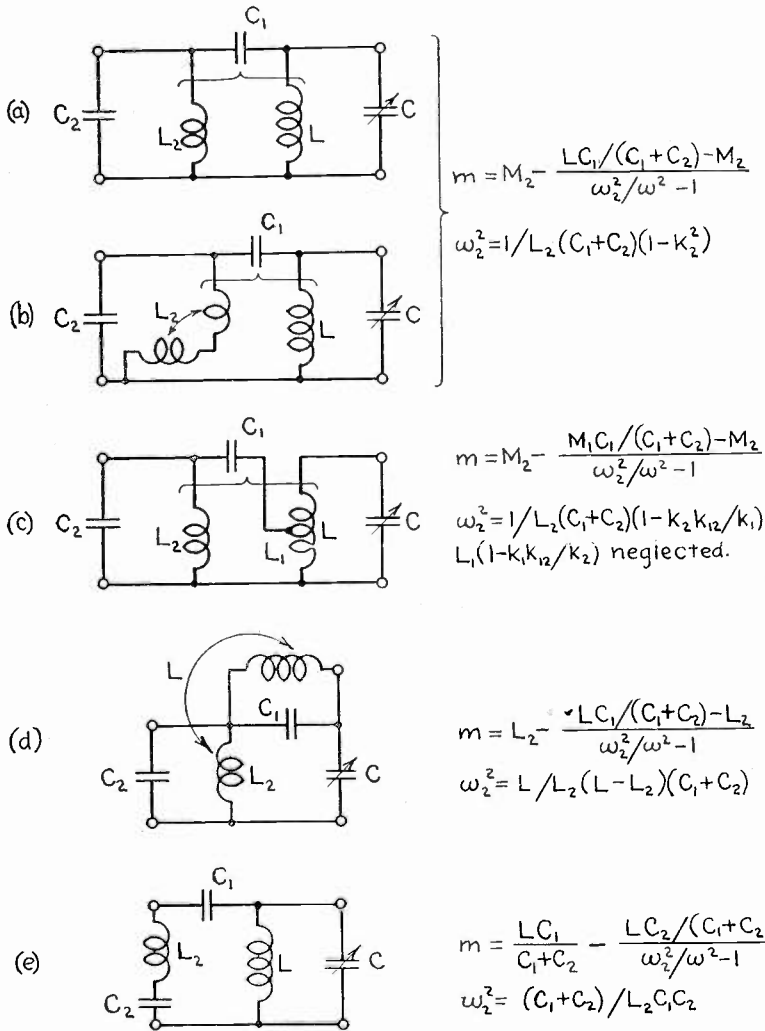

Fig. 22—Tuned r-f coupling systems having a different kind of equation.

L . In types (e) and (g), L_1 and the L_2 coupling coil may be parts of the same coil. In types (f) and (g), C_1 may be intercoil capacitance.

Fig. 21 gives examples of another class of circuits, in which the primary coil, L_2 , is coupled to only one of two coils, L , in the secondary circuit. In type (c), intercoil capacitance may be used for C_1 .

In all the circuits discussed above, except in the simple transformer of Fig. 1, the equivalent mutual inductance, m has a component which

is greater at lower frequencies. In most of these circuits, this is augmented by a fixed component. There are other kinds of combinations which also give desired results. One of these kinds is illustrated by Fig. 22.³

The principle of Fig. 22 differs from that of Figs. 16 to 21 in this way; the equivalent mutual inductance, m has a fixed component, and also a varying component which is greater at *higher* frequencies. These components are so related that the second is subtracted from the first, and therefore m is less at higher frequencies. This is usually the required result in all these circuits. As one step in securing this result, the primary circuit, L_2, C_1, C_2 , is given a natural frequency, ω_2 , which is somewhat *higher* than the range of operating frequencies, ω . The formulas in Fig. 22 show these effects. The first term of m is the fixed component in each case. The second term is of opposite sign and is greater at higher frequencies than at lower frequencies. The second term should always be smaller than the first at operating frequencies.

In the circuits of Fig. 22, L_2 is of the same order of magnitude as L , or even smaller. Type (a) is used in recent screen-grid receivers, with intercoil capacitance for C_1 . In types (b), (c), and (e), also, C_1 may consist of intercoil capacitance.

In a number of the above circuits, one of the primary coils may be used also as a neutralizing coil in r-f amplifiers using triode tubes. The manner of accomplishing this result will appear in one of the examples to follow, Fig. 32. By proper choice of coil polarities, the following primary coils may be used also as neutralizing coils: L_1 in Figs. 17(c), 18(d), 19(b), 20(b), and 20(e); the coupling coil part of L_2 in Fig. 20(a), (c), (d), and (e).

It is not pretended that Figs. 16 to 22 exhaust the number of combinations which can be used to secure a desired variation of the equivalent mutual inductance, but they are representative of the many useful circuits which have grown out of this idea.

PART IV. EXAMPLES OF MANUFACTURED COIL SYSTEMS

There have been many kinds of coil assemblies used in coupling systems like those described herein, which have been commercially manufactured in broadcast receivers during the past six years. A group of ten such receivers has been selected as historically interesting and as representative of these developments, and the more interesting data on the coupling systems of these receivers will now be presented.

³ *Loc. cit.*



The accompanying table gives some data on broadcast receivers numbered I to XI, and on the coupling systems manufactured as part of these receivers. Receiver I is one of the early Neutrodyne sets, which employed simple tuned r-f transformers in both antenna and r-f amplifier circuits, and which is included only for comparison purposes. This data on these receivers are largely self-explanatory. Each number alone refers more specifically to the coupling systems of the tuned r-f amplifier, while the same number followed by (a) refers to

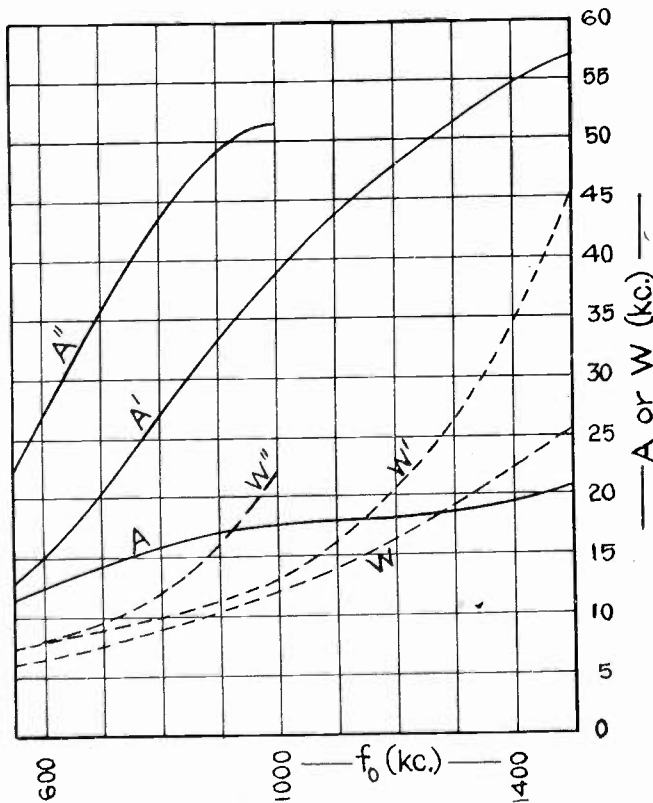

Fig. 23—Performance of coils I and I(a).

the tuned antenna circuit of the same set. Receiver XI has two tuned circuits preceding the first tube, which are designated (a) and (b) respectively. In addition to the tabulated data, photographs and performance curves are given for these examples. To these are added individual circuit diagrams wherever required.

In observing the performance of all these coupling systems, a tuning condenser was used which is representative of good practice at the present time. In the past, there has sometimes been greater dissipation in the tuning condensers, as well as in the accompanying aligning or neutralizing condensers, so that the gain and selectivity

observed for the older examples may be greater than was realized in those receivers. Also, all feed-back or regenerative effects were absent in the observations; these effects are small or negligible except in unneutralized triode amplifiers, where they are so variable as to be difficult of estimation.

Receiver I, embodying the circuit of Fig. 1, is included for comparison purposes. (It is noted that the 201-A tubes now available, used in the measurements, have higher mutual conductance than those available in 1923, so that the observed gain in these cases is uniformly higher than was secured at the earlier date.) Referring to Fig. 23, curve *A* shows the amplifier gain, in terms of voltage ratio from grid to grid. Curve *W* shows the corresponding width of the resonance

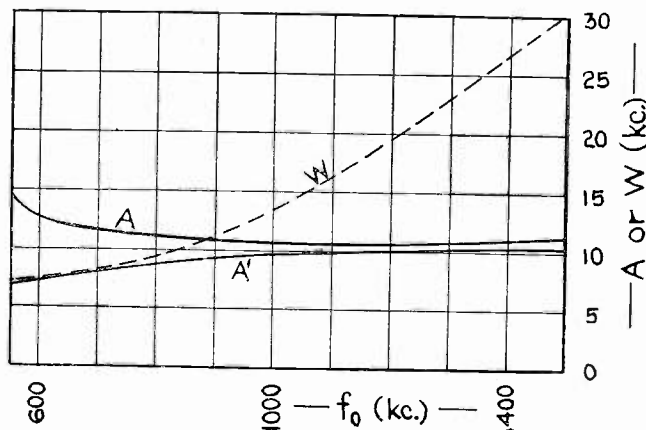

Fig. 24—Performance of coil II.

curve, in kilocycles, between the two points which are one-half the amplitude of the peak; this quantity is called the “width of resonance” in this paper. The *W* values are inversely related to the selectivity, and also give an indication of the side-band attenuation. Both of these effects are accentuated when several tuned circuits are employed, and the “over-all” value of *W* is much less than that for a single tuned circuit. In the antenna circuit of this receiver, two terminals were provided, marked “long antenna” and “short antenna,” respectively. In Fig. 1, these are respectively the upper and lower terminals. The condenser, C_b in series with the former has 250- $\mu\mu\text{f}$ capacitance. Curves *A'* and *A''* show the gain from antenna to the first grid, observed with a standard dummy antenna⁸ connected to the “long antenna” and “short antenna” terminals, respectively. *W'* and *W''* give the corresponding values for width of resonance.

⁸ 200 $\mu\mu\text{f}$, 20 μh and 25 ohms, in series (natural frequency, 2500 kc.); YEAR BOOK, I.R.E., p. 113, 1929.

In the curves of Fig. 23, attention is directed to the large variation of these values over the broadcast band, whereas the ideal condition would be an approach to uniformity. In the amplifier circuit, A varies in the ratio of two to one, and W in the ratio of four to one. The variation of A is further accentuated in proportion to the number of stages in the amplifier. The lowest value of W is only 6 kc, so that the attenuation of 3-kc side bands in the receiver, which has three tuned circuits, would be very detrimental to the fidelity of a-f reproduction. These variations are much greater in the antenna circuit, so it will appear that the improved circuits are even a greater advantage in the antenna coupling system than in the amplifier system.

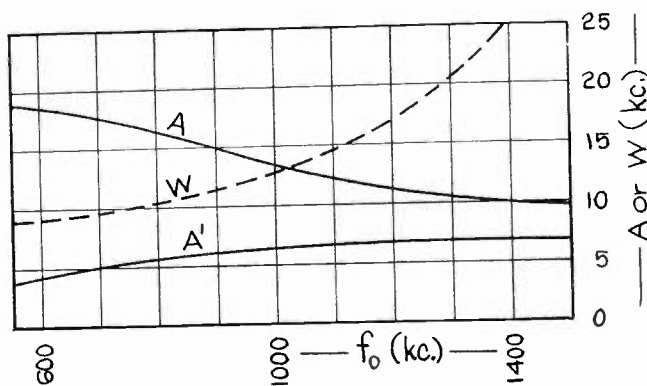

Fig. 25—Performance of coil III.

Reference has been made above to the possibility of inserting a resistance at "X" in Fig. 1, to make the gain more uniform. At this point, it is merely noted that any closer approach to uniform gain, by the use of such resistance means, is more than compensated by the greater departure from uniform width of resonance. This disadvantage is not present in the improved circuits.

Receiver II is the modified TF-6 model already described. In Fig. 24, A and W are the curves of gain and width of resonance in an amplifier stage. A' is the gain curve with the primary coil, L_2 in Fig. 2, replaced by a choke coil of much higher inductance. This destroys the automatic variation of equivalent mutual inductance, so that the A' curve is like that of a simple transformer. The improved curve, A , on the other hand, indicates greater gain at lower frequencies, where the capacitive feed back effects are less important. Curve A has desirable features, therefore, especially when used in this kind of unneutralized r-f amplifier.

Receiver III is the new TF-6 model described above. In Fig. 25 curves A and W indicate the performance of an amplifier stage.

Curve A' was observed with condenser C_1 outside of the primary circuit. A comparison of A and A' shows very well the advantage of the improved primary circuit. As in the preceding example, the gain is lower at higher frequencies, which is consistent with the limitation imposed by the unneutralized capacitive feed-back.

Receiver IV is the TF-5 model already discussed, whose r-f amplifier circuits are similar to those of the preceding example. The same comments apply to this case, whose curves appear in Fig. 26.

The performance of the three preceding examples is very good, especially considering that they were designed by trial, with none of

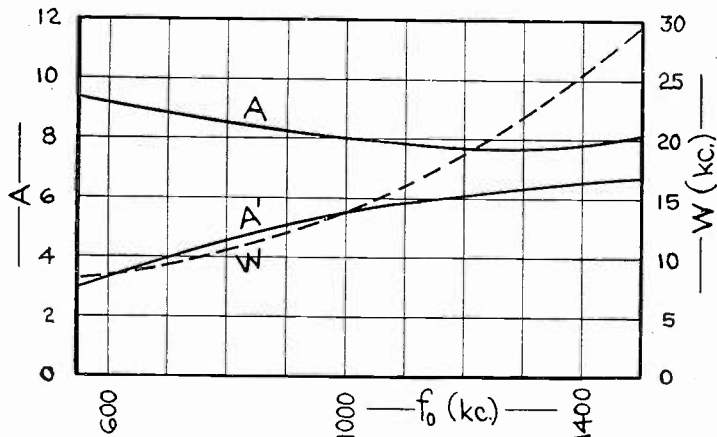

Fig. 26—Performance of coil IV.

the measuring equipment which is now used to test every step in the design of a radio receiver.

The examples to follow represent developments of the Hazeltine Corporation, and were all designed for use in neutralized or screen-grid circuits. Certain problems arose in combining the improved primary circuits with the neutralization of grid-plate capacitive coupling. The following two examples represent two solutions of this problem. The first employs so-called "plate circuit neutralization"¹ which was used in the early neutrodyne receivers. This kind is identified by a neutralizing capacitance between the grid and a point in the plate circuit, of opposite a-c polarity to that of the plate. The second of the following two examples employs so-called "grid-circuit neutralization."⁹ The latter kind must be employed when one of the primary coils is used also as a neutralizing coil; this was suggested above in connection with Figs. 17 to 20.

Receiver V is the Gilfillan design, models 30 and 40, which is the last described in the foregoing historical introduction. The coils

⁹ L. A. Hazeltine, U. S. Patent 1,489,228, April, 1924.

appear in Fig. 9, and the circuits in Figs. 10 and 11. The secondary coils, L , are the same size as those of receiver I. The low-inductance primary coils, L_1 are wound on the end of the secondary coil form, while the high-inductance primary coils, L_2 , are wound on a smaller

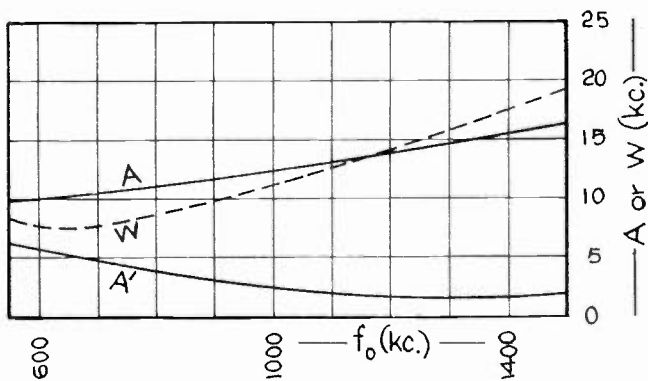

Fig. 27—Performance of coil V.

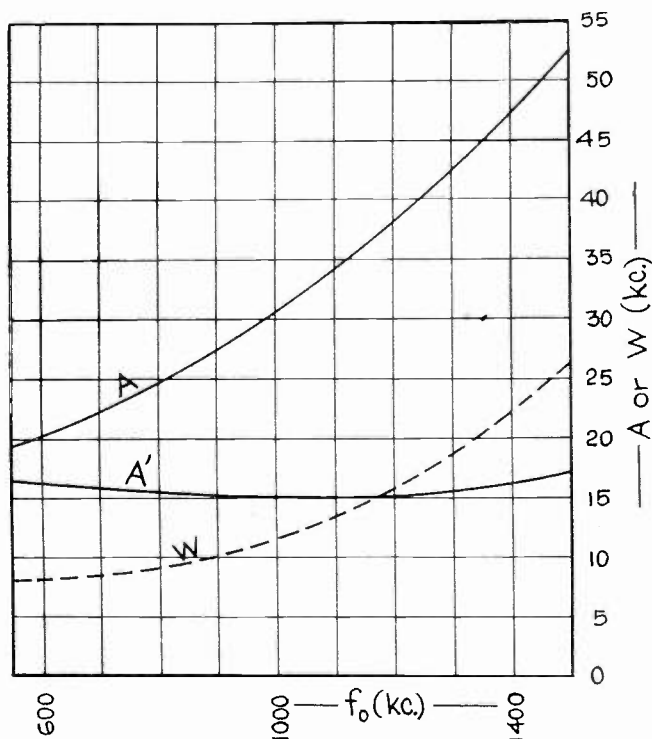

Fig. 28—Performance of coil V(a).

cylindrical form inside the other. In the amplifier system, the total capacitance C_1 , effectively across the primary coil L_2 , is essentially the sum of three components. The condenser C_1' of $350 \mu\mu\text{f}$, is across a total number of turns twice the number of L_2 alone, and is therefore

equivalent to 1400 $\mu\mu\text{f}$ across L_2 alone. The capacitance between L_2 and L_2' is 1130 $\mu\mu\text{f}$, effectively across L_2 . The capacitance between L_1 and L_1' is 105 $\mu\mu\text{f}$; this is in parallel with C_1' and is therefore equivalent to 420 $\mu\mu\text{f}$ across L_2 . This makes a total effective capacitance, C_1 , of 2950 $\mu\mu\text{f}$ across L_2 alone, which is the value given in the table. In the antenna system, denoted by $V(a)$ in the table, the effective parallel capacitance, C_2 in Fig. 19(b), is the apparent antenna capacitance, C_a . The natural frequency, f_2 , of the antenna primary in the table, for this and other examples, is computed for the standard antenna capacitance of 200 $\mu\mu\text{f}$,⁸ but varies with different antennas.

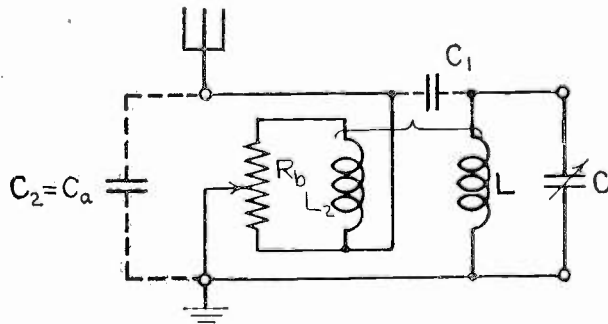

Fig. 29—Antenna circuit VI(a).

The performance of amplifier system V and antenna system $V(a)$, respectively, is shown in Curves A and W of Figs. 27 and 28. Comparing these with the same size coil systems and I and $I(a)$, a substantial improvement is noted: in both cases A is of the same order of magnitude but much more nearly uniform in the latter set; in both cases W is more nearly uniform and has a much lower maximum value, which results in improved selectivity without greater attenuation of the useful sidebands. Curve A' in each case represents the contribution of the high-inductance primary, as part of the total gain. It is seen that this is the major part at the lowest frequencies, while the added contribution of the low inductance primary is the major part at the higher frequencies.

Receiver VI employs a unicontrol Neutrodyne r-f amplifier with simple transformers enclosed in shielding cans. The antenna coupling system, denoted by VI(a), has a high inductance primary circuit⁷ and is so designed that it is capable of alignment relative to the simple amplifier transformers. Furthermore, the alignment is maintained for all values of antenna capacitance and for all positions of the antenna voltage divider used as a volume control. This antenna circuit is shown in Fig. 29, where R_b is this voltage divider, having a total resistance of

⁷ *Loc. cit.*

10,000 ohms. L_2 is wound on a small bobbin and placed near one end of the secondary, L , so as to secure capacitive coupling C_1 by inter-

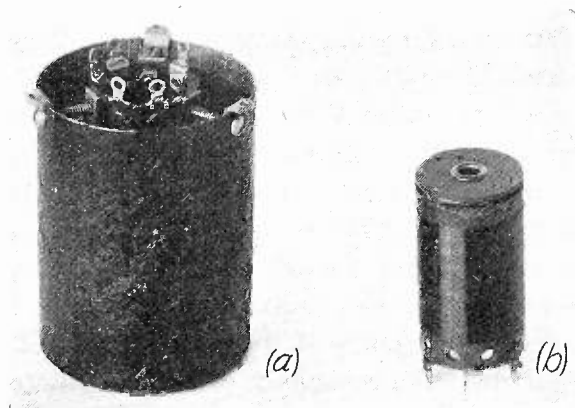

Fig. 30—Coils VI and VI(a).

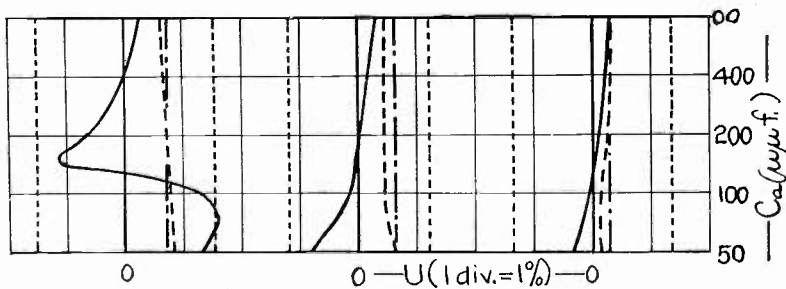
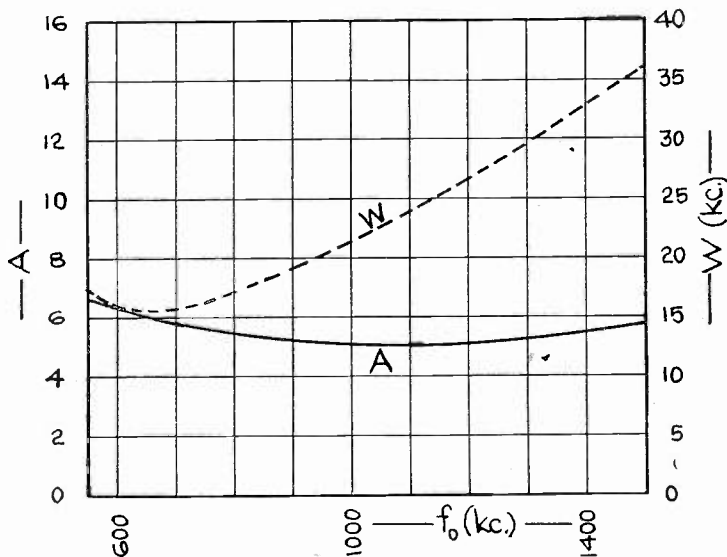

Fig. 31—Performance of coil VI(a).

coil capacitance. C_a is the apparent antenna capacitance. Fig. 30(a) shows an amplifier coil in its shielding can, while (b) shows an antenna

coil removed from its can. The L_2 bobbin is seen at one end of the latter.

The performance of the antenna system VI(a) is shown in Fig. 31. The gain, A , is substantially uniform, and the width of resonance, W , varies only in the ratio of two to one. The U curves give the alignment errors of antenna circuit VI(a) when compared with an amplifier coil VI, for different values of antenna capacitance, C_a and for different settings of the volume control. The circuits are first adjusted to resonance at 1400 kc by means of small adjustable aligning condensers, with a nominal capacitance connected in place of the antenna and with the volume control at the "maximum" position. Assuming identical tuning condensers are connected to the different coils, the U curves indicate the departure from resonance of the antenna circuit when the amplifier coil is tuned to 600, 1000, and 1400 kc., respectively. This departure is expressed in terms of an equivalent percentage error in either L or C . For entirely satisfactory performance, this error should be held within limits equal to the apparent power factor, p , of the entire tuned coupling system, as defined by (41) in the latter part of this paper. By the relationship of (73), p has been computed from W and these limits plotted in dotted lines. The solid curves were observed with the volume control at maximum, representing the greatest effective coupling between the antenna and the tuned circuit. The dashed curves are for the volume control contact at one-half of R_b , while the dot-dash curves are for volume control at minimum. The anomalous shape of the solid curve at 600 kc indicates broad resonance in the primary circuit, but the effect of this is not in any way detrimental. The errors are well within the limits imposed by the dotted lines, especially at the higher frequencies. This is in contrast to the corresponding performance of the simple antenna transformer of Fig. 1, where the percentage detuning at higher frequencies is so large as to require retuning for any considerable change of antenna. The high inductance antenna primary, which has a closed circuit through the antenna or volume control, reduces the effective inductance of the secondary coil coupled thereto;¹⁰ this reduction is about one per cent in this case, and is compensated by making the self-inductance of the antenna secondary one per cent greater than that of the amplifier coils, which difference appears in the table.

Receiver VII is a neutralized receiver employing identical r-f coil systems in both antenna and amplifier circuits; each primary circuit includes a high inductance and a low inductance coil. A partial circuit diagram is shown in Fig. 32, and the coils are shown in Fig. 33.

¹⁰ Part X, treatment of alignment.

Grid-circuit neutralization is secured by the circuit including coil, L_1 , and an adjustable neutralizing condenser, C_n . The coil assembly is enclosed in a shielding can, Fig. 33(a). The coils and primary condenser, C_1 , are shown assembled at (b), with the coil L_1 space-wound and located close outside of the secondary, L . This secures the close

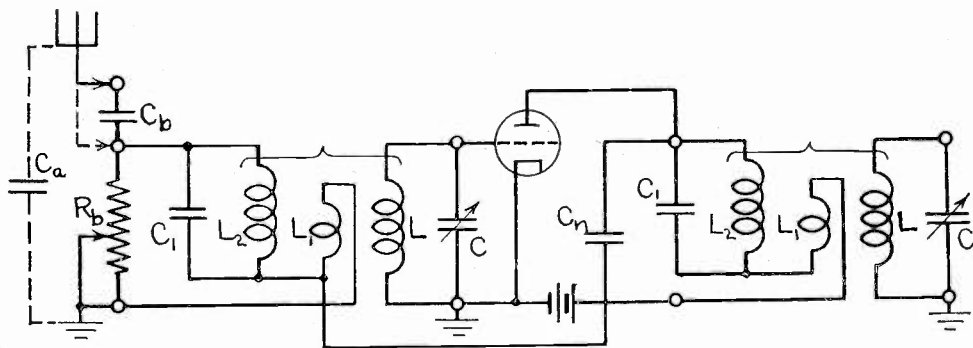

Fig. 32—Antenna and amplifier circuits VII(a) and VII.

coupling required between L_1 and L for complete neutralization. The L_2 bobbin, normally located within the secondary, is shown at (d) with its mounting bracket. Of the two antenna terminals shown in Fig. 32, the upper is marked "long antenna" and the lower "short antenna." The former is in series with condenser, C_b , of 125 μmf . When

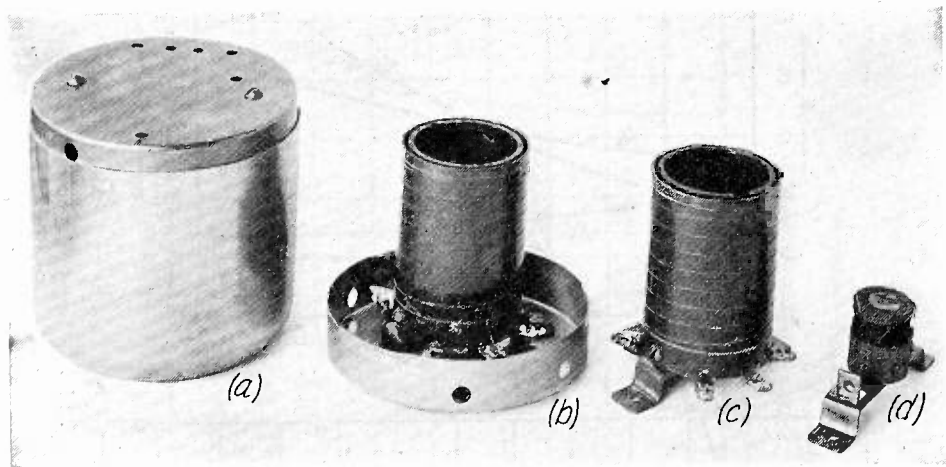

Fig. 33—Coils VII and VII(a).

the antenna capacitance, C_a , exceeds that of C_b , it is connected to the "long antenna" terminal; therefore the effective capacitance across the antenna primary coils need never exceed the value of C_b . Part of the volume control is accomplished by a 20,000-ohm rheostat, R , across the antenna primary circuit. In the table, C_2 for the amplifier

circuit VII is given as $60 \mu\mu f$, the value of C_n which is effectively across the primary coils; C_2 for the antenna circuit is given as $80 \mu\mu f$, the value of C_b in series with the standard value of C_a .

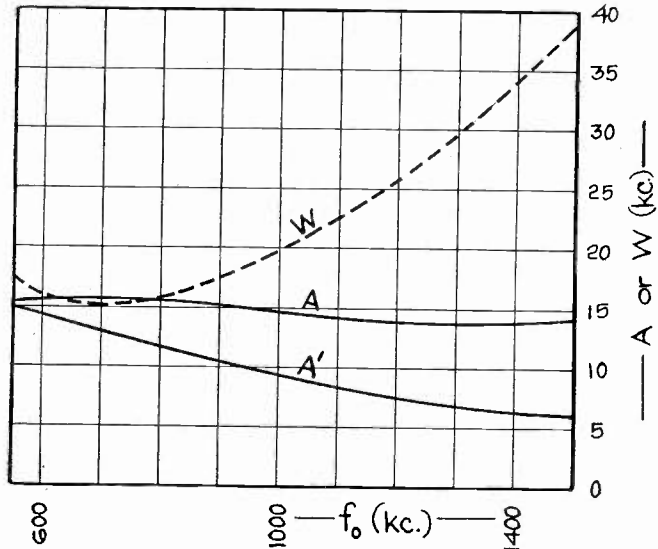

Fig. 34—Performance of coil VII.

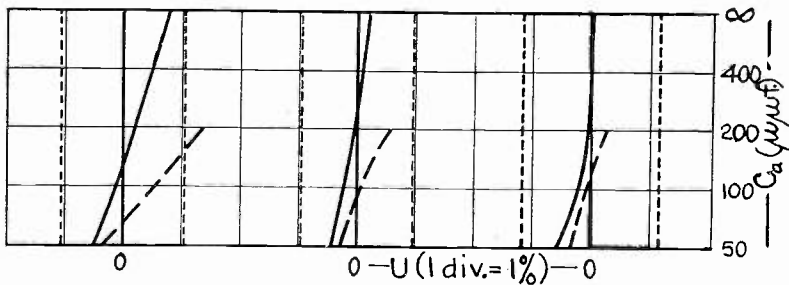
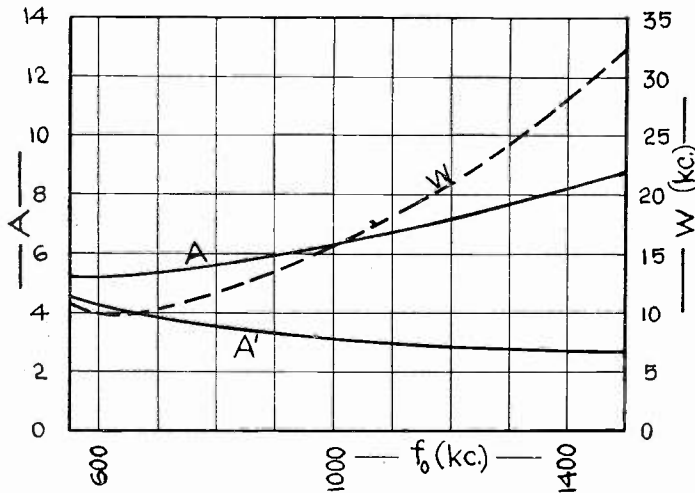

Fig. 35—Performance of coil VII(a).

The performance of the amplifier system VII and that of the antenna system VII(a) are shown in Figs. 34 and 35, respectively. Curves

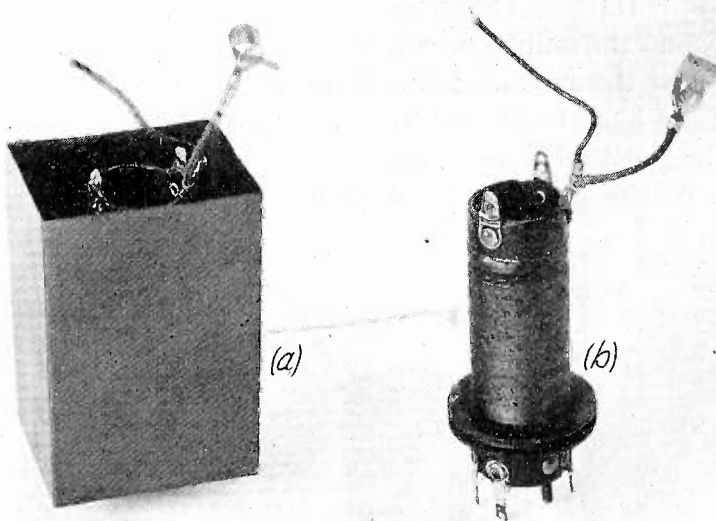

Fig. 36—Coil VIII.

A' show the contribution of the high inductance primaries to the total gain, A . The solid curves of U show the alignment errors using the

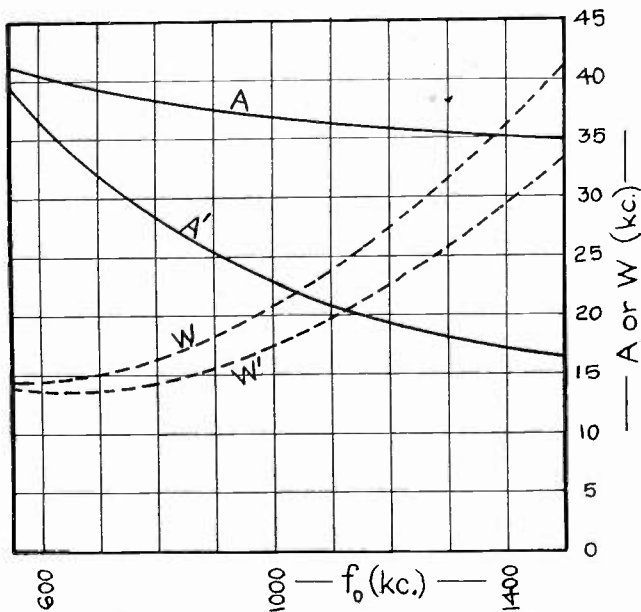

Fig. 37—Performance of coil VIII.

“long antenna” terminal, which is standard for antennas of more than 125- $\mu\mu\text{f}$ capacitance; the dashed curve shows these errors using the

“short antenna” terminal. Both curves were observed with volume control at maximum. The errors are well within the limits, because of the close similarity between antenna and amplifier circuits.

Receiver VIII is a screen-grid receiver employing the circuit of Fig. 18(b), and the amplifier coils are shown in Fig. 36. The L_2 bobbin is located near the grounded end of the secondary coil, L . Capacitive coupling C_1 of $8 \mu\text{mf}$ is secured by a half-turn of insulated wire located between the last two turns at the other end of the secondary coil, and connected to the plate terminal of the primary coil. The parallel

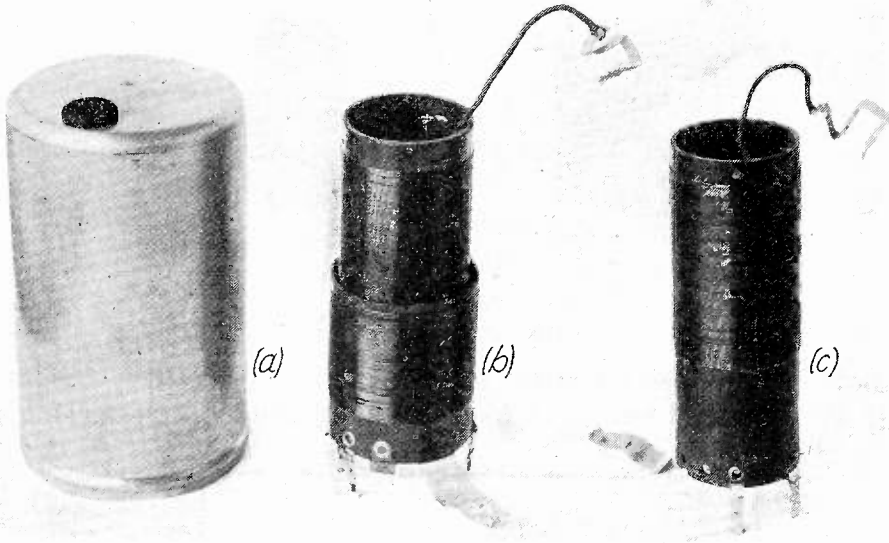

Fig. 38—Coil IX.

capacitance, C_2 , is the sum of two components: $12\text{-}\mu\text{mf}$ total plate capacitance of the amplifier tube and socket, plus $13 \mu\text{mf}$ inherent capacitance of coil L_2 . The performance is shown in Fig. 37. Curves A' and W' were observed with the capacitive coupling, C_1 , disconnected; curve A' indicates the approximate contribution of the L_2 coupling to the total gain, A .

Receiver IX is a screen-grid receiver whose r-f amplifier employs the circuit of Fig. 22(a) and the coils shown in Fig. 38. The required polarity of M_2 and the capacitive coupling, C_1 , are secured by winding the primary and secondary coils in opposite directions, then placing one end of the primary just over one end of the secondary. The direct capacitance, C_1 , is then $12 \mu\text{mf}$, between the two coils. The parallel capacitance, C_2 , is the sum of $12\text{-}\mu\text{mf}$ total plate and socket capacitance, plus about $2\text{-}\mu\text{mf}$ remaining inherent capacitance of coil L_2 . The performance is shown in Fig. 39, curves A and W . The other

curves, A' and W' , relate to a coil system having the same secondary coil but a simple, closely-coupled primary coil. The closer approach to uniformity in curve A is the result of the opposing capacitive coupling, C_1 , utilized in this receiver; this advantage is useful, since two such stages are employed in this amplifier.

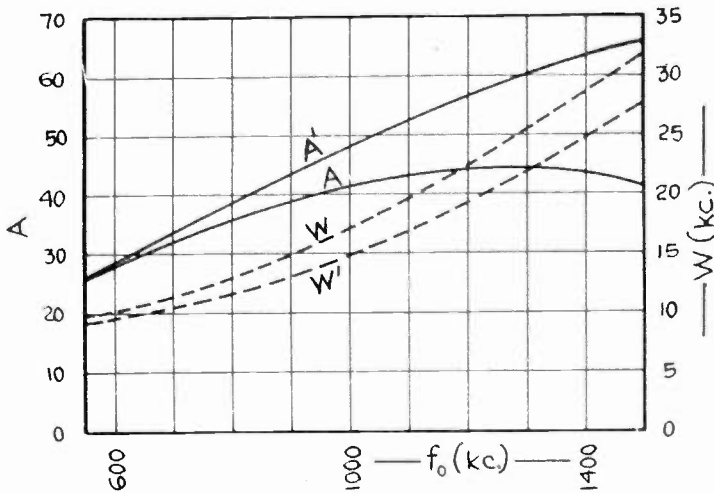

Fig. 39—Performance of coil IX.

Receiver X is a screen-grid receiver whose amplifier employs the circuit of Fig. 19(b), with the antenna circuit denoted by X(a) and shown in Fig. 40. The coils are shown in Fig. 41, where (a) is the shielding can, (b) is an amplifier coil assembly and (c) is an antenna coil assembly. The high inductance bobbin is seen in the end of each

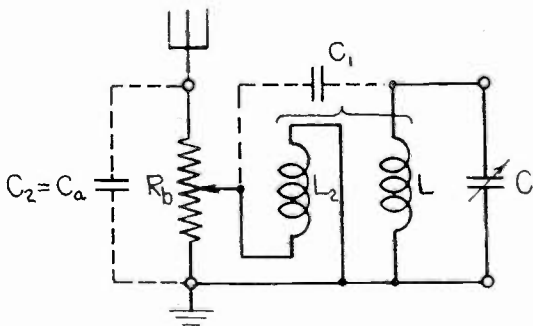

Fig. 40—Antenna circuit X(a).

secondary coil, and the low inductance primary is seen wound over the amplifier secondary coil. In Fig. 40, a small capacity coupling, C_1 , is secured between coils L_2 and L , but could not be isolated for measurement. Part of the volume control is secured by a 10,000-ohm voltage divider, R_b , across the antenna coil. In the am-

plifier system, X , C_1 is the sum of $32 \mu\mu\text{f}$ in a small condenser, plus $9\text{-}\mu\mu\text{f}$ inherent capacitance of coil L_2 . The parallel capacitance, C_2 , is $12 \mu\mu\text{f}$, the total plate capacitance of tube and socket.

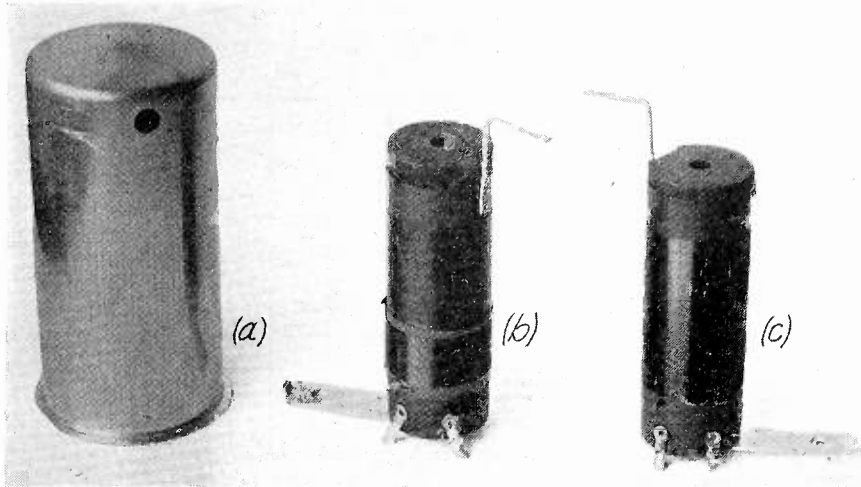

Fig. 41—Coils X and $X(a)$.

The performance of amplifier system X and antenna system $X(a)$ is shown in Figs. 42 and 43, respectively. Curve A' shows the contribution of the high inductance primary, L_2 , to the total gain, A , of the

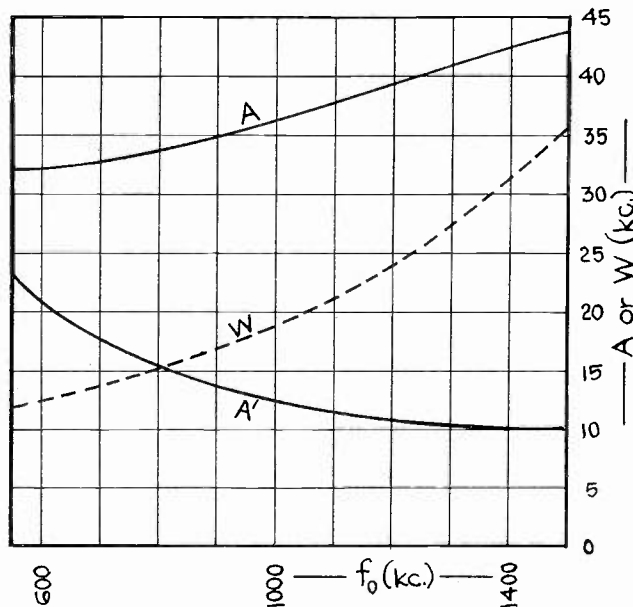

Fig. 42—Performance of coil X .

amplifier stage. The solid curves of U show the alignment errors with the volume control R_b at maximum, while the dashed curves show these errors with the volume control at one-half of maximum resistance.

Receiver XI is a screen-grid receiver, whose amplifier employs the circuit of Fig. 19 (b). Fig. 44 shows the shielding can at (a) and the amplifier coil assembly at (b). The bobbin seen in the end of the

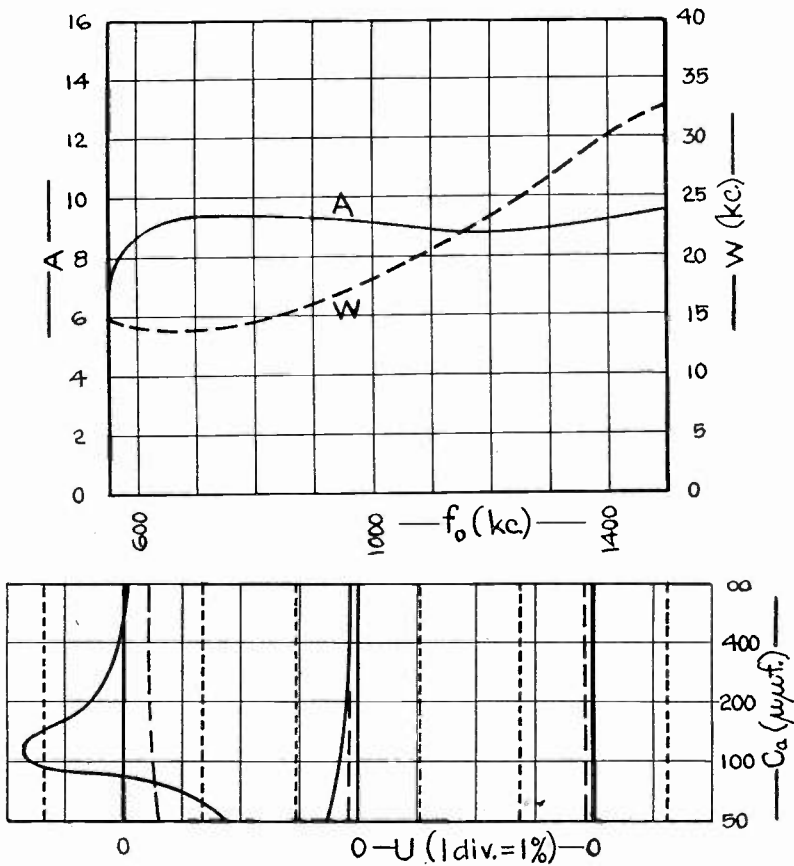

Fig. 43—Performance of coil X(a).

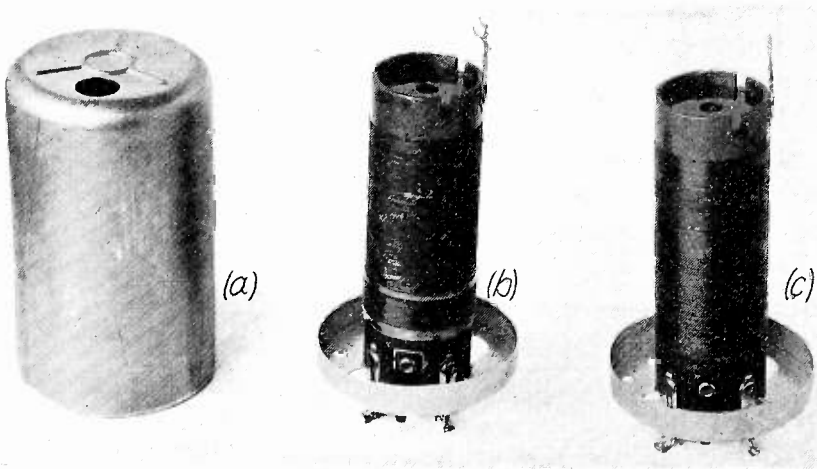

Fig. 44—Coils XI and XI(a).

secondary coil carries the high inductance primary, L_2 ; the other primary, L_1 , is seen wound over the other end of the secondary. The

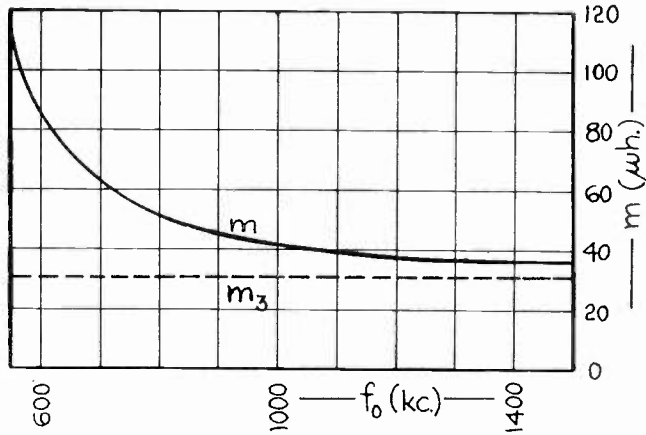

Fig. 45—Equivalent mutual inductance of coil XI.

primary capacitance, C_1 , is the sum of $28 \mu\mu\text{f}$ in a small condenser, plus $9 \mu\mu\text{f}$ inherent in coil L_2 . The parallel capacitance, C_2 , is $12 \mu\mu\text{f}$, the

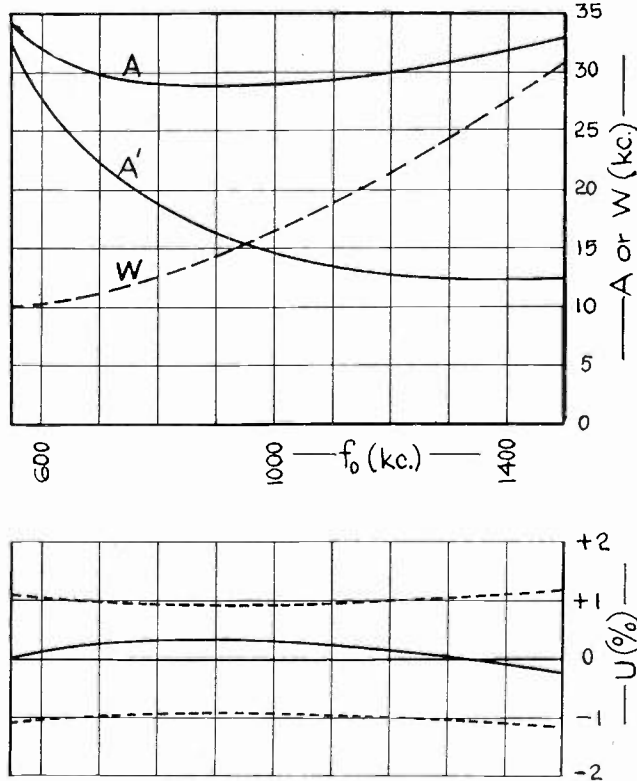

Fig. 46—Performance of coil XI.

total plate capacitance of the tube and socket. The equivalent mutual inductance, m , has been computed for this coupling system by the

formulas of Fig. 19, and is shown in Fig. 45; the dotted line indicates the fixed component, m_3 , while the solid curve indicates the total value, m . The performance of the amplifier circuit is shown in Fig. 46. Curve A' shows the gain without the low inductance primary. Curve U shows the alignment error relative to circuit XI(b), which will be discussed below.

This receiver employs two tuned coupling systems preceding the first tube, in order to reduce cross-modulation from interfering signals, which sometimes occurs in this tube. The circuit arrangement is shown in Fig. 47. Since this receiver employs automatic volume control, there is a "local-distant" switch whereby the antenna may be shunted by a 0.01- μf condenser, C_b , for reception of very strong signals.

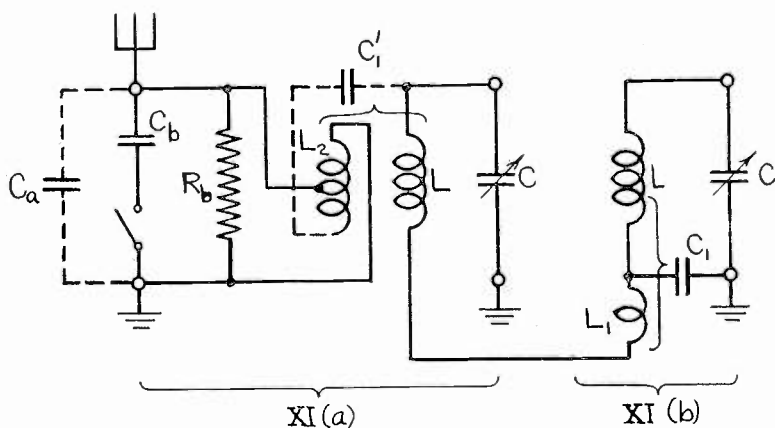

Fig. 47—Antenna circuits XI(a) and XI (b).

The antenna is normally shunted by a 10,000-ohm resistor, R_b , to prevent any marked resonant effects in the primary circuit. The first, or antenna circuit, XI(a), is a modification of the type shown in Fig. 18(b). The high inductance primary coil is identical with that of the amplifier XI, but only half of the turns, L_2 , are included between the primary terminals. The remaining turns are left on open circuit, and their capacitive coupling, C_1' , to the secondary coil takes the place of C_1 in Fig. 18(b). These extra turns result in an increased impressed voltage on C_1' , thereby increasing the coupling value of this capacitance, which is necessarily small. The value of C_1' could not be isolated for measurement, and therefore was included as part of C_2 in the table. This total value given as C_2 is the sum of the antenna capacitance, C_a , plus 31- μf apparent capacitance across the L_2 section of the high inductance primary. This coil assembly is shown in Fig. 44(c).

The second circuit XI(b) is a coupling system of the type shown in Fig. 16(e). The primary circuit has very low impedance, so as to

secure loose coupling to the first tuned circuit. L_1 is only one and a half turns of wire next to the end of the secondary, L , and C_1 is $0.1 \mu\text{f}$. The interesting curves of this coupling have been computed and plotted in Fig. 48; all values have been expressed in terms of the effective coefficient of coupling between the first and second tuned circuits. It is well known that in such cases the maximum gain or minimum loss is secured with so-called "optimum" coupling, while maximum selectivity is obtained with much less coupling. The upper dotted curve shows the optimum coupling coefficient for these two circuits. The lower dotted curve shows the fixed component, resulting from the

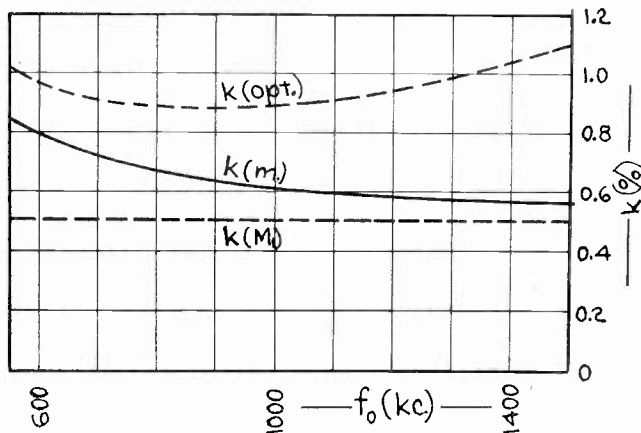

Fig. 48—Equivalent coefficient of coupling, coils XI(a) and XI(b).

mutual inductance, M_1 . The solid curve shows the total coupling derived from the equivalent mutual inductance, m . At the higher frequencies, selectivity and gain are equally important; therefore about half of the optimum coupling is employed, giving almost the maximum values of both gain and selectivity. At the lower frequencies, less selectivity is desired to reduce side-band attenuation; therefore the coupling is increased to nearly the optimum value.

The performance of this antenna circuit, XI(a), taken without the coupling to the second circuit, is shown in Fig. 49. Curve A' was observed with coil L reversed, so that the capacitive coupling, C_1' , was no longer effective. The resultant gain through both first and second circuits is very nearly one-half the gain shown in curve A .

The alignment problem in this receiver is very interesting, since there are three kinds of coupling systems. Condenser C_1 in Fig. 47 is included in both the first and second circuits; therefore a like condenser is included in each of the amplifier circuits, and all of these are used also as by-pass condensers in the grid-bias circuits. The self-inductance of the coupling coil, L_1 , is negligible in so far as alignment is concerned.

The other effects are shown in the lower curves of Figs. 46 and 49. The second circuit XI(b) was taken as a reference standard, because that is the most selective of all the tuned circuits in this set. The others have primary circuits which reduce the effective secondary inductance by a certain amount; in order to correct for that, the secondary self-inductance in those cases was made about one per cent greater, as shown in the table. That effect of the primary circuits is not uniform

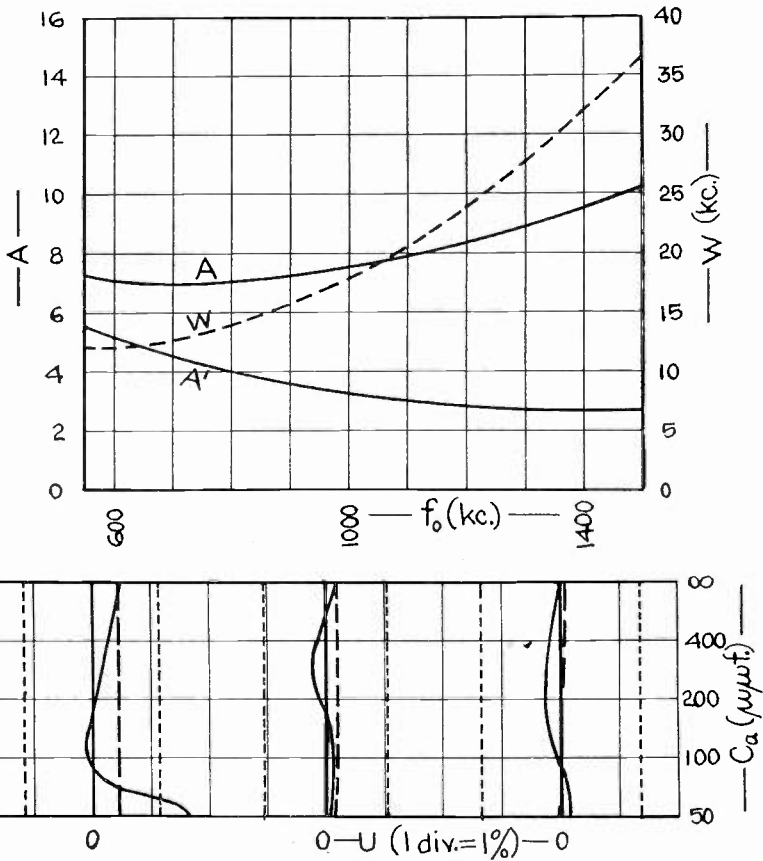

Fig. 49—Performance of coil XI(a).

over the frequency range.¹¹ This is shown by the curve of U for the amplifier coils, in Fig. 46. The net error after the above correction is seen to be quite negligible. The alignment error curves for the antenna circuit are also very good, as seen in Fig. 49; the solid curves are for the "distant" position of the "local-distant" switch, while the dashed curves are for the "local" position.

The foregoing treatment should give a fair cross-section of these improvements in tuned r-f coupling systems, which have been in progress over the past seven years, and which are now so generally

¹¹ Part X, treatment of alignment.

utilized. This line of development is still productive, however, and is not nearly exhausted of its possibilities. To Mr. Trube, to Professor Hazeltine, and to the engineers of the Hazeltine Laboratory is due much credit for their contributions to this work, and their coöperation in connection with the preparation of this paper is gratefully acknowledged.

PART V. REDUCTION OF COUPLED COILS TO EQUIVALENT UNITY-COUPLED TRANSFORMERS

A transformer with unity coupling has unique and useful mathematical properties, though unity coupling is an ideal which can only be approached in an actual transformer. In an iron-core transformer, the coupling can be made so close to unity that corrections can often be neglected. In the air-core transformers under discussion, the departure from unity coupling can seldom be neglected, and in many cases this departure is intentional and essential. Even so it is still

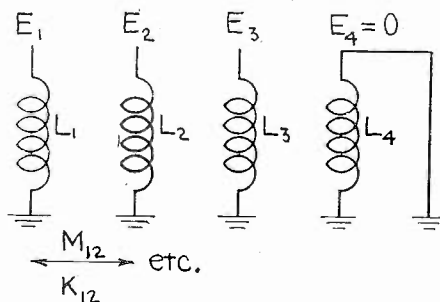

Fig. 50—Representation of shielding can by coil on short circuit.

instructive to resolve these coupled coils into a combination of hypothetical unity-coupled transformers together with "leakage inductances" depending on the actual departure from unity coupling. Only one hypothetical transformer is required where the coupled coil system contains two or three "active" coils plus any number of other coils on short circuit.

Fig. 50 shows a coupled coil system having one coil, L_4 , on short circuit.¹² Where radio coil systems are enclosed in a metal can for a shield, the shield can be approximated by a closely wound helical coil of the same diameter and length, connected on short-circuit, such as L_4 . In the coil systems under discussion, these cans are of low-resistance non-magnetic metals, and therefore the effect on the r-f induc-

¹² The common ground is shown in each figure only as a datum of potential and is not essential except where it forms a return path for current.

tance of the "active" coils is substantially independent of this resistance.¹³

Referring to Fig. 50 and writing the equations for E_1 , etc., in terms of I_1 , L_1 , M_{12} , etc., then equating E_4 to zero, it is possible to solve for I_4 in terms of I_1 , etc., and substitute in the preceding equations. Re-

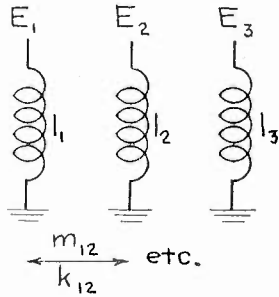

Fig. 51—Equivalent of coils in Fig. 50.

ferring to Fig. 51, a like set of equations can be written. Equating coefficients to make Figs. 50 and 51 mathematically identical:

$$l_1 = L_1(1 - K_{14}^2), \text{ etc.} \tag{2}$$

$$m_{12} = M_{12}(1 - K_{14}K_{24}/K_{12}), \text{ etc.} \tag{3}$$

$$k_{12}^2 = (K_{12} - K_{14}K_{24})^2 / (1 - K_{14}^2)(1 - K_{24}^2), \text{ etc.} \tag{4}$$

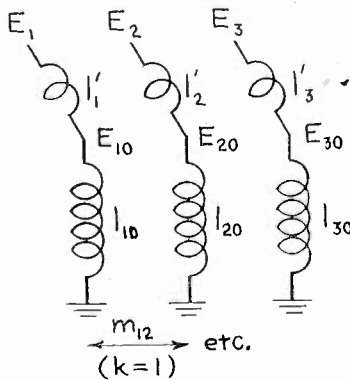

Fig. 52—Reduction of coils in Fig. 51 to equivalent unity-coupled transformer.

These equations apply to any number of "active" coils with one "shield" coil. It is to be noted that L_4 , M_{14} , etc., do not enter, except implicitly in K_{14} , etc.

If L_4 is placed between L_1 and L_2 , for example, $K_{14}K_{24}$ can be equated to K_{12} , making $m_{12} = 0$ (except for resistance in L_4). This illustrates the shielding action of a coil on short circuit.

¹³ This is not true at 1000 cycles, except where a heavy copper can is used (see Part II).

If $K_{14}K_{24}$ is made greater than K_{12} , then m_{12} is changed in sign by the distortion of the magnetic fields, due to L_4 , and may be greatly increased. This and the preceding effect are most pronounced when L_1 and L_2 are so located as to have small M_{12} .

Fig. 52 shows a three-coil unity-coupled transformer (l_{10} , l_{20} , l_{30}) with leakage inductances in series with each coil (l_1' , l_2' , l_3'). Fig. 52 is mathematically identical with Fig. 51 if the mutual inductances are the same, and $l_{10} + l_1' = l_1$, etc. The mutual inductances uniquely determine l_{10} , l_{20} , and l_{30} in the unity-coupled transformer, and the other equations follow:

$$l_{10} = m_{12}m_{13}/m_{23} = l_1k_{12}k_{13}/k_{23}, \quad (5)$$

$$l_1' = l_1 - l_{10} = l_1(1 - k_{12}k_{13}/k_{23}), \quad (6)$$

$$E_{10}/E_{20} = m_{13}/m_{23} = \sqrt{l_1/l_2}(k_{13}/k_{23}), \text{ etc.} \quad (7)$$

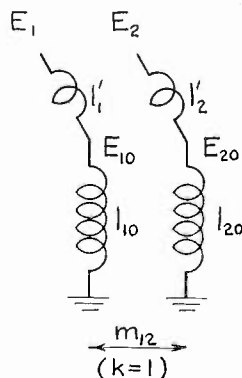

Fig. 53—Reduction of 2 coils in Fig. 51 to equivalent unity-coupled transformer.

The three-coil problem has an interesting special case, in which the leakage inductance of one coil only can be made to vanish:¹⁴

$$k_{12} = k_{13}k_{23} \quad (8)$$

$$l_1' = l_1(1 - k_{13}^2)$$

$$l_2' = l_2(1 - k_{23}^2)$$

$$l_3' = 0$$

$$l_{10} = l_1k_{13}^2$$

$$l_{20} = l_2k_{23}^2$$

$$l_{30} = l_3.$$

Fig. 53 shows a two-coil unity-coupled transformer, l_{10} , l_{20} , with leakage inductances in series with each coil, l_1' , l_2' . Fig. 53 is mathe-

¹⁴ L. A. Hazeltine, U. S. Patents 1,648,808, November, 1927, and 1,692,257, November, 1928.

matically identical with coils l_1 and l_2 of Fig. 51 if m_{12} is the same and $l_{10} + l_1' = l_1$, etc. The solution of this problem is not unique, but depends on the arbitrary choice of one required quantity, say l_{10} :

$$\begin{aligned} l_{20} &= m_{12}^2/l_{10} \\ l_1' &= l_1 - l_{10} \\ l_2' &= l_2 - l_{20} = l_2 - m_{12}^2/l_{10} \\ e_{10}/e_{20} &= l_{10}/m_{12}. \end{aligned} \tag{9}$$

By proper choice of the solution in any two-coil problem, the leakage inductance of one coil can be made to vanish:

$$\begin{aligned} l_{10} &= k_{12}^2 l_1 = m_{12}^2/l_2 \\ l_{20} &= l_2 \\ l_1' &= l_1(1 - k_{12}^2) \\ l_2' &= 0 \\ e_{10}/e_{20} &= m_{12}/l_2. \end{aligned} \tag{10}$$

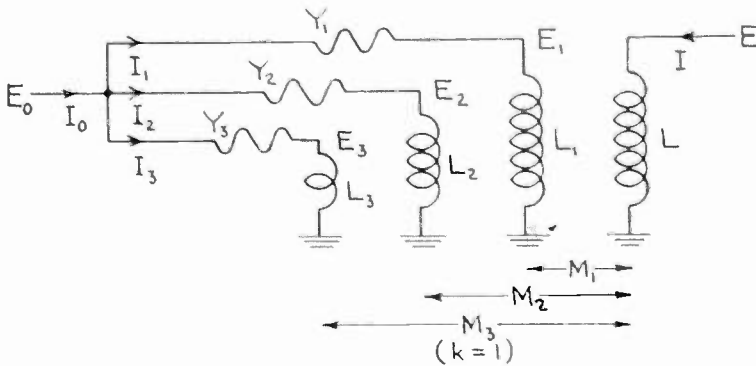

Fig. 54—Coupling system with divided primary circuit.

PART VI. REDUCTION OF DIVIDED PRIMARY CIRCUIT TO EQUIVALENT SIMPLE PRIMARY CIRCUIT

In some of the coil systems under discussion, the primary circuits are complicated, so that any simplifying reduction process is instructive and useful. Part V shows how a two-coil or three-coil system can be reduced to a unity-coupled transformer with leakage reactances. Now the procedure will be shown whereby a primary circuit including several coils of a unity-coupled transformer can be further reduced to include only a single coil of two-coil unity-coupled transformer. The properties of this single coil may vary with the frequency, in which case this latter two-coil system is nothing more than a very useful concept and an aid in picturing the behavior of the more complicated systems.

Fig. 54 shows a circuit in which the primary voltage, E_0 , is coupled through several admittances, $Y_1 \cdots Y_n$ to several primary coils, $L_1 \cdots L_n$, of a unity-coupled transformer. The secondary coil of this transformer is L . The transformer may have other coil arrangements, such as that of an autotransformer, without affecting this solution.

The following analysis will show that the circuit of Fig. 54 is mathematically identical with a simplified circuit shown in Fig. 55, providing the values in the latter satisfy the following equations.

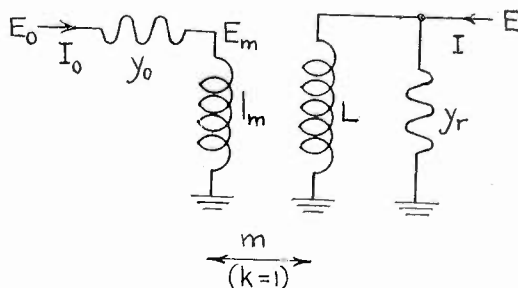

Fig. 55—Reduction of Fig. 54 to equivalent simple primary circuit.

From the properties of unity-coupled transformers,

$$E_1 = E(M_1/L), \text{ etc.} \quad (11)$$

$$E_m = E(m/L) \quad (12)$$

$$I_1 = (E_0 - E_1)Y_1 = E_0Y_1 - EY_1(M_1/L), \text{ etc.} \quad (13)$$

Then (14) and (15) follow for Fig. 54, and the corresponding (16) and (17) for Fig. 55:

$$\begin{aligned} I_0 &= I_1 + \cdots + I_n \\ &= E_0 \sum Y_q - (E/L) \sum M_q Y_q \end{aligned} \quad (14)$$

$$\begin{aligned} I &= (E - I_1 j\omega M_1 - \cdots - I_n j\omega M_n) / j\omega L \\ &= E / j\omega L - I_1 (M_1/L) - \cdots - I_n (M_n/L) \\ &= E / j\omega L - E_0 Y_1 (M_1/L) + E Y_1 (M_1/L)^2 \\ &\quad - \cdots - E_0 Y_n (M_n/L) + E Y_n (M_n/L)^2 \\ &= E / j\omega L - (E_0/L) \sum M_q Y_q + (E/L^2) \sum M_q^2 Y_q \end{aligned} \quad (15)$$

$$\begin{aligned} I_0 &= (E_0 - E_m) y_0 \\ &= E_0 y_0 - (E/L) m y_0 \end{aligned} \quad (16)$$

$$\begin{aligned} I &= E / j\omega L + E y_r - I_0 (m/L) \\ &= E / j\omega L + E y_r - (E_0/L) m y_0 + (E/L^2) m^2 y_0. \end{aligned} \quad (17)$$

Equating the corresponding coefficients of E_0 and E , we have

$$\sum Y_q = y_0 \tag{18}$$

$$\sum M_q Y_q = m y_0 \tag{19}$$

$$\sum M_q^2 Y_q = L^2 y_r + m^2 y_0. \tag{20}$$

The solutions for y_0 and m are apparent, but that for y_r is less simple:

$$\begin{aligned} L^2 y_r &= \sum M_q^2 Y_q - m^2 y_0 \\ &= \frac{\sum M_q^2 Y_q \cdot \sum Y_q - (\sum M_q Y_q)^2}{\sum Y_q} \\ &= \frac{\sum_p \sum_q (M_p - M_q)^2 Y_p Y_q}{2 \sum Y_q} \end{aligned} \tag{21}$$

Summarizing:

$$y_0 = \sum Y_q \tag{22}$$

$$m = \frac{\sum M_q Y_q}{\sum Y_q} \tag{23}$$

$$y_r = \frac{\sum_p \sum_q (M_p - M_q)^2 Y_p Y_q}{2L^2 \sum Y_q} \tag{24}$$

In these equations, y_0 is the total primary admittance when the secondary coil, L , is on short circuit, and y_r is the admittance "reflected" across the secondary when the primary terminal E_0 is on open circuit. When these equations are satisfied, Figs. 54 and 55 are equivalent.

Whether all values in Fig. 55 can be realized by fixed circuit elements, in compliance with conditions (22) to (24), depends on the frequency variation of $Y_1 \cdots Y_n$. It is apparent that y_0 is merely $Y_1 \cdots Y_n$ connected in parallel. But m is not a fixed quantity unless $Y_1 \cdots Y_n$ vary alike with frequency, or fall within other restrictions depending on $M_1 \cdots M_n$, and therefore m cannot in general be realized by a fixed mutual inductance. Though not so simply as y_0 , y_r can sometimes be identified with an appropriate impedance network.

In applying equations (22) to (24), certain suggestions may be offered, which have proved helpful in the solution of problems discussed herein. It is obviously possible to solve any given problem "by parts," that is, to consider first only part of the primary branches, and then to consider the partial y_0 in combination with the remaining primary branches.

If Y_a represents the sum of those of $Y_1 \cdots Y_n$ which have a certain frequency dependence or independence (such as pure capacitances,

inductances, or resistances), then the partial m for Y_a only has a fixed value. Y_a can then be combined with the remainder of $Y_1 \cdots Y_n$ for a final solution.

If Y_a represents the sum of those of $Y_1 \cdots Y_n$ which have no resistance component, then the partial m for Y_a has a value equivalent to a pure mutual inductance which in general varies with frequency but which has no imaginary component.

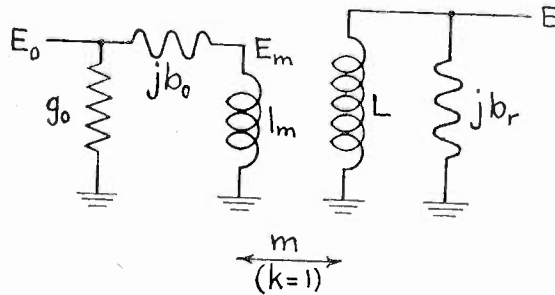

Fig. 56—Special case of divided primary circuit.

In this paper, one problem is a coil system having primary elements, $Y_1 \cdots Y_n$, of negligible resistance, which in some cases are connected to a shunt conductance, g_0 , such as the internal plate conductance, g_p , of a tube or the shunt conductance of an antenna volume-control rheostat. These coil systems can be conveniently solved by parts as

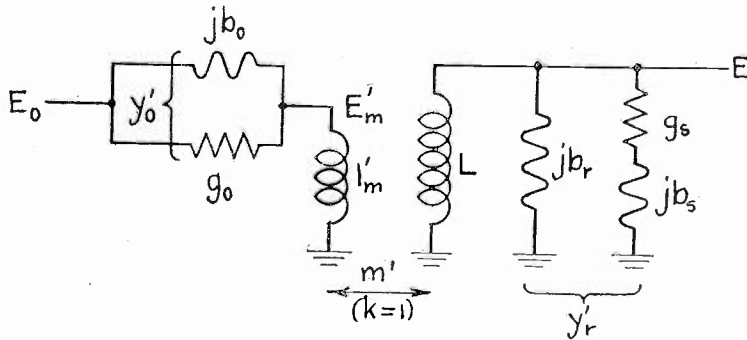

Fig. 57—Reduction of Fig. 56 to equivalent simple primary circuit.

suggested above, first grouping reactive elements of like frequency dependence, then assembling the individual groups of reactive elements, and finally adding the effect of g_0 where present and appreciable.

Fig. 56 is like Fig. 55 except for the addition of g_0 and the assumption that $Y_1 \cdots Y_n$ all have negligible resistance, making $y_0 = jb_0$ and $y_r = jb_r$. Fig. 57 is made equivalent to Fig. 56, by again applying (22) to (24). In Fig. 57, therefore:

$$y_0' = jb_0 + g_0 \tag{25}$$

$$m' = mj b_0 / (j b_0 + g_0) = m / (1 + g_0 / j b_0) \tag{26}$$

$$|m'| = m / \sqrt{1 + g_0^2 / b_0^2} \tag{27}$$

$$\begin{aligned} y_r' &= j b_r + (m/L)^2 j b_0 g_0 / (j b_0 + g_0) \\ &= j b_r + j b_s g_s / (j b_s + g_s) \\ &= j b_r + g_s (1 + j g_0 / b_0) / (1 + g_0^2 / b_0^2) \\ &= j b_r' + g_r' \end{aligned} \tag{28}$$

$$b_r' = b_r + g_s (g_0 / b_0) / (1 + g_0^2 / b_0^2) \tag{29}$$

$$g_r' = g_s / (1 + g_0^2 / b_0^2) \tag{30}$$

$$g_s = (m/L)^2 g_0 \tag{31}$$

$$b_s = (m/L)^2 b_0. \tag{32}$$

Frequently g_0 is much smaller than b_0 , especially in screen-grid circuits, in which case Fig. 57 simplifies to Fig. 58. The latter figure is then not only equivalent to Fig. 56, but is substantially identical thereto with only one exception: g_0 across the primary in Fig. 56 is reflected as g_s across the secondary in Fig. 58.

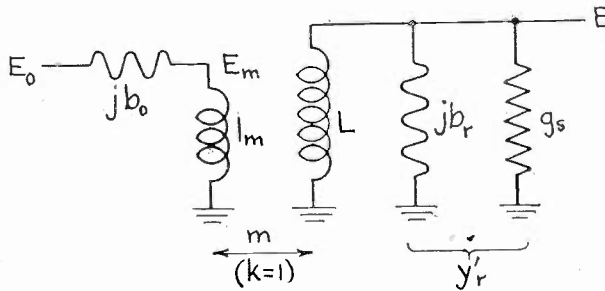

Fig. 58—Special case of Fig. 57.

When g_0 is much smaller than b_0 in Fig. 56, therefore, the coil system behaves very much like a unity-coupled transformer with secondary L and a turns ratio equal to L/m . It is instructive to retain this idea, referring to

$$\tau' = L/m \tag{33}$$

as the “effective” turns ratio of the coil system, regarded as a transformer. In general, τ' varies with frequency and this variation is responsible for the essential improvements described herein.

PART VII. FACTORS WHICH DETERMINE SELECTIVITY OF TUNED CIRCUIT INCLUDING A GENERALIZED IMPEDANCE

The selectivity of a simple tuned circuit including only a fixed inductance and a fixed capacitance, in series or in parallel, can easily

be computed by well-known methods. If, on the other hand, the tuned circuit includes a generalized impedance, such as an arbitrary network of fixed impedances, a special treatment is required.

The tuned coil systems under discussion are solved herein by the process of reduction to an equivalent simple transformer. The primary circuits coupled to the secondary coil affect the apparent impedance of the secondary coil, and this effect is represented by a shunt

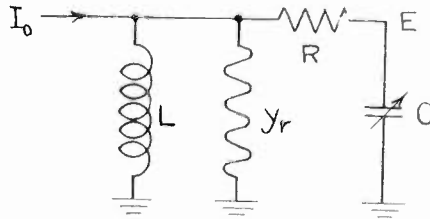

Fig. 59—Tuned circuit with generalized impedance in parallel.

admittance reflected across the secondary inductance of the derived simple transformer.

Fig. 59 shows a “parallel” tuned circuit, where L is the secondary coil inductance, R is the secondary coil resistance, C is the tuning capacitance, and y_r is the parallel admittance reflected from the primary circuit.

It is generally appreciated that R and C in series can be replaced by C in parallel with a derived conductance,

$$g = R\omega^2 C^2 \quad (34)$$

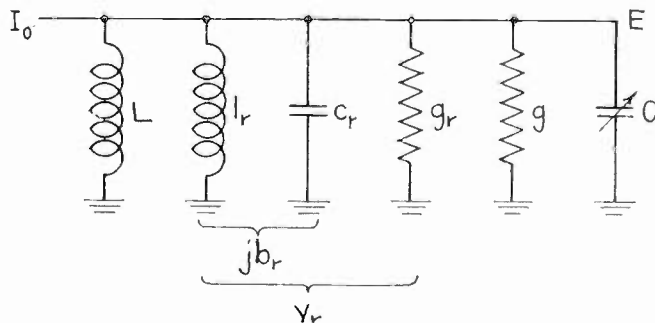

Fig. 60—Reduction of generalized impedance in Fig. 59 to equivalent components.

without appreciable error when $R\omega C$ is much less than unity.¹⁵ This is one step in transforming Fig. 59 into the equivalent Fig. 60.

The next step is the resolution of $y_r (= g_r + j b_r)$ into a parallel combination of l_r , c_r , and g_r , as shown in Fig. 60, which will have the same admittance over a frequency band sufficiently wide to deter-

¹⁵ See footnote 5.

mine the selectivity of the circuit. In the circuits under discussion, the selectivity is so great that this equivalence is required over only a narrow frequency band. Also b_r varies only gradually over the range of operating frequencies, so that b_r can be considered to vary in a linear manner over the narrow frequency band. It happens that the conductances are important only at the resonant frequency, ω_0 , so their gradual variation with frequency need not be considered as affecting the selectivity at a given ω_0 . Then the conditions for equivalence in the vicinity of ω_0 become

$$y_r = g_r + jb_r = g_r + j\omega c_r + 1/j\omega l_r \quad (35)$$

$$b_r = \omega c_r - 1/\omega l_r \quad (36)$$

$$db_r/d\omega = c_r + 1/\omega^2 l_r. \quad (37)$$

Solving the latter two equations for c_r and l_r ,

$$c_r = (b_r/\omega + db_r/d\omega)/2, \quad (38)$$

$$l_r = 2/\omega^2(db_r/d\omega - b_r/\omega), \quad (39)$$

both computed at ω_0 . In general, these values vary with ω_0 , but they are considered as fixed over each narrow band of frequencies which includes a selectivity curve.

Fig. 59 and 60 are therefore equivalent in the vicinity of ω_0 if (34), (38), and (39) are satisfied. The selectivity of Fig. 59 is then the same at ω_0 as that of a simple parallel circuit including $(g + g_r)$, $(c + c_r)$ and an inductance equal to $Ll_r/(L + l_r)$.

It is understood that the circuit is tuned to resonance with ω_0 by adjusting the tuning condenser, C , until

$$\omega_0(C + c_r) = 1/\omega_0 L + 1/\omega_0 l_r. \quad (40)$$

A quantity can be defined,

$$\begin{aligned} p &= (g + g_r)\omega_0 Ll_r/(L + l_r) \\ &= (g + g_r)/\omega_0(C + c_r), \end{aligned} \quad (41)$$

which is called the "apparent power factor" of the tuned circuit, for convenience (although it is not identical with the usual meaning of the term "power factor".) It will appear¹⁶ that this factor determines the selectivity of the tuned circuit as a whole.

As an example of the application of (38) and (39), assume that y_r in Fig. 59 is equivalent to l_s and c_s connected in series:

$$\begin{aligned} 1/y_r &= j\omega l_s + 1/j\omega c_s \\ &= (1 - \omega^2 l_s c_s)/j\omega c_s \end{aligned} \quad (42)$$

¹⁶ Part VIII, equations (70) and (71).

$$g_r = 0 \quad (43)$$

$$b_r = \omega c_s / (1 - \omega^2 l_s c_s). \quad (44)$$

Applying (38) and (39), and defining ω_s as the natural frequency of l_s and c_s ,

$$\omega_s^2 = 1/l_s c_s \quad (45)$$

$$l_r = l_s (1 - \omega_s^2 / \omega_0^2)^2 \quad (46)$$

$$c_r = c_s / (\omega_0^2 / \omega_s^2 - 1)^2. \quad (47)$$

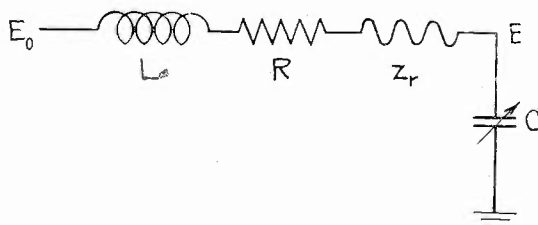

Fig. 61—Tuned circuit with generalized impedance in series.

Figs. 61 and 62 illustrate the corresponding problem where a generalized impedance z_r is connected or reflected in a "series" tuned

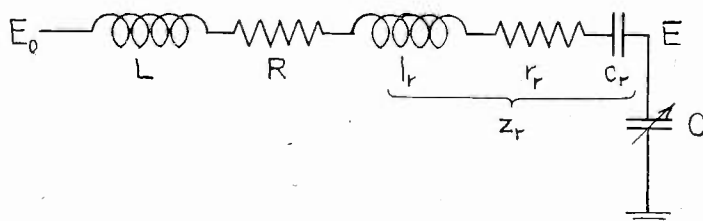

Fig. 62—Reduction of generalized impedance in Fig. 61 to equivalent components.

circuit. This solution is very similar to that for Figs. 59 and 60, so that only the equations need be outlined. The following correspond to the above (35) to (41):

$$z_r = r_r + jx_r = r_r + j\omega l_r + 1/j\omega c_r \quad (48)$$

$$x_r = \omega l_r - 1/\omega c_r \quad (49)$$

$$dx_r/d\omega = l_r + 1/\omega^2 c_r \quad (50)$$

$$l_r = (x_r/\omega + dx_r/d\omega)/2 \quad (51)$$

$$c_r = 2/\omega^2(dx_r/d\omega - x_r/\omega) \quad (52)$$

$$\omega_0(L + l_r) = 1/\omega_0 C + 1/\omega_0 c_r \quad (53)$$

$$\begin{aligned} p &= (R + r_r)\omega_0 C c_r / (C + c_r) \\ &= (R + r_r)/\omega_0(L + l_r). \end{aligned} \quad (54)$$

PART VIII. ANALYSIS OF GENERALIZED TUNED R-F COUPLING SYSTEM

In Parts V, VI, and VII, a number of perfectly general problems have been treated. In Parts IX and X, the treatment will be directed to specific examples of tuned r-f coupling systems, and will be greatly simplified by the use of the preceding solutions as tools. In this Part VIII, however, the treatment will still be sufficiently general to include all the systems which form the subject matter of this paper.

The first step in this treatment is the justification of the "constant current generator" concept to replace the ordinary "constant voltage generator" concept; this was mentioned in Part II.

Figs. 12(a), 13(a), and 14(a) are examples of the ordinary concept, namely, of a generator voltage or e.m.f. which is itself independent of the load but which has an "internal" series impedance so that the terminal voltage is dependent on the current. In Fig. 12(a), E_i is the internal voltage of such a generator, with y_i as the internal admittance, y_0 as the load admittance, and E_0 as the load voltage. Figs. 13(a) and 14(a) are special cases of Fig. 12(a). In Fig. 13(a), E_a is the fictitious voltage generated in an antenna by a passing r-f wave, while c_a is the apparent capacitance of the antenna. In Fig. 14(a), " $-\mu E_p$ " is the fictitious voltage generated in the plate circuit of an amplifier tube, while g_p is the internal plate conductance of the tube.

In tuned r-f amplifiers such as those discussed herein, the mutual conductance, $g_m = \mu g_p$, is the most important factor in determining the amplifying ability of a tube. In the case of the screen tube now widely used, g_m is often the only important factor. This suggests that a different concept might be more useful, which would involve g_m as a first consideration in place of μ . This is one result of changing to the following "constant current generator" concept, as will be seen.

Referring to Fig. 12(a), the load voltage is

$$E_0 = E_i y_i / (y_i + y_0). \tag{55}$$

Now referring to Fig. 12(b), the load voltage is

$$E_0 = I_i / (y_i + y_0). \tag{56}$$

It is apparent that Figs. 12(a) and (b) have the same load voltage if

$$I_i = E_i y_i \tag{57}$$

is the current of the "constant current generator" in Fig. 12(b). By "constant current generator" is meant a generator whose current does not depend on the load. This might also be termed an "infinite

impedance generator", since this also would yield a current unaffected by finite changes in the load.

Figs. 13(b) and 14(b) are special cases of Fig. 12(b). Figs. 13(a) and (b) are equivalent when

$$I_a = E_a j\omega c_a. \quad (58)$$

Figs. 14(a) and (b) are equivalent when

$$I_m = -\mu E_g \cdot g_p = -E_g g_m. \quad (59)$$

In Figs. 13(b) and 14(b), c_a or g_p is now in parallel with the load. Where the load is tuned to resonance with a signal, c_a or g_p affects the condition for resonance and the resulting selectivity. It is therefore logical to consider these elements in combination with the load, and this point of view has proved most useful in solving the problems discussed herein. In the case of the screen tube, g_m in (59) is the important factor, while g_p in Fig. 14(b) is often negligible.

Now applying the theorems of Parts V, VI, and VII, we find that Fig. 15 represents the simplest final form to which these tuned r-f coupling systems can be reduced. By Part V, any system of two or three coils can be reduced to a unity-coupled transformer with leakage inductance. By Part VI, the divided primary circuits can be reduced to a simple primary circuit and in addition a reflected admittance, y_r , across the secondary inductance, L . By Part VII, the susceptance, jb , of this admittance can be resolved into equivalent inductance, l_r , and capacitance, c_r , for computation of selectivity. By the method just described, the constant current generator concept can be introduced and the antenna c_a or the tube g_p regarded as part of the coupling system.

In the general case of three coils, this procedure leaves a part of L as a leakage inductance at "X" in Fig. 15, which vanishes only when

$$k_{12} = k_1 k_2. \quad (60)$$

where k_1 and k_2 are the respective couplings of the two primary coils to the secondary, L , and k_{12} is the coupling between the two primary coils—see (8) above. In the three-coil examples described herein, this condition is approximated so that the errors caused by assuming this value for k_{12} are unimportant or entirely negligible. This assumption is made in the following treatment, in so far as it applies to three-coil systems, because the computations are greatly simplified thereby.

In the solution¹⁷ of Fig. 15, we first note that I_0 flows through the primary of a unity-coupled transformer having a "turns ratio" of L/m . Therefore I_0 through the primary can be replaced by

$$I_0' = I_0 m/L \quad (61)$$

through the secondary inductance, L . The solution for the secondary voltage, E , is then apparent:

$$E = \frac{I_0 m/L}{(g + g_r) + j\omega(C + c_r) + (1/j\omega L + 1/j\omega l_r)}$$

$$= \frac{I_0 m/L}{(g + g_r) + j\omega(C_r + c_r)(1 - \omega_0^2/\omega^2)} \quad (62)$$

where

$$\omega_0^2 = (L + l_r)/Ll_r(C_r + c_r) \quad (63)$$

relates the resonant frequency, ω_0 , of the system to the resonant value, C_r , of the tuning condenser, C . At resonance, the secondary voltage is

$$E_r = I_0 m/L(g + g_r). \quad (64)$$

Substituting for I_0 the value of I_a in (58), we obtain the "voltage amplification ratio" of a tuned antenna system:

$$A = E_r/E_a = j\omega c_a m/L(g + g_r). \quad (65)$$

Substituting for I_0 the value of I_m in (59), we obtain the voltage amplification ratio of a tube with the tuned coupling system in the plate circuit:

$$A = E_r/E_0 = -g_m m/L(g + g_r). \quad (66)$$

When a signal is present at a frequency which differs from ω_0 , the susceptance term

$$b = \omega(C_r + c_r)(1 - \omega_0^2/\omega^2) \quad (67)$$

from (62) must be considered. Let

$$\omega = \omega_0(1 + w) \quad (68)$$

and expand (67) by Taylor's series in terms of w :

$$b = \omega_0(C_r + c_r)(2w - w^2 + w^3 - \dots). \quad (69)$$

Only the first term is important when w is much smaller than unity, as near the peak of a sharp resonance curve. Then the secondary voltage near resonance is

¹⁷ See footnote 5.

$$\begin{aligned}
 E &= \frac{I_0 m / L}{(g + g_r) + 2w \cdot j\omega_0(C_r + c_r)} \\
 &= E_r / (1 + 2jw/p)
 \end{aligned}
 \tag{70}$$

where p is defined by (41) above. The resonance curve is now determined by

$$|E/E_r| = 1/\sqrt{1 + 4w^2/p^2}. \tag{71}$$

For convenience in comparing the resonance curves of the various tuned systems under discussion, the term "width of resonance", W , is used, and is defined as the width of the resonance curve, in terms of frequency difference, between the two points where $|E/E_r| = 1/2$. This quantity, W , is easy to measure experimentally and is a fair basis for comparison of different tuned systems, each having one tuned circuit. From (71),

$$w = \pm p\sqrt{3}/4 \tag{72}$$

at these points. From (68)

$$\begin{aligned}
 W &= f_0(1 + w) - f_0(1 - w) \\
 &= 2wf_0 = f_0 p \sqrt{3}
 \end{aligned}
 \tag{73}$$

gives the "width of resonance".

PART IX. ANALYSIS OF FIRST EXAMPLE

Having laid the required theoretical groundwork, there remains to apply this to some specific coupling systems and to show thereby how the desired computations can be made.

The first example is the circuit shown in Fig. 19(b). This circuit is used in a number of systems described in Part IV and is representative of this subject matter. The preferred coil arrangement of this circuit has a low inductance primary, L_1 , with close coupling, k_1 , to the secondary, L , a high-inductance primary, L_2 with moderate coupling, k_2 , to the secondary, and loose coupling, k_{12} , between the primary coils. The primary capacitances, C_1 and C_2 , have such values that the natural frequencies of L_1 and L_2 , taken with C_1 and C_2 , are respectively much higher and somewhat lower than the broadcast band. Resistances have a small effect, in most cases, on the first part of the analysis, and therefore will be ignored until they become essential to the picture.

Fig. 19(b) is now reduced by (5) and (6) to Fig. 63 having a unity-coupled transformer with leakage inductances:

$$L' = L(1 - k_1k_2/k_{12}) \tag{74}$$

$$L_1' = L_1(1 - k_1k_{12}/k_2) \tag{75}$$

$$L_2' = L_2(1 - k_{12}k_2/k_1). \tag{76}$$

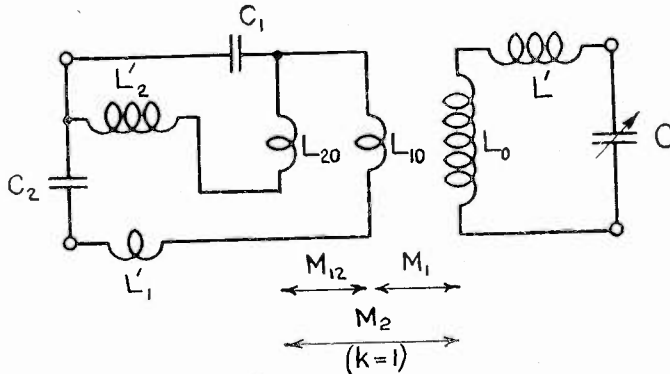

Fig. 63—Reduction of Fig. 19(b) to unity-coupled transformer.

Neither L' nor L_1' are essential to the desired operation of the circuit. The assumption of a value

$$k_{12} = k_1k_2 \tag{60}$$

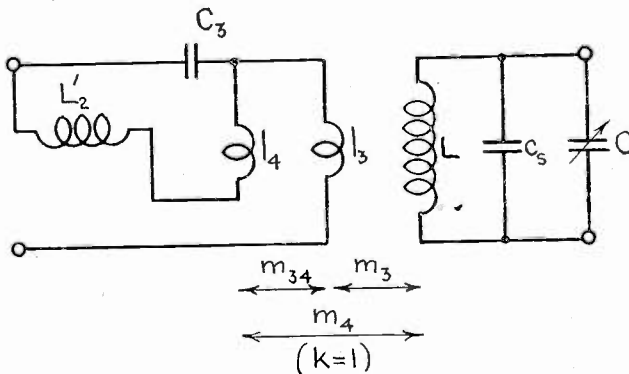

Fig. 64—Further reduction of Fig. 63.

is not far from the usual relationship and does not introduce any important error. The leakage inductances are now

$$L' = 0 \tag{77}$$

$$L_1' = L_1(1 - k_1^2) \tag{78}$$

$$L_2' = L_2(1 - k_2^2). \tag{79}$$

In practice, the reactance of L_1' is quite negligible as compared with that of C_1 , C_2 , or L_2' , and therefore can be neglected.

Fig. 64 is derived by making the above two assumptions, and by reduction of C_1 and C_2 to a single branch, C_3 , by applying (22), (23), and (24):

$$C_3 = C_1 + C_2 \quad (80)$$

$$m_3 = M_1 C_1 / (C_1 + C_2) \quad (81)$$

$$c_s = (M_1/L)^2 C_1 C_2 / (C_1 + C_2). \quad (82)$$

The total mutual inductance in the L_2' path between primary terminals being the same as before,

$$m_3 - m_4 = M_1 - M_2 \quad (83)$$

$$m_4 = M_2 - M_1 C_2 / (C_1 + C_2). \quad (84)$$

The capacitance, c_s , is that reflected across the secondary by this reduction. It is noted that m_3 and m_4 , like M_1 and M_2 , have values independent of the frequency.

Fig. 65 is derived by combining the C_3 and L_2' branches in Fig. 64.

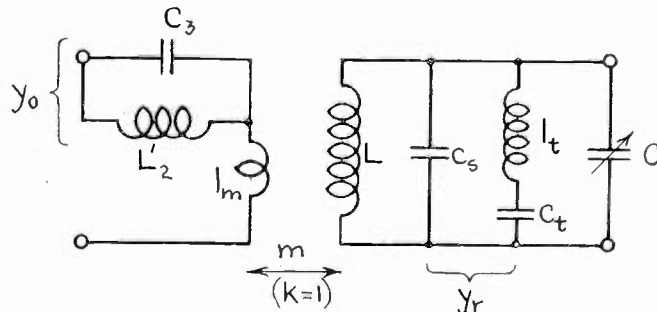

Fig. 65—Final reduction of Fig. 19(b) to equivalent simple primary circuit.

$$\begin{aligned} y_0 &= j\omega C_3 + 1/j\omega L_2' \\ &= j\omega C_3(1 - \omega_2^2/\omega^2) \end{aligned} \quad (85)$$

$$m = m_3 + \frac{m_4}{\omega^2/\omega_2^2 - 1} \quad (1)$$

$$\begin{aligned} y_r &= j\omega c_s + \frac{1}{j\omega l_t + 1/j\omega c_t} \\ &= j\omega c_s + \frac{1}{j\omega l_t(1 - \omega_2^2/\omega^2)} \end{aligned} \quad (86)$$

where

$$l_t = L_2'(L/m_4)^2 \quad (87)$$

$$c_t = C_3(m_4/L)^2 \quad (88)$$

$$\omega_2^2 = 1/L_2' C_3 = 1/(C_1 + C_2) L_2(1 - k^2). \quad (89)$$

In these equations, y_r is the total value obtained by both the above reductions, and is equivalent at all frequencies to fixed elements c_s ,

l_i , and c_i connected as shown. The natural frequency of the high inductance primary circuit is ω_2 defined by (89), which is always less than ω in the usual arrangements. The equivalent mutual inductance, m , has two components, the m_3 component which is fixed and the m_4 component which is much larger at lower frequencies than at higher frequencies.

When the system of Fig. 19(b) is used to couple an antenna to the grid of a tube, C_2 is at least partly the apparent antenna capacitance, c_a . The antenna conductance

$$g_a = R_a \omega^2 c_a^2 \quad (90)$$

when $R_a \omega c_a$ is much less than unity, which is ordinarily true. Then also g_a is much less than b_0 , the reactive component of y_0 , and (31) can be applied in simplified form. Letting g_r represent reflected primary circuit conductance, neglected in (31), the total reflected conductance is

$$g_r' = g_r + g_a(m/L)^2. \quad (91)$$

Reducing to g the resistance, R , of the secondary circuit, as in (34), the total apparent conductance across the secondary circuit is

$$g' = g + g_r' = g + g_r + g_a(m/L)^2. \quad (92)$$

Applying (41) and (47), the selectivity when tuned to ω_0 is determined by the apparent power factor

$$p = g'/\omega_0 C' \quad (93)$$

$$C' = C + c_s + c_i/(\omega_0^2/\omega_2^2 - 1)^2. \quad (94)$$

This last term is taken from (47) above.

When, on the other hand, Fig. 19(b) is used to couple an amplifier tube to the grid of another tube, C_2 may be (1) inherent plate capacitance, (2) an added condenser between plate and filament, or (3) a neutralizing condenser connected to the plate. The plate conductance, g_p is also in parallel with the input terminals, as in Fig. 14(b). In most cases g_p is much smaller than b_0 , the reactive component of y_0 , and (31) can be applied in simplified form. Letting g_r represent reflected primary circuit conductance, neglected in (31), the total reflected conductance is

$$g_r' = g_r + g_p(m/L)^2. \quad (95)$$

Reducing to g the resistance, R , of the secondary circuit, as in (34), the total apparent conductance across the secondary circuit is

$$g' = g + g_r' = g + g_r + g_p(m/L)^2. \quad (96)$$

The selectivity is determined by (93) and (94) above.

The problem of unicontrol of several circuits like Fig. 19(b), one of which is an antenna circuit, will not be treated in detail. This problem is more interesting in the following example and does not warrant a complete treatment in both examples.

PART X. ANALYSIS OF SECOND EXAMPLE

The second example to be treated in detail is the circuit shown in Fig. 18(b). This circuit is used in a number of systems described in Part IV. The usual arrangement of this circuit has a high inductance primary, L_2 , with moderate coupling, k_2 , to the secondary, L , and has primary capacitances, C_1 and C_2 , usually composed of inherent or antenna capacitance. The latter have such values that the natural frequency, ω_2 , of L_2 taken with C_1 and C_2 , is somewhat lower than the broadcast band. The symbols are so connected in the drawing as to indicate that the windings of L_2 and L are connected in opposite directions.

The first part of this solution corresponds to that of the preceding example, and therefore need only be outlined. The assumptions in the first example as to k_{12} and L_1' are not required, however, since this is only a two-coil system and these quantities are absent.

Fig. 18(b) can be reduced to Fig. 64, in which

$$C_3 = C_1 + C_2 \quad (97)$$

$$L_2' = L_2(1 - k_2^2) \quad (98)$$

$$m_3 = LC_1/(C_1 + C_2) \quad (99)$$

$$\begin{aligned} m_4 &= M_2 + m_3 \\ &= M_2 + LC_1/(C_1 + C_2) \end{aligned} \quad (100)$$

$$c_s = C_1C_2/(C_1 + C_2). \quad (101)$$

Fig. 64 has already been reduced to Fig. 65, and the resulting equations (85) to (96) apply equally to this example.

Since this example is both simple and useful, it has been chosen as a basis for a detailed treatment of the alignment problems arising in unicontrol operation of several tuned r-f systems. The nature of these problems has been outlined in Part II. They are most important in antenna circuits, where a resistance is often connected in parallel with the input terminals, for use as a volume control. Therefore the circuit of Fig. 18(b) will now be solved after making this addition.

Fig. 18(b) has already been transformed to Fig. 64 and equations (97) to (101) state the conditions for equivalence. Fig. 66 shows

Fig. 64 with the addition of a conductance, g_0 , across the input terminals. With the aid of equations (22) to (24), Fig. 66 will be reduced to Fig. 67, and the equations for equivalence will be stated.

The effective mutual conductance, m' , is now lower than the former value, m , by the factor appearing in (27) above. This difference need not be treated in more detail.

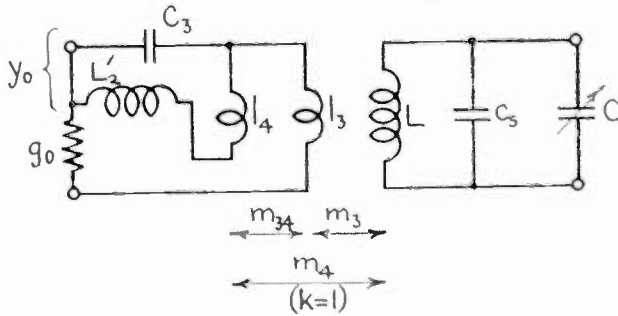

Fig. 66—Addition of shunt conductance to Fig. 64.

The impedances reflected from the primary into the secondary circuit are more interesting, since these determine the alignment errors. Applying (24) to Fig. 66, there are found three different terms in the numerator, each of which will be taken as the numerator of one parallel component of y_r' , in addition to the c_s component already present in Fig. 68.

$$y_r' = j\omega c_s + y_t + y_u + y_v. \tag{102}$$

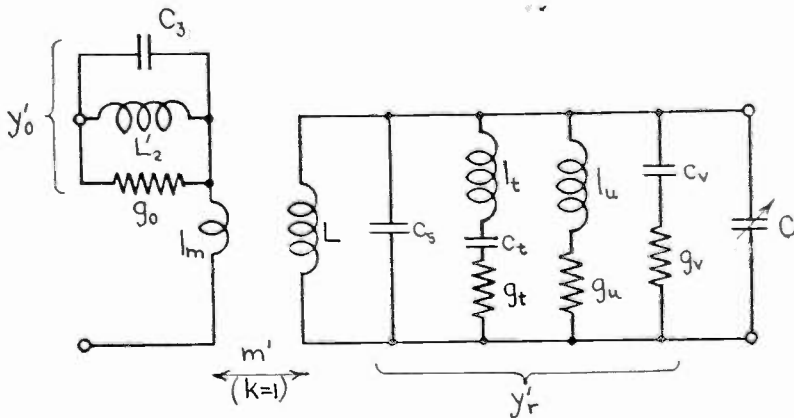

Fig. 67—Final reduction of Fig. 66 to equivalent simple primary circuit.

Inverting each of these three expressions, it is found equivalent to a series circuit of two or three distinct elements, as shown in Fig. 67, having the values given in the following equations.

$$z_t = 1/y_t = j\omega l_t + 1/j\omega c_t + 1/g_t \tag{103}$$

$$z_u = 1/y_u = j\omega l_u + 1/g_u \quad (104)$$

$$z_v = 1/y_v = 1/j\omega c_v + 1/g_v \quad (105)$$

$$\left. \begin{aligned} l_t &= (L_1/m_4)^2 L_2' \\ c_t &= (m_4/L)^2 C_3 \\ g_t &= (m_4/L)^2 C_3 / L_2' g_0 \end{aligned} \right\} \quad (106)$$

$$\left. \begin{aligned} l_u &= (I_2/M_2)^2 L_2' \\ g_u &= - (M_2/L)^2 g_0 / (\omega^2/\omega_2^2 - 1) \end{aligned} \right\} \quad (107)$$

$$\left. \begin{aligned} c_v &= (m_3/L)^2 C_3 \\ g_v &= (m_3/L)^2 g_0 / (1 - \omega_2^2/\omega^2). \end{aligned} \right\} \quad (108)$$

Each of these fictitious elements has a fixed value independent of frequency, except g_u and g_v . These are greater at lower frequencies as long as ω_2 is less than ω .

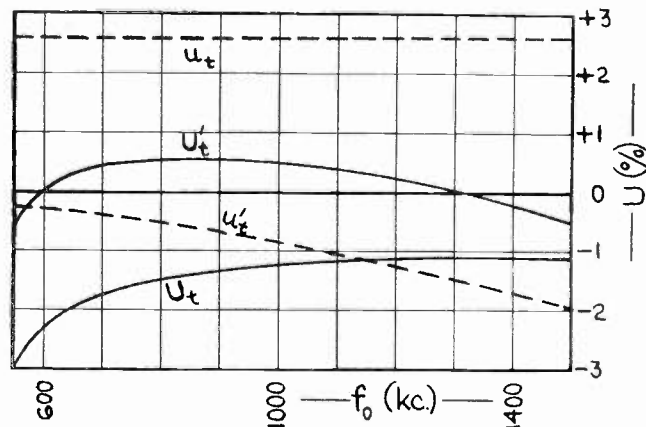

Fig. 68—Alignment errors, Fig. 18(b) circuit compared with simple tuned circuit.

One of the simpler alignment problems is that of tuning at once a pure inductance, L , and a coupling system having a secondary, L_s , with a high inductance primary. This problem will serve to introduce the method of attack, and has already been met in receiver XI, one of the examples in Part IV. It is assumed that ω_2 is substantially lower than the broadcast band, and that g_0 is sufficiently small¹⁸ to have a negligible effect on the resonant frequency, ω , of the coupling system; both conditions are ordinarily met in practice. Fig. 67 then reverts to Fig. 65, determined by equations (97) to (101) taken together with equations (85) to (96). The reflected elements which determine the alignment errors are c_s , c_t , and l_t . The parallel capacitance, c_s , can be matched by an adjustable aligning condenser across the pure

¹⁸ Part VI, Figs. 56 to 58, equations (28) to (32).

inductance. The other two elements alter the effective inductance of the secondary to a degree which varies with the frequency; the fractional change will be called U_t and will be assumed much less than unity:

$$\begin{aligned} L(1 + U_t) &= \frac{L(l_t - 1/\omega^2 c_t)}{L + (l_t - 1/\omega^2 c_t)} \\ &= \frac{L}{1 - U_t} = \frac{L}{1 + L/l_t(1 - \omega_2^2/\omega^2)} \end{aligned} \quad (109)$$

$$\begin{aligned} U_t &= -L/l_t(1 - \omega_2^2/\omega^2) \\ &= -m_4^2/LL_2'(1 - \omega_2^2/\omega^2). \end{aligned} \quad (110)$$

This error becomes rapidly greater at lower frequencies. In Fig. 68 is a curve of U_t , assuming $f_2 = 450$ kc and $m_3^2/LL_2' =$ one per cent. Two corrections can be applied which will greatly reduce this error. The inductance of the secondary, L , can be increased slightly; such an increase is represented by the dotted curve u_t in Fig. 68. Also the aligning condenser across the secondary can be reduced slightly, as indicated by the dotted curve u_t' ; a given change of capacitance represents a per cent change which varies with frequency inversely as the total tuning capacitance. Adding these two corrections moves the error curve to U_t' . The maximum error is now about one-fifth as great as it was before adding these corrections. This method of correction is used in receiver XI, whereby the alignment errors are reduced to those shown in Fig. 46, curve U .

The alignment problem in an antenna coupling system is quite different, but the same method of correction is applicable and useful. This problem has to deal with the detuning effects of antenna capacitance and of volume control schemes such as a parallel rheostat. The tuning of the antenna coupling system must be substantially the same for various values of antenna capacitance, C_a , and for varying parallel conductance, g_0 . The former usually lies between 50 and 400 $\mu\mu\text{f}$; the latter varies between wide limits, so that no assumptions are applicable over its entire range of values. An adequate picture of the essential details can be drawn, however, from the equivalent parallel circuits of Fig. 67, which determine the residual alignment errors.

In the study of Fig. 67, it is noted first that g_t varies inversely, while g_u and g_v vary directly with g_0 . For small values of g_0 , therefore, the branches y_u and y_v are unimportant; for large values of g_0 , the

branch y_t is unimportant. It is also noted that the branches including c_s and c_v are relatively less important at the lower frequencies, because they are smaller relative to the greater total capacitance. The antenna capacitance, C_a , merely enters as part of C_2 and therefore also as part of C_3 . Lower values of C_a result in higher values of ω_2 , m_3 , and m_4 , and consequently in greater values of y_t and y_v . The alignment errors will be studied for two extreme cases. The first corresponds to the use of small values of C_a and g_0 , and of such circuit elements as required to make $f_2 = 550$ kc. The second corresponds to the use of a very large value of C_a , or the equivalent, a very large value of g_0 .

The c_s and y_v branches in Fig. 67 will be considered first. In the former extreme case, the small value of g_0 makes y_v unimportant, and c_s has the value given in (101). In the latter extreme case, the large value of C_a makes m_3 so small that y_v is unimportant, and makes c_s equal to C_1 . The variation of c_s is therefore

$$(c_s)_{\max} - (c_s)_{\min} = \frac{C_1^2}{C_1 + (C_2)_{\min}} \quad (111)$$

This difference, expressed in per cent of the minimum value of tuning capacitance, C , should not exceed twice the apparent power factor, p , defined by (41). These upper and lower values of c_s are plotted as per cent of the tuning capacitance in curves U_s'' and U_s' of Fig. 69. By adjusting the aligning condensers of the other circuits to a value represented by the curve u_s , the net errors are then reduced to within $\pm p$.

The y_t and y_u branches of Fig. 67 will now be considered. In the case of small C_a and g_0 , y_u is unimportant and y_t is very important, since g_u is small and g_t is large. Dividing y_t into its real and imaginary components, g_t and jb_t , it is noted that only the latter affects the resonant frequency, or the effective inductance of the secondary, L . In this case, then,

$$\begin{aligned} 1/j\omega L(1 + U_t) &= 1/j\omega L + jb_t \\ &= (1 - U_t)/j\omega L = (1 - \omega L b_t)/j\omega L \end{aligned} \quad (112)$$

$$U_t = \omega L b_t. \quad (113)$$

Since the natural frequency of y_t is ω_2 , taken equal to the minimum value of ω , b_t will always be negative and will be limited in magnitude by the two following curves:

$$b_t' = -1/\omega l_t(1 - \omega_2^2/\omega^2) \quad (114)$$

$$b_t'' = g_t/2. \quad (115)$$

The same expressed in terms of the equation for U_t are plotted in dotted lines in Fig. 69 as follows:

$$u_t' = -L/l_t(1 - \omega_2^2/\omega^2) \tag{116}$$

$$= -m_4^2/LL_2'(1 - \omega_2^2/\omega^2)$$

$$u_t'' = -\omega Lg_t/2 \tag{117}$$

$$= -(m_4^2/LL_2')\omega C_3/2g_0.$$

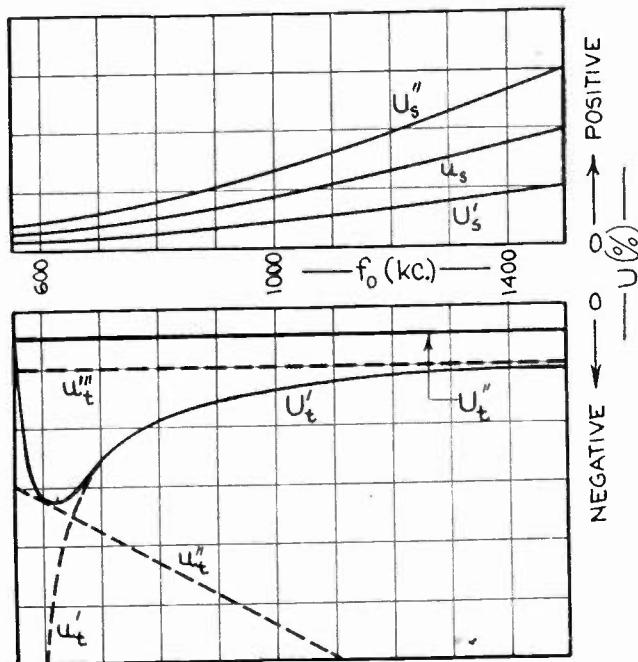

Fig. 69—Alignment errors, antenna circuit compared with simple tuned circuit.

The curve determined by these limits is U_t' , representing the greatest change in the effective inductance of the secondary, L , with small values of C_a and g_0 . The corresponding change for large C_a or g_0 is determined by y_u , and is

$$U_t'' = -L/l_u = -M_2^2/LL_2'. \tag{118}$$

This curve is also plotted in Fig. 69. The inductance correction and an added capacitance correction should be chosen equal and opposite to a curve intermediate U_t'' and U_t' . The difference between these two should not exceed twice the power factor, p , so that the total corrections will leave only a small residual error, as in the case of Fig. 68. The proper application of these rules assures small alignment errors in antenna circuits such as are described herein, irrespective of changes in antenna capacitance or of a shunting volume control.

DISCUSSION

L. A. Hazeltine.¹ The paper by Messrs. Wheeler and MacDonald offers a welcome occasion for me to express an appreciation of the work of the late Carl E. Trube, who initiated the development covered by the paper.

I first knew Trube as a student at Stevens, where his ability and personality were outstanding. His Senior Report was in the field of radio, and its considered judgments and nicety of expression made it the best of all that I passed upon.

Shortly after his graduation, in the summer of 1922, we happened to become associated with the same organization, in the development of radio broadcast receivers—a relationship of mixed rivalry and coöperation that was prophetic of the future. For, when this particular work ceased, Trube undertook the development on his own account of a tuned radio-frequency amplifier that would excel in performance without poaching on the preserves of another—that is, without employing neutralization.

This restriction made his problem much harder than mine; for instability put a severe handicap on sensitivity and selectivity. Trube found, as we all know now, that with variable-capacitance tuning instability was naturally the worst at high frequencies and sensitivity the poorest at low frequencies. My own work, both mathematical and experimental, had shown the same thing, but I was satisfied with a compromise, since I could minimize instability by neutralization. Trube had to find a way out, and necessity was the mother of invention.

Trube's solution made use of the fact that when frequency is changed the reactance of a fixed inductance and that of a fixed capacitance change in opposite senses. He replaced the simple fixed-ratio intertube transformer by a combination of fixed inductance and capacitance so arranged as to increase the sensitivity at low frequencies (where it was most needed) and to increase the stability at high frequencies (where it tended to be least). This was accomplished in the same year that saw the introduction of the Neutrodyne.

It has been said that the normal course of an engineering development is from the simple to the complex and back to the simple again. This seems to be the case here. Trube's first arrangement went too far, the sensitivity being unnecessarily lowered at high frequencies. So he later made the previously fixed capacitance adjustable with the tuning capacitance, proportioning the two to give the desired law for the sensitivity variation. Finally, he changed his circuit arrangement so as to secure the desired quantitative relations without having to adjust any element besides the tuning capacitance, thus going back to the original simplicity of structure. Throughout all of his work, however, there was continuity of purpose and of means; in all sets the user had only the tuning adjustment to control.

In the meantime, the engineers of the Hazeltine Corporation were studying the improvement of the Neutrodyne. The general employment of shielding and the greater uniformity in grid-plate capacity of the available vacuum tubes, had made it possible to remove more completely and permanently interstage couplings and thereby permitted design for higher sensitivity. But the maintenance of stability with the tolerance still allowed in the grid-plate capacity of vacuum tubes and with unavoidable small variations in receiver manufacture remained the limitation in sensitivity. The earlier solutions of this problem were only

¹ Hazeltine Service Corporation Laboratory, Bayside, N. Y.

palliatives, not cures; for they involved the introduction or encouragement of dielectric loss which, though it varied in the proper manner to improve stability at high frequencies and thus permit higher sensitivities at lower frequencies, caused an impairment in selectivity at high frequencies. Realizing these deficiencies, each of the authors of the paper under discussion, not knowing of Trube's work, made studies along the same lines that he had followed.

Then a casual visit from Trube and his answers to my questions concerning the details of his designs suddenly opened my eyes to the fact that his development constituted the one improvement most needed by the Neutrodyne and second in importance only to our previous work on the elimination of interstage couplings. For the problem which he had solved with special reference to an unneutralized receiver was the same problem that was then before us, though in less degree. It was logical, then, that the two developments be carried on together, one naturally supplementing the other. This has been ably done by and under the direction of the two authors of the paper.

Though Trube's work during the past three or four years was in other fields, he took a natural interest and pride in his radio receiving systems. Beside the personal loss that we all feel, who were associated with him, is the regret that his untimely death prevented his taking part in the presentation before the Institute of the development which was his in the first instance and prevented his seeing its anticipated introduction as an essential element in all tuned radio-frequency broadcast receivers.



TEST PROCEDURE FOR DETECTORS WITH
RESISTANCE COUPLED OUTPUT*

BY

G. D. ROBINSON

(U. S. Naval Academy, Annapolis, Md.)

Summary—This paper presents a simple circuit for use primarily in determining the response, to modulation, of a detector with resistance coupled output. Only d-c, 60-cycle a-c, and the corresponding meters are used. The theory of operation of the circuit is briefly explained: This theory neglects the effects of capacity reactances at modulation frequencies but not at carrier frequencies. Sample curves obtained by this method show marked differences between the positive and negative peak values of the audio output of the detector with high percentage modulation of the carrier.

THE fairly general introduction of broadcast transmitters providing modulation approaching 100 per cent has greatly increased the importance of the study of the distortion due to nonlinear response in detector tubes. Due, perhaps, to the relatively small importance of this distortion in the recent past, when modulation percentages seldom exceeded 50 per cent, little information is now available as to the distortion to be expected either in general or when using particular circuits with particular tubes.

While attempting to determine the results to be expected from a UY-224 tube used as a detector with resistance coupled output, without making wave form measurements under actual operating conditions, a simple test circuit was evolved. This test applies only to circuits with resistance coupled output and has frequency limitations in that its results can be expected to be accurate predictions only within the modulation frequency band for which both the series and shunt capacities in the circuit have negligible effects. This band, however, includes all but the edges of the band which is useful, and may include more than the band which is actually used.

To understand the operation of this circuit, consider first the elementary resistance coupled circuit shown in Fig. 1. $VT 1$ is a detector using either plate or grid detection, $VT 2$ is the first amplifier tube following the detector. Apply an unmodulated carrier voltage of the desired magnitude to the detector and consider the voltages after a steady state has been reached. There will be a definite d-c voltage across the condenser C_1 but no current through it. If now the magnitude of the

* Decimal classification: R134. Original manuscript received by the Institute, October 17, 1930. Additional material received by the Institute, January 2, 1931.

carrier is changed, to correspond to modulation, the voltage across the condenser will change more or less gradually to some new value.

In the important band of modulation frequencies within which the reactance of C_1 can be considered to be negligible or zero, only negligible a-c voltages will appear across this condenser. In other words, the voltage variation across this condenser will be negligible and, for test purposes, the condenser may be replaced by a suitable low impedance source of d-c voltage, such as a battery of relatively high voltage plus a low voltage battery and potentiometer. This substitution makes the voltage introduced in this part of the circuit independent of frequency or rate of change of carrier. So far as this element is concerned, the carrier may be changed as slowly as desired and may be left at particular values indefinitely. As a result of this, it should be evident that d-c instruments may now be used to measure either voltages or currents

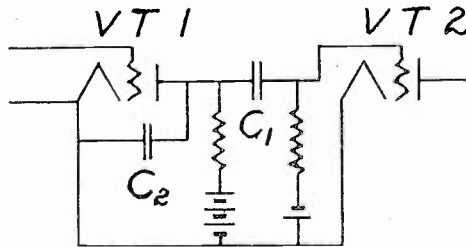

Fig. 1

which in the normal circuit could exist only as instantaneous values. Step-by-step changes may be made in the magnitude of the applied voltage, which corresponds to the carrier, to determine the performance of the normal circuit throughout a cycle of the modulation frequency.

Since the modulation frequency in the test operation is indefinitely low, the carrier may be replaced by commercial power of 60 or even 25 cycles per second.

The detector shunting capacity C_2 used in the test circuit should have the same reactance at 60 or 25 cycles as the corresponding capacity in the actual circuit has for the actual carrier frequency. Of course the stray and interelectrode capacities will be included in this if they have appreciable capacity compared to the shunting condenser to be used in the actual detector operation.

The operation of the test circuit assumes that in the actual circuit the reactance of C_2 , at *modulation* frequencies, has negligible effect or is infinite. This in combination with the assumption of negligible reactance for C_1 provides the limits to the two sides of the modulation frequency band within which the test results should be accurate.

In making an estimate of the highest frequency at which it is legitimate to consider that the effects of shunt capacity are negligible a number of factors will of course be considered. One of these, which is particularly important in the case of screen-grid tubes so designed or so operated as to have very high internal plate circuit resistance, is the influence of the plate circuit coupling resistor and grid-leak resistor.

In an amplifier circuit, in which grid-to-plate capacity currents may be neglected, it may be demonstrated mathematically that the a-c performance of the plate circuit may be determined by considering the internal plate resistance of the tube, the plate circuit coupling resistor, the coupling condenser-grid leak branch of the circuit, and the shunt capacity as all being connected in parallel with each other. The output voltage due to applying an a-c voltage E_g to the grid of the tube may then be found by passing a current $E_g g_m$ through the above parallel circuit.

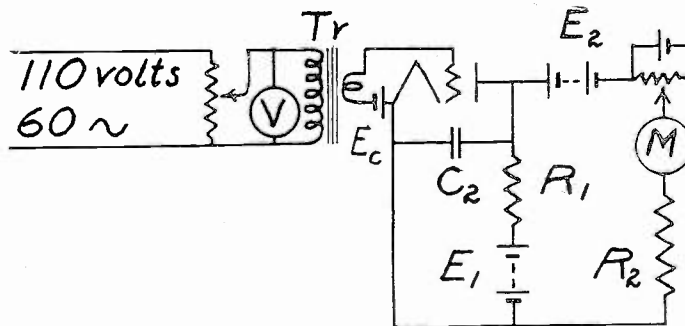

Fig. 2

While the corresponding mathematical demonstration for detector operation is not known to the author, a physical study of the situation appears to give the same result. For example: with any steady value of carrier voltage applied to the detector grid, consider an excess charge (introduced in any manner whatsoever) residing in the shunt capacity. This excess charge in the shunt capacity is able to escape through the plate coupling resistor as well as through the tube by being superimposed upon the plate current. If the internal plate circuit resistance should happen to be infinite the excess charge might still escape in a very short period of time. This is believed to demonstrate that, at least as an approximation, the above equivalent parallel circuit may be applied to the detector. The reactance of the shunt capacity then needs to be compared to the impedance of a *parallel* circuit instead of being compared to the internal plate resistance alone. The latter comparison, if made without considering the former condition, would lead to unduly pessimistic conclusions.

Fig. 2 shows one possible arrangement of the test circuit. Here a

60-cycle power supply is fed to an ordinary a-c voltmeter and the primary of a step-down transformer through a voltage divider consisting of a three terminal sliding contact resistor of perhaps 200 ohms. The step-down transformer Tr of known ratio is used to avoid the greater difficulty involved in measuring small a-c voltages. E_c is the bias voltage of normal size for the plate detection shown. C_2 is a condenser having the reactance corresponding to actual operation with desired carrier frequency as explained before. R_1 is the coupling resistor from the circuit whose action is to be predicted. Likewise, E_1 is a supply voltage equal to that applied in actual operation. R_2 is a resistor whose value in combination with that of the instrument M is equal to the value of grid-leak resistance to be used in actual circuit. E_2 is the adjustable source of voltage which replaces condenser C_1 . Meter M must give a useful reading with the current which will flow through the grid leak with only a few volts applied. For "power detection" a 200-micro-ampere instrument or "megohm voltmeter" may be used. Operation of this circuit for small signal voltages has not been tried but should be successful with a unipivot microammeter or calibrated galvanometer for M .

To test for operation of the detector with a given carrier voltage applied, apply that amount of 60-cycle a-c in grid circuit of detector tube, and then adjust E_2 until M reads zero. At this point M is acting as a galvanometer to indicate zero current flow through E_2 and the grid leak. The circuit is now ready to begin a series of observations. Take a series of observations of V and M extending from zero applied a-c up to double the value of the carrier voltage for which the test is being made. The readings of M , considered as a voltmeter with multiplier R_2 , will give the values of the instantaneous voltages available for application to the grid of the next tube.

A sample of the results obtained is shown in the curves in Fig. 3. This form of graph has been chosen as being well suited to show both the voltage output and the amount of distortion. The abscissas here are plotted as percentage departure of the applied a-c voltage from the initial value assumed for the carrier. The data obtained from one set of observations has all been plotted above the X-axis by neglecting the signs of the reading of the meter M except for marking of the curves. The ordinate of each point on the curves represents the instantaneous voltage output of the detector at the time the modulated wave differs from the carrier by the percentage shown as abscissa. The coördinates may equally well be considered to be the peak audio, or modulation frequency, voltage output of the detector when the maximum modulation is the percentage shown. Since, with plate detection, the removal of

the carrier produces the greatest positive voltage applied to the next grid, the curve marked "Positive Peaks" corresponds to small a-c grid voltages and the one marked "Negative Peaks" corresponds to applied a.c. greater than the unmodulated carrier.

It is interesting to note that the curves shown indicate that this particular set-up, if supplied with a 5-volt carrier with 100 per cent sinusoidal modulation, would put out negative peak voltages 77 per cent greater than the positive ones. This is to be compared with equal peaks for linear response and no distortion, or with a theoretical case of negative peaks three times as large as the positive peaks for an over-

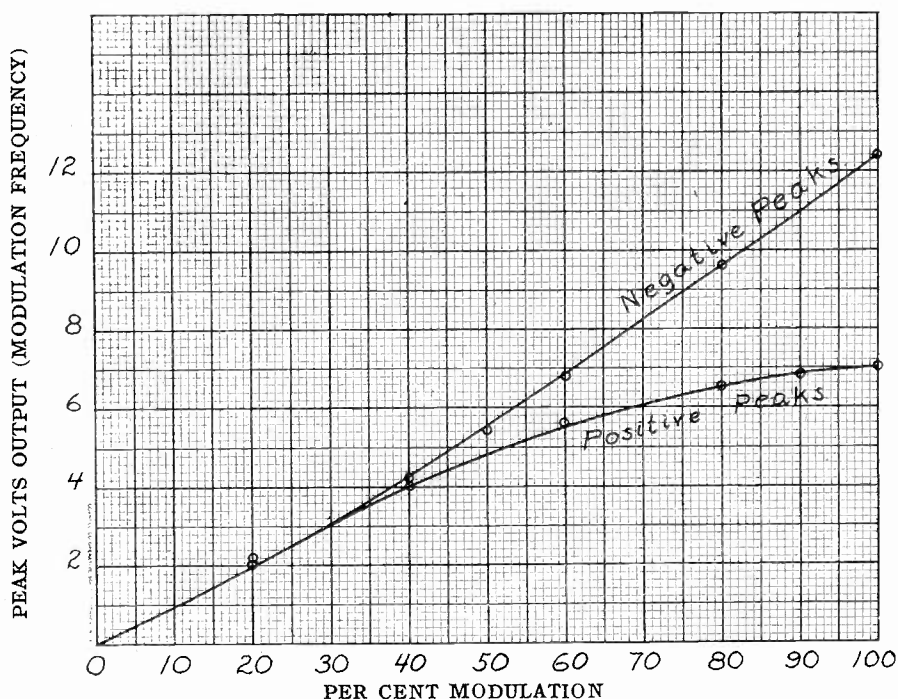

Fig. 3—Plate detection, UX-171-A, 5 volts carrier.

all response following the square law. The failure of the two curves to coincide shows the introduction of even harmonics while the failure of their average to be a straight line shows the introduction of odd harmonics. In the ideal case of linear over-all response these two curves would be straight lines through the origin and would coincide.

While it is not claimed that the values shown are typical, the author was surprised by the relatively small variation from these results shown in a considerable number of tests of plate detection.

These results do not apply directly to choke or transformer coupled circuits, however, it appears that if the impedances involved in two cases are comparable, the choke or transformer coupled circuit should

not be expected to give less distortion than that shown by the above test for nonreactive circuits.

It is suggested that tests of this nature may be used as an indication of the minimum amount of distortion to be expected from a given detector arrangement using choke or transformer coupled output.

This circuit, although designed for detector tests, should also be available for tests of distortion, due to the curvature of the plate current characteristic, in a resistance coupled amplifier. This would require substituting a d-c input for the a-c and setting meter M to zero, by means of E_2 , with no d-c signal voltage applied to the input.

The number of cells required for the operation of this test circuit may be reduced by utilizing a portion of the battery E_1 to replace a part of E_2 . This is done by returning the connection from the bottom of R_2 to a tap on E_1 instead of to the negative terminal of E_1 .



RADIATION MEASUREMENTS OF A SHORT-WAVE DIRECTIVE ANTENNA AT THE NAUEN HIGH POWER RADIO STATION*

BY

M. BÄUMLER, K. KRÜGER, H. PLENDL, AND W. PFITZER

(Published in *Jahrbuch der drahtlosen Telegraphie und Telephonie*, 36, July, 1930. Joint Communication from the Federal Central Post Office and the German Experimental Institute for Aerial Navigation, Berlin, Germany)

Summary—This paper is a report on the experimental investigation of the radiation of a short-wave directive antenna at Nauen. Measurements were made on the ground and also in the air, using an airplane. The results, plotted in the form of radiation characteristic curves, were compared with calculated radiation characteristics. In the case of the horizontal radiation characteristic the agreement between measurement and calculation is comparatively good.

For the vertical radiation characteristic curves calculations were made for the two limiting cases:

- a. Nonreflecting earth surface.
- b. Perfectly reflecting earth surface.

The measured vertical characteristic agrees rather well with case b, from which it follows that the surface of the earth, under the conditions prevailing at Nauen, shows a very high reflecting power. This is also confirmed by the fact that the field strength increases very rapidly from 0 at the surface of the earth as the height increases. It is also found that the radiated energy is highly concentrated in the desired direction in the horizontal as well as in the vertical plane.

PART I

TAKING RADIATION CHARACTERISTIC CURVES ON THE GROUND OF AN ANTENNA SYSTEM OF SIXTY-FOUR ELEMENTS¹

BY

M. BÄUMLER AND W. PFITZER

(Communication from the Federal Central Post Office)

1. The Problem

FOR transoceanic communication with short waves, antennas with highly directional radiation characteristics are used.² The radiation diagram of the directive antenna of station DGY ($\lambda = 16.92$ meters) set up in Nauen and directed toward Japan was to be deter-

* Decimal classification: R125×R270. Original manuscript received by the Institute, June 9, 1930. Translation received by the Institute, September 29, 1930.

¹ These measurements were made on an old antenna system existing in 1927 (compare "Technical Notations" of W. Moser, 1928), which should be considered only in the light of a provisional arrangement. The process of measurements with a modern antenna of 192 elements is dealt with in Part II.

² F. Kiebitz, *Ann. d. Phys.*, 22, 943, 1907; O. Böhm, *E.N.T.*, 5, 413, 1928.

mined experimentally. The directional radio system (Fig. 1) built by the Telefunken Company consists of 64 dipoles in two vertical planes, each with 32 dipoles. In each of the two planes there are 8 dipoles arranged horizontally end to end and four such rows at distances of $\lambda/2$ above each other. Of the two vertical planes, one is excited by the transmitter and the other, at a distance of $\lambda/4$, is radiation coupled and serves as a reflector. The dipoles are connected to the vertical feed lines at the potential loop, and are excited in the same phase. Fig. 1 shows the reflector dipoles which are not fed turned toward the observer.

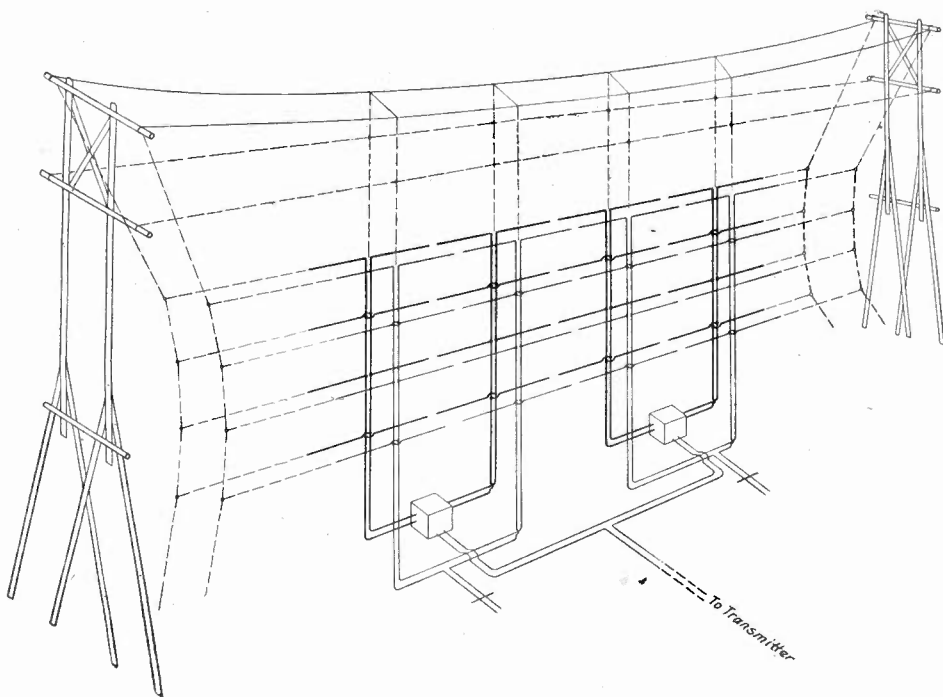

Fig. 1—Directive antenna array, station DGY (shown schematically).

Measurements on an antenna system consisting of 192 elements have not yet been completed. They serve, however, to bear out the fact that the concentration of the projected energy is much more pronounced with an antenna having a great number of elements.

The concentration of the radiated energy in the horizontal plane was first determined by field intensity measurements on the ground, made by the Federal Central Post Office (RPZ). In order to investigate the concentration in the vertical plane the German Experimental Institute for Aerial Navigation expressed its willingness to help. The measurements were aided by the Transradio and the Telefunken Companies.

2. Measuring Apparatus

For measurements on the ground there was used a tuned loop aerial, at whose tuning condenser the potential was measured by means of a vacuum tube voltmeter. The tube voltmeter worked with compensated plate-current indicator in the detector circuit (type RE 064

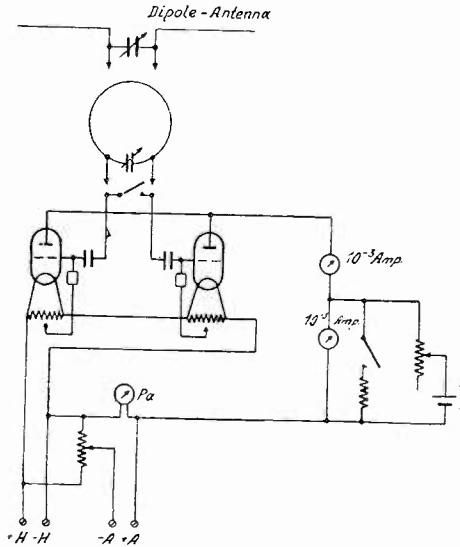

Fig. 2—Circuit diagram of the field strength measuring apparatus.

tube). In order to remove the asymmetrical influence of the antenna effect of the loop, a push-pull circuit was used (Fig. 2) and the point of symmetry of the loop was connected with the filament. Fig. 3 shows schematically the arrangement of the apparatus. C is the tuning condenser, R_g are the grid resistors, and C_e is the earth capacity of the

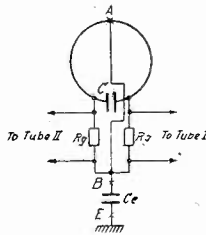

Fig. 3—Spatial arrangement of the measuring apparatus.

batteries and measuring instruments. (Since the push-pull arrangement measures the voltage across R_g as well as that across C , an e.m.f. between points A and E will produce an effect with a vertical loop if the connection between A and B is omitted.) It excites the two tubes in the same phase through the parallel grid resistors R_g . Since the rectifying effect occurs only for the positive half wave, as a result of the parallel

connection of the plates the rectifier effects of both tubes are additive for equiphase as well as counterphase excitation. The strong interference exerted by the long-wave transmitters at Nauen ($\lambda = 13,000$ and $18,130$ meters) on the measuring apparatus could be completely removed by connecting the filaments with the point of symmetry of the loop.

The calibration³ of this simple arrangement in volts per meter, which previously had been used only with longer waves (by inductive coupling with an auxiliary antenna excited by a tube transmitter), was objectionable with short waves because of the connection of a thermoelement in the loop circuit. Therefore, the calibration of the apparatus had to be done without changing the operating arrangement. For this purpose the resonance curve of the loop circuit was obtained by de-

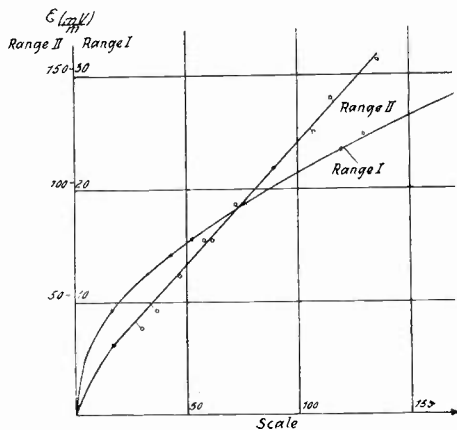

Fig. 4—Calibration curve for the measuring apparatus.

tuning, that is, by changing C , so that the tube voltmeter acted as a resonance indicator. If $h = 2\pi NF/\lambda$, the effective height of the loop and E , the e.m.f. induced in the loop circuit, the field strength $\mathcal{E} = E/h = E\lambda/2\pi NF$. If d is the decrement obtained from the resonance curve and P the voltage indicated at the condenser by the tube voltmeter, then $E = P \cdot d/\pi$. Then for the field strength we get $\mathcal{E} = P \cdot d \cdot \lambda / 2\pi^2 NF$. The potential P read at the tube voltmeter, therefore, need only be multiplied by a constant depending on the frequency. Since the tube voltmeter is independent of the frequency, its calibration curve can be determined with sinusoidal tone frequency.

The calibration curve I of Fig. 4 shows the normal quadratic rectifying effect of the detector with small alternating voltages. Curve II is for greater field strengths, using a shunt across the plate ammeter.

³ M. Bäumler, *E.N.T.*, 1, 160, 1924; *Telegr. u. Fernsprechtechnik*, 17, 193, 1928

Here the detector acts in the region in which, in addition to grid rectification there becomes noticeable plate rectification, which is opposite in its effect on the plate current. Calibration curve II, therefore, is quadratic only in its lower part and is almost linear in its upper part. Field strengths as low as 2 to 3 mv/m can be measured with this simple arrangement.

3. Taking the Horizontal Characteristic

The measurements on the ground could be made only at a distance slightly more than 1 km from the antenna even though the plate power of the last stage of the transmitter was 6.4 kw. At a distance of 2 km the field of the transmitter could no longer be detected with the apparatus. The fields at a distance of 2 km from the beam are therefore smaller than 2 to 3 mv/m. In the measurements the transmitter sent a continuous dash which was modulated with constant tone frequency so that it could be found more easily.

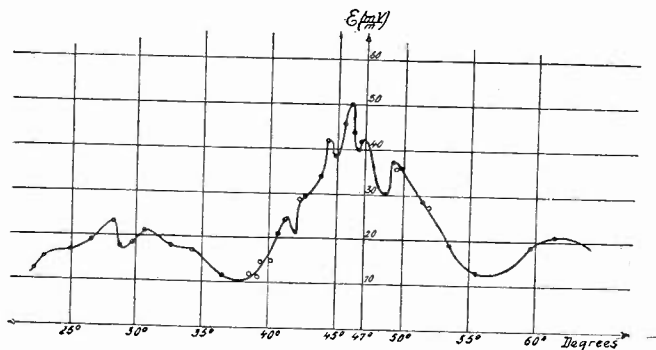

Fig. 5—Field strength radiation characteristic in rectangular coördinates.

In order to draw the horizontal diagram, measurements were made on a perpendicular to the main direction of radiation, which was laid out on the ground at a distance of 1.35 km from the antenna. Consequently, since the individual points of measurement were not the same distance from the center of the antenna, the results of the measurements had to be corrected for a constant distance. The center of the loop used in the measurements was 1.5 meters above the ground. The measurements gave the horizontal diagrams shown in Fig. 5 and 6. The irregularities in the curves can be explained by the character of the ground, some telephone lines along and across the beam direction and a small strip of woodland between the transmitter and the place of measurement. We see from Fig. 7, in which the radiated power is shown proportional to the square of the field strength, that most of the radiation is included in a sector of about 15 degrees. With antennas of this type, therefore, directive transmission can be carried on very well. This

same concentration of energy also was found in making a horizontal diagram with the airplane at greater heights (see Figs. 12 and 14). Differences between ground and air measurements pertaining to the position of maxima and minima and to the magnitude ratio between main and first submaximum may also be ascribed to the ground conditions that were mentioned above.

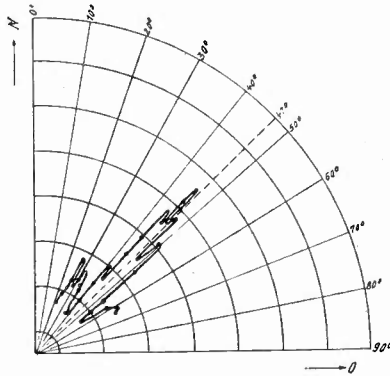

Fig. 6—Field strength radiation characteristic in polar coordinates.

We see from Fig. 5 that there was a field strength of only 50 mv/m in the direction of the main beam 1.35 km from the transmitter. At a distance of 2 km the field must have been even weaker than 2 mv/m, while at this distance fields of the order of magnitude of a few volts per

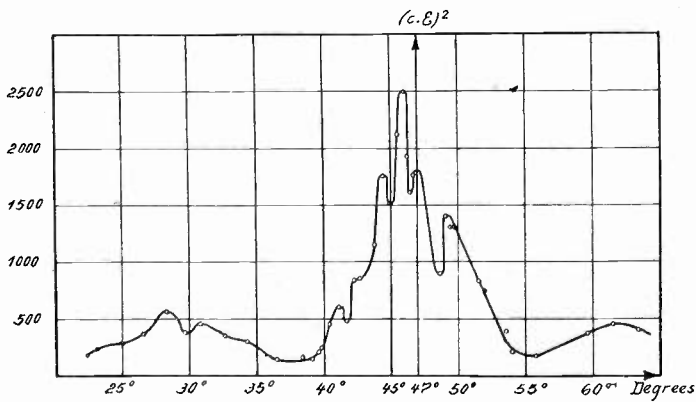

Fig. 7—Power radiation characteristic in values proportional to the square of the field strength.

meter were to be expected. From the calculated diagrams in Figs. 15 and 16 in the second part of this paper, we see that without taking into consideration the influence of the earth the radiated energy in the vertical plane also must be included for the most part within an angle of about 20 degrees. The total radiated power, therefore, is concentrated approximately in a cone with an angle of about 15 degrees and,

therefore, it is included in about 1/100 of the space irradiated by a vertical conductor with good conducting ground. If we assume that 50 per cent of the above-mentioned power of 6.4 kw which is taken by the plate of the last stage of the transmitter is converted into high-frequency energy, we may assume that about 3 kw was radiated from the directive antenna. Since the efficiency of short-wave antennas is high because of the high radiation resistance, this is also true of directive arrays which consist of many antennas coupled by the adjacent field and excited in common. For the radiation power N of a vertical conductor with a field strength ϵ in mv/m at a distance d in km, we get: $N = 0.011\epsilon^2 \cdot d^2$ (watts). With the above assumptions, we should expect to have a field strength of 4 v/m on the ground at a distance of 1.35 km from the transmitter. Since 50 mv/m was measured in the main direction of radiation, only a very small part of the radiated power, about 0.01 per cent, is present at the ground. From this we conclude that the earth must exert a very great influence on the radiation and that it probably reflects these short waves. The main radiation from the transmitter, therefore, must be sought at greater heights above the surfaces of the earth. The necessary investigations were carried out in an airplane by the DVL.

4. Investigation of the Electromagnetic Field near the Ground.

The reflecting power of the ground can be further confirmed by field strength measurements at different distances above the earth. We see from Figs. 8a and 8b that near the ground the field strength in-

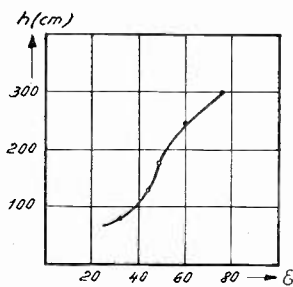

Fig. 8a—Increase in field strength near the ground with increasing height with perpendicular aerial.

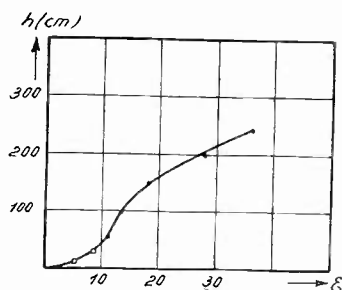

Fig. 8b—Increase in field strength near the ground with increasing height with horizontal aerial.

creases very rapidly with increasing height. The measurement results in Fig. 8a were obtained with a vertical loop, the center of which, because of its geometric dimensions, could be brought only to 80 cm above

the ground. The measurements in Fig. 8b were made with a horizontal loop.

It was found in the measurements that the receiving loop responded best when its plane was parallel to the plane of the transmitting antenna. There is a pronounced minimum corresponding to this maximum, at which the plane of the loop must be perpendicular to the earth as well as perpendicular to the plane of the antenna.

PART II

TAKING RADIATION CHARACTERISTIC CURVES WITH AN AIRPLANE.⁴

BY

K. KRÜGER AND H. PLENDL

(172nd report of the German Experimental Institute for Aerial Navigation, Radio and Electrical Engineering Division)

1. Experimental Arrangement

A FIELD strength measuring apparatus according to the principle described in the first part (Fig. 2) was installed in an all-metal cabin plane (Junkers 213). The aerial was a dipole which was mounted in the longitudinal axis of the airplane as shown in Fig. 9. Preliminary tests during flight showed that the apparatus was not sensitive to the vibrations transmitted by suspension cords and by air currents at full speed. The engine ignition had no noticeable effect on the measuring arrangement. The low selectivity—caused by the high radiation resistance of the dipole—necessitated stopping all short- and long-wave transmitters at the transmitting station with the exception of the one which was being used in the measurements at Nauen. This could be done only during the shutdown early every Monday for two separate half-hour periods. High altitudes were necessary during the measurements, so it was possible to work only on good days and with good ground visibility. During the measuring flight there could not be heavy winds, as otherwise the accuracy of the measurements would be affected unfavorably.

The apparatus was calibrated in values linearly proportional to the field strength. At the present time we shall not take up the determination of the factor which is necessary in order to indicate the field strength in absolute measure.

⁴ After completing the report the authors learned of experiments which had been made in England by the National Physical Laboratory (report for the year 1928, p. 129, published in 1929). In these tests the vertical characteristic of a simple horizontal dipole was determined with the aid of an airplane, the distance of the antenna from the surface of the earth being $2/3\lambda$, using a wavelength of 41 meters. The results obtained on three flights did not give a uniform diagram, which is probably due to lack of symmetry in the measuring set.

therefore, it is included in about 1/100 of the space irradiated by a vertical conductor with good conducting ground. If we assume that 50 per cent of the above-mentioned power of 6.4 kw which is taken by the plate of the last stage of the transmitter is converted into high-frequency energy, we may assume that about 3 kw was radiated from the directive antenna. Since the efficiency of short-wave antennas is high because of the high radiation resistance, this is also true of directive arrays which consist of many antennas coupled by the adjacent field and excited in common. For the radiation power N of a vertical conductor with a field strength ϵ in mv/m at a distance d in km, we get: $N = 0.011\epsilon^2 \cdot d^2$ (watts). With the above assumptions, we should expect to have a field strength of 4 v/m on the ground at a distance of 1.35 km from the transmitter. Since 50 mv/m was measured in the main direction of radiation, only a very small part of the radiated power, about 0.01 per cent, is present at the ground. From this we conclude that the earth must exert a very great influence on the radiation and that it probably reflects these short waves. The main radiation from the transmitter, therefore, must be sought at greater heights above the surfaces of the earth. The necessary investigations were carried out in an airplane by the DVL.

4. Investigation of the Electromagnetic Field near the Ground.

The reflecting power of the ground can be further confirmed by field strength measurements at different distances above the earth. We see from Figs. 8a and 8b that near the ground the field strength in-

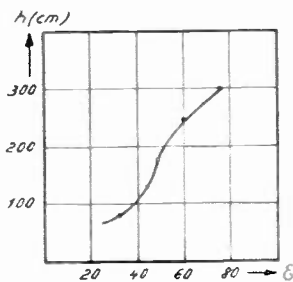

Fig. 8a—Increase in field strength near the ground with increasing height with perpendicular aerial.

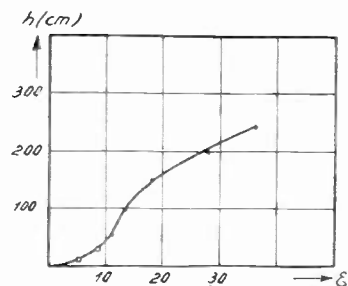

Fig. 8b—Increase in field strength near the ground with increasing height with horizontal aerial.

creases very rapidly with increasing height. The measurement results in Fig. 8a were obtained with a vertical loop, the center of which, because of its geometric dimensions, could be brought only to 80 cm above

the ground. The measurements in Fig. 8b were made with a horizontal loop.

It was found in the measurements that the receiving loop responded best when its plane was parallel to the plane of the transmitting antenna. There is a pronounced minimum corresponding to this maximum, at which the plane of the loop must be perpendicular to the earth as well as perpendicular to the plane of the antenna.

PART II

TAKING RADIATION CHARACTERISTIC CURVES WITH AN AIRPLANE.⁴

By

K. KRÜGER AND H. PLENDL

(172nd report of the German Experimental Institute for Aerial Navigation, Radio and Electrical Engineering Division)

1. Experimental Arrangement

A FIELD strength measuring apparatus according to the principle described in the first part (Fig. 2) was installed in an all-metal cabin plane (Junkers 213). The aerial was a dipole which was mounted in the longitudinal axis of the airplane as shown in Fig. 9. Preliminary tests during flight showed that the apparatus was not sensitive to the vibrations transmitted by suspension cords and by air currents at full speed. The engine ignition had no noticeable effect on the measuring arrangement. The low selectivity—caused by the high radiation resistance of the dipole—necessitated stopping all short- and long-wave transmitters at the transmitting station with the exception of the one which was being used in the measurements at Nauen. This could be done only during the shutdown early every Monday for two separate half-hour periods. High altitudes were necessary during the measurements, so it was possible to work only on good days and with good ground visibility. During the measuring flight there could not be heavy winds, as otherwise the accuracy of the measurements would be affected unfavorably.

The apparatus was calibrated in values linearly proportional to the field strength. At the present time we shall not take up the determination of the factor which is necessary in order to indicate the field strength in absolute measure.

⁴ After completing the report the authors learned of experiments which had been made in England by the National Physical Laboratory (report for the year 1928, p. 129, published in 1929). In these tests the vertical characteristic of a simple horizontal dipole was determined with the aid of an airplane, the distance of the antenna from the surface of the earth being $2/3\lambda$, using a wavelength of 41 meters. The results obtained on three flights did not give a uniform diagram, which is probably due to lack of symmetry in the measuring set.

Fig. 10 shows the calibration curve for the apparatus, which was obtained with a shunt around the plate ammeter. This curve was plotted from measurements made on the ground in Adlershof. At that location a transmitter was set up and the receiving apparatus placed



Fig. 9—Airplane for measurements (longitudinal dipole shown by heavy lines).

at a distance of 10 wavelengths from it. The receiving loop aerial was tuned and adjusted in a manner to obtain optimum results. The current (which is linearly proportional to the received field intensity and is

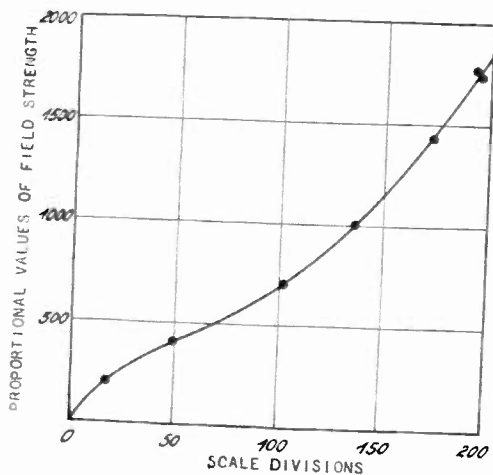

Fig. 10—Calibration curve for the field strength measuring set.

here plotted as ordinate) was varied in the vertical transmitting antenna. The deflection of the pointer on the plate ammeter was read in scale divisions and plotted as abscissa. The pointer was set at zero for zero field strength. A calibration with horizontal aerials at the transmitter and measuring apparatus, corresponding to the actual measure-

ments, could not be carried out on the ground since the field intensities obtainable were much too low owing to the strong reflective power of the surface of the ground. This sort of calibration, therefore, could be carried out only with the airplane, employing a tuned dipole aerial, and gave a curve which was in accord with the values measured on the ground. The distance from the transmitting antenna was more than 16 wavelengths.

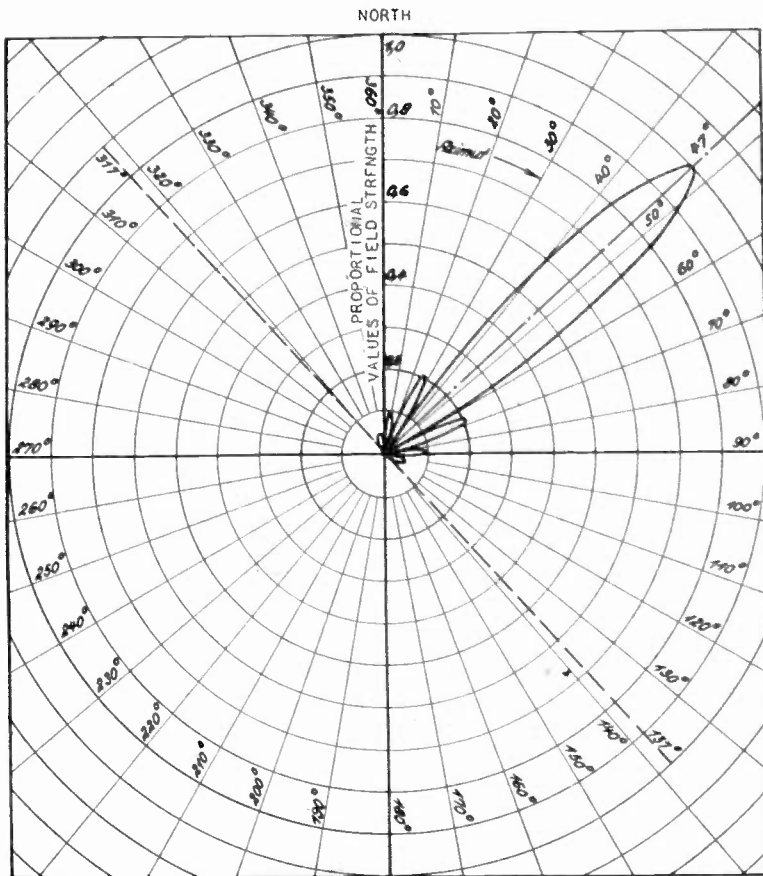

Fig. 11—Calculated horizontal characteristic in polar coördinates.

2. Calculation of the Radiation Characteristics

(a) Horizontal Characteristic

In order to calculate the horizontal characteristic, the horizontal group of 8 horizontal dipoles radiating in phase is alone determinative. From simple considerations given in the supplement the equation follows:

$$K_{sh} = \frac{1}{\cos \theta} \cos^2 \left(\frac{\pi}{2} \sin \theta \right) \cos (\pi \sin \theta) \cos (2\pi \sin \theta).$$

Here θ is the angle between an arbitrary direction of radiation and the

normal to the plane of the antenna. Since θ may pass through a series of values from 0 to 360 degrees the radiation characteristic is obtained as shown in polar coördinates in Fig. 11, and in rectangular coördinates⁵ in Fig. 13. These two horizontal characteristic curves are placed so that the main maximum coincides with the desired direction of 47 degrees. Assuming perfect reflection of the reflector system, there is no radiation in the region from 137 degrees to 317 degrees.

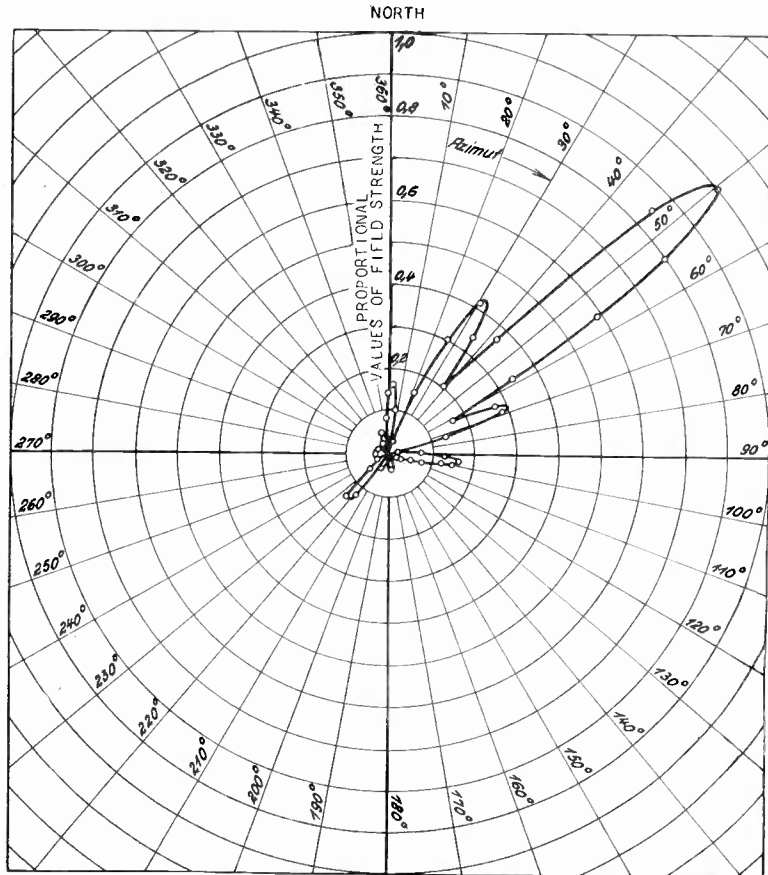

Fig. 12—Horizontal characteristic in polar coördinates of field strength values, determined experimentally.

(b) *Vertical Characteristic*

For the calculation of the vertical characteristic, the vertical group of four horizontal dipoles spaced $\lambda/2$ over each other is the sole determining factor. Two limiting cases are to be distinguished:

(1) The earth does not reflect, and therefore acts like the medium in which the antenna is placed, that is, like air. In this case the equation for the radiation characteristic (see appendix) is as follows:

⁵ In order to get a good comparison, the illustrations must be used as numbered, which differs from their sequence in the text.

$$(K_{4v})_{\text{without earth}} = \cos\left(\frac{\pi}{2} \sin \phi\right) \cos(\pi \sin \phi).$$

Here ϕ is the angle of elevation of the ray in relation to the earth. Figs. 15 and 16 show the corresponding radiation characteristic in rectangular and polar coordinates respectively.

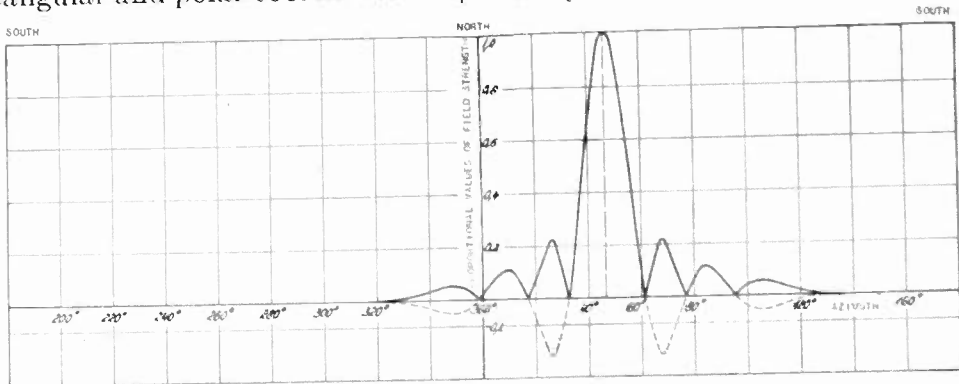

Fig. 13—Calculated horizontal characteristic in rectangular coordinates.

(2) The earth reflects perfectly, and therefore acts like a perfect conductor (infinite conductivity), or like a perfect insulator with an infinitely high dielectric constant. In this case the distance of the dipole from the ground is very important. The perfectly reflecting earth surface can be replaced, from the viewpoint of radiation, by the mirror

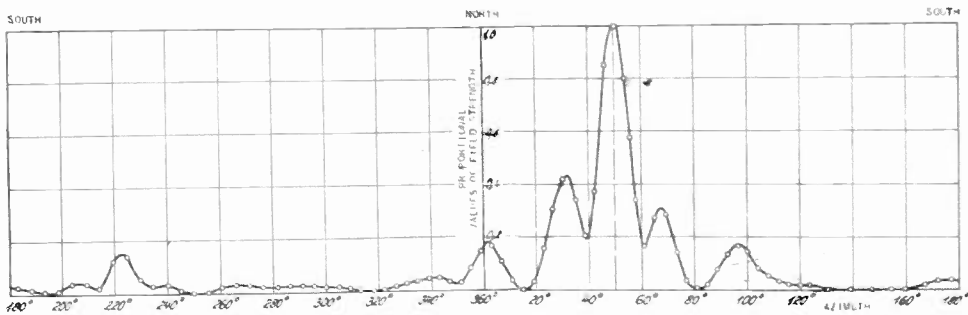

Fig. 14—Horizontal characteristic in rectangular coordinates of field strength values determined experimentally.

image of the overhead antenna arrangement, reflected at the surface. The oscillation in the mirror image is in the opposite phase to that in the antenna (180-degree phase displacement with reflection at the surface). The radiation characteristic equation (see appendix) is then:

$$(K_{4v})_{\text{reflecting earth}} = \cos\left(\frac{\pi}{2} \sin \phi\right) \cos(\pi \sin \phi) \cdot \sin\left(\frac{5\pi}{2} \sin \phi\right).$$

Figs. 17 and 19 show the radiation diagram in polar coordinates and in rectangular coordinates.

3. Taking the Horizontal Characteristic

In order to obtain the horizontal characteristic a circle with a radius of 5 km was flown around the antenna system at constant height.⁶ The readings of the measuring apparatus were taken normally

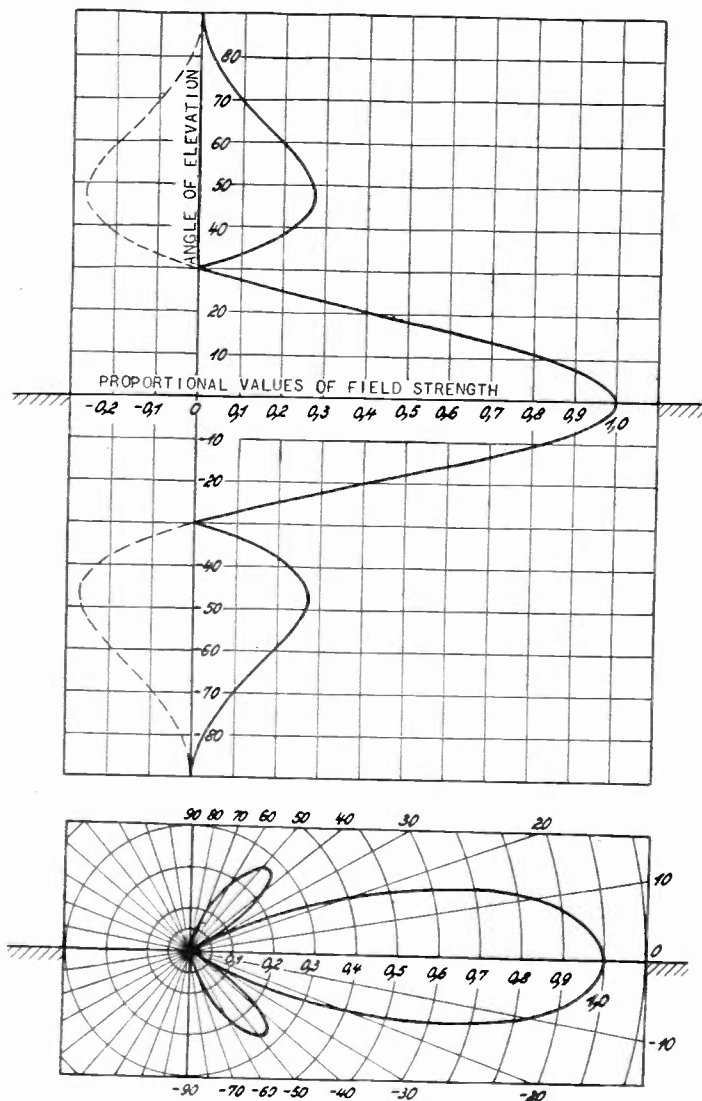

Figs. 15 and 16—Vertical characteristic calculated without the presence of the earth.

every 10 seconds according to the second hand of a stop watch and every 5 seconds if there were great changes in the field strengths. Also at landmarks that were on the chart the time of passing was noted from the same stop watch. These latter values gave the course-time

⁶ Here, in addition to the standard altimeter, a statoscope (differential measuring instrument) was used, which was placed in front of the pilot.

diagram or the angle-time diagram, as shown in Fig. 21. From this the proper angle could be recorded for each time reading and, with the values read, the horizontal characteristic could be plotted. In these measurements the normal of the receiving dipole on the airplane always pointed toward the transmitting antenna (see Fig. 9). The angular velocity with moderate wind average 0.45 degree per second.

Fig. 14 represents the horizontal characteristic in values which are linearly proportional to the field strengths, determined by the calibration curve (Fig. 10) from the curve in Fig. 21. The characteristic curve Fig. 14 can be compared to the calculated diagram in Fig. 13. The shape is similar in the two figures. The agreement in the ratios of the various maxima is good in places and in other places there are rather great differences. The same is true of the angles for the individual maxima

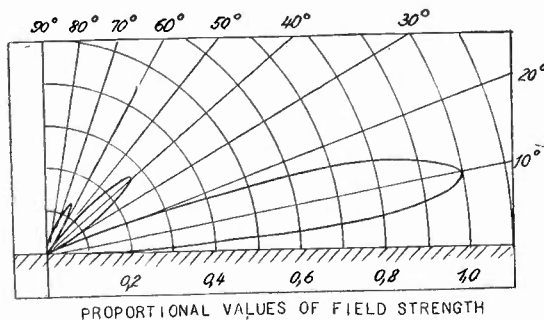

Fig. 17—Vertical characteristic in polar coordinates calculated for a perfectly reflecting earth surface.

and minima. The first secondary maximum is different on the two sides, which might be due to a 30-meter directive system which was installed directly at the right-hand side of the 17-meter system which was being investigated. The maximum at 223 degrees is behind the reflector. Therefore the reflector action is not perfect, but the field strength here is only about 1/7 of the main beam and, therefore, is of the same order of magnitude as the second submaximum of the main beam. The maximum to the rear is not exactly in the elongation of the main maximum, but is displaced about 8 degrees. Fig. 12, which represents the characteristic in Fig. 14 by means of polar coordinates, shows this displacement very plainly. This illustration is comparable to the calculated characteristic (as above) in Fig. 11.

The horizontal characteristic in Figs. 12 and 14 pertained to an altitude of 250 meters above the surface of the earth, corresponding to an angular elevation of 2.9 degrees. The horizontal characteristics which were taken at two other altitudes show an entirely similar shape, one at 125 meters corresponding to 1.4 degrees (curve *a*) and the other at 410 meters corresponding to an angle of elevation of 4.5 degrees

(curve c). All three characteristic curves are drawn in Fig. 22, in scale divisions against degrees of the base circle. Curve b is identical with that in Fig. 21.

In the above radiation characteristic curves the direction of the main beam maximum differs somewhat from the intended direction,

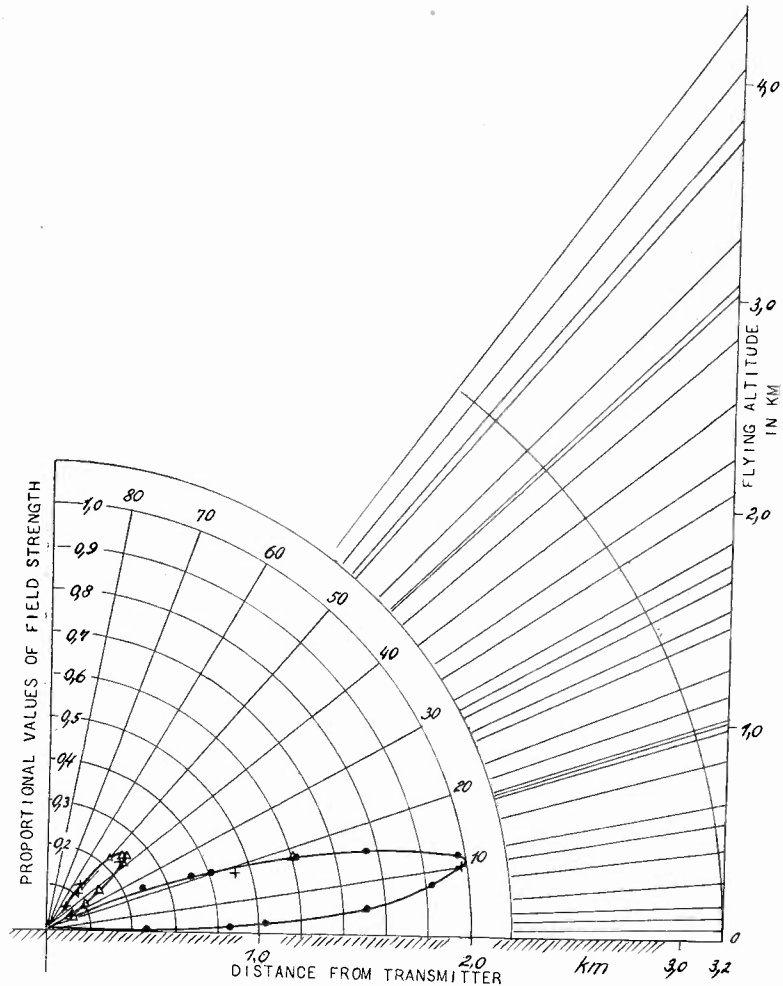

Fig. 18—Vertical characteristic in field strength values, determined experimentally (in polar coordinates).

and it seems that this deviation is smaller with increasing angle of elevation. However, the number of characteristic curves is too small and their angles of elevation differ too little to explain completely this question. In addition, the accuracy obtained in these measurements was not sufficient for this.

In order to give an idea of the speed with which such a horizontal characteristic was obtained, it should be mentioned that the three char-

acteristic curves *a*, *b*, and *c* in Fig. 22, with a repetition of curve *c* as a check, were taken in two half-hour periods, one after the other. This rapid rate of measurement obtained with the airplane, in combination with the comparatively high accuracy, could not even be approximated

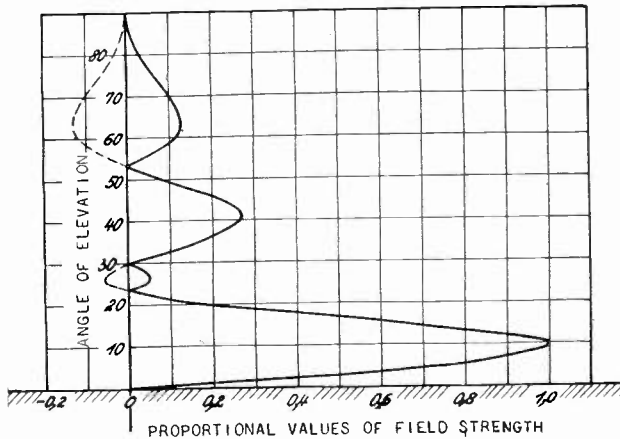

Fig. 19—Vertical characteristic in rectangular coordinates (calculated for a perfectly reflecting earth surface).

on the ground. In addition, there is the fact that with horizontally polarized transmission the field strength values on the ground are very low, as was found by simultaneous ground measurements made by the RPZ (see Part 1). The advantage of making measurements by air-

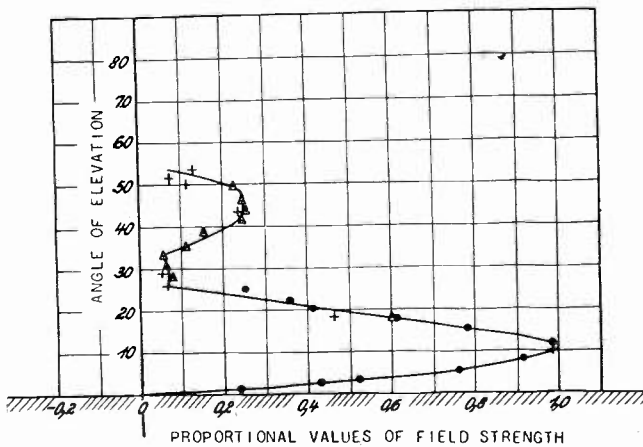

Fig. 20—Vertical characteristic in rectangular coordinates of field strength values, determined experimentally.

plane is shown plainly in determining the horizontal characteristic. In the case of the vertical characteristic, which will be taken up in the following, the airplane was the only way in which it was possible to measure these characteristics with wavelengths of 17 meters and more.

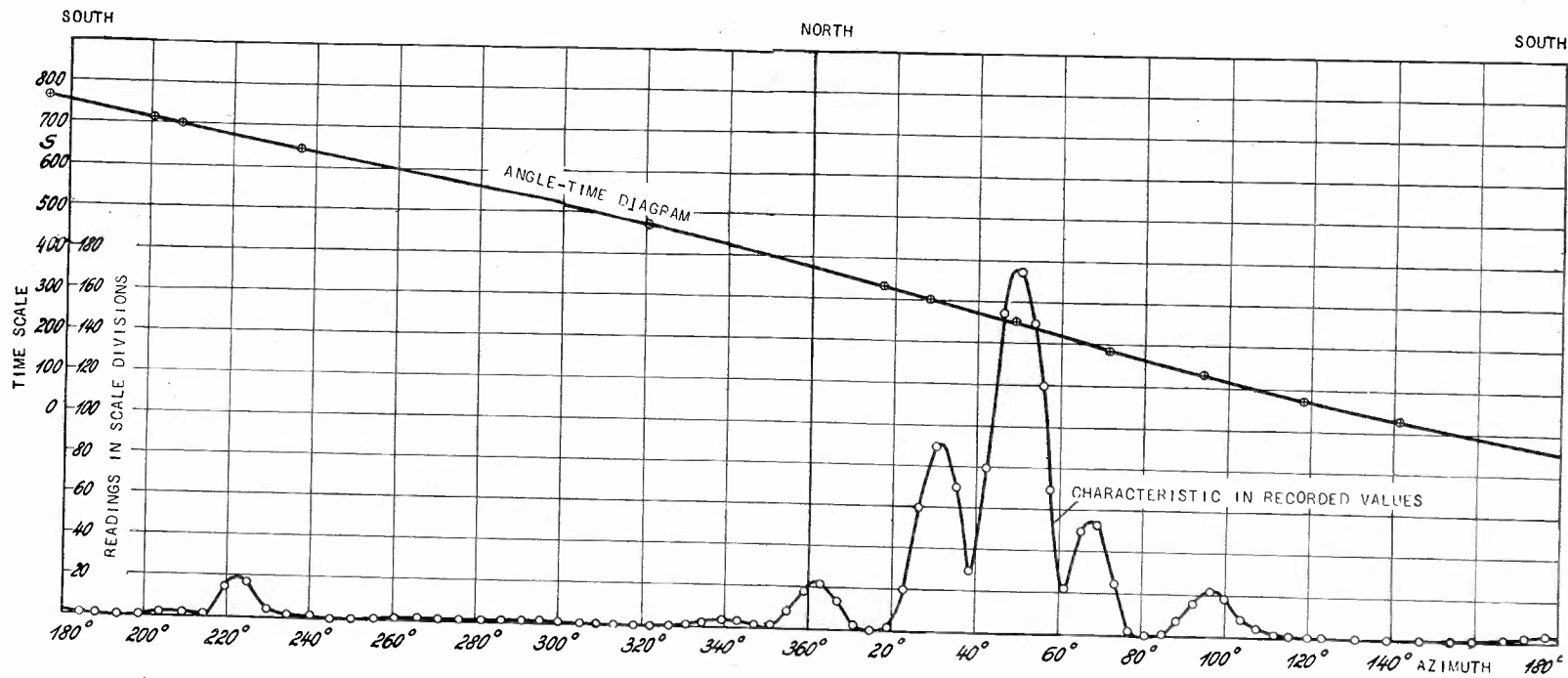

Fig. 21—Horizontal characteristic in recorded values, determined experimentally.

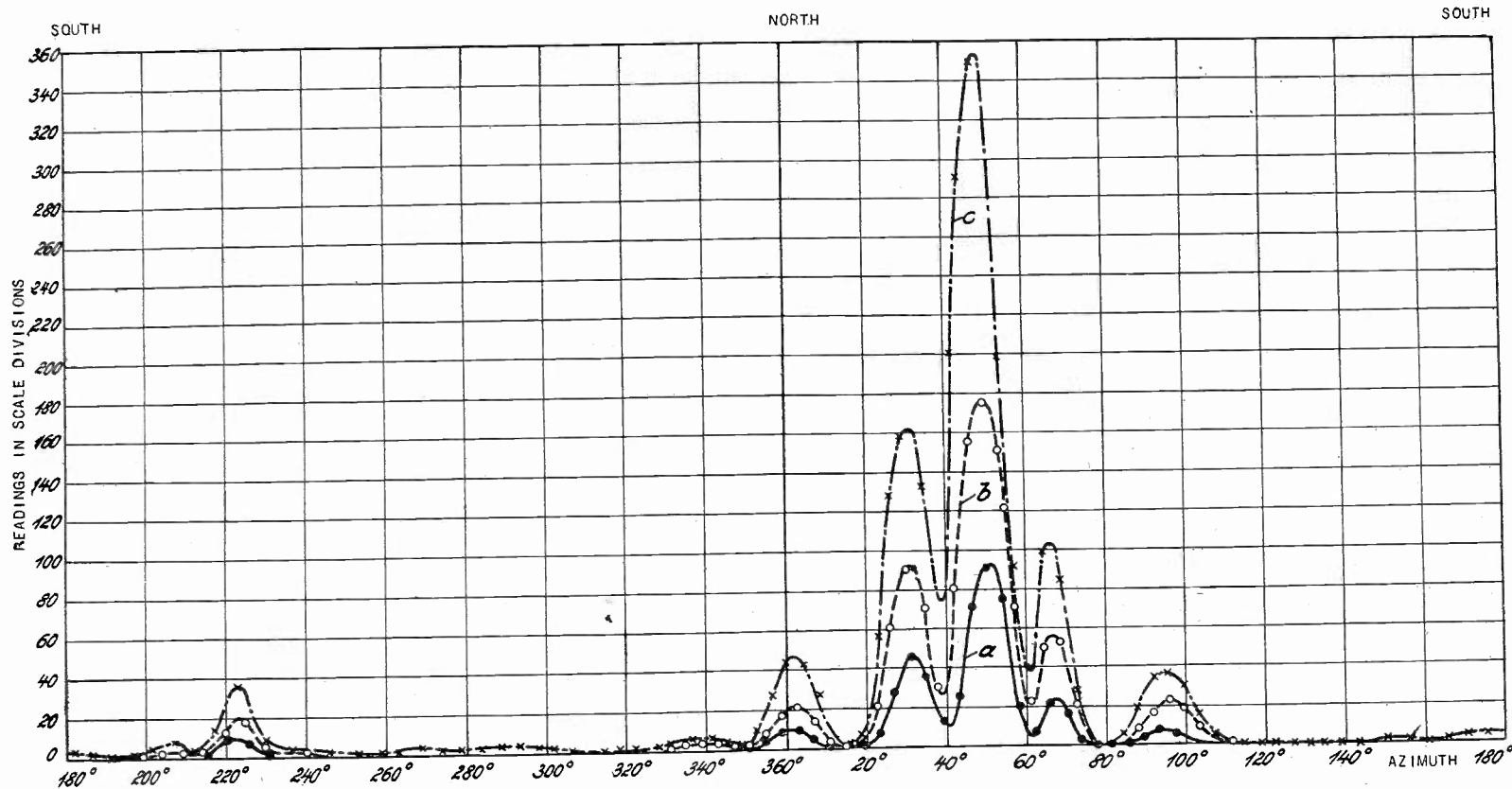

Fig. 22—Horizontal characteristic in recorded values, determined experimentally.

Curve *a*, taken at 125 meters corresponding to 1.4-degree angle of elevation.

Curve *b*, taken at 250 meters corresponding to 2.9-degree angle of elevation.

Curve *c*, taken at 410 meters corresponding to 4.5-degree angle of elevation.

4. Taking the Vertical Characteristic

In order to determine the vertical characteristic, the part of the horizontal characteristic curve which includes the main maximum and the first two submaxima were taken at different altitudes⁷ corresponding to different angles of elevation. These measurements were somewhat simplified, since only the highest values of the three maxima were recorded, and instead of flying on an arc the plane flew along a straight line approximately perpendicular to the horizontal main beam. The distance of the projection of this line of flight from the sending antenna was kept constant at 3.2 km. This base was noted as the line connecting two church towers in Bornicke and Paaren. As the flying base was the same for all altitudes the distance of the horizontal line of flight from the transmitter increased with higher altitude to a maximum of almost twice the base value. In plotting the measurements in the diagram, this change in distance was taken into consideration as the field strengths measured at the different altitudes were reduced to proportional values on the base distance of 3.2 km. Here there is used as a basis the relation $\epsilon = \text{approximately } 1/r$, which holds for spherical propagation without taking damping into consideration, ($\epsilon = \text{field strength and } r = \text{distance}$).

Fig. 18 shows the vertical characteristic in polar coördinates as determined experimentally in the manner described above, and in values which are linearly proportional to the field strength. In this diagram also the flying altitudes are plotted on the base of 3.2 km, as well as the measured radiation and the reduction arc.⁸ There are three different kinds of points (circles, triangles, and crosses) corresponding to three different days. The measurements on the later days were reduced to the first measurement by repeating one or two points of the first measurement, a main maximum if possible. This eliminated slight changes in the sensitivity of the measuring arrangement or in the transmitting current strength, and also checked the measuring arrangement and antenna system for large variations, since an observation was made to see whether the maximum deflection in the main beam was

⁷ The exact determination of altitude was accomplished by working out an air pressure-time diagram taken with the altitude recorder, according to the barometric formula, taking the air temperature into consideration.

⁸ In the case of steep rays it is to be noted that a deviation in the vertical characteristic of the airplane receiving dipole from the circular form can give rise to inaccuracies in the measurements. Experiments made for the purpose showed that these deviations, at the angles coming into consideration, were about of the order of magnitude of the accuracy of the measurements. In regard to the horizontal receiving characteristic of the airplane dipole, it should be stated that in all tests in which the maximum was measured it was so wide that small deviations from the maximum position made practically no difference.

always approximately of the same magnitude. The greatest altitude obtained in the measurements was 4400 meters.

A comparison of the experimentally determined characteristic in Fig. 18 with those calculated in Figs. 16 and 17 shows that the assumption of perfect reflecting power for the surface of the earth (mirror image in opposite phase) is approximated very closely, for the shapes of the curves in Figs. 18 and 17 are very similar. The characteristic curves plotted in rectangular coördinates are more suited for this comparison, as with polar coördinates the smaller amplitudes are suppressed. Therefore, the vertical characteristic is also shown in Fig. 20 in rectangular coördinates. This can be compared with Fig. 19, and the close agreement in the shapes of the curves is apparent. Even the small intermediate maximum at about 28 degrees, which is not shown in the polar diagram in Fig. 17, is indicated in the measured values. The field strength in the first large submaximum in the measured curve is 25 per cent of the field strength in the main maximum, while the calculated value is 27 per cent, showing very good agreement. The angle of elevation for the main maximum was 10.5 degrees when measured and 9.5 degrees when calculated, and for the large submaximum it was 41 degrees and about 45 degrees, respectively. The angles for the minima in the measurements seem to be shifted toward somewhat higher values, and in all cases the shift is more than that which corresponds to the accuracy of measurement. The angles of elevation measured for the maxima and minima are all about the same per cent (10 per cent) higher than calculated for perfect reflection.

Therefore, the results show that under the ground conditions at the Nauen radio station there is almost perfect reflection. Strutt (Philips-Eindhoven) has recently made very exhaustive theoretical and experimental investigations on "the radiation from antennas under the influence of the properties of the ground,"⁹ which agree with our results. Papers by Eckersley and Yagi¹⁰ also take up the problem of reflection from the surface of the earth in the case of short waves. Eckersley shows calculated vertical characteristics for simple antennas with vertical and horizontal polarization. Yagi gives corresponding vertical characteristic curves obtained experimentally with waves from 1 to 2 meters in length. In so far as a comparison of these papers is possible, there is good agreement between calculation and experiment.

⁹ M. J. O. Strutt, *Ann. d. Phys.*, (5) 1, 721, 1929; *Naturwissenschaften*, 17, 727, 1929.

¹⁰ T. L. Eckersley, *Jour. I.E.E.*, 65, 600, 1927; H. Yagi, *Proc. I.R.E.*, 16, 715, 1928.

8. Appendix (Calculations)

The well-known equations¹¹ for radiation characteristics were derived and tabulated in the following for the sake of clarity.

a. Horizontal Characteristic

As already mentioned, for the calculation of the horizontal characteristic the horizontal group of 8 horizontal dipoles radiating in phase, as shown in Fig. 23a, is alone determinative. The equation for the characteristic is obtained in a simple manner by multiplying the equation for the radiation characteristic of one dipole by the equation of the

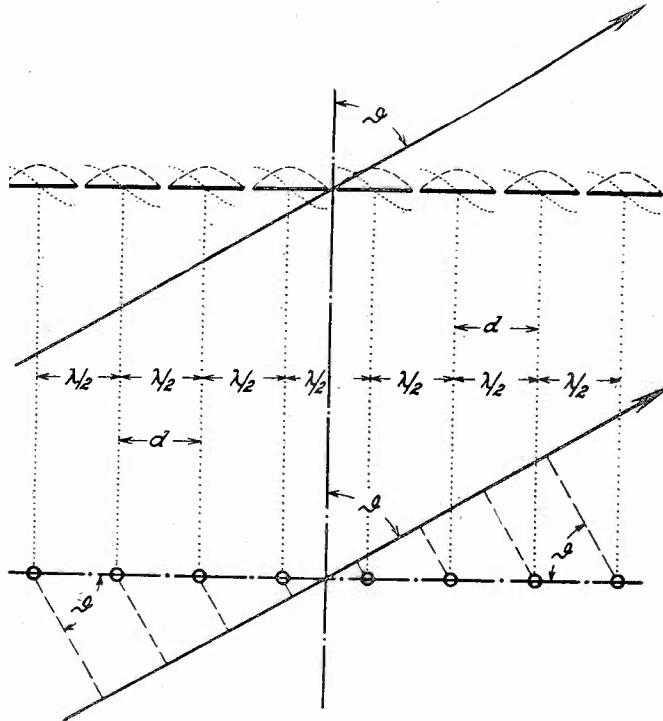

Fig. 23—Schematic diagram of the horizontal dipole group.

group characteristic of 8 equiphase point antennas as shown in Fig. 23b. This figure can be assumed to be derived from Fig. 23a, each dipole being replaced by its center point. The rule for the calculation of the radiation characteristic of a dipole¹² is evident from Fig. 24. The dipole is bisected by the line of symmetry and θ represents the angle between this normal and the beam direction.

¹¹ F. Kiebitz, *Ann. d. Phys.*, 22, 943; R. M. Foster, *Bell Sys. Tech. Jour.*, 5, 292, 1926; L. Bergman, *Ann. d. Phys.*, 82, 504, 1927; H. Plendl, *Jahrb. d. drahtl., Tel.*, 30, 80, 1927; O. Böhm, *E.N.T.*, 5, 413, 1928; and *Telefunken-Zeitung*, No. 52, p. 26, 1929; H. Stenzel, *E.N.T.*, 6, 165, 1929; R. Bechmann, *Telefunken-Zeitung*, No. 53, p. 54, 1930.

¹² M. Abraham, *Ann. d. Phys.*, 66, 435, 1898.

According to Hertz we have the following for the intensity of the electric field at a point P at a great distance r :

$$d\mathcal{E} = \frac{\overbrace{2\pi c}^{\text{constant}}}{\lambda r} \overbrace{i_x dx}^{\text{current element}} \overbrace{\cos \theta}^{\text{direction}} \overbrace{\sin\left(\omega t - \frac{2\pi r}{\lambda}\right)}^{\text{time}} \overbrace{\cos\left(\frac{2\pi x}{\lambda} \sin \theta\right)}^{\text{place}} \overbrace{\phantom{\cos\left(\frac{2\pi x}{\lambda} \sin \theta\right)}}^{\text{phase difference}} \quad (1)$$

The total electric field at P is obtained by integrating over the half antenna length and multiplying by 2:

$$\mathcal{E} = \frac{4\pi c}{\lambda r} \cos \theta \sin\left(\omega t - \frac{2\pi r}{\lambda}\right) \int_{x=0}^{x=l} i_x \cos\left(\frac{2\pi x \sin \theta}{\lambda}\right) dx. \quad (2)$$

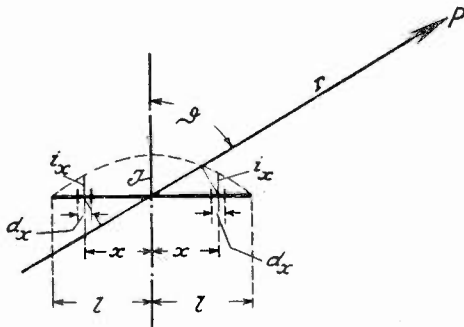

Fig. 24—Single horizontal dipole.

For sinusoidal current distribution we have:

$$i_x = J \cos\left(\frac{2\pi x}{\lambda}\right) \quad (3)$$

where J is the antenna current at the current loop. Substituted in the above equation we get:

$$\mathcal{E} = \frac{4\pi c}{\lambda r} \cos \theta \sin\left(\omega t - \frac{2\pi r}{\lambda}\right) J \int_{x=0}^{x=l} \cos\left(\frac{2\pi x}{\lambda}\right) \cos\left(\frac{2\pi x}{\lambda} \sin \theta\right) dx. \quad (4)$$

After integration (partial method) and simplifying:

$$\mathcal{E} = \frac{2cJ}{r} \frac{\cos\left(\frac{\pi}{2} \sin \theta\right)}{\cos \theta} \sin\left(\omega t - \frac{2\pi r}{\lambda}\right). \quad (5)$$

In the same way we get for the magnetic intensity H at the point P :

$$H = \frac{2J}{r} \frac{\cos\left(\frac{\pi}{2} \sin \theta\right)}{\cos \theta} \sin\left(\omega t - \frac{2\pi r}{\lambda}\right). \quad (6)$$

For the radiation through the unit of surface perpendicular to the radius vector in time dt , we have

$$d\mathcal{S} = \frac{1}{4\pi} \mathcal{E}Hdt, \quad (7)$$

whence, upon substituting,

$$d\mathcal{S} = \frac{J^2 c}{\pi r^2} \frac{\cos^2\left(\frac{\pi}{2} \sin \theta\right)}{\cos^2 \theta} \sin^2\left(\omega t - \frac{2\pi r}{\lambda}\right) dt. \quad (8)$$

For the horizontal characteristic in field strength values we can restrict ourselves to (5), and here it is sufficient to consider only the term that contains the angle θ :

$$K_1 = \frac{\cos\left(\frac{\pi}{2} \sin \theta\right)}{\cos \theta}. \quad (9)$$

This expression gives the well-known dipole characteristic.

There is still lacking the characteristic for the substitute antenna group in Fig. 23b. The distance between the antenna elements is first designated by d . A line of symmetry bisecting the group is drawn for the calculation. The direction of the beam passes through the center of symmetry and θ indicates the angle between the beam and the axis of symmetry (normal) of the plane of the system. The rule for the group characteristic reads:

From the center to the right

From the center to the left

$$\begin{aligned} K_2 = & \cos\left(\omega t + \frac{2\pi \frac{d}{2}}{\lambda} \sin \theta\right) + \cos\left(\omega t - \frac{2\pi \frac{d}{2}}{\lambda} \sin \theta\right) \text{ First point} \\ & + \cos\left(\omega t + \frac{2\pi \frac{3d}{2}}{\lambda} \sin \theta\right) + \cos\left(\omega t - \frac{2\pi \frac{3d}{2}}{\lambda} \sin \theta\right) \text{ Second point} \\ & + \cos\left(\omega t + \frac{2\pi \frac{5d}{2}}{\lambda} \sin \theta\right) + \cos\left(\omega t - \frac{2\pi \frac{5d}{2}}{\lambda} \sin \theta\right) \text{ Third point} \\ & + \cos\left(\omega t + \frac{2\pi \frac{7d}{2}}{\lambda} \sin \theta\right) + \cos\left(\omega t - \frac{2\pi \frac{7d}{2}}{\lambda} \sin \theta\right) \text{ Fourth point} \end{aligned} \quad (10)$$

For $d=\lambda/2$ we get:

$$\begin{aligned}
 K_2 = & \cos\left(\omega t + \frac{\pi}{2}\sin\theta\right) + \cos\left(\omega t - \frac{\pi}{2}\sin\theta\right) \\
 & + \cos\left(\omega t + \frac{3\pi}{2}\sin\theta\right) + \cos\left(\omega t - \frac{3\pi}{2}\sin\theta\right) \\
 & + \cos\left(\omega t + \frac{5\pi}{2}\sin\theta\right) + \cos\left(\omega t - \frac{5\pi}{2}\sin\theta\right) \\
 & + \cos\left(\omega t + \frac{7\pi}{2}\sin\theta\right) + \cos\left(\omega t - \frac{7\pi}{2}\sin\theta\right). \quad (11)
 \end{aligned}$$

If we simplify each of the four lines by means of the trigonometric formula,

$$\cos(\alpha + \beta) + \cos(\alpha - \beta) = 2 \cos \alpha \cos \beta, \quad (12)$$

we get:

$$\begin{aligned}
 K_2 = 2 \cos \omega t \left[\cos\left(\frac{\pi}{2}\sin\theta\right) + \cos\left(\frac{3\pi}{2}\sin\theta\right) \right. \\
 \left. + \cos\left(\frac{5\pi}{2}\sin\theta\right) + \cos\left(\frac{7\pi}{2}\sin\theta\right) \right]. \quad (13)
 \end{aligned}$$

The first member in brackets can be combined with the second, and the third with the fourth, according to the following formula:

$$\cos \gamma + \cos \delta = 2 \cos\left(\frac{\gamma + \delta}{2}\right) \cdot \cos\left(\frac{\gamma - \delta}{2}\right), \quad (14)$$

from which we get

$$K_2 = 4 \cos \omega t \cos\left(\frac{\pi}{2}\sin\theta\right) [\cos(\pi \sin\theta) + \cos(3\pi \sin\theta)]. \quad (15)$$

Simplifying the expressions in brackets again according to (14) we finally obtain

$$K_2 = 8 \cos \omega t \cos\left(\frac{\pi}{2}\sin\theta\right) \cos(\pi \sin\theta) \cos(2\pi \sin\theta). \quad (16)$$

For the relative group characteristic it is sufficient to consider only the terms that contain θ :

$$K_2' = \cos\left(\frac{\pi}{2}\sin\theta\right) \cos(\pi \sin\theta) \cos(2\pi \sin\theta). \quad (17)$$

The relative total characteristic of the horizontal group of 8 dipoles radiating in phase is then obtained by multiplying the expressions in (9) and (17), getting:

$$K_{sh} = \frac{1}{\cos \theta} \cos^2 \left(\frac{\pi}{2} \sin \theta \right) \cos (\pi \sin \theta) \cos (2\pi \sin \theta). \quad (18)$$

b. Vertical Characteristic

(1) Nonreflecting Earth Surface

As already mentioned, in the calculation of the vertical characteristic only the vertical group of four horizontal dipoles spaced $\lambda/2$ above each other is determinative. The separate characteristic of a dipole element perpendicular to its axis is a circle and therefore is a constant

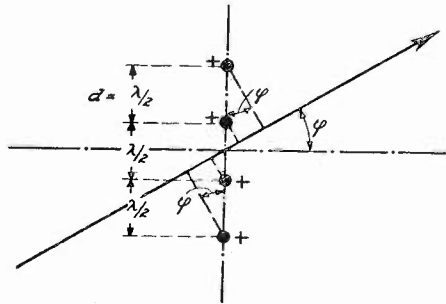

Fig. 25—Schematic diagram of the vertical dipole group without the presence of earth.

in the total characteristic. Consequently, for the determination of the relative total characteristic it is only necessary to determine the relative group characteristic. The dipole arrangement can be seen in Fig. 25. For the calculation a line of symmetry is again drawn bisecting the group. The surface of the earth is parallel to this and, since it does not reflect, it need not be considered. The beam passes through the point of symmetry, ϕ designates the angle (angle of elevation) between the beam and the axis of symmetry (normal) of the plane of the system. The rule for the group characteristic is similar to (10) and is written:

From the center upward	From the center downward
$K = \cos \left(\omega t + \frac{2\pi \frac{d}{2}}{\lambda} \sin \phi \right)$	$+ \cos \left(\omega t - \frac{2\pi \frac{d}{2}}{\lambda} \sin \phi \right)$
First point	
$+ \cos \left(\omega t + \frac{2\pi \frac{3d}{2}}{\lambda} \sin \phi \right)$	$+ \cos \left(\omega t - \frac{2\pi \frac{3d}{2}}{\lambda} \sin \phi \right)$
Second point	

(19)

For antenna spacing $d = \lambda/2$ we get:

$$K = \cos\left(\omega t + \frac{\pi}{2} \sin \phi\right) + \cos\left(\omega t - \frac{\pi}{2} \sin \phi\right) + \cos\left(\omega t + \frac{3\pi}{2} \sin \phi\right) + \cos\left(\omega t - \frac{3\pi}{2} \sin \phi\right). \quad (20)$$

By using the same method of calculation as in (11) we finally obtain:

$$K = 4 \cos \omega t \cos\left(\frac{\pi}{2} \sin \phi\right) \cos (\pi \sin \phi). \quad (21)$$

For the relative vertical characteristic it is again sufficient to consider only the terms containing ϕ , so that for the vertical group of four hori-

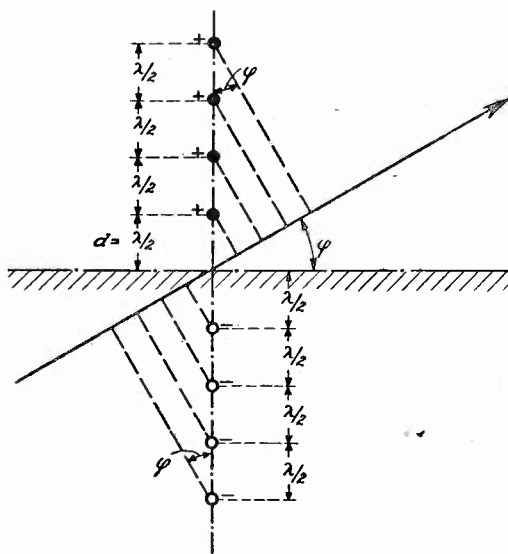

Fig. 26—Schematic diagram of the vertical dipole group for reflecting surface of the earth.

zontal dipoles with nonreflecting earth we get as the relative total characteristic:

$$(K_{4v})_{\text{without earth}} = \cos\left(\frac{\pi}{2} \sin \phi\right) \cos (\pi \sin \phi). \quad (22)$$

2. Perfectly Reflecting Earth

Here likewise the vertical group of four horizontal dipoles spaced $\lambda/2$ above each other is alone determinative and, as in 1, it is sufficient to determine the relative group characteristic. The dipole arrangement can be seen from Fig. 26. The perfectly reflecting surface of the earth is replaced by a mirror image of the overhead antenna arrangement

reflected at the surface. The oscillation in the mirror image is assumed to be in the opposite phase to the antenna oscillation (180-degree phase displacement with reflection at the surface). The surface of the earth is at the same time a line of symmetry. The beam is again passed through the center of symmetry. The angle between the beam and the axis of symmetry is again designated by ϕ and therefore ϕ is the angle of elevation. The rule for the group characteristic is similar to (10), and is written:

From the center upward	From the center downward
$K = \cos\left(\omega t + \frac{2\pi d}{\lambda} \sin \phi\right) - \cos\left(\omega t - \frac{2\pi d}{\lambda} \sin \phi\right)$	First point
$+ \cos\left(\omega t + \frac{2\pi 2d}{\lambda} \sin \phi\right) - \cos\left(\omega t - \frac{2\pi 2d}{\lambda} \sin \phi\right)$	Second point
$+ \cos\left(\omega t + \frac{2\pi 3d}{\lambda} \sin \phi\right) - \cos\left(\omega t - \frac{2\pi 3d}{\lambda} \sin \phi\right)$	Third point
$+ \cos\left(\omega t + \frac{2\pi 4d}{\lambda} \sin \phi\right) - \cos\left(\omega t - \frac{2\pi 4d}{\lambda} \sin \phi\right)$	Fourth point

(23)

For the antenna separation $d = \lambda/2$ we get:

$$\begin{aligned}
 K &= \cos(\omega t + \pi \sin \phi) - \cos(\omega t - \pi \sin \phi) \\
 &+ \cos(\omega t + 2\pi \sin \phi) - \cos(\omega t - 2\pi \sin \phi) \\
 &+ \cos(\omega t + 3\pi \sin \phi) - \cos(\omega t - 3\pi \sin \phi) \\
 &+ \cos(\omega t + 4\pi \sin \phi) - \cos(\omega t - 4\pi \sin \phi).
 \end{aligned}
 \tag{24}$$

By transformation, using the trigonometric formulas:

$$\cos(\alpha + \beta) - \cos(\alpha - \beta) = 2 \sin \alpha \sin \beta \text{ and} \tag{25}$$

$$\sin \gamma + \sin \delta = 2 \sin \left(\frac{\gamma + \delta}{2}\right) \cos \left(\frac{\gamma - \delta}{2}\right), \tag{26}$$

we get, finally, just as in (11),

$$K = -8 \sin \omega t \cos \left(\frac{\pi}{2} \sin \phi\right) \cos(\pi \sin \phi) \cos \left(\frac{2\pi}{2} \sin \phi\right). \tag{27}$$

For the relative total characteristic of the vertical group of four horizontal dipoles radiating in phase and spaced $\lambda/2$ with the perfectly reflecting surface of the earth, considering only the terms with ϕ , we get:

$$(K_{4v})_{\text{reflec. earth}} = \cos \left(\frac{\pi}{2} \sin \phi\right) \cos(\pi \sin \phi) \sin \left(\frac{5\pi}{2} \sin \phi\right). \tag{28}$$

ON THE AMPLITUDE OF DRIVEN LOUD SPEAKER CONES*

By

M. J. O. STRUTT

(Natuurkundig Laboratorium der N. V. Philips' Gloeilampenfabrieken, Eindhoven, Holland.)

Summary—Bragg's method for measuring small amplitudes of vibration was developed technically for the measurement of amplitudes of driven loud speaker cones. It is shown, that amplitudes of 1 micron at 500 cycles may easily be measured within a few per cent. Nodes of symmetrical cones may be radial or circular. It is shown that radial nodes do not influence the effective sound radiation area and the effective mass although circular nodes do. A quantity η is calculated from experimental data, to which both effective mass and effective area are proportional. It is shown that circular nodes exist at as low as 500 cycles in most of the paper cones measured, except especially stiff ones, which up to 2200 cycles did not show any circular node. Effective mass and effective area of most cones diminish rapidly with increasing frequency, so as to become very small at, say, 1000 cycles. Here again, especially stiff cones made a favorable exception. Different loud speaker systems were tested as to proportionality of amplitude to a-c strength. A direct method for measuring the effective mass as a function of the frequency offered a check on these conclusions.

I. INTRODUCTION

MODERN loud speakers have a cone of paper or other material as sound emitter. This cone is driven from the center and is loosely fastened at the circumference. Assuming that the movement of the center is wholly in the direction of the axis of the cone, we can easily determine the particular movements of the cone surface which are disadvantageous to the emission of sound. All nonlinear effects, i.e., the introduction of overtones by the cone itself, have been neglected, as no trustworthy observation of such effects is known to the author.

The movements of the conical surface, by symmetry, may be described as due to circular and to radial nodal lines. These nodal lines influence the acoustic performance of the conical surface in two respects.

At two sides of a nodal line the surface moves in opposite directions. Therefore, the air will have a tendency to stream over a nodal line, in order to equalize pressure differences. This first effect of nodes will be called *acoustic short circuit*. The second effect of nodes has to do with the reaction of the conical surface on the driving point. If the cone had no nodes and moved as a perfectly rigid plate, the reaction would be determined entirely by the mass of the cone, if we neglect

* Decimal classification: R265.2. Original manuscript received by the Institute, November 28, 1930.

sound radiation. This mass can be found by weighing the cone. But if there are nodes, different parts of the surface move in opposite directions. Hence the reaction, which the mass of one part gives to the driving point may be compensated by the reaction of another. We can express this also by saying: *the effective mass* of the cone depends on the motion of the conical surface.

II. ACOUSTIC SHORT CIRCUIT AND VARIATION OF EFFECTIVE MASS

We shall now look a little more closely into the influence of acoustic short circuit and variation of effective mass on the performance of a cone as a sound emitter.

By acoustic short circuit the pressure differences, which are the primary causes of the sound emitted, are partially leveled or extinguished at their origin. Let S be the total surface of the cone and P the amplitude of motion at the center. If the cone is rather flat, as with all the cones described hereafter, the sound amplitude radiated will be proportional to $S \times P$, as long as the amplitude of motion in every part of the cone surface equals P , i.e., as long as the cone is perfectly rigid. As soon as the motion of some parts of the cone is less than P , the cone is no longer perfectly rigid and, with increasing frequency, will show nodes. Let ds denote an element of the cone surface and p the amplitude of motion of this element, then the amplitude of the emitted sound is proportional to

$$\int p \, ds$$

the integral extended over the whole surface of the cone, as long as the wavelength of sound in air is large compared with the dimensions of the cone or with the distance between two nodes. If this latter condition is no longer fulfilled, the emission of sound depends on the motion of the cone in a more complicated way, which will not be discussed in this paper. From the considerations, developed above, we find as a measure of the efficiency of the cone as a sound emitter:

$$\eta = \frac{\int p \, ds}{P \cdot S} \quad (1)$$

It is easy to see, that *radial* nodes of the cone have no effect on η . The cone surface, if only radial nodes occur and if it is otherwise perfectly rigid, being driven at the center, will have the same *mean* displacement

$$\int p \, ds$$

as if no radial nodes were present. Hence η is unaffected by these nodes.

Considering the variation of effective mass of the cone, much the same can be said as regarding the effective radiating surface. In fact, (1) gives the effective mass of the cone, in per cent of the true mass, found by weighing it. The effect of air and other damping on the motion is neglected in this paper.

III. METHOD AND APPARATUS FOR AMPLITUDE MEASUREMENTS

The method, here described, is, so far as is known to the author, essentially due to W. H. Bragg.¹ Referring to Fig. 1, S' is a part of the cone surface, m a small mass with a copper point, f a spring (e.g., of a small clock) and M a micrometer, set on a heavy metal block. The spring f is fastened to M at A . 2π times the characteristic frequency of

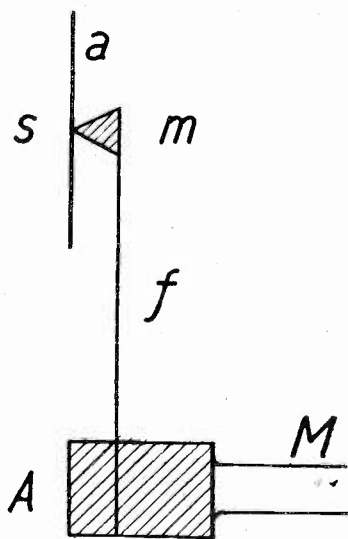

Fig. 1—Schematic arrangement of measuring apparatus. S vibrating surface (amplitude = a); m small mass; f spring; M micrometer (displacement = A).

the spring f with mass m when swinging freely will be denoted by ω_0 . We proceed as follows. While S does not move, M is turned so as to let the point of m just touch S . This is determined electrically by a current flowing from m to S , which surface is provided by a strip of platinum foil, of 10 microns thickness. Now S is set in motion. The point of m no longer steadily makes contact with S but dances. This is observed by the ear and by the electric current flowing from m to S falling to less than half of its former value. The micrometer M is hereupon turned a certain amount, say A , until the contact of m with S is perfect again, as observed by the ear and by the current regaining its first value. In this condition, the maximum acceleration, given to m by the motion of S is

¹ W. H. Bragg, Jour. Sci. Instr., 6, 196, 1929.

just equal in amount and opposite in direction to the acceleration, which m gets from the force, due to the tension of the spring f . Assuming S to move purely periodically and where ω is 2π times its frequency, we have:

$$\omega^2 am = cA$$

where a is the maximum amplitude of the mass m and c the stiffness of f , while:

$$\omega_0 = \sqrt{\frac{c}{m}}$$

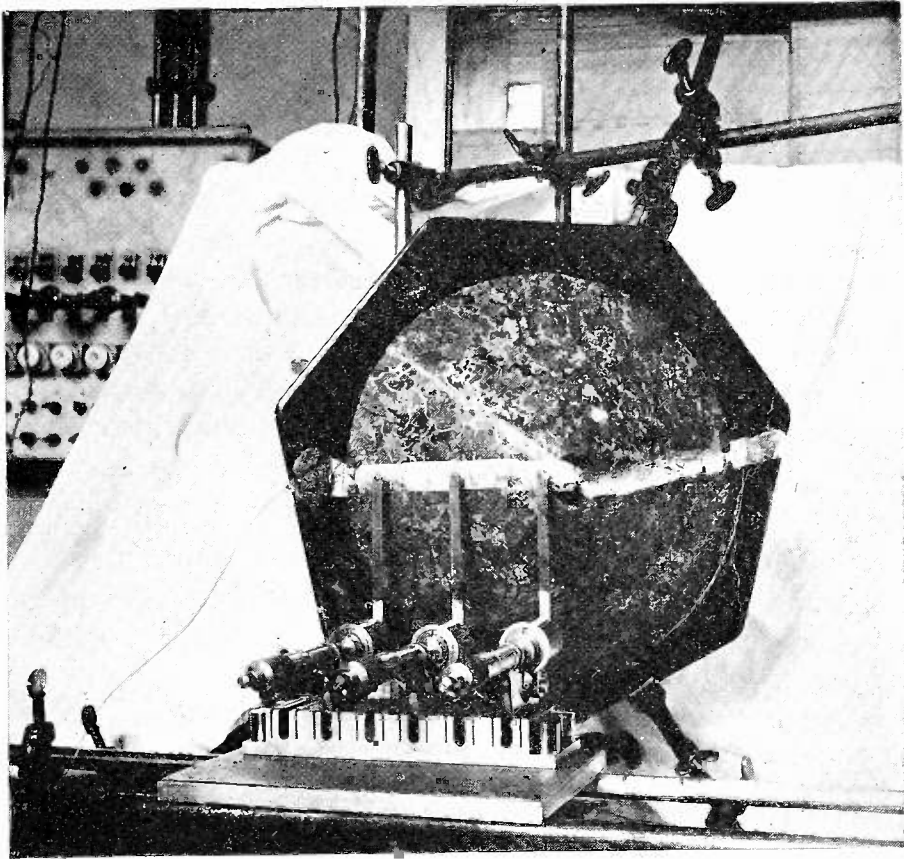

Fig. 2—Photograph of apparatus; three micrometers acting on cone.

Hence, we have:

$$a = A \left(\frac{\omega_0}{\omega} \right)^2 \quad (2)$$

The amplitude a is thus measured by the distance A over which the micrometer was turned, with a large magnification. For instance take $\omega_0 = 2\pi \cdot 10$; $\omega = 2\pi \cdot 10^3$; $A = 1\text{mm}$, then $a = 10^{-4}$ mm. We are able to measure amplitudes of the order of one micron.

Fig. 2 shows a development of the apparatus, the principle of which was just described. We here see three micrometers, each provided with a spring, acting on a loud speaker cone.

IV. TESTS OF THE APPARATUS

Before actually measuring amplitudes of loud speaker cones, our apparatus was tested in different ways. We first measured several times at the same spot of a loud speaker cone the distance A , over which the micrometer had to be turned, and obtained:

1.70 1.64 1.67 1.54 1.61
 1.61 1.59 1.66 1.60 1.70
 mean value: 1.63
 mean deviation: $4.3 = 2.6$ per cent
 maximum deviation: $9 = 5.5$ per cent.

Other series of measurements gave similar results. We concluded that an accuracy of 5 per cent might be reached by our method.

We determined the characteristic frequencies of several springs, varying from $2\pi \cdot 10$ to $2\pi \cdot 30$ by comparison with a tuning fork of known period. With these springs we measured the amplitude of the center of a loud speaker cone and obtained the following results:

$$\begin{array}{lll} \omega_0 = 12 \times 2\pi & A = 3.17 & A\omega^2_0 = 18.10^3 \\ \omega_0 = 33 \times 2\pi & A = 0.46 & A\omega^2_0 = 20.10^3. \end{array}$$

The current through the loud speaker was kept constant. We see, that the A 's are inversely proportional to the $(\omega_0)^2$'s, thereby finding that springs of this stiffness do not considerably influence the motion of the cone.

From the values of ω_0 and A given above we may immediately calculate the absolute value of the amplitude, since $\omega = 2\pi \cdot 256$ in these measurements.

We find from (2):

$$a = 3.17 \cdot \left(\frac{12}{256}\right)^2 = 7. \text{ microns.}$$

Hence, we conclude that the present method enables us to measure amplitudes of vibration, amounting to something like 7 microns, within a few per cent at 256 cycles.

V. LINEARITY OF DIFFERENT LOUD SPEAKER SYSTEMS

In order to obtain sound of good quality from a loud speaker, it is of great importance, that the system should be linear, i.e., that the

amplitude of vibration be exactly proportional to the current through the system. Various methods for testing this linearity have been published previously, but none of them seem as simple and direct as the one here used.

The current through the loud speaker was measured by inserting a

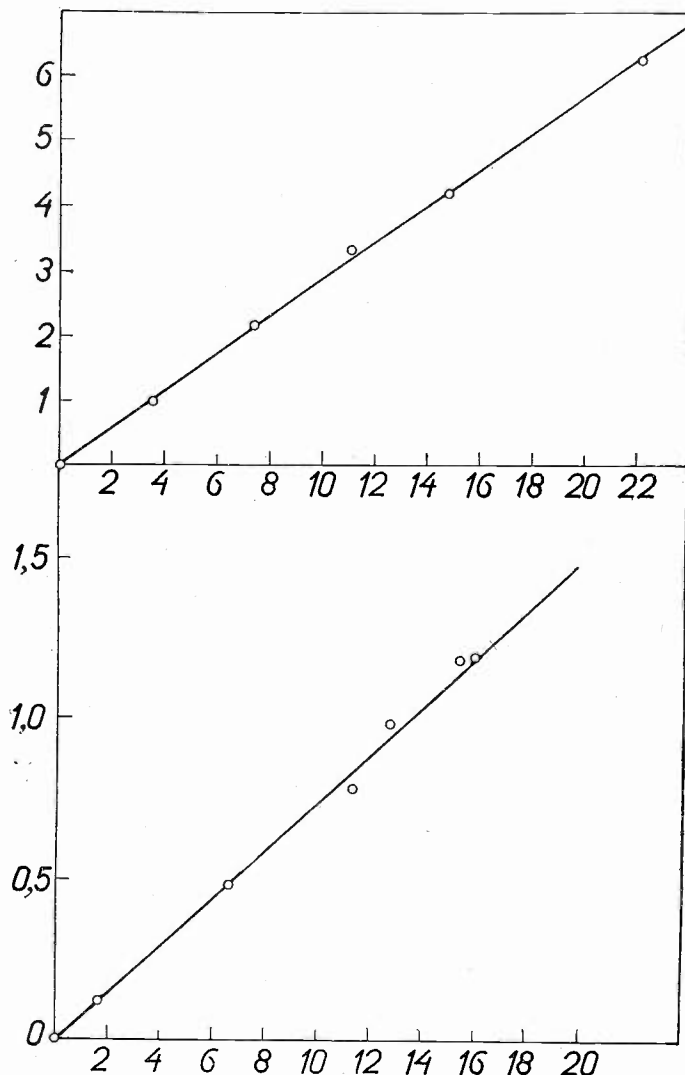

Fig. 3—Test on an electromagnetic system. Vertical axis gives amplitude of vibration in microns versus the horizontal axis for 500-cycle current in milliamperes through loud speaker. Upper graph shows measurements at center of cone; lower graph, on another place of cone.

thermocouple, of commercial Philips' type, into the circuit. This couple, as was determined by a previous experiment, did not show any skin effect or capacity effect at the frequencies used. Hence the d-c check curve of this couple can be used for determining the a-c value.

The first loud speaker system tried was of the so-called electromagnetic type. This system, is used in the Philips' loud speaker type No. 2007 and belongs to the balanced double-working type. The amplitude was measured at a frequency of 500 cycles per second, one time at the metal center of the cone and another time at some place on the paper cone itself. The curves are found in Fig. 3. It is obvious, that within this range, which corresponds with normal loudness, this loud speaker is entirely linear.

The second system was of the so-called electrodynamic type, provided with a spring of a material resembling bakelite. As is clearly

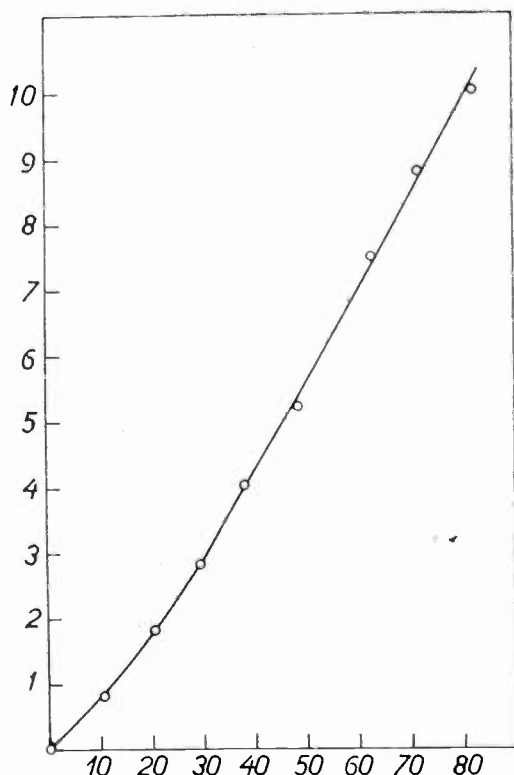

Fig. 4—Test on an electrodynamic system with bakelite spring.

seen from the curve on Fig. 4, this system is somewhat nonlinear. Hence, springs of this material ought to be rejected.

VI. CIRCULAR NODES OF PAPER CONES

The amplitude of paper cones, at a fixed frequency, was measured as a function of the place along one *diameter*. Of course measurements along one *radius* are sufficient to find the motion of the cone, but we always used measurements along a second radius situated diametrically to the first one as a check. The two curves generally coincide closely.

In Fig. 5 two curves, showing the amplitude of vibration as a function of the radial distance from the center of the cone, for a paper cone of the stiffness generally used in commercial loud speakers, are given.

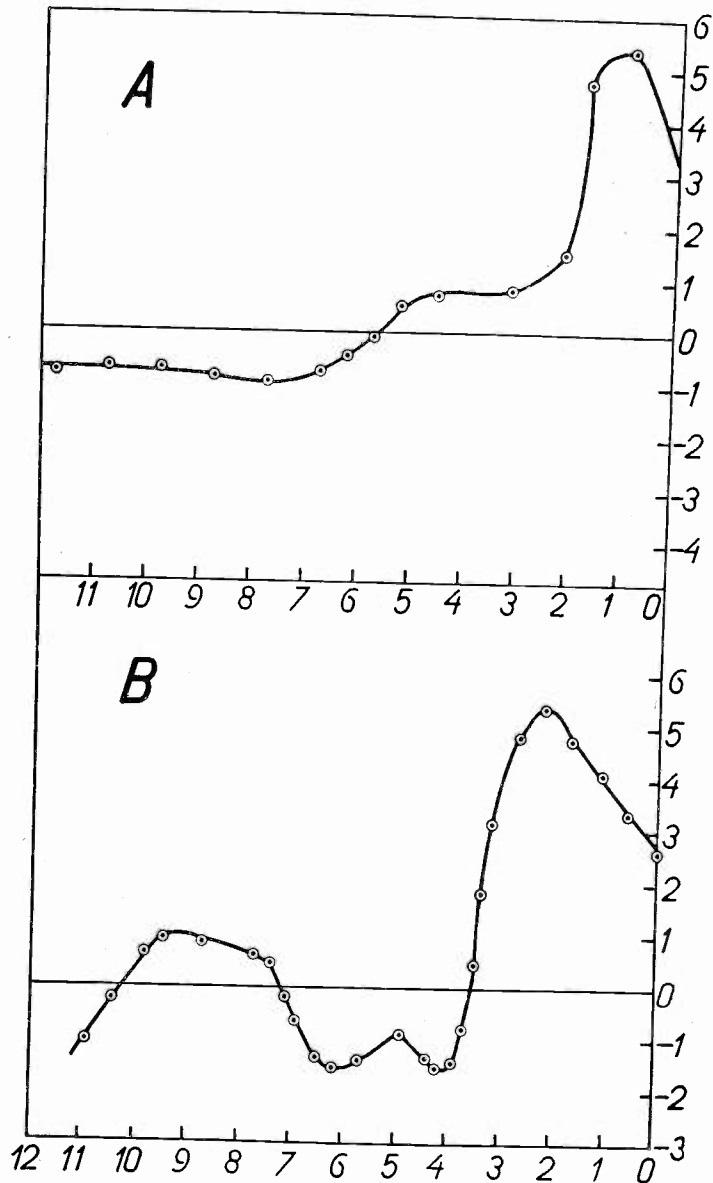

Fig. 5—Vertical axis as in Fig. 3. Horizontal axis gives distance from center of cone in cm. A, at 500 cycles; B, at 821 cycles.

The angle at the apex was 120 degrees. The curves were measured at 500 cycles (curve A) and 821 cycles (curve B). It is seen, that already at 500 cycles one circular node exists and even three nodes at 821 cycles, while the beginning of a fourth one already manifests itself.

After many measurements of this type on different sorts of paper cones, provided with radial and circular ribs, of various thickness and

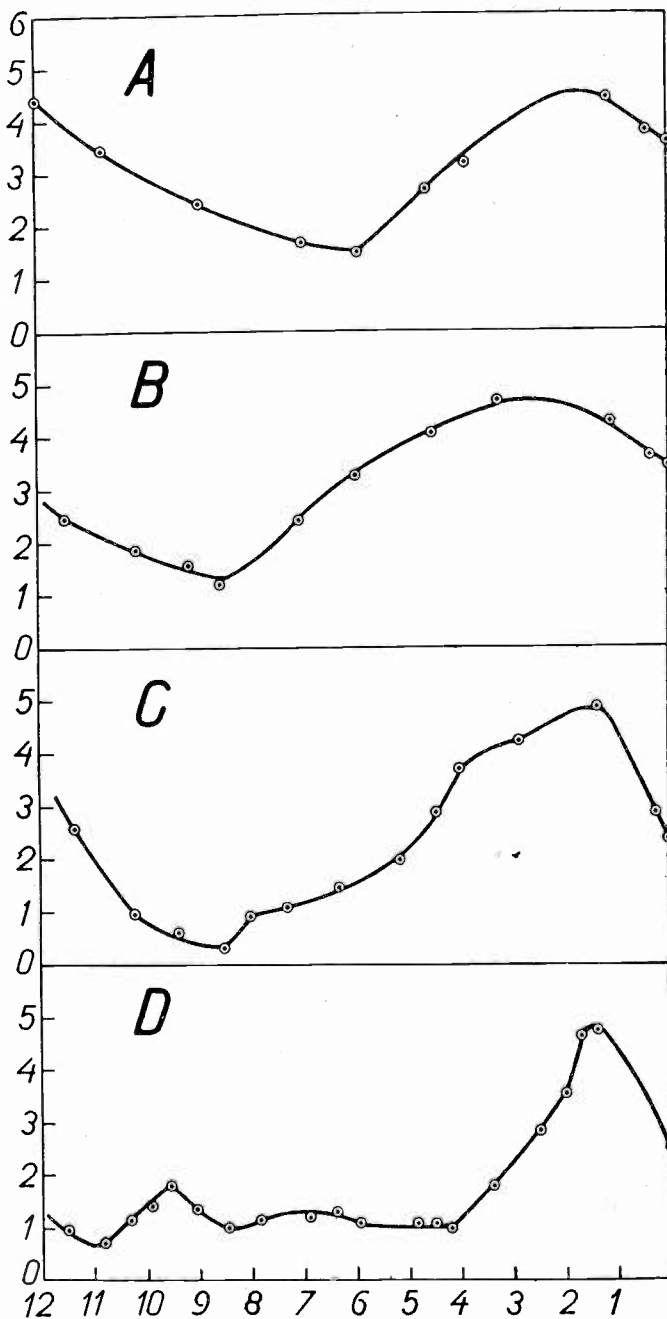

Fig. 6—As Fig. 5 but very stiff cone. A, 500 cycles; B, 821 cycles; C, 1250 cycles; D, 2150 cycles.

material, we arrived at a type of cone, which up to 2150 cycles did not show any circular node. Curves taken on this latter type of cone are

given in Fig. 6, measured at various frequencies ranging from 500 cycles up to 2150 cycles.

The evidence, here given, that ordinary paper cones have circular nodes at even as low as 500 cycles seems to be somewhat unexpected, as most constructors of loud speakers assume that cones are nodeless up to much higher frequencies.

Experiments, still unpublished, were carried out in this laboratory by A. Th. van Urk, concerning the *radial* nodes of paper and other cones. They show, that such nodes occur at as low as 150 cycles and at 600 cycles their number may be twenty or more. In the experiments of van Urk the cones were not driven at the center, as in the ones described above, but farther out toward the circumference.

As was shown above, with symmetrically driven cones *radial* nodes should not have any effect on the emission of sound.

VII. EFFECTIVE MASS AND EFFECTIVE RADIATING SURFACE OF PAPER CONES

From curves such as are given in Figs. 5 and 6 a quantity η , according to (1) may readily be found by numerical integration. This quantity gives the ratio of the effective mass to the mass found by weighing and also the ratio of the effective radiating surface to the radiating surface if the cone were perfectly rigid.

In Table I this quantity is given for three cones, numbered 1 to 3, their stiffness increasing with the number.

TABLE I
Giving η of (1) as a function of the frequency for the paper cones 1-3

Cone No.	freq.				
		500	821	1250	2150
1		0.030	0.0099		
2		0.200	0.185	0.179	
3		0.434	0.287		0.058

Cone 3 was of the type of maximum stiffness. It seems difficult to arrive at larger values of η with paper cones without disproportionately increasing their weight.

In the construction of loud speakers it was often observed that cones of different weight fastened to the same system did not behave as was expected. With increasing weight the amplitude of vibration was expected to diminish rapidly, and hence also the sound emitted. From Table I it is obvious, that except for cones of great stiffness, such as 2 or 3, the mass found by weighing the cone has very little to do with the effective mass, which reacts on the driving system. In fact the effective mass is only a few per cent of the weight. This evidence explains the observations with loud speaker cones, just mentioned.

Direct Measurement of Effective Mass

In order to check the conclusions drawn above from the amplitude measurements, a direct method for measuring the effective mass of cones was devised.

A steel rod of rectangular cross section is connected by means of small coils to a circuit, consisting of two valves, acting as a negative resistance. This circuit automatically sets up and maintains the vibrations of the rod. The period of oscillation mainly depends on the mechanical properties of the rod.

A cone is suspended on and vibrates together with the steel rod. The rod arrangement is shown in Fig. 7.

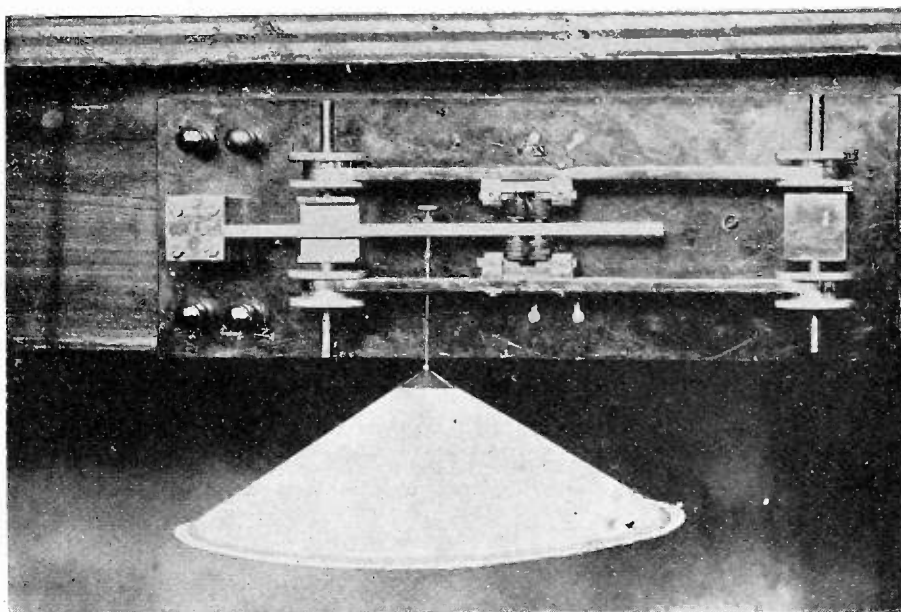

Fig. 7—Apparatus for determining effective mass of cones as a function of the frequency of oscillation.

We proceed as follows. The oscillations of the rod interfere with those of a special constant check oscillator. This latter generator consists of an adjustable valve circuit of special design, and, by using a special valve with tungsten filament, is constant within one twentieth period per second in about ten minutes, if the frequency is of the order of a hundred cycles.

By removing the cone from the rod its oscillation changes a few cycles per second. Now an adjustable mass is fastened in place of the cone to the rod, until its period, as checked by interference with the constant oscillator, is the same as with the cone fastened to it. We hence have a direct measure for the equivalent effective mass of the cone.

This procedure was applied to various cones and a good qualitative agreement with measurements by the amplitude method was reached.

By measuring the time of decay of the rod, first with the cone and then without it, after disconnection from the maintaining circuit, we have measured the total radiation of sound by the cone. In these latter measurements, a special decay-measuring arrangement² was used. A full account of the measurements, mentioned in this chapter, will be published in the near future. Moreover, a paper by the author, in course of publication, deals with the calculation of the effective mass of cones, taking damping into account.

The author takes pleasure in thanking Mr. W. M. Berkhout and Mr. N. S. Markus for their assistance in the measurements herein described.

²*Elektrische Nachrichten Technik*, 7, 280, 1930.



ENGINEERING TESTIMONY BEFORE OFFICIAL BODIES*

BY

EDGAR H. FELIX

(Technical Writer and Consultant to Broadcast Stations, Ridgewood, New Jersey)

Summary—This paper discusses the requirements for the effective presentation of testimony on engineering subjects. The most important qualifications of a witness on technical matters are:

(1) The ability to present technical facts in lay language such that persons without technical training and unfamiliar with the technical terms of the profession are able to grasp the significance of his evidence.

(2) The ability to support every important statement of opinion by an appropriate analogy or citation of recognized authority.

(3) The ability to qualify himself as an expert by a statement of experience bearing directly on the points to which he testifies.

(4) The ability to present his evidence without too much reliance on counsel for guidance.

(5) The ability to testify fearlessly to the truth regardless of how it may affect the outcome of the case or the interests of those who employ him.

AS AN inevitable consequence of the growing economic importance of radio communication, engineers are with increasing frequency called upon to testify before official bodies, such as the Federal Radio Commission, the Commissioner of Patents, and state and municipal bodies.

The average engineer is somewhat out of his element on the witness stand. Because legal counsel is not always well equipped technically, he is often left somewhat to his own devices with the total unfamiliar responsibility of producing good legal testimony. Furthermore, unlike the lay witness, who seems ready to accept the most casual observation to be the foundation for a positive and definite statement of fact, the engineer's training leads him to doubt any observation until he has been able to demonstrate to his own satisfaction that it is a fact.

This attitude is reflected by the care with which a conscientious engineer testifies and the way in which he qualifies any statement in which there is a possibility of error or exception. A meticulously guarded opinion is usually a clarion call to opposing counsel to cross-examination leading to further weakening and qualification of the statement. Yet almost any statement made on the witness stand might be broken down in a similar way, but only engineers, trained in distin-

* Decimal classification: R007. Original manuscript received by the Institute, November 29, 1931.

guishing between proved fact and opinion, are well known for their readiness to admit weaknesses in the structure on which their opinions are built. Thus engineering and law make a very poor mixture which can be improved only by proper preparation for the arduous task of testifying.

QUALIFICATIONS OF AN EFFECTIVE TECHNICAL WITNESS

An effective witness on technical matters has, in addition to a good foundation of engineering knowledge and experience, the following qualifications:

1. The ability to present technical facts in lay language such that persons without training and unfamiliar with the technical terms of the profession are able to grasp the significance of his evidence.
2. The ability to support every important statement of opinion by an appropriate analogy or citation of recognized authority.
3. The ability to qualify himself as an expert by a statement of experience bearing directly on the points to which he testifies.
4. The ability to present his evidence without too much reliance on counsel for guidance.
5. The ability to testify fearlessly to the truth regardless of how it may affect the outcome of the case or the interests of those who employ him.

The principal weakness of the witness who is primarily a practical engineer and not especially experienced in making verbal or written presentations is that he fails to bring out his information in a manner which is comprehensible to those who should be influenced by his testimony. The engineering witness does not appear upon the stand to display his knowledge for the benefit of his colleagues and technical associates, but to communicate information to relatively nontechnical men far removed from the practical operating problems which are his daily lot. No matter how much a witness knows, he is a success as a witness only to the extent that he contributes to the understanding of those who must judge upon his testimony. Furthermore, the testimony must be of a character which is not only within the understanding of the particular bodies before which the engineer appears which may be technically qualified, like the Federal Radio Commission or the Commissioner of Patents, but also to any courts to which the record of the case may be brought by appeal.

PREPARATION TO TESTIFY

By suitable preparation the engineer may greatly enhance the effectiveness of his testimony. In most cases, he is called upon to give state-

ments of opinion as an expert dealing with hypothetical or prospective conditions rather than actual situations. When such testimony is offered, conflicting opinions are often brought into the record by the opposition. Therefore, a necessary preliminary to effective testimony of a controversial character is an adequate statement of qualifications by the witness. The engineer should be prepared to recite his history covering accurately when and where he obtained his technical education and the degrees awarded, and a fairly complete record of his practical training by a complete summary of the significant positions he has held. The statement should be specific as to names and dates.

It is amazing how such details as what particular years were spent in certain positions slip from the mind when on the witness stand. Merely because of confusion, engineers have testified to tenure of positions each over a period of years and months which, when totaled and subtracted from their respective age at the time the statements were made, indicate that their professional engineering experience began in early childhood.

The statement of qualifications should overlook no opportunity to lay the foundations for testimony based upon opinion which is to be given subsequently. For example, if the engineer is to testify as to the prospective service range of a broadcast station, any experience which he has had with field strength measuring apparatus should be detailed in his statement of experience in order to support his qualifications to speak authoritatively on service ranges.

REASON FOR ESTABLISHING QUALIFICATIONS

To illustrate the value of a properly qualified witness, consider the impression on a commission when an engineering witness testifies that the change of frequency requested by station *A* will not interfere with the operation of station *B*. On cross-examination, counsel for station *B* inquires on what facts or evidence the engineer bases that opinion. In numerous instances, the answer to that and to similar questions has been "from my experience with such matters." The reason that engineers specializing in litigation have developed is because it takes considerable experience to learn what is testimony and what is opinion. Such men are trained not only in forming an opinion based on engineering knowledge, but to support those opinions upon a structure of experience, measurements, and specific analogies and by the statements of recognized authorities in the field. Such specialists are able to testify in sufficiently simple language so that their judge or judges can grasp the engineering principles involved. Their qualification to testify is often sustained by a record of numerous previous appearances before

the same bodies and, therefore, by numerous unconflicting statements under oath.

The most important qualification usually lacking in the inexperienced technical witness is an understanding of what is expected of him as an engineer. It is amazing in how many instances the employee-employer relation exerts a superior claim over the obligations to a judicial body. His only purpose in testifying as an engineer is to state the facts as he knows them. If he gives one instant's thought as to how his truthful testimony may affect the outcome of the case prejudicially to his employer, he is certain to lay the foundations for undermining his testimony. Many a case has been won by a frank, fearless, and truthful engineering witness, part of whose testimony has been unfavorable to the case for which he appears, and many a case has been lost by an engineering witness who has attempted to present the facts so that they appear as favorably as possible in support of his employer's case.

An engineer for a broadcast station which had made application for a change in frequency testified that the station involved would not produce serious heterodyne interference with another station several hundred miles distant on the channel sought. This particular application was denied for various reasons. A few months later, however, the same engineer appeared to oppose an applicant seeking an assignment involving approximately the same conditions as to distance and power as in the first case. The engineer's evidence in the previous case was cited by the new applicant and effectively disposed of the engineer's objections in the second case.

Occasionally engineers infused with the idea of serving their employers, present truthful but deceptive testimony by taking advantage of nontechnical bodies. An engineer once testified that because the type of transmitter proposed in a certain location radiated considerably less power in harmonics than any built theretofore, blanketing interference was not anticipated at a certain distance from the proposed transmitter. The statement that harmonic radiation had been reduced by design improvements was entirely truthful but that evidence had no bearing whatever on reduced blanketing interference to favorite broadcast stations on near-by channels as reproduced by average receivers. If there had been no technically qualified opposition, this entirely truthful testimony would have remained unchallenged, but as it turned out, all the testimony by that witness was made ineffective by discrediting his attempt to take advantage of the lack of engineering knowledge on the part of the body hearing the testimony.

It may appear presumptuous to advise engineers to be truthful on the witness stand both in letter and spirit, and I extend my apologies

to the vast majority of engineers who have grasped the ideals of the profession. These ideals are aptly set forth by Alfred Douglas Flinn, director of the Engineering Foundation in the fourteenth edition of the *Encyclopedia Britannica*.

"He should know how to inform, convince and win confidence skillful and right use of facts. He should be alert, ready to learn, open-minded, but not credulous. He must be able to assemble facts, to investigate thoroughly, to discriminate clearly between assumption and proven knowledge. He should be a man of faith, one who perceives both difficulties and ways to surmount them. He should not only know mathematics and mechanics, but should be trained in methods of thought based on these fundamental branches of learning. Organized habits of memory and large capacity for information are necessary. He should have extensive knowledge of the sciences and other branches of learning and know intensively those things which concern his specialties. He must be a student throughout his career and keep abreast of human progress.

"Having been endowed more or less completely with qualifications and capacities requisite for a professional engineer and having developed them with the aid of educational and other institutions and contacts provided by civilized communities, the engineer is under obligation to consider the sociological, economic, and spiritual effects of engineering operations and to aid his fellow men to adjust wisely their modes of living, their industrial, commercial, and governmental procedures and their educational processes so as to enjoy the greatest possible benefit from the progress achieved through our accumulating knowledge of the universe and ourselves as applied by engineering."



OSCILLATIONS IN THE CIRCUIT OF A STRONGLY DAMPED TRIODE*

BY

F. VECCHIACCI

(Naval Electrotechnical and Communications Institute, Livorno, Italy)

Summary—The following is a study of the particular action produced by a triode oscillator when the relation of the inductance to the capacity, L/C , is greater than the square of the internal resistance, ρ^2 , and when the reactive coupling between plate and grid is greater than the limit required for starting oscillation. The shape of the oscillation curve is clearly other than sinusoidal, the frequency is much lower than that usual in the LC circuit, and is determined essentially from the constants of the triode and from the current.

I. INTRODUCTION

IN THE usual triode oscillating circuit, where the reactive plate-grid coupling is absolutely different from the limiting conditions for starting the oscillation, it is well known that these limiting conditions may be practically sinusoidal provided that the resonant circuit has a low decrement, and that the ratio L/C of the inductance to the capacity is not much higher than the square of the internal resistance of the triode, ρ^2 .

In the present paper we shall consider only the case in which the term¹ $\sqrt{L/C}/\rho$ would be very high in order to get equally low values for the decrement, $\delta = \pi\sqrt{L/C}/R_e$, ($R_e = W^2L^2/R =$ equivalent resistance). As was actually found in tests, the oscillation assumed a form very rich in higher harmonics, and the resultant frequency was determined essentially by the triode constants.

The investigation was made on an oscillating circuit, using the classical scheme for inductive coupling. The inductances of the plate and grid are wound on the same closed iron core, thus assuring almost perfect phase opposition in the two voltages, with the advantage of a notable simplification in the study of the same. The oscillation frequency is of the order of 100 cycles/sec.

From this it is deduced that the results obtained in the case studied do not necessarily differ greatly from those obtained with inductance in air for very high frequencies.

* Decimal classification: R133. Original manuscript received by the Institute May 21, 1930. Translation received by the Institute, December 19, 1930.

¹ Of the preceding studies on the subject see: O. M. Corbino, "On the action of a triode with strong magnetic coupling to an iron core between the plate and grid circuits," *L' Elettrotecnica*, 16, 489; July 25, 1929.

II. EXPERIMENTAL CIRCUIT CONSTANTS

The wiring diagram is shown in Fig. 1. The inductances L and L_g are both wound on the same closed iron core and consequently form a coupled resistance with a coefficient $M/\sqrt{LL_g}$, almost unity. In order to make the permeability variable, the value of the inductance L (and here also that of L_g) is not constant: the curve in Fig. 2 determined with sine-curve voltage with a frequency of 50 cycles/sec. gave the effective inductance, $L_e = V/WI_e$, in terms of I_e , the effective value of the current. From the curve in Fig. 2 we see clearly how the effective inductance reaches a maximum with an effective current of about 30 ma.

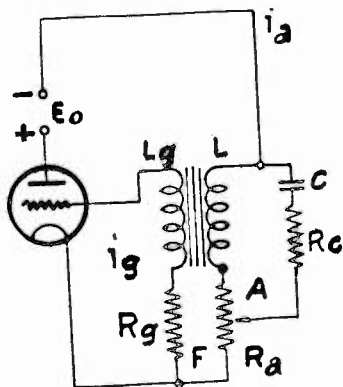

Fig. 1

The triode used has a saturation current of over 200 ma, a maximum variable resistance of 1000 ohms, ρ , and a coefficient of amplification of $\mu = 3.5$ units. This was used for normal operation with a voltage of about 150 to 200 volts. The resistances, R_a and R_c , inserted in the oscillating circuit to give proof of oscillations, are generally kept equal (such was the intention without exception) while the resistance R_g of the grid reaches stability at a value $R_g = kR_a$, k being the ratio of the number of turns of the inductance L_g to that of the inductance L_1 . Normally the value of R_a reaches a value equal to 200 ohms when $k = 1/2$ and 100 ohms when $k = 1$ or 2.

Between the grid and the negative of the filament, as also between the latter and the plate, there are two resistances of about 10^6 ohms each, in order to produce a potential difference in the oscillatory field. Such resistances, which are not shown in the diagram, do not modify it in any manner. In most of the tests the capacity C has the value of 0.1 microfarad, if E_0 is fixed at 100 volts. The free end of the resistance R_c , in series with the condensers, is normally placed in parallel with F , but it may be in parallel with A rather than with F ; it does not modify the action appreciably.

III. EQUIVALENT CIRCUIT AND STATIC CHARACTERISTICS

Due to a known property of transformers, if the internal ohmic drop and the dispersion of flux are considered negligible, that is, if the potential difference between the primary and secondary is negligible, it is possible to calculate the current i_o in the secondary from the cur-

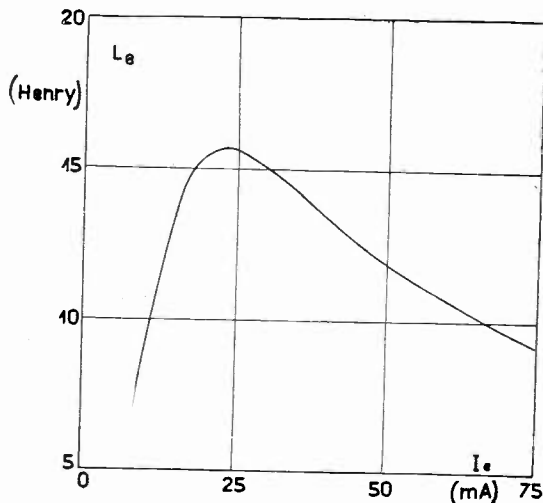

Fig. 2

rent in the primary winding, $i = ki_o$ (k being the transformer ratio.) From the diagram in Fig. 2 it is thus possible to go directly to that in Fig. 3. In this, L and C are of the same magnitude as shown in Fig. 2; r_a and r' are two variable resistances through which the plate current i_a passes, and i' is the secondary current. The primary current

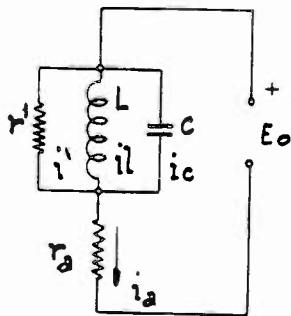

Fig. 3

i_p which passes through the primary windings of the transformer is the sum of the current i_1 , crossing the pure inductance of Fig. 3, and the equivalent i' . The i_1 inductance may be recorded directly by means of a simple oscillograph, by connecting resistance R_c in parallel with point F , and dissipating the oscillations between A and G instead of through A and F , making $R_g = kR_a$.

All these deviations from the hypothesis of no-loss, which is the basis of the present paper, can be determined, in a manner similar to i_a (here the value of r_a), in terms of v_a , that of i_o (and here i' and r') in terms of the same v_a , by means of primary curves; the characteristics of the triode can be determined in a perfectly static manner by means of various combinations of the plate and grid voltage, by means of which v_o is always equal to kv , so that $v = v_a - E_0$. In Fig. 4 the characteristic curves for i_a and i_o are shown as functions of v_a (the grid current in the given curve) which were obtained for a triode with an E_0

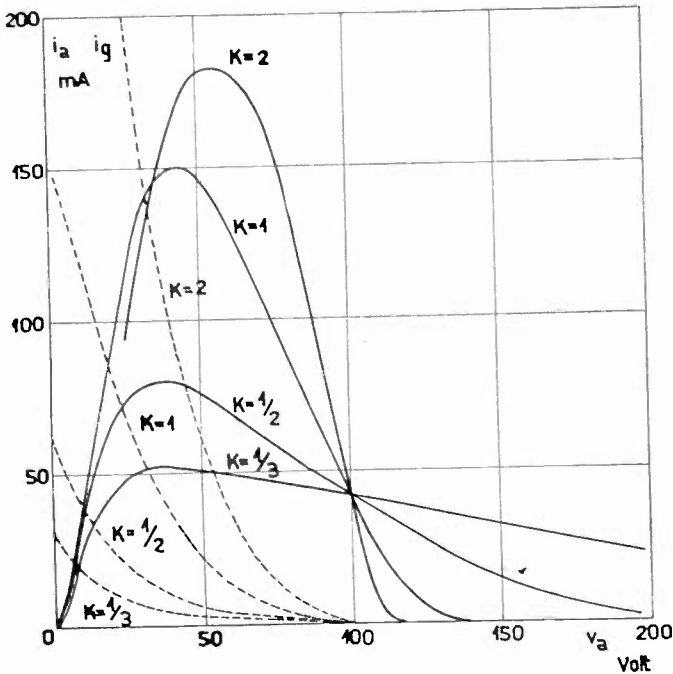

Fig. 4

of 100 volts, for the values $k = 1/3, 1/2, 1, 2$. In Fig. 5 on the contrary, the corresponding characteristic $i = i_a - ki_o$ is given in terms of v_a , in which i represents the sum of the currents i_1 and i_o passing through the inductance and capacity of the equivalent diagram in Fig. 3. In Fig. 6 the characteristics of $i = i_a - ki_o$ are given directly in terms of v_a for $k = 1/2$ and for electromotive forces E_0 of 120, 100, 80, 60, 40 and 30 volts.

This shows that all the various characteristics were found without inserting any supplementary ohmic resistance in the plate circuit or in the grid circuit. In fact, the influences exerted by the various oscillograph resistances are very slight.

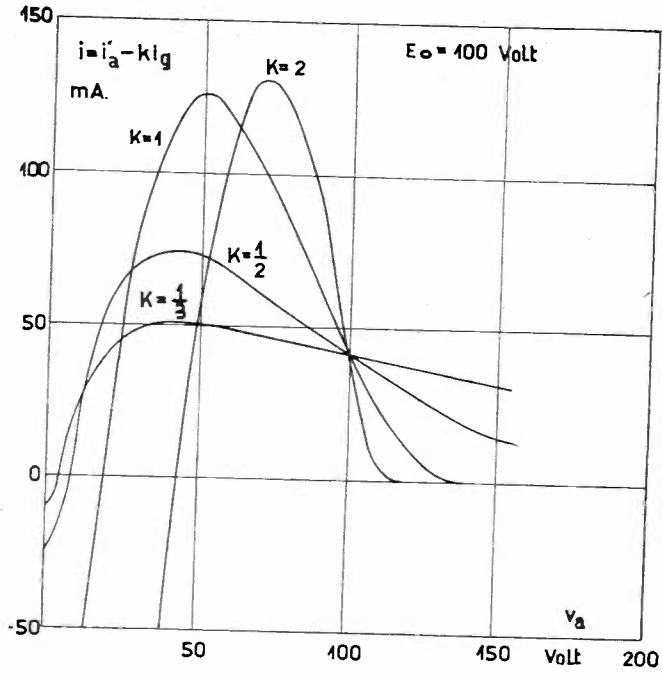

Fig. 5

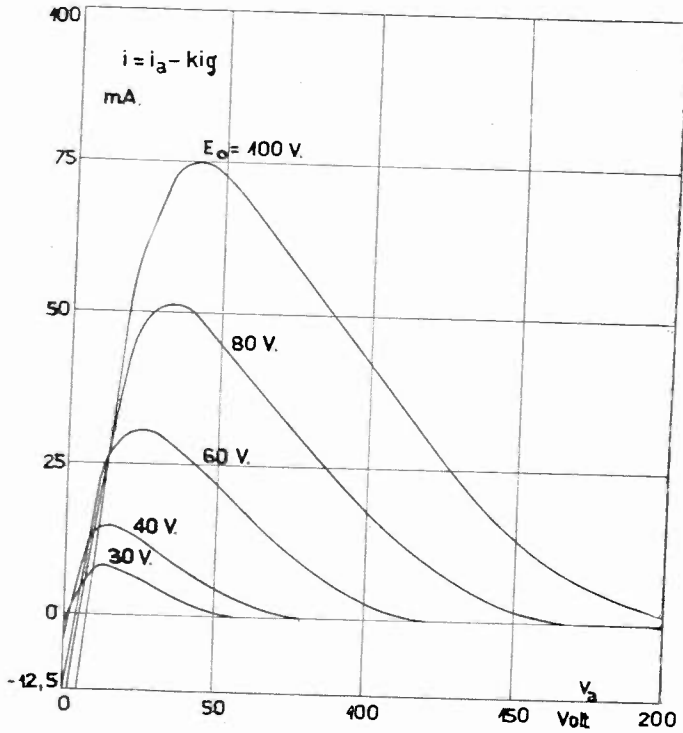

Fig. 6

IV. RESULTS OF THE FUNDAMENTAL EXPERIMENTS

The various tests were made successively with $k=1/2$, 1 and 2, keeping the anodic *emf.*, E_0 , constant at 100 volts.

(a) Test with $k=1/2$. The value R_a is constant at 200 ohms and, therefore, with the exception of the case described below, the values of R_c and R_g are 200 ohms and 100 ohms respectively. Fig. 7 gives some oscillograms² of the various magnitudes in the following order:

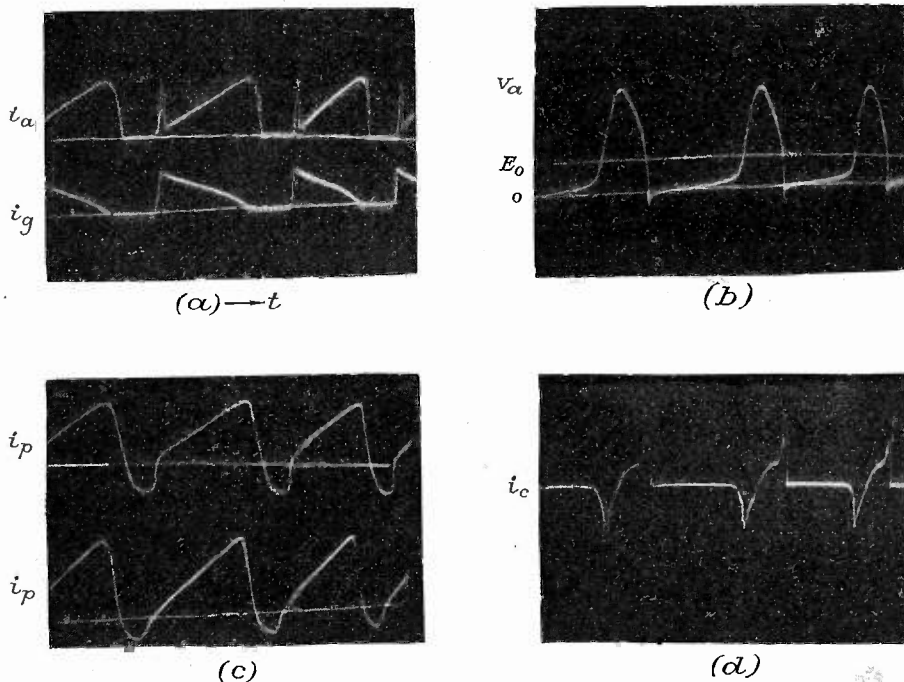

Fig. 7—(a) Above—plate current, i_a
 Below—grid current i_g
 (b) Plate voltage v_a (the line above the zero line is $v_a = E_0 = 100$ volts)
 (c) Above—primary current i_p
 Below—current $i_1 = i_p - 1/2 i_g$
 (d) Capacity current i_c

All the oscillograms are on the same scale by means of which the grid resistance R_g is normally kept at 100 ohms, but was doubled by the i_g field in illustration (a). The maximum value of i_a in oscillogram a occurred at about 75 ma.

In Fig. 8, the dynamic characteristics of the various currents and grid voltages (ordinates) are also given in terms of the plate voltage v_a (abscissas) obtained with the cathode oscillograph by the method mentioned above. The dynamic characteristics of Fig. 8, like all the

² The oscillographic pictures were obtained on an almost linear time scale by the method previously described by the author. *L' Elettrotecnica*, 15, Oct. 25, 1928. Pubblicazione I.E.R.T. della Marina Italiana No. 44.

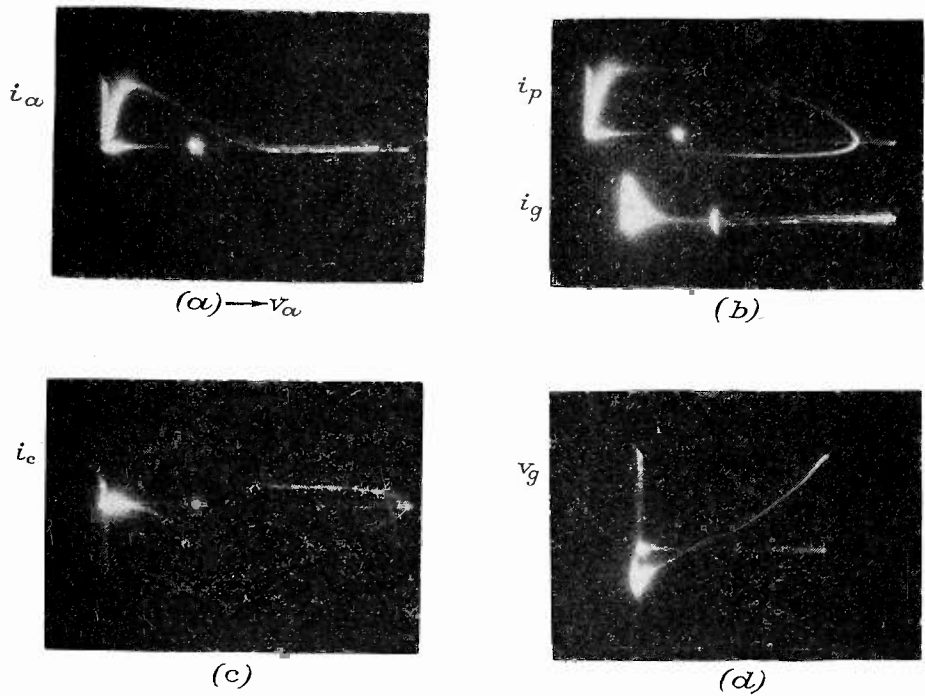

Fig. 8—(a) Plate current i_α
 (b) Above-primary current i_p
 Below-grid current i_g
 (c) Capacity current i_c
 (d) Grid voltage v_α

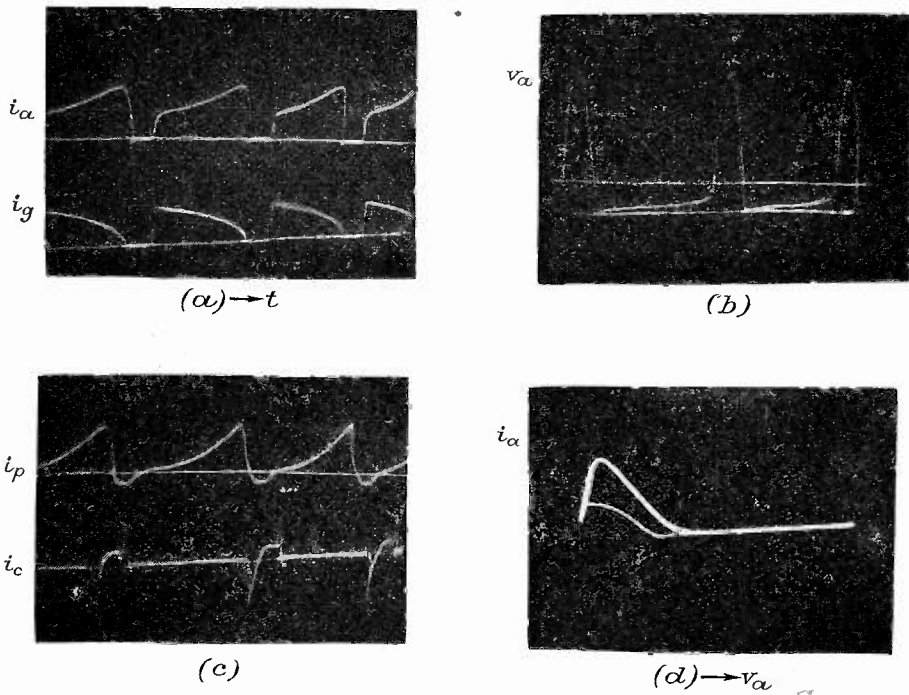

Fig. 9—(a) Above—Plate current i_α
 Below—Grid current i_g
 (b) Plate voltage v_α
 (c) Above—current $i_1 = i_p - i_g$
 Below—capacity current i_c
 (d) Dynamic characteristic $i_\alpha = f(v_\alpha)$

other oscillograms, are reproduced without retouching, because the variation of light due to the various distances give one an idea of the speed of the time variations.

(b) Tests with $k=1$ and 2. The resistance R_a is 100 ohms. The oscillograms relating to $k=1$ are given in Fig. 9, while Fig. 10 gives the oscillograms for $k=2$. Oscillogram d in Fig. 9 and oscillogram c in Fig. 10 are not taken from the photographic negatives but from the diagram as calculated from the shape of the diaphragm.

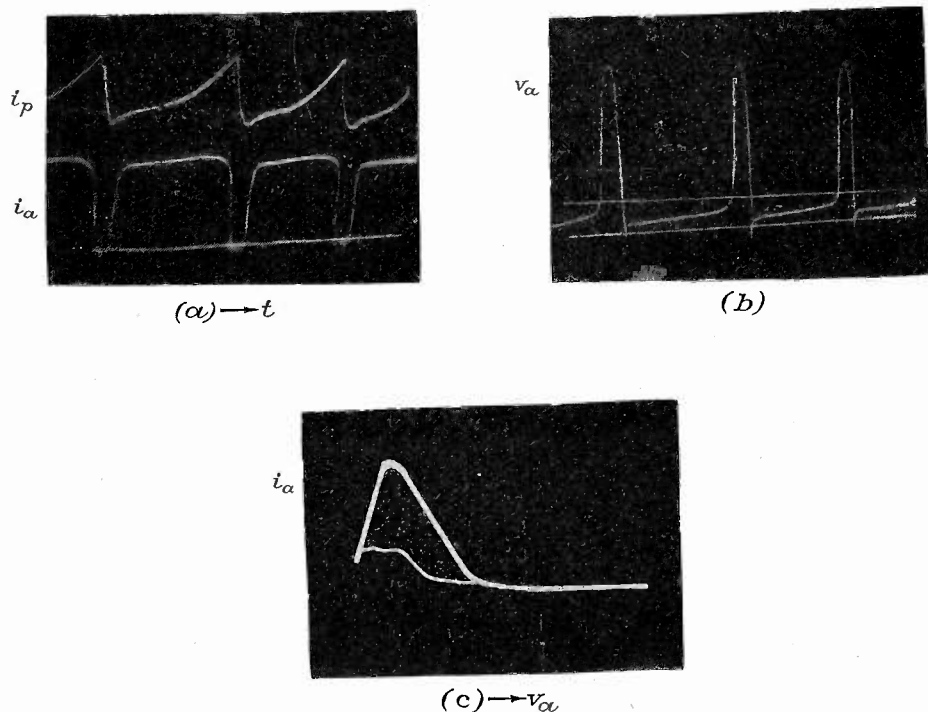

Fig. 10—(a) Above— $i = i_p - 2i_g$
 Below—plate current i_a
 (b) Plate voltage v_a
 (c) Dynamic characteristic $i_a = f(v_a)$

V. Discussion of Results

In the fields measured before, as in the case $k=1/2$, the dynamic characteristics (Fig. 8a) coincided remarkably with the static characteristics (Fig. 4); a closer study of the various oscillograph results obtained in a similar manner (Fig. 7 and 8) showed a subdivision of the oscillation cycle into the following groups:

(a) On leaving the value of the plate voltage, v_0 , not far from zero, the plate current i_a increases slowly until it approaches the maximum value i_1 of the static characteristics (Figs. 7a and 4). The current i_c through the capacity is negligible as compared with the inductive

current i_1 , which does not differ greatly from the anode current i_a with the relatively small grid current. While the plate current approaches the value i_1 , the plate voltage slowly approaches the value v_1 . Obviously this phase of the oscillation, which occupies the greater part of the cycle and during which the triode acts as a positive differential resistance, is essentially determined by the inductance, which stores up the electromagnetic energy passing through the triode.

(b) The plate current drops abruptly to zero when the plate voltage changes from v_1 to v_2 in its static characteristics, and consequently the triode acts as a differential negative resistance. The current i_1 , passing through the inductance decreases slightly while the negative current i_c , passing through the capacity, quickly rises to a value equal and opposite to the induction current. This phase is essentially determined by the capacity, which discharges through the triode.

(c) The plate current remains zero during the interval. The plate voltage leaves v_2 and returns to this value after having passed through a maximum. This phase obviously is determined by an oscillation set in motion by the LC current, without any action of the triode.

(d) At the lowest value of v_2 the voltage v_a drops rapidly, the absolute value of the negative current decreases slightly on passing through the inductance, the positive capacity current fluctuates according to the voltage v_1 . The end of the phase is characterized by the return of the capacity current to zero, after which the phase of the slow increase in the inductance starts again.

(e) When $k=1$ and 2, in relation to the capacity and inductance currents, they develop substantially in the same way as when $k=1/2$, but the diagram of the plate current has a different shape because of the greater importance assumed by the grid current.

VI. ANALYSIS OF THE MECHANISM OF OSCILLATION

(a) The value of the inductance L depends on the action obtained by means of iron and to a greater extent on the value of the current, nevertheless, in the following it will be treated as though it were perfectly constant. In fact it does not appear that the variability of the inductance causes any very pronounced effect on the course of the oscillations.

In order to simplify the analytical treatment, we shall introduce a current that has not been used, and which is defined by the relation $i = i_a - i'$, as the difference between the plate current and the equivalent i' of the diagram in Fig. 3. If $i_a = f(v_a)$ and $i' = f'(v_a)$, which functions can be determined from the static characteristics, then it is evident that $i = f''(v_a) = f(v_a) - f'(v_a)$ gives the static curves in Figs. 5 and

6, one of which is shown in Fig. 11 as a matter of convenience in reference.

In the examination of the mechanics of oscillation, one must always consider the diagram in Fig. 3, by means of which we get the fundamental equation $i_1 + i_c = i$.

(b) When the value of the voltage, $v_a = E_0 + v$, leaves the vicinity of zero, the variation in the current obviously is due to the storage of electromagnetic energy by the inductance. The variation in current takes place very slowly, and the current i may be identified with the

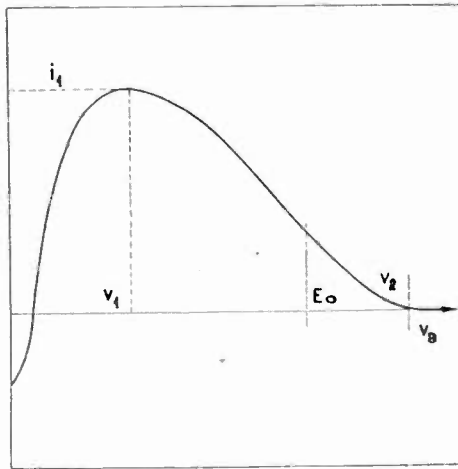

Fig. 11

inductive current i_1 , since the current passing through the capacity assumes a corresponding negligible value. One can write at any instant:

$$v = v_a - E_0 = -L \frac{di}{dt} \tag{1}$$

from which, making $i = i_1$, we get

$$-L \frac{df''(v_a) d(v_a)}{d(v_a) dt} = v_a - E_0 \tag{2}$$

and by simplifying the notation $1/R_p = df''(v_a)/d(v_a)$

$$dt = \frac{L}{R_p} \frac{d(v_a)}{v_a - E_0} \tag{3}$$

Retaining the constant R_p from (3), we get by integration and logarithms:

$$v_a - E_0 = (v_0 - E_0) e^{-[R_p/L(t-t_0)]} \tag{4}$$

Integrating (1) with respect to time and substituting in (4):

$$i_1 = \frac{1}{L}(v_a - E_0)dt + \text{const} = \frac{v_0 - E_0}{R_p} e^{-(R_p/L)(t-t_0)} + \text{const.} \quad (5)$$

From (4), by derivations one can obtain i_c , the capacity current:

$$i_c = -c \frac{d(v_a - E_0)}{dt} = -\frac{c}{L} R_p (v_a - E_0) e^{-(R_p/L)t}. \quad (6)$$

Comparing (5) and (6), it is clearly seen that in order to have i_c negligible as compared with i_1 , it is necessary to have the ratio L/C very high as compared with R_p^2 , that is precisely so in our case.

(c) The capacity comes into consideration when i is almost equal to i_1 , that is, when the differential resistance, $R_p = dv_a/df''(v_a)$, begins to increase noticeably, approaching the greatest magnitude that must be considered for the plate voltage v_1 . At voltage v_1 , at which the differential resistance $dv_a/df''(v_a)$ becomes negative, the capacity is practically all that determines the oscillations, which is easily accounted for if one realizes that without the capacity it would be impossible to have a current i decreasing with time and a voltage, $v = -L di/dt$, negative at maximum inductance at the same time.

During a process analogous to the above it can be shown that on making $L/C \gg \rho^2$, the variation in inductive current must be negligible as compared to the variation of the capacity current. Making $i_c = i_1 - i$, and if the negative differential resistance $-R_n = dv_a/di$, remains constant, we can write.

$$C \frac{dv_a}{dt} = -i_c = \frac{v_a - v_1}{R_n} \quad (7)$$

(7) is a differential equation describing the law of variation of v_a with time, which has a time constant CR_n . Expressing CR_n numerically, it is found that it is much smaller than L/R_p which is seen in (3). In fact, the oscillograph results confirm the great difference between the rapid variation of the current³ i in the phase considered, the slow rise of the inductance, and the present phase of rapid discharge of the capacity.

(d) When v_a reaches the value v_2 , at which current i is zero (now identifiable with i_a of the plate because of the absence of grid current) the oscillations are reduced to those of the free LC circuit without any action on the part of the triode. In accordance with the hypothesis of a

³ By placing a small supplementary inductance in series with the plate circuit, one can get the maximum voltage from it in the form of a sharp break. The oscillator can thus be operated for the production of very high harmonics like the Abraham multivibrator.

constant L , the oscillation in this new phase then describes a damped sinusoidal curve, during which the voltage v_a reaches a maximum and drops to a value of v_2' , when the plate current starts to pass through the triode again.

If we study the various oscillograms for this free oscillation phase, it is seen that there is a good agreement with the data that can be easily predicted theoretically. Since the oscillating current tends to assume a value much lower in descending than that assumed in rising, it is probable that the LC circuit causes a strong positive damping but one must not lose sight of the fact that the inductance effect is large enough to give a constant value of L .

(e) The value v_2' of the plate voltage at which the plate current starts to pass through the triode, may or may not coincide with the value v_2 at the instant the dynamic oscillograph characteristic starts to change from the falling line to the rising line. Let us now refer to the first case ($v_2' = v_2$), which occurs when $k = 1/2$ (Fig. 8a). The oscillograms of the various currents show that on leaving v_2 a new oscillation phase starts, determined primarily by the capacity which quickly flashes across the triode. This takes place as long as the triode has a negative differential resistance, which is the greater part of the period up to a positive resistance, the capacity current predominates over the inductance current which gives great frequency variation of v_a ; it has not sufficient time to undergo any great reduction in absolute value. At the end of the phase, with the value v_a close to zero, the capacity current is reduced almost to zero, and the oscillations begin to be determined by the induced current. The new oscillation phase starting at this point is chiefly due to the slow release of electromagnetic energy.

The value v_0 of v_a , at which the inversion of the sign of the variations of v_a takes place, is related to the value I_2 , assumed when the oscillating current passes through the inductance and capacity during its return circuit in relation to the voltage v_2 . Because of the strong damping of such currents, it seems decidedly lower than when rising in relation to the same voltage. The voltage v_0 also may be negative which is in perfect agreement with the static characteristics.

(f) It is now very easy to calculate, as also in the case in which there were phase displacements between the descending and ascending lines for the dynamic characteristics ($k = 1$ and 2), and this is the case in which v_a is different and lower than v_2 ; the oscillations must start to change in the manner just considered, aside from a minor maximum value for the capacity current in the return circuit, and a greater duration of the phase of diminution of v_a .

The influence of the phase displacement is shown further in the

shape of the plate current curve in which i_a is determined from i_1 and i_c . In the case $k = 1/2$, the oscillograms of i_a clearly show the presence of two maxima of equal amplitude of which one, due to the capacity current in the return circuit, has a very sharp break, in the cases $k = 1$ and 2, the break, which must be very small due to phase displacements, does not appear to be affected by the grid current.

VII. OTHER EXPERIMENTAL RESULTS—INFLUENCE OF THE CAPACITY

Inasmuch as this study is intended to define the properties of the circuit in the case where the ratio $\sqrt{L}/c/\rho$ is very high, the final proofs here described have been calculated with a rather high capacity C , intended primarily to simplify the various oscillograph records. The minimum capacity due to the transformer winding is only 3 $\mu\mu\text{f}$. Decreasing the capacity C from a value of 100 $\mu\mu\text{f}$ to the minimum of 3 $\mu\mu\text{f}$, we see:

(a) That the increase in time and the rise of the line with slow variations in the plate current, due to the discharge of electromagnetic energy by the inductance, always remain practically the same. This is verified also by the increase in capacity by means of small fractions of micromicrofarads.

(b) That varying the capacity changes the duration of the phase in which the plate current is zero, and in which, as we know, the LC circuit oscillates freely of its own accord. For a very small capacity this phase of similar short duration is limited, for example, to less than one tenth of the whole period; accordingly the voltage v_a has very high values, which may reach 1500 volts.

(c) It is found, with slight approximations, that for small capacities (less than 50 $\mu\mu\text{f}$ for example) the maximum value of the voltage v up to maximum inductance and capacity satisfies the law: $v_{\text{max}} = 1/C + C_0$ where C is the external capacity derived from the inductance and C_0 is a constant which gives the actual capacity of the inductance. When increasing the capacity C to the value of 2.8 $\mu\mu\text{f}$, at which oscillation ceases, it is found that only in the immediate vicinity of cessation ($C = 2.7 \mu\mu\text{f}$) the plate current and voltage assume an approximately sinusoidal rise the amount of which, it is understood, depends on the amount of inductance obtained by iron. In the diagrams of the inductive current and capacity, some outline of the irregularity is always visible.

On making tests analogous to those now reported but with $k = 1$ and 2, we find that the particular oscillatory function which depends on the fact that L/C is much greater than ρ^2 , is much more marked than

in the case $k=1/2$. Also the value of the capacity of cessation is decidedly higher.

VIII. OSCILLATION FREQUENCY

Since the phase of slow current variation determined by the inductance takes up the greater part of the cycle, the oscillation frequency is found to be decidedly lower than that usual in the LC circuit and is essentially determined by the constants of the triode, by the type of the coupled reactive grid-plate, and by the constants of transformation. As is known, the duration of the phase of slow variations, T_0 is given by the expression:

$$T_0 = L \int_{v_0}^{v_1} \frac{df''(v_a)}{d(v_a)} \frac{d(v_a)}{v_a - E_0}$$

and in a more general case the value of T_0 may be obtained by graphic integration using as the base the curve $f''(v_a)$ in terms of v_a (static characteristics in Figs. 5 and 6).

Since in every case (especially with $k=1/2$) the effect of the difference v_1-v_0 on the results of rapid and approximate calculation of T_0 is small as compared with E_0 it is possible to keep the voltage v_a constant at a value about $v_1+v_0/2$ during all the phases of load and to keep the corresponding static characteristics perfectly rectilinear. Now we can write:

$$T_0 = L \frac{i_1 - i_0}{E_0 - \frac{I}{2}(v_0 + v_1)}$$

and from the oscillograms with a value of almost zero for i_0 we can assume:

$$T_0 = \frac{Li_1}{E_0 - \frac{I}{2}(v_0 + v_1)}$$

To obtain the complete period, T , and thence the frequency, $f=I/T$ we must add to T_0 the value T_1 , the duration of the free circuit oscillations phase, which can not differ greatly from $T_1=\pi\sqrt{LC}$ according to observations.

TABLE I

E_0	i_1	$E_0 - 1/2(v_0 + v_1)$	f	F
Volt 100	ma 75	80	98	98 cycles/sec
80	51	63	111	116
60	31	47.5	131	135
40	15	33	182	171
30	8.5	25	225	228

The table lists the values of the frequency f , calculated in the same manner for $L = 10$ henries, and also the values of F , determined experimentally for $k = 1/2$ for various values of E_0 of the e.m.f. of transformation (static characteristics of Fig. 6). One may think the approximations too great but it is not possible to get closer agreement between actual and calculated values without them. Giving k the values $1/2, 1, 2, 3$, etc. successively, one finds the values of the frequency as, $F = 98, 61, 36, 31.5$ cycles/sec., having in this case a load agreeing with the static characteristics. It is very interesting to see how the ratio T_0/T_1 (T_0 of the slow variation period) to the normal LC circuit period $T' = 2\pi\sqrt{LC}$, gives the value \sqrt{LC}/ρ in a way independent of the kind of triode used. If the term:

$$\frac{E_0 + \frac{I}{2}(v_0 + v_1)}{i_1}$$

having the values of one resistance, gives the formula

$$\frac{E_0 - \frac{I}{2}(v_0 + v_1)}{i_1} = \frac{\rho}{a}$$

it is seen that the observations of the static characteristics such as the numerical coefficient, depend solely on the type of reactive coupling and, like its value, could change approximately between 1 and 4 according to whether the coupling is slightly or very much beyond the limiting condition for cessation. It can be shown that this result is also applicable to triodes with other characteristics. In general one may then write:

$$\frac{T_0}{T'} = \frac{aL}{2\pi\rho\sqrt{LC}} = \frac{I + 4}{2\pi} \frac{\sqrt{LC}}{\rho}$$

IX. VOLTAGE MAXIMA

The voltage maximum, v_{\max} , at the height of the inductance and capacity reached during the free circuit oscillation phase, may easily be calculated by means of the above on the basis of the value I_0 of the oscillating current at the beginning of the phase. We get:

$$v_{\max} = I_0\sqrt{L/C} e^{-\delta/2\pi \arctan 2\pi/\delta}$$

where δ is the decrement of the circuit itself. As was seen during the analysis of the mechanism of oscillation, one can keep I_0 slightly less

than the maximum value of i_1 of the current i shown by the static characteristics. Putting i_1 in the form $i_1 = E_0/\rho/b$ we find (always in static characteristics) that the numerical coefficient b has values that depend primarily on the degree of reactive coupling and vary from one to about three units; secondly, this same coupling is little or much higher than the limiting conditions for starting oscillations. In general we have:

$$\frac{v_{\max}}{E_0} = (I + 3) \frac{\sqrt{L/C}}{\rho} e^{-\delta/2\pi \arctan 2\pi/\delta}$$

It is necessary to bear in mind continually that the decrement can not be defined with great precision in our case, and that the inductance L is never constant.

Also, the relation v_{\max}/E_0 is then in strict relation to the value of $L/C/\rho$ like the ratio T_0/T considered above. The formula as written gives an explanation of the experimental fact, emphasized above, that the values of the maximum voltages depend on those of the capacity.

X. SYNCHRONIZATION

These oscillations, by their nature, are very sensitive to the synchronizing forces such as are produced by an externally oscillating e.m.f. in the grid circuit. The synchronization may take place by multiplication or by reduction. This second case, suitable for realization with the oscillators we used, permits complete synchronization so that the circuit can not oscillate unless it has a lower frequency, for example by a reduction of 20 units or more. To obtain greater intensity of synchronized action, it is necessary to adopt a synchronizing e.m.f. sufficiently high, but never of greater value than the proper e.m.f. for the synchronized oscillator, because otherwise oscillation will cease.

Circuits thus prepared with special attention to synchronous action, can be used in static reduction installations for the absolute measurement of high frequencies.⁴

XI. CONCLUSIONS

In addition to those described, other tests have been made on circuits with decidedly different characteristics, and all the results obtained are of the same general type as those given here. It certainly can be stated that this study was very general. The fact that the value

⁴ F. Vecchiacci, "Bench for static reduction for the absolute measurement of frequencies up to 10^8 cycles/sec.," *Dati e Memorie sulla Radiocomunicazioni—Consiglio Nazionale delle Ricerche*, Rome, 1930.

of the inductance L is not constant, due to the iron, prevents more precise quantitative results, but this is not very important.

It seems as though a study with an air-core inductance would not be devoid of interest, and research would be valuable on other types of circuits in which reactively coupled auto-oscillation or even negative resistance, would be the source of capacity.

In addition to the static decreasing installations, the particular properties of the oscillation considered may possibly make it useful in stroboscopic regulation of the ignition of neon lamps, in the static elevation of continuous voltages for electrostatic uses, and in the increase of frequency with impulse excitation.



SELECTIVITY, A SIMPLIFIED MATHEMATICAL TREATMENT*

BY

B. DE F. BAYLY

(Department of Electrical Engineering, University of Toronto)

Summary—This paper gives a simple formula for finding the voltage gain of a resonant circuit at different frequencies in terms of that at resonance. Tables and curves are given in decibels below the resonant value so that calculations are quickly made.

Means of converting the ordinary radio-frequency circuit into an equivalent simple resonant circuit are given so that a close approximation of its behaviour may be obtained, especially in cascaded circuits of diverse tuning.

The criteria for maximum gain etc., are discussed by means of the equivalent circuit. A new expression for selectivity is proposed in terms of decibels below resonance. The principle of diverse tuning of cascading circuits to obtain band-pass effects is discussed.

CALCULATION OF RESONANCE CURVES

CONSIDER the circuit of Fig. 1.

$$I = \frac{V}{\sqrt{R^2 + \left(\omega L - \frac{1}{\omega C}\right)^2}} \quad (1)$$

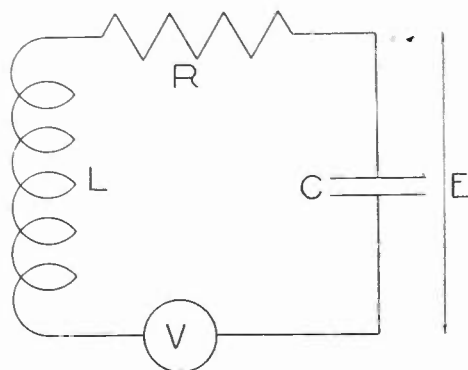

Fig. 1.

$$E = \frac{I}{\omega C} \text{ (neglecting phase angle and considering only absolute values).} \quad (2)$$

* Decimal classification: R162. Original manuscript received by the Institute, July 11, 1930. First presented at a meeting of the Toronto Section May 8, 1929. Presented before Fifth Annual Convention of the Institute, August 19, 1930.

Combining (2) and (3)

$$E = \frac{V}{\omega C \sqrt{R^2 + \left(\omega L - \frac{1}{\omega C}\right)^2}} \quad (3)$$

Let $\omega = K\omega_r$, where ω_r is the angular velocity at resonance, then

$$E = \frac{V}{K\omega_r C \sqrt{R^2 + \left(K\omega_r L - \frac{1}{K\omega_r C}\right)^2}} \quad (4)$$

but

$$\omega_r L = \frac{1}{\omega_r C}$$

$$\therefore E = \frac{V\omega_r L}{K \sqrt{R^2 + \omega_r^2 L^2 \left(K - \frac{1}{K}\right)^2}} \quad (5)$$

Let

$$Q = \frac{\omega_r L}{R}$$

$$E = \frac{V}{\sqrt{\frac{K^2}{Q^2} + (K^2 - 1)^2}} \quad (6)$$

when

$$K = 1$$

$$E_r = QV \quad (7)$$

$$\therefore \frac{E_r}{E} = \sqrt{K^2 + Q^2(K^2 - 1)^2}. \quad (8)$$

But the loss in decibels below resonance

$$= 20 \log_{10} \frac{E_r}{E}$$

$$\text{from (8)} = 10 \log_{10} [K^2 + Q^2(K^2 - 1)^2]. \quad (9)$$

A table is given of various values of K^2 and $(K^2 - 1)^2$ in terms of K and from this the resonance curve in decibels may be quickly found for

any value of Q . (See Appendix I.) A chart has also been prepared (see Appendix II) giving the values directly in terms of various values of Q . The curves are so nearly symmetrical about the axis $K = 1$ that only values of K greater than 1 are given.

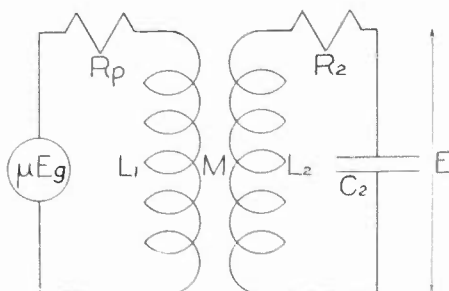

Fig. 2.

Example

In the circuit of Fig. 1 the following are the constants

$$f = 100 \text{ kc} \quad \omega = 6.280 \times 10^6$$

$$L = 240 \mu\text{h} \quad R = 7.54 \text{ ohms}$$

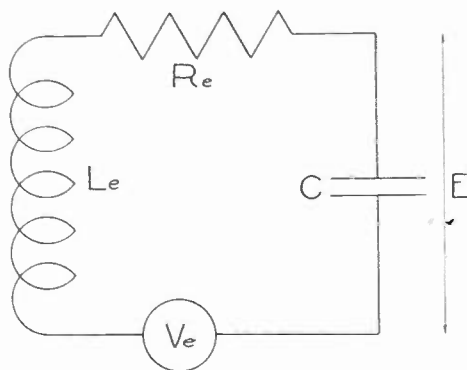

Fig. 3

We find therefore that $Q = \omega L / R = 200$. What will be the loss to a side band 5 kc away? Here $K = 1.005$ and from the chart the loss is 7 db. The loss at 10 kc from resonance would be 12.3 db.

THE TUNED RADIO-FREQUENCY CIRCUIT

The circuit of Fig. 2 is that most commonly employed.

It is easily shown by Thevenin's theorem¹ that as far as the voltage across C_2 is concerned the circuit in Fig. 3 is equivalent when the following conditions hold:

¹ K. S. Johnson, *Transmission Circuits for Telephonic Communication*, p. 79.

$$V_e = \frac{\mu E g \omega M}{|Z_1|} \quad (10)$$

$$L_e = L_2 - \frac{L_1 \omega^2 M^2}{|Z_1^2|} \quad (11)$$

$$R_e = R_2 + \frac{R_1 \omega^2 M^2}{|Z_1^2|} \quad (12)$$

If, as is usually the case, we are only dealing with small changes in ω of the order of one or two per cent, we can consider these equivalent values as constants. The value of Q_e can then be found from $\omega L_e/R_e$ and the circuit treated as before.

In a recent article published since the author presented this, a very comprehensive list of conversions is given.²

CONDITIONS FOR MAXIMUM AMPLIFICATION

The conditions for maximum gain are clear from the equivalent circuit.

The voltage across the condenser C_2 will be greatest when the current flowing in the circuit is greatest.

The conditions for this are:

(1) Reactance is zero.

(2) Maximum ratio of equivalent voltage to equivalent resistance.

(1) If reactance is zero

$$\omega \left(L_2 - \frac{L_1 \omega^2 M^2}{|Z_1^2|} \right) - \frac{1}{\omega C_2} = 0 \quad (13)$$

or

$$X_2 = \frac{X_1 \omega^2 M^2}{|Z_1^2|} \quad (14)$$

(2) The ratio of equivalent voltage to equivalent resistance

$$\frac{E_e}{R_e} = \frac{\frac{\mu E g \omega M}{|Z_1|}}{R_2 + \frac{R_1 \omega^2 M^2}{|Z_1^2|}} \quad (15)$$

² E. S. Purington, "Single- and coupled-circuit systems," *Proc. I.R.E.*, 18, 983-1016; June, 1930.

taking M as the variable and differentiating the maximum is found to be where

$$\omega^2 M^2 = \frac{R_2 |Z_1|^2}{R_1} \tag{16}$$

These two equations are in agreement with previous results.³

MAXIMUM AMPLIFICATION PER STAGE

The voltage across condenser at resonance = $\frac{\omega L_e}{R_e} V_e$

= $Q_e V_e$

∴ the amplification at resonance = $\frac{Q_e V_e}{e_v}$

= $\frac{Q_e \mu \omega M}{Z_1}$

$$\text{Voltage amplification} = \frac{\omega \left[L_2 - \frac{L_1 \omega^2 M^2}{Z_1^2} \right] \mu \omega M}{R_2 + \frac{R_1 \omega^2 M^2}{Z_1^2}} \cdot \frac{\mu \omega M}{Z_1} \tag{17}$$

but from the previous obtained conditions for maximum amplification we then have

$$\text{Voltage amplification} = \frac{\omega \left[L_2 - L_1 \frac{R_2}{R_1} \right]}{2R_2} \cdot \mu \sqrt{\frac{R_2}{R_1}} \tag{18}$$

As R_2 is very much smaller than R_1 this is very close to

$$\begin{aligned} &= \frac{\omega L_2}{2R_2} \cdot \mu \sqrt{\frac{R_2}{R_1}} \\ &= \frac{1}{2} \cdot \frac{\omega L_2}{\sqrt{R_2}} \cdot \frac{\mu}{\sqrt{R_1}} \end{aligned} \tag{19}$$

This will be seen to be the same result as previously obtained. It will also be seen that $Q_e = Q_2/2$ very nearly.³

In passing it might be mentioned that as regards gain $\omega L/(R)^{1/2}$ is

³ V. G. Smith, "A mathematical study of radio-frequency amplification," PROC. I.R.E., 15, 525, June; 1927.

the coil factor of merit. But as regards selectivity $\omega L/R$ is a better guide.

CONSTANT FOR SELECTIVITY

The present method of describing selectivity is usually stated as the width of the band at some percentage of maximum gain.

Now that the use of the logarithmic ratio or decibel is becoming widespread it appears much more useful to quote selectivity in terms of db.

For instance it could be said that at 1000-kc the 5-kc selectivity was 7 db, and the 10-kc selectivity was 15 db. This immediately gives us the important information that the 5 kc side band is reduced in volume 7 db and then the next interfering carrier at a separation of 10 kc was

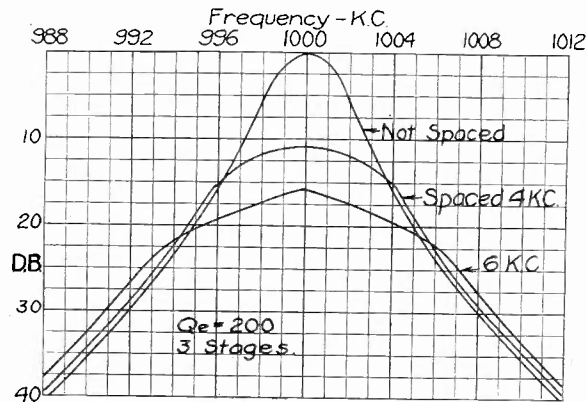

Fig. 4

reduced 15 db below the signal carrier. This information is not readily obtainable from the previous method of description.

In view of the increasing use of linear detectors this information is acquiring greater importance as it is more easily interpreted in terms of the received audio power.

STAGGERED CIRCUITS

It has been proposed at various times that the various stages of a cascaded amplifier be slightly detuned to give less cutting of the side bands and greater freedom from interference.

By means of the methods mentioned earlier, it is possible to construct curves of selectivity of detuned stages. In Fig. 4 is shown the effect of detuning the stages of a three-stage amplifier different amounts at 1000 kc, one stage being tuned higher, one lower, and the third tuned exactly. These curves are easily drawn by means of the table or chart in Appendices I and II. The constant used is $Q_e = 200$

which would be obtained by using the coil having $Q_2 = 400$ in a circuit giving maximum amplification. This is a much better coil than could possibly be used commercially owing to space requirements but it shows the effects of detuning more clearly. Poorer coils show less flattening of the top of the curve.

Several effects are immediately noticed on examination of curves of this type. It has been claimed that the selectivity can be improved by means of diverse tuning or spacing of the several stages. It is seen from the curves that the more the spacing the wider the curve at the base. This means that the interfering signal comes in at least as strong and if anything slightly stronger. The desired signal on the other hand is much reduced in volume. The actual selectivity, therefore, is far less.

The audio response certainly improves with spacing as can be seen by a comparison of the unspaced curve and the curve of 6-kc spacing in Fig. 4.

If better coils are used with staggered tuning the same selectivity with better audio characteristics can be obtained than with an unspaced amplifier having poorer coils. However, modern space requirements insist on such poor coils that the selectivity cannot usually be sacrificed by diverse tuning.

It will be observed in all the foregoing that the effects of regeneration have been omitted. It is almost impossible to allow for the effects mathematically although they can be measured. However, the modern tendency seems to be away from regeneration so the above results may be of interest.

When this paper was originally presented it was considered advisable to give some sort of visible demonstration of the effect of varying the tuning of individual stages of an amplifier, of double-tuned circuits, etc. It was thought that the method might be useful also for lining up r-f amplifiers observing changes in selectivity. A system was devised whereby the curve of selectivity was shown, qualitatively if not quantitatively, on an oscillograph screen.

APPENDIX I
 TABLE OF VALUES OF K^2 AND $(K^2-1)^2$ AS FUNCTIONS OF K

K	K^2	$(K^2-1)^2$
.900	.8100	.03610
.910	.8281	.02955
.920	.8464	.02359
.930	.8649	.01825
.940	.8836	.01355
.950	.9025	.009506
.960	.9216	.006147
.962	.9254	5559
.964	.9293	4999
.966	.9332	4468
.968	.9370	3966
.970	.9409	3493
.972	.9448	3049
.974	.9487	2634
.976	.9525	2249
.978	.9564	1894
.980	.9604	1568
.982	.9643	1273
.984	.9683	1008
.986	.9722	.000773
.988	.9761	569
.990	.9801	396
.991	.9821	322
.992	.9841	254
.993	.9860	195
.994	.9880	143
.995	.9900	100
.996	.9920	.000064
.997	.9940	36
.998	.9960	16
.999	.9980	.000004
1.000	1.0000	.000000
1.001	1.0020	.000004
1.002	1.0040	16
1.003	1.0060	36
1.004	1.0080	64
1.005	1.0100	.000100
1.006	1.0120	145
1.007	1.0140	197
1.008	1.0161	258
1.009	1.0181	327
1.010	1.0201	405
1.012	1.0241	583
1.014	1.0282	795
1.016	1.0322	.001040
1.018	1.0363	1319
1.020	1.0404	1632
1.022	1.0445	1979
1.024	1.0486	2360
1.026	1.0527	2775
1.028	1.0568	3224
1.030	1.0609	3709
1.032	1.0650	4228
1.034	1.0692	4782
1.036	1.0733	5372
1.038	1.0774	5998
1.040	1.0816	6659
1.050	1.1025	.01051
1.060	1.1236	1528
1.070	1.1449	2100
1.080	1.1664	2769
1.090	1.1881	3538
1.100	1.2100	4410

APPENDIX II

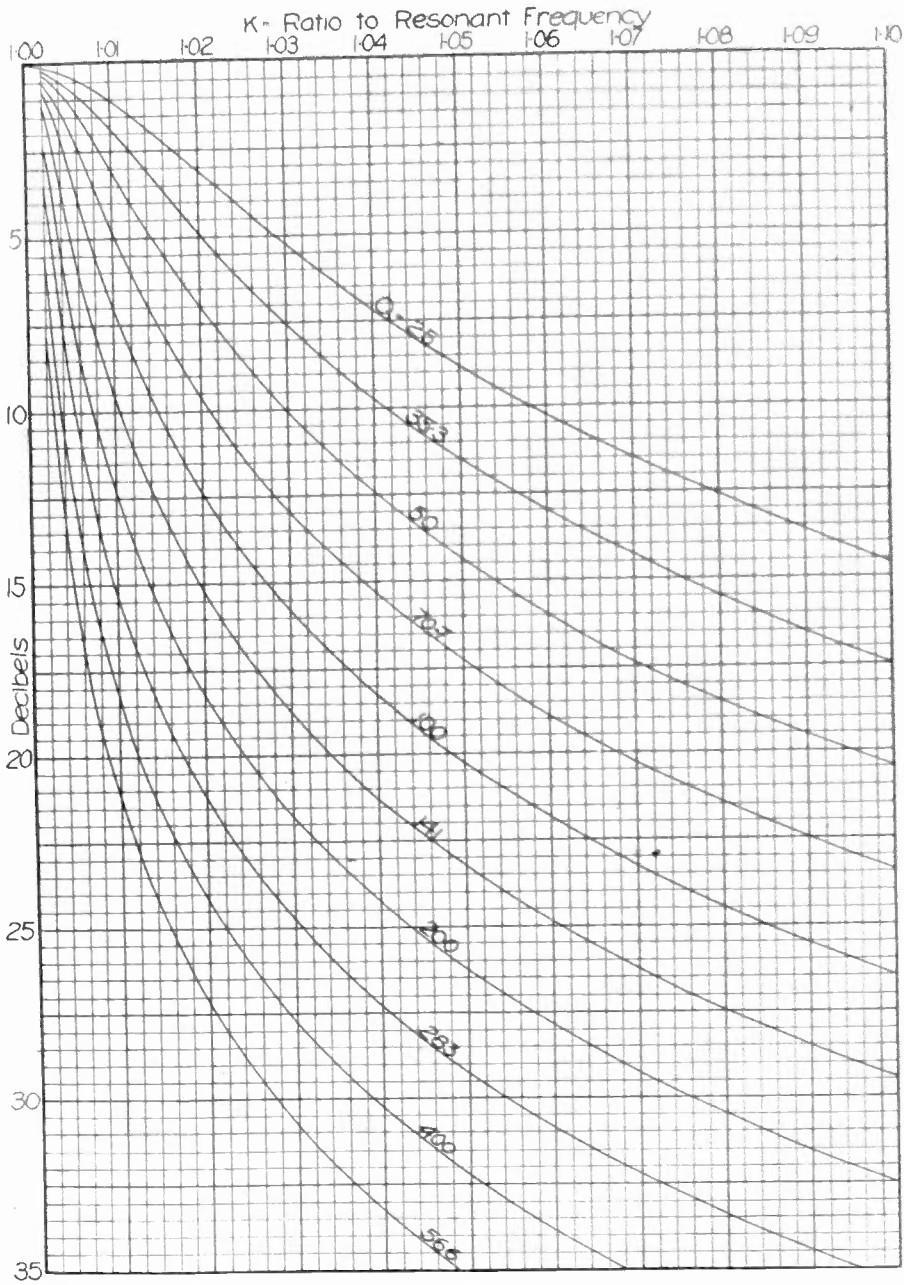

EFFECTS OF SUN SPOTS AND TERRESTRIAL MAGNETISM ON LONG-DISTANCE RECEP- TION OF LOW-FREQUENCY WAVES*

BY

EITARO YOKOYAMA AND TOMOZO NAKAI

(Electrotechnical Laboratory, Ministry of Communications, Tokyo, Japan)

Summary—Daily average variations of sun spots and field intensity are not simply related. What mostly occurs are the effects which vary as the period of the sun's rotation and one-half thereof. Phase relations are generally found in about 180 degrees and 90 degrees. There is no indication of different effects between daylight and darkness waves.

The relation between their monthly average variations is, in general, not obvious. However, direct relation is observed on some stations in summer, whereas inverse relation is noted in winter in several cases, the relation being less clear in the latter season.

Daily average variations of terrestrial magnetism and field intensity are also not simply related. However, field intensity usually reaches its maximum from two to four days before the day of occurrence of magnetic disturbance and then gradually decreases until it reaches its minimum from two to four days after that day. There is also no indication of different effects between daylight and darkness waves. The relation is not clearly found for monthly average variations.

GENERAL CONSIDERATIONS

AUSTIN, Pickard, and other investigators have already made several valuable contributions on similar subjects. The authors have also studied this subject in order to obtain some knowledge of the effects, mainly in the Pacific area. An analysis was made from the results of a series of the field-intensity measurements¹ which were conducted at certain appointed times of the day during the period of more than one year extending from the autumn of 1926 to January, 1928, for the eleven stations whose transmitting wave frequencies were from 14.4 to 30 kc, the distances covered being as far as from 3000 to 18,000 km. The important particulars of the stations are given in Table I.

The change of solar radiation has recently come to be considered as the chief direct cause of the variations of all atmospheric phenomena, such as those of temperature, pressure, magnetic storm, strength of radio waves, etc. As it is believed that Wolf's number of sun spots

* Decimal classification: R113.5. Original manuscript received by the Institute, January 3, 1931. Abbreviated translation of the original paper in Japanese, *Electrotech. Lab. Researches*, No. 273, October, 1929; a companion paper of that in *Proc. I.R.E.*, 18, 1075; June, 1930.

¹ E. Yokoyama and T. Nakai, *Electrotech. Lab. Researches*, No. 229, June, 1928; No. 233, July, 1928; No. 238, September, 1928; No. 258, April, 1929.

varies almost directly as the change of solar radiation, more attention is paid at present to the correlation of the field intensity with sun spots than magnetic storm and others, as long as the direct study on solar radiation will not be extensively carried out. In the present paper, the relation of field intensity to sun spots has, therefore, been worked out more in detail than that to magnetic disturbance.

TABLE I

Name of Station	Wave Frequency in kc	Distance in km and Direction	Time of Measurements	
			LTTS	JCST
Bolinás (KET)	22.9	8145 EEN	14.40	7.40
			4.50	21.50
Bordeaux (LY)	15.7	10200 NNW	1.40	10.40
			11.20	20.20
Kahuku (KIE)	17.8	6095 E	16.30	12.00
			18.30	14.00
Malabar (PKX)	19.2	5920 SW	8.00	10.00
			14.30	16.30
M nte Grande (LPZ)	23.6	18300 E	18.50	7.50
			5.20	18.20
Palo (JRW)	30.0	3280 S	11.20	11.20
			22.20	22.20
Pear Harbor (NPM)	28.6	6115 E	13.30	9.00
			1.30	21.00
Rug v (GBR)	16.0	9490 NNW	2.00	11.00
			11.30	20.30
Saigon (A) (HZA)	18.5	4340 WSW	6.30	8.30
			18.30	20.30
Saigon (B) (HZA)	14.4	4340 WSW	12.40	14.40
Tananarive (HZD)	19.0	11540 WSW	10.00	16.00
Warsaw (AXL)	16.4	8580 NW	2.50	9.50
			14.20	21.20

LTTS = Local standard time at the respective transmitting station.
JCST = Japan Central Standard Time.

SUN SPOTS AND FIELD INTENSITY

In the present study, Wolf's number of sun spots has been referred to those observed by A. Wolfer² at Zürich. In order to separate the effect of sun spots on the field intensity from that due to other causes such as temperature, pressure, etc., the following analytical process has been taken for the results of the field intensity measurements. The whole period of measurements is first divided into sections of 27 days which have been regarded as the period of the sun's rotation or sun spots. The values of field intensity on the days of the same order in each section are then averaged, such as the mean of those on the first

² *Meteorologische Zeitschrift*, January, April, July, and October, 1927; January and April, 1928.

days, that on the second days, and so on. In order to minimize the influence of the season on the field intensity, the value on each day mentioned above is taken as a relative one expressed by the ratio of

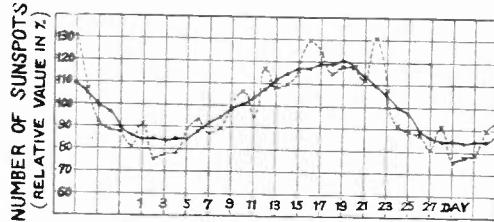

Fig. 1—Daily variation of sun spots.

the actual and the 27-day moving average values. A similar procedure is also applied to the analysis of sun spots.

By the broken-line curve of Fig. 1 is represented the average num-

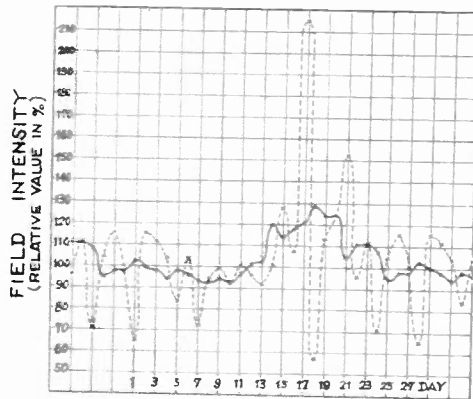

Fig. 2—Daily variation of field intensity for Bolinas. (21.40 JCST)

ber of sun spots thus obtained, and by those of Figs. 2 and 3, as examples, the average field intensity for two of the stations observed. In smoothing out the curves, their 7-day moving averages, which are

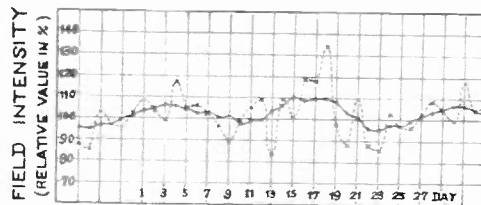

Fig. 3—Daily variation of field intensity for Kahuku. (14.00 JCST)

plotted in the full-line curves of the same figures, have also been taken.

The latter curves of sun spots and field intensities for the stations observed have then been analyzed into harmonics. The fundamental

and the second harmonic together with their phase relations are as shown in Figs. 4 and 5, except for Monte Grande, Pearl Harbor, and Tananarive, for which a sufficient number of data or desired accuracy in the measurements could not be obtained.

As seen in the figures, both in the fundamental and the second harmonic, the phase relations of sun spots to field intensity are mostly in

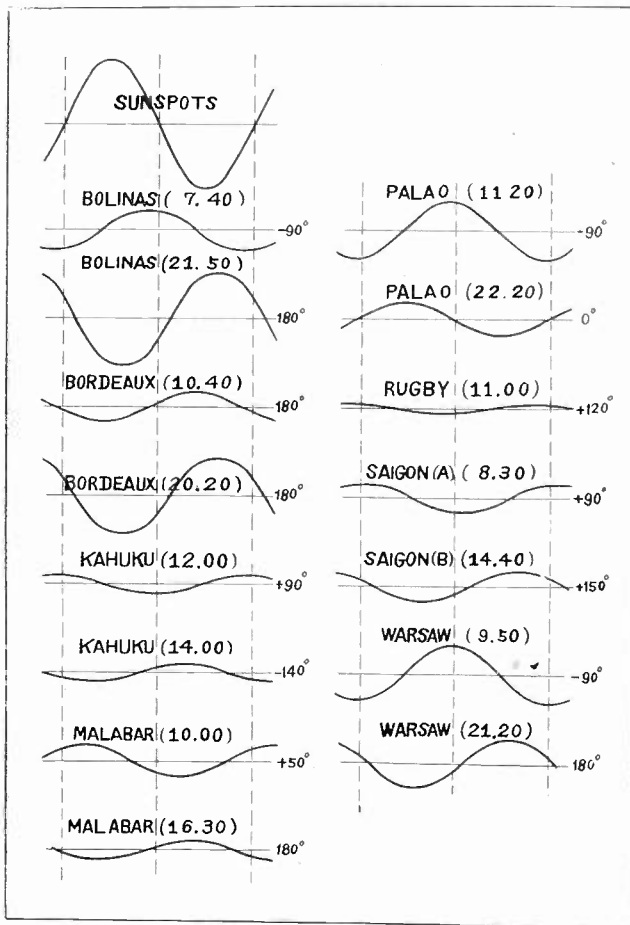

Fig. 4—Effect of sun spots on field intensity showing phase and amplitude of fundamental variation. (Time in JCST)

opposite or in quadrature, though some are found in other phase relations. The amplitudes of the field intensity variations are generally so small that the measuring accuracy of the field intensity should be considered. It is, however, noticeable that the amplitude is not always greater in the fundamental than in the harmonic.

The relations between the monthly averages are briefly considered below. The monthly average curves for the field intensity of the

stations observed have given in previous reports,³ which will not be reprinted here. It must, of course, be understood that those curves involve all other effects rather than that of sun spots. Therefore, the effect of sun spots is, in general, not clearly seen, though the relations for some stations are found to be in agreement in summer, whereas in opposition in winter, an example being as shown in Fig. 6.

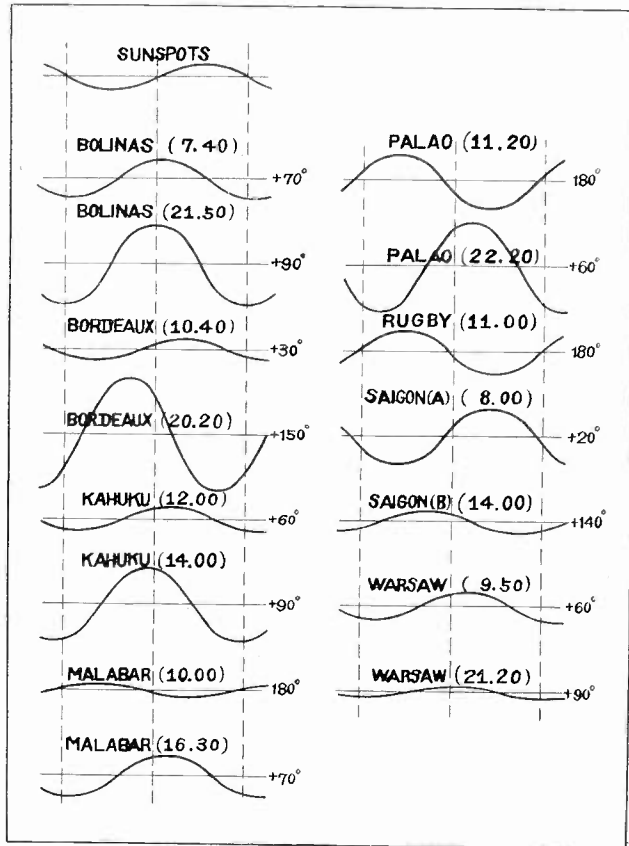

Fig. 5—Effect of sun spots on field intensity showing phase and amplitude of second harmonic variation. (Time in JCST)

It is natural that apparent relations could not be found from the results of the authors' short period observations. If such measurements were continued over several years as those carried out by Austin and the results analyzed, referring only to the number of sun spots which were localized in the central part of the surface of the sun in accordance with the way adopted by Pickard,⁴ the relations might have been found more obviously.

It has been generally concluded by Pickard⁵ that the field intensity

³ See footnote 1.

⁴ G. W. Pickard, Proc. I.R.E., 15, 1004; December, 1927.

⁵ G. W. Pickard, Proc. I.R.E., 15, 749; September, 1927.

of daylight waves varies as the number of sun spots, whereas that of night waves varies inversely as the latter. However, the night variations of the short waves (8000 to 9000 kc) of Honolulu, San Francisco, San Diego, Balboa (Panama), and Staten Island (N. Y.), which were received in Washington in the same year, are against his conclusions, though the daylight variations of the long waves of New Brunswick, Marion, and Tuckerton, which were received at Chelmsford in 1921,⁶ and the night variation of the broadcast waves of WBBM mentioned above are in agreement.

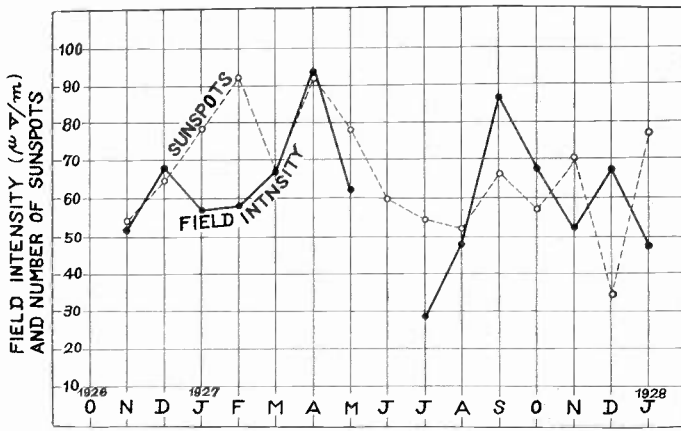

Fig. 6—Monthly average variations of sun spots and field intensity.—Bolinás (2.50 JCST)

In the present study, the relation was found not so simple as concluded by Pickard, and no difference of the effect was observed between daylight and darkness waves.

TERRESTRIAL MAGNETISM AND FIELD INTENSITY

It goes as far as the authors are aware that the sun spots and the magnetic declination vary directly in annual average, whereas the relation is not obvious in monthly and daily averages. As the relation of field intensity to sun spots is not so simple as mentioned above, it will be expected that the relation of field intensity to terrestrial magnetism is not equally simple. The results of analytical study on the daily relation of the former to the latter are as shown in Table II.

As to the variation of terrestrial magnetism, the character numbers which were obtained from the observations made at the Kakioka Magnetic Observatory of Japan have been adopted. There are two kinds of magnetic disturbances—one which extends over the whole world and the other which is localized in a limited area. It is, therefore, a

⁶ C. N. Anderson, *Proc. I.R.E.*, 16, 297; March, 1928.

matter of course that the value observed at Kakioka cannot always be taken as that at any other place.

The character number is divided into three groups, 0, 1, and 2, according to the magnitude of disturbances. Group 0 represents that of a normal day, and group 2 that of a day of severe disturbance (magnetic storm), while group 1 represents that of medium disturbance.

TABLE II

Name of Station	Time of Measurements (JCSST)	Total Number of Disturbances	⊖	∅	∩	⊕
Bolinás	7.40	27	7	3	0	0
	21.50	6	5	3	1	0
Bordeaux	10.40	18	1	4	2	2
	20.20	6	3	2	1	1
Kahuku	12.00	24	10	8	6	2
	14.00	26	8	4	2	4
Malabar	10.00	28	3	3	0	1
	16.30	21	6	2	0	1
Palao	11.20	14	5	7	0	2
	22.20	6	2	2	0	1
Rugby	11.00	21	6	1	2	1
Saigon (A)	8.30	15	5	3	0	2
Saigon (B)	14.40	14	5	2	3	0
Tananarive	16.00	19	6	3	2	1
Warsaw	9.50	8	1	1	1	0
	21.20	20	4	2	3	3

⊖ Number of cases where intensity increased on a day before and decreases on a day after the day of disturbance.

∅ Number of cases where intensity decreases on a day before and increases on a day after the day of disturbance.

∩ Number of cases where intensity decreases on the day of disturbance.

⊕ Number of cases where intensity increases on the day of disturbance.

“Total number of disturbances” in the table means all of magnetic disturbances of the character numbers 1 and 2, counted together, which were used for the present analysis. No attempt, however, has been made to prove that effects other than those of terrestrial magnetism, such as those due to sun spots, meteorology, etc., are separated for the values of field intensity considered. Variations greater than 20 per cent during the period from June to September when the atmospherics are prevalent and those greater than 10 per cent during the remaining period of the year only are taken into consideration, for fear some possible errors might come from the field intensity measurements. Monte Grande and Pearl Harbor are also excluded from the present analysis.

As shown in the table, the relation is not so simple as expected. To attempt an analysis, the effect of the magnetic disturbance was observed mostly on the days immediately before and after the days on

which the disturbances actually took place. Among such cases the field intensity usually reaches its maximum from two to four days before the day of occurrence of disturbance and then gradually decreases until its minimum is reached some days after that day. Even in the case of the same disturbance, there are, however, found a few cases where the field intensity of a station became maximum on a day immediately after the very day and that of another station reached its maximum immediately before.

There appeared three or four magnetic storms over the whole period of measurements. The similar study as arranged in Table II has been

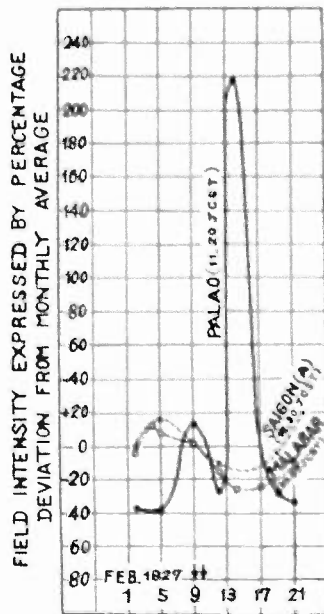

Fig. 7—An example of the relations between magnetic disturbance and field intensities.

made for those cases with the similar results obtained. In the case of magnetic storms, the average greatest value of field intensity was found to be about 130 per cent compared with the monthly average.

In Fig. 7 is shown a conspicuous example for Palao on February 9 and 10, 1927, where the field intensity reached a remarkably high value in the case of the disturbance of the character number 1. The effects on the two other stations are also shown, for comparison, in the same figure. Such a striking effect was never experienced throughout the present experiment even in case of the disturbance of the character number 2.

If the world-wide and local magnetic disturbances be separately taken into account and the exact times of occurrence be known, the mutual relation may be found more definitely.

According to the investigation made by Pickard,⁷ the field intensity of broadcast waves at night reached the maximum from two to four days before and the minimum from two to four days after the day of disturbance, whereas that of daylight long waves went on the contrary. Anderson's experiments^{8,9} on daylight long waves gave the same results as in those of Pickard, whereas the intensity of long waves at night reached the minimum on the day of disturbance. Mesny¹⁰ also endorsed Anderson's conclusions. Wymore's results¹¹ on long-distance, long-wave receptions were in agreement with those of Pickard on daylight waves, while, on the other hand, Wymore's results on medium-distance, long-wave daylight receptions gave the minimum intensity on the day, the maxima being reached some days before and after the day of disturbance. Some other results were obtained with short waves.^{12,13}

In the present analysis, the relation was also not so simple as mentioned above and no different effect was, however, found between daylight and darkness waves.

In conclusion, acknowledgements are due to Prof. Fujiwara, meteorologist, who kindly gave the authors his valuable advice in the course of the present study, Mr. S. Kanda, astronomer, who kindly revised the manuscript and also to Messrs. M. Koyanagi and T. Yamada of this Laboratory who rendered assistance in connection with the preparation of the text.

⁷ See footnote 5.

⁸ See footnote 7.

⁹ C. N. Anderson, *Proc. I.R.E.*, 17, 1528; September, 1929.

¹⁰ R. Mesny, *L'Onde Electrique*, 8, 103; March, 1929.

¹¹ I. J. Wymore, *Proc. I.R.E.*, 17, 1206; July, 1929.

¹² See footnote 10.

¹³ H. B. Maris, and E. O. Hulburt, *Proc. I.R.E.*, 17, 494; March, 1929.



REFLECTION OF ELECTROMAGNETIC WAVES AT IONIZED MEDIA WITH VARIABLE CONDUCTIVITY AND DIELECTRIC CONSTANT*

BY

G. J. ELIAS

(Technical University, Delft, Holland)

Summary—Using the electrical properties obtained by the higher atmosphere on account of the ionization caused by the ultra-violet radiation of the sun and the corpuscular rays sent out from it conclusions are drawn about the height where electromagnetic waves are reflected and the reflected amplitude. In this way results can be obtained in good agreement with the observations. The influence of hydrogen in the upper atmosphere is discussed. Finally the reflection time for a signal is calculated.

NOTATIONS

ϵ	dielectric constant
μ	permeability
g	conductivity
k	exponential constant, determining the variability of ϵ and g
η	quantity in the expression for ϵ
ω	frequency multiplied by 2π
c	velocity of light in vacuo
w	variable, depending on the coördinate z
β	phase angle in the expression for w
ϕ	angle between the direction of propagation and the z -axis
λ	wavelength in vacuo
z	vertical coördinate from the point, where $g = \omega/4\pi$
h	height above the surface of the earth
h_0	value of h , when $z = 0$
h_1	height, where the reflection takes place chiefly
z_1	value of z , when $h = h_1$
x, y	coördinates parallel to the ionized layer
n	number of molecules per unit of volume
n_0	value of n when $h = 0$
n_1	number of ions resp. electrons per unit of volume
c_1, c_2	constants in the expression for n_1 in nitrogen gas
c_1', c_2'	constants in the expression for n_1 in hydrogen gas
q	absolute value of the charge of an electron
l	mean free path of an electron
l_0	value of l when $h = 0$

* Decimal classification: R113.6. Original manuscript received by the Institute, December 17, 1930.

v_0	mean velocity of electrons in thermal equilibrium
m	mass of an electron
α_1	constant, determining the change of density with height in nitrogen gas
α_1'	constant, determining the change of density with height in hydrogen gas
c_ω	constant only dependent on frequency and ionization constants
n_{10}	constant in exponential expression for n_1
σ	constant, determining the duration of a signal
t	time
t_i	time of maximal amplitude of an incident signal
t_r	time of maximal amplitude of a reflected signal
e	base of natural logarithms
i	imaginary unity
\ln	natural logarithm
\log	ordinary logarithm
$H^{(1)}$	Hankel function of the first kind
$p = 2\omega/ck$	
$\alpha = ip \cos \phi$	
$\tau = 2\pi/\lambda_0 (ct - z \cos \phi - y \sin \phi)$	
b, a', b'	constants in the expressions for the reflection time of a signal

When not expressly mentioned units of the Gauss c.g.s. system are used.

1. Let us assume a horizontally stratified layer with a conductivity and a dielectric constant varying in the vertical direction as

$$g = \frac{\omega}{4\pi} e^{kz}, \quad \epsilon = 1 - \eta e^{kz}. \quad (1)$$

The permeability may be equal to unity. Some time ago the author pointed out,¹ that in this case, if the electric field is parallel to the layer, the electric field intensity equals

$$H_\alpha^{(1)}(w) \cdot e^{-i\omega y \sin \phi/c}, \quad (2)$$

where,

$$w = p \cdot \sqrt{1 + \eta^2} \cdot e^{kz/2} \cdot e^{\frac{i(\pi + \beta)}{2}} \quad (3)$$

$$\alpha = ip \cos \phi, \quad p = \frac{2\omega}{ck}, \quad \operatorname{tg} \beta = \frac{1}{\eta},$$

¹ G. J. Elias, *Tydschr. v. h. Nederl. Radio Genootsch*, 4, 79, 1930; *Elek. Nach. Tech.*, 8, 4, 1931.

while $H_\alpha^{(1)}$ is the Hankel function of the first kind. The same expression (2) yields the magnetic field intensity, if this field is parallel to the layer, and if we suppose, that p is a large number, which will be the case, when $k \cdot \lambda$ is small in relation to 4π . When this is not the case, the expression for the magnetic field intensity supposed parallel to the layer is more complicated.

On the supposition that the field is given by (2), we obtain the incident and the reflected wave by approximating the Hankel function for very small values of $|w|$. In this way we procure the reflected wave by multiplying the incident one by the factor.

$$- e^{-p\pi \cos \phi} \cdot \left(\frac{w}{2}\right)^{2\alpha} \frac{\Gamma(1 - \alpha)}{\Gamma(1 + \alpha)}. \quad (4)$$

For a large value of $|\alpha|$ resp. p we can make use of the asymptotic expansion of the Γ -function, which gives us

$$i \cdot e^{-p\beta \cos \phi} \cdot \frac{e^{2i\omega z \cos \phi / c} \cdot e^{2ip \cos \phi}}{(4 \sin \beta \cos^2 \phi)^{ip \cos \phi}} \quad (5)$$

When $|\alpha|$ resp. p is small, the reflection factor (4) reduces nearly to

$$- e^{\frac{-\pi p \cos \phi}{2}} \cdot \left(\frac{p}{2}\right)^{2ip \cos \phi} \cdot e^{\frac{2i\omega z \cos \phi}{2}} \quad (6)$$

The modulus of the reflection factor gives the reflected amplitude, the argument is the phase of the reflected wave.

On the other hand the author calculated² the ionization of the upper atmosphere under the influence of the ultra-violet light of the sun. For the number of ions resp. electrons in the unit of volume with some approximations there was found the formula

$$n_1 = c_1 e^{-c_2 e^{-\alpha_1 h}}. \quad (7)$$

In deducing this expression there was used for the number of molecules in the unit of volume the formula

$$n = n_0 e^{-\alpha_1 h}. \quad (8)$$

Assuming that the upper atmosphere consists only of nitrogen gas and that its temperature is 220 degrees Absolute $\alpha_1 = 1.5 \times 10^{-6}$. The temperature of 220 degrees Absolute was proposed by Wegener.³ In investigations of a more recent date it is suggested that the tempera-

² G. J. Elias, *Tydschr. v. h. Nederl. Radio Genootsch.*, 2, 1, 1923; 3, 1, 1926; *Elek. Nach. Tech.* 2, 351, 1925; *Zeits. f. Hochfrequenz.*, 27, 66, 1926.

³ A. Wegener, *Physik. Zeits.*, 12, 170, 1911.

ture of the upper atmosphere may be higher. If this is really the case α_1 would be smaller with the result, that a particular value of the ionization would be situated at a higher level. Nevertheless, the phenomena described further on would remain substantially unaltered, while the electronic free path for any particular value of the ion density undergoes only a very slow variation by change of temperature, when the variation in height is considerable.

In the publications mentioned the constants c_1 and c_2 were calculated making use of experimental data available, but the necessary

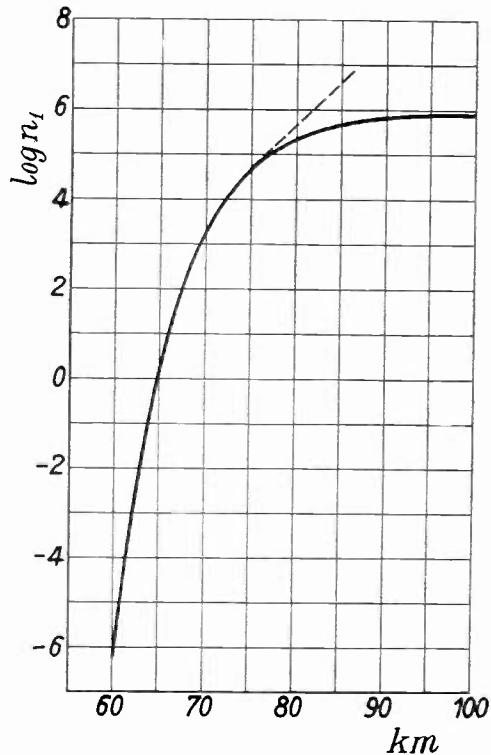

Fig. 1—Ordinary logarithm of ion density in the case of the action of ultra-violet light in nitrogen gas.

data not being all known, same estimations had to be made also. Probably the estimation of the molecular absorption index of the ultra-violet light of the sun in the atmosphere was too low and so there was now taken the tenfold value, namely, 2×10^{-20} . Consequently the ionized layer is raised by nearly 15 km, as was pointed out in earlier publications by the author. In the second place the estimation of the maximum density of the ions resp. electrons was rather too high. So there was put now $c_1 = 10^6$, $c_2 = 2.3 \times 10^5$. With these values the logarithm of the ion density as a function of the height above the earth was plotted. (See Fig. 1.)

In the following pages the author will try to draw conclusions about the reflection of electromagnetic waves, when the ion density varies as just described, making use of results (4), (5), and (6) about the reflection coefficient.

2a. The conductivity and the dielectric constant in the ionized layer are given by the well-known expressions⁴

$$g = \frac{n_1 q^2 v_0 l}{m(\omega^2 l^2 + v_0^2)}, \quad \epsilon = 1 - \frac{4\pi n_1 q^2 l^2}{m(\omega^2 l^2 + v_0^2)}. \quad (9)$$

From (1) we obtain $(1 - \epsilon)/g = 4\pi\eta/\omega$, which gives with the aid of (9) and (2)

$$\eta = \frac{\omega l}{v_0}, \quad tg\beta = \frac{v_0}{\omega l}. \quad (10)$$

Now the electronic free path l varies with h in the manner

$$l = l_0 \cdot e^{\alpha_1 h}. \quad (11)$$

Consequently η and β are functions of h resp. z . In further calculations the electron density n_1 is given by (7) with the constants c_1 , c_2 , and α_1 as mentioned. For v_0 there was put the value 10^7 corresponding to a temperature of 220 degrees Absolute. If this temperature is higher than assumed by Wegener the change of conductivity and dielectric constant on account of the variation of v_0 is not very considerable, while v_0 is proportional to the square root of the absolute temperature. For l_0 there was substituted the value 1.4×10^{-4} , experimentally found by Wahlin,⁵ which seems to be in good agreement with more recent experiments.⁶

In this way we get a curve for $\log g$ and $\log(1 - \epsilon)$, not differing much from the curve in the author's earlier publications.⁷ For the quite exact use of the assumption (1) we ought to have a straight line and not a curve for the quantities mentioned. Now for a relatively small difference of height these quantities may be treated nearly as linear functions of h resp. z , the exponential quantity k being given by the tangential direction of the curve. As we shall see further on the reflection takes place chiefly within a thin layer of the ionized medium. For the calculation of the reflection coefficient we shall take that value

⁴ Eccles, *Proc. Roy. Soc. (London)*, A 87, 79, 1912; *Electrician*, September, 1912; Salpeter, *Phys. Zeits.*, 14, 201, 1913; *Jahrb. d. drahtl. Telegr.*, 8, 247, 1914. The calculation of the mean free path in earlier publications by the author has to undergo a slight correction to deduce formula (9). For this remark the author is indebted to Prof. Dr. H. Benndorf (Graz.).

⁵ Wahlin, *Phys. Rev.*, 23, 169, 1924.

⁶ Bröse and Saayman, *Ann. d. Phys.*, 5, 797, 1930.

⁷ G. J. Elias, *Zeits. f. Hochfrequenz.*, 27, 66, 1926.

of k (and also that of l) corresponding to the thin layer most effective for reflection.

In the formula (9) for g and $1 - \epsilon$ the quantities n_1 and l are dependent on the height h ; they are given by (7) and (11). For the further calculation we shall distinguish between long waves, defined by $\omega l/v_0 \ll 1$, and short waves, for which we assume $\omega l/v_0 \gg 1$. In the intermediate region $\omega l/v_0$ will be of the order of unity.

For short waves the formula (9) for the conductivity reduces to

$$g = \frac{q^2 v_0 n_1}{m \omega^2 l}, \quad (12)$$

for long waves to

$$g = \frac{q^2 l n_1}{m v_0}. \quad (13)$$

By substituting (7) and (11) in (12) resp. (13) we get the exponential factor

$$e^{\pm \alpha_1 h - c_2 e^{-\alpha_1 h}},$$

where the sign $+$ is to be used for long waves, the sign $-$ for short waves, multiplied by a quantity not depending on the height. To identify the so-shaped expression with the assumption (1) for any particular height for long waves we must put

$$\frac{\omega}{4\pi} e^{kz} = \frac{q^2 l_0 c_1}{m v_0} e^{\alpha_1 h - c_2 e^{-\alpha_1 h}}.$$

This equation can be fulfilled in the vicinity of a particular value of h by putting

$$c_\omega + kz = \alpha_1 h - c_2 e^{-\alpha_1 h}, \quad \frac{\omega}{4\pi} e^{-c_\omega} = \frac{q^2 l_0 c_1}{m v_0}, \quad (14)$$

the constant c_ω depending on frequency and ionization constants only. In the same way we get for short waves

$$c_\omega + kz = -\alpha_1 h - c_2 e^{-\alpha_1 h}, \quad \frac{\omega}{4\pi} e^{-c_\omega} = \frac{q^2 v_0 c_1}{m \omega^2 l_0}. \quad (15)$$

In connection with (14) and (15) it must be remembered that $h=0$ corresponds to the surface of the earth, while $z=0$ defines the height, where $g = \omega/4\pi$, as follows from (1).

From (14) resp. (15) we get for an adjacent height h' resp. z'

$$c_\omega + kz' = \pm \alpha_1 h' - c_2 e^{-\alpha_1 h'}. \quad (16)$$

By dividing the difference of the first part of (14) resp. (15) with (16) by $z - z' = h - h'$ we get

$$k = \pm \alpha_1 - c_2 \frac{e^{-\alpha_1 h} - e^{-\alpha_1 h'}}{h - h'},$$

which gives for $h = h'$

$$k = \pm \alpha_1 + \alpha_1 c_2 e^{-\alpha_1 h}. \quad (17)$$

This is the value of k in the neighborhood of any particular value of h . If we assume the conductivity in this region to be proportional to e^{kh} , we have to put for long waves, using (11) and (13)

$$n_1 = n_{10} e^{(k - \alpha_1) h}, \quad (18)$$

and in the same way for short waves, using (11) and (12)

$$n_1 = n_{10} e^{(k + \alpha_1) h}. \quad (19)$$

In these equations k is determined by (17). The "constant" n_{10} will be a function of the height, which can be treated only as a constant within the thin layer most effective for reflection. With the aid of (7) n_{10} may be calculated for every value of h .

b. Reflection occurs chiefly there, where the absolute value $|H_\alpha^{(1)}(w)|$ diminishes rapidly with increasing height.

In the case of short waves ($\omega l/v_0 \gg 1$) the angle β is small. For the order of magnitude of pressure and temperature of the gas here involved p and likewise $|\alpha|$ will be great numbers as we shall see further on. Using then the approximation for large index and large argument of the Hankel function⁸ we infer that in the neighborhood of the point $|w| = |\alpha|$ the absolute value $|H_\alpha^{(1)}(w)|$ diminishes very rapidly with increasing value of $|w|$, while for smaller values of $|w|$ the function decreases very slowly. The modulus $|w|$ increasing from $|\alpha|$ to $2|\alpha|$ causes $|H_\alpha^{(1)}(w)|$ to be multiplied by $e^{-|\alpha|}$ nearly. The corresponding difference in height is only 2 km, if we put $k = 0.75 \times 10^{-5}$, valid for $h = 70$ km.

Thus the reflection of short waves takes place in a height, where $|w| = |\alpha|$. While in this case $\eta \gg 1$, we get on account of (3) nearly $|w| = p \cdot \sqrt{\eta} \cdot e^{kz/2}$. Further, $|\alpha| = p \cos \phi$, and we get for the height of reflection

$$\eta e^{kz_1} = \cos^2 \phi. \quad (20)$$

If the direction of propagation is vertical, $\phi = 0$ and the height of reflection is determined by $\epsilon = 0$, using (1).

⁸ G. N. Watson, A Treatise on the Theory of Bessel Functions, Chap. VIII. Cambridge, 1922.

On the other hand in the considered range of pressure and temperature p and $|\alpha|$ are small quantities for long waves ($\omega l/v_0 \ll 1$), while $\beta = \pi/2$ nearly. For $H_a^{(1)}(w)$ we can use then the well-known asymptotic expansion.⁹ It is obvious then that the function diminishes rapidly in the neighborhood of $|w| = 1$. On account of the small value of p it does not diminish so rapidly as in the former case. The height of reflection corresponding to $|w| = 1$ is given by

$$e^{kz_1} = \frac{1}{p^2}. \quad (21)$$

c. In determining the height of reflection for short waves we shall assume formula (19) for the ion density and for k the value for that height where $|w| = |\alpha|$. In connection with what was remarked previously—that a relatively thin layer of the ionized medium in the vicinity of this point is most effective for reflection—this assumption seems to be allowed as an approximation.

Let the height, where $|w| = |\alpha|$, be $h = h_1$. The ion density being given by (19) we find from (12)

$$g = \frac{q^2 v_0 n_{10}}{m \omega^2 l_0} e^{kh}.$$

For $z = 0$, $g = \omega/4\pi$, and the corresponding height h_0 is given by

$$\frac{4\pi q^2 v_0 n_{10}}{m \omega^3 l_0} e^{kh_0} = 1,$$

which gives us

$$h_0 = \frac{1}{k} \ln \frac{m \omega^3 l_0}{4\pi q^2 v_0 n_{10}}. \quad (22)$$

Further, when $|w| = |\alpha|$,

$$\eta = \frac{\omega l_0}{v_0} e^{\alpha_1 h_1}. \quad (23)$$

Finally the height h_1 is given by (20). From (20), (22), and (23) we get

$$h_1 = h_0 + z_1 = \frac{1}{k + \alpha_1} \ln \frac{m \omega^2 \cos^2 \phi}{4\pi q^2 n_{10}}. \quad (24)$$

Then we have on account of (7) and (19)

$$n_{10} e^{(k + \alpha_1) h_1} = c_1 e^{-c_2 e^{-\alpha_1 h_1}}. \quad (25)$$

⁹ G. N. Watson, *loc. cit.*, Chap. VII.

The quantity k is given by the formula, using (17),

$$k = -\alpha_1 + \alpha_1 c_2 e^{-\alpha_1 h_1}. \quad (26)$$

On eliminating $k + \alpha_1$ from (24) and (25) the result is

$$\frac{m\omega^2 \cos^2 \phi}{4\pi q^2} = c_1 e^{-c_2 e^{-\alpha_1 h_1}}. \quad (27)$$

From (27) we can deduce the height h_1 for any particular value of $\omega \cos \phi$, this product being the quantity on which the height of reflection depends. In this way the following table results

h_1 (in km)	$\omega \cos \phi$
70	2.6×10^6
75	1.3×10^7
80	2.8×10^7

The maximum value of $\omega \cos \phi$, corresponding to the maximum value c_1 of the density of ions resp. electrons, will be nearly 5.5×10^7 . If $\omega \cos \phi$ is still greater no appreciable reflection takes place, but the waves propagate further outward; perhaps they are absorbed if the layer is thick enough. For propagation on long distance $\cos \phi$ will be nearly 0.2 (see further on), thus the limiting frequency for reflection would be nearly $\omega = 2.8 \times 10^8$ (λ being about 7m).

In the same manner the height of reflection can be calculated for long waves ($\omega l/v_0 \ll 1$). The condition $g = \omega/4\pi$ for the height $z = 0$ gives us, using (13) and (18)

$$\frac{4\pi q^2 l_0 n_{10}}{m v_0 \omega} e^{k h_0} = 1. \quad (28)$$

The value of z_1 , which determines the height of reflection is given by (21). With the aid of (28) and (3) we get for this height

$$h_1 = h_0 + z_1 = \frac{1}{k} \ln \frac{m v_0 c^2 k^2}{16\pi \omega q^2 l_0 n_{10}}. \quad (29)$$

Further we infer from (7) and (18)

$$n_{10} e^{(k - \alpha_1) h_1} = c_1 l^{-c_2 e^{-\alpha_1 h_1}}, \quad (30)$$

while (17) gives

$$k = \alpha_1 + \alpha_1 c_2 e^{-\alpha_1 h_1}. \quad (31)$$

From (29), (30), and (31) the height of the reflecting layer can be calculated for the case $\omega l/v_0 \ll 1$. It is found to be nearly 65 km for the

usual long waves and to increase with decreasing frequency. For the short waves the height of reflection was found to increase with increasing frequency. So there must be an intermediate frequency with a minimum height of reflection.

d. Now we supposed in the preceding pages that the upper atmosphere consists of nitrogen and that the ultra-violet light of the sun is the only cause of ionization. In this case the ion resp. electron density reaches a maximum at a height of 90 to 100 km.

But there are two possible reasons for a greater height of the maximum of ionization. In the first place the sun sends out corpuscular rays, ionizing the upper atmosphere, in the second place the high atmosphere not only contains nitrogen gas, but probably other gases also.

The corpuscular solar radiation, in so far as it consists of α -rays, will cause an ionization of the atmosphere at a height not much greater than 75 km, as was shown before.¹⁰ If we suppose that this ionizing agent is powerful enough to cause a sufficient ion density the ionization caused by the combined action of the ultra-violet light and the corpuscular rays may reach a maximum at a greater height than would be the case for the ionization due to the ultra-violet light only. How far upward the ionization would increase and what would be the maximum ion density due to that combined action is quite unknown, but if the upper atmosphere consists of nitrogen gas only it is not probable that the height of maximum ionization would be much greater than 100 km.

But the conditions are wholly changed if the upper atmosphere contains hydrogen gas to an appreciable amount, as Wegener supposed. Then we get, using nearly the same approximations which led to (7), the following equation for the ion density

$$n_1 = c_1' e^{-c_2 e^{-\alpha_1 h} - c_2' e^{-\alpha_1' h}}, \quad (32)$$

where c_2' and α_1' are constants for the hydrogen gas, analogous to c_2 and α_1 for the nitrogen gas. The constant c_1' is, strictly speaking, not a constant, but varies very slowly with the height. For the regions, where hydrogen would be practically the only gas present, thus for the greater values of h , c_1' depends on the properties of hydrogen only and determines the maximum ion density. Probably this value will not differ greatly from c_1 . Using Wegener's suppositions we get $c_2' = 250$, $\alpha_1' = 0.011 \times 10^{-5}$. With the aid of these values, the values of c_2 and α_1 mentioned before, and putting $c_1' = 10^6$ as before for c_1 , Fig. 2 was plotted for the variations of the logarithm of the ion density with height for this case.

¹⁰ G. J. Elias, *Zeits. f. Hochfrequenz.*, loc. cit.

From Fig. 2 we infer that the maximum ion density now is reached at a much greater height than before. At the height of 75 to 80 km, where in the former case almost the maximum ion density was reached, the ionization is now quite inappreciable. The height of reflection h_1 will be given by a formula analogous to (27) viz.,

$$\frac{m\omega^2 \cos^2 \phi}{4\pi q^2} = c_1' e^{-c_2 e^{-\alpha_1 h_1}} - c_2' e^{-\alpha_1' h_1} \tag{33}$$

In the case now considered the hydrogen also will be ionized by the corpuscular radiation of the sun and this ionization will, if this radi-

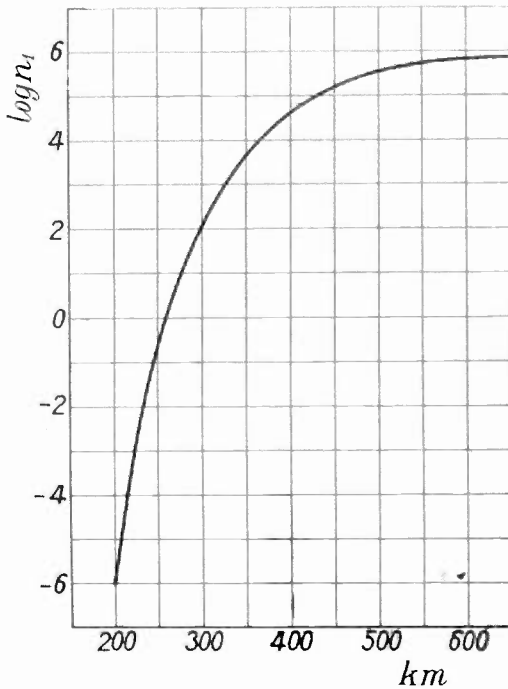

Fig. 2—Ordinary logarithm of ion density in the case of the action of ultra-violet light in a mixture of nitrogen gas and hydrogen gas according to Wegener's assumptions.

tion is powerful enough, extend to a still higher level than the ionization due to the ultra-violet light, as in the case of nitrogen only. In every case the maximum ion density will determine the maximum value of $\omega \cos \phi$ that might be reflected to an appreciable extent, using (33). Thus this limit value will depend on c_1' . The behavior of the "ultra-short" waves with respect to amplitude and height of reflection can thus give information on constitution and properties of the upper atmosphere.

3. The amplitude of the reflected wave follows from (4) and is

$$e^{-p\beta \cos \phi} \tag{34}$$

in proportion to the amplitude of the incident wave.

If $\omega l/v_0 \ll 1$ we can write, using (10), $\beta = \pi/2$, then the reflected amplitude is, with reference to (3),

$$e^{-\frac{\omega \pi \cos \phi}{ck}} \quad (35)$$

For a wavelength of 1 km ($\omega = 1.9 \times 10^6$), being reflected at a height of nearly 65 km, so that in reality $\omega l/v_0 \ll 1$, the quantity $\omega \pi / ck = 10$, using (17) for k . For rays leaving the earth tangentially and being reflected at 65 km height $\cos \phi$ would be 0.15. But we shall put $\cos \phi = 0.2$ while the rays being most effective for transmission will go slightly upward. When $\cos \phi = 0.2$ the reflected amplitude is e^{-2} , a quite appreciable value, which still increases with decreasing frequency. Thus, for wavelengths greater than 1 km the reflection is wholly satisfactory for the case where nitrogen is practically the only gas present.¹¹

If $\omega l/v_0 \gg 1$ we can write, using (10), $\beta = v_0/\omega l$ and the reflected amplitude is

$$e^{-\frac{2v_0 \cos \phi}{ckl}} \quad (36)$$

As remarked on p. 897 the quantities have to be taken for the height where $|w| = |\alpha|$, viz., the height of reflection. Thus the product kl , for which follows from (11) and (17) the relation

$$kl = \alpha_1 l_0 (c_2 - e^{\alpha_1 h_1}), \quad (37)$$

is implicitly a function of the frequency, because h_1 increases with the quantity $\omega \cos \phi$ on account of (27), so that kl decreases with the frequency, when $\cos \phi$ is supposed to remain constant. On account of (36) the reflected amplitude would decrease continually with frequency. For a height of reflection of 75 km, ($\omega \cos \phi = 1.3 \times 10^7$) we thus find $2v_0/ckl = 21$ and the reflected amplitude $e^{-4.2}$, if we put $\cos \phi = 0.2$. The corresponding frequency would be $\omega = 0.65 \times 10^8$ (wavelength of nearly 30 m), while p is found to be nearly 1480, thus a great number indeed (see p. 897).

For greater values of $\omega \cos \phi$ the quantity $2v_0/ckl$ would be still greater, thus the reflection less. Now at a height greater than 75 km the corpuscular rays of the sun will be active also, as pointed out on p. 897. By their influence the value of k will decrease slower than would be indicated by (17); eventually it may remain constant, as is shown by the dotted line in Fig. 1. If we assume that this will really

¹¹ A good agreement with recent observations of Appleton's, (*Proc. Roy. Soc., A*, 128, 133 and 159, 1930), about height and reflection coefficient of the E-layer is reached, if the molecular absorption index of the ultra-violet light is taken four times as great as above, thus, 8×10^{-20} , and a temperature of 275 degrees Absolute is assumed. Thus, this E-layer might be ascribed to the action of the ultra-violet light of the sun.

be the case, the quantity $2v_0/ckl$ in the exponent of (36) will decrease with h_1 on account of (11), and therefore with frequency, so that the reflected amplitude then would increase with frequency.

For a constant value of k for a height greater than 75 km the height of reflection will be given by a formula analogous to (27), viz.,

$$\frac{m\omega^2 \cos^2 \phi}{4\pi q^2} = n_{10} e^{kh_1}, \quad (38)$$

wherein we write the value of k for a height of 75 km, following from (17), namely 0.3, while the value of n_{10} will be determined by the ionization at the height of 75 km, as given by (7) and by substituting $h_1 = 75$ km in (38).

In this way we deduce from (38) that the difference in height of reflection for waves of a wavelength of 15 m with waves of 30 m will amount to 4.6 km, thus waves of 15 m would be reflected at a height of nearly 80 km. The value of $2v_0/ckl$ then is only 10, being nearly one-half of the value for this quantity for waves of 30 m.

The value for the reflected amplitude just found for waves of 15 m is the same as we found for waves of 1 km wavelength. Between these two wavelengths there must be then a region where the exponent in (34) has a greater value. In that region the reflection will be less, in good agreement with the observations.

So as we remarked on p. 900 reflection of the shorter wavelengths will be possible the further ionization increases with height; the reflected amplitude in every case will depend chiefly on the value of k at the height of reflection.

If the upper atmosphere contains hydrogen gas of an appreciable density the ionized layer would be situated at a much higher level as we saw on p. 900. The height of reflection and the reflected amplitude would then be given by formulas analogous to (27), (35), and (37) with constants relating to hydrogen gas. Using Wegener's assumptions the reflected amplitude would be found much smaller than for nitrogen gas only and surely too small to explain the propagation on great distances. For this reason the quantitative assumptions of Wegener about this question are not very probable.

The ultra-gamma rays are active also in ionizing the upper atmosphere.¹² According to the small absorption coefficient of these rays the value of k is nowhere greater than nearly 0.1, as can be deduced from Benndorf's publication. Moreover, the maximum ion density for the same reason will be reached at a much lower level than in the case of ionization by ultra-violet light. With $k = 0.1$ and

¹² H. Benndorf, *Phys. Zeits.*, 27, 686, 1926.

$\omega = 1.2 \times 10^6$ (wavelength nearly 1500 m)—in this case $\omega l/v_0 \ll 1$ —we get from (35) $\omega\pi/ck = 120$, a value for which practically no reflection takes place.

4a. Now we shall calculate the time necessary for the reflection of a signal, consisting in a train of waves with varying amplitude. We assume that the waves are plain and propagate in a direction, making an angle ϕ with the z -axis, and that for a particular point in the direction of propagation the wave amplitude first increases, then reaches a maximum and decreases afterwards. These conditions are fulfilled by the expression

$$f(\tau) = e^{i\tau - \sigma\tau^2}, \quad (39)$$

where,

$$\tau = \frac{2\pi}{\lambda_0}(ct - z \cos \phi - y \sin \phi).$$

Here λ_0 is the wavelength of the signal, the real constant σ determines the duration of the signal for a particular point. The amplitude is a maximum for $\tau = 0$, also in the point $y = z = 0$ for $t = 0$, while in the same point the amplitude is $1/e$ of the maximum amplitude, when

$$t = t_1 = \frac{\pm \lambda_0}{2\pi c\sqrt{\sigma}}. \quad (40)$$

On account of (40) the smaller the constant σ the longer the signal lasts. For a wavelength of 100 m and a value of t_1 of 10^{-1} the constant σ is about 3×10^{-13} . Thus in practical cases we have always $\sigma \ll 1$. This means that the duration of the signal consists of a great number of periods of the propagating wave.

We shall make use of the well-known Fourier integral for an arbitrary function

$$F(\tau) = \frac{1}{2\pi} \int_{-\infty}^{+\infty} \frac{d\omega}{\omega c} \int_{-\infty}^{+\infty} F(u) \cdot e^{i\omega(\tau - u)/\omega_0} du. \quad (41)$$

We get the incident signal by writing $F(u) = f(u)$, the function f being given by (39). To get the reflected signal we have to multiply for every frequency the reflection factor (4), so this factor must be introduced under the integral sign.

If λ_0 is a short wave in order that $|\alpha|$ has a great value we can use (5) for the reflection factor in the following form

$$i \cdot e^{-\rho\beta \cos \phi} \cdot e^{\frac{2i\omega z \cos \phi + 2ip \cos \phi}{c} \left[\frac{1 - \ln(2 \cos \phi) - \ln \sin \beta}{2} \right]}. \quad (42)$$

By introducing (39) and (42) in the integral (41) and integrating with respect to u we get

$$\frac{i}{2\pi\omega_0} \sqrt{\frac{\pi}{\sigma}} \int_{-\infty}^{+\infty} d\omega \cdot e^{-\frac{(1-\frac{\omega}{\omega_0})^2}{4\sigma} + \frac{i\omega\tau + 2i\omega z \cos \phi}{\omega_0 c}} \times e^{-p\beta \cos \phi + 2ip \cos \phi \left[1 - \ln(2 \cos \phi) - \frac{\ln \sin \beta}{2} \right]}. \quad (43)$$

Now assuming that really $\sigma \ll 1$ the value of (43) will be determined practically by the immediate neighborhood of the point $\omega = \omega_0$. Then it will be allowed to substitute in the quantities $p\beta$ and $\ln \sin \beta$ in the exponent of the last factor of (43), quantities varying only very slowly with ω , $\omega = \omega_0$. The named exponent then contains ω only in the quantity p and we get for (43)

$$\frac{i}{2\pi\omega_0} \sqrt{\frac{\pi}{\sigma}} e^{-(p\beta)_{\omega=\omega_0} \cos \phi} \int_{-\infty}^{+\infty} d\omega \cdot e^{-\frac{(1-\frac{\omega}{\omega_0})^2}{4\sigma} + \frac{i\omega\tau + 2i\omega z \cos \phi}{\omega_0 c}} \times e^{2ip \cos \phi \left[1 - \ln(2 \cos \phi) - \frac{\ln \sin \beta}{2} \right]},$$

which gives on integrating

$$i \cdot e^{-(p\beta)_{\omega=\omega_0} \cos \phi - \sigma\omega_0^2 b^2 - \sigma \left(\tau + \frac{2\omega_0 z \cos \phi}{c} \right) \left(\tau + 2\frac{\omega_0 z \cos \phi + 2\omega_0 b}{c} \right)} \times e^{i \left(\tau + 2\frac{\omega_0 z \cos \phi + \omega_0 b}{c} \right)}, \quad (44)$$

where,

$$b = \frac{4}{ck} \cos \phi \left[1 - \ln(2 \cos \phi) - \frac{1}{2} \ln \sin \beta_{\omega=\omega_0} \right].$$

We deduce easily from (44) that the amplitude of the reflected signal is a maximum, when

$$\tau + \frac{2\omega_0 z}{c} \cos \phi + \omega_0 b = 0. \quad (45)$$

The value of this reflected amplitude is $e^{-p\beta_{\omega=\omega_0} \cos \phi}$ related to the maximal amplitude of the incident signal. For the rest the quantity $\sigma\omega_0^2 b^2$ in the exponent of (44) is quite negligible with respect to $p\beta \cos \phi$ in practical cases. It results from (39) and (45) that the time of maximum amplitude of the reflected signal is

$$t_r = -\frac{z}{c} \cos \phi + \frac{y}{c} \sin \phi - b, \quad (46)$$

while this time for the incident signal follows from (39) to

$$t_i = \frac{z}{c} \cos \phi + \frac{y}{c} \sin \phi. \quad (47)$$

Thus,

$$t_r - t_i = -\frac{2z}{c} \cos \phi - b. \tag{48}$$

In (48) we have to take into account that the quantity z is always negative ($z=0$ defines the height, where $g = \omega/4\pi$) and must have a value so great that $|w| \ll 1$, because only in that case may we use the approximation leading to (4). It is easily shown that under these circumstances the time interval (48) is always positive, although b is positive.

Further we can state on account of the positive value of b that in the case considered here ($\omega l/v_0 \gg 1$) the "reflection time" (48) is smaller than it would be if the reflection took place at an ideal mirror on the height $z = 0$ when b would be zero. For the frequency $\omega_0 = 2.8 \times 10^7$ (wavelength nearly 50 m) and $\cos \phi = 1$ we get, making use of the data in the foregoing pages, $b = 8 \times 10^{-5}$ sec. This time increases slowly with increasing frequency. With $\omega_0 = 2.8 \times 10^7$ and $\cos \phi = 1$ we get for the surface of the earth from (48) (z is then -75 km) $t_r - t_i = 4 \times 10^{-4}$ sec.

If we assume $\omega l/v_0 \ll 1$ and also $|\alpha| \ll 1$ (see p. 898 and 899) we can use (6) for small values of $|w|$. Instead of (43) we get then the integral

$$-\frac{1}{2\pi\omega_0} \sqrt{\frac{\pi}{\sigma}} \int_{-\infty}^{+\infty} d\omega \cdot e^{-\frac{(1-\frac{\omega}{\omega_0})^2}{4\sigma} + \frac{i\omega\tau}{\omega_0} + \frac{2i\omega z \cos \phi}{c}} \times e^{-\frac{-\pi p \cos \phi}{2} + 2ip \cos \phi \ln \frac{p}{2}}. \tag{49}$$

As in the former case the value of this integral will be determined by the immediate neighborhood of the point $\omega = \omega_0$, because $\sigma \ll 1$. So in the slowly varying function $\ln p/2$ we may substitute $\omega = \omega_0$. The result of the integration is then

$$-e^{-\sigma \left(\tau + \frac{2\omega_0 z \cos \phi}{c} \right)} \left(\tau + \frac{2\omega_0 z \cos \phi}{c} + 2\omega_0 b' \right) + \omega_0 a' + \omega_0^2 \sigma (a'^2 + b'^2) \times e^{i \left(\tau + \frac{2\omega_0 z \cos \phi}{c} + \omega_0 b' \right) (1 + 2\sigma \omega_0 a')} \tag{50}$$

where,

$$a' = -\frac{\pi \cos \phi}{ck}, \quad b' = \frac{4 \cos \phi}{ck} \ln \frac{\omega_0}{ck}.$$

From (50) it results that the time of maximum amplitude of the reflected signal is

$$t_r = -\frac{z}{c} \cos \phi + \frac{y}{c} \sin \phi - b', \quad (51)$$

for the incident signal this time is given by (47). So we get for the "reflection time"

$$t_r - t_i = -\frac{2z}{c} \cos \phi - b'. \quad (52)$$

Here z will be negative as before, while b' is negative also. Thus, the time interval $t_r - t_i$ will be positive.

If we assume $\omega_0 = 2 \times 10^5$ (wavelength nearly 10 km) and $\cos \phi = 1$ we get, when we use the data of the preceding pages, nearly $b' = -7 \times 10^{-6}$ sec. For the surface of the earth the "reflection time" $t_r - t_i$ is found to be about 5×10^{-4} sec. This time interval is now slightly greater than in the case when b' would be zero, which would be the case if the plane $z = 0$ acted as an ideal mirror.

b. The order of magnitude of the reflection time now found is quite another than that of the long "echo time" found experimentally in many cases.¹³ Thus it does not seem possible to explain these long time intervals with the aid of the assumptions about the ionization pointed out before.

Now the reflection time was also calculated for similar cases assuming the dielectric constant to vary otherwise with the height, the assumptions having no relation to the considerations of the preceding pages. So functions were tried where the dielectric constant has a minimum value at a certain height and the reflection time was calculated for the case that the reflection takes place at the height of this minimum. But the same order of magnitude was obtained as was found here, of course depending on the assumptions made. Only when reflections take place at an infinite height the reflection time is infinite also. A simple case that can be calculated easily occurs when the dielectric constant is a quadratic function of the height, as was approximately supposed by de Groot¹⁴ in a recent paper. Here also the same order of magnitude was found as before.

It is the author's opinion that the possibility of an infinite reflection time, if reflection takes place at a finite height with a reflected amplitude being also finite, has not yet been rigorously proved.

¹³ v. d. Pol, *Tydschr. v. h. Nederl. Radio Genootsch.*, 4, 13, 1928.

¹⁴ de Groot, *Phil. Mag.*, 10, 534-536, 1930.

CORRECTION

AN ANALYSIS OF A PIEZO-ELECTRIC OSCILLATOR CIRCUIT

Dr. Lynde P. Wheeler has brought to the attention of the editorial staff of the PROCEEDINGS the following corrections to his paper, "An Analysis of a Piezo-Electric Oscillator Circuit," which appeared on Page 641 of the April, 1931, issue of the PROCEEDINGS.

In equations (31) and (32) the factor " R_e/L_e " should read " $R_e/L_e\omega_b$." This error, which unfortunately was not discovered until after the proof had been returned to the printer, modifies the conclusions reached in the paper in the following particulars:

1. The magnitude of the correction term σ becomes of the order 10^{-1} instead of 10^{-13} , and hence cannot be neglected. When it is taken into account, H_0 is not independent of y and it is found that the region in which an effective v_{02}/v_m exists is further narrowed down. Qualitatively, however, the conclusions reached in the text require no modification.

2. The magnitude of $tg \theta$ is not constant in the region considered and for the example figured is about 0.7 when oscillations begin (with increasing x), and about 0.3 when they cease. Outside of the range of oscillations on either side $tg \theta$ has larger values.

ERRATUM

A SYSTEM FOR SUPPRESSING HUM BY A NEW FILTER ARRANGEMENT By Palmer E. Craig

The April, 1931, issue of the PROCEEDINGS contained an error in the above paper. Page 669, line 7, should read:

" $R = 2500\omega$. Parallel resistance branch = 3180ω ."

in place of

" $R = 2500\omega$. Parallel resistance branch = 2500ω ."



BOOK REVIEW

The Elementary Principles of Wireless Telegraphy and Telephony, by R. D. Bangay. Third edition. Revised by O. F. Brown. Published by Iliffe & Sons Ltd., London. 268 pp. Price 10s. 6d.

This is an elementary book dealing clearly and simply with the main principles of the subject. The first twelve chapters are taken mainly from the earlier editions of Bangay and deal with fundamental ideas of electricity and magnetism, wave motion, and spark telegraphy, and constitute an excellent means of approach to the understanding of radio. The remaining thirteen chapters are by the reviser who treats the more modern aspects of radio clearly and concisely. The subjects discussed are alternating-current theory, thermionic tubes as detectors, amplifiers, oscillators, radio transmitters and their frequency stabilization, radio reception and design of receivers, a-c supply, loud speakers, short waves, radio direction finding, and wave propagation. Throughout the book the attention is directed to the principles of radio and the simplest circuits which demonstrate these principles rather than to a description of a great deal of more complicated apparatus.

*S. S. KIRBY

* Bureau of Standards, Washington, D.C.



BOOKLETS, CATALOGS, AND PAMPHLETS RECEIVED

Copies of the publications listed on this page may be obtained gratis by addressing a request to the manufacturer or publisher.

The Weston model 551 test set enables engineers to collect data readily for plotting vector diagram relations of polyphase systems to determine the accuracy of connections of watt-hour meters, relays, indicating instruments, and switchboards, and for the proper phasing-out of new apparatus. The model 551 booklet of instructions describes this instrument in detail and may be obtained from the Weston Electrical Instrument Corporation, 591 Freylinghuysen Avenue, Newark, N.J.

Circular MM of the Weston Electrical Instrument Corporation describes their model 301 rectifier type alternating-current instruments. These meters, available as microammeters, milliammeters, and voltmeters, are intended for measuring alternating currents of small magnitude where ordinary types of a-c instruments cannot be used. Voltmeters are available in either 1000 ohms per volt or 2000 ohms per volt movements.

Model 563 d-c circuit tester of the Weston Electrical Instrument Corporation is an instrument for checking resistance values up to 50,000 ohms as well as circuit continuity. It is described in circular LL.

"Fastening" is the title of a twenty-four page booklet describing several types of self-tapping screws made by the Parker-Kalon Corporation, 200 Varick St., New York City. Several applications of these screws to radio production methods are given.

The Arcturus Radio Company of Newark, N.J. has recently issued two eight-page leaflets which give static characteristics of the type 551 variable-mu tetrode and the type PZ pentode.

Catalog GEA-1239A lists a number of miniature ammeters, milliammeters, microammeters, voltmeters, and millivoltmeters for direct- and alternating-current measurements, manufactured by the General Electric Company. Besides the usual D'Arsonval and moving vane instruments, meters having D'Arsonval movements with copper-oxide rectifiers are described for use where sensitive alternating-current meters are required.

A mimeographed data sheet from the De Forest Radio Company of Passaic, N. J., describes their type 575 half-wave mercury vapor rectifier, and intermediate power rectifier having a maximum peak inverse voltage of 15,000 and a maximum peak inverse current of 2.5 amperes.

A four-page folder from the International Broadcasting Equipment Company, 3112 W. 51st Street, Chicago, Ill., described a condenser microphone and amplifier for broadcast and high quality speech transmission. Another bulletin describes speech input transformers and retard coils for public address or other audio systems.

A loud speaker of high output power is described in bulletin Number 101 of the Hoovenaire Corporation, 122 Fifth Avenue, New York City.



REFERENCES TO CURRENT RADIO LITERATURE

THIS IS a monthly list of references prepared by the Bureau of Standards, and is intended to cover the more important papers of interest to the professional radio engineer which have recently appeared in periodicals, books, etc. The number at the left of each reference classifies the reference by subject, in accordance with the "Classification of radio subjects: An extension of the Dewey Decimal System," Bureau of Standards Circular No. 385, which appeared in full on pp. 1433-56 of the August, 1930 issue of the Proceedings of the Institute of Radio Engineers. The classification numbers are in some instances different from those used in the earlier version of this system used in the issues of the Proceedings of the Institute of Radio Engineers before the October, 1930 issue.

The articles listed are not obtainable from the Government or the Institute of Radio Engineers, except when publications thereof. The various periodicals can be secured from their publishers and can be consulted at large public libraries.

R000. RADIO

R007 Butman, C. Mobile radio services. *Radio News*, 12, 895-896; April 1931.

This is the fourth of a series of articles describing the U. S. Radio Laws and Regulations.

R007 Federal Radio Commission issues new orders. *Radio Eng.*, 11, 29-30; March, 1931.

General Order No. 105, effective March 1, 1931, applies principally to schedules and power used by broadcast stations.

R100. RADIO PRINCIPLES

R113.3 Rakshit, H. Radio field-strength survey of the city of Calcutta and its suburbs. *Phil. Mag.*, 11, 174-184; January, 1931.

The method and results of intensity measurements, made within a 12-mile radius of the Calcutta broadcasting station VUC ($\lambda = 370.4$ meters) are given.

R120 McPetrie, J. S. A graphical method for determining the magnitude and phase of the electric field in the neighborhood of an antenna carrying a known distribution of current. *J.I.E.E.* (London), 69, 290-298; February, 1931.

This paper describes a graphical method of procedure by means of which calculations may be made for any desired transmitting antenna arrangement.

R125.1 Walmsley, T. Beam arrays and transmission lines. *Experimental Wireless and the Wireless Engineer*, 8, 25-27; January, 1931; *Jour. I.E.E.* (London), 69, 299-323; February, 1931.

A discussion of the relative gains due to various combinations of half-wave radiators and a description of a special type of array for which economic advantages are claimed.

R130 Benham, W. E. Theory of the internal action of thermionic systems at moderately high frequencies—Part II. *Phil. Mag.*, 7th Series, 457-517; supplement February, 1931.

A comprehensive theoretical treatment, supplementing Part I which appeared in *Phil. Mag.*, 7th Series, page 641; March, 1928.

R131 Barclay, W. A. Output valves in parallel. *Wireless World and Radio Review*, 28, 171-175; February 18, 1931.

- A simplified treatment of the theory of parallel operation and an alignment chart from which the approximate performance of such combinations may be quickly determined is given.
- R131 Nottingham, W. B. Characteristics of small grid-controlled hot-cathode mercury arcs or thyratrons. *Jour. Franklin Institute*, 211, 271-301; March, 1931.
The principle of the grid-controlled arc or thyatron is briefly described and the nominal ratings as regards filament current, maximum plate current, etc., as well as the characteristics of four important thyratrons are given.
- R131
×R334 Henney, K. Characteristics of variable mu-tetrodes. *Electronics*, 2, 540-541; March, 1931.
Operating data and characteristics based on manufacturers' tests are given for improved screen-grid tubes.
- R132 DuBridge, L. A. The amplification of small direct currents. *Phys. Rev.*, 37, 392-400; February 15, 1931.
Three types of d-c amplifying circuit arrangements are described. Their operation is based on a new type of thermionic tube and the current sensitivity exceeds that of any type of electrometer except the Hoffman type.
- R133 Winter-Günther, H. Über die Mitnahmeerscheinungen an Röhren-
generatoren bei verschiedenen Frequenzverhältnissen. (Forced oscillations in vacuum tube generators.) *Zeits. f. Hochfrequenz.*, 37, 39-51; February, 1931.
An oscillographic study of forced oscillations, for various ratios of impressed to resonant frequency, in vacuum tube generators.
- R134 Nelson, J. R. Bias detector overload. *Radio Eng.*, 11, 21-24; March, 1931.
A review of the theory of detector overloading leads to methods of determining overload characteristics of radio receivers and confirms the importance of these characteristics in receiving set design.
- R139 Below, F. Die Anodenrückwirkung bei verschiedenen Röhrenschaltungen und ihre Verminderung. (Reduction of feed-back in various types of vacuum tube circuit arrangements.) *Zeits. f. Hochfrequenz.*, 37, 65-69; February, 1931.
A discussion of the causes and methods of preventing reaction in vacuum tube detectors and amplifiers.
- R144 Antik, I. Über die Berechnung des Wechselstromwiderstandes von eisernen Drähten. (The calculation of the a-c resistance of iron wires.) *Archiv. f. Elektrotechnik*, 25, 125-129; February, 1931.
After deriving formulas for the a-c resistance of iron wires, it is demonstrated that these formulas yield results that agree closely with actual measurements.
- R144 Ollendorff, F. Das Eindringen elektromagnetischer Wellen in hochgesättigtes Eisen. (The penetration of electromagnetic waves in highly saturated iron.) *Zeits. f. Tech. Physik*, 12, 39-50; No. 1, 1931.
An attempt to evaluate high frequency eddy-current losses in saturated iron.
- R145.3 Russell, A. Inductance coefficients of a part of a circuit, and their applications. *Jour. I.E.E. (London)*, 69, 270-280; February, 1931.
Problems in connection with cables and their sheaths can in some cases be usefully discussed by means of certain coefficients which are called, in this paper, partial inductance coefficients. A list of formulas for these coefficients is given for hollow cylindrical conductors, both when they are external to one another and when one surrounds the other.
- R145.5 Guében, G. Contribution to the theory of dielectrics. *Phil. Mag.*, 7th Series, 405-410; February, 1931.
The current in a dielectric was assumed to be due both to the contribution of dipoles and to the presence of ions. The part due to each of these two elements was determined and the general expression of current in a solid dielectric was derived.

- R148.1 Moullin, E. B. An analysis of distortion in resistance amplification.
 ×R132 *Experimental Wireless and the Wireless Engineer*, 9, 118-123; March, 1931.

This method of predicting the output of a resistance-coupled amplifier from the static characteristic involves the assumption of a certain form of equation for the static characteristic, and simple rules for deducing the fractional amplitudes of the second and third harmonic currents which are produced by the curvature of the characteristic.

- R161.1 Wright, E. E. Selectivity and response. *Experimental Wireless and the Wireless Engineer*, 9, 133-134; March, 1931.

This note is an attempt to find, from theoretical reasoning, the responses of a selectively tuned circuit to a steadily modulated wave.

R200. RADIO MEASUREMENTS AND STANDARDIZATION

- R220 Barlow, H. M. A new method of measuring the capacity of small condensers. *Phil. Mag.*, 11, 184-193; January, 1931.

The method described uses a known a-c potential to charge the unknown condenser periodically in opposite directions through ordinary rectifying tubes, and a galvanometer to measure the average current in any one direction, thus allowing the value of C to be readily calculated.

- R243.1 Estes, B. E. An a-c operated vacuum-tube voltmeter. *Radio* (San Francisco), 13, 65-67; January, 1931; 55-56; February, 1931; 49-50, 55; March, 1931.

The varied applications of this type of meter are given.

- R243.1 Schlesinger, K. Ein empfindliches zweistufiges Röhrenvoltmeter für Netzanschluss. (A sensitive, two-stage vacuum tube voltmeter operated from a.c. supply.) *Zeitschrift für Tech. Physik*, 12, 114, 1931.

An a-c operated vacuum tube voltmeter is described, which is not affected by line voltage changes of ± 20 per cent, and has a range of 0.05 to 0.8 volt at frequencies from 50 to 107 cycles.

- R243.1 Kallmann, H. E. Röhren-Voltmeter für Netzanschluss. (A-C operated vacuum tube voltmeter). *Zeits. für Hochfrequenz*, 37, 58-64; February, 1931.

Several types of vacuum tube voltmeters operating from the a-c lighting circuit are described, as well as methods for stabilizing the instrument against line fluctuations.

- R260 Harris, S. Design tests for amplifiers and complete radio receivers. *Radio Eng.*, 11, 25-27; March, 1931.

An engineering discussion of the application of the system of transmission units to various circuit measurements.

- R261 Hollands, L. C. Equipment for testing radio receivers in production. *Electronics*, 2, 545-547; March, 1931.

Panel-mounted testing equipment for making quick and accurate production tests of radio receivers and component parts is described.

- R265.2 Turner, P. K. Some measurements of a loud speaker in vacuo. *Experimental Wireless and the Wireless Engineer*, 9, 129-132; March, 1931.

Abstract of a paper which was read before the Wireless Section of the Institution of Electrical Engineers (London) on February 4, 1931.

R300. RADIO APPARATUS AND EQUIPMENT

- R339 Machlett, R. R. Neon tube light and factors governing its life. *Jour. Franklin Institute*, 211, 319-326; March, 1931.

A discussion of the electrical characteristics and life factors of neon tubes.

- R381 Griffiths, W. H. F. The losses in variable air condensers. *Experimental Wireless and the Wireless Engineer*, 9, 124-126; March, 1931.
A discussion of the losses in variable air condensers, with charts showing the effect of these losses on the power factor at different frequencies.
- R388 Fielder, F. D. Cathode-ray oscillograph operation. *Electric Journal*, 28, 161-164; March, 1931.
A study of timing systems and synchronizing circuit arrangements that are used with the cathode-ray oscillograph in high-voltage surge testing.
- R388 von Ardenne, M. Further advances in the technique of the Braun tube. *Experimental Wireless and the Wireless Engineer*, 9, 127-129; March, 1931.
Describes a newly developed cathode-ray tube which is smaller and more sensitive than previous types and which has a special loop filament that may be heated from a-c supply.
- R390 Thiessen, A. E. Impedance matching networks. *Electronics*, 2, 552-553; March, 1931.
A brief discussion of the problems involved in calculating and building up a terminating impedance.
- R400. RADIO COMMUNICATION SYSTEMS
- R423.21 Der Gross-Rundfunksender Heilsberg. (The high-power broadcast transmitter at Heilsberg). *Elektrotech. Zeits.*, 52, 315-316; March 5, 1931.
A description of this 75-kw crystal-controlled broadcast transmitting station and equipment is given.
- R423.21 Pfaltz, A. KDKA radios new 500 horsepower voice. *Radio News*, 12, 872-873; April, 1931.
A brief, nontechnical description of KDKA's recently completed transmitting station.
- R800. NONRADIO SUBJECTS
- 535.3 Olpin, A. R. and Stilwell, G. R. Formation of photographic images on cathodes of alkali metal, photo-electric cells. *Jour. Opt. Soc. of America*, 21, 177-181; March, 1931.
A method of forming both negative and positive photographic images on the cathodes of potassium and sodium photo-electric cells in vacuum is described.
- 535.38
×R339 Hitchcock, R. C. Light beams operate traffic signals. *Elec. Eng.*, 50, 182-185; March, 1931.
A description of automatic traffic control devices employing grid-glow and photo-electric tubes is given.
- 535.38 Olpin, A. R. New types of photo-electric cells. *Bell Lab. Record*, 9, 310-314; March, 1931.
Response curves and descriptions of several new type photo-electric cells are given.
- 538.11 Vincent, J. H. Further experiments on magnetostrictive oscillators at radio frequencies. *Proc. Phys. Soc. (London)*, 43, 157-165; March, 1931.
Comparative experiments with several circuit arrangements and several kinds of metal indicate that "glowray" is the most suitable for high frequencies. In one case the glowray oscillator was 1.9 mm long, weighed less than a fiftieth of a gram and had a frequency of 1280 kc per second.
- 538.11 Butterworth, S. and Smith, F. D. The equivalent circuit of the magnetostriction oscillator. *Proc. Phys. Soc. (London)*, 43, 166-185; March, 1931.
A theoretical treatment is given of the magnetostriction oscillator, in which the equivalent circuit arrangement is developed and expressions for the circuit elements in terms of the fundamental constants of the material are given.

- 621.382 Steele, R. B. Developments in the art of telegraphy. *Radio Eng.*, 11, 35-41; March, 1931.
A brief discussion of the historical background of the telegraph is followed by a picture of the present day high speed direct-current and carrier-current telegraph systems.
- 621.385.96 Dreher, C. Progress in sound-picture recording. *Electronics*, 2, 542-544; March, 1931.
Several recent advances in sound-picture recording are described.
- 621.385.97 McLachlan, N. W. and Sowter, G. A. V. The theory and performance of certain types of modern acoustic apparatus for reproducing speech and music. *Phil. Mag.*, 11, 1-54; January, 1931.
An analysis of both coil and reed-driven rigid disks as applied to the reproduction of sound is used as a basis for pointing out a comparison between theory and practice.
- 621.385.97 Voigt, B. Eine Methode zur Untersuchung der Schwingungen von Membranen, im besonderen von Lautsprecher-membranen. (A method of investigating the oscillations in membranes, especially loudspeaker membranes). *Zeits. für Tech. Physik*, 12, 76-85; 1931.
A stroboscopic method of analyzing and measuring the motion of vibrating membranes is given.



CONTRIBUTORS TO THIS ISSUE

Bäumler, M.: See PROCEEDINGS for January, 1931

Bayly, B. deF.: Shrewsbury School, England, specializing in mathematics and physics, 1917-1919; studied law in Saskatchewan, worked on communications, CPR telegraphs, telephones, also signal officer in militia, 1920-1925; studied engineering, Toronto University, 1926-1928; lecturer in radiotelegraphy, University of Toronto, 1929 to date. Associate member, Institute of Radio Engineers, 1927.

Elias, G. J.: Born October 5, 1879 at Arnhem, Netherlands. Studied mathematics and physics at Delft and Utrecht Universities. Assistant to Prof. Dr. W. H. Julius, Physical Laboratory, University of Utrecht, 1902-1906; assistant to Prof. Dr. H. du Bois, Bossche Laboratory, Berlin, 1906-1910; assistant to Prof. Dr. H. A. Lorentz, Physical Laboratory, Teyler Foundation, Haarlem, 1910-1916; private docent, University of Utrecht, 1912-1916; professor, Technical University of Delft, 1916 to date. President, "Nederlandsch Radio Genootschap," 1920-1927. Nonmember, Institute of Radio Engineers.

Everitt, William Littell: Born April 14, 1900 at Baltimore, Maryland. Received E.E. degree, Cornell University, 1922; M.S. degree, University of Michigan, 1926. Instructor in electrical engineering, Cornell University, 1920-1922; engineer in charge of laboratory and P.B.X. development, North Electric Manufacturing Company, Galion, Ohio, 1922-1924; instructor in electrical engineering, University of Michigan, 1924-1926; assistant professor of electrical engineering in charge of communication courses, Ohio State University, 1926-1929; associate professor, 1929 to date. Department of development and research, American Telephone and Telegraph Company, summers 1925-1930, inclusive. Associate member, Institute of Radio Engineers, 1925; Member, 1929.

Felix, Edgar H.: Born March 29, 1898. Studied at New York University, Columbia University, and Sheffield Scientific School, Yale University. Radio engineer, radio development section, Signal Corps, 1918; associate editor, *Aerial Age Weekly*, 1919; publicity director, WEAf, 1922-1924; radio technical director, N. W. Ayer and Son, 1924-1926; engineering and general policy consultant to broadcast stations, author, and technical writer, 1926 to date. Junior member, Institute of Radio Engineers, 1917; Associate, 1919; Member, 1925.

Krüger, Kurt: Born October 14, 1898 at Mallnitz, Germany. Studied at Technical High School of Berlin and at the University of Berlin and Wuerzberg; received Ph. D. degree, Wuerzberg, 1922; assistant to Professor Zenneck, Technical High School of Munich, 1922-1926; department for radio and electrotechnics, German Experimental Institution for Air Traffic, Berlin-Adlershof. Nonmember, Institute of Radio Engineers.

MacDonald, William A.: Born December 27, 1895 at New York City, New York. Engaged in operating departments of American and British Marconi Companies, 1913-1916; Physical Laboratory, Western Electric Company, 1916-1917; served as second lieutenant, Signal Corps, 1917-1918; completed communications course in radio, University of Paris, 1919; radio engineer, Camp Alfred Vail, New Jersey; consulting engineering department, Radio Corporation of America,

1920-1924; chief engineer, Hazeltine Corporation, 1924 to date. Member, A.I.E.E. Associate member, Institute of Radio Engineers, 1919; Member, 1926,

Nakai, Tomozo: Born March 10, 1901 at Fukuyama City, Japan. Graduated, electrical department of Osaka Higher Technical School, 1922. Engaged in radio researches, radio section of the Electrotechnical Laboratory, Ministry of Communications, Japan; working on wave propagation 1925 to date. Associate member, Institute of Radio Engineers, 1929.

Plendl, Hans: Born December 6, 1900 at Munich, Germany. Studied Technical High School of Munich, 1919-1923, becoming graduate engineer in 1923. Scientific work for Professor Zenneck at Physical Institute, Technical High School of Munich, 1923-1925, becoming doctor-engineer, 1925. With Professor Meissner in research laboratory, Telefunken Company, Berlin-Adlershof, 1925-1927; at present with Professor Fassbender, department for radio and electro-technics, German Experimental Institution for Air Traffic, Berlin-Adlershof. Nonmember, Institute of Radio Engineers.

Robinson, Gordon D.: See PROCEEDINGS for February, 1931

Strutt, M. J. O.: Born 1903 at Java, Dutch East Indies. Studied at University of Munich; Institute of Technology, Munich; Institute of Technology, Delft; graduated Munich, 1924, Delft, 1926. Assistant, Physics Department, Delft, 1926-1927. Doctor Technical Science, Delft, 1927. Research staff, Philips' Incandescent Lamp Works, Ltd., 1927 to date. Nonmember, Institute of Radio Engineers.

Vecchiacchi, F.: See PROCEEDINGS for April, 1931

Wheeler, Harold A.: Born May 10, 1903 at Saint Paul, Minnesota. Assistant in tests of radio receiving equipment, Bureau of Standards, 1921-1922. Associated with Professor Hazeltine in the study of neutralization of capacity coupling of vacuum tubes, 1922-1923; engineer, Hazeltine Corporation, 1924 to date. Received B.S. degree in physics, George Washington University, 1925; graduate studies in physics department, Johns Hopkins University, 1925-1928; lecturer, 1926-1927. Associate member, Institute of Radio Engineers, 1927; Member, 1928.

Yokoyama, Eitaro: Born July 21, 1883 at Fukui City, Japan. Graduated Engineering College, Tokyo Imperial University, 1908. Engaged in radio researches at the Electrotechnical Laboratory, Ministry of Communications, Japan. One of the inventors of the T.Y.K. oscillation gaps for radiotelephony. Chief of Radio Section, Laboratory, 1920. Member, Institute of Radio Engineers, 1917.



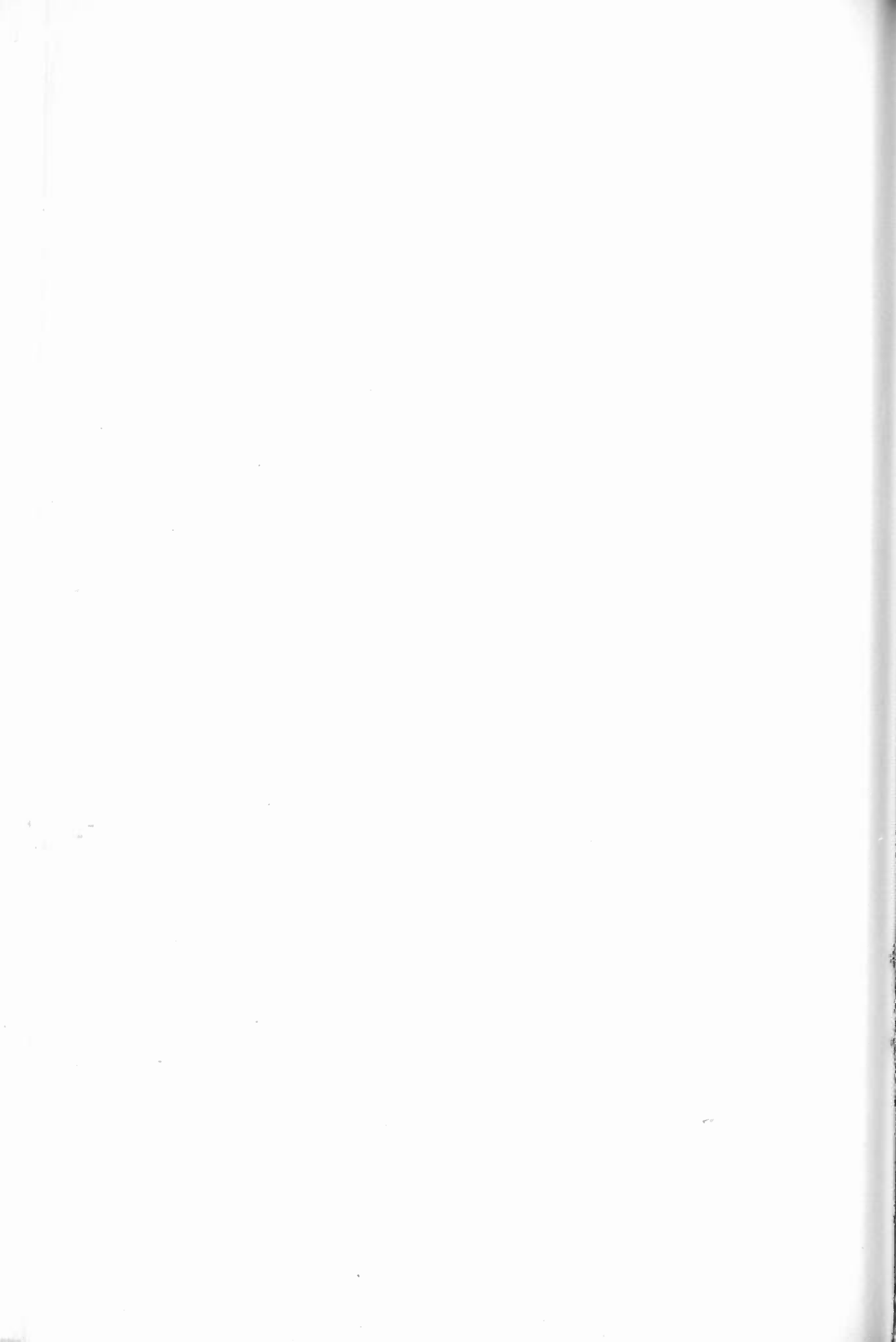

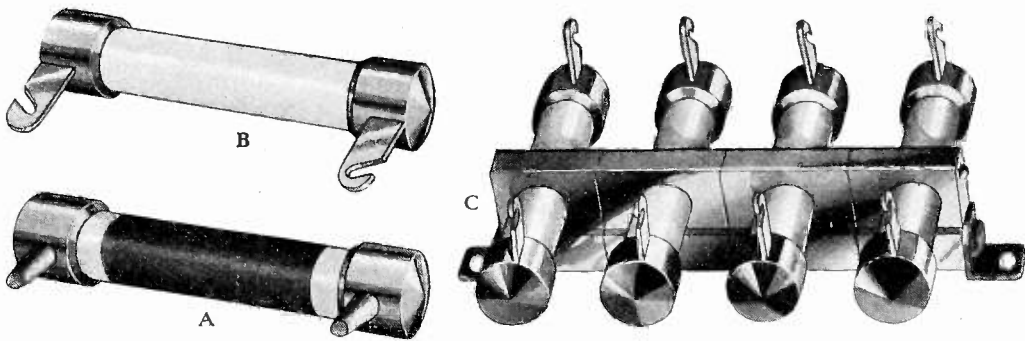

HEAT • COLD • MOISTURE • OVERLOAD
None of these can disturb the accuracy of

METALLIZED RESISTORS

With the new Type "K" Filament

Tests in our own and customers' laboratories have proved that Type "K" Metallized Resistors possess qualities never before attained in a resistance unit.

This new filament was evolved by I R C engineers after years of search for materials that would provide permanent resistance values under any conditions, climatic or otherwise, confronting normal set operation.

Saving in Assembly Costs

Special types of these resistors, shown above, reduce production costs. (A) With special tips—recommended for use in panel mountings. (B) With lugs for ease in soldering (C) Gang mounting, which reduces chassis assembly expense.

Several of our customers, with these special types, have effected important savings. A discussion of your own problems is invited. Curves and data showing tests of Type "K" Filament supplied on request.

International Resistance Co., Philadelphia

In Canada, International Resistance Co., Ltd., 74 Wellington St., Toronto

I R C

Metallized

RESISTORS

Also Precision Wire Wound Resistors

When writing to advertisers mention of the PROCEEDINGS will be mutually helpful.

PENNIES FOR WINGS

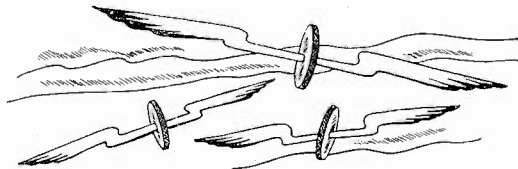

DAY in and day out you take wings by talking over your telephone . . . with friends . . . the grocer . . . the doctor . . . a relative hundreds of miles away . . . and every month you get a bill for this service.

Perhaps a single call made during this period has been worth more to you in time, money or convenience than the whole amount of your bill. But the telephone company makes its charge—not on any such basis—but on what it costs to give the best possible service to its customers.

The Bell System has voluntarily taken the position that the telephone business is a public trust. Its policy is to give the best possible service at the least cost consistent with financial safety.

The more telephone subscribers

there are, the more valuable telephone service becomes to each subscriber. Unlike most other businesses, the telephone industry does not enjoy reduced costs as the number of customers increases. On the contrary, the trend is upward. To offset this, the American Telephone and Telegraph Company takes advantage of every scientific advance and aid to efficiency which can possibly reduce service costs—and these savings are used for the benefit of the subscriber.

The twenty-four Associated Companies in the Bell System are pledged to this ideal . . . to give constantly better telephone service at the lowest possible rates . . . to reduce, by every means in their power, the number of pennies that you pay for wings.

★ AMERICAN TELEPHONE AND TELEGRAPH COMPANY ★



When writing to advertisers mention of the PROCEEDINGS will be mutually helpful.

The type TMV8A BEAT FREQUENCY OSCILLATOR with CURVE DRAWING ATTACHMENT

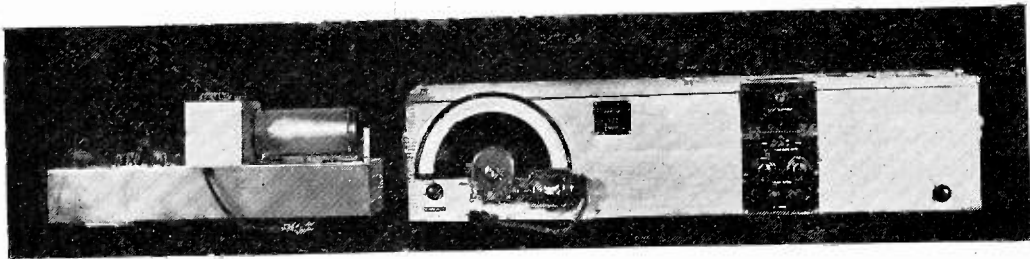

This instrument is a high quality precision oscillator with a frequency range 20 to 10,000 cycles, completely self-contained for operation from 115 v. 60 cycle source. The output voltage varies less than plus or minus 2% for line voltage variations between 105 and 120 volts.

The frequency varies less than 1% with the above line voltage variation. Five watts output into load impedance of 4 to 4,000 ohms, adjustable in six steps. The output varies less than plus or minus 2% over entire scale. Harmonic content less than 3% above 50 cycles, less than 5% below 50 cycles. It contains reed type frequency meter

for adjusting calibration.

The TYPE TMV7A UNIVERSAL CURVE DRAWING ATTACHMENT using SELSYN control is positive and smooth in operation and suitable for use with any laboratory oscillator. It may be operated either manually or by self-contained motor. Automatically returns after a curve is taken. It may be used at a point remote from the oscillator. It is extremely rugged in construction, yet portable.

In addition to the above, other high grade laboratory and test equipment is available. Special equipment designed and manufactured to meet your requirements.

Prices and information on request

ENGINEERING PRODUCTS DIVISION

RCA VICTOR CO. INC.

CAMDEN, N. J.

100 W. Monroe St.—Chicago

235 Montgomery St.—San Francisco

When writing to advertisers mention of the PROCEEDINGS will be mutually helpful.

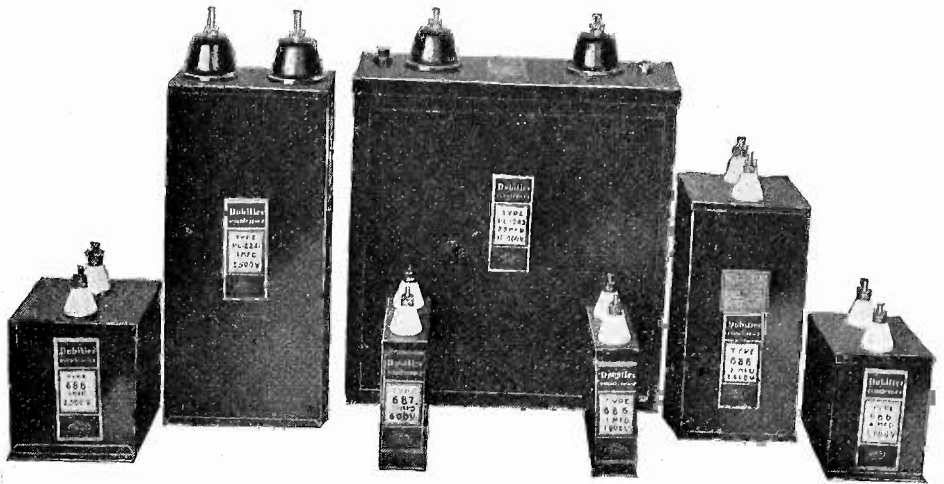

Type	Capacity	D.C. Working Voltage
PL-2394	.25 mfd.	15,000
PL-2393	.1 mfd.	15,000
PL-2656	.25 mfd.	12,500
PL-1943	.25 mfd.	10,000
PL-2170	1. mfd.	6,000
PL-2240	1. mfd.	5,000
PL-2241	1. mfd.	3,500
PL-2242	2. mfd.	3,500
Type 688	1. & 2. mfd.	2,000
Type 687	2. & 4. mfd.	600
Type 686	1., 2., & 4. mfd.	1,000

Leadership

in condenser-art is again evidenced here.

This is a group of types developed to meet today's demands in high-powered radio telegraph and telephone circuits.

Internal construction embodies radical changes over other makes, resulting in improved electrical characteristics and in safety factors which insure that

"You can forget the condensers if they are Dubiliers."

Dubilier
CONDENSER
CORPORATION

4377 Bronx Blvd.
New York, N. Y.

When writing to advertisers mention of the PROCEEDINGS will be mutually helpful.

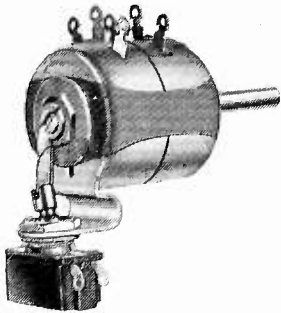
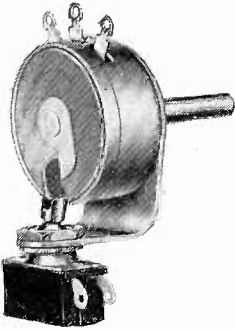
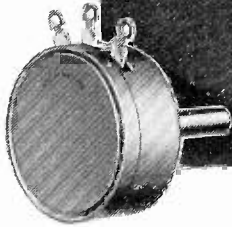
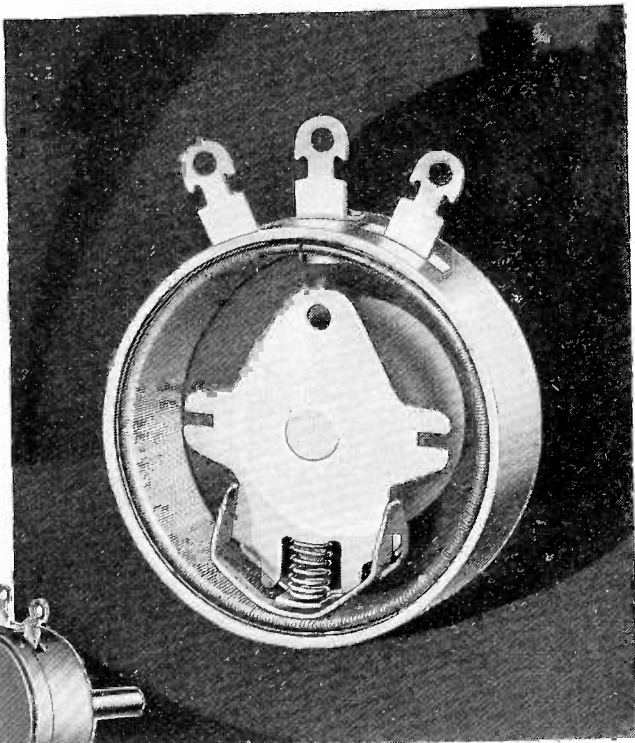

Why is this new unit completely noiseless?

First, because of the design of the variable contactor used in the new FROST-RADIO No. 20 Series Volume Controls, which makes two separate and distinct *line* contacts, totaling $\frac{3}{16}$ "', with the resistance element. Second, because space between turns has been successfully reduced to one ten-thousandth of an inch, permitting the use of *more* turns and *larger* wire. And third, because contact pressure has been greatly reduced, eliminating cutting and scoring . . . The No. 20 Series possesses many other advantages. Write us for further details NOW.

CHICAGO TELEPHONE SUPPLY CO.
HERBERT H. FROST, *Inc.*, Sales Division
GENERAL OFFICES AND PLANT
ELKHART, INDIANA

FROST-RADIO

When writing to advertisers mention of the PROCEEDINGS will be mutually helpful.

ESCO Motor-Generators

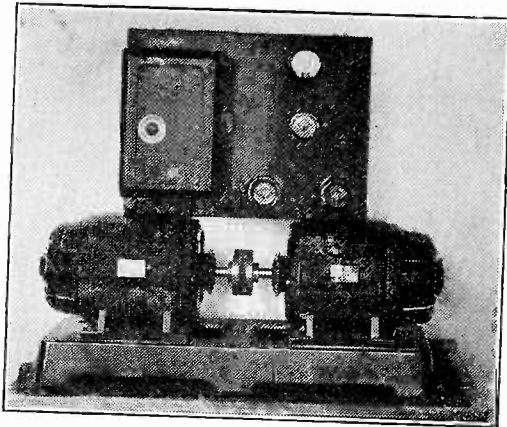

"Fit" the application

"Fit" the power supply

Motors—Generators—Dynamotors—Rotary Converters

Designed · Developed · Manufactured

Quick Delivery · Low Priced

"ESCO" is a company where "Special" does not mean "soak 'em" or "Let 'em wait." Because for twenty years "ESCO" has specialized in the "Special." "Special" voltages, frequency, speed, and mechanical design is the objective of our equipment and organization. **OUR EXPERIENCE IS BROAD.** Below is a list of some of the special applications of our motors and generators, manufactured during this last December.

Telegraph	Speed reducers	Arc lamps	Knitting mills
Airplane dynamotors	Ventilators	Anti-corrosion	Printing press
Wind driven generators	Telechron resetters	Oil burners	Electro plating
Portable gasoline units	Automatic chucks	Automatic whistle	Remote control
Radio beacons	Recording instruments	Ore-vibrators	Movie cameras
Radio transmitters	Elevator door control	Organ generators	Aerial cameras
Television	Elevators	Hoists	Cloth cutting
Talkies	Flexible shafts	Freight trucks	Coin counters
Radio receivers	Riveters	Temperature control	Pneumatic valves
Automobile radio	Gasoline pumps	Polishers	Valve grinders
Valve control	Bottle washers	Stock quotations	Theater dimmers
Water tight doors	Phase shifters	Sun lamps	Cup venders
Pianos	Frequency changers	Bookkeeping unit	Refrigerator
Electric indicators	Hair dryers	Forced draft	Automatic stoker
			Weaving

Why not profit by our long experience? Up to date equipment and practical engineering talent. They are all at your disposal. Write us for bulletins or information.

ELECTRIC  **SPECIALTY**
COMPANY

300 South St.

Stamford, Conn.

Manufacturers of motors, generators, dynamotors and rotary converters.

When writing to advertisers mention of the PROCEEDINGS will be mutually helpful.

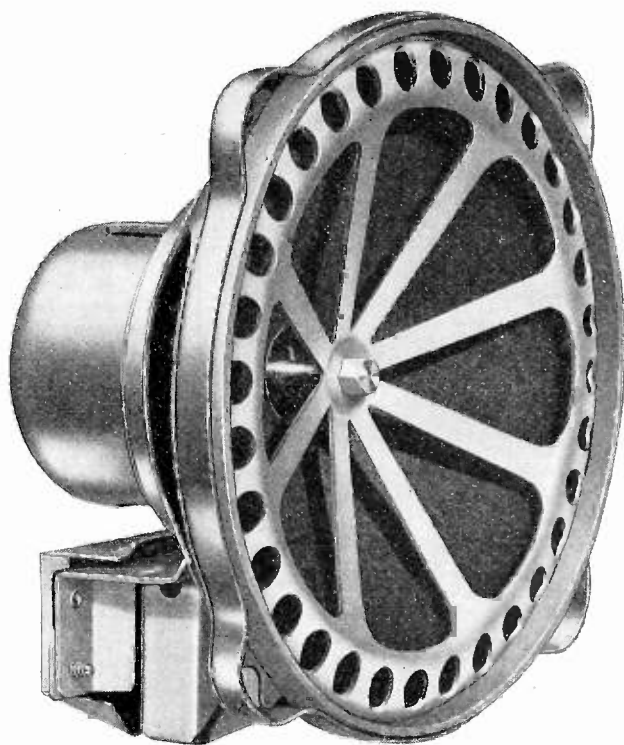

ANNOUNCING

THE NEW MAGNAVOX "140" SYMPHONIC SPEAKER

AT last, a speaker that will reproduce the full range of the human voice, band or symphony orchestra from low G to high C—clear, true and undistorted on every note!

It's another Magnavox triumph—the ultimate in dynamic speaker construction, born of twenty years' pioneering in electro-dynamic sound engineering.

The new Magnavox has many revolutionary construction features, fully covered by

patents and patent applications. And it is sturdier, more durable, easier to mount—wear-proof and trouble-proof—an end to rejections and service.

Only the superior resources, long experience and extensive facilities of the Magnavox Company could produce such an achievement—at a price so attractive no 1931-32 commitments should be made without investigating the new Magnavox "140" Symphonic Speaker.

Magnavox Company Ltd.

Executive and Sales Offices: 155 East Ohio St., Chicago, Ill.

Factories: Fort Wayne, Ind.

SUBSIDIARIES

The Magnavox Company
Electro Formation, Inc.



SUBSIDIARIES

Magnavox (Australia) Ltd.
Magnavox (Great Britain) Ltd.

A COMPARISON WILL PROVE IT A FAR BETTER SPEAKER THAN YOU HAVE EVER SEEN OR HEARD. SEND FOR ENGINEERING DATA.

When writing to advertisers mention of the PROCEEDINGS will be mutually helpful.

COMPARE

the POWER SENSITIVITY of the

ARCTURUS

TYPE PZ

PENTODE

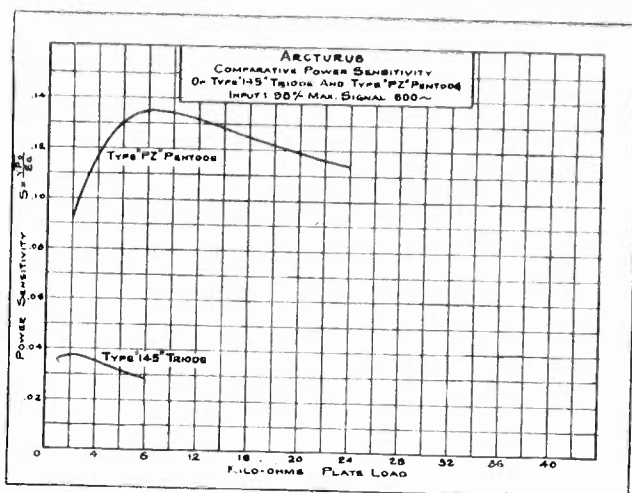

Because of its high "power sensitivity" the Arcturus PZ Pentode is almost 4 times as sensitive as the '45 power tube—a feature of decided importance when considering output, detector overload and plate supply arrangements. Greater volume, increased efficiency, and compactness of set design are the natural results.

COMPARE

the MODULATION DISTORTION LIMITS of the

ARCTURUS

TYPE 551

VARIABLE-MU

These two curves show the maximum input voltages at which the Arcturus 551 and a typical '24 tube operate with practically undistorted amplification. The limits shown correspond to a rise in modulation of 20%. The 551 tube operates without distortion at about 20 times the voltage permissible with the '24 tube.

This and other features of the Arcturus 551 eliminate the need for double pre-selectors, dual volume controls, and "local-long distance" switches. Maximum cross-talk is divided by 500; receiver hiss is reduced. Circuits using this new tube are simpler as well as more efficient.

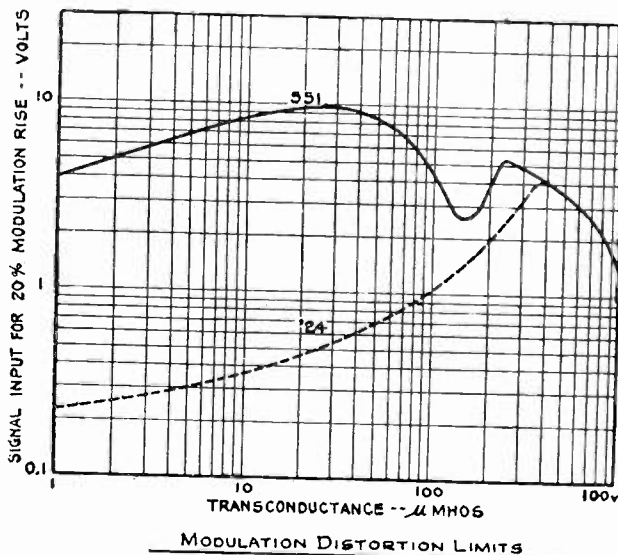

Send for Technical Bulletins giving complete performance data on the Arcturus Type PZ Pentode and the Arcturus 551 Variable-Mu Tube.

ARCTURUS RADIO TUBE CO., NEWARK, N. J.

ARCTURUS

The TUBE with the LIFE-LIKE TONE

When writing to advertisers mention of the PROCEEDINGS will be mutually helpful.

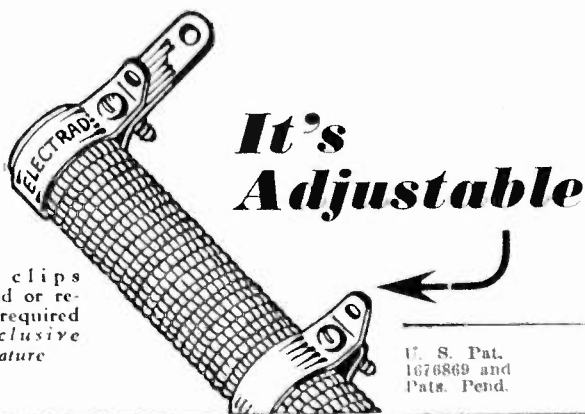

Additional clips easily added or removed as required —an Exclusive Truvolt Feature

U. S. Pat. 1676869 and Pats. Pend.

You Don't Have to be An Engineer to See They're Better

BUT, since you *are* an engineer, the superior features of TRUVOLT Resistors must be obvious.

TRUVOLTS are the most easily adaptable of all resistors. "Fixed" in type, they are readily *adjustable* for any voltage requirement within their range.

The adjustable clips, an exclusive patented TRUVOLT feature, may be added or removed at will. Open-air winding keeps TRUVOLTS cooler.

TRUVOLTS save time in the laboratory and in service work. Fewer units are required to meet all conditions.

TRUVOLTS are made in single or multiple units in all usual resistance values and voltage ratings. Also, 22 stock sizes with adjustable knob control.

A New Sound Equipment Service

As the result of several years' experience in high-power amplifier design, it was a logical step for Electrad to enter the Sound-Equipment field. Two highly-perfected rack and panel installations and an exceptionally efficient portable outfit are now ready—together with all accessories, plus expert engineering and acoustical counsel. *Mail coupon for data.*

ELECTRAD INC.

ELECTRAD, INC., Dept. PE 5, 175 Varick St., New York, N.Y.

Please send me new, complete 36-page Electrad Catalog and data on Sound Equipment.

Name

Address

When writing to advertisers mention of the PROCEEDINGS will be mutually helpful.

FIFTH ANNUAL
RMA Trade Show
AND 7TH ANNUAL RMA CONVENTION
CHICAGO
JUNE 8 to 12

Bu\$ine\$\$ for YOU without Ballyhoo

Everybody Will Be There

Bu\$ine\$\$ will be the key-note during "Radio Week" of June 8. This will be a "bu\$ine\$\$" show and bu\$ine\$\$ for *YOU*, bu\$ine\$\$ for everybody in radio.

The National Furniture Industry and the Music Industry also will be holding conventions and exhibits in Chicago, drawing thousands of visitors, during "Radio Week."

All the new radio products will be on display in the trade show. Every leading manufacturer of receiving sets, tubes, speakers and accessories has reserved exhibit booths in the trade show and demonstration rooms in hotels. There will be *more* new circuits, new tubes, new speakers, new cabinet designs, and new radio products, including home talkies, television, remote control, and other radio devices and products than ever before in one year.

Thirty thousand (30,000) square feet of radio exhibits in the Grand Ball Room and Exhibition Hall of the Stevens Hotel.

**ADMISSION TO THE TRADE ONLY
—NO VACANT BOOTHS—ALL EXHIBITORS REQUIRED TO SHOW THEIR MERCHANDISE.**

Business meetings and entertainment for visitors during entire "Radio Week"—June 8-12—RMA "stag" party Wednesday, June 10—Music Industry banquet, Tuesday, June 9.

Apply now direct to hotels for room reservations.

RMA invitation credentials mailed to the trade about May 1. For information or credentials write to Bond Geddes, RMA Executive Vice-President, Stevens Hotel, Chicago, or,

Twenty-five thousand radio manufacturers, jobbers and dealers expected to attend.

Reduced railroad rates have been granted on all lines—one and one-half fare rate. Secure certificates from local railroad agents. RMA special trains from all sections.

Official hotels—Stevens Hotel (headquarters), Blackstone, Congress and Auditorium Hotels, with demonstration rooms of manufacturers.

INDUSTRIES AND EXHIBITIONS

Radio industries, June 8-12—RMA, National Federation of Radio Associations, Radio Wholesalers Association and National Association of Broadcasters.

Music industry convention and exhibits, Palmer House—June 8-10, during "Radio Week."

Institute of Radio Engineers Annual Convention, Sherman Hotel—June 3-6.

Annual national "Furniture Mart" with 25,000 furniture buyers, jobbers, dealers and manufacturers—June 1-15.

RADIO MANUFACTURERS ASSOCIATION
11 W. 42nd St., N. Y. City 32 W. Randolph St., Chicago

When writing to advertisers mention of the PROCEEDINGS will be mutually helpful.



Isolantite *Insulators*



Isolantite Inc.

When writing to advertisers mention of the PROCEEDINGS will be mutually helpful.

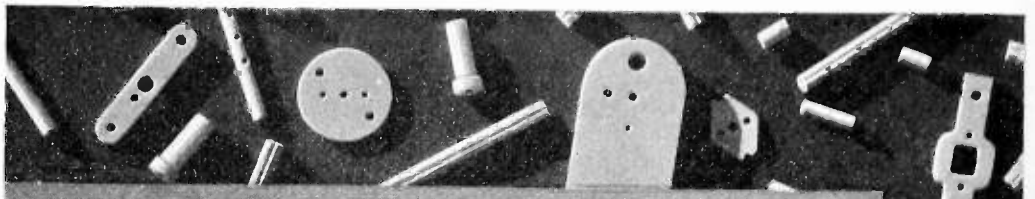

for Vacuum Tubes

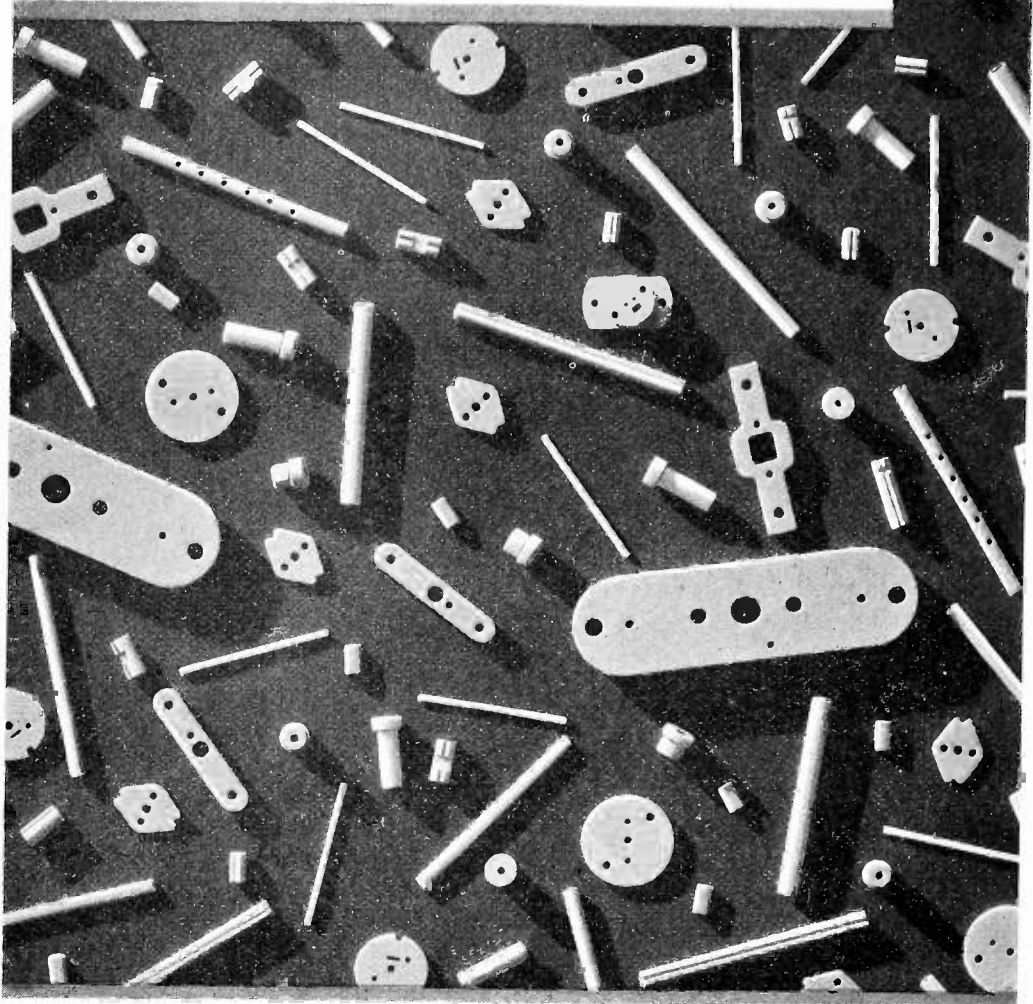

Belleville, New Jersey

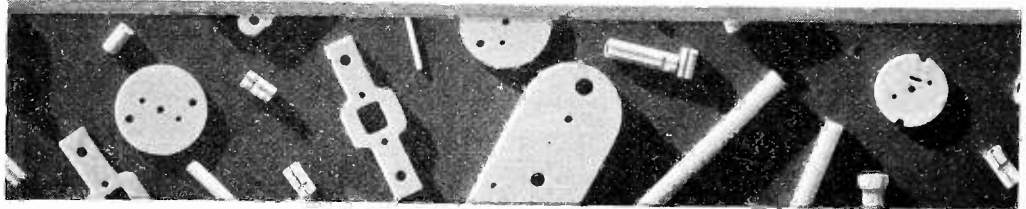

When writing to advertisers mention of the PROCEEDINGS will be mutually helpful.



Your Test Panels Need Jewell Instruments!

Your high-speed production test panels need measuring instruments that not only are accurate but give dependable operation under the severe operating conditions that test panels must withstand.

The Jewell line of Miniature Instruments have proven their ability to retain accuracy and dependability under unusual service in countless production test panels.

This line of sturdy instruments is available in types and scale ranges suitable for incorporation in test panels for every test position on your production line.

All types are readily interchangeable, being mounted in non-scratching bakelite cases, 3 inches in diameter. Shatter-proof glass standard on some instruments; available upon all others if desired.

Write for the booklet listing the full line of Jewell Miniature Instruments.

Jewell Electrical Instrument Co.
1642-D Walnut Street, Chicago, Ill.

31 YEARS MAKING GOOD INSTRUMENTS

JEWELL



Mail the Coupon

Please send me the Jewell Miniature Instrument Booklet.

Name

Address

When writing to advertisers mention of the PROCEEDINGS will be mutually helpful.

SPECIALISTS *in all types of*

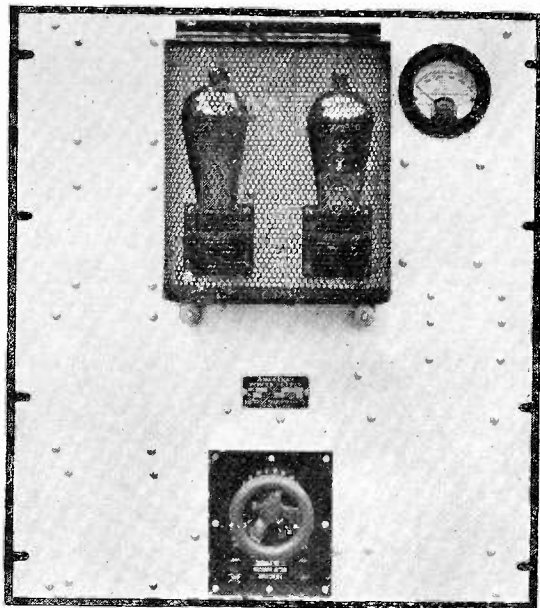

Type P77

Rectifying Equipment

AmerTran engineers are specialists in all types of rectifier equipment—expert at developing apparatus to answer any specific requirements.

The rectifier and filter illustrated here was especially designed for use in large installations where not the slightest ripple can be tolerated. This equipment, Type P77, is a magnified and refined B eliminator of the professional type, capable of supplying

200 mA of filtered d. c. plate current from an a. c. source. Although designed primarily for operation with Type 566 tubes, similar rectifiers with different output ratings are available.

For complete information on the Type P77, write for Bulletin 1072. Our district representatives are always glad to give special personal service.

Licensed under patents of R.C.A. and Associated Companies

AMERICAN TRANSFORMER COMPANY

178 Emmet Street, Newark, N. J.

Representatives in following cities

Boston · Chicago · Cleveland · Knoxville · Montreal · New York
Philadelphia · San Francisco · St. Louis

AMERTRAN

When writing to advertisers mention of the PROCEEDINGS will be mutually helpful.

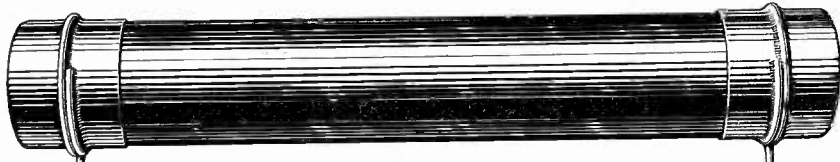

With Leads

Bradleyunit Resistors

Without Leads

Solid Molded for Permanence

Research, more than a quarter century of painstaking costly research, is behind Bradleyunit Resistors.

Years of practical experience in meeting the demands of radio set manufacturers have led to the development of these solid molded resistors, famous for their permanence and accuracy. A huge plant with exceptional facilities for volume production turns out Bradleyunit Solid Molded Resistors by the millions.

These are the factors that produce uniformity in the quality and performance of Bradleyunit Resistors. Get an Allen-Bradley quotation on your next order.

ALLEN-BRADLEY CO.

116 West Greenfield Ave. Milwaukee, Wisconsin

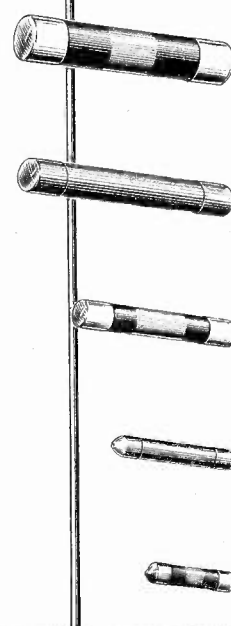
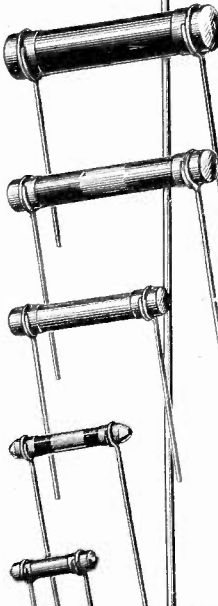

Bradleyometer



Bradley Suppressors



This remarkable "stepped" potentiometer has astounded radio engineers who were skeptical of its advertised performance. They have tried the new Bradleyometer and now know that no other type of potentiometer can rival it in flexibility and adaptability to every electronic unit. Any type of

resistance-rotation curve can be arranged to meet your requirements. Samples will be sent to established manufacturers of electronic apparatus for test and trial.

These fixed resistance units, known as Bradley Suppressors, are doing astonishing things for motor car radio. By using them with suitable by-pass condensers in other parts of the ignition circuit, shielded ignition cables are no longer necessary. For simplicity, reliability and low cost, these units are in a class by themselves. Heat, moisture and age have no effect upon them. They are the last word for motor car radio.

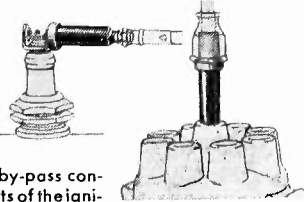

ALLEN-BRADLEY RESISTORS

Produced by the makers of Allen-Bradley Control Apparatus

When writing to advertisers mention of the PROCEEDINGS will be mutually helpful.



ANNOUNCES A NEW POWER TUBE SOCKET

Glazed
Isolantite
Insulation

Novel
Features

Long Life

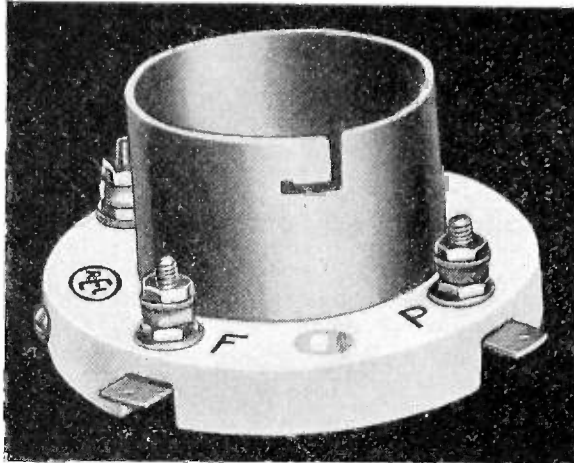

Positive
Under All
Conditions

Rugged
Contact

Economical

CAT. NO. 131

The REL Cat. No. 131 tube socket is a necessity finally realized. The bases are GLAZED ISOLANTITE, the insulator approved by the United States Navy. It can not be effected by moisture. This socket is ideal for use with all standard 50 watt type power and rectifier tubes in any type of circuit. The extra rugged contacts are positive under all conditions. For use with type -30-A, -45, -72 and -11 tubes.

The Cat. No. 131 tube sockets are ready for immediate delivery. Attention dealers, write for prices or else send us your orders direct.

Price \$2.75



MANUFACTURES A COMPLETE LINE OF
APPARATUS FOR SHORT WAVE TRANS-
MISSION AND RECEPTION.

Radio Engineering Laboratories, Inc.

100 Wilbur Ave.

Long Island City, N.Y., U.S.A.

When writing to advertisers mention of the PROCEEDINGS will be mutually helpful.

PERMANENT *STEADY* TENSION IN THE CARDWELL



MID WAY FEATHERWEIGHT CONDENSER

Assembled like fine machinery, with watch-like precision, every sturdy cap screw and stud is held in place by *tension* and the tenacious grip of lock-washers biting into brass and aluminum. Only deliberate tampering will ever loosen this assembly; vibration, shock and temperature changes—never. Suitable for every purpose where a lightweight, compact and small condenser is required. For receiving up to 365 mmfd. For transmitting up to 150 mmfd. with spacing adequate for use in transmitters using up to 75 watt tubes.

The "Midway" has many applications—as a neutralizing capacity for intermediate stages of a vacuum tube transmitter, in aircraft transmitters and receivers, for portable sets; in fact, for any purpose where compactness and light weight are desirable.

Extreme lightness of weight is made possible because with a few minor exceptions aluminum is used throughout. The voltage breakdown is materially increased in the transmitting models by reason of the use of highly polished plates with rounded edges.

The following models are available—

For receiving, in seven sizes—26 to 365 mmfds.

For transmitting, in six sizes—22 to 150 mmfds.

Weight from 4 to a maximum of 7 ounces.

Panel space required $2\frac{3}{4}$ " x $2\frac{1}{8}$ ".

Full particulars will be sent upon request.

CARDWELL CONDENSERS

for High and Low Voltages

*Receiving and Transmitting
and*

MANUFACTURING SERVICE

THE ALLEN D. CARDWELL MFG. CORP'N

93 Prospect Street, Brooklyn, N.Y.

Since Broadcasting Began

"THE STANDARD OF COMPARISON"

When writing to advertisers mention of the PROCEEDINGS will be mutually helpful.

Piezo Electric Crystals

"The Standard of Comparison"



When in the market for Accurately Ground Piezo Electric Crystals suitable for POWER USE, write us stating your requirements and our *seven years* of experience in this specialized field will be at your disposal.

Our prices for grinding these crystals are not the cheapest, but we believe our product to be *second to none* considering output and accuracy of frequency.



"A Trial Will Convince You"



Scientific Radio Service

"The Crystal Specialists"

P.O. Box 86

Mount Rainier, Maryland

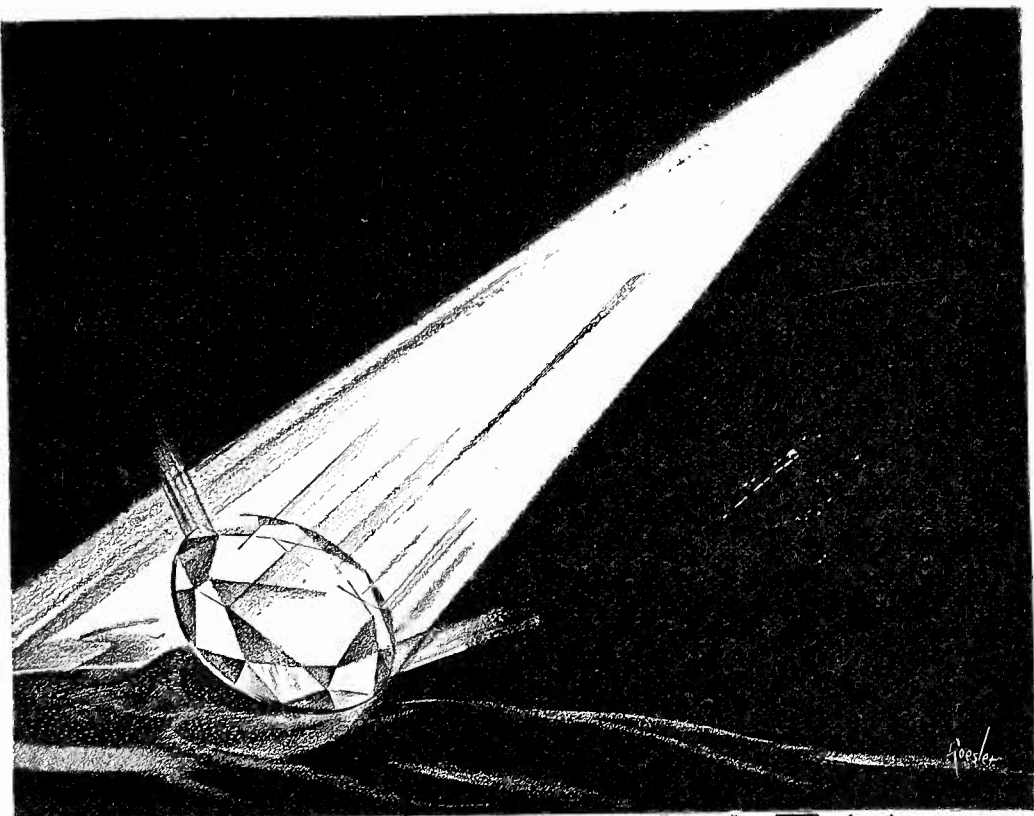

QUALITY THAT ADMITS OF NO SUBSTITUTE

Superficially, under the glare of electric lights, on a black velvet cushion an imitation has all the apparent appearance of a real diamond. But that is all for there is NO substitute for quality.

Yet even the genuine diamond needs the consummate art of the diamond cutter to reveal its inimitable beauty and radiance.

Centralab Volume Controls are more than a mere matter of metal and graphite. They also represent a consummate skill the skill of the engineer; the scientist, plus the intricate precision apparatus for their manufacture and testing.

In appearance, two volume controls may be alike, but there the similarity ends.

For true, noiseless performance cannot be imitated.

Centralab

Volume Controls

Write for new Volume Control Guide 

MAIL COUPON NOW

CENTRAL RADIO LABORATORIES
942 Keefe Ave., Milwaukee, Wis.

Enclosed find 25c for which send me new
VOLUME CONTROL GUIDE.

Name

Address

City State

I.R.E.

When writing to advertisers mention of the PROCEEDINGS will be mutually helpful.

TO PERFECT THE FILTER CIRCUIT



Single hole mounting

One-piece anode

Vent-metal enclosed

Dull Nickel Can

1931 witnesses the definite triumph of the SPRAGUE INVERTED TYPE ELECTROLYTIC CONDENSER which is now specified by most of the leading radio manufacturers, producing the largest volume of radio receivers absorbed by the American public.

No other device can compare with the SPRAGUE CONDENSER for efficiency, economy and performance in the perfecting of the Filter Circuit. Produced with absolute uniformity, Sprague condensers are specified by those who seek maximum efficiency.

Write for illustrated booklet, diagrams, etc.
Department

SPRAGUE SPECIALTIES COMPANY
North Adams, Mass.

Small Space

High Capacity

High Voltage

Self-Healing

SPRAGUE

Electrolytic CONDENSERS

When writing to advertisers mention of the PROCEEDINGS will be mutually helpful.

Designing New Models?

•

Utilize General Cable's coil knowledge and research

Just as the entire receiving set has undergone rapid improvements at the hands of one of America's most progressive industries, so has General Cable kept abreast of—even anticipated—the industry's need for coil improvements.

General Cable Coil Engineers can be of service to you. Through these En-

gineers you apply to your product all the advantages of the combined resources and experience of Dudlo, Rome and other companies affiliated in General Cable. You make modern, well-equipped laboratories your own. General Cable Coil Engineers welcome the opportunity to answer your call at any time.

GENERAL CABLE CORPORATION

420 LEXINGTON AVENUE, NEW YORK • OFFICES IN PRINCIPAL CITIES



When writing to advertisers mention of the PROCEEDINGS will be mutually helpful.



Progress

in the field of electronics necessitates new designs and insulators of special character —

For 16 years the Stupakoff Laboratories, manufacturers of



Stupakoff Insulators

have been designing and producing insulators to keep pace with modern improvements.

We are always ready to work in confidence with manufacturers. Send us your insulator problems.

STUPAKOFF LABORATORIES, Inc.,
Insulators
6619 Hamilton Ave., Pittsburgh (6), Pa.



When writing to advertisers mention of the PROCEEDINGS will be mutually helpful.

The Institute of Radio Engineers

Incorporated

33 West 39th Street, New York, N. Y.

APPLICATION FOR ASSOCIATE MEMBERSHIP

(Application forms for other grades of membership are obtainable from the Institute)

To the Board of Direction
Gentlemen:

I hereby make application for Associate membership in the Institute.

I certify that the statements made in the record of my training and professional experience are correct, and agree if elected, that I will be governed by the constitution of the Institute as long as I continue a member. I furthermore agree to promote the objects of the Institute so far as shall be in my power, and if my membership shall be discontinued will return my membership badge.

Yours respectfully,

.....
(Sign with pen)

.....
(Address for mail)

.....
(Date)

.....
(City and State)

References:

(Signature of references not required here)

Mr. Mr.

Address Address

Mr. Mr.

Address Address

Mr.

Address

The following extracts from the Constitution govern applications for admission to the Institute in the Associate grade:

ARTICLE II—MEMBERSHIP

Sec. 1: The membership of the Institute shall consist of: * * * (d) Associates, who shall be entitled to all the rights and privileges of the Institute except the right to hold the office of President, Vice-president and Editor. * * *

Sec. 5: An Associate shall be not less than twenty-one years of age and shall be: (a) A radio engineer by profession; (b) A teacher of radio subjects; (c) A person who is interested in and connected with the study or application of radio science or the radio arts.

ARTICLE III—ADMISSION

Sec. 2: * * * Applicants shall give references to members of the Institute as follows: * * * for the grade of Associate, to five Fellows, Members, or Associates; * * * Each application for admission * * * shall embody a concise statement, with dates, of the candidate's training and experience.

The requirements of the foregoing paragraph may be waived in whole or in part where the application is for Associate grade. An applicant who is so situated as not to be personally known to the required number of members may supply the names of non-members who are personally familiar with his radio interest.

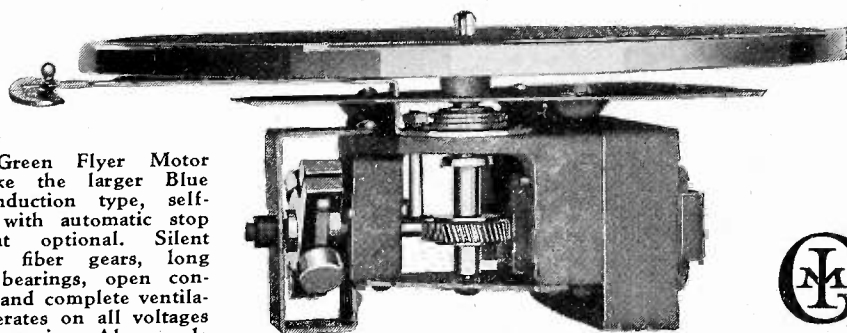

The Green Flyer Motor unit. Like the larger Blue Flyer, induction type, self-starting, with automatic stop equipment optional. Silent spiral-cut fiber gears, long oversize bearings, open construction and complete ventilation. Operates on all voltages and frequencies. Also made for direct current, either 110 or 220 volts. Complete with mounting plate, turntable and speed regulator. *Responsibly Guaranteed.*



***Everywhere
consistently***

superior performance in

**Flyer
Electrics**

ACHIEVING constantly more and more success, Flyer Electrics prove their right to it by the way they stand up in service.

For over two years, leading manufacturers of quality radio-phonographs have one after another adopted these motors permanently. Convinced of their all-around balanced superiority. Banking on the production record back of their development—15 years of steady large-scale production of quality phonograph motors and a quarter century of similar success in electrical manufacturing.

In every instance the Flyer Motor adopted . . . the Green Flyer or the larger Blue Flyer . . . is conspicuously rewarding the confidence placed in it. Everywhere giving consistently superior performance without limit.

When ordering samples please give voltage and frequency.

The GENERAL INDUSTRIES CO.

3146 Taylor Street, Elyria, Ohio

When writing to advertisers mention of the PROCEEDINGS will be mutually helpful.

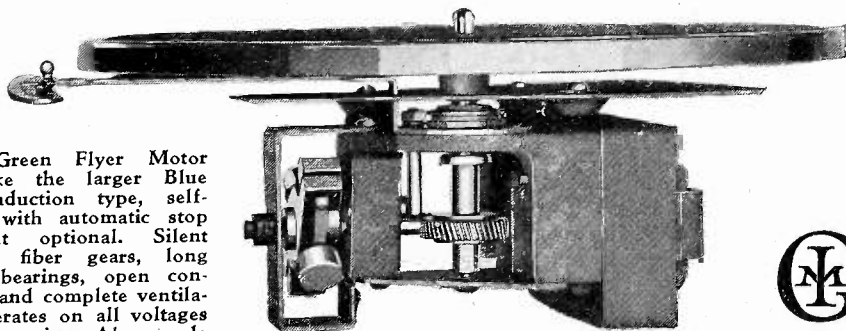

The Green Flyer Motor unit. Like the larger Blue Flyer, induction type, self-starting, with automatic stop equipment optional. Silent spiral-cut fiber gears, long oversize bearings, open construction and complete ventilation. Operates on all voltages and frequencies. Also made for direct current, either 110 or 220 volts. Complete with mounting plate, turntable and speed regulator. *Responsibly Guaranteed.*



***Everywhere
consistently***

superior performance in

**Flyer
Electrics**

ACHIEVING constantly more and more success, Flyer Electrics prove their right to it by the way they stand up in service.

For over two years, leading manufacturers of quality radio-phonographs have one after another adopted these motors permanently. Convinced of their all-around balanced superiority. Banking on the production record back of their development—15 years of steady large-scale production of quality phonograph motors and a quarter century of similar success in electrical manufacturing.

In every instance the Flyer Motor adopted . . . the Green Flyer or the larger Blue Flyer . . . is conspicuously rewarding the confidence placed in it. Everywhere giving consistently superior performance without limit.

When ordering samples please give voltage and frequency.

The GENERAL INDUSTRIES CO.

3146 Taylor Street, Elyria, Ohio

When writing to advertisers mention of the PROCEEDINGS will be mutually helpful.

HERE'S THE ELKON NON-AQUEOUS HI-VOLT CONDENSER

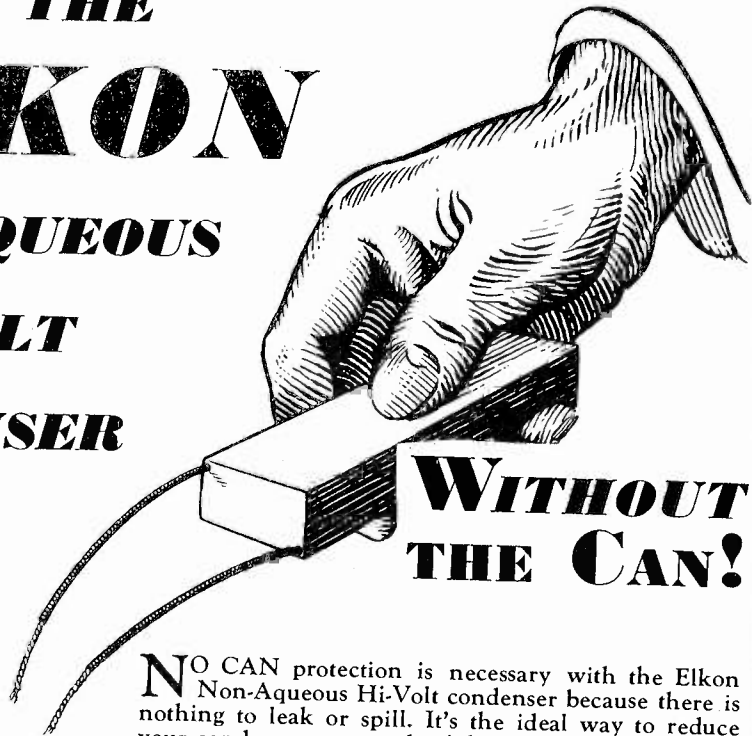

WITHOUT THE CAN!

**—and here's how
you can use it to
save money . . .**

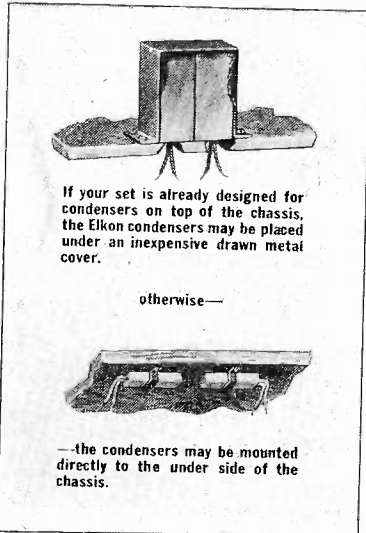

NO CAN protection is necessary with the Elkon Non-Aqueous Hi-Volt condenser because there is nothing to leak or spill. It's the ideal way to reduce your condenser costs and still have the highest standard of filtering quality.

—and here are ten more reasons why many leading set and instrument manufacturers (names on request) have adopted the Elkon condenser as standard equipment:

- 1 Highest Filtering Capacity of any electrolytic condenser.
- 2 High Working Voltage: 450 volts—withstands without injury transient peaks in excess of 575 volts.
- 3 Absolutely Dry: A condenser from which all water is eliminated.
- 4 Low Leakage: Normal rated leakage 0.1 mil per mfd. (After operating short period the leakage is 0.025 mils per mfd.)
- 5 Impervious to Low Temperatures: Operates efficiently from minus 40° F to 125° F.
- 6 Long Life: To reduce replacements and interrupted service periods to a minimum.
- 7 Self Healing: Transient peaks in excess of 575 volts do not injure the Elkon condenser.
- 8 Compactness: Smallest cubical volume per microfarad of any condenser on the market.
- 9 Stability in Operation: To guard against mechanical and electrical variation that would affect action of the circuit.
- 10 Low Cost Per Microfarad Per Voltage Rating: A large safety factor in volt rating for the same cost as lower voltage condensers.

Samples in any combination of capacities you specify will be sent to all recognized manufacturers (metal cans will be supplied if desired). Booklet on request.

ELKON DIVISION
P. R. Mallory & Company, Incorporated
Indianapolis, Indiana

When writing to advertisers mention of the PROCEEDINGS will be mutually helpful.

YOUR NEW PROBLEM . . . *and* ITS SOLUTION!

WITH home recording promising to be an outstanding feature of next year's radio receivers, the problem of HUM is more serious than ever.

Even a slight hum not noticeable in radio reproduction will, when recorded and augmented through reproduction, make itself heard with sufficient volume to prove disagreeable. In this modern day of radio, hum is not to be tolerated in radio or phonograph reproduction.

For more than twenty years, Pacent engineers have concerned themselves exclusively with problems relating to sound amplification. That's why Pacent amplifiers are the best in the field today.

A standard two stage Pacent Amplifier, Cat. No. 2245M (without input transformer) employing one 227 and two 245's in push-pull has a hum level of 23 DB below its maximum output rating. This same amplifier will provide 4.3 watts undistorted power output and has a voltage gain at 1000 cycles of 31 DB with 3.8 volts input. These figures are not theoretical calculations. They are the result of actual measurements made with a stock amplifier.

A Pacent Amplifier, the 170 Recordovox and the 107 Hi-Output Phonovox make a remarkable combination for recording and reproducing. With this apparatus, it is possible to assure professional results.

The Recordovox and Phonovox are available in special manufacturers' types. Write for additional information.

PACENT ELECTRIC COMPANY, INC.
91 SEVENTH AVE., NEW YORK, N. Y.

Pioneers in Radio and Electric Reproduction for over 20 Years.
Licensee for Canada: White Radio, Ltd., Hamilton, Ont.

PACENT

When writing to advertisers mention of the PROCEEDINGS will be mutually helpful.

This FLAT Curve

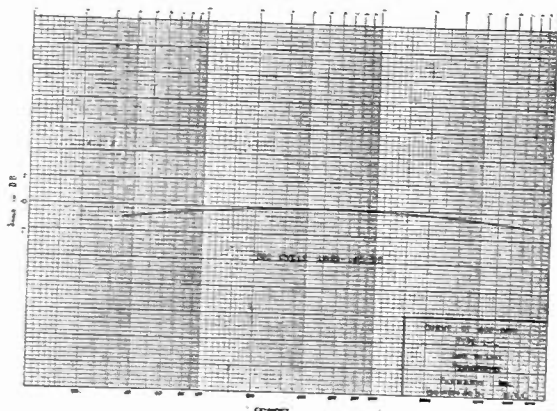

is typical of the response secured by Ferranti Audio Frequency and Special Impedance Matching Transformers . . . used for the exacting requirements of Broadcasting Stations and Laboratories and in speech transmission.

SPECIAL TRANSFORMERS, American built, can be shipped in 48 hours.

FERRANTI AMPLIFIERS meet special needs in educational and commercial work with decidedly *better amplification*.

Write for details and quotations

FERRANTI • INC.
130 West 42nd Street
NEW YORK CITY

When writing to advertisers mention of the PROCEEDINGS will be mutually helpful.

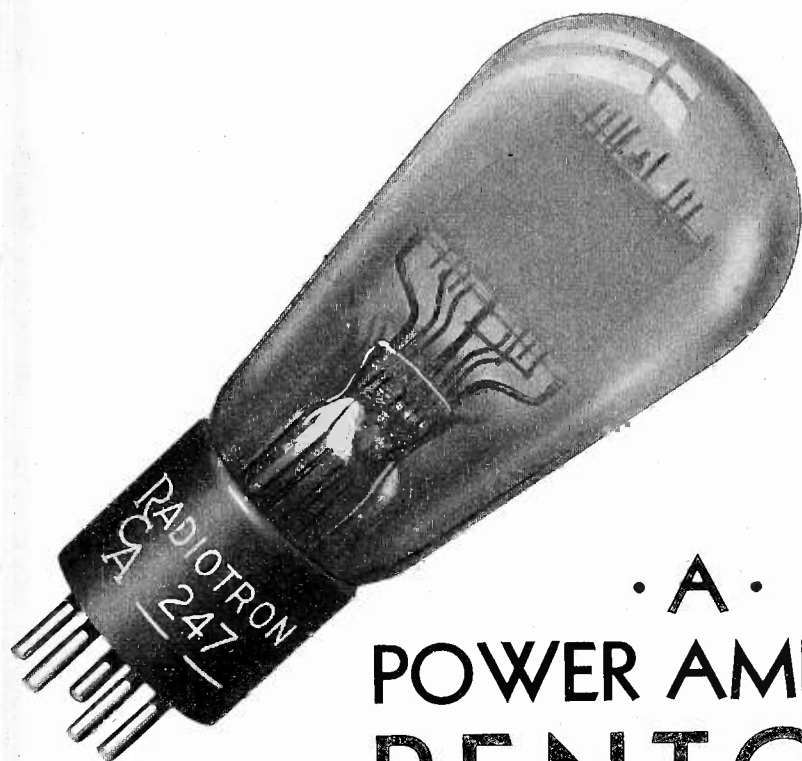

• A •

POWER AMPLIFIER PENTODE NOW AVAILABLE

The RCA-247 has been designed for use in the audio power output stage of newly-designed AC receivers.

ONCE AGAIN the RCA Radiotron Company, Inc., gives the set designers a new tool to work with—the screen-grid power output pentode, RCA-247. Owing to the addition of a “suppressor” grid between the screen and plate, this Radiotron is capable of giving large audio power output for relatively small signal

voltages impressed on the grid. The suppressor is connected to the cathode and is, therefore, operated at the cathode potential. Thus, the suppressor is effective in practically eliminating the secondary emission effects which limit the power output of four-electrode screen-grid types.

The preliminary ratings and characteristics are:

Filament Voltage	2.5 Volts	Plate Current	32 Milliampères
Filament Current	1.5 Amperes	Screen Current	7.5 Milliampères
Plate Voltage, Recommended	250 Volts	Plate Resistance	38,000 Ohms
Screen Voltage, Recommended and Maximum	250 Volts	Mutual Conductance	2,500 Micromhos
Grid Voltage	16.5 Volts	Load Resistance, Approximate	7,000 Ohms
Power Output			2.5 Watts

RCA RADIOTRON CO., INC. ~ HARRISON, N. J.
A Radio Corporation of America Subsidiary

RCA RADIOTRONS

« THE HEART OF YOUR RADIO » »

When writing to advertisers mention of the PROCEEDINGS will be mutually helpful.

Cornell

TRADE MARK REG.

NEW PROCESS CARBONIZED RESISTORS

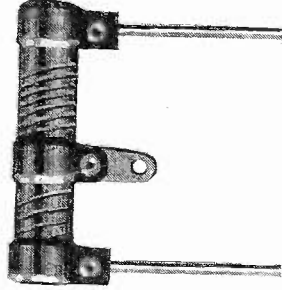

Features
Obtainable in
Radio's Most
Desirable Resistor:

1. 5% or 10% tolerance at less than usual additional cost.
2. Tapped dual units at slightly more than single unit cost.
3. Tapped units save assembly operations.
4. Temperature co-efficient less than $\frac{3}{4}$ of 1% for every 10° centigrade temperature rise.
5. Resistance change averages only 6% while under continuous atmospheric moisture contents of 100% or 0% humidity.
6. Resistance is independent of applied voltage within normal wattage rating.
7. 100% overload for 250 hours shows less than 3% variation in resistance.
8. New process developed exclusively by Cornell has given these units proven dependability.

*Write for samples and let us know your requirements.
We shall be glad to send you full particulars.*

Cornell Electric Mfg. Co., Inc.

Manufacturers of

CORNELL "CUB" CONDENSERS

*Filter and By-Pass Condensers, Interference Filters and
All Types of Paper Dielectric Condensers*

LONG ISLAND CITY, NEW YORK

ROLLER-SMITH *Announces*

A *new* Instrument Type PD

Direct Current VOLT-OHMMETER

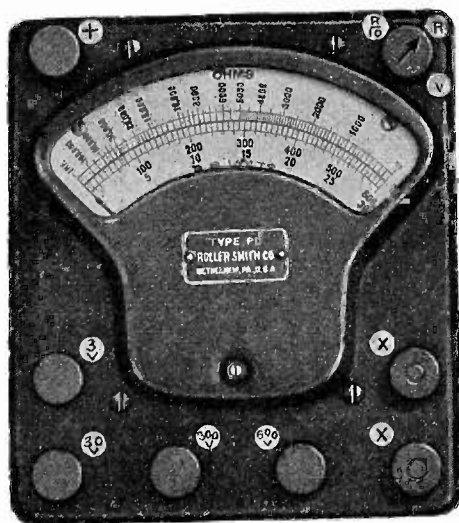

Cat. No. 1050. Size $4\frac{1}{2}$ " x 5" x $2\frac{5}{8}$ "

This instrument is a combination Circuit Tester, four range voltmeter and direct reading ohmmeter, having ranges of 0-3, 0-30, 0-300 and 0-600 volts and 0-10,000 and 0-100,000 ohms. The voltage ranges have a resistance of 1000 ohms per volt.

It is recommended particularly for radio testing.

There is a special type of rheostat included to compensate for the falling off in cell voltage (a 4.5 volt C battery is self-contained), which occurs after the instrument has been in use for a time. Scale is $3\frac{5}{16}$ " long.

A pair of special flexible cables with insulated test prods accompanies each instrument.

Send for your copy of Supplement No. 3 to Bulletin K-100.

Forty years' instrument experience is back of

ROLLER-SMITH COMPANY

Electrical Measuring and Protective Apparatus

Main Office:
2134 Woolworth Bldg.
NEW YORK



Works:
Bethlehem,
Pennsylvania

Offices in principal cities in U. S. A. and Canada

When writing to advertisers mention of the PROCEEDINGS will be mutually helpful.

AEROVOX

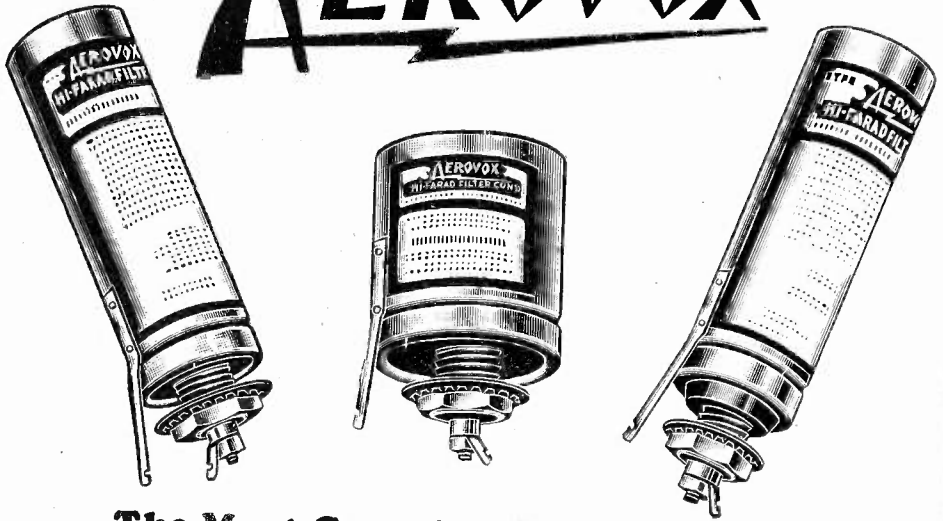

The Most Complete Line of Screw Mounting DRY Electrolytic Condensers in the Radio and Electrical Industries

Available in a wide variety of sizes, capacities, voltage characteristics and mounting features. These units are Dry, Low in Cost per Microfarad per Volt Rating, Compact, Light in Weight, Safe, Surge-Proof, Self-Healing, and provide Long Life, Stable Operation and High Filtering Efficiency. They may be mounted in any position—Upright, Inverted, Horizontal or at any other angle.

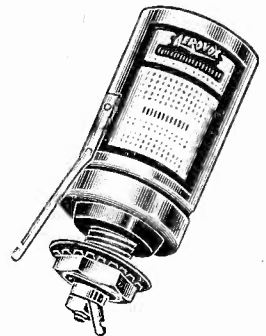
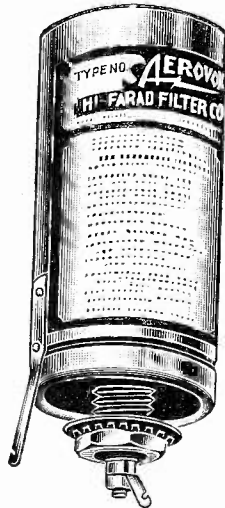
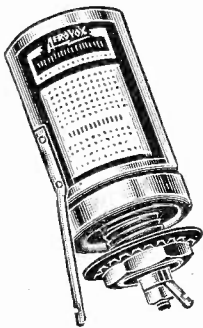

Free!

A copy of a 32-page book, containing a wealth of information on all types of electrolytic condensers will be sent free of charge on request. Just mail the coupon below.

Write for our new 40-page 1931 Condenser and Resistor Manual and Catalog, also the Aerovox Research Worker sent free upon request.

Aerovox Wireless Corporation
80 Washington Street
Brooklyn, N. Y.

Please send me, without charge or obligation, a copy of your book, "The Hi-Farad DRY Electrolytic Condenser."

Name

Address

City..... State.....

AEROVOX

WIRELESS CORP.

70 WASHINGTON ST.,
BROOKLYN, N. Y.

MEMBER
RMA

When writing to advertisers mention of the PROCEEDINGS will be mutually helpful.

CHANGE IN MAILING ADDRESS OR BUSINESS TITLE

Members of the Institute are asked to use this form for notifying the Institute office of a change in their mailing address or any change in the listing of their company affiliation or title for the Year Book membership list.

The Secretary,
THE INSTITUTE OF RADIO ENGINEERS,
33 West 39th Street,
New York, N.Y.

Dear Sir:

Effective please note change in my address
(date)
for mail as follows:

FROM

.....
(Name)

.....
(Street Address)

.....
(City and State)

TO NEW ADDRESS

.....
(Street Address)

.....
(City and State)

Also for the membership list for next year's Year Book note change in my business address (or title) as follows, this ^{is} ~~is not~~ my mailing address:

.....
(Title)

.....
(Company Name)

.....
(Address: Street, City and State)

PLEASE FILL IN, DETACH, AND POST TO THE
INSTITUTE PROMPTLY

Back Numbers of the Proceedings, Indexes, and Year Books Available

MEMBERS of the Institute will find that back issues of the Proceedings are becoming increasingly valuable, and scarce. For the benefit of those desiring to complete their file of back numbers there is printed below a list of all complete volumes (bound and unbound) and miscellaneous copies on hand for sale by the Institute.

The contents of each issue can be found in the 1914-1926 Index and in the 1929 Year Book (for the years 1927-28).

BOUND VOLUMES:

Buckram Binding—

Vol. 10 (1922), \$8.75 per volume to members

Vols. 17 and 18 (1929-1930), \$9.50 to members

Morocco Binding—

Vols. 10 and 14 (1922 and 1926), \$10.25 to members

UNBOUND VOLUMES:

Vols. 6, 8, 9, 10, 11, and 14 (1918-1920-1921-1922-1923-1926), \$6.75 per volume (year) to members

MISCELLANEOUS COPIES:

Vol. 1 (1913) July and December

Vol. 2 (1914) June and December

Vol. 3 (1915) December

Vol. 4 (1916) June and August

Vol. 5 (1917) April, June, August, October and December

Vol. 7 (1919) February, April and December

Vol. 12 (1924) August, October and December

Vol. 13 (1925) April, June, August, October and December

Vol. 15 (1927) April, May, June, July, August, October, November and December

Vol. 16 (1928) February, March, April, May, June, July, August, September, October, November and December

Vol. 17 (1929) February, March, April, May, June, July, August, September, November and December

Vol. 18 (1930) April, May, June, July, August, September, October, November and December

These single copies are priced at \$1.13 each to members to the January 1927 issue. Subsequent to that number the price is \$0.75 each. Prior to January 1927 the Proceedings was published bimonthly, beginning with the February issue and ending with December. Since January 1927 it has been published monthly.

MEMBERS will also find that our index and Year Book supplies are becoming limited. The following are now available:

INDEX AND STANDARDIZATION REPORT

The Proceedings Index for the years 1909-1930 inclusive is available to members at \$1.00 per copy. This index is extensively cross indexed. The 1930 Standardization Report, which contains current Standardization information, is also available to members at \$1.00 per copy.

YEAR BOOK

The 1931 Year Book is available to members at \$1.00 per copy. This Year Book includes the 1930 Standardization Report,—an "up to the minute" report on the most recent standardization information available, as well as the Proceedings Index for the years 1909-1930 inclusive.

Make remittances payable to the Institute of Radio Engineers and send orders to:

THE INSTITUTE OF RADIO ENGINEERS
33 West 39th Street, NEW YORK, N.Y.



HIGH GAIN I-F DESIGN WITH STANDARDIZED UNITS

A shielded intermediate-frequency transformer with "Varitor" condenser tuning in primary and secondary circuits. One hundred and fifty to two hundred kc, with standard production windings or step-up ratios. Mechanically suited to upright or inverted mounting.

DIALS DIRECT DRIVE AND FRICTION DRIVE FULL VISION AND SECTOR VISION

Meeting the manufacturer's predominant requirements of excellence, economy and standardization, these new Full Vision Dials combine the economical requirements of midget receiver design with the luxury and refinement of console type. In kc and metric scales.

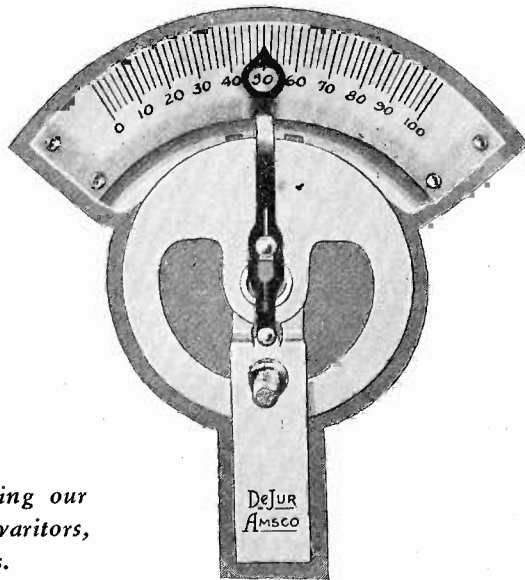

Write for literature describing our complete line of I-F units, varitors, dials, and tuning accessories.

DeJUR-AMSCO CORPORATION

Varitors—Variable Condensers—Power Rheostats—Front Drive Dials
95 MORTON ST., NEW YORK CITY

When writing to advertisers mention of the PROCEEDINGS will be mutually helpful.

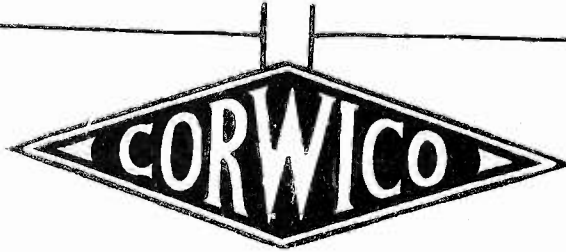

PARALAC

The Moisture Proof Hook-up Wire With
the Slide Back Feature

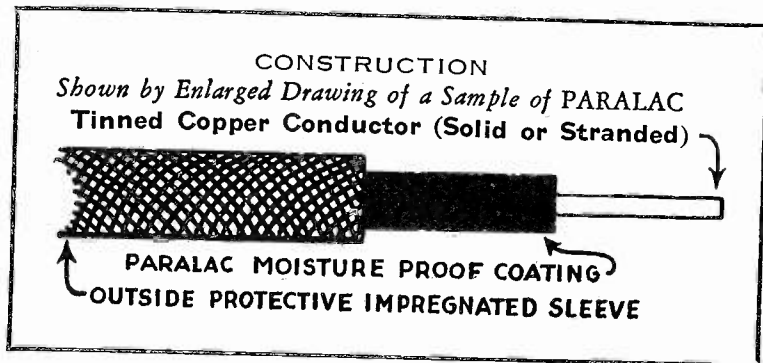

THE ENGINEER needs a high voltage hook-up wire with the slide-back feature, the product also possessing high and constant insulation resistance values.

THE PRODUCTION MANAGER requires a hook-up wire easy to work with, thus saving time in assembly without sacrificing quality.

THE PURCHASING AGENT wants a hook-up wire possessing these characteristics that can be brought within the range of present-day commercial costs.

To fulfill these requirements our engineers have designed **PARALAC**. Recent tests made at the Electrical Testing Laboratories, New York City, show conclusively that **PARALAC** meets all these requirements.

We have copies of these tests on file awaiting your request but—better still, write for a sample of PARALAC and verify our contentions in your own factory.

PARALAC is made with both solid and stranded core in assorted colors from 12 to 24 gauge. Prices on request.

CORNISH WIRE CO., Inc. 30 Church Street, New York
"MADE BY ENGINEERS FOR ENGINEERS"



When writing to advertisers mention of the PROCEEDINGS will be mutually helpful.



An Important Announcement
Regarding
**THE
ACRACON*
ELECTROLYTIC
CONDENSER**

Acracon Electrolytic Condensers are now available in the following capacities at 440 volts peak: 2, 4, 6, 8, 10, 12 and 16 microfarads, and at 475 volts peak, up to 12 microfarads. Lengths range from $2\frac{7}{8}$ inches to $4\frac{1}{2}$ inches, according to the capacity.

All Acracon units are of the single hole inverted type, which was introduced by the Condenser Corporation of America and which has won the approval of the industry.

Specify Acracon Electrolytic Condensers. Also by-pass and filter condensers.

Write Today, Enclosing Specifications!

**All Acracon Features Are Protected by Patents Pending*

Condenser Corporation of America
259-271 Cornelison Ave. Jersey City, N. J.

Chicago
Cincinnati

Factory Representatives in:

St. Louis
San Francisco

Los Angeles
Toronto

and other Principal Cities

When writing to advertisers mention of the PROCEEDINGS will be mutually helpful.



Depend on » » FORMICA

SOME of the most competent American electrical and radio manufacturers have done so for many years. Not a few of them have been continuously among Formica customers for 15 years.

That must mean that Formica is a high quality, uniform material. That the fabricating work done in the Formica plant is accurate and skillful. And that sufficient equipment is available to give prompt service.

All of those conditions do exist and you can depend on them.

Formica has the largest facilities for both the manufacture and the fabrication of laminated phenolic material. It has a well selected and trained organization concentrated for 15 years on improving and producing just one material.

Such concentration must bring results—and it has.

Try the service—send your blue prints for estimates.

**THE FORMICA INSULATION
COMPANY**

4646 Spring Grove Avenue
Cincinnati, Ohio

FORMICA
Made from Anhydrous Bakelite Resins
SHEETS TUBES RODS

When writing to advertisers mention of the PROCEEDINGS will be mutually helpful.

SELECTIVITY SELLS SETS

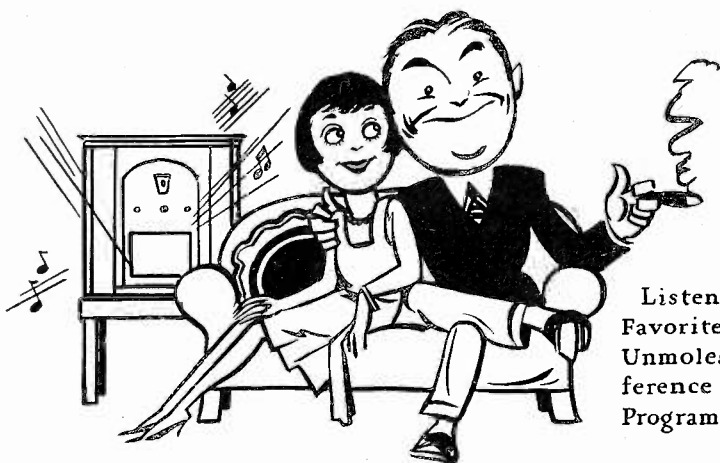

Listening to Your
Favorite Radio Program
Unmolested by Inter-
ference from Competing
Programs

Textolite Safeguards Selectivity

PROGRAMS that once quarreled their way through now flow in with satisfying clarity — where the insulation is right. That's why some of the most prominent radio manufacturers have intrusted the right insulation of their receivers to laminated Textolite.

Here is a superior material that emerged fully tested from one of the greatest research laboratories in the world. It has proved its ability to preserve the original precision of tuning with unflagging fidelity. It possesses a practically constant power-factor under varying conditions.

Don't hesitate to request information on Textolite — in sheets, rods, or tubes — from the eastern or western fabricators, or from the Textolite specialist in the General Electric office of your vicinity.

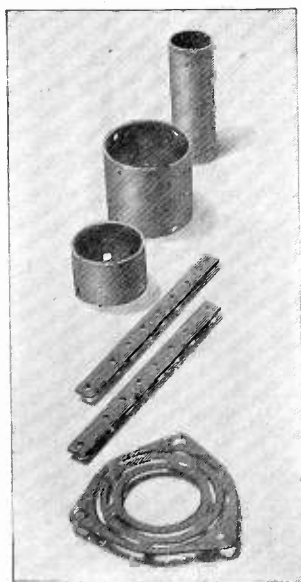

General Fabricating Co. Electrical Insulation Corp.
37 East 18th Street 308 W. Washington St.
New York City Chicago, Ill.

GENERAL  ELECTRIC

885-51D

When writing to advertisers mention of the PROCEEDINGS will be mutually helpful.

Continental Resistors

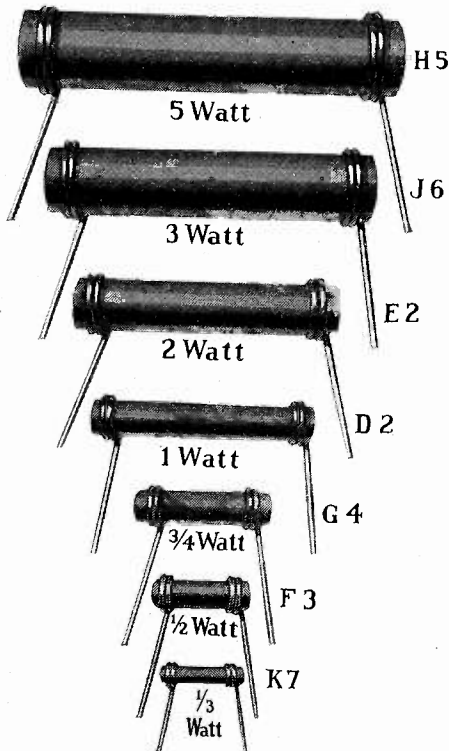

RESISTOR CHARACTERISTICS:

NOISELESS
RESISTANCE CONSTANT
SMALL TEMPERATURE
COEFFICIENT
RUGGED
FIRMLY SOLDERED TERMINALS
DEPENDABLE
COLOR CODED

UNITS SHOWN HALF SIZE

CONTINENTAL SUPPRESSORS

For Radio-Equipped Cars

Stop ignition noise in the automobile radio set when used with suitable by-pass condensers. The distributed capacity is extremely small. The resistors are enclosed in a tough ceramic tube of high crushing and tensile strength, of low coefficient of expansion and of high dielectric strength. They are hermetically sealed in the tube and this renders the suppressors moisture proof.

Suppressors shown full size



Curtis Electro Chemical Condenser

Essential Characteristics

- Full capacity at all voltages
- Uniform capacity at all frequencies
- Low freezing point
- Low internal resistance
- Low leakage
- No nipples, new breather principle
- One hole mounting terminal at bottom

For Further Particulars Write to
Curtis Continental Corp.
13900 Lorain Ave.,
Cleveland, O.

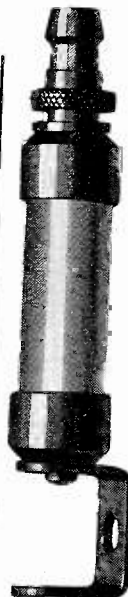

SPARK PLUG SUPPRESSOR



SCREW IN CABLE TYPE SUPPRESSOR



DISTRIBUTOR SUPPRESSOR

Write for Information and Prices
CONTINENTAL CARBON INC.

13900 Lorain Ave.
WEST PARK, CLEVELAND, O.

When writing to advertisers mention of the PROCEEDINGS will be mutually helpful.

ENGINEERS AVAILABLE

Advertisements on this page are available only to members of the Institute of Radio Engineers. For rates and further information address the Secretary, The Institute of Radio Engineers, 33 West 39th Street, New York, N.Y.

Manufacturers and others seeking radio engineers are invited to address replies to these advertisements at the Box number indicated, care the Institute of Radio Engineers. All replies will be forwarded direct to the advertiser.

YOUNG MAN having five years radio experience with the U. S. Coast Guard desires position with opportunity to do research and development work. Has completed one year of high school as well as course in radio engineering given by the Naval Research Laboratories. Work with coast guard includes research and design on radio equipment, especially for high frequency communication and installation of marine compasses and direction finding equipment. Age 24. Box 57.

OPERATOR-ENGINEER having experience since 1926 in the operation, maintenance, design and construction of transmitters desires position. Is interested in installation and maintenance of transmitters, with slight preference for telegraph transmitters. Experience with broadcast transmitters since 1927. Has had two and one-half years of college. Age 32. Box 58.

ENGINEER with six and one-half years' experience in responsible positions desires work preferably in audio frequency field. Has had two and one-half years as chief engineer in manufacturing superheterodyne receivers, two and one-half years as chief engineer and assistant manager of concern manufacturing small transformers and chokes, and one-half year in full charge of engineering and production of resistance and special alloy wires. Immediate position secondary in importance to opportunity. Prefer work in Chicago district but will travel. Salary to be based on opportunity and responsibilities. Married. B.S. in E.E., 1925. Age 34. Box 59.

COLLEGE GRADUATE, having several years experience with design of public address and centralized radio systems and talking picture equipment desires position with opportunity for doing design, development and research in audio systems or on radio equipment. Now employed. Age 25. Box 54.

YOUNG MAN with several years experience building and servicing radio receivers and high frequency transmitters desires position in radio field, preferably with broadcast station. Has high school education as well as radio courses; some musical education. Age, 23. Box 60.

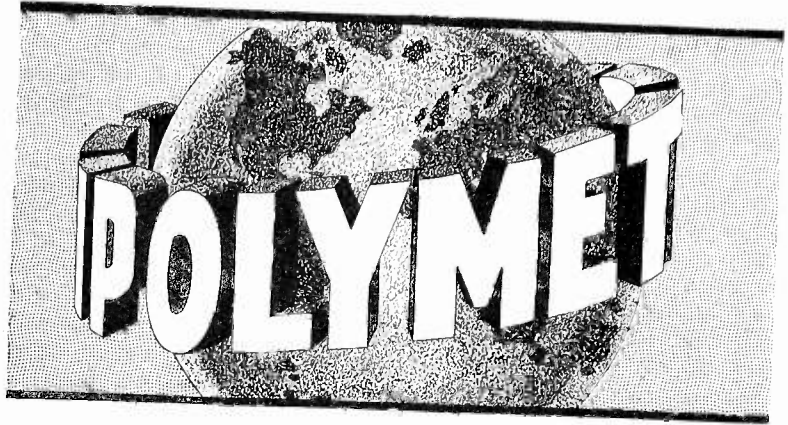

Insured Profit if it's of Polymet Quality

Radio manufacturers throughout the world are learning more and more of the profit resulting from the use of Polymet radio parts.

Manufacturers, dealers, and users profit by the use of Polymet quality products. The manufacturer builds a profitable and satisfied trade, the dealer's sales are more easily made and the user gets more service and value for his money.

Polymet Quality Products include:

PAPER, ELECTROLYTIC and MICA CONDENSERS . . . RESISTANCES
. . . COILS . . . MAGNET WIRE . . . VOLUME CONTROLS . . .
TRANSFORMERS and SOUND EQUIPMENT PARTS.



P O L Y M E T

Manufacturing Corporation
829 East 134th Street, New York City

Canadian Representative

WHITE RADIO, Ltd.

41 West Avenue

North Hamilton, Canada

Representative for the British Isles

A. H. HUNT, Ltd.

Tunstal Road, Croydon, Surrey, England

When writing to advertisers mention of the PROCEEDINGS will be mutually helpful.

PROFESSIONAL ENGINEERING DIRECTORY

For Consultants in Radio and Allied Engineering Fields

ELECTRICAL TESTING LABORATORIES

Tests of Inductances.
Condensers. Transform-
ers etc. Life and charac-
teristics of Radio Tubes

80th. Street and East End Ave.
• • NEW YORK, N.Y. • •

For EXPORT of Material Manufactured
by:

American Transformer Co.
Allen D. Cardwell Mfg. Co.
Corning Glass Works
Dubilier Condenser Corp.
P. R. Mallory
Radio Engineering Labs.
Universal Microphone Co., Ltd.
Ward Leonard Electric Co.
Weston Elec. Inst. Co.

Apply to

AD. AURIEMA, INCORPORATED
116 Broad St.
New York City, N.Y.

JENKINS & ADAIR, INC.

Engineers

Designers and manufacturers of appara-
tus essential to broadcasting, sound re-
cording and sound measurement work.

3333 Belmont Ave., Chicago, U.S.A.

Cable Address: *Jenkadair*

Telephones: Keystone 2130

The J. G. White Engineering Corporation

Engineers—Constructors

*Builders of New York Radio
Central*

43 Exchange Place New York

EIGHT DOLLARS DOES IT!

You can directly acquaint over
8,000 of the most influential and
authoritative radio men of the day
with your services each month
through this Professional Card
Page.

Per insertion \$8.00

Radio, Television and Sound Picture
Patents bought and sold. Applications,
searches and reports for Inventors and
Manufacturers.

Over twenty five years practical ex-
perience as an Engineer and Manufac-
turer in Radio and kindred fields.

H. R. VAN DEVENTER

Consulting Engineer and Patent Attorney

342 Madison Ave., New York City

I. R. E. Members

You will find that the 8,000 active, influential radio men who read the
monthly PROCEEDINGS I.R.E. will help you increase your business
—if you let them know of your services. For detailed yearly, quarterly,
and single insertion rates on this Professional Engineering Directory,
write to:

Advertising Department

Institute of Radio Engineers
33 West 39th St., New York, N.Y.

When writing to advertisers mention of the PROCEEDINGS will be mutually helpful.

Alphabetical Index to Advertisements

A

Aerovox Wireless Corp.....XLII
 Allen-Bradley Co.....XXV
 American Tel. & Tel. Co.....XII
 American Transformer Co.....XXIV
 Arcturus Radio Tube Co.....XVIII

C

Cardwell, Allen D. Mfg. Corp.....XXVII
 Central Radio Laboratories.....XXIX
 Condenser Corp. of America.....XLVII
 Continental Carbon, Inc.....L
 Cornell Electric Mfg. Co.....XL
 Cornish Wire Co.....XLVI

D

DeForest Radio Co.....LVI
 DeJur-Amsco Corp.....XLV
 Dubilier Condenser Corp.....XIV

E

Electrad, Inc.....XIX
 Electric Specialty Co.....XVI
 Engineers Available.....LI

F

Fansteel Products Co., Inc.....LVII
 Ferranti, Inc.....XXXVIII
 Formica Insulation Co.....XLVIII
 Frost, H. H., Inc.....XV

G

General Cable Corp.....XXXI
 General Electric.....XLIX
 General Industries Co.....XXXV
 General Radio Co.. Outside Back Cover

I

International Resistance Co.....XI
 I.R.E.....XXXIII, XXXIV,
 XLIII, XLIV, LV
 Isolantite Inc.....XXI, XXII

J

Jewell Elec. Instrument Co.....XXIII

M

Magnovox Co., Ltd.....XVII
 Mallory, P. R. & Co. Inc.....XXXVI

P

Pacent Electric Co., Inc.....XXXVII
 Polymet Mfg. Co.....LII
 Potter Mfg. Co..... Inside Back Cover
 Professional Eng. Directory.....LIII

R

RCA Radiotron Co., Inc.....XXXIX
 RCA Victor Co. Inc.....XIII
 Radio Engineering Labs.....XXVI
 RMA Show.....XX
 Roller-Smith Co.....XLI

S

Scientific Radio Service.....XXVIII
 Sprague Specialties Co.....XXX
 Stupakoff Labs., Inc.....XXXII

T

Thordarson Elec. Mfg. Co.....LVIII

When writing to advertisers mention of the PROCEEDINGS will be mutually helpful.

I. R. E. EXHIBITION

at

Sixth Annual Convention I. R. E.

One of the most important radio Exhibitions of the year will be held in connection with the Institute of Radio Engineers' Sixth Annual Convention—June 4-5-6, 1931—on the mezzanine of the Hotel Sherman, Chicago, Illinois.

This Exhibition has been planned to give manufacturers of set components, measuring instruments, laboratory equipment and manufacturing aids an opportunity to directly introduce their 1931 products to the influential radio engineers and prominent radio men who will attend the I.R.E. Convention. Competent engineers will be in charge of each Exhibition Booth to answer in a technical fashion the questions of engineers.

Prominent radio men from all parts of the world will be attending this Convention—men whose good-will toward your products will be influential in adding new orders to your list.

Reservations for Booth Space at the I.R.E. Exhibition are being made every day. If you haven't made your reservation, write or wire for detailed information to:

INSTITUTE OF RADIO ENGINEERS

33 West 39th Street
New York City, New York

When writing to advertisers mention of the PROCEEDINGS will be mutually helpful.

TWO NEW DEFOREST RECEIVING TUBES

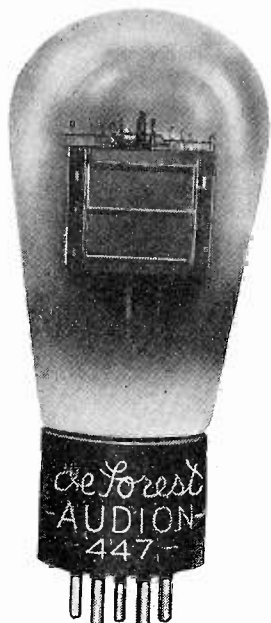

Both Pentode and Variable Mu types of tubes are now bidding for engineering and public favor. And once more, in keeping with the traditions of a quarter-century of pioneering, DeForest research and engineering development talents have been summoned to provide refined versions of standard tubes.

DeForest Pentode Type 447

A power pentode for audio-frequency purposes. In general appearance, it is not unlike the 445 power tube, but has approximately twice the power output. On closer examination, however, the intricate grid structure becomes apparent. Mechanically, this DeForest version is outstanding, with ample clearance between filament and grid to avoid short-circuits. This five-element tube, with many times the usual power tube amplification factor, is serving to provide greater gain between power stage and preceding stages in compact and inexpensive radio sets. Characteristics as follows:

Filament Voltage 2.5
Filament Current in Amperes 1.5
Plate Voltage 250
Screen Voltage 250
Control Grid Bias -16.5
Amplification Factor 100
Plate Resistance in Ohms 35,000
Mutual Conductance in Micromhos 2,500
Plate Current in Milliamperes 32.0
Screen-Grid Current in Milliamperes 6.5
Power Output 3.0 watts
Base Five prong

DeForest Variable Mu Type 451

A variable mu or multi-mu screen-grid tube, in general appearance not unlike the 424 screen-grid tube. Provides maximum sensitivity for handling weak signals, while at the same time safeguarding against overloading, distortion and troublesome cross-talk on loud signals in the multi-stage r.f. circuit. Characteristics as follows:

Filament Voltage 2.5
Filament Current in Amperes 1.75
Plate Voltage Recommended 180
Screen Voltage Recommended 90
Mutual Conductance at grid bias -3 1000 micromhos
Mutual Conductance at grid bias -20 80 micromhos
Plate Current at grid bias -3 5.5 m.a.
Plate Current at grid bias -20 0.65 m.a.

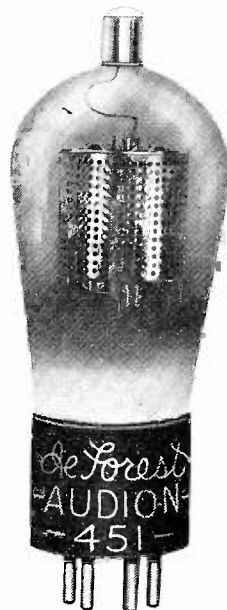

Besides—

The DeForest line of standard receiving tubes includes a new and refined version of each type, due to original research and engineering immediately translated into fresh Audions available to you, through a rigidly controlled production geared to demand.

After all, There's No Substitute for 25 Years' Experience

De Forest Radio Company, Passaic, N.J.
Export Department, 304 E. 45th Street, New York City, N.Y., U.S.A.

de Forest
(AUDIONS)

RECEIVING
AND
TRANSMITTING **TUBES**

When writing to advertisers mention of the PROCEEDINGS will be mutually helpful.

For these NEW TUBES

-for ALL TUBES-

FANSTEEL

Rare Metal

Wire

and Sheet

In your new 1931 tubes, don't try to work with uncertain metals and alloys. Standardize on Fansteel Molybdenum, Tungsten and Tantalum, elementary metals refined from ores and basic salts, finished to accurate dimensions, uniform, dependable. Alloys of these rare metals are available too, and close laboratory check on production makes certain that exact specifications are maintained.

Given such materials to work with, you can not only make better tubes, but also cut production costs through reduction of shrinkage, waste and spoilage. Reduction of costs isn't all, however. There's more at stake than that. The new tubes must be "right"—must win public favor through their performance be-

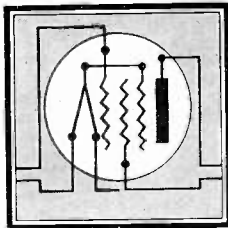

cause for *profits* you need the steady repeat business which only better than average tubes will provide. If the tubes are to be "standard equipment" on a well known set, importance of trouble-free performance can not be overestimated.

Obviously it's a poor time to take chances or cut corners. The very best of materials are only just barely good enough this year. To help manufacturers find the one best metal or alloy for their purposes, Fansteel offers the assistance of its scientific staff on development work.

Fansteel's ample stock assures prompt shipments. Special cooperation to users desiring small lots for experimental use.

Write for samples and prices

FANSTEEL PRODUCTS COMPANY, Inc.

North Chicago, Illinois

TANTALUM · TUNGSTEN · MOLYBDENUM · RARE METAL ALLOYS

When writing to advertisers mention of the PROCEEDINGS will be mutually helpful.

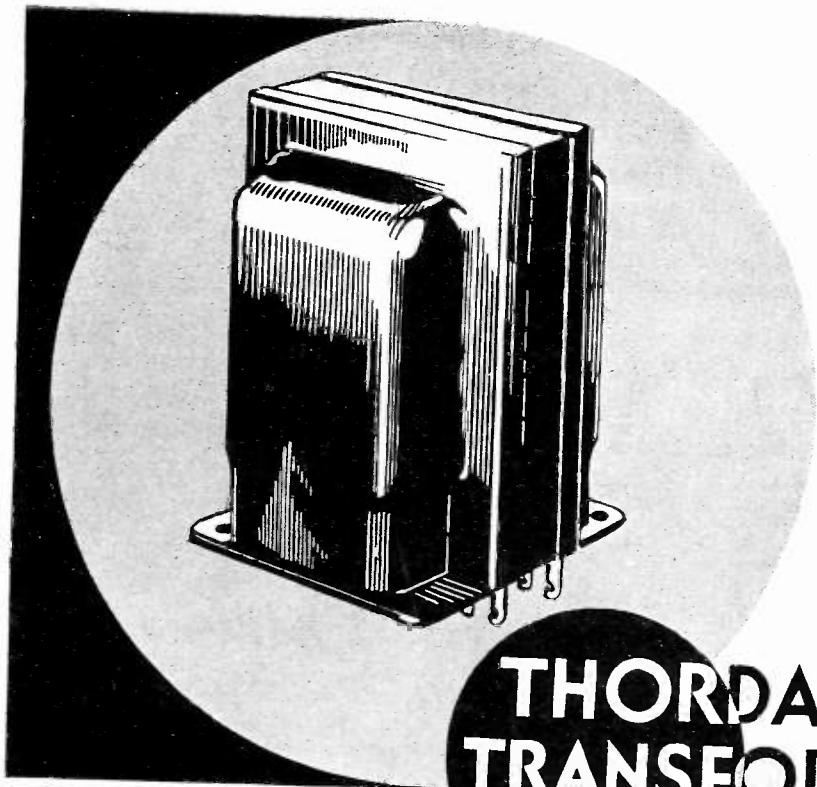

THORDARSON TRANSFORMERS

*Help you
keep costs
down*

UNCEASING RESEARCH . . .
 exacting tests . . . continuous
 modernization of equipment . . .
 keep Thordarson Transformers in
 close step with engineering develop-
 ments in radio and allied fields.
 Vast production . . . advanced
 manufacturing methods . . . make
 their cost low. Let us show you how
 these great advantages, the product
 of almost 40 years' leadership in the
 transformer field, can help to stabi-
 lize your manufacturing profits.

Thordarson Electric Manufacturing
 Company
 500 West Huron Street, Chicago, Ill.

TO THINK OF TRANSFORMERS IS TO THINK OF THORDARSON



When writing to advertisers mention of the PROCEEDINGS will be mutually helpful.

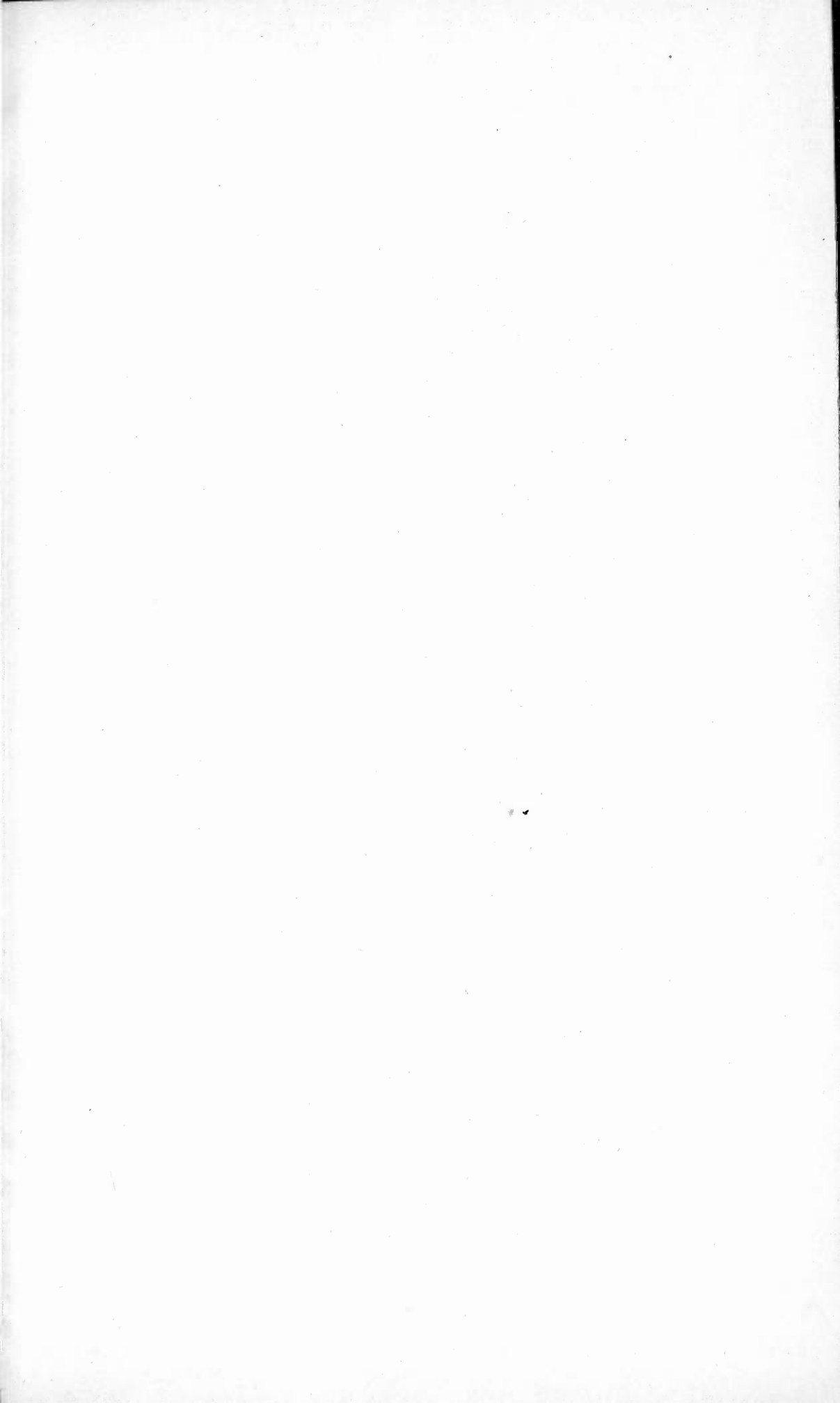



Only Potter Dry Electrolytic Condensers Are Proven by 5 Years' Use

Potter pioneered the Dry Electrolytic Condenser. Today, 5 years engineering experience assures the superiority of Potter Dry Electrolytic Condensers.

500 or 350 Volt Working Potential

Potter Dry Electrolytic capacities are available in two values of working potential. Both types will withstand potential surges greatly in excess of the rated value.

The dielectric in Potter Dry Electrolytic Condensers does not soften or flake, but remains unchanged under long continued service.

Absolutely Dry

This condenser is truly dry. The electrolyte is non-aqueous and is completely sealed in. It cannot *spill, freeze, evaporate*, or in any way impair the operation of the condenser.

Don't sacrifice compact arrangement or increase your production costs by using a capacity unit that requires special mounting arrangements to prevent spilling of a liquid electrolyte.

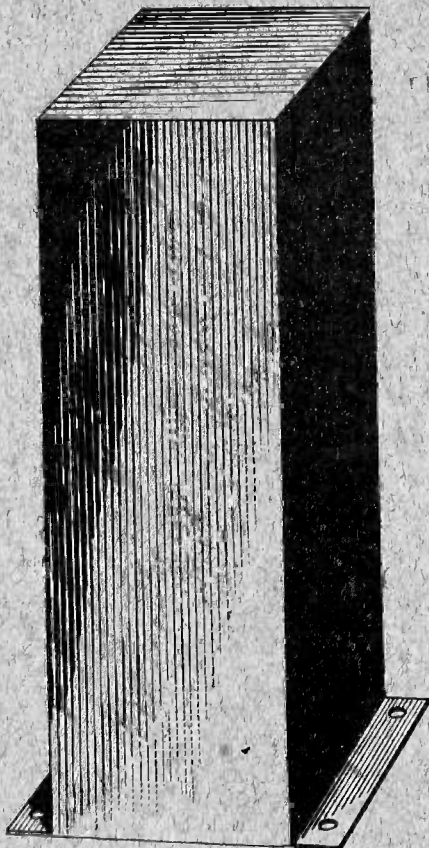

There are no *inverted* or *upright* models of the Potter Dry Electrolytic Condenser. It mounts in any position convenient for your assembly. Write today for a sample to test in your chassis.

THE POTTER COMPANY
1944 Sheridan Rd., North Chicago, Ill.

Potter Condensers

There's something new in AUDIO OCILLATORS

You'll agree—we know you will—that the ideal audio-frequency generator ought to have these features.

- ✓ 1. Single-dial control
- ✓ 2. Good waveform
- ✓ 3. Accurate calibration
- ✓ 4. Frequency stability
- ✓ 5. Complete a-c operation

Check these five points in the specifications of this new General Radio oscillator, development on which has just been completed.

Specifications

The new oscillator, being of the beat-frequency type, has one frequency control to cover 10 to 10,000 cycles per second.

A tuned reed insures an accurate calibration with age, and the engraved frequency scale is 18 inches long which makes for ease in setting. The calibration is accurate to within 2 per cent.

Above 100 cycles per second the total harmonic content is 5% of the fundamental.

The frequency is remarkably stable, a 15-volt change in line voltage, for example, causes a shift of only 3 cycles per second.

All power is supplied from the 110-volt alternating-current mains.

The price of the Type 513-B Beat-Frequency Oscillator is \$450.00. If you aren't already on our mailing list, let us send you a complete description of this and other new equipment for your laboratory. Ask for Catalog F-R4.



GENERAL RADIO COMPANY
OFFICES :: LABORATORIES :: FACTORY
CAMBRIDGE A, MASSACHUSETTS

