

VOLUME 16

DECEMBER, 1928

NUMBER 12

PROCEEDINGS
of
**The Institute of Radio
Engineers**



1929 CONVENTION
Washington, D.C.
May 13-15th

Published Monthly By
THE INSTITUTE OF RADIO ENGINEERS
Publication Office: 450-454 Ahnaip St., Menasha, Wis.

BUSINESS, EDITORIAL AND ADVERTISING OFFICES
33 West 39th Street, New York, N.Y.

Subscription \$10.00 per Annum in the United States
\$11.00 in all other Countries

General Information and Subscription Rates on Page 1617

**HOW
ABOUT
1929
?**

The great radio public is becoming more and more insistent in its demand for better tonal reproduction. No intensive market survey is necessary to show that the receiver manufacturers who recognize this pressure are making the greatest progress this season.

It is to this army of progressive manufacturers of quality receivers that the bulk of Thordarson audio and power supply transformers are being delivered *on schedule*.

Our solicitation of manufacturers' business for this season is a closed book. We will not hazard violating our delivery promises in a mad desire for more orders. We do suggest, however, that receiver manufacturers who are earnestly looking for the ultimate in musical performance will allow us to figure on their requirements for 1929.

3587

**THORDARSON
RADIO**
Supreme in Musical Performance
TRANSFORMERS

THORDARSON ELECTRIC MANUFACTURING CO.
Transformer Specialists since 1895

HURON, KINGSBURY & LARRABEE STS. — CHICAGO, ILL.



*For more
than twenty years*

—Faradon

Today, as two decades ago, experts consider Faradon Capacitors essential to reliable radio transmission and reception.

Then in the "wireless sets" and now in the most luxurious consoles, Faradon Capacitors are accepted as the standard of electrostatic condenser dependability.

We are always ready to assist in the solution of your capacitor problems.

WIRELESS SPECIALTY APPARATUS CO.

Jamaica Plain, Boston, Mass., U.S.A.

Established 1907

Faradon

*Electrostatic Condensers
for All Purposes*

2427

When writing to advertisers mention of the PROCEEDINGS will be mutually helpful.

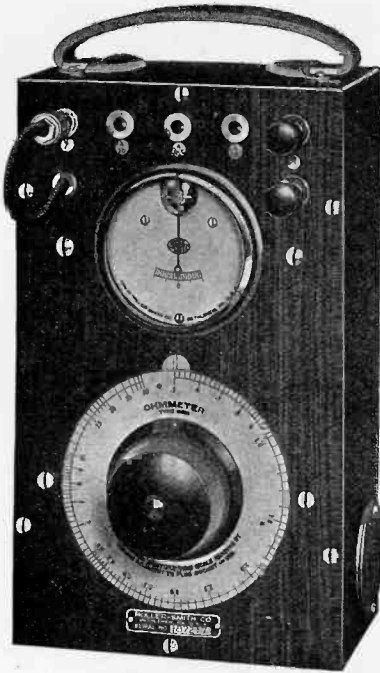

Roller-Smith COM Ohmmeter

Portable direct reading, small, compact, light, rugged, accurate, entirely self-contained. Measures resistance values from .5 ohm to 50,000 ohms. List price \$70.00, subject to discount. Send for new Bulletin No. K-300.



Roller-Smith HTD Circuit Tester

Instantly locates open circuits in coils and circuits. Shows approximate resistance up to 10,000 ohms. Small, compact, self-contained, rugged and dependable. List price \$21.00, subject to discount. Send for new Bulletin No. K-300.

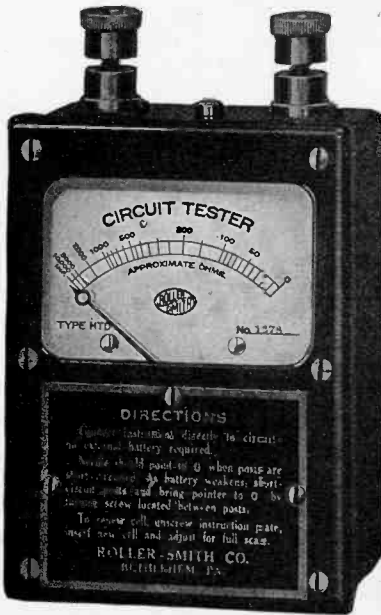

ROLLER-SMITH COMPANY
2134 Woolworth Bldg.
NEW YORK, N. Y.

Offices in principal cities in U. S. and
Canada. Representatives in Australia,
Cuba, and Japan.

When writing to advertisers mention of the PROCEEDINGS will be mutually helpful.

Permanent Insulating Qualities

UNAFFECTED by smoke, salt fogs and fumes, constant in their electrical and physical characteristics, *PYREX Radio Insulators give *permanent* insulation for all radio work.

They represent the true fusion of materials resulting in a homogeneous, non-porous insulator, uniform throughout its structure—high in dielectric strength—low in power loss.

Dust and dirt cannot accumulate on their original diamond-hard and super-smooth surface. There is no “glaze” to check or craze.

Made in several styles and in various sizes: antenna, lead-in, stand-off, bus-bar, inductance shapes, bushings, rods and cylinders.

A treatise on the unique chemical, physical and electrical properties of the special glasses from which these high-test insulators are made will be sent on request. Write for “PYREX Industrial Glass Products.”

CORNING GLASS WORKS
Industrial and Equipment Division

DEPT. R-5

CORNING, NEW YORK

*Trade-mark Reg. U. S. Pat. Off.

When writing to advertisers mention of the PROCEEDINGS will be mutually helpful.

Potter Condensers

On Watch Day and Night



GUARDING the operation of hundreds of thousands of radio receivers, Potter condensers do their part to make them real musical instruments.

Leading radio receiver manufacturers have seen the importance of making a faultless and enjoyable receiver. Engineers have selected Potter condensers after careful tests under operating conditions, so as to give quality and long life to their radio set.

Condensers are today built to meet manufacturers' requirements. This makes it possible to offer to their purchasers a receiver which is equipped with Potter condensers, indicating that the balance of the receiver can be depended upon for the same high standard of performance.

Potter Interference Eliminator

Enjoy radio broadcast programs normally spoiled by interference from oil burner, ice machine motors, fans, violet rays, vacuum cleaners, etc.

Simply connect a Potter Interference Eliminator to the line circuit at the point where interfering device is connected and your troubles will be over.

A Condenser Assembly For Every Use

The Potter Co.

North Chicago, Illinois

A National Organization at Your Service

When writing to advertisers mention of the PROCEEDINGS will be mutually helpful.

Versatile Resistance

A resistance of any value to meet precise circuit conditions at any given moment, yet one that can remain fixed for indefinite periods when a fixed value is required—that spells Clarostat, the versatile resistance. *For instance*

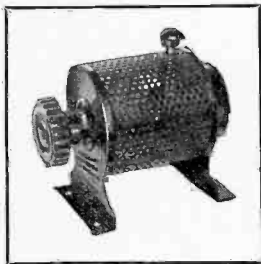

The *Speed Control Clarostat* has been designed primarily for controlling the scanning disk motor of the television transmitter or receiver. Yet it is available as a heavy-duty adjustable resistance for transmission purposes, for laboratory work, for line-voltage control, for heat control, and other applications which will occur to the engineer.

The *Duplex Clarostat* comprises two adjustable resistances in one, with center tap. Resistance values may be adjusted by means of screwdriver blade. Therefore, in absence of knobs, this device amounts to fixed resistors hand-fitted to the requirements.

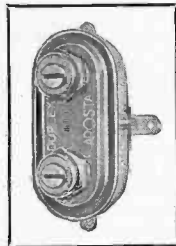

The *Table Type Clarostat* is intended primarily to control loud-speaker volume and tone. Yet it is available for any receiving and experimental application. It requires no tools. A handy connecting block and double pair of cords provides for series or parallel connection in any circuit.

Write for data on the entire line of Clarostats, and how to simplify your designs of radio sets and power units. And do not hesitate to place your resistance problems before us, for we have long specialized in meeting such problems.

Clarostat Manufacturing Company, Inc.



Specialists in Variable Resistors

289 N. Sixth St. ::: Brooklyn, N. Y.

CLAROSTAT

REG. U. S.

PAT. OFF.

When writing to advertisers mention of the PROCEEDINGS will be mutually helpful.

"ESCO"

Synchronous Motors for Television

In addition to building reliable and satisfactory motor generators, "Esco" has had many years of experience in building *electric motors* for a great variety of applications.

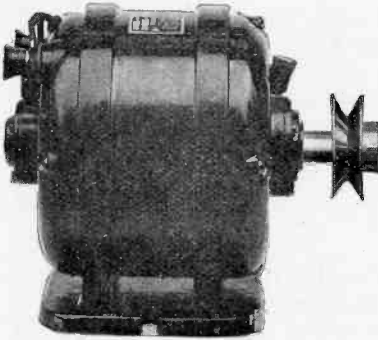

Synchronous motors, small, compact, reliable, self starting are now offered for *Television* equipment. They require no direct current for excitation, are quiet running and fully guaranteed.

Other types of motors suitable for *Television* may also be supplied.

Write us about your requirements.

Machines for operating 60-cycle A. C. Radio Receivers, Loud Speakers and Phonographs from Direct Current Lighting Sockets Without Objectionable Noises of any Kind.

The dynamotors and motor generators are suitable for radio receivers and for combination instruments containing phonographs and receivers. Filters are usually required. The dynamotors and motor generators with filters give as good or better results than are obtained from ordinary 60-cycle lighting sockets. They are furnished completely assembled and connected and are very easily installed.

These machines are furnished with wool-packed bearings which require very little attention, and are very quiet running.

Write for Bulletin No. 243-C.

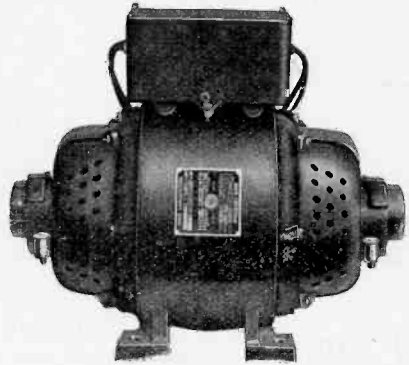

Dynamotor with Filter for Radio Receivers

How can "ESCO" Serve You?
ELECTRIC SPECIALTY COMPANY

TRADE "ESCO" MARK



300 South Street

Stamford, Conn.

When writing to advertisers mention of the PROCEEDINGS will be mutually helpful.

Safe!

TEN METER INSULATION

with

Isolantite

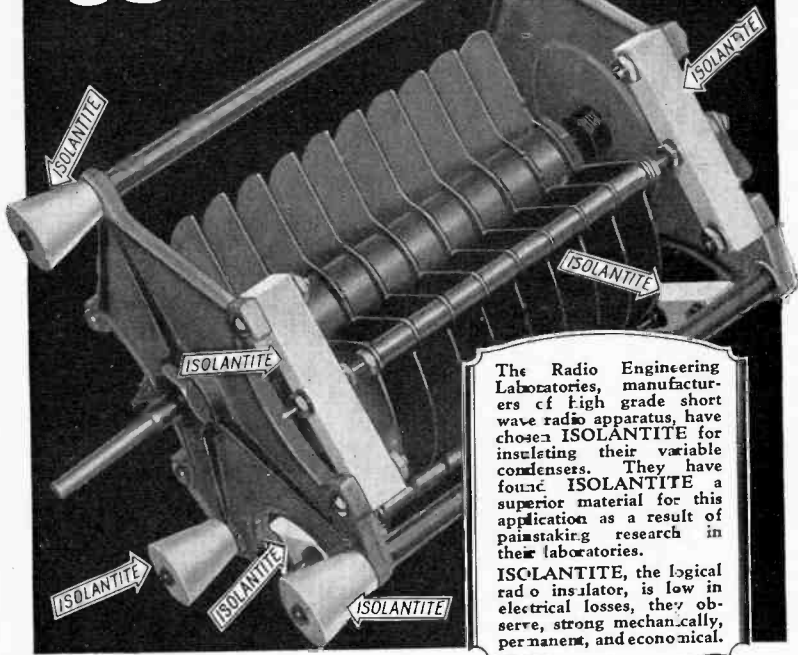

The Radio Engineering Laboratories, manufacturers of high grade short wave radio apparatus, have chosen ISOLANTITE for insulating their variable condensers. They have found ISOLANTITE a superior material for this application as a result of painstaking research in their laboratories.

ISOLANTITE, the logical radio insulator, is low in electrical losses, they observe, strong mechanically, permanent, and economical.

Write for Isolantite Facts

Isolantite Company of America

(Incorporated)

New York Sales Offices
551 Fifth Ave., New York City

When writing to advertisers mention of the PROCEEDINGS will be mutually helpful.

VII

An Investment that Pays Dividends

An indicating instrument is an essential part of the equipment of every good radio receiver installation, since it aids in maintaining efficient operation, secures the best reception and fully protects the financial investment.

To advanced radio enthusiasts and those having professional connections with the industry, the selection of instruments is highly important. Unfailing reliability is the first consideration since accuracy of measurement is a fundamental requisite of success in both research work and commercial activities, and pays the biggest dividends on the investment—whether of time or money.

Illustrated herewith are the Weston Portable A.C. and D.C. instruments which are extremely popular for general radio service and make ideal personal instruments.



Three-Range Instruments for A.C. and D.C. Operated Sets

The fine workmanship, excellent characteristics and dependable performance of these models—No. 528 A.C. and No. 489 D.C.—merit an unquestioned preference over all other makes. Moderate in price, too. Enclosed in beautifully finished bakelite cases—black for D.C. and mottled red and black for A.C. instruments. 750/250/10 volts (1000 ohms per volt resistance) for D.C. service, and 150/3/4 volts for A.C. testing.

Single and Double-Range Instruments

These same models, identical in size and appearance and enclosed in the same bakelite cases, are also furnished as D.C. double-range Voltmeters (with either 1000 ohms per volt or 125 ohms per volt resistance) and as single and double-range Ammeters. For A.C. testing they are supplied as single-range Ammeters and Milliammeters and double-range Voltmeters.

All instruments of the Weston Radio Line are completely described in Circular J—just off the press. Write for your copy.



WESTON ELECTRICAL INSTRUMENT CORPORATION
589 Frelinghuysen Ave. Newark, N. J.

WESTON RADIO INSTRUMENTS

When writing to advertisers mention of the PROCEEDINGS will be mutually helpful.

VIII

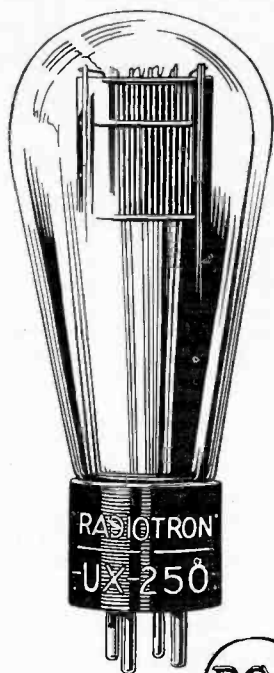

For every use in radio re-
search the quality of RCA
Radiotrons makes them the
first choice of the leading
engineers.

RADIO CORPORATION OF AMERICA
NEW YORK CHICAGO SAN FRANCISCO

RCA Radiotron

MADE BY THE MAKERS OF THE RADIOLA

When writing to advertisers mention of the PROCEEDINGS will be mutually helpful.
IX

SUGGESTIONS FOR CONTRIBUTORS TO THE PROCEEDINGS

Preparation of Paper

Form—Manuscripts may be submitted by member and non-member contributors from any country. To be acceptable for publication manuscripts should be in English, in final form for publication, and accompanied by a summary of from 100 to 300 words. Papers should be typed double space with consecutive numbering of pages. Footnote references should be consecutively numbered, and should appear at the foot of their respective pages. Each reference should contain author's name, title of article, name of journal, volume page, month, and year. Generally, the sequence of presentation should be as follows: statement of problem; review of the subject in which the scope, object, and conclusions of previous investigations in the same field are covered; main body describing the apparatus, experiments, theoretical work, and results used in reaching the conclusions, conclusions and their relation to present theory and practice; bibliography. The above pertains to the usual type of paper. To whatever type a contribution may belong, a close conformity to the spirit of these suggestions is recommended.

Illustrations—Use only jet black ink on white paper or tracing cloth. Cross-section paper used for graphs should not have more than four lines per inch. If finer ruled paper is used, the major division lines should be drawn in with black ink, omitting the finer divisions. In the latter case, only blue-lined paper can be accepted. Photographs must be very distinct, and must be printed on glossy white paper. Blueprinted illustrations of any kind cannot be used. All lettering should be $\frac{3}{16}$ in. high for an 8 x 10 in. figure. Legends for figures should be tabulated on a separate sheet, not lettered on the illustrations.

Mathematics—Fractions should be indicated by a slanting line. Use standard symbols. Decimals not preceded by whole numbers should be preceded by zero, as 0.016. Equations may be written in ink with subscript numbers, radicals, etc., in the desired proportions.

Abbreviations—Write a.c. and d.c., kc, μf , $\mu\mu f$, emf, mh, μh , henries, abscissas, antennas. Refer to figures as Fig. 1, Figs. 3 and 4, and to equations as (5). Number equations on the right, in parentheses.

Summary—The summary should contain a statement of major conclusions reached, since summaries in many cases constitute the only source of information used in compiling scientific reference indexes. Abstracts printed in other journals, especially foreign, in most cases consist of summaries from published papers. The summary should explain as adequately as possible the major conclusions to a non-specialist in the subject. The summary should contain from 100 to 300 words, depending on the length of the paper.

Publication of Paper

Disposition—All manuscripts should be addressed to the Institute of Radio Engineers, 33 West 39th Street, New York City. They will be examined by the Committee on Meetings and Papers and by the Editor. Authors are advised as promptly as possible of the action taken, usually within one month.

Proofs—Galley proof is sent to the author. Only necessary corrections in typography should be made. *No new material is to be added.* Corrected proofs should be returned promptly to the Institute of Radio Engineers, 33 West 39th Street, New York City.

Reprints—With the notification of acceptance of paper for publication reprint order form is sent to the author. Orders for reprints must be forwarded promptly as type is not held after publication.

PROCEEDINGS
OF
THE INSTITUTE OF RADIO
ENGINEERS
(INCORPORATED)

VOLUME 16
1928



PUBLISHED MONTHLY BY
THE INSTITUTE OF RADIO ENGINEERS
(INC.)
33 WEST 39TH STREET, NEW YORK, N. Y.

CONTENTS OF VOLUME 16

1928

NUMBER 1; JANUARY, 1928

	PAGE
OFFICERS AND BOARD OF DIRECTION	2
COMMITTEES	2
INSTITUTE SECTIONS	4
INSTITUTE ACTIVITIES	9
INSTITUTE MEETINGS	10
COMMITTEE WORK	13
EDWIN H. ARMSTRONG, "METHODS OF REDUCING THE EFFECT OF ATMOSPHERIC DISTURBANCES"	15
DISCUSSION ON E. H. ARMSTRONG PAPER BY C. R. ENGLUND	27
HAROLD A. WHEELER, "AUTOMATIC VOLUME CONTROL FOR RADIO RECEIVING SETS"	30
DISCUSSIONS ON H. A. WHEELER PAPER BY G. W. PICKARD AND E. BRUCE	35
GUGLIELMO MARCONI, "RADIO COMMUNICATION"	40
HERBERT C. HAZEL, "A NEW METHOD FOR THE CALIBRATION OF AMMETERS AT RADIO FREQUENCIES"	70
RAYMOND A. HEISING, "EXPERIMENTS AND OBSERVATIONS CONCERNING THE IONIZED REGIONS OF THE ATMOSPHERE"	75
BOOK REVIEW, "RADIO MANUAL"	100
J. B. BRADY, DIGESTS OF U. S. RADIO PATENTS	102
GEOGRAPHICAL LIST OF MEMBERS ELECTED DECEMBER 7, 1927	104

NUMBER 2; FEBRUARY, 1928

OFFICERS AND BOARD OF DIRECTION	108
COMMITTEES	108
INSTITUTE SECTIONS	110
INSTITUTE ACTIVITIES	116
SECTION MEETINGS	118
COMMITTEE WORK	120
CHARLES BAYNE ATKEN, "A PRECISION METHOD FOR THE MEASUREMENT OF HIGH FREQUENCIES"	125
J. W. HORTON AND W. A. MARRISON, "PRECISION DETERMINATION OF FREQUENCY"	137
GEORGE RODWIN AND THEODORE A. SMITH, "A RADIO-FREQUENCY OSCILLATOR FOR RECEIVER INVESTIGATIONS"	155
L. W. AUSTIN AND MISS I. J. WYMORE, "ON THE INFLUENCE OF SOLAR ACTIVITY ON RADIO TRANSMISSION"	166
E. O. HULBURT, "IONIZATION IN THE UPPER ATMOSPHERE"	174
H. B. MARIS, "A THEORY OF THE UPPER ATMOSPHERE AND METEORS"	177
KNOX MCILWAIN AND W. S. THOMPSON, "A RADIO FIELD STRENGTH SURVEY OF PHILADELPHIA"	181
MANFRED VON ARDENNE, "ON THE THEORY OF POWER AMPLIFICATION"	193
ALEXANDER NYMAN, "CONDENSER SHUNT FOR MEASUREMENT OF HIGH-FREQUENCY CURRENTS OF LARGE MAGNITUDE"	208
BOOK REVIEWS, "DIELECTRIC PHENOMENA," "THE PROPAGATION OF RADIO WAVES ALONG THE SURFACE OF THE EARTH AND IN THE ATMOSPHERE"	218
GEOGRAPHICAL LIST OF MEMBERS ELECTED JANUARY 4, 1928	224

NUMBER 3; MARCH, 1928

OFFICERS AND BOARD OF DIRECTION	228
COMMITTEES	228
INSTITUTE SECTIONS	230
INSTITUTE ACTIVITIES	236
COMMITTEE WORK	237
INSTITUTE MEETINGS	241
RALPH BOWN, "OPENING ADDRESS AT ANNUAL CONVENTION"	249
ALFRED N. GOLDSMITH, "ADDRESS OF 1928 PRESIDENT"	252
FREDERICK K. VREELAND, "ON THE DISTORTIONLESS RECEPTION OF A MODULATED WAVE AND ITS RELATION TO SELECTIVITY"	255
EDWARD H. LOFTIN AND S. YOUNG WHITE, "DIRECT COUPLED DETECTOR AND AMPLIFIERS WITH AUTOMATIC GRID BIAS"	281
DISCUSSION ON LOFTIN AND WHITE PAPER BY HENRY SHORE	286
E. O. HULBURT, "ON ROUND-THE-WORLD SIGNALS"	287
ODD DAHL AND L. A. GEBHARD, "MEASUREMENTS OF THE EFFECTIVE HEIGHTS OF THE CONDUCTING LAYER AND THE DISTURBANCES OF AUGUST 19, 1927"	290
CLIFFORD N. ANDERSON, "CORRELATION OF LONG WAVE TRANSATLANTIC RADIO TRANSMISSION WITH OTHER FACTORS AFFECTED BY SOLAR ACTIVITY"	297

	PAGE
L. W. AUSTIN, "REPORT OF THE CHAIRMAN OF THE COMMISSION ON RADIO WAVE PROPAGATION, INTERNATIONAL UNION OF SCIENTIFIC RADIO TELEGRAPHY"	348
DISCUSSION ON "LONG DISTANCE RADIO RECEIVING MEASUREMENTS AT THE BUREAU OF STANDARDS IN 1925" (L. W. AUSTIN), BY B. H. J. KYNASTON	359
T. WALMSLEY, "NOTES ON THE DESIGN OF RADIO INSULATORS"	361
C. A. WRIGHT AND F. T. BOWDITCH, "THE MEASUREMENT OF CHOKE COIL INDUCTANCE"	373
BOOK REVIEW, "APPLIED MAGNETISM"	385
GEOGRAPHICAL LIST OF MEMBERS ELECTED FEBRUARY 1, 1928	386

NUMBER 4; APRIL, 1928

OFFICERS AND BOARD OF DIRECTION	390
COMMITTEES	390
INSTITUTE SECTIONS	392
INSTITUTE ACTIVITIES	398
INSTITUTE MEETINGS	399
INSTITUTE COMMITTEES	405
W. D. TERRELL, "THE INTERNATIONAL RADIOTELEGRAPH CONFERENCE OF WASHINGTON, 1927"	409
A. CROSSLEY, "MODES OF VIBRATION IN PIEZO-ELECTRIC CRYSTALS"	416
J. C. WARNER, "SOME CHARACTERISTICS AND APPLICATIONS OF FOUR-ELECTRODE TUBES"	424
FREDERICK EMMONS TERMAN, "THE INVERTED VACUUM TUBE, A VOLTAGE-REDUCING POWER AMPLIFIER"	447
C. R. HANNA, L. SUTHERLIN, AND C. B. ÜPP, "DEVELOPMENT OF A NEW POWER AMPLIFIER TUBE"	462
DISCUSSION ON HANNA, SUTHERLIN, AND ÜPP PAPER BY J. C. WARNER AND A. V. LOUGHREN	474
HAROLD A. WHEELER, "MEASUREMENT OF VACUUM-TUBE CAPACITIES BY A TRANSFORMER BALANCE"	476
LINCOLN WALSH, "A DIRECT-CURRENT BRIDGE FOR VACUUM-TUBE MEASUREMENTS"	482
E. T. HOCH, "A BRIDGE METHOD FOR THE MEASUREMENT OF INTER-ELECTRODE ADMITTANCE IN VACUUM TUBES"	487
DISCUSSIONS ON "ON THE DISTORTIONLESS RECEPTION OF A MODULATED WAVE AND ITS RELATION TO SELECTIVITY" (F. K. VREELAND), BY HENRY SHORE, J. R. NELSON, AND F. K. VREELAND	494
CARL DREHER, "BROADCAST CONTROL OPERATION"	498
STUART BALLANTINE, "REVIEW OF CURRENT LITERATURE"	513
BOOK REVIEWS, "THE CABLE AND WIRELESS COMMUNICATIONS OF THE WORLD" AND "THE THEORY AND PRACTICE OF RADIO FREQUENCY MEASUREMENTS"	519
W. G. CADY, "BIBLIOGRAPHY ON PIEZO-ELECTRICITY"	521
GEOGRAPHICAL LIST OF MEMBERS ELECTED MARCH 7, 1928	536

NUMBER 5; MAY, 1928

OFFICERS AND BOARD OF DIRECTION	540
COMMITTEES	540
INSTITUTE SECTIONS	542
INSTITUTE ACTIVITIES	548
INSTITUTE MEETINGS	549
INSTITUTE COMMITTEES	554
REPORT TO FEDERAL RADIO COMMISSION	556
A. H. TAYLOR AND L. C. YOUNG, "STUDIES OF HIGH-FREQUENCY RADIO WAVE PROPAGATION"	561
J. H. DELLINGER, "THE STATUS OF FREQUENCY STANDARDIZATION"	579
DISCUSSION ON DELLINGER PAPER BY HENRY SHORE, G. W. KENRICK, AND J. H. DELLINGER	590
STUART BALLANTINE, "DETECTION BY GRID RECTIFICATION WITH THE HIGH-VACUUM TRIODE"	593
I. F. BYRNES, "RECENT DEVELOPMENTS IN LOW POWER AND BROADCASTING TRANSMITTERS"	614
HARADEN PRATT, "APPARENT NIGHT VARIATIONS WITH CROSSED-COIL RADIO BEACONS"	652
H. T. FRIIS, "OSCILLOGRAPHIC OBSERVATIONS ON THE DIRECTION OF PROPAGATION AND FADING OF SHORT WAVES"	658
E. B. JUDSON, "AN AUTOMATIC RECORDER FOR MEASURING THE STRENGTH OF RADIO SIGNALS AND ATMOSPHERIC DISTURBANCES"	666
DISCUSSION ON "ON THE DISTORTIONLESS RECEPTION OF A MODULATED WAVE AND THE RELATION TO SELECTIVITY" (F. K. VREELAND), BY LESTER JONES	671
W. A. SCHNEIDER, "USE OF AN OSCILLOGRAPH FOR RECORDING VACUUM-TUBE CHARACTERISTICS"	674
BOOK REVIEWS, "THE THEORY OF SOUND," AND "CUNNINGHAM TUBE DATA BOOK"	681
GEOGRAPHICAL LIST OF MEMBERS ELECTED APRIL 4, 1928	693

NUMBER 6; JUNE, 1928

OFFICERS AND BOARD OF DIRECTION	696
COMMITTEES	696
INSTITUTE SECTIONS	698
INSTITUTE ACTIVITIES	704

	PAGE
INSTITUTE MEETINGS	706
COMMITTEE WORK	712
HIDETSUGU YAGI, "BEAM TRANSMISSION OF ULTRA SHORT WAVES"	715
DISCUSSION ON YAGI PAPER BY J. H. DELLINGER	740
K. S. VAN DYKE "THE PIEZO-ELECTRIC RESONATOR AND ITS EQUIVALENT NETWORK"	742
GREENLEAF W. PICKARD, "SOME CORRELATIONS OF RADIO RECEPTION WITH ATMOSPHERIC TEMPERATURE AND PRESSURE"	765
LYDD ESPENSCHIED, "TECHNICAL CONSIDERATIONS INVOLVED IN THE ALLOCATION OF SHORT WAVES; FREQUENCIES BETWEEN 1.5 AND 30 MEGACYCLES"	773
ROBERT H. WORRALL AND RAYMOND B. OWENS, "THE NAVY'S PRIMARY FREQUENCY STANDARD"	778
M. A. TUVE AND O. DAHL, "A TRANSMITTER MODULATING DEVICE FOR THE STUDY OF THE KENNELLY-HEAVISIDE LAYER BY THE ECHO METHOD"	794
H. M. TURNER, "A COMPENSATED ELECTRON-TUBE VOLTMETER"	799
FREDERICK EMMONS TERMAN, "NOTE ON THE EFFECTIVE HEATING OF CODE TRANSMITTERS"	802
D. C. PRINCE, "FOUR-ELEMENT TUBE CHARACTERISTICS AS AFFECTING EFFICIENCY"	805
J. R. NELSON, "DETECTION WITH THE FOUR-ELECTRODE TUBE"	822
N. H. WILLIAMS, "THE SCREEN-GRID TUBE"	840
DISCUSSION ON "THE MEASUREMENT OF CHOKE COIL INDUCTANCE" (C. A. WRIGHT AND F. T. BOWDITCH) BY W. O. OSBON AND C. A. WRIGHT	844
DISCUSSION ON "ON THE DISTORTIONLESS RECEPTION OF A MODULATED WAVE AND ITS RELATION TO SELECTIVITY" (F. K. VREELAND), BY U. D. LANDON	848
BOOK REVIEW, "EXPERIMENTAL RADIO"	851
GEOGRAPHICAL LIST OF MEMBERS ELECTED MAY 2, 1928	852

NUMBER 7; JULY, 1928

OFFICERS AND BOARD OF DIRECTION	856
COMMITTEES	856
INSTITUTE SECTIONS	858
INSTITUTE ACTIVITIES	864
INSTITUTE MEETINGS	866
INSTITUTE COMMITTEES	870
H. M. O'NEILL, "CHARACTERISTICS OF CERTAIN BROADCASTING ANTENNAS AT THE SOUTH SCHENECTADY DEVELOPMENT STATION"	872
J. H. DELLINGER AND HARADEN PRATT, "DEVELOPMENT OF RADIO AIDS TO AIR NAVIGATION"	890
MALCOM P. HANSON, "AIRCRAFT RADIO INSTALLATIONS"	921
JOHN R. CARSON, "THE REDUCTION OF ATMOSPHERIC DISTURBANCES"	966
W. A. MARRISON, "THERMOSTAT DESIGN FOR FREQUENCY STANDARDS"	976
DISCUSSION ON "RECENT DEVELOPMENTS IN LOW POWER AND BROADCASTING TRANSMITTERS" (I. F. BYRNES), BY F. M. RYAN AND I. F. BYRNES	981
BOOK REVIEW "THE WORLD OF ATOMS"	983
C. M. JOLIFFE AND ELIZABETH M. ZANDONINI, "BIBLIOGRAPHY ON AIRCRAFT RADIO"	985
REFERENCES TO CURRENT RADIO LITERATURE	1000
GEOGRAPHICAL LIST OF MEMBERS ELECTED JUNE 6, 1928	1015

NUMBER 8; AUGUST, 1928

OFFICERS AND BOARD OF DIRECTION	1020
COMMITTEES	1020
INSTITUTE SECTIONS	1022
INSTITUTE ACTIVITIES	1031
INSTITUTE MEETINGS	1032
COMMITTEE WORK	1034
L. P. WHEELER AND W. E. BOWER, "A NEW TYPE OF STANDARD FREQUENCY PIEZO-ELECTRIC OSCILLATOR"	1035
BALTH. VAN DER POL, "THE EFFECT OF REGENERATION ON THE RECEIVED SIGNAL STRENGTH"	1045
J. M. THOMSON, "CHARACTERISTICS OF OUTPUT TRANSFORMERS"	1053
ALFRED N. GOLDSMITH, "COOPERATION BETWEEN THE INSTITUTE OF RADIO ENGINEERS AND MANUFACTURERS' ASSOCIATIONS"	1065
AUGUST HUND, "NOTES ON QUARTZ PLATES, AIR-GAP EFFECT, AND AUDIO-FREQUENCY GENERATION"	1072
AUGUST HUND, "NOTES ON APERIODIC AMPLIFICATION AND APPLICATION TO THE STUDY OF ATMOSPHERICS"	1077
SYLVAN HARRIS, "EFFECT OF THE ANTENNA IN TUNING RADIO RECEIVERS AND METHODS OF COMPENSATING FOR IT"	1079
W. J. KIMMELL, "THE CAUSE AND PREVENTION OF HUM IN RECEIVING TUBES EMPLOYING ALTERNATING CURRENT DIRECT ON THE FILAMENT"	1089
J. H. DELLINGER, "THE INTERNATIONAL UNION OF SCIENTIFIC RADIOTELEGRAPHY"	1107
J. WARREN WRIGHT, "THE TUNED-GRID, TUNED-PLATE, SELF-OSCILLATING VACUUM-TUBE CIRCUIT"	1113
R. R. RAMSEY AND ROBERT DREISBACK, "RADIATION AND INDUCTION"	1118
GEORGE B. CROUSE, "DEVELOPMENT OF A SYSTEM OF LINE POWER FOR RADIO"	1133
BOOK REVIEW, "HISTORY OF RADIO TELEGRAPHY AND TELEPHONY"	1149
MONTHLY LIST OF REFERENCES TO CURRENT RADIO LITERATURE	1150
APPLICATIONS FOR MEMBERSHIP	1156

NUMBER 9; SEPTEMBER, 1928

	PAGE
OFFICERS AND BOARD OF DIRECTION	1160
COMMITTEES	1160
INSTITUTE SECTIONS	1162
INSTITUTE ACTIVITIES	1168
COMMITTEE WORK	1170
S. W. EDWARDS AND J. E. BROWN, "THE USE OF RADIO FIELD INTENSITIES AS A MEANS OF RATING THE OUTPUTS OF RADIO TRANSMITTERS"	1173
H. DIAMOND AND E. Z. STOWELL, "NOTE ON RADIO-FREQUENCY TRANSFORMER THEORY"	1194
CLAYTON C. SHANGRAW, "RADIO BEACONS FOR TRANSPACIFIC FLIGHTS"	1203
G. BREIT, M. A. TUVE, AND O. DAHL, "EFFECTIVE HEIGHTS OF THE KENNELLY-HEAVISIDE LAYER IN DECEMBER, 1927 AND JANUARY, 1928"	1236
S. C. HOOPER, "CONSIDERATIONS AFFECTING THE LICENSING OF HIGH-FREQUENCY STATIONS"	1240
L. W. AUSTIN, "LONG-WAVE RADIO RECEIVING MEASUREMENTS AT THE BUREAU OF STANDARDS IN 1927"	1252
MONTHLY LIST OF REFERENCES TO CURRENT RADIO LITERATURE	1258
STUART BALLANTINE, "REVIEW OF CURRENT LITERATURE"	1261
BOOK REVIEWS, "WIRELESS PRINCIPLES AND PRACTICE," "NATIONAL PHYSICAL LABORATORY REPORT FOR 1927"	1268
APPLICATIONS FOR MEMBERSHIP	1270

NUMBER 10; OCTOBER, 1928

OFFICERS AND BOARD OF DIRECTION	1274
COMMITTEES	1274
INSTITUTE SECTIONS	1276
INSTITUTE NOTES AND RELATED ACTIVITIES	1281
NOMINATIONS FOR OFFICERS AND MANAGERS FOR 1929	1281
INSTITUTE MEETINGS	1287
COMMITTEE WORK	1290
J. J. JAKOSKY, "ELECTRICAL PROSPECTING"	1305
C. M. JANSKY, JR., "SOME STUDIES OF RADIO BROADCAST COVERAGE IN THE MIDDLE WEST"	1356
J. B. HOAG AND VICTOR J. ANDREW, "A STUDY OF SHORT-TIME MULTIPLE SIGNALS"	1368
A. CROSSLEY AND R. M. PAGE, "A NEW METHOD FOR DETERMINING THE EFFICIENCY OF VACUUM-TUBE CIRCUITS"	1375
FREDERICK EMMONS TERMAN, "SOME PRINCIPLES OF GRID-LEAK GRID-CONDENSER DETECTION"	1384
HAROLD A. WHEELER, "SIMPLE INDUCTANCE FORMULAS FOR RADIO COILS"	1398
VIRGIL M. GRAHAM, "A GANG CAPACITOR TESTING DEVICE"	1401
G. PESSON AND G. MONTEFINALE, "RADIOTELEGRAPHIC CENTER AT ROME (SAN PAOLO)"	1404
DISCUSSION ON "ON THE DISTORTIONLESS RECEPTION OF A MODULATED WAVE AND ITS RELATION TO SELECTIVITY" (F. K. VREELAND), BY R. RAVENHART	1422
A DECIMAL CLASSIFICATION OF RADIO SUBJECTS; AN EXTENSION OF THE DEWEY SYSTEM"	1423
BOOK REVIEW, "RADIO ENGINEERING PRINCIPLES"	1429
MONTHLY LIST OF REFERENCES TO CURRENT RADIO LITERATURE	1430
GEOGRAPHICAL LOCATION OF MEMBERS ELECTED SEPTEMBER 5, 1928	1432
APPLICATIONS FOR MEMBERSHIP	1435

NUMBER 11; NOVEMBER, 1928

OFFICERS AND BOARD OF DIRECTION	1438
COMMITTEES	1439
INSTITUTE SECTIONS	1440
INSTITUTE NOTES AND RELATED ACTIVITIES	1446
INSTITUTE MEETINGS	1448
COMMITTEE WORK	1452
J. R. HARRISON, "PIEZO-ELECTRIC OSCILLATOR CIRCUITS WITH FOUR-ELECTRODE TUBES"	1455
DISCUSSIONS ON HARRISON PAPER BY AUGUST HUNE, J. R. HARRISON, W. G. CADY, AND ALFRED N. GOLDSMITH	1467
J. C. SCHELLING, "NOTE ON THE DETERMINATION OF THE IONIZATION IN THE UPPER ATMOSPHERE"	1471
J. H. DELLINGER, "ANALYSIS OF BROADCASTING STATION ALLOCATION"	1477
EARLE M. TERRY, "THE DEPENDENCE OF THE FREQUENCY OF QUARTZ PIEZO-ELECTRIC OSCILLATORS UPON CIRCUIT CONSTANTS"	1486
A. F. VAN DYCK AND E. T. DICKEY, "QUANTITATIVE METHODS USED IN TESTS OF BROADCAST RECEIVING SETS"	1507
A. F. VAN DYCK AND F. H. ENGEL, "VACUUM-TUBE PRODUCTION TESTS"	1532
V. I. BASHENOFF, SUPPLEMENTARY NOTE TO "ABBREVIATED METHOD FOR CALCULATING THE INDUCTANCE OF IRREGULAR PLANE POLYGONS OF ROUND WIRE"	1553
H. M. TURNER, "THE CONSTANT IMPEDANCE METHOD FOR MEASURING INDUCTANCE OF CHOKE COILS"	1559
ROBERT C. COLWELL, "FADING CURVES ALONG A MERIDIAN"	1570
BOOK REVIEW, "THEORY OF VIBRATING SYSTEMS AND SOUND"	1574

RADIO STATIONS OF THE WORLD ON FREQUENCIES ABOVE 1500 KC	PAGE
MONTHLY LIST OF REFERENCES TO CURRENT RADIO LITERATURE	1575
GEOGRAPHICAL LOCATION OF MEMBERS ELECTED OCTOBER 3, 1928	1605
APPLICATIONS FOR MEMBERSHIP	1612
	1614

NUMBER 12; DECEMBER, 1928

OFFICERS AND BOARD OF DIRECTION	1618
COMMITTEES	1619
INSTITUTE SECTIONS	1620
INSTITUTE NOTES AND RELATED ACTIVITIES	1626
INSTITUTE MEETINGS	1634
COMMITTEE WORK	1637
STUART BALLANTINE, "NOTE ON THE EFFECT OF REFLECTION BY THE MICROPHONE IN SOUND MEASUREMENTS"	1639
AUSTIN BAILEY, S. W. DEAN, AND W. T. WENTRINGHAM, "THE RECEIVING SYSTEM FOR LONG-WAVE TRANSATLANTIC RADIO TELEPHONY"	1645
KEITH B. ELLER, "ON THE VARIATION OF GENERATED FREQUENCY OF A TRIODE OSCILLATOR"	1706
IRVING WOLFF, "SOUND MEASUREMENTS AND LOUDSPEAKER CHARACTERISTICS"	1729
GLENN KOEHLER, "THE DESIGN OF TRANSFORMERS FOR AUDIO-FREQUENCY AMPLIFIERS WITH PREASSIGNED CHARACTERISTICS"	1742
V. D. LANDON, "A BRIDGE CIRCUIT FOR MEASURING THE INDUCTANCE OF COILS WHILE PASSING DIRECT CURRENT"	1771
DISCUSSION ON "RECENT DEVELOPMENTS IN LOW POWER AND BROADCASTING TRANS- MITTERS" (I. F. BYRNES), BY E. L. NELSON	1776
BOOK REVIEW, "HANDBOOK OF CHEMISTRY AND PHYSICS"	1779
MONTHLY LIST OF REFERENCES TO CURRENT RADIO LITERATURE	1780
GEOGRAPHICAL LOCATION OF MEMBERS ELECTED NOVEMBER 7, 1928	1785
APPLICATIONS FOR MEMBERSHIP	1787

PROCEEDINGS OF
The Institute of Radio Engineers

Volume 16

December, 1928

Number 12

CONTENTS

	Page
Officers and Board of Direction	1618
Committees	1619
Institute Sections	1620
Institute Notes and Related Activities	1626
Institute Meetings	1634
Committee Work	1637
Stuart Ballantine, "Note on the Effect of Reflection by the Micro- phone in Sound Measurements"	1639
Austin Bailey, S. W. Dean, and W. T. Wintringham, "The Receiv- ing System for Long-Wave Transatlantic Radio Telephony"	1645
Keith B. Eller, "On the Variation of Generated Frequency of A Triode Oscillator"	1706
Irving Wolff, "Sound Measurements and Loudspeaker Char- acteristics"	1729
Glenn Koehler, "The Design of Transformers for Audio-Fre- quency Amplifiers with Preassigned Characteristics"	1742
V. D. Landon, "A Bridge Circuit for Measuring the Inductance of Coils While Passing Direct Current"	1771
Discussion on "Recent Developments in Low Power and Broad- casting Transmitters" (I. F. Byrnes), by E. L. Nelson	1776
Book Review, "Handbook of Chemistry and Physics"	1779
Monthly List of References to Current Radio Literature	1780
Geographical Location of Members Elected November 7, 1928	1785
Applications for Membership	1787

GENERAL INFORMATION

The PROCEEDINGS of the Institute is published monthly and contains the papers and the discussions thereon as presented at meetings.

Payment of the annual dues by a member entitles him to one copy of each number of the PROCEEDINGS issued during the period of his membership.

Subscriptions to the PROCEEDINGS are received from non-members at the rate of \$1.00 per copy or \$10.00 per year. To foreign countries the rates are \$1.10 per copy or \$11.00 per year. A discount of 25 per cent is allowed to libraries and booksellers.

The right to reprint limited portions or abstracts of the articles, discussions, or editorial notes in the PROCEEDINGS is granted on the express condition that specific reference shall be made to the source of such material. Diagrams and photographs in the PROCEEDINGS may not be reproduced without securing permission to do so from the Institute through the Secretary.

It is understood that the statements and opinions given in the PROCEEDINGS are the views of the individual members to whom they are credited, and are not binding on the membership of the Institute as a whole.

Entered as second class matter at the Post Office at Menasha, Wisconsin.

Acceptance for mailing at special rate of postage provided for in the Act of February 28, 1925, embodied in paragraph 4, Section 412, P. L. and R. Authorized October 26, 1927.

Copyright, 1928, by
THE INSTITUTE OF RADIO ENGINEERS, Inc.
PUBLICATION OFFICE, 450-454 ARNAIP ST., MENASHA, WIS.
BUSINESS, EDITORIAL, AND ADVERTISING OFFICES, 33 WEST 39TH ST.,
NEW YORK, N. Y.

OFFICERS AND BOARD OF DIRECTION, 1928

(Terms expire January 1, 1929, except as otherwise noted)

President

ALFRED N. GOLDSMITH

Vice-President

L. E. WHITEMORE

Treasurer

MELVILLE EASTHAM

Secretary

JOHN M. CLAYTON

Editor

ALFRED N. GOLDSMITH

Managers

ARTHUR BATCHELLER

L. F. FULLER

R. H. MARRIOTT

W. G. CADY

A. H. GREBE

R. A. HEISING
(Serving until Jan. 1, 1930)

J. V. L. HOGAN
(Serving until Jan. 1, 1930)

J. H. DELLINGER
(Serving until Jan. 1, 1931)

R. H. MANSON
(Serving until Jan. 1, 1931)

Junior Past Presidents

DONALD MCNICOL

RALPH BOWN

Committees of the Institute of Radio Engineers, 1928

Committee on Meetings and Papers

J. H. DELLINGER, *Chairman*
E. F. W. ALEXANDERSON
STUART BALLANTINE
W. R. G. BAKER
M. C. BATSEL
R. R. BATCHER
ZEH BOUCK
B. RAY CUMMINGS
W. G. CADY
FRANK CONRAD
CARL DREHER
E. T. DICKEY
EDGAR FELIX
W. G. H. FINCH
H. A. FREDERICKS
J. D. R. FREED

VIRGIL M. GRAHAM
KARL HASSEL
C. R. HANNA
SYLVAN HARRIS
LEWIS M. HULL
S. S. KIRBY
D. G. LITTLE
W. H. MURPHY
E. L. NELSON
G. W. PICKARD
R. H. RANGER
A. HOYT TAYLOR
PAUL WEEKS
W. WILSON
IRVING WOLFF
W. C. WHITE

All chairmen of Meetings and Paper Committees of Institute Sections,
ex officio.

Committees of the Institute—(Continued)

Committee on Admissions

R. A. HEISING, *Chairman*
H. F. DART
LEWIS M. HULL
LEONARD F. FULLER
H. E. KRANZ
F. H. KROGER
A. G. LEE
C. L. RICHARDSON
E. R. SHUTE
F. K. VREELAND

Committee on Publicity

W. G. H. FINCH, *Chairman*
H. W. BAUKAT
ZEH BOUCK
C. E. BUTTERFIELD
DAVID CASEM
ORRIN E. DUNLAP
FRED EHLERT
EDGAR FELIX
E. H. HANSEN
A. H. HALLORAN
L. W. HATRY
J. F. J. MAHER
HUGH S. POCOCK
J. J. RIEGER
J. G. UZMANN
WILLIS K. WING
R. F. YATES

Committee on Membership

H. F. DART, *Chairman*
W. R. G. BAKER
M. BERGER
F. R. BRICK
I. S. COGGESHALL
H. B. COXHEAD
C. M. JANSKY
R. S. KRUSE
PENDLETON E. LEHDE
M. E. PACKMAN
C. L. RICHARDSON
JOHN STROEBEL

Committee on Institute Sections

DONALD McNICOL, *Chairman*
QUINTON ADAMS
ARTHUR BATCHELLER
M. BERGER
W. G. CADY
B. CHAMBERLAIN
L. J. DUNN
F. E. ELDRIDGE
L. F. FULLER
H. C. GAWLER
EARLE D. GLATZEL
E. I. GREEN

F. P. GUTHRIE
L. C. F. HORLE
W. A. KLEIST
PENDLETON E. LEHDE
JOHN R. MARTIN
JOHN H. MILLER
A. M. PATIENCE
GEORGE W. PIERCE
E. R. SHUTE
W. K. THOMAS
J. C. VAN HORN
WALTER VAN NOSTRAND
DON C. WALLACE

Committee on Standardization

L. E. WHITTEMORE, *Chairman*
M. C. BATSEL
EDWARD BENNETT
WILLIAM R. BLAIR
E. L. CHAFFEE
J. H. DELLINGER
E. T. DICKEY
C. P. EDWARDS
GENERAL FERRIE
A. N. GOLDSMITH
J. V. L. HOGAN
W. E. HOLLAND
L. M. HULL
C. M. JANSKY
C. B. JOLLIFFE
F. A. KOLSTER
R. S. KRUSE
GEORGE LEWIS
ELMORE B. LYFORD
R. H. MANSON
ALEXANDER MEISSNER
GINO MONTEFINALE
E. L. NELSON
H. S. OSBORNE
HARADEN PRATT
H. B. RICHMOND
W. J. RUBLE
CARL E. SCHOLZ
H. M. TURNER
K. B. WARNER
A. D. G. WEST
C. A. WRIGHT
HIDETSUGU YAGI

Committee on Constitution and
Laws

R. H. MARRIOTT, *Chairman*
E. N. CURTIS
W. G. H. FINCH
H. E. HALLBORG
J. V. L. HOGAN
G. W. PICKARD
HAROLD ZEAMANS

INSTITUTE SECTIONS

<i>Chairmen</i>	<i>Secretaries</i>
	ATLANTA
Walter Van Nostrand	George Llewellyn, P. O. Box 1593, Atlanta, Ga.
	BOSTON
George W. Pierce	Melville Eastham, 30 State St., Cambridge, Mass.
L. C. F. Horle	BUFFALO—NIAGARA
	CANADIAN
A. M. Patience	C. C. Meredith, 110 Church St., Toronto, Ontario
	CHICAGO
John H. Miller	H. E. Kranz, 4540 Armitage Ave., Chicago, Ill.
	CLEVELAND
John R. Martin	B. W. David, Room 1001, Illuminating Building, Public Square, Cleveland, Ohio
	CONNECTICUT VALLEY
W. G. Cady	George W. Pettengill Jr., 70 Edendale Street Springfield, Mass.
	DETROIT
Earle D. Glatzel	W. R. Hoffman, 615 West Lafayette Blvd., Detroit, Mich.
	LOS ANGELES
Don C. Wallace	W. W. Lindsay, Jr., 927 La Jolla Ave., Hollywood, Cal.
	NEW ORLEANS
Pendleton E. Lehde	Anton A. Schiele, 1812 Masonic Temple, New Orleans, La.
	PHILADELPHIA
J. C. Van Horn	John C. Mevius, 1533 Pine St., Philadelphia, Pa.
	PITTSBURGH
W. K. Thomas	A. J. Buzzard, 911 Penn Ave., Pittsburgh, Pa.
	ROCHESTER
B. Chamberlain	A. L. Schoen, Kodak Park, Rochester, N. Y.
	SAN FRANCISCO
L. F. Fuller	Paul Fenner, Custom House, San Francisco, Cal.
	SEATTLE
W. A. Kleist	Abner R. Willson, 8055-14th Ave., N. E., Seattle, Wash.
	WASHINGTON
F. P. Guthrie	Thomas McL. Davis, (<i>Acting Secretary</i>), 4302 Brandywine St., N. W., Washington, D.C.



ALFRED H. GREBE
Manager of the Institute, 1928

Alfred H. Grebe

MEMBER OF THE BOARD OF DIRECTION OF THE INSTITUTE, 1928

Alfred H. Grebe was born on April 4, 1893 at Richmond Hill, Long Island, N. Y. He graduated from high school and attended the American Wireless Institute. In 1907 Mr. Grebe began his experimental work in radio communication. From 1909 to 1912 he was employed as an operator by the United Wireless Telegraph Company. In 1912 he became associated with the Telefunken Company and the Atlantic Communication Company, with whom he served until 1914. Early in 1915 Mr. Grebe began manufacturing experimental radio apparatus. In 1916 he joined the staff of Kilbourn and Clark Company as a construction engineer.

In 1917 Mr. Grebe began manufacture and development of regenerative receivers. He was one of the earliest manufacturers of radio receivers in the country.

In connection with his work with the Telefunken Company, he was in charge of installation of twenty-seven stations. With Kilbourn and Clark Company he had active charge of construction and installation of fourteen stations. He also was associated with the rearrangement of the old Sayville Transatlantic Transmitter, located on Long Island.

In 1919 he became President of the A. H. Grebe Company, Inc., and has served in that capacity to date. Mr. Grebe was elected an Associate member of the Institute in 1917, and was transferred to the Fellow grade in November, 1927.

Mr. Grebe served as a member of the Board of Direction of the Institute from 1924 through 1926, and was reappointed a member of the Board in January, 1928.

Throughout his long active association with the Institute and its various activities, Mr. Grebe has served on practically all of its committees,

CONTRIBUTORS TO THIS ISSUE

Bailey, Austin: Received A.B. degree, University of Kansas, 1915; Ph.D., Cornell University, 1920; assistant and instructor in physics, Cornell University, 1915-18; signal corps, U. S. A., 1918-19; Fellow in physics, Cornell University, 1919-20; Corning Glass Works, 1920-21; assistant professor of physics, University of Kansas, 1921-22; Department of Development and Research, American Telephone and Telegraph Company, 1922—. Dr. Bailey's work while with the American Telephone and Telegraph Company has been largely along the line of methods for making radio transmission measurements and long-wave radio receiving problems. Associate member, Institute of Radio Engineers, 1925; Member, 1925.

Ballantine, Stuart: (See PROCEEDINGS for February, 1928).

Dean, S. W.: Received A.B. degree, Harvard University, 1919; Cutting and Washington, Inc., 1917; ensign, U. S. Naval Reserve Force, 1918; Radio Corporation of America, 1919-25; Department of Development and Research, American Telephone and Telegraph Company 1925—. Mr. Dean's work has been chiefly in connection with long-wave transatlantic radio receiving systems. Junior member, Institute of Radio Engineers, 1914; Associate, 1918; Member, 1926.

Eller, Keith B.: Born July 25, 1903, at Bradford, Ohio. Received B.S. degree in engineering physics and B.S. in E.E., Ohio State University, 1926; M.S., 1927; instructor in physics at Mendenhall Laboratory, Ohio State University, 1925-27. Research Department, Western Union Telegraph Company, 1927—.

Koehler, Glenn: Born November 20, 1894, at Van Wert, Ohio. Received B.S. degree from University of Illinois, 1918. M.S., University of Wisconsin. Radio research, signal corps, U. S. Army at Camp Alfred Vail, N. J., 1918. Research Department, Western Union Telegraph Company, 1919. Department of Electrical Engineering, University of Wisconsin, 1920 to date. Associate member, Institute of Radio Engineers, 1927.

Landon, V. D.: Born May 2, 1901. Educated Detroit Central High School and Central College. Engineering Department, Westinghouse Electric and Manufacturing Company, 1922—. At present in charge of Receiver Test Laboratory and Radio Frequency Development Laboratory. Associate member, Institute of Radio Engineers, 1927.

Wintringham, W. T.: Received B.S. degree in electric communication engineering, Harvard University, 1924; Department of Development and Research, American Telephone and Telegraph Company, 1924—. Mr. Wintringham's work has been largely along the line of long-wave radio receiving and transmission measurements. Associate member, Institute of Radio Engineers, 1926.

Wolff, Irving: Received B.S. degree, Dartmouth College, 1916; non-technical work, 1916-19; instructor, Iowa State College, 1919-20; instructor, Cornell University, 1920-23; Ph.D., Cornell University, 1923; research on polarization capacity for Heckscher Research Council, 1923-24; research on electro-acoustics, Radio Corporation of America, 1924. Author of a number of papers published in various technical magazines. Member, American Association for Advancement of Science and American Physical Society; member honorary societies, Sigma Xi and Phi Kappa Phi; Associate member, Institute of Radio Engineers, 1927.

The following are biographies of authors whose papers appeared in the October, 1928 issue of the PROCEEDINGS:

Montefinale, Gino: Born June 9, 1881. Educated at Technical Colleges in Italy; entered Naval Academy, London, 1899; officer of the Royal Navy, 1903; radio instructor at the R. N. Telegraphist School, 1908-10; assisted in erection of the high-power Marconi station at Mogadiscio, 1911; radio officer, Red Sea flotilla during Turkish-Italian war; director of radio service in Italian Somaliland, 1912-14; served in dreadnaught squadron during World War; sent to Red Sea as director of the Erytrea radio service, December, 1916; remained at Marconi station of Massawa till armistice; chief of radio laboratory in the dockyard of La Spezia, June, 1919 to April, 1925; chief of radio section of the Italian Navy Department and commander of the S. Paolo (IDO) station, October, 1925 to date. Italian delegate at the International Radiotelegraph Conference of Washington, 1927. Author of several papers on radio subjects and active correspondent of various periodicals and reviews. Member of Specialist Body of the Italian Navy, and member of the Superior Committee of Vigilance on Italian Broadcasting Services. Commander, Royal Italian Navy.

Pession, Giuseppe: Born May 30, 1881. Educated at Royal Naval Academy; appointed midshipman in 1902; director of La Spezia Radiotelegraphic School and teacher of radiotelegraphy at Rome Military Institute of Radiotelegraphy; since 1920 professor of radiotelegraphy and naval magnetism at Naples Royal Superior Polytechnical School; member of several commissions dealing with development and reorganization of the radiotelegraphic services both in Italy and abroad; erection of Rome-S. Paolo station and other radio installations; chief of radio services in Italian Navy Department and commander of Rome radio stations, 1917-24; awarded professor's degree in electrical and radio sciences, Polytechnical School of Naples and Rome, 1924; chief of Italian Postal and Telegraph Administration, 1925 to date. Author of scientific books and active correspondent of scientific magazines. Member of Specialist Body of the Italian Navy; vice-president of radio section, Consiglio Nazionale Delle Ricerche. Captain, Royal Italian Navy.

INSTITUTE NOTES AND RELATED ACTIVITIES

November Meeting of the Board of Direction

The regular meeting of the Board of Direction of the Institute was held in the offices of the Institute in the Engineering Societies Building, New York City, at 2 P.M., November 7th. The following were present: Alfred N. Goldsmith, President; L. E. Whittemore, Vice-President; Melville Eastham, Treasurer; Ralph Bown, Junior Past President; Arthur Bacheller, W. G. Cady, J. H. Dellinger, R. A. Heising, R. H. Manson, R. H. Marriott, C. J. Porter, Assistant Secretary, and John M. Clayton, Secretary.

Acting upon the recommendation of the Committee on Admissions, the Board approved the transfer or election of the following to higher grades of membership:

Transferred to the grade of Fellow: Carl Dreher. Transferred to the grade of Member: Frederick H. Drake, Harold Hardy, Charles T. Manning, and F. W. Van Why. Elected to the grade of Member: Thomas McL. Davis, J. Barton Hoag, and Charles C. Kolster.

Seventy-six Associate members and fourteen Junior members were elected.

Liebmann Memorial Prize Awarded to Dr. Cady

At the New York meeting of the Institute, held in the Engineering Societies Building on the evening of November 7, the 1928 award of the Morris Liebmann Memorial Prize was made to Walter G. Cady, of Scott Laboratory, Wesleyan University.

In presenting the prize, President Alfred N. Goldsmith, of the Institute, made the following remarks:

(President Goldsmith)—In pursuance of the normal duties of the Institute, at this time it becomes my pleasant duty to announce the award of the Morris Liebmann Memorial Prize. This prize is awarded this year to Dr. Walter G. Cady, Head of the Department of Physics of Wesleyan University, for his fundamental investigations in piezo-electric phenomena and their applications to radio technique. With the nature of the work of Dr. Cady, of its importance, its influence on the development of the art, you

are all acquainted. With the progress that has resulted from these applications, you are also acquainted.

I have here the duly engrossed check which is at once a sentimental and material indication of the award in question. Dr. Cady, it is my great pleasure to present to you this check.

(Walter G. Cady)—Mr. Chairman, I appreciate very deeply this honor that you and the Directors of the Institute have conferred upon me. At various times and places I have been present when prizes were awarded, but I find now that the memory of having been a witness of the embarrassment of others is but very little help in knowing just what to say on this joyous occasion.

It was some years ago that I had occasion to measure the capacities and dielectric constants of certain Rochelle salt plates. I mention this because it is a good illustration of a principle that I have for a good many years felt to be rather an important one in experimental work, namely, that whenever you run across anything that seems to be an obstacle, or a source of error in your work, you can't do anything better than try to turn that to your advantage—just as all through life perhaps we try to make benefits so far as possible out of our various trials and tribulations. At any rate, the principle worked in this particular case, for what was at the time a very annoying source of error, as I thought, in carrying out those measurements, turned out to be the beginning of the series of experiments that have led to the applications of piezo-electricity in radio as we have them today.

I shall not attempt to trace out the development of that at all, but simply mention it as an instance of the advisability of being on the watch for opportunities to turn to your advantage those things that of themselves tend to be only obstacles to success.

At that time, when the first papers on this subject were published, I think, Mr. Chairman, that the Board of Directors would have been less inclined to bestow a medal than free transportation to the nearest insane asylum because the practical value of piezo-electricity seemed to be dubious and very remote. Since then the development that has taken place—very largely contributed to, I ought to say, by Professor Pierce, Dr. Miller, Commander Taylor, and others—has brought the use of piezo-electric crystals to the position that they hold today.

Again, Mr. Chairman, I want to thank you for your kindness, and for this honor.

Forthcoming Papers

The following is a partial list of papers on hand for publication in the PROCEEDINGS. These papers will probably appear in early forthcoming issues:

Fading Curves and Weather Conditions—by R. C. Colwell.

Reception Experiments in Mt. Royal Tunnel at Montreal, Quebec—
by A. S. Eve, W. A. Steel, G. W. Olive, A. R. McEwan, and J. H. Thompson.

On the Behavior of Networks with Normalized Meshes—by E. A. Guillemin and W. Glendinning.

A Direct Reading Radio-Frequency Meter—by R. C. Hitchcock.

On the Mechanism of Electron Oscillations in Three-Electrode Tubes
—by H. E. Hollman.

An Auxiliary Frequency Control for R. F. Oscillators—by G. F. Lampkin.

Further Researches on Determination of the Most Favorable Radiation Angle with Horizontal Polarization—by Alexander Meissner.

The Radiation Resistance of Beam Antennas—by A. A. Pistolokors.

A Method of Treating Resistance Stabilized Radio-Frequency Amplifying Circuits—by B. L. Snavely and J. S. Webb.

Detection Characteristics of Three-Element Vacuum Tubes—by Frederick E. Terman.

The Piezo-Electric Crystal Oscillator—by J. Warren Wright.

A Note on the Directional Observations on Grinders in Japan—by E. Yokayama and T. Nakai.

Byrd Antarctic Expedition

In connection with the account of some of the radio activities of the Byrd Antarctic Expedition, appearing in the Institute Notes Section of the PROCEEDINGS for October, an unfortunate omission of the name of Howard F. Mason as one of the members of the radio personnel occurred. Mr. Mason is well known for his previous radio experience with Captain Wilkins in the Arctic Regions, was responsible for the design and construction of much of the radio apparatus of the expedition, and supplied a considerable portion of the facts from which the above mentioned material was formulated for the PROCEEDINGS. He accompanies the expedition in the capacity of radio operator and observer.

1929 Convention

The annual Convention of the Institute will be held in 1929 in Washington, D. C. on May 13th to 15th inclusive, instead of early in January as has been the custom in the past several years.

The tentative Convention plans call for technical sessions and trips during the first two days with a banquet on the evening of the second day. The third day of the Convention will be devoted to participation in the annual meeting of the U.R.S.I.

Complete announcement of the detailed arrangements for

the Convention will be published in an early forthcoming issue of the PROCEEDINGS.

It is suggested that members of the Institute arrange their plans to reserve the three days in May of 1929 for the Convention, as it is anticipated that an extremely interesting program will be presented.

Applications for Membership

The signatures of references for application for transfer or election to any grade of membership in the Institute are not required. Members are requested to so advise prospective applicants in order that such applications may be transmitted promptly to the Institute for consideration by the Committee on Admissions and the Board of Direction.

Changes of Address

The PROCEEDINGS of the Institute are sent to the membership under fourth class mail. The postal regulations do not allow fourth class mail to be forwarded when the addressee has removed from the address given. Such mail, when undelivered to the addressee, is returned by the post office to the Institute office. For this reason members of the Institute are *urged* to notify the Institute office promptly of any change in their mailing address so that copies of the PROCEEDINGS may reach them promptly. A change of address to be effective with a particular issue must reach the Institute office by not later than the fifteenth of the month preceding the date of publication. That is, a change of address to be effective with the October issue must reach the Institute office not later than September 15th.

In notifying the Institute office of change of address, members are requested to indicate not only their change in mailing address but their change in business connection, if any.

The Graf Zeppelin Radio Equipment

Through the courtesy of the Navy Department, we have obtained the following facts regarding the radio equipment and wavelengths used by the *Graf Zeppelin* in its recent transatlantic flight. This data was supplied by the Zeppelin Company of Germany.

The following wavelengths were assigned to the *Graf Zeppelin* whose call letters were DENNE.

Meters
 1875 }
 1887 }
 1911 }
 1935 }
 1961 }
 1987
 2098
 2479 }
 2521 }

Wavelengths only for communication with shipboard stations which can relay telegrams to coast stations.

Sending wave for traffic with shipboard stations.

General call wave of the airship for shipboard and coast stations.

Emergency call wave for European coast stations.

In addition waves 1400 and 900 meters for traffic with other aircraft.

The main transmitter was a 140-watt combination telephone and telegraph outfit having normal ranges of 1500 kilometers for telegraph and 400 kilometers for telephone.

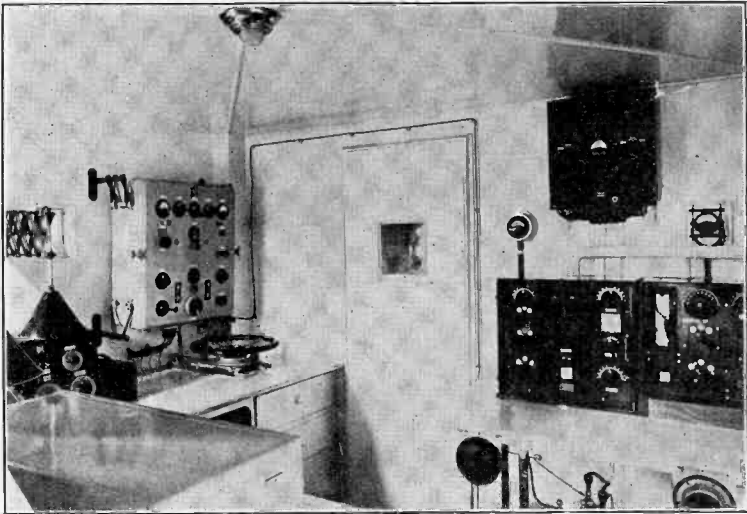

Radio Room on the *Graf Zeppelin*

An emergency vacuum-tube transmitter with a rated output of 70 watts was also supplied. The normal operating range of the emergency set was 750 kilometers for telegraph and 180 kilometers for telephone.

Both transmitters were arranged for straight continuous-wave telegraph as well as for modulated telegraph and telephone.

Two wind-driven generators supplied power for transmitters, one being the main generator and the second a reserve one. In addition, batteries for emergency operation of the generators were supplied.

Three receivers of the superheterodyne type, designed to cover wavelength ranges of 150 to 500 meters, 400 to 4000 meters, and 3000 to 25000 were in operation.

A radio compass, with wavelength of 300 to 4000 meters, was extensively used. The compass coil was located in the buffer bag under the control car and was operated from the radio room.

Two antenna wires, approximately 650 feet in length, were suspended beneath the control car in which the radio equipment was located.

A short-wave transmitter and receiver for experimental work were also carried.

No data as to the effective operation of the radio equipment over long distances are available at this time. It is understood, however, that the *Zeppelin* was in communication constantly with land stations throughout the entire voyage.

Standard Frequency Transmissions by the Bureau of Standards

The Bureau of Standards announces its schedule of radio signals of standard frequencies for use by the public in calibrating frequency standards and transmitting and receiving apparatus. This schedule includes many of the border frequencies between services as set forth in the allocation of the International Radio Convention of Washington, which goes into effect January 1, 1929. The signals are transmitted from the Bureau's station WWV, Washington, D. C. They can be heard and utilized by stations equipped for continuous-wave reception at distances up to about 500 to 1,000 miles from the transmitting station.

The transmissions are by continuous-wave radiotelegraphy. The signals have a slight modulation of high pitch which aids in their identification. A complete frequency transmission includes a "general call" and "standard frequency" signal, and "announcements." The "general call" is given at the beginning of the 8-minute period and continues for about two minutes. This includes a statement of the frequency. The "standard frequency signal" is a series of very long dashes with the call letter (WWV) intervening. This signal continues for about four minutes. The "announcements" are on the same frequency as the "standard frequency signal" just transmitted and contain a statement of the frequency. An announcement of the next frequency to be transmitted is then given. There is then a 4-minute interval while the transmitting set is adjusted for the next frequency.

Information on how to receive and utilize the signals is given in Bureau of Standards Letter Circular No. 171, which may be obtained by applying to the Bureau of Standards, Washington, D. C. Even though only a few frequency points are received, persons can obtain as complete a frequency meter calibration as desired by the method of generator harmonics, information on which is given in the letter circular. The schedule of standard frequency signals is as follows:

RADIO SIGNAL TRANSMISSIONS OF STANDARD FREQUENCY SCHEDULE OF
FREQUENCIES IN KILOCYCLES

Eastern Standard Time	Dec. 20	Jan. 21	Feb. 20	March 20
10:00-10:08 P.M.	4000	125	500	1500
10:12-10:20	4200	150	600	1700
10:24-10:32	4400	200	650	2250
10:36-10:44	4700	250	800	2750
10:48-10:56	5000	300	1000	2850
11:00-11:08	5500	375	1200	3200
11:12-11:20	5700	450	1400	3500
11:24-11:32	6000	550	1500	4000

Frequency Allocation Effective January 1, 1929

For the information of the membership of the Institute there is reproduced below the frequency allocation proposed by the International Radiotelegraph Conference held at Washington in 1927. This allocation will become effective throughout the world on January 1, 1929.

Members interested in a detailed account of the activities of the conference are referred to "International Radiotelegraph Conference" and "General and Supplementary Regulations Relating Thereto," which can be obtained from the Government Printing Office at Washington, D. C., for forty cents.

FREQUENCY ALLOCATION

Frequencies in kilocycles per second	Approximate wavelengths in meters	Services
10- 100	30,000-3,000	Fixed services.*
100- 110	3,000-2,725	Fixed services and mobile services.
110- 125	2,725-2,400	Mobile services.
125- 150 ¹	2,400-2,000 ¹	Maritime mobile services open to public correspondence exclusively.
150- 160	2,000-1,875	Mobile services. (a) Broadcasting. (b) Fixed services. (c) Mobile services.
		The conditions for use of this band are subject to the following regional arrangements:
160- 194	1,875-1,550	All regions where broadcasting stations now exist working on frequencies below 300 kc (above 1000m). } Broadcasting
		Other regions { Fixed services.
		Regions { Mobile Services
		Regional arrangements will respect the rights of other regions in this band.
		(a) Mobile services. (b) Fixed service. (c) Broadcasting.
		The conditions for use of this band are subject to the following regional arrangements:
194- 285	1,550-1,050	(a) Air mobile service exclusively. (b) Air fixed services exclusively. (c) Within the band 250-285 kc (1200-1050m). } Europe { Fixed service not open to public correspondence. (d) Broadcasting within the band 194-224 kc (1550-1340m).
		Other regions { (a) Mobile services except commercial ship stations. (b) Fixed air services exclusively. (c) Fixed services not open to public correspondence.

¹ The wave of 143 kc (2,100m) is the calling wave for mobile stations using long continuous waves.

² The wave of 333 kc (900m) is the international calling wave for air services.

FREQUENCY ALLOCATIONS (Cont.)

Frequencies in kilocycles per second	Approximate wavelengths in meters	Services
285- 315	1,050 950	Radio beacons.
315- 350 ²	950- 850 ²	Air mobile services <i>exclusively</i> .
350- 360	850- 830	Mobile services <i>not open to public correspondence</i> .
360- 390	830- 770	(a) Radio compass service. (b) Mobile services, on condition that they do not interfere with radio compass service.
390- 460	770- 650	Mobile services.
460- 485	650- 620	Mobile services (<i>except damped waves and radiotelephony</i>).
485- 515 ³	620- 580 ³	Mobile services (distress, call, etc.).
515- 550	580- 545	Mobile services <i>not open to public correspondence (except damped waves and radiotelephony)</i> .
550- 1,300 ⁴	545- 230 ⁴	Broadcasting.
1,300- 1,500	230- 200	(a) Broadcasting. (b) Maritime mobile services, waves of 1365 kc (220m) <i>exclusively</i> .
1,500- 1,715	200- 175	Mobile services.
1,715- 2,000	175- 150	Mobile services. Fixed services.
2,000- 2,250	150- 133	Amateurs.
2,250- 2,750	133- 109	Mobile services and fixed services.
2,750- 2,850	109- 105	Mobile services.
2,850- 3,500	105- 85	Fixed services.
3,500- 4,000	85- 75	Mobile services and fixed services.
4,000- 5,500	75- 54	Mobile services.
5,500- 5,700	54- 52.7	Mobile services.
5,700- 6,000	52.7- 50	Fixed services.
6,000- 6,150	50- 48.8	Broadcasting.
6,150- 6,675	48.8- 45	Mobile services.
6,675- 7,000	45-42.8	Fixed services.
7,000- 7,300	42.8-41	Amateurs.
7,300- 8,200	41-36.6	Fixed services.
8,200- 8,550	36.6-35.1	Mobile services.
8,550- 8,900	35.1-33.7	Mobile services and fixed services.
8,900- 9,500	33.7-31.6	Fixed services.
9,500- 9,600	31.6-31.2	Broadcasting.
9,600-11,000	31.2-27.3	Fixed services.
11,000-11,400	27.3-26.3	Mobile services.
11,400-11,700	26.3-25.6	Fixed services.
11,700-11,900	25.6-25.2	Broadcasting.
11,900-12,300	25.2-24.4	Fixed services.
12,300-12,825	24.4-23.4	Mobile services.
12,825-13,350	23.4-22.4	Mobile services and fixed services.
13,350-14,000	22.4-21.4	Fixed services.
14,000-14,400	21.4-20.8	Amateurs.
14,400-15,100	20.8-19.85	Fixed services.
15,100-15,350	19.85-19.55	Broadcasting.
15,350-16,400	19.55-18.3	Fixed services.
16,400-17,100	18.3-17.5	Mobile services.
17,100-17,750	17.5-16.9	Mobile services and fixed services.
17,750-17,800	16.9-16.85	Broadcasting.
17,800-21,450	16.85-14	Fixed services.
21,450-21,550	14-13.9	Broadcasting.
21,550-22,300	13.9-13.45	Mobile services.
22,300-23,000	13.45-13.1	Mobile services and fixed services.
23,000-28,000	13.1-10.7	Not reserved.
28,000-30,000	10.7-10	Amateurs and experimental.
30,000-56,000	10-5.35	Not reserved.
56,000-60,000	5.35-5	Amateurs and experimental.
Above 60,000	Below 5	Not reserved.

² The wave of 500 kc (600m) is the international calling and distress wave. It may be used for other purposes on condition that it will not interfere with call signals and distress signals.

⁴ Mobile services may use the band 550 to 1,300 kc (545-230m) on condition that this will not cause interference with the services of a country which uses this band *exclusively* for broadcasting.

NOTE.—It is recognized that short waves (frequencies from 6,000 to 23,000 kc approximately—wavelengths from 50 to 13m approximately) are very efficient for long distance communications. It is recommended that as a general rule this band of waves be reserved for this purpose, in services between fixed points.

Institute Meetings

BUFFALO-NIAGARA SECTION

The September 17th meeting of the Buffalo-Niagara Section was held in Foster Hall, University of Buffalo. L. C. F. Horle, Chairman of the Section, presided.

E. T. Dickey and F. H. Engel, of the Radio Corporation of America, presented papers on "Quantitative Measurements Used in Tests of Broadcast Radio Receivers" and "Vacuum-Tube Production Tests," respectively.

Forty-three members of the Section attended the meeting.

On October 12th a joint meeting of the Section with the Niagara Frontier Section of the A.I.E.E. and the Radio Association of Western New York was held in Edmond Hayes Hall, University of Buffalo.

Two hundred and twenty members of the combined societies and their guests attended the meeting which was addressed by Richard H. Ranger, of the Radio Corporation of America, on "Recent Developments in Photoradio."

Mr. Ranger's address was supplemented with a demonstration of some of the photoradio devices described.

The next meeting of the Buffalo-Niagara Section will be held on November 14th in Foster Hall, University of Buffalo. I. R. Lounsberry and J. Morrison will be the speakers of the evening.

DETROIT SECTION

On September 20th a meeting of the Detroit Section was held in the Conference Room of the Detroit News Building. Earle D. Glatzel, Chairman of the Section, presided.

E. T. Dickey and F. H. Engel presented papers on "Quantitative Measurements Used in Tests of Broadcast Radio Receivers" and "Vacuum-Tube Production Tests," respectively.

Thirty-six members of the Section attended the meeting.

Following the presentation of the papers, Messrs. Buchanan, Glatzel, Holland, and others participated in its discussion.

A meeting of the Detroit Section was held on October 19th in the Detroit News Building to hear a paper by Dr. H. B. Vincent, of the Engineering Research Department, University of Michigan.

Messrs. Holland, Katzin, Swain, and Glatzel, among others, participated in the discussion which followed the presentation of the paper.

The paper contained a discussion of the theory of detection

of a triode for unmodulated and modulated signals of small magnitude, the developments described being taken from works published on the subject.

LOS ANGELES SECTION

The Los Angeles Section held a meeting on October 15th in the Elite Cafe, Los Angeles. Mr. Thomas McDonough, Vice-Chairman of the Section, presided.

B. F. McNamee read a paper "The Vacuum Tube As Applied to Radio Receiving Apparatus."

L. B. Park delivered a paper on "Telephoto and Transatlantic Telephony."

Forty-eight members of the Section attended the meeting.

NEW YORK MEETING

The New York meeting of the Institute for November was held on the 7th of the month in the Engineering Societies Building, 33 West 39th Street, New York City. Alfred N. Goldsmith, President of the Institute, presided.

Austin Bailey, of the American Telephone and Telegraph Company, presented a paper by Messrs. Bailey, Dean and Wintringham on "The Receiving System for Long-Wave Transatlantic Radio Telephony." The paper is printed elsewhere in this issue of the PROCEEDINGS.

In the discussion which followed the presentation of the paper Messrs. Van Dyke, Pratt, Bailey, and Wintringham participated.

PITTSBURGH SECTION

The Pittsburgh Section held a meeting on September 18th in the Assembly Room of the Ft. Pitt Hotel, Pittsburgh. W. K. Thomas, Chairman of the Section, presided.

J. C. McKinley delivered a paper on "Elimination of Interference from Radio Receivers." The paper described the various methods which are used for the elimination of interference from radio receivers and included various sources of radio interference, which were placed in six general classes. These are static, heterodyning of stations and station noise, sparking applications, defective insulation, industrial applications, and radio receivers. The use of direction antenna in the elimination of interference was described. It was brought out that the underground antenna is selective and seems to be more sensitive to a definite frequency but the general results obtained showed no gain through its use.

Messrs. R. S. Johnson, L. A. Terven, Wolfe, Thomas, and Froelich participated in the discussion. Twenty members of the Section attended this meeting.

On October 9th a meeting of the Pittsburgh Section was held in the Norse Room of the Fort Pitt Hotel. L. A. Terven presided.

Austin Bailey, of the American Telephone and Telegraph Company, presented a paper on "The Receiving System for Long-Wave Transatlantic Radio Telephony." The paper is printed elsewhere in this issue of the PROCEEDINGS.

Messrs. Terven, Wolfe, Horne, McKinley, and Beers participated in the discussion which following the presentation of the paper.

Twenty-eight members of the Section attended the meeting.

SAN FRANCISCO SECTION

The San Francisco Section held its October meeting on the 24th of the month at the Bellevue Hotel, San Francisco.

Ralph M. Heintz, of Heintz and Kaufman, delivered an address on "Short-Wave Transmitting and Receiving Apparatus Designed Especially for Aircraft Service." Replicas of the radio equipment used on the Wilkins North Pole Expedition, the Byrd South Pole Expedition, and the aeroplane *Southern Cross*, which recently flew from San Francisco to Australia, were shown to the twenty-three members and seventeen guests who attended the meeting.

SEATTLE SECTION

On October 26th a meeting of the Seattle Section was held in the Club Room of the Telephone Building. Walter A. Kleist, Chairman of the Section, presided.

A paper on "Dynamic Exponential Loud Speakers" was delivered by Abner R. Willson, Walter A. Kleist, and J. R. Tolmie.

The paper included a series of brief notes on papers previously published by Hanna and others, followed by demonstrations by Messrs. Kleist and Tolmie.

Equations on design of the early horn type speakers followed by the balanced armature and cone types were set up and detailed design data on the plunger type diaphragm receiver unit working into an exponential horn was presented. Both the Hanna and the Wentz and Thuras drive units were discussed. The demonstration included the operation of an ingenious switching system, developed by Mr. Kleist, by means of which the output of a new turn table and amplifier could be put through any one of six loudspeakers with equal power input. The early types of magnetic unit, the later improved types of magnetic unit, and the latest dynamic type of unit were all fitted with six foot exponential horns. The demonstration readily brought out the

increase in volume and quality as the output of the amplifier was advanced from the older to the newer loudspeaker units.

Messrs. Libby, Deardorff, and Hackett participated in the discussion which followed.

Sixty-six members and guests attended the meeting.

The next meeting of the Seattle Section will be held on November 30th in the Club Room of the Telephone Building at Seattle. Professor Austin V. Eastman, of Washington University, will deliver an address on "The Four-Electrode Vacuum Tube."

WASHINGTON SECTION

On October 11th a meeting of the Washington Section was held in the Continental Hotel, 1 Capitol Street, Washington, D. C. F. P. Guthrie, Chairman of the Section, presided.

Austin Bailey, of the American Telephone and Telegraph Company, presented a paper on "The Receiving System for Long-Wave Transatlantic Radio Telephony." The paper is published elsewhere in this issue.

A. Hoyt Taylor, August Hund, H. G. Dorsey, G. D. Robinson, D. G. Howard, F. P. Guthrie, and E. B. Dallin participated in the discussion of the paper.

Forty-nine members of the Section attended the informal dinner preceding the meeting. Seventy-two members and guests attended the meeting.

Committee Work

COMMITTEE ON STANDARDIZATION

The meeting of the Committee on Standardization was held at the office of the Institute on October 16th. The following persons were present: L. E. Whittemore, Chairman; E. T. Dickey, E. N. Dingley, Jr., (representing Lieut. Com. W. J. Ruble), Dr. C. B. Jolliffe, Capt. Edwin R. Petzing (representing Maj. William R. Blair), E. L. Nelson, V. D. Landon (representing M. C. Batsel), Irving Wolff, (representing Subcommittee on Electro-Acoustic Devices), H. M. Turner, L. G. Bostwick (representing H. A. Frederick, of Subcommittee on Electro-Acoustic Devices), and E. W. Bemis, (representing Mr. H. S. Osborne).

The Committee continued its discussion of the reports of the various Subcommittees. The Committee will continue to meet at intervals of approximately two weeks until the final report has been completed for submission to the Board of Direction for formal adoption.

The final report of the Committee on Standardization, it is anticipated, will be published in the 1929 Year Book which will be mailed as a supplement to one of the issues of the PROCEEDINGS.

COMMITTEE ON ADMISSIONS

A meeting of the Committee on Admissions was held in the office of the Institute at 9:30 A.M. on November 7th. The following Committee members were present: R. A. Heising, Chairman; H. F. Dart, and E. R. Shute. The Committee considered twelve applications for transfer or election to the higher grades of membership in the Institute.

COMMITTEE ON MEMBERSHIP

A meeting of the Committee on Membership was held at dinner at the Fraternities Club Grill on November 7th. H. F. Dart, Chairman; H. B. Coxhead, and F. R. Brick were present.

The Committee considered a number of questions relating to means for increasing the membership of the Institute. It was announced that the net increase in members during the past year was over 600.

OBITUARY

With deep regret the Institute announces the death of

Charles Allen Wright

Mr. Wright was born in Vicksburg, Mississippi, in 1884. He graduated from Tulane University and received the M.E.E. degree from Harvard University in 1910. For five years he served as Professor of Electrical Engineering at Iowa State College, Carnegie Institute of Technology, and Ohio State University. In 1926 he was called to take charge of the Radio Division of the National Carbon Company Research Laboratories at Cleveland, a position he held up to the time of his death. He made numerous contributions to the technical literature and took active part in the meetings, discussions and Committee work of the various technical societies of which he was a member, among them this Institute, American Institute of Electrical Engineers, and Society for the Promotion of Engineering Education. At the time of his death he was a reserve officer in the Signal Corps of the U. S. Army with the rank of Captain.

His death will be mourned by a host of friends, associates, and former students.

NOTE ON THE EFFECT OF REFLECTION BY THE
MICROPHONE IN SOUND MEASUREMENTS*

BY

STUART BALLANTINE

(Radio Frequency Laboratories, Inc., Boonton, N. J.)

Summary—The reflection of sound by the diaphragm of the microphone ordinarily used in the measurement of the instantaneous pressure in sound waves causes the indicated pressure to vary from equality with the actual pressure in the undisturbed wave at low frequencies, to twice this pressure at high frequencies. Due to the mathematically irregular shape of the conventional microphone and its mounting the effect cannot be calculated although it can be experimentally determined by comparison with the Rayleigh disk. It is proposed to evaluate the correction for reflection by employing a standard spherical mounting of which the diaphragm occupies a small area about the pole; the increase in pressure for this mounting can be calculated theoretically, and the correction for other mountings can then be obtained by experimental comparison.

The ratio of pressure in the pole of the spherical mounting to that in the undisturbed wave, for a plane wave of the type $Exp i\omega(t-x/V)$ is expressed in terms of Hankel's $H_{n+1/2}^2$ functions, for which tables exist up to the highest orders required for the computations in practical cases. Numerical computations are carried out in full, giving the vector pressure ratio at the pole facing the source for spheres of various diameters and at various frequencies throughout the acoustic range.

IN measuring or recording instantaneous sound-pressure variations with a calibrated condenser microphone it is often assumed that the pressure at the surface of the diaphragm is the same as that which would exist in the undisturbed sound wave; also some investigators have assumed that the pressure is doubled by reflection, therefore that the apparent values are to be divided by a factor of 2. If the diaphragm were of infinite extent, or part of an infinite wall, the pressure would clearly be doubled at all frequencies since the reflection coefficient at the air-membrane interface is very closely equal to unity due to the stiffness of the tightly stretched membrane. If, on the other hand, the dimensions of the microphone were small in comparison with the wavelength of sound, we should then have an ordinary problem of the Laplacian flow of air past an irregular obstacle and the pressure at the diaphragm would approach that in the undisturbed sound field. The effect of diffraction around the microphone then is to cause the apparent pressure (the pressure acting

* Original Manuscript Received by the Institute, September 21, 1928.

upon the diaphragm) to vary from the true pressure in the undisturbed wave, to twice this pressure as the frequency is raised from a low to a high value.

An obvious method of evaluating this effect and rendering useful the ordinary calibrations of the microphone derived from the application to the diaphragm of known alternating pressures produced by the thermophone, piston-phone or by electrostatic means, would consist in the direct comparison with the Rayleigh disk. The sound field at the point to be occupied by the microphone is first measured by means of the Rayleigh disk, the microphone is then substituted, and the overall calibration directly obtained in this way will include the effect of reflection. In the previous comparisons between the thermophone calibration of a condenser microphone and the Rayleigh disk calibration certain discrepancies have been noticed which are probably largely due to diffraction around the microphone.

In a paper to be published elsewhere¹ I have considered the mathematical theory of the effect and suggested a method for evaluating the appropriate corrections by means of a spherical mounting which can be calculated. In view of the increasing interest of radio engineers in acoustic matters I have ventured in the present note to summarize briefly the practical results of computations from this theory.

1. Standard Spherical Mounting. The geometrical volume occupied by the condenser transmitter, and single stage amplifier which is usually mounted with it for the purpose of avoiding long high capacity leads, is of a mathematically irregular shape and not amenable to calculation. To facilitate mathematical investigation we may mount the transmitter and amplifier in a rigid spherical shell with the diaphragm as nearly in the surface as possible. (Fig. 1). The diffraction of sound by a spherical obstacle is a classical problem,² and tables now exist which greatly facilitate the actual numerical computations.

When the relation between the pressure-ratio (actual pressure ÷ pressure in the wave in the absence of the obstacle) and frequency has been calculated for the standard spherical mounting, the effect of reflection with the more usual mountings may be readily evaluated by experimental comparison.

¹ *Phys. Rev.*, Dec., 1928.

² Rayleigh: "Theory of Sound," 2, 218 et seq., (London, 1878): Papers, No. 287, V, p. 112, 1903; No. 292, V, 149, 1904.

Lamb: "Hydrodynamics," 5th Ed., p. 496, (Cambridge, 1924).

2. **Diffraction of a Plane Sound Wave by a Rigid Sphere.** Let the incident plane wave of sound be of the form $Exp i\omega(t - x/V)$, where V is the velocity of sound in air. The effect of diffraction may be represented by the ratio of the pressure (instantaneous) at the pole of the sphere facing the source to the pressure which would exist at the same point of space if the sphere were absent. Computation shows that the pressure at the pole is not substantially different from the average pressure over a small area about the pole so that in the practical case of a finite diaphragm

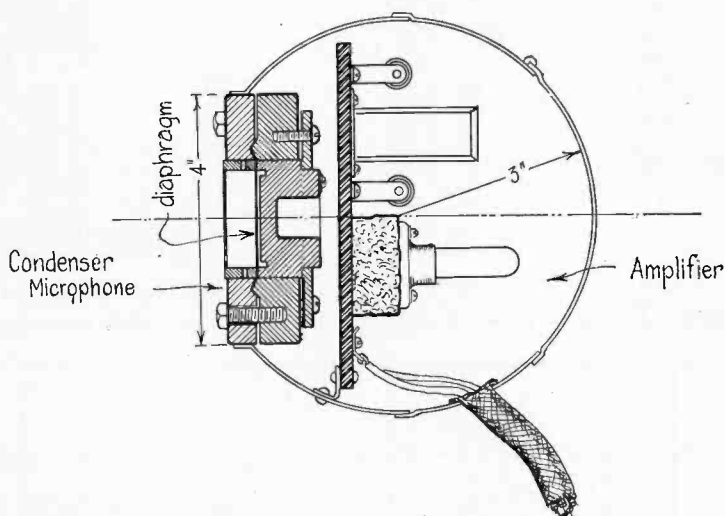

Fig. 1—Standard Spherical Mounting for Condenser Microphone.

area a negligible error is committed by using the polar pressure. The result of the theoretical calculation of the pressure ratio may be expressed as follows:

$$\frac{P}{P_0} = e^{-ika} \sqrt{\frac{2}{\pi ka}} \sum_{n=0}^{\infty} \frac{-(2n+1)i^n}{(-)^n (nJ_{-n-1/2} + kaJ_{-n-3/2}) - i(nJ_{n+1/2} - kaJ_{n+3/2})} \quad (1)$$

(Argument of Bessel functions = ka)

The details of the derivation of this formula may be found in the more extensive paper.

3. **Computations and Curves.** The pressure ratio is a function only of the ratio of the size of the sphere to the wavelength of the

sound. For computations from (1) tables are available³ of $J_{n+1/2}$ for n up to 18, and of $J_{-n-1/2}$ for n up to 6; additional values of $J_{-n-1/2}$ for larger n may be computed from the tables of the related C_n functions given in the *British Association Reports* for 1914 and 1916.⁴ Computations made with the aid of these modern tables are given in the annexed table:

TABLE I

Values of the vector ratio ($|p/p_0| e^{j\psi}$) of pressure at pole of rigid sphere to pressure in incident plane wave at same point for various values of $ka = 2\pi \times \text{frequency} \times \text{radius of sphere} \div \text{velocity of sound in air}$.

ka	Equation (1)	$\frac{p}{p_0}$	Angle ψ (radians)
0.1		1.0005	
0.2		1.0027	
0.3	$0.909 + 0.458i$	1.019	0.168
0.5	$1.043 + 0.299i$	*1.089	0.279
0.7	$0.597 + 1.040i$	1.198	0.345
0.85	$0.468 + 0.374i$	1.325	0.359
1.0	$0.310 + 1.370i$	1.406	0.340
2.0	$1.593 + 0.468i$	*1.660	0.286
3.0	$-1.762 - 0.165i$	1.772	0.235
4.0	$-0.910 - 1.595i$	1.835	0.194
6.0	$1.895 - 0.292i$	1.913	0.128
10.0	$1.540 + 1.207i$	*1.958	0.665 (?)

The angle ψ of the vector ratio is given as well as the absolute value. This is of interest in estimating the dispersion correction

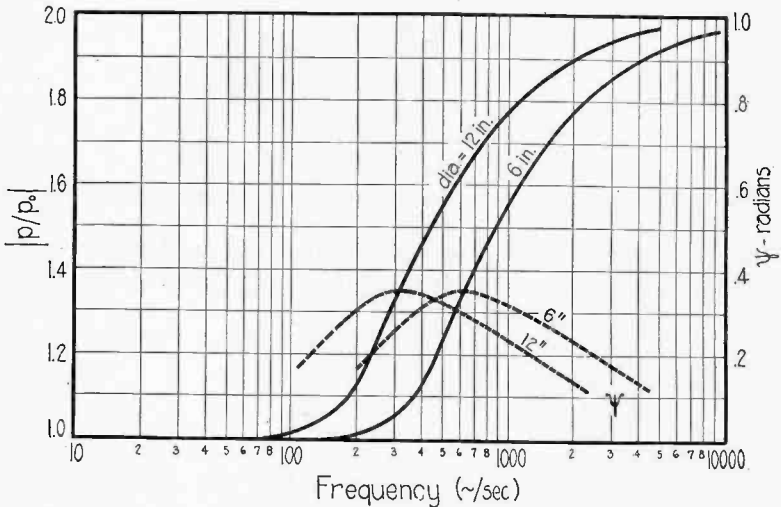

Fig. 2—Increase of Pressure by Reflection from Spherical Mounting. Absolute Value and Angle of Ratio of Pressure at Pole of Sphere to Pressure in Undisturbed Sound Wave.

³ G. N. Watson: "Bessel Functions," pp. 740-743 (Cambridge 1922).

⁴ *British Association Reports*: p. 88-102, 1914; p. 97-107, 1916.

which must be made by means of phase equalizers in the electric circuits when an exact recording of the wave forms of the sound is desired. For many purposes, however, the absolute value of the ratio alone will be sufficient.

Fig. 2 contains a set of curves based upon these computations, which gives the diffraction correction for spherical mountings of various sizes over the audio range of frequencies. The form of the correction curves for other practical mountings may now be obtained experimentally by comparison with the standard mounting. This experimental program is under way and will be reported in a subsequent paper. It is necessary to investigate the functional relation for a single size of each shape; the position of the curve for any other size may be determined by the principle of similitude.

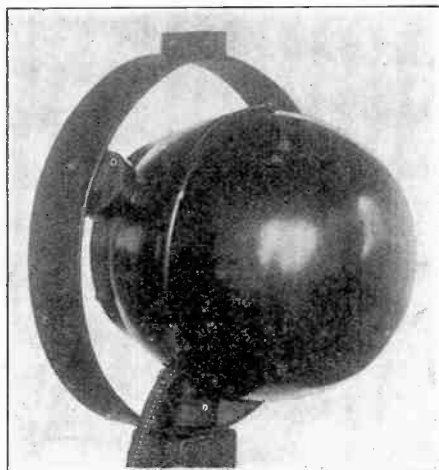

Fig. 3—Photographic View of Experimental Spherical Mounting.

A photographic view of the experimental spherical mounting is shown in Fig. 3. In the case where the condenser transmitter is mounted integrally with the apparatus comprising the first amplifier stage and occupies a volume of reasonable (say cubical) shape, it is often sufficient to estimate an "equivalent sphere" on the basis of equal volume to represent the irregular actual volume. The accuracy of this seemingly crude assumption is somewhat surprising.

Although the condenser microphone has been mentioned

particularly in this discussion, it is obvious that it applies equally well to other pick-up instruments of the exposed diaphragm type, such as for example, the double carbon button microphone used extensively in radio broadcasting and public address systems. When the microphone is used for technical purposes and sound-wave recording it is convenient to compensate the diffraction effect either in the design of the microphone (which is feasible with air-damped types) or by equalization in the electrical circuits.

In conclusion it may be noted that by the reciprocity theorem equation (1) is equally appropriate for the representation of the pressure at a large distance in the sound radiated by a small piston located in the surface of a sphere. This throws some light on the action of baffles for loudspeakers.

THE RECEIVING SYSTEM FOR LONG-WAVE TRANS-ATLANTIC RADIO TELEPHONY*

By

AUSTIN BAILEY, S. W. DEAN, AND W. T. WINTRINGHAM

(Department of Development and Research, American Telephone and Telegraph Co.,
New York City)

Summary—Transmission considerations and practical limitations indicate that in the lower frequency range, frequencies near 60 kc are best suited for transatlantic radio-telephone transmission. A radio receiving location in Maine gives a signal-to-noise ratio improvement over a New York location equivalent to increasing the power of the British transmitter about 50 times.

Various types of receiving antennas are briefly discussed. The wave-antenna is selected as being most suitable for long-wave radio telephony. The various factors affecting wave-antenna performance and methods for measuring the physical constants of wave-antennas are discussed in detail. High-frequency ground conductivities determined from wave-antenna measurements are given. Combination of several antennas to form arrays is found to be a desirable means of decreasing interference. The use of a wave-antenna array in Maine decreases the received noise power by an additional 400 times. If the receiving were to be accomplished near New York using a loop antenna, we would have to increase the power of the British transmitting station 20,000 times to obtain the same signal-to-noise ratio. Comparisons of calculated and observed directional diagrams of wave-antennas and wave-antenna arrays are presented and discussed.

The transmission considerations governing the design of a radio receiver for commercial telephone reception are outlined.

Mathematical discussions of the wave-antenna, antenna arrays, quasi-tilt angle, and probability of simultaneous occurrence of telegraph interference are given in the appendices.

EARLY in October, 1915, engineers of the Bell System stationed in Paris heard the words "good-night Shreeve" which had been transmitted from Arlington. That date then marks the inception of transatlantic radio-telephone receiving. The progress which has been made in the radio-telephone receiving art since these first experiments is demonstrated by contrasting the homodyne receiver and the non-directional antenna then used with the present commercial receiving system employing double-demodulation of single side-band signals and an extensive array of wave-antennas forming a highly directional

* Original Manuscript Received by the Institute, September 13, 1928. Presented before meetings of the following Institute Sections: Pittsburgh, October 9, 1928; Philadelphia, October 10, 1928; Washington, October 11, 1928; and at a New York meeting of the Institute, November 7, 1928.

system. In the pages which follow we shall endeavor to give some of the engineering considerations upon which the design of the present receiving system was based.

CHOICE OF FREQUENCY

In the early development of long-distance radio telegraphy, the strength of the received signal was the principal factor upon which the selection of the operating frequency was based. After the development of the vacuum-tube amplifier, however, the following considerations each became important, especially so for a telephone circuit:

1. The signal-to-noise ratio at the receiving location; which in turn is dependent upon four factors:
 - (a) The efficiency of the transmitting set
 - (b) The efficiency of the transmitting antenna
 - (c) Attenuation in the radio path
 - (d) Variation of radio noise with frequency
2. Band width of the transmitting antenna
3. Receiving antenna efficiency
4. Available space in the frequency spectrum.

1. *Signal-to-Noise Ratio at the Receiving Location.* At the time that the transatlantic radio-telephone development was undertaken engineers of the Western Electric Company Engineering Department (now Bell Telephone Laboratories) had developed a form of water-cooled vacuum tube capable of generating efficiently large amounts of power at any frequency up to perhaps several hundred kilocycles.¹ Therefore transmitter efficiency, although a major problem in itself, imposed no restriction on the frequency for the telephone circuit.

For transmission over a given path, utilizing a particular transmitting antenna with constant power supplied to it, there will be, in general, a frequency at which the greatest signal-to-noise ratio is obtained. To illustrate this point, we have chosen the problem of transmission from an antenna of the type used at the Rocky Point station of the Radio Corporation of America in U. S. A. to a receiving station in England, a distance of approximately 5,000 kilometers. The approximate variation with frequency of loss resistance, radiation resistance, and efficiency of this antenna is shown in Fig. 1. The loss resistance at 60 kilo-

¹ W. Wilson, "A New Type of High Power Vacuum Tube," *Bell System Tech. Jour.*, 1, 4; July, 1922. *Elec. Comm.* 1, 15; August, 1922.

cycles was determined by engineers of Bell Telephone Laboratories, while the data in the lower frequency range were published by Alexanderson, Reoch, and Taylor.² The radiation resistance was calculated from the measured effective height of the antenna. It is seen in Fig. 1 that the antenna efficiency increases with frequency throughout the range we are considering, first rapidly and then more slowly.

For a constant power radiated, radio attenuation tends to cause a decrease in the average received signal strength as the frequency is increased. This effect is in the opposite direction to the effect of antenna efficiency, so that for a given power supplied to the antenna the field strength at a given distance will be a maximum at a certain frequency. In Fig. 2 we have shown the

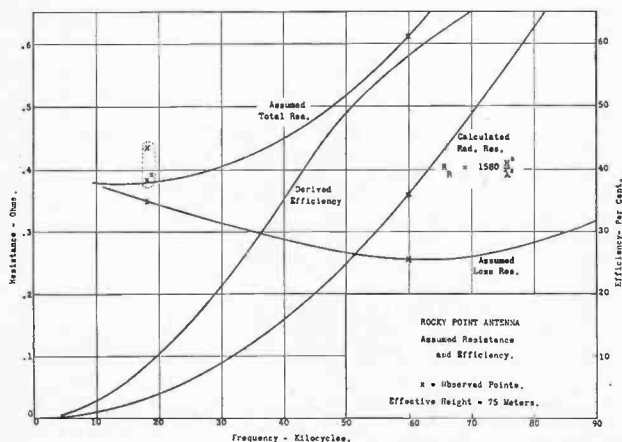

Fig. 1.

calculated field strength at 5000 kilometers for a power of 85.9 kilowatts supplied to the Rocky Point antenna, using efficiency data of Fig. 1 and the radio transmission formula given by Espenschied, Anderson, and Bailey.³ Since this curve reaches a maximum near 18.5 kilocycles, the reason for the operation of early transatlantic radio-telegraph circuits in the range 10 to 30 kilocycles becomes apparent in light of the limitation then placed on the receiving systems.

² E. F. W. Alexanderson, A. E. Reoch, and C. H. Taylor, "The Electrical Plant of Transocean Radio Telegraphy," *Trans. A.I.E.E.*, 42, 707; July, 1923.

³ Lloyd Espenschied, C. N. Anderson, and Austin Bailey, "Transatlantic Radio Telephone Transmission," *Bell System Tech. Jour.*, 4, 459; July, 1925. *Proc. I. R. E.*, 14, 7; Feb., 1926.

Systematic measurements of radio noise by the warbler method,⁴ begun early in 1923, have yielded important information on the variation of noise with frequency.³ From measurements begun by engineers of Bell Telephone Laboratories and continued by engineers of the International Western Electric Company at New Southgate, England, during 1923 and 1924, the average daylight noise curve, in Fig. 2, was obtained. It is seen that the noise decreases with increasing frequency, at first rapidly and then more slowly, being almost constant after passing the frequency of 40 kilocycles.

From the values of signal and noise so obtained, the signal-to-noise ratio has been computed, and is also plotted in Fig. 2. The curve of signal-to-noise ratio reaches a maximum near 44 kilocycles, which would seem to be the optimum frequency for

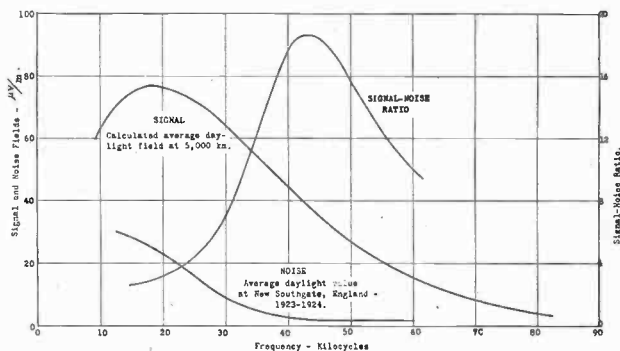

Fig. 2—Variation of Signal, Noise, and Signal-Noise Ratio with Frequency. Transmission from U. S. A. to England. 85.9 kw Supplied to Antenna of Rocky Point Characteristics.

daylight transmission from the Rocky Point station to England. This is not strictly the case, however, since there is some evidence that a phenomenon exists which makes frequencies in the vicinity of 40 kilocycles particularly poor for the transatlantic path. Data published by Anderson⁵ tend to show that the field strength is distinctly subnormal in the vicinity of 44 kilocycles and remains approximately constant from that frequency up to about 60 kilocycles, where the observed values agree fairly well with the calculations. (See later in this paper.)

⁴ Ralph Bown, C. R. Englund, and H. T. Friis, "Radio Transmission Measurements," *Proc. I. R. E.*, 11, 115; April, 1923.

⁵ C. N. Anderson, "Correlation of Long Wave Transatlantic Radio Transmission with Other Factors Affected by Solar Activity," *Proc. I. R. E.*, 16, 297; March, 1928. In connection with reference above see Fig. 19, p. 315.

2. *Band-Width of the Transmitting Antenna.* Since the output of the transmitting set is at a high power level, the circuits coupling it to the antenna must be of the simplest type to reduce the loss to a minimum. In view of this requirement, the antenna constants largely determine the band width of the antenna system. At frequencies much lower than 60 kilocycles it was not possible to secure a sufficient width of band even for commercial telephony from the Rocky Point antenna, but at this frequency reasonably satisfactory results are obtained.

3. *Receiving Antenna Efficiency.* The use of directional receiving antennas is essential to satisfactory and economic results over such distances as the transatlantic radio path (see later in this paper). The directivity of an antenna system of a given kind, size, and cost in general increases with frequency, since the directivity is a direct function of the ratio of the dimensions of the antenna system to the wavelength employed.

4. *Available Space in the Frequency Spectrum.* Each of the above factors operates to make the frequency of 60 kilocycles about the best which could be used in the present state of the art for this transmission path. Fortunately this frequency was so located in the radio spectrum that a band of the desired width free from interference could be obtained.

It has been noted that the radio noise as shown in Fig. 2 varies very little with frequency above 40 kilocycles. There is some doubt as to whether or not this accurately represents the actual state of affairs, since the measurement sets used for measuring the noise would not satisfactorily measure much below one microvolt per meter on account of tube noise. At frequencies of 40 kilocycles and above, especially in the winter, there are many days during which the radio noise is practically absent. On these days the measurements tended to approach the minimum determined by the set noise. The fact that many such readings were incorporated in the average probably tends to mask the true variations of radio noise with frequency in this range. On the other hand, however, they indicate a very real limitation which tends to operate against the use of frequencies higher than about 60 kilocycles unless fields were increased by increase in transmitting power. This would be particularly true during the sunset and sunrise dips and during periods of abnormally poor transmission when the fields fall much below the average. If the set noise limitation could be removed it is quite possible

that frequencies above 60 kilocycles would become more useful. Higher frequencies for radio-telephone use would be particularly advantageous because of the greater band width which could be obtained from the transmitting antenna and because of the greater directivity which could be obtained in the receiving system at the same cost.

SELECTION OF A SATISFACTORY RECEIVING LOCATION

The selection of a suitable receiving location is based upon three major considerations; namely, maximum received signal-to-noise ratio, reasonably suitable terrain for receiving antenna construction, and adequate wire connection facilities between the the location and the more densely populated areas.

Since about 10 per cent of the populations of the United States and the British Isles are located within a radius of 40 miles of New York and London, respectively,⁶ it was natural to decide upon making those cities the terminal points. It would hence be desirable to locate the receiving stations near and with good wire circuits to those cities.

Very early in the history of radio communication⁷ it was, however, realized that in the United States a decrease of radio noise was obtained by a northerly location of the receiving station and, for receiving from European stations, the northern location is further advantageous, since higher field strengths result from the reduced transmission distance. The Radio Corporation of America had already taken advantage of this improvement by locating a receiving station at Belfast, Maine.

To obtain quantitative information on this matter the American Telephone and Telegraph Company made comparative measurements of noise as received on loop antennas at Riverhead, New York; Green Harbor, Massachusetts; and Belfast, Maine, the loops being so oriented as to give maximum receptivity in the direction of England. Although these tests were only continued for a few months at each location, they left no doubt that the absolute level of the noise was less at the northerly locations.

In Fig. 3, there is shown the diurnal variation of improvement in noise conditions (in TU) for average days of each month

⁶ "New York's New 10,000,000 Zone," *Literary Digest*, 95, No. 12, p. 14; Dec. 17, 1927.

⁷ G. W. Pickard, "Static Elimination by Directional Reception," *Proc. I. R. E.*, 8, 358; October, 1920.

at Belfast over Riverhead. The average hourly improvement was determined by averaging the ratios of practically simultaneous observations of noise at the two locations for each hour during any one month and taking a three-hour moving average of the result to reduce the effect of purely local phenomena at either of the two stations. The data for the two half years were taken on slightly different frequencies as is indicated on the figure. Unfortunately, during the month of July only two weeks data were taken on each of the frequencies, namely, 52 and 65 kilocycles, and these data were taken a year apart, namely in 1924 and in 1925. In order to give some idea of the location noise improvement for the month of July we have averaged in the same way the four weeks data thus obtained, and plotted

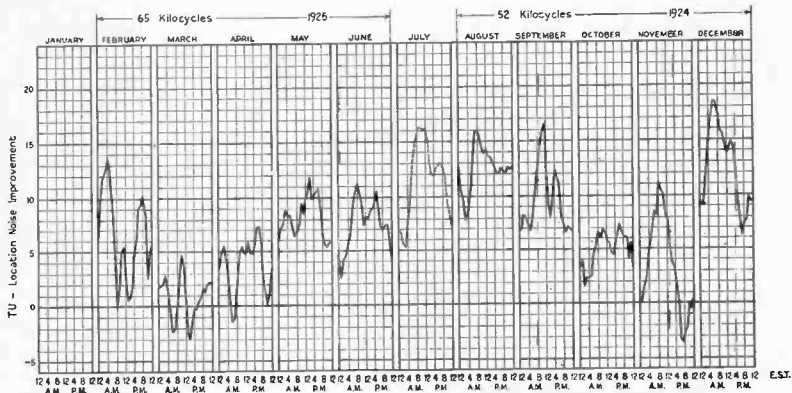

Fig. 3—Transatlantic Radio Noise Measurements. Diurnal Variations of Location Noise Improvement (in Transmission Units) of Belfast, Maine over Riverhead, New York. Three-Hour Moving Averages of Simultaneous Observations.

the result as a broken line. Fortunately, the improvement of the more northerly location is, in general, large during the overlapping business day of England and the United States.

It is apparent that the improvement is a maximum in the middle of the summer when the noise is high, and in the middle of the winter when the field strengths are usually abnormally low. This is important, since the greatest improvement is needed at each of these times.

The monthly averages of variations of noise and of signal have previously been published^{3,5,8}, and the generalizations given above can be confirmed by reference to these articles.

⁸ Ralph Bown, "Some Recent Measurements on Transatlantic Radio Transmission," *Proc. Natl. Acad. of Sci.*, 9, 221; July, 1923.

For calculating daylight radio transmission, several formulas have been proposed.^{9,10,11} In Fig. 4 the heavy curve was calculated from the empirical formula given by Espenschied, Anderson and Bailey,³ and assumes a radiated power of 50 kilowatts. The great circle distance from the transmitting stations used in the transatlantic radio-telephone circuit to various receiving stations is indicated by the name of the receiving station. The average of daily averages of hourly measurements of the field strength made at Houlton and Wroughton during the time that the transatlantic path was entirely in daylight during 1927 is indicated by points

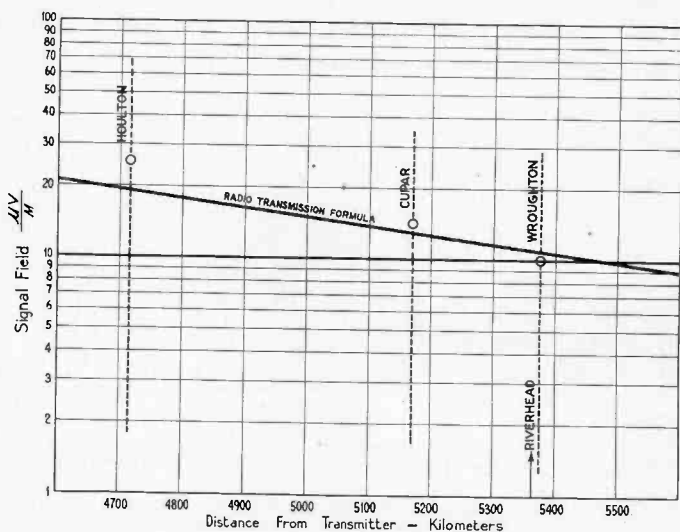

Fig. 4—Transatlantic Radio Daylight Field Strength. Average of Hourly Observations during 1927. Corrected to 50 kw Radiated Power—Frequency 60 kilocycles.

on this figure. The data for Cupar are less complete since this station was not in regular daily operation until May, 1927. The range of variation between the maximum daily average and the minimum daily average for each receiving location is given by the limits of the dotted vertical line. (It is interesting to note that at a frequency of 60 kilocycles and for distances in the

⁹ A. Sommerfeld, "Ueber die Ausbreitung der Wellen in der drahtlosen Telegraphie," *Ann. d. Phys.* 28, 665; 1909.

¹⁰ L. F. Fuller, "Continuous Waves in Long-Distance Radio Telegraphy," *Trans. A.I.E.E.*, 34, pt. 1, 809; 1915.

¹¹ L. W. Austin, "Quantitative Experiments in Radiotelegraphic Transmission," *Bull. Bureau of Std.*, 11, 69; Nov. 15, 1914.

order of 5000 kilometers any of the radio-transmission formulas referred to above will give a computed value lying within the range of variation of average daylight readings.)

The improvement in signal-to-noise ratio obtained by locating the receiving station in Maine instead of in New York is easily seen by reference to Figs. 3 and 4. The improvement due to decrease of noise, during that time of year when improvements are most needed on account of high noise values, is about 10 TU. The improvement due to increase of the average received daylight signal by decrease of the distance is calculated to be 5 TU. During 1927, this improvement was actually observed to be 8 TU. We may, therefore, state in round numbers that the total improvement realized by locating the receiving station in Maine instead of New York was equivalent to a fifty-fold increase of the power radiated by the British transmitting station.

The British General Post Office, during 1926, carried out a set of measurements of field and noise at various locations in the United Kingdom. Those tests led them to the same conclusions as regards the advantage to be obtained by locating their receiving station at some more northerly point.¹² They decided upon a location near Cupar, Scotland, and comparisons made daily from 1230 to 2300 GMT indicate that this location is better for receiving than Wroughton, England. The geometric mean of the improvement in signal-to-noise ratio for the more northerly location during the months May to September, 1927, inclusive, and for the daily period given above is 6.4 TU. This is equivalent to an increase of between four and five times in power from the American transmitting station.

Since such relatively large improvements were to be obtained by northerly locations of the receiving station it seemed best to take advantage of this fact and locate the receiving station in America at some place in the state of Maine. This decision led to further consideration of two factors mentioned above, namely, reliable wire connections to New York and a suitable terrain for antenna construction. The first of these factors required a location along one of the main telephone trunk routes in Maine and the second, since we had decided upon the use of a wave-antenna¹³ for reasons which will be given in the

¹² A. G. Lee, "Wireless Section: Chairman's Address, *Jour. I.E.E.* 66, 12; Dec., 1927.

¹³ H. H. Beverage, C. W. Rice and E. W. Kellog, "The Wave Antenna," *Trans. A.I.E.E.*, 42, 215; 1923.

following section, demanded a rather large and reasonably flat land area available for pole-line construction. A location, although not altogether ideal, was decided upon near Houlton, Maine, about six miles from the Canadian border.

CHOICE OF RECEIVING ANTENNA SYSTEMS

The number of fundamental types of receiving antennas that may be employed for long-wave reception is quite definitely limited. In fact all of the known practical receiving antennas may be considered as falling into one of three principal classes of structure; i.e., the vertical antenna, the loop or coil antenna, and the wave-antenna. The selection of the proper receiving antenna system quite evidently becomes a problem; first, of choosing the best type of antenna from one of these three classes and, second, of choosing a particular antenna structure in the class which is found to be best.

The factors governing the choice of a receiving antenna are as follows:

1. *Directional Discrimination Against Static.* Inasmuch as the signal to be received has a definite average value, the receiving system can only better the circuit in the amount that it improves the signal-to-noise ratio. A directional antenna system affords a means of reducing the received noise in relation to the desired signal.^{7,13} The directional characteristics of the principal antenna types are shown in Fig. 5.

A measure of the directional discrimination of the various antenna types is the Noise Reception Factor (abbreviated *NRF*) which is defined as the ratio of the total noise current received from the antenna in question to that received from a vertical antenna under the conditions of continuous, constant distribution of noise sources about the antenna and of equal output currents for signals from the direction of maximum receptivity. The back end *NRF* is the noise reception factor for the arc between 90 degrees and 270 degrees from the direction of maximum receptivity.

On this basis, the choice rests quite unmistakably with the wave-antenna.

2. *Transmission-Frequency Characteristic.* Since the receiving antenna is to be used on a system for communication by speech, necessitating the transmission of a relatively wide band of frequencies, it must pass such a band without undue discrimination

against any frequency contained therein. To utilize the vertical and the loop antennas efficiently, it is desirable that they be tuned, introducing the frequency discrimination of a tuned circuit. If these types of antennas be used it is necessary, therefore, that the resonance characteristic be studied and means provided to eliminate excessive frequency discrimination within

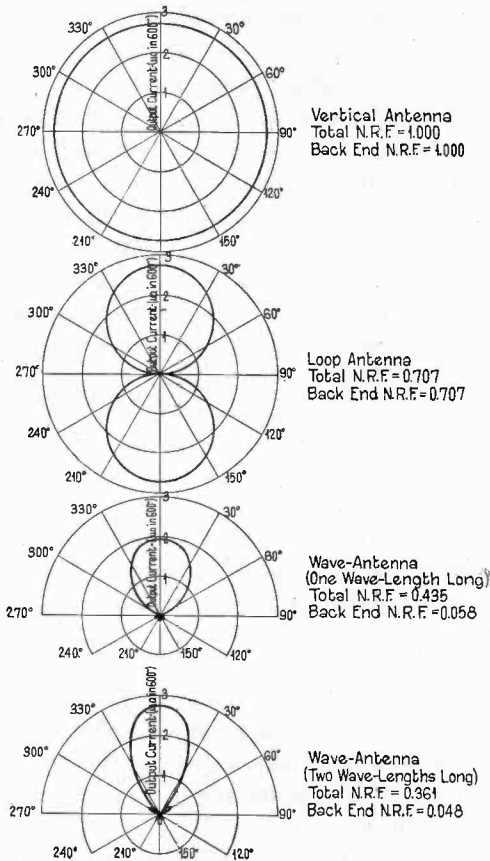

Fig. 5—Comparison of Simple Antennas.

the desired band. On the other hand, the wave-antenna is an aperiodic structure and, in consequence, its transmission-frequency characteristic is so flat that it need not be considered.

3. *Sensitivity.* There are two factors which require that the output from the receiving antenna for a given field strength be as large as possible. First, if the receiving station be located

at any position other than that at the terminal of the antenna, which is necessarily the case if more than one antenna be used in an array, the signal on the transmission line from the antenna to the station must be much greater than the noise currents induced into the transmission lines. If the antenna output be excessively small, it is impossible to balance the transmission lines so completely that this requirement is met. Second, the amount of gain that can possibly be used at the radio receiver is ultimately limited by the noise produced in an amplifier. (This is discussed more fully under "Power Output Required from the Radio Receiver" later in this paper.) To the first approximation, the sensitivity of each of the antenna classes under consideration is a direct function of its physical dimensions. There is, however, a limit to the sensitivity of each antenna class, for mechanical limits govern the maximum size of a vertical antenna, distributed capacity and mechanical considerations limit the loop, and in the wave-antenna a restriction occurs because of the peculiarity that the sensitivity reaches maximum values at definite lengths.

Since cost is likewise a factor governing the ultimate selection of an antenna system, the sensitivities may well be compared for antennas of equal cost. On this basis, a loop or a vertical antenna of effective height of fifty meters is directly comparable with a wave-antenna one wavelength long. By reference to Fig. 5, where the scale is the same for all the directional diagrams, it becomes evident that the sensitivities of all three classes of antennas are of the same order of magnitude, being slightly greater for the vertical antenna and the loop than for the one-wavelength wave-antenna.

4. *Stability.* The sensitivity and frequency-transmission characteristics of the antenna must be substantially constant during changes of weather and seasonal conditions. The antenna classes which require tuning are slightly poorer than the wave-antenna in this respect.

5. *Reproducibility.* Further improvement in directional discrimination against noise is obtained by using several similar antennas in an array. The loop and the vertical antennas probably are best for combining in arrays because several of either type of antenna can be made identical with one another. Wave-antennas combined in an array, however, give satisfactory results.

Although each of these factors governing the choice of the receiving antenna system is important, their relative impor-

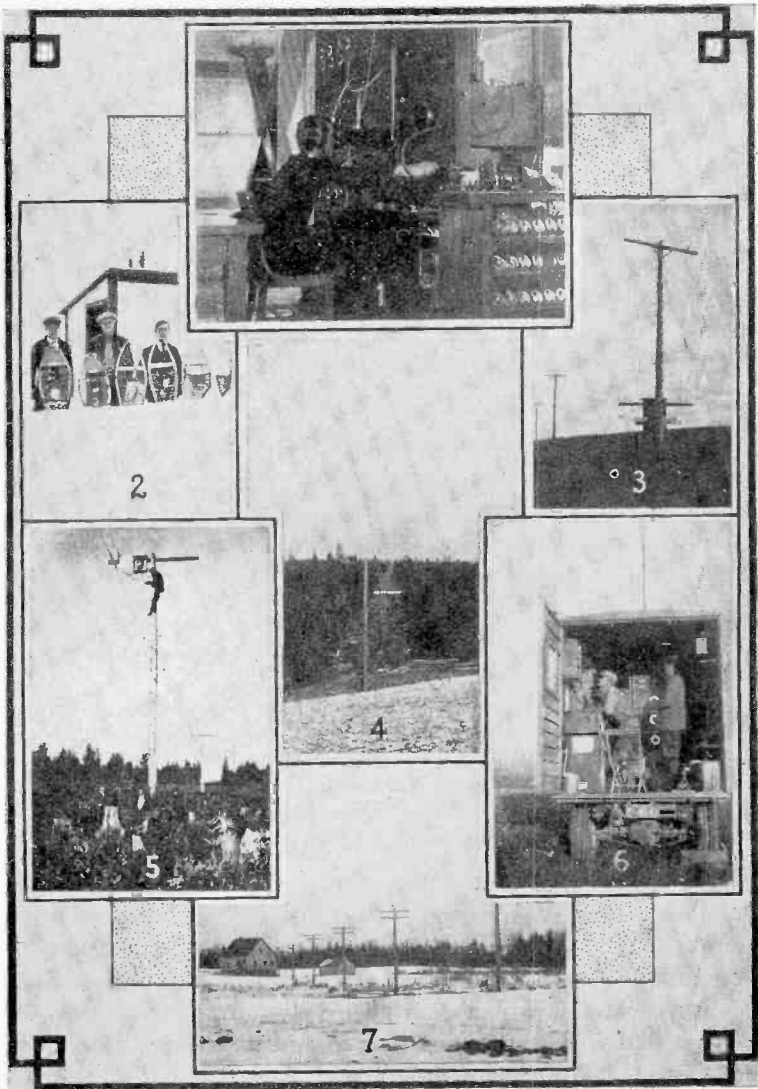

- 1—Measuring Field Strength. 2—Outside An Antenna Terminal Hut.
- 3—Pole Box for Reflection Transformer. 4—The Wave-Antenna A at Houlton
- 5—Measuring Ground Connection Impedance at a Temporary Location. 6—The Sixty-Kilocycle Portable Transmitting Station.
- 7—Transmission Line O-B with Receiving Station in Background.

tance is indicated by the order in which they have been presented. In view of the low noise-reception-factor of the wave-antenna, its lack of frequency discrimination, and its inherent stability, the wave-antenna was selected for the fundamental type of antenna to be used at the receiving station at Houlton.

THE WAVE-ANTENNA

Among the types of antennas which may be considered for use in long-wave radio communication, the wave-antenna¹³ possesses several characteristics which single it out as being unique. The most important of these are:

1. The length of a wave-antenna is directly comparable to and of the same order of magnitude as the wavelength of the signals for which it is designed.

2. Considering the straight horizontal wire comprising the wave-antenna as a grounded transmission line, a termination, equal to the characteristic impedance, is applied to each end of that line. The wave-antenna then becomes an essentially aperiodic antenna.

3. The major response of a properly designed wave-antenna is to the horizontal component of the impressed electric field. The propagated electric wave must therefore have an electric component parallel to the surface over which the wave-antenna is constructed.

4. On the basis of the preceding consideration, the design of a wave-antenna definitely excludes elevation of the antenna above ground to any extent greater (a) than is physically necessary to provide safe clearance and (b) than that height where the loss in the antenna considered as a transmission line reaches a nominal value. Practically, the wave-antenna is constructed as a high-grade telephone line, on 30-foot poles.

It is evident that the major electrical characteristics which distinguish the wave-antenna are intimately connected with the character of the surface over which the antenna is built, and with the details of construction of the wave-antenna. The performance of a wave-antenna at any specified location then can only be determined by constructing such an antenna and measuring its constants. The measurements made in determining the characteristics of any particular wave-antenna are outlined in the following paragraphs.

1. *Ground-Connection Impedance.* It is shown in Appendix 1 that the wave-antenna is considered to be a smooth line with uniformly distributed constants. This assumption is met to a sufficient degree in practice, but, unfortunately, it is impossible to connect to the four terminals of the practical line, since the connections to the ground side of the line must be made by bury-

ing wires in the earth rather than connecting to a discrete terminal which is the real ground. As is shown in Fig. 6a, the actual wave-antenna may still be considered as a smooth line, but between the terminals of the wave-antenna and the terminals that are available at the physical ends of the wave-antenna ground-connection impedances exist. To determine the constants of the wave-antenna, these impedances must be evaluated and taken into account as follows: In Fig. 6a, an impedance Z is applied to the available terminals of the wave-antenna 3-4 and the impedance S measured at the available terminals 1-2; under this condition, the actual terminal and input impedances of the wave-antenna are respectively:

$$Z' = Z + G_2 \tag{1}$$

$$S' = S - G_1 \tag{2}$$

where G_1 and G_2 are the ground-connection impedances at the two ends of the antenna.

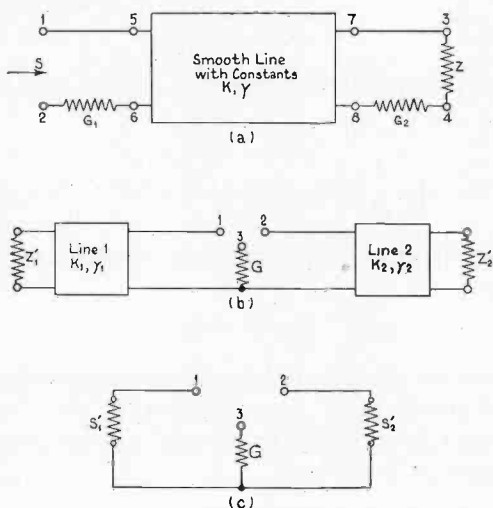

Fig. 6.

Figs. 6b and 6c illustrate the method that was used to determine the ground-connection impedance. In Fig. 6b, lines 1 and 2 represent two smooth ground-return transmission lines extending in opposite directions from the ground-connection for 1/2 kilometer or more, the lines being terminated at the distant end in impedances Z_1' and Z_2' , respectively. In practice one of these lines was the wave-antenna and the other a temporary line of insulated wire laid along the surface of the ground.

For the purpose of analysis, each of the lines may be replaced by its input impedance. This simplification is shown in Fig. 6c, where

$$S' = \frac{K \tanh \gamma s + Z'}{1 + \frac{Z'}{K} \tanh \gamma s} \quad (3)$$

The impedance between terminals 1 and 3 is:

$$S_1 = S_1' + G \quad (4)$$

The impedance between terminals 2 and 3 is:

$$S_2 = S_2' + G \quad (5)$$

The impedance measured between terminals 1 and 2 in parallel and terminal 3 is:

$$S_0 = G + \frac{S_1' S_2'}{S_1' + S_2'} \quad (6)$$

Eliminating S_1' and S_2' from equations (4), (5), and (6) and solving for G :

$$G = S_0 - \sqrt{\frac{1}{2} [(S_1 - S_0)^2 + (S_2 - S_0)^2 - (S_1 - S_2)^2]} \quad (7)$$

By building out either line 1 or line 2 with added series impedances until

$$S_1 = S_2 = S_{12} \quad (8)$$

the expression for the ground-connection impedance simplifies greatly, and incidentally the precision of the determination becomes greater because the number of measurements involved is less. Under this condition

$$G = 2S_0 - S_{12} \quad (9)$$

This latter case is the one that was actually used in measuring the ground impedances.

Since the distribution of ground currents about the buried ground may be different under each of the three conditions that are measured, there is undoubtedly some error in measuring the ground-connection impedance by this method. This error is a second-order effect, however, so that the values determined are reliable within the precision that the method allows, involving

as it does, differences between measurements of high-frequency impedance.

All of the impedance measurements were made using a high-frequency bridge designed and constructed by Mr. C. R. Englund of Bell Telephone Laboratories. This bridge is similar to that described by Shackelton¹⁴ except that the standards used consist of a calibrated condenser and a decade resistance. Impedances having capacitive reactance are measured by direct comparison with the standards, while impedances having inductive reactance are tuned with the standard condenser to parallel resonance and the resonant combination compared with the decade resistance. Impedances involving extremely small reactances, either positive or negative, are built out with a condenser in parallel to a value that may be measured conveniently.

2. *Characteristic Impedance and Propagation Constant.* Since the early days of transmission line study, the characteristic impedance and the propagation constant have been determined by two impedance measurements at the near end of the line with the far end of the line open- and short-circuited, respectively.¹⁵ For two reasons, this method has not been used in our determination of the fundamental antenna constants: first, it is impossible to apply a short to the real terminals of the wave-antenna due to the presence of the ground-connection impedance; and, second, with lines multiple quarter wavelengths long the input impedance, as a result of resonance in the line when it is open-circuited or grounded, attains either extremely large or extremely small values which could not be measured accurately with the available testing equipment.

To obviate these difficulties, Mr. C. R. Englund, of Bell Telephone Laboratories, developed a method of determining the characteristic impedance and the propagation constant of the wave-antenna by measuring the input impedance with two known finite terminations at the far end. Under this condition it may be shown that the characteristic impedance is given by the expression:

$$K = \sqrt{\frac{(S_1 - G_1)(S_2 - G_1)(Z_1 - Z_2) + (Z_1 + G_2)(Z_2 + G_2)(S_2 - S_1)}{(S_2 - S_1) + (Z_1 - Z_2)}} \quad (10)$$

¹⁴ W. J. Shackelton, "A Shielded Bridge for Inductive Impedance Measurements at Speech and Carrier Frequencies," *Bell System Tech. Jour.*, 6, 142; Jan., 1927.

¹⁵ Bela Gati, "On the Measurement of the Constants of Telephone Lines," *The Electrician*, 58, 81; Nov. 2, 1906.

and that the propagation constant is given by:

$$\gamma = \frac{1}{s} \tanh^{-1} \left[K \frac{(S_2 - S_1) + (Z_1 - Z_2)}{(Z_1 + G_2)(S_1 - G_1) - (Z_2 + G_2)(S_2 - G_1)} \right] \quad (11)$$

where the symbols in equations (10) and (11) have the following meanings:

Z_1 = the first termination applied to the available terminals at the far end of the line (ohms)

Z_2 = the second termination applied to the available terminals at the far end of the line (ohms)

S_1 = the impedance measured at the available near-end terminals corresponding to the termination Z_1 (ohms)

S_2 = the impedance measured at the available near-end terminals corresponding to the termination Z_2 (ohms)

G_1 = the ground-connection impedance at the near-end of the line (ohms)

G_2 = the ground-connection impedance at the far-end of the line (ohms)

s = length of the line (kilometers)

K = characteristic impedance (ohms)

γ = propagation constant (hypps per kilometer)

3. *Effective Height.* The effective height of a wave-antenna is defined as the ratio of the voltage produced at any specified point in the antenna to the potential gradient of the electromagnetic field producing that voltage. If the constants of the antenna system are known, the effective height at any point in the antenna system may be calculated from the value at any other point in the system.

A convenient way to measure an effective height of a wave-antenna and obtain a value which may be easily correlated with wave-antenna theory is to introduce in series with the initial-end terminating impedance a voltage which produces the same output current from the antenna as is produced by an electromagnetic wave. The ratio of this induced voltage to the potential gradient of the electromagnetic field has been called "the effective height referred to the characteristic impedance." For small values of the quasi-tilt angle, the total potential gradient of the electric field is very closely equal to the vertical component of the electric field, so that within the precision of measurement we may write:

$$H_e = \left| \frac{E_K}{E'} \right| \quad (12)$$

where

H_0 = Effective height of the wave-antenna referred to the characteristic impedance (kilometers)

E' = The potential gradient of the vertical component of the impressed field. (volts per kilometer)

E_K = The electromotive force introduced in series with the characteristic impedance at the initial end of the wave-antenna producing the same current at the distant end as the impressed field. (volts)

4. *Quasi-tilt Angle and Ground Resistivity.* The measured effective height of a wave-antenna is a function of four constants:

1. The length of the antenna.
2. The height of the antenna.
3. The propagation constant of the antenna.
4. The ratio of the component of the electric wave parallel to the surface over which the antenna is constructed to the vertical component of the electric wave.

In general, the first three of these constants are different in value for antennas constructed at different locations, but they may be varied over a limited range by changing the construction and dimensions of the wave-antenna. The comparison of effective heights, therefore, does not readily yield information regarding the relative suitability of various locations for wave-antenna systems. The ratio of the horizontal component to the vertical component of the impressed field is, however, a constant whose value is dependent solely upon the ground conditions at the location (assuming a fixed frequency for the comparison).

In case the time phase between the horizontal component and the vertical component of the impressed field were zero, the ratio of these two components would represent the tangent of the angle of forward inclination of the propagated wave front. In general, the phase angle between the two components is not zero, so that such a simple relation does not hold. It is convenient, however, to call the ratio of the two components of the impressed field the tangent of the "quasi-tilt angle", where the "quasi-tilt angle" becomes the real tilt angle in the limiting case.

In terms of the effective height, the antenna constants and the vertical component of the impressed field, the current produced at the far end of the wave-antenna is (using the nomenclature of Appendix 1 and to the same degree of approximation as equation (12)):

$$|I_{\theta}| = \left| \frac{H_{\theta} E' \epsilon^{-\gamma S \lambda'}}{2K} \right| \quad (13)$$

or

$$|I_{\theta}| = H_{\theta} \epsilon^{-\alpha S \lambda'} \left| \frac{E'}{2K} \right| \quad (14)$$

In terms of antenna constants alone, it is shown in Appendix 1 that the current produced at the far end of the wave-antenna is:

$$|I_{\theta}| = |I_{E'\theta} + I_{F'\theta}| \quad (125)$$

where

$$I_{E'\theta} = -\frac{1}{\epsilon^{j\theta} \tan T} \frac{S \lambda' F'}{2K} (a + jb) \quad (15)$$

$$I_{F'\theta} = \frac{S \lambda' F'}{2K} (c + jd) \quad (16)$$

also

$$-\frac{F'}{E'} = \epsilon^{j\theta} \tan T \quad (301)$$

In equations (15) and (16), $(a + jb)$ and $(c + jd)$ are abbreviations defined as follows:

$$(a + jb) = \frac{h}{S \lambda'} (1 - \epsilon^{-[\alpha S \lambda' + j2\pi S(m - \cos \theta)]}) \epsilon^{-j2\pi S \cos \theta} \quad (17)$$

and

$$(c + jd) = \cos \theta \frac{1 - \epsilon^{-[\alpha S \lambda' + j2\pi S(m - \cos \theta)]}}{\alpha S \lambda' + j2\pi S(m - \cos \theta)} \epsilon^{-j2\pi S \cos \theta} \quad (18)$$

If we equate expressions (14) and (125), and solve for $\tan T$:

$$\tan T = \frac{ac + bd + \sqrt{(ac + bd)^2 - (c^2 + d^2)(a^2 + b^2 - g^2)}}{c^2 + d^2} \quad (19)$$

where

$$g = \frac{H_{\theta}}{S \lambda'} \epsilon^{-\alpha S \lambda'} \quad (20)$$

It is pointed out in Appendix 3 that the phase angle δ may be expressed as a function of the quasi-tilt angle T and the dielectric constant k . For that reason, the determination of T must be made in two steps. The procedure is as follows: first,

it is assumed that the component of the total received current due to the vertical component of the impressed field is zero, i.e.,

$$(a + jb) = 0$$

Under this condition:

$$T = \tan^{-1} \frac{g}{\sqrt{c^2 + d^2}} \quad (21)$$

Using Fig. 20 of Appendix 3, the value of δ corresponding to this value of T is determined (generally $\delta = \pi/4$). Second, T is reevaluated from (19) using the value of δ so obtained.

The ground resistivity is evaluated from the value of the quasi-tilt angle by using Fig. 20 of Appendix 3.

5. *Directional Characteristics.* The measurement of the directional characteristics of a wave-antenna or a wave-antenna system consists entirely of measuring the effective height of the antenna for several directions of wave propagation, and determining the relative directional receptivity of the antenna in these directions by dividing the effective height for each direction by the value obtained for the direction of the axis of the antenna. For this purpose, the effective height at the output of the antenna system is most convenient to measure and use. This constant is defined as the ratio of the voltage at the input of the radio receiver to the field strength producing this voltage. It is exactly related to the effective height referred to the characteristic impedance (defined in the preceding subsection of this paper) by the real part of the total transfer constant between the termination at the initial end of the antenna and the input terminals of the radio receiver, and an additional factor of one-half because the voltage at the radio receiver is measured across the proper termination.

In certain receiving station locations, it is possible to utilize for determining the relative directional receptivity the regular transmission from existing radio transmitters operating at or very close to the frequency for which the directional characteristic is desired. At sites less favorably located with regard to existing transmitters, the directional characteristic may be measured by transmitting test signals from a portable transmitter, located successively in the several directions for which data are desired, and at least 15 wavelengths from the antenna system.

A distinctly different method of measuring the directional characteristics of an antenna is based on a statistical study of the reduction of noise obtained by its use. While it is difficult to evaluate the directional characteristic exactly by this method, data showing the comparative decrease in noise with the wave-antenna as against a loop or a vertical antenna are of great value in predicting the improvement in a radio circuit to be obtained by its use. As a converse to these results, the statistical combination of the improvement given by the wave-antenna, and a measured directional diagram, yields information on the direction of arrival of static.

Data on wave-antenna characteristics have been taken at several widely separated locations. Two antenna systems have been constructed by the British General Post Office, one at Wroughton, Wiltshire, in southern England, and one at Cupar, Fifeshire, in southeastern Scotland. We likewise have data on our antenna system at Houlton, Maine. The character of the earth under each of these antenna systems is different, resulting in widely different quasi-tilt angles and antenna directional characteristics.

The probable geological formations under individual antennas at each of the three antenna sites mentioned in the preceding paragraph are shown in Fig. 7. The data for the British locations were compiled from the published reports of geological surveys conducted by the British Government, and the data for the Houlton location were taken from the "Soil Survey of the Aroostook Area, Maine," published by the U. S. Department of Agriculture. In Table I, the ground constants are given for these three locations, determined by the method given in Section 4, "Quasi-tilt Angle and Ground Resistivity":

TABLE I

Location	Characteristic Sub-Soil	Quasi-Tilt Angle at 60 kc Radians	Ground Resistivity Ohms per cm ²
Wroughton	Chalk	0.011	3630.
Cupar	Sandstone	0.017	8670.
Houlton	Limestone	0.047	66300.

Fig. 8 shows the directional characteristics, calculated by the method given in Appendix 1, of wave-antennas erected over

the geological formations shown in Fig. 7. In these directional characteristics, it is important to notice that a decrease in quasi-tilt angle increases the relative importance of the component of the received current due to the vertical component of the impressed field (abbreviated to the "vertical effect"). It is evident from Fig. 8 that the relative directional receptivity for the arc between $\Theta = 90$ degrees and $\Theta = 270$ degrees is much smaller and that the effective height is much greater for the antenna at Houlton, for which the ground resistivity is higher than for the other two antennas.

Measured relative directional receptivities are also shown in Fig. 8. The values for the Cupar antenna were determined by using transmission from the several European transmitting stations which are designated on this figure. The measurements on the Houlton antenna system were made using a portable two-kilowatt transmitter located successively at each of the 22 positions shown on the map, Fig. 9. The authors wish to thank Mr. G. D. Gillett for his efficient operation of this transmitter during the summer of 1927.

It is seen that the agreement between the measured and the computed directional characteristic is much better for the shortened Houlton A antenna than it is for the same antenna 0.70 kilometer longer. The reason for this can be appreciated by reference to Fig. 7, where it is shown that the far end of the long antenna is at the top of a rocky hill, while after shortening the far end is in a swamp, at the same average elevation as the remainder of the antenna. The elimination of this sharp rise over rocky ground serves principally to remove an irregularity in the constants of the wave-antenna near the end, so that the entire antenna may be considered more nearly a smooth line. This makes the antenna function more satisfactorily as a unit of an array in connection with other antennas constructed nearby.

6. *Wave-Antenna Arrays.* Since 1899, when S. G. Brown¹⁶ proposed the use of two vertical antennas, separated in space by an appreciable portion of a wavelength and excited at a half-period phase difference, as a means of directional transmission, the use of arrays of antennas for directional transmission and reception has become increasingly important. Antenna arrays

¹⁶ R. M. Foster, "Directive Diagrams of Antenna Arrays," *Bell System Tech. Jour.*, 5, 292; April, 1926. Also see references listed in Foster's paper.

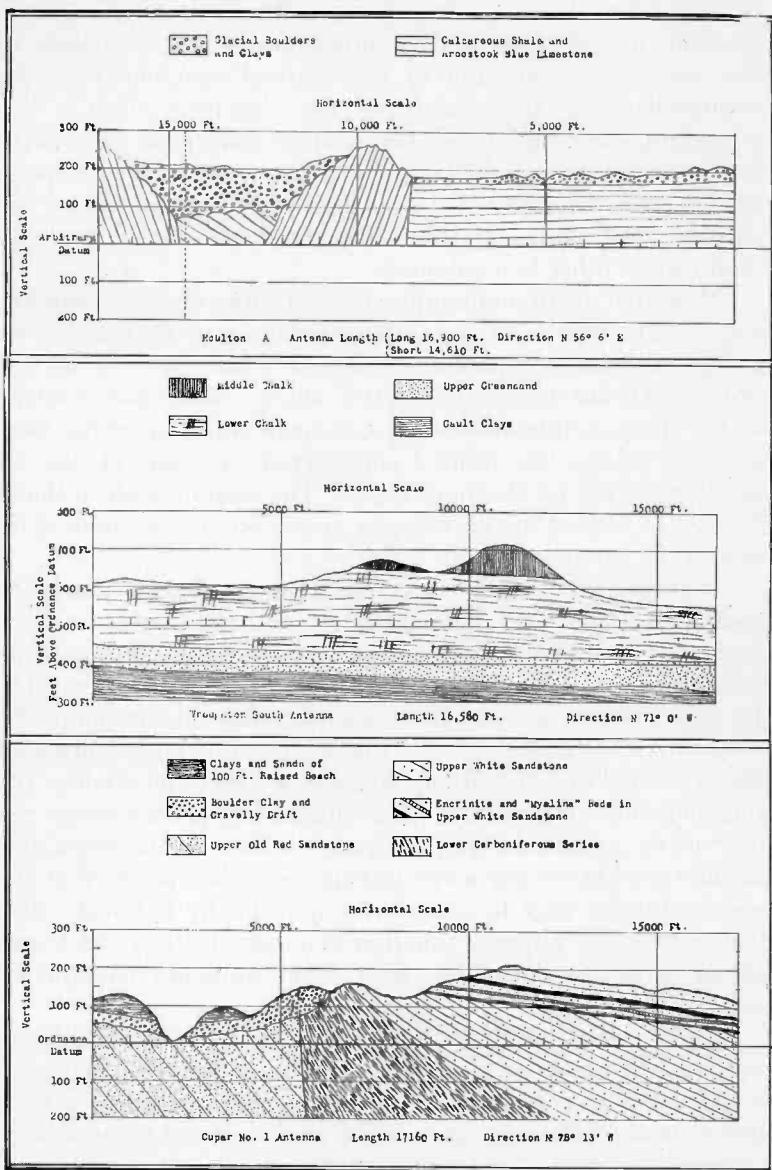
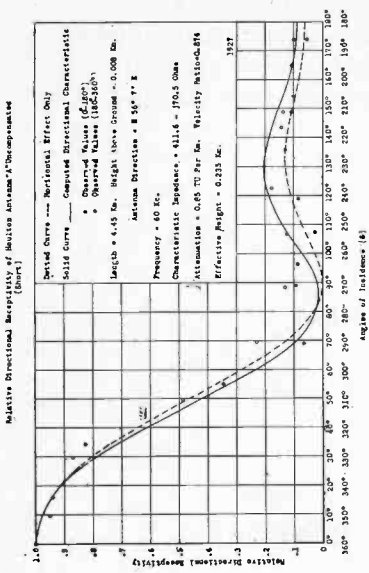
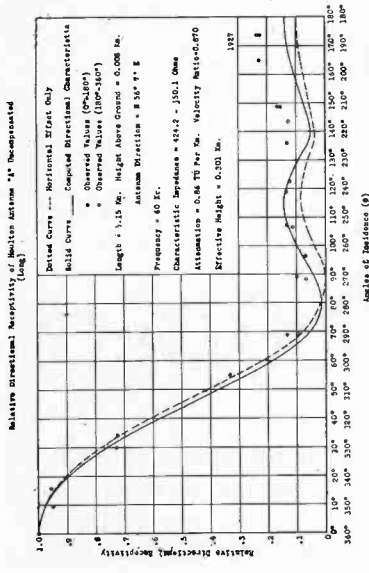
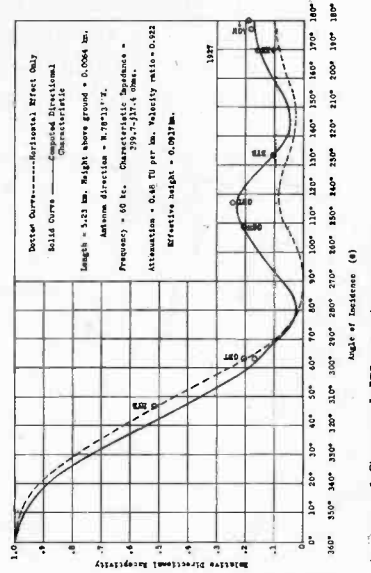

Fig. 7—Cross Section of Probable Geological Formation under Several Wave-Antennas.



Relative Directional Receptivity of Cooper, McElhenny, - Antenna No. 1.



Relative Directional Receptivity of Beaghtler, England - Such Antenna

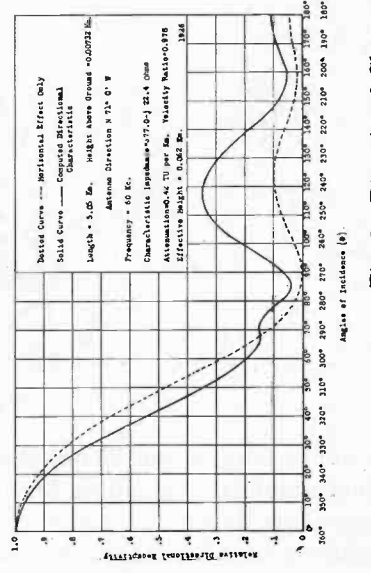

Fig. 8—Directional Characteristics of Several Wave-Antennas.

may be divided into two general classes: (1) arrays of antennas having dissimilar directional characteristics, and (2) arrays of antennas the directional characteristics of which are identical. The array formed by the use of a loop and a vertical antenna to form the familiar "cardioid" is representative of the first class of antenna arrays. Foster¹⁶ has pointed out that the ideal wave-

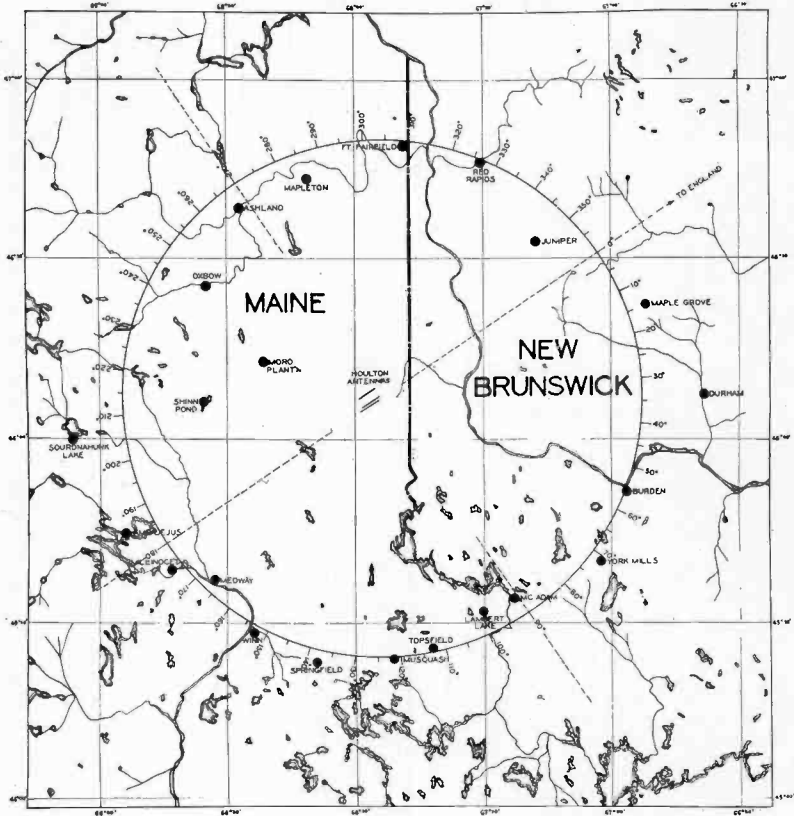

Fig. 9.

antenna may be considered as an array of an infinite number of loop antennas, extending for the length of the wave-antenna, and hence an antenna array of the second class. (An ideal wave-antenna has no attenuation and a velocity of propagation equal to the velocity of radio propagation in free space.)

An important difference between arrays of dissimilar antennas and arrays of identical antennas lies in the following peculiarity

of these two types. In general, the directivity of dissimilar antennas may be increased with no loss in desired signal receptivity by combining them in arrays with little or no separation between the individual antennas. To obtain an increase in directivity by using several identical antennas in an array, however, without too great a sacrifice in desired signal receptivity, the array must cover a space comparable to and of the same order of magnitude as the wavelength of the signals for which it is designed.

It has been stated earlier in this paper that the fundamental form of wave-antenna consists of a single straight horizontal wire, terminated to ground at each end in its characteristic impedance. If the input circuit of a radio receiver be connected across the termination at the end of the antenna most distant from the desired transmitter, (the far end of the antenna) this simple form of wave-antenna can be used as a directional receiving system. If arrangements are made to bring the output from the initial end of the wave-antenna to the radio receiver as well as the output from the far end, the simple wave-antenna immediately becomes available for use as two identical antennas in an array. The ends of these two antennas from which the outputs are taken are separated by the length of the antenna and their axes are parallel but in the opposite sense. If before combining these two output currents, that from the initial end of the antenna is changed in phase and magnitude by the proper amount, it is possible to produce a null point of reception in any desired direction. The name "compensation" has been applied to the use of a single wave-antenna to form this array.¹³ Since this null point is produced by balancing the back-end current from one antenna of the array (relative to its directional diagram) against the front-end current from the other antenna, the null point does not remain in the directional characteristic over a band of frequencies.

A directional diagram of a single antenna compensated to produce a null point at $\theta = 161.4$ degrees (the bearing of the Rocky Point transmitter relative to the axis of the antenna) is shown in Fig. 10. This diagram was calculated, by the method outlined in Appendix 2, from the average of the measured constants of Houlton antennas *A*, *B*, and *D*. In this same figure, measured points are indicated, these points being the average of observations on these three antennas.

Beverage, Rice, and Kellog¹³ have shown that there are

important practical advantages to be gained by constructing the wave-antenna as a two-wire line, and using the metallic circuit acquired thereby as a transmission line to bring the output from one end of the antenna to the radio receiver. The circuits used to bring the output currents from the two ends of the wave-antenna to the radio receiver are shown in Fig. 11. In this case, the radio receiver is located at the initial end of the antenna, so that the predominant desired signal currents are transmitted over the metallic circuit of the wave-antenna to the radio receiver, while the compensation currents are taken directly from the initial end termination when this form of array is used.

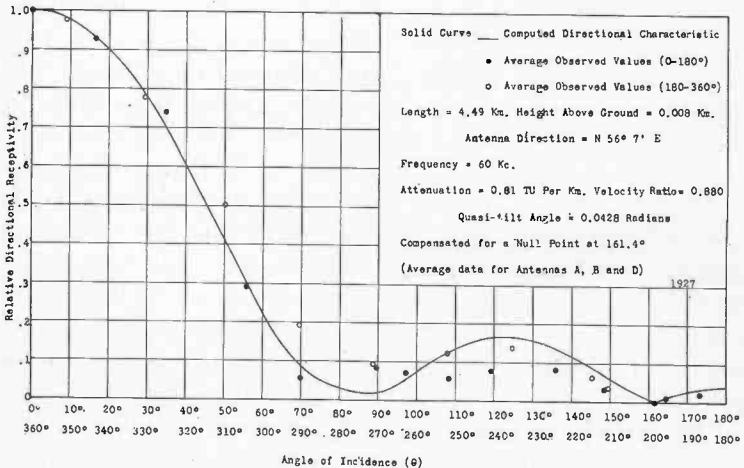

Fig. 10—Wave-Antenna Directional Characteristic. Relative Directional Receptivity of Compensated Average Houlton Antenna. (Short)

To obtain a greater reduction in the Noise Reception Factor (defined under "Directional Discrimination Against Static" earlier in this paper) than is given by compensation, two or more parallel wave-antennas are used in either a lateral array, a longitudinal array, or a combination of the two.

In the lateral array, the initial ends of the wave-antennas are spaced in the direction perpendicular to the axes of the antennas. Since it extends over space in the lateral direction, unless there be undue sacrifice in desired signal, the lateral array can only reduce the width of the directional diagram.

In a true longitudinal array, the antennas are coaxial, but their initial ends are separated by an appreciable fraction of a

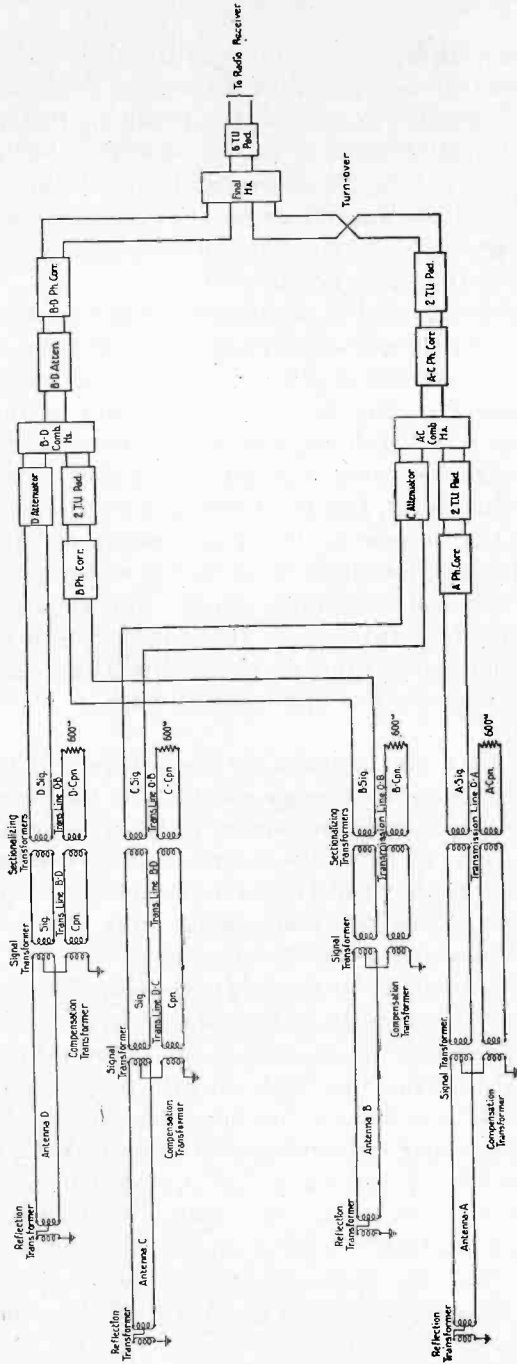

Fig. 11—Houlton Antenna System.

wavelength. If the wave-antennas forming this type of an array overlap one another, then the mutual impedance between them would greatly modify their individual characteristics. In practice, a small amount of lateral spacing between the units of a longitudinal array is necessary to make the mutual impedance negligible. When this type of array is properly designed, the reduction in directional receptivity due to the array is principally in the back-end direction.

The physical layout of the Houlton antenna system is shown in Fig. 12, and the circuits serving to connect the antennas to the radio receiver are shown in Fig. 11. The same letters are used for corresponding line sections in both of these figures. At the time that the directional characteristics of the Houlton antennas were measured, the antenna system comprised only three antennas, *A*, *B*, and *D*. Antenna *A* at that time extended from pole A-33 to pole A-117. Two arrays could then be used: antennas *B* and *D* forming a lateral array, and antennas *A* and *B* forming a modified longitudinal array. In normal operation using either of these two arrays, the transducers in the antenna output circuits were adjusted to combine equal amplitudes of the desired signals from the two antennas in phase with one another.

Using as the unit antenna for the arrays a directional diagram derived from the average constants of the antennas *A*, *B*, and *D*, the directional diagrams of these two arrays have been computed. Fig. 13 shows the computed directional characteristic of the lateral array and Fig. 14 the computed directional characteristic of the modified longitudinal array. On each of these figures, the measured points are shown.

The three antennas *A*, *B*, and *D* represented an uneconomical antenna system inasmuch as but two of the antennas could be used simultaneously in an array. To utilize fully these three antennas, at the same time increasing the discrimination against noise, the fourth antenna *C* has been constructed. To use these four antennas, they are arranged in pairs to form two lateral arrays, and the two lateral arrays arranged in a longitudinal array. The resultant total array quite evidently combines the narrowing of the directional diagram due to the lateral array and the reduction of the back end area of the directional diagram caused by the longitudinal array. A map of this array is shown in Fig. 12.

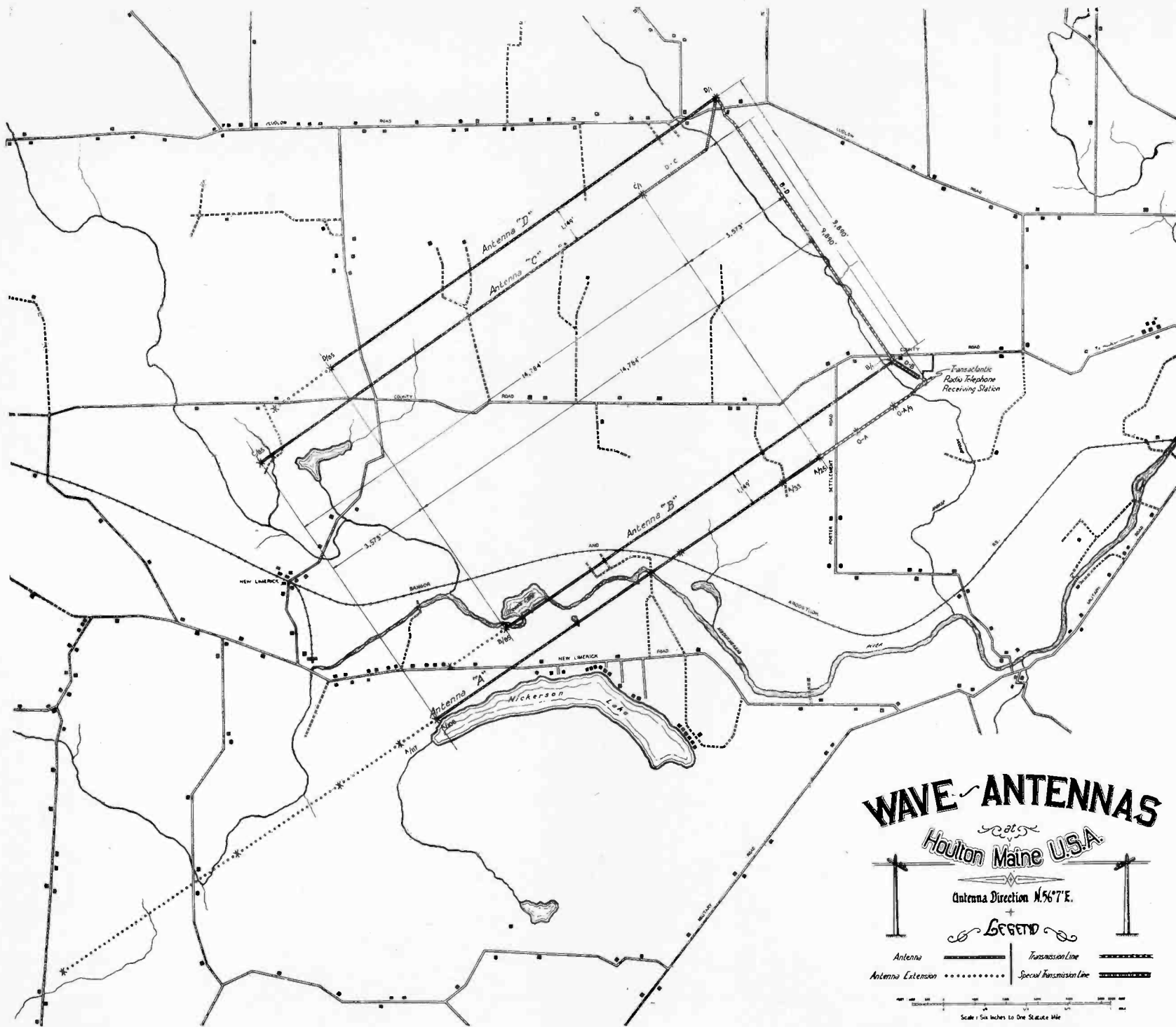

Fig. 12

The circuits for combining four antennas of an array of the type described in the preceding paragraph are shown in Fig. 11. Antennas *A* and *C* form one lateral array; antennas *B* and *D* form the second. Since antennas *C* and *D* are further removed from the station than *A* and *B*, phase correctors are inserted in the circuits from *A* and *B* to compensate for the phase change in the transmission lines from *C* and *D*, so that the desired signals are combined in phase. The combination of the 2 TU fixed pads and the variable attenuators makes it possible to correct for the attenuation in the transmission lines to the more distant antennas. These several output currents are actually com-

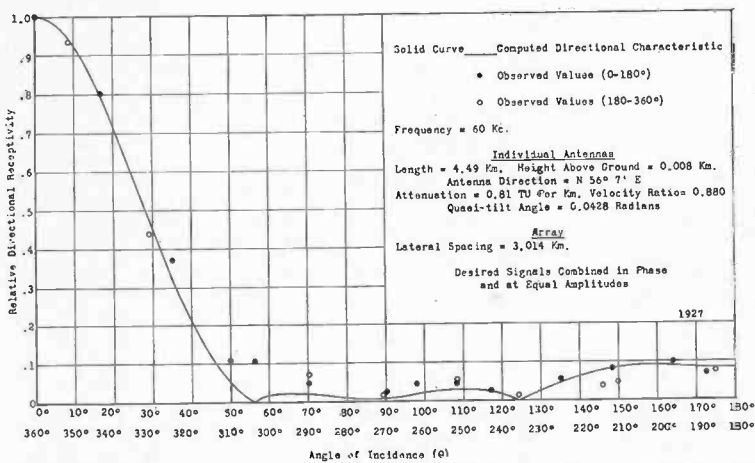

Fig. 13—Wave-Antenna Array Directional Characteristic. Relative Directional Receptivity of Lateral Array of Two Houlton Antennas. (Short)

bined in hybrid coils, since this method of combination prevents the antennas from reacting one upon another through the combining system.

After the antennas are combined in pairs to form two lateral arrays, the lateral arrays are combined in the longitudinal array.

The change of phase of space waves between one antenna and the next in an array is a linear function of frequency, and that on the metallic transmission lines practically so. By using phase correctors which have a phase change linear with frequency,¹⁷ the outputs of the antennas in the array may then be combined to produce a null point or a reduction in receptivity,

¹⁷ O. J. Zobel, "Distortion Correction in Electrical Circuits with Constant Resistance Recurrent Networks," *Bell System Tech. Jour.*, 7, 438; July, 1928.

as a result of the array, which retains the same position in the directional diagram for every frequency within a finite band. The longitudinal array at Houlton is designed and combined to produce such an invariable null point in the direction 161.4 degrees relative to the axis of the wave-antenna array. At this angle of incidence, it is evident that the space waves arrive at the lateral array of antennas *A* and *C* before arriving at the lateral array of antennas *B* and *D*. To bring these undesired signals in phase, therefore, phase shift must be introduced into the output of the first of these arrays. Part of this phase shift is supplied by the metallic transmission lines and part by the phase correc-

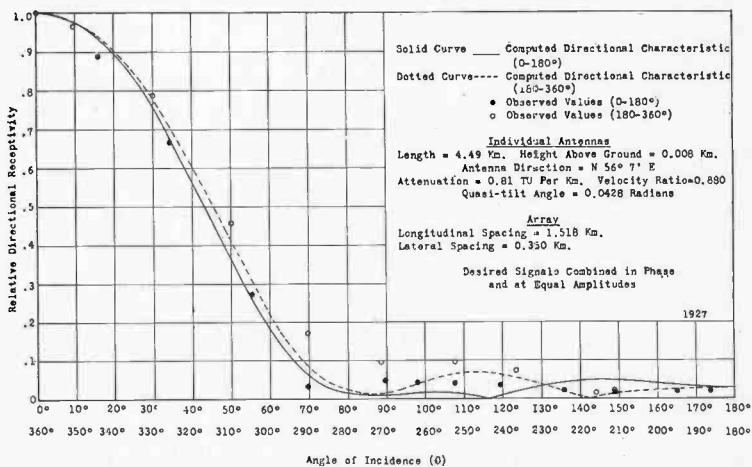

Fig. 14—Wave-Antenna Array Directional Characteristic. Relative Directional Receptivity of Modified Longitudinal Array of Two Houlton Antennas. (Short)

tors in the combining equipment. At this point, the desired signals remain in phase as the frequency is varied, so that a turn-over (reversal) inserted in the circuit to the lateral array of antennas *A* and *C* before the array is combined produces the null point which is invariable with variation of the frequency. Under these conditions, the phase of combination of the desired signals, incident at zero angle, varies as the frequency of the desired signals varies. To minimize the effect of this change in phase over the desired frequency band, the spacing of the antennas in the longitudinal array must be so chosen that the desired signals combine very nearly in phase at the middle of the frequency band. For that reason, the longitudinal spacing

in the modified longitudinal array was decreased at the same time that the fourth antenna was constructed.

At the time that the extension of the antenna system was undertaken, the measured directional characteristics of the an-

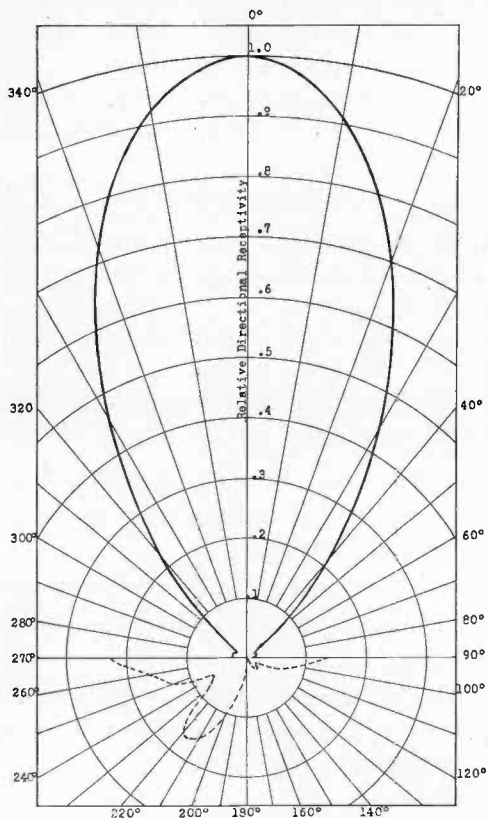

Fig. 15—Wave-Antenna Array Directional Characteristic. Calculated Relative Directional Receptivity of Array of Houlton Antennas *A*, *B*, *C*, and *D*. (From Average Measured Unit Antenna Characteristic.) Dotted Curve—Magnified $\times 10$.

tennas *A*, *B*, and *D* were available, so that the unit directional diagram for use in determining this array characteristic was taken as the average measured characteristic of these three antennas. The calculated directional diagram of the complete Houlton antenna system is shown in Fig. 15. It should be noticed that the scale for the back-end dotted curve is ten times as great as that for the full-line curve for the major lobe.

It is believed that the directional diagram, shown in Fig. 15, represents about the ultimate that can be done economically in a general reduction of back-end area and narrowing of the diagram by means of wave-antennas. Future extensions or redesign of the array at Houlton must be based on the reduction of the relative receptivity in distinct directions determined either by statistical study of the noise received by the antenna system or actual measurements of the direction of arrival of the noise which limits the operation of the transatlantic radio-telephone circuit.

THE RADIO RECEIVER

A description of the design and performance of the radio-telephone receiving set will constitute another paper. The radio receiving equipment employed in connection with the antenna systems was developed and constructed by Bell Telephone Laboratories.

The major transmission requirements upon which design must be based are as follows:

1. The limiting values of the signal field to be received.
2. The output power of the receiving antenna for a given signal strength.
3. Power output required from the radio receiver.
4. The type of telephone transmission to be received.
5. The frequency band to be received.
6. The nature and strength of interference from other radio stations and from noise. The selectivity required to reduce undesired modulation.
 - a. In amplifiers.
 - b. In demodulators.
7. Stability of frequency, gain and transmission-frequency characteristic.

1. *Limiting Values of the Signal Field To Be Received.* The range of daily averages of signal field at 60 kilocycles for all daylight-path hours is shown in Fig. 4. The fields, as previously published data indicate,^{2,5,8} vary diurnally between much wider limits. At night the field frequently approaches, as a maximum, the value calculated on the basis of the inverse distance law. During sunrise and sunset dip periods the field frequently goes to a value less than one microvolt per meter with

even 50 kilowatts radiated from a transmitter 5000 kilometers away. Suppose we take as being approximately correct values, field strengths of 0.4 microvolts per meter as the lower limit and 400 microvolts per meter as the upper limit. We then have determined that the receiving set should have a variation of gain of 60 TU.

2. *The Output Power of the Receiving Antenna for a Given Signal Strength.* From the observed constants of a Houlton wave-antenna and the assumed value of 0.4 microvolts per meter received at zero degree to the antenna direction as the lowest field, we calculate, using equations (125), (126), and (127) in Appendix 1, that the power supplied to the reflection transformer terminals is 3.716×10^{-6} microwatts. This power must suffer loss as a result of the transmission back to the receiving station over transmission lines and as a result of the necessity of providing flexibility in the operation of the apparatus used to combine the output of the antenna in question with the output of other antennas before it reaches the input terminals of the radio receiving set. (See Fig. 11.) This loss is such that the power at the input terminals of the radio receiving set from a single antenna and for the minimum signal field is very nearly equal to 3.7×10^{-7} microwatts. With the combining system actually used, the input to the radio receiver from all four antennas will be 12 TU above this value or 5.9×10^{-6} microwatts.

3. *Power Output Required from the Radio Receiver.* The value of output power required from the radio receiver is really governed by considering the whole radio circuit as a part of a long-distance telephone system. An overall loss of 10 TU has been found satisfactory for long toll circuits. If the telephone lines connecting the circuit terminals to the transmitting and receiving stations have an equivalent of 0 TU then we can place the 10 TU loss in the radio portion of the circuit. If we then supply on a single frequency within the voice-frequency band a power of 1 milliwatt to the input terminals of the radio transmitter, to get a 10 TU equivalent in the radio circuit we must obtain 0.1 milliwatt at the output of the radio receiver.

In the preceding section we determined that the minimum input would be 3.7×10^{-7} microwatts from a single antenna and hence the maximum gain required in the radio receiver to raise this power to the specified 100 microwatts output is 84 TU.

Within amplifiers using three-electrode vacuum tubes noise

is generated in two ways: (a) by thermal agitation¹⁸ in the conductor of the input circuit; and (b) by "Schottky Effect"¹⁹ in the vacuum tubes themselves. Since the transatlantic radio-telephone circuit is so operated that the strength of the voice waves, or "electrical volume," is constant at the output of the radio receiver,²⁰ the maximum allowable noise at this point in the circuit is likewise constant. Good engineering practice specifies that the continuous "tube noise" should be more than 40 TU below the signal or less than 0.01 microwatt for the specified receiver output of 100 microwatts when using any gain up to the maximum of 84 TU. (With uniformly distributed noise over the voice-frequency band, this is equivalent to about 400 noise units.²¹)

4. *The Type of Telephone Transmission To Be Received.* The "single-sideband, suppressed-carrier" type of telephone transmission, invented by John R. Carson,²² has long been used in the Bell System in carrier systems on wire circuits.²³ Since the advantages of single sideband in radio transmission have been described by Hartley,²⁴ and in the radio transmitter by Heising,²⁵ we shall only briefly review the benefits arising from its use.

Transmission of two sidebands with the carrier suppressed represents an improvement over the "carrier and two-sideband"

¹⁸ J. B. Johnson, "Thermal Agitation of Electricity in Conductors," *Phys. Rev.*, 32, 97; July, 1928.

Harry Nyquist, "Thermal Agitation of Electric Charge in Conductors," *Phys. Rev.*, 32, 110; July, 1928.

J. B. Johnson, "Thermal Agitation of Electricity in Conductors," *Nature*, 119, p. 50; Jan. 8, 1927.

¹⁹ Walter Schottky, "Atomare Schwingungsvorgänge an Glühkathodenoberflächen," *Physik. Zeitschr.*, 27, 701; Nov. 1, 1926.

T. C. Fry, "The Theory of the Schroteffekt," *Jour. Frank. Inst.*, 199, 203; Feb., 1925.

J. B. Johnson, "The Schottky Effect in Low Frequency Circuits," *Phys. Rev.*, 26, 71; July, 1925.

²⁰ S. B. Wright and H. C. Silent, "The New York-London Telephone Circuit," *Bell System Tech. Jour.*, 6, 736; October, 1927.

²¹ The noise unit is an arbitrary unit used in the Bell System for comparison of any noise with a certain arbitrary source of noise known as a noise standard. The output of the noise standard may be attenuated to produce the same interfering effect on speech as the noise being measured. See W. H. Harden, "Practices in Telephone Transmission Maintenance Work," *Bell System Tech. Jour.*, 4, 26; January, 1925, for details of making such comparisons.

²² U. S. Patents Nos. 1,343,306 (1920); 1,343,307 (1920); 1,449,382 (1923), to J. R. Carson.

²³ E. H. Colpitts and O. B. Blackwell, "Carrier Current Telephony and Telegraphy," *Trans. A.I.E.E.*, 40, 205; 1921.

²⁴ R. V. L. Hartley, "Relation of Carrier and Sideband in Radio Transmission," *Proc. I. R. E.*, 11, 34; Feb., 1923.

²⁵ R. A. Heising, "Production of Single Sideband for Transatlantic Radio Telephony," *Proc. I. R. E.*, 13, 291; June, 1925.

method ordinarily used in "broadcasting" since all of the transmitter power may be concentrated in the intelligence bearing frequencies. By transmitting only one sideband, further advantages are gained since the frequency space occupied is slightly more than halved for the same grade of circuit, the distortion at the output of the receiver is decreased, and practical simplifications may be made at the transmitting and receiving stations.²⁶ If the radio transmitter radiates equal power in each of the above-mentioned suppressed carrier transmission schemes and if the radio receiver accepts only the intelligence-bearing frequencies in each case, then the signal-to-noise ratio will be the same,²⁴ provided the resupplied carrier is in frequency synchronism in both systems and in addition in phase synchronism with the suppressed carrier in the two-sideband system.²⁶

When receiving single-sideband transmission the carrier suppressed at the transmitting station is resupplied in the radio receiver. Since this carrier will demodulate both sidebands with equal efficiency, the opposite sideband must be eliminated before demodulation to prevent the noise in this sideband from appearing in the voice-frequency output. If the noise power in either sideband is p , then the noise power without the opposite sideband suppression is $2p$ and if we reduce the noise power from the opposite sideband to $0.1p$ the total received noise will be reduced

$$10 \log_{10} \frac{2p}{p+0.1p} = 2.59 \text{ TU}$$

The maximum possible reduction in noise is 3.01 TU,²⁷ so that for engineering purposes a 10 TU suppression of the noise in the opposite sideband may be considered adequate. For other reasons to be brought out later in this paper the opposite sideband loss must be greatly in excess of this value.

Provided the resupplied carrier used to demodulate the single sideband suppressed carrier signals is large relative to the signal magnitude²⁴ at that point in the circuit where we choose to supply it, the only other requirement is that its frequency be correct. Since a displacement of the resupplied carrier 50 cycles above or 20 cycles below the zero of the equivalent voice-

²⁶ J. R. Carson, "Signal-to-Static-Interference Ratio in Radio Telephony," *Proc. I. R. E.*, 11, 271; June, 1923.

²⁷ J. R. Carson, "Selective Circuits and Static Interference," *Bell System Tech. Jour.*, 4, 265; April, 1925.

frequency band is sufficient to give an appreciable decrease in speech intelligibility, its frequency should be maintained within the smaller of these two limits or within plus or minus 20 cycles of the correct value. It is interesting to note that an absolute variation of only one-tenth of this amount can be observed on music and that speech naturalness is similarly affected.

5. *Frequency and Frequency Band To Be Received.* To utilize the power available at the transmitter most effectively, it is essential to transmit only those frequencies contributing most to received intelligibility. The energy of speech lies largely below 500 cycles while the frequencies most important for intelligibility lie between 400 and 2600 cycles.²⁸ By limiting the band transmitted to speech frequencies above 400 cycles some saving is obtained in the transmitter power required. The range of frequencies transmitted may then extend from 58.9 to 61.1 kilocycles with the suppressed carrier at 58.5 kilocycles, and the radio receiver must be designed to accept this band of frequencies. The transmission-frequency characteristic of the overall radio receiving set should not vary more than $\pm 2\text{TU}$ within the band specified above to give a good telephone communication circuit.

6. *Selectivity Requirements.* The selectivity required in the receiving set is such that when the desired signal is at the assumed minimum value no deleterious effects will be caused by undesired signals.

In Fig. 16 there are shown measured daylight field strengths of various existing radio-telegraph stations as observed at Riverhead, New York, and at Cupar, Scotland. Since these measurements could not be indefinitely extended in frequency nor could they take into account all stations which might exist in this range, they may be considered only as a guide in obtaining a curve of the maximum telegraph interference to be expected. These data, in Fig. 16, have been expressed as ratios (in TU) to the minimum desired signal to be received. It is important to note that the directional selectivity of the receiving antenna system used materially decreases the relative magnitude of many of these interfering signals, particularly at the higher frequencies. The American receiving station is now located in Houlton, Maine, instead of Riverhead, New York, and this increase in distance from many of the American high-power

²⁸ W. H. Martin and Harvey Fletcher, "High Quality Transmission and Reproduction of Speech and Music," *Trans. A.I.E.E.*, 43, 384; 1924.

transmitting stations decreases somewhat their field strengths. In view of these factors the "Assumed Maximum Interference," although it is not greater than any observed station field strength, is, in fact, greater than the interfering signals when the outputs from the actual receiving antennas are used instead of field-strength observations.

6a. *Selectivity Requirements Imposed by the Use of Amplifiers.*

To operate a vacuum tube as an amplifier with negligible distortion the peak voltage applied to its grid must be less than a

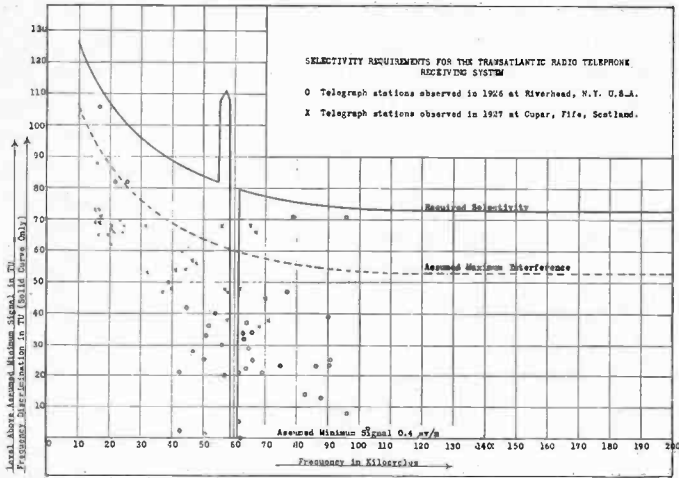

Fig. 16.

limiting value so that the tube always operates over the practically linear portion of its characteristic. If no discrimination were provided against unwanted signals, we would be placed in the peculiar situation of having to supply ample tube capacity in the radio receiver to care for the combined load produced by perhaps 100 telegraph stations each of which, on the average, may have a received signal strength 1000 times the assumed minimum signal. An easy way to decrease the load produced by interference is to insert a filter at the input of the receiving set, which will reduce the required capacity of the first tube. Additional selectivity following the first tube still further reduces the load of undesired signals on the following tubes as more of the capacity of those tubes is used for the desired signals.

Now for design purposes let us assume that the load capacity of each tube is at least 6 TU greater than the capacity required

in the tube for the performance of its functions on the desired signal. The undesired signals may then be allowed to produce on the tube grid a voltage equal to that of the desired signal.

Since each of the undesired signals shown in Fig. 16 are about 60 TU stronger than the minimum desired signal, they must be reduced by that amount to make them each no greater than the desired signal.

It is shown in Fig. 21 of Appendix 4 that, as a result of unit random input voltages from 100 operating radio-telegraph stations, a peak voltage will be produced equal to or greater than 10 such units during less than 0.1 per cent of the time. If the undesired telegraph station signals were all of the same magnitude as the desired signal then the voltage which they would produce would be 20 TU above the voltage of the desired signal.

From purely load considerations then, the total required suppression of every interference-bearing frequency outside of the desired signal receiving band will be

$$60 + 20 = 80 \text{ TU}$$

6b. Selectivity Requirements Imposed by the Use of Demodulators. In all demodulators, the range of desired output frequencies should not be included in the input frequency band because the input frequencies amplified appear in the output of the demodulator as the first order modulation product. The output band of the demodulator should be at a lower frequency than the input band in order to reduce the number of undesired modulation products in the output and in order to obtain the benefit of greater selectivity from circuits operating at lower frequencies. Of course, if all the required selectivity can be conveniently put before the first demodulator, there is no valid reason why multiple-demodulation should be used.

In all demodulators except the final demodulator of a radio receiver, the band of frequencies allowed to pass into the demodulator should not be greater in width than the absolute value of the lowest desired frequency in the demodulator output. This requirement is apparent when we consider second order modulation products of interference within the band accepted by the demodulator. Suppose we assume the use of double-demodulation and choose 30 kilocycles as the lowest desired frequency in the output of the first demodulator. Then if the band impressed upon the demodulator be more than 30 kilocycles in width, two interfering signals within the band might together give a

difference frequency of 30 kilocycles producing load in subsequent stages and possibly tone or noise in the output circuit.

Second order modulation between two signals, one lying within the band accepted by the demodulator and one outside it, may also give rise to interference, due to the difference frequency falling in the output band of the demodulator. Assume that one interfering signal lies within the band accepted by the demodulator and is +60 TU referred to the minimum desired signal at the grid of the first tube. An equal signal at a frequency outside the band and subject to the selectivity provided for meeting the load requirement will be -20 TU referred to minimum desired signal at the same point. Since the second order output from a demodulator is approximately proportional to the product of the grid voltages producing it,²⁹ we may write (in TU):

Relative desired signal = (0) + (Beating oscillator voltage)

Relative interference = (+60) + (-20) = +40

Tests have shown that an interrupted tone, similar to telegraph interference, which is heard at a frequency of 1100 cycles in a telephone receiver is about the most serious frequency of interference to received speech on a telephone circuit, and that frequencies above and below 1100 cycles are of somewhat less importance. Signals at the equivalent 1100-cycle frequency produce a type of interference which good engineering practice requires should be reduced at least 50 TU below the desired signal. (This amount of interference is equal to about 500 noise units at the -10 TU transmission level.²¹)

To satisfy this requirement, the relative desired signal should be 50 TU greater than the relative interference at the output of the demodulator. Assigning a minimum magnitude to the beating oscillator voltage of 90 TU above the minimum desired signal voltage on the grid of the demodulator reduces this type of interference sufficiently. (Using a balanced demodulator arrangement, this value might be reduced some 20 TU.)

Since any two signals at frequencies entirely outside the band accepted by the demodulator are suppressed some 80 TU, we need not consider their second-order modulation products.

If we use double demodulation in a radio receiver as is assumed in the first part of this section, then we must consider other products of modulation with the beating oscillator for frequencies

²⁹ J. R. Carson, "A Theoretical Study of the Three-Element Vacuum Tube," *Proc. I. R. E.*, 7, 187; April, 1919.

distant from the accepted band. Space will not permit us to more than mention these, but since the frequencies to be suppressed are distant from the frequencies to be received their suppression is relatively simple.

In the final demodulator of a radio receiver we must tolerate a certain amount of distortion due to the intermodulation of input frequencies. By limiting the band width into the final demodulator to the same width as the desired output band, the distortion due to intermodulation with interference lying outside the desired band is eliminated. By supplying a large amount of carrier to the final demodulator and by using a balanced demodulator the amount of noise and distortion due to intermodulation of frequencies lying inside the desired band is reduced.

If the desired signal band extends from 58.9 to 61.1 kilocycles and is an upper sideband corresponding to voice frequencies from 400 to 2600 cycles then, in effect, we must supply a carrier at 58.5 kilocycles to produce the proper voice frequencies in the output circuit. This carrier frequency will also demodulate the frequencies below it in such a way as to produce audible signals and for this reason ample protection must be supplied against the opposite sideband if stations are likely to exist in that range. Calculations show that this is the case; for if 100 stations are distributed at random over the 190-kilocycle range between 10 and 200 kilocycles, then the probability that at least one station lies between 55.5 and 58.5 kilocycles is 0.796. If the assumed maximum interference at the equivalent 1100 cycles in the opposite sideband, as indicated by the dashed line in Fig. 16, is 61 TU above the minimum signal and we wish to have it 50 TU below, as previously stated, then we require a selectivity of 61 TU plus 50 TU or 111 TU for this frequency. For other tone-producing frequencies of the opposite sideband similar selectivity requirements have been set up and the resultant for frequencies from 55.5 to 58.5 kilocycles is shown by the solid curve in Fig. 16.

7. Stability. As mentioned in Section 4 above, the carrier for a single sideband receiver must be resupplied at the correct frequency. All of the oscillators in the radio link must have sufficient frequency stability to maintain the voice frequencies at the receiver output correct within 20 cycles per second over long periods of time. Suppose we allow 10 cycles per second variation in frequency to exist at the transmitter and an equal amount at the receiver, then the variation in frequency at the receiver

must never exceed 0.017 per cent if the resupplied carrier is at 58.5 kilocycles. Certain advantages in stability of the resupplied carrier can be obtained by the use of double demodulation in the receiving set and these will be discussed in another paper.

Variations in the efficiency of the transatlantic radio transmission path for long wavelengths occur with time of day and season, but during any individual all-daylight transmission period the transmission efficiency of the path is fairly constant. If the gain of the receiver is constant, then, during this important period of the day, the minimum of circuit adjustments will be required. It is hence desirable that the gain of the entire receiving set be made to hold constant within ± 2 TU for all variations of temperature and of voltage of battery supply, within the operating limits.

It is almost self-evident that the transmission-frequency characteristic through the radio receiver should not vary with temperature and time. Changes of this nature should not exceed 0.5 TU within the transmission band nor 5 TU outside of the transmission band. Design of stable filters and vacuum-tube circuits are essential to produce this result.

The authors have endeavored, in the limited space of the preceding pages, to show what radio transmission considerations must be taken into account in properly designing a receiving system for a commercial radio-telephone circuit. A rather detailed discussion has been necessary to present an accurate picture of the various factors entering into the production of the very essential and highly directional long-wave receiving antenna system employed.

The cooperation of the engineers of the Wireless Section of the British General Post Office, particularly Col. A. G. Lee and Mr. I. J. Cohen, in the measurements made on wave-antennas in England and Scotland, is greatly appreciated and we take this occasion to thank them for having made possible the obtaining of these data. All of our early work in connection with wave-antennas and our initial field trials of lateral and longitudinal arrays of wave-antennas were carried out using wave-antennas located at Belfast, Maine, and Riverhead, New York. These antennas were made available through the courtesy of the Radio Corporation of America, and the authors wish to express to Mr. H. H. Beverage of that organization their appreciation for his interest and assistance during the tests.

Appendix 1

THE WAVE-ANTENNA

Fundamentally, the wave-antenna consists of a straight horizontal wire, terminated to ground at each end in its characteristic impedance.¹³ The determination of the receptivity characteristics of the wave-antenna consists in determining the current flowing in the terminal impedances of the antenna resulting from a field impressed along the antenna.³⁰

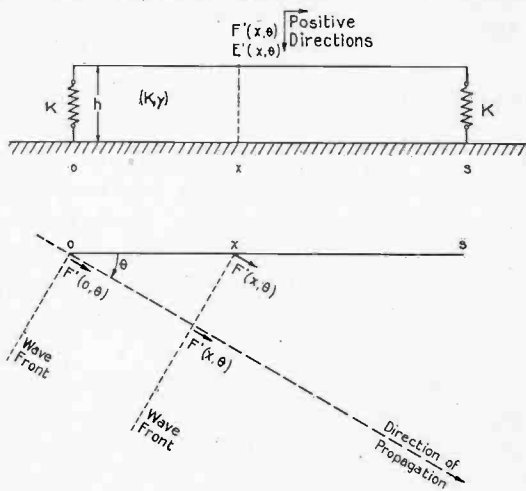

Fig. 17.

The wave-antenna is shown in Fig. 17, consisting of a line of length s extending from $x=0$ to $x=s$. In the nomenclature of the following discussion, letters with no primes refer to the antenna, letters with a single prime ($'$) to the impressed field, and letters with a double prime ($''$) to the resultant field. The wave-antenna is in an impressed electromagnetic field which is defined by the quantities ϕ' , V' , f_w' , and f_g' where

ϕ' = impressed magnetic flux between the lower surface of the wire and the surface of the ground (per unit length).

V' = impressed electric force between the wire and the ground.

f_w' = the impressed electric force *along* the lower surface of the wire.

f_g' = the impressed electric force *along* the surface of the ground.

³⁰ J. R. Carson and R. S. Hoyt, "Propagation of Periodic Currents over a System of Parallel Wires," *Bell System Tech. Jour.*, 6, 495; July 1927.

The total field about the antenna is the sum of this impressed field and a secondary field due to the currents and charges produced in the circuit by the impressed field, so that

$$\begin{aligned} \phi'' &= \phi' + \phi & f_w'' &= f_w' + f_w \\ V'' &= V' + V & f_a'' &= f_a' + f_a \end{aligned} \tag{101}$$

where ϕ , V , f_w , and f_a are the components of the secondary field set up by the currents and charges in the system and ϕ'' , V'' , f_w'' and f_a'' represent the resultant field about the system.

As a result of the impressed field, a current I flows in the wire, and a corresponding superposed current distribution is induced in the ground. If the internal impedance of the wire be z_w and that of the ground be z_a , the resultant longitudinal electric force along the wire may be written

$$f_w'' = Iz_w = f_w' + f_w \tag{102}$$

and similarly the resultant longitudinal electric force along the ground is

$$f_a'' = (-Iz_a + f_a') = f_a' + f_a \tag{103}$$

The second curl law applied to the periphery of the rectangle formed by the vertical at x , the wire, the vertical at $(x + \Delta x)$, and the ground yields

$$zI - f_a' + \frac{dV''}{dx} = -\frac{d\phi''}{dt} \tag{104}$$

where z is the total series impedance of the wire and the ground circuit and is

$$z = z_w + z_a. \tag{105}$$

A summation of the voltages around the above defined rectangle yields

$$f_w' - f_a' + \frac{dV'}{dx} = -\frac{d\phi'}{dt} \tag{106}$$

Subtracting (106) from (104) we get

$$zI - f_w' + \frac{dV}{dx} = -\frac{d\phi}{dt} \tag{107}$$

If we write Q as the charge, C as the capacity to ground, and L as the external inductance, each per unit length of the wire, equation (107) becomes

$$zI + L \frac{dI}{dt} + \frac{1}{C} \frac{dQ}{dx} = f_w' \quad (108)$$

but the line current is decreased by the amount of the charging current and the leakage current

$$-\frac{dI}{dx} = \frac{dQ}{dt} + I_Y \quad (109)$$

where I_Y is the leakage current per unit length of the wire. If the admittance of the leak to ground be designated as Y , the leakage current is

$$I_Y = YV'' = Y(V' + V) \quad (110)$$

Since we are interested only in the steady state, the operator d/dt may be replaced by $j\omega$. Substituting the expression (110) for I_Y into (109) and differentiating with respect to x yields

$$-\frac{d^2I}{dx^2} = \frac{dQ}{dx} j\omega + Y \left(\frac{dV'}{dx} \right) + \frac{Y}{C} \frac{dQ}{dx} \quad (111)$$

By means of (111) we may eliminate Q from (108)

$$(z + jL\omega)I - \frac{1}{Y + jC\omega} \frac{d^2I}{dx^2} = f_w' + \frac{Y}{Y + jC\omega} \frac{dV'}{dx} \quad (112)$$

and if

$$K = \sqrt{\frac{z + jL\omega}{Y + jC\omega}} \quad (113)$$

$$\gamma = \sqrt{(z + jL\omega)(Y + jC\omega)} \quad (114)$$

where K is the characteristic impedance and γ the propagation constant of the antenna circuit, equation (112) may be written

$$\frac{K}{\gamma} \left(\gamma^2 - \frac{d^2}{dx^2} \right) I = f_w' + \frac{YK}{\gamma} \frac{dV'}{dx} \quad (115)$$

When the boundary conditions are applied, equation (115) defines the value of the current I in the wave-antenna in terms of the impressed electromagnetic field specified by V' and f_w' . By equation (101) the resultant voltages at the ends of the antenna are:

$$V''(0) = V'(0) + V(0) \quad (116)$$

$$V''(s) = V'(s) + V(s) \quad (117)$$

To this point, the solution of the wave-antenna problem has been in a rigidly analytic form. While it is possible to determine completely the received current by following through this method of solution, the problem can be greatly simplified and a physical picture of the problem gained by a synthetic process.

The synthetic method of attack consists of replacing the impressed field by a set of electromotive forces identically equivalent to the impressed field in the sense that it produces the same currents and charges.³⁰

The proposed set of electromotive forces is as follows:

- A. A distributed longitudinal electromotive force f_w' per unit length in the wire, i.e., an electromotive force $f_w' dx$ in each element of length dx .
- B. A distributed vertical electromotive force, V' , in the superposed shunt admittance Y between the wire and ground, i.e., an electromotive force V' in each elemental admittance path $Y dx$.
- C. In each end of the wire, $x=0$ and $x=s$, localized series electromotive forces, equal respectively to minus and plus the impressed voltages at those points; i.e., equal to $-V'(0)$ and $+V'(s)$ respectively.

The electromotive force of A is suggested by (107), that of B by (109) and (110), that of C by the terminal conditions expressed in (116) and (117). In the case of a wave-antenna constructed to maintain high insulation resistance, the conductance portion of the superposed admittance Y can be made negligibly small. Under this condition, the susceptance part of this admittance can be combined with the linear capacitance of the wire to alter the propagation constants (K and γ) of the antenna and the voltages induced in the superposed shunt admittances neglected.

By reference to Fig. 17, the impressed field may be identically defined at each point along the antenna.

The longitudinal electromotive force in each element of the wire is

$$\begin{aligned} f_w' dx &= F'(x, \theta) \cos \theta dx \\ f_w' dx &= F'(0) \epsilon^{-\gamma' x \cos \theta} \cos \theta dx \end{aligned} \quad (118)$$

The impressed voltage at the point x along the antenna is

$$\begin{aligned} V'(x) &= h \cdot E'(x, \theta) \\ V'(x) &= h \cdot E'(0) \epsilon^{-\gamma' x \cos \theta} \end{aligned} \quad (119)$$

In (118) and (119) $F'(0)$ and $E'(0)$ represent the horizontal and vertical components respectively of the impressed electric field at the end of the antenna $x=0$, and h represents the height of the antenna above ground. For the purpose of this discussion, it will be assumed that F' and E' are not dependent upon θ . The current produced at the receiving end s by the horizontal component of the impressed field is given by

$$I_{F'\theta} = \int_0^s \frac{F'(0) \epsilon^{-\gamma' x \cos \theta} \cos \theta dx}{2K} \epsilon^{-\gamma (s-x)} \quad (120)$$

From which

$$I_{F'\theta} = \frac{sF'(0) \cos \theta}{2K} \frac{\epsilon^{(\gamma-\gamma' \cos \theta)s} - 1}{(\gamma - \gamma' \cos \theta)s} \epsilon^{-\gamma s} \quad (121)$$

The current produced at the receiving end s by the vertical component of the impressed field is evaluated as follows:

$$I_{E'\theta} = \frac{V'(s)}{2K} - \frac{V'(0)}{2K} \epsilon^{-\gamma s} \quad (122)$$

and by combination of (119) and (122)

$$I_{E'\theta} = \frac{hE'(0)}{2K} [\epsilon^{(\gamma-\gamma' \cos \theta)s} - 1] \epsilon^{-\gamma s} \quad (123)$$

Zenneck's theory of wave propagation³¹ has been developed by Breizig³² to show that the horizontal and vertical components of the impressed field are related by the expression

$$-\frac{F'}{E'} = \epsilon^{i\delta} \tan T. \quad (124)$$

The total current produced at the receiving end s by the impressed field is

$$I_\theta = I_{F'\theta} + I_{E'\theta} \quad (125)$$

³¹ J. Zenneck, "Ueber die Fortpflanzung ebener electromagnetischer Wellen längs einer ebenen Leiterfläche und ihre Beziehung zur drahtlosen Telegraphie," *Ann. der Phys.*, 23, 846; June, 1907.

³² Franz Breizig, "Theoretische Telegraphie," Braunschweig, 1924. 2nd ed., pp. 482-487.

and by application of (124) the constituents of the total current are

$$I_{F'\theta} = \frac{S\lambda'F'}{2K} \cos \theta \frac{1 - e^{-[\alpha S\lambda' + j2\pi S(m - \cos\theta)]}}{\alpha S\lambda' + j2\pi S(m - \cos\theta)} e^{-j2\pi S \cos \theta} \quad (126)$$

$$I_{E'\theta} = \frac{S\lambda'F'}{2K} \frac{h}{S\lambda'} \frac{1}{\epsilon^{j\delta} \tan T} (1 - e^{-[\alpha S\lambda' + j2\pi S(m - \cos\theta)]}) e^{-j2\pi S \cos \theta} \quad (127)$$

In (125), (126), and (127), the symbols have the following meanings

SYMBOL	DEFINITION	UNIT
I_θ	The total current produced at the receiving end of the antenna s by an impressed field propagated at an angle θ from the axis of the antenna.	amperes
$I_{F'\theta}$	The portion of I_θ produced by the horizontal component of the impressed field.	amperes
$I_{E'\theta}$	The portion of I_θ produced by the vertical component of the impressed field.	amperes
F'	The horizontal component of the impressed field. (Positive direction in the direction of propagation along the ground.)	volts per kilometer
E'	The vertical component of the impressed field. (Positive direction downward.)	volts per kilometer
δ	Phase angle between the horizontal and vertical components of the impressed electric field.	radians
T	"Quasi-tilt angle" of the impressed electric field.	radians
K	The characteristic impedance of the wave-antenna.	ohms
γ	The propagation constant of the wave-antenna.	
α	The real part of the propagation constant of the wave-antenna or the attenuation constant.	napiers per kilometer
β	The imaginary part of the propagation constant of the wave-antenna or the phase constant.	radians per kilometer
γ'	The propagation constant of the space waves.	
α'	The real part of the propagation constant of the space waves (assumed equal to zero).	napiers per kilometer

β'	The imaginary part of the propagation constant of the space waves.	radians per kilometer
s	The length of the wave-antenna.	kilometers
h	The height of the wave-antenna above ground.	kilometers
$S = s/\lambda'$	The length of the wave-antenna.	space wave-lengths
$\lambda' = 2\pi/\beta'$	The wavelength of the space waves.	kilometers
$V = \frac{2\pi f}{\beta}$	Apparent velocity of propagation of waves along the wave-antenna.	kilometers per second
V'	The velocity of propagation of the space waves ($= 3 \times 10^8$ km per second)	kilometers per second
V/V'	Velocity ratio.	numeric
$m \equiv V'/V = \beta/\beta'$	Reciprocal of the velocity ratio.	numeric
$j = \sqrt{-1}$ θ	The angle between the axis of the wave-antenna and the direction of propagation of space waves measured in a clock-wise direction.	
$R.D.R. = \frac{I_\theta}{I_0}$	Relative directional receptivity.	numeric

Appendix 2

ANTENNA ARRAYS

The directional discrimination yielded by a single antenna can be increased by utilizing several such antennas in an array.¹⁶ In

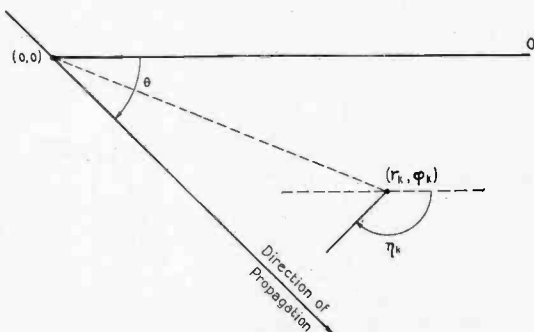

Fig. 18.

Fig. 18, a general array of n antennas is indicated, of which only the first and the k 'th are portrayed.

Each antenna in the array is completely specified by the coordinates of the initial end of the antenna, the angle between the zero axis of the coordinate system and the axis of the antenna, and the current delivered at the receiving end of the antenna for a given electric field impressed on the antenna at each angle of incidence with the antenna. Literally, the first and the k 'th antennas are specified as follows:

	<i>First Antenna</i>	<i>k'th Antenna</i>
Coordinates of initial end of antenna	(0,0)	(r_k, ϕ_k)
Direction of antenna	0	η_k
Current delivered by antenna for a constant electric field propagated in the direction θ	I_θ	$I_{\theta k}$

For the purpose of this discussion, it is sufficiently accurate to assume that the propagation of space waves over the area covered by the array only involves phase retardation, i.e.,

$$\gamma' = j\beta' \tag{201}$$

The output of the k 'th antenna is transmitted through a linear transducer having a transfer constant P_k to a common point where it is combined with the outputs of the other antennas of the array. The current from the k 'th antenna at the point of combination is therefore

$$J_{k\theta} = I_{\theta k} \epsilon^{-j\beta' [r_k/V'] \cos(\theta - \phi_k)} \epsilon^{-P_k} \tag{202}$$

where

$$\theta_k = \theta - \eta_k \tag{203}$$

and

$$\beta' = \frac{2\pi V'}{\lambda'} \tag{204}$$

The total current received from the n antennas of the array is equal to the sum of the currents received from the individual antennas, or

$$J_\theta = \sum_{k=1}^{k=n} I_{\theta k} \epsilon^{-j[2\pi r_k/\lambda'] \cos(\theta - \phi_k)} \epsilon^{-P_k} \tag{205}$$

Equation (205) gives the total current received from any array of antennas for any direction of wave propagation in a horizontal plane. This general expression is not adapted to ready determination of directional characteristics of antenna systems,

but it may be simplified by placing the following restrictions on the individual antennas forming the array and their space relations in the array:

(1) The antennas are all alike. This restriction may be defined by the expression:

$$I_{\theta k} = I_{\theta(k+1)}$$

(2) The axes of the antennas are parallel, as defined by the expression

$$\eta_k = 0 \text{ or } \pi$$

(3) The initial ends of the antennas are equally spaced along straight lines in each sub-group and the sub-groups are equally spaced along straight lines. All of the sub-groups are identical.

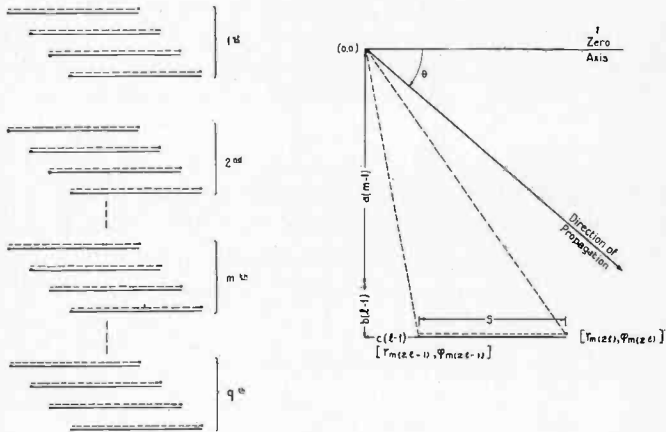

Fig. 19.

The general antenna array conforming to these restrictions is shown in Fig. 19. In this figure, there are q groups of antennas equally spaced by the distance a along a line 90 deg. from the zero axis. In each of these q groups of antennas, there are p antennas, divided into two series, those for which $\eta = 0$ being numbered $1, 3, \dots, (2l-1), \dots, (p-1)$ and those for which $\eta = \pi$ being numbered $2, 4, \dots, 2l, \dots, p$, the initial ends of the second series being removed by a distance s from the initial ends of the first series, along the axes of the antennas of the first series.

Equation (205) applied to this general array gives for the total current received from the array

$$\begin{aligned}
 J_{\theta} = & I_{\theta} \sum_{m=1}^{m=q} \sum_{2l=2}^{2l=p} \epsilon^{-j \frac{2\pi r_{m(2l-1)}}{\lambda'}} \cos(\theta - \phi_{m(2l-1)}) \epsilon^{-P_{m(2l-1)}} \\
 & + I_{\theta-\pi} \sum_{m=1}^{m=q} \sum_{2l=2}^{2l=p} \epsilon^{-j \frac{2\pi r_{m(2l)}}{\lambda'}} \cos(\theta - \phi_{m(2l)}) \epsilon^{-P_{m(2l)}} \quad (206)
 \end{aligned}$$

where

$$r_{m(2l-1)} = \sqrt{[a(m-1) + b(l-1)]^2 + [c(l-1)]^2} \quad (207)$$

$$r_{m(2l)} = \sqrt{[a(m-1) + b(l-1)]^2 + [c(l-1) + s]^2} \quad (208)$$

$$\phi_{m(2l-1)} = \tan^{-1} \left[\frac{a(m-1) + b(l-1)}{c(l-1)} \right] \quad (209)$$

$$\phi_{m(2l)} = \tan^{-1} \left[\frac{a(m-1) + b(l-1)}{c(l-1) + s} \right] \quad (210)$$

In a double summation, the result is independent of the order in which the summations are taken. If then we write

$$u_{\theta} = \sum_{2l=2(m-1)}^{2l=p} \epsilon^{-j \frac{2\pi r_{m(2l-1)}}{\lambda'}} \cos(\theta - \phi_{m(2l-1)}) \epsilon^{-P_{m(2l-1)}} \quad (211)$$

$$v_{\theta} = \sum_{m=1(2l=2)}^{m=q} \epsilon^{-j \frac{2\pi r_{m(2l-1)}}{\lambda'}} \cos(\theta - \phi_{m(2l-1)}) \epsilon^{-P_{m(2l-1)}} \quad (212)$$

$$w_{\theta} = \sum_{2l=2(m=1)}^{2l=p} \epsilon^{-j \frac{2\pi r_{m(2l)}}{\lambda'}} \cos(\theta - \phi_{m(2l)}) \epsilon^{-P_{m(2l)}} \quad (213)$$

$$y_{\theta} = \sum_{m=1(2l=2)}^{m=q} \epsilon^{-j \frac{2\pi r_{m(2l)}}{\lambda'}} \cos(\theta - \phi_{m(2l)}) \epsilon^{-P_{m(2l)}} \quad (214)$$

The expression for the total current may be written

$$J_{\theta} = I_{\theta} u_{\theta} v_{\theta} + I_{\theta-\pi} w_{\theta} y_{\theta} \quad (215)$$

If the transducers in the circuits from each antenna of a pair are so related that

$$P_{m(2l)} - P_{m(2l-1)} = P_c, \quad (216)$$

the expression for the total current becomes

$$J_{\theta} = u_{\theta} v_{\theta} [I_{\theta} + I_{\theta-\pi} \epsilon^{-j [2\pi s/\lambda']} \cos \theta \epsilon^{-P_c}] \epsilon^{-P_1} \quad (217)$$

The directional diagram in terms of relative directional receptivity is

$$RDR = \frac{J_\theta}{J_0} = \frac{u_\theta}{u_0} \times \frac{v_\theta}{v_0} \times \left[\frac{I_\theta + I_{\theta-\pi} \epsilon^{-j[2\pi s/\lambda'] \cos \theta} \epsilon^{-P_c}}{I_0 + I_{-\pi} \epsilon^{-j[2\pi s/\lambda'] \epsilon^{-P_c}} \right] \quad (218)$$

Since there has been no assumption to this point of the character of I_θ , the significance of the coefficients u_θ and v_θ may be determined by assuming

(1) $I_\theta = I_0$, which is the directional characteristic of a vertical antenna

(2) $s = 0$

(3) $P_c = \infty$

Consideration of (218) in light of (211) and (212) under these conditions leads to the conclusion that

$$\frac{u_\theta}{u_0} \text{ and } \frac{v_\theta}{v_0}$$

are the relative directional receptivities of two arrays of vertical antennas placed at the initial ends of the antennas comprising the desired array. If, then, we designate the relationship between antennas indicated by the expression

$$J_c = [I_\theta + I_{\theta-\pi} \epsilon^{-j[2\pi s/\lambda'] \cos \theta} \epsilon^{-P_c}] \quad (219)$$

as *compensation*¹³ and recognize that this expression gives the directional characteristic of a compensated antenna, we may formulate the rule that the directional characteristic of an array of similar parallel unit antennas is equal to the product of the directional characteristic of the unit antenna and the directional characteristic of an array of unit vertical antennas placed at the initial ends of the unit antennas forming the array, the product being taken point-for-point as the angle of incidence increases. The relative directional receptivity of each fundamental array of vertical antennas is termed the array factor, so that similarly, the relative directional receptivity of an array of similar parallel unit antennas is given by the product of the relative directional receptivity of the unit antenna and the array factor. This method may be extended to the solution of a complicated array such as that shown in Fig. 19, by determining the relative directional receptivity for groups of unit antennas, then determining the array factor for these groups taken as unit antennas. Expressed literally for a complex array of this type:

$$RDR_{\text{array}} = [A_1 \times A_2 \times \cdots \times A_n] RDR_{\text{unit antenna}} \quad (220)$$

where $A_1 \dots, A_n$ are the array factors for the fundamental groups into which the complete array may be divided.

Appendix 3

WAVE TILT AND GROUND CONDUCTIVITY

In Zenneck's^{31,32} exposition of the relation between the horizontal and vertical components of a plane electric wave propagated along a horizontal surface between two media, it is demonstrated that these two constituents of the wave in the upper medium (1) are related by the expression

$$-\frac{F'}{E'} = \epsilon^{j\theta} \tan T = \sqrt{\frac{9 \times 10^{11}}{\rho_1} + j\frac{1}{4\pi}\omega k_1}{9 \times 10^{11} + j\frac{1}{4\pi}\omega k_2} \quad (301)$$

where

SYMBOL	DEFINITION	UNIT
F'	The horizontal component of the electric wave in medium 1. (Positive direction in the direction of propagation along the interface.)	volts per kilometer
E'	The vertical component of the electric wave in medium 1. (Positive direction downward.)	volts per kilometer
ρ_1	Specific resistivity of medium 1.	ohms per centimeter cube
ρ_2	Specific resistivity of medium 2.	ohms per centimeter cube
k_1	Dielectric constant of medium 1 and equal to unity for a vacuum.	numeric
k_2	Dielectric constant of medium 2.	numeric
f	Frequency.	cycles per second
ω	$2\pi f$	

Our primary interest is in the case where the first medium is air, and the second medium is the earth beneath an antenna system. In this case the constants of the media may be given the values:

$$\begin{aligned} \rho_1 &= \infty && \text{(air)} \\ \rho_2 &= \rho && \text{(earth)} \\ k_1 &= 1 && \text{(air)} \\ k_2 &= k && \text{(earth)} \end{aligned}$$

Substituting these values into the general equation (301)

$$\frac{F'}{E'} = \epsilon^{j\delta} \tan T = \frac{1}{\sqrt{k}} \left[\frac{\left(\frac{fk\rho}{18 \times 10^{11}} \right)^2}{1 + \left(\frac{fk\rho}{18 \times 10^{11}} \right)^2} \right]^{1/4} \epsilon^{j[1/2 \tan^{-1}(18 \times 10^{11}/fk\rho)]} \quad (302)$$

At this point it is desirable to indicate the significance of the term "quasi-tilt angle" as applied to T . It is seen that $(\tan T)$ is the absolute magnitude of the ratio of the horizontal and vertical components of the electric field. In the case that the time phase between the two components of the field is zero (i.e., $\delta = 0$), T would represent the angle of forward inclination of the propagated wave front. In general, δ is unequal to zero and hence the angle of inclination of the major axis of the ellipse traced by the electric vector is less than T , but it still remains convenient to express the ratio of the magnitudes of the two components of the field as the tangent of an angle. This angle cannot be called the wave tilt, however, but the term "quasi-tilt angle" may safely be applied to it.

The ground constants may be determined from measurement of the "quasi-tilt angle" as the following development shows:

Equation (302) may be written as two equations

$$\tan T = \frac{1}{\sqrt{k}} \left[\frac{\left(\frac{fk\rho}{18 \times 10^{11}} \right)^2}{1 + \left(\frac{fk\rho}{18 \times 10^{11}} \right)^2} \right]^{1/4} \quad (303)$$

$$\delta = \frac{1}{2} \tan^{-1} \left(\frac{18 \times 10^{11}}{fk\rho} \right) \quad (304)$$

Solving equations (303) and (304) as simultaneous equations for δ in terms of k and T and for ρ in terms of f , k , and T yields

$$\delta = \frac{1}{2} \cos^{-1} (k \tan^2 T) \quad (305)$$

$$\rho = \frac{18 \times 10^{11}}{f} \frac{\tan^2 T}{\sqrt{1 - k^2 \tan^4 T}} \quad (306)$$

These two expressions have been evaluated for the extreme range of values of k that would be met in practice (k between 1 and 100)

and for values of T between 0.002 and 0.2 radian and are plotted in Fig. 20. The figures for dielectric constant given by Fleming³³ show that for earth, the maximum value of k to be expected is below 20. It is evident, therefore, that δ is negligibly different from $\pi/4$ for values of T below 0.05 radian in the vicinity of an antenna which is constructed over land. Also Fig. 20 shows that

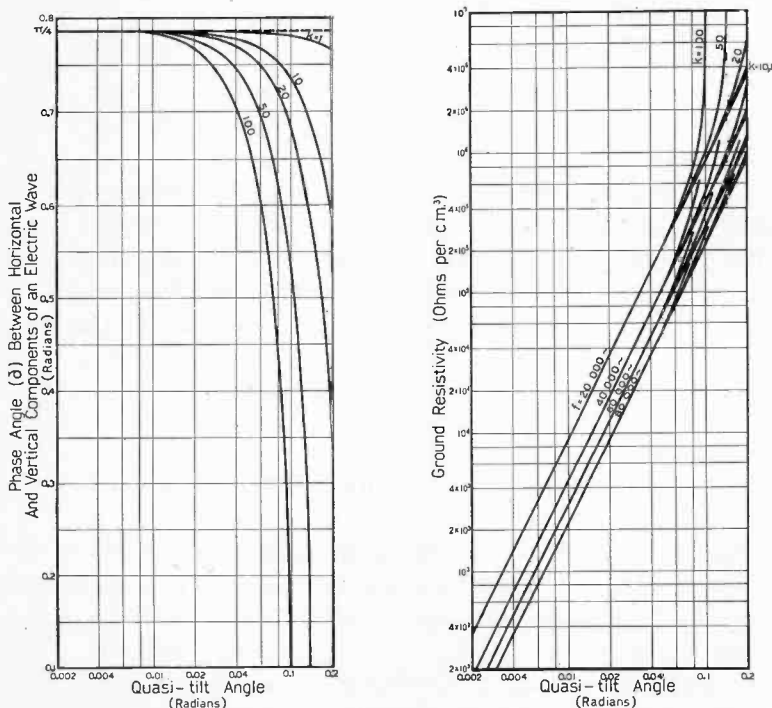

Fig. 20—Relation between Quasi-Tilt Angle, Ground Resistivity, and Phase Angle between Horizontal and Vertical Components of an Electric Wave. (By Zenneck's Formula.)

the specific resistivity is practically independent of k for the same range of T . Fortunately, the measured values of T lie within these limits, so that the time phase difference between the horizontal and vertical components of an electric wave and the ground resistivity may be evaluated with but slight error from measurements of the quasi-tilt angle.

³³ J. A. Fleming, "Principles of Electric Wave Telegraphy and Telephony," Longmans, Green and Co., 1916. 3rd edition, p. 800.

Appendix 4

PROBABILITY OF VOLTAGES GREATER THAN ANY SPECIFIED VALUE
 RESULTING FROM THE SIMULTANEOUS RECEPTION OF
 SEVERAL RADIO-TELEGRAPH STATIONS IN A
 RESTRICTED FREQUENCY RANGE

In order to determine the required load capacity of vacuum tubes for a radio receiver, it is necessary to obtain some estimate of the voltages from interfering signals which may occur at the input of the radio receiver and during how much of the time certain specified voltages are exceeded.

If we assume that there are N telegraph stations within a restricted frequency range, that each station contributes equal unit voltage at the receiver, and that the probability of the key being closed at any one station is constant, then the probability that exactly n stations have their keys depressed at the same time is

$$P_n = \frac{N!}{n!(N-n)!} K^n (1-K)^{(N-n)} \quad (401)$$

where K is the fraction of the total time that each station has its key depressed.

In order to determine the probability that n stations will produce a voltage equal to or greater than any specified value x we have followed Rayleigh's problem of random phases as explained in Volume 6 of his "Scientific Papers," page 618. While the conditions are not all satisfied it can be shown that they are approximately satisfied for the great majority of possible combinations and for small time intervals. The formula of Rayleigh gives the probability that the resultant of n vectors lies within an arbitrary interval $(r - dr/2, r + dr/2)$. Since we will assume sinusoidal voltages in the actual problem under consideration we require the probability that the projection of the resultant on the real axis is greater than a given value of x . This can be calculated by changing the polar coordinates of Rayleigh's formula to rectangular coordinates and integrating with respect to y from $-\infty$ to $+\infty$ and then with respect to x from x to $+\infty$.

The integrated formula then becomes

Probability of a voltage greater than $x = P_x$

$$P_x = A_1 \Gamma\left(\frac{1}{2}, \frac{x^2}{n}\right) + A_2 \Gamma\left(\frac{3}{2}, \frac{x^2}{n}\right) + A_3 \Gamma\left(\frac{5}{2}, \frac{x^2}{n}\right) + A_4 \Gamma\left(\frac{7}{2}, \frac{x^2}{n}\right) + A_5 \Gamma\left(\frac{9}{2}, \frac{x^2}{n}\right) \quad (402)$$

where

$$A_1 = \frac{1}{2\sqrt{\pi}} \left(1 - \frac{3}{16n} - \frac{5}{24n^2} + \frac{105}{16 \cdot 32n^2} \right)$$

$$A_2 = \frac{1}{2n\sqrt{\pi}} \left(\frac{3}{4} - \frac{25}{64n} \right)$$

$$A_3 = \frac{1}{2n\sqrt{\pi}} \left(-\frac{1}{4} + \frac{155}{192n} \right)$$

$$A_4 = \frac{1}{2n\sqrt{\pi}} \left(-\frac{47}{144n} \right)$$

$$A_5 = \frac{1}{2n\sqrt{\pi}} \left(\frac{1}{32n} \right)$$

and

$$\Gamma(p, u\sqrt{p}) = \Gamma(p) [1 - I(u, p-1)]$$

in which

$$p = \frac{1}{2}, \frac{3}{2}, \frac{5}{2}, \frac{7}{2}, \frac{9}{2} \text{ and } u\sqrt{p} = \frac{x^2}{n}$$

Having found u , the I functions of $(u, p-1)$ can be obtained from Pearson's "Tables of the Incomplete Γ -Functions." $\Gamma(p)$ for the values of p given above is found to be

$$\sqrt{\pi}, \frac{1}{2}\sqrt{\pi}, \frac{3}{2} \cdot \frac{1}{2} \cdot \sqrt{\pi}, \frac{5}{2} \cdot \frac{3}{2} \cdot \frac{1}{2} \cdot \sqrt{\pi}, \frac{7}{2} \cdot \frac{5}{2} \cdot \frac{3}{2} \cdot \frac{1}{2} \cdot \sqrt{\pi}$$

The probability of exactly n stations being on at the same time multiplied by the probability that exactly n stations will give a voltage equal to or greater than x equals the probability of obtaining a voltage equal to or greater than x from just n stations.

Hence the summation from $n=1$ to $n=N-1$ of these probabilities for a given value of x will give the probability of obtaining a voltage equal to or greater than x from all of the N stations in the restricted frequency range considered or

$$P_{xN} = \sum_{n=1}^{n=N-1} P_n P_x \tag{403}$$

In a vacuum tube large negative voltages are equally as important as large positive voltages in producing distortion. Equation (403) has been derived for positive values greater than x but negative values greater than $-x$ are equally probable and therefore the fraction of the time that the absolute value of voltage is equal to or greater than x is $2P_{xN}$ or

$$P_{|x|N} = 2P_{xN} \tag{404}$$

Specific cases which approximate the existing conditions of long-wave transatlantic reception have been calculated from

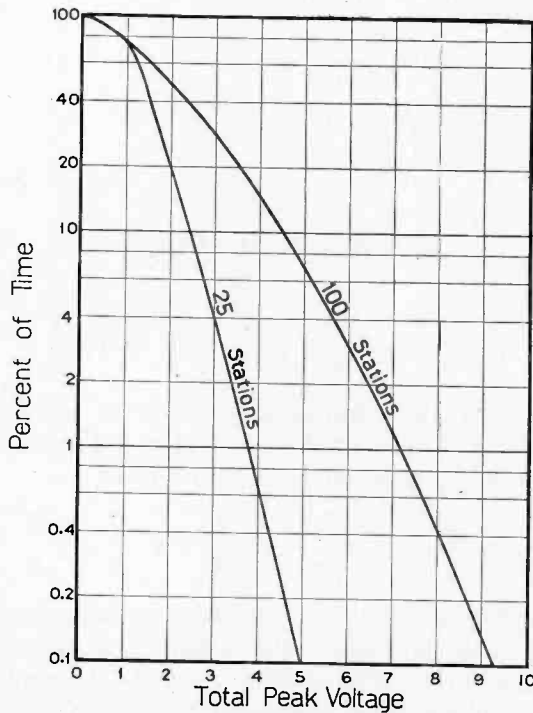

Fig. 21—Voltages Resulting from Several Unit Voltages Each Applied 15 per cent of the Time and with Random Phase and Frequency.

equation (404) and are shown in Fig. 21. These curves are based on the following assumptions:

1. That the number of stations lying in the restricted frequency range is $N = 100$ and $N = 25$.
2. That each station contributes unit peak voltage to the input of the radio receiver.
3. That each station has its key depressed 15 per cent of the total time during any day. $K = 0.15$.
4. That transmissions from all stations are random.

Considerable valuable assistance in the preparation of this appendix has been obtained from Dr. F. H. Murray of this department and the authors wish to express their appreciation of this aid.

ON THE VARIATION OF GENERATED FREQUENCY OF A TRIODE OSCILLATOR DUE TO CHANGES IN FILAMENT CURRENT, GRID VOLTAGE, PLATE VOLTAGE, OR EXTERNAL RESISTANCE*

By

KEITH B. ELLER

(Research Department, Western Union Telegraph Company, New York City)

Summary—The general expressions for the generated frequency of the grid-tuned and the plate-tuned oscillators are developed. In developing these expressions it is assumed that the grid takes a convection current and that there are external resistances in the circuits. The equations which represent the frequency of oscillation of the two types of oscillators are similar and indicate that in order to transform from one type of generator to the other it is only necessary to interchange the plate-circuit constants with the grid-circuit constants.

The effect of making any change in the circuit conditions which causes the grid current to increase is observed to cause the frequency of oscillation to decrease; and likewise any change which does not affect the grid current does not affect the frequency.

For fixed grid-battery voltage and plate-battery voltage the effect of decreasing the filament current below its rated value is to increase the generated frequency for both types of oscillators. This change in frequency is greatest for positive values of grid-battery voltage and low plate-battery voltage. With fixed filament current and plate-battery voltage, the effect of changing the grid-battery voltage from negative to positive values is to cause at first a decrease and then an increase in the generated frequency. This change in frequency is greatest for low plate-battery voltages and high (near rated) filament currents.

For fixed filament current and grid-battery voltage the effect of increasing the plate-battery voltage is first to lower the generated frequency and then to raise it.

For both types of oscillators, the effect of inserting a resistance (0 to 600 ohms) in series with the condenser is to increase the generated frequency for all values of E_c , E_b , and I_f . The presence of this resistance does not greatly affect the shape of the frequency-grid voltage curves. For low values of plate-battery voltage the effect of a resistance in series with the tuned coil is to cause the frequency of oscillations to increase for both types of oscillators. However, for high values of plate-battery voltage the effect of this resistance is opposite for the two oscillators. For high E_b , the effect of increasing the resistance in the inductance branch is to decrease the frequency in the case of a grid-tuned oscillator and to increase the frequency in the case of a plate-tuned oscillator. The equations developed in this paper indicate that the grid current is responsible for the decrease in frequency with increase of the resistance in the inductance branch in the case of a grid-tuned oscillator with high plate voltage.

* Original Manuscript Received by the Institute, July 14, 1928. Contribution from Mendenhall Laboratory of Ohio State University.

For both types of oscillators, the effect of inserting a resistance in series with the tuned circuit as a whole is observed to cause the frequency at first to increase rapidly and then to become constant. For high values of this resistance (10,000 ohms) the frequency of oscillation is practically independent of grid voltage and particularly so for high plate voltage. For low values of plate-battery voltage the effect of a resistance in series with the exciting or tickler coil is to cause the frequency to increase rapidly for values of this resistance less than about 10,000 ohms and to cause only a slight further increase in frequency for values of resistance greater than 10,000 ohms. However, for high values of plate-battery voltage the effect of a resistance in series with the tickler coil is to decrease at first the frequency and then to increase it. The effect of this resistance is in general the same for both types of oscillators. The frequency variation is greatest for positive values of grid-battery voltage.

The grid-tuned generator will oscillate over a much wider range of variables than will the plate-tuned oscillator and frequency variation for the same change in circuit conditions will in general be less for the grid-tuned than for the plate-tuned oscillator.

The above discussion applies to oscillators without a grid-leak and grid condenser.

With properly selected values of grid-leak resistance and grid capacity both the grid-tuned and the plate-tuned oscillators may be made to generate a frequency which is very nearly that given by the equation $f = \frac{1}{2\pi\sqrt{LC}}$ for relatively large changes in E_a , E_b , and I_f . In this work, by using a grid capacity of 0.025 μf and a grid leak of 0.5 megohm the frequency variations were about 0.1 per cent for a 60 per cent change in plate-battery voltage and 0.08 per cent for a 30 per cent change in filament current for the grid-tuned oscillator. For the plate-tuned oscillator the frequency variations were 0.087 per cent and 0.027 per cent for 60 per cent change in E_b and 30 per cent change in I_f , respectively. These figures represent experimental results obtained near 1000 cycles per second. The theoretical equations developed seem to explain all of the experimental curves obtained.

The results of this work indicate that with the given methods of operation, and by holding the values of the grid voltage, plate voltage and filament current constant within practical limits, the plate-tuned oscillator can readily be made to generate a frequency constant to one part in 20,000. By more refined precautions the constancy can be made still greater.

INTRODUCTION

THE variation of frequency of a triode oscillator has been noted and examined by various investigators. The work of Martyn¹ and of Eccles and Vincent² is of particular interest.³ The investigation* by Eccles and Vincent was carried

¹ *Phil. Mag.* 4, Nov. 1927; p. 922.

² *Proc. Roy. Soc.*, 96 and 97 (1920).

³ The subject of stability of thermionic oscillators at radio frequency is dealt with in a somewhat different manner by Lieut. Col. Edgeworth, *Jour. I.E.E.*, 64, p. 349.

on at radio frequencies and the results were almost entirely experimental. Martyn's work, published since the author's investigation was completed, was conducted at frequencies near 1000 cycles per second for a plate-tuned oscillator. Theoretical equations were developed and used to check the experimental observations as to order of magnitude of frequency variation.

This paper is the result of a more complete study of the dependence of the generated frequency of a triode oscillator on the filament current, grid voltage, and plate voltage for two types of circuits—the grid-tuned and the plate-tuned oscillators. In addition, the effect of including external resistance in the various circuits of each type oscillator is shown. Theoretical expressions for the frequency of these two types of oscillators are

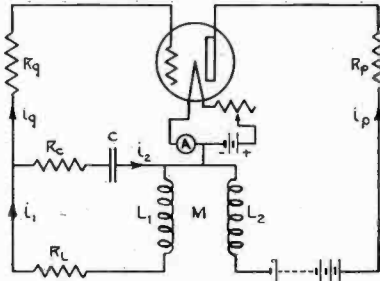

Fig. 1—Tuned-Grid Oscillator.

developed for the case where the grid is assumed to take a convection current and where a resistance is placed in each of the external circuits. Optimum conditions of operation are determined under which the tube oscillator maintains a high degree of stability under changing conditions of filament-current plate voltage and grid voltage. This work is then confirmed experimentally for frequencies near 1000 cycles.

EXPERIMENTAL PROCEDURE

Figs. 1 and 2 show the circuits under test. In the experimental work, four single-pole double-throw knife switches were so arranged as to permit a quick change from one type of oscillator to the other. It will be noticed that coil L_1 was used as the tuned coil for both the grid-tuned and the plate-tuned oscillators. Both types of oscillators were studied at the same time. That is, for a given E_c (grid-battery voltage) and E_b (plate-battery voltage) the variation of frequency with filament current was observed

for both types of oscillators before either the grid or plate voltage was changed. The grid-battery voltage was then changed and the same procedure repeated. After data for the desired range of grid voltages were thus obtained the plate voltage was changed and the entire procedure repeated. The data for the frequency variation as a function of the various external resistances were taken in a similar manner. For each curve shown all external resistances were zero except those mentioned. The filament current was maintained constant for all readings except those which were recorded as a function of filament current. If any change was made which caused the filament current, as read by the meter in the position indicated in Figs. 1 and 2, to vary, this current was brought back to the original value by readjusting

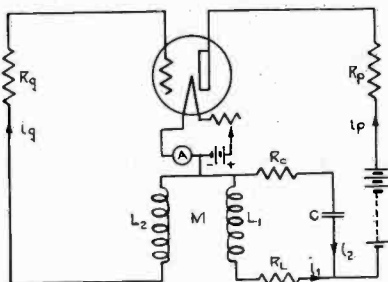

Fig. 2—Tuned-Plate Oscillator.

the filament rheostat. Should the grid and plate return have been connected between the filament and ammeter instead of between the battery and ammeter all of the curves would be somewhat different in shape. The frequency generated was in the neighborhood of 1000 cycles per second.

Various tubes of the UX-201-A type were used in these experimental tests but no difference in the general character of the frequency variation was noted. One set of coils was used throughout, and their relative positions remained fixed. The circuits used had the following constants:

- $L_1 = 257.0$ millihenries
- $L_2 = 213.3$ millihenries
- $-M = 125.1$ millihenries
- $C = 0.100$ microfarad
- Resistance of $L_1 = 14.29$ ohms
- Resistance of $L_2 = 12.30$ ohms

Changes in frequency of the oscillator under test were detected and measured by comparison with a standard oscillator which had been calibrated as a frequency meter. Each oscillator produced an audible tone in a telephone receiver. The frequency of the standard oscillator was set equal to that of the oscillator under test by means of audible beats.

THEORY OF TUNED GRID OSCILLATOR

In nearly all theoretical developments on the thermionic oscillator the grid current is assumed to be small enough to be neglected. In the following development the grid current is assumed large enough to be considered, a condition which frequently holds in practice.

When the grid current is not assumed to be zero it at once becomes necessary to introduce a term ν , which bears the same relation to the grid circuit as μ , the amplification factor, does to the plate circuit. Since the grid is allowed to take a convection current the expression for the grid current will be similar to that for the plate current. Both the grid and plate currents are functions of the grid and plate potentials. Therefore the fundamental relations are

$$\begin{aligned} I_p &= f(E_g, E_p) \\ I_g &= F(E_g, E_p) \end{aligned}$$

where both E_g and E_p are variable. Suppose E_g and E_p vary in such a manner that the plate current I_p remains constant. Then

$$\frac{dI_p}{dE_g} = \frac{\partial I_p}{\partial E_g} + \frac{\partial I_p}{\partial E_p} \frac{dE_p}{dE_g} = 0.$$

If the grid current I_g is held constant,

$$\frac{dI_g}{dE_p} = \frac{\partial I_g}{\partial E_p} + \frac{\partial I_g}{\partial E_g} \frac{dE_g}{dE_p} = 0.$$

Where $E_p = (E_b + e_p)$ and $E_b =$ plate-battery voltage

$E_g = (E_c + e_g)$ $E_c =$ grid-battery voltage

$I_p = (I_b + i_p)$ $I_b =$ steady plate current

$I_g = (I_c + i_g)$ $I_c =$ steady grid current

and

$$\frac{\partial I_p}{\partial E_g} = g_m = \text{mutual plate conductance}$$

$$\frac{\partial I_p}{\partial E_p} = \frac{1}{r_p} = \text{plate conductance}$$

$$\frac{\partial I_o}{\partial E_p} = g_m = \text{mutual grid conductance}$$

$$\frac{\partial I_o}{\partial E_o} = \frac{1}{r_o} = \text{grid conductance.}$$

i_p represents the variation in I_p

e_p represents the variation in E_p

i_o represents the variation in I_o

e_o represents the variation in E_o

μ , the amplification factor, and ν , the "reflex factor"⁴ are defined by the relations

$$\mu = \frac{\frac{\partial I_p}{\partial E_o}}{\frac{\partial I_p}{\partial E_p}} = -\frac{dE_p}{dE_o} = g_m r_p \text{ for } I_p \text{ held constant}$$

$$\nu = \frac{\frac{\partial I_o}{\partial E_o}}{\frac{\partial I_o}{\partial E_p}} = -\frac{dE_p}{dE_o} = \frac{1}{g_m r_o} \text{ for } I_o \text{ held constant}$$

A voltage e_o in the grid circuit is equivalent to a voltage μe_o in the plate circuit. Hence we may write

$$i_p r_p = e_p + \mu e_o$$

A voltage e_p in the plate circuit is equivalent to a voltage e_p/ν in the grid circuit. Therefore we have

$$i_o r_o = e_o + \frac{e_p}{\nu}$$

Where r_p = internal plate resistance
and r_o = internal grid resistance.

These relations will now be used in writing the circuit equations for the grid-tuned oscillator represented by Fig. 1.

$$i_p r_p = e_p + \mu e_o$$

⁴ Llewellyn. *Bell Sys. Tech. Journal*, V, July, 1926.

$$\begin{aligned}
 i_o r_o &= e_o + \frac{e_p}{\nu} \\
 e_p &= - [L_2 D i_p + M D i_1 + R_p i_p] \\
 e_o &= - [L_1 D i_1 + M D i_p + R_L i_1 + R_o i_o] \\
 &= R_c i_2 + \frac{q}{C} - R_o i_o
 \end{aligned}$$

These equations determine the polarity of M , i.e., M is intrinsically a negative quantity. $D = d/dt$; $D^2 = d^2/dt^2$ etc., and q is the instantaneous change on the condenser C .

By means of the above equations the following differential equation is obtained, expressing the current in the oscillating circuit as a function of the circuit constants:

$$a \frac{d^4 i_1}{dt^4} + b \frac{d^3 i_1}{dt^3} + c \frac{d^2 i_1}{dt^2} + d \frac{d i_1}{dt} + e i_1 = 0$$

assuming a sinusoidal current $i = I e^{j\omega t}$ and substituting the proper derivatives gives

$$a\omega^4 - b j \omega^3 - c\omega^2 + d j \omega + e = 0 \quad (1)$$

where

$$\begin{aligned}
 a &= \left\{ [L_1 L_2 - M^2] \left[r_o + \left(1 - \frac{\mu}{\nu} \right) (R_c + R_o) \right] C^2 R_c \right\} \\
 b &= \left\{ [L_1 L_2 - M^2] \left[r_o + \left(1 - \frac{\mu}{\nu} \right) (R_o + 2R_c) \right] \right. \\
 &\quad + (r_p + R_p)(r_o + R_o)L_1 C R_c + (r_p + R_p)L_1 C R_c^2 \\
 &\quad + \left(1 - \frac{\mu}{\nu} \right) [(R_L + R_c)R_o + R_L R_c] L_2 C R_c + \left[(R_c + R_L)r_o L_2 \right. \\
 &\quad \left. - \frac{\mu}{\nu} L_1 R_p (R_o + R_c) \right] C R_c + \left(\mu M r_o + \frac{M}{\nu} r_p \right) C R_c^2 \left. \right\} C \\
 c &= \left\{ \left(1 - \frac{\mu}{\nu} \right) \{ L_1 L_2 - M^2 + 2C R_c [(R_o + R_L)L_2 + R_p L_1] \right. \right. \\
 &\quad + [R_L L_2 + R_p (L_1 + R_L C R_c)] C R_o + (R_L + R_o) R_p C^2 R_c^2 \left. \right\} \\
 &\quad + (L_2 r_o + C R_c^2 r_p) C R_L + \left[(L_2 + \mu M)r_o + \left(L_1 + \frac{M}{\nu} \right) r_p \right] 2C R_c
 \end{aligned}$$

$$d = \left\{ \begin{aligned} &+ [L_1 + (R_L + R_C)CR_C] [(r_p + R_p)r_o + R_o r_p] C \\ &\left(1 - \frac{\mu}{\nu} \right) [(R_o + R_L)L_2 + R_p L_1] + (L_2 + \mu M)r_o \\ &+ \left(L_1 + \frac{M}{\nu} \right) r_p + (R_C + R_L)(r_o + R_o)(r_p + R_p)C \\ &+ (r_p + R_p)(r_o + R_o + 2R_L)CR_C \\ &- [2(R_L + R_o)CR_C + R_o CR_L] \frac{\mu}{\nu} R_p \end{aligned} \right\}$$

and

$$e = \left\{ (r_p + R_p)(r_o + R_o + R_L) - \frac{\mu}{\nu} R_p (R_L + R_o) \right\}.$$

THEORY OF TUNED-PLATE OSCILLATOR

A similar analysis will now be made of the audion oscillator with the oscillatory circuit connected to the plate. Referring to Fig. 2 and using the same definitions of μ and ν , we obtain the following fundamental equations:

$$i_p r_p = e_p + \mu e_o$$

$$i_o r_o = e_o + \frac{e_p}{\nu}$$

$$e_p = - [L_1 D i_1 + M D i_o + R_L i_1 + R_p i_p]$$

$$= - \left[R_C i_2 + \frac{q}{C} + R_p i_p \right]$$

$$e_o = - [L_2 D i_o + M D i_1 + R_o i_o]$$

As in the case of the grid-tuned oscillator, the following expression is obtained for the oscillating current:

$$a' \omega^4 - b' \omega^3 - c' \omega^2 + d' \omega + e' = 0 \tag{2}$$

Where a' , b' , c' , d' , and e' are obtained from the expressions for a , b , c , d , and e , respectively, by changing

$$r_o \text{ to } r_p \text{ and } r_p \text{ to } r_o$$

$$R_o \text{ to } R_p \text{ and } R_p \text{ to } R_o$$

$$\frac{1}{\nu} \text{ to } \mu \text{ and } \mu \text{ to } \frac{1}{\nu}$$

$$\nu \text{ to } \frac{1}{\mu} \text{ and } \frac{1}{\mu} \text{ to } \nu$$

The real and imaginary parts of 1 (or 2) must vanish separately; that is,

$$a\omega^4 - c\omega^2 + e = 0 \quad (3)$$

$$-bj\omega^3 + dj\omega = 0 \quad (4)$$

and
from (4)

$$\omega^2 = (2\pi f)^2 = \frac{d}{b} \quad (5)$$

from (3)

$$\omega^2 = \frac{c \pm \sqrt{c^2 - 4ae}}{2a} \quad (6)$$

Equating (5) and (6) gives the limiting condition for oscillation to be

$$2ad - b(c \pm \sqrt{c^2 - 4ae}) = 0 \quad (7)$$

Equation (3), however, gives the expression for the frequency of oscillation. To simplify the discussion of (3) certain factors will be considered negligibly small and the variation due to the remaining factors will be examined.

THEORETICAL AND EXPERIMENTAL RESULTS

The four variables r_p , r_g , μ and ν were measured, using a General Radio hummer as a source of power. Due to the fact that the filament current was maintained constant, the form of the curves showing the variation of these variables with grid voltage is somewhat different from that usually obtained. The general shape of these curves is indicated in Fig. 3. When computing the frequency by the above formulas it is assumed that the grid potential variation, e_g , is small; in other words, that the average value over the cycle of these variables is the same as that measured by the dynamic method. If the grid potential variation e_g is not small the curve for r_g , r_p , μ or ν , as a function of grid voltage, will not necessarily be symmetrical about the points for which the calculations are made. As a matter of fact, e_g , in this work, was not small and, therefore, the values of r_g ,

r_p , μ and ν , as shown by the curves in Fig. 3, are not the average values over the cycle. However, the frequency curves, as computed by the foregoing equations in which these dynamic values were used, should agree in general shape but not necessarily in numerical value, with the corresponding observed curves. The theoretical curves represent the frequency variation which would

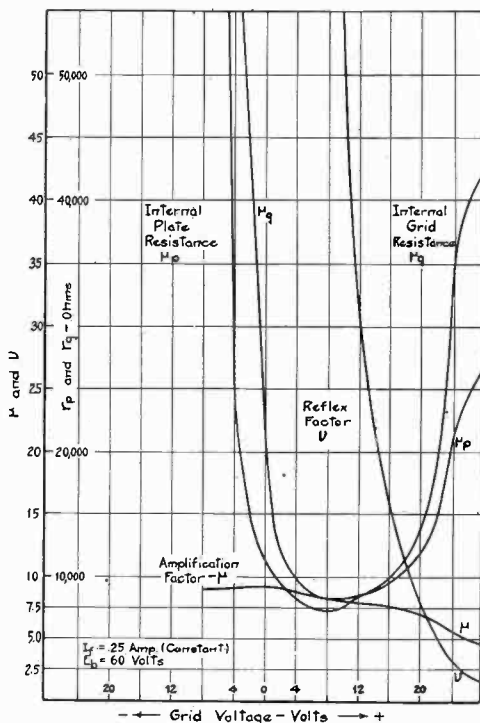

Fig. 3—Variation of Tube Parameters with Grid-Battery Voltage as Measured by Dynamic Method.

be caused by making the given change in the circuit conditions, but at the same time keeping e_o small. In other words, the computed curves assume that the magnitude of e_o is independent of any circuit change and also that e_o is small. The difference between the calculated and observed curves will, therefore, show the effect of a large alternating grid potential upon the frequency. In computing the frequency curves, μ is positive, ν is negative (in general), and M is negative.

The theoretical curves assume that the tube characteristics are linear. Should the non-linear character of the tube character-

istics be taken into account as in the method of Appleton and van der Pol,⁵ the computed curves might be somewhat different.

VARIATION OF FREQUENCY WITH GRID-BATTERY VOLTAGE

Referring to Figs. 1 and 2 it will be noticed that when the external resistances are made zero, we have for the grid-tuned oscillator $R_c=0$ (since a low-loss condenser was used), $R_g=0$, R_L =resistance of L_1 and R_p =resistance of L_2 , and for the tuned-plate oscillator $R_c=0$, R_g =resistance of L_2 , R_L =resistance of L_1 and $R_p=0$.

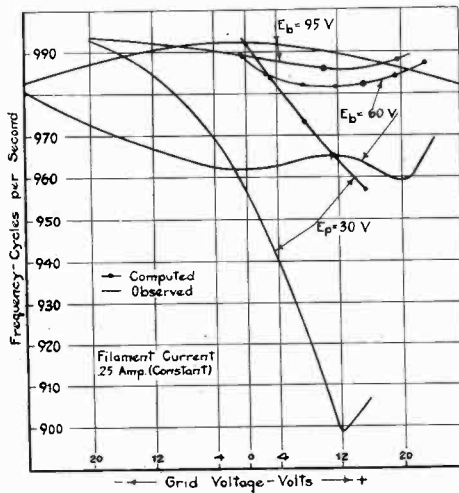

Fig. 4—Variation of Frequency with Grid-Battery Voltage—Grid-Tuned Oscillator.

Under these conditions the expression for the generated frequency of a grid-tuned oscillator becomes

$$f_{(T.G.)} = \frac{1}{2\pi} \sqrt{\frac{1 + \frac{R_L}{r_g} + \frac{R_p}{r_p} + \left(1 - \frac{\mu}{\nu}\right) \frac{R_p R_L}{r_g r_p}}{C \left[L_1 + \frac{\beta}{r_p} \right] + \alpha \left(1 - \frac{\mu}{\nu}\right) \frac{1}{r_g r_p}} \quad (8)$$

and making R_c and $R_p=0$ in (2) gives for the plate-tuned oscillator,

⁵ *Phil Mag.*, 43, 1922.

$$f_{(T.P.)} = \frac{1}{2\pi} \sqrt{\frac{1 + \frac{R_L}{r_p} + \frac{R_o}{r_o} + \left(1 - \frac{\mu}{\nu}\right) \frac{R_o R_L}{r_o r_p}}{C \left[L_1 + \frac{\beta'}{r_o} \right] + \alpha \left(1 - \frac{\mu}{\nu}\right) \frac{1}{r_o r_p}} \quad (9)$$

where $\alpha = (L_1 L_2 - M^2)$, $\beta = (L_1 R_p + L_2 R_L)$, $\beta' = (L_1 R_o + L_2 R_L)$ and $\beta = \beta'$. Since R_L , R_p and R_o are small (about 13 ohms) compared to r_p and r_o , equations (8) and (9) reduce to

$$f_{(T.G.)} = \frac{1}{2\pi \sqrt{C \left(L_1 + \frac{\beta}{r_p} \right) + \alpha \left(1 - \frac{\mu}{\nu}\right) \frac{1}{r_o r_p}}} \quad (10)$$

and

$$f_{(T.P.)} = \frac{1}{2\pi \sqrt{C \left(L_1 + \frac{\beta'}{r_o} \right) + \alpha \left(1 - \frac{\mu}{\nu}\right) \frac{1}{r_o r_p}}} \quad (11)$$

Curves showing the variation of frequency with grid voltage under these conditions are shown in Fig. 4. These curves were obtained with a grid-tuned oscillator, and corresponding curves for the plate-tuned oscillator showed the same general characteristics as would be expected from (10) and (11). For both types of oscillator, as the plate voltage increases any given curve shows less change in frequency for the same change in grid voltage. For low values of filament current the frequency was found to be more nearly constant. Since the internal grid and plate resistances, as measured by the dynamic method, are nearly the same the computed curves for the two types of oscillators would differ very little. The *average* values of the four variables (average over one cycle) r_p , r_o , μ and ν , however, are not the same for the two oscillators, because the magnitude of e_o is not the same in the two cases. This accounts for a small difference observed in the curves for the two oscillators under these conditions.

VARIATION OF FREQUENCY WITH FILAMENT CURRENT

The effect of filament current on the frequency of oscillation can also be studied from (10) and (11). From these equations the frequency variation might be expected to be of the same

general character for both oscillators, and this was found to be true. A few representative curves for the grid-tuned oscillator are shown in Fig. 5. For negative grid-battery voltage the frequency was found to be more nearly constant for low values of plate voltage. However, for positive grid voltage the frequency was more nearly constant when high values of plate voltage were used. The grid-tuned oscillator in general showed less frequency

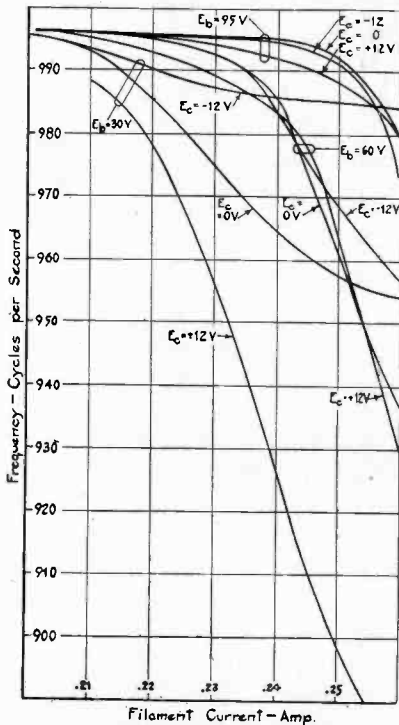

Fig. 5—Variation of Frequency with Filament Current for Various Grid and Plate-Battery Voltages—Grid-Tuned Oscillator.

variation with filament current than did the plate-tuned oscillator.

VARIATION OF FREQUENCY WITH PLATE-BATTERY VOLTAGE

Figs. 6 and 7 are of interest because in addition to showing the frequency variation with plate voltage these two sets of curves are indicative of the relative range of variables over which the two types of generators will oscillate.

The curves shown in Fig. 2 of Martyn's work agree with the curves of Fig. 5 of this work when a negative grid bias is used.

However, as the grid bias is made positive the frequency is more nearly constant for the higher plate voltage.

VARIATION OF FREQUENCY WITH RESISTANCE IN SERIES WITH CONDENSER C

Assume in this case $R_g=0$, R_p =resistance of L_2 , R_L =resistance of L_1 and R_c =variable. Equation (3) for the grid

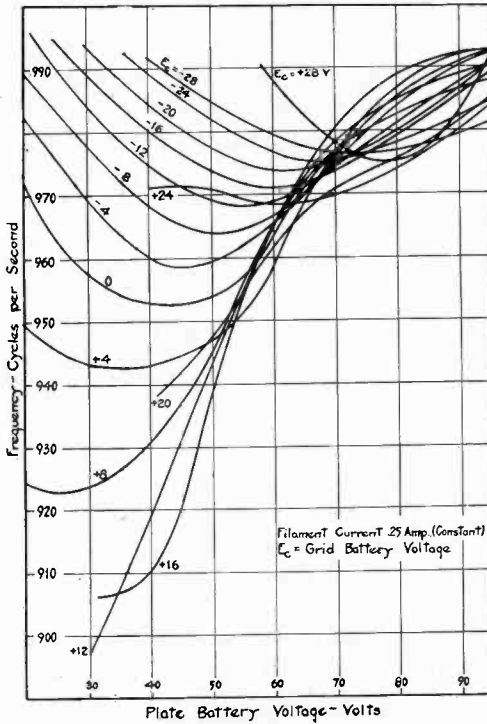

Fig. 6—Variation of Frequency with Plate-Battery Voltage for Various Grid-Battery Voltages—Grid-Tuned Oscillator.

oscillator then reduces to (neglecting terms involving $1/r_p$ and $1/r_g$ in the numerator)⁶:

$$f(T.G.) = \frac{1}{2\pi\sqrt{C\left(L_1 + \frac{\beta}{r_p}\right) + \alpha\left(1 - \frac{\mu}{\nu}\right)\frac{1}{r_p r_g} + \left[\left(L_1 + \frac{M}{\nu}\right)\frac{1}{r_g} + (L_2 + \mu M)\frac{1}{r_p} + \beta\left(1 - \frac{\mu}{\nu}\right)\frac{1}{r_g r_p}\right]CR}} \tag{12}$$

⁶ Equations (12) and (13) were obtained by making $R_g=0$ in the equations preceding (1) and (2), respectively.

The corresponding frequency for a plate-tuned oscillator is given by

$$f_{(T.P.)} = \frac{1}{2\pi \sqrt{C \left(L_1 + \frac{\beta}{r_g} \right) + \alpha \left(1 - \frac{\mu}{\nu} \right) \frac{1}{r_p r_p} + \left[(L_1 + \mu M) \frac{1}{r_p} + \left(L_2 + \frac{M}{\nu} \right) \frac{1}{r_g} + \beta \left(1 - \frac{\mu}{\nu} \right) \frac{1}{r_g r_p} \right] C R_c}} \tag{13}$$

It is interesting to note that these two equations are the same as (10) and (11) with an additional term in the denominator.

Assume that the variables r_p , r_g , μ and ν are independent of changes in R_c . Then since R_c does not appear in the numerator, the effect of R_c will depend upon the sign of its coefficient, which coefficient depends upon the relative values of r_p , r_g , μ and ν .

The term $\beta \left(1 - \frac{\mu}{\nu} \right) \frac{1}{r_g r_p}$ may be neglected in comparison with

$(L_1 + \mu M) \frac{1}{r_p}$ and $\left(L_2 + \frac{M}{\nu} \right) \frac{1}{r_g}$. Therefore the sign of the coefficient of $C R_c$ is determined by the first two terms. If the term

$\left| (L_1 + \mu M) \frac{1}{r_p} \right|$ is greater than $\left| \left(L_2 + \frac{M}{\nu} \right) \frac{1}{r_g} \right|$ then, since

M is negative, μ is positive and ν is negative (generally) the sign of the coefficient of $C R_c$ will be negative. If L_1 is nearly equal to L_2 then the generated frequency should increase with an increase in R_c for both types of oscillators. This is shown to be true by curves *A* and *B* of Figs. 8 and 9.

VARIATION OF FREQUENCY WITH RESISTANCE R_L , IN SERIES WITH THE TUNED COIL L_1

The expressions for the generated frequency are the same as those given in (8) and (9). However, we shall now consider R_L variable. The effect of R_L may be seen a little more clearly, perhaps, if (8) and (9) are rewritten as follows:

$$f_{(T.G.)} = \frac{1}{2\pi} \sqrt{\frac{r_p + R_p + R_L \frac{r_p}{r_g} + \left(1 - \frac{\mu}{\nu} \right) \frac{R_p R_L}{r_g}}{C [L_1 r_p + L_1 R_p + L_2 R_L] + \alpha \left(1 - \frac{\mu}{\nu} \right) \frac{1}{r_g}} \tag{14}$$

and

$$f_{(T.P.)} = \frac{1}{2\pi} \sqrt{\frac{r_p + R_g \frac{r_p}{r_g} + R_L + \left(1 - \frac{\mu}{\nu}\right) \frac{R_g R_L}{r_g}}{C \left[L_1 r_p + (L_1 R_g + L_2 R_L) \frac{r_p}{r_g} + \alpha \left(1 - \frac{\mu}{\nu}\right) \frac{1}{r_g} \right]} \quad (15)$$

Remembering that R_p in (14) is equal to R_g in (15), it is clear that if r_g is nearly equal to r_p , the effect of increasing R_L will be the same for both types of circuits. If, however, r_g is greater than r_p , and this difference is great enough, a given increase in R_L will

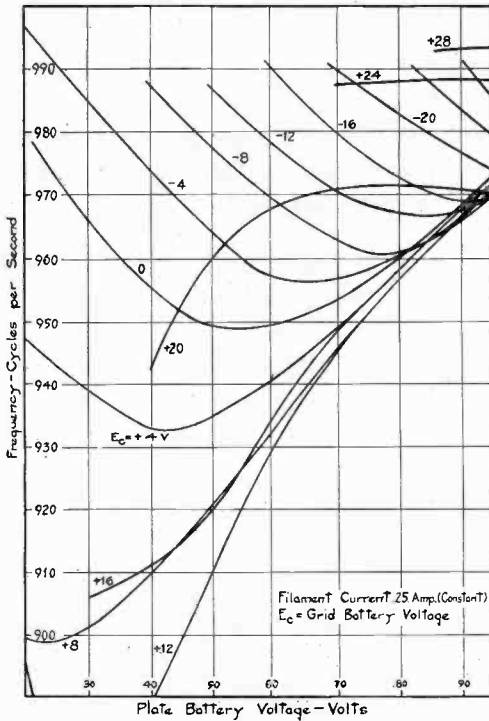

Fig. 7—Variation of Frequency with Plate-Battery Voltage for Various Grid-Battery Voltages—Plate-Tuned Oscillator.

cause the denominator of (14) to increase more than the numerator; that is, to increase R_L in (14) would decrease the generated frequency. For the plate-tuned oscillator, to increase R_L would cause a greater increase in the numerator; that is, to increase R_L in (15) would increase the generated frequency. For example, suppose the grid current is zero (r_g infinite), (14) and (15) reduce to

$$f = \frac{1}{2\pi} \sqrt{\frac{1 + \frac{R_p}{r_p}}{C \left[L_1 + (L_1 R_p + L_2 R_L) \frac{1}{r_p} \right]}} \quad (16)$$

and

$$f = \frac{1}{2\pi} \sqrt{\frac{1 + \frac{R_L}{r_p}}{C L_1}} \quad (17)$$

Clearly in (16) and (17) the effect of R_L is opposite in the two cases. The effect of R_L on the frequency variation for a low and high plate voltage is shown by curves *C* and *D* of Figs. 8 and 9. For low plate voltage the frequency increases with increasing R_L for both oscillators while for high plate voltage the frequency increases for the plate-tuned oscillator and decreases for the grid-tuned oscillator as R_L is increased.

THE VARIATION OF FREQUENCY WITH EXTERNAL GRID AND PLATE RESISTANCE

To study this effect, make the external coil and condenser resistance zero as before. Putting $R_c = 0$ in (1) and rearranging gives for the grid oscillator,

$$f_{(T.G.)} = \frac{1}{2\pi} \sqrt{\frac{1 + \frac{R_p}{r_p} + (R_0 + R_L) \frac{1}{r_0} + \left(1 - \frac{\mu}{\nu}\right) (R_L + R_0) \frac{R_p}{r_0 r_p}}{C \left[L_1 + L_1 \left(\frac{R_p}{r_p} + \frac{R_0}{r_0} \right) + L_2 \frac{R_L}{r_p} \right] + \left[\alpha + (L_1 R_p + L_2 R_L) C R_0 \right] \left(1 - \frac{\mu}{\nu}\right) \frac{1}{r_0 r_p}} \quad (18)$$

The corresponding equation for the plate oscillator is

$$f_{(T.P.)} = \frac{1}{2\pi} \sqrt{\frac{1 + \frac{R_0}{r_0} + (R_p + R_L) \frac{1}{r_p} + \left(1 - \frac{\mu}{\nu}\right) (R_L + R_p) \frac{R_0}{r_0 r_p}}{C \left[L_1 + L_1 \left(\frac{R_0}{r_0} + \frac{R_p}{r_p} \right) + L_2 \frac{R_L}{r_0} \right] + \left[\alpha + (L_1 R_0 + L_2 R_L) C R_p \right] \left(1 - \frac{\mu}{\nu}\right) \frac{1}{r_0 r_p}} \quad (19)$$

Inspection of (18) and (19) will show that, other things remaining constant, to change the external grid resistance in the plate-tuned oscillator will cause the same sort of frequency variations as to change the external plate resistance in the grid-tuned oscillator and vice versa. However, when the external plate

resistance is changed the internal plate resistance does not remain constant because the plate voltage is lowered by an amount equal to the IR drop across the external resistance. For a similar reason the internal grid resistance does not remain constant when an external grid resistance is added. The internal grid resistance goes through the same kind of changes with respect to filament current, grid voltage and plate voltage as does the internal plate resistance (see Fig. 3). Therefore, we may still expect changes

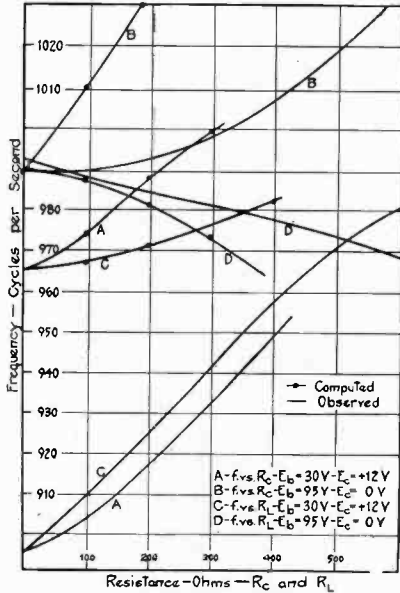

Fig. 8—Variation of Frequency with External Coil and Condenser Resistance—Grid-Tuned Oscillator.

in R_p to cause the same kind of changes in frequency for one type of oscillator as changes in R_g do for the other type.

Now suppose R_g to be made large, 20,000 ohms or more. As the external grid resistance is increased the internal grid resistance will increase because the $I_g R_g$ drop will lower the average grid potential. The internal plate resistance will also increase but in general less rapidly than r_p . Hence, for large external grid resistance (18) and (19) both approximate the relation

$$f = \frac{1}{2\pi\sqrt{LC}}$$

Fig. 10 shows the effect of external plate resistance on a tuned-grid oscillator and Fig. 11 shows the effect of external grid

resistance on a tuned-plate oscillator. The similarity of these two sets of curves is accounted for by (18) and (19). The same similarity was observed for lower values of plate voltage.

THEORY OF THE OSCILLATOR WITH GRID LEAK AND GRID CONDENSER

The elements of the grid circuit are indicated in Fig. 12.

For a thermionic tube to produce self-sustaining oscillations there must be a definite amount of energy transferred from the

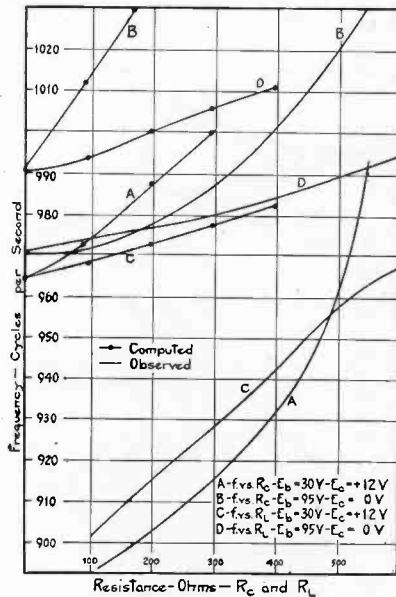

Fig. 9—Variation of Frequency with External Coil and Condenser Resistance—Plate-Tuned Oscillator.

plate circuit back into the grid circuit. Suppose the grid-leak resistance R_1 to be infinite, then clearly the grid will in a short time acquire sufficient negative charge to reduce the plate current and hence the available energy to zero. Under these conditions the circuit will obviously not oscillate. There is then a certain definite maximum charge which the grid condenser C_1 can acquire and yet allow the circuit to oscillate, for any given circuit conditions.

The charge Q_1 on C_1 at any time t after the charge Q_0 starts to diminish is given by

$$Q_1 = Q_0 e^{-\frac{t}{R_1 C_1}} \quad \text{or} \quad \frac{Q_1}{Q_0} = e^{-\frac{t}{R_1 C_1}}$$

Let Q_1 be the maximum charge on C_1 which will allow the circuit to oscillate and Q_0 be the charge on C_1 when $t=0$ (or in other words, let Q_0 be the charge that would accumulate on C_1 if R_1 were infinite); Q_1 and Q_0 are both constant for given circuit conditions. The minimum time in which Q_0 must be reduced to Q_1 is equal to the period of oscillation of the circuit, otherwise a

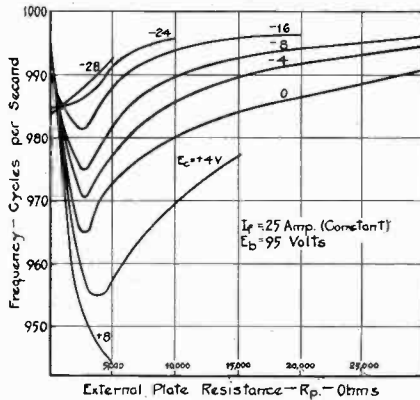

Fig. 10—Variation of Frequency with External Plate Resistance for Various Grid-Battery Voltages—Grid-Tuned Oscillator.

sufficiently large charge would accumulate on the grid and eventually “block” the tube. Hence we have

$$\frac{Q_1}{Q_0} = \epsilon^{-\frac{1}{fR_1C_1}} = \text{constant} < 1$$

Where f = frequency of oscillation of the circuit.

Thus $fR_1C_1 = K$. Therefore, if any two of these quantities are held constant and the third increased, the negative charge on the grid will increase and stop oscillations. Thus if f and R_1 are fixed and the capacity C_1 is increased, the negative charge on C_1 will increase and the circuit will not oscillate continuously but in beats. If R_1 is now lowered so that the charge can leak off before it reaches the critical value the circuit will again oscillate continuously. If the time constant C_1R_1 is lowered, Q_1 decreases and the grid becomes more positive. With $C_1 = 0$ and R_1 is finite, we have simply an external grid resistance.

A circuit using a grid leak and condenser should, therefore, be expected to generate a nearly constant frequency for relatively large changes in the circuit constants. Since the grid is maintained

negative throughout most of the cycle, we may neglect any term or terms in the foregoing equations which involve $1/r_p$. Thus (8) reduces to (16). If R_p/r_p be neglected, this equation reduces to the usual expression for the frequency of a grid-tuned oscillator, namely,

$$f = \frac{1}{2\pi \sqrt{C \left(L_1 + L_2 \frac{R_L}{r_p} \right)}}$$

and (10) reduces to (18), which is the usual form for a plate-tuned oscillator.

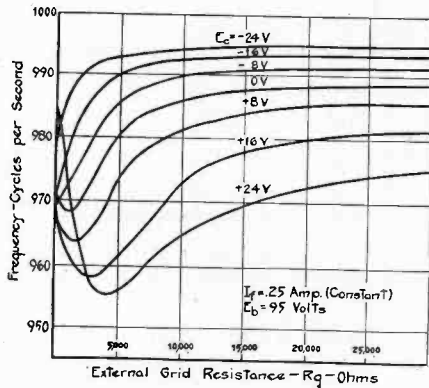

Fig. 11—Variation of Frequency with External Grid Resistance for Various Grid-Battery Voltages—Plate-Tuned Oscillator.

Careful determinations were made of the frequency variations for changes in E_c , E_b , and I_f . The most desirable size of grid leak and grid condenser depends, among other things, upon the frequency of oscillation and the input impedance of the tube. Since the impedance of the condenser must be low compared to that

TABLE I

$E_b = 95$ volts $I_f = 0.25$ amp.		$E_b = 95$ volts $E_c = -4$ volts		$I_f = 0.25$ amp. $E_c = -4$ volts	
Change in E_c volts	Per cent change in frequency	Change in I_f amp.	Per cent change in frequency	Change in E_b volts	Per cent change in frequency
Grid-Tuned Oscillator					
+30 to -30	0.0013	0.20 to 0.26	0.080	30 to 95	0.105
Plate-Tuned Oscillator					
+10 to -10	0.007	0.20 to 0.26	0.027	30 to 95	0.087

of the tube a larger condenser should be used for low frequency than for high frequency. Table I indicates the frequency variation observed while using a grid condenser of $0.025\mu\text{f}$ and a grid-leak resistance of 0.5 megohm.

This small frequency variation shows that it is possible to construct a triode oscillation generator, for low frequencies at least, which can be maintained constant. Obviously, if the generator is to be used as a standard, no such changes, as indicated in the table, will be made in E_c , E_b , or I_f .

GENERAL DISCUSSION

The average grid current and average plate current were observed along with the frequency for nearly all of the runs made.

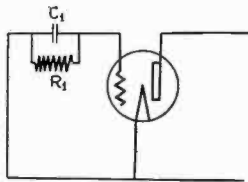

Fig. 12

The variations of these currents are not shown, but the following facts were observed. In order that the generated frequency be

nearly that which is predicted by the equation $f = \frac{1}{2\pi\sqrt{LC}}$

the grid current (as measured by a d.c. meter) must be small. It was also observed that for the generated frequency to be constant for any given change of circuit conditions, the grid current must also be constant for that same change. It will be noticed that these two conditions are both satisfied if we have a large external grid resistance, or better still, if the proper values of grid condenser and grid leak are used.

It is interesting to note that in all cases, except when a grid leak and grid condenser were used, a given change in the circuit conditions caused a smaller frequency variation in the case of a grid-tuned oscillator than in the case of a plate-tuned oscillator. However, when a grid leak and grid condenser were used the plate-tuned oscillator was the more nearly constant for all changes in circuit conditions except changes in E_c .

The frequency variation was observed for several different ratios of L/C (keeping L times C constant) and it was found that

this variation was less when a small L and correspondingly large C were used.

The results of this work indicate the following set of circuit conditions to be very suitable for a constant frequency triode oscillation generator, using a UV or UX 201-A tube and for a frequency range of 1000 ± 100 cycles:

Plate-battery voltage about	100 volts
Grid-battery voltage about	-4 volts
Filament current	0.25 amp. (rated)
Grid condenser	0.025 μ f
Grid leak	0.5 megohm

The plate-tuned oscillator is in general more nearly constant under these conditions.

SOUND MEASUREMENTS AND LOUD- SPEAKER CHARACTERISTICS*

BY

IRVING WOLFF

(Technical and Test Department, Radio Corporation of America, New York City)

Summary—A brief description of the method used to measure loudspeaker response is given. The Rayleigh disk and condenser microphone are compared as sound detectors. A number of loudspeaker sound pressure response curves are shown, and interpreted in terms of pleasantness of reproduction, as determined by low- and high-frequency cut-off, smoothness of response, and tone balance. Tube overloading and the effect of loudspeaker response on its apparent accentuation or diminution is discussed. The effect of room absorption characteristics, room resonances, position of the loudspeaker in the room, and position of the listener with respect to loudspeaker on loudspeaker reproduction is explained by means of diagrams and loudspeaker response curves.

THE success of an attempt to put together the electrical and mechanical apparatus known as a radio set will depend more on the character of loudspeaker used than on any other part of the system. Since the beginning of broadcasting the sound reproducer has usually been the weakest part of the chain which leads to exact reproduction.

Very little actual data has been published on the performance of loudspeakers. The reason for this lack of information lies in the few laboratories which have been equipped to get a satisfactorily exact measure of the loudspeaker performance, and the reluctance of those who have the data to publish what they have, because of the misinterpretation of the performance which the general unfamiliarity with loudspeaker curves would lead to.

The measure of the goodness or poorness of an amplifier from the standpoint of frequency response is usually very simple. Its defects are generally a falling off at the high and low ends with a quite smooth response in the middle. The amplifier which falls off least and has the greatest frequency range is the best, and comparison is simple.

To those who are familiar with good amplifier curves, the first loudspeaker response record is quite shocking. A profile

* Original Manuscript Received by the Institute, September 27, 1928. Presented before meetings of the following Institute Sections: Philadelphia, September 11, 1928; Washington, D. C., September 12, 1928; Atlanta, September 13, 1928; New Orleans, September 15, 1928.

map of the Rocky Mountains may be quite smooth in comparison. When a curve is of this type, it requires interpretation and it is the purpose of this paper to try to interpret in terms of pleasantness of reproduction some response curves which we have taken on various loudspeakers, some commercial, others just laboratory experiments.

Loudspeaker frequency response is usually described very indefinitely. It is mellow, it is tubby, nasal, shrill, reproduces all frequencies evenly. What do these words mean in terms of sound output? When a loudspeaker is described as having fine low or high frequencies, how high or low is meant?

Let us digress for a moment to review briefly the methods by which response curves are taken.¹ The outline of procedure is as follows: (1) Deliver energy to the loudspeaker to simulate what it would get from the last tube of a perfect set. (2) Measure

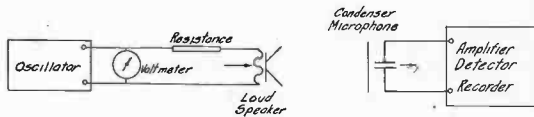

Fig. 1—Schematic Diagram of Loudspeaker Measurement System.

the sound energy at a selected point in front of the loudspeaker at all audible frequencies. The apparatus is shown schematically in Fig. 1. The first part is the same every day electrical problem which is encountered in the measurements of most radio apparatus and needs no further comment.

The second part requires an instrument for measuring sound energy. This instrument for most convenient use should be portable, relatively rugged, and as small as possible, so as not to distort the sound field, due to reflections from its surface.

The familiar condenser transmitter used for broadcast pickup meets the first two requirements but not the latter. The pickup used should preferably be not more than $\frac{1}{2}$ in. in diameter instead of the three inches approximately of the commercial condenser microphone. It is probably only a question of time until one small enough and at the same time sensitive enough is

¹ "Loud Speaker Response Measurements": Erwin Meyer, *Elect. Nach. Tech.*, 3, 290, 1926; 4, 86, 1927; 4, 203, 1927. *Zeit. für Tech. Physik*, 7, 12, 1926. Cohen, Aldridge, and West, *Jour. I. E. E.*, 64, 1023; 1926. E. Gerlach, *Zeit. für Tech. Physik*, 11, 1927. F. Trendelenberg, *Wiss. Veröffentlichungen aus Dem Siemens Konzern*, 5, 1926. I. Wolff and A. Ringel, *Proc. I. R. E.*, 15, 363; May, 1927.

developed. For the present we must correct our results for the distortion caused.

A sound wave is characterized by a to and fro motion of the air, and an oscillatory pressure. In a free almost plane wave, at any point in space the two are practically in phase, and the total energy is very nearly equally divided between that stored as kinetic energy of motion of the air and the potential energy of compression. None of the sound measuring devices used measures the energy directly. Since, however, the energy is equally divided between that connected with velocity and that connected with pressure either of the two may be used as the measuring stick.

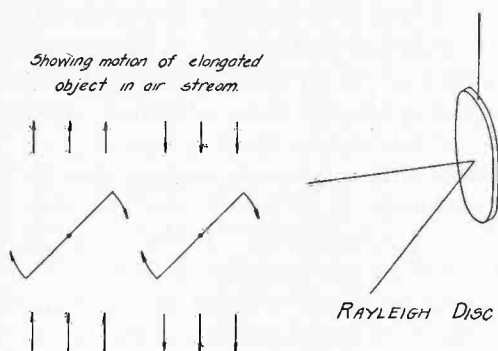

Fig. 2

The condenser microphone depending for its action on the change in capacity caused by the motion of one charged plate close to another is a pressure operated device, since the motion of the plate is caused by the force which is applied to it.

Another instrument which is used for making sound measurements and which has been most extensively used in Germany depends for its operation on the velocity component of the energy.² This neat little device is one of the numerous contributions of Lord Rayleigh to the science of acoustics and has been called the Rayleigh disk. As it is not as familiar as the condenser microphone I think that a rather brief description of it and its action will be interesting. It is illustrated in Fig. 2.

The Rayleigh disk depends for its action on the well known phenomenon that an elongated object pivoted at the center when

² "Rayleigh Disc:" Erwin Meyer, *Elect. Nach. Tech.*, 3, 290, 1926. E. J. Barns and W. West, *Jour. I. E. E.*, 65, 871, 1927. Charles H. Skinner, *Physical Review*, 27, 346, 1926.

placed in a flowing stream will tend to set itself with its long direction perpendicular to the lines of flow. Sound waves consisting of a to and fro motion of the air particles constitute an alternating air stream and will tend to make such an object set itself at right angles to their flow lines, or, which is the same, at right angles to the direction of propagation of the sound wave.

The force tending to turn the object will be stronger as the intensity of the sound wave is stronger. This is quite evidently a device which depends for its action on the velocity of motion of the air particles rather than the pressure which may exist in the wave.

In practice a very thin, small, silvered, mica disk is suspended by a thin fiber. Light reflected from the silvered surface is used to measure the deflection of the disk. A knowledge of the torque brought into play by the suspension fiber and the forces caused by the air flow allow the disk to be calibrated. The measurement then consists of a balancing of these two forces.

The Rayleigh disk has the advantage that it can be made very small (within the $\frac{1}{2}$ in. limit), and therefore causes very little distortion of the sound field. On the other hand the deflecting forces brought into play by sound fields of normal strength are quite minute and require the use of a delicate fiber suspension, so that the instrument is neither stable nor portable.

The loudspeaker response curves shown in this paper have all been taken using the condenser microphone and follow quite closely the procedure which was described more in detail in an article by Mr. Ringel and myself.³

In interpreting loudspeaker response curves for the purpose of estimating the fidelity of the loudspeaker four points should be particularly noted:

1. Low-frequency cut-off
2. High-frequency cut-off
3. Smoothness of response between cut-off points
4. Balance between high and low frequencies.

The effects of some of these factors are fairly well known. The cut-off of low frequencies makes the reproduction lose fullness and body. The removal of high frequencies takes away crispness and distinctness, removing the sibilants from speech.

The interpretation of an uneven response is more difficult and depends on the particular kind of defect which is introduced.

³ I. Wolff and A. Ringel, *loc. cit.*

The type of distortion noticed will be described in connection with the curves which will be shown to illustrate a few of the infinite possible variations.

When a loudspeaker has certain defects such as excessive response in a part of the low-frequency region, a partial compensation may be made by introducing a similar rise in the high-frequency response. In general there is a certain frequency which may be considered as a center of gravity point and which is somewhere in the neighborhood of 1000 cycles, above and below which the total frequency response should about balance when plotted on a logarithmic or musical frequency scale. The response

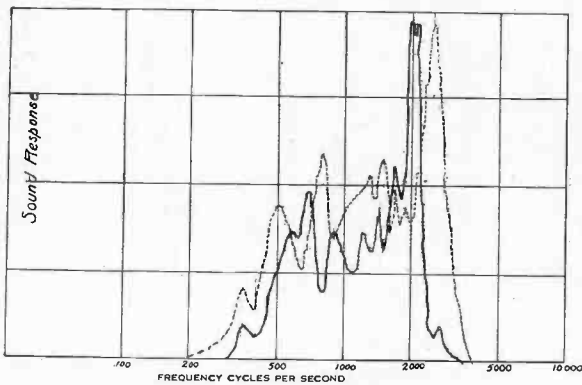

Fig. 3—Old Horn Speaker.

curves shown in Fig. 3 for two horn loudspeakers which were popular in the early stages of radio illustrate the fulfillment and violation of some of these requirements.

It is interesting to take these speakers for study since they were developed in the days before sound pressure curves were known and therefore any peculiarities are certainly the result of an attempt to adjust the materials at hand to give the most pleasing results. It is quite evident that the designers independently chose a frequency of about 1000 as a center and spread their possible frequency range as much as possible on either side. It would have been perfectly simple in either case by simply changing the diaphragm stiffness to have shifted the curves either up or down on the frequency scale, but this apparently would have made the tone balance poor.

The frequency range covered by these loudspeakers is very mediocre, and accounts for what is known as the characteristic

small horn quality. This quality has usually been associated with mechanical reproduction and has been called a metallic quality. This is really a false name for it, as what is heard is only the result of the restricted frequency band, modified by whatever peaks and depressions happen to be present in the transmission range.

The next curve, Fig. 4, shows the response of a more recent loudspeaker which is typical of some of the moving iron speakers which are being sold today. For purposes of comparison the response of the better of the two horns shown in the preceding slide is again given.

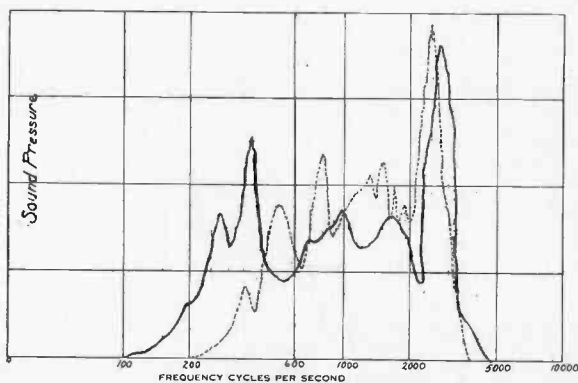

Fig. 4—Illustrating Response with Low- and High-Frequency Peaks.

Several interesting points are brought out by this curve. The low- and high-frequency cut-off points have been considerably extended, which of course means more satisfactory quality. In fact, the extension is now sufficient to remove definitely the metallic, mechanical timbre from reproduction as given by this instrument. It is again interesting to see how closely the area under this curve when plotted on a logarithmic frequency scale balances in the neighborhood of 1000 cycles. You will notice that the response has peaks at both the lower and upper ends. This is a device which is often resorted to in order to give the impression of an extension of the frequency range. The ear would notice the lack of low frequencies due to the failure to respond much below 200 cycles. The peak shown causes a series of notes in the lower musical range to be exaggerated. To the untrained ear this creates the impression of very good low-frequency response. The resonant peak type of low-frequency response is

very easily detected by its booming character and by the continual loudness of certain notes in a limited musical range.

The addition of this low-frequency peak alone would unbalance the response, putting too much emphasis on the lower register; in fact, it is the equivalent from this standpoint of extending the range about one octave lower. For various reasons it may be impossible to extend the higher end to get equilibrium. The next best thing to do would be to raise the whole response above 1000 cycles. If this is still not possible a peak must be added somewhere in the upper range to give the impression of sufficient high-frequency response. The peak at about 2500

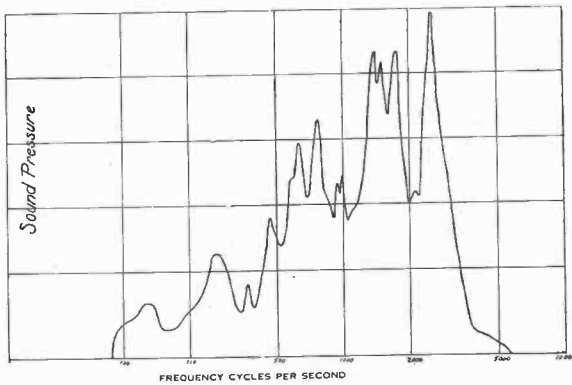

Fig. 5—Typical Loudspeaker Response.

cycles shown in this curve does just this, and has the advantage of being high enough to create the impression of true high frequencies being produced.

A distinctly different kind of response, which appeals to some people, is shown in Fig. 5. This shows a more extended low-frequency response with high-frequency cut-off about the same as on the preceding curve. The balance point is again in the neighborhood of 1000 cycles. While the preceding speaker had its high parts at the two ends with a general depression in the middle, this one concentrates on the high middle range with a tapering off towards the ends. Whether one or the other is preferred is a matter of personal taste. The rising response from 500 to 2500 cycles gives a nasal quality to the reproduction which, when combined with the sharp cut-off at the latter point, makes this speaker quite successful in masking tube overloading.

Under present broadcasting conditions where the range of frequencies transmitted cuts off pretty sharply at 5000 cycles or below, tube overloading on a speaker which reproduces real high frequencies shows up as a roughness, rasp, and very often as a sound which resembles a paper rattle. This is caused by the generation of harmonics and combination tones. These added notes show up particularly badly when they are produced at the higher frequencies, as there is no true transmitted sound of the same frequency to act as a mask.

Fig. 6 illustrates the amount of cutting off which was required in a certain speaker to mitigate this overloading effect. The

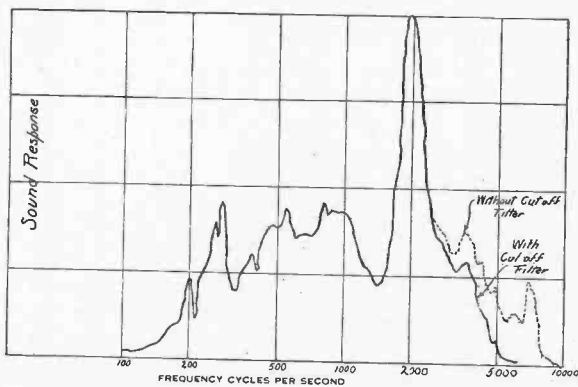

Fig. 6—Showing Elimination of Tube Overloading.

exact position of the cut-off is a matter of judgment. In general, the lower it is made the less the overloading distortion. However, if this is carried too far, the fidelity at the higher frequencies will be reduced.

Up to this point we have been considering loudspeaker response from the standpoint of the sound radiated by the loudspeaker. We will now take up the equally important matter of the effect of external conditions on the sound heard by the listener.

We are sometimes annoyed after having conducted listening tests on a loudspeaker, and having reached the conclusion that it is pretty good, to find it unsatisfactory when moved to a different room or even a different position in the same room. It is therefore very important when taking loudspeaker curves to consider the question of room acoustics and loudspeaker position.

The response curves I have shown have all been taken in a room with absorption characteristics which were intended to simulate those encountered in the ordinary home, and the microphone has been placed so as to receive the sound which could be expected to reach the listener's ear.

The loudspeakers will, however, be used in a wide variety of rooms and in interpreting the response characteristics we should know what changes will be made when some of the conditions are made different.

Some of the factors which may be expected to have a pretty big effect are:

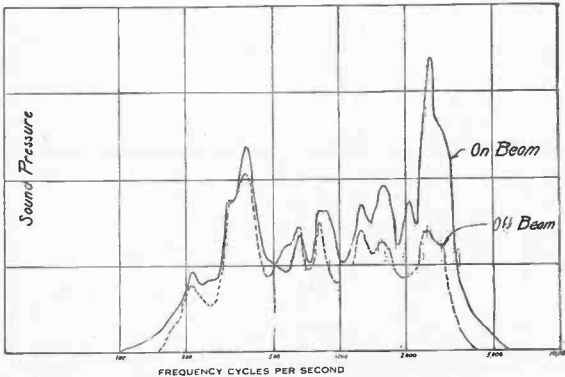

Fig. 7—Illustrating Beam Effect.

Room absorption characteristics

Room resonances

Position of loudspeaker in room

Position of listener with respect to loudspeaker.

Consider the position of listener first. Most loudspeakers radiate more sound towards the front than to the sides, particularly at the higher frequencies where the sound comes out almost in the form of a beam. This effect is a general property of wave radiation and we may generalize by saying that whenever the vibrating surface is small compared to the wavelength being emitted the sound will spread equally in all directions and that for wavelengths small compared to the surface the sound will be sent out in the form of a beam perpendicular to the surface. The result is greater high-frequency response directly in front of the speaker, as illustrated in Fig. 7.

The extent to which the beam effect modifies the loudspeaker response as heard by the audience is also a question of room absorption. To illustrate: Consider a loudspeaker which sends out the same total amount of energy at all frequencies, but concentrates the higher frequency energy so that the ratio of high-frequency to low-frequency energy radiated directly in front is six to one. The sound when it hits the walls of the room will be partially reflected, the amount of the reflection depending on the materials making up the room. In order to make the dis-

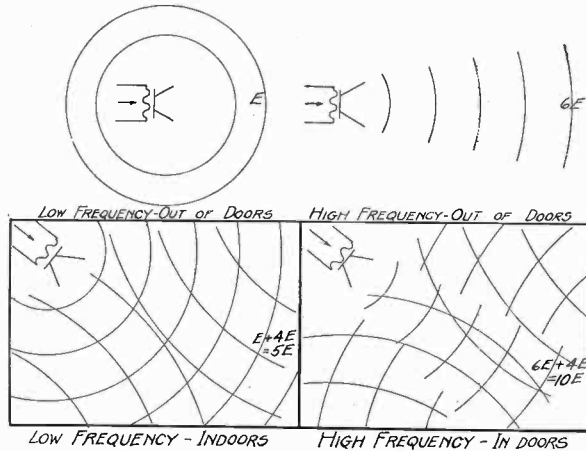

Fig. 8—Illustrating Effect of Room on Loudspeaker Response.

cussion as simple as possible assume that the room has the same absorption at all frequencies.

The sound energy reaching the listener may be considered as made up of two parts, one due to direct radiation from the loudspeaker, the other coming from successive reflections from the walls and other objects in the room. Experiments have shown that the latter energy is pretty uniformly distributed throughout the room after several reflections, leading to the conclusion that the magnitude of the reflected energy will depend only on the total energy radiated by the loudspeaker. When the absorption is small the reflected energy reaching the listener's ear is much bigger than that received directly from the loudspeaker. In a room with small uniform absorption at all frequencies the energy reaching the listener's ear is determined mostly by the total energy radiated by the loudspeaker; in a room with high absorp-

tion it is determined mostly by the energy radiated in the direction of the listener. This leads to the conclusion, which is a little surprising at first, that the loudspeaker response is greatly modified by the room even though it has uniform frequency absorption.

Returning to the loudspeaker which radiates the same amount of energy at all frequencies, but which concentrates the higher frequencies in the form of a beam so that the energy density directly in front is six times that for the lower frequencies, some interesting numerical results may be obtained which are shown diagrammatically in Fig. 8.

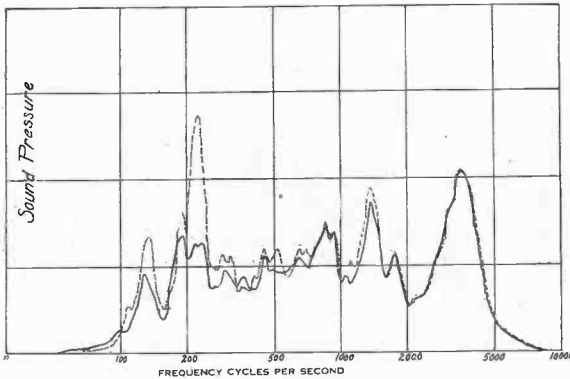

Fig. 9—Illustrating Cavity Resonance.

If the speaker is in a room with very high absorption, or better yet outdoors (equivalent to a room with absorption coefficient equal to 1), the amount of energy reaching the listener is determined entirely by the direct radiation and is in the ratio 6 units high to 1 unit low. When the loudspeaker is placed in a room of smaller absorption the reflected energy may easily be four times as big as the energy which is received by direct radiation when there is no beam. This energy is the same for both high and low frequencies, since the total energy radiated is the same, so that 4 units are added to each, making the ratio 10 units high to 5 units low or 2 to 1 instead of 6 to 1 as previously.

The preceding explains to a certain degree the dropping off of low tones which is very apparent when a loudspeaker is placed in the open. The loss is even more accentuated by the fact that the absorption of the room is not uniform at all frequencies, but

is usually smaller at the low end. Obviously this leads to a greater reflected energy for low tones in the room, and a greater relative decrease in their intensity when the loudspeaker is outdoors.

I will not devote much space to the influence of frequency variations in the room absorption coefficient except to say that the effect can be very considerable. It is perfectly apparent that small absorption at any frequency leads to an increase in intensity at that frequency and that the opposite is true for high absorption.

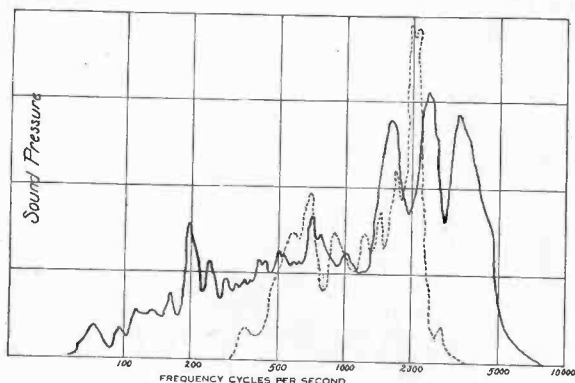

Fig. 10—Modern Loudspeaker in Comparison with Old Horn.

The air in a room which is not very absorbing may resonate to certain frequencies just like any other mechanical vibrator. If the loudspeaker is coupled to the air in the room closely enough this resonance may be excited. There are certain places in the room where the coupling will be such as to induce this resonance more vigorously.

This raises the general question of the effect of the position of the loudspeaker in the room on the response. We have already seen that high frequencies are radiated in a beam. If high response is wanted the speaker should therefore be pointed and placed so as to cover as large a portion of the audience as possible. Placing the loudspeaker in a corner or in any kind of a cavity will usually have a big effect on the response. The space between the back of the speaker and wall or other obstruction will act as a resonant chamber whose vibrations will be excited by the vibrations of the rear side of the speaker diaphragm. It is impossible to say whether this effect will be pleasing or otherwise.

It will depend on the unadulterated response characteristic and whether the resonance is of such frequency as to supply a region which is lacking. The change in the loudspeaker response caused by this resonance is illustrated in Fig. 9.

We have now seen some of the reasons why radio reproduction is still far from the ideal of being the same as the original. Fig. 10 shows a speaker of the household type which compares favorably with anything which has been produced to date and which represents fairly well the better grade of loudspeaker reproduction attainable at this time. The room left for improvement needs no comment.

In order to conclude in a little more optimistic mood the response of the old horn speaker shown in Fig. 3 is superposed for purposes of comparison. The change is at least encouraging.

THE DESIGN OF TRANSFORMERS FOR AUDIO-FREQUENCY AMPLIFIERS WITH PREASSIGNED CHARACTERISTICS

By

GLENN KOEHLER

(Electrical Laboratory, University of Wisconsin, Madison, Wisconsin)

Summary—The requirements of an ideal transformer are stated, and the difficulties encountered in attempting to build transformers for interstage coupling units which will meet these requirements are pointed out. The aim in design for audio amplifiers is stated to be a reasonable voltage amplification for one tube and one transformer which is independent of the frequency over a range necessary for broadcast reception.

The equivalent a.c. circuit for some types of transformers with tube source and tube load is set up and solved. The impedance and voltage amplification characteristics are explained from the solution of the equivalent circuit. Expressions for calculating the constants of the transformer are given. A study of the design relations and voltage amplification characteristics reveals difficulties which are encountered in design and some methods for overcoming these difficulties. The effect of the continuous flux in the core of the transformer is illustrated and a scheme is given for balancing out the continuous flux.

A rather universal type of bridge for making the necessary impedance measurements in connection with transformer studies is shown. This bridge is adapted to measuring iron core coils, which carry both alternating and continuous currents, when either inductive or capacitive reactive.

INTRODUCTORY

THE present general tendency in the design of the various parts and stages of a radio broadcast receiver is toward the ideal for each part and stage separately and not for the entire set as a unit. For example, the design of the loudspeaker is aimed toward a flat frequency response and a constant impedance without regard to the possibilities of correcting some of the defects in the loudspeaker by means of the amplifier which supplies power to the loudspeaker. Assuming that ideal loudspeakers are available, the aim in designing audio amplifiers for broadcast receivers must also be toward the ideal. It is the purpose of this paper to present material for designing transformers for audio amplifiers of the transformer coupled type which are preassigned characteristics that are considered to be ideal for broadcast reception. The material may also be applied to the design of transformers for the audio amplifier of a continuous wave receiver and for other purposes. The discussion of the impedance and voltage amplification characteristics which is given

* Original Manuscript Received by the Institute, September 14, 1928.

in the next section is intended for the case in which the tube source is an amplifier and not a detector. The amplification characteristics for the case in which the tube source is a detector may be such as to warrant a transformer which is designed especially for the detector stage.

An ideal transformer is defined as one which adapts the impedance of the load to the impedance of the source of power in such a way that the power delivered to the load is a maximum. When the load is a pure resistance an ideal transformer will give rise to a phase shift and an attenuation which are independent of the frequency. For any general load impedance the range of frequencies over which there is substantially no change in phase shift and attenuation is very limited. The general requirements of an ideal transformer are as follows: (1) It must have unity coupling between its windings, or, in transformer language, its leakage inductances must be zero. (2) It must have a ratio of turns which will make the load impedance when transferred to the primary substantially equal to the impedance of the source of power. (3) The impedance of the secondary must be several times the impedance of the load. (4) The effective resistance of the primary and of the secondary windings must be very much smaller than the resistances of the source and load respectively. (5) The windings must be free from the effects of distributed capacitances.

The problems of designing transformers for interstage coupling units in audio amplifiers arise from the fact that it is not feasible to fulfill the above requirements for an ideal transformer. The nature of the load and of the source and the frequency range which the amplifier must cover are such that it is difficult to construct a transformer which will fulfill all of the above requirements. It is impossible to fulfill the first four requirements without getting into serious distributed capacitance effects in the windings. The distributed capacitances of the windings have very little effect upon the behavior of the transformer at the low frequencies, but have a very serious effect at the higher frequencies. These considerations and the fact that phase shift in an audio amplifier for broadcast reception causes no loss in intelligibility, place the design of transformers for audio amplifiers on a basis which is somewhat different from that of the ideal. The aim is toward a reasonable voltage amplification for each stage, i.e., one tube and one transformer, of the amplifier which is independent of the frequency over a range which is necessary for broadcast reception.

THEORY AND DISCUSSION OF IMPEDANCE AND VOLT-
AGE AMPLIFICATION CHARACTERISTICS

In Fig. 1 is shown an equivalent circuit diagram of a typical transformer for audio amplifiers, with a tube source of power and tube load. This diagram applies without modification only to certain types of transformers at the higher frequencies at which the load current, due to the capacitance load, is several times the exciting current. In this diagram the symbols which are shown have the following definition:

$\mu_1 E_{1G}$ is the voltage generated in the tube source.

R_T is the internal resistance of the tube source.

C_P is the distributed capacitance of the primary winding.

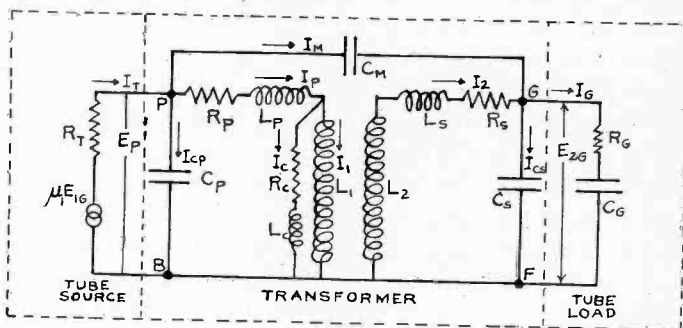

Fig. 1—Equivalent A.C. Circuit of A Transformer with A Tube Source of Power and Tube Load.

R_P and L_P are the resistance and the leakage inductance of the primary.

R_C and L_C are a resistance and an inductance which take care of the core loss and the magnetizing current of the transformer. (See later discussion.) L_1 and L_2 are fictitious inductances which transfer the load current and load voltage of the transformer. The reactances of L_1 and L_2 are always very large compared to all other reactances connected to them. The coupling between L_1 and L_2 is unity. The quantity $\sqrt{I_2/I_1}$ is defined as the ratio of transformation N . N is substantially equal to the secondary turns divided by the primary turns. The numerical value of N may be either positive or negative. N is positive if the directions of the windings are such that currents in the arrow directions, as shown on the diagram, result in fields which aid each other, and negative if the fields oppose each other.

R_S and L_S are the resistance and the leakage inductance of the secondary.

C_S is the distributed capacitance of the secondary.

C_M is the mutual capacitance between the primary and secondary.

R_G and C_G are the equivalent series resistance and capacitance of the tube load.

E_{2G} is the voltage impressed on the grid of the tube load.

The leakage inductances L_P and L_S are due to the load currents which set up fluxes about L_1 and L_2 that link with one coil and not the other. The distributed capacitances C_P and C_S are due to charging currents which flow from layer to layer in the windings of the primary and the secondary coils. C_M is due to the charging current which flows from the outer layer of one winding to the outer layer of the other. C_M may not be present in a particular design. It will be shown in a later section how the leakage inductances and the distributed capacitances can be calculated for a particular design.

At the low frequencies the diagram of Fig. 1 will have to be modified. Usually the sizes of the capacitances C_M , C_S , C_G , and C_P are such that they can be ignored entirely at frequencies below about one third of the first resonant frequency which will be defined later. Also the leakage reactances which are due mainly to the load currents are negligible at the low frequencies below about one third of the first resonant frequency. Then at the low frequencies the transformer acts as an impedance of value $R_P + R_C + j\omega L_C$ in the plate circuit of the tube source. The voltage across the primary is passed on to the secondary in the ratio $E_{2G}/E_P = N$. Consequently it can easily be shown that the ratio of E_{2G} to E_{1G} is given by the expression,

$$\frac{E_{2G}}{E_{1G}} = \mu_1 N \frac{\sqrt{R_C^2 + \omega^2 L_C^2}}{\sqrt{(R_T + R_P + R_C)^2 + \omega^2 L_C^2}} \quad (1)$$

At low frequencies and low flux densities R_C is generally so small compared to R_P that it may be neglected in the denominator of the above expression.

Equation (1) gives definite information on the design for flat voltage amplification at the lowest frequencies. For example, if the voltage amplification of a tube and a transformer is to be equal to or more than 95 per cent of $\mu_1 N$ at the lowest frequency,

the reactance ωL_C must be at least three times $R_T + R_P + R_C$. This might be stated as one requirement of a good transformer for audio amplifiers, i.e., the reactance of the primary winding must be at least three times the resistance of the tube source of power plus the effective resistance of the primary winding at the lowest frequency for which the amplifier is designed. As an example take the transformer which gave the upper curve of Fig. 4. The inductance of the primary of this transformer is, by measurement, 45 henries. The tube source resistance is 8100

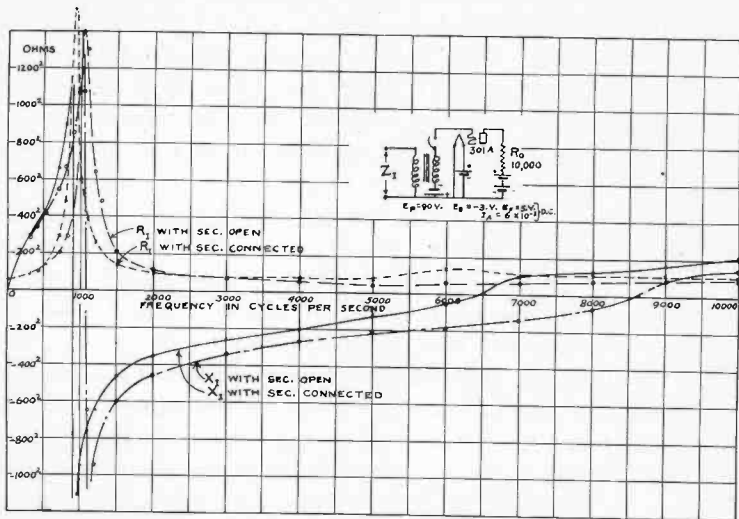

Fig. 2—Typical Impedance vs. Frequency Characteristics of A Transformer with Secondary Open and with Secondary Connected to A Tube as Shown.

ohms and the resistance of the primary winding is 3250 ohms, which makes $R_T + R_P = 11350$. The frequency which is necessary to make $\omega L_C = 11350 \times 3$ is 125 cycles. This checks very well with the upper curve of Fig. 4.

At the lowest frequencies the impedance characteristics of the primary of an audio transformer are essentially the characteristics of a resistance and inductance in series because the effective impedance of the load is several times the impedance of the secondary winding. Fig. 2 is a typical set of impedance characteristics of a transformer for audio amplifiers. Consequently the voltage amplification per stage is given almost exactly by (1) as long as the frequency is less than about one third of the first resonant frequency. The upper curve of Fig. 4 shows the

voltage amplification characteristics for the same transformer which was used in taking the impedance characteristics of Fig. 2. It will be noted that for frequencies up to about 500 cycles the variation in amplification for this particular transformer is what would be expected from (1). The last tube is terminated in a resistance which is a little higher than the internal resistance of the tube. The amplification of the last tube is constant at 4.7. The input capacitance of the last tube is about constant at 60×10^{-12} farads.

For those transformers which conform very closely to the equivalent circuit of Fig. 1 the impedance of the primary builds up to a very high value around the first resonant frequency, i.e., the first frequency at which the reactance falls through zero. This frequency, which can be derived from later theory, is given to a very close approximation by the expression,

$$f = \frac{1}{2\pi \sqrt{L_C \left[C_P + \frac{(C_S + C_G)C_M}{C_M + C_S + C_G} + (C_M + C_S + C_G) \left(N + \frac{C_M}{C_M + C_S + C_G} \right)^2 \right]}} \quad (2)$$

Around this frequency the voltage amplification per stage is substantially equal to $\mu_1 N$ because of the very high impedance which the transformer offers to the tube source. Beyond this frequency and up to the second resonant frequency the combined transformer and load act as a capacitance reactance to the tube source. The impedance falls very rapidly and approaches a value which depends largely upon the resistances of the transformer and tube source.

In order now to explain the impedance and voltage amplification characteristics of the transformer from the first resonant frequency to the highest frequency for which the transformer is useful it will be necessary to develop the equations which apply in this range of frequencies. The two relations which are desired are the expressions for the voltage amplification per stage, E_{2G}/E_{1G} , and the input impedance, Z_1 , of the combined transformer and tube load. The expression E_{2G}/E_{1G} is derived in two steps, i.e., E_{2G}/E_P is derived first and then after Z_1 is derived E_P/E_{1G} can be obtained and finally the expression for E_{2G}/E_{1G} is written. These relations are derived under the following assumptions. First, the reactance of the secondary winding, ωL_2 is several times the equivalent reactance of the load. Second, the core losses and magnetizing current are accounted for by

the resistance R_G and coil L_G which are the equivalent series values of the customary shunt values at a given frequency. Third, as long as the grid of the tube load does not become positive with respect to the negative end of the filament, R_G is generally less than one-fourth of $1/\omega C_G$. This point is illustrated for CX301A tubes by the curves of Fig. 3. It is therefore simpler to consider C_G to be in parallel with C_S and assume that R_S is larger than the d.c. resistance of the secondary coil by an amount which is due to R_G and which can be calculated

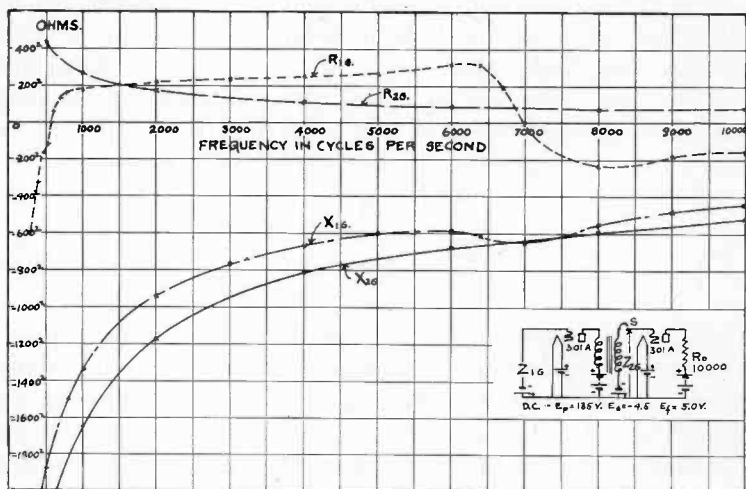

Fig. 3—Input Impedance vs. Frequency Characteristics of the Tubes in the Amplifier for the Upper Curve of Fig. 4.

if C_S , C_G , and C_M are known. It is easily shown that R_S must be increased by R'_G which is given approximately by the expression,

$$R_G' = \left(\frac{C_G}{C_M + C_S + C_G} \right)^2 R_G \quad (3)$$

Under the above assumptions the application of the current and emf laws to the circuit results in the following equations,

$$E_{2G} = (E_P - I_P Z_P)(-N) - I_2 Z_S \quad (4)$$

$$E_{2G} = E_P + I_M j \frac{1}{\omega C_M} \quad (5)$$

$$I_1 = (-N)I_2 \quad (6)$$

$$I_P = I_1 + I_C = I_1 + \frac{E_P - I_P Z_P}{Z_C} \tag{7}$$

$$I_C = \frac{E_P - I_P Z_P}{Z_C} \tag{8}$$

$$I_R = I_G + I_{CS} = I_Z + I_M = -\frac{E_{2G}}{j \frac{1}{\omega C_R}} \tag{9}$$

In the above equations $Z_P = R_P + j\omega L_P$, $Z_S = R_S + j\omega L_S$, $Z_C = R_C + j\omega L_C$ and $C_R = C_S + C_G$.

The above six equations are sufficient to solve for the ratio of E_{2G} to E_P . The solution of these equations yields,

$$\frac{E_{2G}}{E_P} = \frac{\frac{j}{\omega(C_M + C_R)} [(-N) + j(Z_S + N^2 Z_P)\omega C_M]}{Z_C' Z_S + N^2 Z_P - j \frac{Z_C'}{\omega(C_M + C_R)}} \tag{10}$$

In which $Z_C' = 1 + Z_P/Z_C$. Equation (10) gives the voltage transformation of the transformer alone either with the load C_G , or without the load when $C_G = 0$ and $C_R = C_S$. Equation (10) is particularly useful for predetermining the voltage amplification per stage when certain quantities in the expression for the impedance Z_I , which will be pointed out later, are not negligible.

The input impedance Z_I of the transformer with load is derived from (4) to (9) and the additional equation,

$$I_{P'} = I_P + I_M \tag{11}$$

The solution of these equations gives a value for the admittance Y_I' as follows:

$$Y_I' = \frac{I_{P'}}{E_P} = \frac{Z_C' \left(\frac{N}{Z_C'} + \frac{C_M}{C_M + C_R} \right)^2}{N^2 Z_P + Z_C' Z_S - j \frac{Z_C'}{\omega(C_M + C_R)}} + \frac{1}{Z_P + Z_C} + j \frac{\omega C_R C_M}{C_M + C_R} \tag{12}$$

And finally the value of $Y_I = 1/Z_I$, which is equal to $Y_I' + j\omega C_P$ is given by the expression,

$$Y_I = \frac{Z_C' \left(\frac{N}{Z_C'} + \frac{C_M}{C_M + C_R} \right)^2}{N^2 Z_P + Z_C' Z_S - j \frac{Z_C'}{\omega(C_M + C_R)}} + \frac{1}{Z_P + Z_C} + j\omega \left(\frac{C_R C_M}{C_M + C_R} + C_P \right) \quad (13)$$

from which the impedance Z_I can be determined. Fig. 2 shows the impedance characteristics of a typical 2 to 1 transformer which has the constants given in Table I. It will be noted that the general shape of the resistance and reactance curves around the second resonant frequency is accounted for mainly by the reciprocal of the first term in the expression for the admittance.

The next step in the procedure is to obtain the ratio of $\mu_1 E_{1G}$ to E_P . This is done by adding the expression for Z_I to R_T to obtain the impedance which acts against the voltage $\mu_1 E_{1G}$. Then

$$E_P = \frac{\mu_1 E_{1G}}{R_T + Z_I} Z_I \quad (14)$$

or

$$\frac{\mu_1 E_{1G}}{E_P} = \frac{R_T + Z_I}{Z_I} \quad (15)$$

And finally, since the ratio of E_{2G} to E_{1G} is the expression which is desired it can be written from (10) and (15) as follows:

$$\frac{E_{2G}}{E_{1G}} = \mu_1 \frac{\frac{j}{-\omega(C_M + C_R)} [(-N) + j(Z_C' Z_S + N^2 Z_P) \omega C_M] Z_I}{\left[Z_C' Z_S + N^2 Z_P - j \frac{Z_C'}{\omega(C_M + C_R)} \right] [R_T + Z_I]} \quad (16)$$

Equation (16) is of such form that it is difficult to gain from it much of an idea how the voltage amplification of the combined transformer and tube source vary with the frequency. It is also too unwieldy to apply to the design of transformers unless long and tedious calculations are made. However, in order to gain an approximate idea of the variation of voltage amplification with frequency it is fortunate that certain quantities in the equation

are small compared to others for certain types of design and may therefore be neglected. Suppose, for example, one is interested in the frequency at which the voltage amplification is a maximum and beyond which it drops off very rapidly. An examination of (16) and (13) will suggest that this frequency is near the frequency which will make,

$$N^2 Z_P + Z_C' Z_S - j \frac{Z_C'}{\omega(C_M + C_R)}$$

a minimum. Near this frequency the last two terms of (13) can generally be neglected for a first approximation. Neglecting these terms will greatly simplify (16). It will become

$$\frac{E_{2G}}{E_{1G}} = \frac{j \frac{1}{\omega(C_M + C_R)} [-N + j(Z_C' Z_S + N^2 Z_P) \omega C_M]}{R_T Z_C' \left(\frac{N}{Z_C'} + \frac{C_M}{C_M + C_R} \right)^2 + Z_C' Z_S + N^2 Z_P - j \frac{Z_C'}{\omega(C_M + C_R)}} \quad (17)$$

The next approximation depends largely upon the kind of magnetic material which is used for the core of the transformer. It will be remembered that Z_C' is equal to $1 + Z_P/Z_C$, in which Z_C takes care of the core loss and magnetizing current. If Z_C is at least ten times as high as Z_P the error in calling $Z_C' = 1$ will be mainly one of using values for the quantities which are multiplied by Z_C' that are 10 per cent less than they should be. This is not a serious error for the preliminary design of a transformer. The exact quantities can always be calculated after the preliminary design is decided upon. There are also dielectric losses in the distributed capacitances which will tend to make the actual amplification less than the calculated value because these losses will give rise to effective resistances of the windings which are higher than the d.c. resistances.

For the preliminary design and for the purpose of gaining an approximate insight into the part that the windings constants play in the behavior of the transformer Z_C' is set equal to unity. The frequency which makes

$$\omega(L_S + N^2 L_P) - \frac{1}{\omega(C_M + C_R)} = 0 \quad (18)$$

is called the second resonant frequency f_r . The absolute value of (17) is then written in the form

$$\frac{E_{2G}}{E_{1G}} = \mu_1 \frac{1}{\omega(C_M + C_R) \sqrt{\left(N + \frac{C_M}{C_M + C_R} \frac{f^2}{f_r^2}\right)^2 + (R_S + N^2 R_P)^2 \omega^2 C_M^2}} \sqrt{\left[R_T \left(N + \frac{C_M}{C_M + C_R}\right)^2 + R_S + N^2 R_P\right]^2 + \left[X_S + N^2 X_P - \frac{1}{\omega(C_M + C_R)}\right]^2} \quad (19)$$

in which

$$f_r = \frac{1}{2\pi \sqrt{(L_S + N^2 L_P)(C_M + C_R)}} \quad (20)$$

For winding schemes similar to Fig. 5 the mutual capacitance C_M will generally be one-fourth, or less, of $C_M + C_R$. For these schemes then the quantity

$$\frac{f^2}{f_r^2} \frac{C_M}{C_M + C_R}$$

is small compared to N for all frequencies below f_r and does not play much part in the characteristics of the transformer. Also the quantity $(R_S + N^2 R_P)\omega C_M$ will be small compared to

$$\left(N + \frac{f^2}{f_r^2} \frac{C_M}{C_M + C_R}\right)$$

and may therefore be neglected. Consequently for winding designs similar to Fig. 5 the following conclusions can be drawn from (19). It makes very little difference whether the coupling between the primary and secondary is positive or negative. For designs in which

$$R_T \left(N + \frac{C_M}{C_M + C_R}\right)^2 + N^2 R_P + R_S$$

is less than

$$\frac{1}{\omega_r(C_M + C_R)}$$

the maximum voltage amplification of the transformer and tube source will occur substantially at f_r , or the frequency which will satisfy (18). At the frequency f_r the amplification will be substantially equal to

$$\frac{\mu_1 N \frac{1}{\omega_r(C_M + C_R)}}{R_T \left(N + \frac{C_M}{C_M + C_R}\right)^2 + R_S + N^2 R_P} \quad (21)$$

which may be several times $\mu_1 N$ unless the transformer is carefully designed. Above f_r the amplification will drop off very rapidly. The transformer will be useful as a coupling unit up to the frequency f_r .

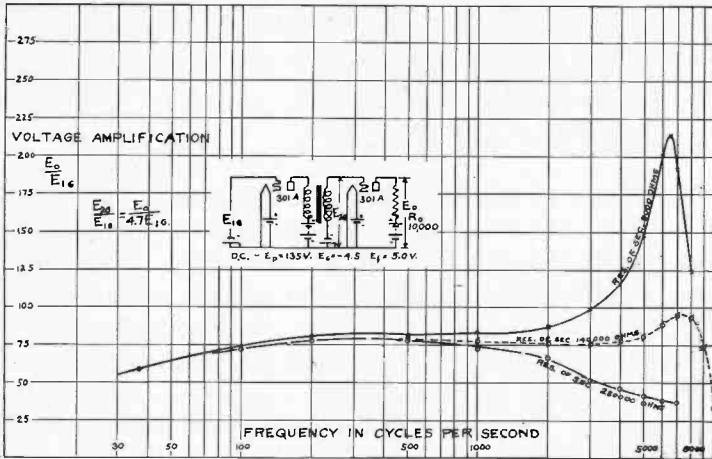

Fig. 4—Amplification vs. Frequency Characteristics Which Show the Effect of Winding Resistance Wire into the Secondary of A Transformer.

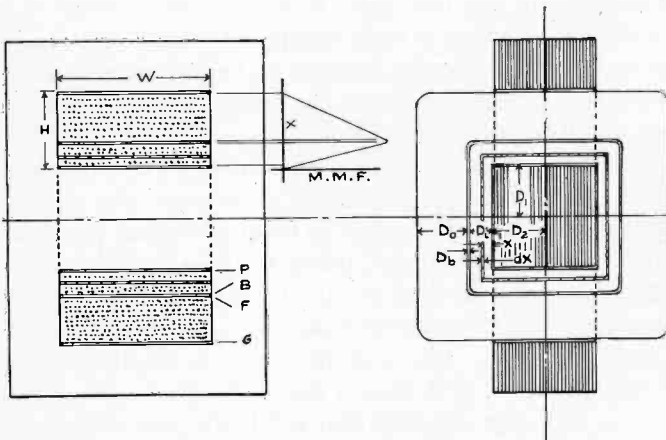

Fig. 5—Simple Winding Scheme for A Transformer.

Fig. 4 shows the amplification characteristics which result from 2 to 1 ratio transformers, with silicon steel cores, which are wound as shown in Fig. 5. For the upper curve the transformer and tubes have the following constants.

TABLE I

$C_M = 28 \times 10^{-12}$ farads, measured value.
 $C_S = 60 \times 10^{-12}$ farads, calculated and checked value.
 $C_G = 60 \times 10^{-12}$ farads, measured value.
 $R_P = 3200$ ohms, measured d.c. value.
 $R_S = 8000$ ohms, measured d.c. value.
 $R_G = 8600$ ohms which reduced to the effective value in series with R_S becomes 3500 ohms.
 $R_T = 8100$ ohms. $\mu_1 = 8.6$
 $N_P = 8000$ turns and $N_S = 16000$ turns. $N = +2$.
 $N^2 L_P + L_S = 3.76$ henries, calculated value.
 $N^2 L_P + L_S = 3.64$ henries, measured at 1000 cycles.
 Area of core equals 5.75 square centimeters.
 Mean length of path equals 14.4 centimeters.

Dimensions of winding space are W equals 3.6 cm and H equals 1.2 cm. The core losses will increase the effective resistance of the transformer less than 10 per cent of the combined d.c. resistances of the primary and the secondary when referred to the secondary. Using the measured value of leakage inductance and the above values for the capacitances f_r calculates to be 6800 cycles. The sum of the capacitances, $C_M + C_S + C_G$, was checked experimentally. Upon substituting the above constants into (19) there results $E_{2G}/E_{1G} = 47.2$ at 6600 cycles under the assumption that the true value of f_r is 6600 cycles. From the upper curve of Fig. 4 the overall voltage amplification at 6600 cycles is 213. The amplification of the last tube is 4.7. Consequently $E_{2G}/E_{1G} = 213/4.7 = 45.4$ which is to be compared with 47.2. This check serves to show that the assumptions and approximations are well within reason for the preliminary designs similar to the transformer which is used for the above data.

There are some interesting things revealed by (19) and (1). Suppose, for example, it is desired to redesign the transformer which is used for the above data so that the voltage amplification is substantially equal to $\mu_1 N$ up to f_r . One method which the equations and the equivalent circuit suggest is to increase the resistance of the secondary winding by replacing the copper wire with resistance wire. This will not affect the amplification at the low frequencies but will have a desirable effect around the frequency f_r . It is also expected that winding a part of the coil with resistance wire and the rest with copper wire will have exactly the same effect as though the same total amount of resistance were distributed throughout the coil. Calculations show that it will require about 140,000 ohms to make the characteristics flat. The appropriate curve of Fig. 4 shows the voltage amplification characteristics which result from a transformer that is wound

with resistance wire in the secondary. The inner three quarters, by turns, of the secondary coil are wound with copper wire and the outer one-quarter with resistance wire having 60 times the resistance of copper. The total resistance of the secondary coil is 140,000 ohms. The other constants of this transformer are not quite the same as those of the original design because the peak is shifted from 6500 to 7500 cycles. The results which are shown serve to show the advantages of using the resistance wire on the secondary coil. The lower curve in the same figure shows the effect of increasing the resistance to 280,000 ohms.

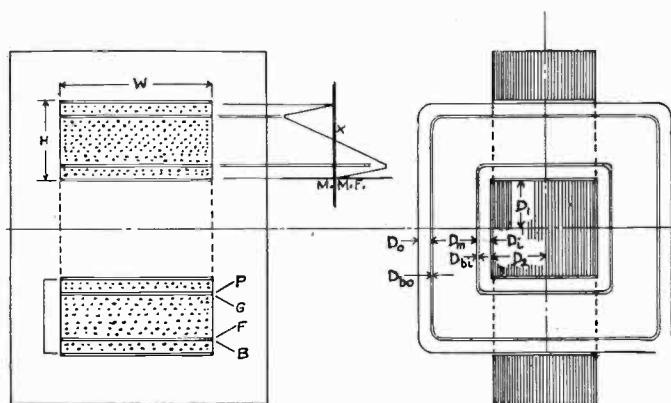

Fig. 6—Winding Scheme for Low Leakage Inductance.

Another thing which (19) suggests is to wind the transformer in such a way that it will have a low leakage inductance. If the winding scheme is of the type shown in Fig. 6 the reduction in leakage inductance is attended by an increase in the mutual, or effective secondary, capacitance no matter how the leads are brought out from the coils. This, however, is not an undesirable feature because with a relatively large effective capacitance across the secondary the action of the transformer will be rather independent of the tube load. After examining the various schemes including the possibilities of splitting either the secondary or the primary winding, the scheme which is shown in Fig. 6 was selected. This scheme gives rise to a large mutual capacitance C_M , but by placing the plate and grid layers next to the inner space between the coils instead of the outer space and by increasing this space the capacitance can be kept comparatively small. For transformers in which the mutual capacitance is the major por-

tion of the effective secondary capacitance the direction of magnetic coupling will have a decided effect. This is revealed by (19). Three transformers were designed for low leakage inductance. Two of these transformers are practically alike except that the coupling is positive in one and negative in the other. The results from these two transformers are shown by the curves A and C of Fig. 7. The constants and the calculated and measured values of amplification at the resonant frequency f_r are as given in the table below.

Constant	TABLE II	
	For Curve A	For Curve C
R_P	3500	3880
R_S	7100	8000
C_M	550×10^{-12}	550×10^{-12}
C_S	60×10^{-12}	60×10^{-12}
$N^2 L_P + L_S$	1.04	0.90
N	-2	+2
f_r	6100	6600

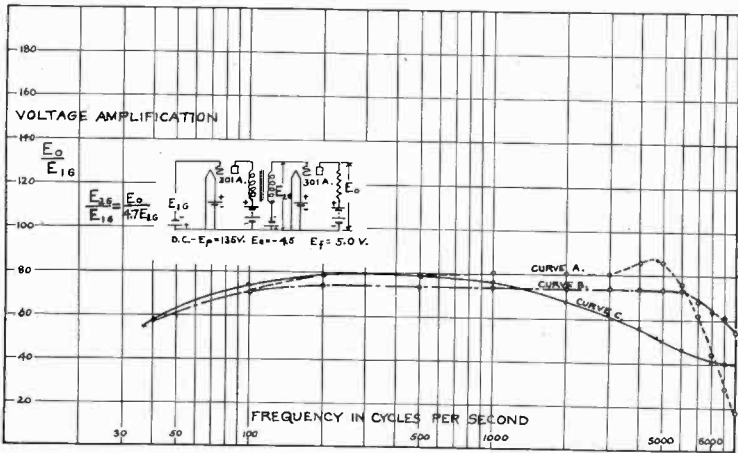

Fig. 7—Amplification vs. Frequency Characteristics of Transformers Which Are Wound According to Fig. 6 for Low Leakage Inductance.

All of the other constants are the same as those for the transformer for figures which are given in Table I. The calculated and measured values of amplification E_{2G}/E_{1G} at the resonant frequency f_r are as follows:

	For Curve A	For Curve C
Calculated	12.6	10.1
Measured	15.5	9.6

A third transformer which results in curve B is wound similar to the one for curve C except that the mutual capacitance is

only 235×10^{-12} farads. The characteristics of curve *A* are the best for radio broadcast reception because the transformer cuts off very rapidly after 5000 cycles.

CALCULATION OF THE TRANSFORMER CONSTANTS

In the theory on the impedance and the voltage amplification characteristics of transformers several constants are used. For a given transformer most of these constants can be measured but when it comes to laying out a new design one must be able to predetermine the constants from which the performance of the transformer can be predicted approximately. It is the purpose of this section to present relations from which the design constants of the transformer can be calculated. Some of the relations are taken from various sources, but are presented for the sake of completeness.

In transformer theory it is customary to take care of the core losses and the magnetizing current by a resistance R and an inductance L in parallel across the induced voltage of the transformer. This is justified because the core losses are nearly proportional to the square of the induced voltage and the magnetizing current is proportional to the induced voltage. The inductance L can be calculated by the expression,

$$L = \frac{4\pi 10^{-9} N_P^2 \mu_r A}{l} \quad (22)$$

in which A is the net area of the core and l is the mean length of the magnetic path, if the relative permeability μ_r of the core material is known at the proper alternating and continuous flux densities. Curves and information similar to that which is given in Fig. 10 are useful for determining the value of L .

The resistance R can be calculated if the hysteresis and eddy current coefficients, K_h and K_e , of the material are known. Since the core losses in audio-frequency transformers are of minor importance and since it simplifies matters the total core losses are assumed to be proportional to the square of the a.c. flux density and are given by,

$$P = V(K_h f + K_e f^2) B^2$$

This is correct for the eddy current losses but only approximate for the hysteresis losses. Then if a new constant K_c is defined by the relation,

$$K_c = K_h f + K_e f^2 = \frac{\text{Total core loss per cu. cm.}}{B^2} \quad (23)$$

it can be shown that

$$R = \frac{E_s^2}{P} = \frac{2\pi^2 10^{-16} f^2 N_P^2 A}{K_c l} \quad (24)$$

The constant K_c can be determined experimentally from test samples at representative values of alternating flux densities and continuous magnetizing forces. If the hysteresis and eddy current losses are separated the constants K_h and K_e can be determined and K_c can be calculated for any frequency.

The hysteresis constant K_c depends entirely upon the kind of material and is independent of any dimensions. For 3.5 per cent silicon steel, which has been used to a large extent for core material, it has the approximate value of 80×10^{-12} when B is in maxwells per square centimeter. At the time of this writing very little has been published on the hysteresis losses in the newer core materials of high permeability at low flux densities. The eddy current constant K_e for laminated cores such as are used in audio-frequency transformers depends upon the conductivity of the material and the thickness of the sheet. When B is in maxwells per square centimeter K_e is given by the equation,

$$K_e = \frac{\pi^2 \gamma t^2}{6 \times 10^{16}}$$

in which γ is the conductivity and t is the thickness of sheet. For 3.5 per cent silicon steel $\gamma = 2 \times 10^4$ mhos per centimeter cube. For "A" metal $\gamma = 2.2 \times 10^4$ mhos per centimeter cube.

The resistance R_c and the inductance L_c are then given by the expression,

$$R_c = \frac{R}{1 + \frac{R^2}{\omega^2 L^2}} \quad \text{and} \quad L_c = \frac{L}{1 + \frac{\omega^2 L^2}{R^2}} \quad (25)$$

At low frequencies and low a.c. flux densities the equivalent core loss resistance R , for most transformers which are suitable for interstage coupling units, is large compared to ωL and L_c is substantially equal to L .

The calculations of the d.c. resistances R_p and R_s of the wind-

ings are well known and need no further discussion. The leakage inductances L_p and L_s are determined from expressions which are taken from electrical texts and which are found to give very good results under certain conditions. Referring to Fig. 5 the leakage inductance expression for the type of winding which is shown is based on the assumption that the flux in a shell dx thick and having the dimensions shown is distributed uniformly over the area and is due to the load ampere turns inside the shell. It is also assumed that the reluctance is equal to W divided by $2\pi 10^{-9}$ times the area of the shell and that the reluctance of the return path through the iron is negligible. It is also assumed that the distribution of the magnetomotive force over the end of the coil is as shown in the figure. Under these assumptions the leakage inductance in henries, when all dimensions are in centimeters, for the winding in Fig. 5 is, for the primary,

$$L_P = \frac{16\pi N_P^2}{10^9\omega} \left[\left(\frac{D_1 + D_2}{3} + \frac{D_i}{2} \right) D_i + \frac{1}{2} (D_1 + D_2 + 2D_i + D_b) D_b \right]$$

and for the secondary,

$$L_S = \frac{16\pi N_S^2}{10^9\omega} \left[\left(\frac{D_1 + D_2 + 2(D_i + D_b + D_0)}{3} - \frac{D_0}{2} \right) D_0 + \frac{1}{2} (D_1 + D_2 + 2D_i + D_b) D_b \right] \quad (26)$$

For a winding of the type which is shown in Fig. 6 the leakage inductances are,

$$L_P = \frac{4\pi N_P^2}{10^9\omega} \left[\left(\frac{D_1 + D_2}{3} + \frac{D_i}{2} \right) D_i + \left(\frac{D_1 + D_2 + 2(D_i + D_{bi} + D_{b0} + D_m + D_0)}{3} - \frac{D_0}{2} \right) D_0 + \frac{S}{2} \right]$$

$$L_S = \frac{4\pi N_S^2}{10^9\omega} \left[\left(\frac{D_1 + D_2 + 2D_i + 2D_{bi} + D_m}{3} \right) D_m + \frac{S}{2} \right] \quad (27)$$

In both of the above expressions,

$$S = (D_1 + D_2 + 2D_i + D_{bi}) D_{bi} + (D_i + D_2 + 2D_i + 2D_{bi} + 2D_m + D_{b0}) D_{b0}.$$

For most transformers the quantities which are multiplied by D_b , D_{bi} , and D_{b0} , which are due to the leakage flux between the

windings, are negligible. There are cases, though, for a winding of the type which is shown in Fig. 6 in which one of these spaces is deliberately increased to reduce the mutual capacitance between windings. For these cases an appreciable error might be made by neglecting the leakage flux in this space.

One thing in particular to be noted is the large reduction in leakage inductance which is effected by employing a winding of the type shown in Fig. 6 instead of the usual type which is shown in Fig. 5. This reduction in leakage inductances is attended by an increase in the mutual capacitance as suggested by the manner in which the leads are brought out. The mutual capacitance caused by a winding of this type will be the major portion of the effective capacitance across the secondary and will be decreased directly as D_{b_i} is increased. The leakage inductance due to the flux in the space D_{b_i} will be a minor portion of the total leakage inductance as long as D_{b_i} is only one-tenth as large as D_i or D_o . Consequently a winding of this type has merits over the simple type which is shown in Fig. 5 because the product of the effective capacitance and total leakage inductance referred to the secondary, which determines approximately the second resonant frequency, can be kept smaller for this type than for the usual type of winding of the same total turns and ratio.

Another type of winding which might be used and which will be discussed in the next section is shown in Fig. 9. It is impossible to derive an expression for the leakage inductance for a transformer wound according to this type that is anything more than a rough approximation. An expression which has been found to give approximate results is based upon the following assumptions. The flux in a pancake section dx units thick is due to the load ampere turns to the right, or the left, of the section and is distributed uniformly over a mean area of dx . MT square centimeters, in which MT is the mean length of turn in the coil in centimeters. The reluctance of the path is equal to the distance H divided by $4\pi 10^{-9}$ times the mean area. These notions give the following expressions for the leakage inductance in henries, when all dimensions are in centimeters, of the split secondary type of winding.

$$L_P = \frac{\pi N_P^2}{10^9 H} MT. \left[\frac{D_m}{3} + \frac{D_{b1}}{2} + \frac{D_{b2}}{2} \right]$$

and

$$L_S = \frac{\pi N_S^2}{10^9 H} MT. \left[\frac{D_r + D_l}{3} + \frac{D_{b1}}{2} + \frac{D_{b2}}{2} \right] \quad (28)$$

The distributed capacitances of the windings for any type of coil are composed of the layer to layer capacitances and the turn to turn capacitances. For multi-layer coils in which the number of turns is many times the number of layers the turn to turn capacitances can generally be neglected. The equivalent capacitance which must replace all of the series of layer to layer capacitances can be arrived at from the charging current which flows from layer to layer and does not contribute to the magnetic field about the coil. Suppose the winding of all layers is started from the same end of the coil. Then, if each layer consumes E volts, there would be E volts across each layer to layer condenser. If J is the number of layers, there would be $J - 1$ such condensers in series. These $J - 1$ condensers would be acting under $(J - 1)E$ volts. The total voltage across the coil would be JE volts. So that the series capacitance which is equal to $C_l(1/J - 1)$ would have to be reduced by the factor $(J - 1)/J$ to get the equivalent condenser across the terminals of the coil. Finally then, the approximate capacitance across the terminals is $C_t = C_l/J$ in which C_l is the capacitance between the mean layers. This is substantially equivalent to the actual winding case in which there are $2E$ volts between two successive layers at one end of the coil and zero at the other end because the average charging current which flows through the winding from layer to layer is substantially the same for the actual arrangement and the arrangement pictured above. The mean layer to layer capacitance for a winding of the type shown in Fig. 5 is given by the expression,

$$C_l = p \frac{MT(\omega - u)}{D_p + D_e} \quad (29)$$

in which p equals 22×10^{-14} for paraffin paper, $W - U$ is the actual length of the winding in centimeters, MT is the mean length of turn in centimeters, D_p is the thickness of the paper, or other insulation, between the layers in centimeters, and D_e is twice the thickness of the insulation on the wire in centimeters.

The calculation of the mutual capacitance C_M depends entirely upon the type of winding. If the transformer is wound according to Fig. 5 the mutual capacitance is the capacitance between the outer layer of the secondary and the inner layer of the primary coils. A metal case placed around the transformer and connected to the F terminal will eliminate practically all of the mutual capacitance but will increase both the primary and

secondary capacitances by small amounts which can be estimated. For a winding of the type which is shown in Fig. 6 the mutual capacitance can be calculated very closely by (29) except that MT is replaced by the proper dimension and p is assigned a value which depends upon the kind of insulation. For this type of winding the mutual capacitance will generally be the major portion of the effective capacitance across the secondary.

DISCUSSION OF THE DESIGN RELATIONS FOR TRANSFORMERS

In the previous sections of this paper are given the necessary relations from which a transformer can be designed and its performance predicted when it is used with a given tube load and tube source. The procedure in designing a transformer for an amplifier with certain preassigned characteristics is one of successive trials by calculation. Due regard must be given to the principles of production. Usually a designer has his own past experience or the experiences of others as a starting point and guide in laying out a new design. The procedure in a general way is to fix the core area, the number of turns, and the length of the magnetic path for a given performance at the lowest frequency by applying (22) for the inductance and (1) for the performance after the resistance of the primary has been calculated. Then a type of winding is selected and the leakage inductance, the secondary resistance, and the capacitances are determined. Finally the approximate performance at the high frequencies is calculated from (19), (20), and (21). After this preliminary design is completed and studied it will become apparent what changes are necessary in the transformer in order to make each stage of the amplifier perform according to the preassigned characteristics. When the design conforms to the preassigned characteristics at the higher frequencies according to the approximate relations the more exact performance may be calculated from the relations which take into consideration the distributed capacitance of the primary winding, the core losses, and the magnetizing current. However, there are some general ideas which are guides in the above procedure. Some of these ideas will be discussed briefly.

In considering the shape of the space into which the wire is to be wound about the core one is first led to a square shape because this shape has the minimum length of path. However, there are other considerations which are favorable to a rectangu-

lar shape in which, for windings of the type shown in Figs. 5, 6, and 8, W is greater than H . Suppose that as W is increased and H decreased the number of turns and core area are held constant. The first thing to be noted is a decrease in the resistance of the winding. This is desirable for the primary winding. The second thing to be noted is that both the alternating and continuous ampere turns per centimeter are decreased because the length of the path is increased. The former tends to decrease L_c while the latter tends to increase L_c by increasing μ_r . The result is that for most transformers L_c will be decreased less than 15 per cent in changing from a square winding space to one in which W is

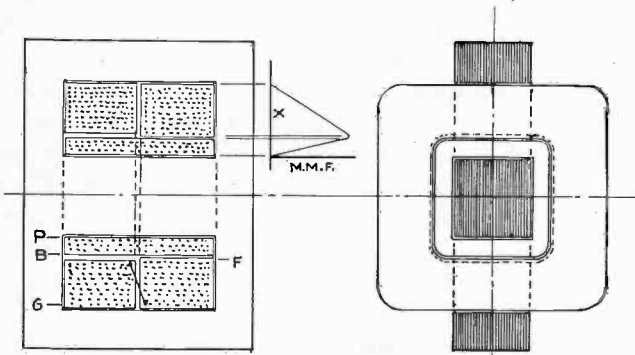

Fig. 8—Winding Scheme for Low Effective Capacitance Across Secondary.

three times H . This percentage may even be less for a high permeability core. Consider as an example a transformer which has "A" metal for the core. Referring to the lower curve of Fig. 10, suppose for example the continuous ampere turns per centimeter are 1 or less for a square winding space. The winding space is now made rectangular so that the length of the path is increased as much as 50 per cent. Due to approximately a 30 per cent reduction in the continuous ampere turns per centimeter the a.c. permeability is increased almost 50 per cent, so that the primary winding has the same inductance as before the changes were made. This is, of course, an extreme case which is used merely to illustrate the point. It would not be equally true for a silicon steel core nor for the same high permeability material when operating between 1 and 2 continuous ampere turns per centimeter. It is appreciated, of course, that the core losses will be higher for the rectangular winding space than for the square

space because it will require more iron in the magnetic circuit. Usually at low frequencies the core losses are small compared to the copper losses and have little effect upon the performance of the transformer. At the high frequencies it might even be desirable to increase the core losses to help limit the amplification at the resonant frequency.

The performance of the transformer at frequencies near the second resonant frequency is also influenced by the shape of the winding space. For coils of the type which are shown in Figs. 5, 6, and 8, as W is increased and H decreased such that the area of the winding space remains constant the distributed and mutual capacitances are increased. The mutual capacitance increases approximately as the first power of W . The effective distributed capacitance increases at a rate slightly greater than the first power of W . The total leakage inductance of the primary and the secondary referred to the secondary decreases faster than $1/W^2$. Consequently the product of the total leakage inductance and the effective secondary capacitance becomes smaller, as W is increased and H decreased, in a favorable manner; i.e., the leakage inductance decreases and the effective capacitance increases. This means that the second resonant frequency increases and that the voltage amplification per stage near the second resonant frequency decreases. For high ratio transformers this effect of making the winding space rectangular is more important than the other two effects which are pointed out above. Therefore, in conclusion it may be stated as a guide in starting a new design that for designs similar to those which are pictured in Figs. 5, 6, and 8, W should be at least three times H .

In Fig. 9 is shown a winding scheme which is especially designed for low effective secondary capacitance and low leakage inductance. This scheme differs from the other ones which are shown in that as dimension H is increased and W decreased the leakage inductance and effective secondary capacitance are both decreased. One bad feature of the scheme is the comparatively high resistance of the primary for a transformer of this type which has the same mean length of path, core area, and number of turns as one of the other designs. Another objection to this type is from a production standpoint. It is more difficult to wind coils of this type than of the other types. However, it is believed that this scheme of winding has merits for a high ratio transformer with high permeability material for the core because the winding

space can be shaped for a very low product of leakage inductance and effective secondary capacitance.

Consider now the shape and relative dimensions of the core. Referring to the diagram in Fig. 5, $2D_1$ is the width of the lamination and $2D_2$ is the width of the stack. The first things to be noted are that the leakage inductances, the effective secondary capacitance, and the resistances of the windings are smallest for a square core section. When there is no continuous magnetomotive force present increasing the width of the stack and decreasing the width of the lamination will result in an increase in the self inductance of the primary because of the decrease in the length of the magnetic path. With continuous magnetomotive force pre-

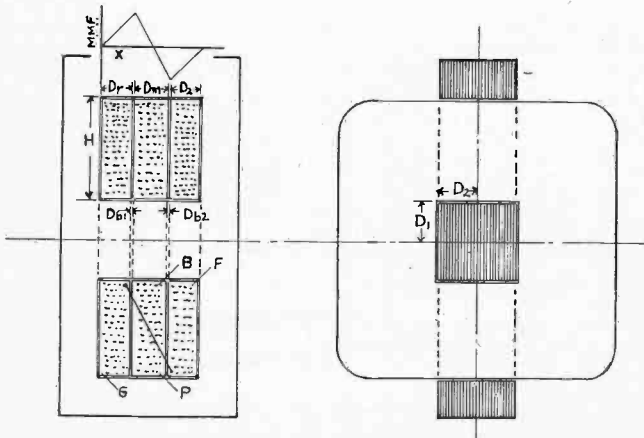

Fig. 9—Winding Scheme for Low Distributed Capacitances and Low Leakage Inductances.

sent the situation is different and the reduction in the length of the path might easily be offset by a reduction in the a.c. permeability if the width of stack is increased and the width of lamination decreased as the core area is held constant. This depends largely upon the kind of core material. In conclusion, then, for a starting point at least a square section should be adopted. For most cases this shape will be as good as any other shape from a performance standpoint.

The practice of winding transformers with number 40 enamel copper wire and placing insulation between the layers which has a thickness equal to about one-fifth of the diameter of the wire is reasonable. There are designs, especially those which are similar

to Fig. 5, which will be better electrically if smaller than number 40 is used on the secondary. The chief objection to using smaller than number 40 is from a production standpoint.

With the advent of high permeability core materials, which are gradually replacing silicon steel, audio amplifier transformers with ratios of 4 or 6 are being built with just as good frequency characteristics as 2 to 1 silicon steel transformers. The worth of a material which has a permeability at least four times that of silicon steel is appreciated, by an example of the following kind. By replacing the silicon steel core of the 2 to 1 transformer which results in curve *A* of Fig. 7 by a material which has four times the permeability this transformer can easily be converted to a 4 to 1

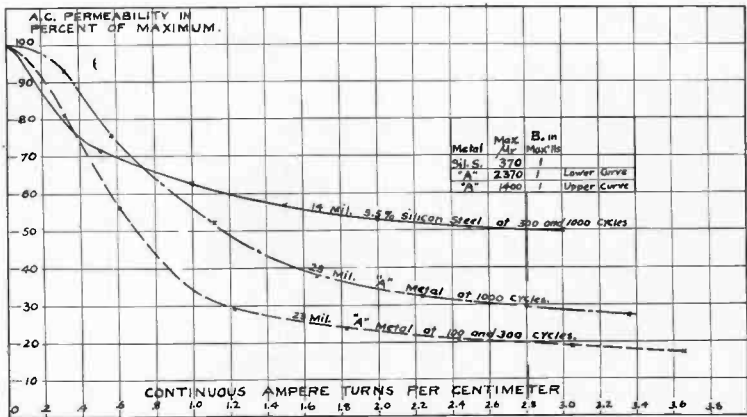

Fig. 10—The Per Cent Change in A.C. Permeability with Continuous Magnetizing Force for Transformer Core Materials at Very Low A.C. Flux Densities.

transformer which will give rise to about the same amplification versus frequency characteristics. This is accomplished by removing half of the primary turns. The result is a transformer which has the same effective secondary capacitance, a slightly lower leakage inductance, and the same primary inductance. The continuous ampere turns per centimeter for a CX301A tube will be approximately 1.2. The "A" metal which results in the curve of Fig. 10 has about the right permeability. By the scheme which is given in the next section, this transformer can easily be redesigned into an 8 to 1 transformer.

A METHOD FOR BALANCING OUT THE CONTINUOUS FLUX IN THE CORE OF A TRANSFORMER

The a.c. permeability of the high permeability materials is reduced so much in per cent by the continuous flux in the core that the feasibility of a third winding on the core of the transformer for balancing out the continuous flux suggested itself to the writer. This winding is used for setting up a continuous flux in the core which is equal and opposite to the continuous flux set up by the continuous plate current in the primary winding. In Fig. 11 is shown the desirable effect which this scheme has on a 4 to 1 transformer which has a high permeability core. The winding may be designed to be excited from either the *A* or *B* battery of the receiving set. The winding and circuit are designed so that the resistance R_a of the auxiliary circuit is at least five times the reactance X_a of the auxiliary winding at the lowest frequency. If the permeability were not affected, this will increase the effective resistance of the primary by $K^2 X_a^2 / R_a$, where K is the ratio of primary turns to auxiliary winding turns. It will decrease the reactance of the primary by 4 per cent or less. The continuous current is regulated so that $I_p N_p = I_a N_a$. As the frequency increases, the reactance X_a increases so that ultimately complete transformer action will take place, and R_a will be transferred as $K^2 R_a$. Consequently $K^2 R_a$ must be large compared to the impedance which the combined transformer and load would have, without the auxiliary winding, at the higher frequencies.

The result of balancing out the continuous flux by a properly designed auxiliary winding is well illustrated in Fig. 11. Suppose, however, the application of this principle is made in another way. There are 4000 turns on the primary of this 4 to 1 transformer. Let 1700 of these turns be used for an auxiliary winding and the other 2300 used for the primary, making the ratio about 7 to 1. The per cent change in amplification with frequency will be about the same for the new design, when the continuous flux is balanced out, at the low frequency around 100 cycles as for the original 4 to 1 transformer with continuous flux present. The overall amplification will be 1.75 times as much for the new design as for the original. The second resonant frequency of the new scheme will be slightly higher than that of the original because the effective secondary capacitance is undisturbed whereas the total leakage inductance referred to the secondary is slightly less for the new scheme. The primary resistance and tube source re-

sistance referred to the secondary will be increased because of the higher ratio. This will improve the characteristics at the high frequencies. In order to balance out the continuous flux it will require $23/17$ as much continuous current in the auxiliary winding as in the primary. For a CX301A tube source this will be about 7×10^{-3} amperes. In order to obtain this current from the B battery or B eliminator of 135 volts it will require 19,300 ohms in series. At the high frequency, when X_a is several times R_a , this value of resistance will be transferred into the primary as 35,300 ohms which is about 4 times the internal plate resistance of

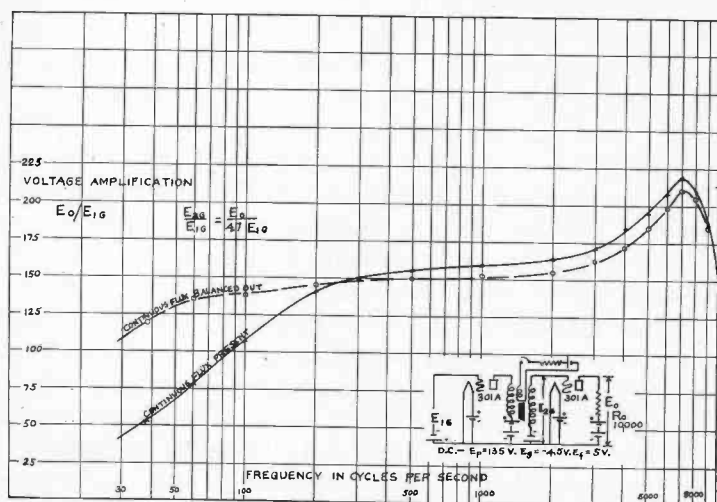

Fig. 11—Amplification vs. Frequency Characteristics Which Show the Effect of Balancing Out the Continuous Flux in the Core of A Transformer.

a CX301A tube. At 100 cycles the reactance of the auxiliary winding is about 4500 ohms when the continuous flux is balanced out of the core. So that the resistance of the auxiliary circuit is about 4.3 times the reactance of the auxiliary coil at 100 cycles. These values are about right for obtaining the desired effect.

MEASUREMENT OF THE TRANSFORMER CONSTANTS

In connection with transformer design studies it is essential that the designer have at his disposal some method of measuring the transformer constants. It is appreciated that any method for measuring the impedances of the windings must be of such a

nature that the impedance can be measured for a particular value of alternating voltage, or current, and of continuous magnetizing current. The method must also be adapted to measure both capacitive and inductive reactance. The bridge scheme of Fig. 12 has been developed to meet these needs. The scheme has been so worked out that the bridge can be balanced without disturbing the continuous current through the transformer. The continuous current is measured by means of an ammeter in the balance indicator circuit. The alternating voltage across the transformer is measured by a detector voltmeter across the bridge arm which is adjacent to the transformer. This voltmeter should not be left on when the final balance is made.

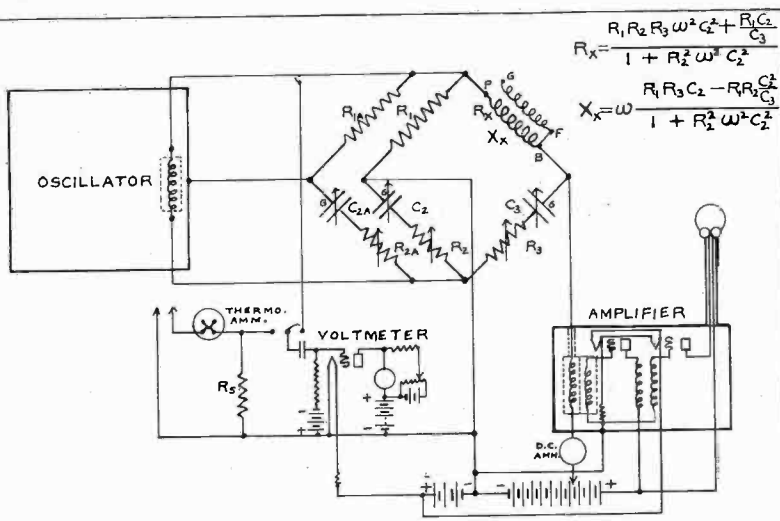

Fig. 12—Bridge Scheme for Measuring Iron Core Coils.

The purpose of the auxiliary, or guard, arm is to bring the oscillator shield to the same potential as the amplifier shield and detector voltmeter. This is essential when the impedance which is being measured is of the same order of magnitude as the spurious capacitive reactances which exist between the source of power and apparatus connected to the balance points of the bridge. This auxiliary bridge, to be effective, must also be balanced at the same time the main bridge is balanced. Usually it is sufficiently accurate to assume that the auxiliary bridge is balanced when $R_{1A} = R_1$, $C_{2A} = C_2$, and $R_{2A} = R_2$. For greater

accuracy, the auxiliary bridge can be balanced by observing with a balance indicator across the balance points. For still greater accuracy the different arms of the bridge can be shielded according to methods which have been given in recent publications provided the constants of the circuit are known after they are shielded. It is believed though that the scheme given is sufficiently accurate for transformer design studies.

A BRIDGE CIRCUIT FOR MEASURING THE INDUCTANCE OF COILS WHILE PASSING DIRECT CURRENT*

By

V. D. LANDON

(Radio Engineering Department, Westinghouse Electric & Manufacturing Company, East Pittsburgh, Pennsylvania)

Summary—A bridge circuit is described in which the inductance of a coil is compared to resistances and a capacitance. A brief comparison is made to other similar circuits.

THERE has been considerable discussion recently in regard to methods of measuring the inductance of iron core coils while passing direct current. This discussion has brought out a variety of circuits using voltmeter ammeter methods. These give sufficiently accurate results for factory measurements, but where greater accuracy is desired a bridge method is much more desirable. However, the method of comparison to a standard inductance is not very practical in this case. The required high value of inductance is difficult to obtain without an iron core. An iron core inductance is obviously unsuitable for a laboratory standard. Obtaining and measuring the required value of direct current is also a problem that must be met.

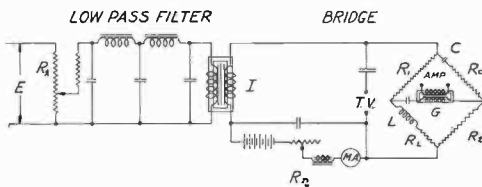

Fig. 1

In the bridge about to be described neither of these problems presents any difficulty. The inductance is measured by comparison with standard resistors and a capacitor. No standard inductor is required. The direct current requires only a direct measurement since its path is not divided.

The circuit of this bridge is given in Fig. 1. It will be seen that the voltage drop across the inductance is balanced against

* Original Manuscript Received by the Institute, August 24, 1928.
Revised Manuscript Received, October 16, 1928.

the drop across a resistance. The phase is corrected by the impedances in the other two legs. Mathematically:

$$\frac{E (R_L + j X_L)}{R_1 + R_L + j X_L} = \frac{E R_2}{R_2 + R_C - j X_C}$$

Solving for the impedance of the coil,

$$R_L + j X_L = R_1 R_2 \frac{R_C + j X_C}{R_C^2 + X_C^2}$$

$$R_1 = \frac{R_1 R_2 R_C}{R_C^2 + X_C^2}$$

$$X_L = \frac{R_1 R_2 X_C}{R_C^2 + X_C^2}$$

$$L = \frac{R_1 R_2 C}{1 + \left(\frac{R_C}{X_C}\right)^2}$$

It will be noticed that where the resistance of the coil is negligible R_C will be negligible and

$$L = R_1 R_2 C$$

The bridge is then balanced for all frequencies. Where the resistance is not negligible the value $R_1 R_2 C$ must be divided by

the correction factor $\left(1 + \left(\frac{R_C}{X_C}\right)^2\right)$. The bridge is then balanced

at one frequency only.

In operation R_D is used to adjust the direct current to the correct value and R_A is used to adjust the alternating current to the desired value. It will be realized that these two operations are quite necessary if accurate results are to be obtained. The effective a. c. inductance of iron core coils varies over quite wide limits when the value of the direct current is changed. The value and frequency of the applied voltage also affects the result to a marked degree. In comparing measurements of such coils it is therefore quite necessary to state the value of the direct current and the value and frequency of the alternating voltage.

Any or all of the units R_1 , R_2 , and C may be varied to obtain an approximate balance. However, it is most convenient to use

R_2 . The accurate balance is then obtained by adjusting both R_2 and R_C until zero signal is fed to the amplifier.

It will be found that when R_2 is adjusted alone, a point of minimum signal is found. R_C is then adjusted and a further reduction made in the signal strength. However, the signal is not yet balanced out completely. When R_2 is adjusted while R_C is slightly off from the correct value, the point of minimum signal is slightly different from the point of zero signal as obtained when R_C has the correct value. Hence, it is necessary to adjust first one and then the other back and forth several times to obtain the correct balance.

It is best to use a fairly small value of R_1 for two reasons. First, if R_1 is a good deal smaller than X_L it may be assumed that the a. c. voltage across the coil is the same as that measured across the input to the bridge. Secondly, less battery is required to supply the direct current when R_1 is small. However, if the ratio of R_1 to X_L is made too large the errors due to various capacities to ground may be magnified. The condenser should be a high quality mica standard condenser. The resistance of such a condenser may be neglected for most purposes.

The transformers marked G and I should both be of the rectangular core type, with primary and secondary on opposite legs so as to minimize undesired capacity. When this is done no correction for stray capacities is necessary to obtain very good accuracy at low frequencies.

The low pass filter is a very desirable feature of the circuit, its purpose being to better the wave form of the applied voltage. If the filter is not used the point of balance is disguised by the presence of harmonics which do not balance at the same settings. A skilled ear can easily differentiate between the fundamental and its harmonics and can tell when the fundamental goes out. However, the apparent sharpness is greatly increased if the value of the harmonic content is kept quite low.

The filter should be so adjusted as to pass the fundamental but not its harmonics. Of course it is necessary to change the characteristics of the filter if the frequency is changed. If a source of alternating current is available, the output of which has a very low harmonic content, the filter becomes unnecessary.

The usefulness of this bridge is not confined to filter choke measurements. It is invaluable in measuring the impedance of

loudspeaker windings at various frequencies. It should be observed that by merely reversing the positions of R_1 and the unknown, this bridge becomes the conventional one for measuring an impedance having resistance and capacity components. With this in mind the setup may be regarded as a general purpose bridge for measuring impedances of any value or power factor.

While this bridge was developed independently by the writer it has probably been used before for various other purposes. It is of interest to note that a very similar bridge for inductance measurements was originated by Maxwell. This is shown in Fig. 2.

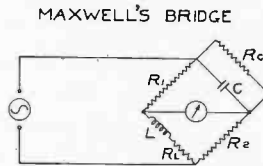

Fig. 2

Theoretically, this bridge has an advantage over that of Fig. 1, in that it balances for all frequencies at the same settings of the controls. The equations for a balance are:

$$L = R_1 R_2 C$$

$$R_L = \frac{R_1 R_2}{R_C}$$

Apparently this bridge is balanced at all frequencies, but unfortunately this does not hold in practice because of the wide variations in the value of R_L when the frequency is changed. Hence, the theoretical advantage of the circuit of Fig. 2 is not a real advantage. In a practical case one circuit is about as far out of balance as the other when the frequency is changed.

This same argument applies to the Anderson bridge shown in Fig. 3. This bridge is a modification of that of Fig. 2 in that the resistor r is added. The equations for balance are:

$$\frac{R_M}{R_N} = \frac{R_X}{R_P} \text{ and}$$

$$L_X = R_M C \left[r \left(1 + \frac{R_P}{R_N} \right) + R_P \right]$$

The reason for the addition of the resistance r is to add a variable which enters into the second equation but not into the first. The idea is that the first equation may be balanced on direct current and then the second may be balanced on alternating current without upsetting the first.

Of course, however, it is found that R_x is of an entirely different order of magnitude on alternating current and on direct current. Hence, it is necessary to readjust the first equation, which upsets the second, and so on.

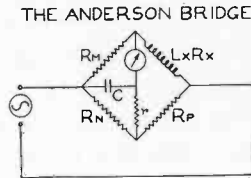

Fig. 3

Thus, with any one of the three circuits shown, in practice it is necessary to make a long series of readjustments of each of two controls to obtain an accurate balance.

It is believed that the Anderson bridge has replaced that of Maxwell to an undeserved extent. The simplicity of the circuits of Fig. 1 and Fig. 2 is a very desirable feature, and the advantages of the Anderson modification very dubious.

The advantage of the circuit of Fig. 1 is the elimination of the divided d. c. path.

Discussion on
RECENT DEVELOPMENTS IN LOW POWER AND
BROADCASTING TRANSMITTERS*

(I. F. BYRNES)

Edward L. Nelson†: In one of the early paragraphs of his paper, Mr. Byrnes discusses the rating of radio transmitters and stresses the importance of excluding losses in the antenna coils in computing the output power. This is a matter which has, at times, occasioned some confusion and his position on this point is well taken. Where radio telephone transmitters are concerned, however, there is another factor of prime significance from a rating standpoint, which is even more frequently neglected, that is, modulation capability. The modulation capability of a transmitter may be defined as the maximum degree of modulation possible without serious distortion, employing a single-frequency sine-wave input and using a rectifier coupled to the antenna in conjunction with an oscillograph or harmonic analyzer to indicate the character of the output. Present day transmitters show wide variations in this important characteristic. In the paper under discussion, for example, the 500-watt Coast Guard transmitter employs one modulator tube for one radio power tube, the 2000-watt Coast Guard set employs one modulator tube for two radio tubes, and the 1-kw broadcasting equipment uses four modulator tubes for one radio tube. It is appreciated that these transmitters were produced for different types of applications where the requirements vary greatly and there is no intention to question the conclusions of the designers. The point is that there must be considerable difference in the modulation capabilities of these sets which will be reflected in the range and grade of service obtainable, yet no indication of this discrepancy is conveyed by present rating practices. In view of the growing importance of telephone applications, it would appear that in the interest of technical accuracy this situation should be recognized and corrected without delay.

Under present day conditions there is much to be gained by

* Presented before New York meeting of the Institute, April 4, 1928. Proc. I. R. E., 16, 614; May, 1928.

† Bell Telephone Laboratories, Inc., New York City

emphasizing this matter of modulation capability. Considerable evidence is available which indicates that the average modulation capability of the broadcasting stations now in service in this country is not greater than 50 per cent. In other words, the majority of stations cannot modulate more than 50 per cent even during the loudest passages in their programs without serious overloading or "blasting" being observed by their listeners. Having in mind that beat-note interference and power limitation is the most serious problem that confronts the broadcasting industry today, it is of interest to note that the same side band power and, therefore, the same signal-to-noise ratio, could be produced by stations of one-fourth the carrier power output provided their modulation capabilities were doubled, that is, made to approach 100 per cent. Or, to consider another alternative, if the carrier outputs were allowed to remain as they are and the modulation were doubled, the service areas of the majority of stations would be increased by a factor approximating four without increase in beatnote interference. Many listeners would, in fact, experience a noteworthy improvement in beat-note conditions since they would then come within the increased service areas of the neighboring stations. It is not intended to imply that the improvement to be had in this manner is a panacea for our present ills, but since it promises to enable 1-kw stations to afford the same grade of service that we now expect from most 4-kw installations, without increase in the beatnote interference zone, it deserves serious consideration from all factors in the industry.

The design of a high quality transmitter capable of complete (100 per cent) modulation is a problem of considerable difficulty. With the Heising system, which is now generally employed on account of its lack of critical adjustments and its excellent characteristics with respect to fidelity, the requirement for complete modulation is that the peak value of the alternating voltage superimposed upon the direct plate voltage impressed on the oscillator or modulated amplifier shall be equal to the direct voltage. Under these conditions the instantaneous peak voltage during the positive half of the cycle is twice the direct voltage and during the negative half of the cycle, the instantaneous voltage reaches zero. With the usual circuit arrangement in which the modulator and radio tubes are fed through a common audio-frequency choke coil, complete modulation without serious

distortion is obviously impossible, regardless of the number of modulator tubes employed, since it requires that an audio-frequency amplifier (the modulator) supply an alternating voltage equal to the direct voltage impressed on its plate. An obvious solution for this difficulty lies in impressing on the modulator tubes a higher plate voltage than is employed on the radio tubes. This may be accomplished by inserting a suitable resistance in series with the plates of the radio tubes together with a relatively large condenser in shunt to by-pass the audio-frequency component. A further requirement is that ample modulator capacity be provided to satisfy the power conditions. It is well known that the power in a completely modulated wave is 50 per cent greater than that represented by the unmodulated carrier. This power must necessarily be supplied by the modulator together with whatever losses are involved in conversion. With the relatively low efficiencies obtainable in audio-frequency amplifiers, a ratio of modulator capacity to oscillator capacity as high as three or five to one may be necessary. These conditions favor that type of system in which the modulation is effected at low power levels and the requisite power output obtained by subsequent power stages amplifying modulated radio-frequency power.

BOOK REVIEW

Handbook of Chemistry and Physics, a Ready-Reference Pocket Book of Chemical and Physical Data. BY CHARLES D. HODGMAN AND NORBERT A. LANGE. Twelfth edition. Chemical Rubber Publishing Company, Cleveland, Ohio. 1112 pages. Price \$5.00.

This handbook of chemical and physical data is too well established as a valuable aid in the laboratory and designing room to require a lengthy review. Although none of the new material is of special interest to the radio engineer, still he will find the volume as a whole to be a true "handbook," and not a mere shelf-book. Among the subdivisions that are likely to be of most service from the radio point of view are the mathematical tables, wire tables, units and conversion factors, definitions, laws and formulas of physics, properties of conductors and dielectrics, laboratory arts and recipes and numerical data on densities, elasticities, strength of materials, thermal expansion, etc. About ten pages are devoted to radio formulas taken from the Bureau of Standards publication on radio instruments and measurements.

W. G. CADY †

† Department of Physics, Wesleyan University, Middletown, Conn.

MONTHLY LIST OF REFERENCES TO CURRENT RADIO LITERATURE*

THIS is a monthly list of references prepared by the Bureau of Standards and is intended to cover the more important papers of interest to professional radio engineers which have recently appeared in periodicals, books, etc. The number at the left of each reference classifies the reference by subject, in accordance with the scheme presented in "A Decimal Classification of Radio Subjects—An Extension of the Dewey System," Bureau of Standards Circular No. 138, a copy of which may be obtained for 10 cents from the Superintendent of Documents, Government Printing Office, Washington, D. C. The articles listed below are not obtainable from the Government. The various periodicals can be secured from their publishers and can be consulted at large public libraries.

R100. RADIO PRINCIPLES

- R112.1 Gratsiatos, J. Über das Verhalten der radiotelegraphischen Wellen in der Umgebung des Gegenpunktes der Antenne und über die Analogie zu den Poissonschen Beugungserscheinungen. (On the behavior of radio waves in the vicinity of the image point of the antenna and on the analogy to refraction phenomena due to Poisson.) *Annalen der Physik*, 86, 1041-1061; August, 1928.

(The electric potential at the image point of a transmitting set and in the vicinity is derived based on the theory of Watson. This gives expressions for the electric and magnetic field.)

- R124 Nestel, W. Untersuchung der Brauchbarkeit von Rahmenantennen für Sendezwecke. (Investigation of the usefulness of coil antennas as transmitters). *Zeitschrift für Techn. Physik*, 9, 143-145; 1928.

The radiation efficiency of coil antennas is investigated by means of Rudenberg's formulas. It is shown that for short waves the coil antenna is almost as efficient as ordinary antennas.)

- R125.6 Wilmotte, R. M. General considerations of the directivity of beam systems. *Journal Institution of Elec. Engrs. (London)*, 66, 955-961; September, 1928.

(Definitions are given for directive efficiency and sharpness of directivity in order to treat theoretically the best condition for an effective beam system. An inclined antenna system with a reflector is suggested and an improvement on the Franklin antenna.)

- R125.6 Wilmotte, R. M. and McPetrie, J. S. A theoretical investigation of the phase relations in beam systems. *Journal Institution of Elec. Engrs. (London)*, 66, 949-54; September, 1928.

* Original Manuscript Received by the Institute, October 15, 1928.

- (The authors derive expressions for the phase relation of beam systems. They assume that the field at all points is due to the radiation field and apply to the amplitude and phase certain factors taking the distance into account. The factors can be read off a graph and their results are checked against experimental investigations due to Tatarinoff.)
- R127 Wilmotte, R. M. The nature of the field in the neighborhood of an antenna. *Journal Institution of Elec. Engrs. (London)*, 66, 961-67; September, 1928.
(Methods for the calculation of the induced voltage in a receiving antenna in the neighborhood of a transmitting station are given.)
- R131 Scroggie, M. G. A direct-reading valve tester. *Experimental Wireless (London)*, 5, 480-84; September, 1928.
(An apparatus is described for the direct indication of the mutual conductance and anode resistance of electron tubes.)
- R132 Beatty, R. T. The stability of a valve amplifier with tuned circuits and internal reaction. *Physical Society Proc. (London)*, 40, 261-268; August 15, 1928.
(Algebraic and graphical treatment of tuned circuit amplifiers.)
- R133 Wechsung, W. Die Erzeugung sehr kurzer elektrischer Wellen mit Wechselspannung nach der Methode von Barkhausen und Kurz. (The production of very short electric waves with alternating current by the method of Barkhausen and Kurz.) *Zeitschrift für Hochfrequenztechnik*, 32, 58-65; August, 1928.
(A continuation of a paper appearing in the *Jahrbuch*, p. 15, 1928. The author extends his experimental work to Barkhausen oscillations with alternating current excitations.)
- R134 A new idea for a detector valve. *Experimental Wireless (London)*, 5, 515; September, 1928.
(The separation of slower moving electrons from the faster ones by means of a magnetic field and a special grid is suggested. This would give rise to a more sensitive detector tube.)
- R140 van der Pol, B. and Van der Mark, J. Le battement du coeur considere comme oscillation de relaxation et un modele electrique du coeur. (The beating of the heart considered as relaxation oscillation and an electric model of the heart). *L'Onde Electrique*, 7, 365-392; September, 1928.
(A review of work on relaxation oscillations and a brief description of the system of frequency division. Compares the action of the heart beat with that of a neon tube oscillator showing that the period of the heart beat has more or less a relaxation period.)
- R150 Sixtus, K. Über den Schwingkristall. (On the oscillating crystal). *Zeitschrift für Techn. Physik*, 9, 70-74; 1928.
(From the static voltage current characteristic of a contact detector it is concluded that oscillations are produced when working in the falling portion of the characteristic. A theoretical formula based only on heating effects at the point of contact confirms the experiment.)
- R190 Eccles, W. H. and Leyshon, W. A. Some new methods of linking mechanical and electrical vibrations. *Physical Society Proc. (London)*, 40, 229-233; August 15, 1928.
(Circuits are shown for which contact detector and neon tube oscillations are controlled either by a tuning fork or a quartz plate.)
- R200. RADIO MEASUREMENTS AND STANDARDIZATION
- R214 Hitchcock, R. C. Piezo-electric frequency control. *Electric Journal*, 25, p. 503; October, 1928.
(An account of the frequency of the station KDKA during the past half year.)

- R283 Symonds, A. A. Loop permeability in iron, and the optimum air gap in an iron choke with d.c. excitation. *Experimental Wireless* (London), 5, 485-490; September, 1928.
(Experimental study of the incremental permeability of iron when d.c. magnetization is superimposed.)
- R284.3 Meissner, A. and Bechman, R. Untersuchung und Theorie der Pyroelektrizität. (Investigation and theory of pyro-electricity). *Zeitschrift für Techn. Physik*, 9, 175-85; 1928.
(Experimental and theoretical investigation of the pyroelectric effects of quartz and Turmalin.)
- R300. RADIO APPARATUS AND EQUIPMENT
- R342 von Ardenne, M. and Stoff, W. The harmful effects of inter-electrode capacity. *Experimental Wireless* (London), 5, 509-514; September, 1928.
(Description of the well-known effects of the tube capacity in amplifiers.)
- R342.2 Barclay, W. A. A graphical construction for resistance amplifiers. *Experimental Wireless* (London), 5, 499-500; September, 1928.
(A graphical method for determining the best values of anode resistance, grid bias, etc., of an amplifier.)
- R342.2 Ramelet, E. Über die neue rein elektronische Verstärkung verwendende Zählmethode für Korpuskularstrahlen. (On a new purely electronic amplification for counting corpuscles). *Annalen der Physik*, 86, 871-913; August, 1928.
(The pure electronic amplification (not amplification by impact ionization as originally employed by Rutherford-Geiger) due to Greinacher has been worked out in more detail by means of a suitable resistance-capacity coupled amplifier.)
- R344 Hollman, H. E. Ein Röhrenoszillator für sehr kurze ungedämpfte Wellen. (A tube generator for very short waves.) *Annalen der Physik*, 86, 1062-1070; August, 1928.
(A tube generating set is described which works down to 36 cm. In some cases waves down to 13.2 cm were measured.)
- R374 Ogawa, W., Nemoto, C., and Kaneko, S. The effect of chemical composition on the sensitivity of galena as a radiodetector and the cold emission from crystals. Researches of the Electrotechnical Laboratory, Japan, No. 230, June, 1928.
(The author explains the action of the crystal detector by means of the difference of electron emissions from the two electrodes forming the contact.)
- R376 Doucet, V. La distortion dans les écouteurs téléphoniques. (On the distortion in telephone receivers). *QST Français et Radio-electricite Reunis*, 9, 27-29; September, 1928.
(Analytical investigation of telephone receivers with regard to distortion.)
- R376 Bauder, R. and Ebinger, A. Untersuchungen über Monotelephone. (Investigations on the Monotelephone). *Zeitschrift für Techn. Physik*, 9, 65-69; 1928.
(Based on the theory of a telephone receiver whose stationary field is large in comparison to the a.c. field. Experiments are carried on with mechanical tuning to resonance. Interesting photographs are shown of the nodal lines developed on the diaphragm.)
- R376.3 Toulon, P. L'évolution et l'avenir de haut-parleurs, exemples de principes nouveaux: Haut-parleurs electro-statiques. (Evolu-

tion and future of loudspeakers, examples of new principles: electrostatic loudspeakers). *L'Onde Electrique*, 7, 393-409; September, 1928.

(Remarks on present day loudspeakers and a description of an electrostatic type.)

- R376.3 Clark, H. A. and Bligh, N. R. Some output power measurements on a moving coil drive loudspeaker. *Experimental Wireless* (London), 5, 491-98; September, 1928.

(Experimental method (using the Heaviside equal ratio inductance bridge) for determining the resistance and reactance of a loudspeaker in the audible range.)

- R384.1 Hull, R. A. The frequency measurement problem. *QST*, 12, 9-19; October, 1928.

(Description of frequency meter and monitor for 1929 to be used by amateurs in keeping their transmitting stations on their proper frequency.)

- R386 Winter-Gunther, H. Zur Theorie der Siebketten. (On the theory of filters). *Zeitschrift für Hochfrequenztechnik*, 32, 41-46; August, 1928.

(A treatment of filter circuits from the standpoint of coupled circuits. Instead of the method due to H. Riegger and L. Cohen, the method of normal coordinates as used by Routh and Lord Rayleigh for mechanical systems is introduced.)

- R386 Mallet, E. Chains of resonant circuits. *Journal Institution of Elec. Engrs.* (London), 66, 968-74; September, 1928.

(The coupled circuit filter is solved with the method of differential equations in order to obtain an expression for the current in the last link of the chain. A graphical solution with an example is given.)

R500. APPLICATIONS OF RADIO

- R580 Taylor, J., and Taylor, W. Some new applications of short radio waves. *Experimental Wireless* (London), 5, 503-508; September, 1928.

(Shows experiments in discharge tubes when high-frequency voltages are applied. It is possible to produce discharges even at very low pressures.)

R800. NON-RADIO SUBJECTS

- 517 Berg, E. J. Heaviside's operational calculus as applied to engineering and physics. *General Electric Review*, 31, 504-509; September, 1928.

(The concluding section of a series of papers on above subject. It gives an application to the linear flow of heat and compiles the formulas used in operational calculus.)

- 534 Lindsay, R. B. High-frequency sound radiation from a diaphragm. *Physical Review*, 32, 515-519; September, 1928.

(From the standpoint of hydrodynamics and sound, an expression is derived for the intensity of the high-frequency sound radiating from piston-like oscillator at a distance from the oscillator greater than the diameter of the circular radiator.)

- 534 Brenzinger, M., and Dessauer, F. Eine neue Methode unmittelbarer Steuerung der Luft durch elektrische Schwingungen. (A new method for the direct control of air waves by means of electric oscillations). *Physikalische Zeitschrift*, 29, 654-58; September 15, 1928.

(A glow discharge is used for changing directly superimposed alternating currents into sound waves. The same principle is also used for making a glow discharge microphone.)

- 534 Meyer, E., and Just, P. Zur Messung von Nachhalldauer und Schallabsorption. (On the measurement of the reverberation time and sound absorption). *Elektrische-Nachrichten Technik*, 5, 293-300; August, 1928.
(A method is given for determining the reverberation time. The experimental curves prove the exponential decay of the sound for an echo.)
- 535.3 Koller, L. R., and Breeding, H. A. Characteristics of photoelectric tubes. *General Electric Review*, 31, 476-79; September, 1928.
(Characteristic curves of light, current, sensitivity, and gas pressure for photoelectric cells.)
- 537.66 Neidl, G. Neuer Versuch zum Johnson-Rahbeck-Effekt. (New experiment with the Johnson-Rahbeck effect). *Zeitschrift für Techn. Physik*, 9, 22; 1928.
(A sphere of mercury is placed on a half conductor, the lower face of which has a metal coating. When an alternating voltage is applied to the mercury and the metal coating, the mercury will vibrate in synchronism with the alternating voltage.)

GEOGRAPHICAL LOCATION OF MEMBERS ELECTED November 7, 1928

Transferred to the Fellow grade	
New York	New York City, 282 West End Avenue... Dreher, Carl
Transferred to the Member grade	
California	Hollywood, KMTR Radio Corp., 1025 Highland Avenue..... Van Why, Forbes William
Illinois	Chicago, University of Chicago, Ryerson Lab..... Hoag, J. Barton
New Jersey	Madison, 14 Fairwoods Road..... Manning, Charles T.
England	London, W. 12, Emlyn Road..... Hardy, Harold
Elected to the Member grade	
Dist. of Columbia	Washington, 4302 Brandywine St. N.W... Davis, Thomas McL.
Massachusetts	W. Somerville, 53 Francesca Avenue... Kolster, Charles C.
Elected to the Associate grade	
Alabama	Phenix City..... Moore, C. M.
California	Berkeley, 2112 Addison..... Howard, L. W.
	Burlingame, 908 Morrell Avenue..... Michalic, Charles Tom
	Hollywood, 1301 Martel Avenue..... Kratz, C. F.
	Marshall, c/o Radio Corporation of America..... Lawrence, Lloyd H.
	Oakland, 643 Poirier St..... O'Brien, Daniel L., Jr.
	Orange, P. O. Box 145..... Charbonneau, L. H.
	San Francisco, 140 New Montgomery, Room 1024..... Stewart, Ronald B.
	San Francisco, KFWL, 1182 Market St., Room 203..... Weir, F. Torres
	San Pedro, U. S. S. <i>Procyon</i> Granum, Alfred M.
	Santa Ana, 1334 S. Parton St..... Sleeper, J. Lloyd
Georgia	Atlanta, 684 Durant Place..... Gue, E. M.
	Atlanta, c/o Radio Station WSB..... Shropshire, A. W.
	Columbus, 731 Broad St..... Cowart, Frank P.
Illinois	Columbus, South Georgia Power Co..... Davis, James C.
	Chicago, 3814 Madison St..... Haire, A. F.
	Chicago, 1119 So. Wood St..... Korb, George William
	Chicago, c/o R. C. A., 100 W. Monroe St. McCune, R. H.
	Chicago, 4137 Jackson Blvd..... Strandjord, Millard F.
	Chicago, 29 No. Morgan Street..... Trier, Stanley S.
Kansas	Rantoul, Chanute Field, Communica- tions Section..... Fiechtner, Theodore G.
	Rockford, 1506 School St..... Johnson, Art A.
Louisiana	Atchison, 202 N. 2nd St..... Dimond, Benjamin Dan
Louisiana	New Orleans, 528 N. Hennessy St..... Salzer, Herman M.
Maine	Belfast, c/o R. C. A..... Morris, Hedley B.
Massachusetts	Braintree, 149 Hollis Ave..... Robison, Philip F.
	Cambridge, Harvard University, Pierce Hall, Room 204B..... Samoiloff, Leon
Michigan	Chatham, Box 631..... Robinson, Forrest D.
	Chathamport, Radio Hotel..... Lee, Walter O.
Missouri	North Cambridge, 128 Clay Street..... Grenier, Henry N.
	Medford, 16 Higgins Avenue..... Yorks, William Ray
Nebraska	South Boston, 157 N. Street..... Brown, George W.
	Crystal Falls, 225 Superior Ave..... Lee, Raymond R.
Missouri	Kansas City, 2803 Linwood Blvd..... Schulze, Heri T.
New Jersey	Norfolk, P. O. Box 226..... Leeman, Wilson
	Cliffwood, Box 31..... Jansky, Karl G.
New Jersey	East Orange, 106 North Walnut St..... Edison, Theodore M.
	Long Branch, 58 Washington St..... Watson, Paul Edwin
	Weehawken, 2 Fourth St..... Girard, E. J.

1786 *Geographical Location of Members Elected November 7, 1928*

New York	Brooklyn, 896 Troy Avenue	Riccobono, Sebastian
	Buffalo, 20 Ullman St.	Mahler, George P.
	East Rockaway, L. I., 47 Waldo Ave.	Van Duyne, Eugene Douglas
	Kenmore, 37 Princeton Blvd.	Voll, Harry F.
	New York City, 161 West 140th Street	Cox, Lloyd V.
	New York City, 562 W. 183rd Street	Gati, Bela
	New York City, 50 W. 57th Street	Leonard, John M.
	New York City, Mackay Radio and Tel. Co., 67 Broad Street	Nivison, T. E.
	New York City, 19 Grove Street	Beardon, Daniel
	Riverhead, L. I., P. O. Box 1077	Tammaro, Joseph Carl
	Rocky Point, Radio Central	Draigh, Canton V.
	Schenectady, 172 Nott Terrace	Schon, Harry
	Schenectady, 9 N. Church Street	Woodworth, John L.
	Charlotte, Y.M.C.A.	Saylor, J. G.
Ohio	Cleveland, 1240 East 167th Street	Shaw, John Joseph
	Fostoria, 642 Lynn Street	Elsa, Farrell F.
Pennsylvania	Shiloh, Box 112	White, Kenneth E.
	Allentown, 806 Union Street	Thomas, Chas. V.
	Pittsburgh, West Penn. Bldg., 14 Wood Street, Room 1304	Sunnergren, Arvid P.
	Waverly, Box 163	Mach, Dahl W.
Rhode Island	Wilkes-Barre, 429 George Ave.	Speicher, Ellsworth J.
Rhode Island	Providence, 42 Greenwich Street	Maker, Albert Edwin
South Dakota	Yankton, 318 W. First Street	Seils, Harry A.
Tennessee	Knoxville, P. O. Box 531	Adcock, S. E.
	Memphis, 43 So. Barksdale	Dowler, R. B.
Texas	Dallas, 3106 St. John Drive	Hinsch, Lincoln A.
	Livingston	McClanahan, C.
Washington	Seattle, 7708 Latona Ave.	Brandt, Oscar T. D.
	Seattle, 904 Telephone Bldg.	Budden, F. W.
	Seattle, 3234 Belvidere Ave.	Hamilton, Edward A.
	Seattle, Pacific Tel. and Tel. Co.	Schreiber, Ernst H.
Seattle, 4026 Evanston Ave.	Sletmo, A. M.	
West Virginia	McMechen, 1104 Caldwell St.	Hicks, William Ray
Wisconsin	Watertown, 314 Water St.	Ebert, Sylvanus J.
Australia	Melbourne, East Camberwell, 6 Beech St.	Fitts, Rupert Alfred
Canada	Victoria, B. C., 2084 Newton St.	Hawkins, Ernest
	Ottawa, 21 Florence St.	Donaldson, Bruce W.
China	Hong Kong, c/o Electrical Dept. P.W.D.	Logan, James Stanley
England	Derbyshire, Buxton, 2 Wood Cliffe	Smith, Harold Ingleby
	Middlesex, Shipperton, Pharaoh's Island, "Kantara"	Henderson, Walter B.
Japan	Shizuoka-Ken, Ogasagun, Kakegawa-cho	
	Kandaiji	Yokoyama, Tetsumi
Elected to the Junior grade		
California	Los Angeles, 1311 Citrus, Hollywood	Fox, B. M.
Nebraska	Clay Center	Hertel, Roger H.
New York	Brooklyn, 6 Bay 23rd St.	Liebner, Barney
	Buffalo, 78 East St.	Feger, Herbert
	Jamestown, 200 Hallock St.	Ellis, James G., Jr.
Pennsylvania	Lancaster, 69 Aurora St.	Pictor, Robert Ezra
	Altoona, 602 E. Grant Ave.	Youngkin, E. E.
	Philadelphia, c/o Atwater Kent Co.	Reid, Floyd Freeman
	Philadelphia, 5737 N. Lawrence St.	Trumpy, J. Walter
	Scranton, 1618 Monsey Ave.	Bartzel, Charles R.
Wisconsin	Milwaukee, 1278 W. 24th St.	Moorbeck, Clinton
England	Manchester, Trafford Park, Metro-Vickers	Thomas, Guy Henry
	Wiltshire, Swindon, 7, Pinehurst Road	Humphreys, Leonard W.

APPLICATIONS FOR MEMBERSHIP

Applications for transfer or election to the various grades of membership have been received from the persons listed below, and have been approved by the Committee on Admissions. Members objecting to transfer or election of any of these applicants should communicate with the Secretary on or before December 29, 1928. These applications will be considered by the Board of Direction at its January 2, 1929 meeting.

For Election to the Fellow grade

Dist. of Columbia	Washington, Naval Communications, Navy Dept.....	Craven, T. A. M.
-------------------	--	------------------

For Transfer to the Member grade

Michigan	Muskegon, 1390 Palmer Avenue.....	Richardson, Avery G.
New York	New York City, 195 Broadway Room 1607....	Misenheimer, Harvey N.
Hawaii	Hilo, Box 923.....	Branch, L. W.

For Election to the Member grade

Massachusetts	Cambridge, 50 Kirkland Street.....	Black, K. Charlton
New Jersey	Bloomfield, 120 Berkeley Avenue.....	Morehouse, W. B.
Germany	Berlin-Charlottenburg, Cauerstrasse 19III....	Kofes, Albert

For Election to the Associate grade

Arkansas	Camden, Box 661.....	Tagart, Sam W.
	Texarkana, 2119 Hickory Street.....	Wallace, L. E.
California	Los Angeles, 947 Francisco Street.....	Heimberger, Albert E.
	San Francisco, 378 Golden Gate Ave., Apt. 235.....	Kelsey, Karl D.
Connecticut	Hartford, 33 Eastview Street.....	Le Conche, Carl
Dist. of Columbia	Washington, 3131 Newton Street, N.E.....	Carroll, Thomas D.
Illinois	Chicago, 4141 Fifth Avenue.....	Felio, Orin J.
	Chicago, 2530 Kedzie Blvd.....	Krueger, Alfred
	Chicago, 2530 Kedzie Blvd.....	Wilm, C. F.
	Galesburgh, 895 West Main Street.....	Mead, Leo R.
Indiana	North Manchester, 702 North Walnut St....	Grove, Claude C.
	Richmond, Box 6, Earlham College.....	Hickman, Roger W.
	Valparaiso, 825 Lincolnway.....	Swanson, Carl R.
Kansas	Topeka, c/o Radio Station WIBW.....	Herider, Ernest D.
	Wichita, 104 Severdale Apts.....	Mitchell, Ray H.
Kentucky	Covington, 3410 Church Street.....	Fraasa, C. F.
Louisiana	New Orleans, c/o Tropical Radio Tel. Co. 321 St. Charles Street.....	Allston, W. F.
	Port Barre.....	Futral, John E.
Maine	Bangor, 331 Center Street.....	Creamer, W. J., Jr.
Massachusetts	Boston, 200 Huntington Avenue.....	Browne, Monte C.
	Boston, 468 Massachusetts Ave.....	Wass, Howard H.
	Cambridge, 28 Gorham Street.....	Shen, Pao-guay
	Cambridge, 28 Gorham Street.....	Tsao, T. C.
	Rockport, 7 Gott Street.....	Mills, William P.
	Springfield, 38 Greenacre Square.....	Nystrom, Raymond A.
Michigan	Ann Arbor, 520 Forest Street.....	Nelson, C. Emory
	Jackson, 1019 First Street.....	Planck, R. M.
Mississippi	Mississippi City, P. O. Box 117.....	Pecoul, Ferdinand Anthony
Montana	Forsyth, Box 1064.....	Roberson, Carl
Nevada	Reno, University of Nevada.....	Sandorf, Irving Jesse
New Jersey	Bridgeton, 150 East Avenue.....	Nichols, Howard Leslie
	East Orange, 71 Leslie Street.....	Woodworth, Fred B.
	Jersey City, 169 Zabriskie Street.....	Weber, Walter
	Orange, 454 Conover Terrace.....	Kynor, Merrill W.
	Union City, 301-33rd Street.....	Masalkovics, Joseph Albert
New York	Brooklyn, 186 Hopkinson Avenue.....	Potter, Max
	Brooklyn, 164 Columbia Heights.....	Stinchfield, J. Maxwell
	Buffalo, 46 Riley Street.....	Oversmith, La Rue H.
	Buffalo, 605 Auburn Avenue.....	Perau, Frederic Henry

New York (cont'd.)	Buffalo, 62 Manden Street.....	Smith, Stanley C.	
	Gardenville, 447 Potter Road.....	Felmet, Albert	
	New York City, c/o Norton Lilly, 26 Beaver Street.....	Berry, Harold C.	
	New York City, 140 West 16th Street.....	Castaneda, Santiago	
	New York City, 118 East 103rd Street.....	Doubles, David J.	
	New York City, 41 West 86th Street.....	Feldstein, Martin A.	
	New York City, c/o Norton Lilly, 26 Beaver Street.....	Francis, Philip	
	Brooklyn, 326 Utica Avenue.....	Gottdenker, Martin	
	New York City, R. C. A., 326 Broadway.....	O'Connor, John G.	
	New York City, 195 Broadway.....	Reinken, Louis W.	
	Rochester, 7 Edmonds Street.....	Steneri, Arthur John	
	Schenectady, 848 Union Street.....	O'Neill, John P.	
	Staten Island, USS <i>Acushnet</i>	Miller, Paul E.	
	Henderson.....	Woolard, E. W.	
	North Carolina	Fargo, 905-5th St., North, No. 19 Rust Apts.	Cook, Tedd W.
North Dakota	Cleveland, 7617 Myron Avenue.....	Crocs, John Stanley	
Ohio	Cleveland, 3516 Storer Avenue.....	Irvine, Robert P.	
	Marion, 177 East Center Street.....	Brown, David Ashton	
Oklahoma	Zanesville, 606 Ridge Avenue.....	Bell, Lewis M.	
	Oklahoma City, Oklahoma Gas & Electric Co.....	Bathe, C. E.	
Oregon	Portland, 873 Belmont Street.....	McCargar, S. Harold	
Pennsylvania	Allentown, 246 S. Madison Street.....	Bowman, Charles W.	
	Allentown, 226 N. 6th Street.....	Haines, A. J. D.	
	Allentown, 2014 Highland Avenue.....	Muthart, John A.	
	Allentown, 949 Hamilton Street.....	Rauhofer, Frank	
	Easton, 426 S. 21st Street.....	Clendaniel, John Edwin	
	Easton, 18 N. 9th Street.....	Raesly, James B.	
	Easton, 1815 Fairview Avenue.....	Weller, Everett Clare	
	Philadelphia, 2209 South Chadwick Street.....	Johnson, Harmon	
	Philadelphia, 765 S. 10th Street.....	Mattia, Ralph F.	
	Wilkinsburg, 215 Ross Avenue.....	Reynolds, C. C.	
	Providence, 4 Pemberton Street.....	Brewster, O. H.	
	West Virginia	Charleston, 4 Maple Terrace.....	Moore, Thomas H.
	Wisconsin	Milwaukee, 1667 Oakland Avenue.....	Hough, W. E.
		Milwaukee, 1405 Bremen Street.....	Strassman, Irving H.
	British Guiana	Demerara, Georgetown, 61 Hadfield St.....	Tasker, Joseph Thomas
Chile	Valparaiso, Casilla 1653.....	Vierling, Gustav	
England	Stockport, North Reddish, 446 Gorton Road.....	Howard, C. Alexander	
India	Baroda, Babajipura.....	Dighe, K. S.	
Ireland	60 Clifton Road, Bangor, Co. Down.....	Jamison, A.	
Mexico	Puerto Mexico, Veracruz, Apartado, 86.....	Bourgeois, Allen B.	

For Election to the Junior grade

Illinois	Champaign, 61 East Green Street.....	Pennington, D. J.
Indiana	Valparaiso, 712 Calumet Avenue.....	Clark, Edgar J.
	Valparaiso, 156 S. Franklin Street.....	Woodworth, Elwyn Crane
Massachusetts	Quincy, 189 Common Street.....	D'Alessandro, Genaro
Michigan	Royal Oak, 286 West Ten Mile Road.....	Alain, J. E.
New York	Brooklyn, 140 Vanderbilt Avenue.....	McGonigle, William J.
Oregon	Salem, 2405 Center Street.....	Poujade, Donald G.
Pennsylvania	Allentown, 38 S. Jefferson Street.....	Foley, W. R.

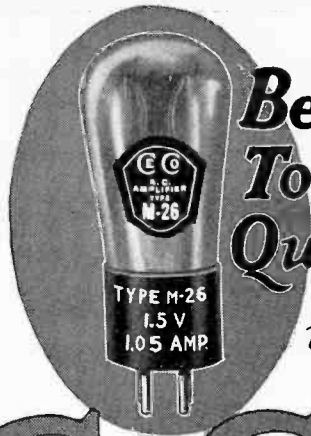

**Better
Tone
Quality**
with

CECO

RADIO TUBES

THE acid test of any radio tube is performance. And it's performance that has made CeCo Tubes the choice of leading engineers for their own sets and specified for the circuits designed by them.

The most noticeable features of CeCo's outstanding quality are *tone*, the greater clarity of reproduction, *their* greater sensitivity and longer operating life.

The CeCo line is most complete, embracing practically all existing types in both A.C. and D.C., as well as in a number of "special purpose" types.

Write for technical data and characteristics, and copy of booklet "Getting the Most out of Your Radio."

CeCo Mfg. Co., Inc.



Providence, R. I.

Used by Millions



When writing to advertisers mention of the PROCEEDINGS will be mutually helpful.

NEITHER great men nor great products require a long story about their virtues. Their very manner of existence and daily accomplishments tell all that the onlooker needs for appreciation and endorsement. Certain automobiles, for example, have won such confidence that no high-pressure selling is required. Their makers know that all the world would own them. And so with Kolster Radio. Such faithfulness in tone quality, such extraordinary selectivity and such distinguished appearance have created, by their presence in thousands of homes in every State in the Union, a powerful structure of confidence within the public mind. Glowing praise is irrelevant when this exists. It is enough to hear on all sides the quiet remark, "*Kolster is a fine set.*"

KOLSTER RADIO CORPORATION,
NEWARK, NEW JERSEY

(c) 1928, Kolster Radio Corporation

When writing to advertisers mention of the PROCEEDINGS will be mutually helpful.

CHROME



The Watch Dog of Power

CHROME, a preservative, guards power when your Burgess "Super B" Batteries are not in use. Thus extra life and service are added. The valuable properties of Chrome in lengthening battery life were long known to scientists, but it remained for Burgess engineers to discover the secret of utilizing Chrome in battery construction.

The year's noteworthy achievement in radio enjoyment and economy is the Burgess "Super B" Batteries

"Super B" No. 22308

is a medium size heavy-duty 45-volt battery designed for general, all around use.

"Super B" No. 21308

is the largest size Burgess heavy-duty 45-volt battery—made especially for heavy-current consuming sets.

These two "Super B" Batteries answer practically all radio set requirements.

BURGESS BATTERY COMPANY

General Sales Offices: CHICAGO

In Canada: Niagara Falls & Winnipeg

BURGESS "SUPER B" BATTERIES

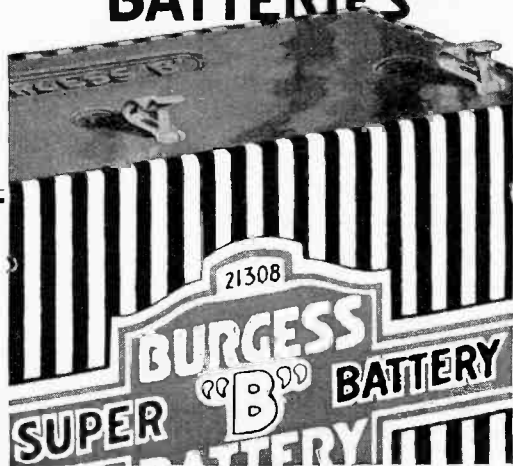

When writing to advertisers mention of the PROCEEDINGS will be mutually helpful.

LEUTZ

FULL WAVE B-C CURRENT SUPPLY

For Laboratory and Experimental Work

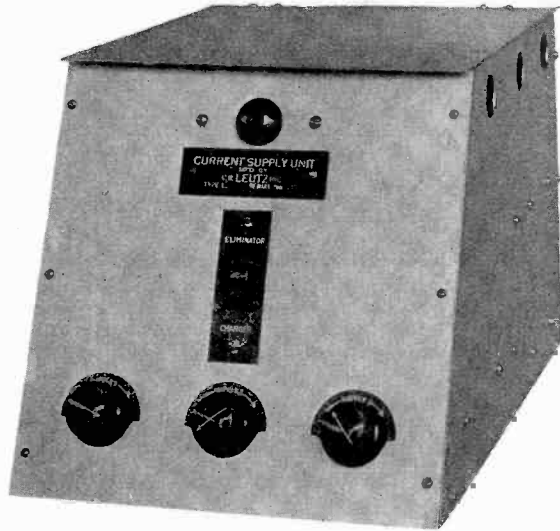

SPECIFICATIONS

Line Supply 110 volts 60 cycles A.C., standard. Made special for 25, 40 or 50 cycles, 110 or 220 volts A.C.

OUTPUT

1. High voltage "B" 450 volts, 130 M.A. D.C.
2. Intermediate "B" voltages, 3 supplies, 0/67½, 0/180, 0/200 all continuously adjustable, D.C.
3. Power Amplifier "C" voltage 35 to 72 volts, D.C.
4. Power Amplifier Filament Voltage, 7½ volts, 2½ amperes A/C.

CONTROL SWITCH. Multiple control switch opens and closes all circuits, including receiver filament circuits and rear outlets for connecting either an "A" supply or storage battery charger. Red bulls eye pilot indicator included.

TUBES. Two UX28r Rectifier Tubes are required.

Prices on this standard Current Supply or on Current Supplies built to special specifications, given upon application.

Literature on Request

C. R. LEUTZ, Inc.

195 Park Place, Long Island City, N.Y.

Cables "*Experinfo*" N.Y.

When writing to advertisers mention of the PROCEEDINGS will be mutually helpful.

DeJUR-AMSCO

"Bathtub" Condensers

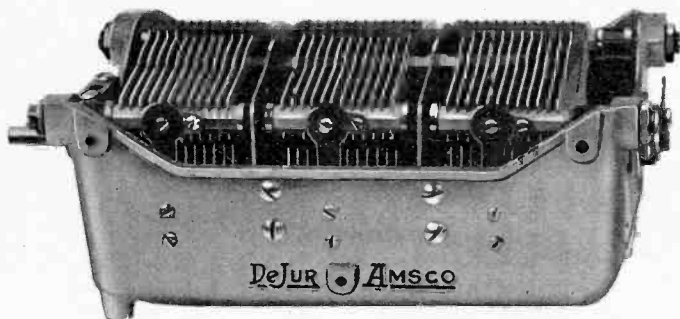

The Perfect Units for Single Control Tuning

These new DeJur-Amsco "Bathtub" Condensers save time in assembling, save space and assure greater rigidity and finer accuracy in single control tuning. They have been adopted by the largest manufacturers of sets and kits and are specified in all the leading circuits. Mounting holes are provided on all sides of the frame, permitting mounting of the condenser in any position necessary for drum dials or regular panel dials. The tuning curve affords a uniform distribution of all stations. DeJur-Amsco "Bathtub" Condensers are available in double, triple and quadruple combinations in all capacities, scientifically calibrated and perfectly matched.

AT YOUR SERVICE

Let the DeJur-Amsco Engineers cooperate with you to solve your particular condenser problem. Submit your specifications and we will gladly quote on your special job.

Resistances

Synthetic, Metallized and Vitreous Enamelled Resistances Made to Specifications or Blue Prints. Write for Catalog.

DeJUR-AMSCO CORPORATION

Broome and Lafayette Sts.

New York City

When writing to advertisers mention of the PROCEEDINGS will be mutually helpful.

W.C. BRAUN COMPANY

WHOLESALE RADIO
HEADQUARTERS

*Official Distributors
for Leading Radio
Products*



As the world's largest distributors, jobbers and wholesalers of a varied line of radio products, the W. C. Braun Co. offers to manufacturers, dealers and custom set builders, a most useful and necessary service.

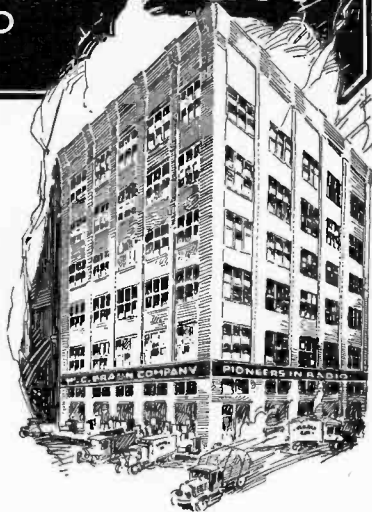

For the dealer and custom set builder we furnish a quick, easy, convenient and economical means of securing any merchandise desired on instant notice by letter, wire or in person. To be able to secure such service, all under one roof, without going to the trouble of buying from a dozen or a hundred different sources, certainly is a service that is well worth while to the manufacturer as well as to the Radio Trade.

Selections—Variety—Service

The list of well-known radio lines represented by us includes practically all the famous names in the radio industry. Besides carrying large selections of varied lines of products of leading parts, equipment and accessory manufacturers, we distribute well-known lines of radio sets and co-operate with our dealers in advertising, window and store displays and in furnishing proper sales aids to insure successful business. In the small-town field as well as in larger radio centers, Braun service means much to the dealer and professional radio man.

Headquarters for Custom Set Builders

We are headquarters for the parts of the country's leading parts manufacturers' products, used in the leading circuits. Parts and supplies for any published radio circuit, whether short wave or broadcast, are immediately available from our stock.

Manufacturers desiring a distributing outlet furnishing world-wide service, are invited to take up their problems with us. Dealers, custom set builders and engineers will find here an organization keyed to fill their needs promptly and efficiently and a request on their letterhead will bring a copy of the Braun's Radio Buyers' Guide—the bible of the radio industry.

W. C. BRAUN COMPANY

Pioneers in Radio

600 W. Randolph St.
CHICAGO, ILLINOIS

When writing to advertisers mention of the PROCEEDINGS will be mutually helpful.

WANTED: *Radio Engineers*

*with commercial experience in the
design and development of—*

DYNAMIC SPEAKERS
PAPER DIELECTRIC
CONDENSERS

ALSO PRODUCTION TEST
ENGINEERS

One of the oldest radio manufacturing companies, located in the vicinity of New York, has openings at the present time for thoroughly experienced radio engineers for the work stated above.

There are also openings for engineers who have had commercial experience in the development of vacuum tube circuits, particularly with Neutrodyne circuit arrangements.

*Write, stating age, education and
commercial experience.*

BOX 820

Institute of Radio Engineers

The Perfect Electric Phonograph Motor

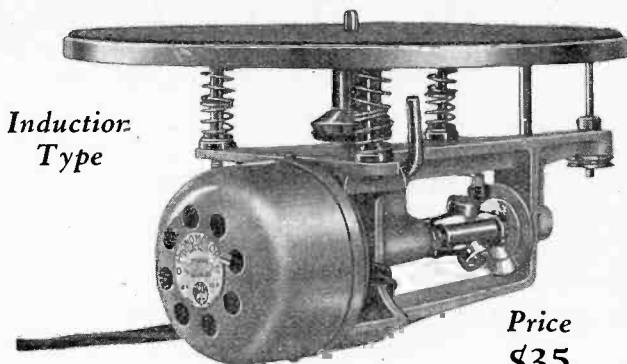

*Induction
Type*

*Price
\$35*

There is Nothing Finer . . .

1. Because—it is of the silent squirrel cage induction type. No commutators, brushes or sparking.
2. The turntable is spring suspended and shockproof; driven by a felt cone friction drive, further insulating against noise.
3. Oversize burnished ball bearings throughout. Large gray iron motor frame for perfect alignment. Accessible lubrication system which needs attention only about once a year. Regular knob and control mechanism integral with casting. The motor may be stalled indefinitely without damage.
4. Low power consumption. 15 watts, approximately $1\frac{1}{2}$ cents for 10 hours. Normal voltage, 110 volts, 60 cycles.

Besides being absolutely sound proof, the Pacent Phonomotor is the sturdiest, longest lasting trouble free phonograph motor made.

The **PACENT Phonomotor**

PACENT ELECTRIC CO., Inc., 91 Seventh Ave., New York City

When writing to advertisers mention of the PROCEEDINGS will be mutually helpful.

**USE
DURHAMS
as
Grid Leaks
Detector Tap
Resistors
Voltage
Dividers
Resistance
Coupling
Battery
Eliminators
TELEVISION**

Metallized

*Wherever Non-Capacitative
Non-Inductive Pure Path of Resistance is
a Vital Factor!*

—whether in factory-made or custom-built radio receivers, whether in battery eliminator circuits, whether in power amplifiers or in television circuits—DURHAM Resistors, Powerohms and Grid Suppressors are the first choice of men who seek first quality results. DURHAM Powerohms are recommended for use in the sensitive resistance-coupled amplifiers in the photo-electric cell circuit of Television apparatus. They are specified in the popular Cooley Rayo-Photo Equipment. They are used by the U. S. Government and by such experienced organizations as General Electric, Western Electric, Westinghouse, Stewart-Warner, Bell Laboratories, and practically every important radio service station and experimental laboratory in the country. Made in all ranges for every practical equipment. Follow the lead of the leaders in radio and tie-up to DURHAMS—radio's leading resistance units.

DURHAM

METALLIZED

RESISTORS & POWEROHMS

International Resistance Company, 2006 Chestnut Street, Philadelphia, Pa.

When writing to advertisers mention of the PROCEEDINGS will be mutually helpful.

ANOTHER CASE OF GAS

But no pulmotor can save a gassy tube.

THE presence of ionization in a supposedly high vacuum tube presents an interesting problem to the engineer—but it means only costly replacements to the dealer.

Occluded gases can be removed with relative ease from the metallic elements of the tube by bombardment. But ceramics, heated only by conduction or radiation, defy strenuous evacuation. No ceramic is used as an inter-element insulating

material in ARCTURUS indirectly heated tubes. The elements are simultaneously subjected to both *internal* and *external* bombardment. And the gas is exhausted by the most efficient vacuum pumps known to science—assuring A-C tubes of highest efficiency.

These are two of the many points of superiority that stimulate universal acceptance among radio engineers as the finest vacuum tubes that can be built. Arcturus Radio Company, 220 Elizabeth Ave., Newark, N. J.

ARCTURUS

A-C LONG LIFE TUBES

WANTED

A Radio Engineer

RECEIVER DEVELOPMENT
and
DESIGN SPECIALIST

QUALIFICATIONS:

Degree in E.E.

Not less than five years' experience
with radio manufacturer of recog-
nized standing.

Experienced in radio measurements.

An opportunity to take charge of import
work with a large New England Radio
Manufacturer established more than
twenty years.

Write Box 822, I. R. E., giving full details
of training, experience, salary expected.
Enclose photograph if available. All re-
plies confidential.

"You Can Forget the Condensers, If They Are DUBILIER'S"

1 mfd. condenser \$5.00

2 mfd. condenser \$8.00



Dubilier

TRANSMITTING CONDENSERS

DUBILIER type 686 condensers have the usual Dubilier high safety factors for use in transmitter filter net works. 1000 volt DC rating. May be connected in series where the working voltage exceeds 1000. Through series parallel connections practically any working voltage and capacity can be obtained.

DC voltage must not exceed 1000; or in A.C. supply filter circuits the transformer voltage must not exceed 750 volts per rectifier plate.

Ask about Dubilier paper condensers also,—the standard of the leading manufacturers.

Write Dept. 81
for free catalog



Dubilier

CONDENSER CORPORATION

10 East 43rd Street

New York City

When writing to advertisers mention of the PROCEEDINGS will be mutually helpful.

XXI

Raytheon



Foto-Cell

Television sending tube
in hard vacuum or
gas filled types

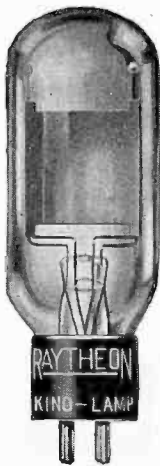

Kino-Lamp

Television receiving tube
adapted to all systems

Price \$7.50

PROGRESS IN TELEVISION

Raytheon Laboratories took up the task of developing tubes for television apparatus as soon as practicable principles of television transmission and reception had been worked out.

Raytheon progress in this field has, therefore, been concurrent with television development as a whole.

We now offer, as equipment of proved efficiency, the Foto-Cell sending tube and the Kino-Lamp receiving tube.

The Foto-Cell has been developed to the point where cells are made which will respond to various frequencies in the light-spectrum.

The Kino-Lamp is being produced in numerous types and styles, which provide suitable light-sources and light-sensitive relays for all systems. These include various types of spot-glow lamps, as well as flat-plate type—all of which will glow in white, blue, green and various tints of orange.

These developments are also effective in phono-film, in sound-reproduction, and in all systems where a sensitive light-relay or a sensitive light-source is needed.

*We invite correspondence and
welcome opportunities to extend
co-operation in television
and allied developments*

RAYTHEON MFG. CO.
CAMBRIDGE, MASS.

When writing to advertisers mention of the PROCEEDINGS will be mutually helpful.

THE RADIO MARKET



The radio audience in the United States, by a recent estimate, amounts to over 41,000,000 people. An audience that is constantly growing more critical — demanding sets that more nearly approach perfection. Radio manufacturers realize that more than ever before their success depends on the mechanical perfection of every part. What more logical place to turn than to Scovill for assistance in manufacturing problems? Scovill, with its up-to-date research department, its facilities for designing and building any special tools or machinery required, its tremendous capacity for volume production, is known as a dependable source of supply for parts and completed articles of metal such as condensers, condenser parts, metal stampings, screw machine parts, switches, etc. Escutcheons and similar parts can be stamped or etched to meet requirements.

Scovill means SERVICE to all who require parts or finished products of metal. Great factories equipped with the last word in laboratories, and modern machinery manned by skilled workmen, are at your disposal. Phone the nearest Scovill office.

SCOVILL

MANUFACTURING COMPANY Waterbury, Connecticut

NEW YORK - CHICAGO - BOSTON - SAN FRANCISCO
DETROIT - PHILADELPHIA - LOS ANGELES - ATLANTA
PROVIDENCE - CLEVELAND - CINCINNATI

Member, Copper and Brass Research Association

When writing to advertisers mention of the PROCEEDINGS will be mutually helpful.

XXIII

NEW PLUG-IN COILS FOR SHORT WAVE RECEPTION

Electrically correct coil form design.

One piece moulded bakelite rib construction.

Threaded Ribs afford accurate spacing of heavy copper enamel wire.

Coils fitted with six plugs allowing three independent windings per form.

Minimum amount of dielectric in coil field.

Mechanically rugged—built to operate under any climatic conditions.

One piece moulded bakelite base fitted with six spring contacts.

Coils adaptable to all popular short wave circuits.

Ideal for low powered transmitters (up to 30 watts input).

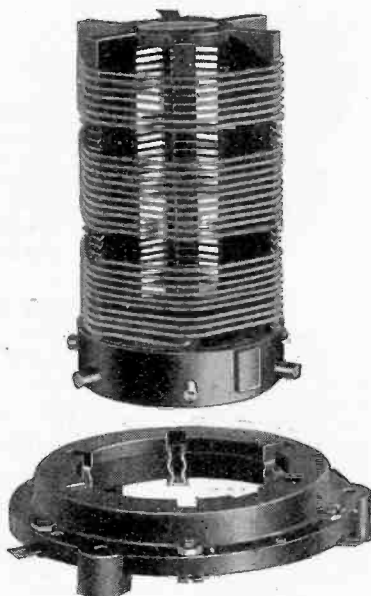

These new REL plug-in coils may be purchased singly to cover specific channels; they are supplied in kit combinations for the new 1929 amateur channels. They also may be purchased singly or in kit combination for various low powered transmitting circuits. The coil forms may also be purchased un-wound if so desired.

Literature describing these new plug-in coils and the new variable condensers, which we announced in the last issue of the Proceedings is ready for distribution.



MANUFACTURES A COMPLETE LINE OF
APPARATUS FOR SHORT WAVE TRANS-
MISSION AND RECEPTION.

RADIO ENGINEERING LABORATORIES

100 Wilbur Ave.

Long Island City, N.Y., U.S.A.

When writing to advertisers mention of the PROCEEDINGS will be mutually helpful.

SM

Audio Amplification

*For Home, School,
Theatre, or Stadium*

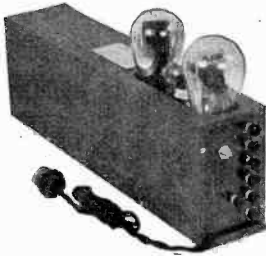

678PD

Among the wide variety of standard Silver-Marshall audio amplifiers, several representative light-socket-powered amplifier systems are illustrated herewith. Where standard equipment may not meet specific requirements, special amplifiers or parts therefore can be designed and built to order.

678PD Phonograph or Radio Amplifier

A compact two stage amplifier, of a type similar to that made by S-M for several theatrical phonograph manufacturers. From radio or record input, it will develop 4500 milliwatts undistorted power to cover up to 2,000 seat theaters when feeding two dynamic speaker units in 40 inch baffles (to one dynamic unit it supplies field current, if desired). Ideal also for home use. Tubes used: one each '26, '81, and '50. Price, WIRED, ready to operate, \$73.00; or KIT, complete, \$65.00.

685 Voice, Record or Radio Unipac

The 685, for portable use, as utilized by the U. S. Shipping Board exhibits at many state and county fairs, gives coverage of 2,000 seat or larger auditoriums, or outdoor crowds of up to 15,000, with optional voice, radio, or record input. Price, 685 Unipac, WIRED, ready to operate, \$160.00, or 685 KIT, complete, \$125.00.

"P.A." Super-Power Rack and Panel Amplifiers

For large theatres, schools, hospitals, auditoriums, or stadiums, requiring the finest amplifying equipment. Any number of standard (or special) unit panels, assembled in S-M racks, will provide for any class of coverage. The system illustrated provides optional selection of one of two microphones, radio, or record input, with master gain control, visual volume level indicator, three stage input amplifier, test meter panel, input amplifier power supply, and two socket-powered push-pull output panels of 15 watts undistorted power output, each with a voltage gain of over 5,000 times, a frequency characteristic flat to 2 T.U.'s from 30 of 4,000 cycles (with cut-off at 4,500 cycles) and with hysteretic distortion practically eliminated, the performance of S-M "P.A." type amplifiers is unconditionally guaranteed superior to any and all competitive American equipment.

The system illustrated lists at \$1,015.00, assembled, ready to install, and will cover four 2,000 seat theaters, or 25,000 people out-of-doors, using dynamic reproducers; or sixty speakers for hospital rooms or apartments.

Full information on these new amplifiers will be mailed free on request. Ask for the 24-page S-M General Catalog, and for Data Sheet No. 9 and Radiobuilder No. 6.

SILVER-MARSHALL, Inc., 862 W. JACKSON BLVD.
CHICAGO, - - U. S. A.

When writing to advertisers mention of the PROCEEDINGS will be mutually helpful.

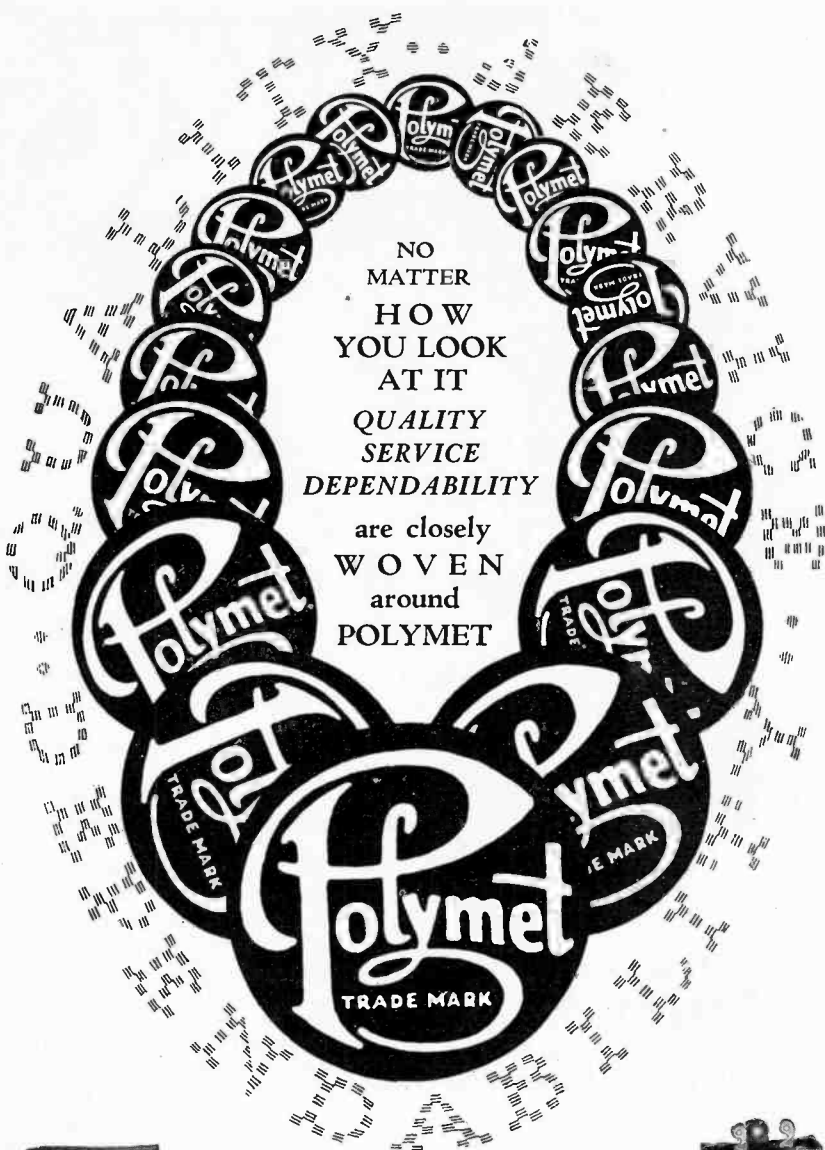

NO
MATTER
HOW
YOU LOOK
AT IT
QUALITY
SERVICE
DEPENDABILITY
are closely
WOVEN
around
POLYMET



POLYMET
MANUFACTURING CORP.
591 Broadway, New York City



POLYMET PRODUCTS

When writing to advertisers mention of the PROCEEDINGS will be mutually helpful.
XXVI



Rising to the needs of a Great Industry

The requirements of the modern radio, are more and more exacting.

As receiving sets improve, coils must be more accurate to keep pace with the fine calibrations of the expert radio engineer.

This is why the world's most successful radio manufacturers turn to Dudlo for their supply of coils for every part of their instruments.

Dudlo coils are not only wound accurately, but every part and material from the core to the outside wrapping is selected and applied

with skill—a skill which could only come from an organization trained over many years of making millions upon millions of coils for every electrical purpose.

No radio unit is any better than its coil and no coil is any better than the wire in its windings. Dudlo draws and insulates the wire and controls every part and process from the copper rod to the finished coil. A complete service to the radio and electrical industries.

DUDLO MANUFACTURING CO., FORT WAYNE, INDIANA

Division of the General Cable Corporation

56 Earl Street
NEWARK, N. J.

105 West Adams St.
CHICAGO, ILL.

4143 Bingham Ave.
ST. LOUIS, MO.

274 Brannan St.
SAN FRANCISCO, CALIF.

When writing to advertisers mention of the PROCEEDINGS will be mutually helpful.

XXVII

EXCEPTIONAL QUALITY
that brings **UNUSUAL ECONOMY**

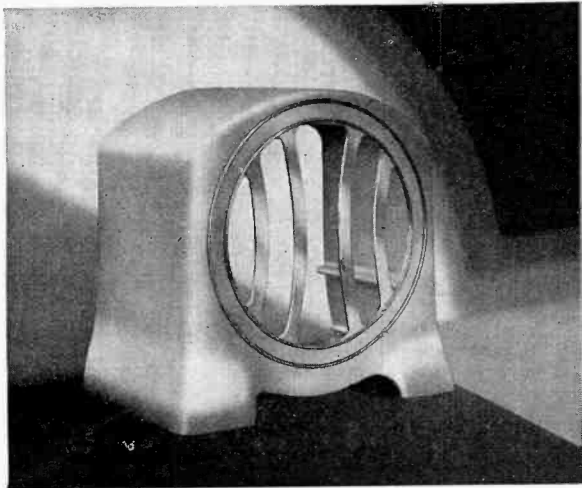

The superior quality of Alumac Die Castings of Alcoa Aluminum is attested by their wide use in high class products in almost every line of industry.

Their close tolerances, their uniformity, their high accuracy, their excellence of finish, all contribute to the manufacturing economies which they almost invariably effect.

If you are already a user of die castings, let us demonstrate to you the unusual excellence of Alumac Die Castings. If you are not, then, in all probability, Alumac Die Castings will enable you to improve your product, speed up production and reduce shop costs. A request will bring one of our die casting specialists to consult with you, without obligation—or, if you prefer, we will send a copy of our Die Casting Booklet, containing interesting and valuable information.

ALUMINUM COMPANY OF AMERICA
Aluminum in Every Commercial Form
2469 Oliver Building, Pittsburgh, Pa.
Offices in 19 Principal American Cities

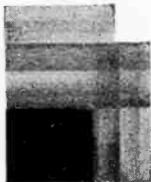

ALUMINUM
ALUMAC
DIE CASTINGS
For Strength, Lightness, Economy

When writing to advertisers mention of the PROCEEDINGS will be mutually helpful.

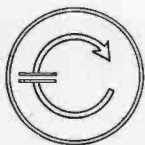

THE HALLMARK

+ THE NAME BEHIND IT



THE DESIRABILITY
OF THE PRODUCT

For centuries the Hallmarks of reputable artisans in precious metals have carried with them unquestioned assurance of excellence.

Likewise, the mark of CARDWELL on a condenser is your guarantee of the quality and excellence of the product which bears it.

Not without reason does a section of a single installation of one of the greatest commercial Radio concerns in the world contain over 40 large CARDWELL transmitting condensers, and you may safely be guided by the choice of those who know and demand the worth that backs up the mark of CARDWELL.

CARDWELL CONDENSERS

For all purposes

Variable—Fixed—Transmitting—Receiving

THE STANDARD OF COMPARISON

Literature upon request.

THE ALLEN D. CARDWELL MFG. CORP.
81 PROSPECT ST., BROOKLYN, N.Y.

*Standard of Accuracy
and Long Life*

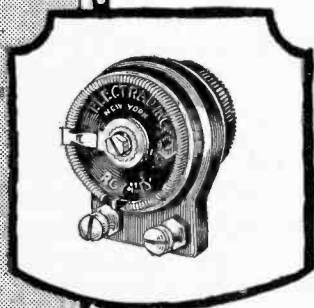

ROYALTY
*Variable High
Resistances*

Exclusively Licensed by Technidyne Corp.
U. S. Pats. 1593658, 1034103, 1034104

ROYALTY Variable High Resistances have established themselves as a foremost choice with manufacturers and set builders because of their uncommon accuracy, efficiency, smoothness of operation, and dependability.

They are widely used as volume controls and are especially adapted for use in high frequency circuits where it is important that resistances which are free from harmful inductance and capacity effects be used.

These resistances are made with the best insulating materials. The resistance element is under control in manufacture and does not change in use. There is no binding—knob and shaft turn smoothly over full range which is covered in one turn.

There is a Royalty for every radio purpose. Our Engineering Department will make recommendations of units with special gradients for specific circuit purposes.

Electrad specializes in a full line of Controls for all Radio Purposes including Television.

Write for Free Hook Up Circulars and
Circuit Data

Dept. A-12
175 Varick Street, New York

ELECTRAD

When writing to advertisers mention of the PROCEEDINGS will be mutually helpful.
XXX



The New
TEMPLE DYNAMIC
Speakers

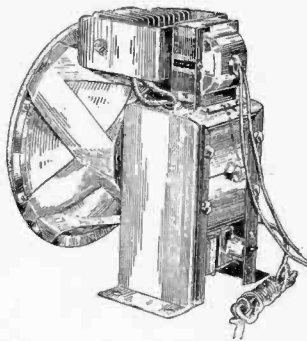

ADD to the approved and accepted principle of sound reproduction the compelling significance of the Temple name and the result is a product which again sets a new standard in speaker excellence.

Temple Dynamics are made only as Temple can make them—that means better.

Available to manufacturers in three chassis models:

- Model 10, 110 volt, A.C., 60 cycle
- Model 12, 110 volt, A.C., 25 cycle
- Model 14, 110 volt, D.C.

Air Column and Air Chrome Models

The renowned Temple Exponential Air Column Speakers are available in several types and sizes. They will fit practically any cabinet or console for size.

The sensational Temple Air Chrome Speakers can also be had in manufacturers' types ranging from a small 9" x 21" to a 24" x 24" speaker.

Write for Full Particulars and Prices

TEMPLE CORPORATION
1925 S. Western Ave., Chicago, U. S. A.

LEADERS IN SPEAKER DESIGN

When writing to advertisers mention of the PROCEEDINGS will be mutually helpful.
XXXI

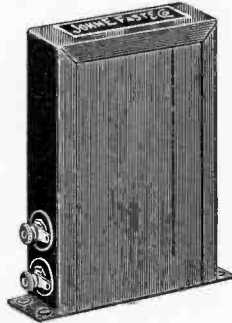
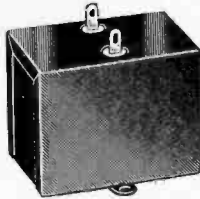
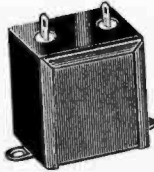

Condenser Specialists

Offer an Unusual Service to Set Manufacturers

Millions of Fast by-pass and filter condensers are in daily use in radio sets made by the leading set manufacturers. They are renowned for their high insulation resistance and excellent and dependable electrical characteristics.

Manufacturers looking for a dependable source of supply, keyed to meet large production problems, on short notice, will find here one of the largest organizations of its kind in the world.

We make one thing and one thing only—wax impregnated paper condensers in die-press steel jackets, in medium and large capacities to fit every known need in radio sets, power units, etc. We make no set hardware, no eliminators, no transformers, no parts, no sets. Our entire concentrated effort is on one product alone—condensers. Such specialization assures highest quality, economical production and real service.

Send us your specifications.

JOHN E. FAST & CO.

Established 1919

3982 Barry Avenue, Dept. I.R.E., Chicago, U.S.A.

MEMBER
RMA

Fixed and Adjustable Resistors for all Radio Circuits



BRADLEYUNIT-B

RADIO manufacturers, set builders and experimenters demand reliable resistors for grid leaks and plate coupling resistors. For such applications Bradleyunit-B has demonstrated its superiority under all tests, because:

- | | |
|--|-------------------------------------|
| 1—Resistance values are constant irrespective of voltage drop across resistors. Distortion is thus avoided | 4—Adequate current capacity |
| 2—Absolutely noiseless | 5—Rugged, solid-molded construction |
| 3—No aging after long use | 6—Easily soldered. |

Use the Bradleyunit-B in your radio circuits

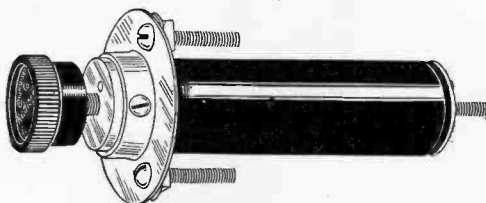

RADIOSTAT

This remarkable graphite compression rheostat, and other types of Allen-Bradley graphite disc rheostats provide stepless, velvet-smooth control for transmitters, scanning disc motors and other apparatus requiring a variable resistance.

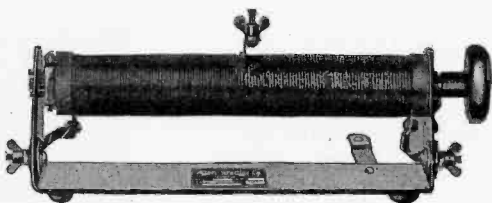

LABORATORY RHEOSTAT

Type E-2910—for general laboratory service. Capacity 200 watts. Maximum current 40 amperes. A handy rheostat for any laboratory.

Write for Bulletins Today!

Allen-Bradley Company

282 Greenfield Avenue

Milwaukee, Wisconsin

When writing to advertisers mention of the PROCEEDINGS will be mutually helpful.

XXXIII

Real Satisfaction

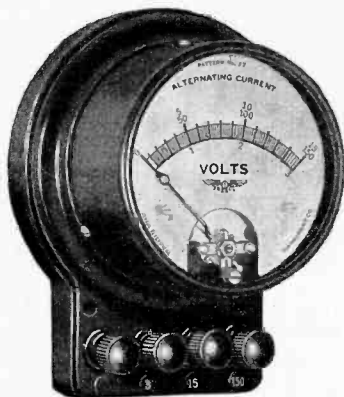

*Pattern
No. 77
Triple Range
A.C. Voltmeter*

Wherever alternating currents are to be measured at commercial frequencies a Jewell Pattern No. 77 portable A. C. Voltmeter will be found extremely satisfactory, due to its handy size, general efficiency, and accuracy in reading.

The Pattern No. 77 ranges are ample to check the voltages likely to be encountered. The instrument illustrated has a triple range of 0-3-15-150 volts, while other single and double ranges, running to 750 volts, are available.

Accuracy, long life and portability are the predominating characteristics of this instrument. It has a well balanced appearance and its construction is such that it will effectively withstand the rough handling incident to use without impairing its reliability.

Our descriptive circular No. 2009 gives complete ranges and prices. Write for a copy.



"28 Years Making Good Instruments"

Jewell Electrical Instrument Co.

1650 Walnut St., Chicago

— J E W E L L —

When writing to advertisers mention of the PROCEEDINGS will be mutually helpful.
XXXIV

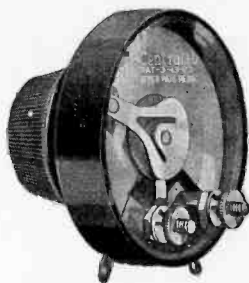

Consider First— The Volume Control

THE volume control of a radio set is one of the parts most used and subjected to the most wear. Care must be taken to choose the type that will give longest, trouble-free service—a type that will not introduce noise to interfere with the quality of reception after a short period of service.

Centralab Volume Controls have a patented rocking disc contact that eliminates all wear on the resistance material. This feature adds to the smoothness of operation in that a spring pressure arm rides smoothly on the disc and NOT on the resistance. The bushing and shaft are thoroughly insulated from the current carrying parts. This simplifies mounting on metal panel or sub base and eliminates any hand capacity when the volume control is in a critical circuit. Full variation of resistance is obtained in a SINGLE TURN of the knob.

Plus these exclusive features, Centralab has carefully studied every volume control circuit and has built-up tapers of resistance to fit each application. These specific resistances are an assurance of a control that will smoothly and gradually vary the volume from a whisper to maximum—No sudden cut-offs on distant signals—No powerful locals creeping through when control is set at zero.

Write for folder of applications

Centralab
CENTRAL RADIO  LABORATORIES
Keefe Ave. Milwaukee, Wis.

A CENTRALAB VOLUME CONTROL IMPROVES THE RADIO SET

When writing to advertisers mention of the PROCEEDINGS will be mutually helpful.

XXXV

HAVE YOU THESE?

Here are two Institute supplies every member should own.



Pins and Watch Charms



Both are of 14K gold, enameled in white, maroon, blue, or gold for the appropriate grade of membership. The pin is supplied with a safety catch and is finished on one side.

The watch charm is fitted with a suspension ring, and is handsomely finished on both sides.

PIN

Price \$3.00, any grade

WATCH CHARM

Price \$5.00, any grade



Proceedings Binders

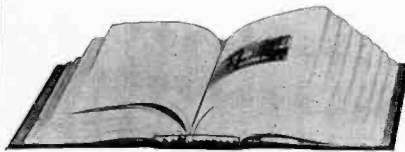

The binder pictured above will hold over twelve individual issues of the PROCEEDINGS. It serves as a temporary transfer binder or as a permanent cover for a year's supply of PROCEEDINGS. It is made of handsome Spanish Grain Fabrikoid in blue and gold. It is so constructed that no matter where the pages are opened they will lay flat. Strap binders hold each copy firmly in place.

Price \$1.50 each or \$2.00 with your name or volume stamped in gold.

To obtain Binders, Pins, or Watch Charms address the Institute office and enclose cash or check with order.

When writing to advertisers mention of the PROCEEDINGS will be mutually helpful.

PROFESSIONAL ENGINEERING DIRECTORY

For Consultants in Radio and Allied Engineering Fields

**The J. G. White
Engineering Corporation**
Engineers—Constructors
*Builders of New York Radio
Central*

Industrial, Steam Power, and Gas
Plants, Steam and Electric Rail-
roads, Transmission Systems.

43 Exchange Place New York

**Q R V
RADIO SERVICE, Inc.**

JOHN S. DUNHAM
J. F. B. MEACHAM

*Devoted to Servicing Broadcast
Receivers Exclusively*

1400 BROADWAY, NEW YORK
WISCONSIN 9780

ROBERT S. KRUSE

*Consultant for development of
Short-wave Devices*

103 Meadowbrook Road

WEST HARTFORD, CONN.

Telephone, Hartford 45327

BRUNSON S. McCUTCHEN

Consulting Radio Engineer

17 State Street

NEW YORK

*Electrical Testing
Laboratories*
RADIO DEPARTMENT

also

**Electrical, Photometric,
Chemical and Mechanical
Laboratories**

80th Street and East End Ave.
NEW YORK, N. Y.

Complete Line of
**RADIO PANELS, TUBING,
RODS AND INSULATING
MATERIALS**

*Drilling, Machining and Engraving to
Specifications*

**TELEVISION KITS, DISCS, NEON
TUBES, PHOTO ELECTRIC CELLS
AND ALL PARTS**

Write for Catalog

Insuline Corp. of America
78-80 Cortlandt St., N. Y.
Cortlandt 0880

**RADIO ENGINEER
WANTED**

To be assistant to the chief engineer, and to have charge of Receiver design. Must be university graduate, and have had at least two years' experience on Neutrodyne A.C. receiver design. Apply, giving age, education, experience, and salary expected, to Box No. 824, I.R.E.

John Minton

I. G. Maloff

JOHN MINTON, Ph.D.

*Consulting Engineer
for*

**Developing — Designing —
Manufacturing**
of

**Radio Receivers, Amplifiers, Transform-
ers, Rectifiers, Sound Recording and
Reproducing Apparatus.**

**Radio and Electro-Acoustical
Laboratory**

8 Church St. White Plains, N. Y.

When writing to advertisers mention of the PROCEEDINGS will be mutually helpful.

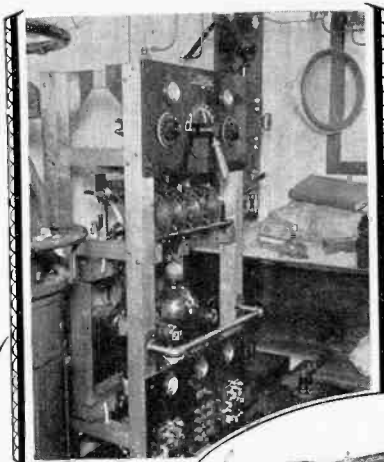

**BYRD'S
RADIO**
*is insulated
with*
FORMICA

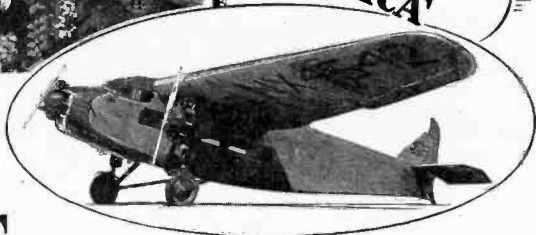

Formica was used by the engineers who designed the sending and receiving apparatus in use by the expedition, for panels, tubing, and other insulating parts.

For fifteen years American radio men have known it as excellent insulation for high or low frequency uses. It is high in quality and uniform—Phenol Fibre at its best.

Every year millions of automotive ignition systems, therapeutic apparatus, circuit breakers and electrical devices of all kinds are insulated with Formica. You can depend upon it.

THE FORMICA INSULATION COMPANY
4646 SPRING GROVE AVENUE
CINCINNATI, OHIO

FORMICA
Made from Anhydrous Bakelite Resins
SHEETS TUBES RODS

When writing to advertisers mention of the PROCEEDINGS will be mutually helpful.

XXXVIII

Alphabetical Index to Advertisements

A	
Allen-Bradley Co.....	XXXIII
Aluminum Co. of America.....	XXVIII
American Transformer Co.....	XLI
Arcturus Radio Co.....	XIX
B	
Braun, W. C., Co.....	XV
Burgess Battery Co.....	XII
C	
Cardwell, Allen D., Mfg. Corp.....	XXIX
CeCo Mfg. Co., Inc.....	X
Central Radio Laboratories.....	XXXV
Clarostat Mfg. Co., Inc.....	V
Condenser Corp. of America.....	XLIII
Corning Glass Works.....	III
D	
De Jur Amsco Corp.....	XIV
Dubilier Condenser Corp.....	XXI
Dudlo Manufacturing Company.....	XXVII
E	
Electrad, Inc.....	XXX
Electric Specialty Co.....	VI
Elkon, Inc.....	XLII
F	
Fast, John E. & Co.....	XXXII
Formica Insulation Co.....	XXXVIII
G	
General Radio Co.....	Outside Back Cover
Grebe, A. H. and Co., Inc.....	Inside Back Cover
I	
International Resistance Co.....	XVIII
I. R. E.....	XXVI, XX, XXXVI
Isolantite Co. of America.....	VII
J	
Jewell Electrical Instrument Co.....	XXXIV
K	
Kolster Radio Corporation.....	XI
L	
Leutz, C. R., Inc.....	XIII
P	
Pacent Electric Co., Inc.....	XVII
Polymet Manufacturing Corp.....	XXVI
Potter Co., The.....	IV
Professional Engineering Directory.....	XXXVII
R	
Radio Corporation of America.....	IX
Radio Engineering Laboratories.....	XXIV
Raytheon Mfg. Co.....	XXII
Roller-Smith Co.....	II
S	
Scovill Manufacturing Co.....	XXIII
Silver-Marshall, Inc.....	XXV
T	
Temple, Incorporated.....	XXXI
Thordarson Electric Mfg. Co.....	Inside Front Cover
U	
United Scientific Laboratories, Inc.....	XL
W	
Weston Electrical Instrument Corp.....	VIII
Wireless Specialty Apparatus Co.....	I

When writing to advertisers mention of the PROCEEDINGS will be mutually helpful.



CONDENSERS

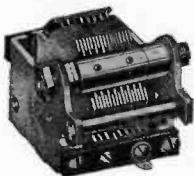

*Universal Compact Type UXB Brass
Condenser (Note Removable Shaft)*

Type UXB Three Gang Condenser

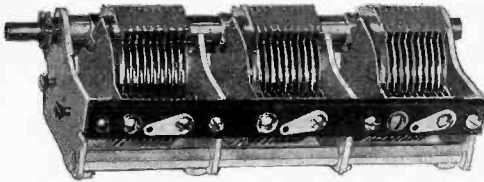

This fine job, which is small and compact, is especially suited for shielded work. The popular type UXB Condensers are used. They can be had in either .0005MF or .00035MF Capacities.

Let us quote on your special specifications

UNITED SCIENTIFIC LABORATORIES, INC.
115-C Fourth Avenue, New York City

Branch Offices for Your Convenience in

St. Louis Boston Cincinnati Philadelphia London, Ontario
Chicago Minneapolis Los Angeles San Francisco

When writing to advertisers mention of the PROCEEDINGS will be mutually helpful.



on *half* of the Keyboard

AND that is what the majority of people who own Radio sets are trying to do . . . And the worst of it is that they do not know any better. They have been listening to "Radioed Music" so long that their ears have become accustomed to only about half of the program which was being broadcast.

Now it is possible to transform those sets so that all of the program is heard.

The AmerTran Power Amplifier, a complete 2 stage Push-Pull Amplifier and its companion Unit, the AmerTran Hi-Power Box supplying 500 volts to the plates of the Power Tubes will make your set superior to the finest manufactured sets.

Learn what radio can be—listen to the whole keyboard as it is played in the studio. Write to us now and let us arrange a demonstration for you. No obligation, of course, but prepare yourself for a musical treat.

Before you buy a new set—let us show you what your old set, AC or DC, will do when it is brought up to date with AmerTran Products.

AmerTran Push-Pull Amplifier—complete 2 stage audio amplifier. First stage AmerTran Push-Pull for two power Tubes. Choice of standard amplifier or UX 227

AC for 1st stage and two 171 or two 210 power tubes for second stage. Price, east of Rockies—less tubes — \$60.00



AmerTran ABC Hi-Power Box—500 volts DC plate voltage, current up to 110 ma; AC filament current for rectifier, power tubes and sufficient 226 and 227 AC

Tubes for any set. Adjustable bias voltages for all tubes. Price, east of the Rockies—less tubes— \$95.00

AMERTRAN

American Transformer Company
Transformer Builders for over 28 years
225 Emmet Street : : : Newark, N. J.

When writing to advertisers mention of the PROCEEDINGS will be mutually helpful.

ELKON DRY RECTIFIERS FOR YOUR PROBLEM

Elkon makes Dry Rectifiers for every conceivable use where it is necessary to change alternating current to direct.

On this page are illustrated a group of 13 low voltage rectifiers varying in size from the small 4.5 volt at 1½ amperes to 28 volts at 2½ amperes.

No matter what your problem of rectification, Elkon has or can make a dry rectifier to solve your problem.

All Elkon rectifiers have the famous self-healing feature insuring long life and freedom from trouble.

Dry, noiseless, smooth, full-wave, cool in operation.

Submit your rectifier problem to the Elkon Engineers — a sample for your exact needs will be forthcoming.

ELKON, INC.
 Division of
 P. R. Mallory & Co., Inc.



The new Elkon "B" or high voltage rectifier. Now being supplied to replace B H type tubes. Has a 5000 hour guarantee.

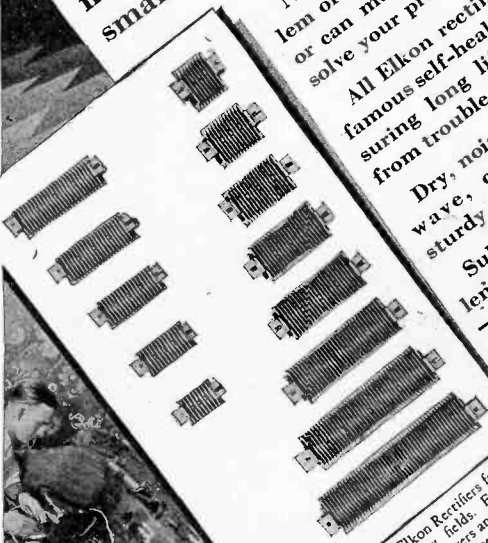

Of course the Wheatstone's Bridge plays its part in the Research Laboratory.

A group of Elkon Rectifiers for varying use in many fields. For example: dynamic speakers, Railway Signals, Telephone.

Elkon Inc., Radio Department,
 Dept. E-41—350 Madison Ave., N.Y.
 Please enclose your address when you write for a sample. (While you are at it, address on sample of page will mail to you.)

When writing to advertisers mention of the PROCEEDINGS will be mutually helpful.

ANNOUNCEMENT

OUR NEW PLANT IS NOW COMPLETE IN EVERY DETAIL. ENTIRELY AUTOMATIC MACHINERY, THE FINEST OF ITS KIND, IS AT YOUR SERVICE. TO THOSE WHO NEED AND APPRECIATE PROMPT DELIVERIES IN QUANTITY WE OFFER OUR FACILITIES.



CONDENSER CORPORATION OF AMERICA
259-271 CORNELISON AVE. JERSEY CITY, N. J.

When writing to advertisers mention of the PROCEEDINGS will be mutually helpful.

XLIII

"... there came wise men from the East to Jerusalem...and they presented unto Him gifts, gold, frank-incense and myrrh."

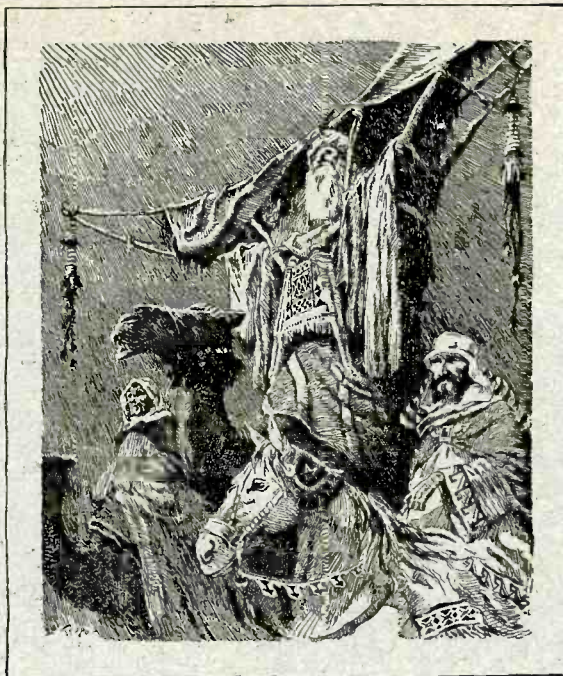

It is our sincere hope that the gifts you make this Christmas may bring to the little worlds into which they go, something of the joy and happiness that the greatest gift of all time has brought to humanity.

A. H. Grebe & Co., Inc.

GREBE
SYNCHROPHASE
TRADE MARK REG. U.S. PAT. OFF.
A-C Six
RADIO

A. H. Grebe & Co., Inc., 109 W. 57th St., New York City
Factory: Richmond Hill, N.Y. Western Branch: 448 S. San Pedro St., Los Angeles, Cal.
Makers of quality radio since 1909

Type 443
Mutual—Conductance Meter

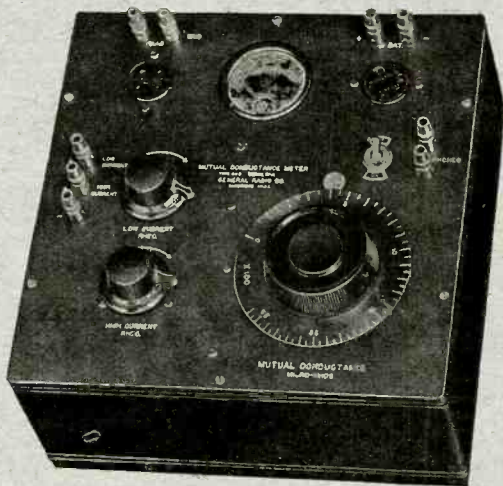

Type 443 Mutual-Conductance Meter
Price - - \$55.00

OF the three fundamental dynamic constants of the three-element vacuum tube (plate impedance, amplification factor, and mutual conductance) the mutual conductance gives the most positive indication of the tube behavior, since it involves the ratio of the other two constants.

Since the mutual conductance is very easily measured, this constant is the one most suited for use as an acceptance standard for purchasers and for use in factory, store or laboratory for rapid checking of tubes against a standard value.

The General Radio Type 443 Mutual-Conductance Meter is a null-point bridge instrument excited by a self-contained microphone hummer and battery. By means of this instrument values of mutual conductance having a precision of within 1% to 2% are quickly obtained by manipulation of the dial. This dial is calibrated to read mutual conductance directly in micromhos from 0 to 2,500 micromhos.

Fully described in Catalog "E".

GENERAL RADIO COMPANY

Manufacturers of Radio and Electrical Laboratory Apparatus

30 STATE STREET

CAMBRIDGE, MASS.