

VOLUME 12

APRIL, 1924

NUMBER 2

PROCEEDINGS
of
The Institute of Radio
Engineers



HARRY UPTON
— I F A —
65 CHASE STREET
SOUTH PORTLAND, MAINE

EDITED BY
ALFRED N. GOLDSMITH, Ph.D.

PUBLISHED EVERY TWO MONTHS BY
THE INSTITUTE OF RADIO ENGINEERS

140th Street and Convent Avenue, New York, N. Y.

Subscription \$9.00 per Annum in the United States
\$9.60 in all other Countries

GENERAL INFORMATION AND SUBSCRIPTION RATES ON PAGE 111

Entered as second-class matter, February 16, 1916, at the Post-Office, at New York, N. Y., under the Act of March 3, 1879.

Acceptance for mailing at special rate of postage provided for in Section 1103, Act of October 3, 1917, authorized October 7, 1918.



Look for the name on the carton

Insist on Cunningham Radio Tubes—there is no higher Quality

THE primary purpose of a trade name is to identify a product or firm in the mind of the buyer. Ask the next Radio enthusiast you meet to state one of the best known names identified with Radio and he will say: "Cunningham."

The presence of the word "Cunningham" on Radio Tubes tells the character and quality of this product—the ideals, engineering skill and service given to the Radio field since the year 1915 by E. T. Cunningham, Inc.

It is the radio tube that has made possible the broad and far reaching application of radio telephony, and that plays

the most important part in the operation of your Radio Receiving Set.

Cunningham Radio Tubes, standard for all makes of receiving sets, built by one of the world's largest manufacturers with unlimited resources, are the product of years of manufacturing experience and the creative genius of the engineers of the great scientific organization, the Research Laboratory of the General Electric Co.

Patent Notices Cunningham tubes are covered by patents dated 2-18-08 and others issued and pending. Licensed for amateur, experimental and entertainment use in radio communication. Any other use will be an infringement.

New Prices On Cunningham Tubes Now in Effect

- O-301A—5 Volts $\frac{1}{2}$ ampere filament.....\$5.00
- O-299—3 Volts .06 amp. Dry Battery Det. & Amp.....\$5.00
- O-300—5 Volts Gas Content Detector.....\$5.00
- C-11—1.1 Volts .25 amp. Dry Battery Det. and Amp. Special Base \$3.00
- C-12—Similar to C-11 with standard base \$5.00

The care and operation of each model of Receiving Tube is fully explained in our new 48-page "Radio Tube Data Book." Copies may be obtained by sending ten cents to our San Francisco office.



E. T. Cunningham Inc.

Home Office
182 Second Street
San Francisco

154 W. Lake Street
Chicago

80 Church Street
New York

Faradon

FOR SERVICE

RADIO CONDENSERS

Constant Capacity
Extremely Low Losses
Safety Gap Protection
High Current Carrying Capacity
Minimum Volume
Moisture-Proof Construction
Long Life
Quick Deliveries

These are some of the reasons why radio engineers specify FARADONS.

There are over 200 standard FARADON condensers on which immediate deliveries can be made. Complete new catalog will be sent on request.

Wireless Specialty Apparatus Company
BOSTON, MASS.

Established 1907



YOU

owners of
Radio Sets
 and
Automobiles

need a **good instrument**, and here it is. The Roller-Smith Cat. No. 1026 Type HD volt-ammeter is a small, compact, accurate little instrument with six ranges, namely, 3, 15 and 150 volts and 150 milli-amperes, 1.5 and 15 amperes. With it you can test your car battery, radio A, B and C batteries, charging rate, tube voltage and current, plate current, etc. The price is quite reasonable and the investment is a good one.

Send for Bulletins K-100 and K-110.

ROLLER-SMITH COMPANY

Electrical Instruments, Meters and Circuit Breakers

MAIN OFFICE:
 2134 Woolworth Bldg., NEW YORK



WORKS:
 Bethlehem, Pennsylvania

Offices in Principal Cities in U. S. and Canada

ACME TRANSFORMERS

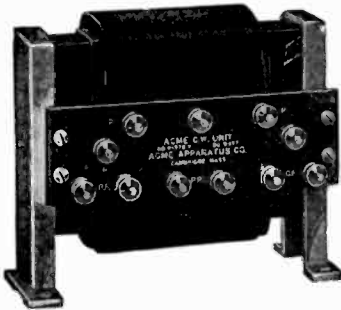

As specialists in the design and construction of Transformers we are prepared to quote prices and delivery on Transformers singly or in quantity.

Our Radio Transformers are well known for their high efficiency and ruggedness.

ACME APPARATUS COMPANY

200 MASSACHUSETTS AVENUE
 CAMBRIDGE 39, MASS.

TRANSFORMER AND RADIO ENGINEERS AND MANUFACTURERS

Constant Impedance
AUDIBILITY METER



Type 164

**AUDIBILITY
METER**

Price, \$36

The ear alone cannot be depended upon to estimate the intensity of received signal strength. Some auxiliary standard of reference must be used.

One of the more common methods is to shunt the telephone receivers. As the receivers are shunted, however, a series resistance of such a value should be added to the circuit that the impedance will remain unchanged.

The Type 164 Audibility Meter is so designed that it is direct reading in audibilities, and keeps the total impedance of the circuit practically constant.

Do not guess at your receiving results. Know the real facts.

Send for Bulletin R

GENERAL RADIO CO.

Manufacturers of

*Radio and Electrical Laboratory
Apparatus*

Massachusetts Avenue and Windsor St.

CAMBRIDGE 39

MASSACHUSETTS

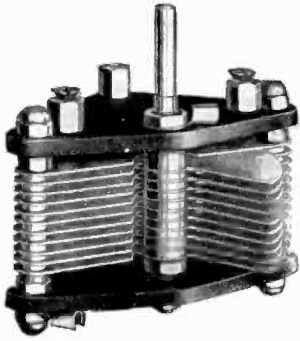

Corner of plate showing method of spacing in the Pacent condenser

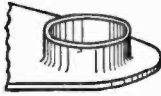

Why Pacent Condensers are Standard with Leading Manufacturers

1. Spacers, integral part of plates eliminating washers.
2. Four finger contact with shaft.
3. Adjustable lock bearing.
4. Bakelite ends (high grade Hard Rubber supplied if preferred).
5. Extra heavy Aluminum plates.
6. High ratio of minimum to maximum capacity.
7. Lower resistance—more selectivity.
8. Endorsed by well-known radio engineers.
9. Made by pioneer radio manufacturers.

Prices on special sizes and specifications will be supplied to manufacturers upon receipt of definite information as to their requirements.

Send for catalogue D-4 describing all Pacent products

Pacent

RADIO ESSENTIALS

Pacent Electric Co., Inc.

22 Park Place, New York



for use on a 110-volt D.C. line. Equipped with the famous Ward Leonard Vitrohm (Vitreous enamelled) Resistor Units. Literature on request.

RADIO BATTERY CHARGER

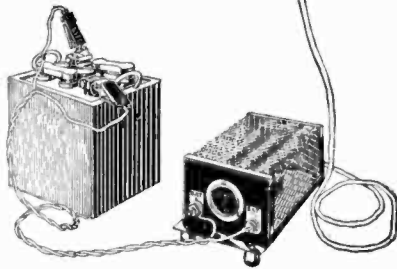

Ward Leonard  Electric Company

Mount Vernon, New York

The GREBE "13"

A Real Receiver for Relay Men

Four Points of Excellence



It is written—

"A single conversation across the table with a wise man is better than ten years' mere study of books."

Talk to those wise in the ways of radio—the real DX men—you will find them using the Grebe "13."

Doctor Hfu

Licensed under
Armstrong U. S.
Pat. No. 1,113,149.



Wave length Range: 80-300 M

There could be no stronger proof of the merit of a receiver than its use by such prominent amateurs as Major Lawrence Mott 6XAD-6ZW (Avalon, Cal.) and M. Leon DeLoy, French 8 AB (Nice, France). The Grebe "13" enjoys that distinction.

A. H. GREBE & CO., Inc.

72 Van Wyck Boulevard, Richmond Hill, N. Y.

Western Branch: 451 East 3rd Street, Los Angeles, Cal.

WESTON

FILAMENT VOLTMETER

Every good set deserves one. Costs little more than a tube, but it is invaluable because it saves many tubes from burning out prematurely. For quick tuning and good reception, it is an absolute necessity. Case diameter $3\frac{1}{4}$ in.

Weston Electrical Instrument Co.
73 Weston Ave. Newark, N. J.
Branch Offices in all Principal Cities.

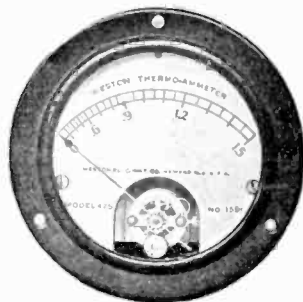

This model 301 Weston Voltmeter is one of seven radio instruments for transmitting and receiving described in booklet "J." This booklet sent free on request.

Electrical
Indicating
Instrument
Authorities
Since 1888

WESTON

STANDARD - The World Over

STANDARD of EXCELLENCE for AUDIO AMPLIFICATION

AMERTRAN

TRADE MARK REG. U.S. PAT. OFF.

Now made in two types. AmerTran AF-6 (turn ratio 5) is for use in the first stage; AmerTran AF-7 (turn ratio $3\frac{1}{2}$) is the companion transformer for use in further stages of amplification.

Long study and experiment are behind this scientifically balanced combination for perfect reproduction.

Price, each type, \$7.00

American Transformer Co., Newark, N. J.
Designers and builders of radio transformers for over 22 years

AMRAD

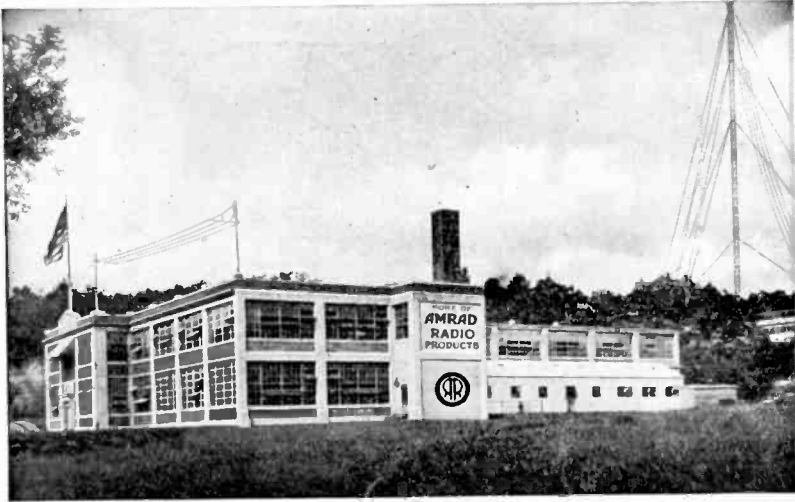

Main Factory of the American Radio and Research Corporation, Medford Hillside, Mass. Home of Amrad Radio. Showing at extreme right Research and Engineering Laboratories and Broadcasting Station WGI, erected June 1915, the World's Oldest Broadcasting Station operating to-day

Exclusive Developments

For nine years this Corporation has specialized in the development of Radio. Among results—

The AMRAD "S" Tube—a Rectifier with NO FILAMENT TO BURN OUT.

The AMRAD BASKETBALL Variometer—a radical improvement over the conventional moulded type.



BASKETBALL VARIOMETER
Remarkably low Dielectric losses and distributed capacity.



The S-TUBE
Rectifies up to 1000 volts A.C. Resulting D.C. has minimum wave ripple with ordinary filter.

AMERICAN RADIO AND RESEARCH CORPORATION

MEDFORD HILLSIDE, MASS.
(4 Miles North of Boston)

New York

Chicago

Radiola Super-Heterodyne, with Radiola Loudspeaker and 6 Radiotrons UV-199; entirely complete except batteries - \$286

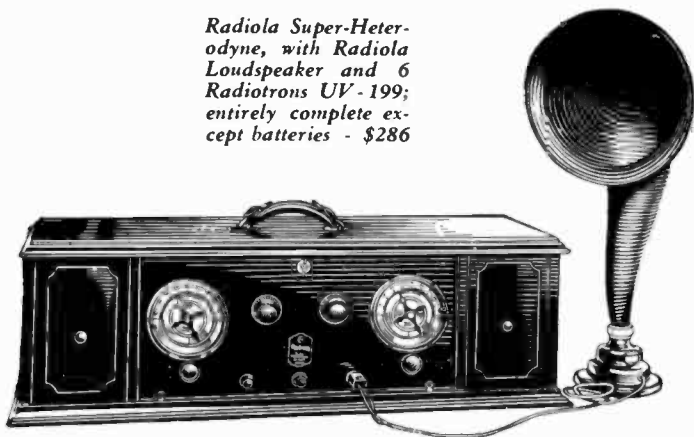

Radiola Super-Heterodyne (Second Harmonic)

An improved Super-Heterodyne receiver. Needs no antenna. And no ground. Brings in far distant stations on the loudspeaker—with no interference from the near stations. Perfectly simple for anyone to operate. Mark the locations of stations on the dials. Carry it anywhere—turn two knobs to the marked spots—listen in.

Radio Corporation of America

Sales Department

233 Broadway, New York

10 So. La Salle Street, Chicago, Ill.

433 California Street, San Francisco, Cal.

Radiola

REG. U. S. PAT. OFF.

Send for the free booklet giving full description of the new Radiolas

Radio Corporation of America.

Dept. 234. Address office nearest you. Please send me your free Radio Booklet

Name _____

Street Address _____

City _____

R. F. D. _____

State _____



This symbol of quality is your protection

PROCEEDINGS OF The Institute of Radio Engineers

Volume 12

APRIL, 1924

Number 2

CONTENTS

	PAGE
OFFICERS OF THE INSTITUTE OF RADIO ENGINEERS	112
L. W. AUSTIN, "RECEIVING MEASUREMENTS AND ATMOSPHERIC DISTURBANCES AT THE BUREAU OF STANDARDS, WASHINGTON, SEPTEMBER AND OCTOBER, 1923"	113
GREENLEAF W. PICKARD, "SHORT PERIOD VARIATIONS IN RADIO RECEPTION"	119
HAROLD P. DONLE, "NEW APPLICATIONS OF THE SODION DETECTOR"	159
J. R. TOLMIE, "THE CHARACTERISTIC SURFACES OF THE TRIODE"	177
FREDERICK W. GROVER, "FORMULAS AND TABLES FOR THE CALCULATION AND DESIGN OF SINGLE-LAYER COILS"	193
JOHN B. BRADY, "DIGESTS OF UNITED STATES PATENTS RELATING TO RADIO TELEGRAPHY AND TELEPHONY, Issued December 25, 1923-February 26, 1924"	209

GENERAL INFORMATION

The PROCEEDINGS of the Institute are published every two months and contain the papers and the discussions thereon as presented at the meetings in New York, Washington, Boston, Seattle, San Francisco, or Philadelphia.

Payment of the annual dues by a member entitles him to one copy of each number of the PROCEEDINGS issued during the period of his membership.

Subscriptions to the PROCEEDINGS are received from non-members at the rate of \$1.50 per copy or \$9.00 per year. To foreign countries the rates are \$1.60 per copy or \$9.60 per year. A discount of 25 per cent is allowed to libraries and booksellers.

The right to reprint limited portions or abstracts of the articles, discussions, or editorial notes in the PROCEEDINGS is granted on the express condition that specific reference shall be made to the source of such material. Diagrams and photographs in the PROCEEDINGS may not be reproduced without securing permission to do so from the Institute thru the Editor.

It is understood that the statements and opinions given in the PROCEEDINGS are the views of the individual members to whom they are credited, and are not binding on the membership of the Institute as a whole.

PUBLISHED BY

THE INSTITUTE OF RADIO ENGINEERS, INC.
140TH STREET AND CONVENT AVENUE, NEW YORK, N. Y.

EDITED BY

ALFRED N. GOLDSMITH, Ph.D.

OFFICERS AND BOARD OF DIRECTION, 1924

Terms expire January 1, 1925; except as otherwise noted.

PRESIDENT

JOHN H. MORECROFT

VICE-PRESIDENT

JOHN H. DELLINGER

TREASURER

WARREN F. HUBLEY

SECRETARY

ALFRED N. GOLDSMITH

EDITOR OF PUBLICATIONS

ALFRED N. GOLDSMITH

MANAGERS

(Serving until January 7, 1925)

MELVILLE EASTHAM
DONALD MCNICOL

LLOYD ESPENSCHIED
JOHN V. L. HOGAN

A. E. REOCH

(Serving until January 6, 1926)

EDWARD BENNETT

LOUIS A. HAZELTINE

(Serving until January 4, 1927)

A. H. GREBE

H. W. NICHOLS

ADVERTISING MANAGER

DE WITT V. WEED, JR.

WASHINGTON SECTION

ACTING EXECUTIVE COMMITTEE

ACTING CHAIRMAN

COMM. A. HOYT TAYLOR
Navy Department,
Washington, D. C.

LOUIS W. AUSTIN
Navy Department,
Washington, D. C.

CAPTAIN GUY HILL
War Department,
Washington, D. C.

BOSTON SECTION

CHAIRMAN

GEORGE W. PIERCE
Harvard University,
Cambridge, Mass.

SECRETARY-TREASURER

MELVILLE EASTHAM
11 Windsor St.,
Cambridge, Mass.

SEATTLE SECTION

CHAIRMAN

R. H. MARRIOTT
Seattle, Washington

SECRETARY

C. E. WILLIAMS
Seattle, Washington

TREASURER

B. A. ENGHOLM
Seattle, Washington

SAN FRANCISCO SECTION

CHAIRMAN

MAJOR J. F. DILLON,
526 Custom House,
San Francisco, Cal.

SECRETARY-TREASURER

D. B. McGOWN,
Custom House
San Francisco, Cal.

COPYRIGHT, 1924, BY

THE INSTITUTE OF RADIO ENGINEERS INC

140TH STREET AND CONVENT AVENUE

NEW YORK, N. Y.

RECEIVING MEASUREMENTS AND ATMOSPHERIC
DISTURBANCES AT THE BUREAU OF STANDARDS,
WASHINGTON, SEPTEMBER AND OCTOBER, 1923*

BY

L. W. AUSTIN

(CHIEF, RADIO PHYSICAL LABORATORY, BUREAU OF STANDARDS,
WASHINGTON, DISTRICT OF COLUMBIA.)

*(Communication from the International Union of Scientific Radio
Telegraphy)*

Changes are reported to have been made at Nauen resulting in an increase of radiation height to 170 m. (557 feet), while the current has been reduced to 270 amperes. This gives a net decrease in calculated field intensity, in America, of about twenty-five percent. The wave frequency is now 23.4 kc. ($\lambda = 12,800$ m.).

The main points to be noted in the September and October measurements are:

(a) The continued increase in strength of Lafayette, already mentioned, which is more than twice as strong in the forenoon (all daylight path) as in the same months last year, with no increase in antenna current.

(b) The unchanged strength of Nauen, notwithstanding its decrease in antenna current.

(c) That the afternoon fading of Lafayette is practically the same as last year, while that of Nauen continues nearly a month later; and that the heavy atmospheric disturbances have also continued much later, altho they were less severe during the summer.

*Received by the Editor, January 15, 1924.

FIELD INTENSITY OF NAUEN AND OF DISTURBANCES
($f=23.4$ kc., $\lambda=12.800$ m.) IN SEPTEMBER, 1923, IN MICROVOLTS
PER METER

Date	9 A. M.		3 P. M.	
	Signal	Dis- turbance	Signal	Dis- turbance
1	82	60
4	29	45	*	120
5	64	80	*	450
6	**	60	*	200
7	42.7	45	*	200
8	60	65
10	60	40	21.5	250
11	72.7	25	*	200
12	64	30	*	280
13	55.7	30	*	200
14	55.7	25	*	160
15	51.2	30
17	38.2	20	*	165
18	24.3	15	8.0	80
19	38.2	40	20.4	200
20	28	35	2.0	150
21	29	80	4.5	350
22	24.3	20	12.2	200
24	29.5	50	2.0	300
25	51.5	20	26.0	180
26	51.5	40	17.0	130
27	25.7	45	23.5	100
28	42.8	30	9.9	130
29	42.8	10	19.2	95
Average	46.2	39.1	7.9	197

*Not heard.

**Not sending.

.....Not taken.

FIELD INTENSITY OF LAFAYETTE AND OF DISTURBANCES
($f=15.9$ kc., $\lambda=18,900$ m.) IN SEPTEMBER, 1923, IN MICROVOLTS
PER METER

Date	9 A. M.		3 P. M.	
	Signal	Dis- turbance	Signal	Dis- turbance
1	198	60
4	120	48	114	100
5	145	85	24.5	500
6	**	60	96	180
7	180	48	54.2	250
8	**	80
10	168	40	96	200
11	235	20	90	180
12	120	36	51.5	300
13	120	25	72.2	200
14	132	30	102	160
15	120	40
17	**	25	108	165
18	**	20	140	80
19	213	50	153	220
20	188	40	38.0	150
21	160	90	140	400
22	102	25	72	250
24	207	60	126	360
25	190	28	120	200
26	126	50	162	155
27	114	90	120	130
28	148	35	165	130
29	196	15	165	115
Average	159	45.8	105.2	210.7

*Not heard.

**Not sending.

.....Not taken.

FIELD INTENSITY OF NAUEN AND OF DISTURBANCES
($f=23.4$ kc., $\lambda=12,800$ m.) IN OCTOBER, 1923, IN MICROVOLTS
PER METER

Date	9 A. M.		3 P. M.	
	Signal	Dis- turbance	Signal	Dis- turbance
1	51.5	50	26.5	200
2	42.8	20	5.4	130
3	42.8	45	17.0	95
4	51.5	25	27.0	85
5	55.7	20	**	110
6	22.8	35	24.0
8	26.7	15	55.7	30
9	55.7	25	42.7	45
10	51.5	30	25.0	60
11	51.5	15	19.0	60
12	60.0	20	16.7	180
13	51.5	15	18.0	65
15	26.7	35	13.6	100
16	17.0	65	2.0	180
17	34.0	15	30.0	30
18	**	15	17.0	35
19	34.2	10	30.0	25
20	35.7	15	30.0	30
22	21.4	15	17.0	40
23	25.7	20	32.0	65
24	42.8	10	17.0	55
25	31.0	10	7.0	100
26	28.0	10	5.0	65
27	25.7	15	17.0	45
29	33.0	20	9.3	100
30	30.0	35	**	55
31	33.2	20	18.0	45
Average	37.4	23.1	20.8	78.1

*Not heard.

**Not sending.

....Not taken.

FIELD INTENSITY OF LAFAYETTE AND OF DISTURBANCES
($f=15.9$ kc., $\lambda=18,900$ m.) IN OCTOBER, 1923, IN MICROVOLTS
PER METER

Date	9 A. M.		3 P. M.	
	Signal	Dis- turbance	Signal	Dis- turbance
1	196	60	160	250
2	204	35	120	160
3	212	50	120	110
4	220	30	132	100
5	220	25	102	150
6	165	40	168
8	165	20	147	35
9	170	30	140	65
10	195	30	96	70
11	126	20	84	80
12	186	25	114	210
13	160	20	132	65
15	90	45	102	150
16	153	80	132	200
17	212	20	150	35
18	170	15	180	45
19	140	15	174	30
20	114	20	138	45
20	90	15	200	50
23	120	25	151	80
24	**	12	66	60
25	**	15	39	150
26	198	15	152	65
27	**	20	102	60
29	160	30	120	100
30	**	40	102	65
31	**	25	150	45
Average	166.6	28.8	128.5	95.2

*Not heard.

**Not sending.

....Not taken.

RATIO OF AVERAGES

Stations	Signal P. M.	Disturbance P. M.	A. M. Signal	P. M. Signal
	A. M.	A. M.	Dist.	Dist.
		September		
Nauen	0.17	5.1	1.2	0.04
Lafayette	0.66	4.6	3.5	0.50
		October		
Nauen	0.55	3.4	1.6	0.27
Lafayette	0.77	3.3	5.8	1.35

SUMMARY: The signal field strengths and the corresponding strengths of atmospheric disturbances are given for the Nauen and Lafayette stations for September and October, 1923.

SHORT PERIOD VARIATIONS IN RADIO RECEPTION*

BY

GREENLEAF W. PICKARD

(CONSULTING ENGINEER, THE WIRELESS SPECIALTY APPARATUS COMPANY
BOSTON, MASSACHUSETTS)

*(Communication from the International Union of Scientific
Radio Telegraphy)*

In any continuous measurement of the field intensity from a distant transmitter, we find both periodic and irregular variations, often of great amplitude, and always of complex form. Some of these changes in the transmission coefficient of the radio circuit may be definitely correlated with solar and terrestrial happenings; for example, transmission is in general better in winter than in summer, better at night than during the day, and is usually adversely affected at the time of intense aurora. These fluctuations are less prominent at the lower transmission frequencies, and increase until several thousand kilocycles is reached. Then, altho the data at our disposal today is quite limited, they appear to decrease, until at ten thousand kilocycles, more or less, the transmission becomes quite uniform.¹ Altho there is little doubt but that these fluctuations are due to changes occurring somewhere in our atmosphere, we are to-day in ignorance as to the mechanism involved.

If we confine our attention to frequencies between five hundred and fifteen hundred kilocycles, that is, to the band now principally filled with radiophone broadcasting, and to overland transmission at distances between one hundred and one thousand kilometers (62 to 620 miles), we find that the average midwinter field intensity is about five times greater than in midsummer.

In the daytime, altho transmission is relatively free from the large amplitude short period variations commonly known as "fading," "swinging" or "soaring," there is usually a slow change from hour to hour, which in the majority of cases appears as a

*Received by the Editor, November 8, 1923. Presented before THE INSTITUTE OF RADIO ENGINEERS, New York, December 12, 1923.

¹"Radio Telegraphy," Marconi. PROCEEDINGS OF THE INSTITUTE OF RADIO ENGINEERS, volume 10, August, 1922, pages 235 to 236.

gradual decrease from morning to night, the morning intensities often being twice those of the afternoon.

About half an hour before sunset at the receiving point, the weak and relatively constant field from the distant station begins to show marked short period fluctuations which grow in amplitude from minute to minute until, soon after sunset, they usually assume grotesquely large amplitudes. The principal change from day to night is an increase in field intensity; in general, the lower limit of the night-time field is approximately the same as the late afternoon field, altho from time to time there will be found a momentary fall to a much lower value than at any time during the day. The upper limit of the night-time field is not so definite; it may be ten, a hundred or even on occasion thousands of times greater than the daytime intensity, depending upon the distance and the character of night.

The amplitude of the short period variations, that is, those fluctuations ranging in duration from seconds to tens of minutes, is principally controlled by the distance between the transmitter and receiver, and this is true of both night and day transmission. At less than eleven kilometers (6.9 miles) from a broadcasting station, there is a well-defined short period fluctuation in intensity during night-time transmission, which is practically absent during the day, and which on some evenings shows an amplitude of ten percent or over. As the distance increases, the amplitude of the variations also increases, becoming readily observable by day at distances of fifty kilometers (33 miles), more or less.

At first there is no change in the character of the fluctuation other than in amplitude, but when a distance of between one and two hundred kilometers (63 and 125 miles) is exceeded, the oscillations of periods ranging from seconds to a minute or two become less prominent, and the longer swings of minutes to tens of minutes are accentuated. At an ill-defined distance of perhaps one hundred and fifty kilometers (94 miles) the amplitude of the shorter period variations appears to be at a maximum.

When continuous records of night-time field intensity from a distant station are made at separated receiving points, I have found that altho the records are of the same general character they are not identical unless the receiving points are practically coincident. A separation of less than six hundred meters (1,970 feet) between two receiving points is sufficient to obliterate most of the detail resemblance between their records, save only for the more prominent long period swings. Equally, simultaneous records at a single receiving point from separated

transmitters show few detail resemblances other than the seasonal and diurnal changes, altho here there is, of course, a difference in frequency.

A comparison of records made on different evenings shows that these evenings may be roughly classified as quiet, moderately disturbed, or highly disturbed for all stations within a two or three hundred kilometer (125 or 188 mile) radius. Whenever a station eleven kilometers (6.9 miles) distant shows marked short period fluctuations, more distant stations will also exhibit the same disturbances. On a quiet night the local station shows little or no variation in field intensity, and the more distant stations show principally long period disturbances.

The records of broadcast transmission which form the principal part of this paper have all been made by reception on non-directional open antennas, as my object here is to present only true changes in intensity of electric field, as distinct from the changes in wave-front which often accompany them. In a subsequent paper I intend to present records made on both stationary and rotating directional aeri-als, in which I have found striking changes in wave-front over very short intervals, some of these changes being very definitely correlated with changes in true field intensity.

The received current in the open antenna is impressed upon a crystal detector, directly if the field intensity is sufficient, but usually after from one to four stages of radio frequency amplification, and the rectified current from the detector is then passed thru a galvanometer. In one form of recorder employed for making these records, the registration is photographic, a beam of light reflected from the galvanometer mirror playing across a sheet of photographic paper wound on a slowly rotating drum, while in another and more portable form of recorder a pointer galvanometer is used, the registration being semi-manual.

One of the arrangements employed for recording is shown in Figure 1. The open antenna *O* includes a filter *F*, for minimizing interference from local stations, a series tuning condenser *C* 1, a loading inductance *L* 1, and a coupling coil *L* 2. A grounded shield *S* electrostatically separates the antenna circuit from the tuned grid circuit *L* 3, *C* 2 of the radio frequency amplifier train. The amplifier circuit here shown is that of Mr. Chester W. Rice,² which I have found very stable and constant, and in every way suitable for this rather exacting work. The voltmeters *VM* 1 and *VM* 2, which measure the filament and plate voltages in the

² United States patent, number 1,334,118.

amplifier train, are essential adjuncts, as it is of first importance that the voltage amplification be kept rigidly constant over long periods.

The amplified radio frequency current resulting from this train is impressed upon a crystal detector *D*, and the rectified current from this detector then passes thru a reflecting galvanometer *RG*, provided with a constant impedance shunt *CIS* for adjusting the deflection to the width of the record sheet. Monitoring telephones *MP* are shunted across the galvanometer circuit, with a series condenser *C 8* to prevent any drain of direct current from the galvanometer circuit. A light projector *P 1*, consisting of a six-volt 2-candle-power lamp, a pinhole diafram, and a lens, throws a beam of light upon the galvanometer mirror, from whence it is reflected to a sheet of photographic paper wound on a kymograph drum *K*, which is normally rotated once an hour by a clockwork motor *M*. A similar light projector *P 2*, provided

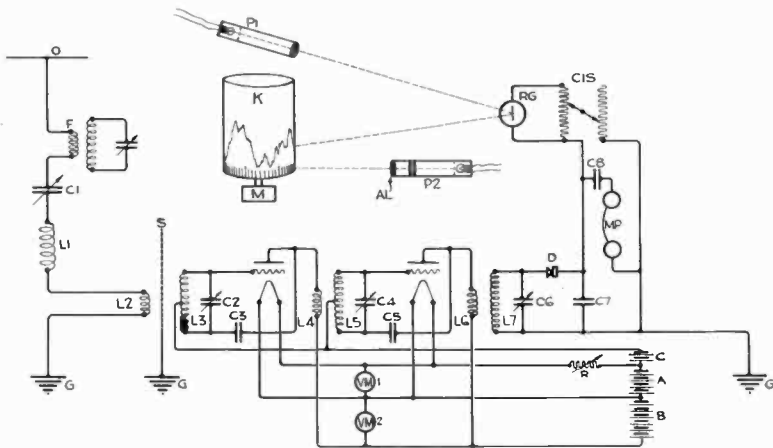

FIGURE 1

in addition with an astigmatic lens *A L*, flashes a short line of light once every minute on the lower edge of the sensitive paper, thus giving a time scale. The galvanometer employed is of fair sensitiveness, giving approximately one millimeter deflection at one meter for a current of 10^{-9} ampere, so that it is not necessary to overload the crystal detector, and so depart from the current-square relation between input and output. The kymograph, galvanometer, and light projectors are, of course, installed in a dark room, with shielded leads running in from the detector, which with its associated amplifier, tuner, and filter is placed in

another room. A crystal detector preceded by a radio frequency amplifier train is extraordinarily stable in adjustment, and the one employed at my receiving station in Newton Centre, Massachusetts,* has operated without readjustment for over five months at a time, with no measurable change in sensitiveness.

Another form of recorder which has been extensively employed in this work, and which has the advantage over the photographic form of portability, freedom from photographic process and delay, and great simplicity, is due to Mr. H. S. Shaw, Jr., who has been associated with me in this work almost from its beginning. A photograph of this recorder is shown in Figure 2. A strip of paper, 9 cm. (3.55 in.) wide, passes around a drum

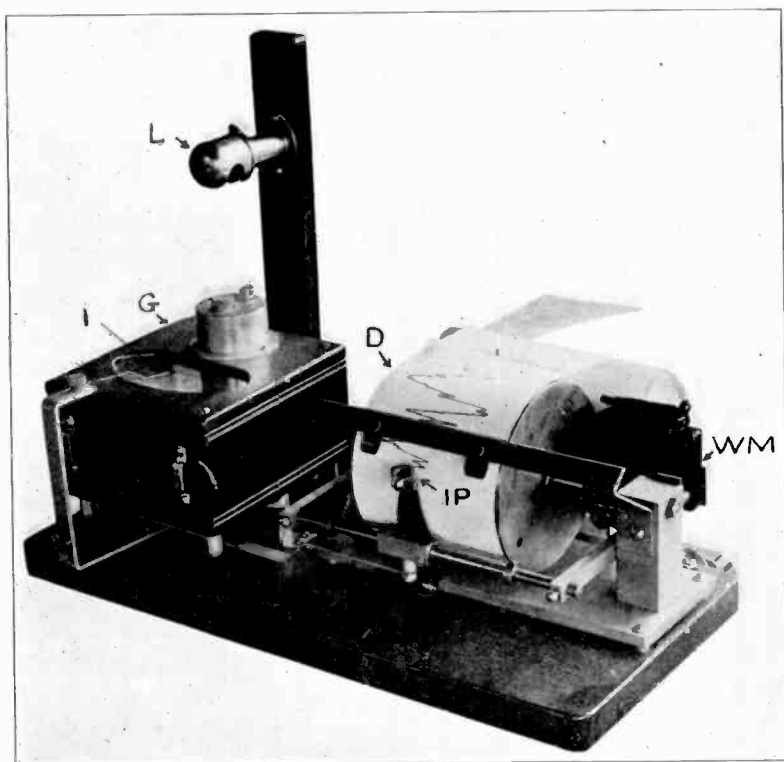

FIGURE 2

D, rotated by a worm and gear drive from a Warren Clock Motor *WM*. A pointer galvanometer *G* to the left of the drum is connected to the crystal detector, and movements of its pointer are followed manually by the index *I* (the shadow of which is

cast on the galvanometer scale by the light *L*) which in turn transmits the motion to an inking pen *IP*, traversing the paper strip. It might be thought that this form of recorder would be rather tedious to operate, but after a few minutes' recording the movements become almost automatic, and a record an hour long is not at all tiresome. The time scale of this manual recorder is made more open than the photographic, being 1.6 cm. (0.63 in.) per minute, while the kymograph scale is only 0.5 cm. (0.19 in.) per minute.

With a fair intensity of electric field, that is, of the order of a thousand microvolts per meter, and a fair sized open antenna, excellent records may be made without any amplification at all, direct from the crystal alone, as may be seen from Figure 3, recorded by Mr. Shaw at Scituate, Massachusetts, from Schenectady, New York, 265 kilometers (165 miles) away.

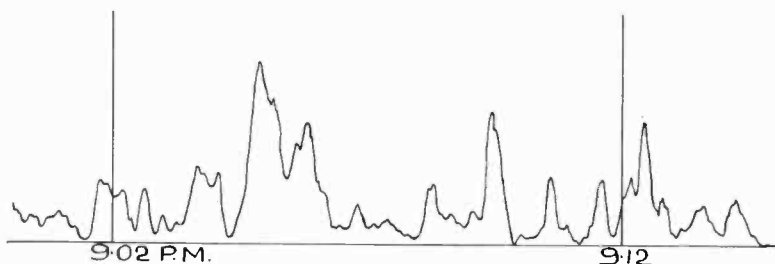

FIGURE 3

Another almost equally simple arrangement is to shunt the crystal detector across the plate impedance of a regenerative tube, and with this good records may be made with electric fields of a few hundred microvolts per meter.

As mentioned above, the ordinates of these records are very closely proportional to the square of the electric field, so that they might properly be termed energy records. For many of these records I have determined approximately the values of the ordinates in microvolts per meter, and I have used this data in determining the seasonal variation in transmission. Owing to the extraordinary complexity of many of these records, it is difficult to determine the mean value over any extended period by mere inspection, and the method which I have adopted is to measure the area of the space between the curve and its base or zero line with a polar planimeter, and divide the result by the length of the base line.

*Newton Centre is 11 kilometers (7 miles) in a westerly direction from Boston, Massachusetts.

Altho the methods outlined above appear and are actually simple, it is not altogether easy to obtain an unbroken series of good records from distant stations. When the field from the distant station is weak, high amplification is necessary, and the outfit is then at the mercy of disturbances, such as local spark station, nearby amateur working, and even a violently oscillating receiver in the immediate neighborhood. Also, the record may start at a time of low field intensity, and the galvanometer shunt and amplification may be so pessimistically chosen that when the intensity rises most of the record will be "off scale."

Before taking up the records in detail, I wish to make clear the relation between the intensities shown on my records and those observed by ear, either from phones on the head or from a loud speaker. In general, the human ear is unable to discriminate between sounds of the same character, but of different intensities, unless the difference is quite large. For example, trained observers making comparisons by ear of telephone transmission over different circuits are usually unable definitely to determine differences of less than one mile of standard cable, that is, a change in amplitude of about ten percent. Such a comparison is, of course, made under the most favorable conditions possible, that is, the two transmissions are rapidly alternated by switching from one circuit to the other. Where there is no standard of comparison, and the observer is listening to a single transmission which is slowly varying in intensity, the change to be observable varies from about thirty to several hundred percent, depending principally on the rate of change and the absolute intensity of the sound in the ear. If the intensity is fluctuating rapidly, that is, every few seconds, discrimination is, of course, at its best, whereas if the change is a smooth one over a period of minutes, it will pass undetected unless quite large. Also, if the sound is very loud, discrimination is very poor. Finally, in listening to transmission from a broadcasting station, the relatively large changes in modulation due to the rapidly changing intensity of the voice or music tend to mask differences due to changes in transmission.

In Figure 4 is shown a simultaneous record of the radio and audio frequency amplitudes in musical selections transmitted from WBZ, Springfield, Massachusetts, to Newton Centre, Massachusetts, a distance of 118 kilometers (74 miles). The fluctuations in intensity shown in the lower or radio frequency record are practically entirely caused by changes in transmission, whereas the variations shown in the upper or audio frequency record are due to both changes in transmission and in modulation. Thus,

from 8.33 to 8.35 P. M. the Springfield transmitter was not being modulated, and the audio frequency record remains near its base or zero line. But over this same period the intensity of the electric field is fairly high, as is shown by the lower record. Inasmuch as the galvanometer employed integrates the rectified radio frequency current over periods of several seconds, and as good broadcasting stations are rarely over-modulated, the radio frequency record, if taken in the immediate neighborhood of the station, would be practically a straight horizontal line, as will appear from the next figure.

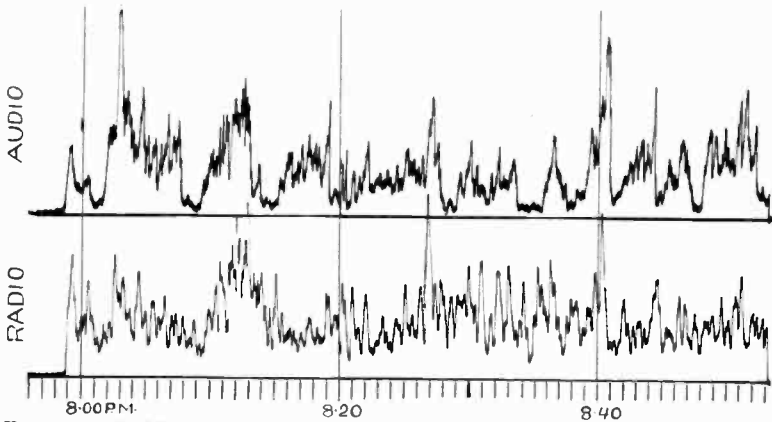

FIGURE 4—WBZ, Springfield, Massachusetts—Newton Centre, Massachusetts, 118 km. (74 miles), April 6, 1923

The first records I shall show are of daytime transmission. In Figure 5 the distance is 11 kilometers (6.9 miles), and the station was then operating at 830 kilocycles (360 meters). The

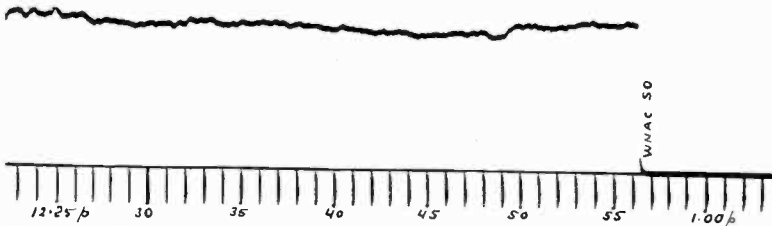

FIGURE 5—WNAC, Boston, Massachusetts—Newton Centre, Massachusetts, 11 km. (6.9 miles), March 1, 1923

more pronounced ripples on this record are undoubtedly due to accidental variations at the transmitter, such as fluctuations in plate voltage due to power line changes, and possibly to occasional

slight over-modulation. If the broadcasting station radiation meter were of the recording type, it would probably make a very similar record. As to the tiny ripples, which occur several to the minute, I am inclined to attribute some of these to true daytime transmission change, in view of the fact that when the distance is increased, these same ripples appear with increased amplitude, but without material change in character.

In Figure 6 is shown a superposed pair of records made in daytime from the Boston station WNAC at 1,080 kilocycles (278 meters) at two receiving points in Newton Centre, separated 550 meters (1,800 feet). The coincidence is practically perfect, which would indicate that the fluctuations shown are either all at the transmitter, or else that they cover a sufficiently large area to include both receiving points. The method employed for insuring coincidence in time was the very simple and effective one of making a sharp jog in the record line whenever the announcer said "WNAC."

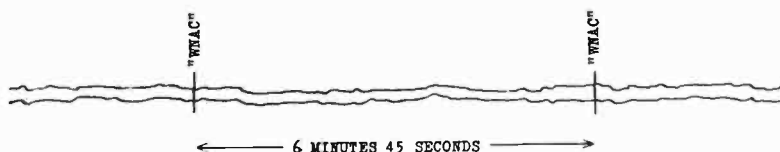

FIGURE 6.

This eliminated any possible difference between the watches of the two observers, and enabled the records to be very accurately superposed.

In Figure 7 are shown daytime records from three distant broadcasting stations, at ranges of 60, 290 and 225 kilometers (38, 181, and 141 miles), respectively. These records are typical of average daytime transmission from these distances on moderately disturbed days. The points marked "s s s" on these records are disturbances due to spark working somewhere in the vicinity of Boston, which are, of course, prominent with the rather high amplification necessary for distant day records.

Daytime transmission is, however, different for the same station from day to day, and this is well illustrated in Figure 8, which is of day transmission from WBZ, Springfield, Massachusetts, to Newton Centre, Massachusetts, a distance of 118 kilometers (74 miles). June 9 was clearly a highly disturbed day

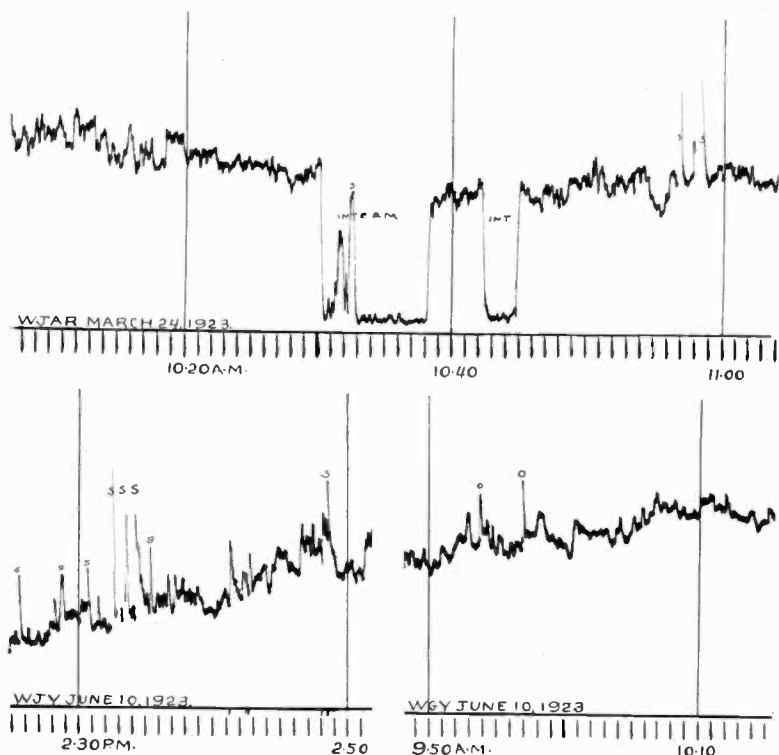

FIGURE 7—Daytime Reception at Newton Center, Massachusetts, from WJAR, Providence, Rhode Island, 60 km. (38 miles), WJY, New York City, 290 km. (181 miles), and from WGY, Schenectady, New York, 225 km. (141 miles)

for radio transmission, June 10 moderately disturbed, while June 16 was obviously quiet. These three records fairly represent the average and extreme cases of transmission over this particular range, and altho taken in summer, do not differ from winter daytime transmission.

The normal transition from day to night conditions is well shown in Figure 9, which covers a period of four hours. The late afternoon record beginning in the upper left-hand corner indicates a highly disturbed day (it merely appears flat by comparison with Figure 8 because of its much lower ordinates) with the usual weak field up to about forty minutes before sunset.

Then well-marked large amplitude fluctuations commence, increasing in intensity, and coming in groups with an interval of about 7 minutes. No special disturbance appears to mark exact sunset at either Newton Centre or Springfield, but the amplitude

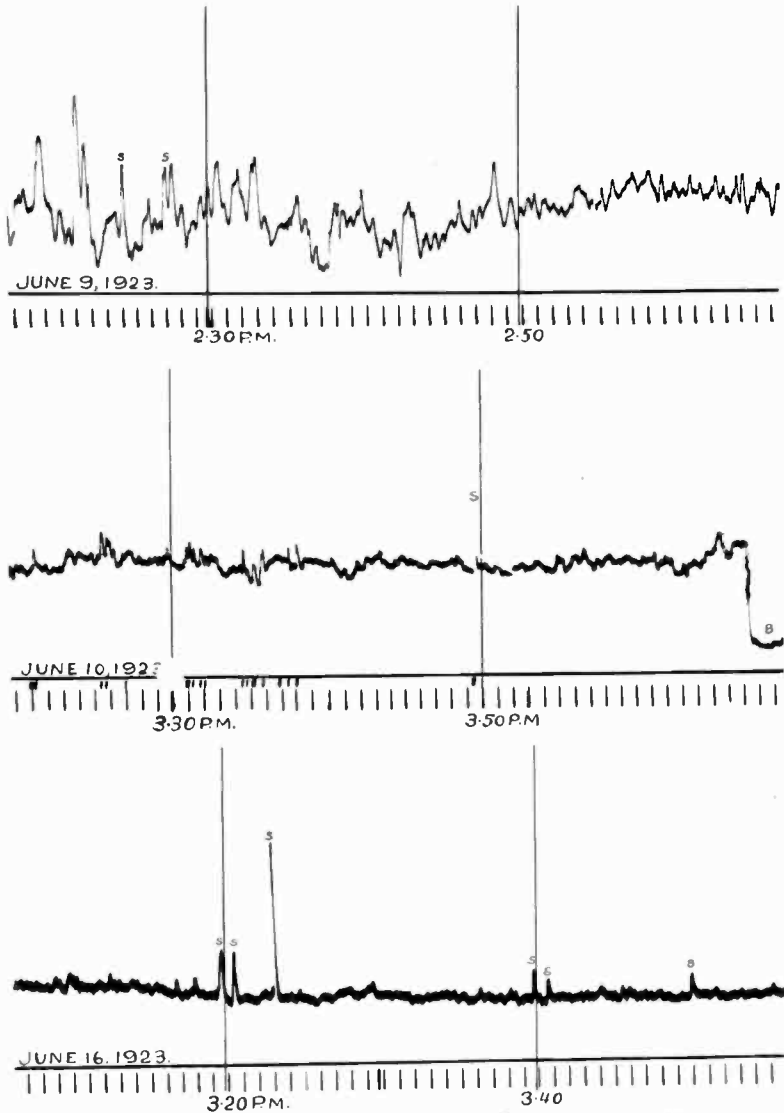

FIGURE 8—WBZ, Springfield, Massachusetts—Newton Centre, Massachusetts, 118 km. (74 miles), Daytime

of the short period fluctuations, and also the mean intensity of the electric field, increases to a maximum about an hour after sunset, and then declines again. This record is typical of many which I have obtained thru the sunset period, and the tendency of the short period oscillations to occur in more or less periodic groups will be shown in many subsequent records.

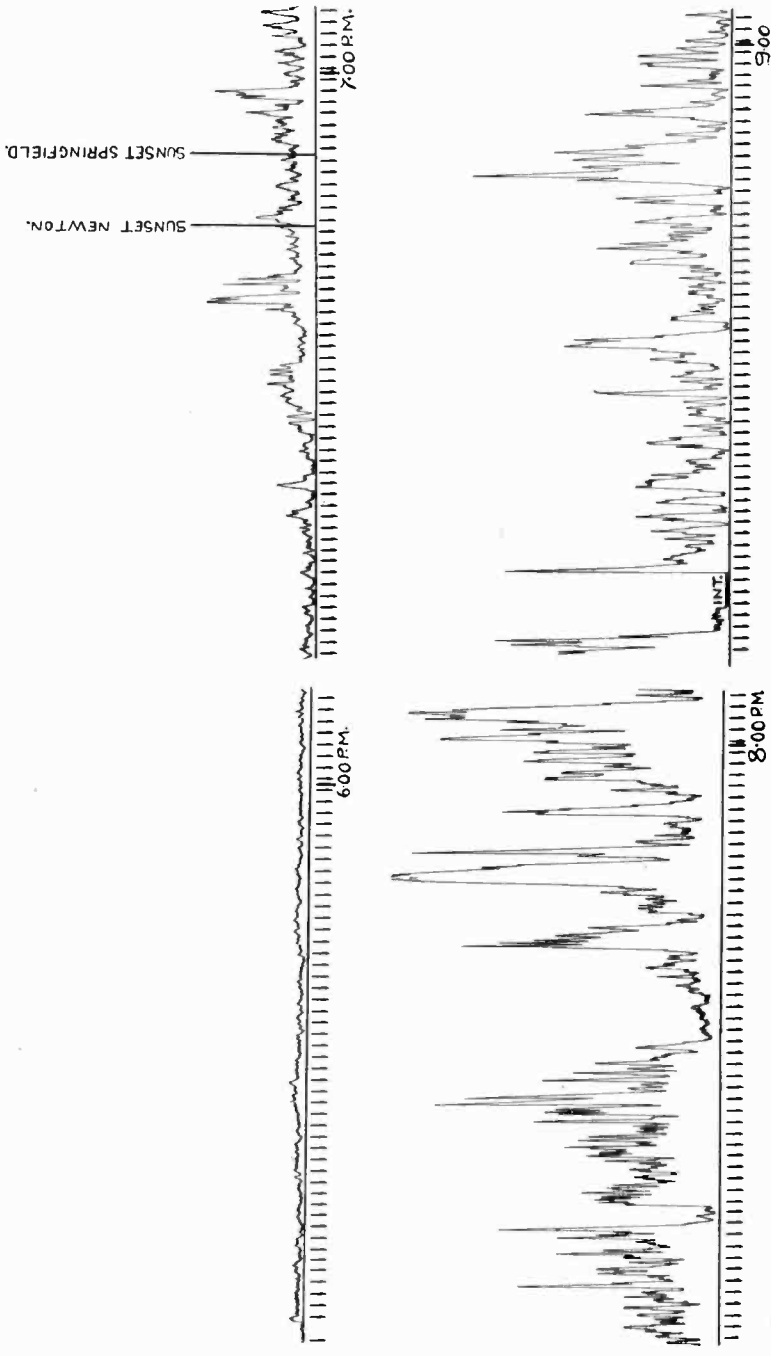

Figure 9—WBZ, Springfield, Massachusetts—Newton Centre, Massachusetts, 118 km. (74 miles), Day to Night, August 15, 1923

Day transmission over short distances, as we have seen from the simultaneous record of Figure 6, does not show any marked differences when recorded at separated points, perhaps because the daytime fluctuations are then too weak to be recorded. But

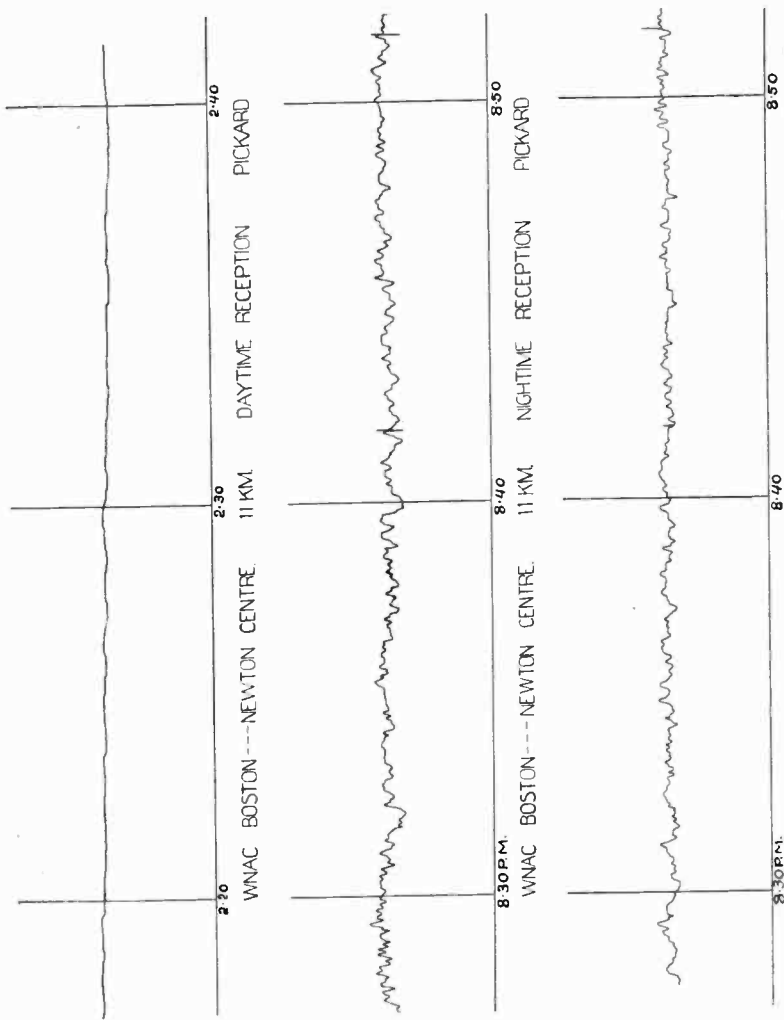

FIGURE 10—WYAC, Boston, Massachusetts—Newton Centre, Massachusetts, 11 km. (6.9 miles), Night-time Reception. Shaw Receiver is 550 m. (1,800 feet) from Pickard Receiver. SHAW.

at night simultaneous records clearly show transmission variations, which are different for even slightly separated receivers. The upper record of Figure 10 is the normal daytime transmission from Boston to Newton Centre, shown merely for comparison, and essentially similar to the records shown in Figure 6. The two

lower records are of night transmission from the same station in Boston, to two points in Newton Centre, separated by 550 meters (1,800 feet). These records are exactly superposed, the announcer check points appearing at 8.42 and 8.52 P. M. on both records, and it will be immediately apparent that there is little correspondence between them. So far as my analysis of such records has proceeded, the only points of similarity are in the longer swings, which are here very poorly shown because of the flattening caused by the small amplitude and relatively long time scale.

At the left-hand side of Figure 11 are shown five night records of transmission from Boston to Newton Centre, ranging from highly disturbed to quiet. At the right-hand side of the same figure are records made from distant stations on the same nights, and within fifteen minutes of the time of the local station records. It will be seen that on the nights when the record from the local station showed marked fluctuations, the distant stations showed a predominance of short period swings, while on the quiet nights the distant stations gave a predominance of longer period variation.

In Figure 12 are shown four night records of WNAC, Boston, Massachusetts, as received at Scituate, Massachusetts, 33 kilometers (21 miles) distant, of which the first 15 kilometers (9 miles) was over sea water, and the remainder over land. These records also show nights that range from quiet to highly disturbed, and differ in no essential respect from those shown in Figure 11, save for a marked increase in amplitude, caused by the increased distance. This increase in amplitude has, however, made apparent some of the longer periods, which, altho present in Figures 10 and 11, are masked by the flattening.

Figure 13, like the preceding figure, is of night transmission from Boston to Scituate, a range of 33 kilometers (21 miles). It covers a period of nearly three hours, and is a beautiful example of oscillation groups with nearly quiescent periods between. There is a strong resemblance to a seismograph record of a distant and severe earthquake. The change of axis just before 8.30 P. M. is perhaps due to a sudden change of adjustment of the receiving apparatus.

The four records shown in Figure 14 are at a distance of 68 kilometers (42 miles) from station WMAF at South Dartmouth, Massachusetts, to Scituate, Massachusetts, the frequency of WMAF being 845 kilocycles (wave length 355 meters). These four records are fairly representative of the different night con-

HARRY UPTON
— I F A —
65 CHASE STREET
SOUTH PORTLAND, MAINE

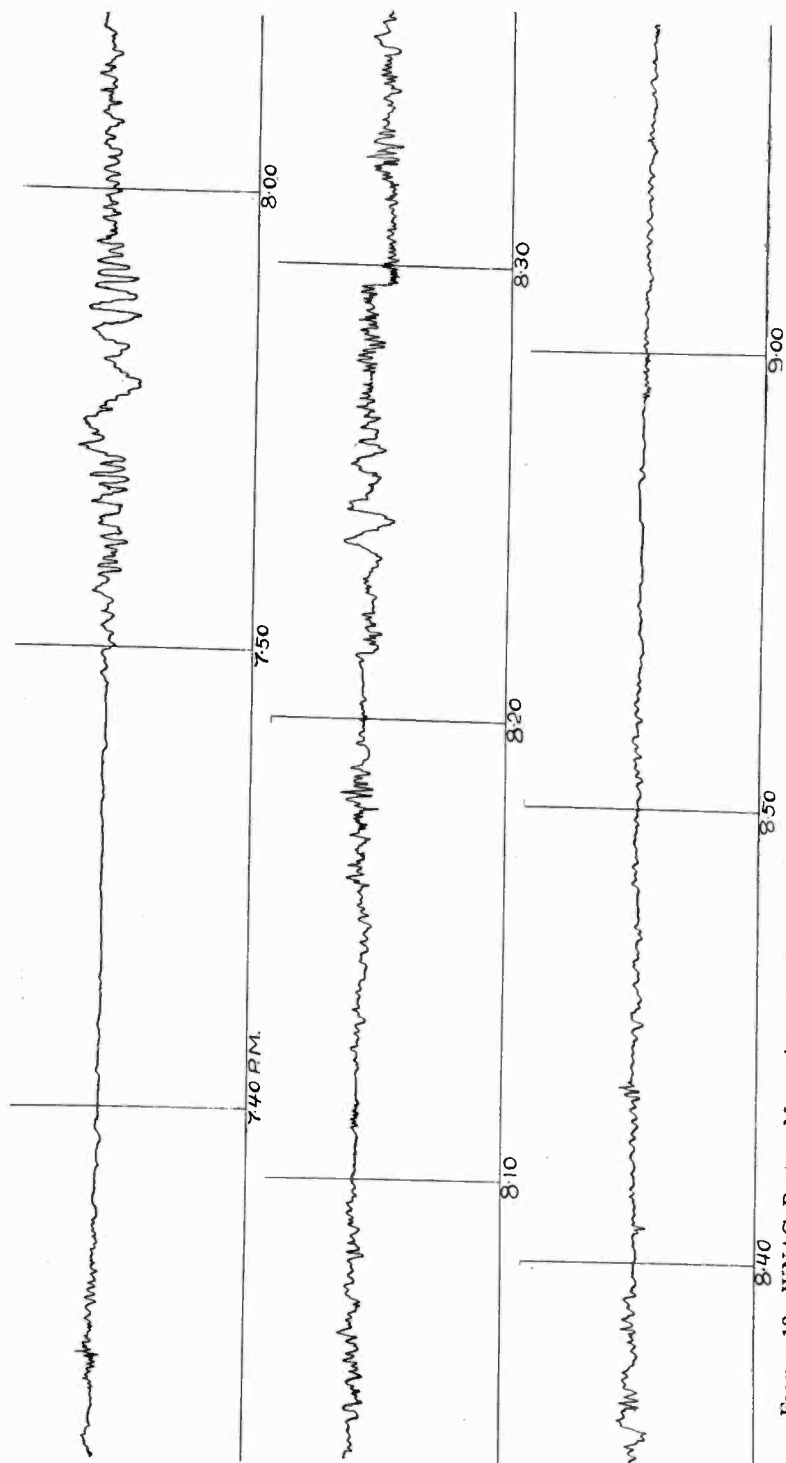

FIGURE 13—W.N.A.C., Boston, Massachusetts—Scituate, Massachusetts, 33 km. (21 miles), July 6, 1923. 15 km. (9 miles) over Sea Water

tion, whereas at night-time not only does the record show an almost complete extinction at times, but the sound entirely vanishes in the monitoring phones, which shows very conclusively that the night intensity of a distant station may fall far below the day-time intensity.

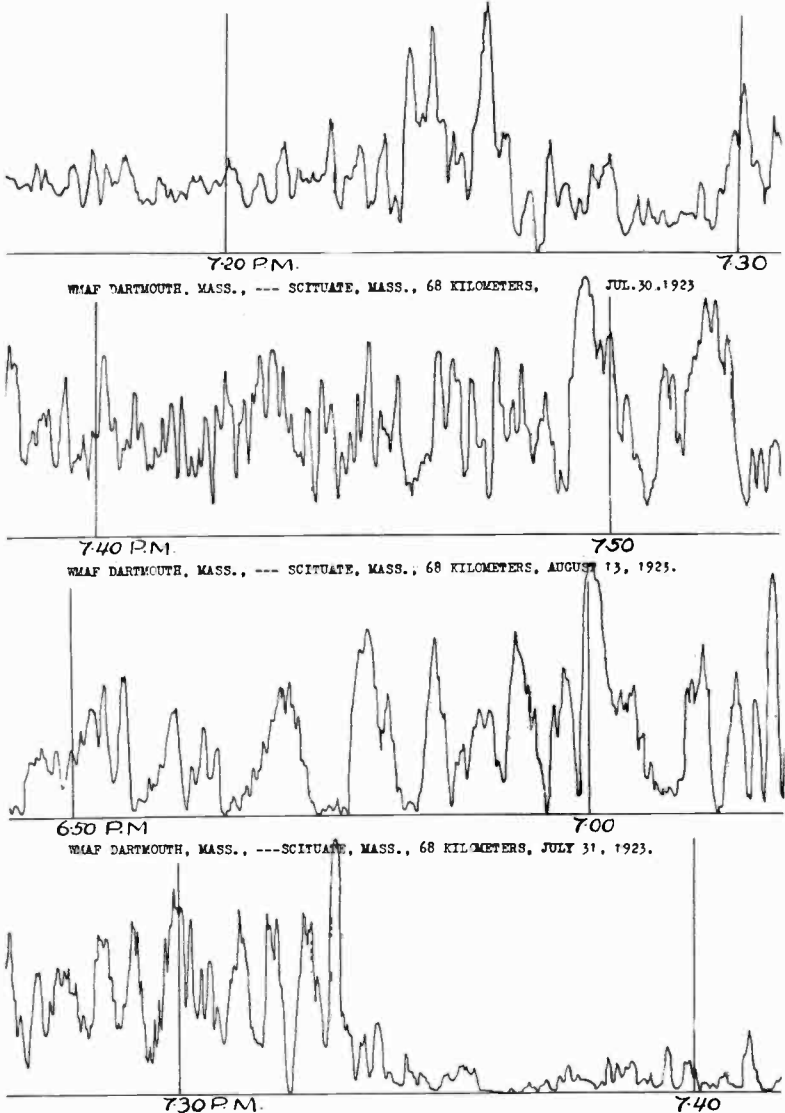

FIGURE 14—WMAF, Dartmouth, Massachusetts—Scituate, Massachusetts, 68 km. (42 miles), July 27, 1923

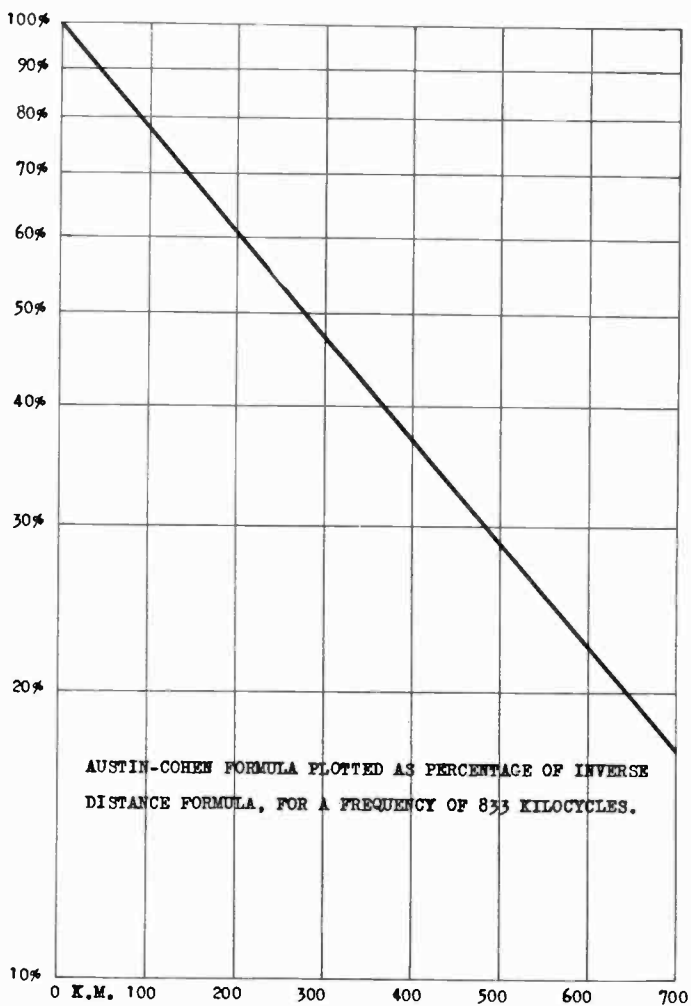

FIGURE 14A

In Figure 14-A I have plotted the Austin-Cohen transmission formula as a percentage of the simple inverse distance formula against distance, for a transmission frequency of 833 kilocycles (360 m.). At 68 kilometers (42 miles), the distance from South Dartmouth to Scituate, the difference in electric field between the two formulas is only about 16 percent, which would appear in the voltage-squared ordinates of my records as a change of some 35 percent. Yet the record shown in Figure 14 shows variations which are at times enormously greater than this. Similarly, as will be seen from succeeding records, the transmis-

sion from Springfield to Newton Centre, 118 kilometers (78 miles) apart, which according to the difference between the Austin-Cohen and the inverse distance should show only 25 percent variation in electric field, or a change in my ordinates of about 56 percent, actually show fluctuations from minute to minute of tens or hundreds of times. On the other hand, Messrs. Nichols and Espenschied^{2A} have found that reception fluctuations in oversea transmission tend to lie between the inverse distance and the Austin-Cohen formula as upper and lower limits. It would appear from this that overland transmission is subject to much greater short period fluctuation than transmission over salt water.

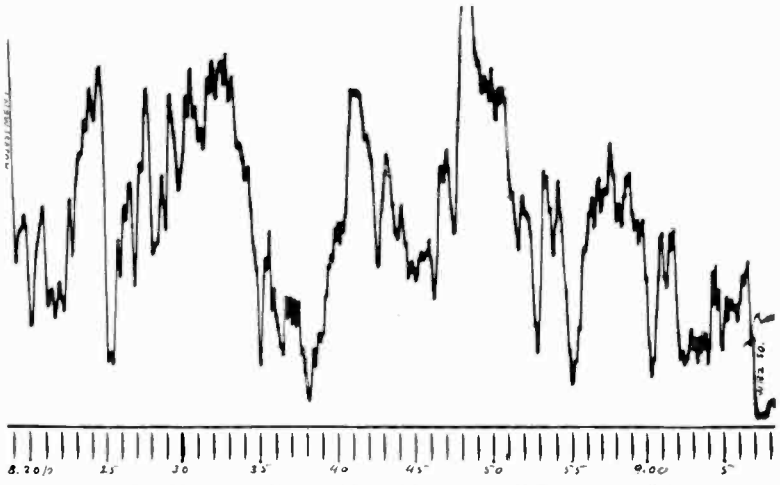

FIGURE 15—WBZ, Springfield, Massachusetts—Newton Centre, Massachusetts, 118 km. (74 miles), February 10, 1923

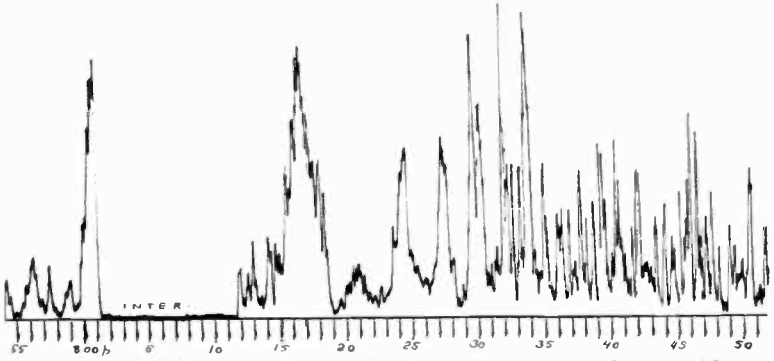

FIGURE 16—WBZ, Springfield, Massachusetts—Newton Centre, Massachusetts, 118 km. (74 miles), April 18, 1923

^{2A} "Radio Extension of the Telephone System to Ships at Sea," PROCEEDINGS OF THE INSTITUTE OF RADIO ENGINEERS, Volume 11, Number 2, June, 1923.

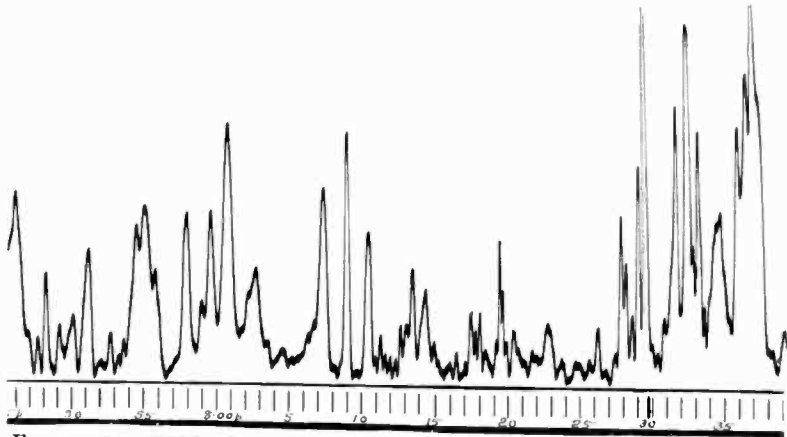

FIGURE 17—WBZ, Springfield, Massachusetts—Newton Centre, Massachusetts, 118 km. (74 miles), June 16, 1923

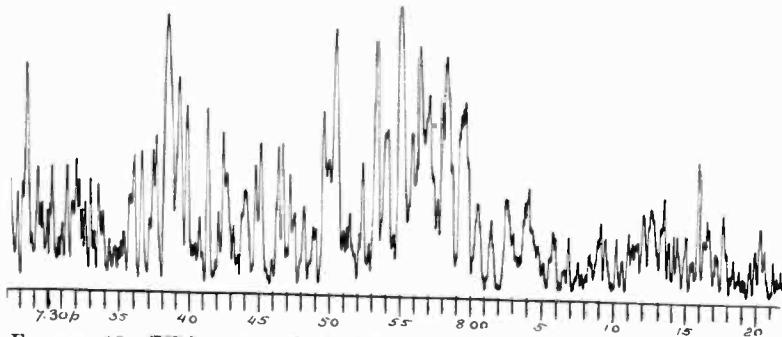

FIGURE 18—WBZ, Springfield, Massachusetts—Newton Centre, Massachusetts, 118 km. (74 miles), September 11, 1923

The four records shown in Figures 15, 16, 17, and 18 are representative of night transmission from Springfield to Newton Centre, a distance of 118 kilometers (74 miles). The first two records are at 750 kilocycles (400 meters), while Figures 17 and 18 are at 890 kilocycles (337 meters), as they are subsequent to the change in frequencies effective on May 15, 1923. These four records run from quiet to highly disturbed nights, and it is interesting in connection with the change in frequency of this station that examination of my numerous records before and after the date of the change does not show any difference which could be attributed to this change.

Figures 19, 20, and 21 are typical of Schenectady to Newton Centre transmission at night, a distance of 225 kilometers (141

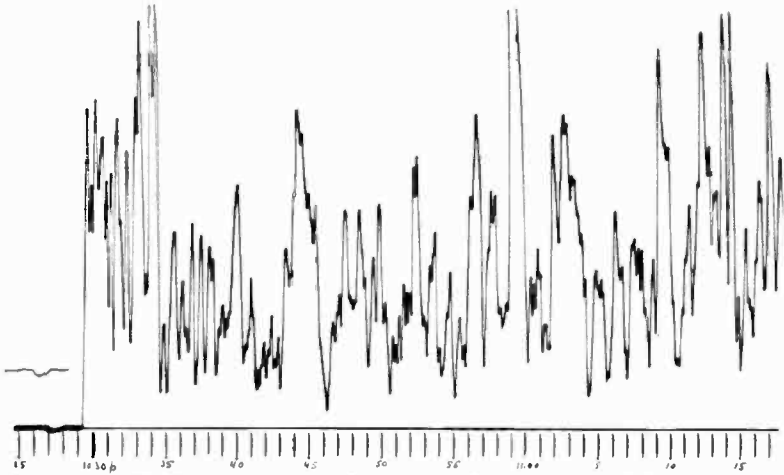

FIGURE 19—WGY, Schenectady, New York—Newton Centre, Massachusetts, 225 km. (141 miles), February 16, 1923

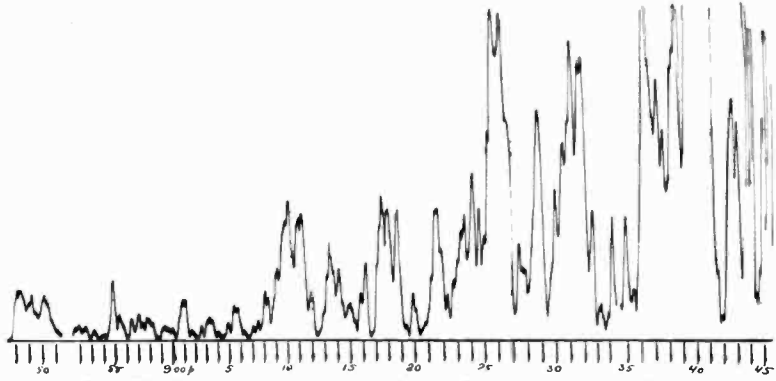

FIGURE 20—WGY, Schenectady, New York—Newton Centre, Massachusetts, 225 km. (141 miles), April 26, 1923

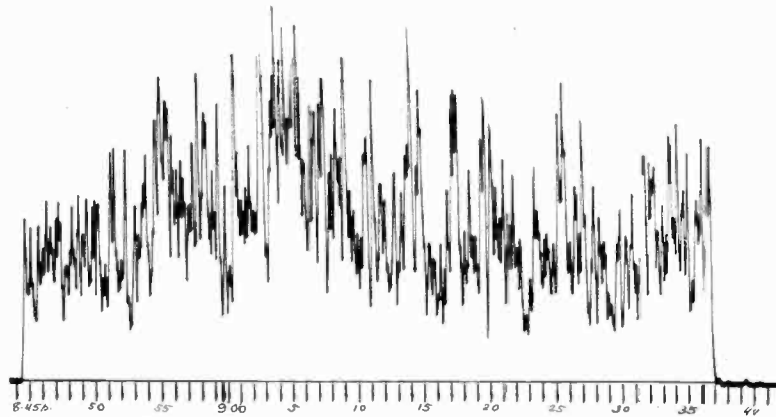

FIGURE 21—WGY, Schenectady, New York—Newton Centre, Massachusetts, 225 km. (141 miles), September 27, 1923

miles). We have now apparently reached the transmission distance at which the shorter period fluctuations are at their maximum, altho perhaps this may really lie somewhere between Springfield at 118 kilometers (74 miles) and Schenectady at 225 kilometers (141 miles). From now on the records shown will have a predominance of the longer period swings.

Figures 22 and 23 are representative of night transmission from WJZ, New York City, to Newton Centre, a distance of 290 kilometers (181 miles). Figure 22 is of the opening night of Broadcast Central (as duplex stations WJY and WJZ are termed), and the interest taken in this by my Newton neighbors is shown by the "squeal" record appearing just above the time scale markings at the lower edge of the sheet. Each time a beat note from a neighboring oscillating receiver was heard in the monitoring telephones, a spot of light was flashed on the record sheet. These squeals are noticeably grouped most closely around low spots in the transmission, and also around any interval when the station was not modulating. It is a fixed idea of the average broadcast listener that when signals are weak or absent his receiver must be suspected and adjusted. At this distance of transmission the character of the record begins to change, and the longer period swings, measured in minutes, begin to become more prominent.

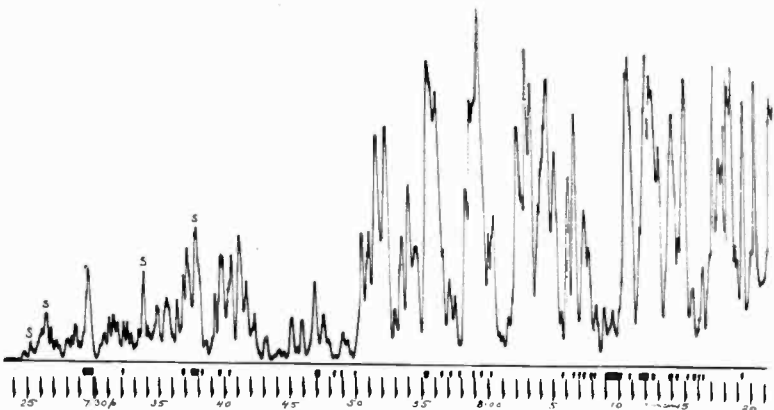

FIGURE 22—WJZ, New York City—Newton Centre, Massachusetts, 290 km. (181 miles), May 15, 1923

Figures 24 and 25 are KDKA, Pittsburgh, Pennsylvania, as received by night at Newton Centre, a distance of 760 kilometers (475 miles). The distance is now great enough to bring out strongly the long period swings, of about five and a half minutes in Figure 24, and about ten minutes in Figure 25.

On quiet evenings, as will be seen from later records of the same station, the long periods are even more in evidence.

This record is typical of night transmission from WCAP, Washington, District of Columbia, to Newton Centre, a distance of 630 kilometers (394 miles). Altho the distance is less than that

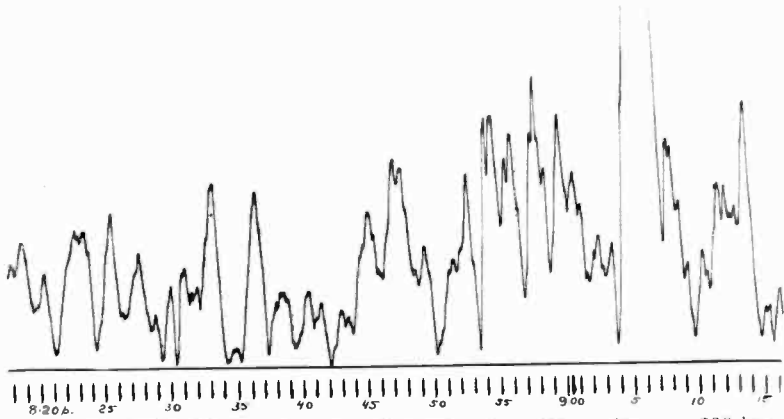

FIGURE 23—WJZ, New York City—Newton Centre, Massachusetts, 290 km. (181 miles), September 16, 1923

of the records shown in Figures 24 and 25, the transmission from this station is always relatively free of fluctuations having a period of one minute or less. It would seem that the ground route followed by the transmission played some part in determining the character of the variations.

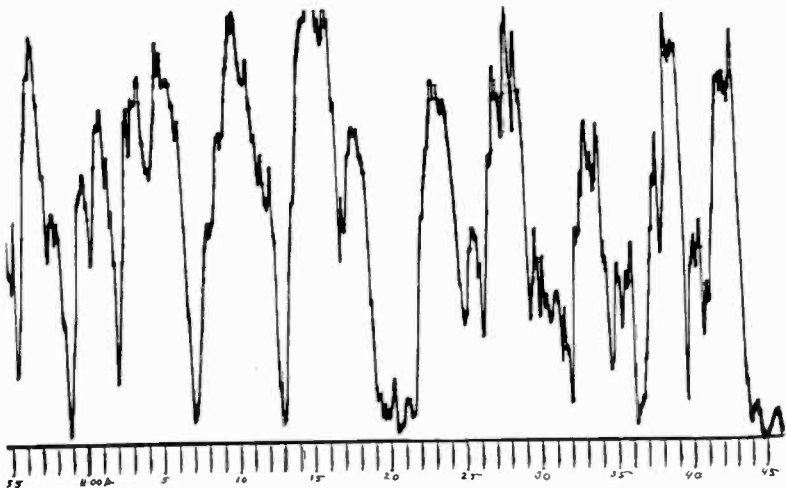

FIGURE 24—KDKA, Pittsburgh, Pennsylvania—Newton Centre, Massachusetts, 760 km. (475 miles), February, 14, 1923

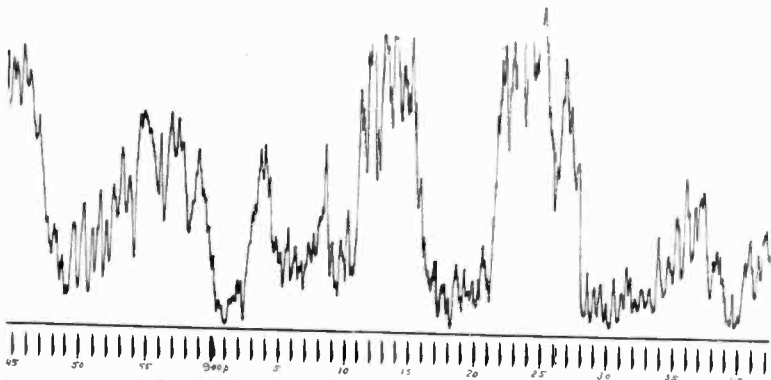

FIGURE 25—KDKA, Pittsburgh, Pennsylvania—Newton Centre, Massachusetts, 760 km. (475 miles), March 22, 1923

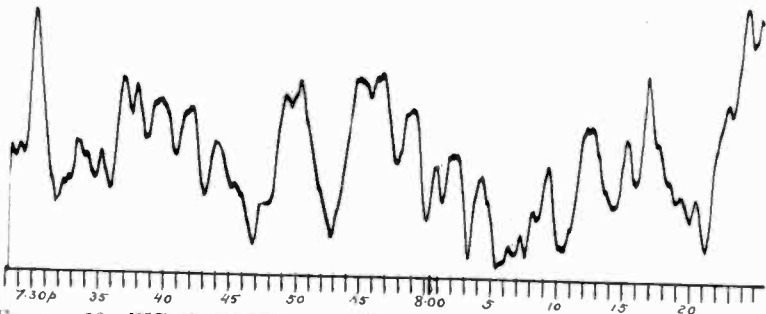

FIGURE 26—WCAP, Washington, District of Columbia—Newton Centre, Massachusetts, 630 km. (394 miles), September 1, 1923

Figure 27 is of night transmission from WDAP, Chicago Illinois, to Newton Centre, Massachusetts, a distance of 1,400 kilometers (875 miles). A long swing of about twenty minutes is clearly brought out in this record, with superimposed periods of about thirty and sixty seconds. This record was made on a moderately disturbed night; on a quiet night the curve is much smoother.

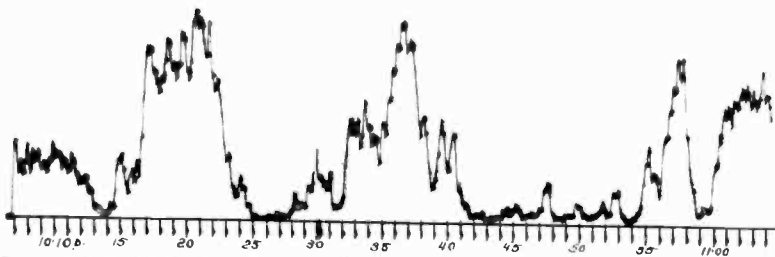

FIGURE 27—WDAP, Chicago, Illinois—Newton Centre, Massachusetts, 1,400 km. (875 miles), August 2, 1923

Figure 28 is of night transmission from WBAP, Fort Worth, Texas, to Newton Centre, Massachusetts, a distance of 2,600 kilometers (1,630 miles). A long period of some fifteen minutes is prominent, and with the rather high amplification necessary for this distant station, the background disturbance becomes quite appreciable.

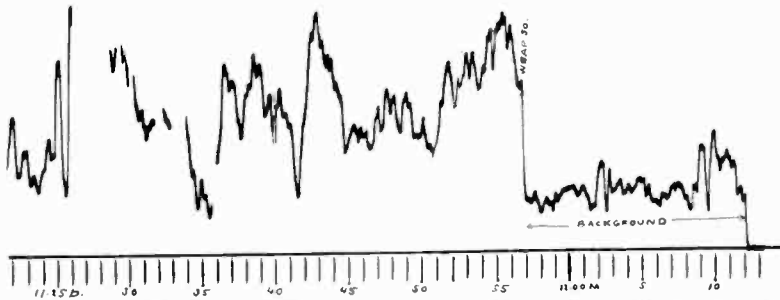

FIGURE 28—WBAP, Fort Worth, Texas—Newton Centre, Massachusetts, 2,600 km. (1,620 miles), February 8, 1923

Figure 29 is a simultaneous night record at Newton Centre of Schenectady, distant 225 kilometers (141 miles), taken at receiving points separated 550 meters (1,800 feet). With the exception of the period of high intensity at about 8.10 P. M., it is difficult to identify any of the detail of one record with that of the other. The longer period swings of these records are, however, substantially the same, and this becomes apparent if the curves are smoothed.

The fact that altho the shorter period swings are not the same on records made at slightly separated points, the longer period fluctuations are substantially identical, is well brought out by Figure 30, which is of night transmission from Pittsburgh, Pennsylvania to Newton. This was made on a quiet evening, so that the short period variations are weak, and altho considerable distortion occurs, particularly around 8.50 P. M., the main features of the two records are the same.

If, however, the receiving points are at all widely separated, there is little or no similarity between their records of a distant station. In Figure 31 the transmitting station is WBZ, Springfield, Massachusetts, and the two receiving points are Newton Centre and Scituate, Massachusetts, 118 and 155 kilometers (74 and 97 miles), respectively, from Springfield, and 41 kilometers (26 miles) from each other. Aside from the general increase in intensity after sunset, which was at 7.20 P. M., there is no correspondence between these two records.

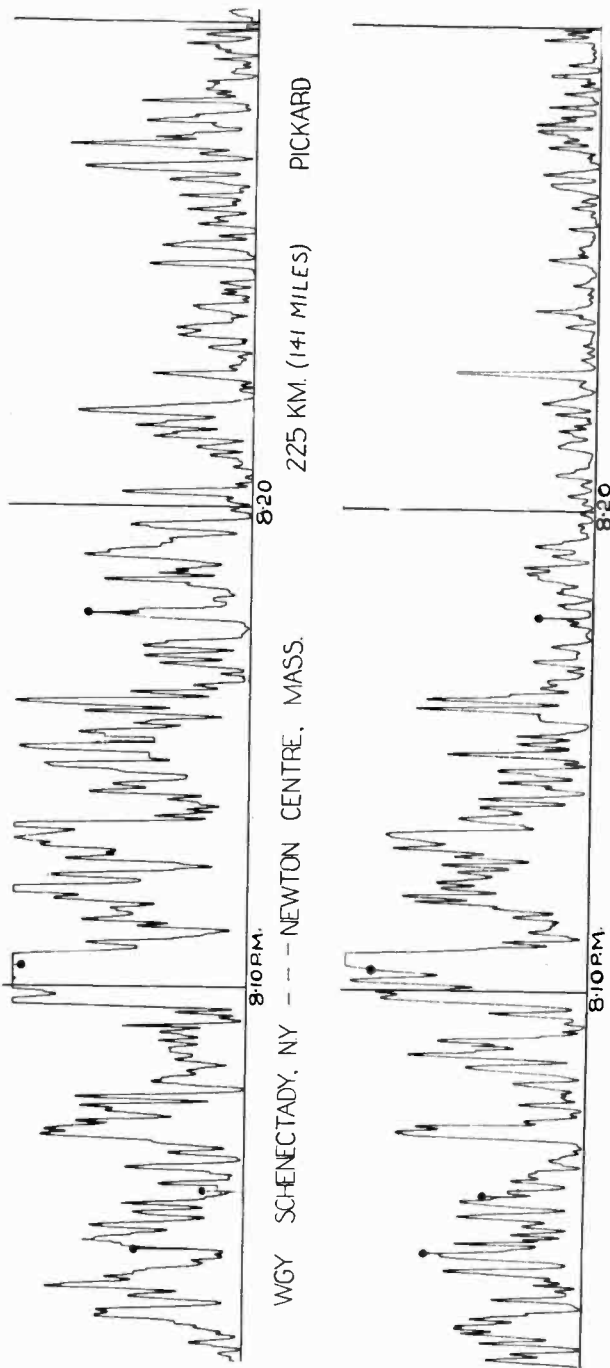

FIGURE 29—WGY, Schenectady, New York—Newton Centre, Massachusetts, 225 km. (141 miles)

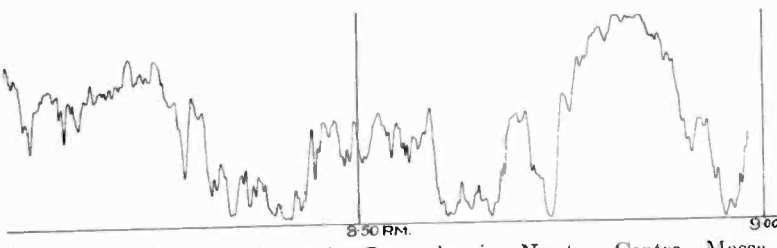
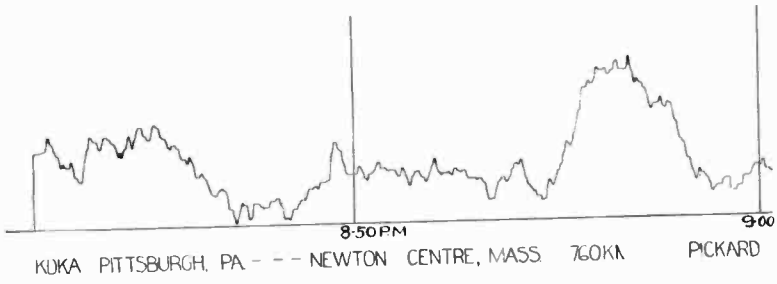

FIGURE 30—KDKA, Pittsburgh, Pennsylvania—Newton Centre, Massachusetts (760 km. (475 miles), SHAW

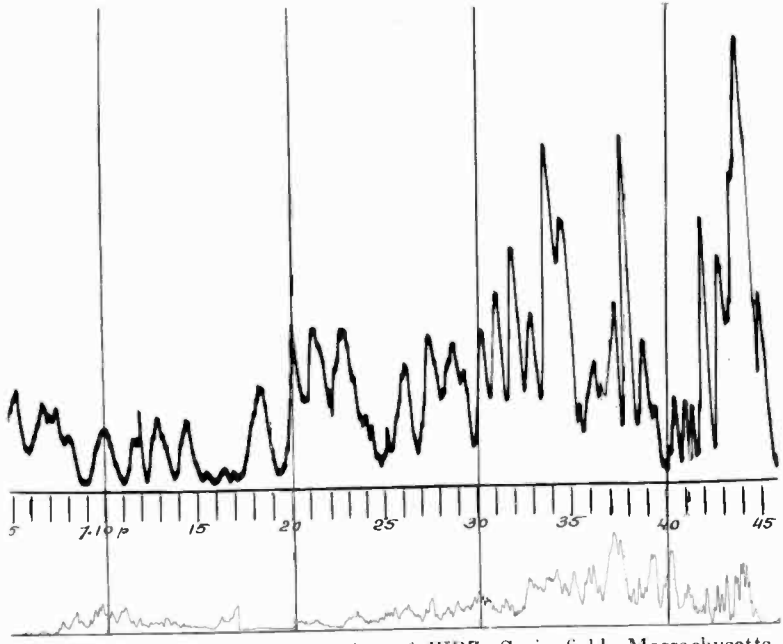

FIGURE 31—Simultaneous Reception of WBZ, Springfield, Massachusetts, at Newton Centre, Massachusetts, and Scituate, Massachusetts, Distant 118 and 155 km. (74 and 97 miles). Scituate is 41 km. (26 miles) from Newton Centre. June 9, 1923

Figure 32 is a simultaneous night record at the same receiving point in Newton Centre, of two stations in Newark, New Jersey, distant 315 kilometers (197 miles), and, of course, operating at different frequencies. There are no points of correspondence between these records, save accidental coincidence of maxima and minima which would occur in the superposition of any two random complex curves.

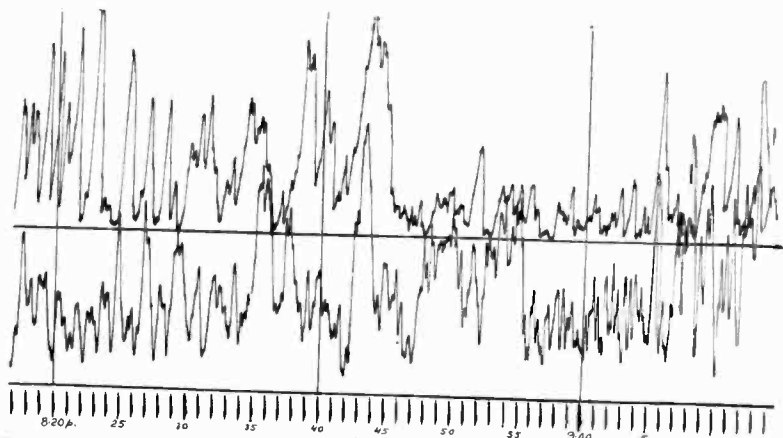

FIGURE 32—Simultaneous Record at Newton Centre, Massachusetts, of WOR and WJZ (original location), both at Newark New Jersey, Distant 315 km. (197 miles), March 2, 1923

Figures 33, 34, and 35 illustrate simultaneous transmission to Newton Centre from widely separated broadcasting stations. As in Figure 32, there is a complete lack of correspondence.

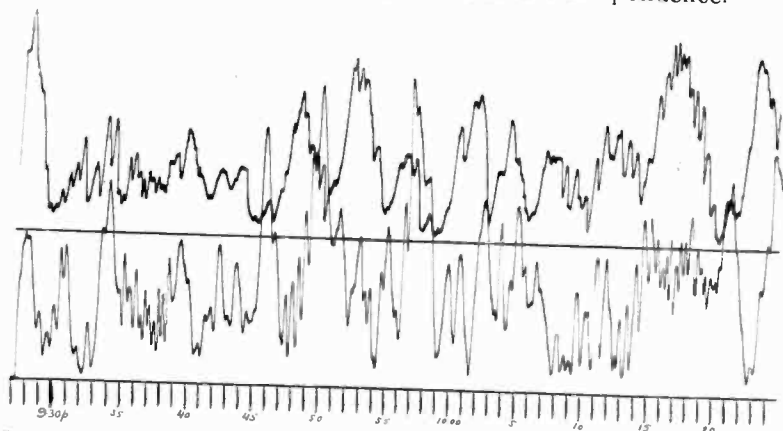

FIGURE 33—Simultaneous Record at Newton Centre, Massachusetts, of WEAJ, New York City, and WJZ, Newark, New Jersey, Distant 290 and 315 km. (181 and 197 miles), March 10, 1923

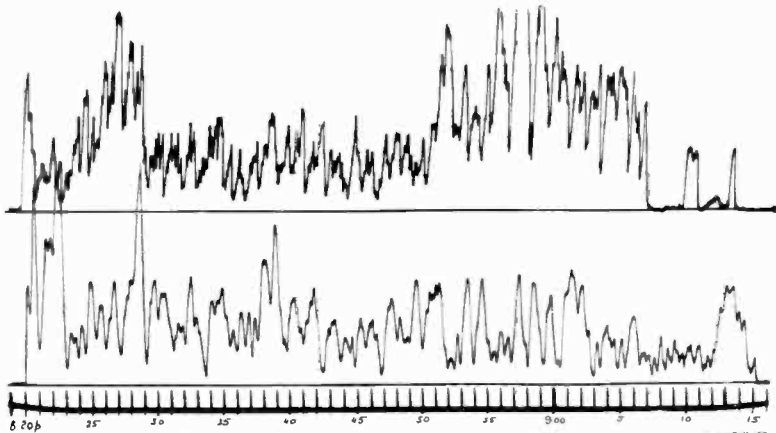

FIGURE 34—Simultaneous Record at Newton Centre, Massachusetts, of WBZ, Springfield, Massachusetts, and WEAF, New York City, Distant 118 and 290 km. (74 and 181 miles), February 24, 1923

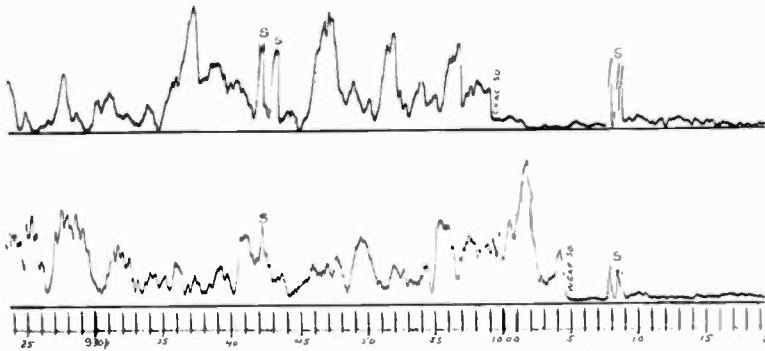

FIGURE 35—Simultaneous Record at Newton Centre, Massachusetts, of CKAC, Montreal, Canada, and WEAF, New York City, Distant 405 and 290 km. (254 and 181 miles), February 24, 1923

In Figure 36, which is a simultaneous night record at Newton Centre from New York City and Springfield, there is one correspondence; namely, the dead period beginning about 8.42 P. M. Unfortunately for further possible points of similarity, Springfield signed off at 9.04 P. M.

I have said above that reception from a distant station is not the same at separated points, unless the separation is very small indeed. In addition to extremely small separation, it is also necessary for identical records that the two antennas be of the same directional properties, and similarly oriented.

In Figure 36-A is shown a simultaneous record on two open antennas, separated only 30 meters (97 feet) on centers. The

two records are substantially identical, and the slight differences between them are probably due to the fact that one of the open antennas was a large T, while the other was of the inverted L type, so that there was a slight difference in directional properties.

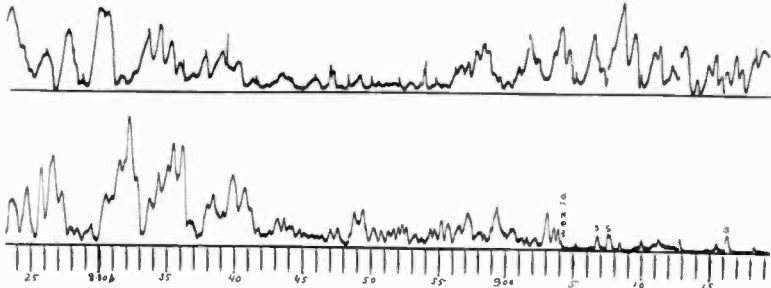

FIGURE 36—Simultaneous Record at Newton Centre, Massachusetts, of WEAJ, New York City, and WBZ, Springfield, Massachusetts, Distant 290 and 118 km. (181 and 74 miles), March 10, 1923



FIGURE 36A—WJAC, Boston, Massachusetts, received at Newton Centre, Massachusetts, 11 kilometers (7 miles) distant, November 13, 1923, on antennas 30 meters (97 feet) apart on centers. Upper record on large open antenna by Shaw; lower record on small open antenna by Pickard. Record is 4 minutes and 40 seconds long

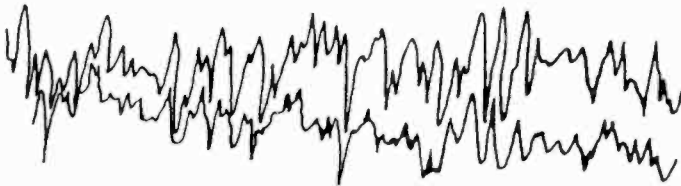

FIGURE 36B—WJAC, Boston, Massachusetts, received at Newton Centre, Massachusetts, 11 kilometers (7 miles) distant, on November 13, 1923, on two small loops, 3 meters (9.7 feet) apart on centers and in line with WJAC. Upper record by Shaw. Record is 6 minutes, 20 seconds

Figure 36-B shows a simultaneous record on two small loops, 3 meters (9.7 feet) apart on centers, and each loop in line with the broadcasting station. Here, also, the records are substantially identical, the slight differences which appear being probably due to differences in the open antenna effect of the two loops, which were compensated.

But in Figure 36-C, which is a simultaneous record made on antennas of different directional properties, the upper record that of a T open antenna, and the lower on a small loop, separated 15 meters (48 feet) on centers, a total dissimilarity appears, both in shape and amplitude, the loop record showing about four times the amplitude of the open record.

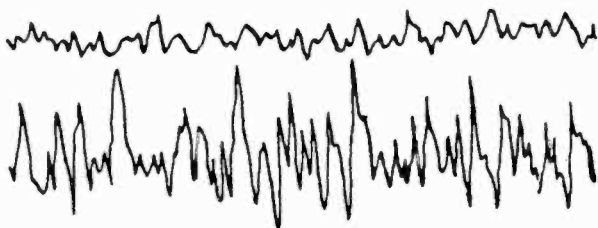

FIGURE 36C—WNAC, Boston, Massachusetts, received at Newton Centre, Massachusetts, 11 kilometers (7 miles) distant, November 13, 1923, on antennas 15 meters (48 feet) apart. Upper record on open antenna by Pickard; lower record on loop by Shaw. Record is 5 minutes long

Figure 36-D is a double record made on two small loops, uncompensated, 3 meters (9.7 feet) apart on centers, at right angles with each other and each loop at 45° from the plane, including the broadcasting station. Here, also, the two records are entirely dissimilar.

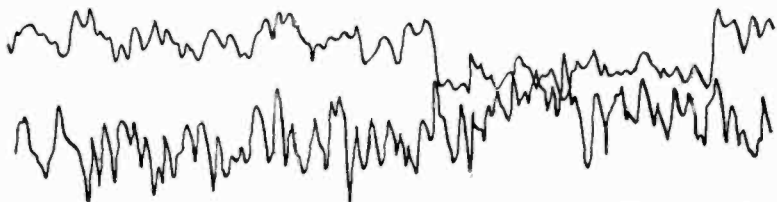

FIGURE 36D—WNAC, Boston, Massachusetts, received at Newton Centre, Massachusetts, 11 kilometers (7 miles) distant, November 13, 1923, on two small loops, 3 meters (9.7 feet) apart on centers. These two loops were at right angles with each other, and at 45° with the radio bearing of the Boston Station. The upper record was made by Pickard on a loop in a NE-SW plane; the lower record is by Shaw on another loop in a NW-SE plane. Record is 9 minutes long

It has been thought that reception variations in loop reception were largely due to changes in the direction of wave-front, and this may be true in some localities, and with certain distant stations. For example, I have often found large short-period variations in the apparent bearing of ship stations at night, when the receiving point was near the water's edge, and the line of

transmission ran grazing along the shore. Under such conditions an apparently weakened or lost signal could sometimes be restored by swinging the loop thru 90° . But inland, and particularly at my principal receiving point in Newton Centre, overland reception from broadcasting stations does not show large changes in wave-front. A loop null point taken on WNAC, Boston, Massachusetts, 11 kilometers (7 miles) distant, remains constant thru an entire evening to within a degree or two, so that the effects shown in the preceding figures can hardly be due to changes in wave-front.

Altho the relation of these short period fluctuations to transmission frequency is a matter which I must reserve for a later paper, I have shown in Figure 36E an interesting simultaneous record, made at Newton Centre on two open antennas separated 30 meters (97 feet) on centers, of the two transmission frequencies KDKA, Pittsburgh, Pennsylvania. The upper record is at 920

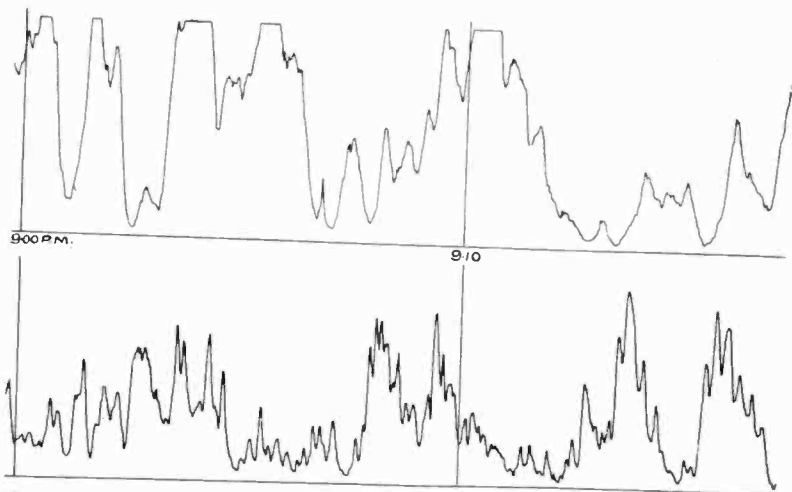

FIGURE 36E—KDKA, Pittsburgh, Pennsylvania, received at Newton Centre, Massachusetts, 760 kilometers (565 miles) November 28, 1923. Upper record 920 kilocycles (326 meters); lower record 3,200 kilocycles (94 meters)

kilocycles (326 meters), while the lower one is at 3,200 kilocycles (94 meters). I selected this particular record because it was out of the ordinary in that there is a general resemblance between the curves; usually reception at 3,200 kilocycles is subject to a much more rapid variation than is here shown. Figure 36F, which is a four-hour record of KDKA at 3,200 kilocycles, is more nearly representative of this transmission.

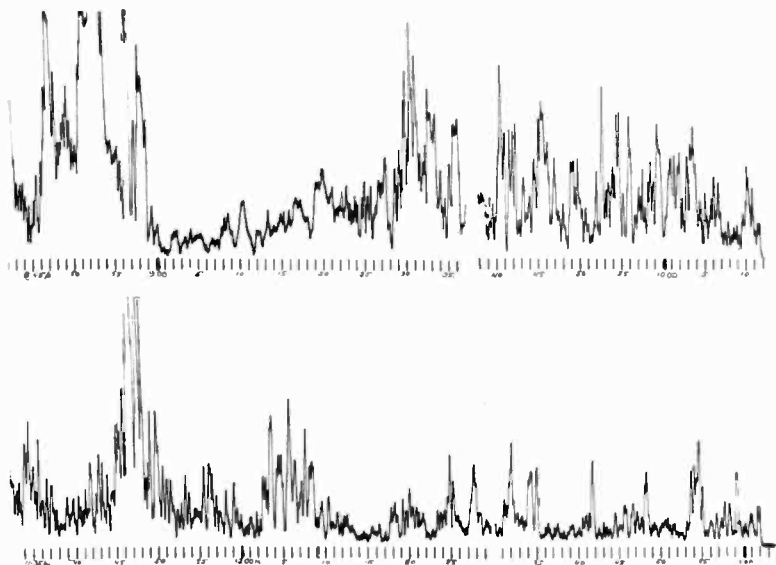

FIGURE 36F—KDKA, Pittsburgh, Pennsylvania, received at Newton Centre, Massachusetts, 760 kilometers (565 miles), 3,200 kilocycles (94 meters), November 29-30, 1923

I have devoted some little study to KDKA's 3,200-kilocycle transmission, and the result, at least in so far as Newton Centre reception is concerned, may be briefly summed up as follows: In the afternoon and early evening reception from KDKA is often better at 3,200 kilocycles than at 920, while later in the evening the lower frequency is usually better. Until recently the higher frequency was quite free of disturbances; now there is a noticeable amount of amateur working at or near this frequency, and a sufficient number of oscillating receivers to muck the quality badly at times.

It has probably been observed by all broadcast listeners that in general the quality of reception from a distant station is markedly inferior to that obtained from a local station, this inferior quality being a matter entirely aside from impairment of reception due to disturbances. I am now convinced that the principal cause of the distortion in reception from distant stations is that the short period variations in transmission are not the same for the carrier wave and its two side bands, and I hope to present in another paper certain records which show this effect. Fortunately there are two obvious remedies for this form of distortion; the use of a single side band for transmission, and the employment of much higher transmission frequencies. Neither

of these remedies will be immediately popular with the average broadcast listener.

So far as the varying intensity of the sound in the telephone receiver is concerned, there are several simple expedients which will markedly smooth out reception from a distant station. Thus, the grids in a radio frequency amplifier train may be floated on a fairly large condenser, shunted by a high resistance. When reception is weak, the grids assume a small negative potential, and amplification is at a maximum. When the input rises, a large negative charge is built up of the grids, and amplification is reduced. Similarly, a separate rectifier connected to the output end of the radio frequency amplifier and to the grids will have the same effect.

So far I have confined myself strictly to my records, which have shown you graphically the facts of short period variations in broadcast transmission. There is as yet no adequate theory as to their cause. But I am sure you will agree with me as to the utility of hypotheses. Scientific progress is literally milestoned with hypotheses, most of which are to-day gravestones. But an hypothesis is at least something concrete, and if it stands the attack of new facts, and the further analysis and correlation of our present knowledge, it may form a stepping-stone to the truth. I have already mentioned a further paper on this subject, and in this I hope to present, among other things, the curious results of harmonic analysis of these record curves, some attempted correlation between these fluctuations and other terrestrial happenings, and simultaneous records of field intensity at a large number of separated points. I also hope to establish rather definitely the size and shape of the area within which these variations are identical. But at the present time I feel very strongly that any attempt at a detailed hypothesis would be decidedly premature, altho some rather general conclusions may not be out of place.

A very odd explanation of these variations has been gaining much vogue in the popular scientific press, to the effect that they are due to other receivers in the neighborhood, particularly if these happen to be of the much maligned single circuit regenerative variety. I have many records of transmission, principally made by audibility meter measurement, which run back over fifteen years, when the density of receivers was far less than at present. These records show exactly the same short period fluctuations that now exist, so that this explanation does not seem very plausible. However, I have recently made a number of

records of reception from distant stations under conditions of severe exposure to nearby regenerative receivers, of which Figure 37 is typical.

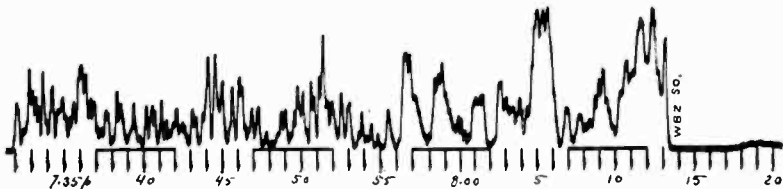

FIGURE 37—WBZ, Springfield, Massachusetts, Received at Newton Centre, Massachusetts, Distant 118 km. (74 miles). Base lines as at 7.37 to 7.42 P.M. Indicate Periods of 5 Minutes each when Single Circuit Regenerative Receiver in Same House and with Adjacent Antenna was in Operation. September 10, 1923

In this record, the broken heavy base line indicates periods when a single circuit regenerative receiver in the same house with my recording set, and with a fair-sized open antenna adjacent to the one employed with the recording set, was in operation. Full regeneration was used almost to the point of oscillation, but this record, like several others which I have made with different exposures of antennas, shows no effect whatsoever.

The fluctuations in radio transmission, at least those of short period, are at first thought most readily explained by the assumption of plural transmission paths; that is, the effect appears to be one of interference. I believe that De Forest was the first to suggest this in 1913,³ for short period variations in night-time transmission from the arc stations of the Federal Telegraph Company on the Pacific coast. Such plural paths may lie in altitude or azimuth, or both, but the favorite explanation has been that reflection takes place at some high level in the atmosphere, because of an ionized stratum called "the Heaviside layer."

In order to deflect electromagnetic waves, we may reflect them from a conducting surface or mirror, refract them by a change in optical density of the medium, or bend them by a two- or three-dimensional periodic structure of absorbing and non-absorbing elements. Inasmuch as, in our atmosphere, all three of these methods call for ionization, and as the maintenance of an ionized state requires energy, it is easy to arrange these methods in decreasing order of energy required to produce the observed effects, which would also seem to be the order of increasing probability.

³ PROCEEDINGS OF THE INSTITUTE OF RADIO ENGINEERS, volume 1, number 1, 1913, pages 42-51.

Maxwell's theory for the relation between the reflecting power of a mirror and its electrical conductivity⁴ requires for the effective reflection of the waves employed in broadcasting a conductivity somewhere between fresh water and sea water. Eccles has computed⁵ the conductivity necessary for refraction of such waves to be out of the order of one-millionth that of sea water. I have approximately calculated the ionization required to reflect the waves on the assumption of a periodic structure; a sort of "mackerel sky"* of ionized clouds, with the result that a considerably smaller number of ions is required than for refraction by a uniform state of ionization. Because of the smaller amount of energy required to maintain such a stratified state, I have considered this the more probable upper-level condition capable of causing reflection-like effects.

Inasmuch as I have found well-defined short period variations of more than ten percent amplitude in transmission over a distance as short as eleven kilometers (6.9 miles), in which the direct path from transmitter to receiver was at least ten times shorter than the total "reflected" path, it would seem to involve nearly normal reflection with an efficiency of one hundred percent or over, on the conventional Heaviside layer hypothesis. If some recent⁶ revisions of our ideas as to the density of our atmosphere at high levels are correct, the Heaviside layer is perhaps twice as high as we have supposed, which apparently removes it as a possible explanation of fluctuations over such short distances of transmission.

In view of the fact that night-time transmission over greater distances than eleven kilometers (6.9 miles) not infrequently falls to much lower levels than at any time during the day, it seems necessary occasionally to invoke the assistance of some form of plural path transmission with its consequent interference effects. But the general tendency of night-time field values is to range between the normal daytime transmission value as a lower limit, and the value given by the transmission formula without the exponential or so-called absorption term as an upper limit. It would seem, therefore, that the principal factor affecting radio transmission was absorption, with reflection-like effects present, but playing a minor role.

⁴ Drude, "Physik des Aethers," page 574.

⁵ Eccles, "London Electrician," 69, pages 1015-1016, 1912.

*A "mackerel sky" is a dappled cloud formation consisting of heaped-up or rounded clouds arranged in wisps or streamers—EDITOR.

⁶ Dobson, "The Characteristics of the Atmosphere up to 200 Kilometers as Indicated by Observations of Meteors," "Quarterly Journal of the Royal Meteorological Society," volume XLIX, 207, July, 1923.

It may at first seem altogether unlikely that such rapid fluctuations as I have found in transmission could be caused by changes in absorption. Absorption can only be explained as due to ionization, and while it does not seem impossible that ionization changes large enough to affect our whole atmosphere might have a diurnal period and so cause the well-marked difference between day and night transmission, it is difficult to imagine such large scale effects varying with periods of minutes and even seconds. One difficulty in the past has perhaps been our tendency to attribute too much of the ionization to the effect of direct sunlight, and too little to the effect of alpha particles shot out by the sun, which continually fall in drifting clouds into our atmosphere. These charged particles may arrive intermittently and at short intervals, perhaps in groups of small, cloud-like masses, and before the outer limit of our atmosphere is reached the earth's magnetic field begins to deflect and comb them out along its own direction. This process continues, perhaps, down to an elevation of some 150 kilometers (94 miles) or less, eventually drawing these clouds out into long streamers in a south to north direction. Then, perhaps, these streamers are captured by the high level air currents, which over the United States at heights of between 100 and 20 kilometers (63 and 13 miles) drift slowly from west to east, and, finally, they become subject to the stronger and varying low level winds.

I have attempted to illustrate this idea in Figure 38. From *A* to *B* the clouds of charged particles are drawn out in a south-to-north direction as they fall; from *B* to *C* they are deflected at nearly right angles to this course, or in a west-to-east direction, and from *C* to *D* they are at the mercy of the variable lower level winds. This results in the development of two striated layers, the upper one running south-to-north, the lower one west-to-east. Some real vision of the upper level structure is perhaps given to us by the aurora, which may be simply electrical discharges following and lighting up these ionized paths.

Such periodic structures as I have outlined could act as gigantic gratings, capable of reflecting as spectra the radiation from distant transmitters, and thus causing interference effects. For stations to our west or east, the upper layer would be more effective; for southern or northern stations the lower, because of the direction of the grating elements. According to this, there should be some difference between east and west transmission on the one hand, and north and south on the other. A com-

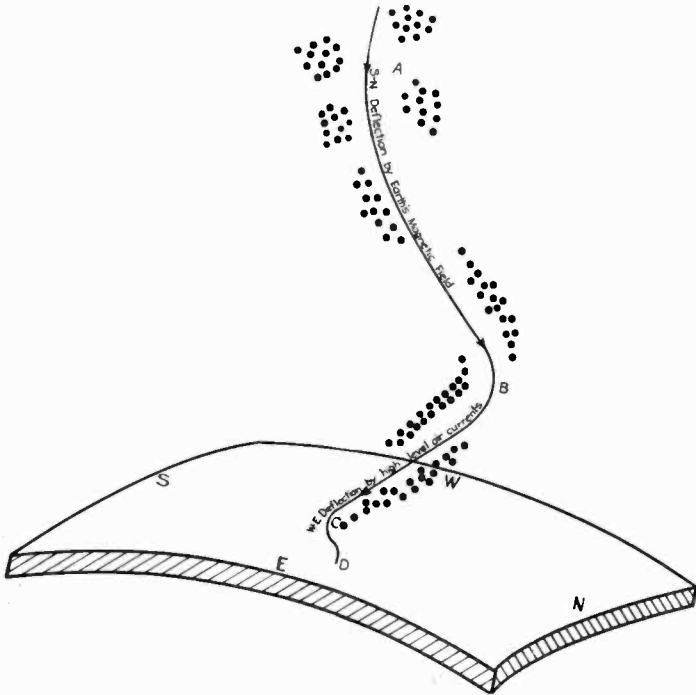

FIGURE 38

parison of a typical west-to-east transmission, such as that of Figure 27, with a typical south-to-north transmission does indeed indicate a difference in the character of the variations.

It is believed that at least a portion of the earth's magnetic field is due to these descending charges, and if this is so, we should expect to find some correspondence between magnetograph records and these transmission records. A magnetograph record does in fact show seasonal and diurnal changes, disturbances of great amplitude at times of intense aurora, and it also shows a variety of short period pulsations, measured in hours, minutes, and even seconds. Periods of 2 to 4 minutes are most frequent, while pulsations following each other at about 30 second intervals are not uncommon. Some days are relatively quiet, that is, free from rapid large amplitude oscillations, others are moderately disturbed, and many are highly disturbed. All of these effects are known in radio transmission, and some of them are shown in my records. In a later paper I hope to present simultaneous transmission and magnetograph records.

My present explanation of the transmission changes presented

in this paper is that they are due primarily to changes in absorption, and secondarily to reflection-like effects.

Both absorption and reflection are caused by ions in our atmosphere, which I assume are not uniformly distributed, but arranged in streamer-like clouds, oriented in the upper levels by the earth's magnetic field, and in the lower atmosphere by air currents. During the day, the direct radiation from the sun adds to this ionization, producing thereby a sufficient uniformity in its distribution so that it acts principally to absorb, thereby masking any reflection effects which would be apparent in its absence. Before sunset the solar ionization decreases, and at night this additional source of ionization vanishes, and the descending ionized structure is unmasked, varying from minute to minute in its effect over a given locality as it drifts with the low level air currents. At times this structure becomes sufficiently periodic to form a two- or three-dimensional grating, and then interference effects are found, including not only transmission minima lower than any daytime value, but also changes in wave-front. Over short distances of transmission, individual or small groups of descending ions at very low levels may account for the short period swings which predominate in such transmission, so that the effect may be confined almost entirely to the lower atmosphere. Over greater distances, the effect would be a sort of statistical average of great numbers of these ion clouds, which would tend to smooth out the shorter period effects, and accentuate the longer periods corresponding with the arrival of large groups over large areas. Certainly there should be a marked correlation between transmission and weather.

Nipher⁷ has found a well-defined correspondence between the horizontal intensity of the earth's magnetism and very local atmospheric disturbances. In Figure 39 his magnetograph records between 4 and 5 P. M. a sharp dip coinciding with the passage of a dense cloud. Other records show the effect of local air movement and small aread showers. Nipher's conclusion is that "local variations in the earth's magnetic field are determined wholly by local weather conditions"—perhaps the apparently very local short period variations in radio reception may be caused by changes in a comparatively minute volume of low level atmosphere.

In conclusion, I wish to acknowledge my indebtedness to Mr. H. S. Shaw, Jr., for his invaluable co-operation in this work, not

⁷ Nipher, "Variations in the Earth's Magnetic Field," *Trans. Acad. of Sci. of St. Louis*, volume XXII, number 4, 1913.

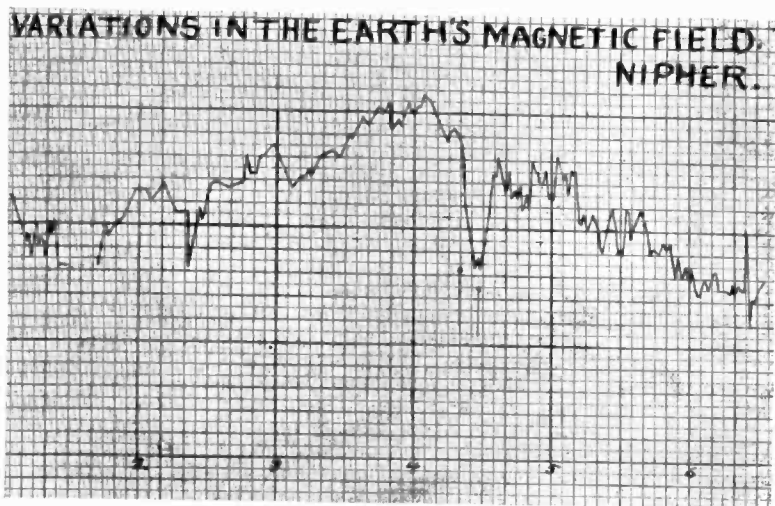

FIGURE 39

only in the design of portable apparatus for recording and in the actual taking of many of the records, but for his many helpful suggestions.

SUMMARY: Continuous records of electric field intensity at distances of from 11 to 2,600 kilometers (6.9 to 1,650 miles) from various broadcasting stations are made by amplifying and rectifying the received current from an open antenna, and recording galvanometer deflections produced by this rectified current. These records show a complex curve containing periodicities ranging from seconds to tens of minutes, the relative amplitude of the short and long period elements varying with the distance. The transition from day to night conditions is shown, and well-marked short period variations ("fading") in night-time reception from a station only 11 kilometers (6.9 miles) distant are found. Simultaneous records at separated receiving points are found to be dissimilar, even with separations as small as 550 meters (1,680 feet), and simultaneous records of different distant stations taken at the same receiving point are also shown to be entirely unlike. A tentative hypothesis for these fluctuations is advanced by the author, in which varying local absorption plays the principal part, but with marked interference effects produced by plural path transmission.

NEW APPLICATIONS OF THE SODION DETECTOR*

BY

HAROLD P. DONLE

(CHIEF ENGINEER, CONNECTICUT TELEPHONE AND ELECTRIC COMPANY,
MERIDEN, CONNECTICUT)

The general principles of one form of our sodion detector, which utilizes a highly electro-positive alkali metal, such as sodium, were recently described and demonstrated before THE INSTITUTE OF RADIO ENGINEERS. It is believed that a description of the details of another form of the sodion tube, together with a brief discussion of its operation, uses, and characteristics, will be of interest.

Possible objections to the previously described form, from some points of view, are the necessary care in handling it on account of its liquid anode and the need of operating it in a definite position. The form now to be described utilizes a solid anode, is of higher sensitiveness and is designed for economy in the filament power required. Its underlying principles are the same as those of the other form and reference is made to my earlier paper¹ for a discussion of some points not treated herein. The type S-13 sodion tube, the applications of which are the subject of the present paper, can be operated in any position, and uses a filament current of less than $\frac{1}{4}$ ampere.

The structure of the S-13 tube is illustrated diagrammatically in Figure 1, where *C* and *A* are the collector and anode electrodes, respectively. These elements are both of nickel. The collector electrode *C* is of the same form and general proportions as in the previously described tube (that is, similar to the letter **U** with the filament *F* lying just within the open side.) The wires supporting these electrodes are sealed thru a glass bead *B* and the entire assembly mounted within a small glass tube *S*. On the outside of this tube or shell are cemented a few turns of resistance wire *R* which are connected directly in series with the filament

* Received by the Editor, October 10, 1923. Presented before THE INSTITUTE OF RADIO ENGINEERS, New York, October 10, 1923.

¹ "A New Non-Interfering Detector"; presented before THE INSTITUTE OF RADIO ENGINEERS, December 20, 1922; published on page 97 of the PROCEEDINGS for April, 1923.

and serve the double purpose of maintaining the proper vapor pressure within the tube and further providing the necessary potential for the collector electrode. During the process of evacuation, which is carried to the highest possible degree, a small quantity of sodium is placed within the tube to provide the necessary operating characteristics.

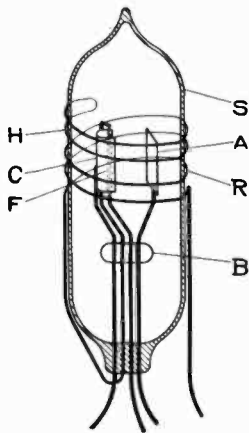

FIGURE 1

In Figure 2 all the elements of this tube are shown before assembly and also a complete tube.

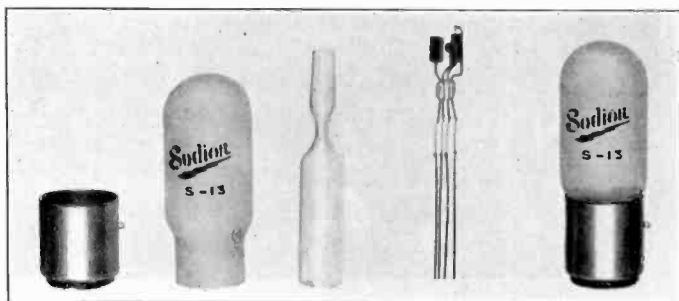

FIGURE 2

A desirable circuit for use with this tube is shown diagrammatically in Figure 3. *H* represents the heater, shown for clarity above the tube and connected in series with the negative end of the filament in order to secure a negative potential for the collector circuit. *C* and *A* are the collector and anode elec-

trodes, and P is the potentiometer which is employed to regulate the potential of the collector for various conditions of operation. Since the greatest collector potential variation need never be more than a few tenths of a volt, there is connected in series with the positive end of the potentiometer a resistance to broaden its adjustment. This combination is connected across the tube terminals, rather than across the battery, in order that its range of adjustment will be independent of battery condition.

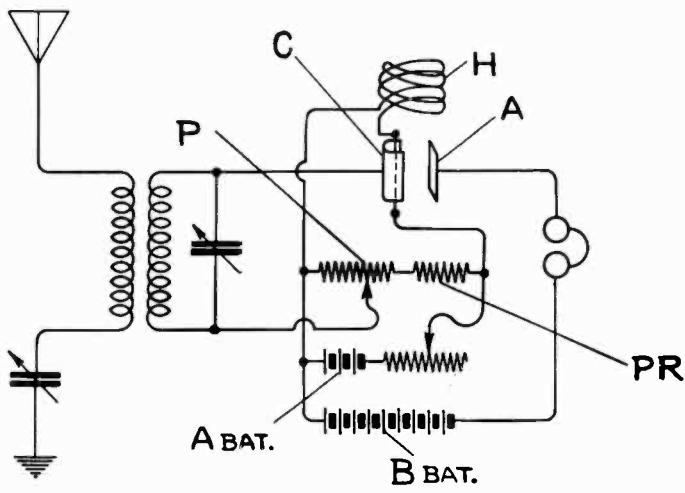

FIGURE 3

The tuning portion of Figure 3 will be recognized as the ordinary double inductively coupled circuit. The range of coupling used is considerably weaker than is common with less sensitive detectors. Thus high selectivity is secured in the antenna circuit, the exceedingly weak coupling preventing detector reaction from increasing the primary damping to an undesirable extent. The response of the sodion tube is not affected greatly by changes in coupling once the circuits are reasonably well separated, and it has been found feasible to simplify the tuner adjustments by using a fixed but weak coupling. The flexibility of the outfit is so great that this coupling need not be changed, even tho the antenna constants vary widely in different installations. Figure 4 is a receiving set using this circuit, designed particularly for use with the sodion detector and having the tuning and detector circuits in separate units. Another circuit suitable for use with this tube is shown in Figure 5. This simple arrangement has the advan-

tage of a single tuning control, and thruout a wide frequency range gives results nearly equal to the circuit of Figure 3. A complete set of this type is shown in Figure 6.

We have found that inexperienced operators will usually secure louder signals and better selectivity with this latter circuit than with the former, due wholly to the fact that they will not properly adjust the double circuit type.

It should be noted that there is only one tuned circuit used

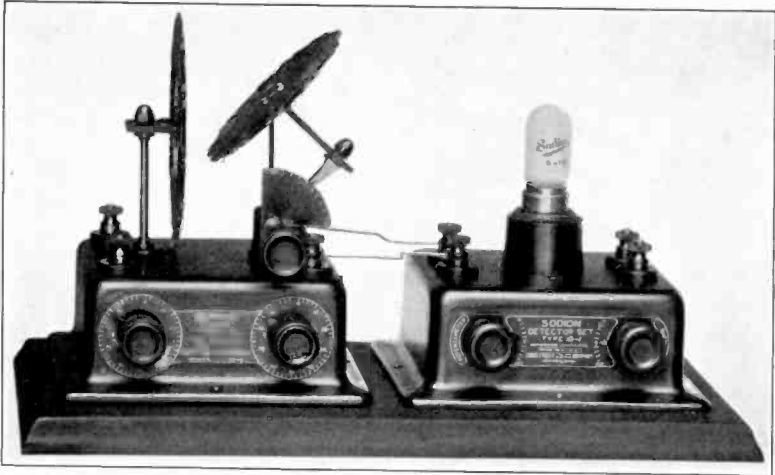

FIGURE 4

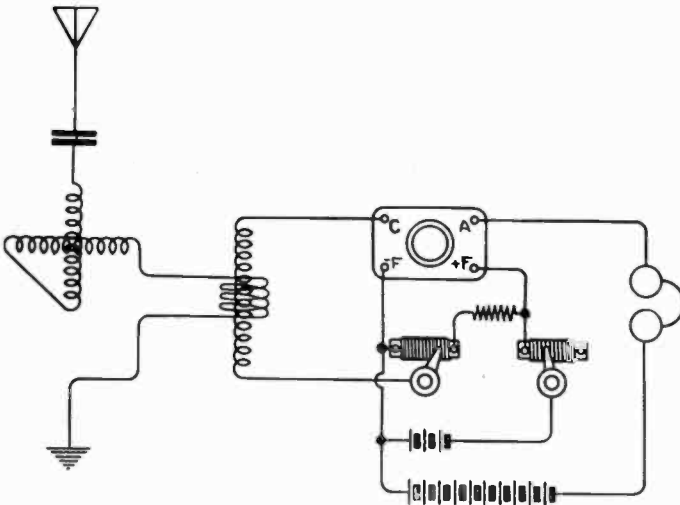

FIGURE 5

in this arrangement, the detector input being inductively coupled. This circuit is made feasible by the high detector sensitiveness, and its inductive coupling adds materially to the selectivity.



FIGURE 6

The fundamental principles underlying the operation of this tube are complicated by a large number of factors. It is not permissible at this time to give more than an elementary description of its operation and a general sketch of some of the phenomena responsible for the reception of signals as well as of the effects produced by an alteration of the various tube adjustments. To aid in this brief explanation of the S-13 tube, the diagram shown in Figure 7 is given. This is an elementary diagram of the tube elements and external circuit, having the necessary sources of potential with an input coil *I* and indicating device *T*. Within the shell *S* is an alkali metal such as sodium, the proper conditions being maintained by the heater described above.

When the cathode or filament *F* is heated to the proper temperature by means of a battery, not shown, electrons will be evaporated from it at a certain rate. Some of these electrons will be accelerated towards the anode by the potential of the

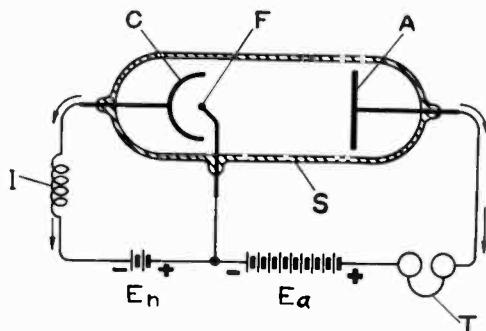

FIGURE 7

battery E_a . Some others will pass to the collector electrode C by reason of their initial velocity of emission. The number of electrons moving to this latter electrode is, however, somewhat reduced by the potential E_n , which partially neutralizes the flow of current thru the collector circuit. The density of the electronic field between filament and anode will be partly controlled by the electrostatic field between collector and filament. The number of electrons moving to the collector and, therefore, the effective potential distribution between collector and filament will be partly determined by the density of the electronic field around the filament, or, in other words, by the magnitude of the space charge.

It is convenient to consider conditions within the tube immediately after the filament is lighted. When the cathode reaches its maximum temperature and the potentials E_n and E_a are applied, there will be a flow of electrons thru the two circuits, in the direction of the arrows in Figure 7. In the anode circuit this electronic flow will be in the direction of the potential of E_a , but in the collector circuit the flow is against the potential of E_n .

So far this description applies to a pure electron tube having electrodes of the form used in the sodion. The alkali metal atmosphere of proper density which is used in these tubes, however, produces certain additional effects, a discussion of which will be interesting.

When the alkali vapor is present, some of the electrons moving between filament and anode and having the necessary ionizing velocities, will collide with atoms of the alkali metal and each such collision will result in movement toward the anode of two electrons. These two electrons are the initial electron and the one secured by ionization of the sodium atom. A positive sodium ion created by the collision will move backward into the dense

field of electrons surrounding the filament, thereby partially neutralizing the space charge. This partial neutralization of the space charge will allow the movement of more electrons to the collector, obviously increasing the flow of current in the collector circuit, thus further overcoming the potential of the battery E_n . This change in field between filament and collector will increase the flow of electrons to A , resulting in an increase in the number of collisions and a repetition of the cycle.

From a consideration of these phenomena it is obvious that the potential distribution between filament and collector will be gradually altered and the current in the collector circuit be increased by successive small increments, each requiring an appreciable length of time on account of the relatively slow motion of the atoms concerned. These increments will cause a gradual increase in the collector current until a condition of equilibrium is attained. This condition of balance will be determined in part and may be controlled by the strength of the fields, the filament temperature, and the vapor pressure, as will be also the time required to reach equilibrium.

Under normal conditions a considerable time is required for the attainment of equilibrium on account of the mutual effects of the two circuits and the relatively slow motion of the heavy positive ions. Therefore, if a potential impulse of short duration is applied to the collector circuit, the polarity of which corresponds to a decrease in the potential of the battery E_n , the effect will be to slightly increase anode and collector currents. Since this impulse is of short duration, no time is allowed for these currents to build up by the previously described phenomena. When the applied impulse is of a polarity corresponding to an increase in the potential of the battery E_n , the initial cause of the ionization phenomena is in part removed, and this will result in a large drop of anode and collector currents, and a considerable time will be required to restore equilibrium. Consequently the increase due to a positive impulse is much less than the decrease due to a negative impulse.

When an unmodulated and relatively high radio frequency signal is applied to the coil I , complete restoration of equilibrium cannot be nearly accomplished before the arrival of the next cycle which will, of course, add to the effect produced by the first in the same direction. Thus the collector current will slowly sag by the addition of these negative potential impulses until equilibrium is re-established under this condition and at a new value determined by the amplitude of the signal impressed.

The final result secured by this phenomenon is a large reduction of anode and collector currents when unmodulated radio frequency voltages are applied to the collector, the reduction being under complete control as to time period, and so on, and, therefore, exceedingly sensitive to weak impulses. It has even been found possible under certain conditions so to increase the time required for restoration of the balance that when spark signals were received, equilibrium was not obtained after the passage of one train before the next arrived. Therefore, it was possible to add these wave trains and to secure an extremely large drop in collector and anode currents which has distinct possibilities for telegraph calling and similar systems.

The typical static characteristics for a tube of this type, Figure 8, 9, 10, and 11 give some idea of the magnitude of these various effects. The increase of collector current due to ionization at various values of collector potential for normal operation is shown in Figure 8, together with the corresponding anode currents. It should be observed that the collector potentials given

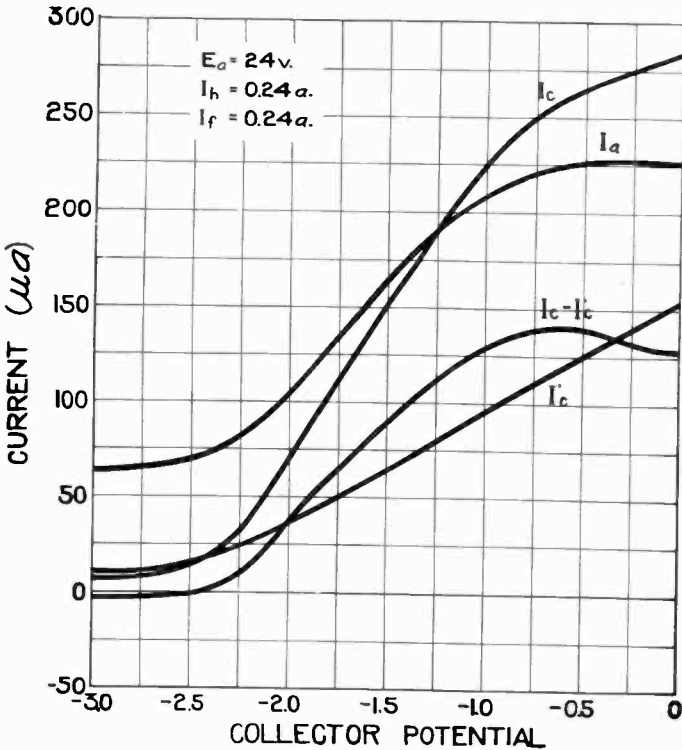

FIGURE 8

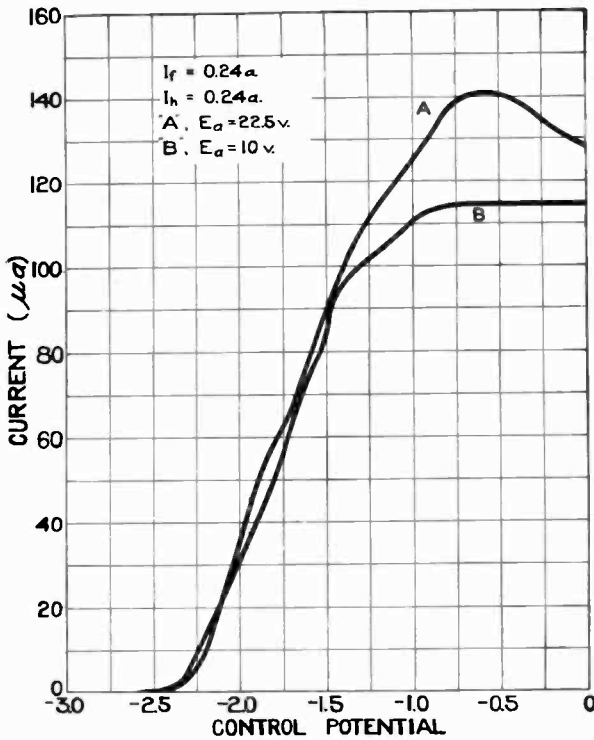

FIGURE 9

here are measured from the negative filament terminal and do not include the heater potential. The curve $I_c - I_c'$ gives an index of the magnitude of build-up of the collector current and potential due to the above-described phenomena, I_c' being the collector current when ionization is prevented in the field between filament and anode by opening the anode circuit. Figure 9 shows the effect on this build-up of a variation of anode potential, Figure 10 the effect of a variation of heater current, and Figure 11 the variation of collector and anode currents with a variation of anode potential.

The effect of a variation of signal intensity on the change in collector current is shown in the curve of Figure 12. This curve was obtained by transmitting from one station a series of modulated signals of known relative power and observing the difference in collector current with and without the signal at a distant receiver. These readings were taken in two ways, first, with a constant value of collector potential adjusted for the maximum signal at moderate power, and secondly, with this potential

adjusted to give the loudest signal for each of the power values used.

A consideration of the two curves of Figure 12 shows the desirability of readjusting the collector potential for various signal intensities.

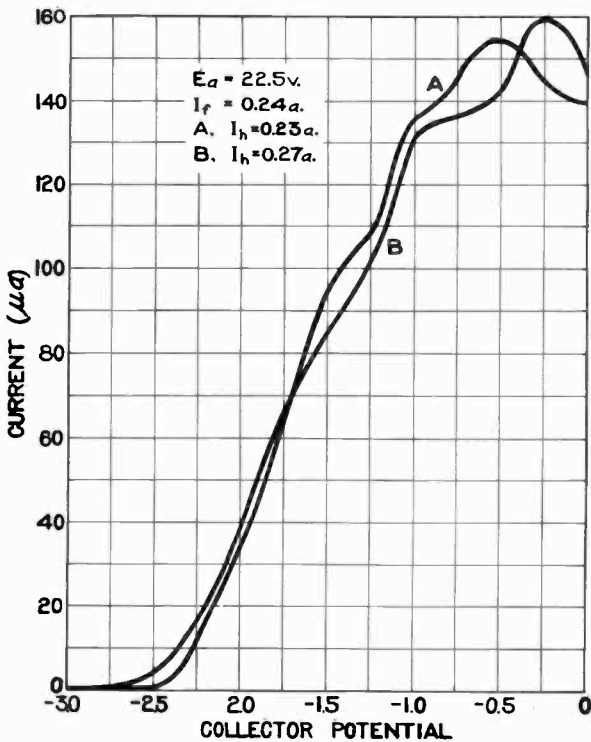

FIGURE 10

Current audibility readings on the modulated signal were also taken with telephone receivers in the anode circuit at the time data for the *B* curve of Figure 12 was secured. The results of these audibility observations are shown in Figure 13. It is interesting to note that the current audibility curve of Figure 13 and the corresponding curve *B* of Figure 12 (showing the change in collector current when adjusted for the best signal on each power) are alike in form.

Figure 14 is the relation of input radio frequency to output audio frequency. This is substantially a straight line and accounts in part for the clear undistorted signals characteristic of this detector.

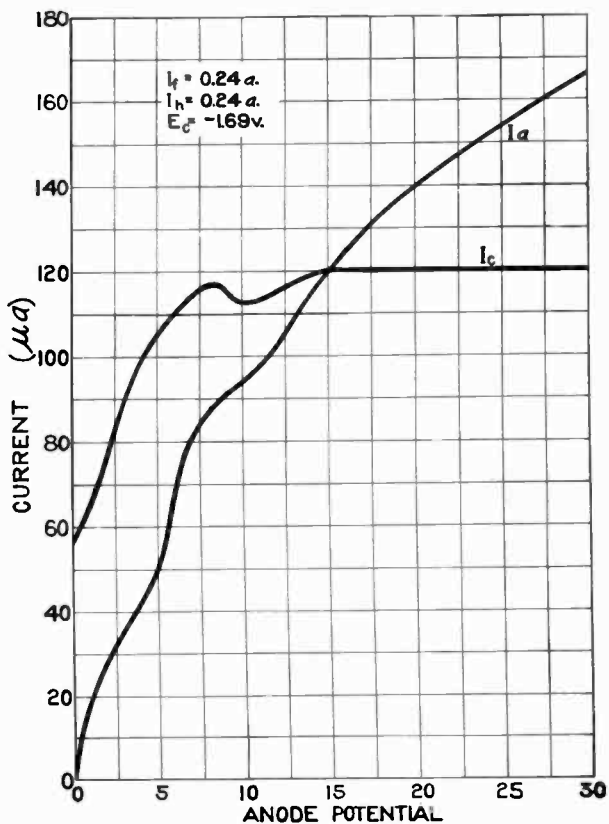

FIGURE 11

Audibility readings are of course exceedingly difficult to secure with even desirable accuracy and characteristic variations are shown by the location of points of observation shown in Figure 13. On the other hand, the micro-ammeter readings of change in collector current plotted in Figure 12 show consistency and considerable precision. It is evident from this that the sodion tube provides us with a new and accurate means of measuring the strength of weak signals.

Thus the tube has interesting possibilities for various measurement purposes, particularly on account of its simplicity and stability. For example, fading observations can be readily made with an extremely simple outfit requiring only an ordinary micro-ammeter in the collector circuit. This may have a small potential applied to its terminals thru a resistance for the purpose of reducing the current thru the meter to allow a scale of, for

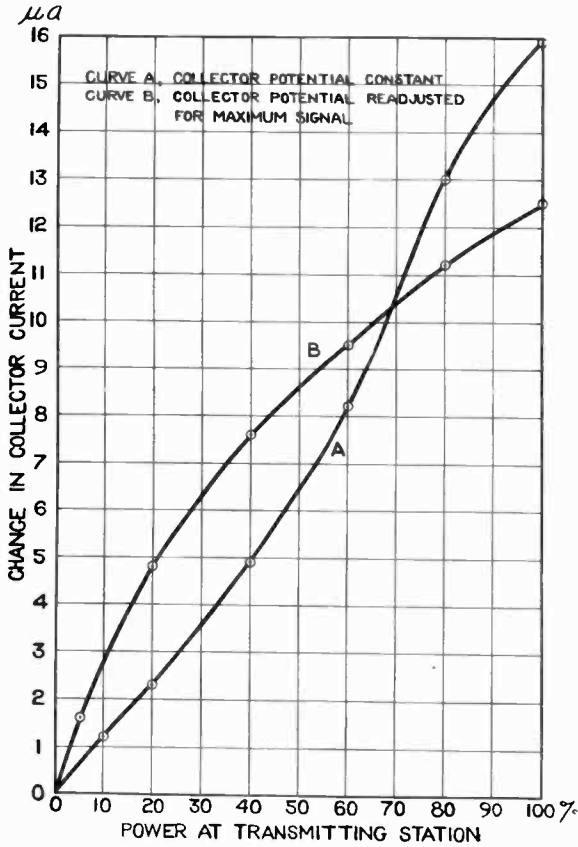

FIGURE 12

example, 100 micro-amperes to be used, and will give excellent results. With such an arrangement readings of collector current change (which have been shown to be proportional to audibility) can easily be taken every few seconds over a period of time. A typical set of observations made in this manner while receiving WGY at Meriden are given in Figure 15 and a similar set for the signal from WJZ in Figure 16.

This system can readily be elaborated by connecting several different circuits, each with its detector and micro-ammeter as described above, to the same antenna. This will allow fading observations to be taken from several different directions and distances simultaneously. Such an arrangement is perfectly practical since no interference can possibly take place between the several circuits.

The change of collector current for a signal secured by these above-described phenomena, when adjusted for telephonic re-

ception, f is very large and the energy change in the collector circuit is very nearly equal to that in the anode circuit.

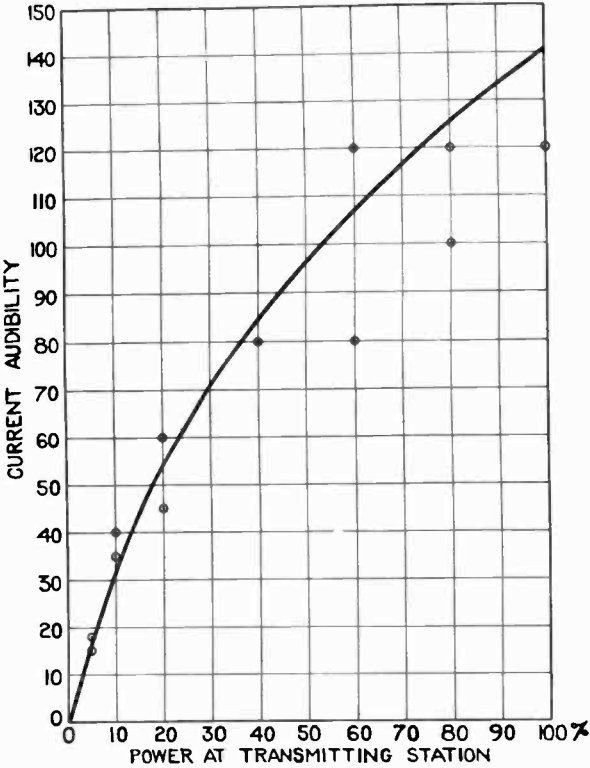

FIGURE 13

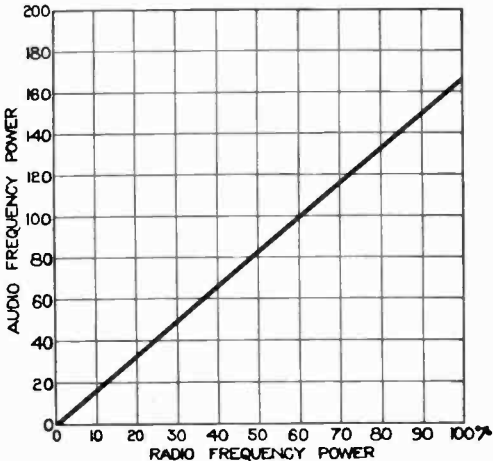

FIGURE 14

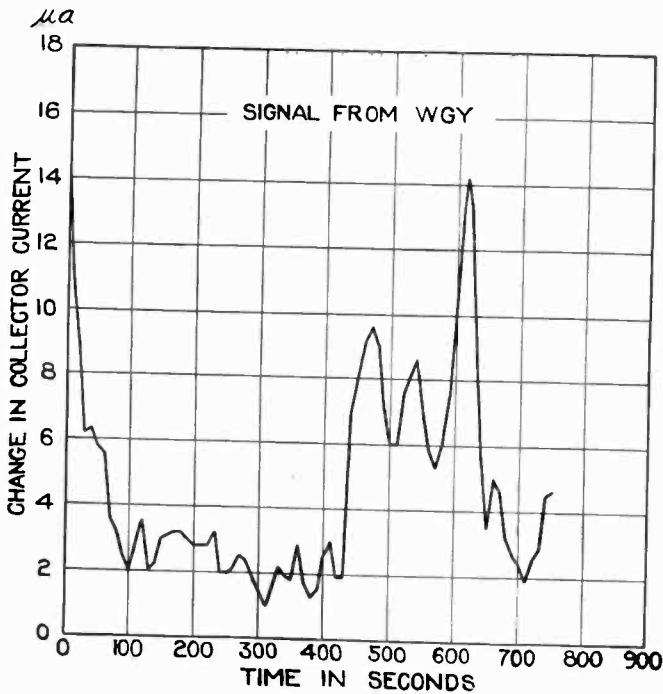

FIGURE 15

Some values of maximum collector current change for various broadcast signals are given in the table below. These were all taken under similar conditions on a small antenna in Meriden, Connecticut.

<i>Station</i>	<i>Change in collector current</i>
WHAM, Rochester, New York.....	5.25 micro-amperes
WEAF, New York.....	6.00 micro-amperes
WGY, Schenectady, New York.....	14.00 micro-amperes
WJZ, New York.....	4.5 micro-amperes
WDAP, Chicago, Illinois.....	5.00 micro-amperes
KDKA, Pittsburgh, Pennsylvania.....	8.50 micro-amperes

The over-all results secured with this tube are at least equal in signal magnitude to those from a regenerator or from an ordinary detector with two stages of amplification, and this without unstable adjustments, distortion, or the possibility of interference with other receiving stations. This latter point is a factor of no little importance, particularly with the rapidly increasing congestion of receivers. The tube has also a broad field in connection with radio frequency amplifying systems either with or without regeneration. The gain secured by using such a sen-

sitive detector is the same in either case, in the former case on account of the obvious impossibility of securing the full value of regeneration more than once in the same circuit.

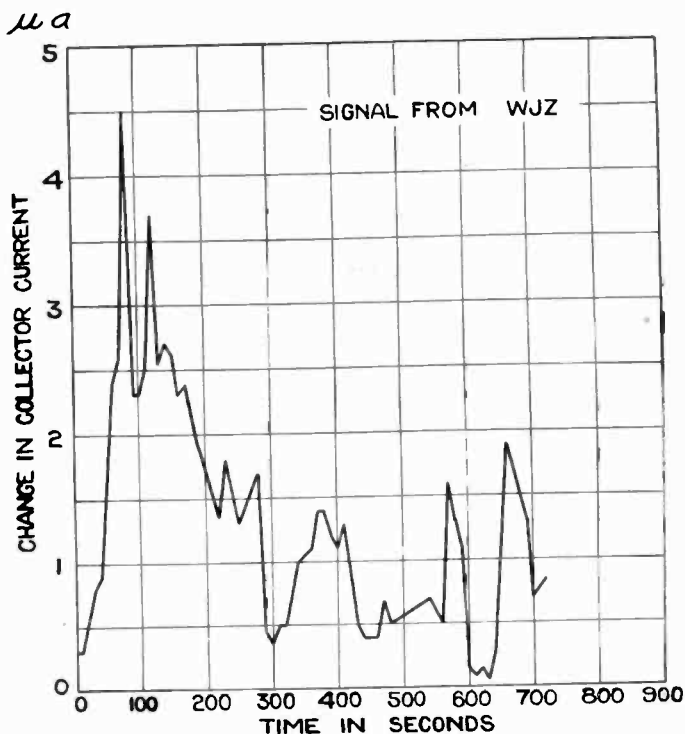

FIGURE 16

The selectivity obtainable with the circuit of Figure 5 is not equal to that of Figure 3, but the addition of a simple radio frequency filter to the circuit will allow a substantial increase in selectivity. This filter may consist of a capacity inductance circuit closely coupled to a coil of a few turns, which latter is connected in series with the ground lead from the set. A filter of this type is shown in Figure 17. The addition of such a device will make the single control circuit very selective and yet the filter adjustments do not noticeably affect the tuning of the receiving set itself.

The meter to measure change in collector current may be applied to a determination of the effectiveness of such a filter in removing a signal from the receiver. The results of a test of this kind are shown in Figure 18.

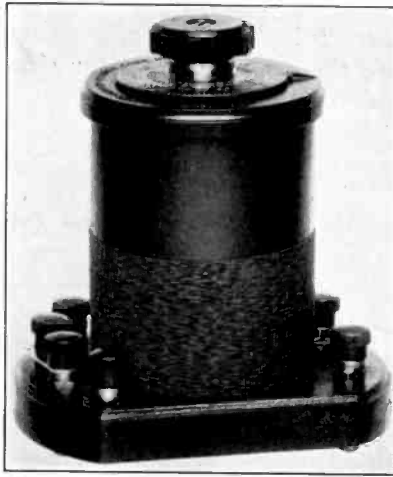

FIGURE 17

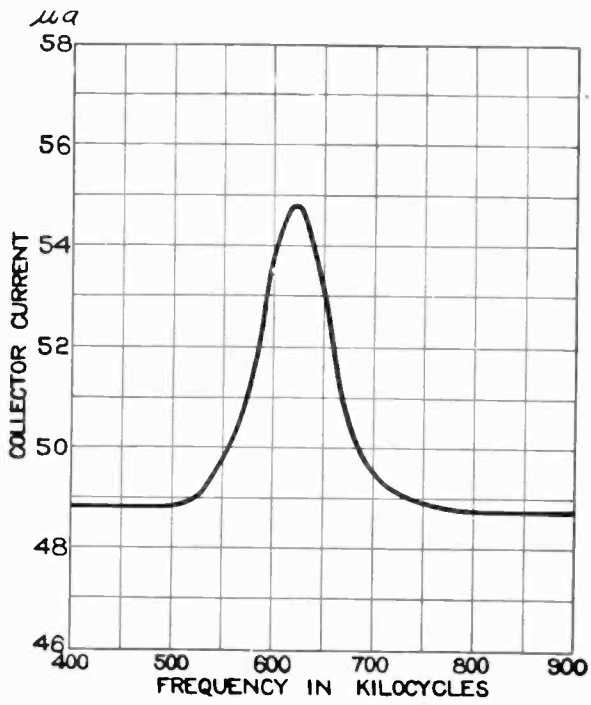

FIGURE 18

Many other uses of the sodion tube are being investigated, and it is evident that the new device will be of utility not only as a radio receiver but as a laboratory metrical instrument.

Research Laboratory of the Connecticut
Telephone and Electric Company,
Meriden, Connecticut,
October 10, 1923.

SUMMARY: Further improvements in a new type of simple detector are described and its operation shown to be the result of ionization of sodium vapor, consequent dissipation of the space charge and the increased current to the "collector" electrode secured thereby. A condition of equilibrium is obtained and is broken up by an impressed signal. On account of the inherent and controllable time element a gradual decrease in anode current for a series of input impulses is secured, resulting in a large alteration of current for impulses of low amplitude and consequently a strong response for weak signals. Power characteristics are given and possibilities indicated of the use of this device in various types of receiving circuit and also in measurement of signal strength, such as for the observations of fading

THE CHARACTERISTIC SURFACE OF THE TRIODE*

BY

J. R. TOLMIE

(SEATTLE, WASHINGTON)

INTRODUCTION

The purpose of this article is to outline a method of representing triode characteristics by means of surfaces rather than by curves. While at first glance this might appear to be an added complication, it is believed that it leads to a clearer physical representation than is possible by the more common method.

The current in the plate circuit of a triode is a function of the filament temperature and of the grid and plate voltages, or $I=f(T, E_g, E_p)$. This function is too complex for ordinary geometrical representation and must be simplified before a visual image of it may be obtained. This may be accomplished by assigning constant values to the variable T which make I a function only of the grid and plate voltages $I=\phi(E_g, E_p)$. Since the value of I depends simply upon the variables E_g and E_p , it may be represented as a characteristic surface, there being one and only one of these surfaces for each particular value of T . Likewise the static characteristic curves, giving the relationship between the plate current and grid voltage, are obtained by holding the filament temperature constant and by assigning fixed values to the plate voltage. Figures 1 and 2 show the two groups of static characteristic curves depending upon the grid and plate voltages, respectively; by comparing these with the characteristic surface in Figure 3 it will be seen that the curves are simply the right angle cross sections of the latter. The surface thus shows the combined action of both the grid and plate voltages in their proper geometrical relationship.

SURFACE CHARACTERISTICS

As shown in Figure 3, the characteristic surface rises precipitously from the reference plane of zero plate current to a parallel plane corresponding to the saturation current. The

* Received by the Editor, August 21, 1923.

directions of the co-ordinate axes are so chosen that the plate current is positive upward from the reference plane, the grid voltage is positive toward the right, and the plate voltage is

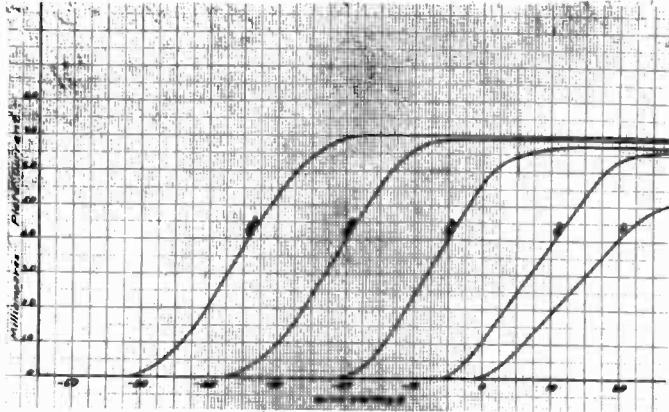

FIGURE 1

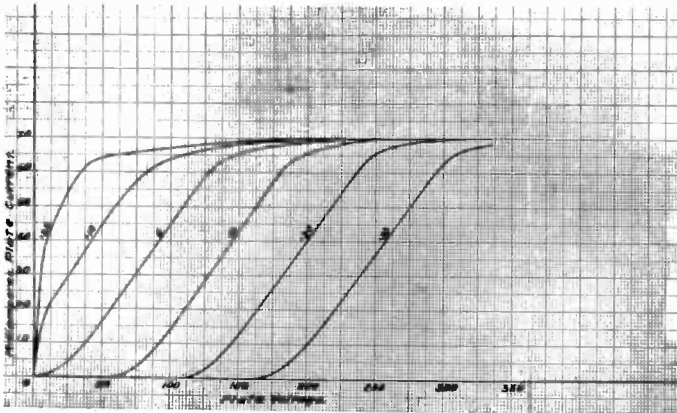

FIGURE 2

positive away from and normal to the grid voltage axis. The active portion of the surface is practically restricted to the cliff-like region running backward and toward the left from the origin or co-ordinates. It is this region that is used in amplifier and oscillator action and the upper and lower bends of which may be used for detector and modulator action. The active region extends indefinitely backward and is limited only by the permissible voltage that may be applied to the plate of the triode. As

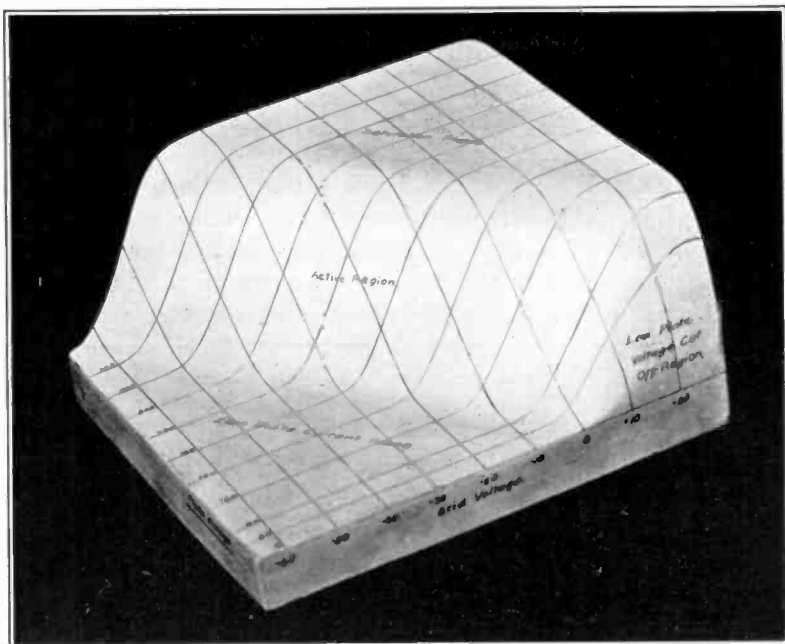

FIGURE 3—Characteristic surface showing Active and Cut-off Regions. Saturation current $I_s = 7$ milli-amperes

very low values of plate voltage are approached, this region swings abruptly toward the right and becomes parallel to the axis of grid voltages. This portion is practically plane and serves as a cut-off region similarly to the saturation and zero current planes. In other words, this low plate voltage region serves to limit the possible variation in plate voltage in the same way that the saturation plane serves to limit the possible variation in plate current. The right hand portion of the characteristic surface is arbitrarily bounded by a vertical plane corresponding to a relatively large value of positive grid voltage.

For high positive values of grid potential, either of two entirely different effects may manifest themselves, depending upon the internal structure of the triode. The first of these may be termed grid absorption and is due to the deflection of electrons from the plate into the grid; this is especially noticeable in triodes having fine meshed grids. The second effect occurs when electrons emitted from the filament reach sufficiently high velocities to cause secondary emission from the plate. This gives rise to a very distinctive surface lying far to the right of the one under consideration. Secondary emission is usually found in triodes

having very coarse grids and which operate with high plate potentials.

It only remains now to note the effect of a variation in filament temperature upon the shape of the plate current surface. Any change in filament temperature will produce a like change in the number of electrons available for maintaining the plate current. This, however, will make little difference except near the saturation region, which will be either raised or lowered, depending upon whether the filament temperature has been increased or decreased. A complete set of characteristic surfaces may thus be mapped out corresponding to all the possible values of filament temperature.

THE IDEAL SURFACE

Thus far the discussion has dealt entirely with the actual characteristic surface of the triode. It will, however, simplify matters to consider a new surface toward which the actual one may approach more or less closely. Such a surface is shown in Figure 4. It will be noticed that the active region is now restricted to a skewed plane which extends clear to the axis of grid voltages. In fact, the low plate voltage cut-off region now becomes a zero-voltage cut-off plane.

Deviation from the ideal surface is caused by a number of factors, among which may be mentioned the drop in potential along the filament, the non-uniform temperature of the filament due to end supports and the limitation of plate current due to thermionic emission.

An approximate equation for the variable plate current may be obtained by expanding the functional relationship $I=f(T, E_g, E_p)$ in a Taylor's series, the expansion being taken about a point P_o corresponding to a given value of the variables T_o, E_{go}, E_{po} lying within the active region. Another relationship between the variables may also be obtained by separating them into steady and variable components.

Thus	$I = I_o + i$	where	$I_o < I_s$
	$T = T_o + t$		$T > 0$
	$E_g = E_{go} + e_g$		$E_{po} > 0$
	$E_p = E_{po} + e_p$		$E_{go} < E_{gc}$

where I_s is the saturation current and E_{gc} is a positive value of grid voltage dependent upon the shape of the low plate voltage cut-off region. For working conditions the variable temperature t is equal to zero, the fixed current I_o is equal to the normal plate current corresponding to the point P_o , e_g is a variable voltage

impressed upon the grid, and e_p is the corresponding variation in the plate voltage. It is important to note that this latter is equal to the impedance drop with sign reversed of the current in the plate circuit; that is, $e_p = -iZ$, where z is the external plate impedance.

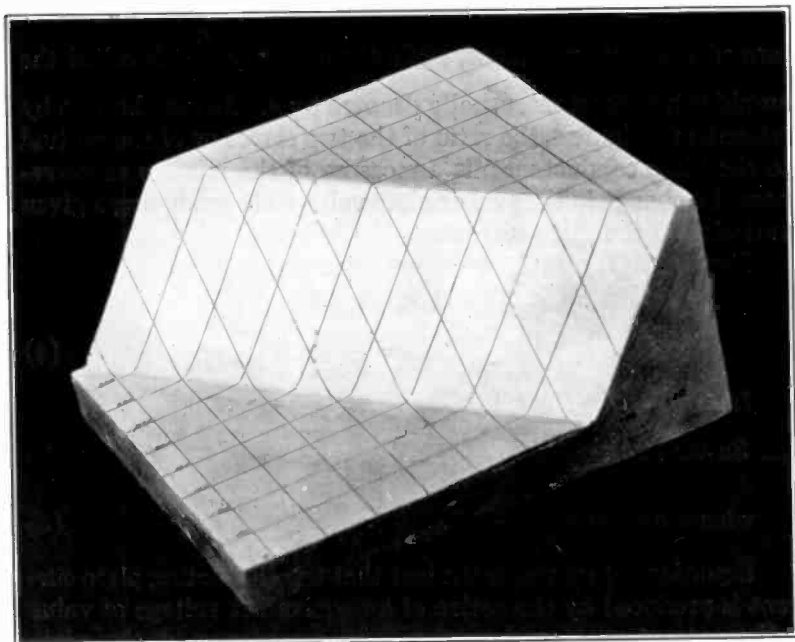

FIGURE 4—Ideal Surface. Saturation current $I_s = 7$ milli-amperes

Expanding,

$$I = I_o + \left(\frac{\partial I}{\partial E_{g_o}} e_g + \frac{\partial I}{\partial E_{p_o}} e_p \right) + \frac{1}{2!} \left(\frac{\partial^2 I}{\partial E_{g_o}^2} e_g^2 + 2 \frac{\partial^2 I}{\partial E_{g_o} \partial E_{p_o}} e_g e_p + \frac{\partial^2 I}{\partial E_{p_o}^2} e_p^2 \right) + \dots \text{ to } n \text{ terms.}$$

Normally this series converges so rapidly that all higher order terms may be neglected, while with an ideal surface only the first two terms are necessary.

Subtracting I_o from both sides of equation (2) and considering an ideal surface

$$i = G_m e_g + G_p e_p$$

where $G_m = \frac{\partial I}{\partial E_{g_o}}$ equals the slope of the active plane with respect to the grid voltage.

and $G_p = \frac{\partial I}{\partial E_{p0}}$ equals the slope of the active plane with respect to the plate voltage.

The quantities G_m and G_p are of the nature of conductances and are usually spoken of as the mutual and plate conductances of the triode. The reciprocal of the plate conductance $\frac{1}{G_p} = R_p$ is

termed the plate resistance, while the quantity $\frac{G_m}{G_p}$ is called the amplification constant, usually denoted by μ . As may be seen by referring to Figure 4, the ratio of the two slopes or of the mutual to the plate conductance, is a measure of the relative effectiveness of a change in the grid or plate voltages in producing a given variation in the plate current.

Equation (3) may be transformed as follows:

$$\begin{aligned} i &= G_m e_g - G_p i Z \\ &= \frac{\mu e_g}{R_p + Z} \end{aligned} \quad (4)$$

In general $Z = R + jX$

$$\text{So that } i = \frac{\mu E_{g \max} \sin(\omega t - \theta)}{\sqrt{(R_p + R)^2 + X^2}}$$

$$\text{where } \theta = \tan^{-1} \frac{X}{R_p + R} \quad (5)$$

Equation (5) expresses the fact that the alternating plate current is produced by the action of an equivalent voltage of value $\mu E_{g \max} \sin \omega t$ working into the total impedance of the plate circuit. A slightly different method of describing the same condition is to consider that the grid voltage is impressed upon a circuit having an equivalent impedance of value

$$Z_1 = \sqrt{\left(\frac{R_p + R}{\mu}\right)^2 + \left(\frac{X}{\mu}\right)^2}$$

the power factor remaining the same in both cases.

Since the plate resistance $R_p = \frac{\partial E_{p0}}{\partial I}$ is also a function of the variables E_g and E_p it may likewise be shown in the form of a surface. Such a plate resistance surface taken from an actual tube is shown in Figure 5. As will be noted, the bottom of the gap corresponds to the value of resistance in the active region of the plate current surface. The sides, which rise precipitously, should continue indefinitely upward since the value of plate resistance rapidly approaches infinity, when the zero-current and saturation planes are reached. The observed data necessary for

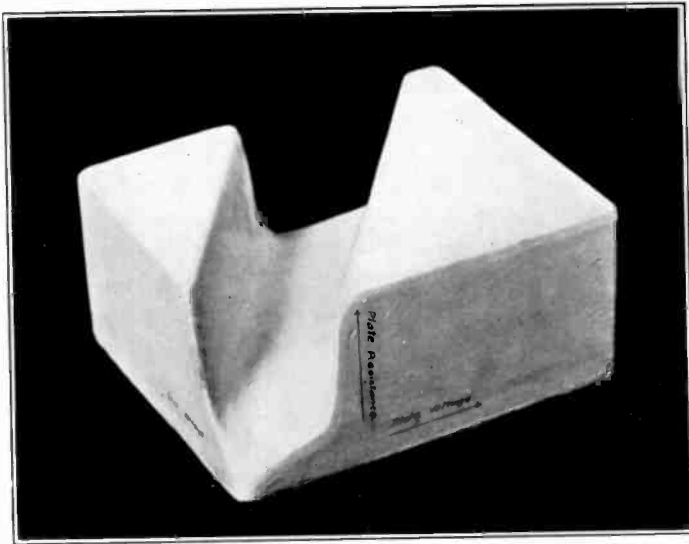

FIGURE 5—Plate resistance surface. Active value of plate resistance.
 $R_p = 18,000$ ohm s.

constructing the surfaces shown in Figures 3 and 5 were taken from a Radiotron type UV-201 amplifying triode. This particular type of triode was selected for the work because of the very wide range of voltages that may be used without causing excessive heating in either the grid or plate structures. The main considerations apply equally well, however, to any type of tungsten filament triode irrespective of its particular power rating.

OPERATION (AMPLIFICATION)

Nearly all of the properties of the triode may be described in terms of the motion of the representative point P upon the characteristic surface. This motion is not restricted to the static characteristic curves, but is perfectly general, thus allowing P to range over any point upon the surface. This gives rise to a new set of curves which are termed the dynamic characteristics. A dynamic characteristic is always obtained when a triode works into some form of a load circuit and is produced by the action of the impedance drop in that circuit. In Figure 6 is shown a set of dynamic curves corresponding to various load resistances in the plate circuit of an amplifier. The group of curves $R_{(0 \dots 4)}$ all pass thru the operating point P_o ($E_{g_o} = -16.5$, $E_{p_s} = 160$) and, as will be noticed, decrease in slope with an increase in load resistance. This is to be expected since the greater the value of R

the more marked will be the effect of the plate Ri drop until when $R = \infty$ there is no variation of plate current whatever and the dynamic curve becomes a horizontal line. This sheaf of dynamic curves is bounded by the horizontal curve for infinite plate resistance and by the static characteristic, shown in full line, corresponding to a load resistance of zero value. The slope of these curves depends simply upon the value of the load impedance and is not dependent to any extent upon the position of the operating point. In other words a change in the position of the operating point will simply shift the dynamic characteristic parallel to itself; see, for instance, the curves R_5 and R_6 in Figure 6. Over the greatest portion of their range the dynamic curves are very nearly straight lines and become curved only as they approach the cut-off regions.

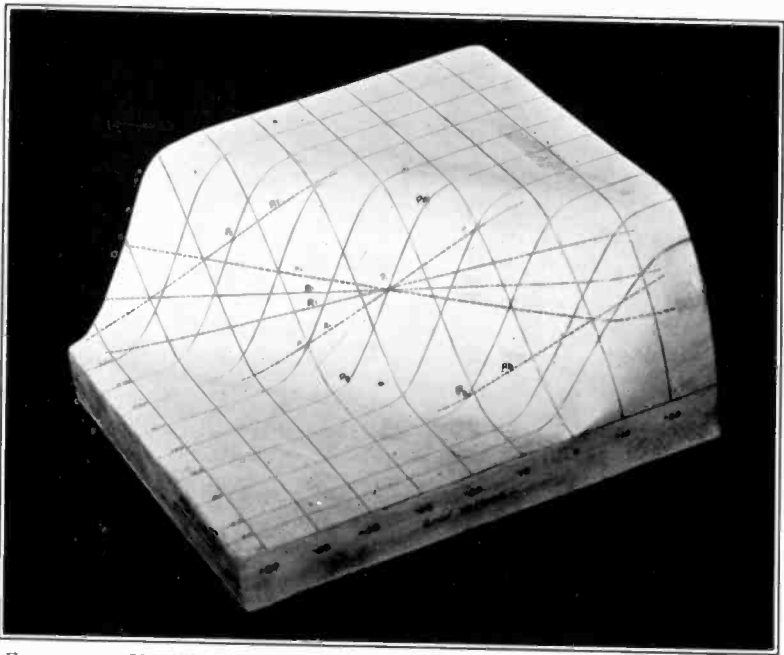

FIGURE 6—Unity power factor dynamic characteristics. Internal plate resistance = 18,000 ohms. External load resistance $R_1 = 20,000$ ohms, $R_2 = 50,000$ ohms, $R_3 = 100,000$ ohms, $R_4 = \infty$, $R_5 = 20,000$ ohms, $R_6 = 20,000$ ohms.

The condition for distortionless amplification is that a linear proportionality be maintained between the values of plate current and grid voltage. This means that the operating point must be kept well within the active plane of the characteristic

surface. When this is not the case and it is allowed to approach too closely to the saturation region, as for example P_4 in Figure 6, considerable distortion will ensue. If now, however, the filament temperature be sufficiently increased, the active plane will be extended upward and correct operation may be obtained. This explains why the triode is often so sensitive to variations in filament temperature.

The triode when functioning as an amplifier is capable of amplifying either voltage, current or power; the adjustments for the three conditions are, however, quite different. To obtain a large voltage amplification it is necessary to have the dynamic curve cut off by the low plate voltage region. This means that a large value of load resistance is required. If this is not the case, a portion of the plate voltage is not being utilized. A glance at the curves in Figure 6 will make this clear. A convenient method of obtaining the effective voltage amplification corresponding to a given load resistance is to determine the variation in plate voltage caused by a given impressed grid voltage. The ratio of these two voltages is then the quantity desired. For example, in Figure 6 with curve R_1 , (A , B) a variation of 27.5 volts in the grid circuit will produce a change of 80 volts in the plate circuit; the effective amplification constant is then equal to 2.9. With an infinite load resistance the effective constant approaches its theoretical maximum, as may be easily checked from the figures, the result being 5.3, which compares favorably with the measured value of 5.5.

For current amplification, just the opposite conditions prevail. The dynamic curve should be cut off by the saturation plane and the maximum current amplification will be obtained when the load impedance is equal to zero.

The condition for best power amplification will then lie between the two conditions already outlined, or when the product of the alternating plate current and plate voltage, for a given grid input, is a maximum. For a given value of alternating grid voltage e_g , this product is equal to

$$\frac{\mu^2 e_g^2 R}{(R_p + R)^2}$$

which is a maximum when $R = R_p$ or when the external resistance is equal to the dynamic plate resistance. This condition is shown by the curve R_1 of Figure 6, where external resistance is approximately equal to the internal resistance. The position of the operating point P is immaterial provided that the grid voltage

s of such a value as to lie entirely within the active region of the surface.

In order to obtain maximum power output, still more rigid conditions must be specified. Stated explicitly, these are as follows: The operating point P should lie on the locus determined by $\frac{I_s}{2}$ and at as high a plate voltage as is consistent with the safe operating temperature of the triode. The upper end of the dynamic characteristic should be terminated by the intersection of the saturation plane and the low plate voltage region, while the lower end should be terminated by the zero plate current plane. These conditions allow for the maximum possible variation both in plate current and plate voltage and consequently give the maximum possible power output. Such a characteristic is shown by the curve R_2 in Figure 6. It is of course necessary to have sufficient grid voltage to work the characteristic over the entire range specified. Since the slope of the dynamic characteristic is determined by the value of the load resistance, there is, then, a particular value of load resistance for each initial position of the operating point P . In other words, there are two conditions that must be met in order to obtain maximum power output from an amplifier. *First, the load resistance must be of such a value as to produce the required dynamic characteristic corresponding to the initial position of the operating point, and second, the grid voltage must be of such a value as to cover the entire range of the above characteristic.*

It will be noticed that the curve R_3 of Figure 6 at no time passes into the region of positive grid voltages; hence, there is no tendency for electrons to flow thru the grid circuit. The only chance for power dissipation is then thru the series capacity circuits of the triode elements and load circuit or by direct leakage. The resultant power amplification under these conditions is, therefore, extremely large. Unfortunately, however, the efficiency falls to low values due to the large amount of plate voltage that remains unvaried.

The dynamic curves as shown in Figure 6 are true only for the condition of unity power factor. Whenever the load impedance is other than a true resistance, the dynamic curve takes on the form of a closed loop, such as is shown in Figure 7. These loops are due to the time phase displacement between the current and voltage waves and are accompanied neither by distortion of wave form nor dissipation of energy other than that due to the load resistance. As will be noted, the two loops are traced

in opposite directions: the direction of motion depending upon whether the current is leading or lagging the voltage. The corresponding curve for unity power factor, where the current and voltage are in phase, is shown by Z_1 .

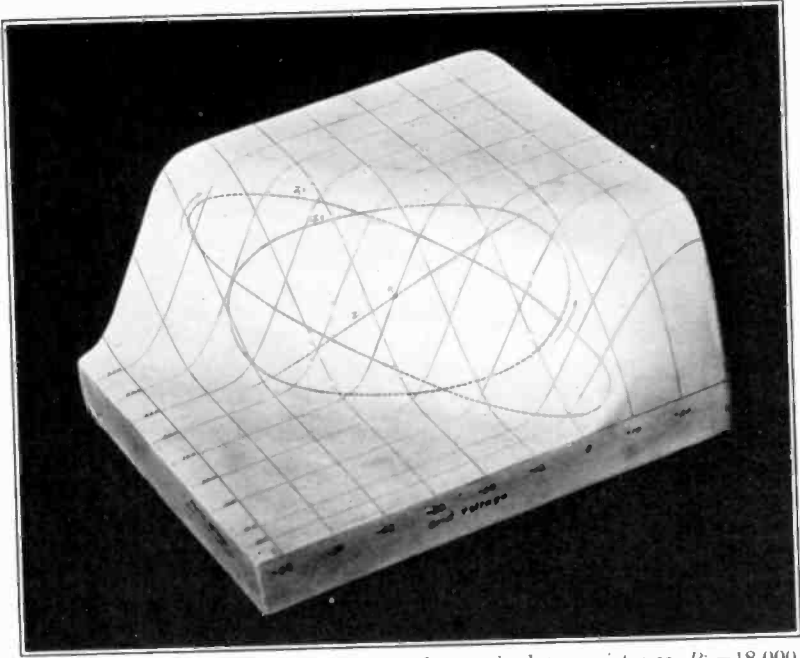

FIGURE 7—Dynamic characteristics. Internal plate resistance $R_p = 18,000$ ohms, Total plate impedance $Z = 38,000$, P.F. = 100 percent; $Z_1 = 38,000$ ohms, P.F. = 50 percent lagging; $Z_2 = 38,000$ ohms, P.F. = 50 percent leading

REGENERATIVE AMPLIFICATION

Regenerative amplification depends upon the cumulative action of the triode and its associated circuits. For instance, if an initial voltage e is impressed upon the grid circuit of a triode, a certain percentage ae of this voltage will be re-impressed upon the grid after a unit interval of time. The quantity (a) may be termed the regeneration constant and is determined by the constants of the triode and its connected circuits. The resultant voltage acting after t units of time, will then be as follows:

$$e_o = e + ae + a(e + ae) + a[e + ae + a(e + ae)] + \dots \text{to } t \text{ terms} \quad (6)$$

Expanding and collecting terms in (6)

$$e_o = e(1 + a)^t \quad (7)$$

The resultant grid voltage thus obeys the compound interest law.

If now the voltage is considered to be reflected back m times as fast as before, the percent returned will be $\frac{a}{m}$ times that impressed and in the same interval of time there will be m times as many reflections.

Thus (7) becomes

$$e_o = e \left(1 + \frac{a}{m}\right)^{mt}$$

However, $\lim_{m \rightarrow \infty} \left(1 + \frac{a}{m}\right)^m = \varepsilon^a$, where ε is the base of natural logarithms.

So that

$$e_o = \varepsilon^{at} e \quad (8)$$

This is the expression for the resultant voltage when the reflections become instantaneous.

The impressed voltage e may be due either to a natural oscillation in the triode circuit or to a forced oscillation from some external source. If the former, it will be of the form $e = E \varepsilon^{-at} \sin \omega t$ where a is the damping factor of the local circuit. The resultant grid voltage will then be

$$e_o = E \varepsilon^{(-a+a)t} \sin \omega t \quad (9)$$

Amplification is thus produced by a decrease in the equivalent decrement of the circuit. The ultimate limit of regenerative amplification is thus reached when the equivalent decrement of the circuit has been reduced to zero; any attempt to pass beyond this point simply results in the production of local oscillation. If, on the other hand, a forced oscillation of the form $e = E \sin \omega t$ is impressed, the resulting voltage becomes

$$e_o = E \varepsilon^{at} \sin \omega t \quad (10)$$

As seen in equation (10) the resulting voltage tends to increase indefinitely with the time. It is, however, limited by the cut-off regions of the characteristic surface. Such an oscillation is shown by the dynamic curve of Figure 8, where the initial amplitude is determined by the intercept (A , B), the starting transient having been neglected.

In the more recently developed super-regenerative system of amplification the regeneration constant a takes on the form of a harmonic function such for example as $a = a_1 + a_2 \sin \omega_o t$, where a_1 determines the amount of fixed regeneration obtainable with a given position of the operating point and a_2 is the amplitude of the variable component corresponding to a frequency of variation

equal to $\frac{\omega_0}{2\pi}$. This variable component is produced by moving the operating point P from the vicinity of one of the cut-off planes to a position nearer the center of the active region. For example, from P_0 to P_1 in Figure 8; as has been shown by Armstrong,¹ this result may be obtained either by varying the grid voltage, or the plate voltage, or by varying both simultaneously. The resulting grid voltage is then expressed by

$$e_0 = E \varepsilon^{|a_1 + a_2 \sin \omega_0 t|} \sin \omega t.$$

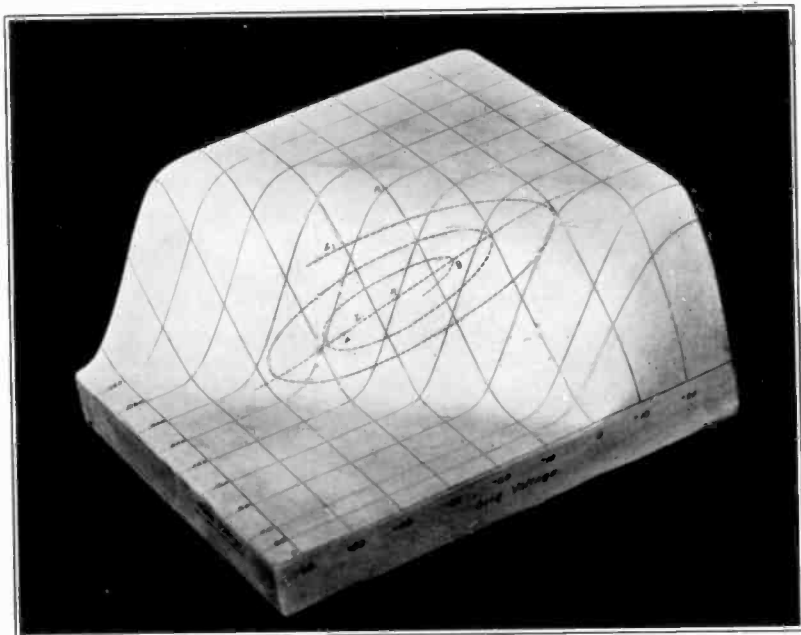

FIGURE 8—Dynamic characteristics. Internal plate resistance $R_0 = 18,000$ ohms. Total plate impedance $Z_1 = 38,000$ ohms, P.F. = 100 percent; $Z_2 = 38,000$ ohms, P.F. = 87 percent lagging. Negative decrement = 1.62

This, moreover, is the same principle that is applied in constant current modulation, the two applications differing mainly in the magnitude of the control frequency corresponding to

$$\frac{\omega_0}{2\pi}$$

The above examples are but a few of the many possible cases where the concept of the characteristic surface may be of assistance.

¹ "Some Recent Developments of Regenerative Circuits," E. H. Armstrong, PROCEEDINGS OF THE INSTITUTE OF RADIO ENGINEERS, August, 1922.

In conclusion the writer wishes to acknowledge his indebtedness to Mr. A. Kalin, of the Electrical Engineering Department, for the photographic reproductions; to Mr. C. J. Albrecht for many valuable suggestions on the construction of the models; and to Mr. T. M. Libby for his very kind assistance in checking the paper.

Electrical Engineering Laboratories,
University of Washington,
June 6, 1923.

SUMMARY: The paper outlines a method of representing triode characteristics by means of surfaces rather than by families of characteristic curves. The physical features of the surfaces are then described in considerable detail and the fundamental equation for the alternating component of the plate current is derived for an ideal surface.

Finally the action of the triode both as a simple and as a regenerative amplifier is described with reference to its characteristic surface.

NOTATION

SYMBOL	NAME	UNIT
a	Regeneration constant	numeric
a_1	Fixed value of regeneration constant	numeric
a_2	Amplitude of variable regeneration terms	numeric
μ	Damping constant	numeric
E_{g0}	Direct grid voltage	volt
E_g	Instantaneous grid voltage	volt
E_{ge}	Constant satisfying boundary conditions	volt
e_g	Variable grid voltage	volt
E_{gmax}	Maximum value of alternating grid voltage	volt
e	Instantaneous impressed voltage	volt
E	Maximum value of impressed voltage	volt
e_o	Resultant voltage after regeneration	volt
E_{p0}	Direct plate voltage	volt
E_p	Instantaneous plate voltage	volt
e_p	Variable plate voltage	volt
ϵ	2.7183 (Base of natural logarithms)	numeric
G_m	Mutual conductance	milli-mho
G_p	Plate conductance	milli-mho
I_o	Direct plate current	milli-ampere
I	Instantaneous plate current	milli-ampere
i	Variable plate current	milli-ampere
I_s	Saturation current	milli-ampere

j	Imaginary unit.....	$\sqrt{-1}$
m	Multiplying factor.....	numeric
μ	Amplification constant.....	numeric
π	3.1416.....	numeric
R_p	Dynamic plate resistance.....	kilo ohm
R	External load resistance.....	kilo ohm
T_o	Fixed temperature.....	degree abs.
T	Instantaneous temperature.....	degree abs.
t	Variable temperature.....	degree abs.
t	Time.....	second
θ	Phase angle.....	radian
X	Reactance.....	kilo ohm
Z	Symbolic impedance.....	complex quantity
Z_1	Resultant impedance.....	kilo ohm
ω	Angular velocity.....	radians per second
ω_o	Modulating angular velocity.....	radians per second

FORMULAS AND TABLES FOR THE CALCULATION AND DESIGN OF SINGLE-LAYER COILS*

By

FREDERICK W. GROVER

(UNION COLLEGE, SCHENECTADY, NEW YORK)

1. INTRODUCTION

Probably no form of inductance coil is of greater fundamental importance than the single-layer helical coil. Formulas are available for the calculation of the inductance of such coils which on the score of accuracy leave little to be desired. The related problem of the design of single-layer coils, that is, the predetermination of the dimensions of a coil to give a chosen inductance has received less attention. However, in view of the large number of radio workers who have occasion to construct coils for themselves, means for making such calculations with a minimum expenditure of time and labor should find an extended use.

Such tables as are at present available¹ are constructed for two variables (diameter and length) and are thus, even when voluminous, applicable to only a limited range of coil dimensions.

In the present paper advantage is taken of the fact that for the calculation of the inductance it is necessary to tabulate constants for a single parameter (the shape ratio) only. It is, therefore, possible to cover the design problems for the whole range of possible helical single-layer coils in the single moderate size table given below. The calculation of this table is based upon the accurate inductance formula of Nagaoka.² The design constants in the table are tabulated for the ratio $\frac{\text{diameter}}{\text{length}}$ or its reciprocal, $\frac{\text{length}}{\text{diameter}}$, values between zero and unity being included for each. Thus all possible shapes of coils are included

*Received by the Editor, November 13, 1923.

¹ Circular 74, Bureau of Standards, pages 286-292, 1918. "Radio and Model Engineering," November, 1922, The Sleeper Radio Corporation, New York.

² "Jour. Coll. of Science," Tokyo, 27, article 6, page 18; 1909.

that shape ratio being used in any given case which is less than unity. No confusion results in practice from this method of procedure, and it offers the great advantage that the table may be constructed with a constant tabular interval of shape ratio throughout the whole range. The tabular interval actually chosen is sufficiently small to give a table of reasonable size, but except for a limited range at the two ends, the differences are small enough to render interpolation practically unnecessary. In the rare cases where interpolation is difficult, the desired quantity may be obtained from the value of one of the other constants for which the differences are favorable, making use of the equation connecting the quantities in question. Each problem will require a single constant to be taken from the table and none but the simplest of arithmetical calculations, which can be performed with a slide rule. An accuracy of one-half of one percent is readily attainable. For work of less accuracy, curves drawn from the tabular values may be useful.

The important case of single-layer coils wound on polygonal forms may be made to rest upon the calculation for an equivalent helical single-layer coil, and is thus included in the scope of this paper.

2. PROBLEMS TO BE SOLVED

The inductance of a single-layer coil depends upon four variables, coil diameter, coil length, number of turns, and the shape ratio. For purposes of design the winding pitch, or better, the number of turns per unit of coil length, is more useful than the total number of turns.

Thus five types of problem are of practical importance, namely:

(a) Given the dimensions and numbers of turns (winding density), to calculate the inductance of the coil.

(b) Given the length and winding density, to calculate the diameter which the coil must have to give a desired inductance.

(c) Given the diameter and winding density, to calculate the length of coil to give a specified inductance.

(d) Given the coil diameter and coil length, to calculate the winding density necessary to give a desired inductance.

(e) Given that a certain ratio of diameter and length is desired, to calculate the dimensions necessary to give a specified inductance, when a certain winding density is assumed.

In the following section are given the formulas and procedure for the solution of each of these problems. For convenience

formulas are given for English units as well as metric. The inductance values are in microhenrys in every case; coil dimensions are in centimeters or inches; winding density in turns per cm. or turns per inch in the metric and English systems, respectively.

For precise values of inductance a correction for insulating space should be applied. The coil length is to be taken *not* between the end turns, but as equal to the winding pitch multiplied by the whole number of turns. That is, the inductance formula applies to a coil length which extends half the winding pitch beyond the center of the last turn at each end of the coil. If this rule is followed the correction for insulating space is usually negligible except in precise work. For completeness its value may be calculated from the formula given below.

3. SUMMARY FOR WORKING FORMULAS

Symbols Used:

L = the inductance of the coil in microhenrys.

d_1 = the diameter of the coil in centimeters.

d_2 = the diameter of the coil in inches.

b_1 = the length of the coil in centimeters = $\frac{n}{n_1}$.

b_2 = the length of the coil in inches = $\frac{n}{n_2}$.

n = the total number of turns on the coil.

n_1 = the number of turns per centimeter of axial length of the coil.

n_2 = the number of turns per inch of axial length.

$r = \frac{d}{b}$ = the ratio of diameter to length.

$R = \frac{b}{d}$ = the ratio of length to the diameter = $\frac{1}{r}$.

δ_1 = diameter of the bare wire, in centimeters.

δ_2 = diameter of the bare wire, in inches.

$\frac{1}{n_1}$ = winding pitch, in centimeters.

$\frac{1}{n_2}$ = winding pitch, in inches.

K = a function of r or R , given in Table 1.

$$B = k r^2 = \frac{k}{R^2}, \quad C = \frac{k}{r} = k R, \quad F = k r = \frac{k}{R}.$$

The values of B , C , and F are obtained from Table 1.

G and H are constants given, respectively, in Tables 2 and 3

to be used in formulas (3) and (4), in making corrections for space occupied by insulation.

PROBLEM A—Given diameter, length, and winding density, to calculate the inductance.

$$L = 0.001 k d_1^2 b_1 n_1^2 \text{ (metric)} \quad (1)$$

The notation "metric" here and elsewhere, signifies that b_1 and d_1 are dimensions in centimeters, n_1 is in turns per centimeter, and the inductance is given in microhenrys.

$$L = 0.00254 k d_2^2 b_2 n_2^2 \text{ (English)} \quad (2)$$

The notation "English" signifies that the dimensions b_2 and d_2 are in inches, n_2 is in turns per inch, and the inductance is given in microhenrys. The factor k is to be taken from Table 1 for the given value of $r = \frac{d_1}{b_1} = \frac{d_2}{b_2}$, or $R = \frac{b_1}{d_1} = \frac{b_2}{d_2}$, according as to which is less in unity. It is to be noted that r and R are both independent of the system of measurements adopted, as long as both dimensions are expressed in the same system. The dimensions b_1 and b_2 must be taken as equal to the whole number of turns, multiplied by the pitch of the winding, that is, as $\frac{n}{n_1}$ or $\frac{n}{n_2}$, as already explained.

For greater accuracy, subtract from the value of the inductance given by (1) or (2), the correction for insulating space ΔL , given in the following formula.

$$\begin{aligned} \Delta L &= 0.00628 n_1 b_1 d_1 (G+H) \\ \Delta L &= 0.0160 n_2 b_2 d_2 (G+H) \end{aligned} \quad (3)$$

or, expressed in terms of the value of L

$$\frac{\Delta L}{L} = \frac{6.28 (G+H)}{k d_1 n_1} = \frac{6.28 (G+H)}{k d_2 n_2} \quad (4)$$

The constants G and H are given, respectively, in Tables 2 and 3. G is a function of the ratio of the bare diameter of the wire to the pitch of the winding, that is, of $d_1 n_1 = d_2 n_2$, while H depends on the whole number of turns alone.

EXAMPLE 1:

$$\begin{aligned} d_2 &= 4 \text{ inches} & n_2 &= 50 \text{ turns per inch} \\ b_2 &= 8.5 \text{ inches} & d_2 n_2 &= 0.015 \text{ inch} \end{aligned}$$

The ratio $r = \frac{4}{8.5} = 0.4706$. From column A of Table 1, we find $k = 8.17$, and thence

$$L = 0.00817 (2.54)^2 (8.5) (50)^2 = 7,056 \text{ microhenrys.}$$

To see if the correction for insulating space need to be considered, we find $n_2 \delta_2 = 0.75$, and thence, from Table 2, $G = 0.27$. The whole number of turns is $n = 50 (8.5) = 425$, so that from Table 3 we find $H = 0.335$. The fractional correction is, therefore

$$\frac{\Delta L}{L} = \frac{6.28 (0.605)}{8.17 (200)}, \text{ or only 2.3 part in a thousand.}$$

Given diameter, length, and the total number of turns, n , to calculate the inductance

$$L = 0.001 F d_1 n^2 \text{ (metric)} \quad (5)$$

$$L = 0.00254 F d_2 n^2 \text{ (English)} \quad (6)$$

The ratio r or R has to be calculated (that one which is less than unity being used) and in Table 1 the value of F is taken corresponding to that ratio.

EXAMPLE 2—To calculate the inductance of a coil having 79 turns, wound on a form of diameter 22.3 cm. The axial distance between the first and the 79th wire was found to be 9.0 cm. Thus the pitch $\frac{1}{n_1} = 0.115$ cm., so that the equivalent length of the coil was 79 times $0.115 = 9.12$ cm.

$$d_1 = 22.3, \quad b_1 = 9.12, \quad n = 79, \quad R = \frac{9.12}{22.3} = 0.409.$$

From Table 1 the value of F corresponding to this value of R is 11.515, so that for the inductance we have

$$L = 0.011515 (79)^2 22.3 = 1602.6.$$

Supposing the wire to have a bare diameter of 0.8 mm., $n_1 \delta_1 = 0.7$, and from Tables 2 and 3, we find $G = 0.20$, $H = 0.33$, and thus

$$\Delta L = 0.00628 (79) 22.3 (0.53) = 6.9 \text{ microhenrys}$$

so that the inductance, corrected for insulating space, is 1,597 microhenrys.

PROBLEM B—*Given inductance, length, and winding density, to find the diameter.*

Calculate from the given data, the quantity.

$$B = \frac{1000 L}{b_1^3 n_1^2} \text{ (metric)} \quad (7)$$

or
$$B = \frac{393.7 L}{b_2^3 n_2^2} \text{ (English)} \quad (8)$$

and find in Table 1, column B, the value of r or R corresponding to this value of B . From this value calculate the diameter from the relation $d_1 = b_1 r = \frac{b_1}{R}$, or $d_2 = b_2 r = \frac{b_2}{R}$.

In general, for purposes of design, it will not be worth while to evaluate the corrections for the insulating space, but in case this is done, it will be first necessary to make the approximate solution, as just shown. With the value of d_1 thus found, the correction to L is found by (3), and the calculation is repeated, using the corrected value of L . This more accurate value of d_1 will not differ much from the first approximation.

EXAMPLE 3—To find the diameter of a coil which, when wound with 40 turns per inch for a length of 6 inches, will give an inductance of 5,100 microhenrys.

$$L = 5,100, \quad b_2 = 6, \quad n_2 = 40.$$

Therefore $B = \frac{393.7 (5,100)}{216 (1600)} = 5.810$, and in column B of Table 1 we find this value of B corresponds to $r = 0.912$. Thus $d_2 = 6 (0.912) = 5.47$ inches.

PROBLEM C—Given the diameter, and the winding density to calculate the length of coil necessary to give a specified inductance L .

Calculate from the given data, the quantity

$$C = \frac{1000 L}{d_1^3 n_1^2} \quad (\text{metric}) \quad (9)$$

or
$$C = \frac{393.7 L}{d_2^3 n_2^2} \quad (\text{English}) \quad (10)$$

With this value of C , find in column C of Table 1, the value of r or R corresponding. Then $b_1 = \frac{d_1}{r} = d_1 R$, and $b_2 = \frac{d_2}{r} = d_2 R$. The total number of turns will be $n = n_1 b_1 = n_2 b_2$.

EXAMPLE 4—Wire is to be wound 15 turns per centimeter on a cylinder 10 centimeters in diameter to obtain an inductance of 1,000 microhenrys. To calculate the length of coil necessary we have $C = \frac{1,000(1,000)}{1000 (225)} = 4.44$, and this value of C in column C of Table 1 corresponds to $R = 0.730$. Thus $b_1 = 0.730 (10) = 7.30$ cm. The total number of turns is 109.5, so that 110 would give the required inductance.

PROBLEM D—Given the dimensions of a winding form, to calculate the winding density necessary in order to obtain a specified inductance.

From the given dimensions calculate the shape ratio r , or R , (less than unity) and with this ratio, find in column D of Table 1 the value of k corresponding. Then the winding density is given by

$$n_1^2 = \frac{1000 L}{k d_1^2 b_1} \quad (\text{metric}) \quad (11)$$

$$n_2^2 = \frac{393.7 L}{k d_2^2 b_2} \quad (\text{English}) \quad (12)$$

EXAMPLE 5—How many turns must be wound per inch of axial length on a coil which is to have a diameter of 5.5 inches, a length of 9.6 inches, and which is to have an inductance of 7,100 microhenrys?

These dimensions give $r = \frac{5.5}{9.6} = 0.573$, and the value of k , corresponding to this value of r , is 7.86. Thus

$$n_2 = \sqrt{\frac{393.7 (7100)}{(5.5)^2 9.6 (7.86)}} = 35.0 \text{ per inch.}$$

Wound thus, the coil will have a total of 336 turns.

PROBLEM E—A coil is to have a given shape ratio (relation of length to diameter). When wound with a given winding density, what must the dimensions be in order that the inductance may have a specified value?

The given shape ratio determines r and R . With the given value of r or R , obtain the value of C corresponding in column C of Table 1, and with this the diameter of the coil may be obtained from

$$d_1^3 = \frac{1000 L}{C n_1^2} \quad (\text{metric}) \quad (13)$$

$$d_2^3 = \frac{393.7 L}{C n_2^2} \quad (\text{English}) \quad (14)$$

Thence the length is obtained from $b_1 = \frac{d_1}{r} = d_1 R$, or $b_2 = \frac{d_2}{r} = d_2 R$.

Or we may solve for the length directly, instead of the diameter, by obtaining for the given value of r or R , the number in column B of Table 1 corresponding, and then

$$b_1^3 = \frac{1000 L}{B n_1^2} \quad (\text{metric}) \quad (15)$$

$$b_2^3 = \frac{393.7 L}{B n_2^2} \quad (\text{English}) \quad (16)$$

With this value of the length, the diameter is found from

$$d_1 = b_1 r = \frac{b_1}{R}, \text{ or } d_2 = b_2 r = \frac{b_2}{R}.$$

EXAMPLE 6—A coil is to be wound on a form for which the

ratio of diameter to length is 2.6, and the wire is to be wound 5 turns per centimeter. What must the dimensions of the coil be, if an inductance of 1,000 microhenrys is desired?

To solve for d_1 , we have $R = \frac{1}{2.6} = 0.3846$, to which the value 1.756 in column C of Table 1 corresponds. Thence $d_1^3 = \frac{(1000)^2}{1.756} (25)$ or $d_1 = 28.35$ cm., and therefore $b_1 = 0.3846 (28.35) = 10.90$ cm.

The number corresponding to $R = 0.3846$ in column B of Table 1 is 30.85, which gives $b_1^3 = \frac{(1000)^2}{30.85} (25)$, or $b_1 = 10.90$, and $d_1 = \frac{10.90}{0.3846} = 28.35$. The two solutions check one another. The coil will have a total of 54.5 turns.

4. CALCULATION OF POLYGONAL COILS

Let

N = number of sides of the polygon.

s = length of side of the polygon.

D = diameter of the circumscribed circle.

d = diameter of the equivalent circular coil (same inductance).

b = axial length of the polygon coil = number of turns divided by the winding number.

Since this section deals only with the determination of the diameter of the circular coil which has the same inductance as the given polygonal coil, only ratios enter, and thus it is immaterial what units are used for the dimensions, as long as the same system is used thruout. Thus the symbols s , D , b , and d , refer to either system. When, however, the diameter of the equivalent circular coil has been found, the further solution of the problem is to be made with the formulas for circular coils, and the formula appropriate to the system of units desired must be chosen.

If the polygon has an even number of sides, the diameter of the circumscribed circle is readily found by calipering over two opposite vertices of the polygon, and subtracting from this the diameter of cross section of the wire. If the number of sides is odd, or in other cases where the given dimension is the length of side of the polygon, the diameter of the circumscribed circle is given by

$$D = \frac{a}{\sin \frac{\pi}{N}} \quad (17)$$

Calculate the ratio $\rho = \frac{b}{D}$. Then from Table 4, the value of $\frac{d}{D}$ corresponding to this value of ρ is to be taken. This enables the diameter d of that circular coil to be found which, wound with the same number of turns n , and having the same length b , has the same inductance as the polygonal coil. Knowing the dimensions of the equivalent circular coil, its inductance may be calculated by (1) or (2), or (5) or (6).

For the problems of design, the calculations of Problem B, C, D, or E are to be made, using the given values of n and b , and where d enters, the value of the equivalent diameter as just described. In Problem B and E, where the diameter d is required, the value calculated by the formulas of these sections is the diameter of the equivalent coil, and the diameter of the circle circumscribed around the desired polygon has to be found. Calculating $\frac{b}{d}$, the value corresponding to the value of d already found, the value of $\frac{d}{D}$ for this value of $\frac{b}{d}$ assumed approximately equal to $\frac{b}{D}$ is taken from Table 4, and thus a first approximation to the desired value of D can be calculated. Using this a new value of $\frac{b}{D}$ is calculated and used in Table 4 to give a second and very accurate value of $\frac{d}{D}$, and thus of D . Formula (7) will then give the required length of a side of the polygonal coil. An example will make these points clearer.

EXAMPLE 7—A hexagonal coil has a side of 10 centimeters and is wound with wire 10 turns to the centimeter, for an axial length of 6 centimeters. To calculate the inductance we have $b_1 = 6$, $n_1 = 10$, $s = 10$. From (17) we find for the diameter of the circumscribed circle the value of 20 cm. (a value evident from elementary geometry also). Thus $\rho = \frac{6}{20} = 0.3$, and Table 4 gives for this value, $\frac{d}{D} = 0.912$. Thus the equivalent circular coil has a diameter of $d = 20 (0.912) = 18.24$ cm.

The inductance is then to be calculated by formula (1). $R = \frac{6}{18.24} = 0.329$, and from Table 1, for this value of R , the value of k is 4.20, so that the inductance is

$L = 0.001 (4.20) (18.24)^2 6 (10)^2 = 838$ microhenrys. Formula (5) gives, using column F in Table 1, $n = 60$,

$$L = 0.001 (12.79) 18.24 (60)^2 = 840 \text{ microhenrys.}$$

The check is sufficiently close.

In Problem B, Case 3, the design has given $d_2 = 5.47$ inches. If we wish to find the equivalent octagonal coil having the same length $b_2 = 6$ inches, and the same number of turns, the calculation is made as follows:

$$\frac{d_2}{b_2} = \frac{5.47}{6} = 0.912, \text{ and if we assume this as a first approxima-}$$

tion to the ratio $\frac{D}{b}$, we find from Table 4 for this value, $\frac{d}{D} = 0.949$.

Thus to a first approximation $D = \frac{5.47}{0.949} = 5.76$ inches.

Using this, we find as a second approximation to $\frac{D}{b}$, $\frac{5.76}{6} = 0.96$,

and the value of $\frac{d}{D}$ corresponding to this in Table 4 does not differ from the previous value by as much as one part in a thousand. Thus we may take as final $D = 5.76$ inches, to which, by (17) the length of side is $s = 5.76 \sin 22^\circ.5 = 2.20$ inches.

TABLE 1

Constants for the Calculation and Design of Single-layer Coils or Solenoids as Functions of the Shape Factor

$$r = \frac{\text{diameter}}{\text{length}} \quad \text{or} \quad R = \frac{\text{length}}{\text{diameter}}$$

r	k	B	C	F	r	k	B	C	F
	Probs. A & D	Prob. B	Prob. C	Prob. A		Probs. A & D	Prob. B	Prob. C	Prob. A
0.00	9.87	0	Infinite	0	0.25	8.90	0.556	35.6	2.225
.01	9.83	0.0010	983	0.098	.26	8.86	.599	34.1	2.304
.02	9.79	.0039	489	.196	.27	8.83	.644	32.7	2.384
.03	9.745	.0088	325	.292	.28	8.79	.689	31.4	2.462
.04	9.70	.0155	243	.388	.29	8.76	.736	30.2	2.540
0.05	9.66	0.0242	193	0.483	0.30	8.72	0.785	29.1	2.617
.06	9.62	.0346	160	.577	.31	8.69	.835	28.0	2.693
.07	9.58	.0470	137	.671	.32	8.65	.886	27.0	2.769
.08	9.54	.0611	119	.763	.33	8.62	.939	26.1	2.844
.09	9.50	.0770	106	.855	.34	8.59	.993	25.2	2.919
0.10	9.46	0.0946	94.6	0.946	0.35	8.55	1.048	24.4	2.993
.11	9.42	.114	85.7	1.037	.36	8.52	1.104	23.7	3.067
.12	9.385	.135	78.2	1.126	.37	8.49	1.162	22.9	3.140
.13	9.35	.158	71.9	1.215	.38	8.45	1.221	22.2	3.212
.14	9.31	.182	66.5	1.303	.39	8.42	1.281	21.6	3.284
0.15	9.27	0.208	61.8	1.390	0.40	8.39	1.342	20.97	3.355
.16	9.23	.236	57.7	1.477	.41	8.36	1.404	20.38	3.426
.17	9.19	.266	54.1	1.563	.42	8.32	1.468	19.82	3.496
.18	9.16	.297	50.9	1.648	.43	8.29	1.533	19.28	3.565
.19	9.12	.329	48.0	1.732	.44	8.26	1.599	18.77	3.634
0.20	9.08	0.363	45.4	1.816	0.45	8.23	1.666	18.29	3.703
.21	9.04	.399	43.1	1.899	.46	8.20	1.735	17.82	3.771
.22	9.01	.436	40.9	1.982	.47	8.17	1.804	17.37	3.838
.23	8.97	.475	39.0	2.063	.48	8.14	1.874	16.95	3.905
.24	8.935	.515	37.2	2.144	.49	8.105	1.946	16.54	3.972
0.25	8.905	0.556	35.6	2.225	0.50	8.075	2.019	16.15	4.037

TABLE 1—Continued

r	k	B	C	F	r	k	B	C	F
	Probs. A & D	Prob. B	Prob. C	Prob. A		Probs. A & D	Prob. B	Prob. C	Prob. A
0.50	8.075	2.019	16.15	4.04	0.75	7.38	4.15	9.84	5.535
.51	8.04	2.092	15.77	4.10	.76	7.35	4.25	9.68	5.59
.52	8.01	2.167	15.41	4.17	.77	7.33	4.35	9.52	5.64
.53	7.985	2.243	15.07	4.23	.78	7.30	4.44	9.365	5.70
.54	7.96	2.320	14.73	4.30	.79	7.28	4.54	9.215	5.75
0.55	7.93	2.398	14.41	4.36	0.80	7.255	4.64	9.07	5.80
.56	7.90	2.476	14.10	4.42	.81	7.23	4.74	8.93	5.86
.57	7.87	2.556	13.80	4.485	.82	7.21	4.845	8.79	5.91
.58	7.84	2.637	13.52	4.55	.83	7.18	4.95	8.65	5.96
.59	7.81	2.719	13.24	4.61	.84	7.16	5.05	8.52	6.01
0.60	7.78	2.802	12.97	4.67	0.85	7.13	5.15	8.39	6.06
.61	7.75	2.885	12.71	4.73	.86	7.11	5.26	8.27	6.115
.62	7.73	2.97	12.46	4.79	.87	7.09	5.36	8.15	6.165
.63	7.70	3.06	12.22	4.85	.88	7.06	5.47	8.03	6.22
.64	7.67	3.14	11.99	4.91	.89	7.04	5.58	7.91	6.27
0.65	7.64	3.23	11.76	4.97	0.90	7.02	5.68	7.80	6.315
.66	7.62	3.32	11.54	5.03	.91	6.99	5.79	7.69	6.365
.67	7.59	3.41	11.33	5.085	.92	6.97	5.90	7.58	6.41
.68	7.56	3.50	11.12	5.14	.93	6.95	6.01	7.47	6.46
.69	7.54	3.59	10.92	5.20	.94	6.93	6.13	7.34	6.51
0.70	7.51	3.68	10.73	5.26	0.95	6.90	6.23	7.27	6.56
.71	7.48	3.77	10.54	5.31	.96	6.88	6.34	7.17	6.61
.72	7.46	3.87	10.36	5.37	.97	6.86	6.45	7.07	6.65
.73	7.43	3.96	10.18	5.425	.98	6.84	6.57	6.98	6.70
.74	7.41	4.055	10.01	5.48	.99	6.82	6.68	6.885	6.75
0.75	7.38	4.15	9.84	5.535	1.00	6.79	6.79	6.79	6.79

TABLE 1—Continued

R	k	B	C	F	R	k	B	C	F
	Probs. A & D	Prob. B	Prob. C	Prob. A		Probs. A & D	Prob. B	Prob. C	Prob. A
1 00	6.79	6.79	6.79	6.79	0.75	6.15	10.93	4.61	8.20
0.99	6.77	6.91	6.705	6.84	.74	6.13	11.17	4.53	8.27
.98	6.75	7.03	6.62	6.89	.73	6.09	11.42	4.44	8.34
.97	6.73	7.15	6.53	6.94	.72	6.05	11.68	4.36	8.41
.96	6.71	7.28	6.44	6.985	.71	6.02	11.94	4.275	8.48
0.95	6.68	7.405	6.35	7.035	0.70	5.99	12.22	4.19	8.55
.94	6.66	7.54	6.26	7.085	.69	5.95	12.51	4.11	8.63
.93	6.64	7.67	6.17	7.14	.68	5.92	12.80	4.03	8.705
.92	6.61	7.81	6.08	7.19	.67	5.88	13.11	3.94	8.78
.91	6.59	7.96	6.00	7.24	.66	5.85	13.43	3.86	8.86
0.90	6.56	8.10	5.91	7.29	0.65	5.81	13.76	3.78	8.94
.89	6.54	8.255	5.82	7.35	.64	5.78	14.10	3.70	9.025
.88	6.51	8.41	5.73	7.40	.63	5.74	14.46	3.615	9.11
.87	6.49	8.57	5.64	7.46	.62	5.70	14.83	3.53	9.195
.86	6.46	8.74	5.56	7.51	.61	5.66	15.22	3.45	9.28
0.85	6.44	8.91	5.47	7.57	0.60	5.62	15.62	3.37	9.37
.84	6.41	9.08	5.38	7.63	.59	5.58	16.04	3.29	9.46
.83	6.38	9.26	5.30	7.69	.58	5.54	16.47	3.21	9.55
.82	6.35	9.45	5.21	7.75	.57	5.50	16.93	3.135	9.65
.81	6.33	9.64	5.12	7.81	.56	5.46	17.40	3.06	9.75
0.80	6.30	9.84	5.04	7.87	0.55	5.415	17.90	2.98	9.845
.79	6.27	10.045	4.95	7.935	.54	5.37	18.42	2.90	9.95
.78	6.24	10.26	4.87	8.00	.53	5.33	18.96	2.82	10.05
.77	6.21	10.47	4.78	8.06	.52	5.28	19.53	2.75	10.15
.76	6.18	10.70	4.70	8.13	.51	5.23	20.12	2.67	10.26
0.75	6.15	10.93	4.61	8.20	0.50	5.19	20.74	2.59	10.37

TABLE 1—Continued

R	k	B	C	F	R	k	B	C	F
	Probs. A & D	Prob. B	Prob. C	Prob. A		Probs. A & D	Prob. B	Prob. C	Prob. A
0.50	5.19	20.7	2.593	10.37	0.25	3.61	57.7	0.902	14.43
.49	5.14	21.4	2.518	10.48	.24	3.52	61.1	.845	14.67
.48	5.09	22.1	2.443	10.60	.23	3.43	64.9	.790	14.93
.47	5.04	22.8	2.368	10.72	.22	3.34	69.1	.736	15.20
.46	4.99	23.6	2.294	10.84	.21	3.25	73.7	.683	15.48
0.45	4.935	24.4	2.221	10.97	0.20	3.16	78.9	0.631	15.78
.44	4.88	25.2	2.148	11.095	.19	3.06	84.8	.581	16.10
.43	4.83	26.1	2.076	11.23	.18	2.96	91.3	.532	16.43
.42	4.77	27.05	2.004	11.36	.17	2.85	98.7	.485	16.78
.41	4.715	28.05	1.993	11.50	.16	2.74	107.2	.439	17.15
0.40	4.66	29.1	1.863	11.64	0.15	2.63	119.7	0.395	17.55
.39	4.60	30.2	1.793	11.79	.14	2.52	128.4	.352	17.98
.38	4.54	31.4	1.724	11.94	.13	2.40	141.8	.312	18.44
.37	4.475	32.7	1.656	12.095	.12	2.27	157.8	.273	18.93
.36	4.41	34.0	1.588	12.26	.11	2.14	177.0	.236	19.47
0.35	4.35	35.5	1.522	12.42	0.10	2.007	200.7	0.201	20.07
.34	4.28	37.0	1.456	12.59	.09	1.865	230	.168	20.72
.33	4.21	38.7	1.390	12.77	.08	1.717	268	.137	21.46
.32	4.14	40.5	1.326	12.95	.07	1.560	318	.109	22.29
.31	4.07	42.4	1.263	13.14	.06	1.396	388	.0837	23.26
0.30	4.00	44.4	1.200	13.33	0.05	1.220	488	0.0610	24.40
.29	3.925	46.7	1.138	13.53	.04	1.032	645	.0413	25.80
.28	3.85	49.1	1.078	13.74	.03	0.828	920	.0248	27.60
.27	3.77	51.7	1.018	13.96	.02	.603	1508	.0121	30.15
.26	3.69	54.6	0.959	14.19	.01	.345	3450	.0034	34.50
0.25	3.61	57.7	0.902	14.43	0.00	0	Infinite	0	Infinite

TABLE 2

Values of the Correction Term G , in Formulas (13) and (14). As a Function of the ratio $n_1 \delta_1 (= n_2 \delta_2)$ of the bare diameter of the wire to the winding pitch.

$n_1 \delta_1$	G	$n_2 \delta_1$	G	$n_1 \delta_1$	G	$n_1 \delta_1$	G
1.00	0.56	0.50	-0.14	0.30	-0.65	0.10	-1.75
.95	.51	.48	.18	.28	.72	.09	1.85
.90	.45	.46	.22	.26	.79	.08	1.97
.85	.39	.44	.26	.24	.87	.07	2.10
.80	.33	.42	.31	.22	-0.96	.06	2.26
0.75	0.27	0.40	-0.36	0.20	-1.05	0.05	-2.44
.70	.20	.38	.41	.18	1.16	.04	2.66
.65	.13	.36	.46	.16	1.28	.03	2.95
.60	.05	.34	.52	.14	1.41	.02	3.36
.55	-0.04	.32	.58	.12	1.56	.01	-4.05
0.50	-0.14	0.30	-0.65	0.10	-1.75		

TABLE 3

Values of the Correction Term H in Formulas (13) and (14), as a Function of the Total Number of Turns, n of the Coil.

n	H	n	H
1	0.00	40	0.315
2	.11	45	.32
3	.17	50	.32
4	.20	60	.32
5	.22	70	.32
6	0.23	80	0.33
7	.24	90	.33
8	.25	100	.33
9	.26	150	.33
10	.27	200	.33
15	0.29	300	0.33
20	.30	400	.335
25	.30	500	.34
30	.31	700	.34
35	.31	1000	.34

TABLE 4

Values of the Equivalent Diameter Ratio for Calculations with Polygonal Coils.

Triangle		Square		Hexagon		Octagon		Twelve-sided	
$\frac{b}{D}$	$\frac{d}{D}$	$\frac{b}{D}$	$\frac{d}{D}$	$\frac{b}{D}$	$\frac{d}{D}$	$\frac{b}{D}$	$\frac{d}{D}$	$\frac{b}{D}$	$\frac{d}{D}$
0	0.827	0	0.900	0	0.955	0	0.974	0	0.989
0.01	.729	0.01	.844	0.01	.928	0.01	.958	0.01	.981
.02	.718	.02	.838	.02	.925	.02	.957	.02	.980
.03	.711	.03	.834	.03	.923	.03	.956	.03	.980
.04	.705	.04	.831	.04	.922	.04	.955	.04	.980
0.05	0.700	0.05	0.828	0.05	0.921	0.05	0.954	0.05	0.979
.06	.696	.06	.826	.06	.920	.10	.952	.10	.978
.07	.693	.07	.824	.07	.919	.15	.951	.15	.978
.08	.690	.08	.822	.08	.918	.20	.951	.20	.978
.09	.687	.09	.821	.09	.918	.30	.950	.30	.978
0.10	0.685	0.10	0.820	0.10	0.917	0.40	0.950	0.40	0.977
.15	.676	.15	.815	.15	.916	.50	.950	.50	.977
.20	.670	.20	.812	.20	.914	1.00	.949	1.00	.977
.30	.662	.30	.808	.30	.912				
.40	.657	.40	.805	.40	.912				
0.50	0.654	0.50	0.803	0.50	0.911	$\frac{D}{b}$		$\frac{D}{b}$	
.60	.652	.60	.802	.60	.911	0.50	0.949	0.50	0.977
.70	.651	.70	.802	.70	.911	0	.949	0	.977
.80	.650	.80	.801	.80	.910				
.90	.649	.90	.801	.90	.910				
1.00	0.648	1.00	0.800	1.00	0.910				
$\frac{D}{b}$		$\frac{D}{b}$		$\frac{D}{b}$					
0.50	0.646	0.50	0.799	0.50	0.910				
.00	.643	0	.798	0	.909				

SUMMARY: A set of tables for the simple calculation of the inductance of single layer helical and polygonal coils and their design is given; together with full illustrations of their use.

Union College,
Schenectady, N. Y.

DIGESTS OF UNITED STATES PATENTS RELATING TO
RADIO TELEGRAPHY AND TELEPHONY

ISSUED DECEMBER 25, 1923—FEBRUARY 26, 1924

BY

JOHN B. BRADY

(PATENT LAWYER, OURAY BUILDING, WASHINGTON, D. C.)

1,478,638—H. G. Cordes, filed May 10, 1917, issued December 25, 1923.

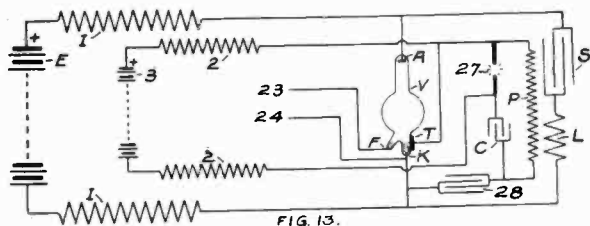

FIG. 13.

NUMBER 1,478,638—Electric Oscillator

ELECTRIC OSCILLATOR of linear-sinusoidal characteristic in which oscillations are started by superposing a transient current upon a direct current and the oscillations sustained by means of a sustained alternating current. The oscillator comprises a direct current capacitance charging circuit, a direct current discharger circuit, a sinusoidal discharge circuit, and a uni-directional current relay discharger therefor. An auxiliary oscillating current relay discharger actuating circuit is coupled to the said discharge circuit for actuating the relay discharger of the oscillator.

1,478,806—A. F. Victor, filed March 1, 1922, issued December 25, 1923.

METHOD OF DELIVERING ILLUSTRATED LECTURES OR SONGS, comprising an arrangement at a radio broadcasting station of a manually operated picture projecting apparatus and a similar apparatus at a radio receiving station. The lecturer at the radio transmitting station produces a signal when he desires the next

*Received by the Editor, March 18, 1924.

picture displayed, enabling the operator at the radio receiving station to make a similar change, so that the audience may follow the words of the lecturer by observing the displayed picture.

1,479,146—R. E. Marbury, filed March 5, 1921, issued January 1, 1924. Assigned to Westinghouse Electric and Manufacturing Company.

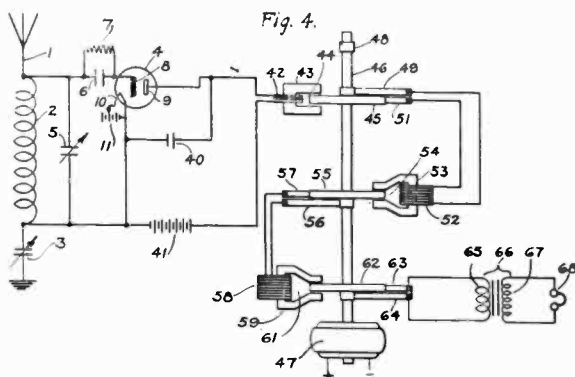

NUMBER 1,479,146—Radio Receiving System

RADIO RECEIVING SYSTEM wherein signals are amplified after rectification by means of a dynamo-electric machine, the incoming signals operating to produce a change in the magnetic flux of the machine for affecting the current output.

1,479,256—H. K. Sandell, filed August 28, 1919, issued January 1, 1924.

SPACE CURRENT DEVICE or electron tube wherein a block of insulating material is employed to support the electrodes with non-conductive spacing means supported by the electrodes independent of the block.

1,479,315—G. W. Pickard, filed January 12, 1921, issued January 1, 1924. Assigned to Wireless Specialty Apparatus Company.

ELECTRICAL CONDENSER AND PROCESS FOR MAKING THE SAME, in which the plates are formed by dielectric having thin film metal deposits on opposite sides thereof. The plates are stacked so that the metallic films contact with each other separated by the base dielectric material.

1,479,475. O. Minton, filed January 19, 1923, issued January 1, 1924.

RADIO RECEIVING APPARATUS, in which the tubing system comprises two inductance coils connected in series and mounted for relative movement to vary the inductance linkage between them with a connection from a point of the circuit between the coils to the ground. The radio receiving apparatus which may be a radio frequency amplifier, detector, and audio frequency amplifier is directly connected across the terminals of the two inductance coils which are shunted by a variable tuning condenser.

1,479,638—V. K. Zworykin, filed August 28, 1922, issued January 1, 1924.

MULTIPLE REGENERATIVE LOOP ANTENNA AND CIRCUIT, in which one of the loops in the system is connected with the grid circuit of a detector tube and two or more loops are directly connected in the plate circuit of the tube forming a compact regenerative system.

1,479,778—H. J. Van Der Bijl, filed September 30, 1918, issued January 1, 1924. Assigned to Western Electric Company.

VACUUM TUBE DEVICE showing a construction wherein the plate electrode is formed in two parallel planes, the material of one plane being supported by metallic members which extend out from the other plane which in turn is substantially supported within the tube.

1,479,991—R. W. King, filed August 13, 1919, issued January 8, 1924. Assigned to Western Electric Company.

ELECTRON DISCHARGE DEVICE, in which the anodes are supported in the tube by forked metallic members mounted on the press. The tube structure also includes a block of insulating material supported by the anode, which insulating material in turn includes supporting connections for the grid and cathode.

1,480,208—W. G. Housekeeper, filed April 15, 1921, issued January 8, 1924. Assigned to Western Electric Company.

VACUUM TUBE, in which the filament electrode is supported by a spring suspension device anchored in an insulating member supported from the glass press of the tube.

1,480,216—J. Mills, filed October 11, 1916, issued January 8, 1924. Assigned to Western Electric Company.

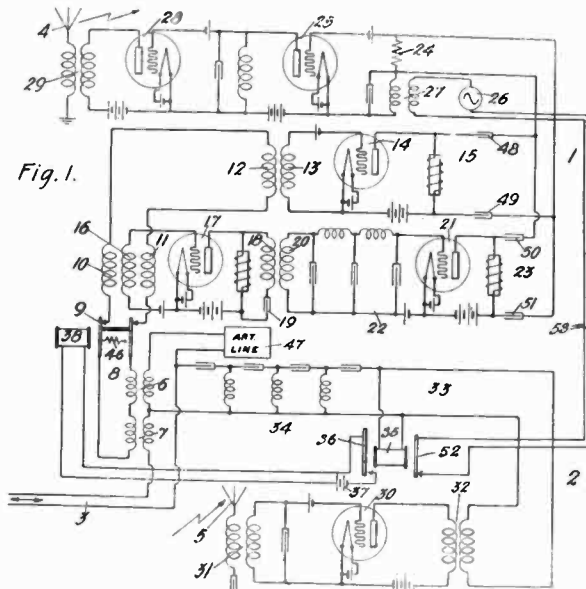

NUMBER 1,480,216—Transmission System

TRANSMISSION SYSTEM, in which a plurality of terminal stations comprising a radio telephone transmitting and receiving system and a line wire telephone system are employed. The object of the invention is to provide a circuit arrangement and system to prevent a circulation of power between the local transmitting and receiving system, or to insure that the signals received by a radio receiving system will be transmitted along the line wire in such manner as to not thereby effect the transmission of the same signal from the local radio transmitting station.

1,480,217—J. Mills, filed December 29, 1916, issued January 8, 1924. Assigned to Western Electric Company.

METHOD AND MEANS FOR SIGNALING, wherein the intelligible interception of signals transmitted is prevented. This is accomplished by superposing on the outgoing talk or signal currents a complex noise formed by currents of several frequencies lying in the most important part of the voice frequency range. To clarify the signal at the proper receiving station, the invention provides for the superposition upon the incoming talk and its

combined noise of a complex noise similar to the noise originally superimposed but exactly opposite in the phase of all its components. The noise is thus suppressed from the signal which may be received free from confusion.

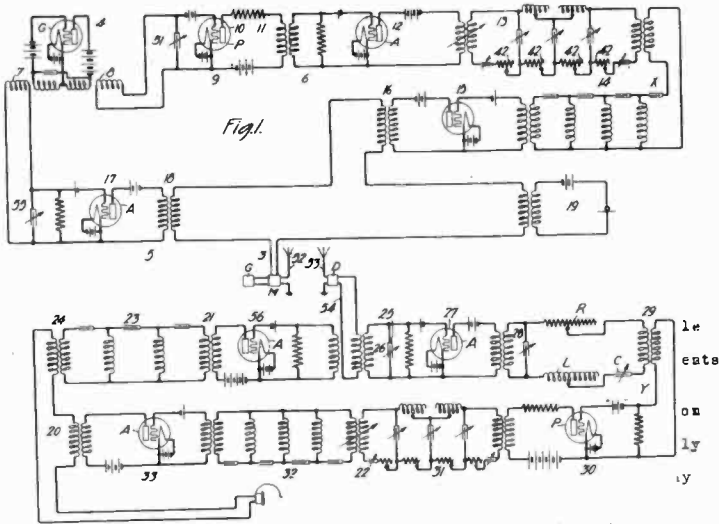

NUMBER 1,480,217—Method and Means for Signaling

1,480,219—A. McL. Nicolson, filed June 25, 1917, issued January 8, 1924. Assigned to Western Electric Company.

VACUUM TUBE, in which the grid electrode is supported by a spring tension member which compensates for the expansion of the grid under changes in temperature in the tube whereby a uniform distance is maintained between the grid and the other electrodes at all times.

1,480,227—G. H. Stevenson, filed May 16, 1921, issued January 8, 1924. Assigned to Western Electric Company.

IMPEDANCE ELEMENT for use in high frequency alternating current circuits. The construction of the element is such that the value of its impedance may be accurately adjusted. An electrostatic shield is provided for the winding in the element.

1,480,388—A. L. Golden, filed September 16, 1919, issued January 8, 1924. Assigned to National Radio Company, of San Francisco, California.

OSCILLATOR for arc circuits in which the arc is formed between a pair of tungsten metal electrodes submerged in distilled water.

1,480,534—Alfred Crossley, filed August 16, 1922, issued January 8, 1924. Assigned to Hartman Electric Mfg. Company.

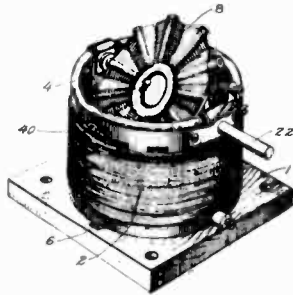

NUMBER 1,480,534—Variocoupler

VARIOCOUPLER having extremely small electrostatic coupling between the windings. The variocoupler has a cylindrical stator and a flat rotor on which the secondary winding is arranged in such manner that the conductors are at all times approximately in a plane passing thru a diametrical line through the cylindrical stator. Sufficient electromagnetic coupling may be introduced to neutralize the effects of capacity coupling to secure substantially zero coupling.

1,480,604—W. Dubilier, filed January 27, 1921, issued January 15, 1924. Assigned to Dubilier Condenser and Radio Corporation.

TERMINAL CONNECTION FOR CONDENSERS, in which the conducting plates have terminals extending from the sides of the stack which are gripped together by a smooth round metallic hook.

1,480,659—Q. A. Brackett, filed December 7, 1920, issued January 15, 1924. Assigned to Westinghouse Electric and Manufacturing Company.

SIGNALING SYSTEM employing an arc which is controlled to produce signals with radiation of only a single wave. The arc is maintained in uninterrupted operation while the energy is supplied either to an oscillatory circuit or to a non-oscillatory circuit in the process of producing signals.

1,480,891—H. I. Becker, filed July 20, 1921, issued January 15, 1924. Assigned to General Electric Company.

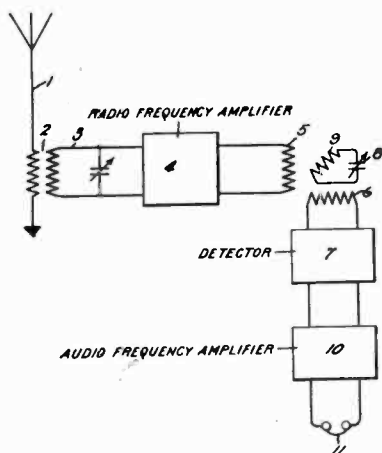

NUMBER 1,480,891—High Frequency Receiving System

HIGH FREQUENCY RECEIVING SYSTEM, in which a link circuit is provided between a radio frequency amplifier and the detecting circuit for preventing disturbing currents from being transferred from the amplification circuit to the detection circuit.

1,481,422—Gilles Holst, E. Oosterhuis, and J. Bruijnes, filed June 1, 1922, issued January 22, 1924. Assigned to Naamlooze Vennootschap Philips' Gloeilampen-Fabrieken, of Eindhoven, Netherlands.

ELECTRIC DISCHARGE TUBE, in which the gas filling in the tube comprises neon to which 0.5 to 5 percent argon is added. The inventors state that the ionization potential of argon is lower than the potential at which the first inelastic collision in the first mentioned gas occurs.

1,481,945—J. Weinberger, filed March 3, 1921, issued January 29, 1924. Assigned to Radio Corporation of America.

RADIO RECEIVING SYSTEM, with a circuit arrangement between the antenna and the input of the receiver for eliminating interference. The system includes primary and secondary circuits with a pair of connections across the primary and secondary circuits, each connection comprising two parts including capacity and inductance in series, with one of the parts common to both connections and the other two parts arranged to couple the primary and secondary circuits. All of the factors in the circuits are adjustable to secure selectivity.

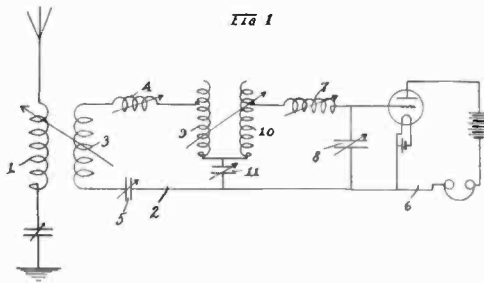

NUMBER 1,481,945—Radio Receiving System

1,482,122—W. N. Fanning, filed March 30, 1922, issued January 29, 1924.

RADIO SYSTEM for operating a signal or alarm upon the receipt of a certain definite call by radio. The device is particularly described in connection with a receiver on shipboard to sound an alarm for operation upon receipt of an "SOS" distress call.

1,483,383—H. K. Sandell, filed November 2, 1922, issued February 12, 1924. Assigned to Mills Novelty Company of Chicago.

RADIO RECEIVING SYSTEM comprising a loop antenna having two parts, one of which is connected in the grid circuit of a detector tube and the other in the plate circuit forming a regenerative system. The loops are spaced apart in parallel planes on the antenna frame and a condenser provided in one corner of the antenna frame which forms a variable tuning connecting means between the loops.

1,483,860—O. Von Bronk, filed September 3, 1921, issued February 12, 1924. Assigned to Gesellschaft für Drahtlose Telegraphie M.B.H., Halleisches, Berlin, Germany.

ANTENNA ARRANGEMENT FOR RADIO TELEGRAPHY, in which the antenna is supported by a conducting mast and an electromotive force applied to the antenna mast substantially equal and opposite to the electromotive force normally induced in the mast by radiation from the antenna.

1,484,189—J. A. Proctor, filed July 6, 1920, issued February 19, 1924. Assigned to Wireless Specialty Apparatus Company.

RADIO RECEIVING APPARATUS, utilizing a combined closed loop antenna and an open antenna. The open antenna comprises a conductor which is structurally separate from the turns of the

loop antenna, but which is wound with the turns of the loop. The loop and antenna circuits are coupled with the receiving circuit.

1,484,269—E. Mayer, filed June 21, 1923, issued February 19, 1924.

METHOD AND ARRANGEMENT FOR PRODUCING NON-DAMPED OSCILLATIONS, in which a mechanical interrupter connected to a charging circuit is provided in circuit with a separate circuit arranged to receive energy from the charging circuit and produce oscillations. The charging of the circuit proceeds until the electrical energy stored in said circuit is such that when oscillations begin the momentary value or strength of the oscillation current is substantially equal and opposite with respect to the value of the charging current and the circuit then oscillates under such conditions that the charging current will be substantially equal to the amplitude of the oscillation current still existing after one complete oscillation. The circuit can then be broken without sparking and after a brief period of interruption and re-charging, more oscillations take place as before during a relatively longer period, and this operation can be repeated as long as oscillations are needed.

1,484,405—A. Oswald, filed January 12, 1920, issued February 19, 1924. Assigned to Western Electric Company.

SIGNALING SYSTEM having means for controlling a distant responsive device such as a call signal which will not respond to to false signals or electrical disturbances. A slow acting indicator is provided at the receiver which will only be actuated by the call signal. A source of opposing voltage is arranged at the receiver to cause the indicator to cease to respond upon cessation of the signaling waves.

1,484,411—H. S. Read, filed September 14, 1920, issued February 19, 1924. Assigned to Western Electric Company.

RADIO RECEIVING SYSTEM having a circuit arrangement for preventing radiation of the locally generated wave energy from the receiving antenna. The circuit arrangement includes a radio frequency amplifier, a local oscillator, and a detector and a circuit interconnecting the output of the amplifier and oscillator and the input of the detector which precludes radiation of energy from the local oscillator into the antenna.

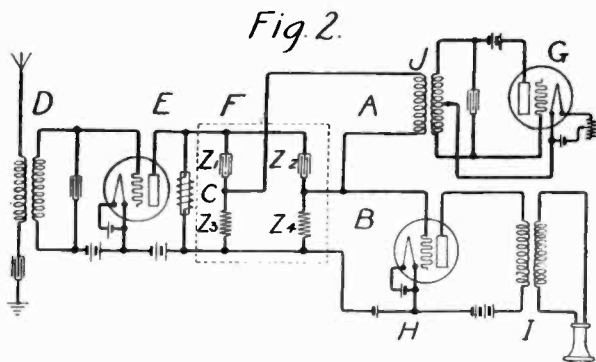

NUMBER 1,484,411—Radio Receiving System

1,484,605—J. H. Hammond, Jr., filed August 20, 1917, issued February 19, 1924.

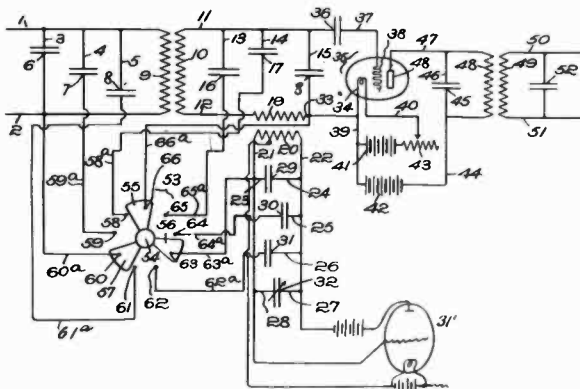

NUMBER 1,484,605—Radio-Dynamic Receiving System

RADIO-DYNAMIC RECEIVING SYSTEM employing beat reception in which tuning is facilitated by an arrangement whereby two series of periodic impulses having different frequencies are impressed upon the oscillatory circuit. Periodic electrical beats are produced in the oscillatory circuit. The frequency of the beats may be maintained constant by varying the frequency of one of the series of impulses.

1,485,080—E. T. Jones, filed December 27, 1921, issued February 26, 1924.

SWITCH particularly designed for transferring connections from the antenna ground system to the radio transmitter or the radio receiver. The switch has a shaft mounted on the extremity

of an elongated support with switch blades carried by the shaft adapted to enter contacts on either side of the support when the switch shaft is rotated.

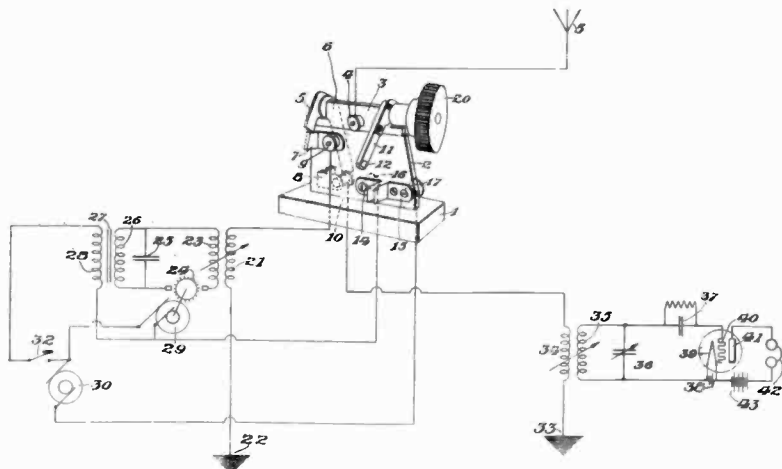

NUMBER 1,485,080—Switch

1,485,111—J. Bethenod, filed August 2, 1921, issued February 26, 1924.

RADIO TRANSMISSION SYSTEM, in which a plurality of radio frequency generators are provided at the same station for simultaneous operation to obtain multiplex transmission. The antenna is divided into two separate sections adapted to radiate different wave lengths. The generators are connected to these sections of the antenna and a connection of substantially infinite impedance provided in each of the sections to the wave lengths of the other section for limiting induction effects therebetween.

1,485,156—H. D. Arnold, filed August 28, 1917, issued February 26, 1924. Assigned to Western Electric Company.

SYSTEM OF DISTRIBUTION, in which an oscillation generator delivers current at a constant frequency, regardless of the nature of the load by reason of the fact that the load is prevented from reacting on the generator. An asymmetrically conducting repeater is placed between the output circuit of the oscillator and the load circuit permitting the transferring of alternating current to the load circuit, but preventing reaction from the load circuit upon the generator.

RADIO TELEGRAPH SYSTEM wherein signals are automatically transmitted and received directly in print. The system contemplates the broadcasting of news by radio from a central transmitting station to newspaper offices where the news may be received on a machine which automatically prints the signals. The system is also applicable in commercial radio for eliminating the human equation in handling heavy traffic. The invention introduces automatics in a practical way into radio.

1,494,087—F. M. Ryan, filed August 14, 1922, issued February 19, 1924. Assigned to Western Electric Company.

RADIO BROADCASTING EQUIPMENT for controlling the radio transmitter. The patent describes circuit arrangements between a studio and a radio transmission room whereby a person in either room may broadcast. Signal indicators are provided in each room to indicate automatically that the circuits are in operating condition for broadcasting from that particular room.

**LIST OF RADIO TRADE MARKS PUBLISHED BY PATENT OFFICE
PRIOR TO REGISTRATION**

(The numbers given are serial numbers of pending applications)

149,747—"VACTUPHONE" for telephone for aiding hearing. Globe Phone Company, Reading, Massachusetts. Claims use since April 12, 1921. Published December 25, 1923.

155,450—"UV" for vacuum tubes. Radio Corporation of America, New York City. Claims use since October 19, 1920. Published January 1, 1924.

157,776—"UC" for electrical condensers. Radio Corporation of America, New York City. Claims use since about August, 1921. Published January 1, 1924.

166,471—"Q-R" for complete radio sets and parts thereof. Robinson Specialty Company, Keyport, New Jersey. Claims use since on or about January, 1922. Published January 1, 1924.

170,674—"TEST-RITE" for condensers. Scholes Radio Manufacturing Corporation, New York City. Claims use since August 14, 1922. Published January 1, 1924.

187,534—"MICROSTAT" for rheostats. Premier Electric Company, Chicago, Illinois. Claims use since June, 1923. Published January 1, 1924.

- 187,856—"TELOS" for radio receiving sets. Danziger-Jones, Incorporated, New York City. Claims use since February 3, 1923. Published January 1, 1924.
- 164,007—"RACO" in ornamental design for antennas. Ross Antenna Company, Providence, Rhode Island. Claims use since April 1, 1922. Published January 8, 1924.
- 170,764—"GEM" for radio apparatus. Gem Radio Company, Brooklyn, New York. Claims use since September 27, 1922. Published January 8, 1924.
- 187,634—"B-METAL" for radio receiving apparatus. B-Metal Refining Company, Detroit, Michigan. Claims use since January 15, 1923. Published January 15, 1924.
- 181,105—"LISTENING IN—THE WORLD OVER" in ornamental design for radio headsets. N. Baldwin, Incorporated, Salt Lake City, Utah. Claims use since February 28, 1923. Published January 22, 1924.
- 173,684—"THE STENTOR—THE VOICE FROM THE SKIES" in ornamental design for loud speakers. Stentorphone Company, Los Angeles, California. Claims use since August 1, 1921. Published February 12, 1924.
- 175,822—"T T" for loud speakers. John S. Timmons, Philadelphia, Pennsylvania. Claims use since about July 31, 1922. Published February 12, 1924.
- 186,609—"PERFECTONE" in ornamental design for radio receiving apparatus. Perfectone Radio Corporation, New York City. Claims use since October 1, 1923. Published February 12, 1924.
- 188,636—"MONODYNE" for radio receiving apparatus. National Airphone Corporation, New York City. Claims use since about May 15, 1923. Published February 19, 1924.
- 188,637—"GOLD GRAIN" for detectors and receiving sets. National Airphone Corporation, New York City. Claims use since October 12, 1922. Published February 19, 1924.
- 189,237—"NU-TRON" in ornamental design for amplifiers and tubes. Fred W. Brown, Bethesda, Ohio. Claims use since November 22, 1923. Published February 19, 1924.
- 189,884—"DICTO GRAND" for loud speakers. Dictograph

Products Corporation, New York City. Claims use since March 6, 1923. Published February 19, 1924.

180,464—"ACME" for radio apparatus. Acme Apparatus Company, Cambridge, Massachusetts. Claims use since about March 1, 1919. Published February 26, 1924.

180,480—"THE LITTLE GIANT" for radio apparatus. Metropolitan Radio Corporation, Newark, New Jersey. Claims use since on or about August 1, 1922. Published February 26, 1924.

Not claims *but proven facts*

Under test, Radion Panels show the lowest phase angle difference, the lowest di-electric constant and the highest resistivity.

Radion Panels are absolutely impervious to moisture, gases and most acids. And this is true for both sides of the panel.

No other panel is as easy to work. Radion Panels do not chip under the saw or drill.

The beauty of Mahoganite Radion Panels cannot be surpassed, while the soft sheen of the black panels is equally attractive.

Dials, V. T. Sockets, Condenser ends, Insulators, and Knobs are also made of Radion.

It will pay you to test Radion for yourself. Any co-operation which we can give in such a test will be furnished gladly.

American Hard Rubber Co.
11 Mercer Street New York

RADION

Panels, Dials, Knobs, Sockets

Concerning **BURGESS BATTERIES**

The unique position of esteem and confidence occupied by Burgess Radio Batteries is a natural development of the conservative policy which has characterized the manufacture, advertising and sale of Burgess products.

It will be of interest to the thinking battery buyer to know that a Burgess product is neither advertised nor sold until its merit has been proven, not only by our own rigid tests, but also those of the foremost radio engineers, manufacturers and experimenters in the country.



Through friendly criticism and suggestions, together with extensive research and engineering by the C. F. Burgess Laboratories the efficiency of Burgess Batteries has increased to a degree which we believe is not equalled elsewhere.

"ASK ANY RADIO ENGINEER"

BURGESS BATTERY COMPANY

ENGINEERS - DRY BATTERIES - MANUFACTURERS
FLASHLIGHT - RADIO - IGNITION - TELEPHONE
GENERAL SALES OFFICE: HARRIS TRUST BLDG., CHICAGO
LABORATORIES AND WORKS: MADISON, WISCONSIN

BRANCHES

NEW YORK BOSTON KANSAS CITY MINNEAPOLIS
WASHINGTON PITTSBURGH ST. LOUIS NEW ORLEANS

IN CANADA

PLANTS: NIAGARA FALLS AND WINNIPEG
BRANCHES: TORONTO MONTREAL ST. JOHN

BRACH VACUUM RADIO PROTECTO R



Selected by leading engineers.
Endorsed by National Board of
Fire Underwriters.
Built to Protect—Not to Meet
a Price.



L. S. BRACH MFG. CO.

NEWARK, N. J.



MAGNET WIRE & WINDINGS

FOR RADIO

WRITE TODAY FOR PRICES AND SAMPLES

DUDLO MANUFACTURING CO., FORT WAYNE, IND.

Pacific Coast Representative

A. S. Lindstrom, 111 New Montgomery St., San Francisco, Cal.



Brandes

When Radio broadcasting began, Brandes was ready! For thirteen years, Brandes had been preparing for the public acceptance of Radio. The demand for radio reproducers increased with almost unbelievable rapidity. In keeping up with this demand, Brandes quality was never sacrificed.

When the next development in radio comes, whenever it may be, Brandes will stand ready with a tremendous organization prepared to cope with the demand. An organization carefully trained through years of experience to deliver a practical instrument of unquestioned quality.

To this end Brandes is constantly developing so that the industry may be better served.

C. BRANDES, Inc.

237 Lafayette Street

New York City, N. Y.

Matched Tone

TRADE MARK REG. U.S. PAT. OFF.

Radio Headsets

MURDOCK

Radio

Standard Since 1904

Announcing

Murdock
Hazeltine Neutrodyne*
Receiver Type CS-32

*Registered U. S. Patent Office
Licensed by Independent Radio Mfrs., Inc.
under Hazeltine Patents

Circulars and Prices
on Request

WM. J. MURDOCK CO.
CHELSEA 50, MASS.

Sales Offices:

CHICAGO

SAN FRANCISCO

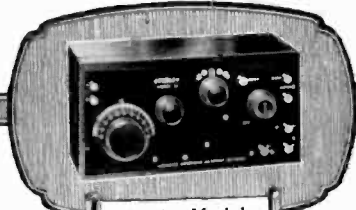

Crosley Model
\$18.50

**IN 24 DAYS THE CROSLLEY MODEL 51
Became The Biggest Selling Radio Receiver
In The World**

On Monday morning, February 4th, Powel Crosley, Jr., returned to His desk after a two weeks' hunting trip. He brought with him the idea of an entirely new Radio Receiving Set to be added to the Crosley line.

A short conference with his engineers followed. On Tuesday morning, February 5th, a model had been completed, tested and immediately put into production.

On Tuesday afternoon, February 5th, night letters were sent to the leading distributors of The Crosley Radio Corporation announcing this new Model 51. Wednesday afternoon, the orders commenced coming in. Announcements were made in leading metropolitan newspapers of the country on Saturday and Sunday, February 9th and 10th. Shipments commenced about February 13th, and were immediately followed by an avalanche of complimentary letters and orders.

Production started at 50 a day—was increased to 200—then 300—and on February 28th, just 24 days after the thought of this set had been put into being, the production reached 500 a day. Orders were received on February 28th for 1,113 of these sets—every effort being made to increase the production to 1,000 sets per day to supply the phenomenal demand for this new model.

The demand for this set has not in any way lessened the sale but has increased the orders on various other models in the Crosley line.

**NOW WHAT IS THIS SET THAT HAS MADE
SUCH AN ENVIABLE RECORD? WHICH IN 24
DAYS HAS, WE BELIEVE, BECOME THE
BIGGEST SELLING RADIO RECEIVING SET
ON THE MARKET?**

It incorporates a genuine Armstrong regenerative tuning and detection circuit, to which has been added a one-stage of audio frequency amplification. With the well-known Crosley Sheltran 9 to 1 ratio transformer, giving an unusual volume. Thus, this set uses 2 vacuum tubes.

For local and nearby stations, it will operate a loud speaker, giving phonograph volume in the home. Under reasonably good receiving conditions it will bring in stations up to 1,000 miles, with sufficient volume for the average-sized room.

When receiving conditions are bad, however, head phones should be used on distant stations.

This Receiver is unusually selective—it incorporates standard sockets so that all makes of tubes can be used.

A glance at this beautiful instrument sells it, and the results it gives create many friends for it. Perhaps the most startling thing of all is its price—\$18.50. Add 10% West of the Rocky Mountains.

Licensed under Armstrong Regenerative Patent
No. 1,113,149

THE CROSLLEY RADIO CORPORATION

formerly
The Precision Equipment Company and Crosley Manufacturing Company
461 ALFRED STREET CINCINNATI, OHIO

CROSLLEY
Better — Cost Less
Radio Products

PROFESSIONAL ENGINEERING DIRECTORY

For Consultants in Radio and Allied Engineering Fields

MONTAGUE FERRY

38 So. Dearborn St., Chicago

*Radio Apparatus
Design*

The J. G. White Engineering Corporation

Engineers—Constructors
Builders of New York Radio Central

Industrial, Steam Power and Gas
Plants, Steam and Electric Rail-
roads. Transmission Systems.

43 Exchange Place New York

Electrical Testing Laboratories

Electrical, Photometrical,
Chemical and Mechanical
Laboratories

RADIO DEPARTMENT

80th Street and East End Ave.
New York, N. Y.

Your Card here will be seen
by over 2,500 Institute of
Radio Engineers members.

Rate: Per single issue . . . \$ 5.00

Rate: Per year (six issues) 25.00

ARISTOS

"COPPERWELD" WIRE

TRADE MARK REG. U. S. PAT. OFF.

(Made by the Molten Welding Process)

**ADOPTED AND USED BY THE LARGEST
RADIO COMPANIES IN THE WORLD**

**For aerials, Copperweld has advantages over
solid copper or bronze**

Radio frequency currents, because of "skin effect," flow along the exterior of wires. The smooth exterior thickness of copper on Copperweld Wire gives it practically the same high electrical conductivity as a solid copper wire (see Letter Circular No. 62, U. S. Bureau of Standards).

Greater strength is given by its steel core. No. 14 Copperweld Antenna Wire has **50% greater strength** than No. 14 hard-drawn copper or 7-No. 22 stranded copper wires. It stays up under severe loads when copper and stranded copper wires sag and break.

For ANTENNA, No. 14 Bare Copperweld Antenna Wire
For LEAD-IN, No. 17 Rubber Insulated Copperweld Wire
For GROUND Wire, same as Lead-In Wire
For GROUNDING to earth, Copperweld Ground Rods, $\frac{1}{2}$ " diam.

Larger sizes for commercial stations

Copper Clad Steel Company

New York

San Francisco

Chicago

Mills and Main Office, Braddock P. O., Rankin, Pa.

THE DeForest name
has been in the fore-
front of radio research
for twenty-three years.
DeForest invented the
three-electrode vacuum
tube which makes
present-day radio pos-
sible. The sets and
parts made to-day by
the DeForest Company
are worthy of the
DeForest name.

DeFOREST

*Reg. U. S. Pat. Off.





Pioneers in the development of sound reproducing apparatus.

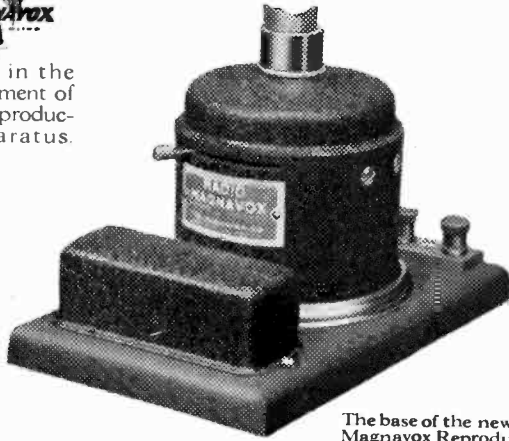

The base of the new model Magnavox Reproducer R3, showing volume control

Important features now offered in Magnavox Radio—the Reproducer Supreme

THE Magnavox electro-dynamic principle obviates the need of any mechanical adjustment to regulate the air-gap or change the position of moving parts. This famous principle of operation permits the use of an electrical volume control.

This control directly affects the character of the electrical circuit which creates the sound, controlling the sensitivity of the instrument and also its volume of reproduction.

Moreover, this electrical control produces a great saving of current (already reduced in the new R3 and R2 to a maximum of .6 ampere) for, by its action, the current value can be reduced to a minimum

of .1 ampere. The new Magnavox electro-dynamic Radio Reproducers R3 and R2, in fact, are equipped with the first true sound controlling device ever designed. See them at your dealers and write us for catalog.

THE MAGNAVOX CO.
OAKLAND, CALIF.
N. Y. Office: 370 Seventh Ave.
Perkins Electric Limited, Toronto,
Montreal, Winnipeg, Canadian
Distributors

EVEREADY

Radio Batteries

—they last longer



EVEREADY "B" BATTERY
No. 766
In the new metal case

Thirty years of Dry Cell experience and a large research organization are back of EVEREADY Radio Batteries.

There is an EVEREADY Battery for every radio need.

Dry Cell "A" Batteries—

Storage "A" Batteries—

"B" Batteries for all sets—from the smallest portable to the largest permanent installation.

"C" Batteries for improving quality of reception and increasing "B" Battery life.

Manufactured and Guaranteed by

National Carbon Company

New York—San Francisco

Headquarters for Radio Battery Information

CANADIAN NATIONAL CARBON CO., Limited.
Factory and Offices: Toronto, Ontario

DUBILIER

CONDENSERS

The Standard for High-Frequency Engineering

Fifteen years of specialized research and manufacturing experience lie behind Dubilier Condensers. As a result Dubilier Condensers are now used by practically every broadcasting, commercial and government station in the world, and in millions of radio receiving sets.

Dubilier research has kept steady pace with progress in high-frequency engineering. As new problems arise the high-frequency engineer may confidently turn to the Dubilier organization for condensers of the type that he requires.

Dubilier condensers are of many types, sizes and capacities. They range from the smallest condenser used in the home radio receiver to units as large as 3,500 KVA.

The Dubilier research organization will be pleased to design condensers for special engineering purposes.

Dubilier Condenser and Radio Corp.
48-50 West Fourth Street, New York



Dubilier 3,500 KVA
Condenser, 50,000 V.-
70 amp.

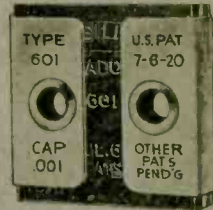

Dubilier Micadon for
Radio Reception

