

VOLUME 11

OCTOBER, 1923

NUMBER 5

PROCEEDINGS  
*of*  
The Institute of Radio  
Engineers



EDITED BY  
ALFRED N. GOLDSMITH, Ph.D.

PUBLISHED EVERY TWO MONTHS BY  
THE INSTITUTE OF RADIO ENGINEERS  
140th Street and Convent Avenue, New York, N. Y

Subscription \$9.00 per Annum in the United States  
\$9.60 in all other Countries

GENERAL INFORMATION AND SUBSCRIPTION RATES ON PAGE 457

Entered as second-class matter, February 16, 1916, at the Post-Office, at New York, N. Y., under the Act of March 3, 1879.

Acceptance for mailing at special rate of postage provided for in Section 1103, Act of October 3, 1917, authorized October 7, 1918.

27 APRIL 1976  
CO193LOT15/2000+117  
JN J. BOTKIN

# *Faradon*

**FOR SERVICE**

## **RADIO CONDENSERS**

---

**Constant Capacity  
Extremely Low Losses  
Safety Gap Protection  
High Current Carrying Capacity  
Minimum Volume  
Moisture-Proof Construction  
Long Life  
Quick Deliveries**

These are some of the reasons why radio engineers specify FARADONS.

There are over 200 standard FARADON condensers on which immediate deliveries can be made. Complete specification list and price list will be sent on request.

**Wireless Specialty Apparatus Company**  
**BOSTON, MASS.**

*Established 1907*

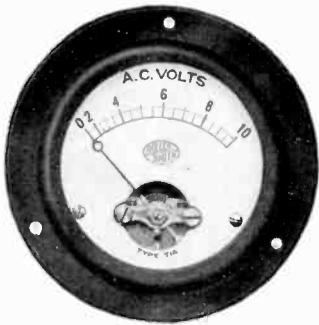

Type TIA Voltmeter, Base  
Flush Model

## A New Bulletin On Small Panel Instruments

is now ready. It covers not only our line of three and one-half inch thermal instruments, but also our lines of A. C. and D. C. Instruments in the same size cases. All ranges required in modern radio work are included.

If you use small instruments at all you will be interested in this Bulletin which gives full details. In writing us mention Bulletin No. K-10.

## ROLLER-SMITH COMPANY

Electrical Instruments, Meters and Circuit Breakers

MAIN OFFICE:  
2134 Woolworth Bldg., NEW YORK



WORKS:  
Bethlehem, Pennsylvania

*Offices in Principal Cities in U. S. and Canada*

## ACME TRANSFORMERS

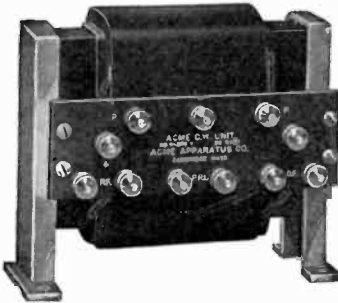

As specialists in the design and construction of Transformers we are prepared to quote prices and delivery on Transformers singly or in quantity.

Our Radio Transformers are well known for their high efficiency and ruggedness.

## ACME APPARATUS COMPANY

200 MASSACHUSETTS AVENUE  
CAMBRIDGE 39, MASS.

TRANSFORMER AND RADIO ENGINEERS AND MANUFACTURERS

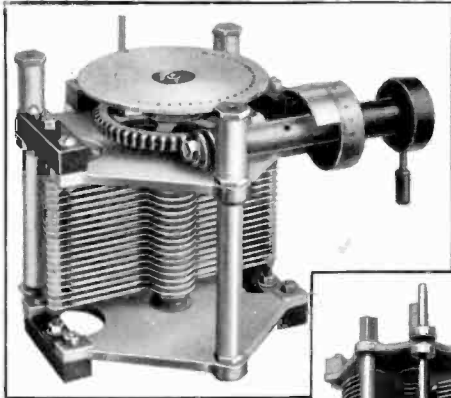

Type 222  
Precision  
Condenser

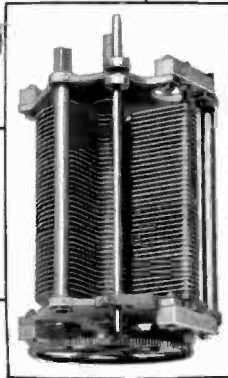

Type 246  
Variable Air  
Condenser

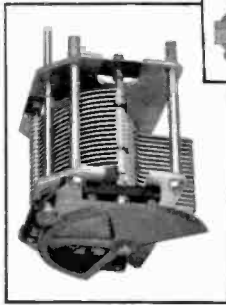

Type 239  
Variable Air  
Condenser

Type 247  
Variable Air  
Condenser

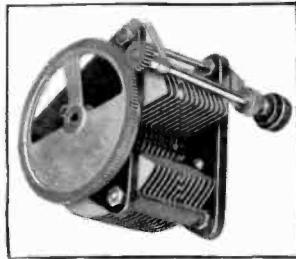

## Condensers

for every need—  
each the best in its  
field. From

\$3.25 to \$90.00

The General Radio Co. was the first in this country to supply low loss condensers commercially. For over 8 years it has maintained a research laboratory for the study of dielectric losses.

*Bulletin Recovering apparatus made by the General Radio Co. sent on request.*

# GENERAL RADIO COMPANY

*Manufacturers of Electrical and Radio Laboratory Apparatus*

Massachusetts Ave. and Windsor St. Cambridge, Mass.

5368

# Genuine PACENT Duo Lateral Coils Mounted

REG. U. S. PAT. OFF.

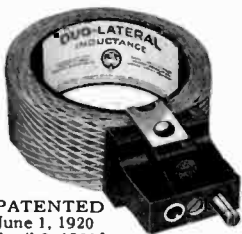

PATENTED  
June 1, 1920  
April 3, 1923

**T**HE Genuine Duo Lateral Coil, PACENT, has been recognized by authorities as the most efficient inductance.

Careful and thorough study of coil equipment requirements has resulted in the development of these new Pacent Products, *the last word in mounted coil equipment.*

## A Complete Line of Improved Coil Equipment

- I—PACENT COIL PLUG  
Cat. No. 110—Price \$1.00
- II—COIL PLUG RECEPTACLE  
Cat. No. 111—Price \$1.00
- III—MOUNTED COILS  
Prices \$1.40 to \$3.85
- IV—MICROMOUNT  
(Three Coil Mounting)  
Cat. No. 115 with base \$9.50  
Cat. No. 115A less base \$8.00
- V—MICROCOUPLE RECEPTACLE  
Cat. No. 118—Price \$2.00
- VI—PANEL RECEPTACLE  
Cat. No. 119—Price \$1.50

Send for descriptive booklet D-10 and specifications

*Don't improvise—Pacentize*

PACENT ELECTRIC COMPANY, INC.  
22 PARK PLACE NEW YORK, N. Y.

# Pacent

## RADIO ESSENTIALS



for use on a 110-volt D.C. line. Equipped with the famous Ward Leonard Vitrohm (Vitreous enamelled) Resistor Units. Literature on request.

## RADIO BATTERY CHARGER

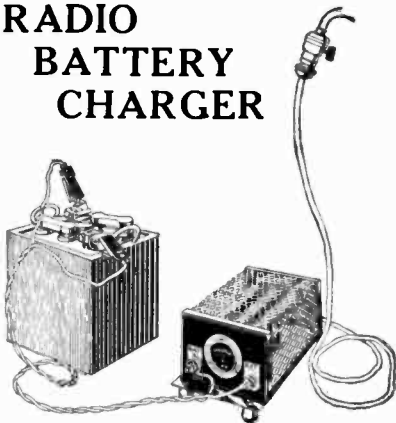

# Ward Leonard Electric Company

Mount  
Vernon  
New York



## Broadcasting Pays Its Debt to Amateur Radio

THE early experimental work of the Radio Amateur has made possible the radio concerts which thousands now enjoy.

### The GREBE "13"

*A Real Receiver for Relay Men*

Sharper Tuning                      Greater Range  
Quieter Operation

This Instrument is a refinement of the GREBE Broadcast Receiver, especially adapted to meet the requirements of long distance work on 80-300 metres.

It is significant that A. H. Grebe & Co., Inc., so closely linked with amateur radio since its earliest days, is the one company to build such an instrument for the relay man.

"If an artisan wants to do his work well, he must begin by sharpening his tools."—Confucius.

To make worthwhile DX Records one must first acquire a thoroughly efficient receiver.

*Doctor H.A.*



This Receiver successfully combines Regeneration and Tuned Radio Frequency Amplification. In the non-oscillating condition, it builds spark signals to greater volume—in the oscillating condition all spark signals and practically all "mush" notes are suppressed.



Licensed under  
Armstrong U. S.  
Pat. No. 1,113,149.

Special resistance units permit you to use any of the standard tubes in any desired combination. A tuning dial, graduated in wavelengths enables you instantly to locate a desired station.

Ask your dealer or write us for complete information.

## A. H. GREBE & CO., Inc.

72 Van Wyck Boulevard      Richmond Hill, N. Y.

Western Branch: 451 East 3rd Street, Los Angeles, Cal.

W

W

# The New Plug

## A WESTON Product

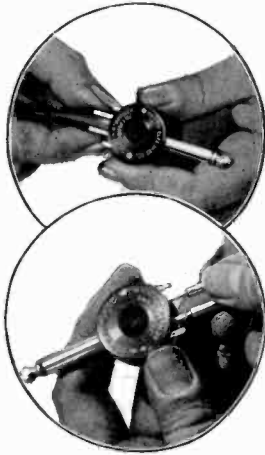

Unique—exceptionally handy—especially constructed for speed and perfect contact.

Originally designed for our own use—but is now offered to the public because of its special features.

When you are in a hurry just shove the terminals into a Weston plug—instant contact.

Or to disconnect with equal speed, press the triggers and pull out your terminals. No tools required; no broken fingernails.

A design typical of Weston workmanship.

Try one and see if this plug is not infinitely superior to any plug you have ever used.

*Buy one at your dealer's. If he can't supply you, we will fill your order direct*

Weston Electrical Instrument Co.  
72 Weston Ave. Newark, N. J.  
*Makers of the World's Standard Electrical Instruments*

Electrical  
Indicating  
Instrument  
Authorities  
Since 1888

# WESTON

STANDARD - The World Over

# The AMERTRAN

- REG. U.S. PAT. OFF. -

Price \$7

A Super Audio Frequency Amplifying  
Transformer Without Distortion

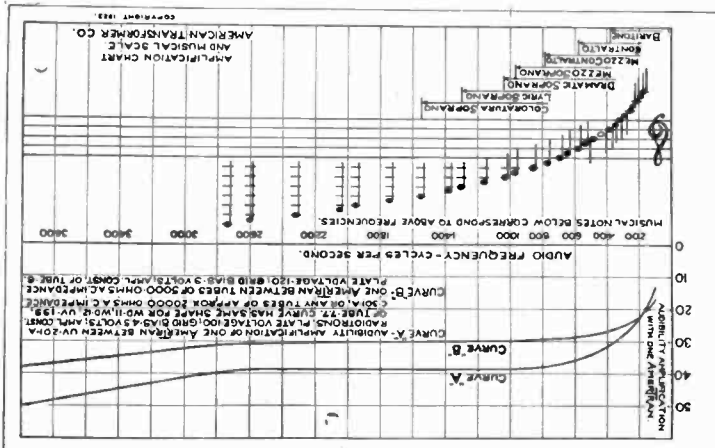

American Transformer Company

Newark, N. J.



# AMRAD

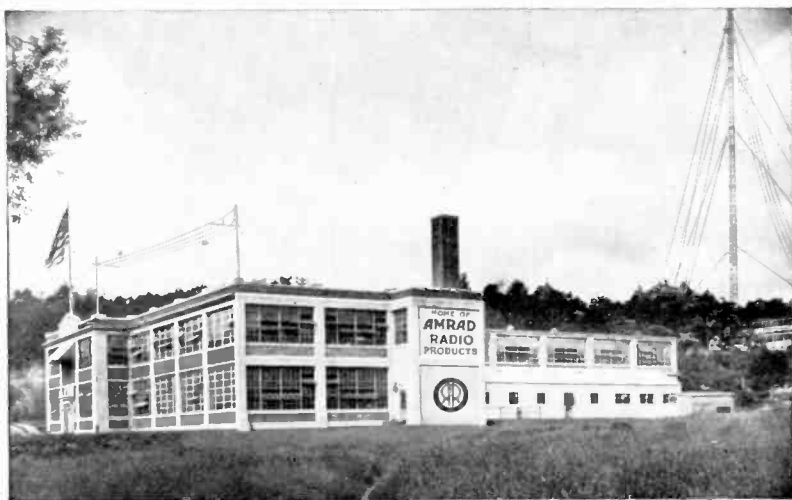

Main Factory of the American Radio and Research Corporation, Medford Hillside, Mass. Home of Amrad Radio. Showing at extreme right Research and Engineering Laboratories and Broadcasting Station WGI, erected June 1915, the World's Oldest Broadcasting Station operating to-day

## Exclusive Developments

For eight years this Corporation has specialized in the development of Radio. Among results—

The AMRAD "S" Tube—a Rectifier with NO FILAMENT TO BURN OUT.

The AMRAD BASKETBALL Variometer—a radical improvement over the conventional moulded type.



BASKETBALL VARIOMETER

Remarkably low Dielectric losses and distributed capacity.



The S-TUBE Rectifies up to 1000 volts A.C. Resulting D.C. has minimum wave ripple with ordinary filter.

**AMERICAN RADIO AND RESEARCH CORPORATION**

MEDFORD HILLSIDE, MASS.

(4 Miles North of Boston)

New York

Chicago

# 3,600,000 Radiotrons/ already made and sold!



**Radiotron  
WD-11**  
For detection  
or amplification  
\$6.50

**T**HIS one fact reveals at a glance the growth of radio! 3,600,000 Radiotrons already sold! It was the perfection of the RADIOTRON that made popularization of radio possible—and every vacuum tube set needs Radiotrons for clear reception and amplification—for sensitivity—and long distance reception.

**Radiotron  
UV-201-A**  
The super-  
amplifier tube  
\$6.50

**Radiotron  
WD-12**  
The standard base  
dry cell tube \$6.50

**Radiotron  
UV-200**  
The long distance  
detector \$5.00

**Radiotron  
UV-199**  
The little tube of  
big performance  
\$6.50



*This symbol of quality  
is your protection*

## Radio Corporation of America

Sales Department, Suite 2092  
233 Broadway, New York

District Sales Offices  
10 So. La Salle St., Chicago, Ill.  
433 California St., San Francisco, Cal.

# PROCEEDINGS OF The Institute of Radio Engineers

Volume 11

OCTOBER, 1923

Number 5

## CONTENTS

	PAGE
OFFICERS OF THE INSTITUTE OF RADIO ENGINEERS . . . . .	458
L. W. AUSTIN, "OBSERVATIONS ON LAFAYETTE AND NAUEN STATIONS IN WASHINGTON, MARCH 1, 1922, TO FEBRUARY 28, 1923" . . . . .	459
FRANCIS W. DUNMORE AND FRANCIS H. ENGELS, "A METHOD OF MEASURING VERY SHORT RADIO WAVE LENGTHS AND THEIR USE IN FREQUENCY STANDARDIZATION" . . . . .	467
CHARLES A. CULVER, "AN IMPROVED SYSTEM OF MODULATION IN RADIO TELEPHONY" . . . . .	479
Discussion on the above paper . . . . .	493
W. W. BROWN, "RADIO FREQUENCY TESTS ON ANTENNA INSULATORS" . . . . .	495
Discussion on the above paper . . . . .	523
D. C. PRINCE, "VACUUM TUBES AS POWER OSCILLATORS" (PART III) . . . . .	527
MARIUS LATOUR AND H. CHIREIX, "THE EFFICIENCY OF THREE-ELECTRODE TUBES USED FOR THE PRODUCTION OF CONTINUOUS WAVES IN RADIO TELEGRAPHY, THAT IS, THE CONVERSION OF DIRECT CURRENT INTO ALTERNATING CURRENT" . . . . .	551
JOHN B. BRADY, "DIGESTS OF UNITED STATES PATENTS RELATING TO RADIO TELEGRAPHY AND TELEPHONY; Issued June 26, 1923-August 21, 1923" . . . . .	559

## GENERAL INFORMATION

The PROCEEDINGS of the Institute are published every two months and contain the papers and the discussions thereon as presented at the meetings in New York, Washington, Boston, Seattle, San Francisco, or Philadelphia.

Payment of the annual dues by a member entitles him to one copy of each number of the PROCEEDINGS issued during the period of his membership.

Subscriptions to the PROCEEDINGS are received from non-members at the rate of \$1.50 per copy or \$9.00 per year. To foreign countries the rates are \$1.60 per copy or \$9.60 per year. A discount of 25 per cent is allowed to libraries and booksellers.

The right to reprint limited portions or abstracts of the articles, discussions, or editorial notes in the PROCEEDINGS is granted on the express condition that specific reference shall be made to the source of such material. Diagrams and photographs in the PROCEEDINGS may not be reproduced without securing permission to do so from the Institute thru the Editor.

It is understood that the statements and opinions given in the PROCEEDINGS are the views of the individual members to whom they are credited, and are not binding on the membership of the Institute as a whole.

PUBLISHED BY

THE INSTITUTE OF RADIO ENGINEERS, INC.  
140TH STREET AND CONVENT AVENUE, NEW YORK, N. Y.

EDITED BY

ALFRED N. GOLDSMITH, Ph.D.

## OFFICERS AND BOARD OF DIRECTION, 1923

Terms expire January 1, 1924; except as otherwise noted.

### PRESIDENT

IRVING LANGMUIR

### VICE-PRESIDENT

JOHN H. MORECROFT

### TREASURER

WARREN F. HUBLEY

### SECRETARY

ALFRED N. GOLDSMITH

### EDITOR OF PUBLICATIONS

ALFRED N. GOLDSMITH

### MANAGERS

(Serving until January 2, 1924)

EDWIN H. COLPITTS

LLOYD ESPENSCHIED

JOHN V. L. HOGAN

GEORGE H. LEWIS

### DONALD McNICOL

(Serving until January 7, 1925)

MELVILLE EASTHAM

JOHN H. MORECROFT

(Serving until January 6, 1926)

EDWARD BENNETT

LOUIS A. HAZELTINE

### ADVERTISING MANAGER

DE WITT V. WEED, JR.

## WASHINGTON SECTION

### ACTING EXECUTIVE COMMITTEE

#### ACTING CHAIRMAN

COMM. A. HOYT TAYLOR

Navy Department,  
Washington, D. C.

LOUIS W. AUSTIN

Navy Department,  
Washington, D. C.

#### CAPTAIN GUY HILL

War Department,  
Washington, D. C.

## BOSTON SECTION

#### CHAIRMAN

GEORGE W. PIERCE  
Harvard University,  
Cambridge, Mass.

#### SECRETARY-TREASURER

MELVILLE EASTHAM  
11 Windsor St.,  
Cambridge, Mass.

## SEATTLE SECTION

#### CHAIRMAN

J. R. TOLMIE  
University of Washington  
Seattle, Washington

#### SECRETARY

ALBERT KALIN  
University of Washington  
Seattle, Washington

#### TREASURER

ARCHIE BOLSTAD  
SEATTLE, WASHINGTON

## SAN FRANCISCO SECTION

#### CHAIRMAN

MAJOR J. F. DILLON,  
526 Custom House,  
San Francisco, Cal.

#### SECRETARY-TREASURER

D. B. MCGOWN,  
Custom House,  
San Francisco, Cal.

COPYRIGHT, 1923, BY

THE INSTITUTE OF RADIO ENGINEERS INC.

140TH STREET AND CONVENT AVENUE

NEW YORK, N. Y.

OBSERVATIONS ON LAFAYETTE AND NAUEN  
STATIONS IN WASHINGTON, MARCH 1, 1922, TO  
FEBRUARY 28, 1923\*

By

L. W. AUSTIN

(UNITED STATES NAVAL RADIO RESEARCH LABORATORY, WASHINGTON, D.C.)

(*Communication from the International Union for Scientific Radio  
Telegraphy*)

With the completion of the February observations on Nauen and Lafayette, data covering a year have been obtained, using the telephone comparator method of measurement. The comparison of the two stations mentioned is of especial interest on account of their great difference in wave length, which permits at least a first step in the study of the relation of wave length to the reception of trans-Atlantic signals.

There are three main questions to be considered: first, the determination of the correct formula for the representation of the average conditions of transmission; second, the effect of wave length on the ratio between strength of signal and atmospheric disturbance; and third, the effect of wave length on the degree of variability of signal.

For purposes of analysis, the field intensities produced by the two stations in Washington at 10 A. M. and 3 P. M. have been averaged for each month, together with the intensities of the corresponding atmospheric disturbances. The field intensities for daylight transmission over salt water, calculated from the formula:

$$E = 120 \pi \frac{I_s h}{\lambda d} \epsilon^{-\frac{0.0015 d}{\sqrt{\lambda}}} \quad (1)$$

assuming 480 amperes for Lafayette and 380 amperes for Nauen, are

$$E \text{ (Lafayette)} = 31.5 \text{ microvolts per meter}$$

$$E \text{ (Nauen)} = 15.3 \text{ microvolts per meter.}$$

The average observed field intensities of the morning observations, when daylight conditions prevail over the whole trans-

\*Received by the Editor, June 4, 1923.

mission path, at all times of the year, are 72.3 microvolts per meter for Lafayette, and 30.4 for Nauen. It is seen that these values are approximately twice those calculated, but that the ratio between the observed and calculated values is approximately the same in each case, being 2.0 for Nauen and 2.3 for Lafayette. This indicates that the relation between wave length and field intensity is expressed with a good degree of approximation by the above formula, and that the difference between observed and calculated values lies elsewhere. A part of the explanation doubtless lies in the fact that Equation 1 is based on the assumption that the wave propagation takes place over an infinite plane.

TABLE 1

AVERAGE MONTHLY FIELD INTENSITY OF LAFAYETTE  
( $\lambda = 23,400$  m.) AND NAUEN ( $\lambda = 12,500$  m.) IN MICROVOLTS PER  
METER

1922	Lafayette		Nauen	
	10 A.M.	3 P. M.	10 A. M.	3 P. M.
March.....	64.0	62.0	33.2	28.1
April.....	82.6	60.8	43.0	31.4
May.....	87.1	31.1	39.8	5.5
June.....	58.3	17.3	33.5	4.1
July.....	81.6	17.6	37.2	6.4
August.....	69.2	20.5	31.1	5.8
September.....	77.5	46.8	33.8	12.7
October.....	70.5	45.2	28.7	19.3
November.....	48.9	79.0	17.0	26.3
December.....	.....	103.0	24.0	24.2
1923				
January.....	.....	98.5	22.3	29.6
February.....	82.9	95.8	21.1	26.3
Average.....	72.3	56.3	30.4	18.3

For the spherical earth, the assumption is true only for moderate distances. For great distances the formula must be written:

$$E = 120 \pi \frac{I_s h}{\lambda r \sin \phi} \varepsilon^{-\frac{0.0015 d}{\sqrt{\lambda}}} \quad (2)$$

where  $r$  is the radius of the earth and  $\phi$  the angle between the sending and receiving stations as seen from the earth's center. For the distance from Nauen to Washington the two formulas differ by about 20 percent. It is probable also that the conditions of transmission vary somewhat from year to year, so that perhaps a closer agreement between observed and calculated values can not be expected.

For the purpose of comparing the effects of wave length on transmission, without regard to the difference in transmitting power at the two stations, the Lafayette intensities in Tables 2 and 3 have been reduced to the strength of those of Nauen by dividing the observed averages by the calculated ratio of the intensities of the two stations. In Table 2, the values of the forenoon and afternoon field intensities and of the corresponding disturbances are given, and from these are derived the variability ratios and the ratios of signal to disturbance in Table 3.

The Tables show that the forenoon signals are stronger during the spring and summer than in autumn and winter. On account of the fading, the afternoon signals are very much weaker than those of the forenoon during the late spring and summer, while in winter the afternoon signals are in general somewhat stronger than the forenoon. The afternoon atmospheric disturbances are in all months stronger than the forenoon, with the exception of April at 12,500 meters, when a powerful disturbance storm in one forenoon upset the usual ratio. The Tables indicate that while the ratio of the P. M./A. M. signals for the whole year are equal at the two wave lengths, the shorter wave fades much more in the afternoon during the strong fading season beginning earlier in the year and continuing later. It is seen that the ratio of signal to disturbance in the morning strongly favors the shorter wave, while the variability in the forenoon, that is the ratio of strongest to weakest signal in each month, is greater for the shorter wave in the ratio of 6.2 to 4. The strongest signal observed in the forenoon during the whole year for the longer wave was thirteen times as strong as the weakest, while on the shorter wave the strongest signal was twenty-four times stronger than the weakest. It has been impossible to draw definite conclusions in regard to the variability in the afternoon during the fading season as, on account of the weakness of the signals and the strength of the disturbances, both stations were below audibility a number of times. This happened much more frequently in the case of Nauen than in that of Lafayette.

TABLE 2

	$\lambda$	A. M.		P. M.	
		Signal	Disturbance	Signal	Disturbance
1922					
March.....	23,400	31.0	94	30.0	125
	12,500	33.2	33	28.1	53
April.....	23,400	40.1	160	29.5	185
	12,500	43.0	90*	31.4	48
May.....	23,400	42.4	438	15.4	990
	12,500	39.8	109	5.5	120
June.....	23,400	28.4	202	8.4	754
	12,500	33.5	87	4.1	464
July.....	23,400	39.6	191	8.5	548
	12,500	37.2	51	6.4	368
August.....	23,400	33.6	124	10.0	519
	12,500	31.1	131	5.8	440
September....	23,400	37.7	109	22.8	256
	12,500	33.8	50	12.7	132
October.....	23,400	34.5	66	22.6	162
	12,500	28.7	28	19.3	66
November....	23,400	23.6	36	38.4	55
	12,500	17.0	17	26.3	25
December....	23,400	....	30	50.0	31
	12,500	24.0	13	24.2	16
1923					
January.....	23,400	....	19	48.1	25
	12,500	22.3	9	29.6	12
February....	23,400	40.2	12	46.4	20
	12,500	21.1	6	26.3	10
Averages	23,400	35.1	123	27.4	306
	12,500	30.2	52	18.3	146

\*Disturbance; storm on morning of April 14.



TABLE 3

	$\lambda$	Signal	Dis-	A. M.	P. M.	A. M.
		P. M.	turb-	Signal	Signal	Signal
		A. M.	ance	Dis-	Dis-	Max-
			P. M.	turb-	turb-	imum
			A. M.	ance	ance	Min-
						imum
1922						
March	23,400	0.97	1.33	0.33	0.24	1.62
	12,500	0.84	1.60	1.00	0.53	8.7
April	23,400	0.74	1.15	0.25	0.16	7.5
	12,500	0.72	0.51	0.48	0.66	7.6
May	23,400	0.36	2.25	0.097	0.016	12.9
	12,500	0.13	1.1	0.37	0.046	3.04
June	23,400	0.30	3.7	0.14	0.011	5.0
	12,500	0.12	5.3	0.38	0.0089	4.6
July	23,400	0.21	2.87	0.21	0.016	2.0
	12,500	0.17	7.22	0.73	0.017	1.87
August	23,400	0.30	4.18	0.27	0.019	2.5
	12,500	0.19	3.35	0.24	0.013	2.5
September	23,400	0.61	2.34	0.35	0.089	2.2
	12,500	0.38	2.65	0.68	0.096	10.7
October	23,400	0.64	2.45	0.52	0.136	2.16
	12,500	0.67	2.36	1.03	0.292	10.8
November	23,400	1.62	1.52	0.66	0.70	2.5
	12,500	1.54	1.47	1.00	1.05	9.55
December	23,400	.....	1.03	.....	1.61	.....
	12,500	1.0	1.23	1.85	1.51	3.54
1923						
January	23,400	.....	1.31	.....	1.93	.....
	12,500	1.30	1.33	2.48	2.46	3.9
February	23,400	1.15	1.67	3.34	2.32	1.55
	12,500	1.15	1.67	3.52	2.63	8.0
Averages	23,400	0.69	2.15	0.62	0.61	4.0
	12,500	0.69	2.08	1.13	0.78	6.2

The strong disturbance and fading season, May to September inclusive, is the most interesting portion of the year to the American radio engineer, since most of the difficulties of reception from Europe occur during this period. The afternoon fading is due partly to what appears to be a local atmospheric absorption which is accentuated during the late afternoon in summer by the signal weakening which follows sunset at the European transmitting stations. The averages for these months have been taken separately from Tables 2 and 3 and are shown below in Table 4.

TABLE 4

AVERAGES IN THE DISTURBANCE AND FADING SEASON							
Wave Length	Signal A. M.	Disturbance A. M.	Signal P. M.	Disturbance P. M.	Signal P. M.	Signal Disturbance	Signal Disturbance
					A. M.	A. M.	P. M.
23,400 m.	36.3	213	13.0	614	0.355	0.212	0.030
12,500 m.	35.1	85.6	6.9	305	0.198	0.48	0.036

From this it is seen that the shorter wave fades in the afternoon 1.79 times as much as the longer. This is nearly inversely proportional to the wave length ratio which is 1.87. It also appears that the shorter wave, considering the ratio of signal to disturbance, is 2.45 times better for reception than the longer in the morning, and that the two wave lengths are practically equal in efficiency in the afternoon. The afternoon signal averages during the fading months are somewhat uncertain, for, while Lafayette could be depended on to send the U. R. S. I. signals at three o'clock, it was never quite certain that Nauven was actually sending on the days when it was not heard. On a few days, because of the pressure of other work, observations were omitted, but the importance of recording these omissions was not at first realized. These uncertainties rendered the May afternoon record of little value and also affected the early part of the June record.

The analysis for the year is somewhat at variance with the conclusions drawn from the earlier and more limited observations,

which indicated that the wave length of 23,400 meters was much superior to 12,500 meters for summer reception in Washington. It now appears that during the difficult times of reception, summer afternoons, the signal-disturbance ratio is nearly the same for the two wave lengths, but the greater variability of the shorter wave undoubtedly leaves the balance somewhat in favor of the longer. The greater variability of Nauen may be due partly to the greater distance the signal travels overland before reaching the ocean, that is, to a local absorption at the sending end. This is supported by the fact that Ste. Assise (14,500 m.) is considerably more constant in intensity.

The signal disturbance ratio in the afternoon during the fading season (as given in the Tables) represents conditions which would appear to make reception entirely hopeless at these times, but it must be remembered that the values given represent reception without any attempt to diminish the natural intensity of the disturbances by uni-directional reception, or by other means. It is also to be remembered in considering the variability of signal, that the afternoon fading in Washington is much greater than in some places farther north, but on the other hand, it is probable that in some tropical countries even worse conditions may be found.

**SUMMARY:** The results of one year's observations of the signal strength at Washington, of the Lafayette Station (23,400 m.) and the Nauen Station (12,500 m.) and of atmospheric disturbances are given in tabular form and discussed. The relative usefulness of these two wave lengths for continuous communications is analyzed.



# A METHOD OF MEASURING VERY SHORT RADIO WAVE LENGTHS AND THEIR USE IN FREQUENCY STANDARDIZATION\*

BY

FRANCIS W. DUNMORE, *Physicist*

AND

FRANCIS H. ENGEL, *Assistant Physicist*

(BUREAU OF STANDARDS, WASHINGTON, D. C.)

## I. IMPORTANCE OF WAVE FREQUENCY STANDARDIZATION

The rapid increase in the number of radio transmitting stations thruout the country and the subsequent increase in the interference produced by these stations has led to the assignment of new frequencies to these stations by the Department of Commerce.<sup>1</sup> In this new allocation the frequencies assigned to the various transmitting stations are closer together than before. These wave frequencies, in the case of the radio broadcasting stations, are 10 kilocycles apart, and the separation is even less in other classes of service. It is obvious that the effectiveness of these frequency assignments is dependent on the accuracy with which each station is adjusted to its allotted frequency, and the care with which these frequencies are maintained.

Radio inspectors and station operators will be able to maintain the stations closely on the assigned frequencies as a result of recent work by the Bureau of Standards in improving the accuracy of its frequency standards and making these standards more generally available.<sup>2</sup> Several independent methods of establishing the standard of frequency were used and satisfactory agreement between them obtained. It is the purpose of this paper to describe in detail one of the methods of frequency standardization. In this method the basis of the frequency

\*Published by permission of the Director of the Bureau of Standards of the United States Department of Commerce. Received by the Editor, July 26, 1923.

<sup>1</sup> See "Report of Second National Radio Conference" in "Radio Service Bulletin," April, 1923.

<sup>2</sup> A brief general description of this work may be found in an article by J. H. Dellinger which appeared in "Radio Broadcast," July, 1923, page 241.

determination was the direct measurement of the wave lengths of very short waves.

## II. PRINCIPLE OF METHOD EMPLOYED

The method was based on the direct measurement, in linear measure, of the wave length of very short standing waves on a pair of parallel wires. The waves thus used as a basis had a frequency<sup>3</sup> of 33,000 to 19,000 kilocycles, or wave lengths from 9 to 16 meters. The production and measurement of these waves is described in III below. Frequencies of lower values, that is, in the usual radio range, are measured in terms of these ultra-radio frequencies thru a process in which accurate frequency ratios are determined from harmonics of an electron tube generator. This process makes use of the harmonics in a low-frequency (relatively long wave) generating set, which when combined with the ultra-frequency (short wave) generating set produces a beat note in a receiving set tuned to the ultra-frequency (short wave) generating set. For example, suppose a generating set *B* (see Figure 1) to be operating at a frequency of 30,000 kilocycles (10 meters), this wave length being accurately measured and maintained by a method to be described below. Another

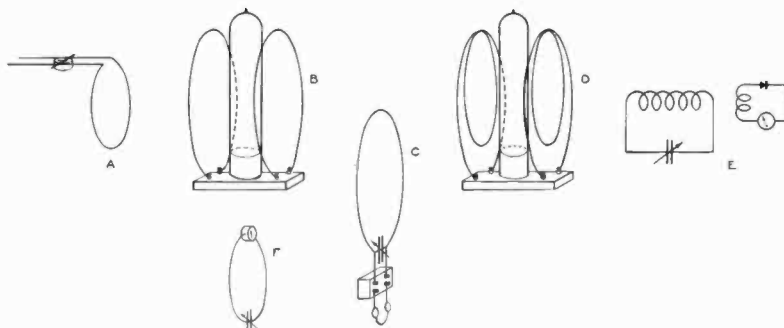

FIGURE 1—Arrangement of Apparatus for Wave-Frequency Standardization

generating set *D*, the frequency of which (wave length) may be varied from 30,000 to 1,000 kilocycles (10 to 300 meters) is put in operation near the first set *B*. A receiving set *C* placed near both generating sets is tuned to 30,000 kilocycles (10 meters). The wave length of *D* is adjusted until it is about equal to that of *B* by measuring it just as *B* was measured. When it is so

<sup>3</sup>Wave length in meters is converted to frequency in kilocycles by dividing 299,820 by the wave length. For most purposes the approximate ratio, 300,000, is sufficiently accurate.

adjusted the difference in frequency between *D* and *B* produces a beat note which is heard in the receiving set *C*. This note disappears when the exact adjustment is obtained, that is, when the two frequencies are identical. This process is known as the zero beat note method. The frequency of *D* is then gradually decreased until a second beat note is heard in *C*, and this is likewise made to disappear by exact adjustment. This beat note indicates that *D* has been adjusted to 15,000 kilocycles (20 meters), and that its second harmonic 30,000 kilocycles (10 meters), is producing a beat note with *B* which is heard at *C*. The wavemeter *E* is then adjusted to resonance with *D*, thus establishing the 15,000 kilocycle (20 meter) point on it. The frequency of *D* is further decreased until another beat note is heard in *C*. This means that *D* has been decreased to 10,000 kilocycles (30 meters), its third harmonic which is 30,000 kilocycles (10 meters) combining with *B* giving the beat note heard in *C*. The wavemeter *E* is then adjusted to resonance with *D* and establishes the 10,000-kilocycle (30 meter) point on the wavemeter. Thus by continually decreasing the frequency of *D*, the 4th, 5th, 6th, etc., up to the 30th harmonic may easily be utilized and the wavemeter *E* calibrated down to 1,000 kilocycles (300 meters). By changing the frequency of generating set *B* to 20,000 kilocycles (15 meters), the wavemeter *E* may be calibrated by a similar process down to a frequency of 300 kilocycles (1,000 meters), and so on. The method outlined above requires the following:

- A. The development of apparatus for the generation of very high frequencies or short waves.
- B. An accurate means for measuring waves of this order of length.
- C. Means for utilizing the short-wave generating set thus standardized for determining the frequency of the low-frequency generating set which in turn is used for the calibration of the standard wavemeter.

### III. APPARATUS USED

#### A. ULTRA RADIO-FREQUENCY GENERATING SET

For the purpose of making these measurements an ultra radio-frequency generating set was necessary.<sup>4</sup> The one as constructed is shown in Figure 2. Figure 3 gives the circuit diagram. Coil *C*

<sup>4</sup> See "Directive Radio Transmission on a Wave Length of 10 Meters," by F. W. Dunmore and F. H. Engel. "Bureau of Standards Scientific Paper," number 469.

\*Diameter of number 12 Brown and Sharpe gauge wire = 0.0808 inch = 0.0317 cm.

consists of a single turn 18.5 cm (7.3 in.) in diameter of number 12 Brown and Sharpe gauge copper wire\* for plate coupling and a similar turn *D* for grid coupling. The coils *C* and *D* were spaced about 3 cm. (1.18 in.) apart. *J* is a radio-frequency by-pass condenser and may also be used to vary the wave length slightly. The three-electrode tube used was rated at 50 watts. It was a coated filament type. The capacity between the elements of the tube together with the coils *C* and *D* form the oscillatory

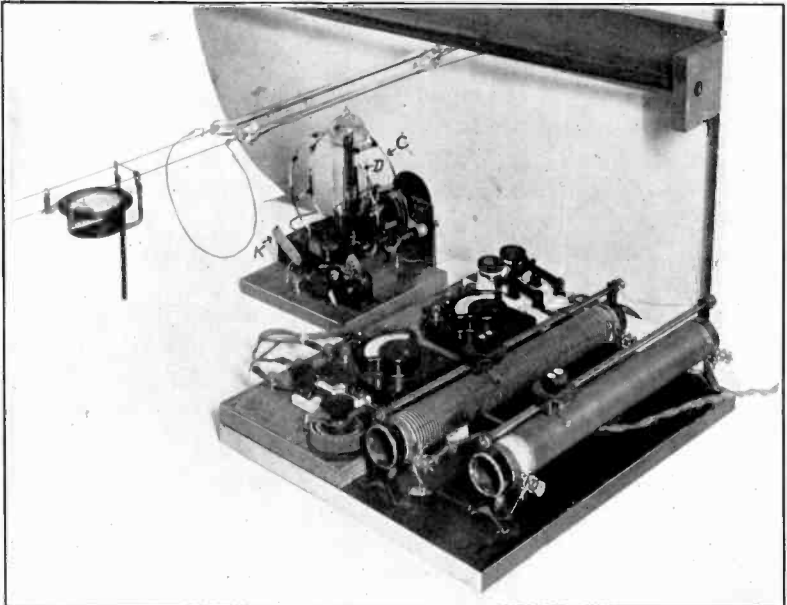

FIGURE 2—Ultra Radio-Frequency Generating Set Shown Coupled to Parallel Wire System

circuit. It is this internal capacity which determines the upper limit of the frequencies obtainable with a given tube. To keep the radio-frequency currents out of the battery circuits, three choke coils were used as shown at *K*. These consisted of thirteen turns of number 20 copper wire\* wound  $\frac{1}{4}$  inch (0.64 cm.) apart on a wooden core  $\frac{1}{2}$  inch (1.27 cm.) in diameter. These chokes were found necessary to maintain stable operation of the generating set. This generating set produced a frequency of 33,000 kilocycles (wave length of 9 meters). By connecting a variable air condenser across the grid and plate, the frequency could be decreased to 17,640 kilocycles (17 meters).

\*Diameter of number 20 wire = 0.032 inch = 0.081 cm.



## B. APPARATUS FOR MEASURING SHORT WAVE LENGTHS

The apparatus used for measuring<sup>5</sup> these ultra frequencies is shown in Figure 2.

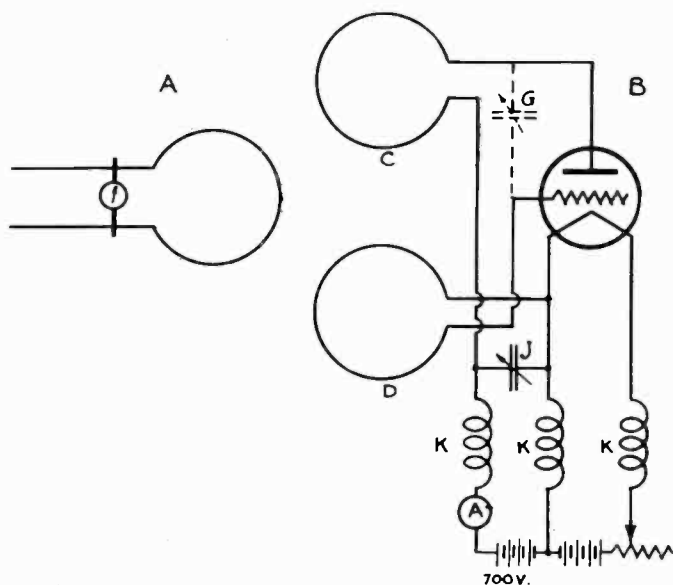

FIGURE 3—Circuit Diagram of 33,000 to 19,000 Kilocycles (9 to 16 meters) Generating Set

The parallel wire system used is shown terminating in a wire loop. The system consisted of two parallel number 14 bare copper wires† about 45 feet (13.7 m.) long strung between glass insulators as shown. The wires were separated about 4 cm. (1.58 in.) and were held under tension by means of two heavy springs (not shown). The ultra radio-frequency generating set was coupled to the looped end as shown. The apparatus to the right is the control panel, by means of which the output of the generating set is held constant. The wave length is measured by moving the thermo-galvanometer, to be seen suspended from the wires, along the wires until it shows a maximum indication of current. This point is marked on the wires and the galvanometer moved still further along the wires until a second current maximum is indicated. The distance between these two points of current maxima is one-half a wave length. If the parallel wires are sufficiently long, a number of such points may

<sup>5</sup> See "Electric Oscillations in Straight Wires and Solenoids," by J. S. Townsend and J. H. Morrell, "Philosophical Magazine," August, 1921.

†Diameter of number 14 wire = 0.064 inch = 0.0163 cm.

be found. Considerable work was done in order to find the best method of indicating the resonance point. The one finally adopted was the sliding thermo-galvanometer as shown suspended from the wires in Figure 2. It consists of a sensitive thermo-galvanometer (full scale deflection = 115 milliamperes), the terminals of which are connected to the two wires thru sliding contacts shown at the right. The two supports at the left are insulated from the instrument. An interesting point in connection with the use of this instrument at frequencies of 30,000 kc. (10 meters) was that a low resistance shunt across the terminals of the instrument greatly improved the accuracy with which this instrument could be set on the current maxima. The shunt consisted of a piece of number 14 copper wire soldered across the instrument terminals at the sliding contact. This shunt is clearly shown in Figure 2. By the use of this shunt the resistance of the circuit was materially decreased so that the sharpness of resonance was greatly improved. In fact, the point of maximum current was so critical that a movement of the galvanometer 1 millimeter (0.04 inch) either way along the wire at the point of maximum current indication gave a very noticeable decrease in deflection. With such a sensitive indicator it is apparent that the locations of the current maximum may be accurately obtained and the distance between them determined with great precision. A calibrated steel tape was used for measuring distances on the parallel wires. Several measurements of wave lengths of the order of 9 meters have shown variations of only 1 millimeter in 4.5 meters. Thus the indicating instrument may be set on the current maximum to within an accuracy of 1 part in 4,500. Much experimental work was done on the parallel wire method of wave length measurement in order to determine any possible sources of error. Measurements were made under various conditions such as different lengths of wires, different spacing between wires, different size wire, and different methods of indicating current maximum, but none of these changes influenced the accuracy of the measurements. Measurements were also made on an entirely different parallel wire system located on the roof of the radio laboratory. As a check on the method, the results of these measurements were compared with those obtained indoors on much shorter wires, by means of ultra radio-frequency wavemeter shown in Figure 4. This instrument had a range of approximately 35,000 kc. to 32,000 kc. (8.5 to 9.5 meters) and was calibrated by means of the parallel wire system located on the roof and by two different methods of indi-

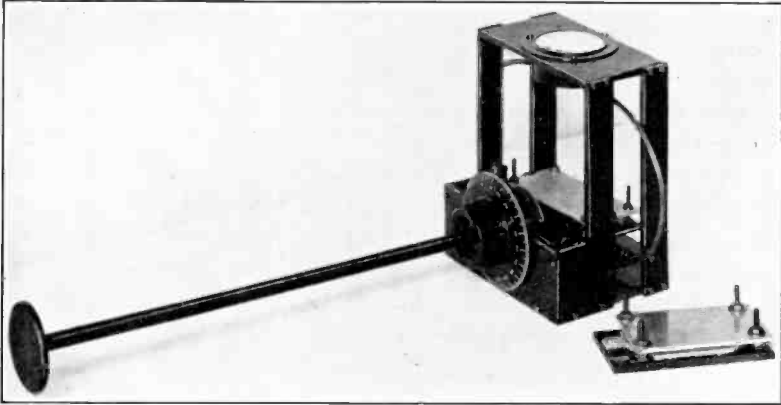

FIGURE 4—Ultra Radio-Frequency Wavemeter

ating the resonance points on the shorter parallel wire system indoors. The results of this calibration are shown in curve form in Figure 5. It will be seen from these three curves, which are practically coincident, that the parallel wire method of wave length measurement as used is reliable. This method of checking the parallel wire measurements of wave length would undoubtedly have revealed any inherent error.

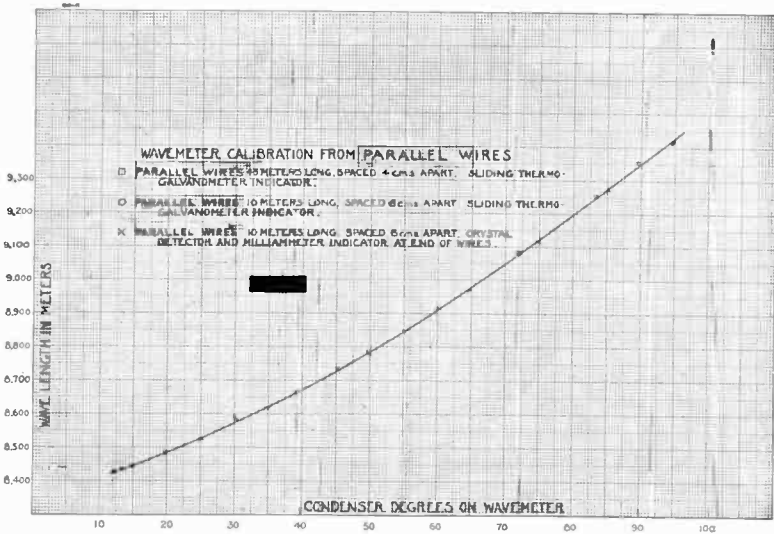

FIGURE 5

### C. ULTRA RADIO-FREQUENCY WAVEMETER

For the purpose of investigating the accuracy of the method

of wave length measurements on parallel wires and in order to keep a check on the steadiness of the frequency of the ultra radio-frequency generating set when using it to establish wave length standards, an ultra radio-frequency wavemeter as mentioned above was constructed. It is shown in Figure 4. This instrument consisted of a single turn of number 5 Brown and Sharpe gauge copper wire,\* the terminals of which were connected to a 50 micromicrofarad 2-plate variable air condenser. A fixed air condenser was connected in parallel with the variable air condenser. It consisted of two fixed plates spaced approximately  $3/64$  inch (0.12 cm.) apart. The upper plate was  $2\frac{1}{8}$  inches (5.4 cm.) by  $4\frac{5}{8}$  (11.7 cm.) inches. The lower plate was  $1\frac{3}{4}$  inches (4.43 cm.) by 4 inches (10.2 cm.). This air condenser was removable so that one of different capacity could be inserted, thereby increasing the range of the wavemeter. Such a 2-plate air condenser is shown in Figure 4 beside the wavemeter. A thermo-galvanometer is inserted in series with the single turn. It is shunted with a piece of number 14 Brown and Sharpe gauge copper wire  $1\frac{1}{4}$  inches (3.16 cm.) long. The wavemeter condenser was provided with a long handle so that the capacity effects of the operator's body were avoided when adjustments were being made.

#### D. LOW RADIO-FREQUENCY GENERATING SET

In stepping up from the wave lengths measured on the parallel wires to the longer wave lengths, ordinarily used for radio communication, a generating set rich in harmonics and variable in frequency from 300 to 16,600 kc. (18 to 1,000 meters) was employed. This is shown in Figure 6. By means of a set of interchangeable coils, the frequency may be varied over the range from 300 to 16,600 kc. (18 to 1,000 meters). A set of single-turn, two-turn, and six-turn coils are shown in the photograph. These may be easily substituted in the plate and grid circuit of the tube. The frequency may also be varied by means of three variable air condensers connected in parallel across the grid and plate of the electron tube generating set. The larger of these condensers has a capacity of 0.001 microfarad, the next 0.0001, and the smallest about 0.00005 microfarad. This latter condenser is provided with a long insulated handle so that the final adjustment for zero beat note may be more easily obtained.

\*Diameter of number 5 wire = 0.182 inch = 0.461 cm.

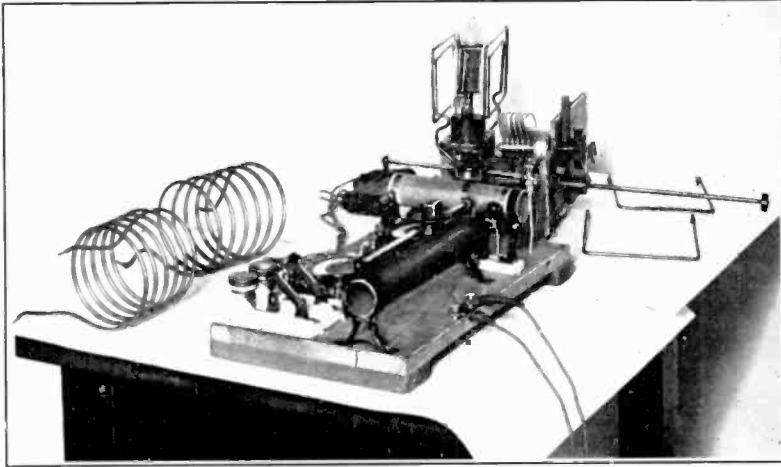

FIGURE 6—Low Radio-Frequency Generating Set

#### E. ULTRA RADIO-FREQUENCY BEAT-NOTE RECEIVING SET

An ultra radio-frequency receiving set was used for the purpose of determining when the low-frequency generating set was tuned so that one of its harmonics was equal to the frequency of the ultra radio-frequency generating set. This is shown in Figure 7. It was designed to cover a frequency range of approximately 15,000 to 37,000 kc. (8 to 18 meters). The tuning element consists of a single turn of number 12 Brown and Sharpe gauge copper wire\* connected to a 0.00025 microfarad variable air condenser, the terminals of which were connected to the input of an electron tube detector with two stages of audio-frequency amplification. This receiving set was located about five feet (1.53 m.) from the two generating sets. By tuning it to the frequency of the ultra radio-frequency generating set, confusion caused by the presence of beat notes from harmonics in the ultra radio frequency generating set, was eliminated.

#### IV. STANDARD WAVEMETER CALIBRATION

The wavemeter standardized in the course of these measurements was the standard wavemeter of the Bureau of Standards.<sup>6</sup> The following is a detailed description of the procedure employed when calibrating the standard wavemeter using the method and apparatus described above. A comparison of this calibration

\*Diameter of number 12 wire = 0.0808 inch = 0.0317 cm

<sup>6</sup> See "Standard Radio Wavemeter, Bureau of Standards Type R70-B," by R. T. Cox, "Journal of the Optical Society of America," volume 6, number 2, page 162.

with two other calibrations obtained by entirely different methods agreed within 0.2 per cent.

The ultra radio-frequency (short-wave) generating set was put into operation and its wave length accurately determined by means of the parallel wire measurements. It was found to be 9.005 meters, which is equivalent to 33,290 kc. During the course of the calibration these parallel wire measurements were repeated from time to time to insure the constancy of the frequency of the generating set *B*. The wavemeter *F* was used as a constant check on the frequency of the generating set *B*, and thus reduced the number of parallel wire measurements considerably.

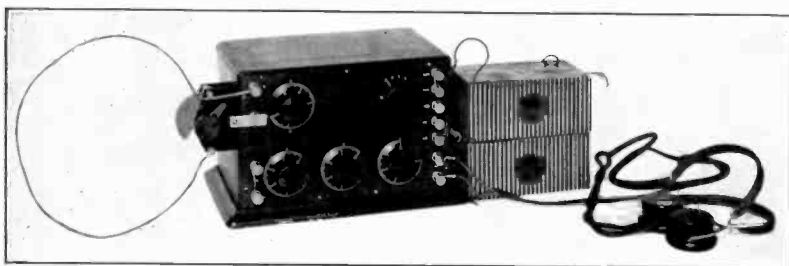

FIGURE 7—Ultra Radio-Frequency Beat-Note Receiving Set

The generating set *D*, Figure 1, was next started and its frequency adjusted to be approximately 16,645 kc. (18.010 meters) by using the parallel system. The operator using the receiving set *C* adjusted the frequency of generating set *D* until a beat note was heard. This beat note is equal to the difference in frequency between the second harmonic of generating set *D* and the fundamental of generating set *B*. Using the vernier condenser on generating set *D*, its frequency may be adjusted until the beat note becomes inaudible, thus indicating that the frequency of the first harmonic of generating set *D* is exactly equal to the fundamental of generating set *B*. From this it follows that the fundamental frequency of the generating set *D* is one-half that of the fundamental of generating set *B*, or  $= \frac{33,290}{2}$  kc. = 16,645 kc. (18.010 meters).

The wavemeter *F* which was to be calibrated was next tuned to resonance with the fundamental of generating set *D*, the beat note being held at zero. This fixed the 16,645 kc. (18.010 meter) point on the wavemeter.

To obtain the next point on the wavemeter, the frequency of

the generating set *D* was slowly decreased until a second beat note was heard at the receiving set *C*. This beat note indicated the presence of the third harmonic of the generating set *D*. No intermediate beat notes were heard because the receiving set was tuned to 33,290 kc. (9.005 meters). By careful adjustment of the generating set *D*, the zero beat note was obtained as before.

After this adjustment had been made, the fundamental frequency of the generating set *D* is one-third that of the fundamental of generating set *B* or  $\frac{33,290}{3}$  kc. = 11,096 kc. (27.015 meters). The wavemeter *E* is again tuned to resonance with the fundamental of the generating set *D*, thus establishing the 11,096-kc. (27.015-meter) point on the wavemeter.

This process was repeated until the 34th harmonic of generating set *D* was reached, giving a calibration of wavemeter *E* up to 979.2 kc. (306.17 meters). By changing the fundamental of generating set *B* to 18,367 kc. (16.324 meters) the wavemeter *E* was calibrated by the same process to a frequency of about 352.7 kc. (850 meters).

This process can be extended to calibrate a wavemeter of much greater range by decreasing the frequency of generating set *B*.

#### CONCLUSION

The direct measurement of very short wave lengths by means of standing waves on parallel wires was found to be convenient, practical and accurate. The method of setting a radio-frequency generating set on a given frequency by means of the zero beat method was found to be an extremely simple and reliable one.

This in combination with the parallel wire method of precision wave length measurement gives a combination with which wave frequency standards may be accurately determined.

Radio Laboratory,  
Bureau of Standards,  
Department of Commerce,  
Washington, D. C.  
June 27, 1923.

**SUMMARY:** The paper describes one method of establishing frequency standards employed by the Bureau of Standards which is based on the direct measurement, in linear measure, of the wave length of very short standing waves on a pair of parallel wires. The wave lengths measured were from 9 to 16 meters, the currents having frequencies from 33,000 to 19,000 kilocycles per second. The apparatus for generating these ultra radio-frequency cur-

rents is described, as well as the details of the method used in measuring the wave length of the waves which they produce on the parallel wires.

A method is described for calibrating a wavemeter at frequencies from 30,000 kilocycles to 352 kilocycles (10 to 850 meters). This method makes use of the harmonics in a second radio-frequency generating set, one of which, when combined with the output from the ultra radio-frequency generating set, produces a beat note in a receiving set tuned to the ultra radio-frequency. The zero beat note method is used to obtain an exact setting. Knowing the frequency of the ultra radio-frequency generating set by direct measurement on the parallel wires, and the order of the different harmonics being used in the second radio-frequency generating set, the frequency of the latter may be determined over the range from 30,000 kilocycles to 352 kilocycles (10 to 850 meters).



# AN IMPROVED SYSTEM OF MODULATION IN RADIO TELEPHONY\*

By

CHARLES A. CULVER

(CANADIAN RADIO CORPORATION, LIMITED, TORONTO, CANADA)

The ideal system for effecting voice modulation of the output of a radio frequency oscillation generator has not yet been devised. An approach to such an arrangement or means would be the introduction of some agency or device whereby one might vary, by means of the voice, the normal ohmic component of the resistance of an antenna system between rather wide limits, one limit being a value greater than the normal value, and the other limit being less than the normal value. Such a device should act on the *resistance* of the radiating system alone, and only affect the primary or radio frequency power circuit as a result of changing the load in the antenna. Such a modulating device should be able to produce a radical increase and decrease in the resistance of the antenna, without a great change taking place in its own constants. While there have been developed devices which will *increase* the resistance of an antenna, there has yet to be produced the device which will *decrease* the resistance of a transmitting antenna, particularly when an appreciable amount of power is involved. We must, therefore, await with interest the development of some such device or electrical organization.

## LIMITATIONS OF FORMER SYSTEMS

Turning to existing systems, we find the two modulating schemes which are the most widely used to be the "drainage" or "absorption" method and the Heising or "constant current" method.

The drainage or absorption method may be effected either by means of the so-called magnetic modulator, or by means of tubes alone. By either scheme a part of the radio frequency energy delivered by the oscillating power circuit is diverted by or absorbed in the device and hence less radiation results. A

---

\*Received by the Editor, May 23, 1923. Presented before THE INSTITUTE OF RADIO ENGINEERS, New York, June 6, 1923.

number of the larger English radiophone sets utilize the drainage system, the control being effected by means of a pyramidal bank of large tubes, which in turn are controlled by the voice. The quality of the resulting speech is excellent, but the system has the obvious disadvantage that practically as many tubes are required for modulation as are required to serve as high frequency generators.

The so-called "constant current" or Heising system, as is well known, also requires the use of as much or more tube capacity for modulation as for power. This system also gives excellent quality and deep modulation. It, however, possesses a marked disadvantage other than that due to the number of tubes required. Let us examine this particular limitation.

If it be assumed that the carrier wave is represented by the relation  $i = A \sin \omega t (1 + K \sin \bar{\theta} t)$ , Heising<sup>1</sup> has pointed out that if  $K$  be unity, that is, if complete or 100 percent modulation obtained, "The effective radio frequency power rises to a peak value of four times the non-signaling value, and has an average value of 3/2 the non-signaling value." By the integrating the complete expression for the power thruout a complete frequency cycle there results:

$$P = \frac{3}{2} \left( \frac{A^2 R}{2} \right)$$

which leads Mr. Heising to the conclusion that "The power content of the completely modulated wave is 3/2 the power content of an unmodulated wave of the same average current."

If then in operating a radiophone transmitting set we adjust our oscillating tubes to give their maximum non-signaling output, the peak load on the tubes when complete modulation obtains, will be four-fold the quiescent load, and the tubes will be subjected to an average load the magnitude of which is 50 percent greater than the non-signaling value. It is obvious that notwithstanding the fact that this heavy overload is more or less intermittent, it will, without doubt, materially shorten the life of the oscillator tubes. In power engineering, it would, of course, be considered doubtful practice to subject a generating unit to an overload of from 50 to 400 percent, even tho such a condition did not obtain continuously.

This serious overloading can, of course, be avoided, as is sometimes done, by adjusting the radio frequency oscillating circuit, so that the non-signaling power output has a value con-

<sup>1</sup>"Modulation in Radio Telephony," PROCEEDINGS OF THE INSTITUTE OF RADIO ENGINEERS, R. A. Heising, August, 1921.

siderably below the normal possible output of the tubes. This means that the amplitude of the non-signaling value of the carrier wave is less than the tubes are capable of maintaining, with the result that the range of the station is materially lessened. In short, to secure 100 percent modulation, and at the same time not seriously overload the tubes, they must be operated at reduced output.

Further, since the modulating tubes in the "constant current" system are of the same capacity as the power tubes, it usually becomes necessary, in order effectively to control the internal resistance of the modulating tubes, to introduce one or more steps of power amplification between the microphone and the modulating circuit. This is true even for tubes having a capacity as low as 50 watts. On the large broadcasting sets employing this system of modulation, a power amplifying tube having a wattage capacity comparable with the power and modulating tubes is used, and has associated with it several steps of amplification involving smaller tubes. The necessity of employing a substantial train of amplifying tubes between the microphone and the modulator tubes is, in and of itself, a serious limitation. Reference will be made to this feature in a later paragraph.

In considering any modulation system, there is naturally involved the question of the relative importance of the non-signaling amplitude of the carrier current, and the variation taking place in this due to the modulation brought about at the transmitting station. For a given amplitude of non-signaling carrier wave which may reach a receiving station, the response in the telephone receiver, is, of course, proportional to the *change in the amplitude of the carrier wave*, this in turn depending upon the modulation at the transmitting station. However, the *actual amplitude of the carrier current* is also an important factor. This is evident when we consider the relation of the amplitude of the non-signaling carrier current to the maximum change which can take place in this current. Even tho complete modulation obtains, the current amplitude cannot have a minimum value less than zero or a maximum greater than twice the non-signaling value. In short, the total change that can occur is  $2A$ , where  $A$  represents the amplitude of the non-signaling carrier current. Obviously, then, if we reduce the output of our tubes to avoid excessive overloading, the value of  $A$  will be correspondingly reduced, with the result that the maximum change,  $2A$ , will be lessened and the signal strength accordingly diminished. By the same reasoning it is also evident that one may, if de-

sired, secure the same signal strength by utilizing a somewhat greater amplitude of non-signaling carrier wave and a lesser degree of modulation. Indeed, for other reasons, it is better operating practice not to adjust the equipment to give 100 percent modulation. It will thus be seen that the *absolute value* of the non-signaling carrier current is a factor of importance, as well as the *change* in its value. This point has been a matter of considerable debate, and it possesses both general and special interest in a discussion of the limitations of the "constant current" system of modulation.

### GRID-LEAK METHOD

In order to provide a system which would not seriously overload the tubes as a result of modulation taking place, and which would at the same time reduce the total number of tubes required to effect modulation, as well as give a higher ratio of distance covered to total watts consumed, a system has been devised which in actual practice has given very gratifying results. This system falls under the general heading of types of modulation, known as the control of generation principle, or, more popularly, grid modulation.

The simple method of introducing the secondary of a modulation transformer in the grid circuit of a radio frequency power organization is well known. Such a system, however, has not been found to be entirely satisfactory for use in sets utilizing more than a few watts, and then only with high impedance tubes.

In the system to be described, and which is shown in diagrammatic form in Figure 1, the usual grid leak resistance is replaced by a three-electrode tube, and the plate-to-filament resistance of this grid-to-leak tube is controlled by means of the voice thru the usual modulation transformer connected to its grid. In this system the control tube functions as a variable resistance. The system may be utilized in connection with generating organizations, other than the well-known circuit outlined in the drawing.

The author independently worked out this system of modulation during August, 1920. It later developed that the De Forest laboratories were apparently doing some work along the same line at about the same time, and a patent<sup>2</sup> has recently been issued to C. V. Logwood covering a balanced generating circuit which incidentally incorporates a modulating scheme similar in certain respects to the one outlined in this paper. In the September

<sup>2</sup>U. S. Patent 1,440,834, filed July 2, 1921. Assignee to the De Forest Telephone and Telegraph Company.



Measurements made by means of a special electrostatic voltmeter having negligible intrinsic capacity show that, in general, as the grid leak resistance is decreased and the grid leak current correspondingly increased, the potential difference between the grid of the oscillator and the grounded side of the filament increases. In other words, the grid becomes more negative with respect to the filament. These variations in the grid potential result in corresponding variations in the effective alternating current output of the power tube.

The oscillogram shown in Figure 2 illustrates the relation of the grid or control current to the alternating current output. In securing this record an alternating current of small magnitude was passed thru the primary of the modulation transformer.

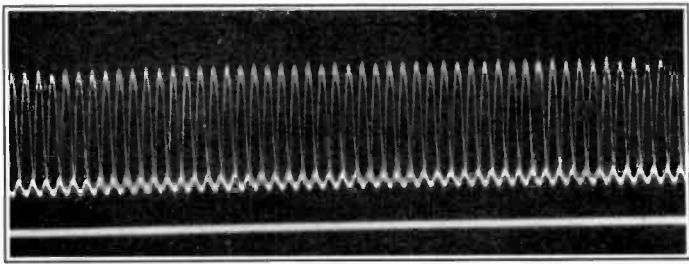

FIGURE 2—Oscillogram Showing Relation of Grid Leak Current to Alternating Current Output. Alternating Current in Primary of Modulation Transformer. Upper Curve Grid Leak Current

The upper curve shows the grid leak current, and the lower curve the corresponding radiation current as picked up and rectified in a closed resonant circuit placed near the transmitting set. Figure 3 shows the phase relations when voice control obtains.

When using a tube, having a static characteristic shown in Figure 4 as an oscillator, the constants are so adjusted that the

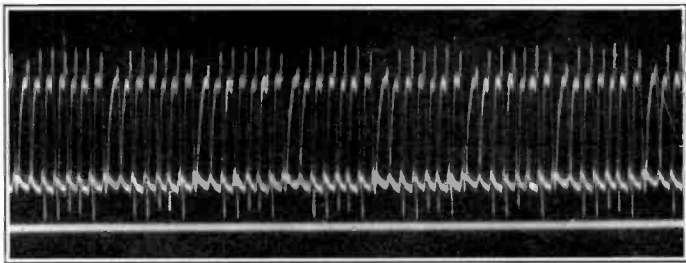

FIGURE 3—Oscillogram Similar to Figure 1, Except Voice Modulation Obtains

grid of the oscillator has a negative potential of the order of 350 to 700 volts with respect to the filament, and the grid bias of the tube which functions as a modulator is accordingly adjusted so that its operating point remains within the proper limits. The exact potential value at which the grid of the oscil-

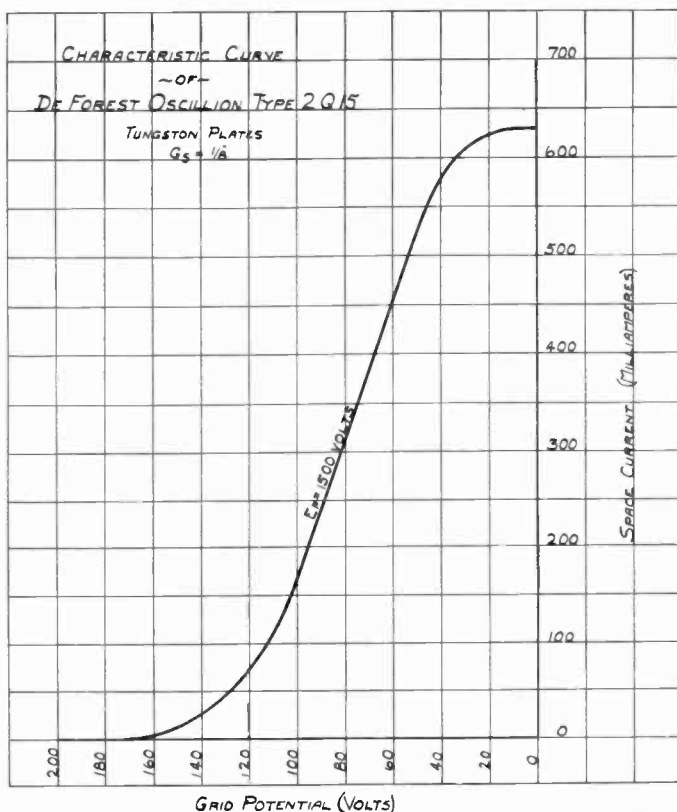

FIGURE 4—Characteristic of Power Tube, Type de Forest 2-Q-15

lating tube is held depends upon the number of power tubes being operated in parallel and upon the relation of the wave length to the antenna constants. In practice the adjustments are usually such that the average value of the oscillator grid potential is decreased when modulation is taking place, voice modulation producing a variation in oscillator grid potential of the order of 100 volts. The adjustments are commonly such that the average signaling value of the antenna current is less than the non-signaling value, the tubes being normally operated at or near their maximum output.

The characteristics of the tube used for effecting modulation by this method must obviously be of such a nature that the tube will withstand the potential developed between the grid and filament of the oscillator; it must also be able to dissipate, when in a non-oscillating condition, the heat developed by the grid-leak current.

Figure 5 shows a family of static curves for the type 1-Q-15 tubes used as modulators in the broadcasting sets, and Figure 6 the corresponding characteristics of the type D tube used as a modulator in the type 1-T sets.

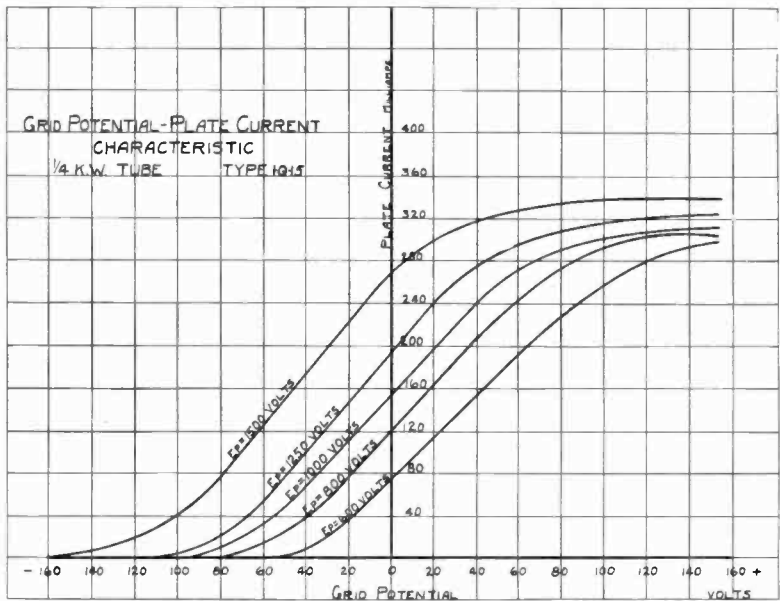

FIGURE 5—Characteristic of Modulator Tube, Type de Forest 1-Q-15

#### DESCRIPTION OF NEW EQUIPMENT

Two of the several types of actual equipment incorporating the grid-leak method of modulation, and which are in commercial operation, are shown in Figures 7 to 10, inclusive. The type 4-T units are used chiefly for broadcasting purposes, and the type 1-T for private commercial communication.

The 4-T type utilizes 4 De Forest tubes, type 2-Q-15, as oscillators, and 2 De Forest type 1-Q-15's as modulators. The power tubes are usually operated at an anode potential of 1,800 volts, and when drawing a total plate current of 0.6 to 0.7 ampere will develop from 10-12 amperes in an antenna having average



broadcasting characteristics, the output being approximately 750 watts. The grid-leak current is of the order of 125 milliamperes. Both the power and modulator tubes are operated at a constant filament potential of 15 volts, each tube being provided with a voltmeter. The plate circuit of each power tube is fused, and the filament circuit of the individual tubes may be opened by means of switches located at the lower edge of the power tube panel. This feature, combined with the adjustable inductance

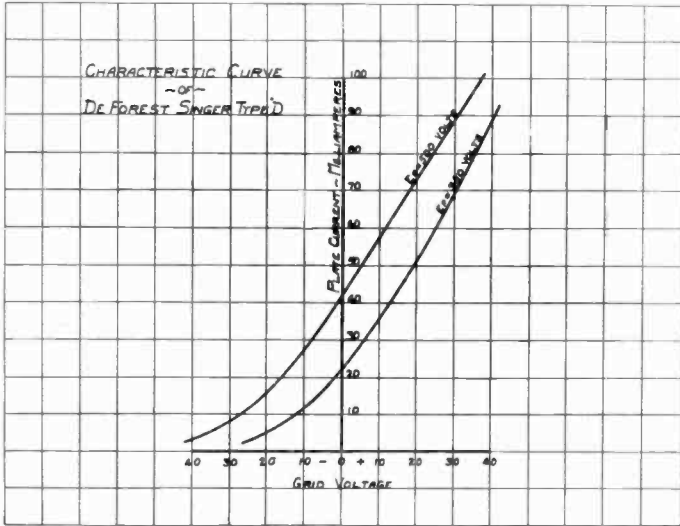

FIGURE 6—Characteristic of Modulator Tube, Type de Forest D

switch controlling the external plate impedance, makes it possible to cut out a given power tube without shutting down the set. This is a particularly valuable feature in broadcasting work. If a power tube goes out of commission during the rendition of a number in the studio, the operator at the board adjusts the plate impedance and proceeds without interrupting the transmission. If desired, he may adjust the circuit constants so that the remaining tubes will temporarily carry the full load, and thus maintain the output of the station at its normal value.

In addition to the usual anode voltage, space current, and radiation meters, a grid-leak current meter is provided, the latter serving as a modulation or control indicator.

Direct current power for these transmitting sets is supplied by a three-unit motor generator outfit consisting of a 2,000-volt, 2-commutator dynamo and a 20-volt machine for supplying the

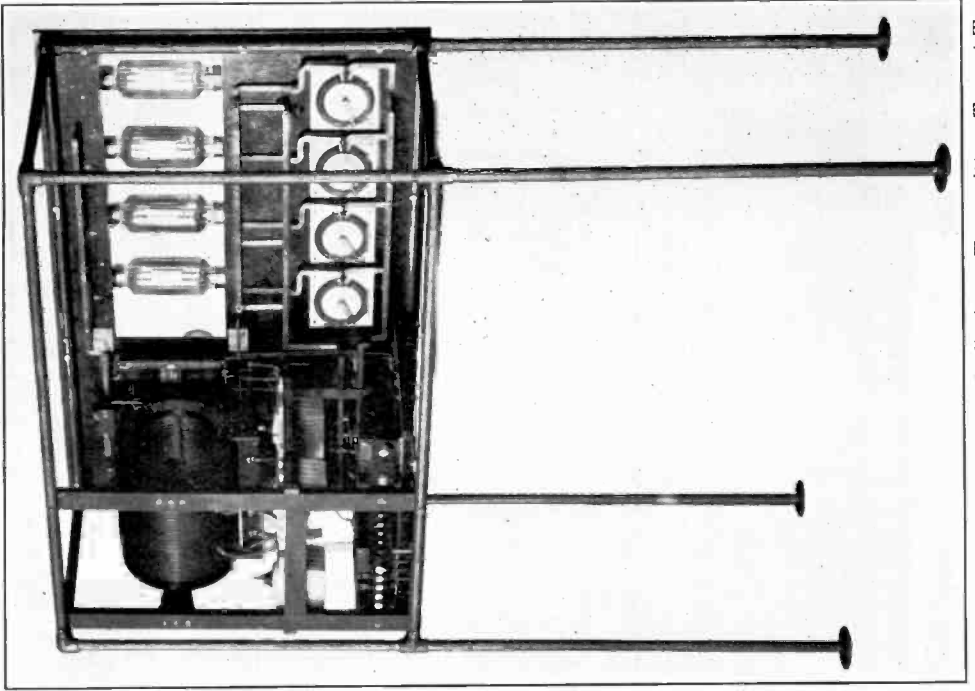

FIGURE 8—Photograph of Radiophone Transmitter, Type 4-T,  
Back View

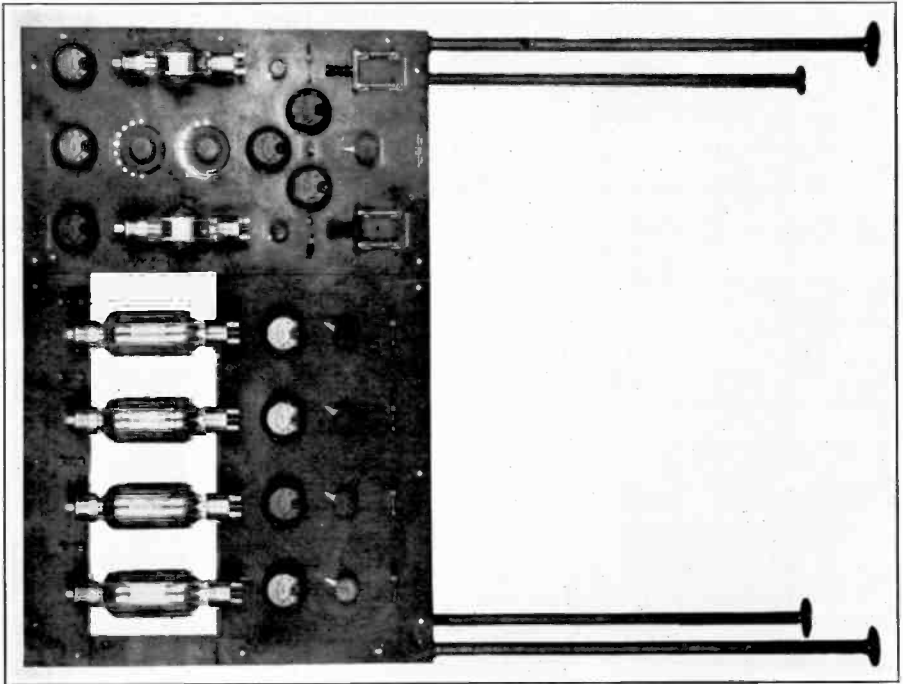

FIGURE 7—Photograph of Radiophone Transmitter, Type 4-T,  
Front View

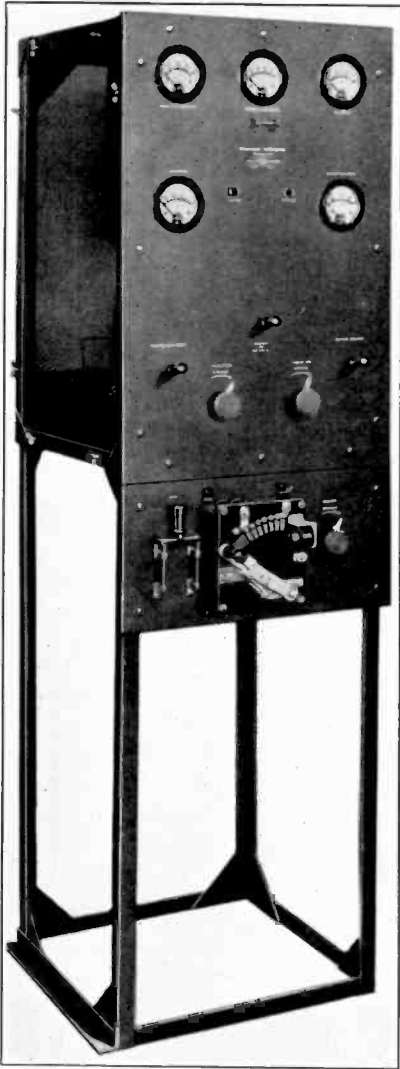

FIGURE 9—Photograph of Radiophone Transmitter, Type 1-T, Front View

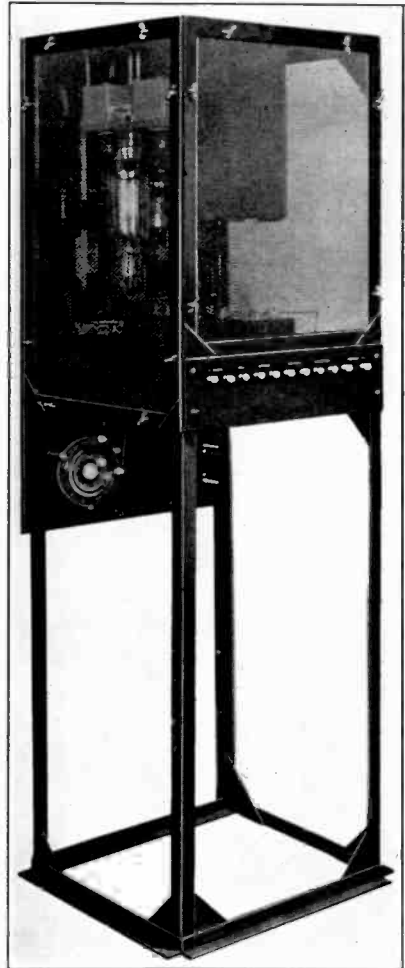

FIGURE 10—Photograph of Radiophone Transmitter, Type 1-T, Back View

filaments of the power tubes, these units being directly coupled to a driving motor of suitable capacity.

An interesting bit of radio history was written last fall, when the first one of these broadcasting sets to be installed was operated for eight hours daily during a period of two weeks at the time of the Canadian National Exhibition, without suffering an interruption.

The 1-T transmitters do not differ essentially from the type just described, except in size. This type utilizes a single De Forest 2-Q-15 tube as oscillator and a De Forest type "D" tube as modulator. This transmitting unit has a normal output of 150 to 200 watts, the antenna current being of the order of 5 amperes.

#### COMPARISON OF EFFICIENCY

This paper is entitled "An Improved System of Modulation," and the justification for such a caption will be evident from an examination of the following table:

To Deliver 500 watts to Antenna	Constant Current Method	Grid Leak Method
Power consumed by oscillator tubes.....	1,040 watts	1,080 watts
Power consumed by modulator tubes.....	312	none
Power consumed by power amplifier tubes.....	400	none
Total power consumption.....	1,752	1,080

In preparing the above table the data for the constant current system were taken from published statements regarding a well-known and widely used commercial type of broadcasting equipment.

In explanation of the third item in the table under the grid-leak method, it may be said that when using an ordinary microphone no amplification whatever of the voice currents is required. When, however, the comparatively insensitive pick-up devices

commonly employed in broadcasting are used, a 5-watt power tube is utilized as a speech amplifier. Obviously this does not add materially to the total power consumed. In making the above comparison, reference was not made in either case to the number of steps of voltage amplification employed between the pick-up and the transmitting set, for the reason that local circumstances govern this factor in both cases. However, it may be said that two steps of voltage amplification have, to date, met all requirements.

In the last analysis the convincing evidence as to the comparative merits of any system of radio communication is the transmission ratio, that is, the ratio of miles covered to total watts consumed by the equipment. Engineering tests made for the purpose of comparing the grid leak system of modulation with other methods show that the mile-watt ratio is entirely comparable, if not greater, in the case of the new system. One of the several Canadian broadcasting stations employing this system of modulation is located at Regina, Saskatchewan. The owners of that station state that a conservative average estimate of the night range would be one thousand miles (1,600 km.), and a day range of four hundred miles (640 km.). They add the statement that recently the afternoon broadcasts were heard every day for two weeks in Seattle, the distance being approximately eight hundred miles (1,280 km.), and this across the mountains. The total anode input to the set did not exceed 600 watts. It should, however, be said that conditions for radio communication in Middle and Western Canada are probably somewhat more favorable than in the eastern provinces. A night transmission ratio of 0.9 would probably be a more fair figure. That is, for every 1,000 watts consumed by the transmitting equipment, 900 miles can be successfully covered under average reception conditions.

No corresponding figures are available for the equipment using the constant current system, but judging from various published reports, and as well as from actual personal observations on the transmission from those sets, it would appear that the average night transmission ratio would not exceed 0.6. In making the above comparison we refer to the night ratio, because the greater part of the broadcasting is done then, and it is thus possible to secure more data under those conditions. It is fully appreciated that it is extremely difficult to make reliable quantitative comparisons in regard to radio transmission, but the figures are, in the case of the new system, conservative, and would

appear to indicate that it is in fact an improved system of modulation.

The ideal outlined at the beginning has not yet been attained, but an effective system of voice control has been developed which gives faithful modulation, and which materially reduces the number of large capacity tubes required for efficient radio-phone operation.

**SUMMARY:** After describing the commonly employed absorption and constant current systems of radio telephone modulation, the author discusses a system of modulation wherein the resistance in the grid circuit of the power oscillator tubes is vocally varied, this resistance being itself the plate circuit of a suitable vacuum tube. Operating data on sets embodying this method are given.

## DISCUSSION

C. V. Logwood (by letter):\* I would like to ask Dr. Culver if, in calculating the efficiency as outlined in his table of the relative power input to output as compared to the constant current method, he took into consideration the adjustment for grid potential.

In my experiments in the development of this system for the Canadian Independent Telephone Company in 1922 and the De Forest Radio Telephone and Telegraph Company in 1921, as well as my earlier work in 1917,† I have found that considerable grid current flow is very essential for modulation depth and clarity. This grid current flow must pass thru the two power tubes used as modulators with a negative biasing battery of 45 volts, in order that the grid current flow from the power tubes does not exceed the safe current flow from the grids, which I believe is 40 milliamperes per power tube. It would seem to those interested in this subject that considerable power is lost in overcoming this biasing battery voltage which performs two things: amplification and a check for the grid current.

I ask this question because one can secure maximum radiation when the grid flow from each 2Q-15 power tube does not exceed 3 milliamperes thru the proper grid leak resistance. For clarity and depth of modulation it is absolutely essential to have the full grid current flowing from each power tube and this, I believe, will lower the efficiency by 200 watts.

I would like to know if Dr. Culver has taken into consideration the relative percentage of modulation of the circuit described to the constant current method when both are modulating at a given percentage, for instance, 25 percent. That is, will it require greater power amplification in watts for 25 percent modulation using the constant current method than that which is required to modulate at the same efficiency with the parallel oscillating circuit as described in his paper?

From my own conclusion I am quite sure that the parallel oscillating circuit is not much more efficient than the constant current method after all calculations are checked up, granting an equal degree of clarity.

\*Received by the Editor, June 27, 1923.

†C. V. Logwood, United States patent number 1,397,432.





# RADIO FREQUENCY TESTS ON ANTENNA INSULATORS\*

By

W. W. BROWN

(RADIO ENGINEERING DEPARTMENT, ALTERNATOR SECTION, GENERAL  
ELECTRIC COMPANY, SCHENECTADY, NEW YORK)

With the installation of 200 kilowatt Alexanderson alternators in the New Brunswick, New Jersey and Marion, Massachusetts, radio stations, it was found that the insulators previously used in the antennas at these stations were unsuited to the new conditions. There were a number of different types of insulators available at that time, but very little information was available on their characteristics for radio frequency, high voltage, continuous wave use.

Insulators for use on radio frequency continuous wave circuits should be so designed that the dielectric flux density is very low as compared with the densities permissible in insulators for 60-cycle circuits. The reason for this is that the dielectric hysteresis loss for a given flux density is nearly proportional to the frequency for the best insulators, and the power factor<sup>1</sup> in some less perfect dielectrics increases as the square or higher power with the frequency. A type of insulator, the limitation of which on a 60-cycle circuit might be flashover or even puncture, might be unsuitable for use on a radio frequency circuit of a much lower voltage, because of heating of the dielectric.

In designing an insulator that will have a low dielectric loss at radio frequency, the following conditions need be considered:

1. The dielectric hysteresis loss is proportional nearly to the square of the flux density.
2. The flux density decreases with increasing distance between electrodes.
3. The flux density is directly proportional to the specific inductive capacity of the dielectric.

\*Received by the Editor, February 14, 1923. Presented before THE INSTITUTE OF RADIO ENGINEERS, New York, March 7, 1923.

<sup>1</sup>E. F. W. Alexanderson, "Dielectric Hysteresis at Radio Frequencies," PROCEEDINGS OF THE INSTITUTE OF RADIO ENGINEERS, June, 1914.

In considering these conditions, the desired insulator should have:

1. low flux density,
2. long distances between electrodes, and
3. be of a material which has a low specific inductive capacity.

The type of antenna insulator that most nearly fulfils these conditions is a cylindrical rod or tube the length of which is several times its diameter. This type of insulator with a dielectric of porcelain is used almost exclusively for high voltage radio antennas.

An insulator composed of a porcelain rod 2 inches (5.08 cm.) in diameter and 20 inches (50.8 cm.) long with a metal cap on each end, if subjected to high voltage continuous wave at radio frequency, would exhibit a temperature rise of the porcelain rod much higher near the fittings than near the middle. This is due to the fact that the dielectric loss is proportional nearly to the square of the density, and the density is greatest at the fittings.

The arrangement of an antenna insulator with reference to the supporting structure and the antenna proper may be such that the dielectric density at one end of the insulator is greater than at the other end. The density usually is greatest at the end next to the antenna and lowest at the grounded end. (Under certain conditions, the reverse of this relation exists.) This is because of the fact that one end of the insulator may be shielded by the surrounding structure to such an extent that the dielectric flux, which leaves the unshielded end, reaches the shielded end thru the surrounding structure and thereby reduces the density thru the dielectric at the shielded end.

This suggests the possibility of providing an electrostatic shield on one or both ends of this type of insulator to reduce the density thru the dielectric, and this has been found to be entirely feasible. By the use of these shields, the radio frequency voltage rating of insulators of this type may be greatly increased and the dielectric losses reduced.

Insulators of this type, with well designed fittings and shields, have a relatively small dielectric loss and are very satisfactory under dry weather conditions. Under wet weather or salt spray conditions, the surface leakage is high and various arrangements of shields have been provided to protect the surfaces.

A series of tests were made in Schenectady, for the Radio Corporation of America, to determine primarily the characteristics of the various available types of antenna insulators. Stand-

ard types of insulators, for other than antenna circuits, were tested to determine their suitability for operation with radio frequency, continuous wave transmitters. Subsequent tests have been made at the Radio Corporation's high power stations. Power for all these tests was supplied by 200 kilowatt Alexanderson alternators at frequencies between 18,000 and 28,000 cycles per second.

#### TEST EQUIPMENT AT SCHENECTADY

Figure 1 shows diagrammatically the circuits used at Schenectady to obtain the high voltage at radio frequency continuous waves.

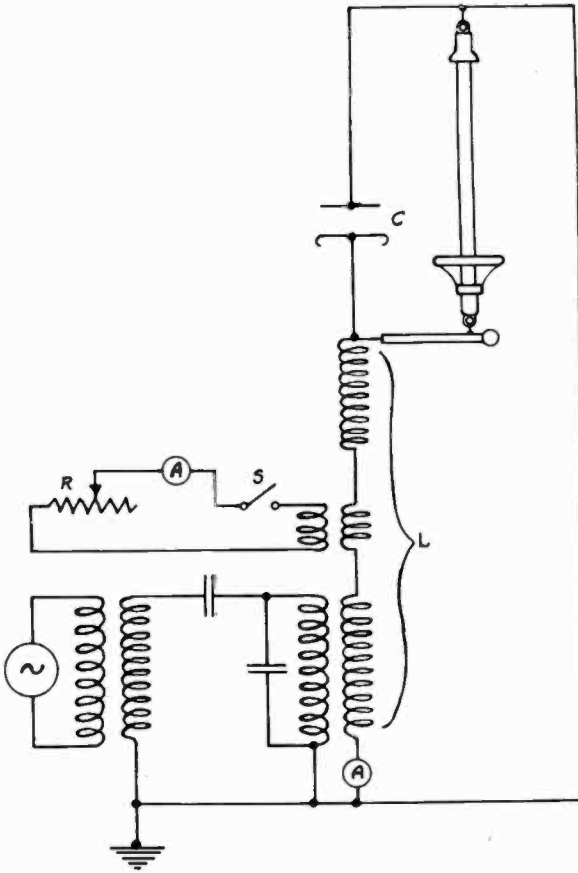

FIGURE 1

A 200-kilowatt Alexanderson alternator, thru suitable transformers and tuning condensers supplied energy to the resonant circuit *L*

and  $C$  shown in the diagram. The total inductance in the resonant circuit was 84.5 henrys, which has an inductive reactance of 11,500 ohms at 21,700 cycles. The value of  $C$ , the capacity reactance of which is 11,500 ohms at 21,700 cycles, is 0.000637 mf. The area of the lower or high voltage condenser plate was 384 sq. ft. (35.7 sq. m.). Insulators under test were suspended from the steel framework of the building. A 4-inch (10.16 cm.) diameter metal tube with a 10-inch (25.4 cm.) diameter sphere on the outer end conducted the high voltage from a point between the  $L$  and  $C$  of the resonant circuit to the insulator under test.

The test voltage was calculated by multiplying the measured current in the ground side of the resonant circuit by the measured inductive reactance  $L$  at the operating frequency.

The circuit containing resistance  $R$  was used to determine the loss in the insulator under test. The principle of measuring the insulator loss by this method is the substitution, for the insulator under test, of an artificial load circuit that will absorb the same energy from the resonant circuit that is absorbed by the insulator. The method of making these measurements was as follows: With the test insulator in circuit, frequency of the power supply was varied thru resonance and the maximum resonant current noted. The test insulator was then removed from circuit, under which condition the maximum resonant current was higher than with the test insulator in circuit, other conditions remaining unchanged. Switch  $S$  was then closed, and the calibrated resistance  $R$  was varied until the maximum resonant current was the same as with the test insulator in circuit. Under this condition, the measured current in the auxiliary circuit, squared, times the ohmic resistance was an indication of the watts loss in the insulator.

The loss in porcelain tube insulators under dry conditions was too low to measure by this method at voltages which would have been excessive for the same insulator under rain conditions. The loss in large insulators at high voltage, under rain conditions, was readily determined by this method.

Figure 2 is a photograph which shows part of the test apparatus. The condenser plate mounted on top of the inductance coil is in a fixed position. The grounded wire screen directly above the fixed condenser plate was movable and provided means to obtain resonance in the circuit over a range of frequency.

A precipitation of approximately 0.2 inch (0.5 cm.) per minute, Schenectady city water having a resistance of 3,400 ohms per centimeter cube, was used in making the rain tests.

Resistance of rain water varies between 10,000 ohms per centimeter cube in smoky atmosphere to 70,000 ohms per centimeter cube in clean atmosphere.

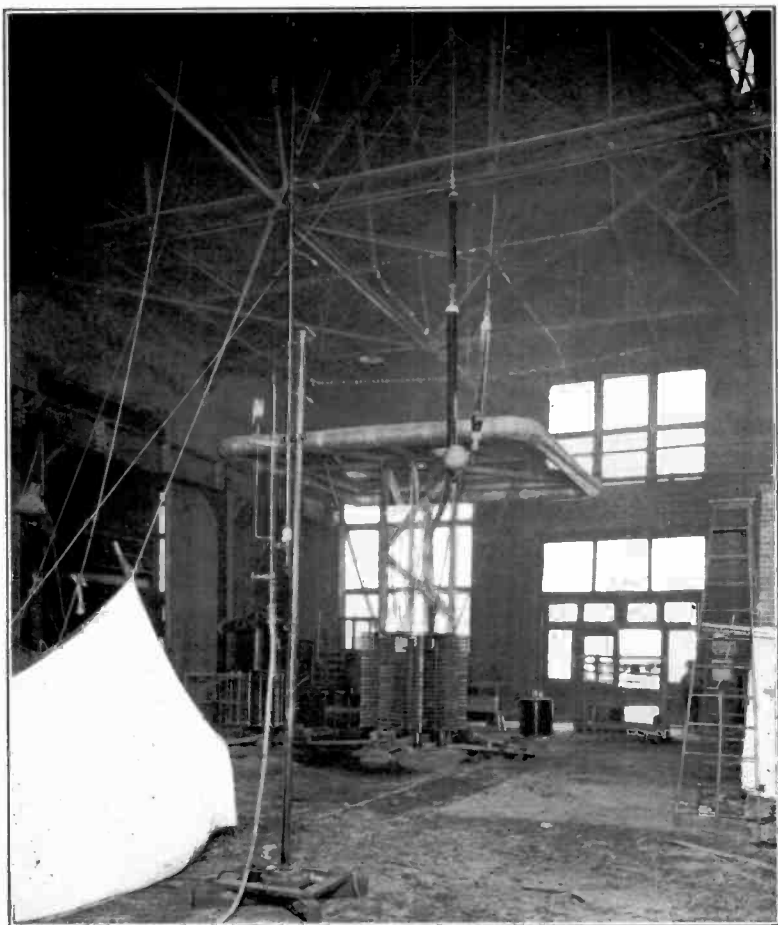

FIGURE 2

#### TEST DATA

Figure 3-A shows the heating characteristics under both dry and rain conditions of a porcelain tube having an outside diameter of 2 inches (5.08 cm.) and a clear length of 32 inches (81.4 cm.) between metal fittings. Figure 3-B shows comparable data on the same insulator, but with an electrostatic shield on the high-tension—lower—end. The effect of the shield is to re-distribute the losses along the length of the tube and to lower the flashover under rain conditions from 138 kilovolts to 125 kilovolts.

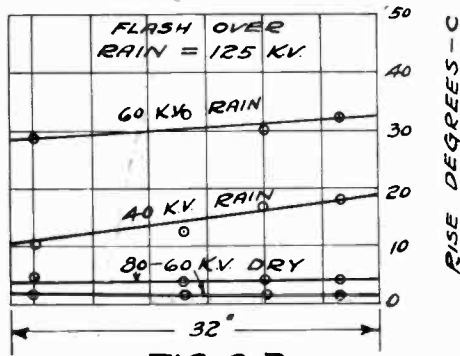
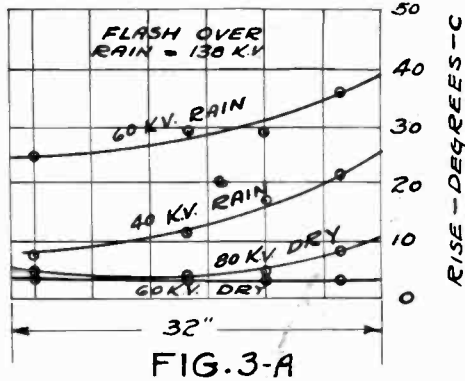
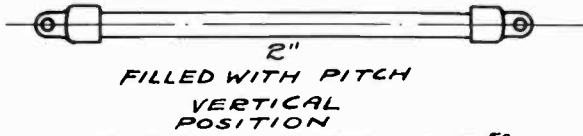

FIGURE 3

The method of obtaining these data was to apply a definite voltage for 30 minutes, the length of time for the temperatures to become practically constant. The voltage was then removed, a strip of felt attached lengthwise to the porcelain tube and thermometers placed thru holes in the felt with the thermometer bulbs against the porcelain.

Figure 4-A shows heating data under dry and rain conditions on a  $2\frac{3}{8}$  inch (6.02 cm.) by  $3\frac{1}{2}$  inch (8.89 cm.) diameter porcelain tube with a clear length of 30 inches (76.2 cm.) A 20-inch (50.8 cm.) diameter cast aluminum electrostatic shield was attached to the high voltage end. The insulator was in a vertical position.

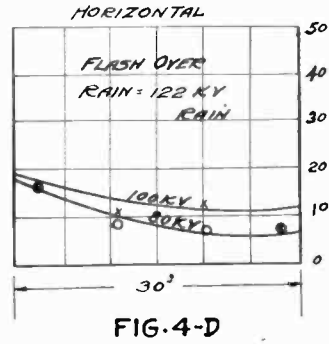
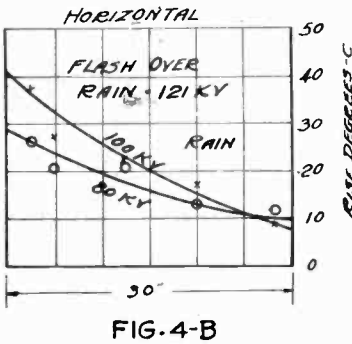
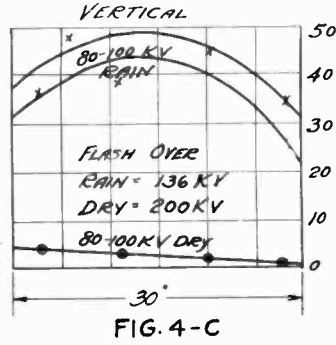
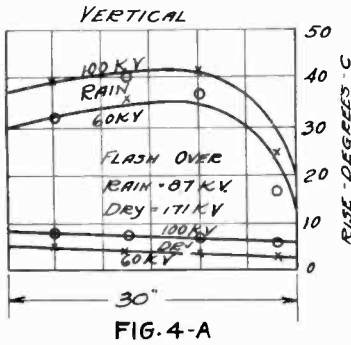
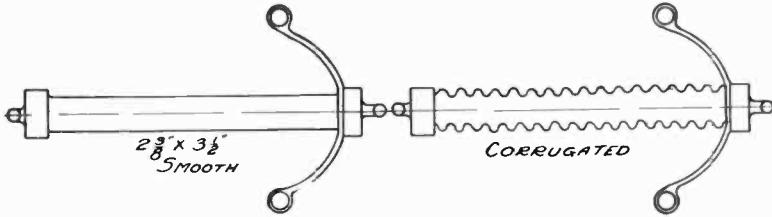

FIGURE 4

Figure 4-B shows the data on the same insulator under rain conditions, but with the insulator in a horizontal instead of a vertical position. The temperatures under dry conditions, also under rain conditions, in a horizontal position, indicate the pro-

portions of the shield and the length of the insulator are such that the losses in the grounded end are much greater than in the high potential end. The low flashover of 87 kilovolts under rain conditions with the insulator vertical, as compared with flashover of 121 kilovolts with the insulator horizontal, indicated an advantage in breaking up the water stream.

Figures 4-C and 4-D show the heating data on an insulator of the same general dimensions as the insulator shown in Figure 4-A, but having corrugations instead of a smooth surface. The indicated improvements in the corrugated tube, as compared with the smooth tube insulator are: higher flashover dry; higher flashover under rain conditions in a vertical position, and lower losses under rain conditions with the insulator in a horizontal position. Higher losses are indicated under rain conditions in the corrugated tube than in the smooth tube with the insulator in a vertical position. Since low losses are of greater importance than high flashover, the lower losses in a horizontal position are counteracted by higher losses in a vertical position with a resultant small, if any, improvement by corrugations.

Figure 5 shows heating data on a 2 inches (5.08 cm.) by  $3\frac{1}{2}$  inches (8.89 cm.) tube insulator with a clear length of 40 inches (101.6 cm.) and with a 20 inches (50.8 cm.) diameter electrostatic shield.

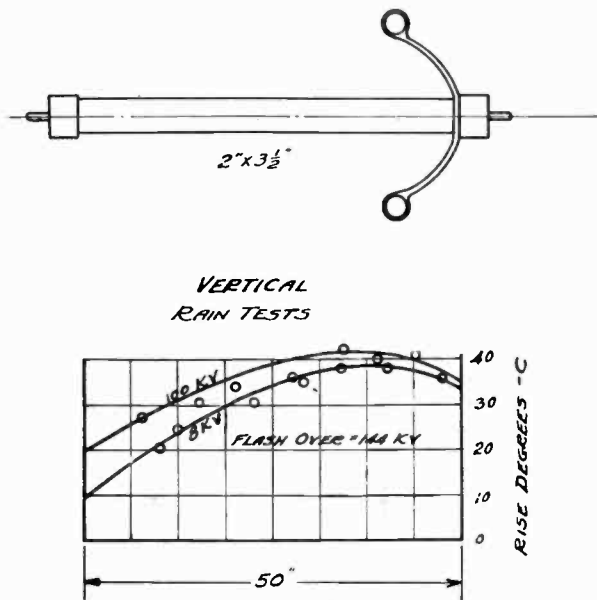

FIGURE 5



Figure 6 shows heating data on a 2 inch (5.08 cm.) by  $3\frac{1}{2}$  inch (8.89 cm.) tube insulator with a clear length of 50 inches (127 cm.) and without the electrostatic shield. The effect of the physical position of the insulator is shown.

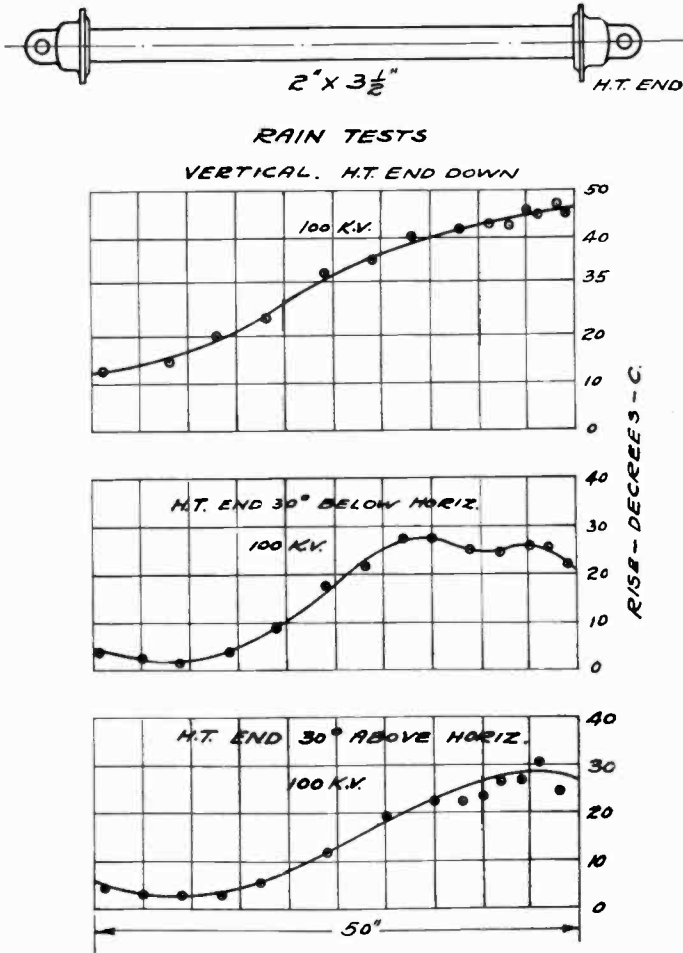

FIGURE 6

Figure 7 shows heating data on a  $2\frac{3}{8}$  inch (6.02 cm.) by  $3\frac{1}{2}$  inch (8.89 cm.) tube insulator with a clear length of 60 inches (152.4 cm.) and with the 20 inch (50.8 cm.) diameter electrostatic shield. The effect of the physical position of the insulator is shown. The loss in this insulator in a vertical position under rain conditions is estimated to be more than 500 watts

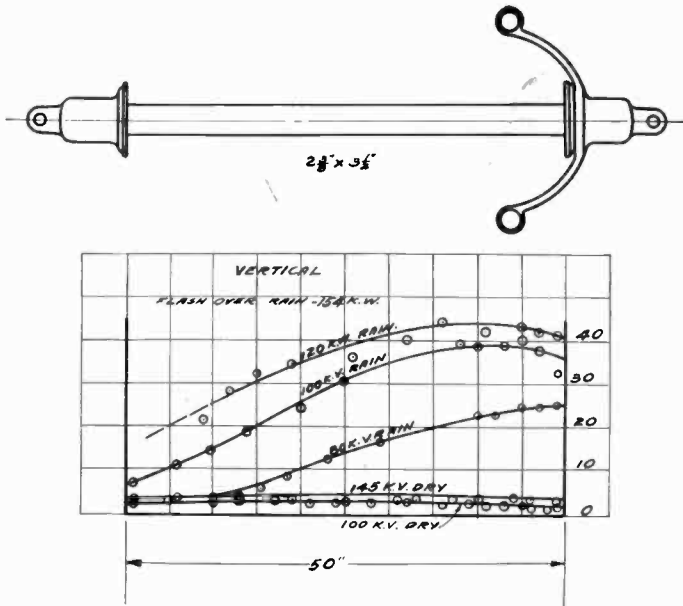

FIGURE 7

at 100 kilovolts. This estimate is based on the measured loss in the insulator shown in the next Figure.

Figure 9 shows the possibility of distributing the loss along the length of the 60-inch (152.4 cm.) porcelain tube by the use of metal electrostatic-rain shields attached to the tube. By placing these shields in a definite position along the tube, it is possible greatly to reduce and improve the distribution of losses along the entire length, under rain conditions, without impairing the distribution under dry conditions. The highest temperature rise at 100 kilovolts with the electrostatic shields on the tube is 15 degrees; with the cast shield alone is 48 degrees. The flash-over is practically the same with and without the electrostatic-rain shields. The measured loss of 360 watts, as shown in the bottom graph in Figure 9, was the basis used to estimate the loss at 100 kilovolts under the conditions shown in Figure 8.

Figures 10 and 11 show the effect of "breathers" in the metal fittings. These fittings are attached to porcelain tubes with cement which contains moisture. The cement is dried by placing the complete insulator in an oven. With the tube sealed tightly at both ends, it appears that moisture is trapped inside the tube and produces additional losses in the insulator, as indicated by the temperature data in Figures 10 and 11. It was determined

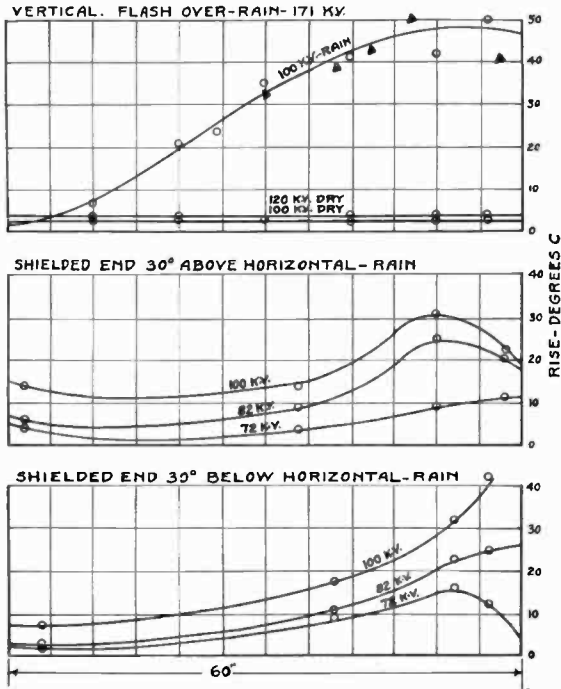
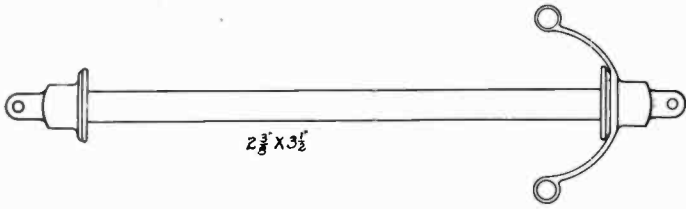

FIGURE 8

conclusively that the lower temperatures obtained with "breathers" were not due to circulation of air thru the tube. After the air inside the tube has been dried, it appears to make but little difference whether the "breathers" are open or closed. Ingenious methods have been devised by the manufacturers to provide the insulators with "breathers" that will permit the escape of moisture but prevent water from entering.

#### TUBULAR INSULATORS WITH SHIELDS AT THE RADIO CORPORATION OF AMERICA'S HIGH POWER STATION

Figure 12 shows an arrangement of salt and rain shields, designed by Mr. J. L. Finch, of the Radio Corporation of America,

to prevent rain and salt spray from depositing on the porcelain of the insulator. This was designed to meet an unusually severe

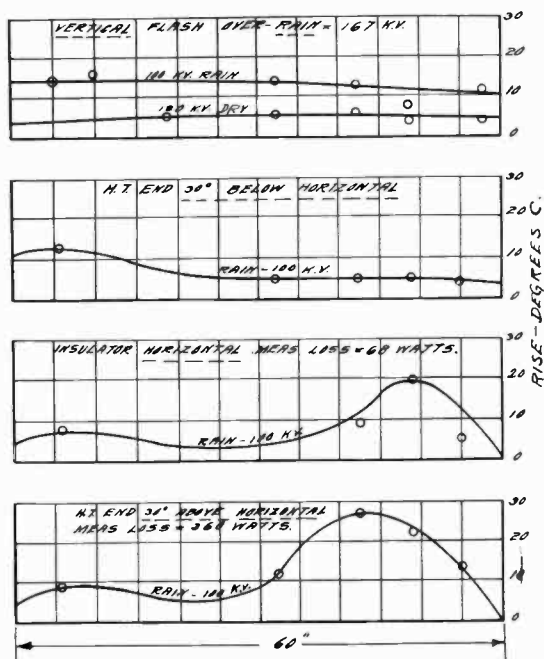
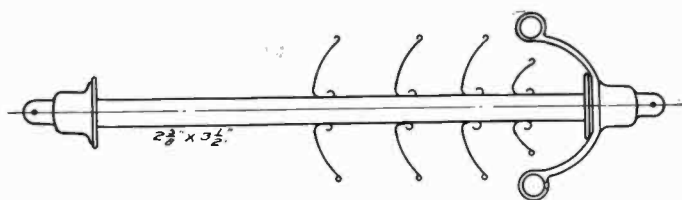
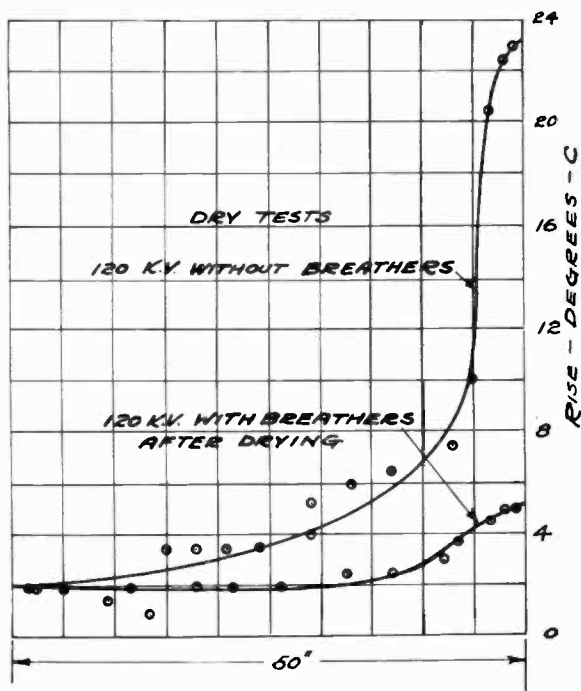
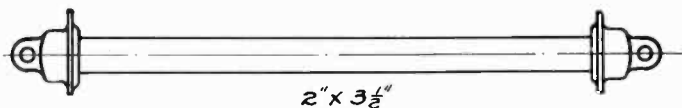

FIGURE 9

condition of salt spray at the Radio Corporation's station at Kahuku, Hawaiian Islands. From Mr. Finch's description of the conditions there, the salt spray deposits a coating of salt which does not appear harmful when the coating is dry. Under rain conditions, the deposit becomes conducting and causes the insulators to have high leakage and flashover from end to end at less than 100 kilovolts. There were no indications of corona or any sign of failure at the time the insulator with sample shields was put in service, and the insulator has now been in service for several months.



NOTE: CORONA APPEARS AT 125 KV

FIGURE 10

Figure 13 shows an arrangement of rain and electrostatic shields on antenna insulators as used at the Radio Central station. In this arrangement, there are two insulators in series between each antenna conductor and grounded support. Each of these insulators has a 40-inch (101.6 cm.) clear length of porcelain and each is fitted with a cast aluminum corona shield on the bottom and a formed aluminum rain-electrostatic shield on top. The distribution of voltage across these two insulators in series was measured by Mr. C. W. Hansell, of the Radio Corporation, and found to be approximately 75 percent of the total voltage across the unit on the high voltage side.

Figure 14 shows another arrangement of electrostatic-rain

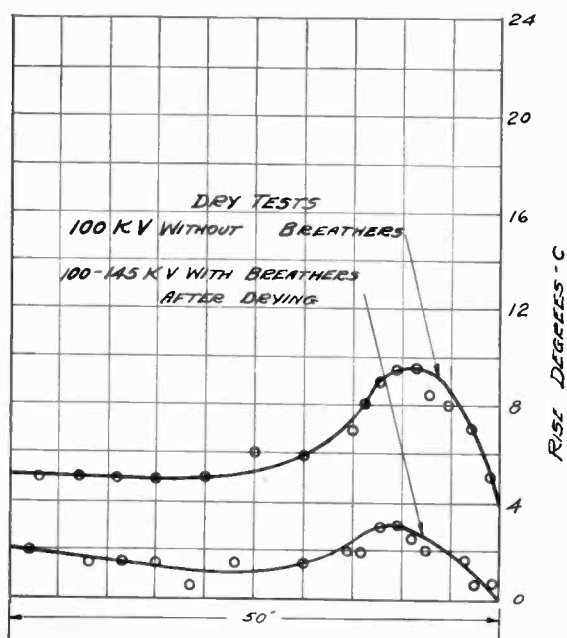
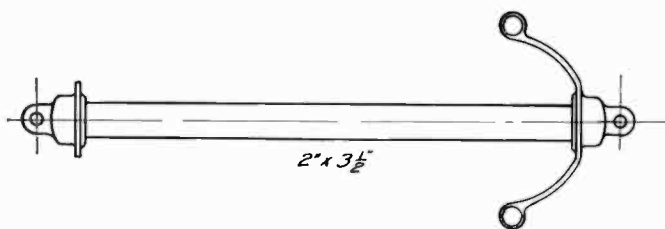

FIGURE 11

shields as used at Radio Central station on insulators having a 60-inch (152.4 cm.) clear length of porcelain.

GENERAL DATA

Figure 15 shows heating data on an insulator which has an

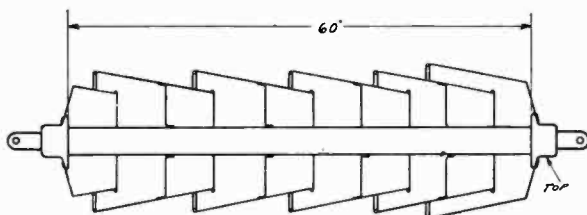

FIGURE 12—Salt and Rain Shield for Antenna Insulator

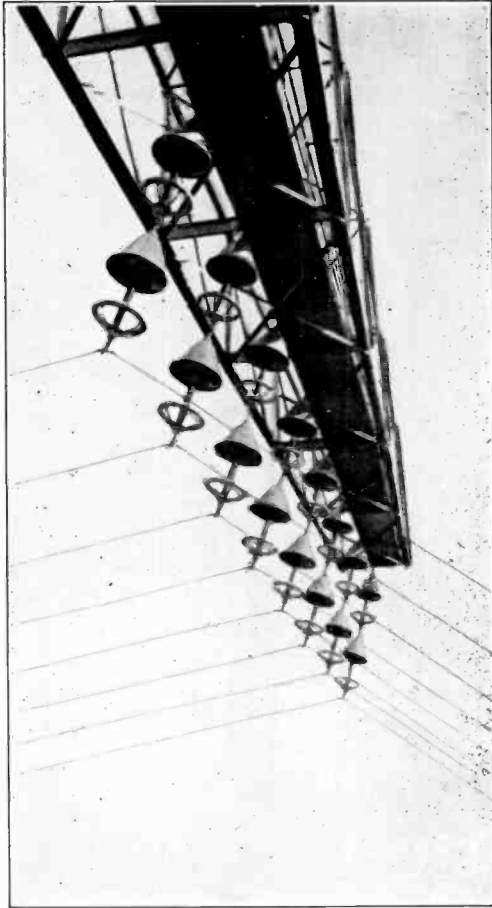

FIGURE 13

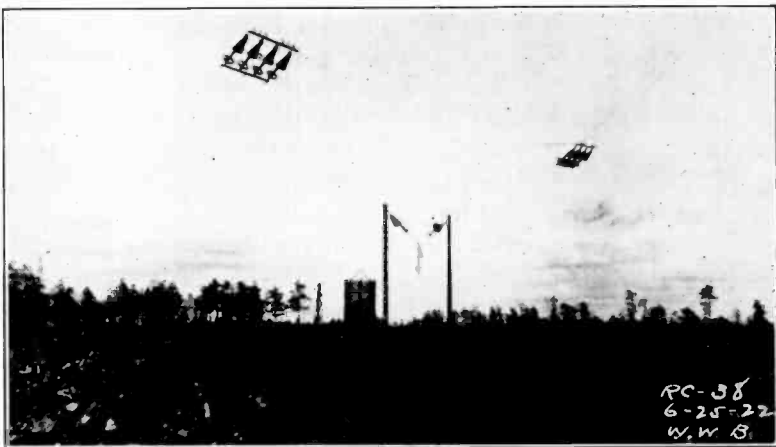

FIGURE 14

internal electrostatic shield as indicated. Under dry conditions there was no appreciable heating to 75 kilovolts; flashover occurs at 154 kilovolts. Under rain conditions there was appreciable temperature rise at 50 kilovolts and flashover occurred at 89.5 kilovolts. The temperatures indicated were obtained after an application of 87 kilovolts for thirteen minutes under rain conditions.

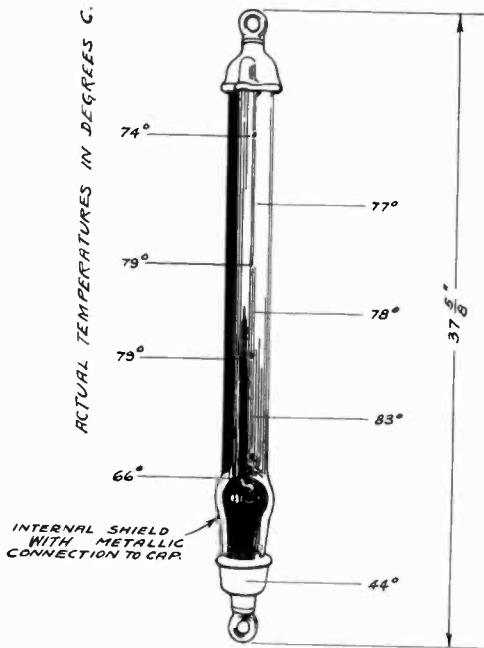

FIGURE 15

Figure 16 shows flashover of the insulator with internal shield under rain conditions.

Figures 17 and 18 show corona, leakage, and flashover values at 100,000 cycles damped wave and at 60 cycles continuous wave under dry and rain conditions on the 60-inch (152.4 cm.) tube type of insulator and the internal shield type.

Figure 19 shows the nature of failure of an insulator composed of a treated rod in the center, surrounded by a porcelain tube, and with the space between the rod and tube filled with pitch. Failure of these insulators at relatively low voltage is believed to be due to moisture in the wood or sharp corners on the metal fittings which start carbonization of the wood. Carbonization once started continues lengthwise thru the rod—not on the sur-



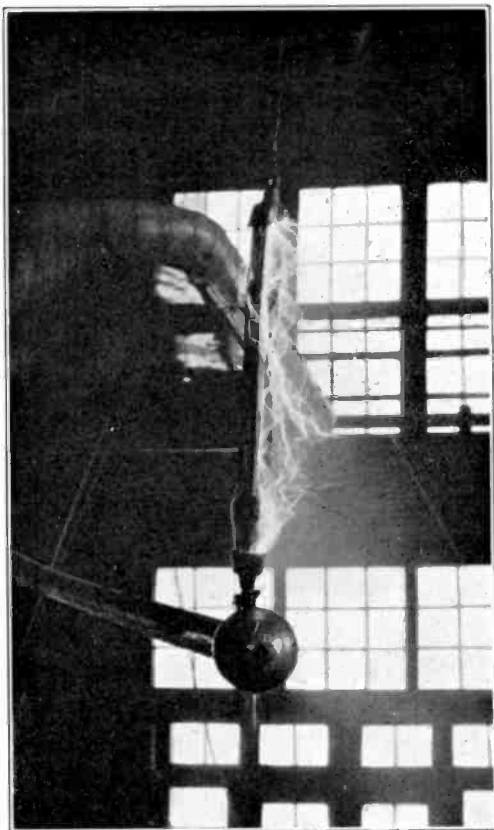

FIGURE 16

face of the rod—until breakdown occurs. This is clearly shown in the photograph.

The tubular insulator previously shown in Figure 3 does not contain the wooden rod, but has been furnished with a pitch filling. In testing, at radio frequency, samples of these insulators, a number of them exhibited characteristics of high grade insulators; others failed by leakage on the inside of the tube at relatively low voltage. These failures must have been due to entrapped moisture or impurities in the pitch.

Tubular insulators of porcelain are manufactured by wet process methods. Smaller insulators for outdoor radio service, manufactured by dry process methods, have proved unsatisfactory because of the fact that moisture is absorbed.

Tests were made on an insulator made from 1-inch (2.54 cm.) diameter manila rope five feet (152.4 cm.) long, the rope having

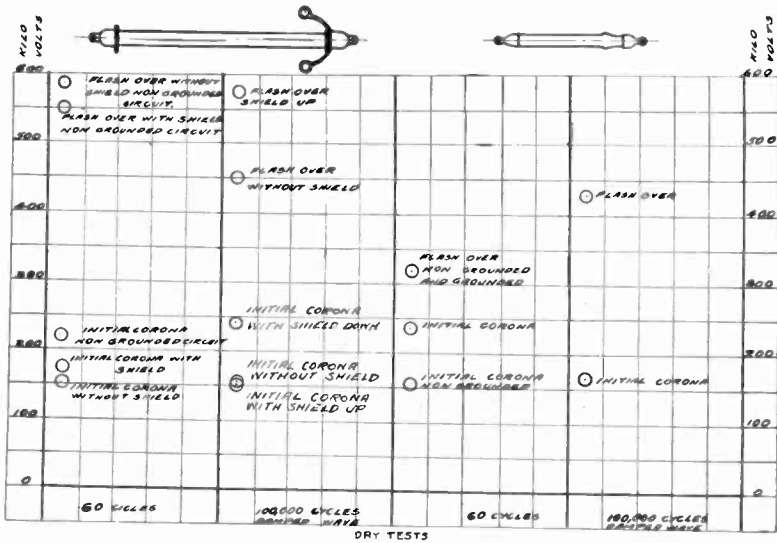

FIGURE 17

been impregnated with linseed oil by a vacuum process. The high voltage end was protected by a bell-shaped shield 20 inches (50.8 cm.) in diameter and 16 inches (40.6 cm.) long. Under dry conditions, the insulator first showed signs of stress at 91

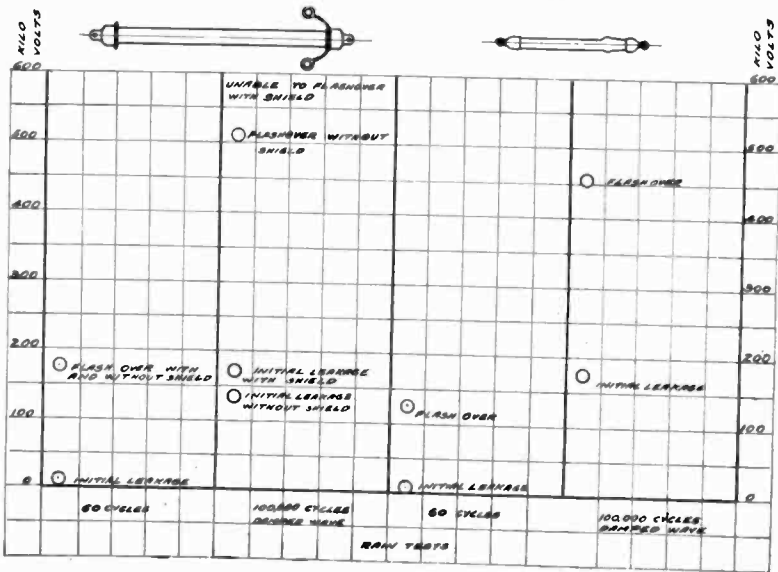

FIGURE 18

kilovolts at a section 6 inches (15.2 cm.) outside of the shield—22 inches (55.8 cm.) from the high voltage end of the rope. The point of stress was indicated by smoke. Under rain conditions at 30 kilovolts, a temperature rise of 25 degrees above water temperature was obtained, quite evenly distributed along the length of the rope. Immediately after the rain test, a 30 kilovolt

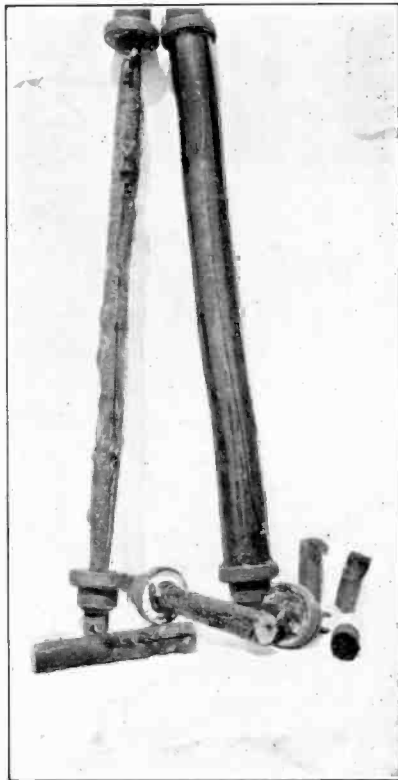

FIGURE 19

run was made for 30 minutes, after which a temperature rise of 40 degrees above air was obtained, quite evenly distributed along the length of the rope. Steam arose from the rope over its entire length and occasional sparking was observed on the surface. Under both the rain and drying conditions, apparently, the point of greatest stress was not 6 inches (15.2 cm.) outside the shield, as under dry conditions, but 8 inches from the grounded end.

Figure 20 shows various types of insulators which have and are being used for antenna insulators.

## DISTRIBUTION OF VOLTAGE ACROSS INSULATORS IN SERIES

The uneven distribution of voltage across insulators in series is the subject of a number of published articles that treat the subject quite thoroly.<sup>2</sup>

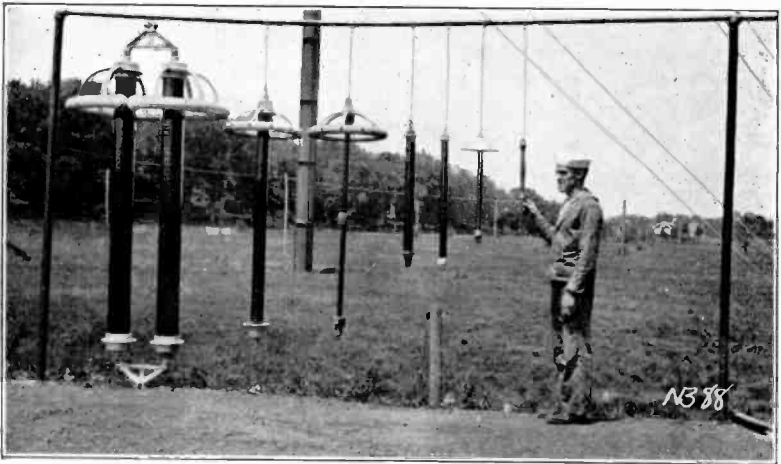

FIGURE 20

The voltage across any insulator in a series group is directly proportional to the current thru the insulator. The electrostatic capacities between the insulator fittings and the nearby ground and high voltage structures tend to cause uneven current to flow in the various insulators, as shown in Figure 21. In this Figure, condensers  $C_1$ ,  $C_2$ ,  $C_3$ ,  $C_4$ , and  $C_5$  represent the electrostatic capacities between fittings of each insulator; condensers  $C_6$ ,  $C_7$ ,  $C_8$ , and  $C_9$  represent the capacities of fittings to ground, and condensers  $C_{10}$ ,  $C_{11}$ ,  $C_{12}$ , and  $C_{13}$  represent the capacities of fittings to the high voltage structure. Capacities to ground tend to increase the current thru insulators toward the high voltage end of the string, and capacities to the high voltage structure tend to increase the current thru insulators toward the grounded end of the string. The best way to obtain a more even distribution of voltage is to increase the capacities to the high voltage structure, represented by condensers  $C_{10}$ ,  $C_{11}$ ,  $C_{12}$ , and  $C_{13}$  in this Figure.

An example of series insulators in an antenna is in the Marconi

<sup>2</sup> Baum: "Voltage Regulation and Insulation," "Journal of the American Institute of Electrical Engineers," August, 1921.

Peek: "The Insulation of High Voltage Transmission Lines," "General Electric Review," February, 1922.

Chireix: "Distribution of Voltage Along an Insulator Chain," "Radio-electricité," volume 3, number 7, July, 1922.

type antennas as originally erected at the New Brunswick and Marion stations.

A triatic was suspended between two towers, and a string of 21 compression type insulators in series was used to insulate each end of the triatic from the grounded towers. The antenna conductors were suspended from the triatic by tubular insulators. Considering the triatic insulators as a unit, it has been found by measurement that approximately two-thirds of the total antenna voltage exists across the triatic insulators and one-third across the antenna insulators.

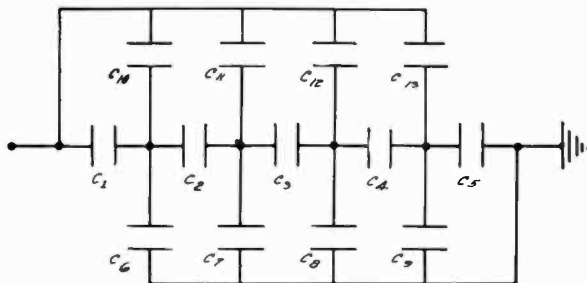

FIGURE 21

The measured distribution of voltage across the triatic insulators is shown in Figure 22 A. An arrangement of shields to re-distribute the voltage across these particular insulators was devised by Mr. J. L. Finch, of the Radio Corporation. The arrangement of shields and the re-distribution of voltage is shown in Figure 22 B.

Tests were made in Schenectady on a string of 20 of these triatic insulators to determine the general characteristics of these strings without and with shields. These characteristics were obtained on a basis of heating of the insulators rather than on voltage distribution. Figures 23 A and B show the results of these tests, which indicate that the effectiveness of the shielding arrangement devised by Mr. Finch increased the flashover and practical operating voltage threefold.

#### SUPPORTING INSULATORS, BUSHINGS, AND SO ON

Supporting insulators for operation with high voltage radio frequency continuous waves, whether for indoor or outdoor service, should be designed or chosen on the same general basis as insulators for antennas.

The built-up type of supporting insulator in which the sec-

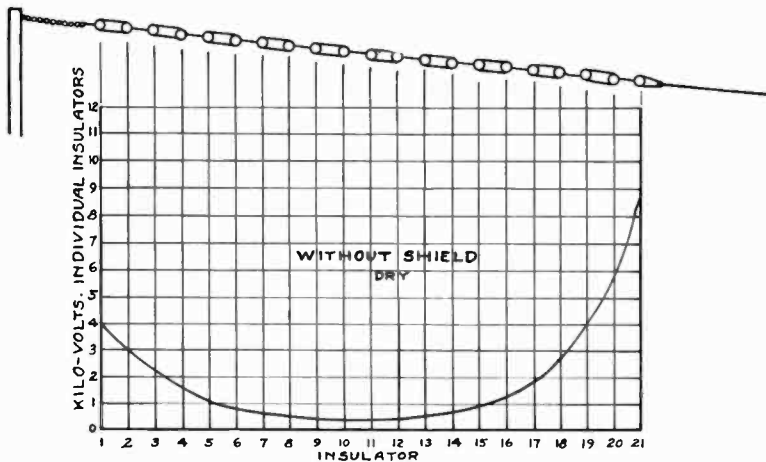

FIG. 22 A

DATA  
 ONE INSULATOR  
 DRY FLASH OVER = 16.9 KV.  
 RAIN FLASH OVER = 11.7 KV.  
 HEAT RUN-RAIN-AT 10. KV.  
 TEMP. RISE = 5°C.

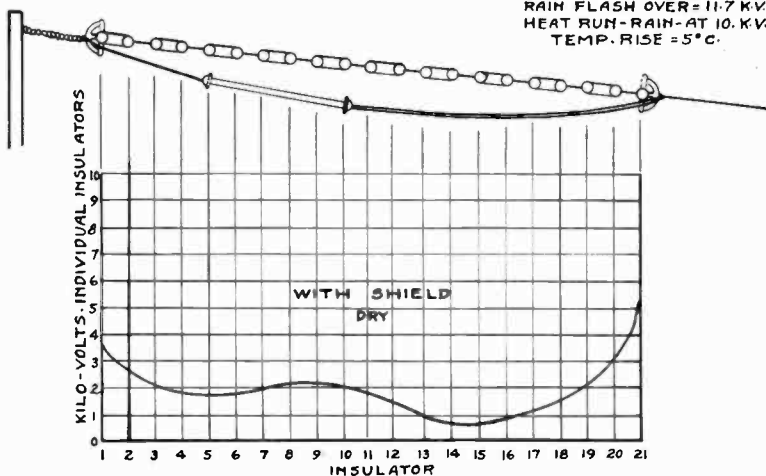

FIG. 22 B

FIGURE 22

tions are fastened together with metal fittings, are not suitable because of their relatively high flux density with the resulting high dielectric losses and the uneven distribution of voltage across the individual sections.

Figure 24 shows in outline an antenna wave change switch which has corrugated porcelain post type insulators. Spun

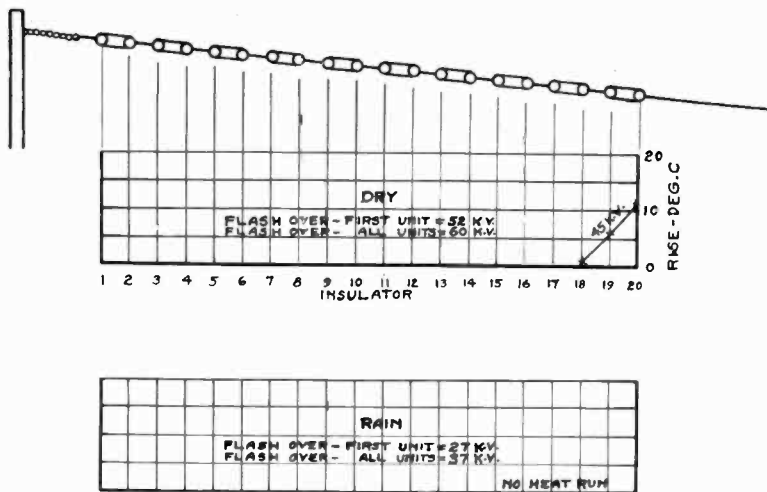

FIG. 23A

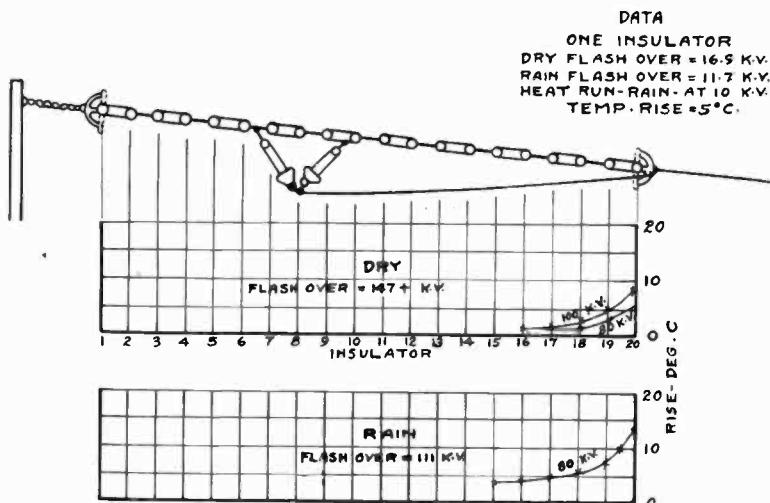

FIG. 23B

FIGURE 23

aluminum rain-electrostatic shields protect the high voltage ends of the insulators.

Figure 25 shows corona at 113 kilovolts and flashover at 119 kilovolts under dry conditions on the switch shown in Figure 24. Corona, as shown in the top photograph, is due to the small conductor used during these tests and to unprotected edges of fittings. These conditions do not exist in actual installations.

In Figure 26, the photograph at the top shows corona and leakage at 109 kilovolts on the same switch under rain conditions. The photograph at the bottom, in Figure 26, shows repeated flashover at 116 kilovolts under rain conditions. For all of these tests, the switch arm was closed in one position and grounded and the voltage applied to the open contact clip.

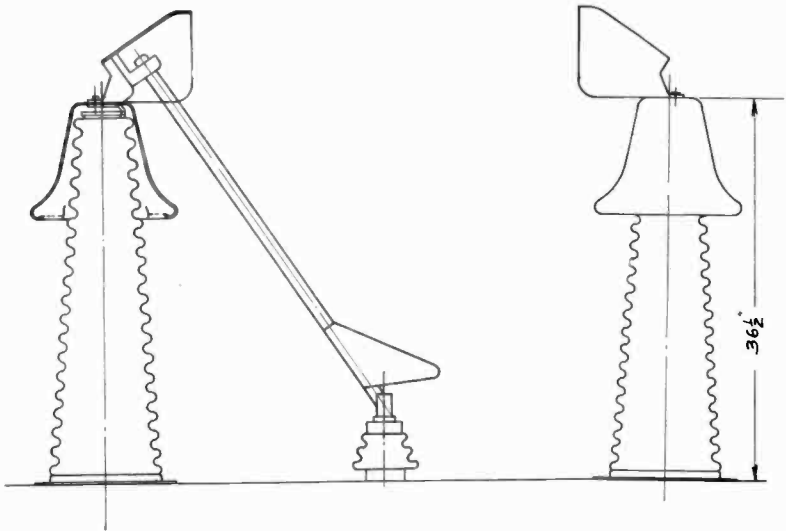

FIGURE 24

Figure 27 shows in outline several types of supporting insulators and bushings suitable for the requirements of radio circuits.

#### VISUAL CORONA POINT AT 27,000 CYCLES ON CONDUCTORS

Incidental to the insulator tests made at Schenectady, an investigation was made on conductors of various sizes to determine the critical visual corona point. A sample conductor 30 feet (9.15 m.) long under test was suspended horizontally at an average height of 15 feet above ground. A large semi-circular metal plate—grounded—was placed near the center of the 30 foot (9.15 m.) span of wire to simulate a mast of the New Brunswick type. The usual corona point was determined on each size of conductor at distances from 1 to 8 feet (30.5 cm. to 244 cm.) between the wire and the mast. Figure 28 shows the results of these tests. Under the conditions of the test, it is considered that the mast determined, to a large extent, the corona point for the short distances, but that, for the longer distances, the effect



of the ground beneath the wire was the determining factor. These factors should be taken into account in applying these data to antenna conditions. The shielding effect between multiple wires in an antenna will tend to increase the corona point.

The tests referred to in this paper were made at the direction of Mr. E. F. W. Alexanderson. I wish to take this opportunity to acknowledge with thanks the helpful co-operation of Mr. C. H. Taylor, Mr. J. L. Finch, and Mr. C. W. Hansell, of the Radio

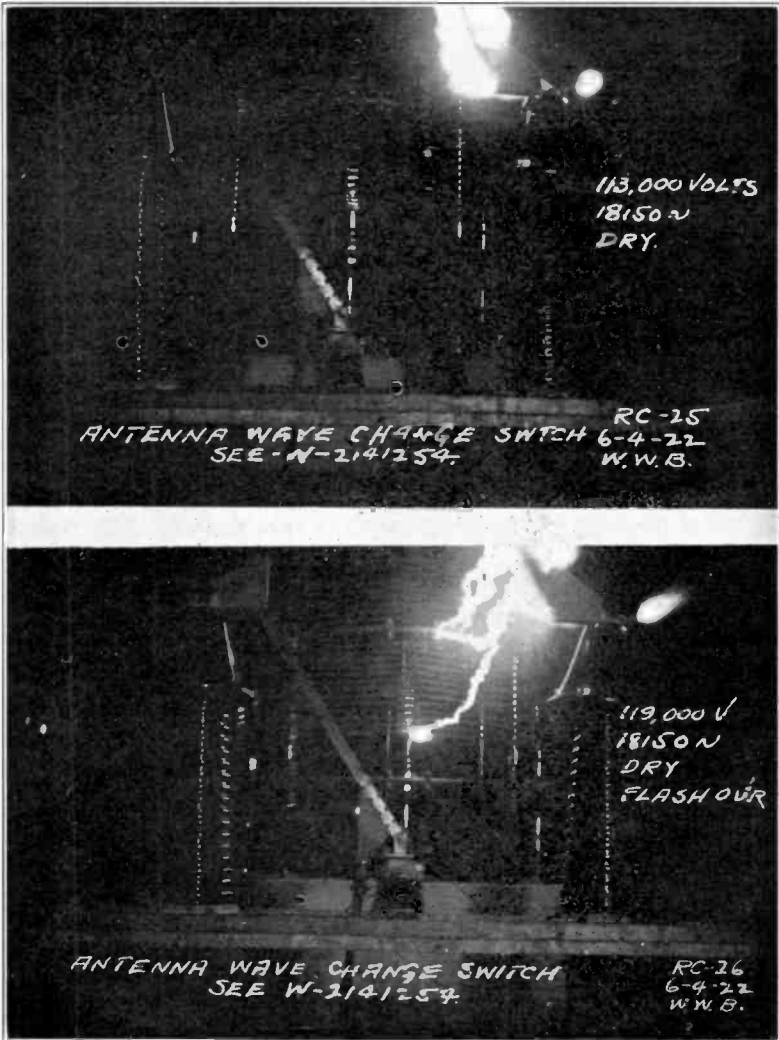

FIGURE 25

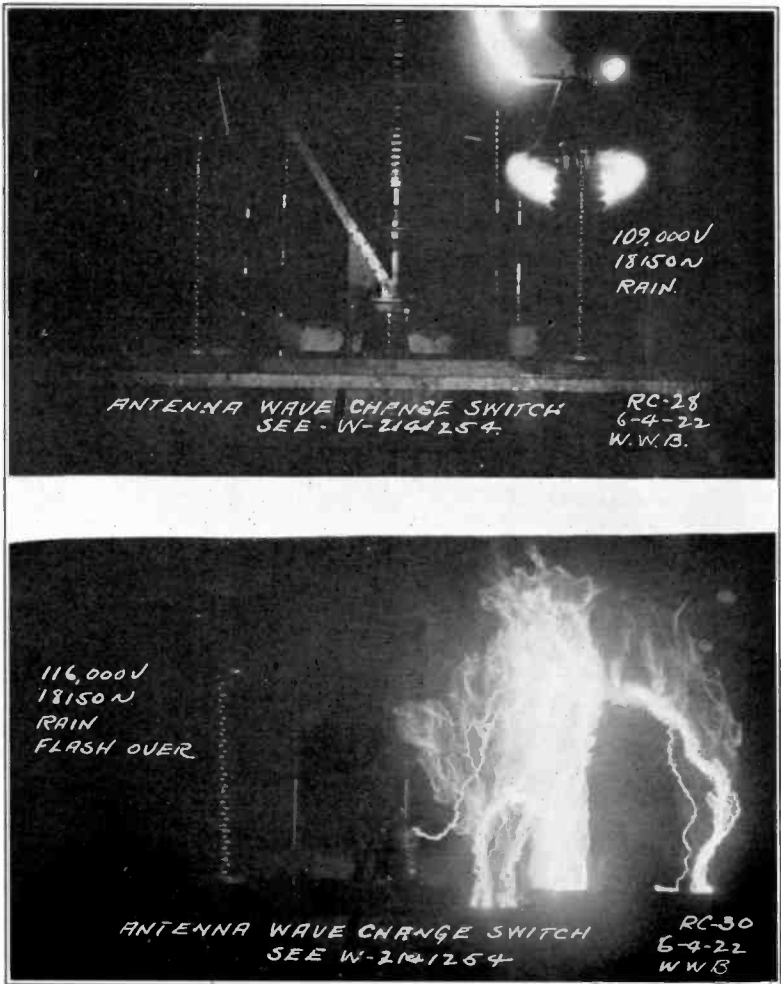

FIGURE 26

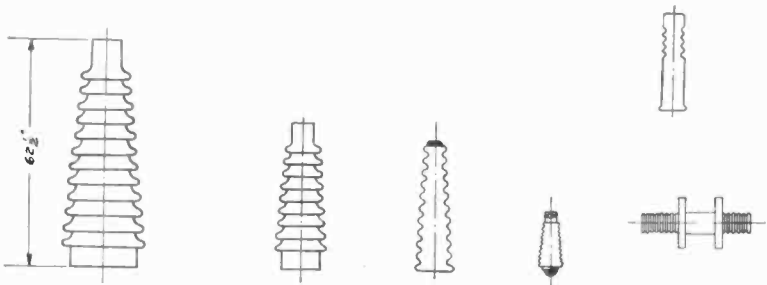

FIGURE 27

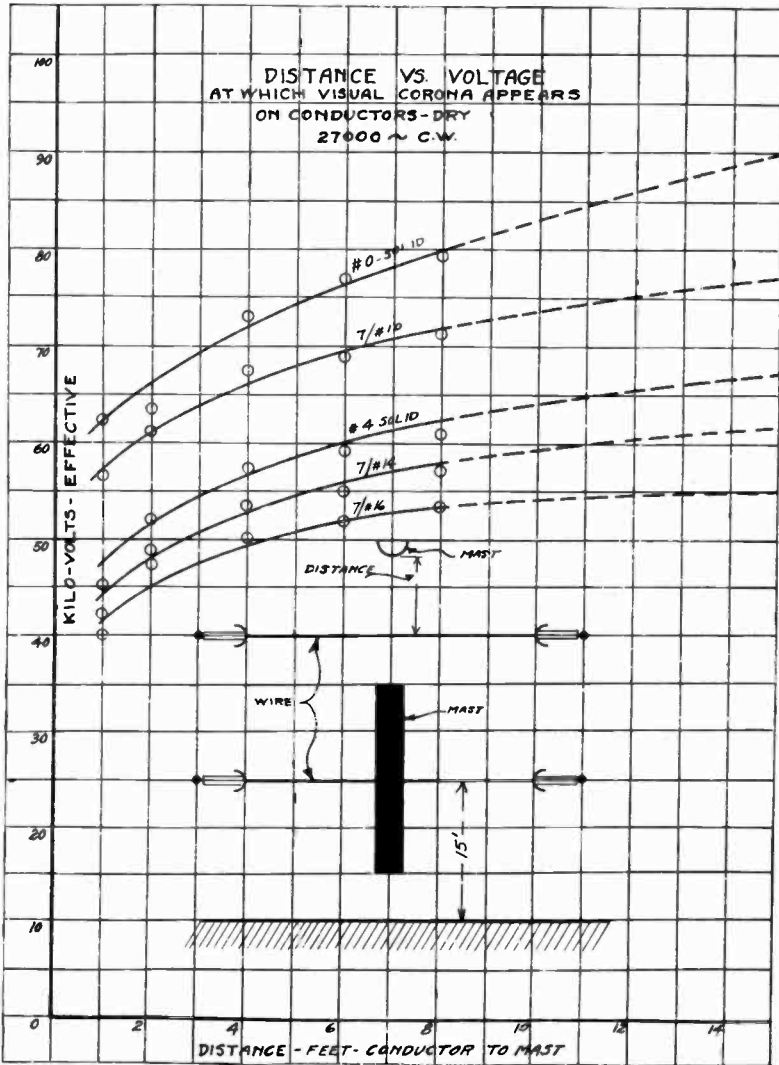

FIGURE 28

Corporation of America; Mr. A. K. Hawley and Mr. A. G. Benard, of the Locke Insulator Company, and Mr. S. P. Nixdorff, of the General Electric Company.

February 12, 1923.

General Electric Company,  
Schenectady, New York.

**SUMMARY:** After analyzing the design considerations for high voltage radio frequency continuous wave antenna insulators, there are given data on the heating, losses, and flashover points of a number of sizes and forms of porcelain rod insulators, both dry and wet. The effect of rain shields, electrostatic strain shields, and "breathers" on the behavior of the insulators is discussed.

The voltage distribution across insulators in series was determined. Its effects on design are given. A study of visual corona point on conductors at radio frequencies is included.

## DISCUSSION

D. C. Prince (by letter):\* The author of this paper has stated that dielectric flux density, which is merely another way of saying potential gradient, decreases with increasing distance between electrodes. He does not attempt to formulate the law of that variation, because the law is much too complicated to be covered in brief and would represent a digression from his subject.

It is often useful to form a general idea of what is accomplished when electrodes are moved apart, in reducing capacity, dielectric flux density and potential gradient, all of which are closely related. The capacity of two concentric cylinders, one of which has twice the diameter of the other, is about 80.8 microfarads per meter of length. To find the capacity between a large cylinder and a small wire along its axis, it is only necessary to find how many times the wire size must be doubled to obtain the cylinder diameter. Each time the diameter is doubled is equivalent to a condenser of 80.8 mmf. capacity per meter in series, so that the final capacity is 80.8 in micro-microfarads per meter length divided by the number of doublings.

If a potential difference is established between wire and cylinder, the different 80 mmf. condensers divide the voltage equally. Thus, if the wire diameter is one-quarter inch (0.64 cm.) and is doubled ten times to give a cylinder diameter of 10 feet 8 inches (2.7 m.), a voltage of 1,000 will give 100 volts drop in the first one-eighth inch (0.32 cm.) from the conductor and 100 volts in the last 2 feet 8 inches (0.68 m.) from the cylinder. This gives a ready measure of the concentration of potential gradient and dielectric flux around a wire lying along the axis of a cylinder.

The capacity of a wire to a plate with which it is parallel is the same as that of the same wire to a concentric cylinder having a diameter four times the distance from wire to plate. This assumes the distance between wire and plate to be several diameters, so that the equipotential surfaces immediately around the wire are nearly concentric cylinders. If the capacity of wire to cylinder and wire to plate are the same and the same voltage is impressed, the same gradient around the wire will result.

If a single long insulator or a string of insulators is stretched from a wire, it obviously varies the potential distribution somewhat. However, a consideration of the potential gradients in air is the first step to a realization of the phenomena underlying the concentrations of voltage gradient and dielectric flux density which produce the results discussed in Mr. Brown's paper.

---

\*Received by the Editor, March 4, 1923.

A. O. Austin (by letter):\* In looking over the paper it would appear that the insulators placed on test are practically all of the porcelain rod type. This type of insulator has been used to a very large extent owing to war conditions. The mechanical hazard of this type of insulator will cause it to be eliminated, simply as a matter of time.

Most systems can operate with a cap and pin type of suspension insulator when the same is modified slightly.

For the very large high grade stations it is advisable to insulate the tower by inserting insulators at several different zones, particularly near the top. By using a method of this kind, the effective height of the tower is increased and a high degree of reliability is maintained. The absence of a large number of insulators in multiple also cuts down leakage losses, which is a decided advantage.

Insulators of the insulated control type are far more reliable and can be operated at a much higher voltage than any of the insulators with the bare screen. The problem involved in insulating the super-power lines of the future are the same as those in connection with radio work in many respects.

W. W. Brown (by letter): In comparing the problems involved in insulating high power radio antennas and super-power lines of the future, we must not lose sight of the fact that flux densities which are permissible in insulators for 60 cycles can seldom be used in insulators subjected to radio frequency continuous waves, because of the high dielectric loss. It is because of the fact that a tubular or rod insulator may be effectively shielded in a simple manner and obtain satisfactorily low flux densities in the dielectric that this type of insulator gives satisfactory service at radio frequencies.

Statistics show that, mechanically, the tubular type of insulators is entirely satisfactory, as mechanical failures are extremely rare under all conditions in which the electrical ratings are not exceeded.

The effective height of a given antenna is undoubtedly higher with the insulated towers than with grounded towers. When it is considered that so-called insulated tower is electrostatically coupled to antenna and ground, the apparent advantage of insulating the tower is not fully realized. It is our opinion that the difficulties encountered in insulating the large tower structures and the expense involved are not justified by the advan-

---

\*Received by the Editor, March 4, 1923.

tages which might be realized. The trend, in the design of large antennas, appears to be away from insulated towers. An example of this is the 860-foot (262-meter) tower at the Tuckerton Station which was originally erected with insulators, but these have since been removed.

April 18, 1923.





# VACUUM TUBES AS POWER OSCILLATORS\*

(PART III)

By

D. C. PRINCE

(RESEARCH LABORATORY, GENERAL ELECTRIC COMPANY, SCHENECTADY, N. Y.)

## CHAPTER VI

### POWER AMPLIFIER CIRCUIT

Because of its constant frequency characteristics, there are some applications for which it is desirable to secure a higher power radiation by establishing a lower power oscillation under very constant conditions and then amplifying these oscillations by means of a higher power vacuum tube. The problems encountered by doing this are most pronounced when the load circuit is very highly tuned. It is therefore instructive to examine the operation of a power amplifier for conditions such as those presented by a large trans-Atlantic antenna.

Figure 42 has been drawn up showing the effects on the primary circuit given at various frequencies and with various degrees of coupling. We are informed that changes in wind and temperature may change the antenna capacity sufficiently to change its resonant frequency 0.3 percent.

First assume that an amplifier battery is conductively coupled to the antenna as shown in Figure 44. For simplicity, we will select a coupling of 20 ohms, since this is the largest scale coupling curve completely shown on Figure 42. The following table shows the total impedance presented to the tube output current from the curve at various amounts of detuning.

Detuning % . . . . .	0	0.05	0.10	0.15	0.20	0.25	0.30
Resistance . . . . .	22.2	20	16	11.5	8.4	6.2	4.7
Reactance . . . . .	0	6.4	10.3	11.2	11.0	10.1	9.2
Impedance . . . . .	22.2	21.0	19.0	10.1	13.8	11.95	11.32

\*Received by the Editor, March 15, 1923. Continued from PROCEEDINGS OF THE INSTITUTE OF RADIO ENGINEERS, volume 11, numbers 3 and 4, June and August, 1923.

It is apparent that maximum impedance occurs at resonance. Since with constant emission and grid excitation the current cannot rise with decreasing impedance, we may assume it constant. Output is then the square of current times resistance. Input remains constant.

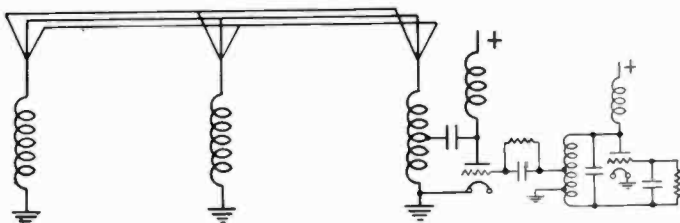

FIGURE 44—Power Amplifier Circuit Directly Connected to Antenna

$$200 \text{ kw. at } 22.2 \text{ ohms} = \sqrt{\frac{200,000}{22.2}} = 95 \text{ amperes.}$$

If the efficiency at resonance is 80 percent, input is  $200/0.8 = 250$  kw. The corresponding outputs and losses are shown in the following Table. Antenna current is proportional to the square root of power output and is also given.

Detuning %.....	0	0.05	0.10	0.15	0.20	0.25	0.30
Resistance (effective).....	22.2	20	16	11.5	8.4	6.2	4.7
Output Kw.....	200	180	144	103.5	75.7	55.8	42.3
Loss Kw.....	50	70	106	146.5	174.3	194.2	207.7
Antenna Current %.....	100	95	85	72	61.5	53	46

It is apparent that detuning 0.1 percent doubles the loss and reduces the current to 85 percent of its maximum value. A further detuning to 0.3 percent again doubles the tube loss and reduces the radiation to less than 50 percent. At the wave length being used 0.1 percent represents 18.3 cycles and 0.3 percent represents 54.9 cycles. It is doubtful if these frequency variations would justify the adoption of this system in this case. The variations in tube loss and antenna current are undoubtedly more important than the slight frequency variations.

By interposing an intermediate circuit between antenna and tubes, the situation is altered somewhat. The circuit is shown in Figure 45. The impedance characteristics can still be taken from Figure 42.

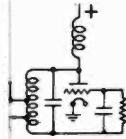

Antenna

ary reactance  
 yves represent  
 antenna.

ve component  
 ce component  
 uired coupling  
 amplifier im-  
 e a current of  
 tance. Then,

s leading.

s lagging.

ce.

pon the choice  
 ith any other

nows that the  
 or a detuning  
 within the ob-  
 e passed thru  
 r lesser varia-

ie coupling as  
 ims resistance  
 chart. This  
 edance of the  
 is leg is then

Kva. in condenser are  $\overline{217^2} \times 51 = 2,400$  wattless leading.  
 Kva. in inductance are  $\overline{208.8^2} \times 53 = 2,310$  wattless lagging.  
 Actual power is  $208.8^2 \times 2 = 87.2$  kw.  
 Total 90 Kva. leading, 87.2 kw. energy.

125.2 kva. total

$$\text{Impedance is } \frac{11,070^2}{125,200} = 978 \text{ ohms}$$

$$704 \text{ ohms reactance}$$

$$682 \text{ ohms resistance}$$

These values are also independent of the choice of 11,070 volts impressed.

Now the vacuum tubes which would supply 200 kw. to this antenna would have an efficiency of about 80 percent and space charge drop of about 10 percent. For purposes of calculation, we may assume that the method of Chapter II is sufficiently accurate, therefore from Figure 14 the angle during which current flows is  $125^\circ$ .

The fundamental component of output current is  $\frac{11,070}{612} = 18.1$  amperes. The current wave is found as follows: Since the space charge drop is 10 percent, the impressed direct potential is

$$11,070 \times 1.41 \times \frac{100}{90} = 17,320 \text{ volts}$$

The average current is

$$\frac{200,000 \times \frac{100}{80}}{17,320} = 14.45 \text{ amperes,}$$

but, since all the current flows in  $125^\circ$ , the average while flowing is

$$14.45 \times \frac{360}{125} = 41.6 \text{ amperes.}$$

$$\cos 62.5^\circ = 0.463.$$

The average between  $-62.5^\circ$  and  $+62.5^\circ$  (referred to the line of symmetry) =

$$\frac{1}{125^\circ} \int_{-62.5^\circ}^{+62.5^\circ} \cos \theta d\theta = \frac{180^\circ}{\pi \times 125^\circ} \times 2 \sin 62.5^\circ = 0.814$$

To this scale the maximum ordinate is 1.

The average positive value of the curve is  $0.814 - 0.463 = 0.351$ . This same curve, converted to a scale at which the average for  $125^\circ$  is 41.6 amperes, is the positive part of the curve.

$$i = \frac{41.6}{0.351} \cos \theta - \frac{41.6}{0.351} 0.463$$

$$= 118.5 \cos \theta - 54.9$$

A Fourier analysis of this wave gives, as the r.m.s. value of the fundamental component, 18.1 amperes, as would be expected.

Now, when the antenna is detuned, the current cannot increase, due to the fact that both emission and grid excitation have remained constant. It may decrease, however, especially since the circuit impedance has been increased by detuning. If we should arbitrarily limit the current to a low value, the alternating plate voltage would be low and the current would be limited in no way by the voltage. As the current is gradually raised, a point is approached where the plate voltage becomes zero for a moment. As this point is approached, the angle during which current can possibly flow is rapidly cut down. Referring to Figure 46, which shows the plate current and plate voltage waves, while  $C < E$  there is no limit to the time during which current can flow, but when  $C = E$  then  $2\gamma$  is the greatest angle unless the current wave is decidedly deformed. If emission and grid excitation are such that, with the reduced angle, the voltage cannot be maintained, giving  $C > E$ , the value of  $C$  cannot rise further. If, on the other hand,  $C$  can be maintained even with  $\alpha < \gamma$ , the current can continue to rise until  $\alpha + \beta = \gamma$ . At this point the current wave for a given grid excitation can rise no farther for the shape of the current curve is dependant upon grid excitation and no current can flow with the plate negative. In order to find out whether  $C$  can be greater than  $E$ , it is only necessary to solve the border line case where  $C = E$ .

Referring to Figure 46, it may be assumed that, for our purpose, the current which does flow is part of the same sine wave of 118.5 amperes amplitude, but that the other or bias term changes.

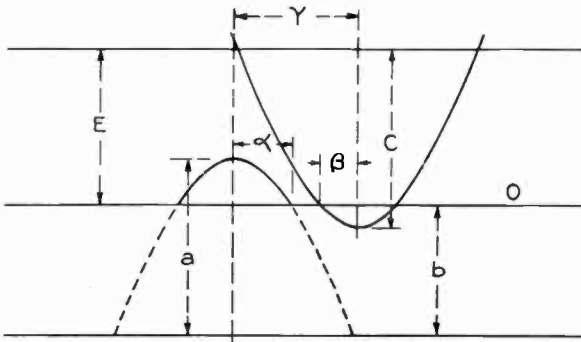

FIGURE 46—Plate Voltage and Current Relations in a Power Amplifier Circuit

Let  $E$  = direct voltage impressed = 17,320 volts.  
 $a$  = amplitude of current wave = 118.5 amperes.  
 $b$  = bias of current wave = 54.9 amperes minimum.  
 $C$  = amplitude of voltage wave.  
 $\gamma$  = power factor angle of circuit =  $\cos^{-1}0.697 = 46^\circ$ .

$$\beta = \cos^{-1} \frac{E}{C}$$

$$a = \cos^{-1} \frac{b}{a}$$

$Z$  = circuit impedance.

$R$  = apparent resistance.

$m$  = amplitude of fundamental component of plate current.

$$\text{Circuit absorption} = \frac{C^2}{2Z^2} R = \frac{C^2 \times 682}{2 \times 978^2} = 356 \times 10^{-6} C^2$$

$$\text{Tube output} = \frac{m C \cos \gamma}{2}$$

For a steady state, the output and absorption are equal, therefore:

$$356 \times 10^{-6} C^2 = \frac{m C \cos \gamma}{2}$$

$$C = \frac{m \cos \gamma}{712 \times 10^{-6}}$$

By Fourier's method:

$$\begin{aligned} m &= \frac{1}{\pi} \int_{-a}^{+a} (a \cos^2 \theta - b \cos \theta) d\theta \\ &= \frac{1}{\pi} \left[ a \left( \frac{\theta}{2} + \frac{1}{4} \sin 2\theta \right) - b \sin \theta \right]_{-a}^{+a} \\ &= \frac{1}{\pi} (aa + \frac{a}{2} \sin 2a - 2b \sin a) \end{aligned}$$

If  $C > E$ ,  $a < \gamma$ . In the dividing case  $C = E$  and  $a = \gamma$ .

Then  $b = a \cos \gamma = 118.5 \times 0.697 = 82.6$ , and

$$\begin{aligned} m &= \frac{1}{\pi} \left( 118.5 \times \frac{46\pi}{180} + \frac{118.5}{2} \sin 92^\circ - 2 \times 82.6 \sin 46^\circ \right) \\ &= 12.5 \end{aligned}$$

$$C = \frac{12.5 \times 0.697}{2 \times 356 \times 10^{-6}} = 12,240 \text{ volts}$$

It appears therefore that, altho with an unrestricted current angle the voltage could have risen so that  $C = 1.41 \times 18.1 \times 978 = 25,000$  volts, the restriction in current angle prevents a higher

value than 17,320, which is  $E$ . Actually, it is restricted to a slightly lower value, because considerable current must flow at the point in the cycle when the alternating plate voltage is at its maximum value. If we assume that a difference between plate and filament potentials of 1,000 volts will be sufficient, then for  $C = 16,320$

$$m = \frac{16,320 \times 2 \times 356 \times 10^{-6}}{0.697} = 16.7$$

To determine the current curve, assume a series of values of  $\alpha$ . The computation is shown in the Appendix to this Chapter (Table III), from which, by interpolation, for  $m = 16.7$ ,  $\alpha = 53^\circ$   
 Output =  $C^2 \times 356 \times 10^{-6} = 16,320^2 \times 356 \times 10^{-6} = 94.8$  kw.

Input =  $E \times i$  average

$$\begin{aligned} &= 17,320 \times \frac{1}{\pi} \int_0^{53^\circ} (118.5 \cos \theta - 71.3) d\theta \\ &= \frac{17,320}{\pi} \left( 118.5 \sin 53^\circ - 71.3 \times \frac{53}{180} \pi \right) = 158.8 \text{ kw.} \end{aligned}$$

Loss = 64 kw.

Thus, by using an intermediate circuit, the loss has been prevented from rising as rapidly as when no intermediate circuit was used. A further detuning causes a further rise in impedance with probably lessened loss.

The method here used is too approximate for great reliance to be placed upon it, altho it shows the order of performance, which may be expected with a power amplifier circuit using a grid resistance bias. An exact study can, of course, be made by the method developed in Chapter I. Due to the inconstancy of grid phase angle, many special phenomena are bound to occur under detuned operation. Upon their seriousness, in any given case, will depend the care which must be exercised in maintenance of adjustment.

APPENDIX TO CHAPTER VI

TABLE III

ANALYSIS OF CURRENT WAVE TO FIND UNITY P. F. COMPONENT

Let $\alpha =$	45°	50°	55°	60°
$\alpha$ (radians)	0.787	0.875	0.960	1.050
$\sin \alpha$	0.707	0.768	0.820	0.867
$\sin 2 \alpha$	1.00	0.98	0.94	0.867
$\cos \alpha$	0.707	0.643	0.573	0.500
$b = 118.5 \cos \alpha$	0.837	76.2	68.0	59.3
$\frac{\alpha \alpha}{\pi}$	29.7	33.0	36.2	39.6
$\frac{a}{2\pi} \sin 2 \alpha$	18.9	18.5	17.75	16.35
$\frac{2b}{\pi} \sin \alpha$	37.7	37.3	35.5	32.8
$m$	10.9	14.2	18.45	23.15

CHAPTER VII

IMPROVEMENT OF OSCILLATOR EFFICIENCY BY THE USE OF HARMONICS

In all of the foregoing analyses, it was assumed that the circuits were so tuned as to respond sinusoidally. Thus the doubly periodic circuits have been adjusted to avoid having one frequency a multiple of another, and so on. As long as the circuit response is sinusoidal, the fundamental current component in phase with the voltage alone represents output and all other components are loss. The following discussion shows that efficiency and output conditions may be changed materially if arrangements are made to have the load circuit responsive to certain harmonics, so that all input on these harmonics need not be absorbed as tube loss.

Referring to Figure 47, let:

- $X$  = impressed direct potential.
- $e_p$  = instantaneous drop from plate to filament.
- $e_g$  = instantaneous drop from grid to filament.
- $i_p$  = instantaneous plate current.
- $i_g$  = instantaneous grid current.



Then

$X i_p$  = instantaneous input.

$(X - e_p) i_p$  = instantaneous output neglecting grid loss.

$e_g i_g$  = instantaneous grid loss.

$(X - e_p) i_p - e_g i_g$  = instantaneous net output.

$\frac{(X - e_p) i_p - e_g i_g}{X i_p}$  = instantaneous efficiency.

$\theta_1$  = Angle at which  $i_p = 0$ .

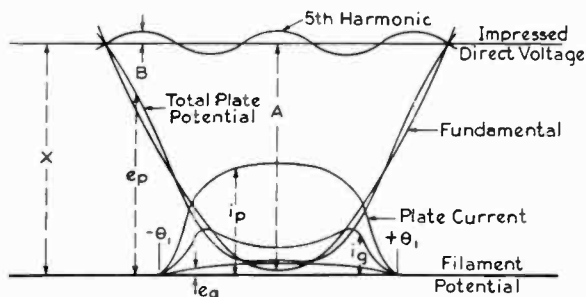

FIGURE 47—Plate Potential and Current Waves for Circuit Containing an Harmonic Trap

Neglecting for the moment the grid loss,  $\frac{(X - e_p)}{X}$  = instantaneous efficiency. For high average efficiency, it is only necessary to keep  $e_p$  small for a considerable portion of the cycle.

This can be done by utilizing a voltage wave which is not a pure sine wave, but contains harmonics in the proper phase relations to give a flat topped wave as shown in Figure 47. It is obviously not sufficient to show that such a harmonic, if it existed, would improve efficiency. The harmonic must be set up in a circuit tuned to it, and the losses of that circuit must be supplied by the oscillator. Otherwise, the whole matter is of hypothetical interest only. We will, therefore, assume a desired harmonic to exist in the voltage wave and examine whether there will be sufficient output on that harmonic to maintain the harmonic voltage.

Let,

$$e_p = X - A \cos \theta + B \cos n \theta$$

Then

$(A \cos \theta - B \cos n \theta) i_p$  = output neglecting grid losses, that

is:

$A \cos \theta \cdot i_p$  = output on the fundamental

$-B \cos n \theta \cdot i_p$  = output on the  $n$ th harmonic.

If, when  $i_p$  is determined by means of a tube characteristic, the harmonic in question is shown to have a sufficient positive output, it may be built up in a resonant trap circuit as shown in Figure 49, to maintain the voltage wave in its proper amplitude and phase. If the harmonic output is very small, it may not be sufficient to sustain the voltage. If it is negative, a harmonic voltage in the wrong phase will be built up. This will give a peaked rather than a flat topped voltage wave and reduce the efficiency rather than increase it.

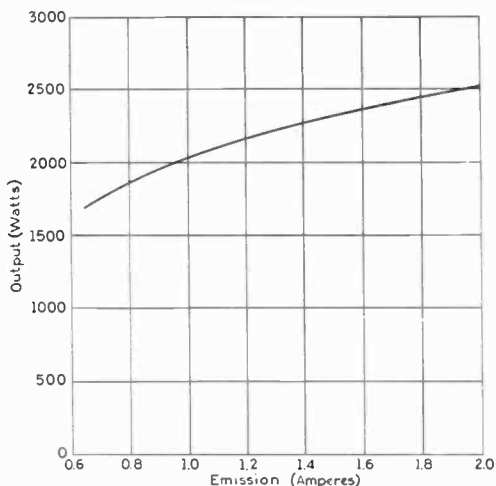

FIGURE 48—Calculated Variation of Output of a UV-206 Radiotron with Emission at 15,000 v. d. c. and 350 Watts Tube Loss

The cases of positive and negative harmonic outputs can readily be demonstrated by calculating for the same current wave the harmonic output on two different harmonics. The assumed characteristic is shown on Figure 4. For sinusoidal plate and grid excitation, the outputs, losses and efficiencies are shown in Table IV. Obviously from Figure 47 the instantaneous harmonic outputs for  $\theta_1 = 0$  are negative for a flat topped wave. In order for the net output to be positive, therefore, three half cycles of the harmonic must occur while current is passing. That is, if a fifth harmonic is to be built up, the opening angle should be approximately  $108^\circ$  and, if a third harmonic is desired, approximately  $180^\circ$ . The corresponding values of  $\theta_1$  are  $54^\circ$  and  $90^\circ$ , respectively or, for round numbers,  $60^\circ$  and  $90^\circ$ ,  $\theta_1$  being half the opening angle.

Table V shows the calculated performance using a fifth harmonic in the voltage wave. It is apparent that at  $\theta_1 = 60^\circ$  sixteen watts are available to sustain the harmonic oscillation, while for  $\theta_1 = 90^\circ$  no energy is available. Table VI shows the corresponding calculated performance using a third harmonic in the plate potential. For  $\theta_1 = 60^\circ$  the harmonic output is -77 watts, so that the harmonic would tend to build up in the wrong phase and no good results would follow. For  $\theta_1 = 90^\circ$  thirty-eight watts are available for losses in the harmonic trap circuit. The relation between available harmonic watts and harmonic voltage is determined by the trap circuit design.

Thus with the characteristic and circuit constants shown, it is possible, with an efficient harmonic trap, to improve over-all efficiencies materially. The output of a properly designed tube is limited by the permissible heat dissipation. The variation of output with efficiency is, therefore, expressed by the relation,

$$\frac{\text{Output}}{\text{Losses}} = \frac{\text{Efficiency}}{1 - \text{Efficiency}}$$

On this basis, when  $\theta_1$  is  $60^\circ$ , the output is increased 57 percent by the use of a fifth harmonic circuit, and when  $\theta_1$  is  $90^\circ$ , an increase of 95 percent is obtained by the use of a third harmonic circuit.

Such an increase as that noted assumes that efficiency is solely a function of opening angle which is not necessarily the case. Table VII shows the effect of varying emission on efficiency and output for  $\theta_1 = 60^\circ$ . From this it appears that by maintaining the opening angle and increasing the emission, the efficiency is only slightly affected, so that without harmonic circuits a higher emission merely overheats the tube.

Some additional output can be obtained by increasing emission and reducing opening angle without harmonic circuits. The increase of 57 percent in output at  $\theta_1 = 60^\circ$  by using a fifth harmonic corresponds to an emission increase of approximately 51 percent, that is, from 0.7 to 1.1 amperes. Figure 48 shows the increase of output obtainable by increasing emission and reducing opening angle to maintain constant loss. The increase of emission from 0.7 to 1.1 would increase output 20 percent without the use of an harmonic circuit. The increase possible by the use of the harmonic circuit must rightly be referred to this figure. The net improvement ascribable to the harmonic is therefore  $\frac{157 - 120}{120}$ , or 30 percent. That no such

gain is obtainable by further increase in emission, without harmonics, is apparent from the curve.

Where the harmonic output is insufficient to maintain the oscillations in the harmonic circuit, it is necessary to reinforce it. Anything which will flatten the current wave will add to the harmonic output. Emission limitation tends in this direction or a small part of the harmonic energy may be returned to the grid and the harmonic built up to any desired value. The fraction of the total harmonic energy supplied in this latter way must be relatively small as otherwise there is nothing to maintain the proper phase relations.

Figure 49 shows the type of circuit in which a plate potential harmonic can build up.

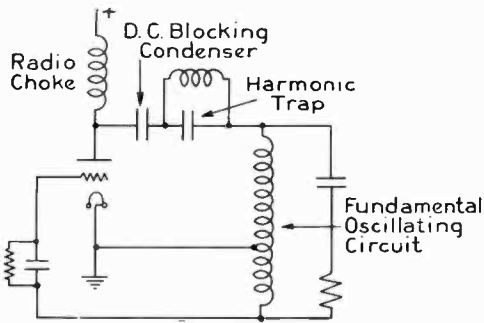

FIGURE 49 Harmonic Trap Oscillating Circuit

The foregoing conclusions are based on calculations from characteristic curves and not upon input and loss tests of an oscillating tube. To this extent they are theoretical. The principles involved in the calculations are all simple and have been verified by tests on sine wave circuits. Since the characteristics of different types of tubes are apt to vary, particularly with regard to the harmonic content of the current wave, the proper method of securing harmonic energy cannot be stated in the general case. The amount of increase in output obtainable depends upon the efficiency of the tube as represented by the percentage of the total voltage necessarily lost in space charge drop. The higher the efficiency in this respect, the greater will be the percentage improvement from the use of the harmonic circuit.

TABLE IV  
 15,000 Volts 0.7 Ampere Emission  
 Plus 650 Grid Maximum  
 813 Minimum Plate

$\theta_1$	50°	60°	70°	80°	90°
Input.....	1,828	2,165	2,500	2,860	3,180
Electron Loss.....	264	380	523	717	928
Total Loss.....	316	415	546	730	932
Output.....	1,512	1,750	1,954	2,130	2,248
Efficiency.....	82.7	80.9	78.2	74.5	70.7

TABLE V  
 15,000 Volts 0.7 Ampere Emission  
 Maximum Fundamental 15,000  
 Maximum Fifth 800  
 Maximum Plus Grid 640

$\theta_1$	50°	60°	70°	80°	90°
Input.....		2,100			3,150
Electron Loss.....		224			778
Total Loss.....		274			782
Fundamental Output....		1,826			2,368
Efficiency.....		87			75
Fifth Harmonic Output. (Counted as Loss)		16			0.1

TABLE VI  
 15,000 Volts 0.7 Ampere Emission  
 Maximum Fundamental 16,400  
 Maximum Third 2,200  
 Maximum Plus Grid 640

$\theta_1$	50°	60°	70°	80°	90°
Input.....		2,130			3,110
Electron Loss.....		165			496
Total Loss.....		198			538
Fundamental Output....		2,009			2,572
Efficiency.....		.....			82.5
Third Harmonic Output. (Taken as loss where +)		-77			+38

TABLE VII  
 15,000 Volts  
 Minimum Plate 800 Volts  
 Maximum Plus Grid 640 Volts  
 $\theta_1 = 60^\circ$

Emission.....	0.7	1	1.5
Input.....	2,165	2,820	3,570
Electron Loss.....	380	468	560
Total Loss.....	415	505	617
Output.....	1,750	2,315	2,953
Efficiency.....	80.9	82	82.5

## APPENDIX

### RADIOTRON THEORY

A brief review of some of the less obvious features of tube performance may contribute to the solution of certain problems. In the following discussion an attempt is made to cover the various factors briefly, giving the theoretical equations and indicating the degree of correspondence between quantitative theory and practice.

#### EMISSION

A tungsten filament heated gives off electrons. The volts, amperes, watts, and temperature for a given emission from a ten-mil filament are shown in Figure 50. The values so obtained practically never correspond to those observed in an actual radiotron. The reasons for the departure are of two kinds. Temperature effects are introduced by the other electrodes and by the filament-supporting structure and by the emission currents themselves. The enclosing electrodes tend to reflect a considerable amount of heat back to the filament. In a perfectly symmetrical cylindrical tube reflected heat is focused on the filament so that the rated current may considerably overheat it and increase emission. Voltage has a less effect since the increased temperature is accompanied by increased resistance. The usual unsymmetrical filaments are not so positioned as to receive any great heat reflection.

Leads and supports exert a cooling effect on the ends and other parts of the filament. These effects reduce emission. Such

a reduction is easily allowed for by considering the effective filament somewhat shorter than the actual length.

If the filament-heating current is alternating, and of a different frequency than the circuit in which the tube is being used, the current in the ends of the filament will be increased symmetrically by the emission current. This effect offsets the cooling due to the leads. If the filament heating is by direct current, or is synchronized with the emission one end of the filament is unduly heated and the total emission is increased considerably.

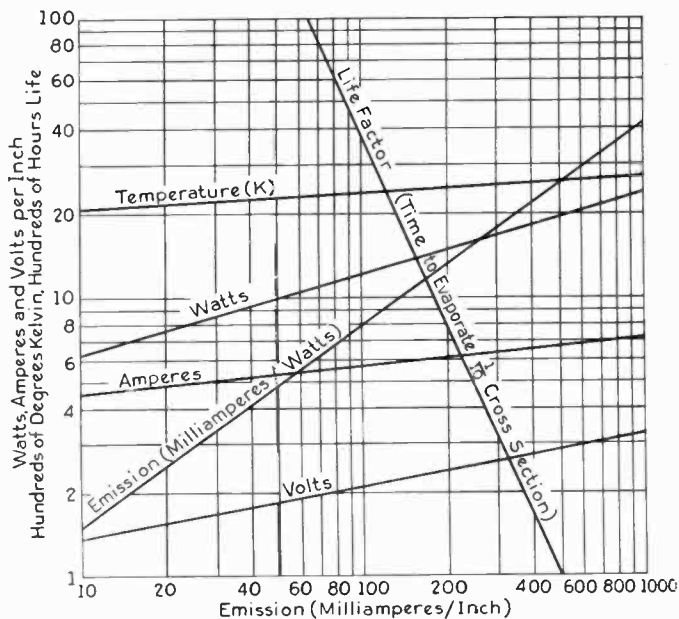

FIGURE 50—Heating Energy for 10 mil (0.01 inch or 0.025 cm.) Filament. For filament of diameter  $d$ , holding temperature constant:

$$\begin{aligned} \text{Emission}_d &= \text{Emission}_{10} \times \frac{d}{10} & \text{Watts}_d &= \text{Watts}_{10} \times \frac{d}{10} \\ \text{Fil. amp.}_d &= \text{Fil. amp.}_{10} \times \left(\frac{d}{10}\right)^{\frac{3}{2}} & \text{Life}_d &= \text{Life}_{10} \times \frac{d}{10} \\ \text{Fil. volts}_d &= \text{Fil. volts}_{10} \times \left(\frac{d}{10}\right)^{-\frac{1}{2}} \end{aligned}$$

The greatest filament life is obtained when the heating is most uniform over the whole length. This requires either asynchronous heating or heating and emission currents in quadrature.

Besides heating effects, the form of the filament may greatly

affect emission. A closely wound helical filament electrostatically shields the insides of its turns. A similar though less marked effect occurs with **V** and **W** filaments. The potential differences between adjacent legs of filaments also interfere with emission from the positive portions.

Altho, theoretically, these shielding effects should appear as changes in space charge rather than in emission, the voltages required to draw off all the electrons emitted become too high for observation in static tests. A typical example of the discrepancy between theoretical (straight filament) and observed emission for a **V** filament is shown in Figure 51. As stated above, a straight filament along the axis of a cylinder will practically equal the theoretical emission or may even be higher, due to heat reflection. It will be noted that the observed emissions in Figure 51 are much closer to the theoretical for large filament current.

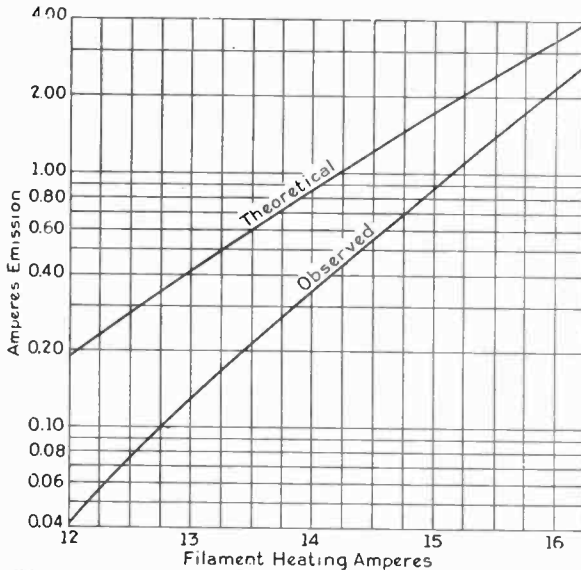

FIGURE 51—Electron Emission for a UV-218 Kenotron.  
 "V" Shaped 18 mil. (0.018 inch or 0.0457 cm.) Tungsten  
 Filament—1.25 inches (10.8 cm.) Active Length

One possible explanation is that, at higher temperatures, the electrons are able to pass by initial velocity out of the regions most shielded by the other strands of filament and supports. The transition from space charge to emission limit is very gradual in tubes having complicated filaments. A good example of this is found in Figure 52. This tube has a double **V** filament



and support all close together. Theoretical emission is 10 to 12 amperes, but saturation begins to set in at 5 amperes below which point it is presumed that only the outsides of the filament strands are active. Theoretical data is, therefore, not directly applicable in determining emission with present types of filament.

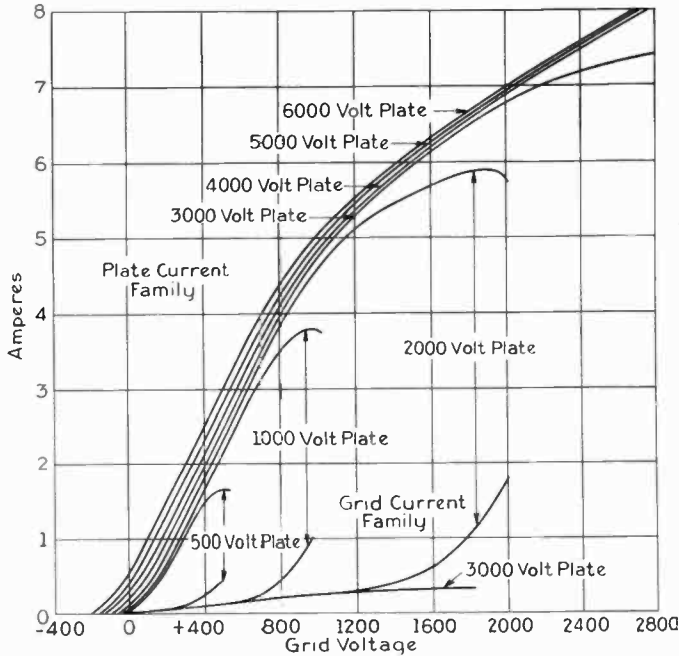

FIGURE 52—Extrapolated Characteristics of a Water-Cooled Radiotron

### SPACE CHARGE

The theoretical space charge equation for cylindrical tubes is,  $i = 14.65 \times 10^{-6} \frac{LV^3}{R\beta^2}$ . For  $\beta^2 = 1$ , this relation is plotted in Figure 53.  $\beta^2$  is a function of relative radii of cathode and anode. When the cathode is more than one-tenth the anode diameter,  $\beta^2$  is no longer unity. For conditions where  $\beta^2$  is different from unity, its value is plotted in Figure 54. The above formulas assume that the filament is a constant potential surface. The filament-heating current causes a drop along the filament so that it is not a constant potential surface. The error involved by neglecting this drop is plotted in Figure 55. For an anode potential less than the filament drop, the filament being excited

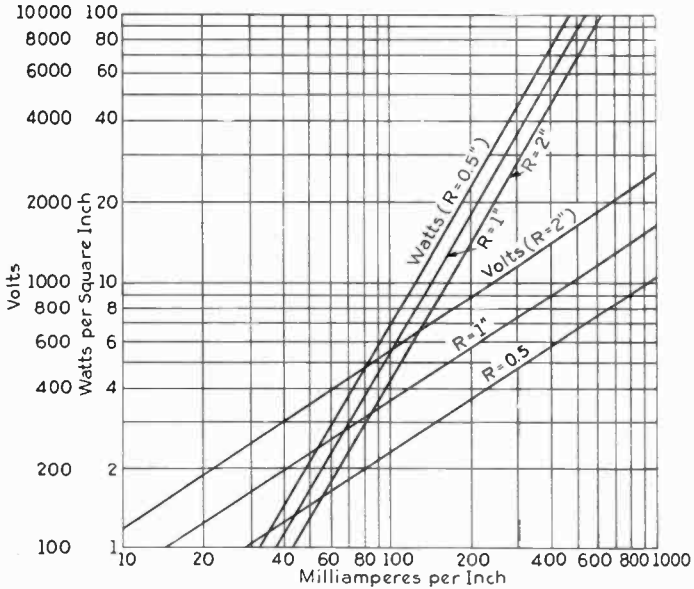

FIGURE 53—Space Charge for Cylindrical Anode of Radius  $R$  Computed from Formula  $i = 14.65 \times 10^{-6} \frac{LV^{3/2}}{R}$

by direct current, the space charge current is given by the relation

$$i = 0.4 \times K \frac{1}{r^n} \frac{V^{5/2}}{V_o}$$

$$K = 14.65 \times 10^{-6} \text{ for a cylindrical anode}$$

$$n = 1 \text{ for a cylindrical anode}$$

$$V_o = \text{Filament drop.}$$

Some misapprehension exists regarding the closeness of these formulas to practice. In a three-electrode tube, it has been found empirically that the plate voltage-plate current curve for zero grid volts approximates a parabola, and this has been cited by some authors in disproof of the  $3/2$  power law. In the three-electrode tube, the potential which must be used is the resultant of plate and grid potentials. For amplifier tubes this resultant voltage is practically always of the same order of magnitude as the filament voltage, so that the characteristic varies between the  $3/2$  and  $5/2$  power with the square law as a frequent average. This is clearly brought out by van der Bijl ("The Thermionic Vacuum Tube," page 236).

The correspondence between theory and observation is shown by Figure 56. The active length necessary to make theoretical

and observed curves coincide is  $2\frac{3}{8}$  inches (6.04 cm.), which, allowing for the cooled ends of the filament, is very close to what would have been expected. The exponent is  $3/2$ . In this case the filament voltage is 11. The departure from the three halves power law is, therefore, only 0.1 percent, according to Figure 55.

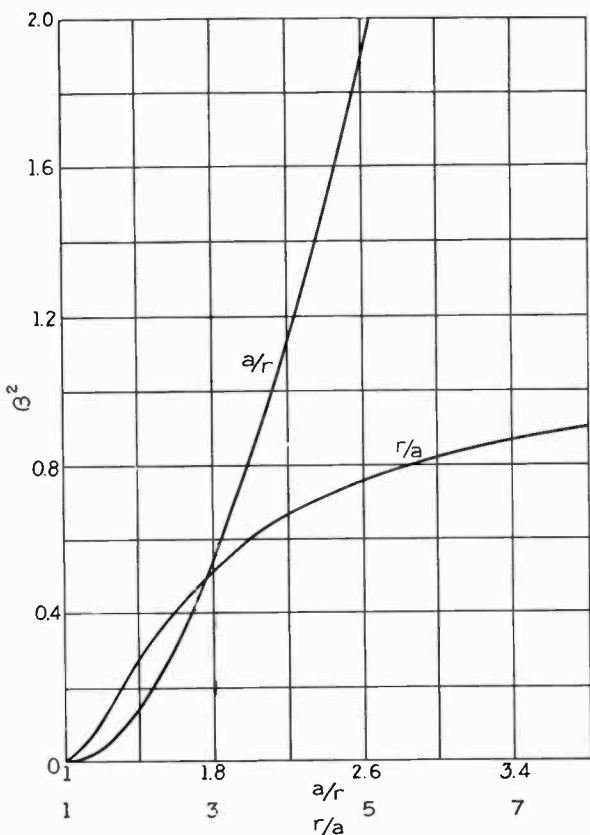

FIGURE 54—Space Charge for Cylindrical Anode and Cathode of Infinite Length.  $i = 14.65 \frac{L V^{\frac{3}{2}}}{r \beta^2} \times 10^{-6}$ ,  $i$  is current in amp.,  $E$  is potential in volts,  $r$  is radius of anode,  $a$  is radius of cathode.  $L$  is the length of the section considered. For large values of  $r/a$  the value of  $\beta^2$  approaches unity

In the case of a radiotron, the potential effect inside the grid is a composite of grid and plate voltages. Also the diameter of a cylinder, which would have the same electrostatic effect, is a compromise between grid and plate. For a close mesh grid

the equivalent diameter is little different from the grid diameter. Figure 57 gives the theoretical space charge current for a tube having the same filament and plate as the kenotron in the preceding paragraph, but with a grid added. Observed values correspond with the theoretical within the limits of experimental error. It appears that below currents at which saturation begins to become apparent, theoretical space charge equations may be used with a high degree of accuracy if the active filament length and effective anode diameter are known.

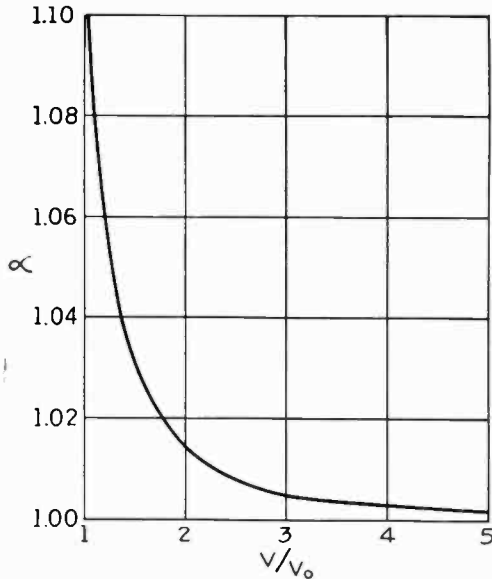

FIGURE 55—Correction for Filament Drop.

$$i = \frac{KL}{r^n} \left( V - \frac{V_0}{2} \right)^{\frac{3}{2}} \times a$$

$V$  is potential between anode and negative end of filament.  $V_0$  is filament drop. For  $V < V_0$

the active filament length is  $L \times \frac{V}{V_0}$  giving

$$i = 0.4K \frac{LV^{\frac{3}{2}}}{r^n V_0}$$

#### AMPLIFICATION CONSTANT

No really successful theoretical equations for amplification constant for radiotrons seem to be available at present. The older formulas usually assume the grid wire diameter very small compared with the spacing. These formulas are greatly in error for very many amplifier and most power oscillator tubes. Even without this limitation, the presence of grid supports is a serious

source of error. In general, therefore, only empirical methods are available for predetermination of  $\mu$ .

The determination of amplification constant has, however, been given much study, and a large mass of empirical data is available.

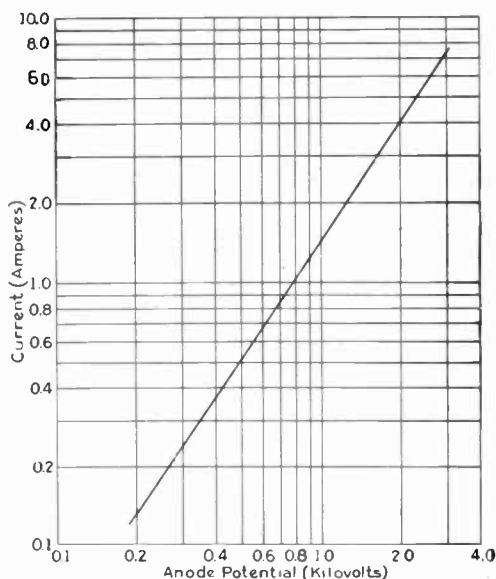

FIGURE 56—Space Charge Characteristic UV-218 Kenotron. "V" Shape 18 mil. (0.018 inch or 0.046 cm.) Filament 5.5 inch (14.0 cm.) long. Plate 1.5 inch (3.8 cm.) diameter by 3 inches (7.6 cm.) long.

NOTE:—This curve obtained by test checks the theoretical values assuming 2.375 inches (6.04 cm.) effective length for each leg of "V"

#### DIVISION OF PRIMARY ELECTRONS

The most fundamental law applying to the division of current between grid and plate is that the velocity of an electron is proportional to the square root of the potential thru which it has fallen. By the application of this law, an electron cannot strike an electrode negative with respect to the cathode by a potential more than that corresponding to the emission velocity. Therefore, for negative grid potentials, the grid current is zero.

Except near the grid wires themselves, the grid exerts a nearly uniform effect upon the electrons and, as the electrons repel each other, their distribution as they approach the grid is quite uniform. As they approach the grid, they pass into a field radial

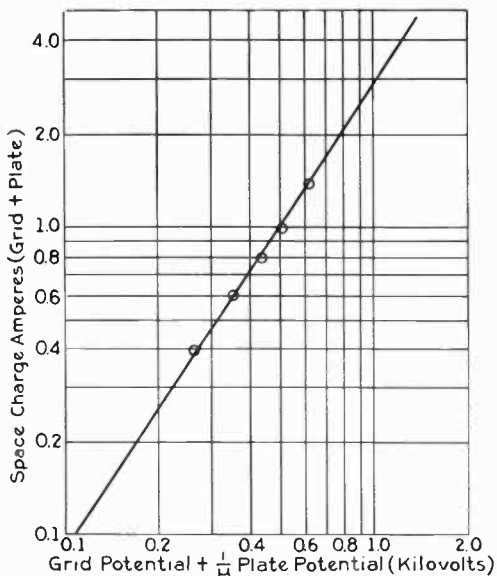

FIGURE 57—Space Charge Current for a UV-206 Radiotron. "V" Shaped 18 mil. (0.018 inch or 0.046 cm.) Filament 5.5 inch (14.0 cm.) long. Plate 1.5 inch (3.8 cm.) diameter by 3 inch (7.6 cm.) long. Grid 30 turns per inch (11.8 turns per cm.) 10 mil. (0.01 inch or 0.025 cm.) wire 0.75 inch (1.9 cm. diameter).  $\mu = 250$

NOTE—The curve is the theoretical curve using 2.375 inch (6.04 cm.) active filament length and grid diameter. Experimental points were taken at 16.1 amperes filament.

with respect to the grid wires. Since they have already attained most of their velocity, their inertia will prevent their following this radial field, provided their velocities are in a materially different direction. Those which would strike the grid without deflection will strike it as long as it is positive. A small number of additional electrons will be sufficiently deflected to strike the grid. The number striking will then be a function of projected grid area and, provided the plate is sufficiently positive to collect those which pass thru, the ratio of grid to plate current will be independent of their relative potentials. There is good evidence that the division of primary electrons is determined in this way.

#### SECONDARY EMISSION

If the conclusion of the preceding paragraph is correct, the departure of the grid-plate current ratio is due to secondary

emission. Quantitatively, secondary emission is not well understood. Qualitatively, it is known that an electron striking a surface with a velocity of more than about 5 volts may bound off or knock off one or more other electrons. The number is varied by the velocity of bombardment, by the condition of the surface, and by the presence of traces of gas. The velocity of secondary electrons may be a considerable fraction of the bombarding velocity and be of the order of fifty or sixty volts.

Such secondary electrons are normally given off by both grid and plate of a radiotron and greatly affect the current division. For high plate potential and low grid potential, the secondaries travel in greatest numbers from grid to plate so that the grid current may not only be reduced below the projected area value, but may even become negative and cause blocking. As the grid and plate voltages approach one another, the greatest flow turns toward the grid, which may not only receive more current than that determined by the projected area ratio but even more than the plate itself. This accounts for the shape of the characteristics which are included in the body of the report.

The loss of electrons from plate to grid operates to give saturation and to limit the amplitude of oscillations. Its effect is entirely stable, but it operates to limit possible tube output and efficiency. Loss of electrons from grid to plate operates to reduce grid loss and is an advantage up to the point of current reversal. It would still represent an advantage, since the grid then contributes to the output, except that the reversed grid current upsets the usual biasing arrangements.

The geometrical factors that enter into the interchange of secondary electrons are closeness of grid and plate by comparison with plate-filament spacing. When plate and grid are relatively close together, compared with the distance to the filament, there is little space charge between grid and plate, so that there is little opposition to secondary interchange. The reverse is true for large grid to plate spacings.

Much of the material from which the curves in this section were derived was obtained from Dr. Irving Langmuir.

**SUMMARY:** Chapter VI. In the "master oscillator" or "power amplifier" circuit oscillations are generated by a small power source and then amplified. In the amplifier there is no definite phase relationship between plate and grid potentials. The phase is determined by the tuning of input and output circuits. The effect of variations in grid and plate circuit tuning upon output and losses is developed for both direct coupling to the antenna circuit and coupling thru an intermediate circuit.

Chapter VII—It is shown by the general method of Chapter I that considerable increases in both efficiency and tube output can be obtained by introducing harmonics into the plate voltage wave. The purpose of these har-

monics is to flatten the top of the wave so that tube losses may be maintained at a minimum value during a large part of the time during which current is flowing.

Appendix—The general explanations of vacuum tube phenomena are supplemented by more detailed data giving the correspondence between theoretical, ideal, and actual values for emission and space charge. The theory of division of primary electrons between grid and plate when both are positive is explained. The effects of secondary emission in producing blocking and influencing efficiency are discussed.



THE EFFICIENCY OF THREE-ELECTRODE TUBES  
USED FOR THE PRODUCTION OF CONTINUOUS WAVES  
IN RADIO TELEGRAPHY, THAT IS, FOR THE CONVER-  
SION OF DIRECT CURRENT INTO ALTERNATING  
CURRENT\*

BY

MARIUS LATOUR AND H. CHIREIX

(PARIS, FRANCE)

It is known that the anode-circuit efficiency of three-electrode tubes operating as alternating current generators, and in particular as generators of radio frequency currents such as used in radio telegraphy, may, with appropriate adjustments, practically attain 70 to 80 percent and thus exceed the value of 50 percent which, at first sight, appears as the theoretical limit attainable only when the tubes operate at full power and assuming that they have rectilinear characteristics.<sup>1</sup>

It does not appear to the authors that there has so far been given a precise mathematical explanation of this situation. The object of the present note is to furnish such an explanation.

Let us first consider the case wherein the generated alternating current wave shape is not taken into account, but in which the object is to supply maximum alternating power to a resistance. We shall later on consider the case wherein pure sinusoidal wave shape power only is admitted and sought. It shall be shown that, even in the latter case, high efficiency may be obtained by appropriate adjustments.

For the sake of clearness, let us assume in both cases that the tube operates with separate grid drive.

CASE 1—The arrangement is that shown in Figure 1, wherein:

*S* represents a source of alternating current of any wave shape whatever;

*e* represents a negatively connected battery the function of which is to shift the operating point.

---

\*Received by the Editor, June 11, 1923.

<sup>1</sup> This theoretical 50 percent efficiency follows from theoretical researches on amplifiers by assuming that the output resistance load is equal to the internal tube resistance and that maximum power is drawn from the amplifier tube. (See Latour, "London Electrician," December 1, 1916.)

$E$  represents an anode battery of  $V$  volts which feeds the tube through the parallel arrangement of a choke  $L$  having a large inductance-to-resistance ratio working as an auto-transformer at the terminals of which is branched the load resistor  $r$ .

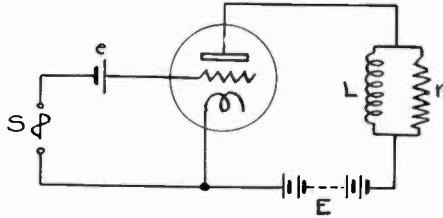

FIGURE 1

Let  $i$  be the instantaneous value of the anode current which may be of any wave shape whatever. We shall set out three relative values of this current:

1. the maximum value  $i_{max}$ .
2. the mean value  $\frac{1}{T} \int_0^T i \, dt = i_{mean}$
3. the effective value  $\sqrt{\frac{1}{T} \int_0^T i^2 \, dt} = i_{eff}$ .

The mean current  $i_{mean}$ , which is a direct current, passes thru the choke  $L$ . The oscillating current which, at a given moment, passes in the resistor  $r$  is  $(i - i_{mean})$ . It may easily be shown that the oscillating power given out in the load resistor  $r$  is, as a result, exactly  $r(i_{eff}^2 - i_{mean}^2)$ . The power supplied by the battery  $E$  is  $(V i_{mean})$ . The efficiency is therefore:

$$\eta = r \frac{i_{eff}^2 - i_{mean}^2}{V i_{mean}}$$

Let us suppose that the tube operates with a maximum current  $i_{max}$  equal to the saturation current of that particular working characteristic. It is also assumed that this maximum current  $i_{max}$  occurs simultaneously with the maximum positive grid potential. The voltage applied between the anode and cathode is therefore:

$$V - r(i_{max} - i_{mean}) = \epsilon \tag{1}$$

It being taken that the tube operates at full power, the voltage  $\epsilon$  may be found with fair exactness. It represents the voltage required to absorb the electronic current  $i_{max}$  when the

grid is saturated. Practically,  $\epsilon$  is very small in comparison with  $V$ . This implies that the maximum oscillating power is given out when the maximum oscillating voltage is practically equal to the anode battery voltage.

The resistance  $r$  must so be chosen that:

$$r (i_{max.} - i_{mean}) = V - \epsilon$$

that is

$$r = \frac{V - \epsilon}{i_{max.} - i_{mean}}$$

The efficiency may then be expressed by:

$$\left( i - \frac{\epsilon}{V} \right) \left( \frac{i_{eff.}^2 - i_{mean}^2}{i_{max.} - i_{mean}} \right) = \left( 1 - \frac{\epsilon}{V} \right) \left( \frac{\frac{i_{eff.}^2}{i_{mean}^2} - 1}{\frac{i_{max.}}{i_{mean}} - 1} \right) \quad (2)$$

The efficiency may be determined as long as  $\epsilon$  and the anode current wave-shape are known. The wave-shape may be ascertained experimentally by the use of either a reflection oscillograph or of a Braun tube. Let us examine a few particular cases:

(a) To begin with, the highest efficiency operation would be that in which the source  $S$  would have an electromotive force curve of such a shape that the grid voltage would abruptly become positive and thus remain constant during half a cycle and then suddenly negative and thus remain constant during the other half cycle.

For an appropriate setting of the battery  $\epsilon$ , the anode current would alternately take the values 0 and  $i_{max.}$  (See Figure 2)



FIGURE 2

In that case, equation 2 gives us the expression:

$$\eta = \left( 1 - \frac{\epsilon}{V} \right)$$

which approaches 1 for a negligible value of  $\frac{\epsilon}{V}$ .

(b) Another case which more closely approaches that met in practice is that in which the anode current is made up of half-sinusoids and is annulled during a whole half-cycle (Figure 3).

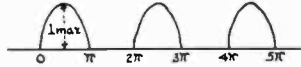

FIGURE 3

This shape of current is practically obtained by a proper setting of the battery  $\varepsilon$ , together with sinusoidal grid excitation. By applying formula 2 to the latter case, we obtain:

$$\eta = \left(1 - \frac{\varepsilon}{V}\right) \left(\frac{\frac{\pi^2}{4} - 1}{\pi - 1}\right) = \left(1 - \frac{\varepsilon}{V}\right) (0.69)$$

(c) Lastly, the theoretical and classical case in which the anode current assumes the shape  $\frac{1}{2}(1 + \sin \omega t)$  (see Figure 4) gives:

$$\eta = \left(1 - \frac{\varepsilon}{V}\right) (0.5)$$

This latter case therefore prevents efficiencies exceeding 50 percent.<sup>2</sup>

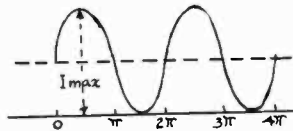

FIGURE 4

CASE II.—Efficiency in oscillating power of pure frequency, void of harmonics.

We shall modify the arrangement of Figure 1 as shown in Figure 5 by adding a condenser  $C$  in shunt to the choke  $L$ . In the present case, we will assume the choke  $L$  to have a small inductance such that it may form, with the condenser  $C$ , assumed to have a large capacity, a circuit tuned to the fundamental frequency. Furthermore, the oscillatory circuit  $LC$ , is supposed to be without losses. Under these conditions, if we consider the anode current function in terms of a Fourier series, it may be seen that the mean current ( $i_{mean}$ ) passes thru the choke  $L$  just as in the preceding case and that the anode current harmonics mainly take the path of the condenser  $C$  whilst the resistor  $r$  is traversed by the fundamental frequency current only. From the fundamental current point of view, the circuit  $LC$  behaves

<sup>2</sup> Exactly 0.50 efficiency is found by admitting that the maximum oscillating voltage is equal to the anode battery voltage just as the maximum oscillating current is equal to the mean direct anode current.

like an infinite resistance. On the other hand, the harmonics hardly give rise to any voltage across the condenser  $C$ . If the foregoing diagram be modified in accordance with Figure 6, by the insertion, in series with the load resistor  $r$ , of an oscillatory circuit  $lc$  tuned to the fundamental frequency, we obtain a network which is equivalent to the ordinary arrangement wherein two separate inductively coupled oscillatory circuits are used. This amounts to saying that the arrangement corresponds to a fairly broad practical application of three-electrode tubes.<sup>3</sup>

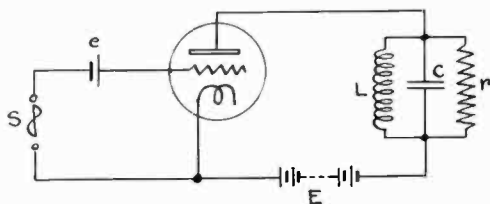

FIGURE 5

Let us continue, designating the mean current by  $i_{mean}$ , and let us also designate the amplitude of the fundamental alternating current term by  $j_{max}$ .

The energy consumed in the resistor  $r$  during each half cycle is

$$\frac{1}{2} r j_{max}^2.$$

assuming that the current attains its maximum value simultaneously with the grid saturation in such a manner that

$$r j_{max} = V - \varepsilon.$$

The energy consumed in the resistance  $r$  is therefore:

$$\frac{V - \varepsilon}{2} j_{max}.$$

The energy supplied by the source  $E$  being, on the other hand  $V i_{mean}$ , the efficiency becomes

$$\eta = \frac{1}{2} \left( 1 - \frac{\varepsilon}{V} \right) \frac{j_{max}}{i_{mean}}$$

The expression for the efficiency is particularly simple.

If we make use of the Fourier series for curves of the kind represented by Figures 2, 3, and 4, which are symmetrical about the vertical axis, we know that the fundamental term will be given by the formula:

<sup>3</sup> The arrangement using a single oscillating circuit comprising the aerial, as extensively utilized in small power sets, is covered by the British Latour patent number 147,462, of 1915.

$$j_{max.} = \frac{2}{T} \int_{t_1}^{t_2} i \sin \omega t dt$$

the interval between  $t_1$  and  $t_2$  corresponding to the length of time, in a half cycle, during which there flows a current in the anode circuit.

On the other hand, we have:

$$i_{mean} = \frac{1}{T} \int_0^T i dt$$

the efficiency may then be expressed by:

$$\eta = \left(1 - \frac{\varepsilon}{V}\right) \frac{\frac{1}{T} \int_{t_1}^{t_2} i \sin \omega t dt}{\frac{1}{T} \int_0^T i dt}$$

Let us again consider a few particular cases.

a')  $i = \frac{1}{2}(1 + \sin \omega t)$ . (See Figure 4.) The numerator integral must be taken between 0 and  $T$  and its value is  $\frac{1}{4}$ . The denominator being  $\frac{1}{2}$  the efficiency becomes:

$$\eta = \left(1 - \frac{\varepsilon}{V}\right) (0.5)$$

b') The anode current is made up of half-sinusoids and is nil during a whole half-cycle. (See Figure 3.) The numerator integral must be taken between 0 and  $\frac{T}{2}$  and is expressed by:

$$\frac{1}{T} \int_0^{\frac{T}{2}} \sin^2 \omega t dt$$

Its value is  $\frac{1}{4}$ . The denominator integral is equal to  $\frac{1}{\pi}$  and the efficiency may therefore be written down as follows:

$$\eta = \left(1 - \frac{\varepsilon}{V}\right) \cdot \frac{\pi}{4}$$

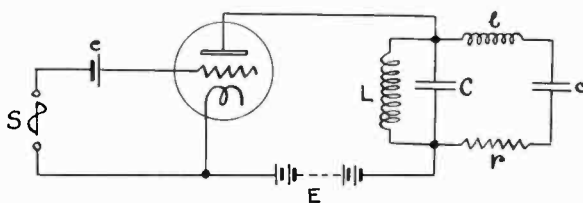

FIGURE 6

c') A plate current of value  $i_{max}$  flows, but between certain times. (See Figure 7). The numerator integral is to be taken between the time  $\frac{1}{\omega}(\frac{\pi}{2} - \theta)$  and the time  $\frac{1}{\omega}(\frac{\pi}{2} + \theta)$ . This integral then equals  $\frac{\sin \theta}{\pi}$ . The denominator integral is, on the other hand,  $\frac{\theta}{\pi}$ . The efficiency may therefore be expressed by:

$$\eta = \left(1 - \frac{\varepsilon}{V}\right) \frac{\sin \theta}{\theta}$$

For  $\theta = \frac{\pi}{2}$ , the efficiency is equal to  $\frac{2}{\pi} \left(1 - \frac{\varepsilon}{V}\right)$ . It improves and aims asymptotically towards  $\left(1 - \frac{\varepsilon}{V}\right)$  when  $\theta$  decreases.

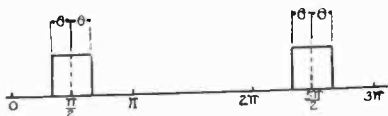

FIGURE 7

When  $\theta$  is small, we obtain an impulse excitation of the oscillatory network  $LC$ , and the particular wave-shape of the exciting current has but very little effect; it does not intervene any more than does the shape of an impulse to a pendulum in giving rise to harmonics in its-motion provided that the duration of the impulse is sufficiently short.

Furthermore, it is to be remarked that the expression  $\frac{j_{max.}}{i_{mean}}$ , which determines the efficiency, may assume the same value  $k$  for different current wave-shapes (rectangles, triangles, parabolas, fractions of sinusoids, and so on, followed by a more or less prolonged zero period); the length of time during which the anode current flows having nevertheless to be very much shorter, relatively to the duration of the whole cycle, as  $k$  is given values closer to 1<sup>4</sup>.

It is to be remarked that the operation with reduced plate current duration leads us to high  $\frac{j_{max.}}{i_{mean}}$  ratios, that is, to the necessity of having large cathode dimensions. From that point of view, the current wave-shape might matter, for it modifies the ratio  $\frac{j_{max.}}{i_{mean}}$  for a given value of  $k$ . In any case, this ratio must be

as small as possible and even more so since  $\varepsilon$  is a direct function of  $i_{max}$ .

If we particularly consider the case  $c'$  previously described, it may be noticed that there exists an analogy between the three-electrode tube and the rotary spark gap in their respective operation. As a matter of fact, we may imagine replacing the three-electrode tube by a spark-gap which would close the circuit at the very frequency for which the oscillatory circuit  $LC$ , is tuned. From that point of view, the operation of a three-electrode tube at very high frequency is not unlike that of spark-gaps in older radio telegraphic practice.

Thruout the preceding, we have considered the three-electrode tube when operating with separate grid drive. The high efficiency operation of the tube, when using self-excitation, presents a second problem. The self-exciting arrangement must allow of obtaining, for the grid voltage, the voltage wave-shape corresponding to the high efficiencies described above. However, as this grid voltage may practically be sinusoidal, no particular difficulty will be met.

In concluding it may be said that, theoretically, three-electrode tubes constitute converters of direct current to alternating current having unforeseen efficiencies.

While many radio frequency alternator efficiency figures may have been published, it might be added that but those radio frequency multipliers built by the Société Française Radio-Electrique have efficiencies which are high enough to compete with those which it is possible to obtain with three-electrode tubes.

Lastly, it is to be noted that the result of the above investigations may also be applied to magnetically controlled vacuum tubes such as those of the "magnetron" type.

<sup>4</sup> In particular, the case of fractions of sinusoids gives,  $\theta$  having the same meaning as in  $c'$ , an efficiency expression:

$$\eta = \left(1 - \frac{\varepsilon}{V}\right) \cdot \frac{\theta - \frac{\sin 2\theta}{2}}{2(\sin \theta - \theta \cos \theta)}$$

This expression tends towards  $\left(1 - \frac{\varepsilon}{V}\right)$  when  $\theta$  approaches zero and towards  $\left(1 - \frac{\varepsilon}{V}\right) \frac{\pi}{4}$ , when  $\theta$  is equal to  $\frac{\pi}{2}$ . With equal efficiencies  $\theta$  is greater for fractions of sinusoids than for rectangles, the ratio  $\frac{i_{max}}{i_{mean}}$  being slightly higher.

**SUMMARY:** The theoretical limiting efficiencies of vacuum tube oscillators, for various wave forms of plate current, are mathematically investigated and discussed.





other by practically 180 degrees, causing in the primaries *P3* and *P4* currents dephased substantially 180 degrees, which, however because of the differential winding or connection of the primaries *P3* and *P4* cumulatively effect the secondary *S3*, producing in the telephone *Ph* an audible note having a frequency of 1,000 per second which note appears for long and short periods according to the length of time the key *k* is depressed at the transmitter to form dots and dashes.

Re. 15,642—C. F. Smith et al, filed May 17, 1920, issued July 3, 1923.

**ELECTRIC CONDENSER**, particularly useful for grid condensers. The condenser is formed by thin metal foils separated by thin flexible dielectric wrapped around a relatively thin stiff body of insulating material, the ends of which project beyond the wrapping and contain terminals connected with the different sheets of foil. This invention has been previously described in these digests in connection with the original patent 1,395,931 dated November 1, 1921.

1,460,439—G. W. Pickard, filed April 22, 1922, issued July 3, 1923. Assigned to Wireless Specialty Apparatus Company.

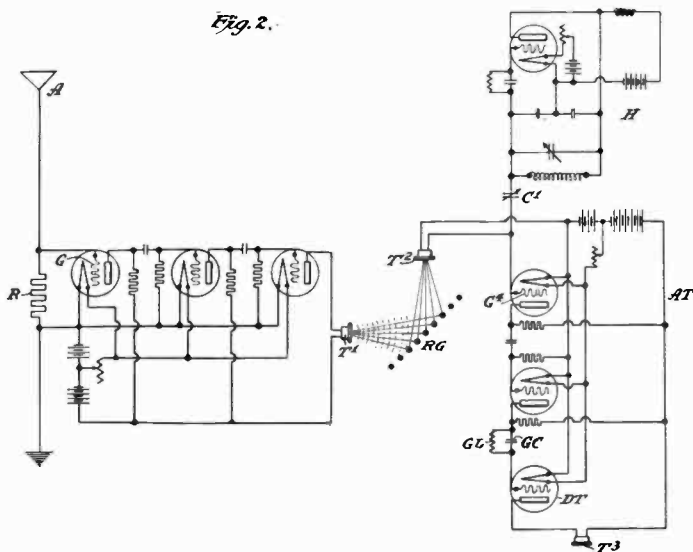

NUMBER 1,460,439—Interference Preventer

**INTERFERENCE PREVENTER** for radio receiving systems. The

received signal energy is converted into air waves and directed towards a reflection grating composed of elements distributed periodically in tune with the desired air wave frequency. A receiver diafram is arranged to be actuated by air waves reflected from said reflection grating. A circuit is provided for converting the currents set up by movement of said diafram into intelligible signals.

1,460,636—P. J. Armagnat, filed August 9, 1920, issued July 3, 1923.

WAVEMETER operating on the principle of comparison of an electromotive force obtained thru a coupled circuit with the difference of potential produced at the terminals of a resistance by the oscillating current to be measured.

1,460,734—W. H. Ruf, filed April 27, 1922, issued July 3, 1923.

RADIO DETECTOR formed to be carried around on the finger. A complete radio receiving set is shown in this patent having a crystal detector and a frame which fits over the finger.

1,460,801—R. H. Marriott, filed June 20, 1921, issued July 3, 1923.

DIRECTIONAL RADIO RECEIVING SYSTEM using a loop antenna circuit and a connection to earth. An electron tube circuit having its grid and filament connected with the ground connection is provided. A connection is established between the plate circuit and the loop circuit. The arrangement has the effect of repeating the loop-to-ground potential and impressing the energy upon the loop circuit.

1,461,064—De Loss K. Martin, filed February 10, 1921, issued July 7, 1923. Assigned to American Telephone and Telegraph Company.

MULTIPLEX TRANSMISSION CIRCUITS particularly adapted for radio operation wherein a carrier frequency is generated for each of three channels by modulating one frequency in accordance with another frequency, thereby producing a fundamental frequency and two side frequencies. Each of the several frequencies may then be modulated in accordance with a signal and the antenna circuit may be arranged to have a plurality of degrees of freedom corresponding to the several frequencies. At the receiving station the antenna is likewise arranged to resonate at



lator with conducting mounts carried by the ends of the insulator and constituting closures therefor. Metal coatings and insulating layers are arranged in and completely enclosed by the tubular insulator and conducting mounts forming elements of the condenser.

1,461,754—G. H. Clark, filed March 3, 1921, issued July 17, 1923. Assigned to Radio Corporation of America.

*Fig. 4*

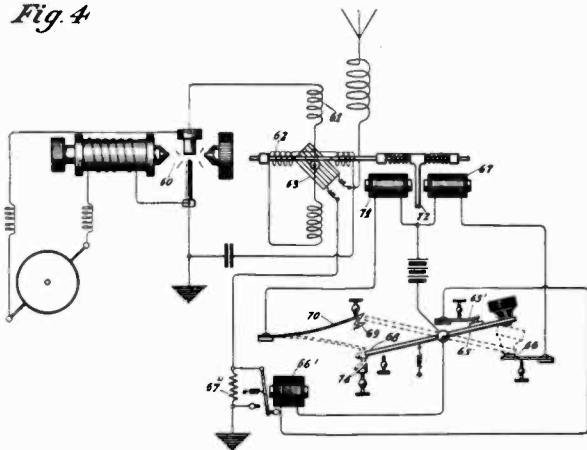

NUMBER 1,461,754—Transmitting and Receiving Apparatus for Radio Telegraphy

TRANSMITTING AND RECEIVING APPARATUS FOR RADIO TELEGRAPHY for more clearly defining the dots and dashes in signaling and eliminating the "tailing-off effects" in signals at the end of each dot or dash. A circuit is provided for annulling this tailing-out in the receiving system which is accomplished by sending out a counter wave from the transmitting station that more than annuls the dying-down current at the end of each dot or dash and produces an electromagnetic wave  $180^\circ$  from the main wave, but this is brought into effect only at the end of each dot or dash. This opposed electromagnetic wave tends to induce a current that is out of phase with the dying-down current and the combination of the two effects results in sudden termination of the dots and dashes.

1,462,038—R. V. L. Hartley, filed December 30, 1916, issued July 17, 1923. Assigned to Western Electric Company.

MODULATING SYSTEM for radio or line wire transmission. The

invention makes use of reactance modulators of the transformer type for controlling the radio frequency output by varying the mutual inductance between the primary and secondary windings of the transformer in accordance with a signal to be transmitted. The amplitude of the radio frequency currents radiated depends upon the coupling between the primary and secondary windings and by varying this coupling, that is, the mutual inductance in accordance with the signal, a modulation of the carrier wave is effected. The variation in coupling is effected by varying the permeabilities of the transformer cores in accordance with the signal currents. The secondary windings of the two transformers are connected to the antenna in opposition to each other, so that no radio frequency power is radiated in the absence of signaling currents. The effect of signaling currents is to increase the permeability of one transformer core, and to decrease the permeability of the other transformer core. This disturbs the balance of the opposed secondary windings, and modulated radio frequency power is radiated.

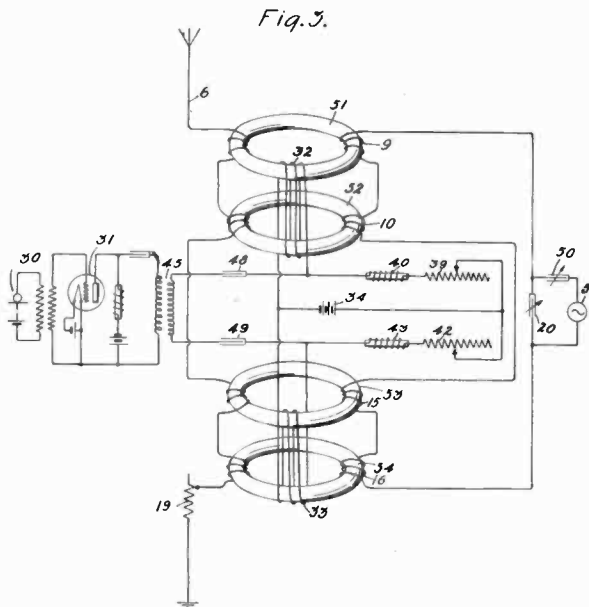

NUMBER 1,462,038—Modulating System

1,462,057—P. I. Wold, filed September 27, 1920, issued July 17, 1923. Assigned to Western Electric Company.

SWITCH MECHANISM FOR VACUUM TUBES AND THE LIKE,

whereby a new tube is automatically cut into a circuit upon the burning out of the filament in a tube normally operating in a circuit. A relay is provided having its winding in the plate circuit of one tube and controlling the position of an armature carrying contacts which distribute connections from the tube electrodes to the associated circuits. Upon interruption of the plate current by burning out of the tube the armature moves to connect a new tube into the circuit.

1,462,882—H. Chireix, filed March 24, 1922, issued July 24, 1923.

RECEIVING SYSTEM, including an electron tube with a thermostat in the plate circuit thereof with a divided heating coil on the thermostat. A relay is arranged to disconnect a portion of the heating coil of the thermostat and an indicating device is provided which co-operates with the thermostat to respond to a signal on receipt of radio energy.

1,463,386—W. L. Carlson and E. C. Hanson, filed April 22, 1920, issued July 31, 1923.

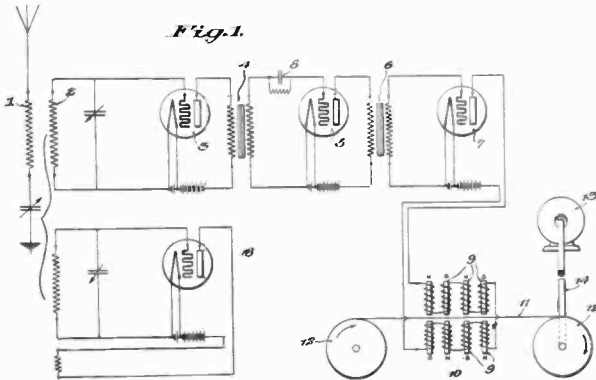

NUMBER 1,463,386—Radio Telegraph System

RADIO TELEGRAPH SYSTEM employing a telegraphophone. A plurality of electromagnets are used in conjunction with the telegraphophone wire. These magnets are spaced apart in proportion to the frequency of the signals to be received and the linear speed of the recording arrangement. The plurality of magnets integrate the received signal energy over a relatively large area of the recording wire, insuring a substantial signal record.

1,463,391—E. C. Hanson and W. L. Carlson, filed February 11, 1920, issued July 31, 1923.

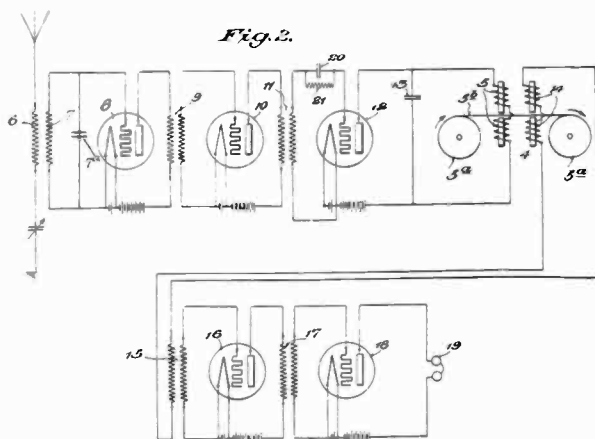

NUMBER 1,463,391—Radio Telegraph System

**RADIO TELEGRAPH SYSTEM** employing a telegraphone. An initial signal record is placed upon the telegraphone wire which in reproduction would tend to produce a continuous note. Incoming radio signals are caused to erase the initial record. The signals are then translated by operating the telegraphone at slow speed for reading the signals left on the wire.

1,463,554—A. N. Pierman, filed February 4, 1922, issued July 31, 1923.

**MOUNTING FOR STEMS OF CRYSTAL DETECTORS** of simple and inexpensive manufacture. The rod or stem which terminates in the detector whisker is supported between strands of wire made taut upon a terminal post of the detector.

1,463,797—L. A. Charbonneau, filed July 9, 1920, issued August 7, 1923.

**OPTICAL TELEGRAPHY**, wherein signals sent out by a transmitting station may be received only by those stations for which the message is intended. Infra-red rays are emitted and are received by making of the property of these rays for extinguishing the phosphorescence of certain phosphorescent substances.

1,463,813—J. W. Harris, filed December 29, 1916, issued August 7, 1923. Assigned to Western Electric Company, Incorporated.

**ELECTRON EMITTING CATHODE AND PROCESS OF MANUFACTURING THE SAME**, which comprises the applying of coatings of



mixed barium, strontium, and calcium compounds to the filament conductor. A platinum compound is distributed between the coatings. The barium, strontium, and calcium compounds are then reduced to their oxides and the platinum compound is reduced to platinum.

1,463,860—W. Wilson, filed July 22, 1920, issued August 7, 1923. Assigned to Western Electric Company, Incorporated.

ELECTRON DISCHARGE DEVICE having its electrodes arranged for operation of the tube at high power where high temperature will have no detrimental effects on the tube construction. The lead-in wires for the grid and the anode are positioned away from the lead-in wires for the cathode and are sealed in between flare of the press and the neck of the tube.

1,463,994—J. H. Hammond, Jr., filed February 15, 1918, issued August 7, 1923.

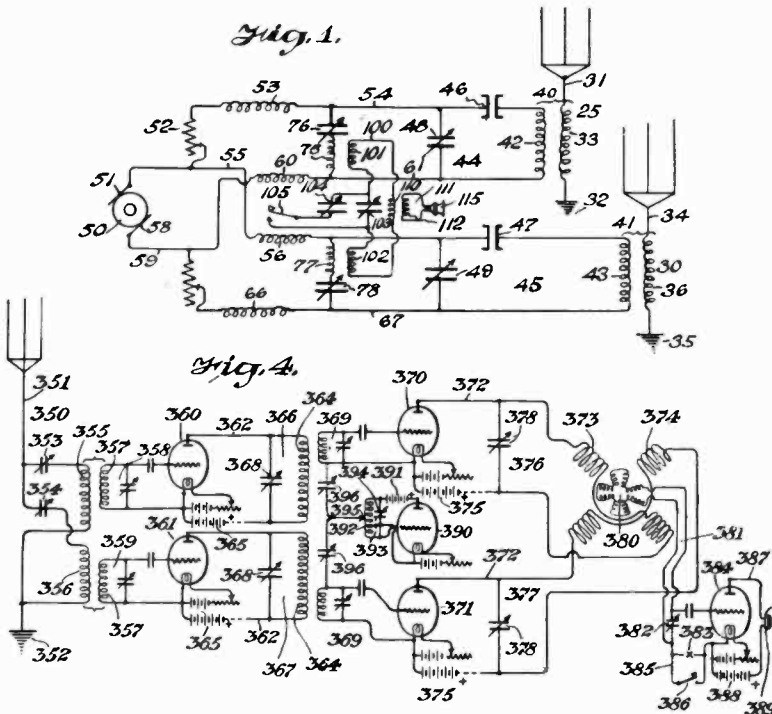

NUMBER 1,463,994—System for the Transmission and Reception of Radiant Energy

SYSTEM FOR TRANSMISSION AND RECEPTION OF RADIANT ENERGY, which consists in transmitting a plurality of series of waves in such manner as to maintain a predetermined phase relationship among a plurality of the series and then modifying the phase relationship and causing the functioning of a receiving device as a result of the modification of said phase relationship whereby secret transmission may be secured.

1,464,083—S. Loewe, filed March 19, 1921, issued August 7, 1923. Assigned to Western Electric Company, Incorporated.

RECEIVING APPARATUS FOR RADIO FREQUENCY SIGNALING, comprising a coil antenna connected with the receiving apparatus with a source of locally produced oscillations connected directly across a portion of the coil antenna.

1,464,086—W. E. Beatty, filed December 27, 1918, issued August 7, 1923. Assigned to Western Electric Company, Incorporated.

METHOD OF AND MEANS FOR SECRET SIGNALING, wherein a plurality of different signaling waves are employed and each modified in accordance with a particular group of signals which when combined at the receiver produce an intelligent sequence of signaling.

1,464,097—R. A. Heising, filed August 7, 1920, issued August 7, 1923. Assigned to Western Electric Company.

TWO-WAY SIGNALING SYSTEM for radio operation in which the transmitter and receiver are permanently associated with the same circuits and the response of the receiver to energy in the local transmitter circuit is substantially reduced or eliminated.

1,464,104—A. McL. Nicolson, filed July 26, 1917, issued August 7, 1923. Assigned to Western Electric Company, Incorporated.

SELECTIVE APPARATUS FOR SIGNALING CIRCUITS, comprising an electron tube construction wherein the anode is separated by a dielectric from the grid electrode and the filament. The dielectric may be in the form of a sheet which encloses the grid electrode. The tube is connected in a circuit which has at times substantially zero space current with means responsive to an impressed alternating current to establish the space current.

1,464,124—W. Wilson, filed July 26, 1917, issued August 7, 1923. Assigned to Western Electric Company, Incorporated.

**THERMIONICALLY ACTIVE SUBSTANCE AND METHOD OF MAKING THE SAME**, comprising the heating of a metallic filament in a vacuum and sputtering a coating of an alkaline earth oxide on to the filament in the vacuum, and then baking the coated filament in the vacuum.

1,464,168—W. T. Booth, et al, filed July 9, 1917, issued August 7, 1923. Assigned to Western Electric Company, Incorporated.

**ANTENNA SYSTEM** for airplane radio operation. An automatic reeling device is provided whereby a motor is operated to reel out the antenna to a predetermined distance for signaling and automatically retracting the antenna after the signaling is completed.

1,464,322—F. A. Kolster, filed November 26, 1920, issued August 7, 1923. Assigned one-third to Cornelius D. Ehret.

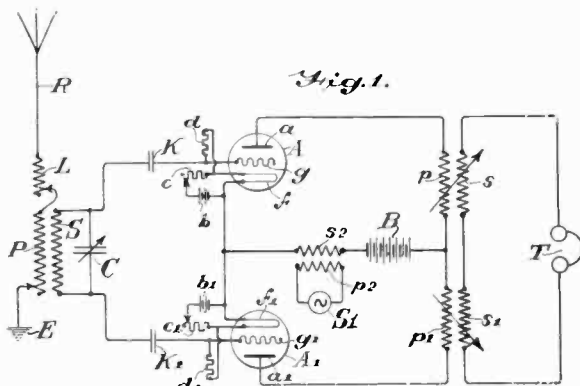

NUMBER 1,464,322—Radio Receiving Method and Apparatus

**RADIO RECEIVING METHOD AND APPARATUS** particularly designed for continuous wave signaling where a local source of audible frequency energy operates the signal responsive device when a signal is being received. When no signal is being received the source  $S^1$  will cause impression upon the circuit of the telephone  $T$  of a current which would produce a response whereby if it were not for the fact that the couplings  $p$ ,  $s$  and  $p^1$

$s^1$  produced, by suitable winding or mode of connection, equal and opposite effects upon the circuit of the telephone  $T$ . Accordingly, when no signal is being received the source of  $S^1$  has no effect upon the telephone  $T$ . When, however, continuous signal waves are received, the circuit  $SC$  being attuned thereto, as well as the antenna circuit, opposite ends of the inductance or secondary  $S$  will attain widely different potentials, the potential of the grid  $g$  rising for example, while the potential of the grid  $g^1$  falls. The current in one anode circuit therefore greatly increases, while the other greatly diminishes, and accordingly the net effect of the couplings  $p$ ,  $s$  and  $p^1$ ,  $s^1$  no longer is zero, and there is transferred to the circuit of the telephone  $T$  current which causes its response evidence by the production of a sound, the frequency of which is equal to or corresponds with the frequency of the current delivered by the source  $S^1$ .

1,464,533—S. Loewe, filed August 26, 1921, issued August 14, 1923.

RADIO RECEIVING SYSTEM employing an antenna system which is connected with a receiving amplifier. A source of local oscillation is connected with the input circuit of the receiving amplifier and conductively connected with the antenna system and with said input circuit.

1,464,565—L. Espenschied, et al, filed April 13, 1921, issued August 14, 1923. Assigned to American Telephone and Telegraph Company.

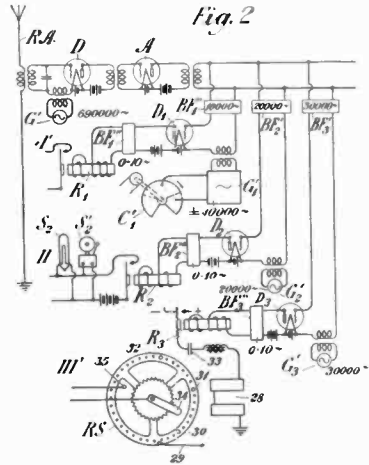
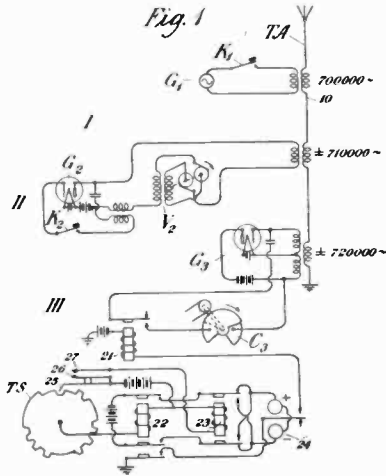

NUMBER 1,464,565—Call System for Radio Telephony

CALL SYSTEM FOR RADIO TELEPHONY, in which control apparatus is shown which is extremely selective for the purpose of preventing interference due to static or other causes. To actuate a ringing circuit at the receiver the ringing frequency is periodically varied at a sub-audible rate over a range such that the frequency coincides with the locally produced frequency at periodic intervals.

1,465,108—E. F. W. Alexanderson, filed September 16, 1918, issued August 14, 1923. Assigned to General Electric Company.

UNI-DIRECTIONAL RADIO RECEIVING SYSTEM which permits the receiving of signals of any desired wave length at a receiving station to the exclusion of other signals having the same wave length coming from directions other than that which the desired signals come.

1,465,264—F. G. Goldstone, filed September 14, 1920, issued August 21, 1923. Assigned to Joseph Frances Bernard and John Bruce Bolitho, of London, England.

ELECTRIC CONDENSER, comprising a set of stationary and rotatable plates which have the form of a shell or cup. The movable elements having the appearance of hemispheres and intermeshed with the stationary elements to vary the capacity of the condenser.

1,465,357—R. A. Heising, filed September 27, 1919, issued August 21, 1923. Assigned to Western Electric Company.

RADIO COMMUNICATION system wherein more than one radio message may be transmitted and received simultaneously. The transmitter is modulated at separate modulation frequencies and these may be simultaneously received and caused to interact at the receiver with a locally produced frequency of such value that a resultant radio frequency wave is produced which is in effect a carrier frequency and still inaudible. The frequencies are then separated, selected, and detected to obtain the separate speech components.

1,465,358—R. A. Heising, filed September 29, 1919, issued August 21, 1923. Assigned to Western Electric Company.

SIGNALING by multiplex method in radio wherein interference, due to certain parasitic and undesirable waves of certain frequencies is eliminated. A plurality of carrier waves is trans-

mitted from the transmitting station, each being modulated in accordance with speech. Normally the carrier waves have frequencies differing too slightly to be efficiently selected at a receiving station. Therefore a wave of a frequency differing from any of the carrier waves is transmitted along with the carriers and combined at the receiver with each of the carriers to produce at the receiver speech modulated waves of such characteristics as to be readily separated.

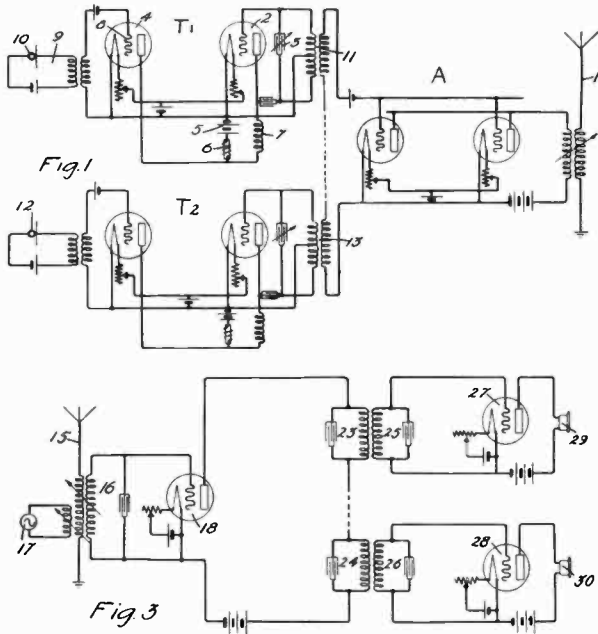

NUMBER 1,465,357—Radio Communication

1,465,394—W. H. Housekeeper, filed November 6, 1920, issued August 21, 1923. Assigned to Western Electric Company, Incorporated.

**CONTROL APPARATUS FOR EVACUATED VESSELS** for measuring gas pressure by observing the ionization of the gas. Fluctuations in gas pressure within the electron tube give corresponding fluctuations in the intensity electron discharge from the heated filament. A circuit is shown in this patent wherein a relay under control of the anode circuit, and hence the electron stream, operates to short-circuit the cathode for regulating the electron stream.

1,465,381—R. F. Trimble, filed November 4, 1918, issued August 21, 1923. Assigned to Western Electric Company, Incorporated.

GRID ELECTRODE AND ITS CONSTRUCTION, wherein a pair of supporting wires are provided bent upon themselves to form an arched portion with the ends of the wires welded and cross wires extending between the supporting wires framing the grid structure in a cage-like frame.

1,465,732—R. A. Heising, filed September 23, 1919, issued August 21, 1923. Assigned to Western Electric Company.

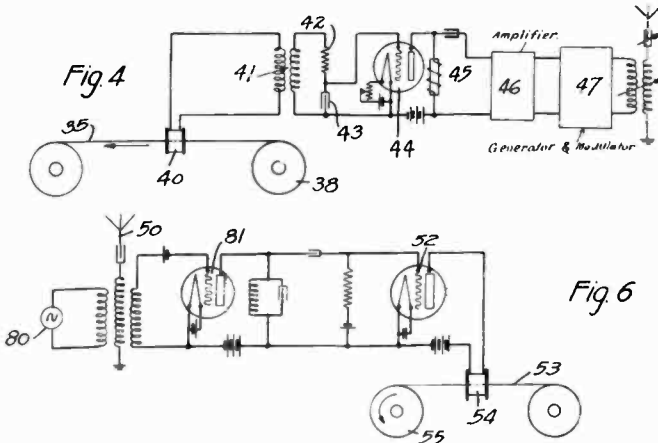

NUMBER 1,465,732—System of Communication

SYSTEM OF COMMUNICATION, wherein traffic handled thru a radio channel may be increased more nearly to compete with the quantity of traffic which can be handled over land lines and cables. A system for storing the signals is provided, employing the telegraphone. The signals to be transmitted may be impressed on the telegraphone record in a forward direction and then transmitted from the storage element in a reverse direction. The transmitted signals may be received at a distant receiver on a storage element, such as a telegraphone wire in the same reverse direction. The signals may then be translated for the purpose of reading by operating the telegraphone record to reproduce the signals in a forward direction.

LIST OF RADIO TRADE MARKS PUBLISHED BY THE PATENT OFFICE PRIOR TO REGISTRATION

(The numbers given are serial numbers of pending applications):

- 169,626—"DOMESTIC" for telephone receivers. The Domestic Electric Company, Cleveland, Ohio. Claims use since about May, 1922. Published July 10, 1923.
- 171,473—"SATURN" in ornamental design for telephone jacks for telephone receivers. Saturn Manufacturing Company, New York, N. Y. Claims use since August 18, 1922. Published July 10, 1923.
- 173,956—"GLORAD" for radio transmitting and receiving sets. Globe Radio Manufacturing Company, New York City. Claims use since May 22, 1923. Published July 10, 1923.
- 178,282—"RA-MO-PHONE" for cabinets for radio receivers, motion picture machines and phonographs. Radio Motion Picture Phonograph Corporation, Long Island City, New York. Claims use since December 1, 1922. Published July 10, 1923.
- 171,135—"MOGUL DRY-STORAGE BATTERIES" in ornamental design for storage batteries. Mogul Electric Company, Seattle, Washington. Claims use since July 1, 1922. Published July 31, 1923.
- 171,142—Elements of Audion in ornamental design for radio transmitting and receiving sets. Bruno Radio Corporation, New York City. Claims use since July 1, 1922. Published July 31, 1923.
- 179,976—"WEARITE STORAGE BATTERY" in ornamental design for storage batteries. Wearite Storage Battery Company, Philadelphia, Pennsylvania. Claims use since March 10, 1923. Published July 31, 1923.
- 180,142—"RAJAH" for radio receiving sets. Rajah Radio Guild, University City, Missouri. Claims use since March 15, 1923. Published July 31, 1923.
- 171,275—"TWIN ADAPTER" for connector plugs for radio telephone and telegraph apparatus. Pacent Electric Company, Incorporated, New York City. Claims use since not less than one year. Published July 31, 1923.
- 180,279—"GERACO" in ornamental design for radio receiving apparatus. General Radio Corporation, Philadelphia, Pennsylvania. Claims use since May 1, 1922. Published August 7, 1923.



- 166,124—"PIANOLA" for radio transmitting and receiving sets. The Aeolian Company, New York, N. Y. Claims use since prior to June 14, 1922. Published August 21, 1923.
- 179,567—"SENSITONE" in ornamental design for radio transmitting and receiving apparatus. Harold R. Wakem and Company, Chicago, Illinois. Claims use since September 1, 1922. Published August 21, 1923.
- 179,630—"PICK OF THE MARKET RADIO" in ornamental design for radio receiving apparatus. George Kenneth Thompson, Boston, Massachusetts. Claims use since on or about April 13, 1923. Published August 21, 1923.
- 180,140—"A K" in ornamental design for radio receiving apparatus. Atwater Kent Manufacturing Company. Claims use since on or about March 1, 1922. Published August 21, 1923.
- 180,706—"THE ROYALTY OF RADIO" for radio receiving sets. The Colin B. Kennedy Company, St. Louis, Missouri. Claims use since April 1, 1923. Published August 21, 1923.



---

# RADION Panels

are  
impervious to  
moisture

## 18 Stock Size Panels

Radion being an insulation material especially made for wireless use, has the lowest phase angle difference, lowest dielectric constant, highest resistivity and supreme moisture, gas and acid-repelling properties.

**American Hard Rubber Co.**  
11 MERCER STREET NEW YORK

*Manufacturers and Moulders of*

# RADION

*Panels - Dials - Knobs - Sockets - Insulators*

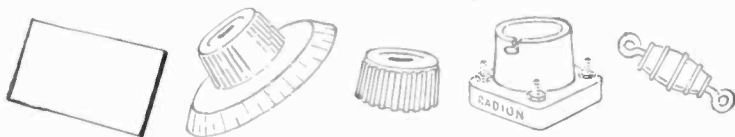

ARISTOS **"COPPERWELD"** WIRE

TRADE MARK REG. U. S. PAT. OFF.

(Made by the Molten Welding Process)

**ADOPTED AND USED BY THE LARGEST  
RADIO COMPANIES IN THE WORLD**

**For aerials, Copperweld has advantages over  
solid copper or bronze**

Radio frequency currents, because of "skin effect," flow along the exterior of wires. The smooth exterior thickness of copper on Copperweld Wire gives it practically the same high electrical conductivity as a solid copper wire (see Letter Circular No. 62, U. S. Bureau of Standards).

Greater strength is given by its steel core. No. 14 Copperweld Antenna Wire has *50% greater strength* than No. 14 hard-drawn copper or 7-No. 22 stranded copper wires. It stays up under severe loads when copper and stranded copper wires sag and break.

For ANTENNA, No. 14 Bare Copperweld Antenna Wire

For LEAD-IN, No. 17 Rubber Insulated Copperweld Wire

For GROUND Wire, same as Lead-In Wire

For GROUNDING to earth, Copperweld Ground Rods,  $\frac{1}{2}$ " diam.

*Larger sizes for commercial stations*

**Copper Clad Steel Company**

**New York**

**San Francisco**

**Chicago**

**Mills and Main Office, Braddock P. O., Rankin, Pa.**

**350 to 400 vs 200 to 600**

The new allocation of wave lengths comes very fortunately for the manufacturer at the season when the demand is slackening. This provides a breathing space for him to study his products to determine whether they still are effective under the new conditions.

The Laboratories offers facilities for experimentation of this kind.

**Electrical Testing Laboratories**

**80th Street and East End Avenue, New York, N.Y.**

# EVEREADY

## Radio Batteries

*—they last longer*

Thirty years of Dry Cell experience and a large research organization are back of EVEREADY Radio Batteries. There is an EVEREADY Battery for every Radio need.

Dry Cell "A" Batteries—

Storage "A" Batteries—

"B" Batteries for all sets — from the smallest portable to the largest permanent installation.

"C" Batteries for improving quality of reception and increasing "B" Battery life.



EVEREADY "B" BATTERY

No. 766

In the new metal case

*Manufactured and Guaranteed by*

NATIONAL CARBON COMPANY, INC.

Long Island City, N. Y.

# EVEREADY

## Radio Batteries

*— they last longer*

# Burgess, the *Radio Battery*

*Specified by radio engineers—designed and built by wireless specialists—and recommended by the leading manufacturers of radio equipment.*

Burgess Radio Batteries, the result of years of careful experiments, are built under exacting manufacturing standards which must meet the requirements of strict laboratory formulas and tests—a supervision that insures their perfect operation.

For professional or amateur radio use, where noiselessness, long life, high capacity and uninterrupted, dependable service are essential, Burgess has no superior. All progressive jobbers and dealers handle Burgess Radio Batteries.

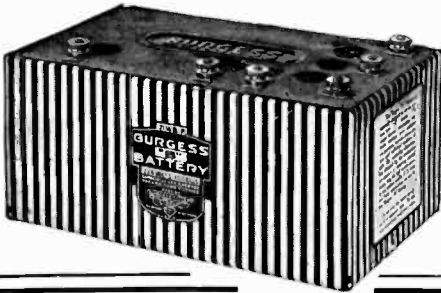

## Burgess Battery Company

DRY BATTERIES  
 Engineers—Manufacturers  
 Flashlight—Radio—Ignition—Telephone. General Sales Office: Harris Trust Bldg., Chicago. Laboratories and Works: Madison, Wis. Branches, New York, Boston, Washington, Kansas City, St. Paul, New Orleans. In Canada:

General Offices and Works:  
 Niagara Falls, Ont.  
 Winnipeg, Toronto,  
 Montreal, St. John

# BRACH VACUUM LIGHTNING ARRESTER



For 17 Years a Leader in the Field of Protective Apparatus



L. S. BRACH MFG. CO.

NEWARK, N. J.

# DUDLO MAGNET WIRE and WINDINGS

have been developed especially to meet the exacting requirements of radio apparatus construction. With our large, modern plant and large force of workers skilled in the handling of fine wire, we are able to give you the utmost satisfaction in taking care of your wire and coil requirements.

WRITE TODAY FOR PRICES AND SAMPLES

DUDLO MANUFACTURING CO., FORT WAYNE, IND.

Pacific Coast Representative

A. S. Lindstrom, 111 New Montgomery St., San Francisco, Cal.

# *Murdock*

## Radio Headphones

STANDARD SINCE 1904

*Announcing New Prices*

2000 OHM SETS . . . \$4.00

3000 OHM SETS . . . 4.50

*Better Made Now  
Than Ever*

**WM. J. MURDOCK CO.**

WASHINGTON AVENUE

CHELSEA, MASS.

# PROFESSIONAL ENGINEERING DIRECTORY

For Consultants in Radio and Allied Engineering Fields

## THE J. G. WHITE Engineering Corporation

Engineers—Constructors  
*Builders of New York Radio Central*  
Industrial, Steam Power and Gas  
Plants, Steam and Electric Rail-  
roads, Transmission Systems.  
43 Exchange Place, NEW YORK

## MONTAGUE FERRY

38 So. Dearborn St., Chicago

*Radio Apparatus  
Design*

*Your Card Here  
Will Be Seen  
By Over 2,500  
I. R. E. Members*

**This Space Costs  
\$5.00 per Issue  
or  
\$25.00 per Year**

## NOVO "B" BATTERIES FOR RADIO

22½ - 45 & 105 VOLTS

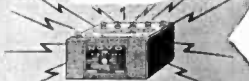

**NOISELESS  
DEPENDABLE  
GUARANTEED**

**ASK YOUR DEALER**

**NOVO MANUFACTURING CO.**

424-438 W. 33<sup>RD</sup> ST.  
NEW YORK

531 SO. DEARBORN ST., CHICAGO.

## WANTED

PROCEEDINGS of the  
INSTITUTE OF RADIO  
ENGINEERS for the years  
1913, 1914, 1915 and 1916.

Owners willing to sell any or  
all of these volumes please  
address

## Vail Librarian

Massachusetts Institute  
of Technology

Cambridge, Mass.



THE DeForest name has been in the forefront of radio research for twenty-three years. DeForest invented the three-electrode vacuum tube which makes present-day radio possible. The sets and parts made to-day by the DeForest Company are worthy of the DeForest name.

**DeForest**

•Reg. U. S. Pat. Off.

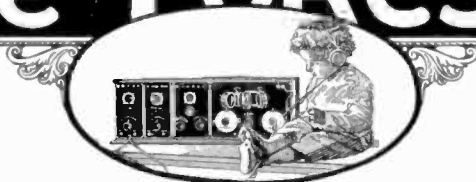

## A Magnavox Reproducer and Power Amplifier in One Unit

**A**FTER exhaustive study and tests by our engineers, this has been successfully accomplished, and the new instruments of the unit type here illustrated in one and two stages of amplification may now be had through Magnavox dealers everywhere.



The new Magnavox Combination Sets A2-R [2-stage] and A1-R [1-stage] insure the utmost in convenient, home radio reproduction.

### *Reproducers*

- R2 with 18 inch horn \$60.00
- R3 with 14 inch horn \$35.00
- M1 with 14 inch horn; for dry battery sets . \$35.00

### *Combination Sets*

- A1-R consists of Magnavox Reproducer with 14 inch horn and 1-stage Amplifier . . . \$59.00
- A2-R same with 2-stage Amplifier . . . \$85.00

### *Power Amplifiers*

- A1-One-stage . . \$27.50
- AC-2-C-Two-stage 55.00
- AC-3-C-Three-stage 75.00

Magnavox Products can be had of good dealers everywhere. Ask for a demonstration

**THE MAGNAVOX CO.**  
Oakland, Cal.  
New York Office: 370 Seventh Avenue  
Canadian Distributors:  
Perkins Electric Co., Ltd., Montreal

# MAGNAVOX PRODUCTS

10-R No Radio Receiving Set is complete without them

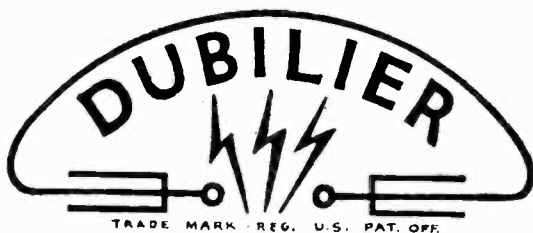

If the right condenser  
is the problem.

**T**HE Dubilier Condenser &  
Radio Corporation is the  
largest manufacturer of  
condensers in the world.

Its long experience in meet-  
ing the special requirements  
of governments and manu-  
facturers may be freely  
drawn upon by radio en-  
gineers.

**DUBILIER CONDENSER AND RADIO CORP.**

48-50 West Fourth St., New York

*Branch Offices in the Following Cities*

Los Angeles, Cal.

Atlanta, Ga.

Chicago, Ill.

St. Louis, Mo.

Huntington, W. Va.

Pittsburgh, Pa.

Washington, D. C.

Distributed in Canada by Canadian General Electric Company, Ltd., Toronto



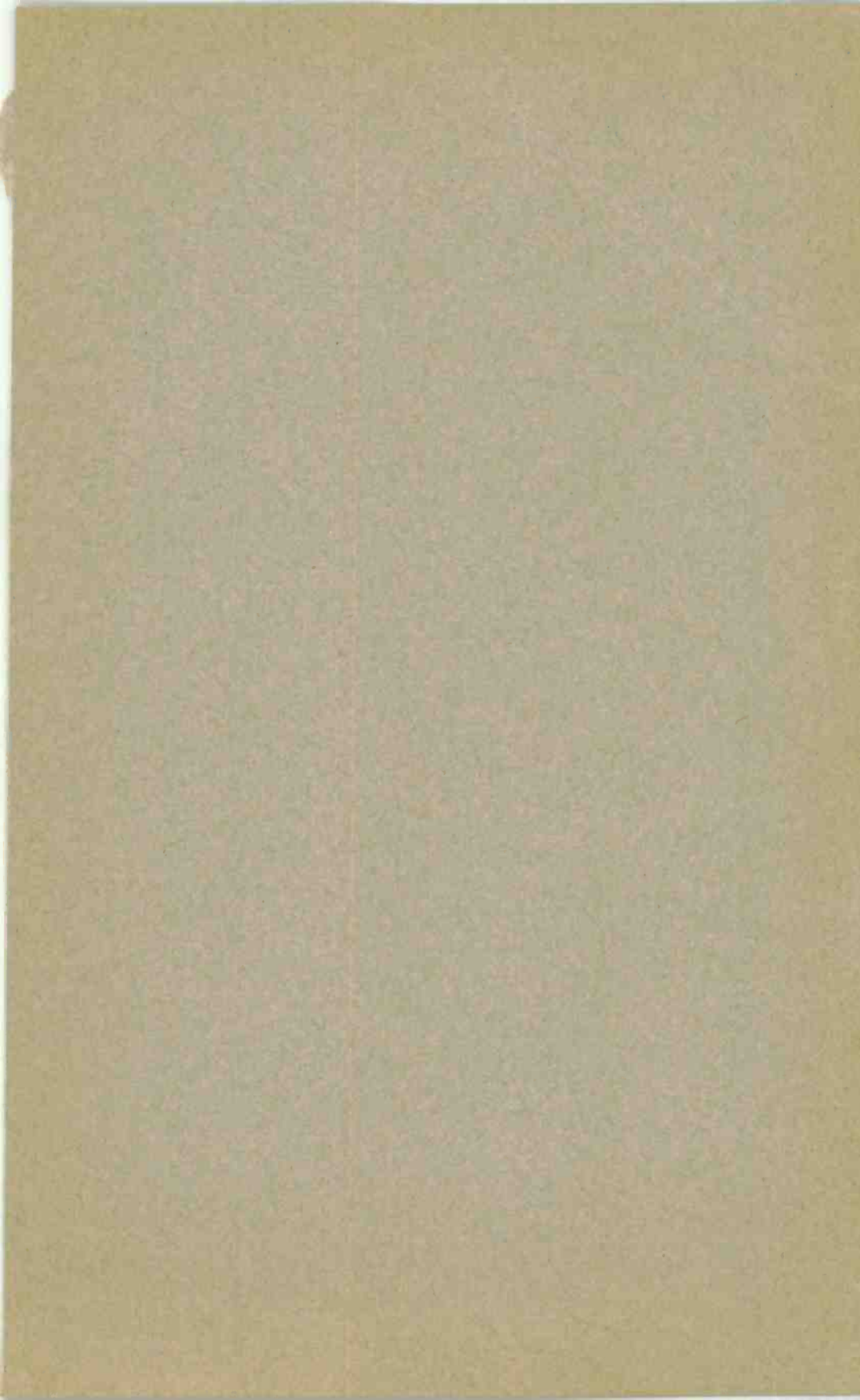



# Brandes

Delicate laboratory tests require headsets that are perfectly matched in tone—accurate in construction—dependable in performance.

For more than fifteen years Brandes *Matched Tone* Headsets have met the most exacting laboratory requirements. They are delicate but dependable—scientifically skilful in design and perfect in finish.

They are, therefore, the choice of the foremost radio engineers of the country.

## NEW PRICES

Superior  
\$6.00

Navy Type  
\$8.00

C. BRANDES, Inc., 237 Lafayette St., N. Y. C.

*Matched Tone*  
TRADE MARK REG. U.S. PAT. OFF.  
Radio Headsets