

VOLUME 4

APRIL, 1916

NUMBER 2

PROCEEDINGS
of
**The Institute of Radio
Engineers**
(INCORPORATED)

TABLE OF CONTENTS

TECHNICAL PAPERS AND DISCUSSIONS



EDITED BY
ALFRED N. GOLDSMITH, Ph.D.

PUBLISHED EVERY TWO MONTHS BY
THE INSTITUTE OF RADIO ENGINEERS, INC.
ONE HUNDRED AND ELEVEN BROADWAY
NEW YORK

THE TABLE OF CONTENTS FOLLOWS ON PAGE 97

GENERAL INFORMATION

The right to reprint limited portions or abstracts of the articles, discussions, or editorial notes in the Proceedings is granted on the express condition that specific reference shall be made to the source of such material. Diagrams and photographs in the Proceedings may not be reproduced without securing permission to do so from the Institute thru the Editor.

Those desiring to present original papers before the Institute of Radio Engineers are invited to submit their manuscript to the Editor.

Manuscripts and letters bearing on the Proceedings should be sent to Alfred N. Goldsmith, Editor of Publications, The College of the City of New York, New York.

Requests for additional copies of the Proceedings and communications dealing with Institute matters in general should be addressed to the Secretary, The Institute of Radio Engineers, 111 Broadway, New York.

The Proceedings of the Institute are published every two months and contain the papers and the discussions thereon as presented at the meetings in New York, Washington, Boston or Seattle.

Payment of the annual dues by a member entitles him to one copy of each number of the Proceedings issued during the period of his membership. Members may purchase, when available, copies of the Proceedings issued prior to their election at 75 cents each.

Subscriptions to the Proceedings are received from non-members at the rate of \$1.00 per copy or \$6.00 per year. To foreign countries the rates are \$1.10 per copy or \$6.60 per year. A discount of 25 per cent. is allowed to libraries and booksellers. The English distributing agency is "The Electrician Printing and Publishing Company," Fleet Street, London, E. C.

Members presenting papers before the Institute are entitled to ten copies of the paper and of the discussion. Arrangements for the purchase of reprints of separate papers can be made thru the Editor.

It is understood that the statements and opinions given in the Proceedings are the views of the individual members to whom they are credited, and are not binding on the membership of the Institute as a whole.

COPYRIGHT, 1916, BY
THE INSTITUTE OF RADIO ENGINEERS, INC.
ONE HUNDRED AND ELEVEN BROADWAY
NEW YORK, N. Y.

CONTENTS

	PAGE
OFFICERS AND PAST PRESIDENTS OF THE INSTITUTE	98
COMMITTEES OF THE INSTITUTE	100
E. F. W. ALEXANDERSON AND S. P. NIXDORFF, "A MAGNETIC AMPLIFIER FOR RADIO TELEPHONY"	101
Discussion on the above paper	121
A. HOYT TAYLOR AND ALBERT S. BLATTERMAN, "VARIATIONS IN NOCTURNAL TRANSMISSION"	131
Discussion on the above paper	149
FULTON CUTTING, "THE THEORY AND DESIGN OF RADIO TELEGRAPHIC TRANSFORMERS"	157
Discussion on the above paper	201

OFFICERS AND BOARD OF DIRECTION, 1916
(Terms expire January 3, 1917; except as otherwise noted.)

PRESIDENT

ARTHUR E. KENNELLY

VICE-PRESIDENT

JOHN L. HOGAN, JR.

TREASURER

WARREN F. HUBLEY

SECRETARY

DAVID SARNOFF

EDITOR OF PUBLICATIONS

ALFRED N. GOLDSMITH

MANAGERS

(Serving until January 1, 1919.)

EDWIN H. ARMSTRONG

WILLIAM H. G. BULLARD

(Serving until January 2, 1918.)

LOUIS W. AUSTIN

JOHN HAYS HAMMOND, JR.

(Serving until January 3, 1917.)

LLOYD ESPENSCHIED

ROBERT H. MARRIOTT

GUY HILL

JOHN STONE STONE

ROY A. WEAGANT

ADVERTISING MANAGER

LOUIS G. PACENT

WASHINGTON SECTION

EXECUTIVE COMMITTEE

CHAIRMAN

COLONEL SAMUEL REBER

War Department,
Washington, D. C.

SECRETARY-TREASURER

GEORGE H. CLARK

Navy Department,
Washington, D. C.

CHARLES J. PANNILL
Radio, Va.

BOSTON SECTION

CHAIRMAN

A. E. KENNELLY,

Harvard University,
Cambridge, Mass.

SECRETARY-TREASURER

MELVILLE EASTHAM,

11 Windsor Street,
Cambridge, Mass.

SEATTLE SECTION

CHAIRMAN

ROBERT H. MARRIOTT,

715 Fourth Street,
Bremerton, Wash.

SECRETARY-TREASURER

ALEXIS A. PAYSSE,

Hotel Burke,
Seattle, Wash.

PAST-PRESIDENTS

SOCIETY OF WIRELESS TELEGRAPH ENGINEERS

JOHN STONE STONE, 1907-8

LEE DE FOREST, 1909-10

FRITZ LOWENSTEIN, 1911-12

THE WIRELESS INSTITUTE

ROBERT H. MARRIOTT, 1909-10-11-12

THE INSTITUTE OF RADIO ENGINEERS

ROBERT H. MARRIOTT, 1912

GREENLEAF W. PICKARD, 1913

LOUIS W. AUSTIN, 1914

JOHN STONE STONE, 1915

STANDING COMMITTEES

1916

COMMITTEE ON STANDARDIZATION

JOHN L. HOGAN, JR., <i>Chairman</i>	Brooklyn, N. Y.
E. F. W. ALEXANDERSON	Schenectady, N. Y.
LOUIS W. AUSTIN	Washington, D. C.
FERDINAND BRAUN	Strassburg, Germany
A. A. CAMPBELL SWINTON	London, England
GEORGE H. CLARK	Washington, D. C.
WILLIAM DUDELL	London, England
LEONARD FULLER	San Francisco, Cal.
ALFRED N. GOLDSMITH	New York, N. Y.
GUY HILL	Brooklyn, N. Y.
LESTER ISRAEL	New York, N. Y.
FREDERICK A. KOLSTER	Washington, D. C.
GEORGE H. LEWIS	Brooklyn, N. Y.
VALDEMAR POULSEN	Copenhagen, Denmark
GEORGE W. PIERCE	Cambridge, Mass.
JOHN STONE STONE	New York, N. Y.
CHARLES H. TAYLOR	Kahuku, Hawaii
ROY A. WEAGANT	Aldene, N. J.
JONATHAN ZENNECK	Munich, Germany

COMMITTEE ON PUBLICITY

GEORGE S. DAVIS, <i>Chairman</i>	New York, N. Y.
JOHN L. HOGAN, JR.	Brooklyn, N. Y.
ROBERT H. MARRIOTT	Seattle, Wash.
LOUIS G. PACENT	New York, N. Y.
DAVID SARNOFF	New York, N. Y.
ROBERT B. WOOLVERTON	San Francisco, Cal.

COMMITTEE ON PAPERS

ALFRED N. GOLDSMITH, <i>Chairman</i>	New York, N. Y.
GEORGE H. CLARK	Washington, D. C.
MELVILLE EASTHAM	Cambridge, Mass.
JOHN L. HOGAN, JR.	Brooklyn, N. Y.
ALEXANDER MEISSNER	Berlin, Germany
SIR HENRY NORMAN	London, England
WICHI TORIKATA	Tokyo, Japan

SPECIAL COMMITTEES

COMMITTEE ON WAVE LENGTH REGULATION

JOHN STONE STONE, <i>Chairman</i>	New York, N. Y.
E. F. W. ALEXANDERSON	Schenectady, N. Y.
LOUIS W. AUSTIN	Washington, D. C.
H. BOEHME	New York, N. Y.
WILLIAM H. G. BULLARD	Radio, Va.
LEE DE FOREST	New York, N. Y.
MELVILLE EASTHAM	Cambridge, Mass.
LLOYD ESPENSCHIED	New York, N. Y.
LEONARD FULLER	San Francisco, Cal.
ALFRED N. GOLDSMITH	New York, N. Y.
JOHN L. HOGAN, JR.	Brooklyn, N. Y.
FREDERICK A. KOLSTER	Washington, D. C.
RALPH A. LANGLEY	New York, N. Y.
FRITZ LOWENSTEIN	Brooklyn, N. Y.
EMIL E. MAYER	Tuckerton, N. J.
GREENLEAF W. PICKARD	Boston, Mass.
SAMUEL REBER	Washington, D. C.
FREDERICK SIMPSON	Seattle, Wash.
T. LINCOLN TOWNSEND	Washington, D. C.
ROY A. WEAGANT	Aldene, N. J.
ARTHUR G. WEBSTER	Worcester, Mass.
LEONARD D. WILDMAN	Fort Leavenworth, Kans.

COMMITTEE ON INCREASE OF MEMBERSHIP

JOHN L. HOGAN, JR., <i>Chairman</i>	Brooklyn, N. Y.
WARREN F. HUBLEY	Newark, N. J.
DAVID SARNOFF	New York, N. Y.

A MAGNETIC AMPLIFIER FOR RADIO TELEPHONY*

By

E. F. W. ALEXANDERSON

(CONSULTING ENGINEER, GENERAL ELECTRIC COMPANY)

ASSISTED BY

S. P. NIXDORFF

GENERAL CONSIDERATIONS

The name of "magnetic amplifier" has been given to a device for controlling the flow of radio frequency currents because this name seems to describe its function when it is used for radio telephony better than would any other. As the same device can be used for a variety of other purposes the above name may in some cases not seem so appropriate. However, the essential part of the theory that will be given refers to the amount of amplification which is possible of attainment and the methods of securing a higher ratio of amplification than would be given by the device in its simplest form.

The fundamental principle of varying an inductance by changing the permeability of its iron core is suggested in the early work of Fessenden as a means for changing the tuning of a radio antenna. The magnetic amplifier constructed as shown in Figures 1 and 2 was, on the other hand, developed as an accessory to an alternator having a solid rotor in order to take advantage of the better mechanical construction of a solid steel rotor and yet produce the results that could be obtained by field control in a machine having a completely laminated magnetic circuit. The aggregate of the constant field alternator and the stationary controlling device has, as will be shown, the effect of a machine with variable field excitation. This analogy refers not only to the proportionality between excitation and electromotive force but also to such phenomena as self-excitation and instability.

If two windings (e. g., *A* and *B* in Figure 2) are related to each other and a common magnetic structure as shown in Figures 1 and 2, it is apparent that there is no direct transformation of energy possible from one winding to the other. Each turn in the controlling or exciting winding *B* includes

*Presented before The Institute of Radio Engineers, New York, February 2nd, 1916.

both the positive and negative branch of the flux produced by the A. C. winding, *A*, and hence there is no voltage induced in *B*. The current in either winding *A* or *B*, on the other hand, influences the permeability of the common magnetic material; and, therefore, changes the inductance of the other winding. If a current flows in either winding sufficient to saturate the iron, it is thereby rendered practically non-magnetic and the

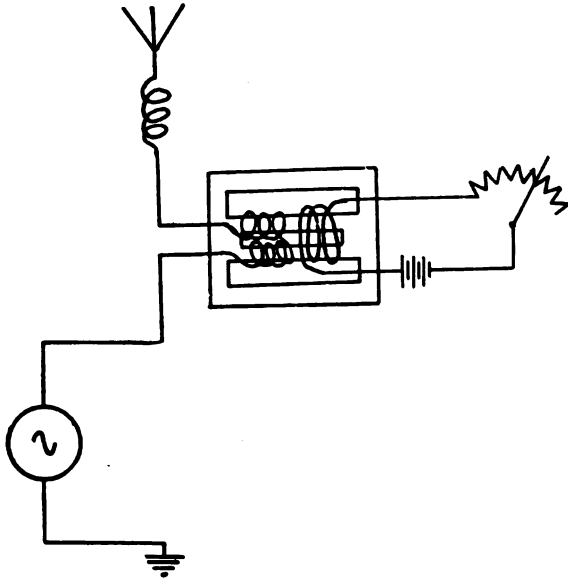

AMPLIFIER IN SERIES WITH ALTERNATOR.

FIGURE 1—Combination of Alternator and Amplifier in a Simple Form

inductance of the other winding is reduced to the value it would have if the coil included only air. If, on the other hand, a current flows in the other winding which gives a magnetomotive force equal and opposite to the first, the iron is rendered magnetic again. Inasmuch as the two branches of winding *A* are wound relatively opposite to winding *B*, the one branch will oppose the ampere-turns of winding *B* on one half cycle and the other branch during the next half cycle. In order to have any large flux variation in winding *A*, the opposing ampere-turns must be at least equal to the ampere-turns in winding *B*. The relation of currents in these windings is substantially the same as that between the primary and secondary current in a transformer,

altho in this case one is an alternating and the other a direct current, or a current of a different frequency. It is thus obvious how the current flow in winding *A* can be regulated in proportion to the controlling current in winding *B*. When the magnetic amplifier is used in shunt to the alternator (Figure 2), it has the immediate object of controlling the voltage rather than the current. The combined characteristics can be derived from the

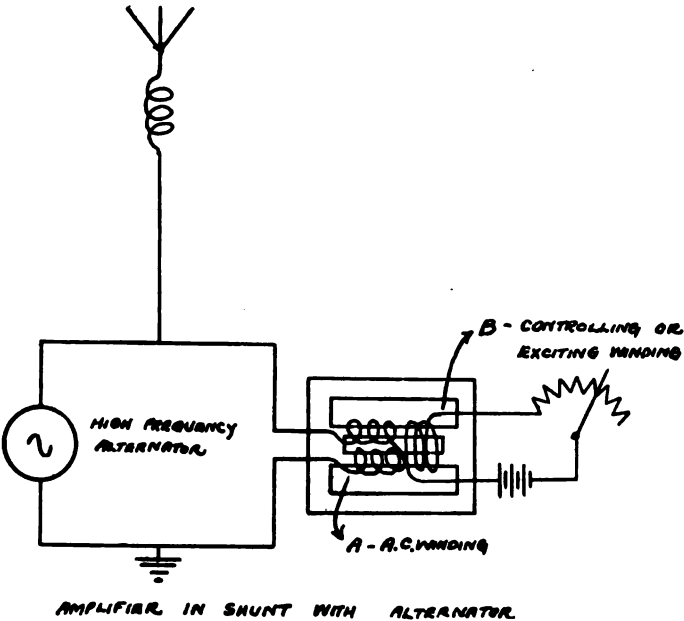

FIGURE 2—Combination of Alternator and Amplifier in a Simple Form

characteristics of the alternator when operating on an antenna, and at the same time controlled by a variable shunt across its terminals, as shown in Figure 5.

As indicated in Figures 1 and 2, it is possible to connect the amplifier either in series with the alternator or in shunt to the alternator. Of these two arrangements, the shunt connection is preferable because the effect of the amplifier on the alternator is the same as if the electromotive force of the alternator in the antenna circuit had been reduced; whereas the amplifier in the series connection does not influence the electromotive force in the antenna circuit but changes the tuning of the antenna. The result of this change in antenna tuning has an undesirable

effect on the speed characteristics of the alternator, because it is found upon further analysis that the control does not become effective unless the alternator is operated on the upper or unstable side of the tuning curve of the antenna. If, on the other hand, the alternator is operated on the stable side of the tuning curve, the change in tuning partly neutralizes the intended controlling effect.

RATIO OF AMPLIFICATION

The method of arriving at a theory for the ratio of amplification can perhaps be best explained by the following mechanical analogue.

A throttle valve in a steam pipe may be designed so that it is perfectly balanced and it might move on ball bearings so that an infinitely small effort would be sufficient to throttle an infinitely large flow of power. If, on the other hand, the valve were to be opened and closed 1,000 times in a second, the accelerating of the moving parts against their inertia would intermittently absorb considerable energy. Altho this would be "wattless" energy (inasmuch as the energy consumed in accelerating would be given back in retarding), the device which performs this movement must control considerable power. In addition, if there be frictional resistance to motion, still more energy will be required *thruout* the cycle, and this is not "wattless" energy. In analogy to this, we must ask ourselves what are the corresponding "wattless" and "watt" energy in our magnetic valve which must be overcome in opening and closing it at the frequency of a telephone current. The answer is: the "wattless" energy is that required to create the magnetic field neglecting hysteresis (and eddy current losses). The "watt" energy is that lost during any number of cycles because of hysteresis. This energy is the integrated area of the saturation curve between the limiting points between which the changes take place. The energy of the controlling field is not necessarily equal to the energy of the radio frequency field but of somewhat the same order of magnitude. The wattless flow of energy is proportional to the energy per cycle and the number of times per second the energy must be delivered and returned. It can, therefore, be said that the ratio of amplification is proportional to the ratio between the frequency of the radio current and that of the controlling current.

However, the assumption that the energy per cycle is the same in the radio frequency and in the controlling circuit is



FIGURE 3—75-Kilowatt Radio Frequency Alternator Used for Tests

only a first approximation. The object of design and improved arrangements is evidently to make this energy ratio as favorable as possible; in other words, to produce a maximum flux variation in the radio frequency circuit for a minimum variation in the controlling circuit.



FIGURE 4—Amplifier Coil Used for Tests

In order to understand these relations it is necessary to make a further study of the laws governing changes of permeability. The object of the magnetic amplifier, when used for radio telephony is not only to control the radio energy but also to reproduce a telephone current in its true shape. An important part of the analysis is, therefore, a study of the conditions that

lead to linear proportionality between the controlling and the controlled current.

MAGNETIC THEORY AND CHARACTERISTICS

The magnetic amplifier can be operated in two ways, as indicated by the diagram on Figure 6. In one case, when the two A. C. windings are in series, the current in both windings is definite; and the flux in the corresponding branches of the

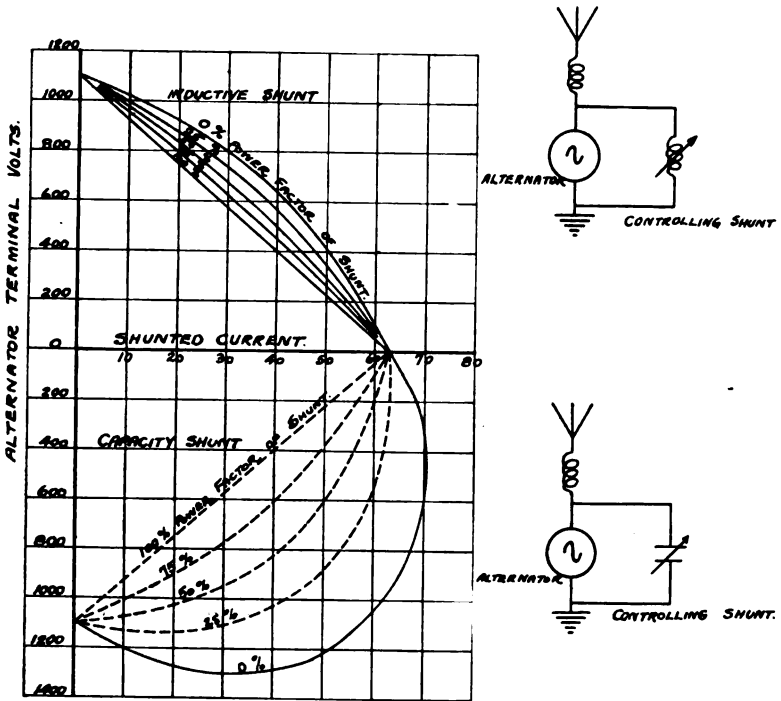

FIGURE 5—Characteristics of Alternator When Controlled by Variable Shunt Impedance

core adjusts itself accordingly. In the second case when the two A. C. windings are in multiple the currents in each winding are not immediately obtainable; because a cross current of a strength not yet defined may flow between the two windings. We know on the other hand that the flux variations in the two branches of the core must be identical, inasmuch as they produce the same terminal voltage in the multiple connected windings.

The characteristics of the amplifier winding in series and multiple connection, as obtained from tests, are shown in Figure 6. The upper curve represents series and the lower, multiple connection. The curves are plotted in ampere-turns and volts per turn, so as to make the conclusions independent of the number of turns. Both curves represent the same D. C. excita-

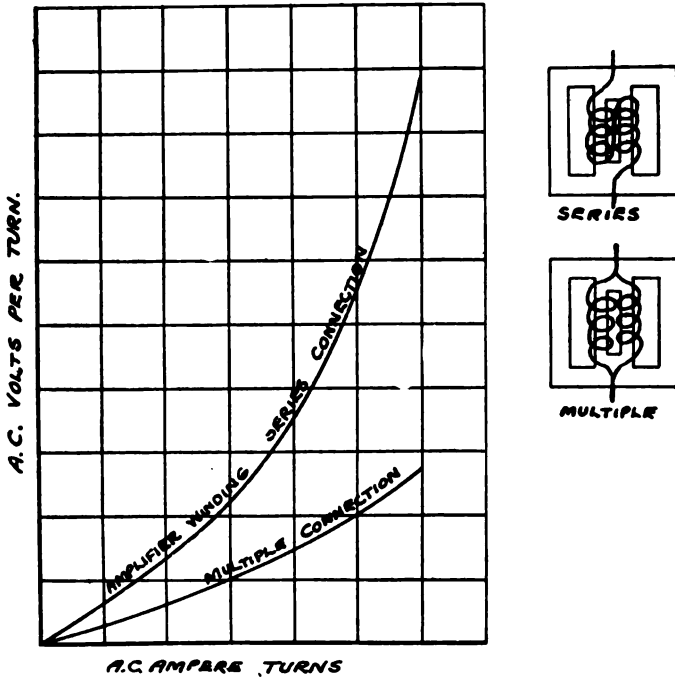

FIGURE 6—Comparative Volt Ampere Curves With the Same D. C. Excitation

tion. These curves, as well as theoretical considerations, show that the multiple connection gives a lower curvature and a lower impedance. For zero D. C. excitation it is evident that the volt-ampere curves for these two connections must be identical. It thus follows that the change of impedance corresponding to a given D. C. excitation is greater with the multiple connection. The multiple connection is, therefore, altogether more advantageous because a lower impedance with a certain control means greater sensitiveness; and a lower curvature means larger currents can be carried without causing saturation will be shown later. While thus the second mode

of operation with multiple A. C. winding appears to have better characteristics, there are some other considerations which must be taken into account before it can be concluded that this connection could be used.

OBJECT OF SHORT CIRCUIT CONDENSER

In the multiple connection, the flux variations are forced, as already explained, by the short circuit that is formed between

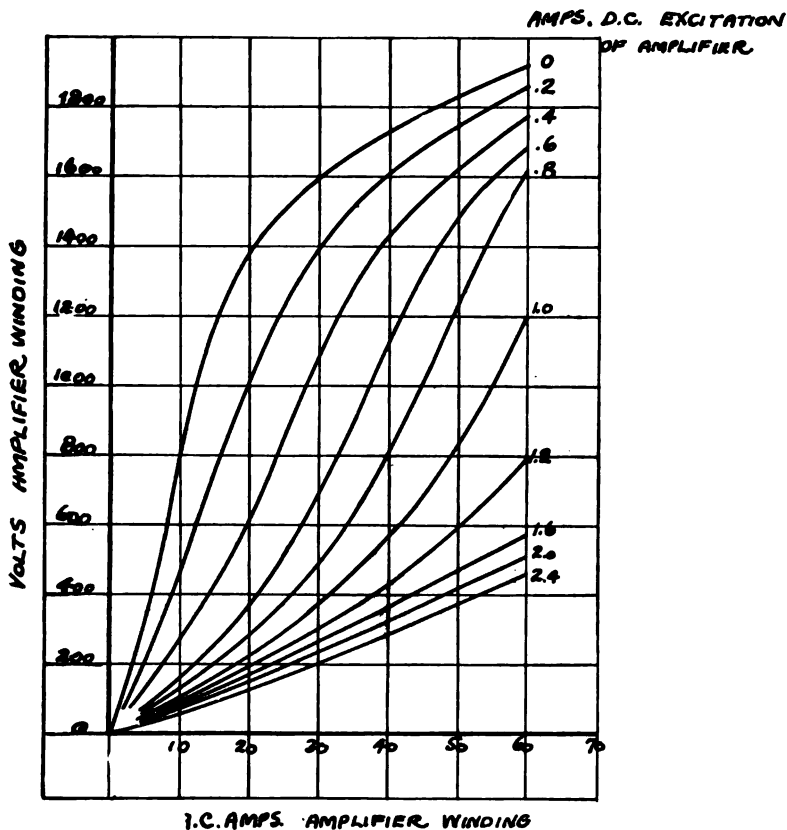

FIGURE 7—Characteristics of Amplifier Coil Windings in Multiple

the two multiple coils. The induced current in this short circuit tends to oppose any changes in the average flux, and thus a telephone current in the controlling winding would simply cause a corresponding short circuit current between the two A. C.

coils without producing the desired flux variations. This difficulty can, however, be overcome by taking advantage of the fact that the A. C. winding needs to operate only at radio frequencies, which are very much higher than the frequency of the telephone current. It is, therefore, possible to find a condenser of such value that it acts as a short circuit for the radio

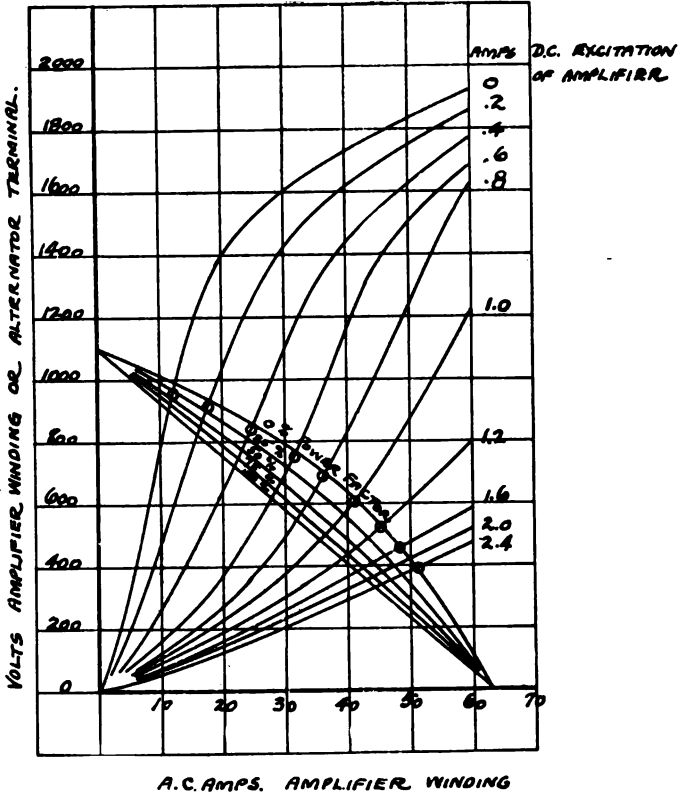

FIGURE 8--Alternator and Amplifier Characteristics Superimposed

currents and an open circuit for the telephone current. Accordingly a condenser is introduced in series with each of the A. C. coils as shown in Figure 9.

COMBINATION OF ALTERNATOR AND AMPLIFIER

In order to demonstrate how the magnetic amplifier can be used for controlling the voltage of an alternator, reference may again be made to the alternator characteristics as shown in

Figure 5. The alternator voltage is plotted against the current in the shunt circuit. The magnetic amplifier is used as this shunt circuit and the volt-ampere characteristics of the amplifier can, therefore, be directly combined with the volt-ampere characteristics of the alternator. The volt-ampere characteristics of the amplifier are shown in Figure 7. Figure 8 shows the alternator and amplifier characteristics superimposed. The intersections between the sets of curves give the alternator voltages at the corresponding amplifier excitations, and thus another curve can be plotted between alternator volts and amplifier excitation. This curve as obtained from test is the upper curve in Figure 9, which approaches the X axis asymptotically with increasing excitation of the amplifier.

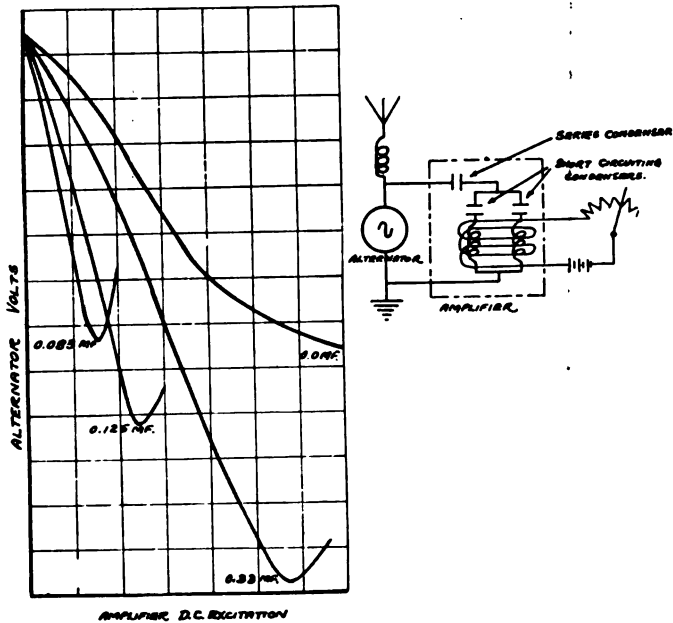

FIGURE 9—Curves Obtained from Test Showing Sensitiveness of Alternator Voltage Control with Different Series Condensers

totically with increasing excitation of the amplifier. It is possible in this way to reduce the voltage practically to zero without using an excitation which is excessive from the point of view of heat capacity of the exciting winding. A magnetic amplifier may be used in this way as a controlling device for radio telegraphy. However, in this form, it is not well adapted for tele-

phony; because, as shown by the curves, the relation of volts of alternator to amperes of excitation departs too far from the desired linear proportionality. Such proportionality can be obtained by the introduction of a series condenser as shown in Figure 9, while at the same time the sensitiveness of the amplifier is greatly increased so that a much smaller control current is

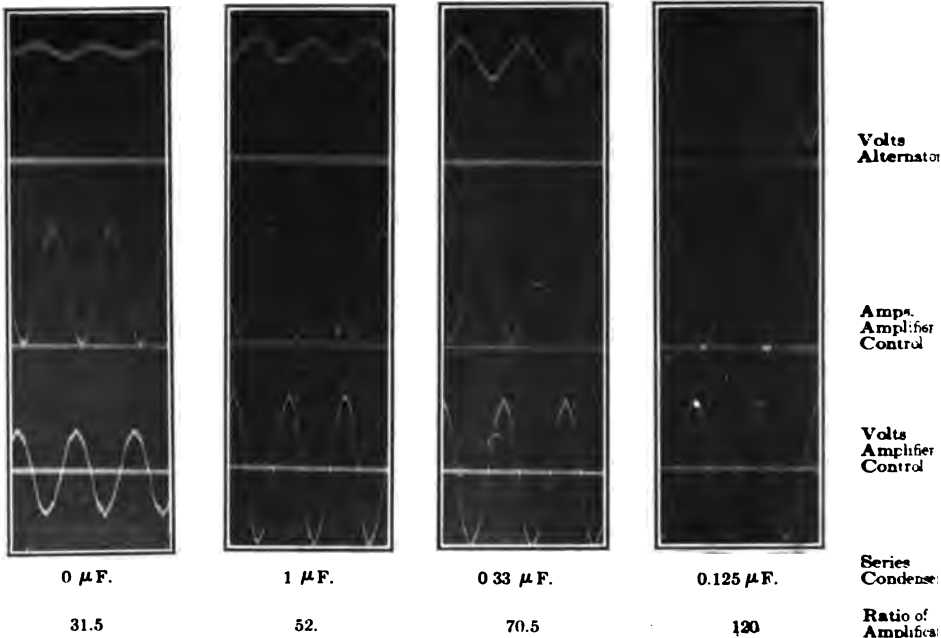

FIGURE 10—Oscillograms Showing Ratio of Amplification with Different Series Condensers.

needed. If the condenser is chosen so that it exactly neutralizes the inductance of the amplifier winding at some definite value of excitation, the resulting impedance at this excitation becomes a minimum; and the impedance at any lower excitation is determined by the difference between the inductive reactance of the amplifier coil and the capacity reactance of the series condenser. The smaller this difference, the lower will be the amplifier excitation that gives minimum impedance and the corresponding minimum of the alternator voltage. This means that the sensitiveness of the amplifier is increased because a smaller excitation is needed to reduce the alternator voltage. The increase of

sensitiveness that can be obtained in this way is, however, not unlimited. If the minimum impedance is obtained as a result of a large inductive and a large capacitive reactance, the core loss due to hysteresis and eddy currents becomes appreciable and appears as an equivalent resistance which cannot be neutralized. Figure 9 shows, from results of tests, the variations of alternator voltage that can be obtained by different values of series condenser and the corresponding increase of the sensitiveness of the amplifier. The sensitiveness is represented by the steepness of the curves. It can be seen from the shape of these curves that the increased sensitiveness is gained at the expense of range of control or difference between maximum and minimum voltage. However, all the curves show a practically linear proportionality between excitation and voltage over almost the whole range available. The difference in sensitiveness with various series condensers is also illustrated by oscillograms, Figure 10. The upper curve represents alternator voltage. The two lower curves represent amperes and volts, respectively, impressed upon the amplifier controlling winding, the frequency of the controlling current being 500 cycles. The effect of departure from linear proportionality and the consequent distortion of wave shape is shown in Figure 16.

The amplification ratio is defined as the difference between the maximum and minimum kilowatts output divided by the effective alternating volt-amperes supplied to the controlling winding. The ratio of amplification can be derived directly from the oscillograms with reference to the calibration of the oscillograph curves. The ratio of amplification for operation suitable for telephone control ranges from 100:1 to 350:1.

INSTABILITY

The voltage which results from the combination of alternator and amplifier can be determined as has been explained by the intersection of the alternator and amplifier characteristics. When the curves have a definite and sharp intersection point a definite alternator voltage results from each excitation of the amplifier. If, on the other hand, the curves should have such a shape that the alternator and amplifier characteristic curves become parallel in some place, the intersection becomes indefinite and the result is instability and generation of self-excited oscillations. This is a condition that must be avoided for telephone control; whereas it may have useful applications for other

purposes. The conditions that lead to instability can be graphically analyzed as shown in Figures 11 and 12. Figure 11 cor-

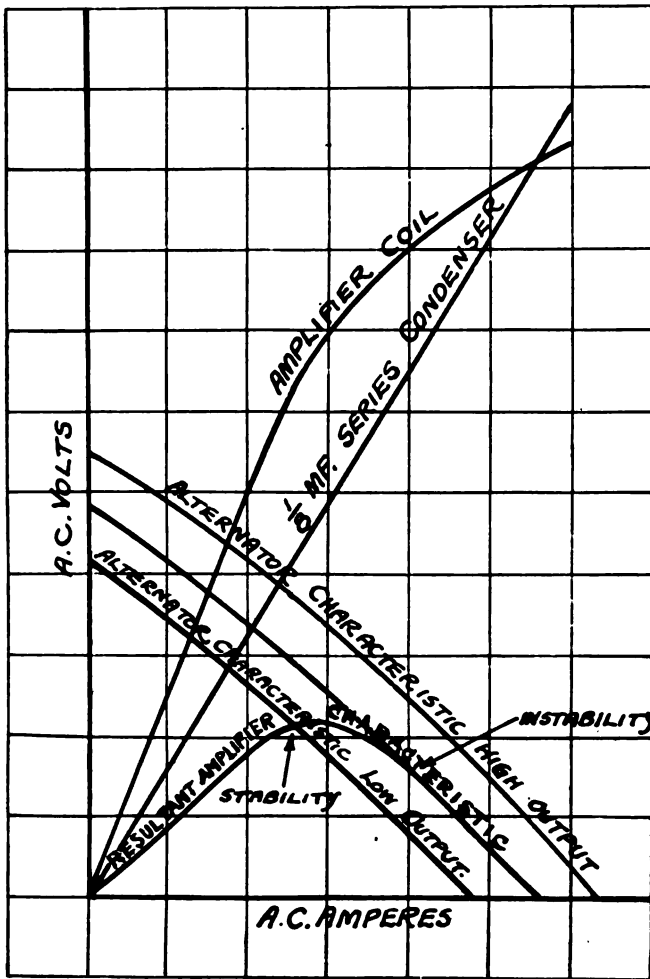

FIGURE 11—Graphic Analysis of Instability

responds to a series condenser of $1/8 \mu\text{f.}$ (microfarad) which leads to instability at higher generator outputs; whereas, Figure 12 corresponds to a series condenser of $1/3 \mu\text{f.}$ and represents a condition which is stable for all voltages at which the generator can be operated. The upper curve in each diagram is the volt-ampere curve of the amplifier coil and the straight line thru the

origin represents the series condenser. The lower curve is the difference between the volts amplifier coil and volts series condenser, which is for the present purpose a sufficiently close

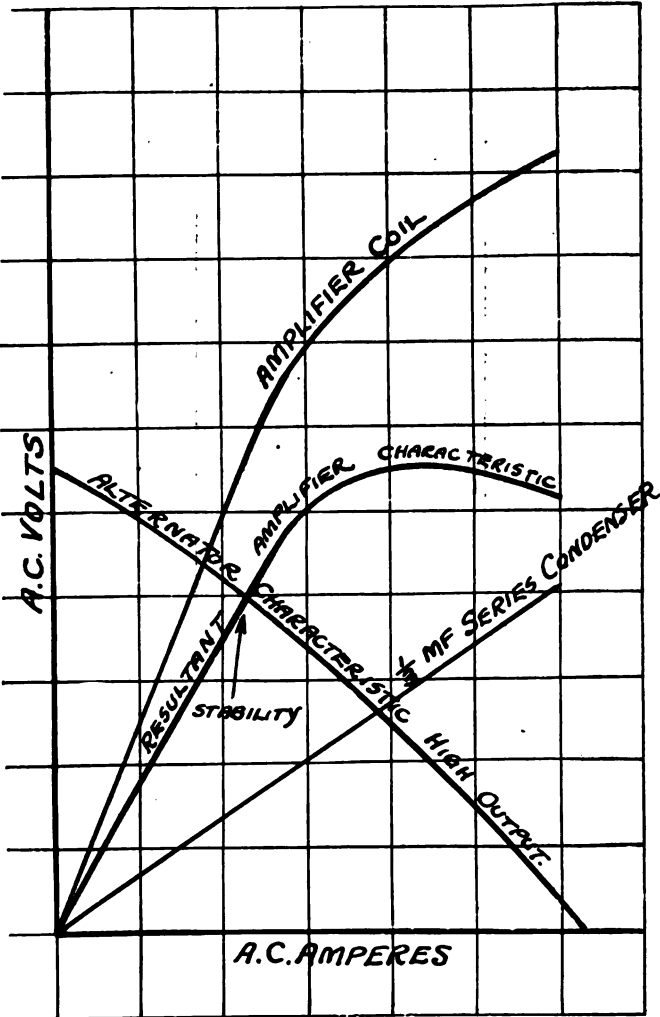

FIGURE 12—Graphic Analysis of Instability

approximation of the volt-ampere curve of the combination. This resultant volt-ampere curve in Figure 11 rises to a maximum, then falls again and crosses the zero line. The crossing of the zero line means change from inductive to capacitive impedance.

With reference to any circuit which has a volt-ampere characteristic with a bend in it, it can be said that as long as the volt-ampere curve is rising, the circuit is stable where it is connected to a source of constant potential, and wherever the volt-ampere curve is drooping, the circuit is unstable on a constant potential. The rising part of the curve corresponds to a

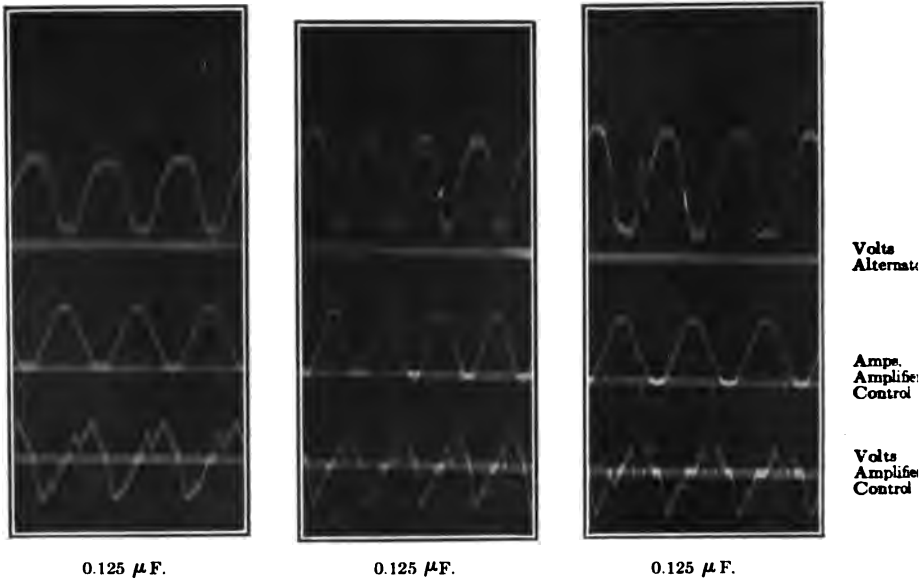

FIGURE 13—Oscillograms Showing Instability at Higher Alternator Voltage

positive resistance and the drooping side to a negative resistance. Well-known types of negative resistance are electric arcs or series commutator generators. A circuit of this character is stable only when operated on a source of potential which has characteristics equally or more drooping than the drooping volt-ampere curve. These same curves (Figures 11 and 12) show the volt-ampere characteristics of the alternator. In Figure 12, the resultant characteristic is only slightly drooping at the end, whereas, in Figure 11 the condition for instability is indicated by the place where the volt-ampere curve of the amplifier is more drooping than the volt-ampere curve of the alternator. Figure 11 also shows that the alternator curve corresponding to low output intersects the amplifier curve at the stable portion and the characteristics for increased output reach the unstable portion

of the resultant amplifier curve. This change from stability to instability is shown by the series of oscillograms on Figure 13. The instability as shown by the self-excited oscillations re-occurs at the same place of the wave which is the point at which the characteristic curves are tangent, as shown on Figure 11.

SHUNT CONDENSER

A further improvement in sensitiveness can be obtained by using a combination of shunt and series condenser. The shunt condenser is so proportioned as to make the amplifier take lead-

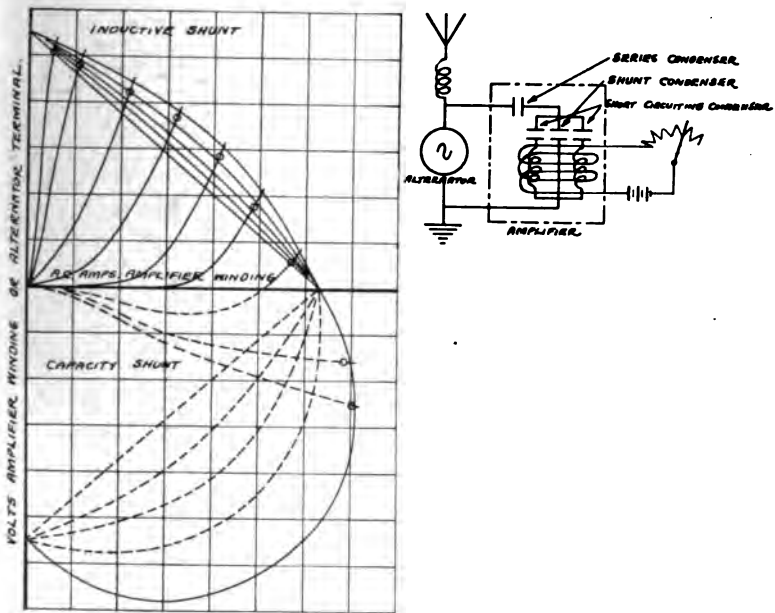

FIGURE 14—Volt-ampere Characteristics of Amplifier with Shunt and Series Condenser Showing Intersection with Alternator Characteristic

ing instead of lagging current at low excitation. Complete characteristic curves of the amplifier with shunt and series condenser and the superimposed alternator characteristics are shown in Figure 14. The series of oscillograms, Figure 15, show the effect of different amounts of shunt condenser. While the series condenser is used within the limits of stability to increase the sensitiveness, the shunt condenser has the object of allowing

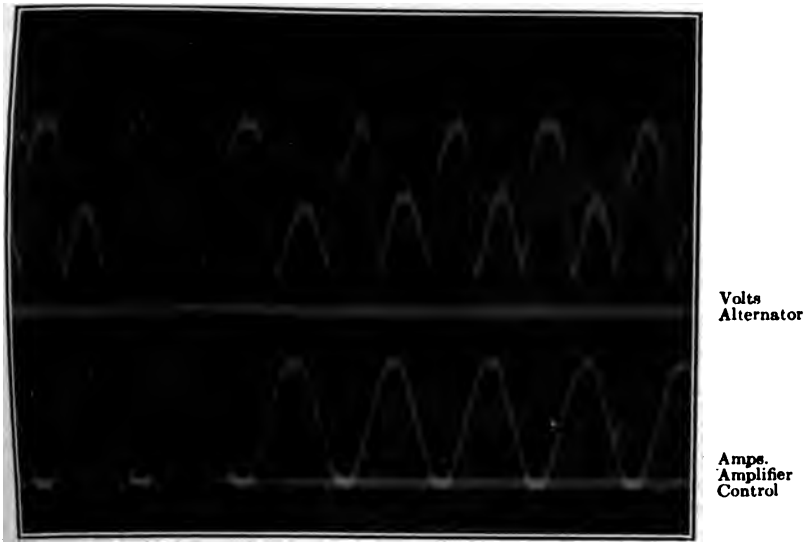

FIGURE 16—Oscillogram Showing Distortion when Range of Linear Proportionality of Control is Exceeded

arcing key for telegraphy, and particularly will make possible high speed telegraphy at the same rate and with the same means as high speed automatic telegraphy on land lines. Oscillograph

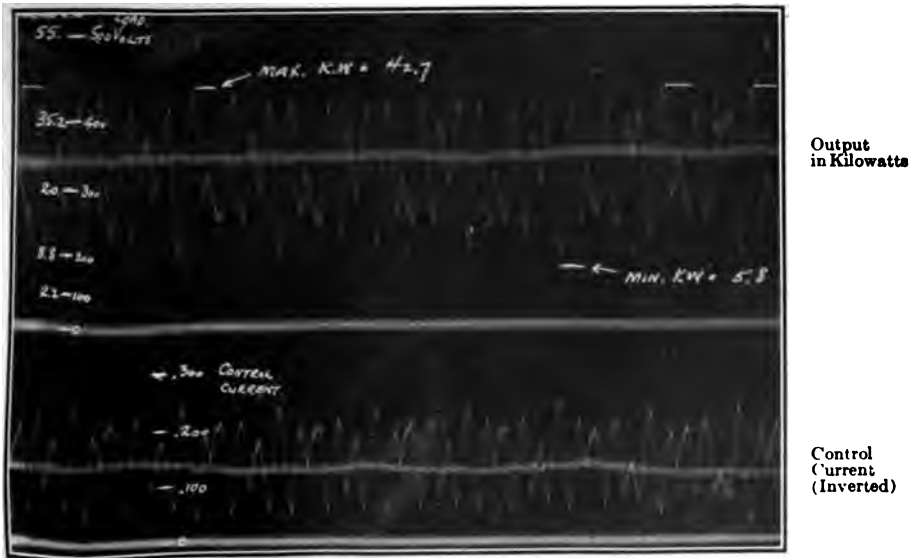

FIGURE 17—Oscillograms Showing Telephone Control

records have been taken of telegraphic control transmitting from 500 to 1,500 words per minute.

The structure and the mode of operation of the magnetic amplifier which has been described is such that there appears to be no limit to the power that might be controlled in this way if the apparatus is designed with suitable dimensions. The 72 kilowatt control which has been demonstrated may be sufficient for most purposes, but there would be nothing surprising if several times this amount of energy were to be used in trans-Atlantic radio telephony or high speed telegraphy in order to make the service thoroly reliable.

SUMMARY: A magnetic amplifying device is described for permitting the control of radio frequency currents by varying the saturation of the iron core of an inductance included in the radio frequency circuit. The arrangement of windings of the amplifier is such that the controlling winding has no radio frequency E. M. F. induced in it, nor does it induce currents in the radio frequency coils.

Various arrangements of this amplifier in connection with a solid steel rotor, radio frequency alternator are shown, notably those in series with the alternator and those in parallel. "Short-circuiting" condensers are connected to each of the radio frequency coils. A shunt condenser across both coils and their "short-circuiting" condensers increases the sensitiveness for reasons which are given. Another condenser inserted in series with the entire amplifier is employed to obtain linear proportionality of amplification and increased sensitiveness. The ratio of amplification is found to be proportional to the ratio of the frequency of the radio current to that of the controlling current.

The control of the output of a 75 K. W. alternator of radio frequency for telephonic purposes is then shown by oscillograms to be accurate, and the numerical characteristics of alternator and amplifier separately and in combination are given.

DISCUSSION

M. I. Pupin: It is not clear to me how the control circuit current is varied. How is this control current obtained?

E. F. W. Alexanderson: Figures 1 and 2 show the controlling current regulated by rheostats in order to produce variations in the controlling current. The rheostat may represent a microphone or any other source of amplified telephone current. In the experiments referred to, the amplification was accomplished by a vacuum tube relay.

M. I. Pupin: Then the variation in the output from 4 to 45 kilowatts is produced by a variation in the saturation of the iron of the shunt impedance?

E. F. W. Alexanderson: The control is accomplished entirely by the variation of saturation in the iron.

J. Zenneck: Mr. Hogan has called attention to the fact that the problem discussed by Mr. Alexanderson is closely analogous to the problem of the frequency doublers. The device used by Mr. Alexanderson consists substantially of two iron cores, which are magnetised by a direct current in the same direction, whilst two radio frequency coils are wound on them in opposite directions. If we put on each of these iron cores a secondary coil and connect these secondary coils in series, we have nothing but the ordinary frequency doubler; in the secondary coils an E. M. F. of double frequency is induced.

This arrangement of frequency doubler has been used some three years ago for radio telephony by the Gesellschaft für drahtlose Telegraphie (Telefunken). Just as has been done by Mr. Alexanderson, they controlled the direct current directly or indirectly by means of a microphone. Just as obtained by Mr. Alexanderson, they got a relay action or amplifying effect; since, in their arrangement, any change of the direct current influenced the E. M. F. induced in the secondary circuit and also the impedance of this circuit and therefore the tuning. In a paper entitled "A Contribution to the Theory of Magnetic Frequency Doublers" which I read before THE INSTITUTE OF RADIO ENGINEERS in September, 1915, this amplifying action was indicated by the fact that, in the equation for the secondary current I_2 , the numerator (representing the secondary E. M. F.), as well as the denominator (representing a complicated form of impedance), contained the direct current I_0 .

The main difference between Mr. Alexanderson's device and that of the Gesellschaft für drahtlose Telegraphie is that in the former the primary current is affected by the audio frequency control current whereas in the latter the secondary current of the frequency doubler is affected. In other words, Mr. Alexanderson uses the unloaded frequency doubler, the Gesellschaft für drahtlose Telegraphie the loaded doubler.

A detailed description of the devices used by the Telefunken Company has been given in the "Elektrotechnische Zeitschrift," 1914, number 29, and in the "Jahrbuch der drahtlosen Telegraphie," volume 9, 1915, page 502 by L. Kühn. It is well known that this arrangement has proven to be very satisfactory in operation. In 1912 or 1913, a good radio telephonic connection between Berlin and Vienna was thus obtained.

Of course the fact that a magnetic amplifying arrangement has been previously used for radio telephony does not in any way detract from the credit due Mr. Alexanderson; his device showing so many interesting features differing widely from those hitherto used.

Louis Cohen (communicated): Hitherto it has been the practice of radio engineers to avoid the use of iron in any form in oscillatory circuits, because of the eddy current and hysteresis losses that would be thus introduced. Mr. Alexanderson has shown, however, by his splendid researches that this is not generally true. If proper attention is given to lamination and design, iron may be used in radio frequency circuits without the accompanying losses hitherto thought inevitable. The investigations of Mr. Alexanderson on the effect of frequency on circuits containing iron paved the way for the development of the magnetic amplifier discussed in this paper. The authors are to be congratulated on their achievement in the development of this device. It unquestionably represents fine engineering skill in the conception of the method and the working out of the design.

It appears to me that the fundamental principle of the method for amplification discussed in the paper, namely: the variation of inductance of a tuned circuit by a change in current in an auxiliary circuit, will find its application to other problems in connection with radio frequency circuits. One that suggests itself immediately is the amplification of incoming signals in radio telegraphy. Suppose the controlling circuit *B* is connected in the antenna, and the coil *A* is part of a separate tuned circuit

excited by an alternator, or coupled to an arc circuit (any suitable arrangement will do so long as the oscillations in the circuit comprising coil *A* are forced), then any signal acting on the antenna will by the current generated thereby in coil *B* produce a change in the permeability of the iron core and thus change the inductance of coil *A*. If the circuit containing coil *A* was originally tuned to the frequency of the impressed E. M. F., then a change in inductance will cause a considerable change in the current in that circuit, which may be a great many times larger than the current in the antenna. It may be that the authors have already considered the use of their method for this particular purpose, and perhaps found it unsuitable; but if so I am sure that other radio engineers as well as myself would be glad to hear from them on this point.

In regard to the use of the shunt condenser shown in Figure 14, it appears to me that the improvement produced by it is due to the fact that a loop circuit is thus introduced. The condition may be represented diagrammatically as shown in Figure 1. If

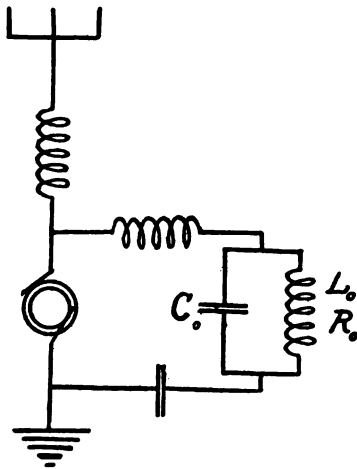

FIGURE 1

the circuit is tuned as a whole to the frequency of the impressed E. M. F., then a change in the inductance L_o of the loop circuit not only detunes the circuit, but also introduces a change in resistance of the circuit which may under certain conditions be very large. In fact the impedance of the loop circuit ($R_o L_o C_o$) is

$$Z = \frac{R_o}{(1 - L_o C_o \omega^2)^2 + R_o^2 C_o^2 \omega^2} + j \frac{L_o \omega (1 - L_o C_o \omega^2) - R_o^2 C_o \omega}{(1 - L_o C_o \omega^2)^2 + R_o^2 C_o^2 \omega^2}$$

If the value of $L_o C_o \omega^2$ differs from unity; that is, the loop circuit is not tuned separately to the frequency of the alternator, then we may neglect the terms $R_o^2 C_o^2 \omega^2$ and $R_o^2 C_o \omega$ as being very small in comparison with the term $(1 - L_o C_o \omega^2)$, and we have

$$R' \text{ (effective resistance)} = \frac{R_o}{(1 - L_o C_o \omega^2)^2}$$

It is obvious, therefore, that a change in the inductance of the loop circuit not only changes the tuning constant of the circuit, but causes also a change in the effective resistance of the circuit. If the authors could give us the data on the constants of the circuits they used, it would be interesting to calculate the change in resistance of the circuit thus produced.

Now, while we are on the subject of the use of iron in radio frequency circuits, I may be permitted to mention a somewhat different method for amplification by the use of iron in the circuit, that I have thought of some time ago. I never had the opportunity to make any experiments, and I am offering this in the form of a suggestion.

The principle of the method is indicated in Figure 2. The loading coil of the antenna contains an iron core (a), preferably

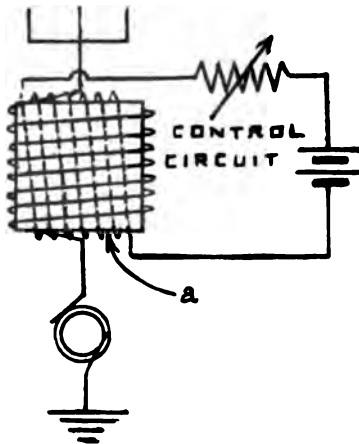

FIGURE 2

in the form of a bundle of fine iron wires, and which forms part of the control circuit. It is evident that the magnetic fields in re produced by the currents from the antenna and control are at right angles. A greater current flow in the control

circuit causes a greater twist of the iron molecules at right angles to the alignment produced by the current in the antenna circuit, and this would represent a change in the magnetic flux of the loading coil; which means, of course, a change in the value of the inductance, thus causing a detuning of the antenna circuit. I have made some preliminary calculations which lead me to believe that considerable amplification could be obtained by this method. To obtain the best results, however, considerable care will have to be exercised in the design, the dimensions of coil, the lamination of the core, etc.; so that a small current in the controlling circuit may produce sufficient cross magnetisation to change appreciably the inductance of the loading coil in the antenna circuit.

Alfred N. Goldsmith: Professor Zenneck has pointed out a similarity between the direct-current-controlled frequency doubler and the Alexanderson magnetic amplifier. The enormous advantage of the Alexanderson device is that the direct-

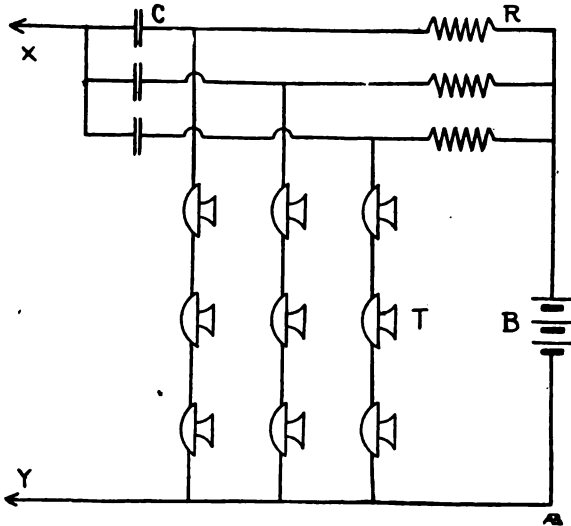

FIGURE 3

current-control circuit has no large radio frequency electromotive forces induced in it. On referring to Dr. Kühn's paper, cited by Professor Zenneck, it will be found that very special means had to be adopted to prevent the radio frequency currents

induced in the control circuit from becoming extremely dangerous.

In connection with the obtaining of a sufficiently powerful control current, Dr. Kühn used the ingenious arrangement shown in the figure. Here the transmitters T , arranged in sets of say three in series, are worked in parallel by the use of steadying resistances R which prevent current overload on any one set of transmitters. By the use of the fixed condensers C , all the transmitter sets are, in effect, placed in parallel so far as the alternating current obtained from them is concerned. The output, which is the control current, is tapped from the points X , Y .

J. Zenneck: It seems to me that Professor Goldsmith's statement that no radio frequency electromotive forces are induced in the control circuit of the Alexanderson amplifier is incorrect. It would be correct if the iron cores were not unsymmetrically saturated. But, under the actual working conditions, an E. M. F. of double frequency would be obtained in the control circuit of the Alexanderson amplifier just as in the Telefunken device.

On the other hand, a quantitative difference arises from the fact that in the Alexanderson amplifier not all the current supplied by the alternator flows thru the radio frequency winding on the iron cores. It is, however, difficult to say whether the double frequency E. M. F. in the direct current circuit will be less than in the case of the controlled frequency doubler.

E. F. W. Alexanderson: Professor Zenneck points out that an electromotive force of double frequency is induced in the controlling circuit of the magnetic amplifier on account of the iron being unsymmetrically magnetised. This is true when the two alternating current coils are used in the series connection as shown in the upper diagram of Figure 6. On the other hand, the preferred multiple connection, as shown in the lower diagram, has the characteristic of suppressing the second harmonic by forming a local short circuit. It is the short circuit for the second harmonic which affects the resulting permeability of the iron in the way illustrated in the characteristic curves of Figure 6, and results in increase of sensitiveness. Measurements have been made of the induced double frequency voltage in the control windings with the alternating current coils in series as well as in multiple. If conditions are made favorable for the generation of the second harmonic, very high voltages appear in the control windings which were, in one case, actually damaged by this voltage.

But, inasmuch as the object of the magnetic amplifier is not to produce a second harmonic, it is easy in various ways to suppress the same and the method shown in Figure 6 has in addition the advantage of improved characteristics of the amplifier.

Lee De Forest: Mr. Alexanderson's paper is indeed exceedingly interesting but I regret that it was too short. Just where it became the most interesting for me, it stopped. I would have liked to have heard some more of the exact part played by the amplifying audion, that interesting device with so many new names.

I would like to direct comparison between this high power radio telephone method and the method recently developed by the Western Electric Company and tried out at Arlington, where the audion amplifier principle was worked to the limit. In that case they started, as Mr. Alexanderson did, with a microphone and amplified the voice currents thru an audion amplifier, and kept on amplifying them. In the first oscillating audion circuit the radio frequency currents were modulated by the microphone, then these modulated radio frequency currents were amplified in a bank of some twenty bulbs, and finally the current from this bank was amplified in a bank of 500 bulbs.

This ensemble of amplifying audion tubes put a total energy of 11 kilowatts in the antenna; beautifully controlled by the voice, it is true, but having the modest upkeep renewal cost of something like ten thousand dollars per month. So as a practical engineering proposition, there is absolutely no comparison between that method and the method worked out by the General Electric Company. I believe that I am entitled to express that sort of opinion of the audion if anyone is! This is the situation as it stands to-day. No one can say, however, that the situation will not be altered very materially in one, two or three years, after we learn how to build oscillions for large power outputs, say for 5 or 10 kilowatts each. That will create a very different situation. It is difficult to say, therefore, which of the two methods discussed possess the greatest practical promise.

It is obvious that there are going to be two classes or two lines of development of high-power radio telegraphy and telephony. Since the present seems to be an era of word coining, I propose the term "*sans-ferric*" as applying to methods such as the oscillion and Poulsen arc, in which no iron whatever is involved in the radio frequency generating apparatus, as distinguished from the several alternator methods which are now being developed.

The method of generating sustained oscillations by the oscillation, on a large scale, has been thus far worked out by telephone engineers who were familiar, first of all, with the audion amplifier in long distance telephone lines. They were deeply impressed by the possibilities inherent to this device, and they worked out their problem as telephone engineers could be expected to work it out, from the telephone engineers' point of view, rather than that of a radio engineer.

On the other hand, the General Electric engineers have tackled the problem from a power engineering standpoint. The paper of Mr. Alexanderson therefore is a little less clear to radio engineers than it might have been. Too little has been said therein about the tuning problems involved, particularly when the amplifier circuit including series and shunt condensers is connected, across the radio frequency alternator. It would be very interesting to us to know just what are the oscillation constants of this amplifier circuit in combination with the antenna, and alternator, for different frequencies and just what amount of detuning is involved to obtain the extraordinary variations of radiated energy amplitude which Mr. Alexanderson's curves illustrate. For, after all, it is largely a question of detuning, of signaling by means of change of wave length.

E. F. W. Alexanderson: In connection with the subject of amplifying telephone currents, it should be pointed out that the magnetic amplifier can itself be used for amplifying in several stages. The radio frequency alternator is used for furnishing the energy for the first stage amplifications and the radio frequency energy which is modulated by a magnetic amplifier is then rectified. The amplified telephone current thus obtained is used for controlling a magnetic amplifier in a second stage. I do not wish to express any opinion as to the relative merits of this method of amplification compared with a vacuum tube relay; however, there are a number of acceptable methods of amplifying the telephone current to the magnitude necessary for controlling the high power device described in the paper.

The suggestions made by Mr. Cohen are much to the point. The possibility of using the magnetic amplifier in a receiving circuit has been thought of and the portion of the paper dealing with audibility was partly included to give suggestions in that direction. In regard to the change of effective resistance accompanying the change of inductance, these relations can be treated mathematically as Mr. Cohen

points out. As an approximate basis, it can be assumed that the power factor of the iron core inductance is 35 per cent, when not saturated, and that the effective resistance decreases proportionately to the square of the inductance when saturated.

VARIATIONS IN NOCTURNAL TRANSMISSION*

By

A. HOYT TAYLOR

(DEPARTMENT OF PHYSICS, UNIVERSITY OF NORTH DAKOTA)

AND

ALBERT S. BLATTERMAN

(DEPARTMENT OF ELECTRICAL ENGINEERING, WASHINGTON UNIVERSITY,
ST. LOUIS, MISSOURI)

INTRODUCTION

The following is an account of certain experiments in nocturnal transmission, carried out by radio stations "9XN" (University of North Dakota, Grand Forks) and "9XV" (Washington University, St. Louis, Missouri), in an attempt to test the interference theory of "fading" and "swinging" effects, and to correlate, if possible, transcontinental weather conditions with radio transmission.

The radiation current at Grand Forks being limited to 13 aerial amperes, and that at St. Louis to 7, the observations were necessarily limited to the periods of twilight and total darkness; and since the distance between the stations is 1,250 kilometers (780 miles), no observations were possible during the mid-summer period of violent strays and bad transmission.

Incomplete as the work is, it is hoped that certain features of it are of sufficient interest to be presented at this time.†

PRELIMINARY DISCUSSION

An immense number of observations on transmission variations must have been made by operators, amateurs, and others, but comparatively little of this data is available for study and criticism.

A number of important papers have however been published.

*Presented before The Institute of Radio Engineers, New York, January 5, 1916, by Professor Taylor for the joint experimenters and authors.

†It should be stated that work in this direction was undertaken earlier between the University of North Dakota, then "9YN," and "8XA," the University of Michigan; but was tacitly abandoned on account of various experimental difficulties due principally to lack of sufficient radiation at that time at "9YN," and to the use of a wave whose length was poorly adapted to the Michigan aerial. A breakdown of the Michigan primary condenser putting a stop to such tests as were then being attempted, the work was taken up under more favorable conditions at Grand Forks, with St. Louis.

Austin's investigations have established an empirical formula for transmission (over salt water) which is identical in form with the Sommerfeld equation for intermediate distances, except that the exact value of the absorption term and its manner of dependence on wave length seem to be still a matter of dispute.

A wide study of seasonal variations in transmission has been made by Marriott¹ using what might be called a statistical rather than a quantitative method. The paper is full of valuable material, and shows clearly the well-known seasonal variation. It refers mainly to over-sea transmission.

Austin has curves showing quantitatively the seasonal variation in daylight overland transmission between Washington and Philadelphia, 185 kilometers, and Washington and Norfolk, 235 kilometers.² His results are in good agreement with those of Marriott, altho wide variations in individual observations are noticeable.

Overland transmission is more irregular, and experiences a wider seasonal variation than that over the sea. It shows a very high daylight absorption and variations depending on the nature of the country traversed.³ Nocturnal overland transmission is especially erratic, and seems to depend to a certain extent on the weather conditions of the preceding day.⁴ One of the writers has shown that cloudy weather during the daytime makes for good nocturnal transmission, especially if the cloudiness has been quite general, and markedly so if the cloudiness has prevailed in the neighborhood of sender only.⁵

Cloudiness, in the immediate vicinity of receiver only, has little or no effect.

It has been suggested⁶ that the effect was due to a modification of the soil conditions by rain, but this has been disproved by observations taken at Grand Forks on "VBA," Port Arthur, Ontario, during a six weeks period in the fall of 1913, when, altho often cloudy, not a drop of rain was recorded in the territory between Port Arthur and Grand Forks. The beneficial effect of cloudiness was nevertheless almost uniformly noted in this period.

The received energy in nocturnal transmission often attains

¹"Radio Range Variation," "Proc. I. R. E.," March, 1914.

²"Seasonal Variations in the Strength of Radiotelegraphic Signals," "Proc. I. R. E.," June, 1915.

³A. H. Taylor, "Diurnal and Annual Variations in Radio Transmission," "Phys. Rev.," Nov., 1914.

⁴A. H. Taylor, "Wireless and Weather," "Electrical World," Aug. 30, 1913.

⁵A. H. Taylor, "Radio Transmission and Weather," "Phys. Rev.," May, 1914.

⁶"Electrical World," Aug. 30, 1913. Editorial note.

values so high that divergence according to the inverse square law seems impossible. That this may be due to a combination of reflection and refraction has been suggested by Eccles,¹ Kennelly,² Barkhausen,³ and Kiebitz.⁴ The first three papers mentioned deal with refraction and reflection in very high ionized layers. In connection with this it is interesting to note Fleming's recent suggestion that electrons driven off from the sun by radiation pressure may reach the earth's atmosphere.⁵ According to Humphreys,⁶ cosmic dust may also play a role in ionizing the outer layers of the earth's atmosphere. Thus ultra-violet light may not be the only agent tending to produce a difference in wave velocity at different levels.

The theory of Kiebitz deals with the increase in refractive index brought about by the presence of water vapor at relatively low altitudes. The effect would be to refract the waves unfavorably for good transmission.

None of these theories would seem to have anything to do with the favorable effect of clouds at low levels, except that of Kiebitz, which predicts an effect opposite to that observed.

One of the writers⁷ has therefore suggested that a portion of the energy is reflected from a surface of electrical discontinuity at the cloud level, thus passing from sender to receiver as between two roughly parallel surfaces of earth and clouds, and not following the inverse square law. This portion, passing thru a region known to be weak in ionization, is feebly absorbed.

During the day time, the sun in some way destroys this layer of electrical discontinuity.

A second portion, entering the middle ionized portion would be refracted back according to the Eccles theory, especially during nocturnal transmission.

A third portion, passing completely thru the middle ionized region would be reflected at the upper, permanently ionized (Heaviside) layer. It would be heavily absorbed by day and less heavily at night.

A fourth portion of the radiation would pass out into space and be lost; and, no doubt, a surface wave travels in the crust of the earth. It is not clear to us, however, that this surface

¹"The Electrician," Sept. 27, 1912, and Sept. 19, 1913.

²"Proc. I. R. E.," July, 1913.

³"Elektrot. Zeitschr.," Heft 16, 1914.

⁴"Jahrbuch der drahtlosen Teleg. und Telephonie," June, 1913.

⁵Royal Inst. lecture on "Photo-electricity." See "Scientific American Supplement," July 10, 1915.

⁶"Astophysical Journal," May, 1912.

⁷A. H. Taylor, "Phys. Rev.," May, 1914.

wave should be considered separately. The application of suitable boundary conditions to the general wave equations causes the appearance of a term interpreted as a surface wave but a mathematical surface cannot contain energy. If the energy transmitted thru the earth is to be reckoned with, it must be as a volume distribution of energy and, as such, it would be rapidly absorbed, so as to be of little moment in long distance work.

If the original wave is split by reflection and refraction into several components of differing phase, it is probable that many of the vagaries of nocturnal transmission are due to interference. This point will be kept in mind in discussing the results to follow.

DESCRIPTION OF APPARATUS

The St. Louis station radiated 7 aerial amperes at 850 meters wave length with a logarithmic decrement of 0.14 and a spark pitch of 700 per second produced by a 2-gap rotary discharger, and 70-cycle transformer. The St. Louis aerial is 30 meters in height, 8.5 meters in breadth, and 100 meters long. It consists of 8 wires, their size being 7 strands of number 20 wire,* with a lead taken 15 meters from the north end.

The St. Louis receiver consisted of an inductive coupler, tuning condensers, 3,200 ohm Brandes telephones, and an audion detector. The shunted telephone method of measuring audibility was used at St. Louis thruout the tests.

Grand Forks used the following waves during the tests:

Wave length	Aerial amps.	Log. Decrement	Height to center of capacity
1500 m	12.0	0.11	25 m
850 m	12.5	0.09	27 m
500 m	11.5	0.18	27 m

The 1,500 meter-wave was radiated from a three-wire antenna 6 meters broad at the far end, and 4 meters broad at the near, or lead-in end. This aerial is 245 meters long, but field tests have so far not detected any marked directivity in the 1,500 meter-wave.

Since the aerial points 15° east of south, the directive effect, if present at all, would be unfavorable for St. Louis. The capacity of this aerial is 0.013 microfarad.

The other two waves were radiated from a 46 meters long, 5 wire aerial, 4 meters in breadth, the lead-in connection being taken from a point 15 meters from the near end.

This antenna has a capacity of approximately 0.0012 micro-

*Diameter of Number 20 wire = 0.032 inch = 0.81 millimeters.

farad. Number 14 stranded phosphor bronze wire is used in both aeri-als.

A spark pitch of 1,100 per second, from a 60-cycle transformer supply, was obtained by the use of an 8-gap rotary discharger giving a well quenched spark.

The receiving set used for the St. Louis tests comprised an inductive coupler, tuning condensers, 3,200-ohm telephones, and a double audion receiver.¹

The long aerial, with series condenser was found to be the better for reception of all waves exceeding 750 meters in length.

The Grand Forks observations were rather unsatisfactory, partly on account of the smaller radiation at St. Louis, and partly on account of an attempt to use a special method of quickly getting the audibility with the audion. This method was later found to be unreliable, and the shunted telephone method was used thereafter.

The writers are well aware of the criticisms which have been made to the method of the shunted telephone,^{2, 3} but feel that the simple shunt ratio used with the audion receiver gives a fair estimate of the relative strength of signals if the *effective* values, at the received spark frequency, of telephone resistance and inductance be used in computing the shunt ratio. If the spark has harmonics, the tone that fades away last in shunting out a signal should be that of the frequency used in the shunt ratio calculation. At 750 cycles, the effective resistance of a 3,200-ohm "New Navy" telephone is 6,200 ohms, while its inductance is 1.48 henrys. At 1,000 cycles, the figures are 7,250 ohms and 1.36 henrys. We are indebted to Mr. H. S. Sheppard of the Department of Electrical Engineering, University of Michigan, for the graph from which these figures are taken. Individual telephones, even of the same make, will probably show variations, but these values show how widely the telephone impedance may differ from the ohmic resistance.

METHOD OF TESTS

Observations on signal strength were taken hourly thruout the night, with 15-minute periods near sunset and sunrise. Primarily two waves were used by Grand Forks, 1,500 meters and 500 meters, with a 2-minute interval necessary to make the shift in aeri-als and in transmitter connections, as the transmitter

¹A. H. Taylor, "Electrical World," March 13, 1915.

²F. Braun, "Jahrb. der drahtlosen Teleg. und Telephonie," April, 1914.

³L. Israel, "Proc. I. R. E.," June, 1915.

is not located in the same room with the receiving and controlling apparatus. After a two minute rest, the St. Louis wave was observed. The calls were of 3-minute duration. The wave lengths were chosen by both stations of such values as to create a minimum of interference with other stations. During part of one test, a seconds ticker was used at Grand Forks for sending the signals, but irregular and rapid sending, usually with an automatic key, was found more satisfactory and less deceptive.

Observations on general transmission conditions from other stations were made from time to time during the night; and an attempt was made in all cases except one, subsequently mentioned, to have the sensibility of the receiver as nearly uniform as possible by checking the audion with a standard buzzer test, set for the desired wave length, or with a perikon detector of very constant adjustment. It is a matter of regret that the conditions of constant sensibility were not fulfilled at Grand Forks as well as could be desired, inasmuch as two audion bulbs were burned out during the tests, making unavoidable some alterations in sensibility.

The tests were run on the nights of December 23, 1914, January 7, January 28, March 6, April 17, and June 10, 1915. Besides these tests, the two stations had a standing appointment for 9:30 and 10:00 P.M., Central time, on every Monday and Thursday evening until about May 1, when the St. Louis signals were no longer audible at Grand Forks.

RESULTS

Curves I, II, and III of Figure 1 present the data of the first test, on December 23, 1914. The Grand Forks waves show the greatest regularity in this test, but pronounced fading effects were observed in the St. Louis wave, altho it was audible from 7:45 P.M. to 7:40 A.M. Curve I shows the reception of the 500-meter wave, and curve II the 1,500-meter wave at St. Louis. curve III shows the reception of the 850-meter wave at Grand Forks.

Figure 2 shows the weather map* for December 23. Cloudiness evidently prevailed over the larger portion of the region between the stations, and the map for the following day (not shown), indicates that Grand Forks was changing from cloudy to clear, with the reverse true for St. Louis.

The extraordinary regularity of the 1,500-meter wave during

*The writers wish to acknowledge their indebtedness to Prof. H. E. Simpson, of the Special U. S. Weather Bureau, University, N. D., for the loan of the maps.

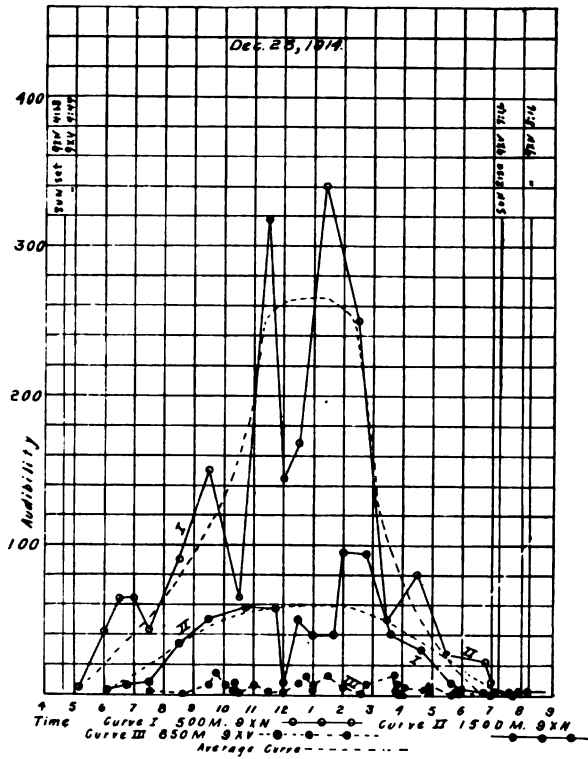

FIGURE 1

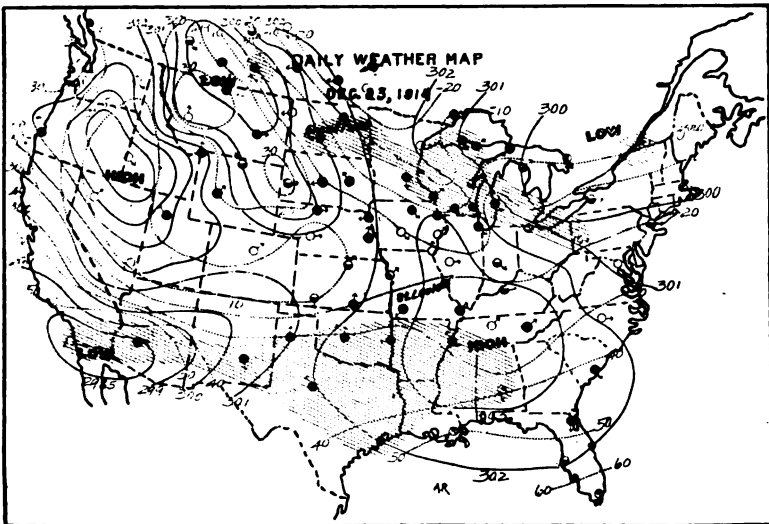

FIGURE 2

the first half of the night contrasts sharply with the fluctuations of the 500-meter wave. It is doubtful whether the fluctuations of the 850-meter wave are synchronous with those of the 500-meter wave. Experience has shown that fluctuations may occur so rapidly that tests for reciprocity of transmission must be made almost simultaneously to be of any great value. Further special tests are contemplated on this point.

The 1,500-meter wave shows wide variations between 11:45 and 3:40, which are almost exactly duplicated by the 500-meter wave. This was not due to maladjustment of the St. Louis receiver, as the operator reported that other stations to the south and east, sending in this interval, showed little change in intensity.

For neither wave do the curves seem to be symmetrical about the solar midnight. Grand Forks reported good transmission from the south and east, and fair transmission from the west. St. Louis reported transmission in general not better than the average for mid-winter. Good transmission was reported there from south and east.

Enormous variations in the signals of various amateurs in Michigan and Ohio on short waves were reported at Grand Forks and similar results at St. Louis.

The 1,500-meter wave persists well into daylight, being still received at 8:15 A.M. when discontinued. The St. Louis wave, of 850 meters, altho varying widely at Grand Forks, was reported at Memphis as fairly steady. (Memphis is about 250 miles (400 km.) further from Grand Forks than St. Louis and on the same line approximately.)

Taking the audibility of the 1,500-meter wave at 8:00 A. M. as 2, and assuming the midnight audibility of 58 as corresponding to a nearly unabsorbed wave, the absorption coefficient of the Austin-Cohen formula is calculated as 0.00158 at 8:00 A.M. The oversea value given by Austin is 0.0015. Subsequent tests showed this wave to disappear after 10:00 A.M. in mid-winter, and not to be audible at all during the daytime after early spring. Comparing, in a similar way, the midnight audibility of 232, on the average, for the 500-meter wave, with its twilight audibility of unity often observed at St. Louis in mid-winter at 5:00 P.M., the value of the absorption coefficient at twilight would be 0.00155. The value of the expression $i^2 h^2 / \lambda^2$, (where i = sender current, h = height to center of capacity, and λ = wave length), is 6.6 times as large for the 500-meter wave as for the 1,500-meter wave. This would give the ratio of audibilities, if unabsorbed

or equally absorbed, received thru equivalent aerial resistance for each wave, as 6.6 in favor of the short wave.

The observed ratio as deduced from the curves of Figure 1 is 4.0. Data on the equivalent aerial resistance at St. Louis is not available, but since a series condenser is used for the 500-meter reception, it is likely that the resistance for that wave is higher than for the 1,500 meter. The ratio 4.0 is therefore probably too small; and we may conclude that the two waves are either not much absorbed in mid-winter at midnight, or that they are equally absorbed. The latter possibility is not to be seriously considered. These speculations are not based upon peak values, but upon average audibilities in the middle of the night.

The absorption at mid-day, even in mid-winter is certainly much higher; as is also the mid-summer midnight value.

Figure 3 shows the data obtained on January 7, 1915, which was a night of very poor transmission between Grand Forks and St. Louis, altho Grand Forks reported excellent transmission from east coast stations. The weather map, Figure 4, shows very cloudy conditions prevailing to the east of Grand Forks, with mixed weather, largely clear, to the south.

The short wave was audible only after 8:30 P.M. The long wave was weak, but persistent at both ends of the night and until 9:30 A.M. The wide fluctuations in the two waves are nearly synchronous.

The St. Louis wave, 850 meters, was audible at 8:42 P.M., but repeatedly inaudible during the night, reaching a maximum about midnight and disappearing just before sunrise at Grand Forks.

Figure 5 and Figure 6 present the data of January 28, which was a night of generally fair transmission. The weather map shows average condition of cloudiness.

All three waves are very irregular, the shortest showing a high value abnormally early, and reaching its best transmission at 1:30 A.M. The 850-meter wave shows its highest maximum and most rapid fluctuation at 4:45 A.M. The 1,500-meter wave is also erratic, and much stronger than the 500-meter between 2:30 and 4:30. This has never been observed before or since except in early morning or evening, when the transmission was poor for both waves. The maximum at 3:40 A.M. is extraordinarily high for this wave.

The variations in the long and short waves seem to be synchronous between 9:00 P.M. and midnight, but at 1:00 A.M. are

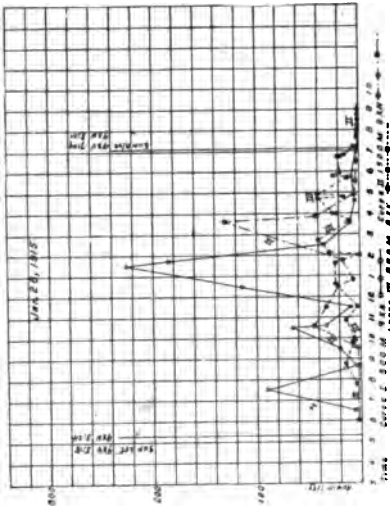

FIGURE 5

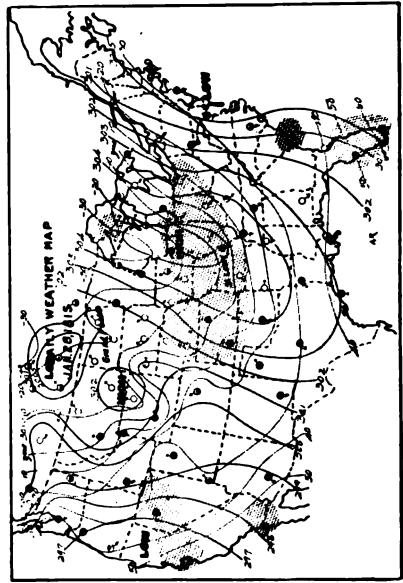

FIGURE 6

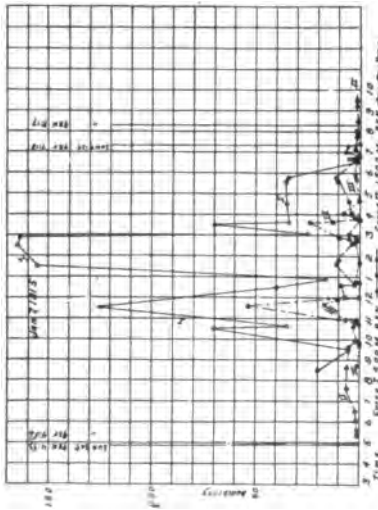

FIGURE 3



FIGURE 4

in opposite directions. It would seem as tho conditions affecting average transmission are not necessarily the same as those causing fading and "freaks."

Figures 7 and 8 show the results of the test of March 6. The transmission was good for the spring season, but noticeably poorer than in mid-winter. There was general cloudiness between the two stations. In this test Grand Forks used a third wave, of 850 meters, to determine whether fading was reciprocal. A leaky insulator gave the 1,500-meter wave a higher decrement and somewhat smaller radiation than usual, which may partly account for its being so weak at St. Louis. Unfortunately this was not discovered until after the next test and the exact date of the appearance of the leak is not known. This wave was quite steady, showing no trace of the wide variations present in the 500-meter wave at 8:40, 11:40, 1:40, and 3:40. The 850-meter wave of Grand Forks (curve IV), shows variations, but they are not so great as those of the 500-meter wave, nor are they synchronous with them. This wave was not started until 10:00 P.M.

The abnormally high audibility of St. Louis at Grand Forks (curve III), on 850 meters, was due to the use of the double audion there in ultraudion adjustment.* It is not always possible to obtain this adjustment with short waves but it was done on the night of this test with two new bulbs, which subsequently refused to take the adjustment under 2,500-meter wave lengths. It is very doubtful whether the shunted telephone method is reliable with the ultraudion, but since the calculated audibilities will at least show the trend of the transmission, they are here presented.

The steadiness of the St. Louis wave early in the evening is remarkably good, and the general trend of the transmission for both 850-meter waves is the same in the later half of the night, but the variations certainly do not seem to be synchronous. Both 850-meter waves disappear 30 minutes before sunrise at St. Louis; but the 1,500-meter wave, weaker in the night, persists until sunrise at Grand Forks.

About the first of April, 1915, and on a few days later in 1915, a sudden falling off in the transmission was noted. The curves of Figure 9, for the test of April 17, show the 1,500-meter wave to have been inaudible thru the greater part of the night.

There was a very extraordinary clearing up between the stations in the early morning, extending, at St. Louis, to eastern

*See "Electrical World," March 13, 1915: and Armstrong, "Proc. Inst. Radio Engineers," September, 1915, page 224 *et seq.*—EDITOR.

and Gulf stations. "NAA" (Arlington, Virginia) was reported at 9:00 P.M. Central time at Grand Forks as unusually strong for the time of year. The St. Louis wave was not picked up until 1:45 A.M., at an audibility of 3, which was its maximum. No curve for this wave is shown.

The 500-meter wave, picked up first at 7:33 P.M. was last heard at 4:46 A.M., while the 1,500-meter wave, picked up first at 10:35 P.M. persisted until 5:36 A.M.

The 850-meter wave of Grand Forks, started at 11:00 P.M., was received with an audibility of 63, and disappeared, as far as can be determined, at about the same time as the 500-meter wave. Both show maxima between 3 and 5 A.M., with disappearance between 5 and 6. The wide fluctuations of these two waves do not appear to be synchronous. On the other hand, the synchronism of the fluctuations of 500-meter and 1,500-meter waves is very striking. The maximum of the 850-meter wave at 2:00 A.M. corresponds roughly to the best reception of the St. Louis wave of the same length at 1:45 A.M.

Figure 10 shows the weather conditions. General cloudiness prevailed between the stations, probably accounting for the fact

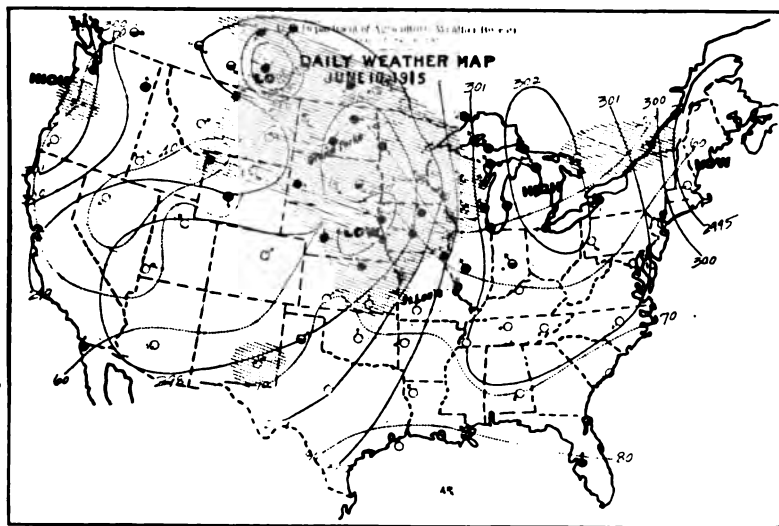
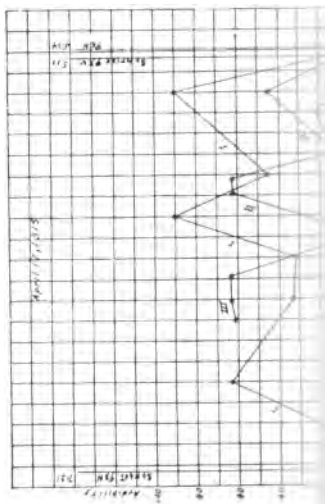

FIGURE 11

that the transmission was unusually good for so late in the spring.

The next test was made on the night of June 10, without

... used. Straws were



... out the signal showed
... but they come thru
... between stations, which
... are caused as favorable
...
... disappearance of the
... of the year

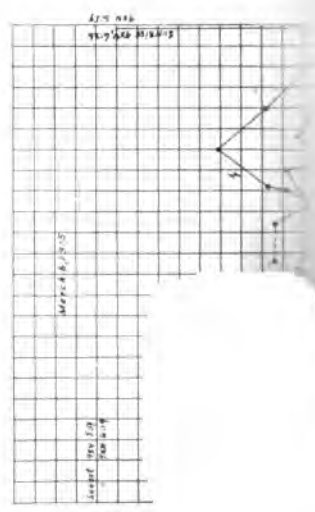

or a little earlier, suggest sudden changes in surface conditions which probably have something to do with the falling off of transmission in the spring. This almost sudden variation has also been noted between Grand Forks and Denver.

DISCUSSION OF RESULTS

There seem to be two kinds of fluctuations in nocturnal overland transmission. The first is a rapid fading, and the second is a slow swinging in signal strength. The first may be due to changes, in the nature of interference effects. These could be local at the sender or at the receiver, or they might be caused by rather sharp surfaces of discontinuity almost anywhere between the stations.

The second or slower effect may be due to refracting masses of moving ionized air in the path of transmission, producing at times a lens-like concentration and at other times a dispersive effect. It might be contended that all of the fluctuations can be accounted for on this basis.

The presence or absence of true interference effects has a most important bearing on the transmission theories outlined in the first part of this paper. Fortunately the tests seem to throw a little light upon this point.

It will be noted that nearly all rapid variations in the 1,500-meter wave are duplicated by the 500-meter wave, which is its third harmonic, and which should show interference maxima and minima wherever the 1,500-meter wave does so. On the other hand, very few coincidences in fluctuation are observed between the 850-meter waves and either of the others. A path difference of 250 meters, 1,250 meters, 1,750 meters, etc., or 1, 5, 7, 11 . . . half wave lengths, would create destructive interference for the 500-meter wave without greatly affecting the 1,500-meter wave. In other words, while every interference maximum or minimum of the 1,500-meter wave should be duplicated in the 500-meter wave, the reverse is not necessarily true. This seems to be in agreement with the results, and presents a strong argument for the presence of true interference

experiments on reciprocity of transmission are too few to be decisive.

If speculation be based upon them, it is that while general transmission conditions are reciprocal, rapid fluctuations are not necessarily so.

These experiments emphasize the superior transmission

short waves in mid-winter at night, and of the longer waves in the day time. The greater steadiness of the longer wave is noticeable.

It is suggested that the almost sudden spring drop in transmission is connected with the disappearance of the ice sheet and the consequent changes in conductivity and dielectric constant of the earth's surface. Surface ionization due to stirring up of the soil by spring plant growth may play a role.

The generally favorable effect of cloudy days on the following nocturnal transmission is confirmed, thus suggesting that sometimes the conditions causing fluctuations may be at low atmospheric levels.

Simultaneous measurements on the signals of "CWH," a St. Louis amateur, then using a 500-meter wave, made in Fargo and Grand Forks at one time last winter showed his signals to have faded out entirely at Grand Forks while seeming to increase in strength at Fargo, which is 120 kilometers (75 miles) south of Grand Forks. A similar case, involving greater distance between observing stations was reported to one of the writers by "7CE," of Boise, Idaho. In this case the signals faded out at the nearer receiving station but came in strong at the farther one. These and similar cases speak against a general dispersion and in favor of interference.

Surfaces of discontinuity suitable for causing interference effects with short waves should be more numerous, and the discontinuity sharper. This is in accord with the well-known fact that extreme cases of fading and "freaks" happen more often with short waves and over short distances. St. Louis reported a case of fading observed between "5AK" and "5XC," a distance of 56 kilometers, and another regularly observed between St. Louis and "9DB," 160 kilometers. If fading effects over such short distances are due to interference, it probably occurs at the cloud level. In the most striking cases observed at Grand Forks, namely with various amateurs in Ohio, distant 1,300 to 1,500 kilometers, the interfering wave might have come from a very high altitude.

The general trend of the transmission curves shows that the daylight ionization responsible for the general absorption disappears more slowly in the evening than it reappears in the morning: in other words, the transmission is not symmetrical about the solar midnight. This contradicts the statement of W. H. F. Murdock¹ that "at sunset they (the ions) disappear

¹"The Electrician," Jan. 29, 1915.

as rapidly as they came at sunrise." The transmission curves obtained in Australia by Balsillie show the same asymmetry as those of this paper.¹

Nipher has observed a change of atmospheric permeability with wind gusts.² If this effect were connected in any way with transmission changes it should be present by daylight. Were it possible, by the use of high power and short waves, to examine short wave transmission by daylight over long distances, some daylight fading and swinging might be observed, altho the behavior of longer waves indicates the contrary.

In connection with the somewhat speculative value of the absorption coefficient deduced for twilight transmission it is of interest to note that one of the writers³ showed that if transmission takes place according to the equation of the form given by Austin, for a given distance there is a critical wave length giving the best transmission.

Cohen has expressed this in a more general form⁴ by the equation $\lambda = \frac{\alpha^2 d^2}{4}$, where if $\alpha = 0.00157$ (the average for the 500-meter and 1,500-meter waves), and $d = 1,250$ kilometers, the optimum wave length would be $\lambda = 960$ meters, which wave should show 28 per cent better audibility than the 1,500-meter wave during the twilight and early morning period. This result has not yet been subjected to experimental test, but mid-day comparisons at Minneapolis (distant 450 kilometers) of the 500-meter, 850-meter, and 1,500-meter waves of "9XN" have decidedly favored the longest wave. Assuming the correctness of the Cohen formula, this result indicates again the high value of the mid-day absorption, as compared with that of early morning.

Since at the most there was but an hour difference in sunset between the two stations, and the general direction is north and south, it was not to be expected that the Marconi-Pickard sunset and sunrise effect would be manifested. Some traces might have been noted had the longest wave been strong enough to warrant good daylight observations.

The sudden drop in the half hour preceding sunrise emphasizes the important role played by the high altitudes which are then being influenced by sunlight.

¹"Electrician," Nov. 13, 1914.

²Francis E. Nipher, "Trans. St. Louis Acad. Sciences," Vol. XXII, No. 4.

³A. S. Blatterman, "Electrical World," Aug. 15, 1914.

⁴Cohen, "Electrical World," Oct. 17, 1914.

The writers realize the incompleteness of this attempt to get systematic data on nocturnal transmission, and venture the following suggestions for further work. First, observations should be almost continuous, in order not to miss the more rapid variations. Second, a greater range of wave length is desirable. Third, sufficient power to extend observations well into daylight should be used. Fourth, thoro tests on reciprocity of transmission are necessary. Finally, coöperation with various stations in different directions would be useful in comparing simultaneous transmission thru regions having widely varying weather.

August 15, 1915.

SUMMARY: Experiments on night transmission, on wave lengths of 500, 850 and 1,500 meters between two inland stations 1,250 kilometers apart are described. The bibliography of wave absorption is first considered critically.

The average transmitting current was 12 amperes and the decrements varied from 0.09 to 0.18. The effective height of the transmitting antenna was 27 meters. Receiving was done with an audion tested against a constant exciting circuit. In making audibility measurements by the shunt-to-telephone method the true impedance at the audio frequency in question was used. Observations were made hourly during night, with fifteen-minute periods near sunset and sunrise.

The curves of signal strength are not symmetrical about the solar midnight. In general, the fluctuations of the 500 meter-wave follow those of the 1,500 meter-wave, but not necessarily *vice versa*. The 850 meter-wave does not seem to fluctuate in marked synchronism with either of these. This is explained on the basis of definite wave interference. Short waves are superior by night, long waves by day, generally.

The disappearance of the ice sheet between the stations and the breaking up of the soil seems to account for a spring drop in transmission. Cloudy days markedly favor the following night transmission. Fading and "freak" effects are more numerous on short waves, thus favoring the interference explanation.

It is suggested that future observations should be almost continuous, of long wave length range, of high power, reciprocal between stations, and in various directions.

DISCUSSION

J. Zenneck: It is well known that the received current depends largely on the decrement of the receiving antenna as well as on the decrement of the transmitting antenna. Both of these decrements are dependent on atmospheric conditions; wet weather, for instance, generally causes a very marked increase in the decrement of the antenna. Therefore, measurements of the received current are only comparable if it is sure that the decrements of the transmitting and receiving antennas have remained constant, or if both of these decrements have been measured and their actual variations taken into account. It is not sufficient to keep the current at the transmitting antenna constant. I should like to ask Professor Taylor if he would kindly tell us whether he has taken into consideration the decrements of the transmitting and receiving antennas and their possible changes caused by atmospheric conditions.

As to the desirability of the co-operation of as many stations as possible with the object of obtaining statistics relative to the transmission of signals, this is perhaps a matter of opinion. It is so very easy to observe changes in the strength of the received signals and so very difficult to make sure that these changes are really due to atmospheric conditions. I should therefore advise that great care should be exercised in selecting stations with which to carry on such work. Uncertain and unreliable material is worse than no material at all.

J. Zenneck (communicated): In connection with the experiments made by Professor Taylor, I should strongly recommend that all measurements on the variation in strength of radio telegraphic signals, be made by using a *galvanometer*, as Dr. Louis W. Austin did in his experiments (PROCEEDINGS OF THE INSTITUTE OF RADIO ENGINEERS, Volume III (1915), page 103). Results obtained by the telephonic method of measuring the strength of the received signals may always have been influenced by physiological or psychological effects (R. H. Marriott, PROCEEDINGS OF THE INSTITUTE OF RADIO ENGINEERS, Volume II (1914), page 37), and therefore never possess the same degree of reliability as those obtained by the *galvanometer*.

A. Hoyt Taylor: I would like to point out to Professor Zenneck that, altho there are in the neighborhood of several hundred stations within our range, there are only two with

whom we have co-operated. Professor Zenneck has referred to a very interesting point; that is, the study of the decrement. For instance, we discovered at "9 X N" a very slight leakage of an insulator by noting that the decrement of the 1,500 meter wave jumped from 0.11 to 0.13, indicating that something was wrong. In reply to Professor Zenneck's suggestion that variation in the decrement might account for the apparent variations in transmission, I would like to point out that in wet weather where one gets abnormally high decrements and a lowering of energy radiated, we invariably get an improvement in the transmission. In other words, the change of decrement is in the wrong direction to explain our results. Very large variations in decrement might be shown on an amateur set with wooden insulators but, with a good sending and receiving set, it would be entirely impossible to get decrement variations of a sufficient magnitude to account for even a small percentage of the changes which we have observed. At "9 X N" we observed the decrements of both sending and receiving circuits, altho at St. Louis we observed only the decrement of the sending circuit. I fully realize the value of Professor Zenneck's criticisms of the co-operation idea and regret that there are not more stations in my part of the country with whom I can confidently co-operate and know that their observations will be reliable.

W. H. G. Bullard: Whereas I have not had much personal experience along the lines which constitute the subject of this paper, I have received considerable information thru official reports that bear on the general subject, and have formed some theories as to the conditions which give rise to the phenomenon of falling away and increasing of radio signals on the approach or recession of sunrise or sunset. This is particularly noticeable in localities where a rapid change of temperature accompanies either sunset or sunrise, and noticeably so in Alaska where most marked phenomena occur. Such theory as I have formed also to some extent accounts for some of the static disturbances noticed, particularly on high, large capacity antennas.

I have preferred to think of a large conducting surface, if such may be imagined, at some distance above the earth, and with which it is associated as the conducting surface of a high condenser with the intervening atmosphere as the dielectric. The height of this conducting surface will depend, considerably, on the temperature; the higher this is, the higher above the

earth this conducting surface and the less the capacity of the condenser. Consequently the electric waves are held between two surfaces of different distances apart, dependent upon the temperature. With the higher temperature of daylight, the signals should be correspondingly weaker than when the conducting surfaces are nearer together, as during night when the temperature falls. Under the condition of night when the temperature is lowered, the conducting surfaces are nearer together, the energy is concentrated in a smaller space, with the result that signals at a given station are of increased intensity. The phenomenon of increased strength of signals due to fading of daylight is marked in Alaska, and it is in such localities also that the most marked changes of temperature exist, and that the temperature rapidly falls immediately on the disappearance of the sun. The reverse takes place just after daylight, when there is a rapid increase of temperature after sunrise and signals immediately fall away. This seems to indicate that in places where the rate of change of temperature is greatest, there should be the greatest change noted in intensity of received signals.

On the surface of this conducting medium at some distance above the earth (which surface may be compared to the surface of the ocean), there are zones of static electric disturbances of greater or less amplitude, precisely as there are waves of greater or less height on the ocean's surface. These zones or regions dip below the surface on which they exist and may give up their charges to an antenna that is high enough to receive them and produce the characteristic sounds of static. Many of these zones will be small and cannot reach the antenna, but when an extra large zone comes along, it deposits an extra large charge. Static disturbances are most generally marked along about the time of sunset and sunrise and their effects might similarly be traced to the raising or lowering of the conducting area due to the rapid change of temperature at those times. After sunrise, the conducting area is higher and not so many static regions can reach the antenna while on the lowering of the area due to the lowering of temperature, these waves are within the reach of high antenna and so give up their charges.

It will take considerable study and observation to test such a theory, but I think those who are investigating the changes in intensity of radio signals under various meteorological conditions would do well to approach this subject from the point of view of changes of temperature, from whatever causes these may be due.

Speaking of what Professor Taylor says relative to co-operation with observing stations, I have the pleasure of controlling to a certain extent, the activities of a considerable chain of radio stations, fifty-five at least, from high to low and medium powered, and I can assure Professor Taylor that any of these stations which will be of use to him will gladly co-operate at any time of the day or night, and will guarantee to have observers in those stations who will in all respects be competent to take such measurements as he may desire. Further, I should like to announce publicly that it is the policy of the Naval Radio Service at all times actively to co-operate along any lines that will tend to the betterment of the art, and would like to have it known, that altho in some quarters, the government by certain of its activities, has been accused of hindering the art, yet it always stands ready to place its stations, as far as compatible with the public interests, at the disposition of those who may have any ideas they may wish to develop, and will gladly help thru its personnel or its material.

V. Ford Greaves: I have been very much interested in Professor Taylor's paper. It illustrates some of the difficulties of the radio inspection service of the Government in determining whether or not a certain radio station will transmit 100 miles (160 km.).

I have noted what Professor Taylor said in regard to the operation of unlicensed stations in the vicinity of St. Louis. On account of the limited appropriation and small inspection force, it has not been possible to devote much time to the inspection of inland stations. The radio service will appreciate reports of the operation of such stations from those who are interested in reducing unnecessary interference.

I read in the newspapers that the Marconi Company is to equip a considerable number of barges plying the Mississippi between New Orleans and Minneapolis, with radio apparatus to be used for commercial business. Undoubtedly this will result in more thoro inspection service in the central States, provided Congress will make the necessary appropriation.

Roy A. Weagant: I do not really think that I can add anything to the information of the evening. We are all under very serious obligations to Professor Taylor for tackling this problem. Those of us who attempted to do anything with it, found that the combination of an infinite number of variables is a very serious proposition to work out on a definite basis. My own

observations have been that almost all the phenomena that we get together at various times seem to fit in with almost any of the various theories which have been advanced to account for them. Personally I do not know how we can hope to get any information in this particular line of investigation, except as Professor Taylor has suggested; namely, making a really tremendous number of observations over a very long period of time. Professor Zenneck, speaking from a world of actual experience, pointed out the difficulty of making measurements really mean anything. My own experience is that variations, due to variations of the apparatus alone, are often thousands of times greater than anything happening in the intervening medium. I do not know of any commercial form of radio detector, of sufficient reliability, combined with sufficient sensitiveness to make readings at all quantitative. The audion, with which we are all familiar, generally changes its sensitiveness from the minute you close the switch on it. It is not constant in any two consecutive instants, hardly, and not at all over any considerable period of time. More or less similar remarks are true of any form of detector in use.

A. Hoyt Taylor: I can assure Mr. Weagant that there is a method of checking the sensitiveness of audions and will be glad to show him the details of it if he so desires.

R. H. Langley: Professor Taylor has discussed some very interesting phases of the effect of weather conditions on radio telegraphic transmission distances. It is interesting to note that complete weather records have been kept, in the United States for forty-five years. The Signal Corps of the Army organized a weather service in 1871. Temperature records were kept at the Army Posts as far back as 1820. But in spite of this vast quantity of data, weather predictions are still more or less inaccurate and unsatisfactory. If we are to rely, therefore, upon such predictions for predetermining the possibility of communications between any two radio stations at any given time, the value of such predeterminations must be small. It is also apparent that radio stations could not be rated in terms of the maximum distance which could be guaranteed under the worst conditions, since this would be almost nothing. And again, how shall we specify what shall be considered to be worse or best, or average conditions?

The possibility of predicting weather conditions by their effect on radio transmission seems also to be very small, since the

actual change in radio range occurs almost without exception, hours and even days after the meteorological conditions which produced that change have come into existence. This, of course, is not true of the effects of sunlight, sunrise, sunset, moonlight, and so forth, but these require no prediction.

A. S. Blatterman: Professor Zenneck's remarks on the possibility of antenna decrements seriously affecting the reported results of our experiments may be misleading. It is true, as Professor Zenneck says, that received antenna current is affected to an extent by the antenna decrements at receiver and sender. This statement must however be taken with caution; it may not at once be apparent just what is the order of magnitude of the effect. Among the factors affecting antenna decrement are wave length, rain, snow and ice and anything acting to alter the conductivity of the earth in the immediate neighborhood of the station, that is, the effective resistance of the antenna and its earth connection. Of the total resistance of the antenna a part, the radiation resistance, represents useful radiant energy and this part of the resistance term is independent of ordinary changes in atmospheric conditions. It depends on the geometric configuration of the aerial system, as is well known, and on the effective height of the aerial and the wave length. For a given set of these conditions, it is therefore only that part of the decrement (and resistance) representing Joulean losses which can affect the aerial current. In a well designed sending antenna the constant radiation resistance may be many times the variable ohmic resistance of the wires, leaks and earth plates, and therefore the small changes which occur in the latter due to atmospheric changes only slightly affect the whole effective value of antenna resistance and hence the currents.

Admitting, however, that the decrement has a noticeable effect this certainly cannot be taken to explain the very sudden and extraordinary changes in signal strength which have so often been observed; for, while it is well known that the decrement of a given aerial varies from instant to instant thruout the day there are no records, at least to my knowledge, which show the sudden decided variations in this quantity which would be necessary to explain such rapid fading effects as are exemplified by curve 11, Figure 1.

One might entertain for a moment the notion that changes in the average of the ordinates of the transmission curves for different days were indications of lower or higher decrements

at the antennas, were it not, as Professor Taylor has already pointed out, that in wet weather when one would expect weaker signals we have always found that transmission actually improved. But it certainly cannot explain the *sudden* fading which we are studying.

I must take exception to Mr. Weagant's remarks in which he would dismiss all idea of swinging and fading in transmission and lay it to irregular detector action. We are quite sure that our curves are not plots between detector sensibility and time. Personally I have observed the fading effects for about seven years with a great many different detectors, the electrolytic, the crystals and the audion, and if intelligently handled and tested from time to time, it is a practical certainty that variations in sensibility are totally inadequate to obscure the changing conditions between stations. Moreover, one frequently hears the signals from one station getting stronger while those of another are fading out, which shows pretty positively that the detector is not to blame. If Mr. Weagant really believes that irregular detector sensibility overshadows the changing meteorological conditions between stations, I can only say that he cannot have directed his attention to transmission at night over land, especially on the shorter wave lengths.

I might say that since preparing the paper we have been studying more in detail the question of reciprocity in transmission and hope to present some material on this in the near future.



THE THEORY AND DESIGN OF RADIO-TELEGRAPHIC TRANSFORMERS *

By
FULTON CUTTING
(RADIO ENGINEER)

The conventional radio plant charges the condenser of the oscillating circuit by means of a transformer whose primary is connected to an alternating current source. The character of the phenomena is well shown in Figure 1, which is a picture

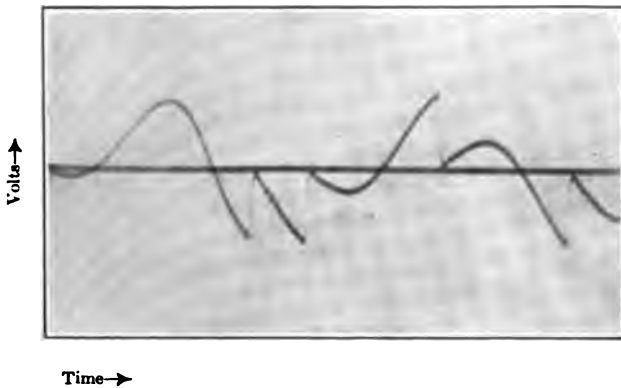

FIGURE 1—Voltage Across a Sparking Condenser Taken with an Electrostatic Oscillograph. (No Residual Condenser Charge.) 60 Cycles

taken with an electrostatic oscillograph of the voltage across a condenser charged thru a transformer by a 60 cycle a. c. source and discharging across a gap. The voltage of the condenser rises as current flows into it until the sparking voltage is reached and discharge takes place. The radio (high) frequency oscillation across the gap is over so quickly and the energy of the condenser dissipated that the phenomena of sparking appear, from an audio (low) frequency standpoint, simply as if the charge

* A portion of this paper was presented before The Institute of Radio Engineers, Boston Section, March 25, 1915.

had been suddenly conjured away. The condenser immediately starts filling up until the sparking voltage is again reached and another charge is spilt into the oscillating circuit.

From a mathematical standpoint we may treat this condition of affairs as a special case of coupled circuits acting under an impressed electromotive force.

The primary of the two circuits contains resistance, inductance, and an alternating impressed e.m.f., and the secondary contains resistance, inductance, and capacity. Sparking is represented simply as a discontinuity in the condenser charge.

Such a discontinuity sets up transient terms in the two circuits. For each fresh condenser discharge, new transient terms are set up; so that if the phenomenon is recurrent, the currents in the two circuits will be made up of the usual forced term plus a string of transient terms in different stages of damping. The present treatment assumes that the oldest of these transient terms has dwindled to a size that can be neglected. That is, the phenomenon of continued charging and discharging of the condenser is assumed to have reached a steady state. Under this assumption it is proposed to find expressions from which the output of the transformer may be computed.

Figure 2 represents the circuits. The primary and secondary currents are i_1 and i_2 . The rest of the letters have their conventional meanings.

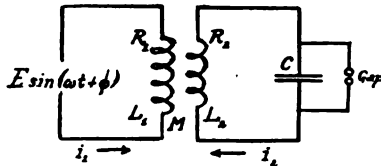

FIGURE 2—Diagram of Circuits

The differential equations of the two circuits are:

$$(1) \quad L_1 \frac{d i_1}{d t} + M \frac{d i_2}{d t} + R_1 i_1 = E \sin (\omega t + \phi_0)$$

$$(2) \quad L_2 \frac{d i_2}{d t} + M \frac{d i_1}{d t} + R_2 i_2 + \frac{1}{C} \int i_2 d t = 0$$

Eliminating the i_1 's:

$$(L_1 L_2 - M^2) \frac{d^3 i_2}{d t^3} + (R_1 L_2 + R_2 L_1) \frac{d^2 i_2}{d t^2} + \left(R_1 R_2 + \frac{L_1}{C} \right) \frac{d i_2}{d t} + \frac{R_1}{C} i_2 = E M \omega^2 \sin (\omega t + \phi_0)$$

or:

$$(3) \quad \frac{d^3 i_2}{dt^3} + \omega (\gamma_1 + \gamma_2) \frac{d^2 i_2}{dt^2} + \omega^2 (a \gamma_1 \gamma_2 + \theta^2) \frac{d i_2}{dt} + \omega^3 a \gamma_1 \theta^2 i_2 = \frac{E M \omega^2}{a L_1 L_2} \sin(\omega t + \phi_0)$$

where:

$$a = 1 - \frac{M^2}{L_1 L_2}$$

$$\gamma_1 = \frac{R_1}{a L_1 \omega}$$

$$\gamma_2 = \frac{R_2}{a L_2 \omega}$$

$$\theta^2 = \frac{1}{a L_2 C \omega^2}$$

These four constants have zero dimensions. a depends on the coefficient of coupling; that is, on the geometry of the transformer and is independent of the values of the inductances. γ_1 and γ_2 are of the nature of modified damping terms. θ is the most important quantity in the whole investigation. It turns out that it is the ratio of the natural period of the two circuits to the impressed period.

Equation (3) is a linear differential equation with constant coefficients; so that to find the free solution, we proceed in the usual way, and put:

$$i_2' = B e^{kt}$$

which on substitution in the left-hand member of (3) yields the cubic:

$$(4) \quad k^3 + \omega (\gamma_1 + \gamma_2) k^2 + \omega^2 (a \gamma_1 \gamma_2 + \theta^2) k + \omega^3 a \gamma_1 \theta^2 = 0$$

for the determination of k . We shall not attempt to solve this equation, but we shall simply designate its three roots by:

$$k_1 = k_1$$

$$k_2 = -\Delta + j \omega'$$

$$k_3 = -\Delta - j \omega'$$

Now as these satisfy (4) we must have:

$$(k - k_1) (k - k_2) (k - k_3) = 0.$$

Expanding this expression and equating its coefficients with those of (4), we get the relations:

$$(5) \quad -k_1 + 2\Delta = \omega (\gamma_1 + \gamma_2)$$

$$(6) \quad -2 a \omega \gamma_1 k_1 + \Omega^2 = \omega^2 (a \gamma_1 \gamma_2 + \theta^2)$$

$$(7) \quad -k_1 \Omega^2 = a \omega^3 \gamma_1 \theta^2$$

where:

$$\Omega^2 = \Delta^2 + \omega'^2$$

We shall now be able to get approximate roots for the cubic

(4). Dividing (6) by (7):

$$\frac{1}{-k_1} \left(1 - \frac{2 a \gamma_1 k_1 / \omega}{\Omega^2 / \omega^2} \right) = \frac{1}{a \omega \gamma_1} \left(1 + \frac{a \gamma_1 \gamma_2}{\theta^2} \right)$$

Neglect $\frac{2 a \gamma_1 k_1 / \omega}{\Omega^2 / \omega^2}$ and $\frac{a \gamma_1 \gamma_2}{\theta^2}$ in comparison with unity. This we shall see later is an excellent approximation. It gives us:

$$(8) \quad k_1 = -a \omega \gamma_1$$

$$(9) \quad \Omega^2 = \omega^2 \theta^2$$

$$(10) \quad \Delta = \frac{\omega}{2} (\gamma_1 (1-a) + \gamma_2)$$

These results, however, are not necessary for the present and we shall write the free solution simply as:

$$i_2' = B_1 \varepsilon^{k_1 t} + B_2 \varepsilon^{k_2 t} + B_3 \varepsilon^{k_3 t}$$

By routine methods, we may without much labor find the "forced" solution of (3), which is:

$$i_2'' = -I_2 \cos(\omega t + \phi_2)$$

where:

$$(11) \quad I_2 = \frac{E M \omega}{a L_1 L_2 \omega^2 \sqrt{(\gamma_1 + \gamma_2 - a \gamma_1 \theta^2)^2 + (\theta^2 + a \gamma_1 \gamma_2 - 1)^2}}$$

$$(12) \quad \phi_2 = \phi_0 - \tan^{-1} \frac{\gamma_1 + \gamma_2 - a \gamma_1 \theta^2}{\theta^2 + a \gamma_1 \gamma_2 - 1}$$

So the complete solution of (3) is:

$$(13) \quad i_2 = -I_2 \cos(\omega t + \phi_2) + B_1 \varepsilon^{k_1 t} + B_2 \varepsilon^{k_2 t} + B_3 \varepsilon^{k_3 t}$$

Turning now to the primary and proceeding in the same manner, we get by eliminating the i_2 's from (1) and (2):

$$(14) \quad \frac{d^3 i_1}{dt^3} + \omega (\gamma_1 + \gamma_2) \frac{d^2 i_1}{dt^2} + \omega^2 (a \gamma_1 \gamma_2 + \theta^2) \frac{d i_1}{dt} + \omega^3 a \gamma_1 \theta^2 i_1 \\ = \frac{E \omega}{a L_1 L_2} \left\{ R_2 \cos(\omega t + \phi_0) - \left(L_2 \omega - \frac{1}{C \omega} \right) \sin(\omega t + \phi_0) \right\} \\ = -\frac{E \omega Z_2}{a L_1 L_2} \sin \left(\omega t + \phi_0 - \tan^{-1} \frac{R_2}{L_2 \omega - \frac{1}{C \omega}} \right)$$

where:

$$Z_2 = \sqrt{R_2^2 + \left(L_2 \omega - \frac{1}{C \omega}\right)^2}$$

$$= L_2 \omega \sqrt{a^2 \gamma_2^2 + (1 - a \theta^2)^2}$$

$$\frac{R_2}{L_2 \omega - \frac{1}{C \omega}} = \frac{a \gamma_2}{1 - a \theta^2}$$

The coefficients of the left-hand member of (14) are the same as those of (3). The free solution of the primary will, therefore, be of the same form as that of the secondary and we can write at once as the complete solution of (14):

$$(15) \quad i_1 = I_1 \cos(\omega t + \phi_1) + A_1 e^{k_1 t} + A_2 e^{k_2 t} + A_3 e^{k_3 t}$$

where:

$$I_1 = \frac{E Z_2}{a L_1 L_2 \omega^2 \sqrt{(\gamma_1 + \gamma_2 - a \gamma_1 \theta^2)^2 + (\theta^2 + a \gamma_1 \gamma_2 - 1)^2}}$$

$$\phi_1 = \phi_2 - \tan^{-1} \frac{a \gamma_2}{1 - a \theta^2}$$

In equations (13) and (15) we have written in all six undetermined constants. The differential equations, however, admit of only three independent constants, and so that there must be relations between the A 's and the B 's. These relations are found by substituting (13) and (15) in (1) and (2). Leaving out the forced terms since these satisfy the differential equations identically, we get:

$$\sum \epsilon^{k_i t} \left(A_i (k_i + \Delta) + k_i \frac{M}{L_1} B_i \right) = 0$$

$$\sum \epsilon^{k_i t} \left(B_i (k_i + a \omega \gamma_2 + a \omega^2 \theta^2) + k_i \frac{M}{L_2} A_i \right) = 0$$

$i = 1, 2, 3$

These equations must be satisfied for all values of t . The coefficients of the $\epsilon^{k_i t}$'s do not involve t , so they must, therefore, each be identically zero. This gives:

$$(16) \quad A_i \left(1 + \frac{a \omega \gamma_1}{k_i} \right) = - \frac{M}{L_1} B_i$$

$$(17) \quad B_i \left(1 + \frac{a \omega \gamma_2}{k_i} + \frac{a \omega^2 \theta^2}{k_i^2} \right) = - \frac{M}{L_2} A_i \quad i = 1, 2, 3$$

It must be noted that these two equations are not independent. One is easily transformed into the other by means of the cubic (4). Having found the relations between the A 's and the B 's, we are now in a position to evaluate them in terms of

the constants of the circuits by means of the terminal conditions.

As mentioned above, the problem to be considered is that of a condenser charged thru a transformer and periodically discharged. We shall only consider the cases of discharge occurring every integral number of half cycles. It is necessary to assume that all the phenomena concerned are regular and symmetrical. That is, we assume that what goes on between any two successive sparks is similar to what goes on between any other successive sparks. Also if sparking occurs in different phases, no magnitudes will be altered but only signs. These restrictions are made so as to rule out anything in the way of a situation where sparking during the positive phase takes place at a different voltage or phase from sparking during the negative phase. Our conditions are, therefore, those of uniform operation under a steady state, and one mathematical expression covering the interval between sparks will tell the whole story.

Time is measured from the moment after sparking. That is, we start the interval with the condenser discharged, the residual charge being an experimental constant. The duration of the condenser discharge is extremely small. In this short time the magnetic field cannot appreciably change, so the currents are taken as continuous (this being verified by experiment). Remembering that the phenomena between sparks are identical, we see that the currents at the beginning of the interval between sparks must be equal in magnitude to the currents at the end. Let us say that the condenser discharges every n half cycles of the impressed e.m.f. and we get:

$$(18) \quad i_1(t=0) = (-1)^n i_1(t=n\pi/\omega)$$

$$(19) \quad i_2(t=0) = (-1)^n i_2(t=n\pi/\omega)$$

$$(20) \quad q(t=0) = -Q_0$$

where $-Q_0$ is the residual charge. q the charge in the condenser is given by:

$$(21) \quad q = \int i_2 dt = -\frac{I_2}{\omega} \sin(\omega t + \phi_2) + \frac{B_1}{k_1} \varepsilon^{k_1 t} + \frac{B_2}{k_2} \varepsilon^{k_2 t} + \frac{B_3}{k_3} \varepsilon^{k_3 t}$$

Applying (18), (19), and (20) to (15), (13), and (21) respectively:

$$\left\{ \begin{array}{l} \sum A_i \left(1 - (-1)^n \varepsilon^{\frac{n\pi k_i}{\omega}} \right) = 0 \\ \sum B_i \left(1 - (-1)^n \varepsilon^{\frac{n\pi k_i}{\omega}} \right) = 0 \\ \sum \frac{B_i}{k_i} = \frac{I_2}{\omega} \sin \phi_2 - Q_0 \end{array} \right. \quad i = 1, 2, 3$$

Together with (16) and (17) these equations enable us to get the A 's and B 's explicitly in terms of the constants of the circuits. For convenience put:

$$l_i = 1 - (-1)^n \varepsilon^{\frac{n\pi K}{\omega}}$$

$$m_i = -\frac{L_i}{M} \left(1 + \frac{\alpha \omega \tau_1}{k_i} \right) = \frac{B_i}{A_i}$$

$$p = \frac{I_2}{\omega} \sin \phi_2 - Q_0$$

$$k_i = 1/k_i \quad i = 1, 2, 3$$

Eliminating the B 's, equations (22) become:

$$l_1 A_1 + l_2 A_2 + l_3 A_3 = 0$$

$$m_1 l_1 A_1 + m_2 l_2 A_2 + m_3 l_3 A_3 = 0$$

$$m_1 k_1 A_1 + m_2 k_2 A_2 + m_3 k_3 A_3 = P.$$

Solving:

$$A_1 \begin{vmatrix} l_1 & l_2 & l_3 \\ m_1 l_1 & m_2 l_2 & m_3 l_3 \\ m_1 k_1 & m_2 k_2 & m_3 k_3 \end{vmatrix} = \begin{vmatrix} 0 & l_2 & l_3 \\ 0 & m_2 l_2 & m_3 l_3 \\ P & m_2 k_2 & m_3 k_3 \end{vmatrix}$$

Similarly for A_2 and A_3 . Calling the left-hand determinant H we have:

$$A_1 = l_2 l_3 (m_3 - m_2) \frac{P}{H}$$

$$A_2 = l_1 l_3 (m_1 - m_3) \frac{P}{H}$$

$$A_3 = l_1 l_2 (m_2 - m_1) \frac{P}{H}$$

Expanding:

$$\begin{aligned}
 A_1 &= -j \frac{2^{\alpha} \omega \gamma_1 \omega' L_1 \varepsilon^{-\frac{n\pi\Delta}{\omega}}}{\Omega^2 H} \left(\frac{I_1}{Z_2} \sin \phi_2 - \frac{Q_0}{M} \right) \left(\cosh \frac{n\pi\Delta}{\omega} - (-1)^n \cos \frac{n\pi\omega'}{\omega} \right) \\
 A_2 &= \frac{L_1}{H} \left(\frac{I_1}{Z_2} \sin \phi_2 - \frac{Q_0}{M} \right) \left(1 - (-1)^n e^{\frac{n\pi k_1}{\omega}} \right) \left[1 - (-1)^n \varepsilon^{-\frac{n\pi\Delta}{\omega}} \left(\cos \frac{n\pi\omega'}{\omega} - j \sin \frac{n\pi\omega'}{\omega} \right) \right] \left(1 + m_1 - \frac{\alpha \omega \gamma_1 (\Delta - j\omega')}{\Omega^2} \right) \\
 A_3 &= -\frac{L_1}{H} \left(\frac{I_2}{Z_2} \sin \phi_2 - \frac{Q_0}{M} \right) \left(1 - (-1)^n \varepsilon^{\frac{n\pi k_1}{\omega}} \right) \left[1 - (-1)^n \varepsilon^{-\frac{n\pi\Delta}{\omega}} \left(\cos \frac{n\pi\omega'}{\omega} + j \sin \frac{n\pi\omega'}{\omega} \right) \right] \left(1 - m_1 - \frac{\alpha \omega \gamma_1 (\Delta + j\omega')}{\Omega^2} \right) \\
 H &= j \frac{2L_1^2}{\Omega M} \left[\left(1 - (-1)^n \varepsilon^{\frac{n\pi k_1}{\omega}} \right) \left(1 - \frac{2\alpha\omega\gamma_1\Delta}{\Omega^2} + \frac{\alpha^2\gamma_1^2\omega^2}{\Omega^2} \right) \left\{ \frac{\omega'}{\Omega} - (-1)^n \varepsilon^{-\frac{n\pi\Delta}{\omega}} \cos \left(\frac{n\pi\omega'}{\omega} + \tan^{-1} \frac{\Delta}{\omega'} \right) \right\} \right. \\
 &\quad \left. - m_1 \left(1 - (-1)^n \varepsilon^{\frac{n\pi k_1}{\omega}} \right) \left\{ \Omega \left(1 - \frac{2\alpha\omega\gamma_1\Delta}{\Omega^2} \right) - (-1)^n \varepsilon^{-\frac{n\pi\Delta}{\omega}} \sqrt{\omega'^2 \left(1 - \frac{2\alpha\omega\gamma_1\Delta}{\Omega^2} \right)^2 + (\alpha\omega\gamma_1 + \Delta)^2} \left(1 - \frac{\alpha\omega\gamma_1\Delta}{\Omega^2} \right) \right\} \right. \\
 &\quad \left. \cos \left(\frac{n\pi\omega'}{\omega} + \tan^{-1} \frac{(\alpha\omega\gamma_1 + \Delta) \left(1 - \frac{\alpha\omega\gamma_1\Delta}{\Omega^2} \right)}{\omega \left(1 - \frac{2\alpha\omega\gamma_1\Delta}{\Omega^2} \right)} \right) \right] + \frac{2\alpha\omega\gamma_1\omega' m_1 \varepsilon^{-\frac{n\pi\Delta}{\omega}}}{k_1 \Omega} \left\{ \cosh \frac{n\pi\Delta}{\omega} - (-1)^n \cos \frac{n\pi\omega'}{\omega} \right\}
 \end{aligned}$$

Before proceeding further, it will be well to make some approximations. These approximations would ordinarily be made at a later stage of the investigation, but their introduction here will not affect the final result. The gain in simplicity is worth the sacrifice of elegance.

Terms of the order of Δ^2/Ω^2 will be neglected in comparison with unity. m_1 is of this order, and ω' may be replaced by Ω with the same degree of accuracy. We have then for the approximate value of the constants:

$$(23) \left\{ \begin{aligned} A_1 &= -2 a \omega \gamma_1 L_2 (1-a) \left(\frac{I_1}{Z_2} \sin \phi_2 - \frac{Q_o}{M} \right) \times \\ &\quad \frac{\cosh \frac{n \pi \Delta}{\omega} - (-1)^n \cos n \pi \theta}{(1 - (-1)^n \varepsilon^{\frac{n \pi k_1}{\omega}}) \left(\varepsilon^{\frac{n \pi \Delta}{\omega}} - (-1)^n \cos n \pi \theta + \frac{\Delta}{\omega \theta} \sin n \pi \theta \right)} \end{aligned} \right.$$

$$A_2 = \frac{L_2 \omega \theta}{2} (1-a) \left(\frac{I_1}{Z_2} \sin \phi_2 - \frac{Q_o}{M} \right) (a - j b)$$

$$A_3 = \frac{L_2 \omega \theta}{2} (1-a) \left(\frac{I_1}{Z_2} \sin \phi_2 - \frac{Q_o}{M} \right) (a + j b)$$

where

$$a = \frac{\frac{\alpha \gamma_1}{\theta} \varepsilon^{\frac{n \pi \Delta}{\omega}} + (-1)^n \sin n \pi \theta - (-1)^n \frac{\alpha \gamma_1}{\theta} \cos n \pi \theta}{\varepsilon^{\frac{n \pi \Delta}{\omega}} - (-1)^n \cos n \pi \theta + (-1)^n \frac{\Delta}{\omega \theta} \sin n \pi \theta}$$

$$b = \frac{\varepsilon^{\frac{n \pi \Delta}{\omega}} - (-1)^n \cos n \pi \theta - (-1)^n \frac{\alpha \gamma_1}{\theta} \sin n \pi \theta}{\varepsilon^{\frac{n \pi \Delta}{\omega}} - (-1)^n \cos n \pi \theta + (-1)^n \frac{\Delta}{\omega \theta} \sin n \pi \theta},$$

and from these we get:

$$(24) \left\{ \begin{aligned} B_1 &= m_1 A_1 = \text{negligible} \\ B_2 &= -\frac{\omega \theta}{2} \left(\frac{I_2}{\omega} \sin \phi_2 - Q_o \right) \times \\ &\quad \frac{(-1)^n \sin n \pi \theta - j \left(\varepsilon^{\frac{n \pi \Delta}{\omega}} - (-1)^n \cos n \pi \theta \right)}{\varepsilon^{\frac{n \pi \Delta}{\omega}} - (-1)^n \cos n \pi \theta + (-1)^n \frac{\Delta}{\omega \theta} \sin n \pi \theta} \\ B_3 &= -\frac{\omega \theta}{2} \left(\frac{I_2}{\omega} \sin \phi_2 - Q_o \right) \times \\ &\quad \frac{(-1)^n \sin n \pi \theta + j \left(\varepsilon^{\frac{n \pi \Delta}{\omega}} - (-1)^n \cos n \pi \theta \right)}{\varepsilon^{\frac{n \pi \Delta}{\omega}} - (-1)^n \cos n \pi \theta + (-1)^n \frac{\Delta}{\omega \theta} \sin n \pi \theta} \end{aligned} \right.$$

ϕ_2 which depends on ϕ_0 , the phase of the e.m.f. when $t=0$, is still undetermined. We may get light on this point by a consideration of the final charge in the condenser as a function of ϕ_2 .

Putting (24) into (21) and letting $t = \frac{n\pi}{\omega}$, we get the final charge in the condenser, Q , that is, the charge at the moment of sparking.

$$(25) \quad Q = (-1)^n \frac{2I_2}{\omega} \sin \phi_2 \left[\frac{(-1)^n \cosh \frac{n\pi\bar{\Delta}}{\omega} - \cos n\pi\theta}{(-1)^n \varepsilon^{\frac{n\pi\Delta}{\omega}} - \cos n\pi\theta + \frac{\Delta}{\omega\theta} \sin n\pi\theta} \right] \\ - (-1)^n Q_0 \left[\frac{(-1)^n \varepsilon^{-\frac{n\pi\Delta}{\omega}} - \cos n\pi\theta - \frac{\Delta}{\omega\theta} \sin n\pi\theta}{(-1)^n \varepsilon^{\frac{n\pi\Delta}{\omega}} - \cos n\pi\theta + \frac{\Delta}{\omega\theta} \sin n\pi\theta} \right]$$

Let us for the moment keep resistance, inductance and capacity constant, and fix our attention on the spark length and the phase ϕ_2 . Mathematically Q is now a function of ϕ_2 only. Changing the gap length changes the discharge voltage, and consequently the final condenser charge, so that physically, Q , depends only on the length of the gap. Since we have only one independent variable from the mathematical point of view, and similarly only one from the physical point of view, these two must coincide. Best adjustment of spark length, therefore, will mean the ϕ_2 given by:

$$\frac{\partial Q}{\partial \phi_2} = 0.$$

The differentiation is not necessary, since we see at once that for maximum Q we must have:

$$\phi_2 = \pi/2,$$

which gives from (12):

$$\phi_0 = \pi/2 + \tan^{-1} \frac{\gamma_1 + \gamma_2 - a\gamma_1\theta^2}{\theta^2 + a\gamma_1\gamma_2 - 1}$$

Q becomes:

$$(26) \quad Q = (-1)^n \frac{2I_2}{\omega} \left[\frac{(-1)^n \cosh \frac{n\pi\Delta}{\omega} - \cos n\pi\theta}{(-1)^n \varepsilon^{\frac{n\pi\Delta}{\omega}} - \cos n\pi\theta + \frac{\Delta}{\omega\theta} \sin n\pi\theta} \right] \\ + (-1)^n \frac{Q_0}{Q} \left[\frac{(-1)^n \varepsilon^{-\frac{n\pi\Delta}{\omega}} - \cos n\pi\theta}{(-1)^n \varepsilon^{\frac{n\pi\Delta}{\omega}} - \cos n\pi\theta + \frac{\Delta}{\omega\theta} \sin n\pi\theta} \right]$$

This form is chosen as $\frac{Q_0}{Q}$ is a constant whose value depends on the quenching of the gap.

We are now in a position to write down the expression for output of the system.

This will be taken as the energy, W_2 , lost by the condenser thru discharge.

$$W_2 = \frac{1}{2C} (Q^2 - Q_0^2) = \frac{Q^2}{2C} \left(1 - \frac{Q_0^2}{Q^2}\right)$$

$$(27) \quad W_2 = \frac{2E^2 \theta^2 (1-a) (1 - Q_0^2/Q^2)}{aL_1 \omega^2 [(\gamma_1 + \gamma_2 - a\gamma_1 \theta^2)^2 + (\theta^2 + a\gamma_1 \gamma_2 - 1)^2]} \times \left[\frac{(-1)^n \cosh \frac{n\pi\Delta}{\omega} - \cos n\pi\theta}{(-1)^n \varepsilon^{\frac{n\pi\Delta}{\omega}} - \cos n\pi\theta + \frac{\Delta}{\omega\theta} \sin n\pi\theta} + \frac{Q_0}{Q} \left(\varepsilon^{-\frac{n\pi\Delta}{\omega}} - (-1)^n \cos n\pi\theta - (-1)^n \frac{\Delta}{\omega\theta} \sin n\pi\theta \right) \right]^2$$

Q_0 is ordinarily zero. The oscillograms show that the voltage across the condenser is suddenly reduced to zero at the moment of sparking. This is to be expected since the spark presumably goes out when the energy of the closed circuit is all transferred to the antenna. This may happen after one or more beats have occurred in the oscillating circuits. The number of beats that are executed before the spark goes out depends, of course, on the quenching properties of the gap. We care very little, however, about this part of the whole phenomenon. As long as the gap does not arc, the duration of the spark is infinitesimal as compared to the periods of time with which we are dealing. The value of Q_0 is all we require, and the physical evidence is that it is zero. Putting $Q_0 = 0$ we have two important cases:

(a) $n = 1$, or two sparks per cycle:

$$(28) \quad W_2 = \frac{2E^2 \theta^2 (1-a)}{aL_1 \omega^2 [(\gamma_1 + \gamma_2 - a\gamma_1 \theta^2)^2 + (\theta^2 + a\gamma_1 \gamma_2 - 1)^2]} \times \left[\frac{\cosh \frac{\pi\Delta}{\omega} + \cos \pi\theta}{\varepsilon^{\frac{\pi\Delta}{\omega}} + \cos \pi\theta - \frac{\Delta}{\omega\theta} \sin \pi\theta} \right]^2$$

(b) $n=2$, or one spark per cycle:

$$(29) \quad W_2 = \frac{2E^2 \theta (1-\alpha)}{aL_1 \omega^2 [(\gamma_1 + \gamma_2 - \alpha\gamma_1\theta^2)^2 + (\theta^2 + \alpha\gamma_1\gamma_2 - 1)]} \times \left[\frac{\cosh \frac{2\pi\Delta}{\omega} - \cos 2\pi\theta}{\varepsilon^{\frac{2\pi\Delta}{\omega}} - \cos 2\pi\theta + \frac{\Delta}{\omega\theta} \sin 2\pi\theta} \right]^2$$

The latter case is the better of the two for experimental purposes and is plotted in Figure 3. The curves shown illustrate the effect of tuning on output. a , L_1 , E , and ω are held constant and are therefore grouped on the left-hand side of the equation as a multiplier of the output, W_2 . In this way it is possible to plot actual values so that W_2 may be found numerically from the curves by simply assigning values to the constants and the independent variable, θ . $\gamma_1(1-\alpha) + \gamma_2$ represents the damping and is taken as a parameter. $\theta \left(= \sqrt{\frac{1}{aL_2C\omega^2}} \right)$, it should be remembered, is the ratio of the free period of the system to the impressed, and its variation may best be regarded as due to the variation of the capacity, C , since this is the only quantity which changes θ without also changing γ_1 and γ_2 .

The salient feature of the output curves is that on either side of resonance, $\theta=1$, when the free period is equal to the impressed, there are maxima. The positions of these maxima are only slightly affected by the damping. That is, tuning is more or less independent of the resistances. Tuning, moreover, is not affected by the primary inductance, but the output is inversely proportional thereto. The output, also, as might be expected, is proportional to the square of the impressed voltage. The secondary inductance and the capacity are directly connected with tuning (that is, the value of θ), but have no influence outside of this on the magnitude of the output.

The coupling factor α (one minus the square of the coefficient of coupling) enters explicitly in numerator and denominator, and implicitly as well, since θ , γ_1 , and γ_2 all depend on α .

The curves in Figure 5 show the relation between coupling and output. In this case, θ is fixed and the output multiplied by a constant term is plotted against α . For brevity a new letter is introduced.

$$D = \alpha (\gamma_1 (1-\alpha) + \gamma_2) = \frac{R_1}{L_1 \omega} (1-\alpha) + \frac{R_2}{L_2 \omega}$$

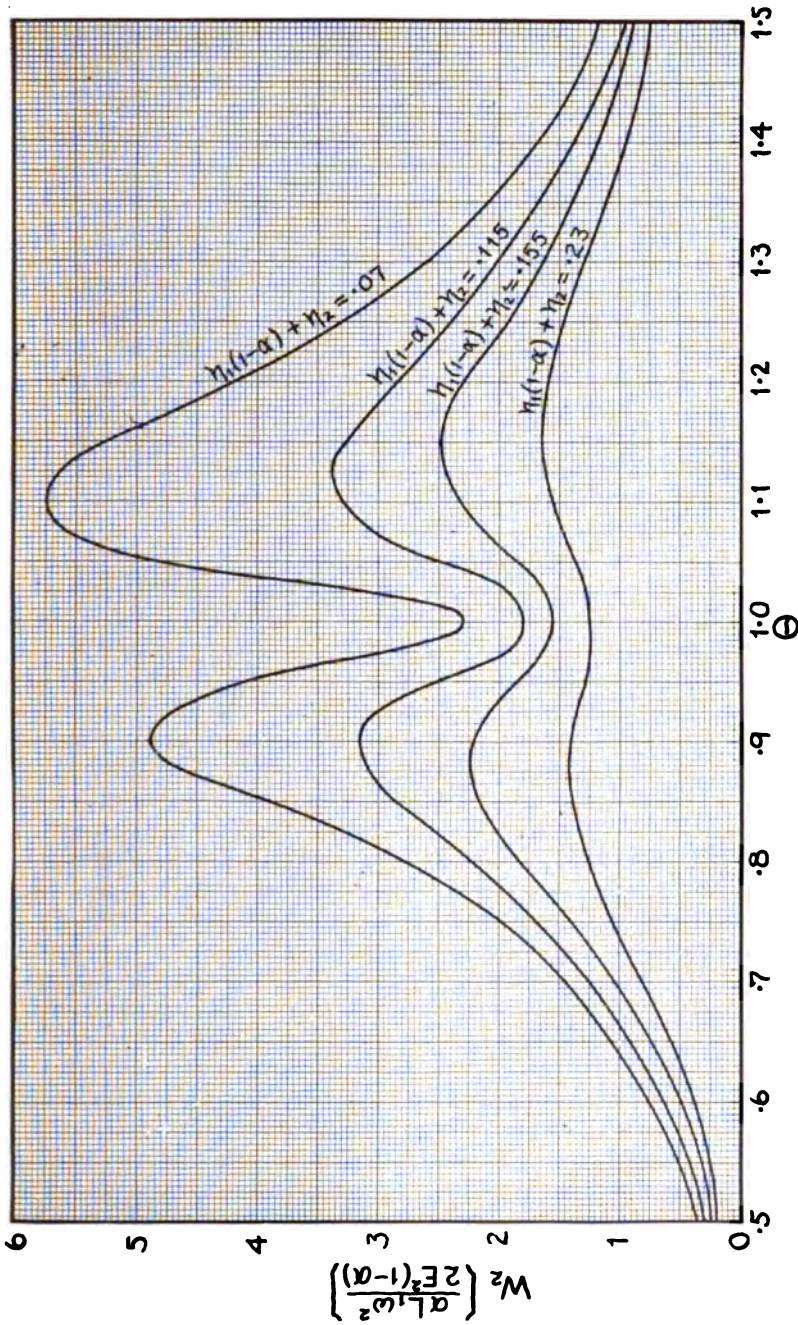

Fig. 3 Transformer Characteristics One Spark per Cycle

$$\text{Plot of } W_2 \left(\frac{\alpha L_1 \omega^2}{2 E^2 (1 - \alpha)} \right) = \frac{\theta^2}{\left\{ \eta_1(1 - \alpha) + \eta_2 \right\}^2 + \left\{ \theta^2 - 1 \right\}^2} \left\{ \frac{\cosh \frac{2\pi\theta}{\Delta} - \cos 2\pi\theta}{e^{\frac{2\pi\theta}{\Delta}} - \cos 2\pi\theta + \frac{\Delta}{\omega B} \sin 2\pi\theta} \right\}^2$$

This term is taken as constant, in spite of its dependence on α , in order to facilitate plotting. The error due to this is not great along the useful portions of the curve,—that is, in the region

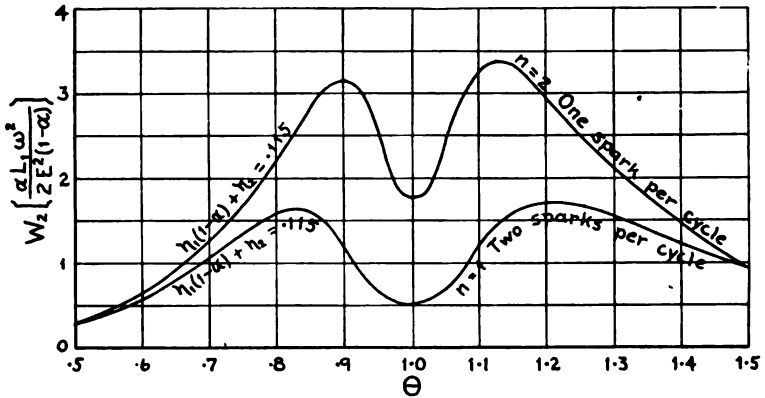

Fig. 4 Transformer Characteristics for One and Two Sparks per Cycle

where α is small. At first sight it will appear singular that for $\alpha=0$, (unity coupling), there is no output. The reason for this is that when α approaches zero the capacity must be increased indefinitely in order to keep θ constant. At $\alpha=0$, therefore, the

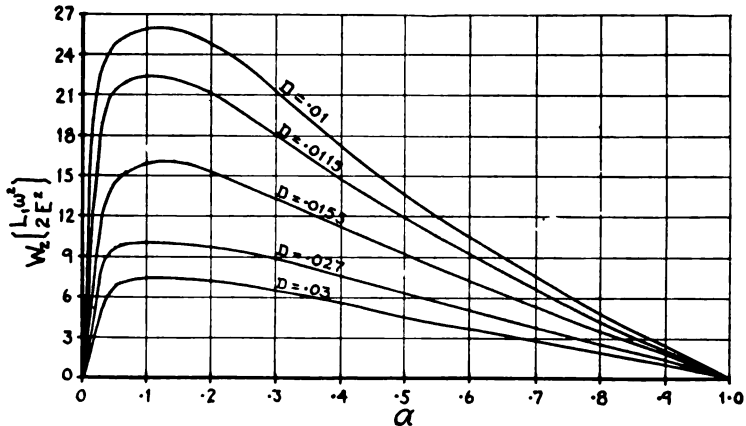

Fig. 5 Effect of α on Output $\theta=0.9$ $n=2$

$$W_2 \left\{ \frac{L_1 \omega^2}{2 E^2} \right\} = \frac{(\frac{1}{2} - 1) \theta^2}{\left[\frac{1}{\alpha} D \right]^2 + (\theta^2 - 1)^2} \left\{ \frac{\cosh \frac{\pi}{2} D - \cos 2\pi \theta}{e^{\frac{1}{2} D} - \cos 2\pi \theta + \frac{D}{2\theta \alpha} \sin 2\pi \theta} \right\}^2$$

condenser is infinitely large and its potential cannot be raised without an infinite supply of power. If, however, instead of keeping θ constant, C and L_2 are held fast, the output approaches a definite limit as α approaches zero. This limit is:

$$\lim_{\alpha \rightarrow 0} W_2 = \frac{1}{2} C E \frac{L_2}{L_1} \left(\frac{1}{1 + (DL_2 C \omega^2)^2} \right) \quad (30)$$

The expressions for the condenser charge, and the primary and secondary currents at any moment are:

(a) Condenser charge, q :

$$(31) \quad q = -\frac{I_2}{\omega} \left[\cos(\omega t + \phi_2 - \pi/2) - \epsilon^{-\Delta t} \cos(\phi_2 - \pi/2) \right] \times \frac{\sqrt{2 \frac{\epsilon^{\frac{n\pi\Delta}{\omega}}}{\epsilon^{\frac{n\pi\Delta}{\omega}} - (-1)^n \cos n\pi\theta} - (-1)^n \cos n\pi\theta}}{\epsilon^{\frac{n\pi\Delta}{\omega}} - (-1)^n \cos n\pi\theta + (-1)^n \frac{\Delta}{\omega} \sin n\pi\theta} \times \left[\cos\left(\omega\theta t - \tan^{-1} \frac{\Delta}{\omega\theta} + \tan^{-1} \frac{\sin n\pi\theta}{(-1)^n \epsilon^{\frac{n\pi\Delta}{\omega}} - \cos n\pi\theta}\right) \right]$$

(b) Secondary current, i_2 :

$$(32) \quad i_2 = I_2 \left[\sin(\omega t + \phi_2 - \pi/2) - \theta \epsilon^{-\Delta t} \sin \phi_2 \right] \times \frac{\sqrt{2 \frac{\epsilon^{\frac{n\pi\Delta}{\omega}}}{\epsilon^{\frac{n\pi\Delta}{\omega}} - (-1)^n \cos n\pi\theta} - (-1)^n \cos n\pi\theta}}{\epsilon^{\frac{n\pi\Delta}{\omega}} - (-1)^n \cos n\pi\theta + (-1)^n \frac{\Delta}{\omega} \sin n\pi\theta} \times \left[\sin\left(\omega\theta t + \tan^{-1} \frac{\sin n\pi\theta}{(-1)^n \epsilon^{\frac{n\pi\Delta}{\omega}} - \cos n\pi\theta}\right) \right]$$

(c) Primary current, i_1 :

$$\begin{aligned}
 (33) \quad i_1 = & -I_1 \left[\sin \left(\omega t + \phi_2 - \pi/2 - \tan^{-1} \frac{a\gamma_2}{1-a\theta^2} \right) + \frac{(1-a)\theta \sin \phi_2}{\left(\varepsilon^\omega - (-1)^n \cos n\pi\theta + (-1)^n \frac{a\gamma_1}{\theta} \sin n\pi\theta \right) \sqrt{(1-a\theta^2)^2 + a^2\gamma_2^2}} \right] \times \\
 & \left\{ \frac{2a\gamma_1}{\theta} \left(\frac{\cosh \frac{n\pi\Delta}{\omega} - (-1)^n \cos n\pi\theta}{1 - (-1)^n \varepsilon^{n\pi a\gamma_1}} \right) \varepsilon^{n\omega t} \right. \\
 & \left. - \varepsilon^{-\Delta t} \sqrt{2\varepsilon^{\frac{n\pi\Delta}{\omega}}} \left(\cosh \frac{n\pi\Delta}{\omega} - (-1)^n \cos n\pi\theta + (-1)^n \frac{a\gamma_1}{\theta} \sin n\pi\theta \right) \right. \\
 & \left. \sin \left(\omega t + \tan^{-1} \frac{a\gamma_1}{\theta} \varepsilon^\omega + (-1)^n \sin n\pi\theta - (-1)^n \frac{a\gamma_1}{\theta} \cos n\pi\theta \right) \right. \\
 & \left. \varepsilon^\omega - (-1)^n \cos n\pi\theta - (-1)^n \frac{a\gamma_1}{\theta} \sin n\pi\theta \right\}
 \end{aligned}$$

ϕ_2 , it should be remembered, is equal to $\pi/2$ for the condition of maximum output,—that is, ideal adjustment of the spark gap. In practice, this condition is never realized on account of the irregular action of the gap as shown in Figure 6. At resonance ϕ_2 is nearly $\pi/2$ but off resonance it may be considerably different

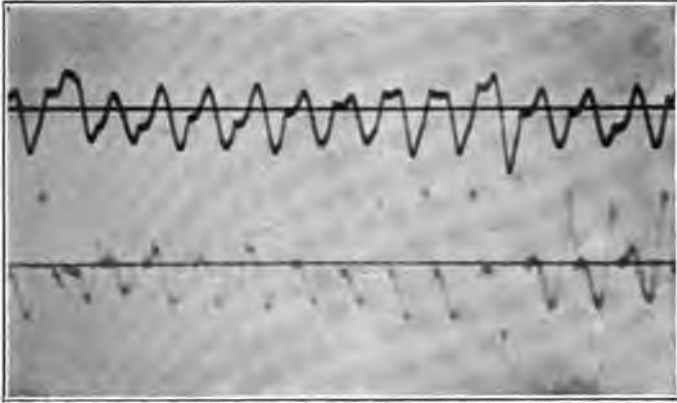

Time→

FIGURE 6—Condenser Voltage (bottom) and Secondary Current (top) of 500 Cycle Transformer Circuit Showing Irregularity of Phase and Length of Spark

from this valve. Figure 7 is plotted from (31) and (32) on the assumption that $\phi_2 = 2\pi/3$. The dashed curves represent the forced components of current and condenser charge, and the dotted curves represent the free components. The sum of these give the actual current and condenser charge. These computed curves closely resemble the curves shown in the oscillogram, Figure 8, which was taken for the same circuit constants. It will be noticed that both the calculated and observed curves of voltage (or condenser charge which is proportional thereto) start concave downwards after the sudden drop from maximum voltage to zero which represents the sparking point. In other respects as well, such as the rapid rise before sparking, the curves are similar. At the moment of sparking there is a discontinuity in the first derivative of the current. In fact the cur-

rent, which before sparking was decreasing, actually increases slightly after sparking. It should be noticed also that in both the computed and observed cases the current is partly rectified.

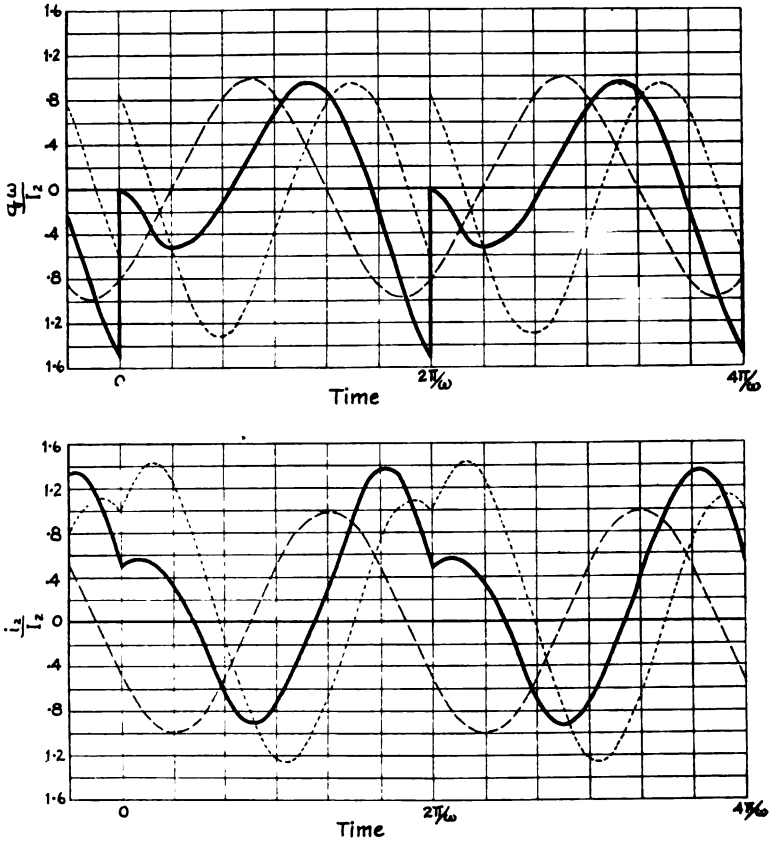
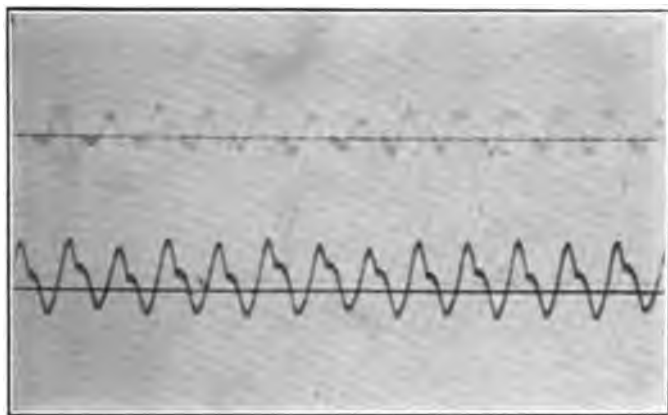

Fig. 7 (Top) Calculated Voltage Wave } for $\Theta = 1.2$
 (Bottom) Calculated Current Wave } for $\eta_1(1-\alpha) + \eta_2 = 0.09$
 ----- free component $\phi_2 = 120^\circ$
 ———— forced component

The energy input, W_1 , for the period between discharges, that is from $t=0$ to $t = \frac{n\pi}{\omega}$, is:

$$W_1 = \int_0^{\frac{n\pi}{\omega}} i_1 E \sin(\omega t + \phi_0) dt$$

$$\begin{aligned}
 (34) \quad W_1 = & \frac{2E^2}{aL_1\omega^2[(\gamma_1+\gamma_2-a\gamma_1\theta^2)^2+(\theta^2+a\gamma_1\gamma_2-1)^2]} \times \\
 & \left[\frac{n\pi}{4} \left\{ (\gamma_1+\gamma_2-a\gamma_1\theta^2)(1-a\theta^2) + a\gamma_2(\theta^2+a\gamma_1\gamma_2-1) \right\} \right. \\
 & + \left. \left\{ \frac{(-1)^n \cosh \frac{n\pi\Delta}{\omega} - \cos n\pi\theta}{(-1)^n \frac{n\pi\Delta}{\omega} - \cos n\pi\theta + \frac{a\gamma_1}{\theta} \sin n\pi\theta} \right\} \right] \times \\
 & \left\{ \theta^2(1-a) \frac{\left(\theta^2 + \frac{\Delta^2}{\omega^2} - 1\right) \left(\theta^2 - 1 - a\gamma_1^2(1-a\theta^2)\right) - \frac{2\Delta}{\omega}(\gamma_1+\gamma_2-a\gamma_1\theta^2)}{\frac{2\Delta^2}{\omega^2}(1+\theta^2) + (1-\theta^2)^2} \right. \\
 & \left. - a\gamma_1(1-a) \left(a\gamma_1(\theta^2+a\gamma_1\gamma_2-1) - (\gamma_1+\gamma_2-a\gamma_1\theta^2) \right) \right\}
 \end{aligned}$$



Time →
 FIGURE 8—Condenser Voltage (top) and Secondary Current (bottom) of 500 Cycle Transformer Circuit for $\theta = 1.2$, $\gamma_1(1-a) + \gamma_2 = .09$.
 One Spark per Cycle

MEASUREMENT OF CONSTANTS

The constants that enter in the theory are L_1 , L_2 , a , C , γ_1 , γ_2 , E , and ω (Δ and θ are simple functions of these). Of these C and ω may be measured with ease and accuracy. A voltmeter measurement of E is accurate only when the generator is sinusoidal. This will be taken up later. What especially ab-

sorbs our attention, however, is the measurement of L_1 , L_2 , and α , since it is principally on these that tuning depends.

In measuring the constants of an electric circuit it is desirable, if possible, to use methods which will involve only the use of ordinary voltmeters, ammeters, and wattmeters. In doing this, however, we must always be on our guard to see whether or not the readings of the instruments have the same meaning as the quantities used in the theoretical relations. If, for instance, a transformer is operated close to resonance the currents will be sinusoidal, but the voltage will be characteristic of the generator. A voltmeter across the line, therefore, may read much too high, for the reading is due to the fundamental plus all the harmonics which in the particular case exist only in the voltmeter circuit and contribute nothing to the main circuit. The oscillogram shown in Figure 9 is an example of sinusoidal currents driven by an electromotive force abounding in harmonics.

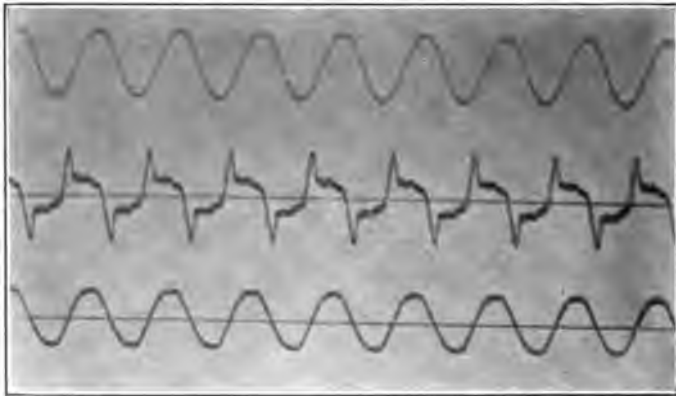

FIGURE 9—500 Cycle Transformer Circuit Resonated to Fundamental. Primary Current (bottom), Primary Voltage (middle), Secondary Current (top). Non-Sparking

Measurements to determine the constants are made under steady state, non-sparking conditions: Equations (13) and (15) afford the expressions we want. Taking I_1 , I_2 and E as the root-mean-square values of sinusoidal currents and electromotive force, we have:

$$(35) \quad I_1 = \frac{EL_2 \omega \sqrt{(1 - \alpha \theta^2)^2 + \alpha^2 \gamma_2^2}}{\alpha L_1 L_2 \omega^2 \sqrt{(\gamma_1 + \gamma_2 - \alpha \gamma_1 \theta^2)^2 + (\theta^2 + \alpha \gamma_1 \gamma_2 - 1)^2}}$$

$$(36) \quad I_2 = \frac{E M \omega}{a L_1 L_2 \omega^2 \sqrt{(\gamma_1 + \gamma_2 - a \gamma_1 \theta^2)^2 + (\theta^2 + a \gamma_1 \gamma_2 - 1)^2}}$$

Resonance we shall define as that condition where the natural period of the two circuits is the same as the impressed period, that is:

$$\theta = 1,$$

or

$$(37) \quad L_1 \omega \left(L_2 \omega - \frac{1}{C \omega} \right) = M^2 \omega^2$$

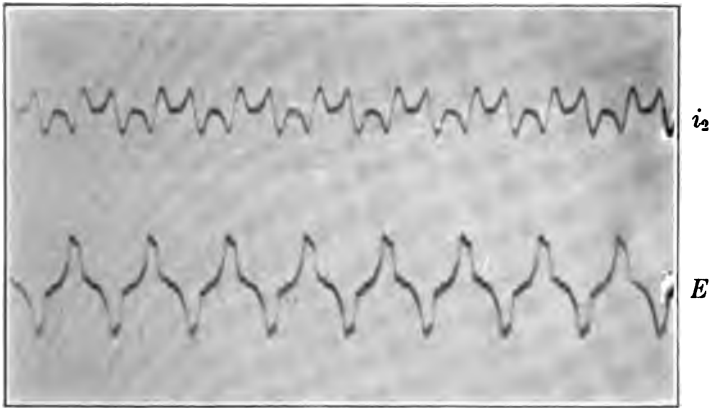

FIGURE 10—Primary Voltage (bottom) and Secondary Current (top). Result of Small Capacity, Illustrating Necessity of Operating Close to Resonance. Non-Sparking

At this adjustment the primary and secondary currents are very nearly a maximum.

When the voltage is not sinusoidal, great care must be taken to screen out the harmonics from all the currents. This is done by taking all measurements at resonance. Owing to the sharpness of tuning of radio circuits, adjustment for resonance to the fundamental is so bad an adjustment for the harmonics that the currents are practically sinusoidal, as in Figure 9. The following procedure will give the various constants:

(1) L_2 :

Connect the secondary of the transformer in series with a condenser to the source of e.m.f. Resonate, and we have:

$$L_2 = 1/C' \omega'^2$$

This method is especially adapted to air transformers. For iron transformers, it is not so good, as the large impedance of the secondary makes it difficult to supply even the power required

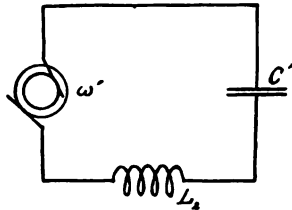

ILLUSTRATION A

for the iron losses, with the result that the magnetization of the iron is far below normal. This leads to incorrect results.

(2) L_1 :

If large capacity is available repeat (1) replacing L_2 by L_1 . This is the only direct method of measuring primary inductance since the volt-ampere, and the three voltmeter methods are inappropriate if the voltage contains harmonics to any marked degree. For iron transformers, an exploring coil should be used to ensure this test being made at the normal magnetization of the iron.

(3) α and L_1 :

Resonate the transformer and measure primary current, $I_{1,r}$, and secondary current, $I_{2,r}$. Then from (35) and (36), putting $\theta = 1$:

$$a = \frac{1}{L_2 C_r \omega^2}$$

$$\frac{M}{L_1} = \frac{I_{1,r}}{I_{2,r}} = \frac{L_2}{M} (1-a)$$

$$L_1 = \left(\frac{I_{2,r}}{I_{1,r}} \right)^2 L_2 (1-a)$$

This last relation solved for L_2 is:

$$L_2 = L_1 \left(\frac{I_{1,r}}{I_{2,r}} \right)^2 + \frac{1}{C_r \omega^2}$$

At this point it is interesting to note that the degree of magnetization of the iron has hardly any effect on the position of resonance. That is, the transformer will resonate on the same condenser for weak as well as for strong magnetization of the iron. The reason for this will be understood from an examination of the condition for resonance—(37). As usual the resistance

terms have been neglected. There is another point, however, in which the formula is not strictly accurate. From the very beginning of the investigation, altho no reference was made to it at the time, it was assumed that the mutual inductance of the primary with respect to the secondary was the same as the mutual inductance of the secondary with respect to the primary. On account of the vagaries of the iron this assumption is not strictly accurate. We should have written M_1 and M_2 instead of simply M , giving:

$$L_1 \omega \left(L_2 \omega - \frac{1}{C \omega} \right) = M_1 M_2 \omega^2$$

This done, however, we are not so badly off as might be supposed, for if M_1 is a certain complicated function of the time, L_1 is a multiple of that same function, and if M_2 is another different function of the time, L_2 is a multiple of that different function. If coupling is close, as is ordinarily the case with iron transformers, $\frac{1}{C \omega}$ will be small as compared to $L_2 \omega$, so we see that altho L_1 , L_2 and M_1 , M_2 change with the time, their ratios do not change and the resonance condition is always fulfilled.

The method for measuring γ_1 and γ_2 depends on a measurement of voltage. If this voltage contains harmonics which contribute nothing to the resonant circuits, the ordinary voltmeter will read too high. Harmonics which are excluded from the transformer will get thru the voltmeter circuit. The wattmeter will read correctly, for altho harmonics may get thru the voltage coil, their integral effect over a whole period will be zero unless the same harmonics appear in the current. The power factor, therefore, will always be found too low if the voltage wave is distorted.

To correct this error, it is necessary to make a "resonant" voltmeter. This is accomplished by putting in series across the line an inductance, a capacity, and a milliammeter. The circuit is tuned to resonance so that the milliammeter reads the ohmic drop across the line. If the circuit is exactly a thousand ohms resistance, the milliammeter will be direct reading. Before each reading, however, it is essential to tune the circuit with precision or the ammeter will read too low. Tuning is effected either by varying the condenser or by using an inductance of the variometer type. Maximum reading of the ammeter will represent the actual value of the fundamental component of the voltage.

Equipped with such an instrument, we may proceed to measure damping coefficients:

(4) Δ , γ_1 and γ_2 :

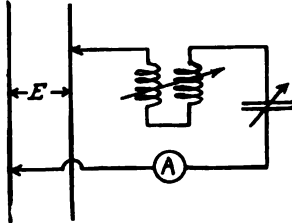

ILLUSTRATION B

Combining (35) and (36) with $\theta = 1$,

$$\Delta = EC_r \omega^2 \frac{I_{1,r}}{2 I_{2,r}}$$

$$\gamma_2 = \frac{1-\alpha}{\alpha} \sqrt{2(1-P.F.)}$$

where $P.F.$ is the power factor.

$$\gamma_1 = \frac{\frac{2\Delta}{\omega} - \gamma_2}{1-\alpha}$$

The expression for γ_2 is very inaccurate if α is small. But if α is small we may approximate and write:

$$\gamma_1 + \gamma_2 - \alpha \gamma_1 \theta^2 = \gamma_1 (1-\alpha) + \gamma_2 = \frac{2\Delta}{\omega}$$

Using this substitution it is unnecessary for ordinary purposes to know either γ_1 or γ_2 explicitly.

The methods for α all include the inductance of the generator in the inductance, L_1 , of the primary. If α for the transformer alone is desired the following method is convenient.

(5) α for transformer alone:

Repeat (1):

$$L_2 C' \omega'^2 = 1.$$

Short-circuit the primary, and resonate again:

$$\alpha L_2 C \omega^2 = 1$$

So that we get:

The accuracy of this method depends on the fact that the inductance of the generator is very small as compared to the inductance of the secondary of the transformer; so that including the generator in the secondary does not have an appreciable effect on the resonance. This method is suitable only for air transformers.

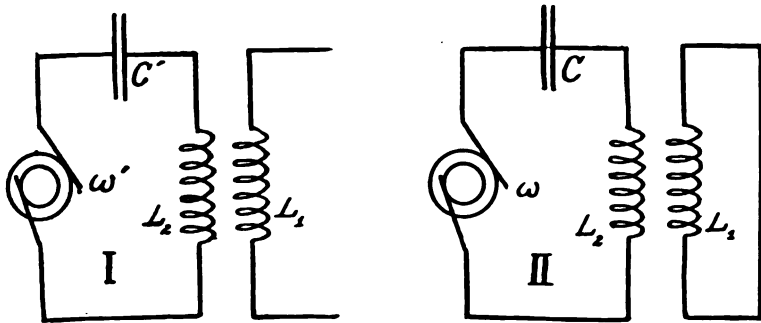

ILLUSTRATION C

There are a few points about the technique of resonance measurements that it is well to mention before leaving this subject. Resonance, it will be remembered, is defined as the condition where $\theta = 1$. At this point both primary and secondary currents are approximately a maximum, and the resonant point may be found by the use of an ammeter. Maximum secondary current will give maximum condenser voltage. This leads to another method of detecting resonance. An electrostatic voltmeter shunted across the condenser will give maximum reading at resonance. For radio work, this method is very sensitive. The condensers ordinarily used are small, and a few milliamperes will often raise the condenser to a potential of several hundred volts.

In most resonance measurements it is necessary to apply very low voltages. If the full voltage of a generator be applied to a resonated transformer, the result is a bigger load than putting a dead short-circuit across the terminals of the generator. A dead short-circuit is somewhat controlled by the reactance of the armature, but even this is neutralized when the transformer is resonated. What saves the generator from destruction is the insulation of the secondary and the establishment of short-circuits the condenser and de-

When resonating an unknown inductance care should be taken that a harmonic in the electromotive force is not resonated instead of the fundamental. The accompanying oscillogram, Figure 11, shows the result of using a capacity resonant to the third harmonic. A large current is flowing in both primary and

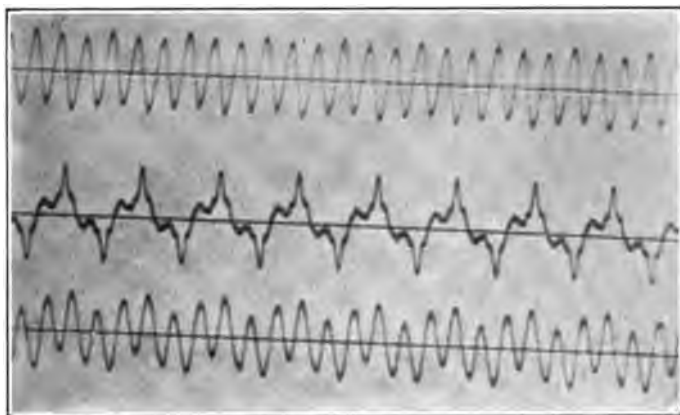

FIGURE 11—500 Cycle Transformer Circuit Resonated to Third Harmonic. Primary Current (bottom), Primary Voltage (middle), Secondary Current (top)

secondary, but the fundamental has almost entirely disappeared. Tuning is sharp. In one case two kilowatts of third harmonic power was the output of a 500 v. 5 k.w. Holtzer-Cabot generator. In another case, thru accidental adjustment of capacity, the third harmonic current attained such a value as to cause an arc to pass over the top of the Leyden jars.

Harmonic currents may be distinguished from the fundamental in several different ways. The oscillograph, of course, shows immediately just what is going on. Secondly, if considerable harmonic current is flowing into Leyden jars, the jars will sing with a note higher than that of the fundamental.

Lastly the n th harmonic will raise the condenser to a potential only $1/n$ th as large as a fundamental current of the same value.

EFFECT OF E.M.F. WAVE SHAPE

After the emphasis that has been laid on measuring transformer constants at resonance, the question naturally arises, of what purpose this serves if the transformer is not operated at

resonance. Leaving aside the fact that this method alone gives us true values of inductances, coupling, etc., the conditions at resonance closely approximate the conditions at actual operation. Transformers are usually operated with a condenser about three-quarters or one and a quarter the resonant condenser. At both these points the currents are still close to pure sine waves. Above resonance this is very much the case. Even at twice resonant condenser value the currents are nearly sine waves. Below resonance, the third harmonic begins to appear, but at one-half resonant condenser value it does not yet appear in the secondary current strongly enough to have much influence on tuning (see Figure 12 and Figure 13). Sparking has the effect

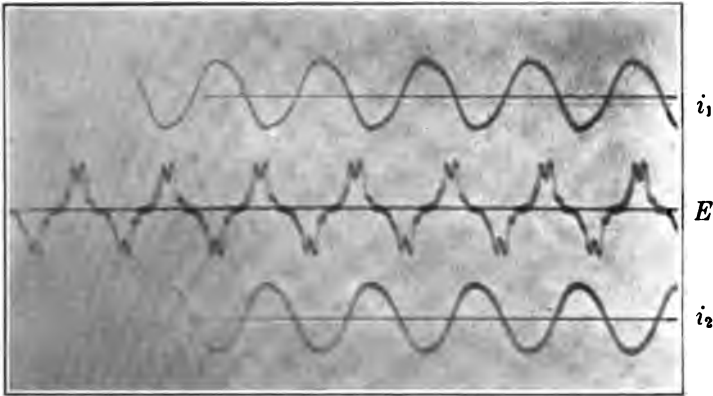

FIGURE 12—Voltage and Currents at Twice Resonant Condenser. Non-Sparking

of increasing the apparent size of the condenser and will consequently tend to diminish the harmonics. At both these points, the currents are still close to pure sine waves. We arrive, then, at the important conclusion that the shape of the e.m.f. wave has no effect on the shape of the current wave. All voltage waves possessing the same fundamental will act alike—they deliver only fundamental current.

GENERATOR DESIGN

Since harmonics are excluded from the transformer circuits, we see that the shape of the generator e.m.f. wave has no influence on the phenomena of charging the condenser, provided

the system is somewhere near resonance. A flat-topped e.m.f. wave will give the same result as a peaked wave provided the fundamentals of both are equal. It becomes unnecessary, therefore, in designing radio generators to make any effort to obtain flat-topped or peaked waves, or even sinusoidal waves. No advantage will be gained by any special wave form except perhaps the sinusoidal, for in that case alone will a voltmeter across the generator terminals read effective voltage.

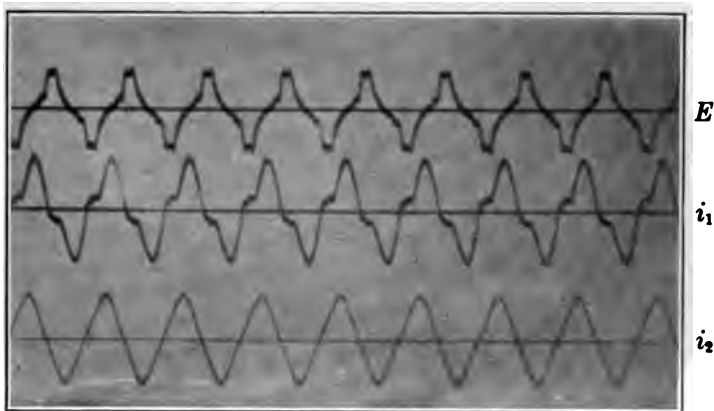

FIGURE 13—Voltage and Currents at Half Resonant Condenser. Non-Sparking

SUPPLEMENTARY METHOD FOR α

In view of the fact that at twice resonant condenser the currents are sinusoidal (Figure 12), the following method may be used for determining α .

Resonate the transformer and measure primary current I_1 , and secondary current, I_2 . This applies to (43); that is:

$$\frac{I_{1,r}}{I_{2,r}} = \frac{L_2}{M}(1-\alpha)$$

Adjust the condenser to twice resonant value, that is $\theta^2 = 1/2$, and measure primary current $I_{1,2r}$ and secondary current $I_{2,2r}$. Then combining (35) and (36) with $\theta^2 = 1/2$, we get:

$$\frac{I_{1,2r}}{I_{2,2r}} = \frac{L_2}{M}(1-\alpha/2)$$

Solving for α :

$$\alpha = \frac{\frac{I_{1,r} - I_{1,2r}}{I_{2,r}} - \frac{I_{1,2r}}{I_{2,2r}}}{\frac{I_{1,r}}{I_{2,r}} - \frac{1}{2} \frac{I_{1,2r}}{I_{2,2r}}}$$

This method is insensitive for close coupling.

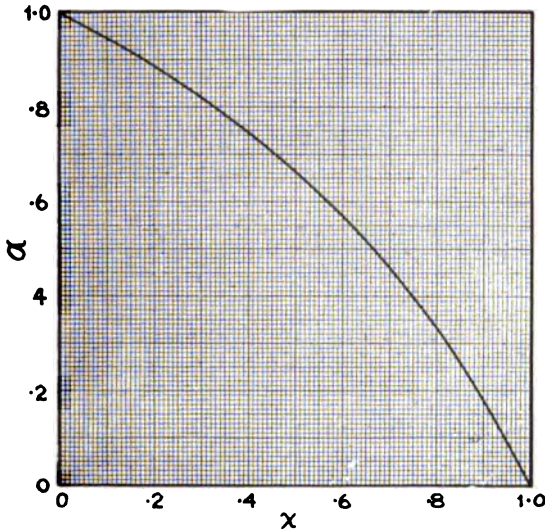

Fig. 14 Curve for finding α

$$\alpha = \frac{1-x}{1-\frac{x}{2}} \quad x = \frac{I_{1,2r}/I_{2,2r}}{I_{1,r}/I_{2,r}}$$

If the coupling is close, put an exterior inductance in the primary. Thus loosened, measure the new coupling factor α' . If C_r' is the new resonant condenser, the real α is given by:

$$\alpha = \alpha' \frac{C_r' \omega'^2}{C_r \omega^2}$$

EXPERIMENTAL VERIFICATION OF THEORY

OUTPUT OF A SPARKING CONDENSER

Object: Given a condenser charged by an alternating current source thru a transformer, and discharging regularly, to find the energy lost by the condenser during a discharge. This is to be repeated for various condenser values.

General Method: Oscillograph the condenser voltage determining, V , the voltage at the instant of sparking, and V_0 , the residual voltage after sparking. The energy lost per discharge is then given by:

$$W_2 = \frac{1}{2} C (V^2 - V_0^2).$$

Apparatus: The alternating current source is a 5 K. W., 250 volt, 500 cycle Holtzer-Cabot motor-generator set. This feeds the primary of a step up, closed core transformer. The secondary of the transformer is connected across a battery of Leyden jars. The jars discharge thru a rotary, synchronous gap, the energy of the radio frequency oscillation being absorbed by an auxiliary circuit in place of an antenna.

The rotary synchronous gap is simply an insulated copper arm carried on a projection of the generator shaft. This arm revolves inside a brass ring split into two halves. Set screws project thru the ring forming spark points. The spark passes from one-half of the ring thru the revolving arm and out the other half. A rubbing contact on the arm provides a means of using one air gap alone instead of two in series. The length of the gap is adjustable by giving an angular displacement to the split ring. Adjustment should be made so that the spark occurs before the spark points are opposite each other. This makes up for irregularities of voltage and insures the occurrence of a spark each time the points pass. Adjustment for sparking after the points have passed each other is a manifestly unstable condition for regular sparking.

A stroboscope is connected to the auxiliary oscillating circuit to observe the regularity of sparking. (This is not shown on the wiring diagram, Figure 15.)

The condenser voltage is measured by means of an oscillograph of the electromagnetic type. The high-potential side of a current transformer is connected across the Leyden jars, in series with a running water resistance. The water resistance is simply a glass tube, water entering the grounded end and leaving the high tension end in a broken stream. The secondary of the current transformer is short-circuited thru the vibrator of the oscillograph.

The current transformer is a small toroidal core with the primary and secondary wound on top of each other. The electrical theory of this transformation is taken up in another paper.

Measurement of sparking voltage is accomplished in the fol-

lowing manner. The spot of light from the vibrator is focused on a transparent screen. A scale is marked on the screen so that the maximum displacement of the spot may be easily observed. The spot is first brought to the zero of the scale, or its position simply noted. Then, when current is turned on, the spot becomes a band and the extreme excursion of the spot is easily

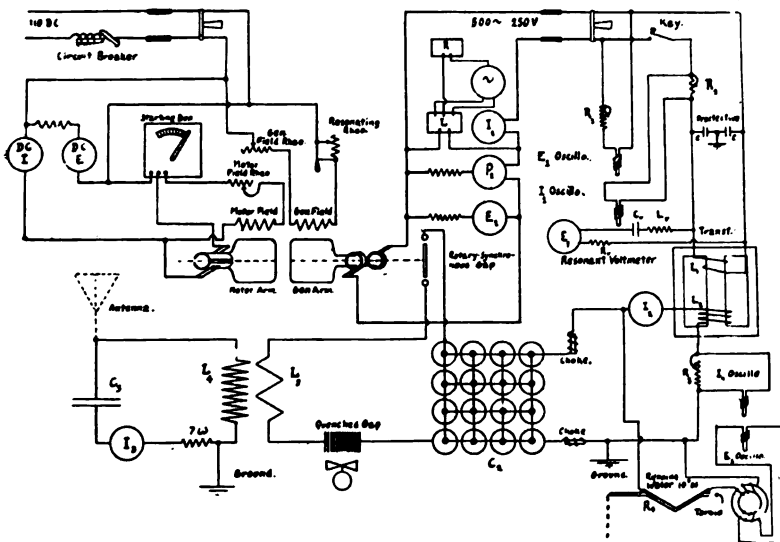

FIGURE 15—Wiring Diagram of 500 Cycle Radio Set

observed. This simple method is available because maximum potential is always sparking potential. There are exceptions to this, but only for "freak" adjustments of the rotary synchronous gap (as in Figure 23). The residual potential in the case of the rotary synchronous gap is found to have the convenient value of zero. This is shown by numerous oscillograms.

Besides the ordinary electrical instruments a "resonant" voltmeter is shunted across the terminals of the generator in order to determine the value of the 500 cycle fundamental.

Calibration: To calibrate the oscillograph, resonate the transformer cutting down the generator field so that there shall be no sparking. Read the secondary current, I_2 , and the deflection of the oscillograph, D , in centimeters. Now:

$$D \propto V.$$

where V is the maximum secondary voltage. Also,

$$V = \sqrt{2} \frac{I_2}{C_r \omega}$$

The oscillograph, therefore, reads $\frac{\sqrt{2} I_2}{C_r \omega D}$ volts per centimeter.

Details of the Method: During a run, keep all the transformer constants fixed. Also keep the frequency constant and similarly the impressed voltage as read on the "resonant" voltmeter. In order to leave the generator armature out of the calculations, keep these last two constant for all conditions of load. Starting at resonant condenser and proceeding above and below resonance by increments or decrements of one Leyden jar, read the primary wattmeter and the maximum condenser voltage as given by the oscillograph. At each point adjust the rotary synchronous gap so as to give the greatest condenser voltage without spoiling the regularity of sparking.

This adjustment consists simply in lengthening the gap until there is a change to a lower spark frequency. Proper adjustment is at the point just preceding break down.

During the test, keep the flow thru the water resistance constant. Re-calibrate the oscillograph at frequent intervals to make sure that the water resistance does not vary.

Transformer Constants.

In order to determine the constants of the transformer alone without the generator, the following procedure is necessary:

(1) Primary inductance— $L_{1,t}$:

(a) Put a paper condenser in the primary circuit, and resonate with open circuited secondary, maintaining normal magnetization of the iron by the use of an exploring coil.

$$L_o + L_{1,t} = \frac{1}{C_r' \omega^2}$$

where $L_{1,t}$ is the inductance of the transformer primary and L_o the inductance of the generator armature.

To get L_o , short-circuit the generator thru an ammeter. Then if E_o is the open circuit voltage—

$$L_o = \frac{E_o}{I \omega} \quad \text{or:}$$

(b) Take open circuit voltage and current readings at normal saturation. Then if E_1 is the value of the fundamental voltage and E_3 the value of the third harmonic,

$$L_{1,t} = \frac{E_1 + E_3/3}{I_{1,o} \omega}$$

The higher harmonics are too small to contribute an appreciable amount of current.

(2) Secondary inductance— L_2 :

Owing to the symmetry of the transformer we can take—

$$L_2 = \frac{n_2^2}{n_1^2} L_1$$

where n_1 and n_2 are the respective number of turns of primary and secondary.

(3) Over-all coupling— a :

Resonate the transformer:

$$a = \frac{1}{L_2 C_r \omega^2}$$

This a is for the whole system, generator included.

(4) Transformer coupling— a_t :

$$a_t = 1 - (1 - a) \frac{L_o + L_{1,t}}{L_{1,t}}$$

(5) Resonant condenser for transformer alone— $C_{r,t}$:

$$C_{r,t} = \frac{1}{a_t L_2 \omega_t^2}$$

where ω_t is the frequency at which the set is to be operated.

(6) Damping— $\frac{2\Delta}{\omega}$:

Adjust the condenser to the value $C_{r,t}$ and the frequency to ω_t . Read E , the fundamental of the impressed voltage, and the primary and secondary currents, $I_{1,r}$ and $I_{2,r}$:

$$\frac{2\Delta}{\omega_t} = E C_{r,t} \omega_t \frac{I_{1,r}}{I_{2,r}^2}$$

From these readings we also get:

$$\frac{1 - a_t}{a_t L_{1,t} \omega_t^2} = \frac{I_{1,r}^2}{I_{2,r}^2} C_{r,t}$$

or:

$$a_t = \frac{1}{\frac{I_{1,r}^2}{I_{2,r}^2} C_{r,t} L_{1,t} \omega_t^2 + 1}$$

This value of a_t should check up with the value of a_t already obtained.

Numerical Values for Constants.

Closed Core Transformer.

$n_1 = 30$ turns; $n_2 = 1600$ turns; $R_1 = 0.0151$ ohms; $R_2 = 34$ ohms.

(1) $L_{1,t}$:

(a) Resonance at $-C_r^1 = 9.2 \mu f$; 473 cycles.

$$L_o + L_{1,t} = 0.0123 \text{ henrys.}$$

Short circuit:

$E_o = 47.5$ volts; $I_o = 29.3$ amp.; 535 cycles.

$$L_o = 0.00048 \text{ henrys.}$$

$$\therefore L_{1,t} = 0.0118 \text{ "}$$

(b) Open circuited secondary—Curve plotted for different magnetizations of iron (Figure 16). At "550," normal magnetization.

$$L_{1,t} = 0.0114 \text{ henrys.}$$

Average of (a) and (b):

$$L_{1,t} = 0.0116 \text{ henrys.}$$

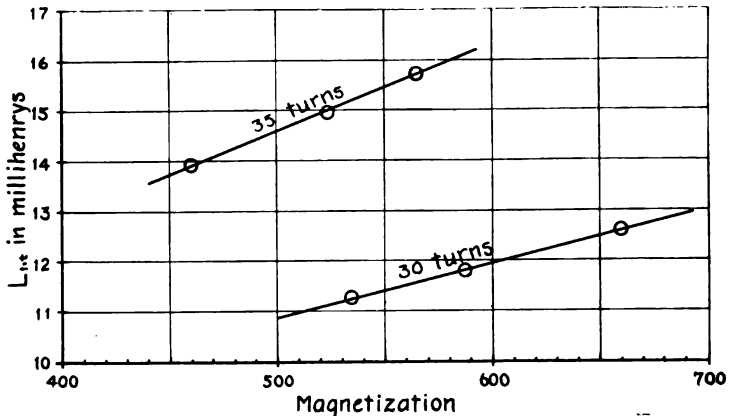

Fig. 16 Inductance of Transformer Primary vs. Magnetization of Iron

(2) L_2 :

$$L_2 = \left(\frac{1600}{30} \right)^2 0.0116$$

$$= 33.0 \text{ henrys.}$$

(3) "Over-all" a :

Resonance at:

$$C_r = 0.018 \mu f; 500 \text{ cycles.}$$

(4) Transformer a_t :

$$a_t = 1 - 0.83 \frac{0.0121}{0.0116} = 0.134$$

(5) Resonant transformer condenser: $C_{r,t}$ at 530 cycles;

$$C_{r,t} = \frac{1}{0.134 \cdot 33 \cdot (2\pi \cdot 530)^2}$$

$$= 0.0204 \mu f.$$

(6) Damping— $\frac{2\Delta}{\omega}$:

$$C_{r,t} = 0.02 \mu f; E = 13 \text{ volts; } 530 \text{ cycles;}$$

$$I_1 = 24.5 \text{ amp.; } I_2 = 0.485 \text{ amp.}$$

$$\frac{2\Delta}{\omega} = 0.090$$

Also:

$$\frac{1-d_t}{a_t L_{1,t} \omega_i^2} = 0.51 \cdot 10^{-4}$$

The check for a_t gives:

$$a_t = 0.132.$$

This agreement is rather better than we have a right to expect.

Theoretical Output of Transformer.

The expression for the output of the transformer in terms of the constants just determined is:

$$W_2 = \frac{2E^2 0.51 \cdot 10^{-4} \theta^2}{(0.09)^2 + (\theta^2 - 1)^2} \left[\frac{\cosh 0.283 - \cos 2\pi\theta}{\varepsilon^{0.283} - \cos 2\pi\theta + \frac{0.646}{\theta} \sin 2\pi\theta} \right]^2$$

This is for one spark per cycle with impressed voltage E . The whole expression involving θ may be found from Figure 3 by means of the accompanying interpolating graph, Figure 17.

Experimental Results.

Calibration of oscillograph.

$$\mathcal{D} = 13/32'' \quad C = 0.02 \mu f, \quad \text{cyclage} = 530 \quad I_2 = 0.730.$$

\therefore Deflection is equivalent to 1190 volts per $1/32''$.

Voltage Readings:

The sparking voltages for different condenser values in the vicinity of resonance are given in Figure 18. The energy output per spark discharge, W_2 , is plotted (Figure 19) against the square root of the ratio of calculated resonant capacity to actual capacity—that is the ratio of the impressed period of the circuit to its free period.

Discussion of Results.

The theoretical and experimental curves plotted in Figure 19 show substantially that the theory is correct. In both cases there is a marked depression for $\theta = 1$; that is, resonance adjustment. It should be noted that this resonance adjustment with the impressed e.m.f. on the transformer held constant, is not the same resonant adjustment as that which includes the generator. Including the generator, increases α and conse-

quently decreases the product $C \omega^2$ for resonance. The two maxima of the experimental curve come at the same value of θ , as do those of the theoretical curve. That these maxima are smaller than the theoretical may be explained by the irregularity of the spark length. The accompanying oscillogram, Figure 20, altho without zero lines, gives an idea of the sort of surge that runs thru both current and voltage. This surge appears to have some regularity. It is not, however, sufficiently

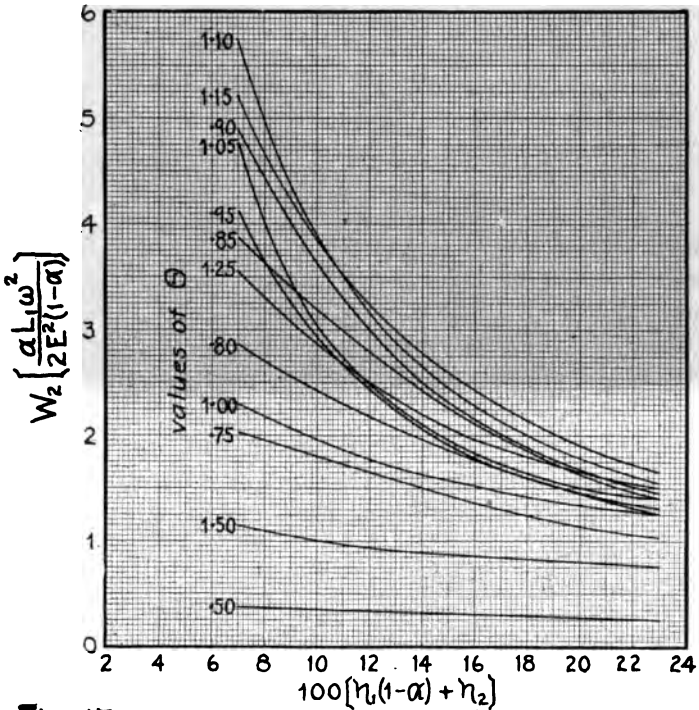

Fig. 17 Curves for Interpolation

regular to be due to some slow electrical period, and its cause has not been traced out. This irregularity of spark length necessitates setting the gap for a lower sparking voltage than that which would correspond to a regular phenomenon. If this is not done the gap begins to spark intermittently. The result is that the average sparking voltage (which is the quantity observed) is lower than what it would be for uniform sparking. At the resonant position, the variation of the spark length is

C in μf	E in volts	P in K.W.	D in inches	V in volts
.014	146	3.8	24/32	28,600
.016	146	4.3	24½/32	29,200
.018	146	4.5	22/32	26,200
.020	146	4.0	18/32	21,400
.022	146	4.1	19/32	22,600
.024	146	4.0	19/32	22,600
.026	146	4.0	17/32	20,200
.032	146	3.8	14/32	16,700

FIGURE 18—Sparking Voltages for Different Capacities

very much smaller; so that a longer adjustment of the gap is possible; and a correspondingly greater output in proportion is reached.

For two sparks per cycle, it was not possible to get a complete output curve. At resonant adjustment the phenomena

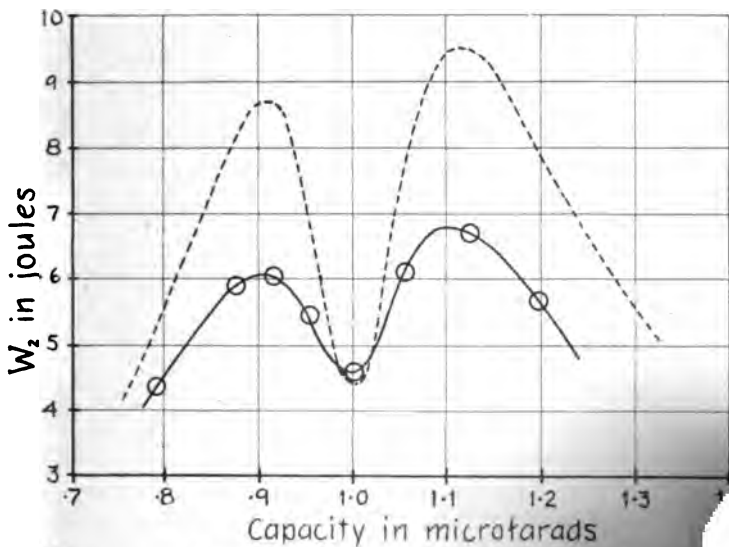

Fig. 19

Energy Output per Spark Discharge

----- Computed

— O — Observed

went over from two to one spark per cycle. The rotary synchronous gap could not be shortened sufficiently to obtain two sparks per cycle. The reason for this may be seen from the theoretical curve for two sparks per cycle, Figure 4. The output at resonance is very small so that the necessary gap length must be small. If the gap is too long the discharge will stop completely, or under proper conditions go over into one of fewer sparks per cycle.

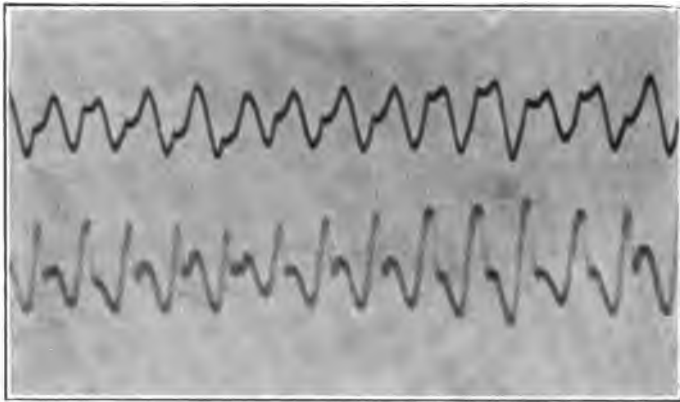

Time →
FIGURE 20—Condenser Voltage (bottom) and Secondary Current (top) Showing Surging of Spark Length. One Spark per Cycle

There is also a practical disadvantage in operating at two sparks per cycle. The maxima come further from the resonant point than in the case of one spark per cycle. The result is that it is difficult to get the sparking condition started. On closing the switch the voltage will not build up so high as for a position closer to resonance, and sparking may not start. If the gap is shortened to a length which will allow sparking to start, the phenomenon is very apt to pass over from two sparks a cycle to four or more sparks per cycle. Once started, however, the condition of two sparks per cycle will persist with a gap length longer than that required for starting.

Transformer Design.

The question of transformer design is usually one of designing a transformer for a given condenser, power, frequency, and efficiency. The problem is solved by starting at the condenser end. Let us say, for instance, that we wish a spark once a

cycle, the frequency being 500 cycles per second. Let us, moreover, choose to operate with a condenser smaller than the resonant condenser, since this is a point of better efficiency than for a capacity larger than resonant.

Taking $\theta = 1.1$, we must make $\alpha L_2 = \frac{1}{1.21 C \omega^2}$. The output is about the same for α between 0.05 and 0.2. The power factor increases as α decreases so it is well to take α small. Of course, this means a large L_2 and greater expense for winding, but it has the advantage of making $\frac{2\Delta}{\omega}$ large with the result that the tuning of the transformer is not so sharp. α , however, should be large enough to make the transformer self-controlling; that is, the current with short-circuited secondary should be within bounds. The value of the short-circuit primary current is: $I_{1,s} = -\frac{E}{\alpha L_1 \omega}$. Having chosen α , we get immediately the value of the secondary inductance, L_2 . The actual realization of a given α for any particular type of iron transformer can only be obtained by a careful calculation of leakage fluxes.

There remains the calculation of the primary inductance, L_1 . This is inversely proportional to the power output. From the curves L_1 may be calculated provided we know $\gamma_1 (1 - \alpha) + \gamma_2$. Now at resonance:

$$E/I_1 = R_1 (1 - \alpha) + R_2 \frac{L_1}{L_2}$$

The right-hand member is the apparent resistance of the whole circuit. If P is the power we may write approximately:

$$P (1 - \text{Effic.}) = I_1^2 \left[R_1 (1 - \alpha) + R_2 \frac{L_1}{L_2} \right]$$

where I_1 is the full load current. This will give

$$R_1 (1 - \alpha) + R_2 \frac{L_1}{L_2}$$

So we have:

$$\gamma_1 (1 - \alpha) + \gamma_2 = \left[R_1 (1 - \alpha) + R_2 \frac{L_1}{L_2} \right] \frac{1}{\alpha L_1 \omega}$$

L_1 may now be found by use of the curves by a simple trial and error method. The result, however, will not be very trustworthy. The actual working output cannot be expected to come up to the theoretical output, and so the calculated value of L_1 will probably be too large. The character of the gap, in

so far as it affects the phase of sparking, has considerable bearing on the output; so that L_1 can never be a quantity determined with the same accuracy as L_2 . It is easy, however, to wind the primary with taps so that the output may be adjustable.

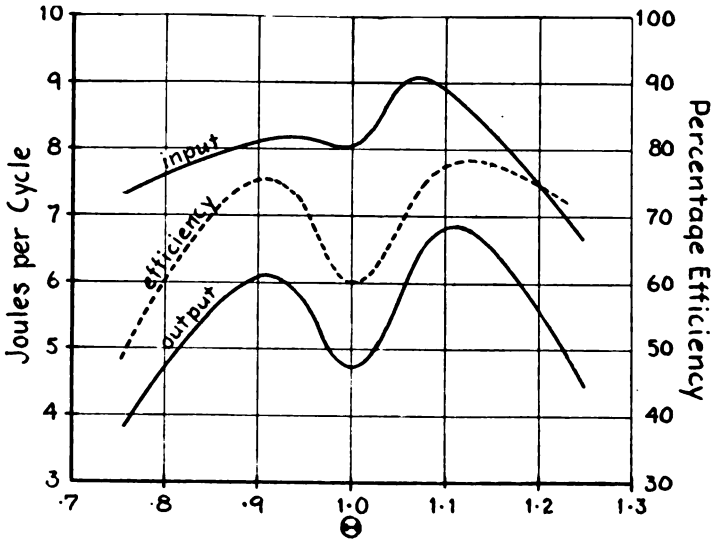

Fig. 21 Experimental Curves of Input, Output, % Efficiency

▣ The desired efficiency is attained by the ordinary calculations for the quantity of copper and iron necessary.

At this point it is well to mention that a proper gap is essential to the operation of any transformer. Too much stress cannot be laid on this. With the condenser fixed the output depends on the length of the gap only. In what has gone before it was, of course, assumed that the gap was such as to get the best possible results out of the rest of the system.

Figure 23 shows the effect of a very poor adjustment of the synchronous gap used in the preceding experiment. Sparking occurs at a low voltage but a large current is flowing in the secondary which causes a useless rise of voltage and waste of power.

Air Transformers.

In all our equations, the primary and secondary inductances enter always as the products $L_1\omega$ and $L_2\omega$. At 500 cycles

($\omega = 3,000$) the inductances required are small compared to those used at commercial frequencies. The omission of iron in the transformer circuit immediately suggests itself, and is, in

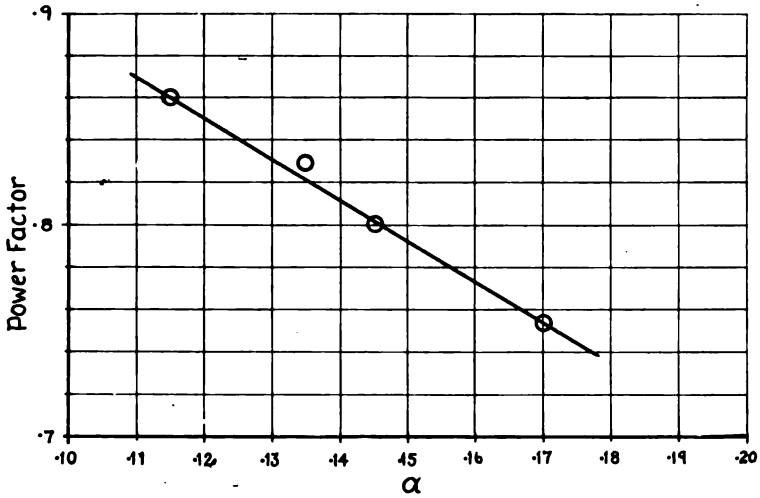
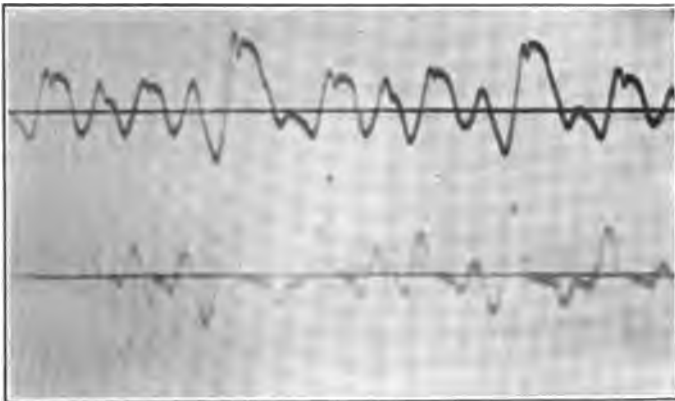

Fig.22 Experimental Curve of Power Factor vs. α

fact, entirely practical. For the last four months, a small 2 K. W. air transformer has been in constant operation at the Cruft Laboratory with entirely satisfactory results.



Time →
 FIGURE 23—Condenser Voltage (bottom) and Secondary Current (top) for Short Adjustment of Rotary. Gap Showing Early Spark and Occasional Arcing. One Spark per Cycle

The problem in the design of air transformers is: given the efficiency, to get the proper inductance in primary and secondary and at the same time reasonably close coupling. Loose coupling decreases the power factor and is therefore undesirable.

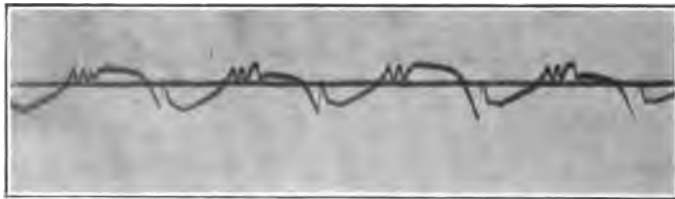

Time→

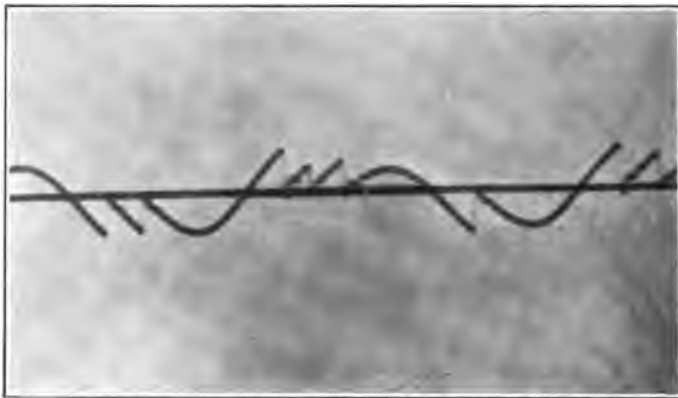

Time→

FIGURE 24—Types of Irregular Sparking. Condenser Voltage
Taken with an Electrostatic Oscillograph. 60 Cycles

How to get enough inductance is the principal question. The Maxwellian form for coils immediately suggests itself as being economical of copper. Two coils of this shape placed side by side make a good transformer, efficient and easy to build, but with rather loose coupling, and consequently not too good a power factor. Moreover, if α is large, the output tends to be low, and L_1 must be made small to counteract this effect. If L_1 is small the inductance of the generator armature has a greater loosening effect on the coupling than if L_1 is large. α is therefore further increased by a small L_1 and we go from bad to worse. It is, in fact, so important not to get the coupling

too loose that much effort should be expended in this direction.

Sandwiching a set of coils always increases the coupling. With extensive sandwiching we may get the effect of the primary and secondary practically occupying the same space and consequently almost unity coupling. This cannot be pushed too far in practice as it involves too much insulation and a poor space factor. A poor space factor necessitates larger overall dimensions and a consequent increase in copper. A desirable form for an air transformer for 500 cycles is one with a secondary winding between two primary windings in series, the overall dimensions of both coils set up and including the insulation between coils being Maxwellian. That is, the cross sections of the two windings side by side should be a square of which the length of the side should be about four times the mean diameter of the coils.

Air transformers are increasingly easy to build as the frequency is raised. At 1,000 cycles the secondary inductance need be only one quarter as great, for the same condenser, as at 500 cycles. This indicates that it is desirable to replace the 500 cycle set sparking twice a cycle by a 1,000 cycle set sparking once a cycle. A cheap and efficient air transformer having a good power factor may then be built. There is, moreover, the added advantage already stated that we may operate closer to resonance for one spark per cycle with a resulting improvement in the regularity of the spark frequency. The arguments used for changing from 1,000 cycles may equally well be applied to the proposition of increasing the frequency above 1,000 cycles and sparking still fewer times per cycle so as to keep the spark frequency at about 1,000 sparks per second. Progress in this direction depends on the question of generator design.

The essential difference between iron and air transformers is that the efficiency of the former is handicapped by a fixed iron loss, whereas the efficiency of the latter may be made as close to one as we please. Of course the iron loss of a transformer may be reduced by decreasing the quantity of iron, but pushing this to extremes means passing over into the domain of the air core.

CRUFT LABORATORY,

May 29, 1915.

SUMMARY: Starting with the general solution of the differential equation of the circuit and a steady sparking state, expressions for input, output, currents, and condenser charge are calculated by means of the boundary conditions of the interval. The boundary conditions are continuity of currents at sparking and a residual condenser charge experimentally determined. Calculated current and voltage waves for a special case are compared with an oscillogram taken for the same transformer constants. A number of curves illustrating the quantities studied (and also curves facilitating their computation) are given; and, on comparison, are found to agree closely with oscillograms taken during actual operation.

On the basis of the derived theory, a complete set of transformer measurements are explained, and numerical illustrations given. The effect of harmonic components in the e.m.f., and the avoidance of their effects are explained, together with the effect of the wave form of the e.m.f.

In connection with the experimental verification of the theory, there are described the necessary measuring apparatus, including the oscillographs.

The design of the transformer to meet any desired requirements is then treated in detail from the theoretical and practical standpoints. The use of air core power transformers at frequencies of 500 cycles and over is considered and found to be feasible. An interleaved set of coils of "Maxwellian" cross section is recommended for the "sandwiched" primary and secondary. An actual satisfactory transformer of this type for 2 K. W. is described.

DISCUSSION

J. H. Morecroft (communicated): Mr. Cutting's paper on the radio transformer deals with a very complex phenomenon, as one might well believe by glancing at some of the equations given therein.

Every time the switch of an alternating current circuit is closed, there may exist for several cycles after the closing, currents and voltages much higher (or lower) than the values which exist during the so-called steady state, which values are given by the ordinary formulas—connecting voltage, current and impedance. These irregular values are due to the so-called transient current, a current which may be oscillatory or exponential and which enables the circuit to "settle down" to its normal operating condition.

The time during which the transient term lasts depends upon the damping of the circuit, of course; in radio circuits it may perhaps be 10 or 20 cycles but when a radio set is sparking once per cycle, a transient turn is introduced at each and every cycle. Every time a spark occurs a new transient turn is added to those already in the circuit; thus at a given instant the actual current in the secondary circuit is made up of a great many currents, mathematically speaking; one of these is the steady state term, another is the first cycle of the transient term introduced at the last spark, another the second cycle of the transient term introduced by the previous spark, etc. If the damping of the circuit is such that the twentieth cycle of a transient is the last to be of any appreciable value, the above summation of terms must be carried out to the twentieth cycle of the transient introduced by the spark occurring twenty sparks before the one considered. (Natural frequency = impressed frequency, assumed.)

The brief analysis given above holds also for the form of the voltage wave across the condenser in the secondary circuit; thus every time a spark occurs, the condenser voltage is reduced nearly to zero; between the times of successive sparks the voltage wave will not be a sine wave but a complex form as indicated for the current.

In my classroom I have called this phenomenon the "steady state of transients" because, altho the form of wave may be very complex, it recurs periodically. I have never been able to solve the problem completely and so feel that we owe Mr. Cutting our thanks for the arduous work which is apparent in his deriva-

tions. It is inconvenient that the phenomenon does not lend itself to more simple treatment than the author has found possible; thus the average radio engineer will not care to calculate the input to his transformer from an expression as formidable as that given in equation 34 or some of its predecessors. However, such equations may be entirely the fault of the phenomenon and not that of the author.

I found some difficulty in following some of the author's derivations; thus in the part headed "Details of Method" occurs the expression

$$L_{1,t} = \frac{E_1 + E_3}{I_{1,c} \omega} / 3$$

This equation, I take it, presupposes a knowledge of the equation of the voltage wave but what is the meaning of I_1 ? If it is the reading of an ordinary ammeter in the circuit, the expression seems to me to be incorrect.

The question of armature reaction on the voltage generated in an alternator also seems to receive no attention by the author; thus the value of L_o obtained by the method given may be much too large; using an ordinary alternator, the inductance so obtained may be twice the actual value of inductance. In the case of a radio alternator having relatively high armature reactions, the error might be much greater.

In the experimental results given to confirm the theory, the terminal voltage of the alternator was held constant, so that in so far as the steady relation between I and E are concerned, the armature inductance is neglected. The transient terms, however, cannot be made independent of the armature inductance as this helps to determine their period, amplitude, etc. It seems to me that in this particular the experimental results do not apply to the theory.

The actual experimental data given in tabular form is very disappointing. Even when the phenomenon being investigated is very steady, the measurement (as carried out by the author) of the width of an oscillograph beam to 1/32 inch (0.8 mm.) is somewhat questionable. When the irregularity of the sparking of the ordinary gap is considered, it seems to me doubtful whether the recording of a measurement of the beam to 1/32 inch means very much; the conditions of sparking must have been very irregular, otherwise the power input could surely have been measured more accurately.

Assuming, however, that the sparking voltages are measured to $\pm 1/64$ inch (0.04 cm.) (this means that the position of the outer

extremity of a beam could be located to about 1/100 inch (0.025 cm.)), I calculated the value of W_2 from the author's data; thus the reading given as 14/32 inch was considered as something between 14.5/32 inch and 13.5/32 inch. The author's Figure 19, then takes the form of my Figure 1. The curve for W_2 may be

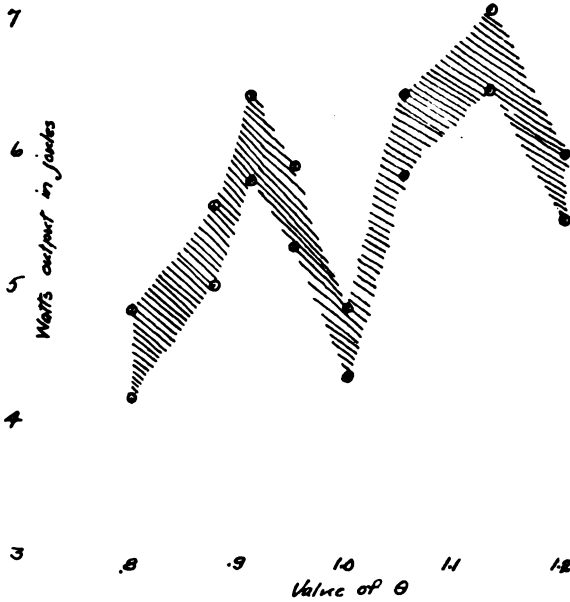
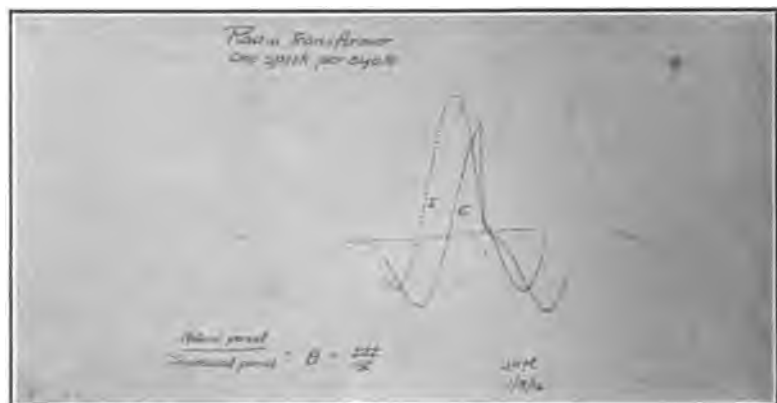
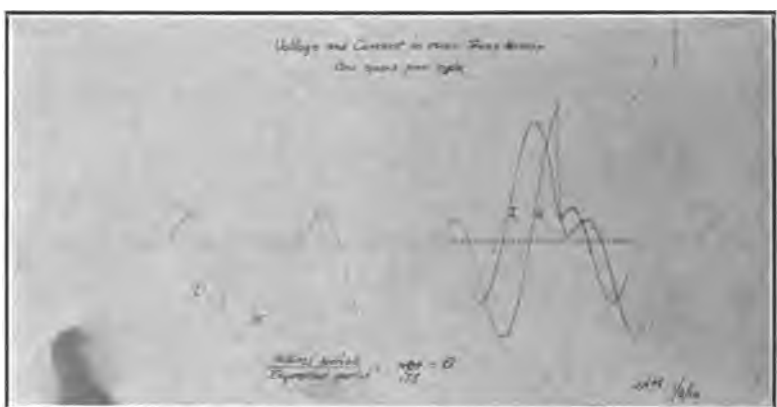
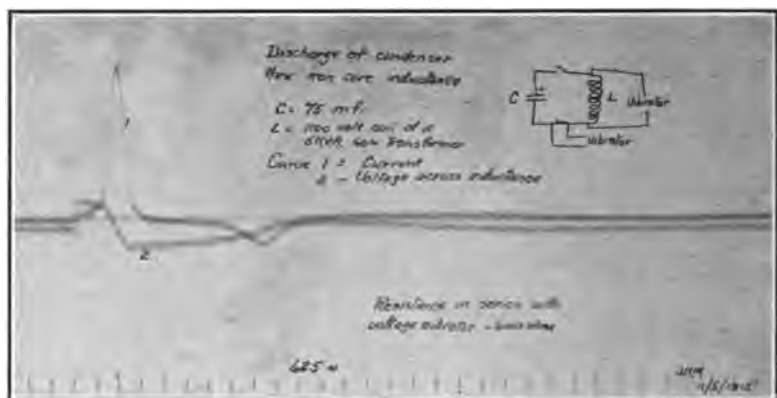

FIGURE 1

drawn anywhere thru the shaded area with equal justification. It will be noticed that the form of the curve for θ less than 1, is different from the author's. This is because the value of W_2 was incorrectly calculated by Mr. Cutting. For $\theta=0.87$, he should have had 5.3 joules, but in the figure 5.9 joules is plotted.

The curve for efficiency in Figure 21 is still more doubtful because it depends not only upon Figure 19, but also on the idea that the sparks took place uniformly, one per cycle, and that the voltage of each spark was the same.

Under the heading of "Transformer Design," the author recommends the use of a condenser smaller than that required to give resonance. It is well known, however, that a radio set must have a condenser larger than that required for resonance to give uniform sparking.



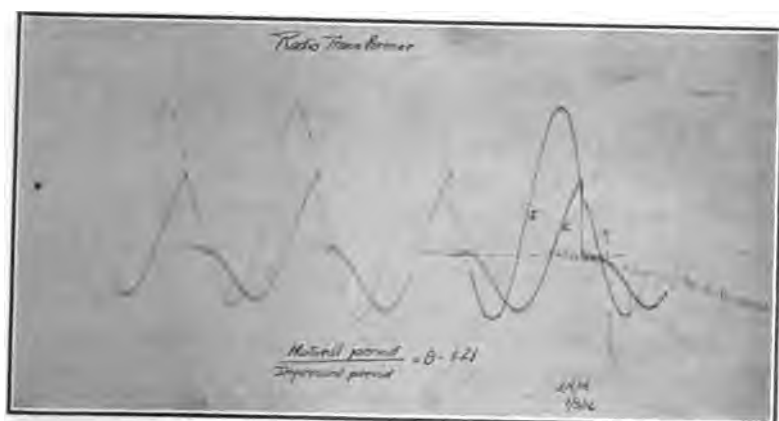
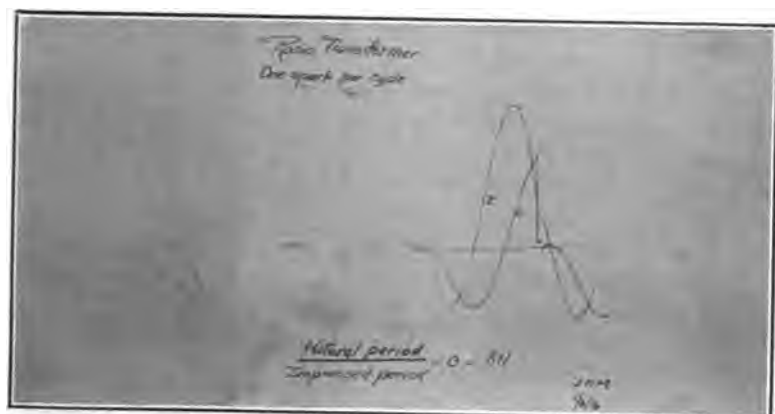
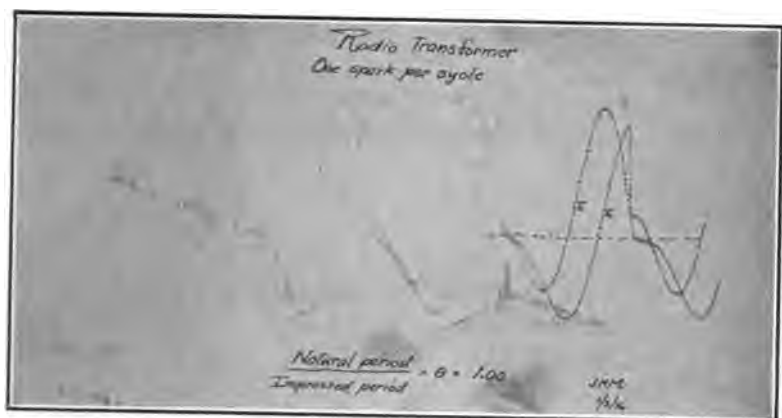

Why did the author use a quenched spark in series with a rotating spark gap?

I thought it possible to obtain a set of readings perhaps more accurate than those of Mr. Cutting and more in accordance with the premises of his theory; thus in his experiment he assumed there was one spark per cycle; I made certain that such was the case. He had deflections of the order of $1/2$ inch (1.2 cm.), whereas I got deflections of 2 inches (5 cm.), and moreover was able to measure this larger quantity with less error than he did in his smaller measurements. It must be remembered in this connection that the efficiency, etc., at which the theory arrives, depend upon the squared value of this measurement.

I performed a series of tests on a 150-cycle alternator. The armature was equipped with a rotating switch (a fiber disk with steel inserts arranged 360 degrees (electrical) apart), and this switch was connected across the condensers; thus forming a short circuit on the condensers, once per cycle. The resistance of this discharge path was so chosen that the condenser could practically discharge during the time of short circuit. This time was about 15 degrees (electrical). The insulated brush bearing on the fiber disk was movable over 360 degrees of arc, so that the condensers could be short circuited on any portion of the cycle desired.

An oscillograph vibrator in series with 1,200 ohms resistance was connected across the condensers and the image from this vibrator was thrown upon the upper transparent screen of the oscillograph. The oscillograph motor (which actuates the oscillating mirror) was driven from another source of power so as not to disturb anything in the test circuit. For each value of capacity in the secondary circuit the position of the short circuiting brush was varied until the short circuit occurred at the maximum voltage it was possible to obtain.

A second vibrator of the oscillograph was connected to a variable source of continuous voltage and adjusted to the same deflection per volt as was the first. Then as the short circuit brush was moved this "measuring vibrator" was made to follow the peak of the voltage wave; thus making it possible to ascertain when the peak was highest and at the same time give the "spark voltage" by the indication of a voltmeter connected to the terminals of the vibrator.

The oscillograph motor was run at $1/2$ synchronous speed so that two complete cycles were thus seen on the transparent screen and the uniformity and regularity of the wave noted.

As the whole adjustment was carried out in the dark, narrow beams of light could be used making it possible to read the spark voltage to ± 1 volt.

The alternator used had a smooth core armature with an inductance less than 1 per cent. of that of the outside circuit; the armature reaction was negligibly small so that the voltage acting in the circuit was practically the same for all adjustments of secondary condenser. The transformer used had an air core so that the variable effect of the iron core on the resistance and inductance of the circuit might be eliminated.

The form of the oscillatory current in a circuit having a closed iron core (as I judge had the transformer used by Mr. Cutting) is not of such a shape as can be written in the simple form used by the theory in question. To illustrate this phase

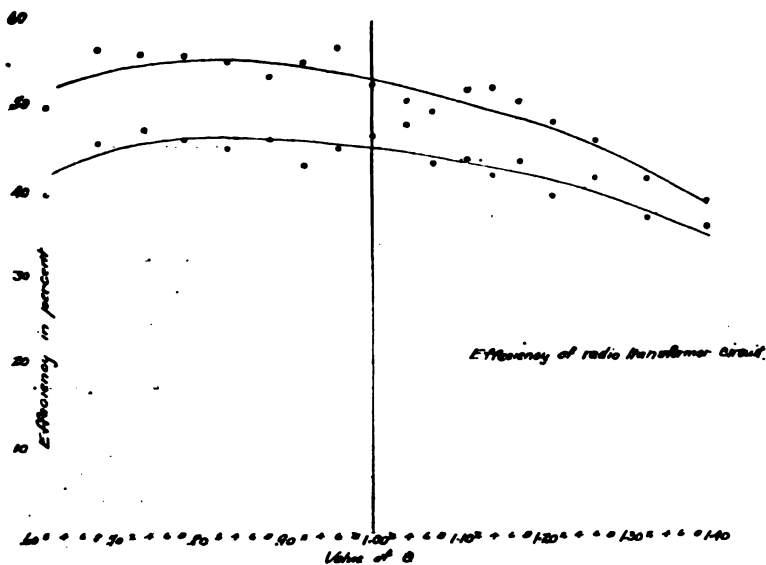

FIGURE 2

of the problem I give an oscillogram showing the form of oscillatory current and condenser voltage in such a circuit. While I cannot say to what extent this effect existed in Mr. Cutting's circuit, I am almost sure that the free oscillations were by no means of the simple form he has assumed.

The values of constants used in my test were as follows:

Inductance of alternator armature.....	0.000276 henrys
Inductance of transformer primary.....	0.0295 henrys
Resistance of transformer primary.....	1.87 ohms
Inductance of transformer secondary.....	0.0400 henrys
Resistance of transformer secondary.....	2.27 ohms
Mutual inductance of transformer.....	0.0253 henrys
Coupling.....	73.5 per cent.

Secondary capacity varied from 20 microfarads to 115 microfarads.

Several runs were made and efficiency curves were determined. They were all of the same form. Two of them are given in my Figure 2. It seems as tho the points obtained must be more accurate than those given by Mr. Cutting and yet I could find no depression in the curve at the resonance point in any of the curves I obtained. I am giving five oscillograms of the current and voltage curves in the circuit I tested; they serve to show the type of curves on which my measurements were made.

It seems to me, therefore, that more experimental confirmation of the formulas given is called for before we can regard the theory proved.

Fulton Cutting: I am much gratified to see the interest that Professor Morecroft has shown in my solution of the problem which he has properly called "The Steady State of Transients."

The expressions involved have, to be sure, a somewhat forbidding appearance; but to me appear relatively simple on account of the struggle I had to reduce them to their present form.

Equations (28) and (29) for instance, were, before approximations were introduced, composed of expressions like those appearing on page 164, and I consider it very fortunate that it was possible to boil down these expressions to the form obtained.

Professor Morecroft gives the results of some experiments which he claims are not in accordance with mine, and which do not fit the theory. He uses a method which should give consistent results, and I am surprised that his observations are not more uniform. If he can measure potentials to one volt, his points, I should think, would lie more closely on a smooth curve. The efficiency curve he obtains has no depression at the point $\theta = 1$, whereas, the curve I obtained has a marked depression at this point. Now this has no bearing on the theory,

as I did not derive theoretically an expression for efficiency. The reason for that is that the expression obtained by dividing output by input becomes practically indeterminate for the point $\theta=1$. In order to get something reliable at $\theta=1$, the principal point of interest, it might be necessary to keep all the terms which were negligible in the expressions of output and input. This, I am sorry to say, I did not have the patience to do, much less plot the results, if I had done it. In any event, it is very improbable that the theoretical curve of efficiency corresponding to Professor Morecroft's experimental case should have any marked depression at $\theta=1$. The constants used give $n_1(1-\alpha)+n_2=0.21$. This is a very dull circuit. Its output curve is almost coincident with the bottom curve of Figure 3, and so we can only expect that the efficiency curve is also dull, and should show little, if any, depression at $\theta=1$. It is a pity Professor Morecroft did not plot on output instead of efficiency, for in that case his results might be compared directly with the curves of Figure 3.

Professor Morecroft seems to think, that I had no method of determining whether or not sparks were occurring once a cycle, but that I simply "assumed" that they were. In the first place, the ear detects "missing" in a rotary gap, almost as easily as in an automobile motor. Secondly, if the rotating mirror of the oscillograph is driven non-synchronously, as was the case, any irregularity of sparking is at once seen, as the eye registers the instantaneous tracing of the light spot.

It seems as if Professor Morecroft were unduly exercised over the presence of iron in my transformer. He shows an oscillogram labeled "Discharge of condenser thru iron core inductance." The circuit here is almost aperiodic, so that I cannot see that it has much bearing on the problem. The simplicity of the free oscillation of the transformer circuit is well shown by the close agreement between the oscillogram of Figure 8, and the corresponding calculated curves of Figure 7. Close to resonance I have been unable to detect, oscillographically or otherwise, the difference between air and iron transformers.

It would seem as if free periods and resistance terms should vary cyclically when iron is present. Perhaps they do, but with the transformer I used (which has a low flux density), I never found any evidence of much irregularities. Measurements of damping factors and inductances are, of course, much more easily measured for air transformers than for iron. They are advantageous for experiments on that account, but I did not find that there is any other difference between them.