

IEEE  
spectrum**features****19 Spectral lines: The metric system**

F. K. Willenbrock

*Within the next decade the United States will be predominantly metric, judging by recommendations based on a recent study authorized by Congress in the interests of facilitating worldwide dissemination of technical information*

**20 Systems approach toward nationwide air-pollution control****I. The problem, the system, the objective**

Robert J. Bibbero

*From a national viewpoint, the present embryonic air-pollution control system is sub-optimal because it is fragmented, insufficiently coordinated, and fails to achieve economies of scale; in short, we have only just begun to reap cost-benefit advantages*

**32 Power supply aspects of semiconductor equipment**

Harold A. Gauper, Jr., John D. Harnden, Jr., A. M. McQuarrie

*New data on unbalanced firing angles and RFI-free switching devices, along with methods of power control and resulting harmonics, ought to go a long way toward filling the void in the literature of semiconductor influences upon power sources and related equipment*

**44 Where would you like to have your heart attack?**

*The most dramatic application of telemetry to health care is the transmission of the ECG from a patient in a moving emergency vehicle to a monitoring dispatching point*

**55 The technological dilemma of the United States**

J. H. Hollomon, A. E. Harger

*Although an individual firm cannot appropriate all of the benefits of any new development, it must bear most of the cost of that development. Only society as a whole can afford the risks resulting from technical uncertainty*

**63 The Long Island Sound submarine cable interconnection**

P. Gazzana-Priaroggia, J. H. Piscioneri, S. W. Margolin

*Modern high-capacity mass-impregnating facilities, plus the development of extra-fluid alkylates, have made possible the world's longest oil-filled submarine cable crossing*



Copyright © 1971 by

THE INSTITUTE OF ELECTRICAL AND ELECTRONICS ENGINEERS, INC.

# Make Waves...



**just about any waveform  
you can imagine**

HP's 3310A is the function generator that gives you seven different waveforms—in three different modes—in one inexpensive package.

In its basic form, the 3310A gives you a continuous output of square waves, sine waves, and triangle waves — plus positive and negative ramps and pulses—for only \$595.

And for only \$140 more, you can get the 3310B, which lets you generate each of these seven waveforms in two other modes — single-cycle and multiple cycle "bursts." These can be triggered either manually or

by an external oscillator; starting-point phase can be varied by  $\pm 90^\circ$ .

In either the "A" or "B" version, the 3310 gives you a choice of ten frequency ranges—from 0.0005 Hz to 5 MHz—and an output voltage range from 15 mV pk-pk to 15 V pk-pk into 50 $\Omega$  load. Dc offset of  $\pm 5$  V into 50 $\Omega$  load is also standard.

Both the 3310A and 3310B can be used in frequency-response and transient-response testing, as a waveform converter, for generating phase-coherent waveforms, and as a frequency multiplier or divider,

among other things. Applications include testing television and communications systems, radar systems, and analog or digital circuits.

For further information on the 3310A and 3310B, contact your local HP field engineer, or write to Hewlett-Packard, Palo Alto, California 94304. In Europe: 1217 Meyrin-Geneva, Switzerland.

090/41A

**HEWLETT *hp* PACKARD**

SIGNAL SOURCES

Circle No. 1 on Reader Service Card



# Spectral lines

**The metric system.** With Great Britain already embarked on a program of metrication and Canada intending to do the same, the United States was about to be the only large technically advanced country still using non-metric units in most of its business and many of its engineering transactions—until the U.S. Congress took cognizance of this in 1968 by passing an act requiring a study and a report to be made. This study has now been completed and a report entitled “A Metric America: A Decision Whose Time Has Come”<sup>\*</sup> has been released by the Secretary of Commerce. It was written by a National Bureau of Standards team headed by Daniel V. DeSimone.

The report recommends:

- that the U.S. change to the International Metric System (SI) deliberately and carefully;
- that this be done through a coordinated national program;
- that Congress assign the responsibility for guiding the change, and anticipating the kinds of special problems described in the report, to a central coordinating body responsive to all sectors of our society;
- that within this guiding framework detailed plans and timetables be worked out by the sectors themselves;
- that early priority be given to educating every U.S. schoolchild and the public at large to think in metric terms;
- that immediate steps be taken by Congress to foster U.S. participation in international standards activities;
- that in order to encourage efficiency and minimize the overall costs to society, the general rule should be that any changeover costs shall “lie where they fall”;
- that the Congress, after deciding on a plan for the nation, establish a target date ten years ahead, by which time the U.S. will have become predominantly, though

<sup>\*</sup> Available from the Superintendent of Documents, Government Printing Office, Washington, D.C., 20402, for \$2.25. Order by title and SD Catalog No. C13.10:345.

not exclusively, metric; and

—that there be a firm government commitment to this goal.

The study was based on a number of extensive surveys made of industries, individuals, professional societies and trade associations, etc. The IEEE participated in the study, and was a participant in the first Metric Study Conference in 1970. The Institute was represented by Dr. W. T. Wintringham, past chairman of the IEEE Standards Committee.

Such views were also presented at other conferences and were expressed by the respondents to the various surveys conducted by the U.S. Metric Study. A clear-cut majority of these respondents in *all sectors* of the society felt that conversion to the metric system is inevitable and/or desirable, and that it should follow a coordinated national program. It was evidence such as this that led in large part to the recommendations outlined in the report.

In 1965 the IEEE Standards Committee approved a recommendation that a changeover to SI units be initiated and that all IEEE journal editors and authors be urged to adopt SI units to the greatest extent possible. As a result, the IEEE recommended practice for using SI units has been fully adopted by IEEE SPECTRUM and is followed by a large majority of authors in all other IEEE journals.

It is certainly in the best interests of facilitating the worldwide dissemination of technical information in the electrical/electronics field for common units to be used throughout the world. Therefore, IEEE members will surely endorse the effort of the U.S. to convert to metric units as fast as practical. The various organizational groups of the IEEE may well find that there are steps that can be taken to facilitate the conversion for their constituents.

*F. K. Willenbrock*  
Senior Past President

# Systems approach toward nationwide air-pollution control

## I. The problem, the system, the objective

*Despite Congressional approval of the Clean Air Act in 1963, air-pollution control is still in its embryonic stages. The solution may lie in a nationally applied systems analysis*

**Robert J. Bibbero** Honeywell Inc.

*There is currently an acute awareness of the serious nature and spread of air pollution over many parts of the United States and other industrialized countries. Not only is air pollution costly, it is a hazard to health and life. The most recent federal estimate<sup>1</sup> set the direct annual cost of air-pollution damage (in 1968) to materials, homes, vegetation, and health in the U.S. at \$16.1 billion—and this is not the full accounting. Far more costly in human terms have been the episodes of intense air pollution that have taken a tragic toll of lives several times during this century: more than 1000 deaths in 1909 at Glasgow, Scotland; a large toll during 1936 in the Meuse Valley, northern Europe; 20 deaths and an estimated 6000 ill in 1948 at Donora, Pa.; and the infamous London “episode” of 1952 in which 4000 persons died within a few days. It may be conjectured that mere happenstance alone has preserved cities such as New York or Los Angeles from disasters of this magnitude. In view of the seriousness of the present pollution problem, IEEE Spectrum is presenting a three-part article—of which this is the first part—intended to explore a systems approach to large-scale air pollution. Part I covers the overall concept of a nationwide system, Part II will explore the necessary technical requirements, and Part III will outline mathematical models and describe control techniques.*

---

The national cost of air-pollution damage and the price of abatement have not been fully reckoned and, since the rare episodes involving death cannot be forecast or their probability calculated, there is no common agreement on the best strategy of control. Ignorance, an emotionally charged public, and pressures placed on power utilities<sup>2</sup> and industry demanding performance and profits have engendered widely divergent philosophies.

One group, fearing known and unknown dangers, rejects any partial measures, advocates the strictest possible limitations of air-polluting emissions at their source, and calls for a NASA-type crash program to develop even more effective controls.<sup>3</sup> At the other extreme, many U.S. industries have opposed any government regulation of air pollution and, to quote a Standard Oil chairman, “have repeatedly put off action because all the facts were not in.”<sup>4</sup> To compensate for this laissez-faire approach requires air-monitoring “alerts,” which reduce emissions only when threatened by the actual onset of an episode.

Cost-effective measures, variable with conditions, have been rejected by both extremes, and not only because costs and benefits are (and in some respects may always be) unquantifiable. Some argue for fixed, stringent abatement on medically conservative grounds. Sociological objections to variable emission standards that do not fall equally on all polluters have been voiced.<sup>5</sup> Authorities claim that cost-benefit evaluations are too complex to enforce and too sophisticated for our legal system.<sup>6</sup> One group has analyzed optimum abatement strategies for the city of Chicago and adjudged industry activity curtailment to be economically unfeasible.<sup>7</sup> Yet, it has been shown that optimum, controlled abatement schedules can provide desirable air quality in some cities at one sixth the cost of fixed abatement.<sup>8</sup>

Clearly, on reasoned consideration, a compromise—a mixed strategy—is needed. For reasons of health, esthetics, and economics the day-to-day levels of ambient pollution must be lowered, and these benefits can be achieved only by source abatement. But the costs of emission control can be enormous in some industries. Over \$10 million spent for air cleaning in a single generating plant has not been unknown,<sup>2</sup> and the growth of population and energy use will compound these costs many times. Sheer economic necessity and the specter of power brownouts or automobile curbs will force a

cost-benefit optimization of emission levels at some point short of absolute safety. Our most valuable resource for achieving optimum control is the wind and the weather, the chief scavengers of air pollution.<sup>9</sup> To make best use of the atmosphere we must keep close tabs on the current levels of air pollution and the meteorological dilution capabilities in and around our cities. To prevent episodes of high concentration we must not be content with alerts when they become imminent, but must be capable of forecasting pollution levels well in advance—a capability beyond current practice, perhaps even current theory. We have much to accomplish before reaching a satisfactory compromise with our overburdened air environment. In the long term, this will be achieved only by a mixed strategy compounded of optimal abatement, adequate ambient monitoring, and preventive episode control based on accurate forecasting.

The chief sources of air pollution are those generating waste products from combustion processes. The burning of coal and oil in power plants, domiciles, and industrial furnaces results in sulfur and nitrogen oxides and the fine particles or particulates that are the ingredients of a typical London smog. The gasoline engine emits copious quantities of carbon monoxide, as well as unburned hydrocarbons and nitrogen oxides—all converted by sunlight into the “Los Angeles” type of smog. Atmospheric processes and meteorological factors, including precipitation, wind, and air turbulence, are the agents that dilute, mix, and disperse air contaminants away from urban areas. In many areas, and for much of the time, these factors follow *normal* patterns of air movement, suggesting the establishment of regional “air sheds” or zones in which the buildup of dangerous concentrations can be prevented by control of contaminant emission at the source. Localities in deep valleys, or those where atmospheric layering (inversions) promote stagnation of the atmosphere, can limit the number, strength, or geographic arrangement of pollution sources. The establishment of “air quality control regions” (AQCR) by the prior federal law and the policy of state, local, and regional regulation of emissions, earlier followed the air-shed philosophy, which has indeed been useful in reducing chronic air pollution in many of these places.

The catch to this approach lies in the word “normal.” It is unfortunately true that most severe episodes of air pollution are associated with meteorological conditions that are unusual for the region. Most of these cases have occurred during prolonged large-scale atmospheric stagnation, characterized either by calm or by light variable winds, great stability, and sometimes fog. These conditions are not in themselves rare but their persistence over several days is uncommon. For several decades prior to the December 1952 London episode, only one such fog was recorded. The meteorological conditions conducive to the Meuse Valley disaster were found only five times in 30 years.

It is possible to forecast large-scale atmospheric stagnation conditions over many areas of the United States and such a service is, in fact, operative. It is not possible, however, to predict by current statistical techniques the frequency or probability of the atypical meteorological events that can lead to a severe local air-pollution episode. Zoning, air quality regions, and regu-

lation of sources to fixed emission standards therefore cannot be used as a basis for preventing episodes with any predetermined amount of risk. This applies to any degree of emission control or “rollback,” receding as far back as the equivalent population and power levels of 1873, when an episode in London similar to the 1952 event occurred.

Emission control is expensive if applied to existing sources, as evidenced by electric precipitators for fly-ash removal or tall chimney stacks for smoke dispersal at costs running into five or six figures. Limiting the number of sources by regional zoning costs us in other ways by limiting our utilization of energy, transportation, and housing. Admitting these points, it is clear that excessive source control is not an optimal solution to the everyday control of air pollution, and no solution at all to the problem of dangerous episodes.

No matter what reasonable (or unreasonable) degree of source emission control is imposed, there is a finite and *unpredictable* risk of dangerous concentration buildup in some localities—unpredictable in the sense that its probability is unknown. It is a major premise of this article, however, that it will soon be possible to *forecast* the onset of air-pollution episodes in a locality, given sufficiently good information about the current state of source emissions and meteorological conditions. This will be an extension of the stagnation forecasts just mentioned, supplemented in great detail by a mathematical model simulating the local meteorology and the dispersion of pollutants in and around each problem area. Forecasting the event will not by itself be sufficient to prevent it from happening. It will be necessary to utilize this information in reducing the current pollution emissions to a level that the atmosphere can disperse. This latter step in itself is not new, but is the basis of the air-pollution “alert” systems in Los Angeles, New York, and Chicago, and the Rijnmond system in the Netherlands. In each of these, current levels of ambient air pollution are sampled and compared with meteorological forecasts. If unfavorable, orders are issued to industrial and other sources to curtail their emission. The novel element will be in the forecasting—in “feedforward control.” By being able to compute air-pollution levels for each portion of a city sufficiently well in advance (several hours or a day), given the source emissions as input, it will be possible to select an emergency abatement schedule that will minimize both the health risk to all inhabitants and the disruption of other priorities of urban life.

Unfortunately, the full capabilities for achieving feedforward control of air pollution do not exist, nor is the writer aware that they are being seriously planned in other than an abstract way. The instrumentation, meteorological and chemical, that will be required is much more than has been allowed for in federal budgets or planning. The dynamic mathematical models of the polluted atmosphere that will permit such detailed forecasts have not yet been developed. It will be expensive, complex, and difficult to sell to hard-nosed political leaders in these times of conflicting urban priorities. What, then, is the payoff? Why should we strive to achieve this capability?

In the first place, feedforward control permits implementation of the most economical mix of abatement strategies, both for the short and the long term. Reduc-

tion of all emissions to an absolutely safe level will be impractically expensive, burdensome, or, in the most critical localities, impossible. On the other hand, a policy of minimal emission control, except during forecasted emergencies, would involve more frequent "slamming on the brakes" as average pollution levels creep upward and random fluctuations push them more frequently over the critical margins of safety, and would be no solution at all to the multibillion dollar problems of material and vegetation damage, visibility, chronic illness, and soiling that distress the average citizen. The optimum strategy is clearly a mix of these two extremes. As such, chronic air pollution will be kept down to something approaching a cost-benefit level, where the incremental costs of improved air quality equal those of air-quality damage less the societal cost of episodes. Admittedly, we do not yet know where this level is. At the same time, the feedforward system of emergency control will give us the highest possible assurance of safety for children, old people, and the chronically ill and feeble.

The second benefit of the mixed strategy is growth potential. Air pollution will grow, despite some statements to the contrary, because it is intimately intermixed with increasing per capita energy utilization and population growth,<sup>10</sup> with a quadrupling of the latter forecast by the year 2030.<sup>11</sup> The only alternative we can live with is rationing and reduction of energy use and the means of production. Automobile emissions of hydrocarbons can be reduced by enforcement of current federal statutes, but will rise again after 1980 because of the vehicle population growth.<sup>12</sup> Even before that time comes, chemical plant capacity for hydrocarbons will increase to the extent that their increased emissions will largely offset the automotive reductions.<sup>13</sup> Automotive nitrogen oxide emissions, the other ingredient of Los Angeles smog, will continue to increase during this period. The potential for sulfur oxide emissions from fossil fuel (coal and oil) used in power and industrial plants will continue to rise at a rate of about 50 percent of the 1960 level each ten years until 1990, when it will (hopefully) fall off as a result of nuclear power installations.<sup>14</sup> This increase will be partially offset to the extent that less-available natural gas, low-sulfur oils, or expensive coal desulfurization processes can be utilized.

Improved medical knowledge, perhaps more than any other factor, certainly will increase our awareness of the problems of air pollution. As researchers delve more deeply into the effects of air contaminants, the levels considered to be dangerous to health will be lowered and the number of suspect pollutants will rise. Correspondingly, the degree of day-by-day control or the number of emergency control situations forecast will increase.

It should be emphasized that a rigid strategy of fixed abatement levels will not possess the requisite flexibility to cope with the emergency situation. More and more, we will be forced to take an optimum path. Fortunately, our knowledge and capability to implement sophisticated solutions to this deeply rooted problem will improve in concert with the need.

Granted the need, what are the problems? The remainder of this article will be devoted to descriptions of the technical problems to be overcome and to the current state of the art. All of the problems are not technical. The first and foremost consideration is that of national

will—recognition of the real nature of the problem and willingness cooperatively to implement a difficult solution. The problem must be tackled nationwide—hence the title of this article—not because of any concept of a centrally located control center, but because the funding, research, and development effort can only be supported at the federal level. Moreover, the problem itself is becoming nationwide, requiring implementation of controls at locations ranging from San Francisco and Denver to Atlanta and Philadelphia; in turn, the legislation needed to implement control must be nationally applicable.

Accordingly, the hardware and software that must be developed under this kind of program must have nationwide applicability, with appropriate tailoring to a specific locale and its topography, climate, and source distribution. Instruments that are economical and appropriate for the task must be deployed in considerably larger quantities, but this constitutes only part of the problem. With little doubt, the biggest technical gap lies in the state of the art of atmospheric models appropriate to cities and built-up areas. In a recent *SPECTRUM* article,<sup>15</sup> E. S. Savas cited experiments supporting the concept of small pockets of high pollution concentration that may move about to random locations under the influence of winds and turbulence. The atmospheric model, then, must make it possible to track and predict the location of these high concentration pockets rather than merely to monitor the average over a city or a few suspected "worst points." However, the necessity for a much finer scale of measurement and prediction is compensated, as Savas points out, by the possibility of finer control over the emission sources, with correspondingly less cost to the emitters and less inconvenience to the population.

Air pollution, this writer believes, requires a total systems solution as much as military air defense does. The analogy is doubly apt since, without warning and counteraction, more episodes similar to the 1948 Donora tragedy can be expected whenever statistical fluctuations from rising urban pollution levels coincide with unfavorable weather variables. For defense against such disasters, crowded urban areas will require a real-time capability for surveillance, prediction, decision, and quick control reaction; in short, a system capability quite beyond the present stance.

### **Description of the system**

As a first step in the effort to expose the intransigent problems of air-pollution control to the powerful weapons of systems analysis, we will attempt to describe the goals of the overall effort and the diverse activities, existing and planned, in such a manner as to define them as parts of a system. The form of the organization and the constraints on its operation can then be identified. Only when this is done can the interrelationship between subsystems be clarified and one proceed further to specify the detailed objectives and functions of each of the many parts, such as sensors, computing hardware, or software.

Over 14 000 air quality monitoring devices are currently operated by various local and federal agencies. Approximately 10 percent are continuously operated, automatic analyzers; of the remainder, some are as simple as dust-collection jars. Such devices may be considered an embryonic national air quality control

system insofar as their operations have been supported and loosely coordinated by federal agencies. The total effort is highly fragmented and in an early, formative growth stage, so care must be taken in ascribing systems goals or objectives to this collection.

Nevertheless, three functions must be performed by any such system if it is to be viable: *identification* of air pollutants and their current concentration and distribution; *prediction* of their future status in a timely manner; and *control* over pollution sources to abate undesirable trends.

With some exceptions, it will be shown that current efforts are unable to satisfy more than the first of these needs. Severe fiscal and technological constraints on systems development exist, but if our society grants sufficient priority from the present time onward, most of them can be removed within this decade. Longer-term constraints on the extent of air-pollution control will derive from cost-benefit decisions—basically, the changing social and economic tradeoffs between air purity and power or production efficiency. Given the present imbalance of air quality and control measures, it is safe to guess that these limits will not be reached for a long time.

Current federal plans indicate that there will be less than 800 air quality monitoring stations and 4000 industrial source monitoring installations, each comprised of two to six analyzing instruments, by 1974. Statistical sampling considerations, considered later, suggest that this number is perhaps two orders of magnitude less than needed to perform the nationwide system functions. It must be assumed, then, that a second-generation system has yet to be planned and implemented, and that this system will be far more costly and less fragmented.

This is *not* to say that a nationwide system will be a single, monolithic entity, controlling air-pollution sources from a central location. The unit of current technical efforts is the self-contained “air shed,” or federally established air quality control region, whose boundaries are theoretically selected so as to minimize air-pollution transfer into or out of the area. (In practice, compromises are made to suit political and demographic realities.) Although the concept is admittedly relative in that pollution transport across these boundaries does occur to some degree (there is also question as to the statistical validity of the air-shed idea, considering the rate of meteorological conditions associated with disastrous high-pollution episodes), there is no question that local weather is a prime factor in air pollution and that weather phenomena are strong functions of location, topography, and time. Local, or at least decentralized, air quality monitoring, prediction, and control is certainly a requirement, with adequate provision for exchange of data between local control centers or through a master data bank.<sup>16</sup>

### Organization and goals

Since current efforts to control air pollution are so highly fragmented and responsibility is divided among state, local, and federal agencies, there is no *national* air-pollution control system. Therefore, to speak of system goals on this level is not strictly justified. There is, nevertheless, a concerted attempt to combat this problem at all levels of government by development of technical specifications of air quality, measuring instrumenta-

tion, and control methods, and by legislation to fund and activate educational, monitoring, and local control agencies. The physical abatement of pollutant emissions of necessity must be accomplished by the very vehicles, industrial plants, and local activities that cause them in the first place, acting under the spur of social pressures, enforcement agencies, and the penalties provided by law.

In this sense, a nationwide control system can be envisioned, at least ideally. Given a system, its goals, its objectives, and the functional relationship of its parts can be examined. Without this viewpoint, the activities at the various levels appear chaotic and powerless, which, in fact, they would be without some form of unifying directive.

A generalized diagram of the system would appear something like Fig. 1. This, clearly, is a loosely coupled miscellany of new and old political activities, technical functions, and public and private organizations, all of which affect in some way the status of the air environment and of the animate and inanimate receptors.

The goals of the system, impelled somewhat vaguely by public opinion and more strictly defined through the elective and legislative process, may be expressed as follows: to identify and prevent or abate adverse trends of national and local air-pollution concentration affecting the receptors (humans, agriculture and husbandry, climate or visibility, and materials). Less explicitly, the system strives (or should strive) to identify and monitor similar changes in the global atmosphere adversely affecting the air resource, the world climate, or other environmental factors.

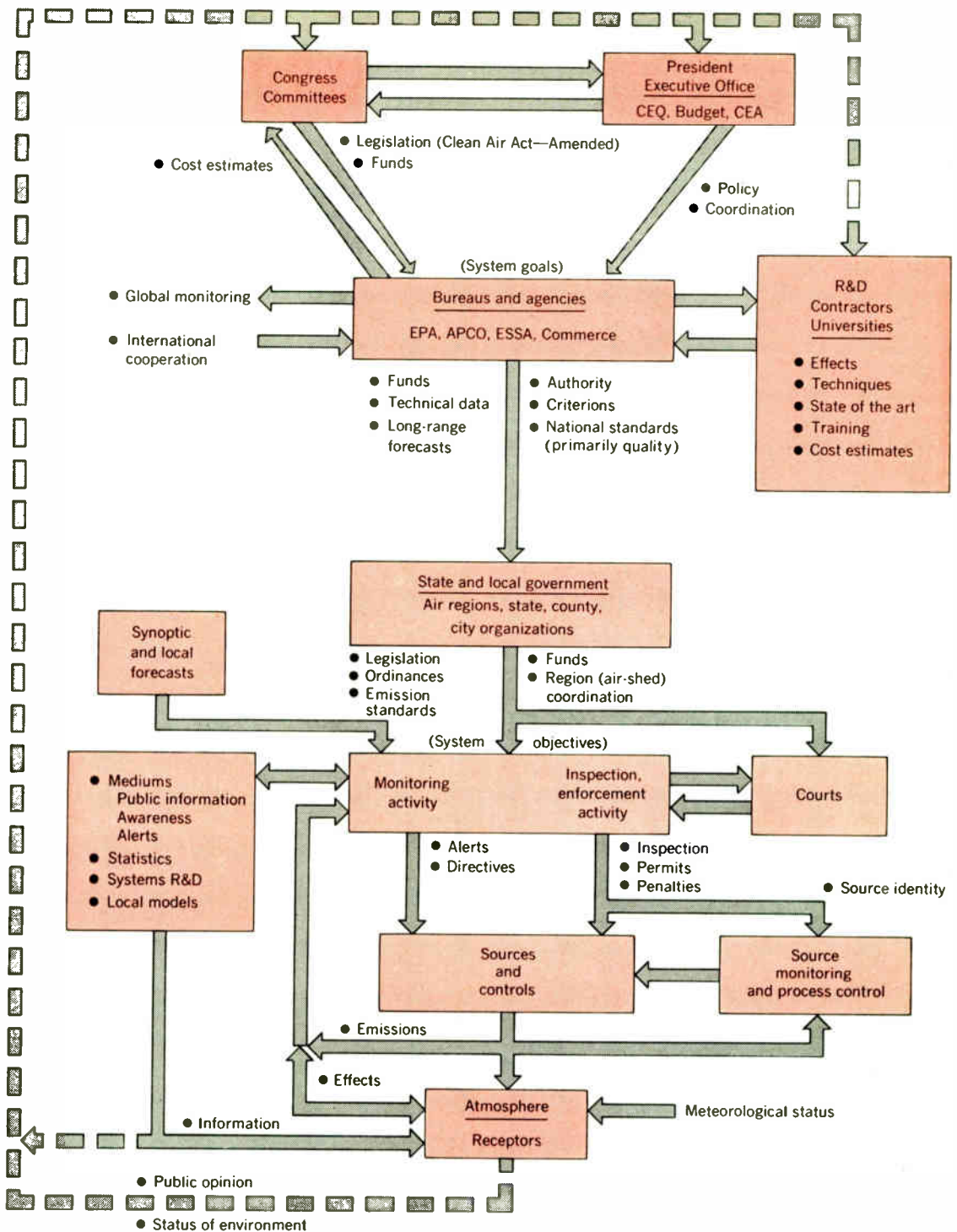
### System functions

As already noted, the operating functions of the system are identification, prediction, and control.

*Identification* implies causal or statistical knowledge of the dose-response and time-concentration behavior of receptors to all significant pollutants as well as their synergistic combinations. This knowledge must be built into the criteria and standards that form the core of the operative technical functions. In turn, this is generated for the system by parallel research activities, which form an auxiliary loop, and process data from the real world as well as the laboratory. It further requires a monitoring network of such temporal, spatial, and physicochemical capabilities as to be able to measure current concentrations and trends of all the pollutants of interest.

*Prediction* implies an extrapolative capability or mathematical model of the atmosphere and pollution system and the necessary computing capacity to implement a timely prediction of future pollutant distributions in both space and time. In turn, these capabilities require a knowledge (still incomplete) of the atmospheric reactions of pollutants, their sources, transport, diffusion, and decay; inputs of meteorological theory and data; as well as instruments, computers, and software. The time scale must be matched to the control function performed. Only for emergency control of local episodes need it be in real time—that is, a calculation rapid enough to permit effective control action to be taken.

*Control* activity results from information obtained through the predictive subsystem or through registration, inspection, or self-monitoring of the sources in response to an emission standards code. The latter is based on air



**FIGURE 1. A system of nationwide air-pollution control.**

quality standards, which in turn result from the identification subsystem criteria. Physical control requires techniques to abate pollutant emissions or authority to permit or regulate operation of a facility. When local pollution concentrations cannot be kept below standards, control also requires an interface with the community, such as the communications mediums, so as to alert sensitive receptors to take appropriate action on their own behalf. A data- and information-retrieval capacity also serves to generate long-term-trend statistics to

evaluate local system operation or improve predictive models. In some instances, the latter will also be used directly in the control loop in order to evaluate the best means of abating the threat of severe pollution episodes; for example, shutdown or alternate sources. Ideally, this will be done on a cost-effective basis, perhaps using linear programming techniques. It is implied that this kind of predictive simulation (during episodes, at least) must be computed at high speed so as to allow for timely action.



In exercising the control function, the monitoring activity or a cooperating enforcement branch acts to identify emission-code violators by processing data from fixed sensors, by mobile or remote sensors, or through cooperative use of stack sensors.

### Constraints and cost effectiveness

Table I lists system functions along with those constraints that in the writer's opinion will limit the degree of control possible or desirable both in the near and long terms. Near term implies the next two to five years and long term, ten years or more.

In the near term, many of the system constraints will be technical, but given sufficient priority, they should be relieved well before the end of the decade. Although research into long-range effects of trace pollutants on human health and on the balance of ecosystems will be a continuing task, other current technical problems lie within present capabilities. These problems include the development of reliable low-cost sensors, the refinement of transport and diffusion theory, adequate photochemical

reaction models, and improvement of some control techniques. Other problems, involving legal or political organization and funding, show signs of early resolution, but it must be emphasized that this optimistic assessment is based solely on personal opinion. It is not intended that the overwhelming effects of societal and economic factors be minimized—the need for community and national will to overcome air-pollution evils and to allocate an economic priority to this task among other pressing urban problems is certainly real. But, with some hopefulness, an increasing respect for the needs of the air environment has been noted recently, even among those individuals and communities who stand to lose directly by curtailment of their polluting plants and projects.

In the long term, there will remain three basic types of constraint. One is based in social motivation, which eventually is reflected in legislation. Such limits involve fundamental choices as to the amounts and sources of power to be produced, mass transportation, urban population distribution, and also the means for allocating

## I. Control-system functions and constraints

System Function	Near-Term Constraints (1972-1976)	Long-Term Constraints (1980-?)
<b>1. Identification</b>		
a. Identification of pollutants and synergistic combinations	Ignorance of effects on receptors and ecosystems, atmospheric reactions, and combinations.	Natural background. Cost-benefit limits to pollution control.
b. Definition of dose-response and time-concentration behavior	Experimental limitations, long-term effects, reliance on statistics and epidemiology.	Continuing problem, especially long-term effects on humans.
c. Existence of monitoring network	Funds to establish networks. Network design criteria ill-defined. Poor fit to political divisions.	—
Spatial placement of sensors	Federal delay in defining air regions. Weak design criteria. Lack of survey data. Sensor cost per unit area.	Cost-benefit limits to control.
Chemical capability of sensors	Adequate sensors unavailable or costly to purchase for use.	—
Time response of sensors	Some sensors very slow.	—
<b>2. Prediction</b>		
a. Mathematical model, physical theory	Incomplete physicochemical theory, especially of photochemical dynamics.	—
Computing software	High cost of programming.	—
Computing hardware	—	—
b. Meteorological data	Data criteria incompletely defined. Some data (e.g., profile) inadequate.	Cost-benefit limits of small-scale meteorological monitoring.
c. Source survey and data	Detailed surveys costly.	Continuing problem. Ultimately, cost of telemetering network.
<b>3. Control</b>		
a. Air quality and emission standards	Conflict with technology growth. Self-interest of individuals and groups.	Limitation on public education, economic practices, and social motivation.
b. Legal authority to control	Authority lacking or penalties weak in some areas.	Same as 3a.
c. In-stack, mobile, or remote detection gear and organization	Inadequate or costly in-stack gear. Few remote sensors developed. Cooperative system incomplete.	Ultimately, same as 2c.
d. Community communications	—	—
e. Optimizing control model or simulation	Model theory incomplete. Programming, possibly hardware costs.	—
f. Physical control techniques	Control techniques costly, inadequate in some cases. Possible shortage of low-sulfur fuels. Inadequate municipal incinerator funding. Inadequate alternates to automobile transport.	Cost-benefit limits. Population distribution and growth limits on mass-transportation effectiveness.

pollution costs between the public and private sectors. Of this constraint, systems analysis has little to say. The second constraint, that of assessing the medical and human effects of trace contaminants, may be with us for a long time. The last constraint, involving cost effectiveness, is, at least in theory, amenable to analysis.

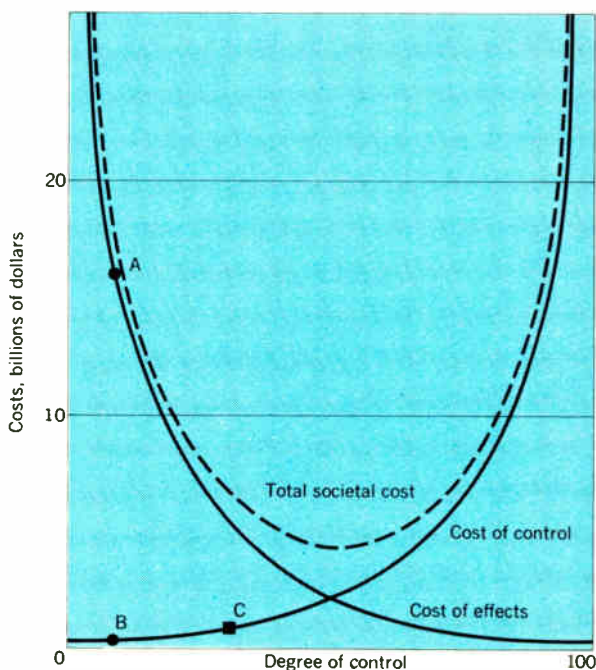
The cost-effective approach toward establishing the desirable degree of air-pollution control has been criticized, as noted earlier, on the grounds that we cannot yet plot curves of the cost of air-pollution effects or of the cost of controls as a function of the degree of control. The pioneer work in this field was only recently published (in 1967) after a three-year study by the economist R. Ridker.<sup>17</sup> We can predict the general shape of these curves, however, since the cost of effects will certainly decrease and the cost of control will rise as a greater degree of control is imposed. Following Ridker, we can draw a hypothetical graph as in Fig. 2. Here, the sum of effects and control costs represents the total societal cost, regardless of who is to pay. Clearly, the optimum degree of control will correspond to the minimum total cost. This will be achieved when the marginal costs—the slopes of the effects and control cost curves—are equal.

It is difficult to quantify either curve for many reasons. The direct cost of the effects of a concentration level of one pollutant is a function of the damage to each receptor (person or object) that is attacked at that level, multiplied by the cost of damage and by the number of receptors. These costs must be computed for various levels, for different pollutants, and for their combinations. For the most part, these data are not known and are not even constant; the number of receptors, for example, will change with time. Furthermore, the "utility" or dollar cost each person would put on the loss of such esthetic intangibles as scenic visibility or art works will vary widely. The cost-of-control curve is equally elusive,

since the costs will change with the growth of technology and may be far from a smooth function of control. Work is under way to amass the missing information; meanwhile, we must be content with deductions from a few data.

It is useful to know, at least, which side of the optimum control point we are now on, and, if to the left, roughly how far we can travel before it does not pay to clean up the atmosphere further. The estimate quoted at the outset, \$16 billion for the cost of effects in 1968, gives one clue. Another estimate, \$200 million for expenditures in air-pollution control during the same year, only 1/80 of the effects cost, is quoted by Yocum and McCaldin.<sup>18</sup> These two estimates are plotted as points *A* and *B*, respectively, on Fig. 2. A third clue, cited by the Council on Environmental Quality (CEQ) in its 1970 report to Congress, gives a cost of \$4.5 billion through 1975 or \$900 million per year to implement the 1967 Air Quality Act in 100 metropolitan centers, using assumed emission standards similar to those of New York and San Francisco.<sup>19</sup> This represents the cost of a remission of 70 percent from the 1967 levels of sulfur oxides, particulates, and hydrocarbons, but by no means represents the total cost of "clean air." Furthermore, it includes only the control expenditures, primarily the costs of gas-cleaning equipment and low-sulfur fuel, with no allowance for monitoring or episode-prediction instrumentation. Regardless of these shortcomings, if we plot this point (*C*) on the hypothetical curves of Fig. 2, the need for further progress toward optimum conditions is strongly suggested. It is apparent that during the next five to ten years, when capital expenditures will still be required, we should spend at least five times the 1968 amount, or not less than \$1 billion per year, on air-pollution control, plus whatever is necessary for monitoring and episode-warning instrumentation, without concern about overshooting the optimum. If this sum seems excessive, comfort can be taken from the CEQ statement that the amount represents less than one percent of the annual output of the industries concerned.

FIGURE 2. Cost-effective control.



### Monitoring subsystem magnitudes

Estimates by Bertrand<sup>20</sup> of the air-pollution instrument market assumed that by 1980 there would be 750 air-monitoring stations in the United States. More recently, a study has been published by HEW in a report to Congress on manpower<sup>21</sup> that predicts the 1974 needs of state, region, and local control agencies by means of a model. The model, based on economic, geographic, and demographic causes of air pollution, assumes a completely functioning control system complying with federal law. It predicts 366 agencies (staffed by 5168 people) compared with 194 in 1969. Of these, 127 will require more than three persons. From the 1974 requirements for monitor-network operating technicians, the number of stations in the network can be computed, assuming one operator services two continuously operating stations or five intermittent stations (Table II).

Note that the total of Table II is compatible with Bertrand's estimate. Of side interest is the average number of continuous stations in a network—3.7—which is a significant indicator of the data-processing load. Utilizing similar reasoning, it has been deduced that the number of monitoring stations supported by industry, primarily stack- or process-emission analyzers, will be of the order

of 4000. The wide discrepancy between these two numbers (4000 and 790) is confirmed in Bertrand's estimates of the relative markets for stack and atmospheric monitors.

### System objectives

Although many of the state and local components of the current national air-pollution control system have anticipated federal law, the unifying force is now the Clean Air Act enacted by Congress in 1963, amended by the Air Quality Act of 1967, and further amended in 1970. Except in the case of automobile engines, the 1967 Act required the states to bear responsibility for establishing air quality standards, control legislation, and the machinery to implement them. Then, the role of the federal government was to translate the goals into air quality control regions, within which standards were uniform, and to support the states financially and technically.

In the 1970 amendments, the trend toward more direct federal control was confirmed, and authority for federal air quality standards, which have since been published,<sup>22, 23</sup> was granted (see Table III). Authority for federal emission standards for some stationary sources has also been provided. In general, the 1970 Clean Air Act amendments have speeded up the formation of a working, nationwide air-pollution control system by arbitrarily assigning as air quality control regions any areas not already so designated, by establishing federal air quality standards, and by demanding that the states implement these standards without delay through the legislation of appropriate emission standards and controls. In so doing, the problems of defining "air sheds" and of diffusion modeling have been momentarily side-stepped, and the questions of cost-benefit held in abeyance, but not, as some infer, put to rest permanently.<sup>24</sup>

There is much good in completing the formation of state control machinery as soon as possible and little risk in setting the highest possible goals, since there is small chance of overshooting them. Nevertheless, as already pointed out, an ever-expanding potential for air pollution means that attempts to obtain "background" quality levels with close to zero emissions will become increasingly difficult, and are sure to evade fulfillment. The 1970 amendments call for immediate action with the tools at hand but do not preclude the improvement of either tools or goals as our knowledge of dispersion and measurement grows. There is no argument with the idea of mandating quality standards well below the level required to protect the public health—the so-called "primary standards" (see following). But when we speak of air quality goals—the "secondary standards"—which are established to prevent "any known or anticipated effects" of a pollutant, we are immediately constrained to weigh the cost of any effects and are led back to the question of cost-benefit analysis.

The system objectives, as a result of this new division of responsibility, must be considered on the level of the federal government and its agencies (EPA and APCO); state, regional, and local agencies; and the sources that are to be controlled. In control systems terminology, "supervisory control" and adaptive goal-setting occur at the federal level, "feedback control" is exerted at the state, regional, and local levels, and the sources represent the "controlled plant" and its minor regulatory loops.

## II. Composition of 1974 state/local air-monitor network subsystem

	Operators	Stations
State, region, local		
—continuous stations	234	468
Local areas (25 000–50 000 population)—intermittent stations	64	322
Total:	298	790

Different time scales are encountered at each level. Federal policy (except in the case of emission standards) is concerned with future decades; local monitoring agencies measure and react to concentrations averaged over minutes, hours, or as long as a year; whereas source controls must react at process speeds.

The specific technical objectives of the current national subsystems, defined in part by the 1970 federal law, are detailed in Boxes I, II, and III (pp. 28–30).

### Second-generation system

The objectives of the national air-pollution control system as just reviewed appear complex and unwieldy. This is because it is still in the formative stage and is affected by political, growth, and ignorance factors. A mature system with funding measured in billions of dollars will have overcome most of these influences. Such a second-generation system will have only four functions:

1. Monitoring current pollutant levels.
2. Forecasting and predicting future trends and steady-state levels.
3. Exerting effective control and abatement.
4. Preventing dangerous "episodes" by quick reaction control.

In the second-generation system, it is assumed that the important pollutants and their critical concentrations are already known, that the mathematical models and monitoring networks are installed and operating, and that all important sources are known or registered and are capable of having their emissions controlled both in the physical sense (as by fuel switching or operating changes) and in the legal sense.

In short, such a second-generation system will consist of individual control agencies acting at each air quality control region or metropolitan center and having these four functions.

*Current level monitoring* is a basic requirement, prerequisite for the performance of all other functions in an effective manner. In addition, monitoring satisfies the need for public information and, indirectly, the long-range feedback outlined in Fig. 1. The bewildering variety of air-pollution receptors and effects complicates the problem of providing an easily understood pollution index. Ideally, this should be expressed as a single number. As a measure of the difficulty that is encountered, a recent proposal attempts to combine the effects of six known pollutants and their interactions and reactions with the atmosphere in a single formula.<sup>25</sup> Even this complex expression is admittedly incomplete.

The monitoring system also provides records for legal, administrative, and statistical histories. The last can improve mathematical models of the air-shed transport and diffusion characteristics, aid medical- and receptor-

effects research, and act as a long-term quality control check.

*Forecasting* in real time (see following section) provides an early warning to sensitive receptors of potentially dangerous episodes of pollutant concentration. It permits timely control measures to be initiated and, through models (simulators), selection of the most effective control means. Long-term predictive capability, on the other hand, is a tool to aid in decisions on source permits, land use and zoning, and selection of legal emission standards.

*Control* is the corrective response to short- or long-term predictions of future pollutant concentrations. In the long term, average levels can be held below dangerous values by withholding permits for new sources or placing more stringent restrictions on emissions. The effects of these source modifications can be evaluated with computer-implemented models of the air-shed topography and meteorology. Controlled sources may monitor their own compliance with normal and emergency orders by means of stack or ambient monitors, supplemented by patrols of the controlling agencies, providing "feedback."

Violation detection is a specific form of control requiring identification of uncooperative sources. Sensors capable of detecting pollutant emissions from remote locations or point sensors may be used in combination with wind direction and other clues. The violator must

### III. National primary and secondary air quality standards as of May 1971\*

Air Pollutant	Primary		Secondary	
	$\mu\text{g}/\text{m}^3$	ppm	$\mu\text{g}/\text{m}^3$	ppm
<i>Sulfur dioxide</i>				
Annual arithmetic mean	80	0.03	60	0.02
Maximum 24-hour concentration†	365	0.14	260	0.10
Maximum 3-hour concentration†	—	—	1300	0.50
<i>Particulate matter</i>				
Annual geometric mean	75	—	60	—
Maximum 24-hour concentration†	260	—	150	—
<i>Carbon monoxide</i>				
Maximum 8-hour concentration†	10 k	9	10 k	9
Maximum 1-hour concentration†	40 k	35	40 k	35
<i>Photochemical oxidants</i>				
Maximum 1-hour concentration†	160	0.03	160	0.03
<i>Hydrocarbons (nonmethane)</i>				
Maximum 3-hour concentration† (6-9 a.m.)	160	0.24	160	0.24
<i>Nitrogen dioxide</i>				
Annual arithmetic mean	100	0.05	100	0.05

\* Data are corrected to 25°C and 1013 mbar (1 mbar = 100 N/m<sup>2</sup>).  
† Not to be exceeded more than once per year.

#### I. Federal subsystem objectives<sup>22, 23, 25, 26</sup>

A. To require states to take responsible social, technological, and legislative action to protect the public from adverse air-pollution effects, and to take federal action if the states fail to do so in a timely and effective manner.

1. Publish a list of those air pollutants that affect public health and welfare, resulting from numerous and diverse sources, and for which air quality criteria (see following) are planned.
2. Publish such criteria promulgating the latest scientific knowledge of effects, including such factors as atmospheric conditions, interaction between pollutants, and known or anticipated effects on the environment and the economy.
3. Designate air quality control regions (AQCR) based on jurisdictional boundaries, urban-industrial concentrations, existing air quality levels, and any other factors (such as meteorological or topographical) necessary to provide for effective implementation of air quality standards. States may further subdivide these regions into more suitable units.
4. Publish national ambient air quality standards for the guidance of states. These include "primary" standards, deemed necessary to protect health and air quality goals, or "secondary" standards, to protect the public welfare from any known or anticipated effect (see Table III). Along with standards, the Environmental Protection Agency (EPA) publishes reference (referee) methods for determining the concentration of each pollutant in the atmosphere.
5. Classify each AQCR in accordance with its present air quality (measured or estimated) into one of three priorities (Table IV). The highest concentration, Priority I, requires the greatest degree of monitoring (Table V).

6. Require from states, subject to federal approval, plans to implement the air quality standards by means of legislation, organization, and emission standards ("control strategy"). If state plans are not forthcoming or are inadequate, federal plans will be implemented. The minimum number and types of monitors for regional air quality surveillance are specified (Table V).

B. To publish, directly, emission standards for specified categories of new stationary sources, including new federally owned sources. These standards will be based on the greatest degree of emission control achievable through the latest technology. To provide for certification of such sources, and to enforce compliance with standards.

C. To publish national emission standards for hazardous or other selected air-pollution agents for which there are no federal air quality standards but which are adverse to health and welfare, and to provide for certification and enforcement of these standards or for prohibition of their emission. As of March 31, 1971, three hazardous agents have been identified, viz.:

- Asbestos
- Beryllium
- Mercury

D. To establish emission standards for vessels, aircraft, and vehicles; certify new vehicles or engines; establish emission standards and certify controls for used vehicles; and control fuel additives.

E. To exercise emergency powers to enjoin immediately any emission of air pollution endangering health.

not only be located and identified, but legal proof of the degree of violation must be obtained. Some major stationary sources are required to maintain recording sensors or facilities for sample probes used by pollution inspectors. Ultimately, effective system operation may demand installation of remote reading sensors at major sources to permit continuous telemetering of data to a processing and monitoring center.

*Quick reaction control* of concentrations approaching the level of dangerous episodes can be exerted by demanding abatement of emissions from major stationary sources or alerting the general public to reduce automobile operation, etc. The communications mediums can be utilized to alert sensitive receptors in the general public, e.g., to reduce school activities and take other palliative measures.

### Real-time air-pollution data processing

Real-time or rapid processing of air-pollution data has been mentioned several times during this article, but the need for this capability frequently has been questioned. Since the requisites for early warning and for short-term forecasting of dangerous air-pollution levels are similar, they should be established before discussing implementation.

It is axiomatic, of course, that the rate of data acquisition and processing should not exceed that of which it is put to use. If the purpose is a long-term one, such as to gain data for zoning decisions or to assess annual trends, there is no need for hourly or daily information and it is wasteful to process data in real time. It is equally clear that the delay between the event and the act of doing

### IV. Priority of air quality control regions

Pollutant	Priority Class		
	I	II	III
	Concentration, $\mu\text{g}/\text{m}^3$		
	Greater Than	From-To	Less Than
<i>Sulfur oxides</i>			
Annual arithmetic mean	100	60-100	60
24-hour maximum	455	260-450	260
<i>Particulate matter</i>			
Annual geometric mean	95	60-95	60
24-hour maximum	325	150-325	150
<i>Note: The more restrictive of the 24-hour or annual average determines the priority.</i>			
	(Equal To or Greater Than)		
<i>Carbon monoxide</i>			
1-hour maximum	21 k	—	21 k
8-hour maximum	14 k	—	14 k
<i>Photochemical oxidants</i>			
1-hour maximum	170	—	170
<i>Nitrogen dioxide</i>			
Annual arithmetic mean	100	—	100
<i>Note: In the absence of measured data, classification with respect to carbon monoxide, photochemical oxidants, and nitrogen dioxide will be on the basis of population. Any region containing a metropolitan area exceeding 200 000 will be classified as Priority I. All others will be classified Priority III.</i>			

something about high air-pollution concentrations, even if that action is merely a warning, should depend on how long it takes to harm the receptor of pollution—especially if that receptor is a human being.

Air contaminants taken into the body have a charac-

## II. State, regional, and local subsystem objectives<sup>26</sup>

A. To prepare, submit to the federal agency (EPA), and implement approved plans for the attainment of air quality standards (primary) and goals (secondary) for each pollutant in accordance with the following detailed requirements.

1. Attain primary air quality standards within three years and secondary goals within a reasonable length of time.
2. Prepare an adequate "control strategy" consisting of emission requirements, timetables for conformance, and other measures needed to show achievement of air quality goals, allowing for current levels of pollution and providing for projected growth in population, vehicle traffic, etc. Demonstrate the adequacy of the strategy by use of a "model" of the anticipated air-pollution levels either a diffusion model or a simple proportional reduction based on the highest measured concentration of the pollutant in the region.
  - a. Current emission levels shall be determined by a detailed (by county) inventory of emission from area sources and point sources (those emitting more than 25 tonnes/year of pollutant).
3. Provide a system for monitoring air quality data, to consist of at least a minimum number of devices and sites (see Table V). Determine existing air quality and report changes every three months.
  - a. Provide the following emergency action criteria and procedures:
    - i) A surveillance system including rapid data

processing to identify the approach of pollutant concentrations toward episode levels (Table VI).

ii) Daily forecasts of atmospheric stagnation capable of being updated every 12 hours.

iii) An emergency emission-reduction plan that includes abatement action for each major source (over 100 tonnes/year emission).

iv) Procedures for control and communication of status and action during episodes, including communication with sources and the public (see Fig. 1).

4. Establish system of controls and permits for stationary and transportation sources of emission consistent with the attainment of air quality standards. Include source inspection, tests on point sources, emission monitoring and enforcement procedure, and a means of detecting excessive source emissions.

5. Provide intergovernment cooperation to prevent emissions from one region from interfering with the air quality of another.

6. Require reports on emissions from source operators.

7. Provide for periodic testing and inspection of motor vehicle sources.

8. Certify new stationary sources for compliance with federal or higher standards.

9. If desired by the state, adopt standards and plans to implement an air quality higher than the federal standard.

## V. Minimum requirements for regional air quality surveillance system

Region Class (see Table IV)	Pollutant	Minimum Number of Monitoring Sites	Minimum Sampling Frequency
I	Particulates	1 per 50 k population up to 10 sites and	I
		1 per 250 k up to 8 sites	C
	Sulfur dioxide	1 per 100 k up to 10 sites and	I
		1 per 250 k up to 8 sites	C
	Carbon monoxide	1 per 250 k up to 8 sites	C
	Nitrogen dioxide	1 per 100 k up to 10 sites and	I
Oxidants	1 per 250 k up to 8 sites	C	
II	Particulates	3	I
	Sulfur dioxide	3	I
III	Particulates	1	I
	Sulfur dioxide	1	I

Note: I = Intermittent, one 24-hour sample every 6 days  
C = Continuous

teristic half-life (during which half the remaining material is eliminated) ranging from less than 20 minutes for gases such as sulfur dioxide to six months or more for lead and dust. If the local ambient concentration of these substances suddenly rises, perhaps as a result of wind shift or diurnal emission patterns, the concentration in the receptor's critical organs rises exponentially, after a time reaching equilibrium equivalent to three or four half-lives.<sup>29</sup> Fluctuations cycling at rapid intervals (about 0.1 half-life) will have little effect on the concentrations within the body. Thus, the biological effects of a rise in the level of sulfur dioxide, among other pollutants, will be maximized after one hour or less. This sets an upper bound on the time delay that can be tolerated in acquiring and processing information on dangerous concentration increases. The lower bound will be of the order of one or two minutes.

In practice, the U.S. Public Health Service continuous-air-monitoring program (CAMP), taking data from eight major cities since 1962, has utilized data-averaging intervals as short as five minutes, which matches excellently the considerations just stated. Data taken by this agency have been subjected to extended statistical analysis, showing regular distribution patterns<sup>30</sup> that may be used to indicate how frequently a real-time data-processing capability may be needed for early-warning decisions, considering only the normal fluctuations of emissions and weather conditions. For example, a one-hour-average sulfur-dioxide concentration of 0.5 part per million (by volume), which if sustained for 24 hours would lead to increased mortality,<sup>31</sup> occurred in three out of eight cities between 0.1 percent and 10 percent of the time, or about 400 hours a year in Chicago, 40 in Philadelphia, and 9 in St. Louis. In five out of the eight cities, a one-hour average of 0.25 ppm was measured between 0.1 percent and more than 10 percent of the time; this concentration adversely affects older bronchial sufferers.<sup>32</sup> Locations with low sulfur dioxide, such as Los Angeles, that do not appear on the lists have similar needs for real-time data to warn of undesirable rises in the concentration of other pollutants, such as ozone and

## VI. Levels for declaring air-pollution "alert" and "warning"\*

	Alert	Warning
SO <sub>2</sub> (24-hour average)	0.3 ppm	0.6 ppm
Particulate (24-hour average)	3.0 COH†	6.0 COH
SO <sub>2</sub> × COH (24-hour average)	0.2 ppm	1.0 ppm
CO (8-hour average)	15 ppm	30 ppm
O <sub>x</sub> (1-hour average)	0.1 ppm	0.4 ppm
NO <sub>2</sub> (1-hour average)	0.6 ppm	1.2 ppm
(24-hour average)	0.15 ppm	0.3 ppm

\* Example of state plan from 1970 federal act.

† COH = coefficient of haze.

Note: An "alert" or "warning" is declared when any indicated level is reached and meteorological conditions are such that this condition can be expected to continue for 12 more hours. "Emergency" is reached when "warning" levels are exceeded and concentrations continue to increase or are expected to do so.

hydrocarbons. In none of the cities considered can the need for real-time data be completely disregarded because of the unpredictable occurrence of "episodes," which may not follow the normal statistics of the CAMP data.

## Conclusion

It has been seen that a comprehensive systems approach toward solving the air-pollution problem—the potential magnitude of which is inextricably bound to the growth of our population, energy consumption, and manufacturing wealth—must encompass cost-benefit tradeoffs among the broadest possible mix of emission controls and levels and the carefully monitored use of the atmosphere as a dispersal means and sink. Only by investing in an optimum system can we assure our future health and safety without squandering the resources badly needed elsewhere. From a national view, our current embryonic system is suboptimal because it is fragmented, insufficiently coordinated, and fails to achieve economies of scale and the control of externalities

### III. Source-control subsystem objectives<sup>26, 27</sup>

A. To control emissions from new sources using the latest techniques and in conformance with state or federal requirements for certification (see Box I).

B. To establish and maintain records from monitoring equipment showing compliance with emission standards. Also, to maintain records and reports on fuels if required by state regulations.

C. To abate emissions that are in violation of applicable performance standards within time limits (72 hours in some cases) or cease operation, under penalties; avoid emission of prohibited hazardous pollutants (see Box I).

D. To prepare a preplanned control strategy for air-pollution episode alerts in accordance with region/state regulations; implement when required to do so by the control activity.

E. For all sources, to control emission of pollutants in undesirable or illegal amounts by the most economical means meeting requirements, including process changes or plant relocations, if necessary.

(the "free" use of air by polluters).<sup>33</sup> The goals or functions of the desired mature system include identification and prediction of ambient pollutant concentrations and its optimal control under both normal and abnormal meteorological conditions. Unfortunately, technical, scientific, legal, and political constraints still exist today, preventing quick fruition of such a system, but we have only begun to reap the advantages of following the cost-benefit curve.

The optimum system must produce information and predictions about unhealthy air-pollution concentrations in "real time," as experienced by the human receptor. The technical means by which exotic chemical and meteorological data may be acquired and applied to predictive mathematical "models" of the polluted air space will be the next topic of this series.

#### REFERENCES

1. Barret, L. B., and Waddell, T. E., "The cost of air pollution damages: A status report," U.S. Dept. of Health, Education, and Welfare, NAPCA (USPHS), July 1970.
2. Friedlander, G. D., "Power, pollution, and the imperiled environment—Part II," *IEEE Spectrum*, vol. 7, pp. 65–75, Dec. 1970.
3. Berry, R. S., "Perspectives on polluted air—1970," *Bull. At. Scientists*, vol. 26, p. 40, Apr. 1970.
4. Jamieson, J. K., "The role of industry—air quality," *J. Air Pollution Control Assoc.*, vol. 21, p. 63, Feb. 1971.
5. Bowen, D. H., Editorial, *Environ. Sci. Technol.*, vol. 4, Oct. 1970.
6. Atkisson, A., and Gaines, R. S. (eds.), *Development of Air Quality Standards*. Columbus, Ohio: Merrill, 1970, p. 208.
7. Parson, D. O., and Croke, E. J., "An economic evaluation of sulfur dioxide air pollution incident control," APCA Paper 69-20, New York, N.Y., June 22–26, 1969.
8. Kohn, R. E., in Atkisson and Gaines, *op. cit.*, pp. 108–109; also Norsworthy, J. R., and Teller, A., "The evaluation of the cost of alternate strategies for air pollution control," APCA Paper 69-172, New York, N.Y., June 22–26, 1969.
9. Hilst, G. R., "Utilizing our present atmospheric environment," M.I.T. Industrial Liaison Program Symposium on Air Pollution, May 5–6, 1970.
10. Black, G., "Energy, air quality, and the systems approach," policy studies in sci. and technol. paper 104, George Washington Univ., Washington, D.C., July 1970, pp. 17–18, 33.
11. Austin, A. L., and Brewer, J. E., "World population growth and related technical problems," *IEEE Spectrum*, vol. 7, p. 46, Dec. 1970.
12. "Control techniques for carbon monoxide, nitrogen oxide, and hydrocarbon emissions from mobile sources," NAPCA (USPHS), Mar. 1970.
13. "Olefins, aromatics face steady growth," *Chem. Eng. News*, vol. 48, p. 24, June 8, 1971.
14. "Control techniques for sulfur oxide air pollutants," NAPCA (USPHS), Jan. 1969.
15. Savas, E. S., "Feedback controls on urban air pollution," *IEEE Spectrum*, vol. 6, pp. 77–81, July 1969.
16. Katz, E. L., and Morgan, T. R., "Analysis of requirements for air quality monitoring networks," presented at ann. APCA meeting, St. Louis, Mo., June 14–18, 1970.
17. Ridker, R., *Economic Cost of Air Pollution*. New York: Praeger, 1967.
18. Yocum, J. E., and McCaldin, R. O., in *Air Pollution*, A. C. Stern, ed. New York: Academic Press, vol. 1, 2nd ed., 1968, p. 651.
19. Fogel, M., et al., "Comprehensive economic cost study of air pollution control costs," Report FR-OU-55, Research Triangle Inst., Durham, N.C., Feb. 1970.
20. Bertrand, R. R., "The market for air pollution instrumentation 1970–80 (interim analysis)," presented at ann. APCA meeting, St. Louis, Mo., June 14–18, 1970; see also *J. Air Pollution Control Assoc.*, vol. 20, pp. 801–803, Dec. 1970.
21. "Manpower and training needs for air pollution control," Rept. of Sec'y, U.S. Dept. HEW, to Congress (June 1970), U.S. Government Printing Office, Washington, D.C., 1970.
22. "Air pollution—1970. Part 5," Hearings before the Senate subcommittee on air and water pollution, Public Works Com-

mittee, 91st Congress, 2nd session, on S.3229, S.3406, S.3546, Appendix, U.S. Government Printing Office, Washington, D.C., 1970.

23. "National primary and secondary ambient air quality standards, Code of Federal Regulations, Title 42, Part 410," *Environ. Reporter*, vol. 31, pp. 1301–1315, 1971.
24. Sussman, V. H., "New priorities in air pollution control," *J. Air Pollution Control Assoc.*, vol. 21, pp. 201–203, Apr. 1971.
25. "Air quality criteria for particulate matter," Report AP-49, NAPCA (USPHS), Jan. 1969, pp. iii, xiii.
26. "Proposed regulations of the EPA for preparation, adoption, and submission of implementation plans conforming with the national ambient air quality standards (42CFR, Part 420)," *Federal Register*, part 2, Apr. 7, 1971.
27. Stern, A. C. (ed.), *Air Pollution*. New York: Academic Press, vol. 11, 1968, p. 537.
28. Babcock, L. R., Jr., "A combined pollution index," *J. Air Pollution Control Assoc.*, vol. 20, pp. 653–659, Oct. 1970.
29. Saltzman, B., "Significance of sampling time in air monitoring," *J. Air Pollution Control Assoc.*, vol. 20, p. 663, Oct. 1970.
30. "Air quality criteria for sulfur oxides," NAPCA (USPHS), Apr. 1970, p. 33–35.
31. *Ibid.*, p. 161.
32. *Ibid.*, p. 162.
33. Black, G., *op. cit.*, pp. 47–49, 83.

Reprints of this article (No. X71-101) are available to readers. Please use the order form on page 8, which gives information and prices.



**Robert J. Bibbero (SM)** received the B.S. in chemistry from the University of California in 1938, was a graduate fellow in chemical engineering during 1938–1939 at the University of Michigan, and was awarded the M.S. in electrical engineering by the University of Buffalo in 1948.

In addition, he studied electronics and control-systems engineering at M.I.T. in 1942 and 1953. After serving as ordnance and electronics officer in the U.S. Navy during 1942–1945, he joined the Linde Air Products Co. research laboratories, where he worked with high-temperature ceramics. In 1948, he became a group leader in servomechanisms at Bell Aircraft Corp. and subsequently contributed as both engineer and manager to a number of significant aerospace, military, and industrial automation R&D programs. He successively held the positions of Servo Department head at Republic Aviation, chief engineer of both the Hillyer Instrument Co. and the Bulova R&D laboratories, and engineering manager of Burrough's Control Instrument Division. In 1965, he became vice president, then president, of Technical Analysis Group Inc.; and in 1970 he joined Honeywell Industrial Division's New Business Development Department, where he is concerned with planning future air-pollution control systems.

Mr. Bibbero has been granted four U.S. Patents and is the author of more than 40 contributions to technical journals and encyclopedias and the book, "Automatic Control Dictionary." He has served as editor and consultant to Reinhold Publishing Corp., the U.S. Army Research Office, and other private and government organizations. In addition, he is on the reviewing staff of "Science Books," a publication of the AAAS, has served the IEEE in various important capacities, is a member of the Air Pollution Control Association, and is a professional engineer in both New York and Pennsylvania.

# Power supply aspects of semiconductor equipment

*Although the semiconductor technology has had a truly pervasive influence on all users in our society, semiconductor effects upon power sources and allied equipment have been largely neglected in the literature to date*

**Harold A. Gauper, Jr., John D. Harnden, Jr., A. M. McQuarrie**  
General Electric Company

*This article presents data concerning the often "unmentioned" influences of semiconductors upon power sources, other equipment, and the user. The influence of methods of power control and the resulting harmonics is considered in detail, including some new data on the effect of unbalanced firing angles. Also presented is information relative to metering accuracy, radio, telephone, and control-circuit interference, lamp flicker, and semiconductor influence, including the characteristics of a new RFI-free switching device. In addition, aspects of regulatory agencies are considered, and detailed references for further in-depth study are given.*

The use of semiconductor components is almost universal. It is estimated that over two trillion ( $2 \times 10^{12}$ ) semiconductors were produced in 1968.<sup>1</sup> In addition to the wide acceptance and application in consumer electronic products for entertainment, substantial numbers of semiconductors have been finding their way into industrial apparatus as well as consumer products of a more general nature. Moreover, the increasing economic attractiveness of power thyristors, including SCRs and triacs, is causing further upsurge in the application of these devices. Thyristor ratings of 4000 amperes are already being proposed for a single device, and up to 1200 amperes for transistor arrays.

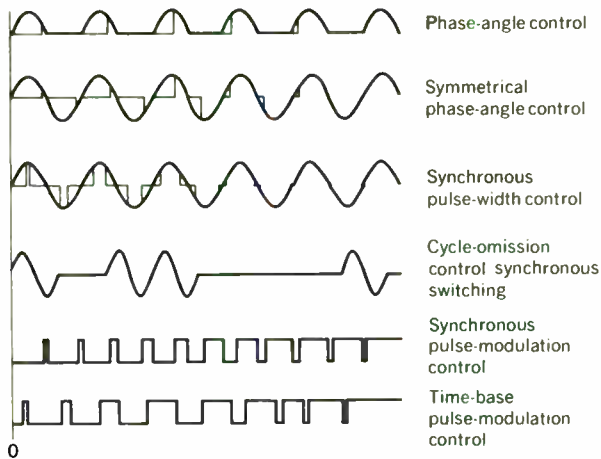
Not surprisingly, many articles covering new electronic applications have presented suggestions for new product designs that feature many of these semiconductor com-

ponents. Little attention, however, has been given to the problems of the utility and distribution system—that is, the power source—and its relationship to power conversion equipment utilizing modern solid-state technology. Since such potential can have a marked influence on the power source, it is desirable to focus on the more important determining factors, including waveshape effects, load and circuit power factors, and methods of gating and power control, since these types of equipment deviate from the more classical and traditional linear and quasi-linear analysis techniques. Special emphasis is placed on the effect of power-conditioning equipment upon magnetic components, including transformers and metering, as well as the related problems of radio noise interference, telephone interference, and lamp flicker. Supportive to this is a consideration of the dynamic characteristic of the semiconductor and the influence of higher-frequency operation—as is found in the "electronic transformer" concept just becoming popular for power-conditioning applications.

## Power control

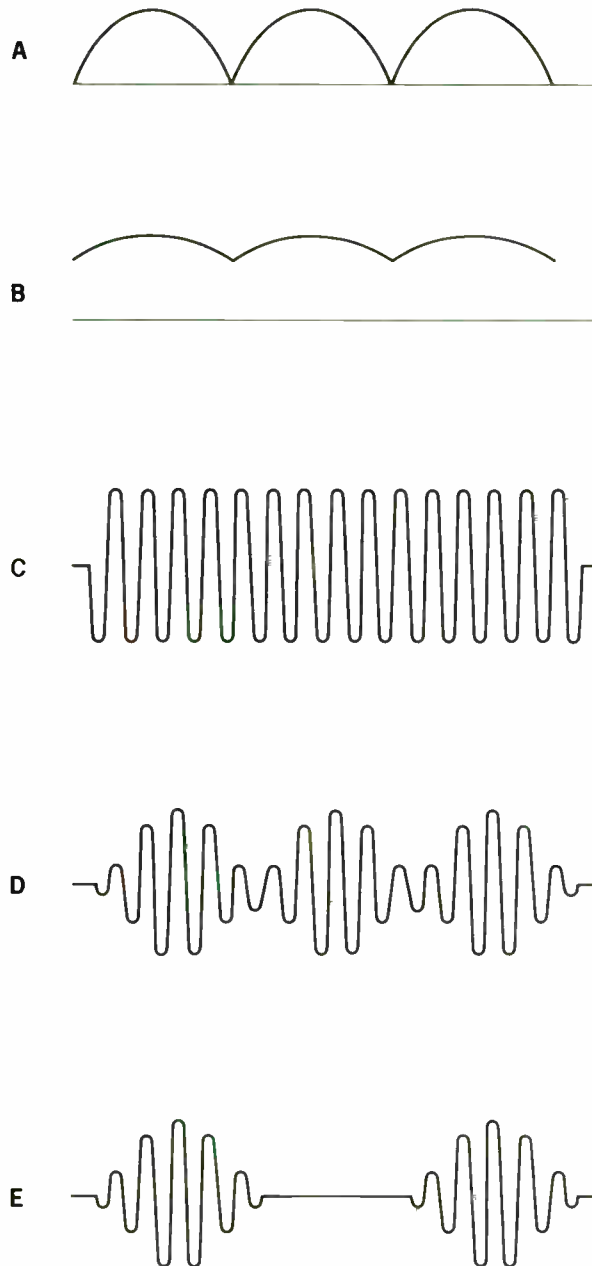
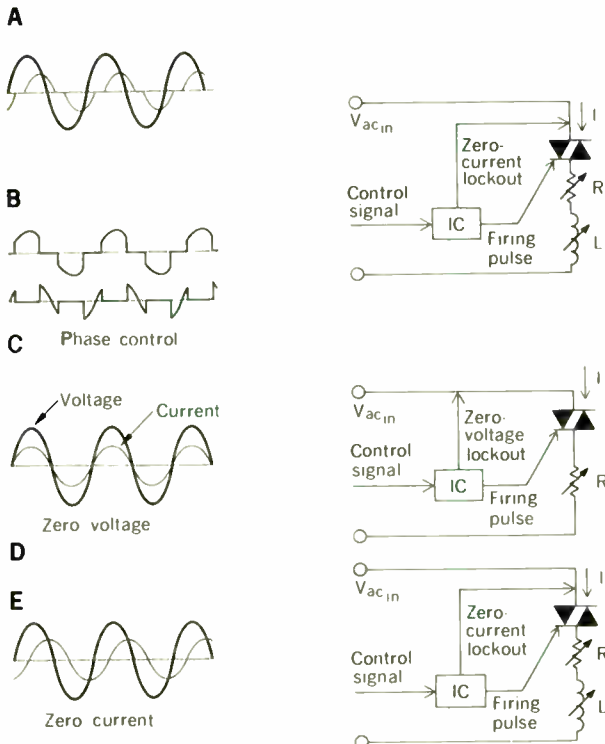
Power conditioning using semiconductor components can take many forms (as shown in Fig. 1), depending on the source (ac or dc), type of load, and control characteristics desired. In each case, the power is switched "on" and "off" by the semiconductor element in varying ways—thereby giving rise to some basic questions concerning harmonic content, waveshape, noise, metering, and other factors, which will be the main focus of this article. Figure 2 displays the voltage and current for phase control and synchronous switching. In Fig. 2A (phase-control opera-





**FIGURE 1. Typical power-conditioning waveforms.**

**FIGURE 2. Voltage, current, and logic relationship (phase control and synchronous switching) for resistive and inductive loads. A—Phase control of inductive load showing supply voltage and current. B—Voltage across triac. C—Voltage across load. D—Zero-voltage switching of resistive load showing supply voltage and current. E—Zero-voltage switching of inductive load showing supply voltage and current.**



**FIGURE 3. Single-phase waveforms. A—Full wave unfiltered. B—“Typical” full wave filtered. C—High-frequency output from dc source. D—Fully modulated high-frequency, full-wave, unfiltered output. E—Half-wave, unfiltered, high-frequency modulation.**

tion), the power is controlled in a relatively lossless fashion by adjusting the conduction angle from full-on to full-off. In the case of a resistive load, the voltage and current are naturally in phase, resulting in a somewhat simpler method of control than for the inductive load. The semiconductor and load voltages are shown in Figs. 2B and 2C respectively. All of the conventional rectifier-type circuits are applicable, so that half-wave conduction is sometimes used, as in the rectifier mode, involving ei-

ther controlled or uncontrolled semiconductor elements. The conversion of power results in the generation of spurious frequencies and often some lost energy since completely perfect components are not available and methods of power conditioning involve the generation of harmonics, causing power-factor problems and wave-shape distortion. For example, these factors can produce unwanted heating in generators, transformers, and power-factor-correction capacitors. The engineering art of controlling the propagation of harmonic voltages and currents is available in the literature and is becoming better appreciated by the practicing circuit designer. Although these problems have often been present in previous equip-

ment using tubes and magnetic amplifiers, wider acceptance and application exploitation have dictated further appreciation of some of these basic problems.

In Figs. 2D and 2E the synchronous-switching type of power control is diagrammed for both unity power factor and reactive load. This method of control using thyristor devices was proposed as early as 1958,<sup>2</sup> and is rapidly gaining considerable acceptance, particularly with regard to thermostatic-type functions in conjunction with electric-heating applications because of the practical elimination of radio noise problems.<sup>3-11</sup> There are, of course, additional problems that arise in conjunction with this method of power switching; namely, those associated with lamp flicker.<sup>12-17</sup> The application of both phase control and synchronously switched loads in home and industrial applications is at a high and accelerating level.<sup>18-20</sup> Figure 2 shows the logic conditions required for integrated-circuit control—a method that is gaining wide acceptance.

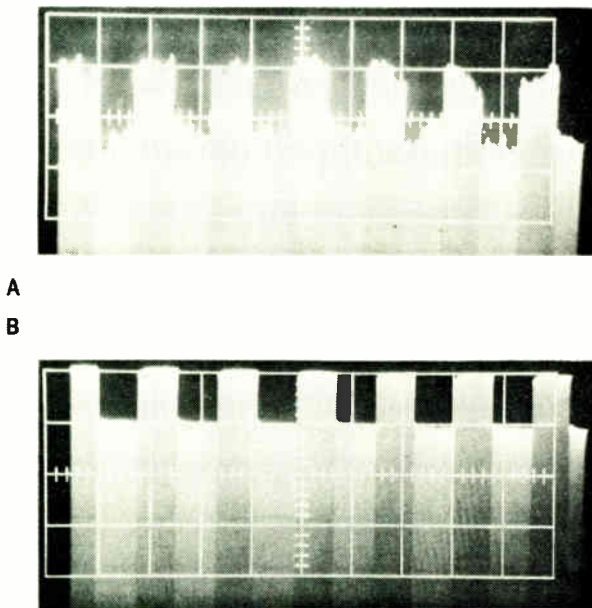
Figure 3 illustrates additional power-conditioning waveforms that will become increasingly prevalent in the next few years. To develop an understanding for the potential of power conditioning, the reader is referred to Fig. 3A, which is a simple rectified waveform. By adding filtering, a better dc level is obtained, as in Fig. 3B. Battery chargers and other types of dc power supplies used in electronic equipment for entertainment are application areas for simple waveforms of this type. In addition, the availability of low-cost, high-performance transistors and thyristors operating at higher than 60 Hz should provide the designer with a new freedom quite independent of the 60-Hz power line.<sup>21</sup> In the past, frequency multipliers have been used only in limited quantities because of their cost and their performance restrictions. A much broader concept is that of inversion, whereby unrestricted frequency is produced. Present techniques using commer-

cially available components can produce high power at up to 30-50 kHz with good efficiency; 1 kW at 500 kHz has also been reported. Therefore, the development engineer now has at his disposal a new tool that will enable motors to be operated over wide speed ranges with high efficiency and also will provide for possible miniaturization.

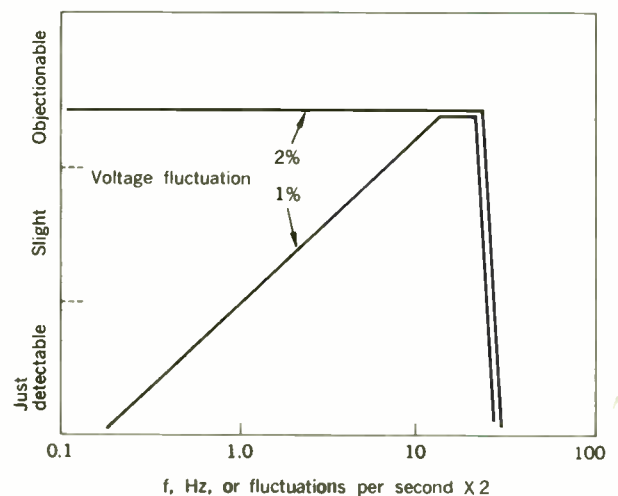
Discharge lighting, such as that in fluorescents, can be optimized and pulses can be produced for various power-supply purposes such as ultrasonic cleaners.<sup>22-25</sup> Many high-frequency lighting installations have been in operation for years. The higher efficiency inherent in this mode of operation means higher output, less loss, and greater economy of operation. In addition, the ballast apparatus is greatly simplified at higher frequencies. As mentioned previously, it is expected that the application of electronic power conversion technology in the lighting industry will be a significant factor for the future. The generation of non-60-Hz power often will be based on the use of a rectifier with subsequent output waveforms as in Figs. 3C, D, and E. Depending on the nature of the power supply and the degree of filtering present, the output waveforms can approach either a sinusoidal or a square waveshape, according to the circuits chosen and the intended application. Although inversion has been discussed broadly, time-ratio or pulse-modulation techniques are also included, since these are becoming increasingly important in producing equipment with faster inherent response, better device utility, and more favorable filtering.

The application of static switching concepts using solid-state control makes circuits available that can both open and close either without or with controlled delay, usually minimizing RF interference and electrical transients as compared with normal switching contacts. This fast operating speed could also mean more effective system protection, since power can be removed in a half-cycle (if phase commutation is utilized) or in a few microseconds (if external commutation is provided). A further adaptation of static switching involves "multiplexing" concepts, which are presently being developed for airplanes to conserve conductor weight, etc.,<sup>26</sup> but in time could influence other wiring and distribution systems,

**FIGURE 4. Voltage regulation of branch circuits. A—Load switched to independent branch circuit at rear of house (vertical scale: 0.5 V/div; horizontal scale: 0.5 s/div). B—Load switched to television outlet at front of house (vertical scale: 5 V/div; horizontal scale: 0.5 s/div).**



**FIGURE 5. Curve showing the effect of frequency of lamp flicker on its objectionability.**



including vehicles as well as buildings, homes, and apartments.

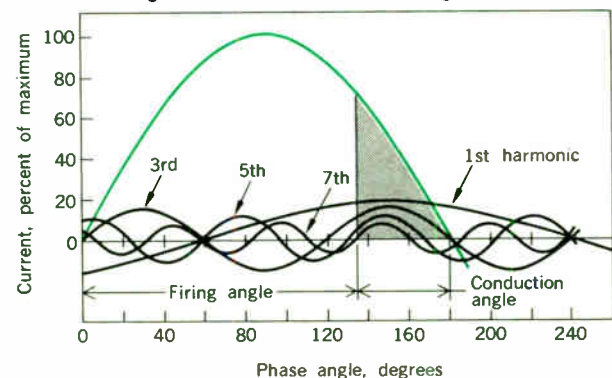
### Waveshapes

Figure 4 depicts the effect on line voltage in a small residence for two operating conditions involving a 1.1-kW load connected to 115-volt service. In Fig. 4A, the voltage shown is located at a television outlet in the front of the house at the time the load was switched to an independent branch circuit at the rear of the house. Notice that the peak-to-peak voltage variation is of the order of 0.7 volt. In Fig. 4B, the same load was reconnected and plugged into the television outlet with the resultant voltage modulation shown. This voltage variation is a function, first, of the total equivalent circuit all the way back from the television outlet and includes the watt-hour-meter impedance, circuit-protection impedances, and power-distribution transformer, and, second, of the network. The resulting manifestations of objectionable characteristics such as incandescent-lamp flicker will depend on the rate at which cycling occurs (as in Fig. 5). It will be seen that for switching speeds of the order of seconds the flicker is unacceptable, whereas if it occurs at a slower rate there exists a point at which it may not be irritating, though still visible.

It is desirable to consider the characteristics involved in the phase-controlled mode of operation mentioned earlier. Various harmonics will be shown in order to convey the dependence on conduction angle and circuit configuration. The selected harmonics are only a portion of the total Fourier series representation for any given waveform.

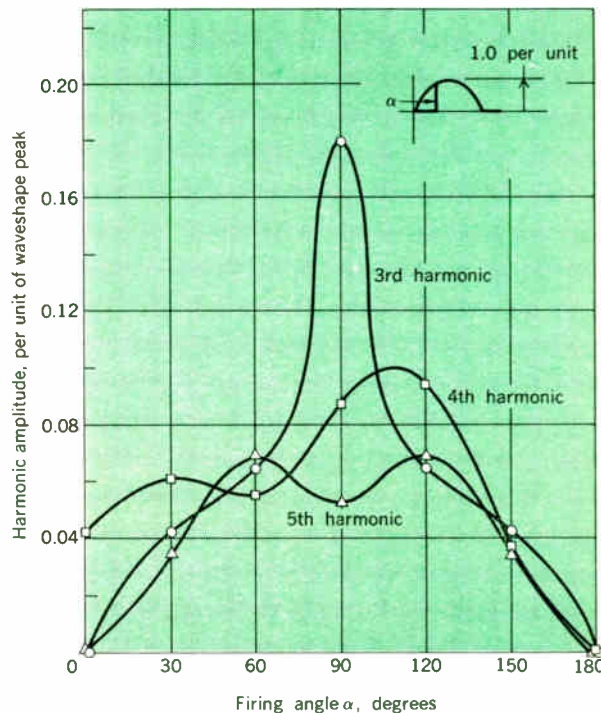
Figure 6 indicates the true load-current and load-voltage waveform (tinted area) for a firing angle of 135 degrees. Superimposed on this is a representation of the Fourier analysis of the waveform, which clearly indicates that there are higher harmonics contained within the waveform that can be the source of considerable consternation if not properly understood and coped with. Several additional examples will help to acquaint the reader with the various harmonics resulting from different types of load circuits commonly used. In Fig. 7, the third, fourth, and fifth harmonics are shown as a function of the firing angle  $\alpha$ . Figure 8 reveals the presence of harmonics with a single phase-controlled thyristor as in Fig. 7 and the addition of an anti-

**FIGURE 6. Harmonic analysis for full-wave phase control of 135 degrees with resistance loading.**



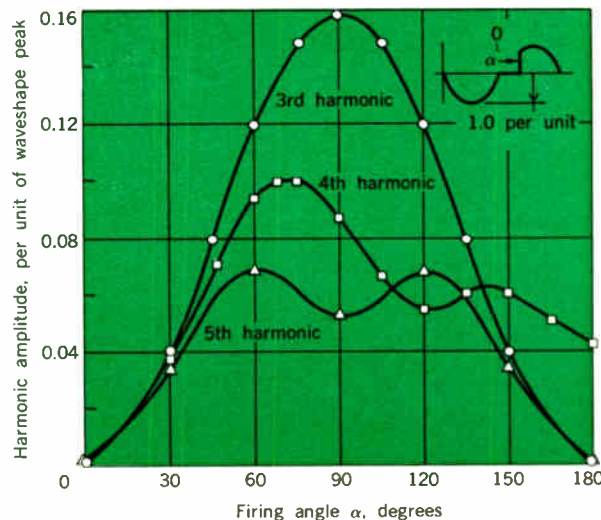
parallel diode to provide full 180-degree conduction.

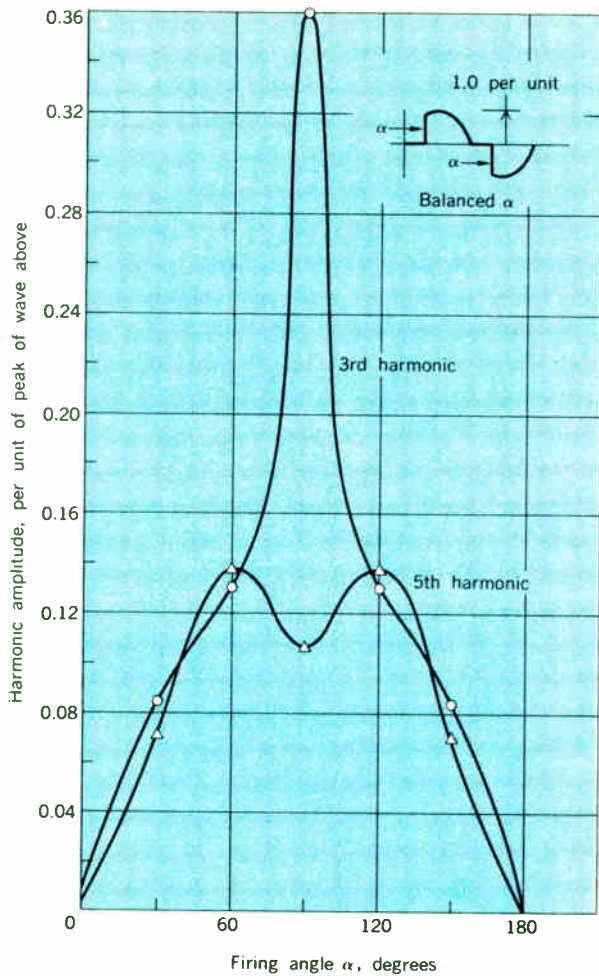
At the present time, the most significant mode of operation in most home situations is the ac phase-controlled (triac) type of waveform, which is analyzed in Fig. 9. Notice in this example that there are no even harmonics present if one assumes that the firing angles for the positive and negative half-cycles are identical. Since this is not necessarily the case, it will be interesting to examine the effect of an unbalance between these two angles. In a given piece of equipment, it is very unlikely that this conduction angle will be perfectly symmetrical. Reasons for this dissymmetry can be attributed to harmonics already present in the ac supply, which could produce an



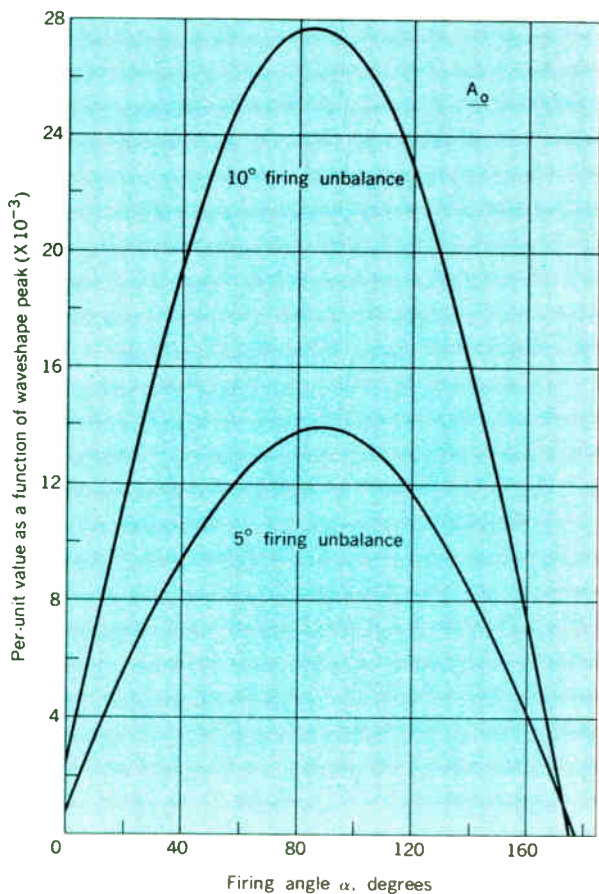
**FIGURE 7. Half-wave harmonic content versus firing angle.**

**FIGURE 8. Fixed half-wave plus variable half-wave harmonic content versus firing angle.**





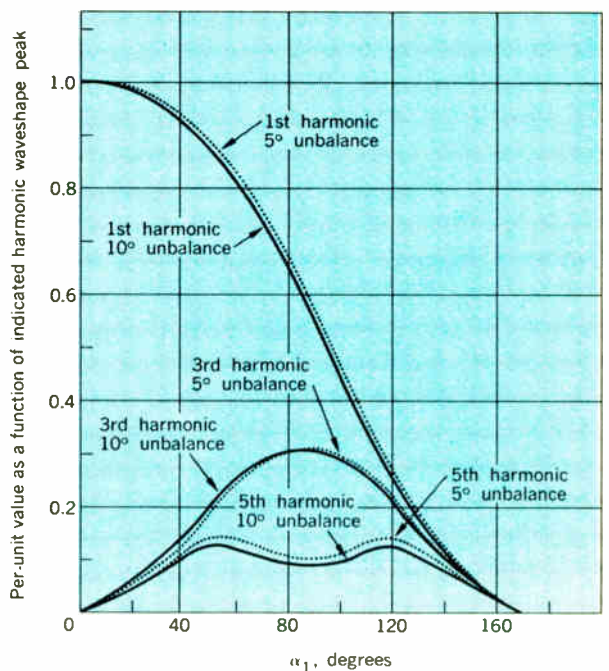
**FIGURE 9 (left).** Balanced ac phase-control harmonic analysis (3rd and 5th harmonics).



**FIGURE 10 (lower left).** Balanced ac phase-control harmonic analysis with deliberate unbalance introduced showing fixed component of Fourier equivalent.

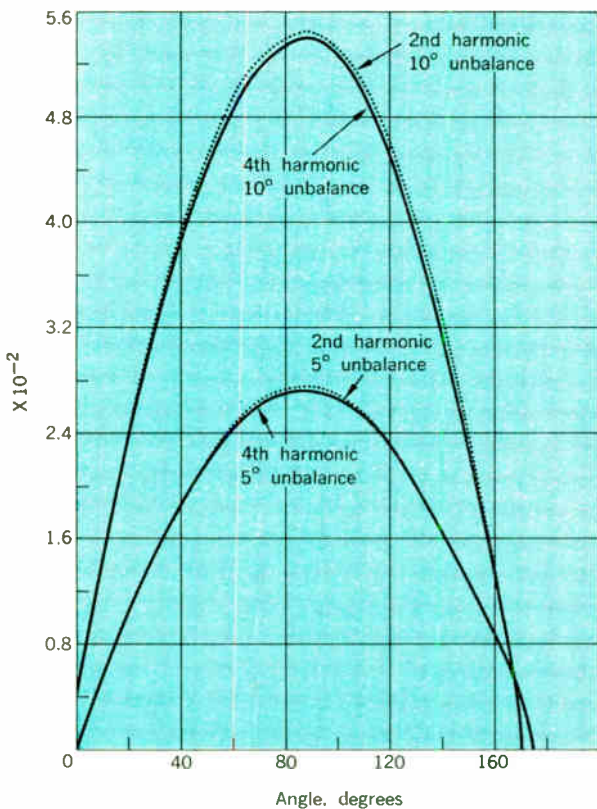
unbalance by magnetic gating. In the case of semiconductor gating, if different pulse generators are used for the positive and negative half-cycles, dissymmetry is almost inherent. A common circuit involves the use of a trigger diac device for both half-cycles. However, commercial tolerances on these devices are of the order of  $\pm 10-15$  percent, so it is conceivable that unbalance will be present from unit to unit. There is also the introduction of triggering devices with deliberately unequal positive and negative trigger points designed to eliminate hysteresis in simple controls such as dimmers. Figure 10 shows that a nonnegligible dc component is introduced and presents data for a 5-degree and 10-degree unbalance. The odd harmonics are shown in Fig. 11 and are generally similar to those of Fig. 9. Figure 12 shows the even harmonics that are beginning to appear, although they are smaller in magnitude than the odd harmonics. The significance of the dc component can only be ascertained in terms of the amount of load being controlled and the effect on transformers and other magnetic structures in the distribution system. As a point of emphasis, it has been shown that the presence of unbalance in an otherwise symmetrical phase-controlled system will introduce a dc component, as is also true of cases involving half-wave or partially controlled systems.

**FIGURE 11.** Balanced ac phase-control harmonic analysis with deliberate unbalance introduced showing odd harmonics of Fourier equivalent.



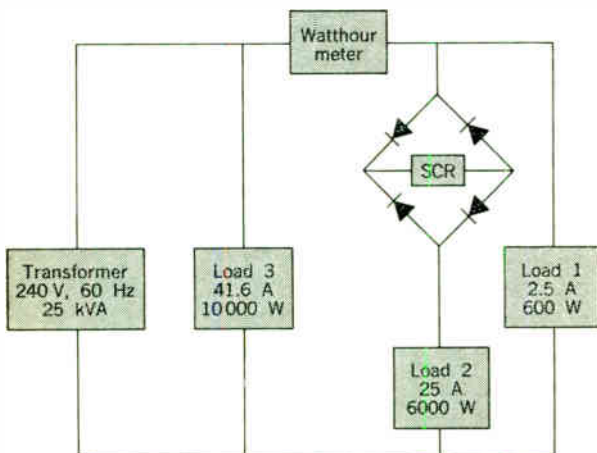
### Effect on metering

One of the first questions that naturally arise concerns the effect of waveshape upon accuracy of instrumentation. This can take the form of trying to determine the performance of the circuit in the development and design phases as well as the problems associated with equitable and accurate watt-hour-meter readings in this field. Instrumentation questions are important and a number of articles have been published that treat this area.<sup>27-31</sup> Included in the metering discussion, of course, is the problem associated with inverter and chopper waveform

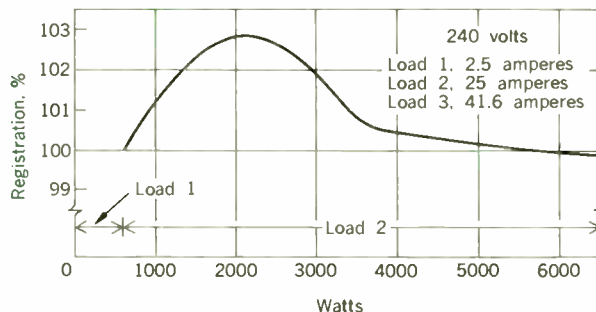


**FIGURE 12.** Balanced ac phase-control harmonic analysis with deliberate unbalance introduced showing even harmonics of Fourier equivalent.

**FIGURE 13.** Watt-hour-meter test circuit.

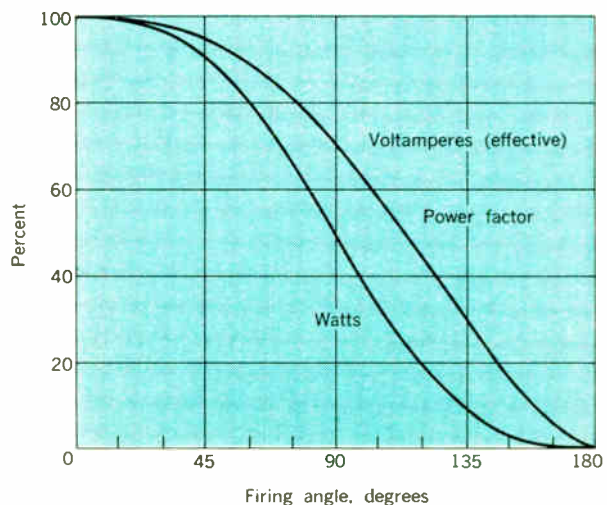


instrumentation at high frequencies as well as the 60-Hz examples discussed thus far. Some data have been published concerning the metering accuracy of watt-hour meters using controlled and uncontrolled loads in a simulated home environment. The block diagram of Fig. 13 indicates which two loads are being metered from a 240-volt, 25-kVA transformer. Connected to the terminals of this transformer was a 10-kW resistive load that was not included in the watt-hour-metering accuracy evaluations. A 6-kW resistance load was phase-controlled in parallel with a fixed, smaller-resistance load. Figure 14 examines the percent registration of the watt-hour meter as the percentage of load carried by the phase-controlled system when it was varied from full-off to full-on. Notice that there is a small error, indicating slightly more watt-hours than have actually been utilized. This is the worst error measured for a number of tests, and in general the amount of error involved is significantly less than that indicated by this curve. There is some effect on watt-hour-meter performance in the presence of synchronously switched loads. This, however, is mainly found for short periods of the order of cycles. For example, in a 1-kW synchronously switched load with a three-cycle-on and a three-cycle-off type of operation, a 3 percent error in metering is found. It should be pointed out, however, that in most situations this rapid cycling would produce an intolerable lamp-flicker problem.



**FIGURE 14.** Meter error for the circuit of Fig. 13 as a function of the conduction of variable load.

**FIGURE 15.** Phase-control power factor, VAR, and watts.



### Power factor

The power factor of electric apparatus is important. Figure 15 gives the power factor for a resistive load that is being phase-controlled. This is a lagging power factor and is of the type already found in abundance in most applications involving motors, transformers, and ballast equipment. The power factor associated with inversion and chopper equipment will depend in part on the nature of the power supply involved in producing the conversion. If a simple capacitor-type filter is used to provide an intermediate dc link, then leading power factors may be associated with this type of equipment. However, it is additionally necessary to consider the harmonic content of the current drawn from the line as well as the peak value of the current, its rms value, etc. In some applications, the objective is to eliminate 60-Hz components; thus it is not very desirable or practical to reinsert inductive components at power frequency.

### The 'electronic transformer'

The "electronic transformer" makes use of inverter techniques to transform the 60-Hz line into a higher intermediate frequency, such as 20 kHz; hence, smaller size is readily achieved. Applications are already under way in television sets and houseware products.

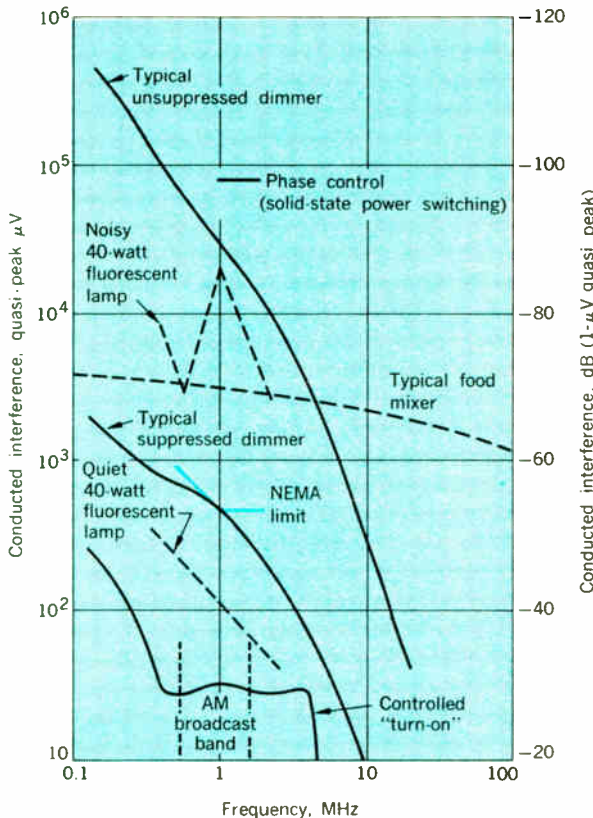
### Radiation

Each time a circuit is energized or deenergized, one must be concerned with the disturbance that may be caused.<sup>32-37</sup> Whenever a thyristor energizes a resistive circuit, load current goes from zero to the load-limited

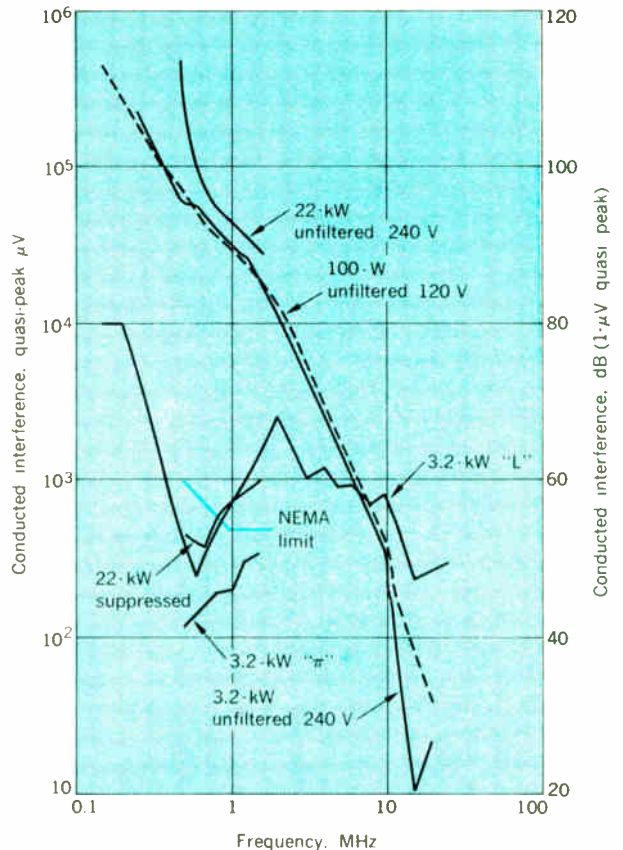
current value in a few microseconds. As has been shown, the frequency analysis of such waveforms gives an infinite spectrum of energy, in which the amplitude decreases proportionately with frequency. For example, in applications where phase control is used, the AM broadcast band would suffer severe interference, with fewer problems for television and FM (see Fig. 16). Figure 16 plots quasi-peak microvolts of conducted interference. This is one of two basic types of radio-frequency interference (RFI): that which is conducted through the power lines; and radiation from the circuit itself. Such interference can be minimized by keeping the physical size of the current loops formed by the thyristors and the RFI network to a minimum. In addition to these two forms of radiation, there are also questions concerning telephone interference and acoustical noise. The curve at the top of Fig. 16 represents a typical unsuppressed 600-watt lamp dimmer design using thyristor switches. Notice that a curve is also drawn for a typical food mixer and for a noisy 40-watt fluorescent lamp. Thus it is seen that thyristor control is not alone in producing interference in the AM band, whereas for FM and television thyristor interference is negligible compared with other conventional components.

An increasing number of articles are appearing that deal with suppression techniques<sup>38-42</sup>; others deal more particularly with semiconductor devices and circuits.<sup>43-47</sup> The least complicated form of filter is a simple inductor in series with the load to slow the rate of current buildup. This would give a filter effectiveness of about 20 dB per decade, which is inadequate for the degree of suppression thought to be desirable or to meet the NEMA dimmer

**FIGURE 16. Conducted interference for various common loads at 115 volts, 60 Hz. NEMA limit derived from Ref. 48.**



**FIGURE 17. Conducted interference as a function of power level and filter types.**



limit in the AM band.<sup>48</sup> In order for an economical inductor design to result, it is far better to use a combination of inductance and capacitance. As a rule of thumb, the proper values for  $L$  and  $C$  may be found by making  $LC$  equal to  $LR$ . This will result in a value of inductance that is a tenth of that needed for a purely inductive filter. In a practical circuit, one side of the power device is connected to the heat sink, which, because of its inherent metallic characteristic and physical dimensions, is a significant capacitance with respect to ground. Thus the heat-sink capacitance acting with the stray line capacitance can affect the performance of the inductance, depending on its connection and location within the circuit. In general then, to result in the best filter effectiveness, the location of the inductance should be such that the capacitances involved in these strays are effectively in parallel with the additional capacitance that is being added to the circuit. Figure 16 demonstrates that it is fairly easy to provide a characteristic that is in keeping with proposed NEMA standards by using a small inductance and capacitance.

### Controlled turn-on

Earlier, the synchronous mode of operation was described as a technique for eliminating radio noise interference. However, there are applications in which a continuous output rather than an on-off output is necessary, and thus it is interesting to consider the future direction of thyristor developments. If, for example, it were possible to develop the proper characteristic in the semiconductor itself, it might be feasible to eliminate the extra filter components associated with present designs. To

illustrate this point, reference should be made to the bottom curve of Fig. 16. This plot shows clearly for the first time that a controlled "turn-on" in a silicon semiconductor device can very effectively reduce interference problems without the need for additional expensive and cumbersome filter components.

In Fig. 17, additional data are plotted for 220-volt applications. Carried over as a point of reference from Fig. 16 is the 100-watt, 120-volt unfiltered lamp curve (dashed). Figure 17 shows the unfiltered performance for a 22-kW and a 3.2-kW system; corrected curves with "L"- and  $\pi$ -type suppression are given for the 3.2-kW case. Figure 18 provides an interesting comparison between the typical suppressed 115-volt curve from Fig. 16 and various modes of synchronous operation. Notice that there is a significant scale change in this and the previous curves. The conducted interference for back-to-back SCRs operating with a synchronously applied gating signal, causing conduction to take place at an instantaneous voltage of less than 5 volts at the anodes, produces satisfactory levels with respect to the referenced NEMA standard. If dc continuous gating is applied to the SCRs, providing the most complete ac power flow, still further reduced radiation is observed. For anode voltages less than the 5 volts noted, lower values of radiation will be observed. As an interesting reference, the bottom curve on the chart is for a silicon bridge rectifier connected to a 100-watt incandescent lamp.

In discussing radio noise, one must consider the semiconductor characteristics themselves. The noise generated by the turn-on properties of the semiconductor usually are emphasized, but it is also important to note that the turn-off characteristic can influence the noise as well. Semiconductor reverse recovery is capable of generating varying amounts of RFI, a result of minority carrier storage. The devices do not immediately block when the circuit causes current reversal. It may take a few microseconds for the charge stored in the device to be swept out before the device is capable of again blocking the flow of reverse current. When this action takes place, the current may stop quite rapidly, giving rise to the so-called "snap-off effect." This effect in conjunction with any circuit inductances and capacitances can result in significant problems. So-called "fast-recovery rectifiers," for example, will have energies of one percent of conventional rectifiers and thus are helpful from the radiation as well as the circuit-component point of view. Figure 19 aptly illustrates this, depicting the simple two-switch inverter operating from a dc source. Note that for an ordinary

FIGURE 18. Conducted interference for corrected loads compared with a silicon bridge.

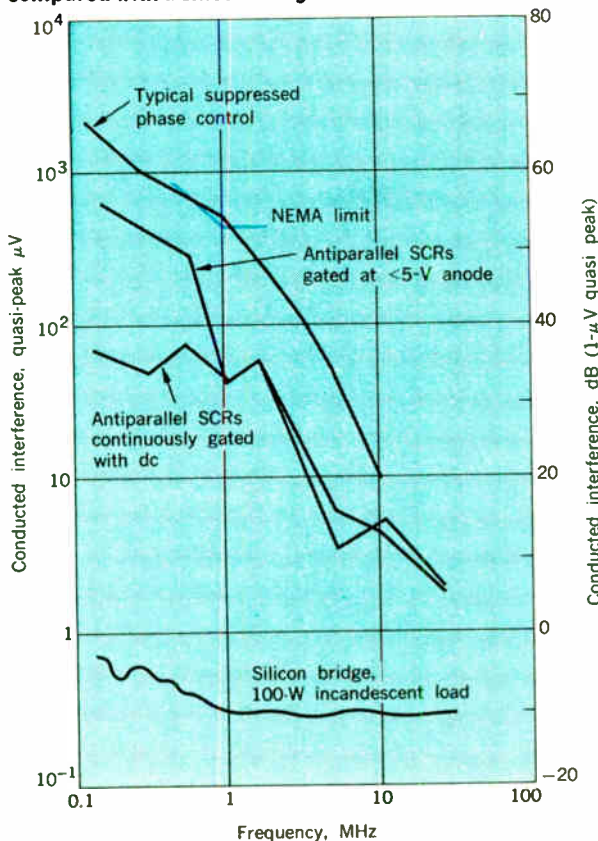
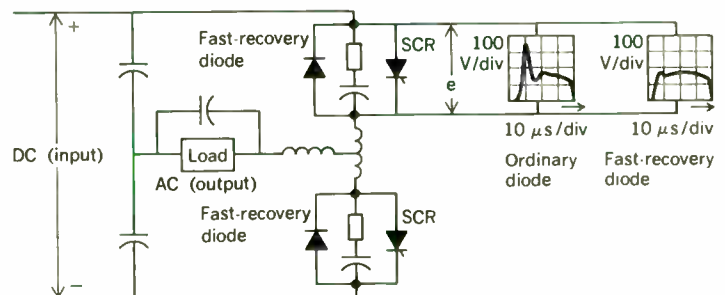


FIGURE 19. Circuit effect of diode speed.



diode the peak voltage requirement for the SCR is considerably greater than required in the presence of a more ideal fast-recovery diode.

### Telephone interference

Telephone interference considerations have arisen many times in the past, particularly in conjunction with large rectifier installations. The principles of inductive coordination presented more than 30 years ago provide a base for compatible growth of both telephone and electric power systems, so only infrequent problems have arisen with regard to the telephone system. The degree of interference may be measured using a standard harmonic analyzer or by using a telephone noise meter, with a built-in weighting network. The harmonic components are weighed in accordance with the 1960 curves agreed upon by the joint committee of the Edison Electric Institute and the Bell Telephone System.<sup>49</sup> The current-time product for harmonic current sources is the significant influence measurement. It measures the distortion of the power current and may be used to predict the telephone influence factor (TIF) for the power system voltage. There are at present no national government standards for power system harmonic content to insure interference-free telephone communications. However, as a result of improved power cable technology, such as triplex, underground installations, and other factors, telephone interference problems resulting from thyristor loads have not reached significant proportions.

### Information and control circuits

In the previous discussion, primary emphasis has been upon the interface between the power equipment and the power supply. However, in order to insure satisfactory equipment performance, it has become increasingly evident that emphasis needs to be placed on factors that have not been previously considered with any degree of caution in electric apparatus.<sup>50-53</sup> As the controls become more complex, the use of integrated circuits, especially digital types, is more widely spread, and the tendency is to use higher speed, lower voltage, and lower current-logic levels, and thus the equipment is more susceptible to stray power fields.<sup>54-57</sup> As the current rate of change increases, the maintaining of reference potentials and the reduction of unexpected interference voltages become more difficult. For example, 0.3 meter of conductor has a self-inductance of approximately 0.1  $\mu\text{H}$ ; therefore a rate-of-current change,  $di/dt$ , of 100 A/ $\mu\text{s}$  will develop a 10-volt transient along what was otherwise thought to be a zero-potential conductor.<sup>58,59</sup>

It should also be apparent that under these sharp voltage conditions the electric or capacitive coupling may

become as important as the mutual inductance existing between circuits. Not only is it necessary to worry about the near-field characteristics of sharp changes in voltage and current but, in this day of increasing communication equipment utilization, it is necessary to worry about the total ambient-induced effects as well. For example, a 50-VA dc-to-dc square-wave converter operating with a chopping frequency of about 10 kHz was reported to have caused interference in the broadcast band of automobile radios up to 0.8 km away from the equipment.

Industrial frequency-changer and power-conditioning equipment can also be a problem. A 20-kW frequency changer operating at 3 kHz was radiating excessively from more than 15 km away and required subsequent field correction in order to comply with FCC noninterference requirements. In coping with these considerations, it is desirable to examine the power lost from a circuit by radiation that will give a field strength of 10  $\mu\text{V}/\text{m}$  at various distances from a radiating source. This field represents a strong signal to a good receiving system, including automobile radios. If an isotropic radiator near ground is assumed—one that propagates energy uniformly—then the radiating power required at that distance to produce 10  $\mu\text{V}/\text{m}$  can be obtained from Table I. It will be seen that the amount of energy is rather negligible with regard to most power-conditioning equipment.

Another consideration is the amount of radiated energy that might be expected from a reasonably short wire, say 0.3 meter long, carrying a typical 1-kHz current with a trapezoidal shape as displayed in Fig. 20. Based on this 1-ampere peak waveform, 10  $\mu\text{V}/\text{m}$  would be produced at a distance of 150 meters for a frequency of 500 kHz and 400 meters for a frequency of 1500 kHz. Fortunately, most power-conditioning equipment is used with smaller circuit area and is contained in metal enclosures, which provides about a 1000-to-1 reduction in radiated fields.

As the influx of MOS circuitry expands, so do the problems associated with electrostatic fields, in addition to most of the other factors already mentioned.

### Gating

Increasing operational reliability requirements for all types of electric equipment require the designer to use care in circuit and component selection, and in fabrication details such as wiring location, shielding, and proximity of power and signal devices. Increasing interest in optical gating has had as its prime objective alleviation of some of these problems. Fortunately, the probability of success is enhanced by rapidly declining component prices. An application in which light gating has been used for some time can be seen in HV dc "valve" firing, as described in Fig. 21.

### Regulatory aspects

There are at present a number of military specifications dealing with interference that may or may not be applied to other power-conversion equipment. Modern military and sophisticated communications design is causing increasing need for quieter, better-controlled equipment.<sup>60-63</sup> The Federal Communications Commission, in paragraph 15.31, Part 15 (radio-frequency devices) of "Rules and Regulations," says that "an incidental radiation device shall be operated so that the radio frequency energy radiated does not cause harmful interference."<sup>64</sup> If the fundamental operating frequency is 10 kHz or above, it is

**I. Radiated power required for 10  $\mu\text{V}/\text{m}$  at various distances**

Distance, km	Power, $\mu\text{W}$
0.16	0.04
0.32	0.17
0.80	1.08
1.61	4.30
16.10	430.00
32.20	1 720.00
80.50	10 800.00



generating radio frequency deliberately. Such equipment is then subject to other technical limitations of Part 15 or Part 18 (industrial, scientific, and medical equipment). Depending on the specific use of the energy—induction heating, welding, or ultrasonics—different limits of radiation in power-line conductors are applicable. Currently, these technical limitations are placed on the manufacturer of the equipment, who is responsible for compliance before selling the equipment, whereas the user is responsible for maintaining and operating the equipment in such a fashion as to cause no harmful interference.

Two recently introduced consumer products (an ultrasonic cleaner and an electric razor) based on solid-state power conditioning for the home market have been tested and produced the interference recorded in Fig. 22. In the case of the ultrasonic cleaner, conducted interference in excess of the NEMA WD-2 1970 limit is easily observed. In the case of the electric razor, the performance is quieter than for many conventional electric razors using no solid-state devices, but still has been measured to be in excess of the NEMA limit.

### Industrial interference aspects

Electronic power-conditioning equipment has been used in industrial applications for many years. It is important to remember, however, that mercury-arc devices have considerably longer dynamic turn-on, rise time, etc., than their solid-state counterparts. At the same time that the equipment manufacturer has been turning to faster and faster power devices, he has also been increasing the speed of controls and sensors; thus, the susceptibility to malfunction and interference has been growing and proper coordination between these is vital.<sup>65,66</sup> This will often require a look at the total system, including distribution,

quality, and continuity of power.<sup>67-71</sup> Also, the influence of the equipment in a system at large will depend on how successfully transients and other side effects are initially treated, with the objective of providing reliable, harmonious, long-life operation.<sup>72,73</sup> However, proper procedures are apparently being instituted by reputable manufacturers so that automatic process equipment, electronic controls, and computers all can survive in the same environment.

### Conclusion

The application of solid-state devices has become so universal that it is virtually impossible to keep completely informed as to their total penetration of the market. It is estimated that more than 800 domestic manufacturers use thyristor devices, and this represents only a fraction of the solid-state devices being found in products.

Further, considerable commercial pressure is being exerted by integrated-circuit technologies on more conventional electromechanical and electromagnetic equipment, causing significant new market opportunities to emerge. The popular acceptance of solid-state technology will be characterized by such things as touch controls, automatic programming, and the numerous new products and services made possible by electronics. The way in which services are furnished to the home and the way in which services are accounted for (such as automatic meter reading) will be undergoing evolutionary changes that are largely dependent on integrated-circuit technologies.

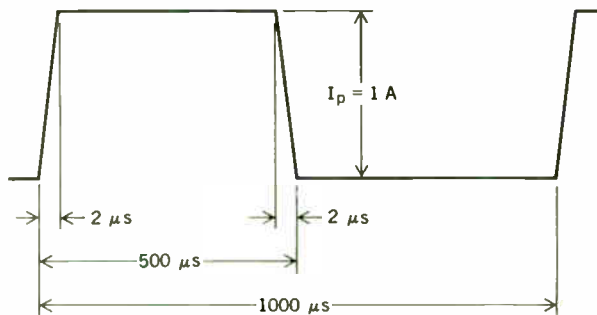


FIGURE 20. Typical 1-kHz current waveform for radiated energy calculation.

FIGURE 21. Optical gating.

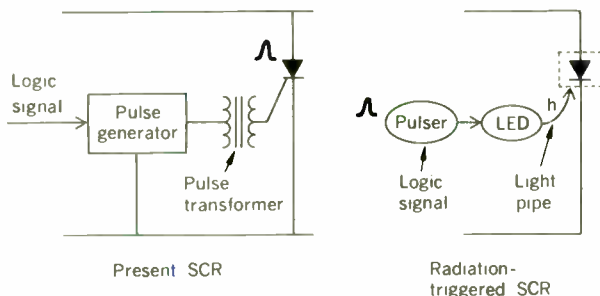
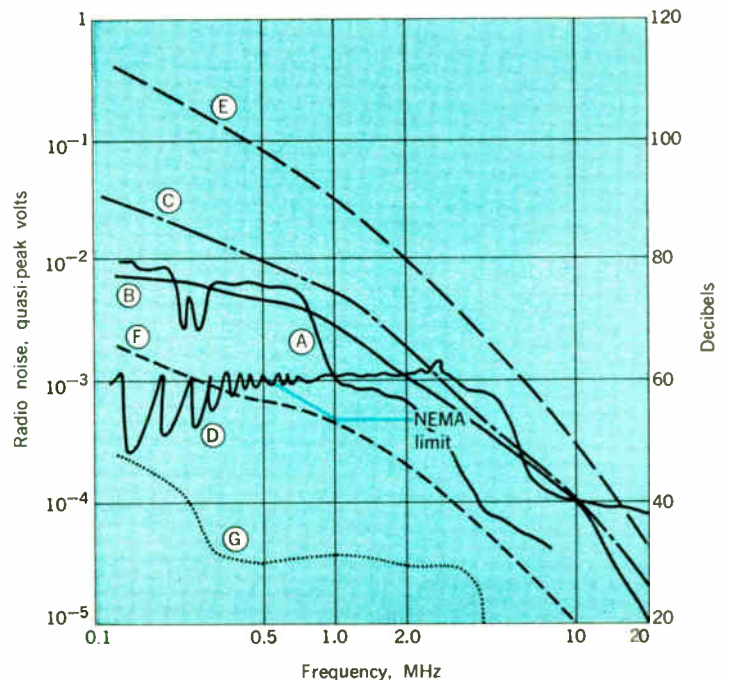


FIGURE 22. Conducted interface for "power-conditioned" equipment up to 100 watts.

- Ⓐ 80-W, 30-kHz lighting inverter (experimental)
- Ⓑ Sonic cleaner, about 25 kHz
- Ⓒ Sonic cleaner, about 50 kHz
- Ⓓ "Solid-state" electric razor
- Ⓔ Dimmer, unsuppressed
- Ⓕ Dimmer, suppressed
- Ⓖ Controlled "turn-on"



This will result in greater and greater electric power consumption in the home.

The major factors that influence the extent to which these new products will constitute a serious problem for the power source, and indeed for each other, have been presented here. The severity of any of these problems will depend on the success of increased emphasis on engineering details, their successful translation into manufacturable designs, the degree of compliance with the requirements of cognizant regulatory agencies, and the emphasis of reputable manufacturers on quality products serving the best interest of the customer. Some degree of surveillance and standardization appears to be necessary if product compatibility and user satisfaction are to result.

The authors are grateful for the assistance of many of their General Electric colleagues; without their cooperation this article would not have been possible.

#### REFERENCES

1. *Electron. Des.*, vol. 17, p. 54, Aug. 2, 1969.
2. Harnden, J. D., Jr., "The controlled rectifier—Key to the continuing control renaissance," *Proc. Special Tech. Conf. on Non-linear Magnetics and Magnetic Amplifiers*, pp. 414–424, Aug. 6–8, 1958.
3. Nairn, J. L., and Thalmer, D. A., "Zero-crossing detector suppresses transients," *Contr. Eng.*, vol. 11, p. 129, Oct. 1964.
4. Gutzwiller, F. W., "RFI-less switching with SCR's," *Electron. Equipment Eng.*, pp. 51–53, Mar. 1964.
5. Reed, J. D., "Zero-crossing sync circuit for SCR's," *Electron. Equipment Eng.*, p. 74, Aug. 1964.
6. Kram, W. P., Watrous, D. L., Harnden, J. D., Jr., and Galloway, J. H., "Monolithic switch system for low cost power control," *Proc. Nat'l. Electron. Conf.*, vol. 23, pp. 285–290, 1967.
7. Phillips, R. A., "Zero point switching eliminates EMI," *Electron. Engr.*, p. 92, Mar. 1969.
8. Buchanan, J. K., "SCR zero point switching eliminates RFI," *Electron. Engr.*, pp. 46–48, Jan. 1968.
9. Jensen, S., "Mini interference," *Electronics*, vol. 40, pp. 4–7, Oct. 30, 1967.
10. Gutzwiller, F. W., "RFI-less switching with SCR's," Publication 660.7, General Electric Co., Semiconductor Products Dept.
11. Bhaumik, A. K., Rectan, D. K., and Phadke, A. G., "A solid state synchronous switch for use in transient and modeling studies," *IEEE Trans. Instrumentation and Measurement*, vol. IM-16, pp. 81–85, Mar. 1962.
12. Thomas, R. J., "How much flicker," *Transmiss. Distrib.*, pp. 34–36, May 1964.
13. Eargle, V. H., "Residential light flicker," AIEE Conf. Paper CP 62-353.
14. *Distribution Data Book GET 1008J*, General Electric Co., June 1962, p. 48.
15. "Urge utilities study flicker limits," *Elec. World*, p. 49, Nov. 3, 1958.
16. "Light flicker problems, electric power distribution for industrial plants," IEEE Publication 141, Oct. 1964, pp. 55–58.
17. Saita, M., and Marisada, K., "The influence of flickering light on visual comfort," *Nat'l Tech. Rept.* 14, 1968, pp. 1–9.
18. Harnden, J. D., Jr., "Effects and applications of solid state appliances," IEEE Conf. Paper 69CP619-PWR.
19. Graniere, G. J., "Thyristors for power switching applications," RCA Tech. Paper ST4035.
20. "Optimum solid state control parameters for improved performance of in-space electric heating systems," Publication 671.12, General Electric Co., Semiconductor Products Dept., Sept. 1968.
21. Bedford, B. D., and Hoft, R. G., *Principles of Inverter Circuits*. New York: Wiley, 1964.
22. "High frequency lighting," Rept. 53, National Academy of Sciences, 1968.
23. Peach, N., "What do high frequencies promise?," *Power*, pp. 157–164, Nov. 1963.
24. Campbell, J. H., Schultz, H. E., and Schlick, J. A., "A new 3000-cycle fluorescent-lighting system," *IEEE Trans. Industry and General Applications*, vol. IGA-1, pp. 19–24, Jan./Feb. 1965.
25. Wollfram, F. M., "Solid-state ballasting of fluorescent and mercury lamps," *IEEE IGA 4th Ann. Conf. Record*, C5-IGA, Oct. 1969.
26. Dickey, L. D., and Jones, C. M., "Solid-state switching for aircraft electric systems," *IEEE Spectrum*, vol. 7, pp. 73–79, Nov. 1970.
27. McQuarrie, A. M., "Controlling loads with SCR's," *Distribution*, 1st quarter, pp. 4–7, 1967.
28. Anderson, J., "Study of harmonics produced by infinitely variable phase controls and their effects on the metering of residential loads," General Electric Co., Meter Dept., Oct. 1967.
29. Branda, M. R., and Helmick, C. G., "Inverter instrumentation—What should it tell you?," *IEEE IGA 3rd Ann. Conf. Record*, C27-IGA, pp. 847–860, 1968.
30. Stanton, K. N., "Instrumentation for thyristor control," *IEEE IGA 3rd Ann. Conf. Record*, C27-IGA, pp. 707–713, 1968.
31. Erlicki, M. S., Schieber, D., and BenUri, J., "Power measurement errors in controlled rectifier circuits," *IEEE Trans. Industry and General Applications*, vol. IGA-2, pp. 309–11, July/Aug. 1966.
32. "Noise effects in control systems," *Machine Des.*, pp. 146–156, Dec. 19, 1968.
33. Schmidt, W. C., "Electrical noise in control system installations," *IEEE IGA 3rd Ann. Conf. Record*, C27-IGA, pp. 229–238, 1968.
34. Willard, F. G., "Prevention and treatment of noise in control signals," *IEEE Trans. Industry and General Applications*, vol. IGA-5, pp. 266–272, May/June 1969.
35. Klicek, B. E., "Reducing electrical noise in instrument circuits," *IEEE Trans. Industry and General Applications*, vol. IGA-3, pp. 90–96, Mar./Apr. 1967.
36. Beadle, R. G., et al., "Reduction of electrical noise in computer and control installations in steel mills," *IEEE Trans. Industry and General Applications*, vol. IGA-3, pp. 79–89, Mar./Apr. 1967.
37. Weit, J. G., "Noise in signal systems associated with static converters," *IEEE IGA 5th Ann. Conf. Record*, 70C1-IGA, pp. 799–806, 1970.
38. Kaiserswerth, H. P., "Radio interference suppression, Part I: Fundamentals," Bulletin 2, Siemens Electronic Components, 1967, pp. 25–27.
39. Kaiserswerth, H. P., "Radio interference suppression, Part II: Radio interference suppression chokes and capacitors," Bulletin 2, Siemens Electronic Components, 1967, pp. 72–75.
40. Kaiserswerth, H. P., "Radio interference suppression, Part III: Interference suppression filters and units," Bulletin 3, Siemens Electronic Components, 1968, pp. 7–11.
41. Kaiserswerth, H. P., "Practical RF interference suppression in three household appliances," Bulletin 2, Siemens Electronic Components, 1967, pp. 126–129.
42. Skopal, T. E., "Stop noise problems before they start," *Electron. Des.*, vol. 17, pp. 90–94, Jan. 4, 1969.
43. "NEAR Task 1—Typical breadboard controls," Final Rept., Office of Civil Defense, Contract 62-185/MRI 2600-1.
44. Schaller, R., "Radio interference suppression of silicon rectifier diodes," Bulletin 2, Siemens Electronic Components, 1967, pp. 171–173.
45. Schaller, R., "Radio interference suppression of SCR's," Bulletin 3, no. 1, Siemens Electronic Components, 1968, pp. 23–26.
46. Schaller, R., "Radio interference suppression of SCR's," Bulletin 3, no. 3, Siemens Electronic Components, 1968, pp. 84–86.
47. Zinder, D. A., "Suppressing RFI in thyristor circuits," Appl. Note AN-295, Motorola Semiconductor Products.
48. "Semiconductor dimmers for incandescent lamps," NEMA Standards Publication WD-2-1970.
49. Ball, W. C., and Poarch, C. K., "Telephone influence factor (TIF) and its measurement," *AIEE Trans. Communication and Electronics*, vol. 79, pp. 659–664, 1960 (Jan. 1961 section).
50. "Thyristor warning issued by electricity council," *Electron. Weekly*, p. 2, Aug. 2, 1967.
51. Goers, R. E., "Quiet—wiring zone," *IEEE IGA Conf. Record*, pp. 249–253, 1968.
52. Nalle, D. H., "Elimination of noise in low level circuits," *IEEE IGA 1st Ann. Conf. Record*, 34C36, pp. 721–735, 1966.
53. "Interference control techniques," Sprague Tech. Paper 62-1.
54. Schmidt, W. C., and Oliverio, J. C., "Electrical noise reduction in industrial control systems," *IEEE Trans. Industry and General Applications*, vol. IGA-5, pp. 259–265, May/June 1969.
55. Budzilovich, P. N., "Electrical noise: Its nature, causes, solutions," *Contr. Eng.*, vol. 16, pp. 74–78, May 1969.
56. Rexrode, L. O., "Noiseproof a digital electronic control system," *Contr. Eng.*, vol. 15, pp. 66–71, Nov. 1968.
57. Wavre, A., "Application of integrated circuits to industrial

control systems with high noise environments," *IEEE Trans. Industry and General Applications*, vol. IGA-5, pp. 278-281, May/June 1969.

58. Mohr, R. J., "Interference coupling—Attack it early," *EDN*, pp. 33-41, July 1, 1969.

59. Gauper, H. A., Jr., "Regulatory and industrial aspects of power conversion interference," *1965 IEEE Industrial Static Power Conversion Conf. Record*, IEEE Publication 34C20, pp. 109-111.

60. Jobe, D. B., "Updating equipment to meet MIL-STD-461 power line conducted interference requirements," *Freq. Technol.*, pp. 18-20, May 1969.

61. "Electromagnetic interference characteristics, requirements for equipment," Military Standard MIL-STD-461, U.S. Department of Defense.

62. "Measurement of electromagnetic interference characteristics," Military Standard MIL-STD-462, U.S. Department of Defense.

63. "Definitions and system of units, electromagnetic interference technology," Military Standard MIL-STD-463, U.S. Department of Defense.

64. "Rules and Regulations," vol. 11, Federal Communications Commission, Superintendent of Documents, U.S. Government Printing Office, Washington, D.C.

65. Kojihara, H. H., "Quality power for electronics," *Electro-Technol. (New York)*, pp. 46-50, Nov. 1968.

66. "The native interface," *Machine Des.*, p. 182, Apr. 25, 1968.

67. Baggott, A. J., "Liabilities and assets of waveform distortion," *IEEE Conf. Electricity Distribution (Edenboro, England)*, pp. 179-186, Oct. 20-22, 1970.

68. Lycett, J. D., "Quality of supply—Recent studies of voltage transients and harmonic distortion," *IEEE Conf. Electricity Distribution (Edenboro, England)*, pp. 311-317, Oct. 20-22, 1970.

69. Emergy, F. P., and Irani, D., "Power transmission at high frequency," 1965 Houston Conf. Supplement, *IEEE Trans. Aerospace*, vol. AS-3, pp. 402-410, June 1965.

70. Dunn, T. E., "System compatibility: Static power supplies and power distribution," *IEEE IGA 5th Ann. Conf. Record (70CI-IGA)*, pp. 643-650, 1970.

71. Baggott, A. J., "The use of thyristors to modify power systems wave shapes for telecontrol purposes," *IEEE Conf. Power Thyristors and Their Applications Publication 53*, pt. 1, pp. 488-497.

72. Greenwood, A., *Electrical Transients in Power Systems*. New York: Wiley, 1971.

73. Martzloff, F. D., and Hahn, G. J., "Surge voltages in residential and industrial power circuits," *IEEE Trans. Power Apparatus and Systems*, vol. PAS-89, pp. 1049-1055, July/Aug. 1970.

**Reprints of this article (No. X71-102) are available to readers. Please use the order form on page 8, which gives information and prices.**



**Harold A. Gauper, Jr.** (SM) received the B.S. in electrical engineering from the University of Wisconsin in 1943 and joined the General Electric Company that same year. As a member of the corporate R&D staff, he has the responsibility of developing methods for the analysis, prediction, measurement, and control

of electrical noise and susceptibility. Since 1951, he has been fully engaged in investigating the electromagnetic compatibility of systems for military, industrial, and domestic use. He also represents GE in the formulation of related standards and regulations by government, professional societies, and industrial agencies. In the defense and aerospace arena, he has made major contributions to the Polaris, Poseidon, Atlas, Minuteman, and other programs, as well as the manned space programs in which GE has participated. Mr. Gauper has served on the IEEE EMC Group Administrative Committee, in addition to many committees and panels for such groups as SAE, NEMA, and ANSI. He was recently appointed to the Electromagnetic Radiation Management Advisory Council established by the Director of Telecommunications Policy, Executive Office of the President.



**John D. Harnden, Jr.** (SM) received the bachelor's degree in electrical engineering from Union College in 1950, joining GE immediately after graduation as a member of the engineering test program. After completion of this program in 1952, he joined GE's Advanced Technology Laboratories in Schenectady,

N.Y., as a development engineer. For over a decade he has been responsible for the application of new

semiconductor components to electric power systems for amplification, modulation, interruption, control, and conversion. He has had extended experience in the design and application of switching circuits and has pioneered in the use of semiconductors to handle high currents and voltages. From 1962 to 1963, he had major technical responsibility for GE's support of the NEAR program, and received a management award in 1963 for this work. At present, Mr. Harnden is engaged in developing and proving the feasibility of a wide variety of next-generation semiconductor devices. He is actively engaged in the IEEE Magnetics Group, serving on several of its committees. Author of over 30 technical papers and coauthor of three books on solid-state electronics, he has approximately 50 patent applications filed in his name, both in the U.S. and ten other countries.



**A. M. McQuarrie** (SM) received the B.S. degree in engineering from the University of Alberta (Canada) in 1940, joining the Canadian General Electric Company in the fall of that year as a test engineer at Toronto. He has been with GE ever since, working on various engineering and manufacturing assignments

at various locations throughout the Western Hemisphere. Graduating from the test program in 1941, he worked on aircraft-instrument design at the Peterborough plant, transferring to the meter department in Quebec, Canada, as manager, engineering in 1948. In 1952, Mr. McQuarrie joined the International General Electric Company, serving in Schenectady, N.Y., Argentina, and Brazil in consulting and managerial capacities for IGE affiliates. Returning to North America in 1956, he re-joined Canadian General Electric's meter department, where he has been assigned to advanced development engineering and design, taking an active role in developing many of that department's products.



**MOBILE TRANSMISSION OF ECG SIGNALS** from emergency vehicle of the Nassau County Police Department is monitored by distant cardiologist who instructs police or other paramedics as to treatment and care of the patient. (Courtesy Pioneer Medical Systems)

## Where would you like to have your heart attack?

*Chances for survival are best near a hospital with a modern cardiac care unit and an ambulance service equipped for ECG telemetry*

**A special staff report**

*The trend toward centralization of population has created new problems in health care both in the sparsely settled hinterlands and within the resultant crowded urban areas. Communication links, including closed-circuit television, are already providing new means for consultation and for rendering psychiatric assistance. Wireless cardiac monitoring is helping to prevent relapse in coronary patients and transmission of electrocardiograms from moving vehicles is a dramatic step in delivering the patient alive to the emergency room. This report summarizes the conclusions of an Engineering Foundation Conference on "Engineering in Medicine—Biotelemetry" held at New England College, Henniker, N.H., August 2-4, 1971.*

At the August conference on "Engineering in Medicine—Biotelemetry," sponsored by the Engineering Foundation, some three dozen engineers and doctors considered present and forthcoming applications of specialized communications to health care. Workshop summaries, equivalent to sets of practical recommendations, were formulated before the group adjourned its sessions at New England College in Henniker, N.H.

The most dramatic application of telemetry to health care is the transmission of the electrocardiogram (ECG) from a patient in a moving emergency vehicle to a monitoring dispatching point. Trained paramedical personnel who man the vehicle are competent to employ a defibrillator or to administer suitable drug dosages. Their observation of an ECG oscilloscope trace in the vehicle enables them to perform an initial diagnosis and to establish radio contact with a cardiologist at the central control point. The cardiologist makes his diagnosis after viewing the telemetered oscilloscope pattern before him and then orders the paramedic to take an appropriate action. This procedure has legal sanction in the states in which these systems are in use, the licensed physician being always in charge and responsible.

### **Better use of prehospital time**

The function of an ambulance or other emergency vehicle is to deliver the patient live to the hospital. It has been increasingly recognized that the majority of deaths from acute myocardial infarction (AMI) occur before hospital admission. AMI denotes death of heart muscle tissue following the stoppage of blood flow secondary to coronary artery occlusion. As reported by J. F. Pantridge, M.D. (Royal Victoria Hospital, Belfast, Ireland),

among men of middle age and younger, 63 percent of such deaths occur within an hour of the onset of symptoms.

Because most deaths occur before hospital admission, a mobile coronary care unit was started in Belfast in January 1966. The system provides a junior physician and nurse as well as monitoring apparatus, drugs, intravenous solutions, and a portable defibrillator. Telemetering equipment and radiotelephone keep the team in contact with the hospital coronary care unit. It is of interest that hospital mortality of patients managed by the mobile unit is lower than that recorded among patients admitted to coronary care units in the usual way, reducing the mean from 22.6 percent to 12.3 percent. In 1969, for example, among 447 patients with acute myocardial infarction managed by the mobile unit, ventricular fibrillation (chaotic, uncoordinated muscular contractions of the heart leading to no blood flow) was corrected outside the hospital and before transport in 14 patients, or 3 percent.

### Mobile cardiac unit

An ambitious program in Montgomery County in Maryland makes use of a Heartmobile, a special motor vehicle, high enough for standing, equipped with a demand pacemaker, cardioverter, resuscitator, and ECG and pulse recorder connected to the transmitter of the two-way radio communications equipment. The vehicle is staffed by paramedical personnel, including a nurse with experience in treating cardiac patients, a cardiology technician, and a driver who is an experienced emergency-room technician. The Heartmobile is credited with saving at least one life each month since being put into service in March 1970. Manned by two three-member teams, its

availability is limited to weekdays from 8 o'clock in the morning until midnight. The cost of the equipped vehicle was about \$60 000 and salaries at present amount to about \$45 000. Such costs are too high for the average community and those in charge of the program believe that future trends will be in the direction of rescue squads supplied with portable equipment for handling coronary attack victims. Although extensive special training is necessary for personnel, it is estimated that equipment would cost about \$5400 for each squad.

### Nassau County experience

Dr. Costas T. Lambrew, cardiologist at the Nassau County Medical Center in East Meadow, N.Y., described an emergency mobile system that has been in operation since March 1971. The program serves an area containing some 1.5 million people that has heavy traffic problems and many automobile-induced injuries. The community has tended to meet this challenge by providing a county-wide police service with which is associated an ambulance service operated by uniformed civilian personnel. Emergency vehicles are available in the eight precincts into which the county is divided, and there are seven roving vehicles. An average of ten hospitals receive patients.

The relatively flat terrain that is characteristic of all Long Island makes for relatively reliable radio communication. A remote transmitter and receiver are now mounted on a water tower on the North Shore; the main antenna for the hospital base station is atop a new 19-story Center building, providing excellent communication.

Concern for the large number of cardiac patients dying outside the hospital (35 percent) and Dr. Lambrew's desire to develop a means for avoiding arrhythmia have

## What we know and what we need to do

### *Report of the Emergency-Vehicle Workshop*

#### 1. Why have telemetry at all?

Health care delivery systems of the future trend toward centralized physician/decision makers. Remote personnel will be paramedical people who will need to supply some classes of information so that treatment can be decided upon and ordered by the physician. Therefore, remote parts of the system—for example, emergency vehicles—will require two-way communications of two kinds: voice communication, and telemetered biosignals; also, given adequate technological control, video communication.

#### 2. What are the most important roles of EVs?

- (a) Cardiac disabilities.
- (b) Vehicular accidents.
- (c) Drug overdoses.

3. The prime objective of emergency-vehicle service is simply to get the patient into the hospital, alive. There are three major emergency physiological problems: (a) respiratory block, (b) disturbances in electrical activity of the heart (bearing principally on maintenance of cardiac-pulmonary function), and (c) hemorrhage. If the emergency-vehicle services can deal adequately with problems of ventilation and electrical and mechanical dis-

abilities of the cardiovascular system, one of their most important functions will have been accomplished.

4. Given these needs, one sees that a large part of the emergency procedure will involve simple, direct observation such as signs of shock and easily read and interpreted signals such as blood pressure. Such information is most readily transmitted, if required, by voice communication. In many cases—if not most—transmission of medical data from direct observation is more important than transduction and telemetering of physiological signals. Patients in emergency situations are usually classified by potential physiologic threat, which can be observed and verbally described to a remote physician.

5. The biological signals that appear to be important for emergency transduction would appear to be limited to (a) electrical activity of the heart, (b) mechanical activity of the heart, and (c) the concentration of blood oxygen and carbon dioxide. There seems to be little need for other telemetry signals, especially given the less than ten minutes typical transit time from pickup to hospital in an urban area. And in such a brief time, a



**NORMAL ECG shows recurring healthy rhythm of the heart.**

resulted in a system whereby patients are monitored by paramedics with portable ECG equipment during the ambulance trip. The ECG output is used to modulate the mobile transmitter and the resultant demodulated pattern is observed by the cardiologist on duty at the monitoring point. He gives instructions to the ambulance personnel, possibly to apply voltage pulses from a defibrillator if severe arrhythmia has already begun. A cassette magnetic-tape recorder provides a permanent record for analysis and as possible legal protection. Of some 1300 patients so far managed during this program, 234 complained of chest pains, 550 were found to have suffered traumas, and the balance had other problems. The paramedics have been taught to consider a patient with chest pains a probable cardiac case. The experience to this point shows that 28 patients worsened, 18 were resuscitated, and 25 were found dead on arrival of the ambulance at the pickup point. The average time of an ambulance between pickup and arrival at the hospital is 6.8 minutes.

Keeping this time short is important because of the roughly 500 000 who die in the United States each year from AMI, 40 to 70 percent of the deaths occur within the first hour after the onset of symptoms.

It is planned to extend treatment to administration of drugs after the paramedical personnel have been given further training. A patient with a developing arrhythmia is better treated with either atropine or lidocaine—depending on the nature of the arrhythmia, visible on the ECG trace to the monitoring cardiologist—than to proceed into fibrillation.

The Nassau County situation is ideal in many respects and the solutions effective there cannot necessarily be applied to all medical or engineering problems.

#### **Serving the Hartford area**

Less fortunate in his choice of terrain, Dr. Robert J. Huszar of St. Francis Hospital, Hartford, Conn., became a cardiologist by way of an earlier hobby in electronics.

patient simply cannot be coupled into many monitoring systems.

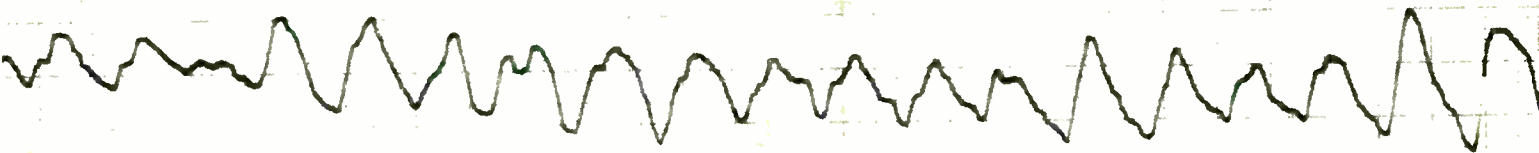
6. With respect to these three measurements, the first—electrical activity of the heart—is technically in hand and proven valuable. The second, mechanical action of the heart, is only partially approached by blood-pressure measurement (and it should be noted that this need not be telemetered; verbal reporting may suffice). Fundamental research is required and should be encouraged for other indexes of deteriorated cardiac function. Monitoring mechanical parameters, along with electric signals, should be useful. With respect to the third class of measurements, the techniques for monitoring blood gases are still imperfect, and further development of transduction (and perhaps telemetering) technology appears to be called for.

7. Planners of emergency-vehicle health services have two distinct technological problems. The first, to decide what measurements are required or are useful, is not well explored; disagreement exists among experts and more investigation clearly is required. But for now, at least, the number is small. The second problem area, that of technical integration of spoken and telemetrically transduced information into communication networks, is also imperfect, but principally because elegant system design has not yet matured on a widespread basis. State-of-the-art communications techniques and components seem adequate. Bandwidth require-

ments are modest, but adequate communication frequency assignments have yet to be made. It should be noted that a single voice channel may also be used on a time-shared basis for telemetry signals. The principal difficulties appear to be economic.

8. There are several reasons for expanding the technology of telemetering physiological signals besides that of immediate meeting of threat to the patient's life. One is to find out more about pre-hospital patient monitoring and care, a topic about which little is known. Another is further to train paramedical personnel, for if such people are to play an important role in the medical care of the future, then they must have adequate remote consultative facilities with physicians who will provide final medical judgment. However, we should not try to substitute biometric telemetry for the adequate training of paramedical personnel. Sophisticated measurement, quantification, and automation do not necessarily lead to improvement. Then, too, there are reasons of physical control for legal purposes; for example, since paramedical personnel are not medically licensed, the physician, to maintain ultimate control and responsibility, must have available those data about which sophisticated decisions must be made. ECG waveforms provide one example.

9. The several successful but isolated and incomplete experiments in emergency-vehicle telem-



**LETHAL ARRHYTHMIA showing ventricular fibrillation.**

Besides contributing engineering knowledge unusual in an M.D., he has found it necessary to develop means for funding his \$42 000 project without federal assistance. When fully operational, the system will serve a population of over a half million within Hartford (260 000) and surrounding communities. Costs include portable equipment for five coronary ambulances and extension of monitoring to two other hospitals. In addition to radiotelephone transceivers, remote receivers, and tower and telephone-line rental, the cost of ECG and defibrillation equipment is included.

The communications/telemetry equipment, which Dr. Huszar designed, combines a portable ECG signal modulator and monitoring system with existing land mobile voice-communication equipment. The Cardio-Alert amplifies the ECG signal, generates an FM subcarrier, provides a visual and audible heart-rate readout, automatically keys the transmitter by abnormal heart rates, and generates a calibration signal. At the receiving end of the

telemetry system, a demodulator and amplifier give a suitable output for the oscilloscope, direct writer, or tape deck. The system has been designed to provide continuous monitoring at the patient's location and en route to the hospital with periodic short transmissions of the ECG to the hospital when necessary for evaluation. If the physician wants to interrupt the ECG transmission, he operates a tone recall at the hospital that is picked up in the ambulance during an automatic 0.5-second silent period that alternates with the 15-second ECG transmit cycle.

The present radiotelemetry system comprises a base station with transmitter and receiver atop the highest building in Hartford. It is connected by telephone line to remote consoles located in the St. Francis Hospital Research Laboratory and Emergency Room. The two-way portable voice/telemetry equipment has been in use in a private ambulance serving the area for more than two years.

etry systems clearly indicate that there is value in the approach and that widespread evolution and incorporation of such systems should be encouraged. But progress is observed to be rather slow, particularly in light of present technological resources. What holds back more advanced development? There are four basic reasons:

(a) There is no leadership and little pressure to achieve widespread use of advanced methods.

(b) There is no central clearinghouse for medical, engineering, and funding information for use by would-be service innovators.

(c) Efforts so far have been fragmented and ill-supported, and consequently the art is embryonic. There is not yet a critical mass of know-how or positive evidence of successful design and practice.

(d) Funding agencies, most particularly federal ones, appear to be dollar-limited and more concerned with other problems.

10. Listed in the following are the fundamental needs we see; the items are more or less equal in importance—no rank ordering is intended.

(a) Proposals and funding for pilot experimental projects on a regional (for example, statewide) basis, especially to find a full list of useful measurements that will permit establishment of a data base on which emergency medical services can be objectively evaluated.

(b) A national information clearinghouse and

consultation availability on medical, engineering, and legal details.

(c) Studies of optimum systems design.

(d) Extensive leadership at local levels and pressure on local governments to provide tax funds. (Emergency-vehicle service is estimated to cost as little as 75¢ per year for each person in a densely populated urban community, whereas in rural areas unit costs will probably be slightly greater.)

(e) A public-relations campaign to create a grass-roots demand for emergency-vehicle services that are at least as adequate as other local services, such as police and fire, that may be even less important to the entire populace now.

(f) Development and extension of regional programs sponsored by community hospitals and clinics.

11. In summary, emergency-vehicle medical service appears to have a minor component in technological problems (both medical and engineering) that can be dealt with by modest research and development effort, and it has a major component in the economic and widespread-deployment aspects. Considerable effort is required here. A national organization would appear to be called for. Shiny Cadillacs with chrome stretchers can be replaced by useful meat wagons if we see to it.

*L. D. Harmon  
Workshop Chairman*

Cleveland, Ohio. It is used for educational purposes between University Hospital and the Veterans Administration Hospital several kilometers away. A problem with visual (laser) communications is scintillation of the signal as a result of atmospheric turbulence. In the intensity-modulation system described, the laser beam is made to blink sinusoidally at 30 MHz and the intelligence is carried on a frequency-modulated subcarrier. Capable of handling a color television channel, the circuit is claimed to be 99.9 percent reliable over a few kilometers, with a signal-noise ratio of 50 dB. It has functioned without loss of quality in very bad weather, including heavy snow.

### Government support limited

The federal government's representation at the conference was headed by Dr. Edward J. Burger, Jr., Office of Science and Technology, Executive Office of the President, whose keynote address cautioned that people outside engineering are questioning technology, and to beware the concept of a gadget looking for a job. He urged that the types of information required by a physician be listed in order to decide how technology can improve its acquisition. His exhortation to consider the interplay between devices and people was frequently reechoed throughout the meetings.

From a medical viewpoint, Dr. David D. Rutstein, Harvard University Medical School, Boston, Mass., urged that the important end result of applying technology be to diminish disease, disability, and untimely death.

Federal representatives from the areas of financing indicated clearly that funds are in very short supply, if not completely unavailable, and Dr. Arthur Barsky, from the National Center for Health Services Research and Development, stated that their present time frame is not five years but two.

Representatives from other branches stated that support for suitable health projects is already being provided and more is available, especially in cooperative ventures that do not require dollar funding. Among these were Dr. John D. Chase of the Veterans Administration; Col. Richard S. Malone, School of Aerospace Medicine, Brooks Air Force Base, Tex.; James T. Richards, NASA; and Bernard Shacter, National Institutes of Health.

In reporting the evaluation of some 1400 grant-in-aid programs, Charles E. Lathey, Office of Telecommunications, Department of Commerce, mentioned both Project 2020 and MAST, essentially health-care studies that are supported by the Department of Transport.

Although biotelemetry has not yet become a factor in either program, the radio communications necessarily available make further exploitation using instrumentation a practical follow-on.

Project 2020 is a study comparing the effectiveness of helicopters with land ambulances in Nebraska. Although it has been completed, no final report is yet available. The work was performed in part by the University of California at Los Angeles and the eventual report will be available from the National Technical Information Service, Springfield, Va.

MAST (Military Assistance to Safety and Traffic), now in the demonstration phase at five sites, provides helicopters and crews from existing military capability to be utilized at the request of civil authorities. Voice

communication is provided, because the military vehicles are so equipped.

Three of the sites are Army bases: Fort Sam Houston, San Antonio, Tex.; Fort Lewis, Wash.; and Fort Carson, Colo. Two sites are Air Force bases: Mountain Home AFB, Boise, Idaho, and Luke AFB in Arizona. The medical study is being made by Ohio State University and Stanford Research Institute is handling the vehicular study for the Department of Defense.

Modulating the signal with physiological data has not yet been tried. In one case reported, however, it was requested that the Coast Guard transport a heart patient from one of the British islands into Miami, Fla. The Coast Guard asked for a heart specialist to accompany the flight and a Fire Department representative took portable ECG equipment with him. Readings were successfully transmitted back to Miami without an external antenna through an open door of the helicopter that was oriented in the direction of the receiving station.

### FCC rule-making

Practical considerations of obtaining licenses for the operation of specific radio systems from the Federal Communications Commission were discussed by Dr. Fred B. Vogt, University of Texas. By the time of publication of this report, comments must have been received by FCC on their proposal to provide frequencies for biotelemetry (SPECTRUM, Sept. 1971, p. 106).

The conference was led by Charles W. Garrett, National Academy of Engineering, and James T. Richards, National Aeronautics and Space Administration, was cochairman. The workshops were headed by Leon D. Harmon, John G. Webster, and James N. Brown.

Alexander A. McKenzie

Considerable information has been furnished since the Conference through the kindness of several individuals: Al Feiner, Dr. Pierre M. Hahn, Dr. Robert J. Huszar, Dr. Costas T. Lambrew, Charles E. Lathey, Norman Lemieux, Capt. Frank Parker, Miss Elizabeth A. Penick, Mrs. Charlotte J. Sanborn, Dr. Fred B. Vogt.

### SELECTED BIBLIOGRAPHY

- "Biomedical electronics," special issue, *Proc. IRE*, Nov. 1959.
- Caceres, C. A., (ed.), *Biomedical Telemetry*. New York; Academic, 1965.
- Miller, A., et al., "Recent developments in biomedical engineering," NEREM Record, pp. 112-123, Nov. 1966.
- "Recommendations for standardization of instruments in electrocardiography and vectorcardiography, report of Subcommittee on Instrumentation Committee on Electrocardiography, American Heart Association," *IEEE Trans. Bio-Medical Engineering*, vol. BME-14, pp. 60-68, Jan. 1967.
- Stark, Lawrence, et al., "Status of research in biomedical engineering," *IEEE Trans. Bio-Medical Engineering*, vol. BME-15, pp. 210-231, July 1968.
- Lown, Bernard, and Selzer, Arthur, "The coronary care unit," *Am. J. Cardiol.*, vol. 22, pp. 597-602, Oct. 1968.
- Grace, W. J., "The mobile coronary care unit and the intermediate coronary care unit in the total systems approach to coronary care," *Chest*, vol. 59, pp. 363-368, Oct. 1970.
- Pantridge, J. F., "Mobile coronary care," *Chest*, vol. 58, pp. 229-234, Sept. 1970.
- Mackay, R. S., *Bio-Medical Telemetry* (2 ed.). New York: Wiley, 1970.
- "Communications technology for urban improvement," National Academy of Engineering, 1971; available from National Technical Information Service, Springfield, Va. 22150, \$3.00.

Reprints of this article (X71-103) are available to readers. Please use the order form on page 8, which gives information and prices.



# The technological dilemma of the United States

*Whether a society effectively uses technology for productive and beneficial purposes depends upon many factors—among them the availability of capital, the supply of skilled labor, and the economic and political structure of the society*

*J. H. Hollomon, A. E. Harger* *Massachusetts Institute of Technology*

*The rapid growth of federally supported research and development during and following World War II, and particularly between 1950 and 1960, appears to have had several major effects on the technological activity of the United States and its industry. However, the most important effect of this growth was the rise in the cost of research and development, including the cost of the technical personnel involved in it. In an assessment of the U.S. investment in R&D for space and defense versus civilian-oriented research and development, it is seen that the United States lags behind the eight European nations studied, and trails Japan even further. With this in mind, it is clear that if both the social and material needs of the people are to be met, new policies and new directions are required of governmental, industrial, and academic institutions.*

During these times of rapid change, of the increasing awareness of social problems, of declining trade balances, of inflation, and of unemployed scientists and engineers, thoughtful attention must be directed to the United States' science and technology policy. And one important aspect of such a policy concerns the way in which technology is used by society, particularly how it affects civilian or industrial activity.

Many people have struggled to quantify the influence that new technology has upon industrial development, economic growth, and social advance. Qualitatively, the dependence of a modern economy on the use of new technology is an accepted fact: Technology becomes embodied in more effective production machinery, in more skilled labor, and in products and services that better serve social needs. The direct connections between research and development, and the resultant particular practical benefits, are more difficult to specify. However, it is these connections that must be understood if science policy—national or corporate—is to be effective.

In any attempt to assess the direct consequences of investment in research and development, it must be clearly established that the particular investment has been di-

rected toward the purposes that are being considered. For example, suppose we are looking for the sources of general economic health in the nation; we must recognize that the R&D that has been aimed toward spaceflight and defense is unlikely to have had as significant an influence as an equivalent R&D activity directed toward, say, improvements in productive efficiency in the automotive industry.

Clearly, the effects of R&D on a nation as a whole cannot be understood without distinguishing among the various economic sectors. In the United States, for example, where most workers are engaged in service activities and most R&D is devoted to manufacturing, the overall rate of change in productivity cannot be expected to correlate with the amount of national civilian-oriented research and development.

Other factors influence the consequences of R&D. Most important is the delay, of almost indeterminate length, between an investment in research and development and the appearance of its results in the world. Recent studies have indicated that this time delay has shortened but, even so, any major new technological development does not diffuse throughout the society in less than five to ten years.

In a recent analysis, Harvard's Richard B. Freeman found—after taking the time delay into account as best he could—a good correlation between the growth rates and profitabilities of different industrial sectors and the R&D that was performed in those sectors in prior years.<sup>1</sup> These correlations are illustrated in Figs 1–3, in which R&D intensity is indexed by the ratio of R&D expenditures to sales. Increases in value added, a term denoting the difference between the value of a manufactured product and that of the materials at the beginning of the manufacturing process, indicate output changes unadjusted for price increases. Output increases adjusted for price changes are measured by the increase in the Federal Reserve Board Index of Production. Changes in labor productivity are measured by the change in the industry's index of production divided by the number of employees

Essentially full text of an article appearing in the July/August issue of the *Technology Review* of the Massachusetts Institute of Technology. The article is copyrighted (1971) by the Alumni Association of M.I.T.

in the industry. The rank-order relationship in Fig. 3—like Figs. 1 and 2—indicates a positive and significant correlation between growth in industrial output and R & D intensity.

Prof. William N. Leonard of Hofstra also has shown that R&D spending by companies (excluding federal R&D) relates significantly to growth rates of sales, assets, and net income, based on 16 industries performing nearly all manufacturing activity.<sup>2</sup>

Since World War II there have been other analyses, both for particular industries and for the economy as a whole, that relate the effects of R&D to their economic consequences. It is clear that, for our type of national economy at least, industry underinvests in R&D relative to the total social return it generates in comparison with alternate investments. This underinvestment arises be-

cause an individual firm cannot appropriate all of the benefits of any new technical development, but must bear most of the cost of that development. In other words, many of the results of a particular development are not of direct benefit to a firm, but indirectly affect other firms that use those results. Furthermore, when a development is highly risky, a firm may forgo investment in it because of the cost of failure even though the rewards of the most probable outcome would fully justify the investment. To put the matter another way, individual firms will underinvest in order to minimize their risk, though the expected rewards from investment in development, on an average basis for many firms, could be quite high. This situation becomes more serious the larger the initial development cost and the more radical the new technology. For instance, in the development of nuclear power the risk may be such that no firm exists with the capability of investing at the early stages of the technology. Only society as a whole can afford the risks or the uncertain costs resulting from technical uncertainty.

A summary of these studies of the effects of R & D commissioned by the National Science Foundation indicates that the contributions of research and development to economic growth and productivity, even with this underinvestment, are positive, significant, and large.<sup>3</sup>

### Industry versus space and defense

During and following World War II, the United States invested heavily in research and development, as illustrated by Fig. 4. The most rapid increase occurred between 1953 and 1959, and resulted largely from increases in federal funding (Fig. 5); since 1964 there has been a decrease in total effort relative to the gross national product. It is clear that, as the federal government began to invest more and more in R&D, industry did not follow suit as rapidly; and that, conversely, as the federal investment decreased, industrial investment tended to rise.

The recent growth of the U.S. R&D effort is less dramatic when measured not in dollars, but in the number of

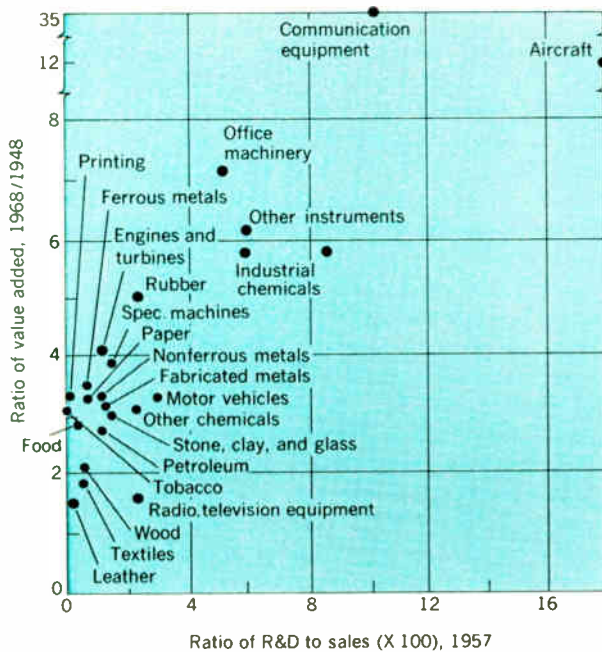


FIGURE 1. Increases in value added versus R&D intensity.

FIGURE 2. Increases in deflated output per Federal Reserve Board Index versus R&D intensity.

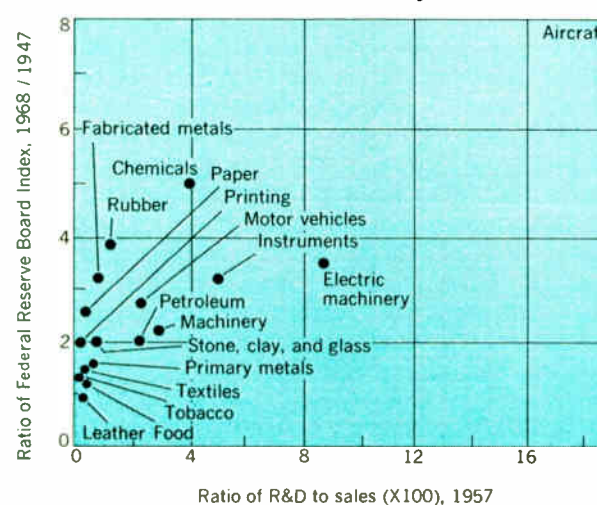
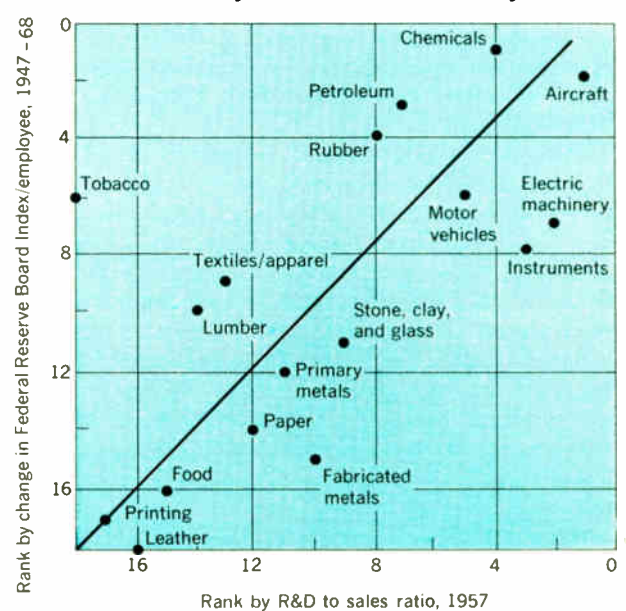


FIGURE 3. Productivity rank versus R&D intensity rank.



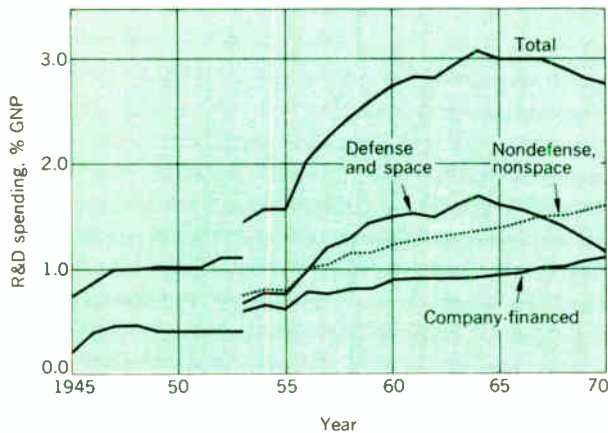
scientists and engineers involved (Fig. 6). The costs of technical work have risen much more sharply than the general rates of inflation and of improvement in productivity. Indeed, the rapid growth of federal R&D has itself done much to raise the costs. The major increases illustrated in Fig. 7 correspond to the increases in federal R&D support (Fig. 5). A dominant source of the rise in costs was in the increase of salaries relative to that of others in the economy (Fig. 8).

During the period 1950–1960, the rapid increase in space and defense R&D increased the demand for the new technical people. (For considerations of the supply of and demand for engineers and scientists, see Refs. 4–6.) Apparently there was, within industry, a transfer of technical personnel from industrial to governmental projects. Because of this competition and the great increase in R&D support, salaries rose, and the cost of R&D, and probably of other technological activities, rose significantly.

Figure 9 illustrates a dramatic effort of this extraordinary demand. Between 1950 and 1965, nearly 100 000 more engineering jobs were created than there were graduates available with engineering degrees. During these years, the increase in the number of new engineers reported to be employed was substantially greater than the number of new engineers entering the labor force from higher education. Thus, it appears that industry must have been

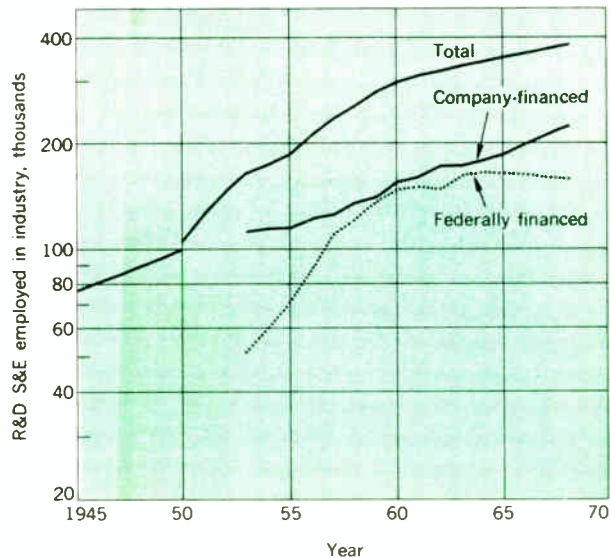
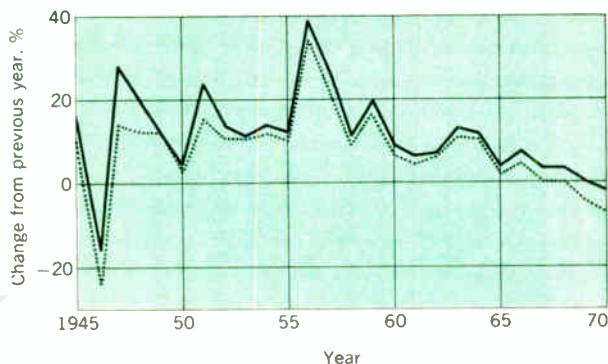
upgrading technicians to take the place of trained people who were transferred to federal programs. A related consequence of the rapid growth of R&D must have been a decrease in the average level of training, if not skill, of the remaining industrial engineers.

Since 1950, there has been an increase in industrial funding for research and development. However, its impact has been limited by rising costs. Figure 10 illustrates the year-by-year change in the number of industrial scientists and engineers per 1000 employees in those companies performing R&D. Even these figures are somewhat inflated, for some of these scientists and engineers were no doubt engaged in R&D related to products sold for defense and space purposes. The illustration



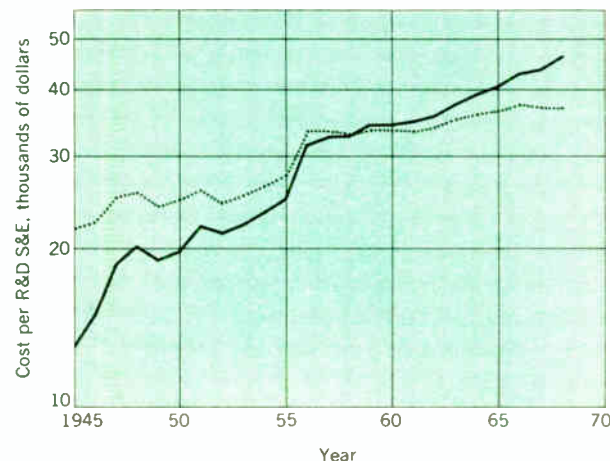
**FIGURE 4.** Research and development spending in the United States since World War II, shown as percent of GNP (Sources: DOD, 1945–53; NSF, 1953 on.)

**FIGURE 5.** Year-to-year changes in total federal R&D support. Solid line represents current dollars; dashed line shows 1958 dollars using the implicit GNP deflator.



**FIGURE 6.** Postwar growth of R&D in industry in terms of the number of scientists and engineers employed (1953–61 company/federal estimates are by the authors; 1961–68 company/federal estimates are from the National Science Foundation). (Sources: DOD, 1945–50; NSF [with Bureau of Labor Statistics], 1950–57; NSF, 1958–68.)

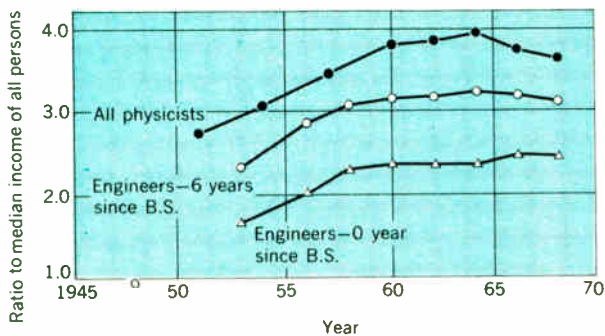
**FIGURE 7.** Increases in the cost of research and development per R&D scientist and engineer in industry. Solid line represents current dollars; dashed line shows 1958 dollars using the implicit GNP deflator. (Sources: DOD, to 1952; NSF [BLS], 1953–56; NSF, 1957 on.)



shows that R&D for industrial purposes has remained about constant for nearly ten years.

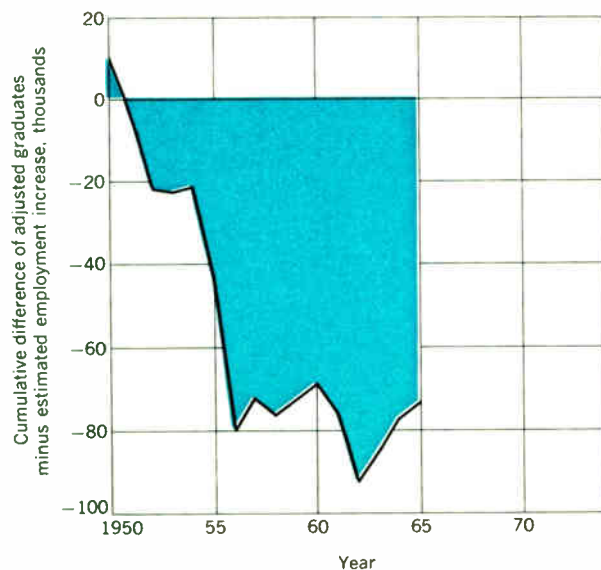
Other factors have probably affected the industrial investment in technology. Interest rates have continually risen in the United States during this period and, according to some economists at least, this has retarded capital investment. Not only is capital investment required in order to infuse new technology into the economy, but large investment commitments in general tend to stimulate research and development. In addition, it is likely that the combination of high government demand and rapid obsolescence of technology in the space and defense fields attracted a disproportionate fraction of venture capital to these industries and was an important contributing factor to the rising price of capital.

During the past several years, the decline of the federal effort has not been compensated for by the slight increase in industrial activity. The result has been unemployment of scientists and engineers, particularly those who were



**FIGURE 8. Salaries of physicists and engineers as a ratio to median income of all persons. (Sources: Median income from Bureau of Census; data for engineers from Engineering Manpower Commission; data for physicists from the American Institute of Physics.)**

**FIGURE 9. Cumulative progress of the appearance of "engineers" for whom no engineering degrees were awarded (assuming no cumulative surplus or deficit in January 1950). (Sources: NSF [BLS] for employment; U.S. Office of Education for degrees.)**



connected with space and defense. Crude estimates indicate the total unemployed to be of the order of 100 000.

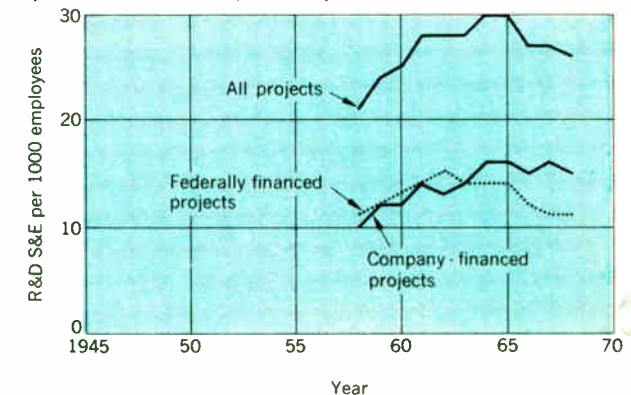
To reiterate, the rapid and large growth of federally supported research and development, occurring particularly between 1953 and 1960, appears to have had several major effects on the technological activity of the United States and its industry. The most important effect of this growth was the rise in overall cost of research and development. This increase occurred not only in the cost of R&D to the government, but, very significantly, in the cost of this activity to industry. A major factor in this cost rise was the increased cost of the technical personnel involved. The rise in the rank of starting engineers and scientists in the income distribution, relative to the rest of the population, dramatically illustrates this increase (Fig. 11).

Starting salaries for engineers with bachelor degrees, for example, rose during the period of rapid R&D expansion from the 77th percentile in the rank of income of all people in the United States, to about the 86th percentile. During this same period, it is estimated by Freeman<sup>1</sup> that about 20 to 30 percent of the increased activity supported by the federal government was made possible by a transfer of people from industrially supported projects. The remaining increase was accomplished by absorbing the supply of new technical people.

### University as supplier

The increase in demand generated by federal funds had a significant effect on the choice of fields by those attending universities. The fraction of college graduates opting for science, mathematics, and engineering has changed very little since World War II (Table I). Hugh Folk has pointed out that the choice of a broad field by students does not appear to be affected by demand, which influences only the choice of lucrative activities within broad fields.<sup>7</sup> Changes in salaries and stipends affect the choices between fields, and determine in part whether or not students decide upon graduate education in particular fields. However, though those in science and engineering have been supported mostly by federal funds to universities, the proportion of scientists and engineers among all Ph.D.'s has not increased appreciably. Apparently, the federal funds merely permitted the universities to re-

**FIGURE 10. Number of R&D scientists and engineers employed per 1000 employees in those companies reporting research and development activity. (Sources: NSF, 1962-68; authors' estimates, 1958-61.)**



**1. Men's bachelor and first professional degrees in engineering, physical science, and mathematics as a percent of all men's bachelor and first professional degrees<sup>7</sup>**

Year	Percent of Total Men's Bachelor and First Professional Degrees			Total
	Engineering	Physical Science	Mathematics	
1948	17.5	4.8	1.5	23.8
1949	17.2	4.5	1.3	23.0
1950	15.8	4.7	1.5	22.0
1951	14.8	4.4	1.5	20.8
1952	13.4	4.4	1.5	19.3
1953	12.0	4.2	1.6	17.8
1954	11.9	4.4	1.5	17.7
1955	12.3	4.6	1.5	18.3
1956	13.1	4.7	1.6	19.4
1957	14.0	4.7	1.7	20.4
1958	14.5	4.7	2.0	21.2
1959	14.9	4.8	2.6	22.3
1960	14.7	4.9	3.3	22.9
1961	14.0	4.7	3.7	22.3
1962	13.2	4.7	4.0	21.9
1963	12.1	4.6	4.0	20.7
1964	11.7	4.5	4.2	20.4
1965	11.5	4.3	4.0	19.8
1966	11.8	4.5	4.4	20.7

distribute their resources to meet a rapidly rising social demand for graduate education in all fields of knowledge. Changes in salaries and stipends affected choices toward engineering and physics, for example. Figure 12 illustrates the relationship between the year-by-year increase in the number of freshman enrollments in engineering and the changes in incentives predicted from salary changes.<sup>8</sup>

There has been some shift between engineering and

mathematics, but, in any event, the response of the new supply of technical people to economic factors is sluggish and cyclical. The yearly new supply of graduate scientists, mathematicians, and engineers has varied from 33 000 to a high of 61 000. In recent years, this new supply has been about equal to the reported increase in new employment of scientists and engineers, implying little upgrading of people who did not have "certificates" as scientists or engineers.

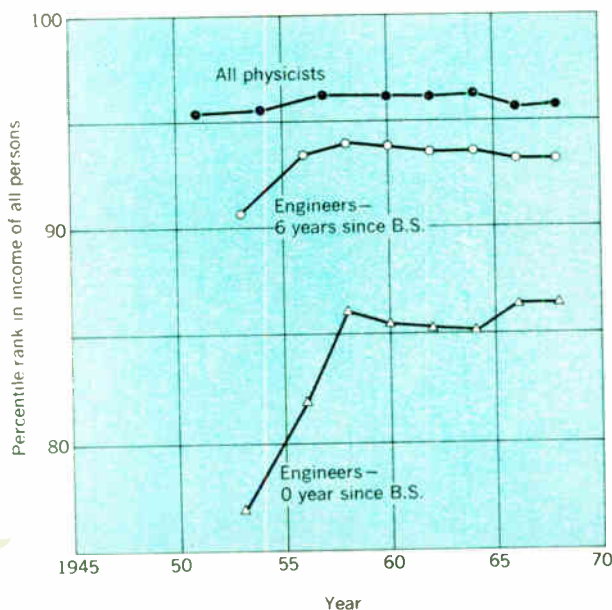
There has been great growth in the support of research in universities by the federal government, largely attributable to the support of biomedical research in university medical schools and affiliated hospitals. However, for the physical sciences, and especially engineering, the largest share of this growth has derived from the Department of Defense, the Atomic Energy Commission, and the National Aeronautics and Space Administration. This support surely biased university activity away from industrially related research, especially that connected with the less glamorous industrial problems.

**The practical loss**

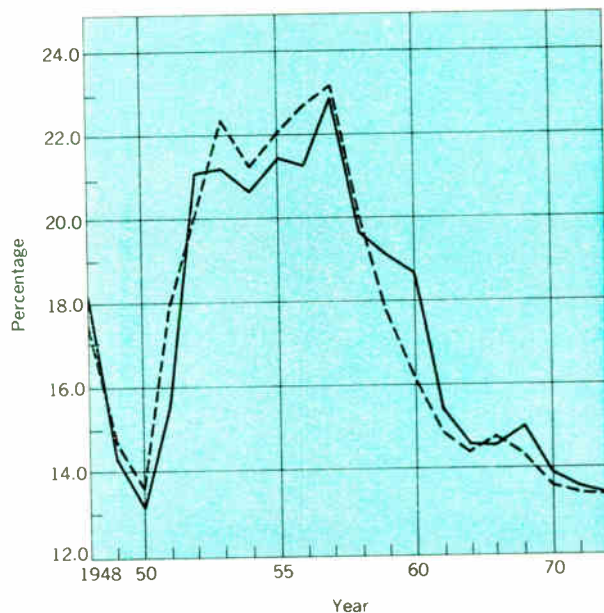
Although it is probably impossible to assess all effects of federal policy over the past several decades, there are several feasible possibilities. It seems reasonable to expect that, ten years or so after a relative decline in technical activity, its consequences should begin to be evident. For example, the rate of increase in productivity might begin to diminish. Although the dependence of productivity upon a wide range of other factors—such as the availability of capital—is well recognized, eventually a reduction in investment in technical activity devoted to industrial purposes should be reflected in a decreased rate of improvement in productivity. And indeed, in the last few years productivity increases have declined.<sup>9</sup>

There is another way in which we can deduce the effects

**FIGURE 11. Percentile rank of median salaries of engineers and physicists in income of all persons. (Sources: Bureau of Census, Engineering Manpower Commission, American Institute of Physics.)**



**FIGURE 12. Percentage of freshmen in engineering compared with proportion predicted by relative engineering salary levels one year earlier. Solid line shows predicted proportion; dashed line represents actual proportion.**



of the postwar research and development policies. Boretzky has compared the technical activity of Europe and Japan with that of the United States for the period 1959–65 (just following the rapid growth of the United States effort).<sup>10</sup> Table II compares the total R&D efforts for these years as fractions of national GNPs at market prices, for the United States, Japan, and the major European countries. The defense and space portion of the total effort and the civilian effort are also included for comparison. Superficially at least, this table would indicate a significant advantage of the United States for all R&D, and a somewhat lesser advantage for its “civilian-oriented” activity.

However, when R&D efforts are translated into cost-equivalent terms, and into the number of scientists, engineers, and technicians employed (Table III), the results are startling. The last column in Table III expresses cost-equivalent expenditures for R&D as fractions of the GNPs, the latter converted to equal-purchas-

ing-power terms. When the comparison is thus made on the basis of cost-equivalent expenditures, the relative advantage of the U.S. investment in civilian R&D disappears. Even more significant, about 30 to 35 percent more scientists, engineers, and technicians were engaged in civilian-oriented R&D in the eight European countries studied than in the United States. This group of countries has a slightly greater population than the U.S., but a one third smaller GNP. When compared on this basis, the relative effort in Europe was substantially greater than that in the U.S.—the reason being, basically, that the relative cost of R&D personnel is less in Europe than in the United States.

Furthermore, there was no substantial investment in defense and space R&D in any of the European countries except the United Kingdom; there was not a disproportionate rise in salaries, and there was no marked displacement of scientists and engineers from industrial to national projects. Although European data for more re-

## II. Approximate proportions of national resources at market prices devoted to R&D: U.S. and eight selected West European countries, averages for 1959–65; and Japan, 1963

Country*	Total R&D Expenditures as Percent of GNP at Market Prices	R&D Paid for by Government Funds		R&D Expenditures for Defense and Space		R&D Expenditures for Industrial and Other Civilian Purposes	
		As Percent of GNP	Percent of Total R&D	As Percent of GNP	Percent of Total R&D	As Percent of GNP	Percent of Total R&D
United States	3.3	2.12	64.2	1.92	58.3	1.38	41.7
United Kingdom	2.2	1.32	60.0	0.85	38.6	1.35	61.4
France	1.5	1.03	68.9	0.62	41.0	0.88	59.0
Germany	1.4	0.62	44.0	0.13	9.0	1.27	91.0
Netherlands	1.8	0.63	35.0	0.09	5.0	1.71	95.0
Belgium	0.8	0.19	24.0	0.03	4.0	0.77	96.0
Norway	0.7	0.41	58.0	0.05	7.0	0.65	93.0
Sweden	1.5	0.74	49.0	0.33	22.0	1.17	78.0
Italy	0.5	0.16	33.0	0.03	6.0	0.47	94.0
Japan (1963 only)	1.4	0.4	28	..	..	1.4	100.0

\* U.S. and Europe; after Boretzky<sup>10</sup>; Japan: OECD.

## III. Alternative estimates<sup>10</sup> of comparative civilian R&D efforts in 1959–65: U.S. versus Western Europe and Japan

Country	Civilian R&D Effort				Comparative Level of GNP in 1964 in Dollars of Equal Purchasing Power U.S., 100 (5)	Ratio of Columns (2) and (5) (6)
	U.S.-Cost-Equivalent Expenditures		Employment of Professional Manpower			
	\$ Million (1)	Percent of U.S. (2)	Full-Time-Equivalent Number, thousands (3)	Percent of U.S. (4)		
United States	7762	100.0	231.9	100.0	100.0	1.00
United Kingdom	1994	25.7	102.3	44.1	16.2	1.59
France	967	12.5	54.1	23.3	13.9	0.90
West Germany	1896	24.4	76.0	32.8	17.5	1.39
Italy	333	4.3	22.9	9.9	9.2	0.47
Netherlands	436	5.6	26.2	11.3	3.4	1.65
Belgium	185	2.4	10.7	4.6	2.8	0.86
Norway	54	0.7	3.3	1.4	1.1	0.64
Sweden	289	3.7	14.2	6.1	2.7	1.37
Western Europe, eight selected countries	6154	79.3	309.7	133.5	66.8	1.19
Japan	1460	18.8	168.4	72.6	14.9	1.26

Note: Expenditures = annual average; employment: 1962 (median of 1959–65).

cent years are not readily available, it seems likely that—in view of the slow growth of research activity in the U.S. relative to other OECD countries in these years—the disparity is now even greater. As early as 1955, the number of scientists and engineers engaged in non-space, non-defense activity in Europe must have been higher than in the U.S.

A comparison between Japan and the United States is even more depressing. During the 1959–65 period, the Japanese spent a significantly larger portion of their GNP, on an equivalency basis, for civilian R&D than did the United States. With one half the U.S. population and one fifth its GNP, Japan employed 70 percent as many professional R&D personnel in its civilian effort as did the United States.

### Spin-off?

Many would argue that the analysis thus far has neglected the indirect effects of the U.S. space and defense research and development efforts. It is clear that the R&D that has been supported by the government must have been beneficial to at least some industrial activities. Further, the government provided a market for sophisticated technical goods, which no doubt stimulated R&D activities that were transferable to civilian products. However, granted that this indirect effect of space- and defense-oriented work presumably exists, the question is, how significant is it?

Boretzky analyzes this matter in what seems to be an effective way.<sup>10</sup> Consider the efforts of ten people engaged in federal R&D; how much effort aimed at a particular industrial objective, on the average, are these ten equivalent to? Boretzky argues that their absolute maximum equivalent is  $3\frac{1}{3}$ , and the minimum is perhaps one half a civilian researcher. In other words, 5 to 33 percent of a given amount of space and defense R&D might be considered to be the “direct” effect of that effort on the economy.

Assuming a “spin-off” as high as 20 percent (for both Europe and the United States), a new measure of the effective number of scientists and engineers can be derived. It turns out that the U.S. still lags behind Europe and Japan on a comparative population basis. In the specific field of nuclear technology not related to military applications, Boretzky makes a more startling comparison. He estimates that 50 percent more scientists, engineers, and technicians are involved in this work in Europe than in the United States.

This disparity in technical effort, existing for more than ten years, may have begun to be reflected in U.S. trade with Europe and with Japan. Consider the trade balance in the technologically intensive products of chemicals, machinery, electrical equipment, transportation equipment, and instruments. In 1968, the United States had a favorable balance of trade of these products with Europe of \$1.5 billion. From 1962 to 1968, however, the rate of growth of imports of these products from Europe averaged 20 percent, and the rate of growth in their export from the United States averaged only 9 percent. During this same period the U.S. trade balance with Japan in these products turned from a \$300 million surplus to a \$500 million deficit. While U.S. imports from Japan were growing at 32 percent a year, U.S. exports to Japan were increasing at only 7 percent a year.

If the trend continues, Boretzky estimates that by 1973,

in technologically intensive products alone, there will be a trade deficit with Europe of almost \$2 billion. The situation with respect to Japan is even more disturbing: he estimates that the U.S. “technological” trade deficit to Japan will be almost \$5 billion by 1973.

It is clear, of course, that monetary factors and relative labor cost factors are also important to trade-balance considerations. It is only in high-technology products with rapid potential for growth (and in agriculture, where the U.S. has long maintained a technological lead) that the United States has had much of a potential advantage—and it is here (except in agriculture) that we find the downturn.

Clearly, analysis of a matter as complicated as the relationship between technology, the economy, and social welfare can never be complete, nor can conclusions drawn from incomplete analysis ever be taken with assurance. Nevertheless, it appears that in the United States there has been substantial underinvestment in the kinds of technical effort that are necessary for the improvement of the nation’s industrial output and the quality of its life. In recent years this underinvestment in technology for civilian pursuits has been made substantially greater as a result of the large commitment of the United States to activities related to defense and space. The natural working of the economic system, which would in any case have led the industry to invest too little in technical activities, has been further distorted because of the higher cost of research and development resulting from the federal effort. Even in the government sector of research and development, all the European countries and Japan spend more than 20 percent of government R&D for civilian purposes whereas the U.S. spends less than 6 percent. Thus the competitors of the U.S. supplement the industrial investment in R&D for civilian purposes to a much greater degree than does the United States (Table III).

### The choice of strategies

The country is now faced with a dilemma. There are 100 000 scientists and engineers out of work; there are large unsatisfied social needs; the U.S. is suffering adverse effects from its past uses of technology; and its economic growth is faltering. At the same time, the costs of education and of research and development continue to rise, sustained apparently by the social and political structure that has been set up.

Direct R&D investments by the federal government—whether for defense, space, or social welfare purposes—will, if they are too large, draw off technical activity that could be turned to industrial improvement, just as was experienced in the 1950s. Substantial increases in the availability of new scientist and engineer graduates would eventually lower their relative prices, but there would be a period of costly and inhumane readjustment. On the other hand, restrictive policies to discourage young people either from opting for technical education or from continuing at the university for advanced graduate education are, of course, self-defeating in the long term.

Like any complex public problem, this dilemma will not be resolved by any single public policy decision. Addressing the social tasks directly, perhaps the most important single action that is required is a substantial increase in support for the improvement, both in quality and efficiency, of those public services in which private industry

plays only a small role, such as education and the delivery of health care. Likewise, those socially desirable activities in which private incentives for technical work are small or nonexistent, such as the improvement of living conditions in the cities and of the safety of the transport system, require significantly increased support.

To simply spend enough to reemploy unemployed scientists and engineers by immediate federal research and development funding in these social fields is not the answer, for not enough is known about the task; nor would such a move (which would in any case face great social obstacles) encourage industry to play its own part. For the present, in these fields we must not only invest in R & D, but we must devise ways of changing the structure of the delivery systems of social services and of the education of technical people to facilitate the adoption and diffusion of new techniques. A major effort of direct government support to meet these social needs is required.

A second major effort would be the encouragement of university research related to improving industrial productivity, to reducing the waste and pollution of industry, and generally to problems associated with the productivity, products, and adverse effects of industrial production. This federal support to universities would redress the present academic bias, especially in engineering, toward the kinds of work that tend to improve defense and space capabilities.

In some way, also, government must underwrite industrial research and development itself, since the economy has always tended to underinvest in it, and its present overcostliness results from past federal policies. This can be done either directly by subsidy or indirectly through tax rebates. The entire set of corporate and government policies that encourage potential high-export industries needs to be reviewed.

Whether a society effectively uses technology for productive and beneficial purposes depends upon a large number of factors—the supply of technically trained people, the willingness to invest in them, the capital necessary to embody the technology in useful machines and processes, the level of general education, the skill of the potential labor force, the economic and political structure of the society. The effective use of technology requires that a large number of appropriate conditions be met simultaneously; a single missing ingredient (for example, the absence of available capital or the necessary management attitudes) may completely halt either technological innovation or the spread of technology within the society.

If the United States is to meet the social needs of the time and to continue to provide for the material needs of the population, new policies and directions are required of the nation's governmental, industrial, and academic institutions.

#### REFERENCES

1. Freeman, R. B., "Engineers and scientists in the industrial economy," unpublished.
2. Leonard, W. J., "Research and development in industrial growth," *J. Political Econ.*, pp. 232-256, Mar./Apr. 1971.
3. "A Review of the Relationship Between Research and Development and Economic Growth/Development," National Science Foundation, Division of Science Resources and Policy Studies, Washington, D.C., 1971.
4. Alchian, A. A., Arrow, K. J., and Capron, W. M., "An economic analysis of the market for scientists and engineers," RM-2190-RC, The Rand Corp., 1958.

5. Arrow, K. J., and Capron, W. M., "Dynamic shortages and price rises: the engineer-scientist case," *Quarterly J. Econ.*, pp. 292-308, May 1959.
6. Blank, D. M., and Stigler, G. J., *The Demand and Supply of Scientific Personnel*. New York: National Bureau of Economic Research, 1957.
7. Folk, Hugh, *The Shortage of Scientists and Engineers*. Lexington, Mass.: Heath, 1970.
8. Freeman, R. B., *The Market for College-Trained Manpower*. Cambridge, Mass.: Harvard University Press, 1971.
9. "Annual report of the Council of Economic Advisors," in *Economic Report of the President—1970*, U.S. Government Printing Office, Washington, D.C.
10. Boretsky, Michael, "Trends in U.S. trade and the international competitiveness of U.S. industry," unpublished.

Reprints of this article (X71-104) are available to readers. Please use the order form on page 8, which gives information and prices.



**J. Herbert Hollomon** (right), currently serving as consultant to the president and the provost of the Massachusetts Institute of Technology, was formerly president of the University of Oklahoma. Under President Kennedy he served as Assistant Secretary of Commerce for Science and Technology, and as Acting Undersecretary of Commerce under President Johnson. He is a graduate of M.I.T., receiving the B.S. degree in 1940 and the D.Sc. degree in metallurgy in 1946. His industrial experience was gained with the General Electric Company, where he was a research associate in 1946, assistant to the manager of the Metallurgy Research Department in 1949, manager of the Metallurgy and Ceramics Research Department in 1952, and general manager of the General Engineering Laboratory in 1960. Dr. Hollomon is a prolific author and was the founder and first publisher of "Acta Metallurgica." He is a founding member of the National Academy of Engineering.

**Alan E. Harger** (at left) received the B.S. degree in chemistry from the Massachusetts Institute of Technology in 1969 and then joined the staff of BASF Systems, Inc., in Bedford, Mass. He has been with M.I.T. since May 1970, first as assistant director of the Division of Sponsored Research, and currently as administrative assistant to Dr. Hollomon.



# The Long Island Sound submarine cable interconnection

*Improved technology has made possible the design and construction of a highly desirable intertie between New England and geographically isolated Long Island*

**P. Gazzana-Priaroggia** *Pirelli S.p.A.*

**J. H. Piscioneri** *Northeast Utilities Service Company*

**S. W. Margolin** *Long Island Lighting Company*

*This article discusses the design and installation of a 300-MVA, 19-km, 138-kV, high-pressure, oil-filled submarine cable for spanning the Long Island Sound between Norwalk, Conn., and Northport, N.Y. The use of self-contained, oil-filled cable for this crossing represents a major contribution in the field of cable technology. This long-desired intertie became a reality with the development of new low-viscosity impregnants—capable of coping with severe hydraulic transients—and with improved design, manufacturing, and installation techniques. The associated terminal facilities and system considerations are also described.*

The Long Island Interconnection is the longest oil-filled submarine cable crossing in the world. This venture, undertaken jointly by the Connecticut Light and Power Company (CL&P), an affiliate of Northeast Utilities (NU), and the Long Island Lighting Company (Lilco), links for the first time the facilities of these two companies. Constructed at a total cost exceeding \$10 million, it will provide for economic interchange of power as well as added reliability and system stability.

Each company has assumed title to that portion of the pothead-to-pothed system lying within its state boundaries. The cost of terminal facilities, rights of way, and

civil work on each shore have been borne separately.

This 19-km, 138-kV crossing provides a direct 300-MVA interchange between the Lilco and CL&P station facilities at Northport and Norwalk respectively. To geographically isolated Long Island, this attractive intertie was not economically justifiable until very recently. From a technical point of view, the problem of crossing the depths of the Long Island Sound was discouraging.

This project was undertaken as a result of joint studies by both companies. What brought it into economic focus was the high cost of alternatives in providing power supply requirements for each system. Technically, the choice as to the nature of the system had to be made. The high cost of ac/dc terminals precluded the use of dc power supplies. Three types of cable installations were considered: (1) self-contained oil-filled cable; (2) pipe-type cable; and (3) solid dielectric cable.

Solid dielectric cable was rejected because of skepticism concerning its performance at 138 kV. Pipe-type cable was under serious consideration. However, it was ultimately rejected for the following reasons:

1. With a single pipe, complete loss of capacity would result from a single contingency.
2. Repair time would be extensive.

Essentially full text of a paper presented at the IEEE Power Engineering Society Winter Meeting, New York, N.Y., January 31–February 5, 1971. Also published in the July/August 1971 issue of IEEE TRANSACTIONS ON POWER APPARATUS AND SYSTEMS.

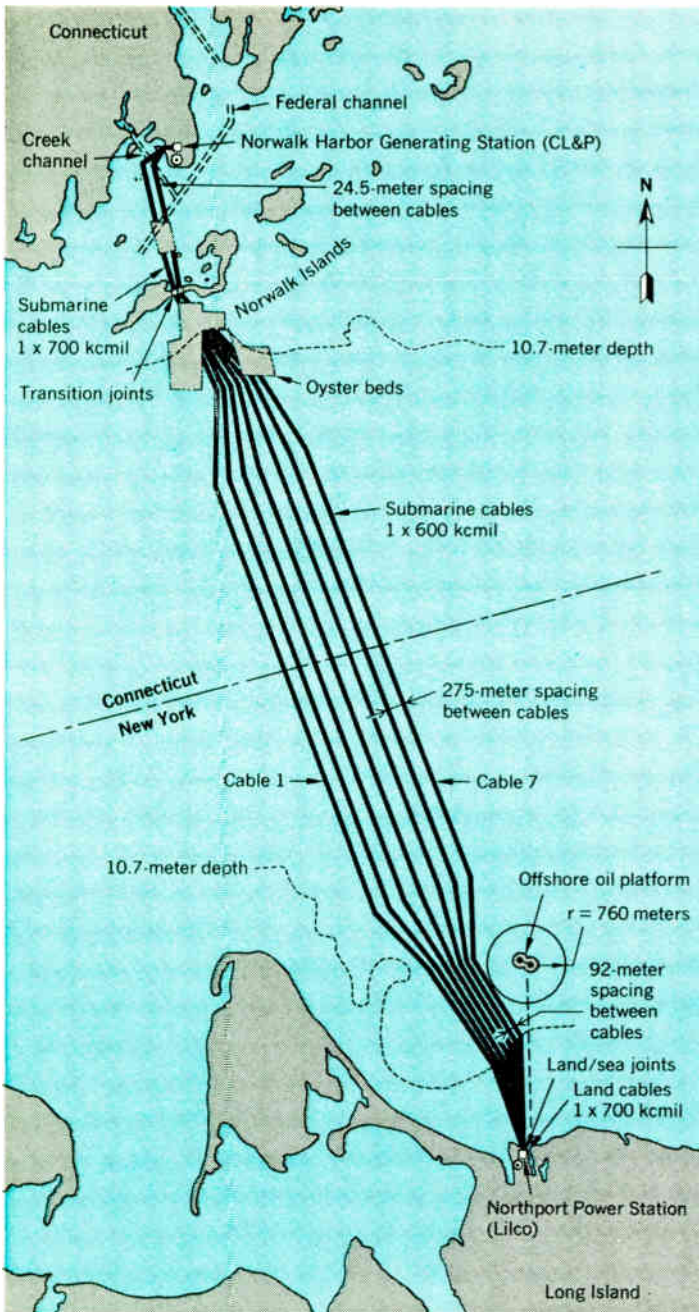
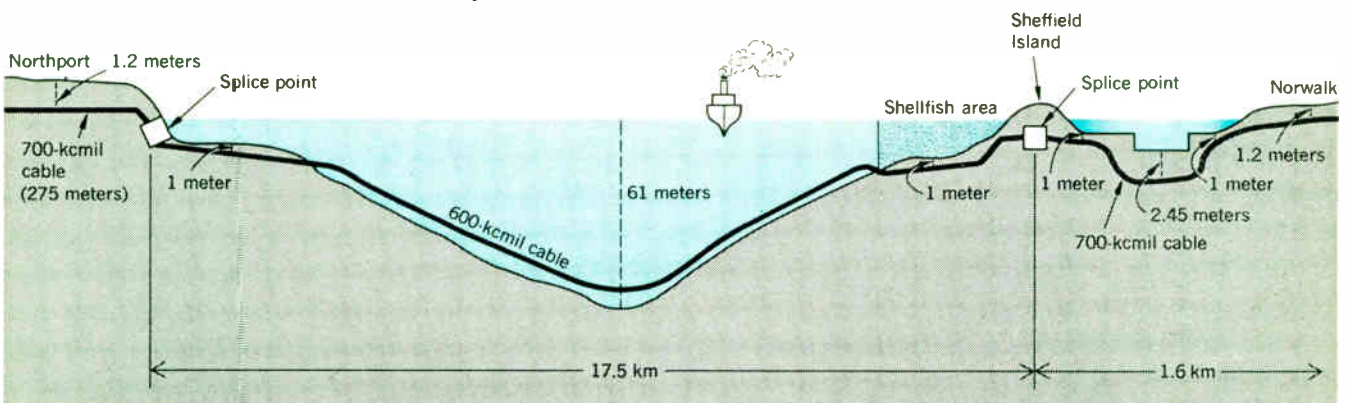


FIGURE 1. Plan view of 138-kV cable system.

FIGURE 2. Profile of 138-kV cable system.



3. Positive prevention of water ingress at a fault location presented difficulties.

A seven-conductor system (six conductors plus a spare) of single oil-filled cables was chosen. Optimum reliability results from its use because repair to a damaged cable can be made quickly and without any loss of rated capacity. Comprehensive marine surveys indicated that the bottom of the Sound was amenable to the use of a multi-conductor system.

The cable was designed, manufactured, and installed on a turnkey basis by Pirelli S.p.A. of Milan, Italy, and Pirelli Construction Company of Eastleigh, England. With modern high-capacity mass-impregnating facilities, the manufacturer was able to produce cable in splice-free lengths up to 65 km. This capability, and the development of extra-fluid alkylates as cable impregnants, were two important factors contributing to the feasibility of this interconnection. Using these low-viscosity oils, the manufacturer was able to reduce the core diameter substantially and yet (1) guarantee positive oil feed to cable insulation under all conditions of load and (2) prevent water ingress during contingencies. Accordingly, this intertie represents a significant contribution to the state of the art.

### The general system

This project was the culmination of extensive joint planning. Encouraged by recent technical progress in the development of submarine cables, studies began some five years ago between Northeast Utilities and the Long Island Lighting Company. These studies investigated the pooling benefits and nature of this new interconnection, as well as the type of ratings on associated equipment that would be required at each terminal.

Northport, N.Y., and Norwalk, Conn., were the logical terminals, since this was the shortest distance between two large generating stations on the two systems. Therefore, the tie would act as an immediate backup for both generating stations. In addition, substantial transmission capacity already existed at these locations in both systems.

The choice of a 138-kV 300-MVA tie took into account costs of several alternatives plus certain limitations of the existing systems. The use of 345-kV cable was not practical because Lilco did not have this transmission voltage on its system and the existing NU 345-kV system was remote from Norwalk Harbor.

A nominal 300-MVA rating was chosen for the tie because of the exit capacity of the Northport and Norwalk Harbor generating stations and any increase in rating would have resulted in an inordinate increase in cost. Because of its higher capacity, 138 kV was chosen rather than 115 kV.

Figures 1 and 2 show, in general, the plan and profile of the cable system from Northport to Norwalk, the details of which will be discussed later. The choice of seven cables (six plus a spare) over a four-cable system (three plus a spare) was adopted mainly to take advantage of flexibility during contingencies. Even with two or more cables faulted, 50 percent of full power would be transmissible.

With the cable system parameters fixed, a transient network analyzer (TNA) study was initiated to establish equipment designs and operating procedures for the submarine interconnection.<sup>1</sup> Studies of many contingencies and configurations indicated a need for a  $\pm 25$ -degree phase-angle regulator controlling circulating power in the Connecticut–Long Island–New York State loop, which the new interconnection would complete. It also showed the need of  $\pm 10$  percent load tap changes on the 138/115-kV autotransformer that joins the different transmission-voltage levels of New England and New York.

The large capacitive energy—about 100 Mvar—that will be stored in the cable and the need for transformer terminations at both ends were unusual enough to warrant the study of transient overvoltages in various switching situations. The TNA study also established the necessary insulation coordination and lightning arrester requirements at the terminals. Table I summarizes the station equipment, ratings, and operating restrictions determined as a result of the TNA study.

## Terminating facilities

The cable terminating facilities consist of individual potheads for the seven cables, each having 2000/5-ampere multiratio external bushing transformers. The cables connect to a 300-MVA, 138/115-kV autotransformer

## I. Station equipment and restrictions

### Station facilities

Northport	300-MVA, $\pm 25$ -degree phase-shifting transformer
Norwalk	300-MVA, 138/115-kV autotransformer, with $\pm 10$ percent tap changing under load

### Oil circuit breaker ratings

Northport	138 kV, 2 kA, 15 000 MVA, 650 BIL
Norwalk	115 kV, 2 kA, 10 000 MVA, 550 BIL

### Lightning arresters

Northport	120-kV impulse, with 168-kV switching-surge characteristics
Norwalk	138-kV bus: 14.4-kV sparkover and 168-kV reseal 115-kV bus: 108-kV sparkover and reseal value with IR characteristics of 120-kV arresters

### Operation restrictions

1. Phase shifter, autotransformer, and cable must be energized together and only from Northport
2. Phase shifter must be on 0° phase shift when energizing
3. Planned deenergization accomplished from Northport

through six manually removable cable links and two manual group-operated three-pole single-throw disconnect switches with key-interlocked grounding switches. The spare cable connects to a spare cable bus through fixed cable-link grounding switches. The cable links are removable, permitting the spare bus to be connected in place of any one of the cables while deenergized. The switching of the spare cable current transformers into the relaying circuit is accomplished by current-short-circuiting test switches.

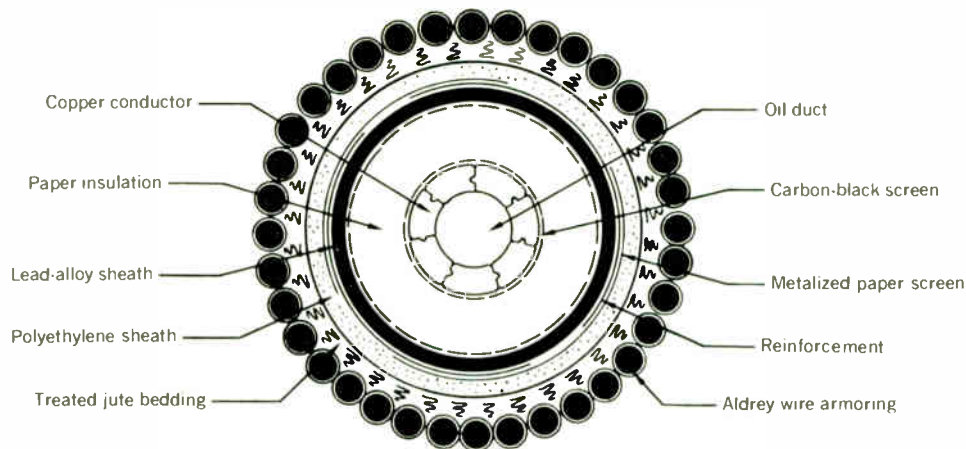
Relaying for the interconnection consists of line-primary, backup, and transfer-trip protection, transformer primary and backup protection, 115-kV transformer bus protection, and breaker failure protection. Primary protection consists of a high-speed solid-state relaying package containing a dual-comparer phase-comparison system with a wide-band frequency-shift audio-tone transmitter-receiver. Backup line protection consists of a high-speed electromechanical relaying system, which is a combination of step-distance phase relays with self-contained overcurrent fault detectors and an instantaneous ground directional overcurrent relay arranged in a permissive overreaching transfer trip scheme. The relays act as the transferred tripping devices, keying the transmitter and the permissive devices for local tripping in the event of a received transferred trip signal.

A 6000-MHz space diversity microwave system using single-sideband multiplex is used to transmit all relay, telemeter, and voice intelligence. The microwave system has a capacity for 420 channels. The channel-signaling rack is wired for 36 channels, of which there are initially nine channels in use. Two channels are allocated to voice communication, five are used for protective relaying, two are used for telemetering, and two are spares.

## System details and design

In the design of the cables, many factors peculiar to the physical nature of the routes had to be taken into account. Northport and Norwalk are popular boating areas, and to avoid damage from anchors embedment of the cables in water less than 11 meters deep was necessary. For the main crossing in deeper water, the cables lie directly on the bottom. Because of the shallow water between Sheffield Island and Norwalk, continuous embedment was required over an extended distance (about 8000 feet, or 2440 meters). This fact, and the higher ambient water temperature (10°C average) in the interisland area, posed a thermal problem necessitating the use of larger conductors to avoid derating system capacity. This was resolved by using 600 kcmil (0.3 mm<sup>2</sup>) for the main 17.6-km crossing and 700 kcmil (0.35 mm<sup>2</sup>) cable in the interisland area of Norwalk and for the shore portions at both terminals. Sheffield Island was a convenient location to construct the transition splices between conductors. At Northport, the land/sea splices were made at the shoreline. Shoreline splices were not necessary at Norwalk because of the use of 700-kcmil submarine cable from Sheffield Island to the terminals. The only requirement at the Norwalk shore was to strip the armor off the land portion of the potheads and to single-point-bond the ends at the shoreline.

Figure 3 shows the cross sections of the 600- and 700-kcmil cables; Table II gives the dimensions. Shown in Table III are the physical, electrical, and thermal data of the installation.



**FIGURE 3. Cross section of 138-kV oil-filled cable.**

## II. Dimensions of 138-kV oil-filled submarine cable

Size of Conductor, kcmil (mm <sup>2</sup> )	Nominal Thickness, mils (mm)		Diameter Over Lead Sheath, mils (mm)	Nominal Thickness of Polyethylene Sheath, mils (mm)	Net Weight of Cable, lb/ft (kg/m)
	Insulation	Lead Sheath			
600 (0.3)	388 (9.6)	88.5 (2.25)	2040 (51.8)	115 (2.92)	8.0 (11.9)
700 (0.35) sea	384 (9.5)	90.5 (2.30)	2080 (52.9)	190 (4.83)	8.5 (12.7)
700 (0.35) land	384 (9.5)	90.5 (2.30)	2080 (52.9)	190 (4.83)	7.2 (10.7)

## III. Cable data

### Physical

Dimensions	see Table II
Single-core cables required	6
Spare cables	1
Maximum laying depth	±61 meters
Cable separation in deep water	±275 meters
Embedment depth	1 meter
Land-cable arrangement:	
Burial	direct (in thermal sand layers)
Configuration	flat
Separation	1 meter
Burial depth	1 meter
Protection	concrete slabs

### Electrical

Rated voltage	138 kV
Nominal power	300 MVA
Impulse insulation level (BIL)	650 kV
3-phase circuit configuration	grounded neutral
Rated current per phase	630 amperes
Frequency	60 Hz
3-phase short-circuit symmetric current:	
From Northport	14.0 kA
From Norwalk	17.5 kA
Daily loss factor:	
Normal	63 percent
Emergency	50 percent
Voltage level on spare cable	50 kV dc

### Thermal

Ambient temperatures, °C:	Min.	Max.
Long Island Sound	0	25
Sheffield Island to Norwalk	10	35
Land	5	25
Air	-10	35
Thermal resistivity of soil:		
Sound bottom	70°C·cm/W	
On land (design)	90°C·cm/W	

### The hydraulic system

The cable impregnant, a synthetic extra-fluid alkylate, is a benzene derivative with a C-9 hydrocarbon chain. It was introduced by the cable manufacturer for use with long oil-filled submarine cable. It behaves like a mineral oil yet it has the advantage of a lower viscosity and better electric stability. The fluid is colorless and has a favorable evaporation rate; therefore, leakage in controlled amounts as the result of cable failure will not constitute an environmental hazard.

In the cable, the oil is normally maintained between 170 and 270 lbf/in<sup>2</sup> gauge (1170 and 1860 kN/m<sup>2</sup>) by a custom pressure system designed and fabricated by Jerome Underground Transmission Equipment Inc. of Farmingdale, N.Y. A pump house is located at each terminal and consists of a 10,000-gallon storage tank, three oil pressure pumps, three vacuum pumps, an annunciator, and necessary control equipment. Normally, at each end all seven cables are served by pressure pumps, one of which starts automatically when pressure drops below 190 lbf/in<sup>2</sup>. If pressure continues to drop, a second pump will come in service at 170 lbf/in<sup>2</sup>, and at 150 lbf/in<sup>2</sup> low-pressure alarm indication will occur. Action will then be taken for manual starting of a third emergency pump at a lower pressure, after which investigation will begin to determine the source of pressure loss. Normal pump operation is terminated after 1 hour. Pump relief valves are set to limit pressure at 250 lbf/in<sup>2</sup>.

Design of the pump units posed some difficult problems not normally encountered with pipe-type units. The extremely low viscosity of nonylbenzene oil makes it ineffective as a pump lubricant. Moreover, the oil has a powerful solvent action, and thus a clean system is required to avoid contamination. The oil storage tanks must be maintained under a constant vacuum seal to keep the oil in a degasified condition. Nitrogen, customarily

used for pipe-type cable systems, could not be used as an oil seal because it would readily diffuse into the oil.

The oil pumping units are designed merely to maintain a static pressure, and therefore there is to be no intentional oil flow. However, drastic changes in load will produce pressure differentials along the cables. For example, a sudden switching off of full load (300 MVA) would result in an approximate 63 lbf/in<sup>2</sup> reduction in pressure at the center of the cable below terminal pressure. And, as might be expected, the switching on of full load at an ambient temperature of 0°C would cause an overpressure at the midpoint of the cable system of approximately 70 lbf/in<sup>2</sup>. Figure 4 graphically portrays the pressure distribution of the oil in the cable for these conditions of load variation.

These maximum and minimum pressures occur after intervals of approximately 10 and 20 minutes, respectively, from the time of switching. The mechanical stress that ensues from these transients had to be taken into account in the design of cable reinforcement tapes, especially in the 600-kcmil crossing lengths.

Were it not for the oil-feed problem during a complete severance, a lower pressure would have been adequate. The most severe contingency would be severance near one end, in which a minimum manifold pressure of 190 lbf/in<sup>2</sup> would be required to prevent water ingress (see Fig. 5). A pumping unit was indicated for this application, not only because of the high pressure levels required, but also because of the need to cope with oil loss if the cable became cut.

A noteworthy advantage of the use of a small-diameter oil duct is the surface-tension phenomenon that occurs if the cable is cut. Very high surface tension on the "meniscus" separating water and oil favorably reduces water ingress, and therefore water migration tends to be localized. Laboratory experiments have shown that for relatively small diameters of the oil channel this surface tension very easily prevents the mixing of the two liquids.

Reservoir capacity was designed to guarantee (1) automatic oil supply at full pressure to a damaged cable during the interval of the thermal transient caused by load interruption; (2) sufficient time to perform proper valving manually; and (3) continuation of oil supply at reduced pressure for long periods, during which time the damage can be evaluated and the "capping operation" can be mobilized and performed.

### Manufacture of cable

The cable was manufactured at the Pirelli S.p.A. Arco Felice Works near Naples, Italy. This relatively new facility has been designed and constructed with the capability of producing long, continuous lengths of high-voltage submarine cable. Although the first submarine cable manufactured was paper-insulated and impregnated with a viscous compound (the Sardinia-Corsica-Italy 200-kV dc cable), the facilities were designed also for the production of oil-filled cables.

Essentially the machinery installed at Arco Felice is similar to, yet much larger than, conventional units used in the manufacture of oil-filled cables by the mass-impregnation process. The production of long lengths of cable involves consideration not only of dimension but of techniques imposed by extensive operation under stringent requirements. Certain problems, occurring in various production stages, had to be resolved prior to the success-

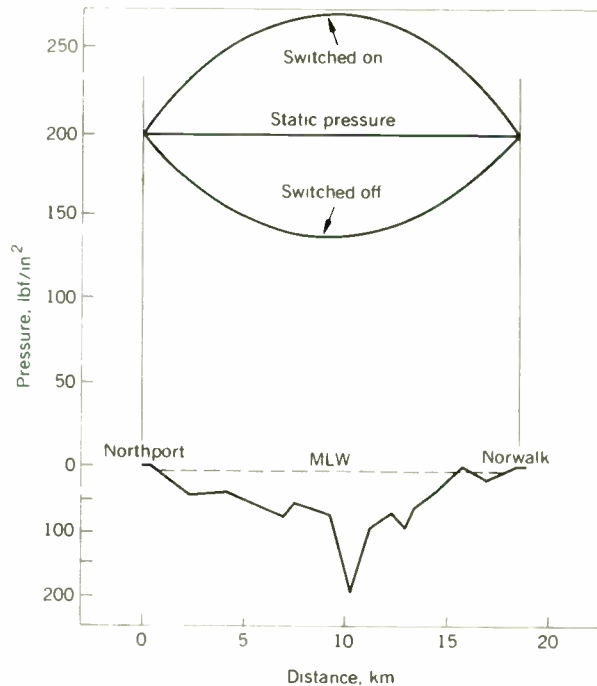
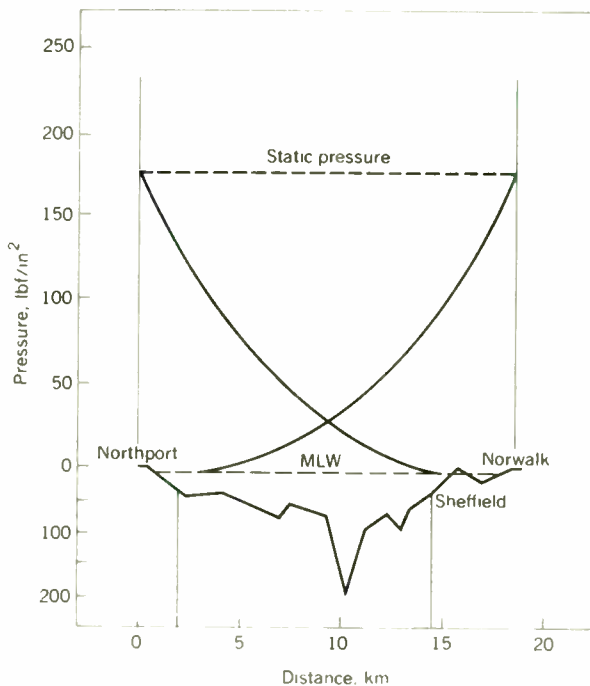


FIGURE 4. Transient pressure distribution for sudden switching of normal load (630 amperes).

FIGURE 5. Transient pressure distribution for cable severance at various points.



ful manufacture in 1966 of the 66-kV oil-filled cable linking Corfu Island with mainland Greece and, in 1968, of the Long Island cable.

Copper hardness must be selected to guarantee adequate tensile strength during laying and to allow for electrical welding during stranding. Welded joints, where required, must be artificially hardened using special tooling. As can be seen in Fig. 3, the seven copper segments

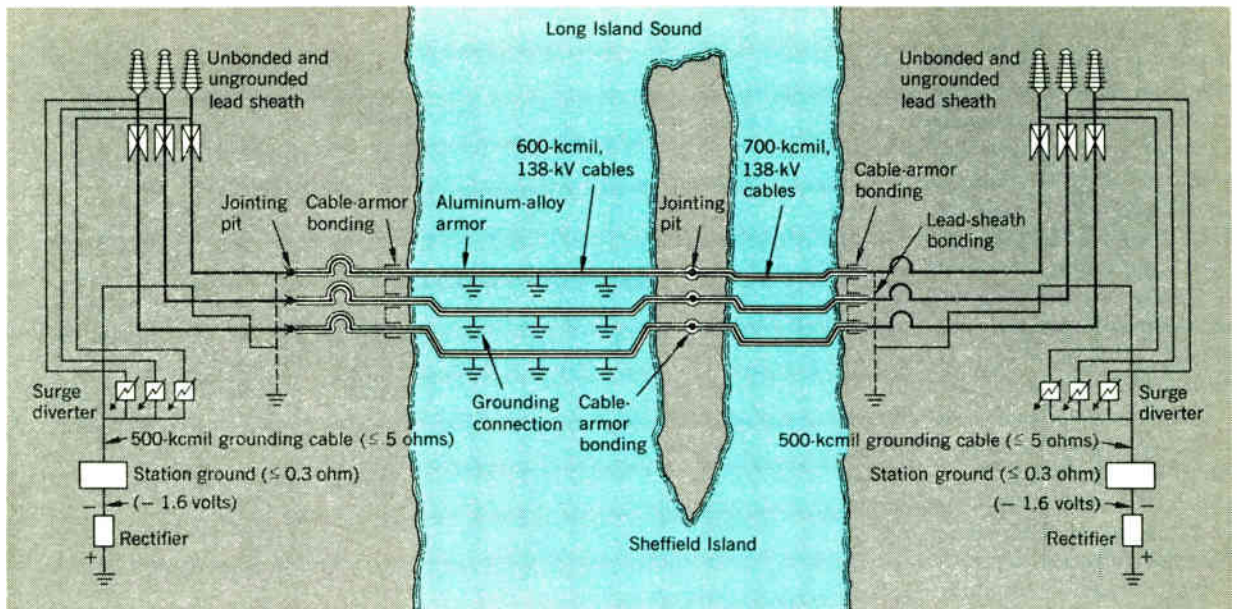


FIGURE 6. Grounding arrangement.

in a single layer are interlocked for self-support during manufacture, shipping, and installation.

To evacuate, dry, and impregnate the cable in long lengths, a special annular tank—15 meters in diameter, with a capacity of 200 m<sup>3</sup> (about 55 000 gallons)—was designed and constructed. The tank is able to rotate during coiling operations so that the cable will not be subjected to torsion.

The method of “siphon” lead sheathing has been long established in the cable industry. However, in this case the exceptional dimensions of the siphon and impregnating tank presented substantial unknowns. Large amounts of degasified oil were necessary (more than 8 m<sup>3</sup>/h) through the siphon in a direction opposite to that of the cable feed. This was to create an oil ambient around the cable having as low a gas saturation level as possible. The volumes of oil needed and the lack of lubricity of the extremely fluid oil called for special circulating-pump design.

The entire impregnation and lead extrusion for this project were accomplished in just two runs. The first consisted of 48 km of 600-kcmil cable and 22.5 km of 700-kcmil cable. In the second run, a length of 64 km of 600-kcmil cable was processed. Continuous lead extrusion for cables of such length and the use of very thin oil created thermal conditions much more critical than had been encountered in the past. This required special development work.

It is noteworthy that, in manufacture, only three accidental interruptions occurred during the lead-sheathing process. Each discontinuity required the use of a factory-repair flexible joint.

### Grounding

The lead sheaths as well as the aluminum armoring on the submarine portions are bonded together at the two shorelines (see Fig. 6). Circulating currents are induced in the lead sheath and in the armoring. The sum of the

induced currents in the sheath, armor, and the surrounding seawater (approximately 10 percent of the total) is practically equal and opposite to the current in the copper conductor. Each cable, therefore, acts as a coaxial circuit and the unusually low reactance results in an  $X/R$  ratio of less than unity.

To prevent excessive voltage gradient across the polyethylene sheath, additional grounding connections between the lead sheath and aluminum armor were made along each cable at 3.2-km intervals. As the cable system approaches the Northport shore, the armorings are bonded at a single point using a special bonding boxes. Bonding of the lead sheath is accomplished at the land/sea joints.

The cable-grounding connections are designed to carry a current of 6 kA for 2 seconds, which is sufficient to cope with traveling or short-circuit waves coming from sources external to the cable circuit.

In the land section of Northport, the lead sheaths are bonded together only at the land/sea joints and grounded by connection to the station-ground bed. The lead sheaths are open-circuited at the pothead bases to avoid circulating currents that would limit the current-carrying capacity of the cable.

At Norwalk, where there are no land/sea splices, special bonding boxes are employed at the shore and filled with a bituminous compound. Here, bonding connections for the lead and for the armor are provided. The lead sheaths are bonded at a single point and connected directly into the station ground.

In Norwalk, as well as in Northport, the lead sheaths are open-circuited at the potheads, which means that electrically the pothead base is floating above ground. The induced voltage at the floating connection under full-load conditions is approximately 70 volts at Northport and 25 volts in Norwalk.

In the event of a symmetrical short circuit of approximately 17.5 kA, the foregoing voltage values increase to

2000 and 700 volts respectively. In both Northport and Norwalk the bases of the insulated potheads are connected to protective gap-type surge diverters, which are tied into the station ground. The requirements for these surge diverters are as follows:

1. To discharge any traveling secondary waves induced in the lead sheath by primary lightning waves traveling along the overhead lines in the cable conductors.

2. To discharge the currents induced in the lead sheath by primary switching surges traveling along the cable conductors. From the study of the oscillograms and from results obtained from the TNA study, these primary switching surges appear to be similar to sinusoidal damped waves having a natural frequency of about 250 Hz and a peak value of about 220 kV with a duration of 30 ms. In this case the induced currents on the lead sheath are evaluated at approximately 2.7 kA for 30 ms.

3. To extinguish the discharge arc even when the permanent induced voltage of the base of the potheads reaches the maximum value of 130 volts corresponding to the maximum emergency current of 1100 amperes.

4. To limit the maximum discharge level that can be taken by the polyethylene jacket with no risk of puncture. This level is specified as 3 kV and offers a very large margin of safety with respect to the testing level of the jackets (30-kV ac spark test during manufacture).

To limit the overvoltages that may be built up on the grounding points of the lead sheaths at both shores, these points are connected to the main station grounds using bare copper conductors (500 kcmil). These ground conductors are transposed in between the cables of each circuit in order to minimize the voltage induced by the currents of positive sequence flowing in the cable conductors. The station grounds in both stations have a resistance of less than 0.3 ohm and are cathodically protected by means of rectifiers supplying a -1.6-volt bias.

### Installation of cables

Prior to the cable installation, three separate marine surveys were conducted. The first one was intended primarily for a pipe-type cable, but much of the information was valid for use with any type of installation. Four separate routes were investigated as to the following:

1. Bottom contour and subbottom profile.
2. Current metering to determine the magnitude and direction of the bottom currents.
3. Measure of water temperature at different depths and at different times of the year.
4. Inspection of the sea bottom by divers.
5. Core sampling.

When the decision was made to use seven single oil-filled cables, several factors indicated that the general area of their route system would be remote from the four survey routes previously studied. Thus, a second marine survey was undertaken for

1. Specifically setting the seven cable routes.
2. Measuring the route distances precisely to determine the cable shipping lengths.
3. Inspecting the sea subbottom to a depth of about 1.5 meters in the embedment area, with particular attention to bedrock and large boulders, using seismic equipment and radio-navigational devices.

Just prior to the start of the excavation, a third survey was made to augment the previously accumulated bottom information. This final survey attempted to define along

each route where boulders, rocks, and ledge (if any) would be encountered. The routes were walked by divers, and hand probings, using water lances, were made at 7.5-meter intervals. The data helped to establish the type of equipment and method of excavation to be used. However, the information was general in nature and the precise amount of rock to be removed still remained unknown.

Three methods were considered to embed the cable in areas less than about 11 meters in depth:

1. Plowing and jetting simultaneously while laying.
2. Laying the cable first and jetting and plowing later.
3. Pretrenching, laying, and then backfilling.

Method 1 was rejected mainly because, though acceptable for plastic and rubber-type cable, it might have placed undue mechanical stress on an oil-filled lead-sheathed cable. Method 2 would require complete prior removal of all rocks without any chance of late remedy after laying. Both methods would be slow and would increase the exposure to sea action and boating hazards for extended periods (months). In spite of some anticipated minor drawbacks, the third method—pretrenching—was adopted. It was the only practical method to guarantee safe handling of the cable with a minimum of sea exposure. Also, a substantial portion of the required pretrenching would be in fact accomplished by the preliminary rock-removal phase (necessary in any case).

Various modes of excavation were employed, depending upon depth and nature of the bottom material. In areas of relatively soft, rock-free bottom and where there was sufficient flotation, a suction dredge was used. Areas of rock and hardpan required use of a clamshell-type dredge. In very shallow areas approaching the shorelines, the cable was hand-jetted after laying.

The theory of pretrenching called for the excavation of one trench at a time. It was reasoned that time would be of the essence and that each cable would have to be quickly installed before any premature backfilling took place by sea action. With this in mind, it was planned to excavate the first trench using a suction and/or clamshell dredge, side-casting removed material where possible. Using a specially baffled discharge tube, the dredge would backfill the first trench while proceeding to excavate the second trench. This would be possible only where routes were parallel.

In some cases, the suction dredge in its subsequent route was unable to accomplish adequate backfill of the trench previously dredged. A combination of light silty material and bottom currents resulted in the disbursement of dredge discharge material over a wider area, so in some places very little material actually fell into the trenches. Consequently, in those areas where backfilling was not properly effected by either dredge discharge or natural wave motion, obtaining 1 meter of bottom cover over the cable posed a problem. In depths less than 2 meters mean low water (MLW), the Corps of Engineers required transportation of excavated material away. Also, in very rocky areas, the excavated material was removed to assigned dumping areas. Thus, after the cables had been laid, there was a deficiency in available material in some areas with which to backfill the trenches properly. This situation was satisfactorily remedied as follows:

1. In silty and sandy areas, the wide-slope trenches were backfilled by means of a heavy steel beam towed along the bottom by a vessel.

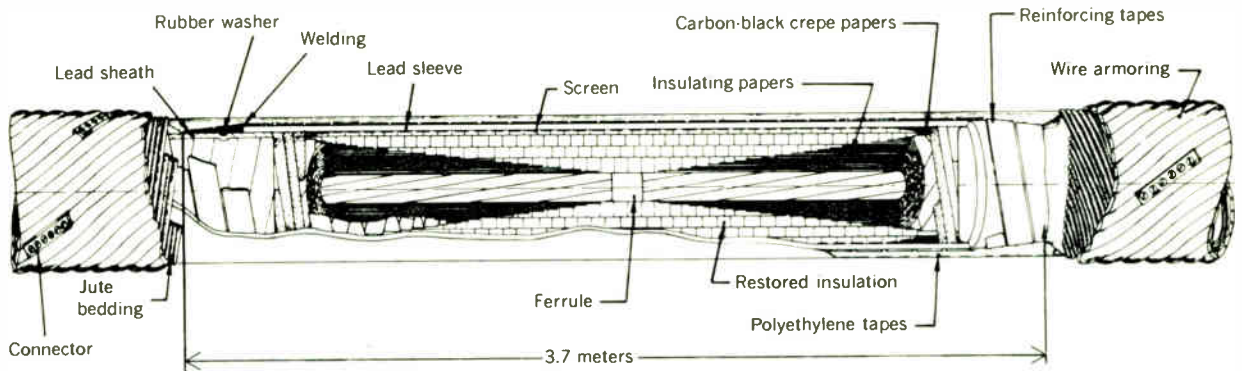


FIGURE 7. Flexible repair joint.

2. In rocky areas and in those places where the beam method was not effective, the cable was covered with bags of portland cement.

3. In those areas where it was deemed advisable by the contractor, hand jetting was employed.

Two procedures were used to lay the cable. In the inter-island area, the cables were payed out from a barge, floated by sections from Norwalk to Sheffield Island, and then guided into the trenches by divers. The barge was kedged along with a system of four anchors using a low-intensity laser beam to keep on station.

This same procedure was used in the Sound crossings where the cable was to be embedded (less than 11 meters deep). However, in deeper water, the cable was laid directly on the bottom, using custom-designed tensioning machinery having a maximum braking capacity of about 2.5 tonnes. The laying barge was propelled by a tug at a speed of about 2 nmi/h (3.7 km/h). Transverse control was maintained by two small vessels secured at right angles to the cable barge responding to a continuous electronic positioning system readout.

From the time the cable left the factory until the permanent oil units were in service, constant oil pressure was maintained by portable oil tanks. These reservoirs were of the double chamber, pneumatic diaphragm type. During laying, however, portable pumping units were used capable of supplying 0.3 m<sup>3</sup>/h at a variable pressure. During the cooling transient occurring at the time of laying (assuming that the cable temperature was significantly higher than the water temperature) the feeding pressure of the pumping unit was continuously increased. This was in accordance with calculations based on laying speed and temperature drop. This pressure increase had to match three requirements: (1) The relative oil pressure in the cable should never become negative. (2) The oil pressure in the cable while bending on the wheels of the laying machine should never exceed a safe limit. (3) The flowmeter installed aboard the laying barge should always indicate a very small but constant oil flow from shore to vessel. As an example, during the laying across the Sound, the starting pressure of the pumping unit was 25 lbf/in<sup>2</sup> and the final pressure was 85 lbf/in<sup>2</sup>.

#### Factory tests

All of the 138-kV cable was constructed with a wall thickness reduction of approximately 23 percent from the standard 0.505 inch (1.28 cm) established by the Associa-

tion of Edison Illuminating Companies. Testing in accordance with AEIC specifications, as was done at the factory, therefore imposed a degree of stringency greater than normal. To prove the watertight integrity of the cables, other tests were performed as follows:

1. *Internal-pressure tests.* Three-meter samples each of 600- and 700-kcmil submarine cable were pressure-tested internally for a 24-hour period at oil pressures of 600 and 400 lbf/in<sup>2</sup> respectively. The pressure was increased 14 lbf/in<sup>2</sup> per minute. There was evidence of oil leakage at 1320 lbf/in<sup>2</sup> for the 700-kcmil specimen and at 1440 lbf/in<sup>2</sup> for the 600-kcmil piece.

2. *External-pressure tests.* One 4.6-meter sample of 600-kcmil submarine cable including one grounding connection was pressurized externally for a week at ambient temperature to 135 lbf/in<sup>2</sup> in salt water. No internal pressure was applied to the cable. After the test, the grounding connection was stripped off and the absence of water under the polyethylene jacket was ascertained by means of a cobalt chloride test.

Another 4.6-meter sample was tested and inspected in a similar manner except that the external salt-water pressure was applied according to the following schedule:

8 hours	at 118 lbf/in <sup>2</sup>
16 hours	no pressure
8 hours	at 294 lbf/in <sup>2</sup>
16 hours	no pressure
8 hours	at 118 lbf/in <sup>2</sup>
40 hours	no pressure
8 hours	at 294 lbf/in <sup>2</sup>
16 hours	no pressure
8 hours	at 118 lbf/in <sup>2</sup>
16 hours	no pressure
8 hours	at 294 lbf/in <sup>2</sup>
16 hours	no pressure

#### Flexible repair joints

Notwithstanding the assumption that, in principle, each of the seven cables from pothead to pothead should be splice-free, it was recognized that a repair joint must be available in case of emergency during manufacture or laying, or for any repair in future service. Such a repair joint should be flexible, to allow the easiest and safest means of handling the cable.

The flexible joint designed by the manufacturer for this crossing is shown in Fig. 7. The ferrule is of the semiflush compression type. The cable heads have a very long taper.



The insulation is restored tape by tape. The joint sleeve is welded to the cable sheath and makes a tight fit. The reinforcement tapes are reapplied in such a manner as to insure strengths that are equal to or greater than those of the original tape. The polyethylene jacket is also restored through the use of self-amalgamating polyethylene tapes.

After the jute bedding is restored, the wire armor is reconstituted by the use of specially designed screw connectors. The diameter of the finished joint is practically identical to the original cable diameter. In order to insure that the highest dielectric quality is achieved in the repair joint, the restored insulation is hand-applied in a very-low-humidity air-conditioned enclosure and then it is filled with a degasified oil under a vacuum seal.

### Damage and repair of cables

Before the project's completion, the No. 7 cable (the most easterly) sustained damage from two separate accidents. The first occurred about 600 meters north of Sheffield Island when a kedging anchor associated with the dredging of another cable trench made contact with the previously laid No. 7 cable. Although the conductor was not severed, the armor, polyethylene jacket, and lead sheath were badly damaged. Oil leakage was kept under control by portable pumping units until the day after the accident, when the damaged portion of the cable was cut away and the two ends were temporarily capped.

The second accident occurred about 4 km north of Northport in about 15 meters of water. The first indication of trouble was a low-pressure alarm operation at the terminals. At the time, the cables were being temporarily fed by portable pressure tanks. Emergency steps were taken immediately to insure that there would be an adequate supply of oil at the two ends to avoid the risk of entrance of water into the cable. The magnitude of pressure drop (from 25 to 20 lbf/in<sup>2</sup>) indicated that a cut in the cable had occurred.

The next day it was learned that an oil tanker, maneuvering with her anchors, had caught the No. 7 cable. The vessel was without a tug because of a strike and, in rough seas, was approaching an oil facility off Northport when the mishap occurred. Investigation by divers revealed a cut in two places (only one severance). Within a period of ten days, the damage was located and both ends were raised, capped, and resubmerged. The total rate of oil loss from both ends during this contingency period was approximately 0.46 m<sup>3</sup> per day, which compared very favorably with calculated values.

The length of damaged cable removed included the region of visual damage plus an "insurance margin" in the event of broken reinforcement tapes. The repair segment needed was in excess of the maximum available spare length (550 meters), so two pieces were joined together. It is felt that the disadvantage of this extra joint was offset by the opportunity to replace a segment sufficiently long (910 meters) to ensure with confidence that no incipient damage remained. All of the four required repair joints were of the flexible type previously discussed.

The authors wish to acknowledge the valuable work of the many people who took part in the research, development, and design of this cable, as well as those responsible for the organization and installation of the difficult interconnection. They are grateful to the utilities and to the manufacturers for permission to publish this article.

### REFERENCE

1. Fox, B. M., and Madsen, A. M., "Surge study sets guides for L.I. Sound intertie," *Elec. World*, pp. 33-36, May 12, 1969.

Reprints of this article (No. X71-105) are available to readers. Please use the order form on page 8, which gives information and prices.



**P. Gazzana-Priaroggia (SM)** was born in Casale Monferrato, Italy, in 1917. He received the Ph.D. degree in electrical engineering from the Politecnico di Milano in 1940. In 1945 he joined the staff of the Research Laboratories of Pirelli S.p.A. Cable Division in Milan, where he carried out research in telecommuni-

cation and power cables. He became manager of the Power Cables Laboratory in 1955, manager of the Research Laboratories in 1958, deputy chief engineer in 1964, and chief engineer in 1966. Dr. Gazzana-Priaroggia is a fellow of the Institution of Electrical Engineers, London, and a member of CIGRE.



**J. H. Piscioneri (M)** was born in Springfield, Mass., in 1929. He received the B.S. degree in marine engineering from the Massachusetts Maritime Academy in 1950 and the B.S.E.E. degree from the University of Massachusetts in 1957. In 1957 he joined the Westinghouse Electric Corporation, East Spring-

field, Mass., where he did design and development work on hermetic motors for refrigeration applications. From 1958 to 1966 he was employed by Western Massachusetts Electric Company and was involved primarily with the design of distribution facilities. Since 1966 he has been associated with Northeast Utilities Service Company, where his responsibilities have been mainly in underground transmission. Mr. Piscioneri is a member of Tau Beta Pi and is a Registered Professional Engineer in Massachusetts.



**S. W. Margolin (M)** received the B.E.E. degree in 1949 from the City College of the University of the City of New York. Then for two years he worked with the New York State Department of Highways and the New York City Departments of Subways and Traffic. Since joining the Long Island Lighting Company

19 years ago he has worked in distribution engineering, chiefly in the design and planning of underground supply to large shopping centers and networks, and at present in underground transmission and cable rating, including pipe-type and submarine cable systems. He is a member of Tau Beta Pi and Eta Kappa Nu and is a Registered Professional Engineer in the State of New York.

# New product applications

## Direct frequency synthesizer can be locked to external standard

The model 5100 programmable frequency synthesizer has a range from 0.001 Hz to 2 MHz with 0.001-Hz resolution across the entire range. Output frequency is selected by ten front-panel controls. It can also be programmed remotely from contact closures or positive logic in binary or BCD format, with 46 parallel bits or four 12-bit bytes. When programmed using a 46-bit binary word, the output amplitude and phase continuity are maintained between frequencies, undisturbed by any switching transient. It is shown in Fig. 1.

The output amplitude can be varied continuously as well as in 1-dB steps to 85 dB from a maximum of 10 volts peak-to-peak with 50-ohm source impedance. Programmable attenuation is optional. Total distortion is less than 0.1 percent to 1 MHz with non-

harmonic, spurious components more than 70 dB below the fundamental output frequency. Harmonic components are more than 60 dB down.

Frequency synthesis can be accomplished in two different ways, directly or indirectly. By the direct method, a sequence of arithmetic operations, either analog or digital, is performed directly on the output of a reference frequency standard to produce the desired output frequency. By indirect synthesis, the output frequency is produced by a variable voltage-controlled oscillator that is phase-locked to the reference standard. The steps required for direct and indirect analog frequency synthesis are shown in Fig. 2.

The model 5100 equipment uses the technique of direct digital synthesis shown by the block diagram in

Fig. 3. The reference frequency standard is used as the clock signal for digital arithmetic logic that produces sequential sample values of the desired output frequency, with at least four samples per output cycle. The digital samples are then converted to analog voltages by a D/A converter and smoothed by a low-pass filter to produce the analog output. By this method, the stability of the output frequency is directly related to that of the reference standard.

Besides good short-term stability, digital synthesis provides a number of other improvements in performance. Inherently, digital operation leads to programmability and fast switching. In the binary-word format this synthesizer maintains amplitude and phase continuity in switching between any two frequencies—that is, with no switching transient—with a programming delay of only 0.5  $\mu$ s before switching. As a result, linear frequency sweeping or frequency hopping—including FSK signaling—is easily programmed.

In application the new synthesizer finds use as a laboratory frequency standard, for precise frequency-response measurements, computer-controlled frequency generation, sweeping, or hopping, in automatic testing, radar and sonar signal generation, and for testing communication systems.

Details can be obtained from Rockland Systems Corporation, 131 Erie St. East, Blauvelt, N.Y. 10913.

Circle No. 55 on Reader Service Card



FIGURE 1. Front-panel controls permit the synthesizer to be set quickly.

FIGURE 2. Direct and indirect analog synthesis schemes.

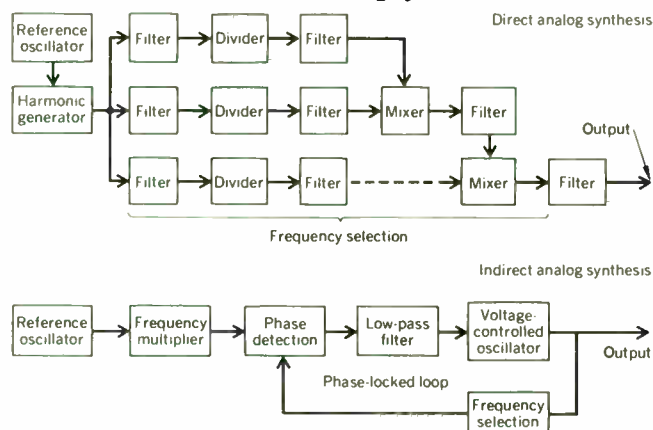


FIGURE 3. Direct digital synthesis block diagram.

