

THE NEWSPAPER FOR
THE HOBBYIST OF VINTAGE
ELECTRONICS AND SOUND

MORE PAGES
EVERY QUARTER

To give more needed space in The Horn Speaker, especially after going to the smaller format, the March, June, September and December editions will be planned for 12 pages. During the period of a year the newspaper will have more space.

THE HORN SPEAKER

Concerning My Invention—The Audion

By LEE DE FOREST

October
Twenty-fifth
1922.

EDITOR, RADIO BROADCAST,
Garden City, Long Island.

DEAR SIR:

My attention has recently been called to an article published in the RADIO BROADCAST by Professor J. H. Morecroft under the title "What Every One Should Know About Wireless and Its Makers." In this article I find mention of my invention of the Audion and several references to the Audion which are by no means in accord with the facts. I am persuaded that Professor Morecroft in no way intended to do an injustice to me or your readers, and will himself in all fairness welcome a brief statement on the genesis of the Audion.

From time to time the statement has appeared, as in the case of the Morecroft article, in effect that in my invention I contributed the grid to a rectifier or two-element vacuum tube, and thereby created the Audion or the three-electrode vacuum tube, the present heart and soul of radio communication. What could be more simple in the way of an explanation? What at the same time further from the truth and still further from a knowledge of the simple facts of radio principles?

Professor Morecroft says: "It seems strange that Fleming did not at once jump to the idea

of the Audion, but the history of science is full of just such occurrences—a worker on the point of making an important discovery, yet missing it by the merest chance."

Had Fleming thought of the grid, had he inserted it in the Edison Valve, he would have had exactly what he did have, a rectifier—but with a grid-shaped anode—nothing more. Had I come to this stage by the route Fleming followed, I should have done exactly as Fleming did—missed it exactly as he missed the Audion.

To recognize that the anode battery circuit is as essential a feature of the Audion as is the third electrode, that by virtue of this local energy alone is the Audion a relay device and therefore an amplifier of transcendent value, instead of a mere rectifier of received alternating current—seems such a simple proposition, so self-apparent, that I have always been at a loss to understand why any one should fail to grasp it. Yet such is the very common position of many writers: "The Audion is the Fleming valve with a third electrode." "Its inventor improved the Fleming valve merely by the addition of the grid." I doubt if such misleading stupidities were elsewhere ever preached in the history of the electrical art.

Add a third, or any number of electrodes to the Fleming valve and it remains the Fleming valve—a mere rectifier, possessing the utility of the rectifier and nothing more.

Continued on page 2

Practical Pointers on Cabinet Wood-

By W. S. STANDIFORD

ELECTRICAL experimenters can make neat-looking cabinets, but often fall down in their finishing work. It is too bad to get so far along with the construction of a set and then omit those finishing touches that make it a pleasure to look at and to operate. As crudely finished apparatus is generally the result of a lack of knowledge of the processes and materials needed rather than to lack of interest or carelessness, a few practical pointers may prove helpful.

At the outset, it cannot be emphasized too strongly that a clean, smooth exterior is necessary in order to get a first-class finish, whether the wood is to be painted, enameled, oil-finished in natural-colored woods, or varnished. The first thing to do is to decide what kind of wood the box is to be made of, whether it is open- or close-grained, and also whether it contains any sap, as such conditions will make necessary different methods of working.

Open-grained woods include: Oak, ash, chestnut, walnut, mahogany, and butternut. These require fillers.

Close-grained woods include: Pine, cherry, maple, birch, cypress, whitewood, poplar, sycamore, beech, and redwood. These and others like them do not need fillers, but can be finished in natural colors or stained, as preferred. Five operations in wood finishing are needed: sandpapering, staining, filling, varnishing, and polishing.

First, plane the wood as smooth as possible. Then tack a piece of No. 00 sandpaper on a level block of wood and rub with the grain, using moderate pressure and taking care when working near the edges, not to round them. Wipe all dust from the surface with a cloth; if any remains, rough spots in the finished product will result. Staining comes next, if pine or poplar are used to imitate the appearance of more costly woods. By using pine or poplar, radio cabinets can be made which will

Continued on page 2

MANHATTAN ELECTRICAL SUPPLY CO. INC. 23

MESCO ROTARY SPARK GAP

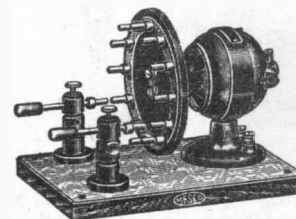

List No. 222

A Rotary Spark Gap is required in every transmitting station by the Federal authorities for the reason that this type of gap produces a pure wave of low damping decrement. It also increases the efficiency of any transmitting station from 20 to 30 per cent.

This Rotary Spark Gap emits a high musical note, more audible to the human ear, can be heard at greater distances than the note from the stationary type, and cannot be mistaken for static or other atmospheric disturbances, a fault common with the stationary gap due to its low frequency note.

The rotating member has twelve sparking points mounted on a hard rubber disk and is carried on the motor shaft.

The Gap can be successfully used on any of our spark coils or transformers up to and including 1 K.W. capacity.

It is also fitted with two stationary electrodes with special adjusting devices.

Our Standard Globe Motor is used, which will operate on 110 A. C. or D. C. circuits and attains a speed of 4,500 R.P.M. Also made with our Globe Battery Motor which can be operated on a six volt circuit.

List No.	Price
222 Mesco Rotary Spark Gap, 6 volts.....	\$19.00
223 Mesco Rotary Spark Gap, 110 v., A. C. or D. C.....	20.00
216 Rotary Unit only, with two Stationary Electrodes, 1 1/2 in. shaft	8.00

HIGH EFFICIENCY SPARK GAP.

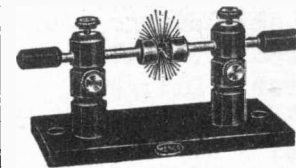

List No. 465

This spark gap is adapted for all stations from the smallest up to 1/2 K. W. capacity. The base is of polished hard rubber, and the standards are of hard rubber composition of the highest insulating properties. The hard rubber ends on the brass rods permit the length of the gap to be varied while sending. Spark terminals are of zinc, as used by commercial stations, and are renewable.

List No.	Price
465 High Efficiency Spark Gap.....	\$4.50

ZINC SPARK GAP.

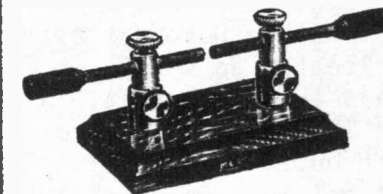

List No. 467

Extensively used for coils up to 2 inch spark. Base is of polished oak, standards are nickel plated and spark terminals are of zinc. Hard rubber ends are provided so that the length of the gap can be varied while sending.

List No.	Price
467 Zinc Spark Gap.....	\$1.20

STANDARD SPARK GAP.

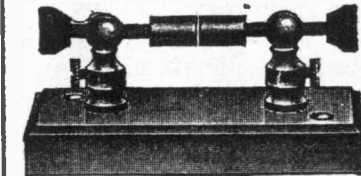

List No. 421

The Standard Spark Gap is mounted on a large porcelain base which insures excellent insulation. The gap terminals are zinc plugs of generous proportions mounted on threaded rods so that the spark length has a very fine adjustment. The horizontal rods are held in split binding posts, keeping them in perfect alignment.

List No.	Price
421 Standard Spark Gap.....	\$2.40

From MESCO catalog, 1919

Berliner Gram-o-phones

Canada.

Type "A"
\$15.00Type "B"
\$28.00

1902 prices

Type "E"
\$22.00Type "C"
\$45.00

FINDS OF THE MONTH

For about a month or two before Christmas my son and his wife had been looking for an interesting old radio as a present to add to my collection. As Christmas came closer, they still hadn't found just what they were looking for. Then, obeying a wifely wish by carrying the trash from their apartment to the nearby "Dempster", my son spotted a still partly gleaming radio chassis back among the debris. After some "digging", he emerged with one large and one smaller chassis, intact except for two tube shields and one broken tube - a 1936 Scott All-wave hi-fidelity receiver! Diligent polishing made it a sparkling Christmas present indeed!

Charles J. Hinkle
Fredericksburg VA 22401

I have been real fortunate this past year. First off I cornered a D-17 DeForest with a DeForest speaker. Then I located an A-K 5A in Denver and was able to buy it. A real jewel. Then I got a DeForest F5 Delux with built in speaker. It also has all original DeForest tubes. Sure does work well. I have sold a lot of sets also. Not bad for a country boy.

On my A K 5A breadboard, the factory sticker says printed Sept. 1923. So, I believe that the 5A was a genuine production model for last quarter of 1923 and 1924. No list has said so as of now. Thought I would pass along this bit of information.

Bill Miller
Greely, Colorado

DeFOREST

The evolution of the Audion patent claims marks, in a general way, the evolution of the Audion—first it was a gas effect in the open air, then in an enclosed vessel, then in an exhausted vessel, exhausted like an incandescent lamp—then to higher and higher degrees of vacuua (as early as 1912 I employed an X-ray vacuum) But always it was a relay. Always the "B" battery was employed. The control electrode idea even preceded the enclosed vessel. And never was the Audion "the Fleming valve with merely a grid added."

Professor Morecroft continues: "The thing which he (De Forest) actually did, namely, the insertion of the third electrode into a Fleming valve, was a most wonderful contribution to the radio art." It was not. Remember that a mere valve with three electrodes is still only a valve—with one electrode too many.

Unfortunately, prior to the year 1917, very little, indeed scarcely anything at all, appeared in radio history concerning the Audion art, although nearly a decade had elapsed since my first patents were granted on the Audion. It

was in this period of bitter commercial rivalry that certain British radio interests first saw fit to attempt to discredit an American invention and put forth the suggestion, altogether at variance with the truth, that an American had simply put another electrode in the two-electrode tube. There is no excuse, however, why, at this late day, such an untruth should persist in American radio history, above all, when the whole world is making use of the Audion in radio communication as well as in long distance wire telephony and the successors of these same English commercial rivals are now operating under the original De Forest Audion patent licenses. In fact, their entire radio system, outside of the generators and aeriels, is built around the three-electrode-anode-voltage vacuum tube.

Very truly yours,

CABINET FINISHING

look as if an expensive natural-colored wood were used. In wood finishing, much trouble in working will be avoided by the purchase of the best stains and materials obtainable. There are two kinds of stains on the market: water and oil stains, each having their good points. Oil stains are those in which the coloring pigment is dissolved in linseed oil or turpentine; water is the solvent for the other. As pine wood in some cases has more or less sap, this wood, after being colored with an oil- or water-stain, when dry, should have two coats of white shellac varnish applied, each coat to be lightly sandpapered after drying.

This shellac coating effectually keeps any sap from discoloring the finish; varnishing, rubbing down, and polishing can then follow. The best way to use water- or oil-stains is to apply them with a brush and then rub them into the wood with a piece of cheese-cloth. This distributes the color evenly and absorbs surplus moisture (which in the case of water-stains is apt to raise the grain of wood, thus making more sandpapering necessary) and also makes a uniform color tone. If the first application does not give as deep a color as is desired, give it another one. If you want to use an open-grain wood, such as mahogany or walnut, and use a stain to make it deeper in color, the pores will have to be filled after staining. Otherwise staining can be omitted; but the filling is necessary. Supposing that such a wood has been stained; get a paste filler of a color to match the stain as nearly as possible; put some filler on a small piece of cotton cloth and rub it on the wood. As soon as this filler has dried a little (don't let it get hard) continue to rub the surface until all pores have been filled up, rubbing off the surplus, the idea being to have nothing but the pores contain filler.

After it is dry and smooth, give it a coat of white shellac varnish. This should be rather thin, and may be diluted with alcohol if desired. All surplus varnish must be wiped off the brush before applying it to the surface, for if too thick a coating is applied, it will not

be clear enough to allow the stain to show. The first coat of shellac will take about three hours to dry, after which you should apply another one. Rub the dried surface with fine sandpaper until the wood is smooth. Don't rub it too hard or you will cut through the shellac. Varnishing comes next. Good brushes should be used as cheap ones are generally coarse and shed their bristles. The varnish must not be too-cold as this prevents it from flowing freely. Have only enough varnish on the brush to give a level coating when it is brushed across the grain. Finish off by rubbing lightly, with the grain, letting it dry thirty hours, or until thoroughly hard.

Purchase some FF grade pumice stone at a paint store; likewise a rubbing felt. Dip the latter into linseed oil, then into pumice

stone which will now adhere to the felt. Rub the varnished surface lightly along the grain. Continue this process until all small depressions have disappeared. This may be ascertained by looking diagonally over the surface when it is held to the light. All hollow places will now show as dark spots. The surplus pumice stone should be carefully removed with a soft cloth.

Give it another coating of varnish and let it dry, then repeat the operation with the pumice stone. The cabinet will have a dead, non-glossy finish. Those who prefer a shining polish can easily obtain it by dipping a piece of felt into linseed oil and into powdered rotten stone (to be bought at a paint store) and going over the surface in the same manner as with the pumice stone. A higher polish can be obtained on the last coat by giving it the rotten stone treatment, and then rubbing the hard varnish with a soft cloth dipped into linseed oil, using plenty of "elbow-grease" until a high polish is obtained. The surplus should be wiped off with a chamois skin. The above gives a durable finish; one that will not scar easily. If all the work has been done carefully, you will have a neat-looking cabinet that will be envied by your friends who have not learned polishing work, which is quite easy when you know how to do it.

This article from Radio Broadcast, January 1923 explains how wood was finished in 1923.

The Brunswick Method of Reproduction

New Tone Betterments *Demand your consideration of The Brunswick*



The Ultona
Plays All Records Better

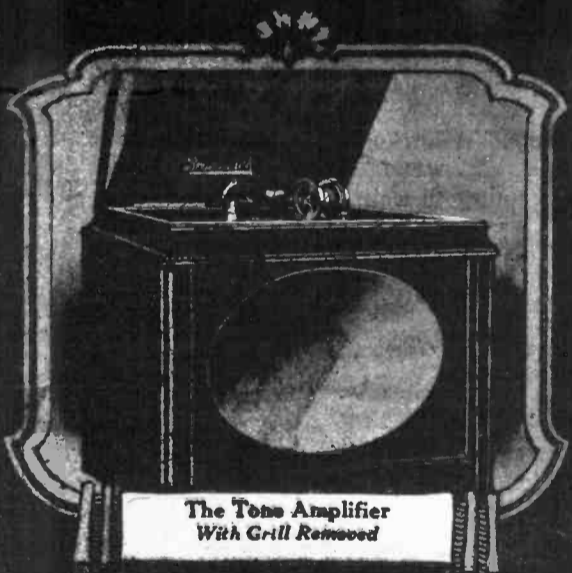

The Tone Amplifier
With Grill Removed



In Many Styles and Finishes

THE Brunswick Method of Reproduction, although it has many advantages, primarily brings better tone. All its features combine toward that coveted achievement.

Suppressed or muffled tones are absent. There is a roundness or fullness of expression that is quickly noted, the first time you hear The Brunswick.

The Ultona, the all-record reproducer obtained only on The Brunswick, obtains the utmost from the record. It brings out intonations often slighted. It plays each type of record exactly as intended, being adjustable at the turn of a hand.

Furthermore, it practically eliminates so-called "surface noises." It is the only counter-balanced reproducer. It travels a cushioned path around the infinitesimal grooves of the record, its suspension so perfect that the needle follows every undulation.

The Tone Amplifier, built to conform to acoustic laws, is an-

other feature of the Brunswick Method of Reproduction. Here again tone waves, having been reproduced perfectly, are allowed to amplify and develop naturally.

This Tone Amplifier is built entirely of moulded wood, so shaped as to permit proper vibration of tone waves. There is no clashing caused by imprisoned tone waves.

In every particular and considered as a unit, the Brunswick Method of Reproduction is one of the greatest advancements in the phonographic art. It brings final perfections, new refinements.

Your ear will quickly detect the superiority of The Brunswick. A comparison will award The Brunswick first choice.

So if you seek the utmost in a phonograph, be sure to hear The Brunswick first. Visit a Brunswick Dealer. Ask also to hear Brunswick Records, which can be played on any phonograph with steel or fibre needles.

THE BRUNSWICK-BALKE-COLLENDER COMPANY
General Offices: 623-633 S. Wabash Ave., Chicago

Branch Houses in Principal Cities of United States,
Mexico and Canada

Canadian Distributors: Musical Merchandise Sales Co.,
819 Yonge St., Toronto

Brunswick

PHONOGRAPHS AND RECORDS

CORRECT PLAYBACK OF SPOT RECORDINGS

Proper playback of spot recordings is equally if not more important than the actual recording. Here are additional facts which will interest the practical recordist.

RALPH L. POWER.....

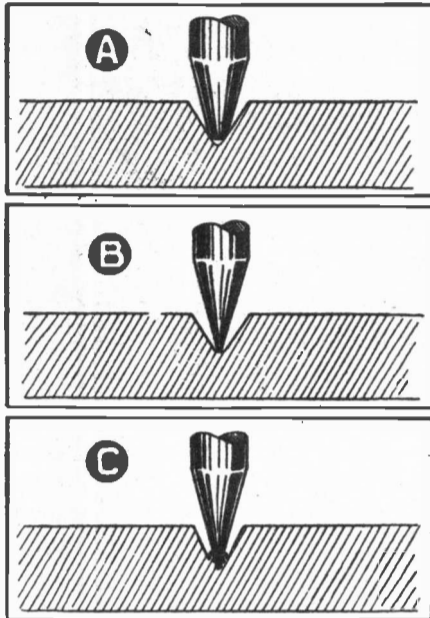

Fig. 2. A, correct needle and groove combination; B, incorrect combination; and C, Deterioration of the groove when the arrangement shown in B is employed.

IMPORTANCE OF USING CORRECT NEEDLE

It might be well at this time to illustrate by the accompanying sketches, the types of grooves now in general use in instantaneous recording and call to the attention of the user that the selection of the proper needle has a very definite bearing upon hiss level and general performance in playback, likewise the life of the record.

Figure 2A shows a groove with a sharp or V bottom, and a playback needle with a round point having a radius at the point of approximately 0.002-in. Note that the point of the needle bears above the bottom of the groove and actually rides on the side walls only. Figure 2B shows a groove having a bottom curvature, cut by a stylus having a radius at the exact point of 0.002-in., being played-back by a sharp-pointed needle.

A study of these illustrations reveals that use of the combination shown in Fig. 2A should mean reproduction without groove hiss; and a material extension of the life of the acetate record. On the other hand, it will appear to even the casual observer that the sharp-pointed needle shown in Fig. 2B will pick-up all of the hiss

inevitably lying at the bottom of the groove. Further, accumulation of dust and foreign particles at the bottom of groove contribute to the groove hiss so objectionable in most recordings.

A worthwhile suggestion would be that every user of acetate discs equip himself with a microscope for examination of all record grooves and needle points, to make sure of proper needles in the playing of acetate discs.

If a record were played back as shown in Fig. 2B, eventually the groove would be deformed or roughened as illustrated in Fig. 2C, resulting in a decided increase in hiss level after the first playing, the roughened or fringed edges setting up a hiss that would be very evident in the speaker when the record was being played; and which would gradually increase with repeated playbacks.

Of very great importance is the fact that only needles having the very finest polish should ever be used on acetate. A rough point or points that have become rusty will tear and roughen the groove and side walls of an acetate record.

Needles that have once been played on a standard (or "commercial") shellac pressing should never be used on an acetate record because of the very simple fact that there is a slight abrasive in ordinary commercial records that grinds the point of the needle to conform to the groove. The abrasive actually tears the surface of the needle which if used to play an acetate will in turn tear and roughen the acetate groove. A needle in this condition actually becomes a cutting tool as will be readily perceived by examining its point under the microscope.

SUMMARY

Microscopic examinations of hundreds of acetate records have shown very conclusively that when not played on proper equipment having the features and details previously mentioned, the results are an ironing-out or straightening of the high frequencies—possibly "rubbed out" would be the proper term to use—as a result of being played back just once with

a pickup having a stiff or highly-damped armature; or excessive weight or pressure on the playback needle; etc.

While it is fully appreciated that there are various shapes of grooves in general use they all, however, follow the same general order in that they are V grooves. Some have rounded bottoms and some have sharp bottoms. Regardless of the radius of the bottom of the groove or whether sharp or rounded, a playback needle such as shown in Fig. 1 having a bullet or ball-bearing point, gives by far the most satisfactory results in playback and long life to both the needle and record.

If acetate records are to become popular and commercially advantageous, they must be given more consideration in the matter of playback.

Simplicity and sturdiness of construction being vital in a part as constantly used and handled as a phono pickup, in the commercial design used as the basis of this article the well-understood magnetic principle was retained; the construction was highly refined; and, the parts, especially the armature, were made dwarf-like by comparison with the older types. As an example, the armature is only 25/64-in. in length from pivot to end; and, complete, weighs only 0.825-gram. Adjustment is easily understood by every technician and Service Man, and no delicate tools are required; which simply means that any irregularity may be easily and quickly corrected without sending the part to some distant point for service.

The pickup here illustrated (Fig. 1A) and described is not intended to be used as a technical device, but rather to fill the urgent need for a practical pickup capable of everyday use in the playing of cellulose and all other types of records. It will give faithful reproduction at full volume; and its negligible wear extends the usable life of records many times over. An instrument such as described, with a reasonable amount of care should give satisfactory service over a long period of time.

This article has been prepared from data supplied by courtesy of Universal Microphone Co.

RADIO-CRAFT for NOVEMBER, 1937

Club News

THE MID-AMERICA ANTIQUE RADIO CLUB

The following is some interesting news from Bob Lane.

"The Mid-American Antique Radio Club had a great meeting January 19, at the Chapel Woods Country Club. It snowed 3 inches that morning but we still had 48 show up. Some came from 50-75 miles away. Dale Goodwin flew in from Aurora, Colorado. We had Grace Enlow as guest speaker, he was the last one to be the "Shadow" of that radio series. We had swap & sale of radios and talks on Radio Premiums of Orphan Annie and Captain Midnight radio series. Our dues are \$1.00 a year and we are getting a membership card and list of all members addresses when joining. We have members from hundred of miles away. Any who want to join can by sending their dollar to me. Next meeting is March 23. We meet every 2 months.

Robert Lane,
2301 Independence Ave.,
Kansas City, Missouri 64124.

SOUTHWEST VINTAGE RADIO AND PHONOGRAPH SOCIETY

The members at the last meeting decided to elect officers to serve for a certain length of time at the next meeting, March 15, 1975. Presently, they have only temporary officers. As one member said, "Any-

one can now join and help us organize or tell us how." The meeting will be at Electronics Center, 2929 N. Haskell, Dallas, Texas at 7 p.m., March 15, 1975.

Plans have been made for an exhibit of early microphones at the meeting.

LETTERS

EDITOR'S MAILBAG

Sir:

Please find enclosed my subscription renewal. I think you are doing a super job on your paper. I wonder if anyone else is interested in collecting wind generator and light plant manuals, catalogs etc. Keep up the good work.

K. A. Ladd
7525 Wentworth Ave.
Richfield, Minn. 55423

Dear Mr. Cranshaw:

I really enjoy The Horn Speaker newspaper, my main interests are most anything in the way of wireless sending and receiving apparatus before about the year 1924, ditto for phonographs. About now I am attempting to build a very long wave radio receiver that will tune way down to 13,000 cycles, the bottom end of radio. I have a fair collection of antique radio sets that use type UV201, type UV201-A, UX201-A, type WD-11, WD-12, UV199, UX199 and VT-1 tubes. A few of them are home brew sets. Most of

my collection still work, in fact I still use a couple of antique radios most every day.

One in my house is a six tube neutrodyne with three tuning dials, the other one in my workshop is a three circuit grid leak triode detector + three stage audio amplifier and it sure is loud with type UV201 tubes, I put type UX171-A in last stage and I put 250 volts B-battery and 45 volts grid bias battery on it. All my radios made before 1925, and use horn speakers.

LaVerne Laatz
RR 1
Marseilles, Ill. 61341

The Horn Speaker;

I have an old Edison phonograph with 3 dozen wax cylinders that I must sell because I cannot keep them properly anymore.

Mrs. Orlin C. Johnson
832 N. Hibbard St.
Staunton, Ill. 62088

SUBSCRIPTION RATES FOR THE HORN SPEAKER

Regular rate:

One year.....\$4.50
Two years.....\$8.00
Special rates for one year (mailed in envelope)
First class.....\$8.00
Air mail.....\$12.00
Foreign air mail..\$16.00

\$3.00 remittance for subscription after October 31, 1974 pays for 7 months. \$4.50 as stated pays for the yearly subscription.

The Classic Radio

by J. W. F. Puett

KINGS OF THE AIRWAYS

Radio madness reached its peak among the affluent connoisseurs in the last six years before World War II. The outstanding performance of E. H. Scott radio receivers was known the world over and the era of custom installations was flourishing.

It probably all started with several custom designed models of the Allwave Imperial. One example exists today with a totally-different custom console and special tuner with extended range to 80 MHz.

In 1935, the wife of a wealthy customer commissioned E. H. Scott "to build for her, regardless of cost, the most perfect sound reproducing instrument that could be designed." The result was the Scott Quaranta. This 40-tube model was offered in the December 1935 *Scott News* at \$2,500.00 - "completely installed in your home by engineers from the Laboratory."

The Quaranta was housed in two large consoles. The first console contained the automatic record changer and tuner chassis. The tuner chassis was almost identical to the tuner used in the Allwave Imperial. The four speakers and 20-tube amplifier were housed in the second console which was very ornate with detailed wood carvings. The combined weight of both consoles was 616 pounds.

Two channels were utilized in the Quaranta audio system. Each channel was rated at 50 watts (RMS) for a total channel-to-channel output of 100 watts. The mid-range and high frequency amplifier utilized eight tubes and "handled frequencies from 125 to 16,000 Hz." the bass amplifier utilized twelve tubes and "handled frequencies from 30 to 125 Hz."

The speaker system consisted of a "mid frequency" speaker located above the low frequency speaker, "so that the fundamental frequencies of speech and music were reproduced at normal height above the floor, and just above ear level when sitting down." Two high frequency speakers were located at the top of the cabinet with their sound being directed through exponential horns and difusing vanes. A volume expander was incorporated in the Quaranta to "add vivid realism to music and voice."

At least two Scott Quaranta models were built. A duplicate model was built by E. H. Scott--"for my own personal use."

With the introduction of the Scott Philharmonic in 1937, custom installations boomed. In an increasing number of modern homes of that period, much of the furniture was built into the rooms. Scott receivers were incorporated in many applications with the built in look. In many

of these custom installations, the receiver dial and control knobs were concealed behind built in doors in library and drawing room walls and even under the stair steps in one installation which I have seen.

Many owners had special custom cabinets built which matched their existing furnishings. These cabinets varied from ornate formal consoles to relatively simple secretary desks. I have seen an Allwave Imperial installed in a special home made desk with glass panels through which the chrome-plated chassis could be seen.

Remote control systems were also available, providing a choice of twelve different stations or switching from radio to phonograph records. One such system was even installed in a plush yacht with remote control and speakers in the master bed room, and on the sun and lower decks.

Remote speakers with special ornamental grills were used extensively in custom installations. Some more elaborate systems featured remote speakers in every room of the house.

Many of these kings of the airways are gone now. Many were built



in; they had no cabinets or consoles. They were "junked" in the remodeling of the fine old homes in which they were once a vital part of the splendor.

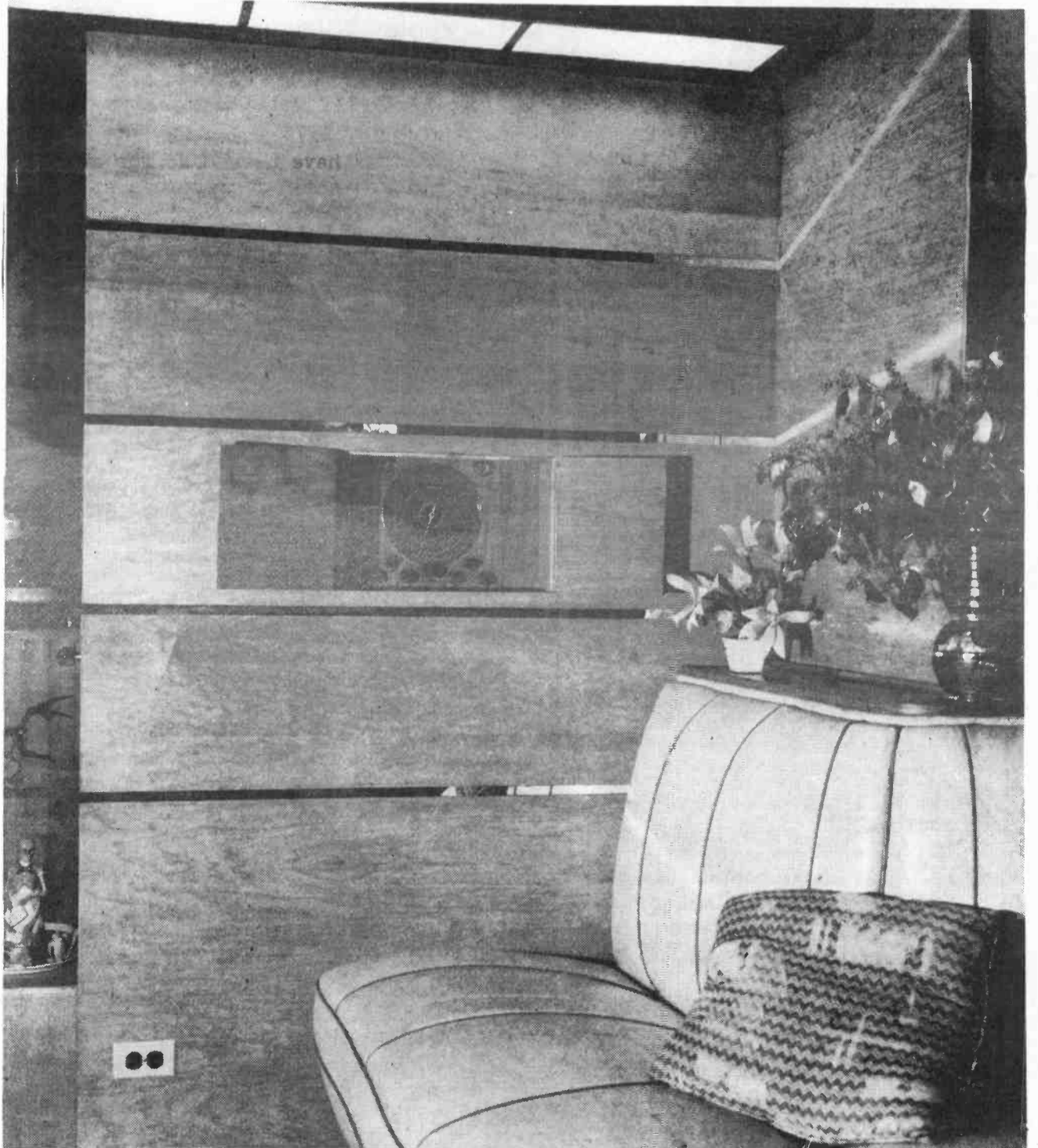

Custom built Scott Philharmonic in custom installation, late thirties

SIGHT AND SOUND TELEVISION SET (1743)

(Andrea Radio Corp.)

SIXTEEN TUBES are used in this newly-marketed "duolateral" superheterodyne which employs 2 intermediate frequencies, one for video and one for audio. Illustrated is the table model 1-F-5 which uses the special 5-in. short-neck cathode-ray tube, making possible a depth of cabinet not much greater than a standard, table-type broadcast set.

The standard set model covers 2 sight and sound channels, 44 to 50 and 50 to 56 megacycles, although other frequencies can be used by merely changing the tuning unit. This model features "sharp focus" image reception, and "picture tone" sound (which is claimed to be distinctly different from the tone of broadcast reception).

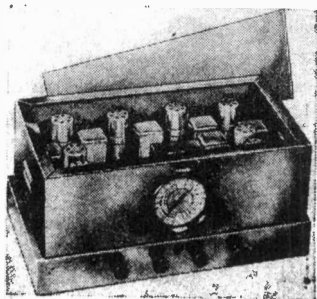

1934

This receiver is composed of 2 chassis. The tuner measures 19 1/2 x 12 x 9 1/2 ins. high. The power supply measures 19 1/2 x 7 x 8 ins. high. Any unit used in the construction of this set that becomes defective within 2 years will be replaced free of charge either for parts, material or labor.

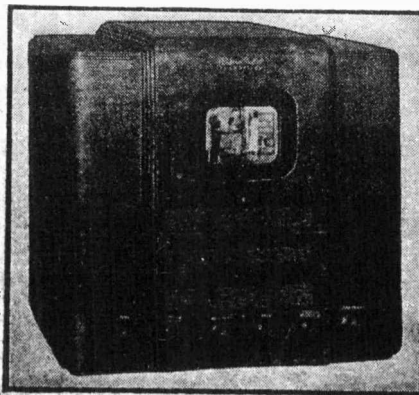

Sight and sound television set. (1743)

1939

12 TUBE ALL-WAVE SUPER. (No. 536)

ONE manufacturer is concentrating his entire sales energy on a new 12 tube all-wave superheterodyne. A 4 position switch controls the range of 11 to 570 meters. This set incorporates a noise and sensitivity control, electron-coupled beat-frequency oscillator, A.V.C., phonograph connections, meter tuning, manual band spreading, Wunderlich second-detector, and provision for headphone connection. Utilizes 5 type 68 tubes, one 2A7, one Wunderlich, 2 2B6s and 2 5Z3s. The undistorted output of the push-pull power amplifier is 12 W. The antenna-to-speaker fidelity is rated at 20 to 4,000 cycles, uniform to 10 db. The selectivity immediately adjacent to high-power locals is 9 kc. The sensitivity is 1/4-microvolt absolute.

1939 ad
A REAL HOWARD Communication Receiver*
COVERS BROADCAST WAVELENGTHS DOWN TO 7 METERS

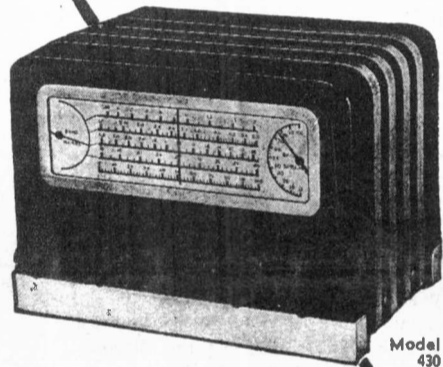

Model 430

BUILT with Traditional HOWARD QUALITY

Only \$29.95 net

4 Bands—6 Tubes
Built-in Speaker
Complete ready for
plug-in A.C. Outlet

HERE is a radio set that will thrill every lover of distant and short wave reception. An ultra-sensitive receiver with electric bandspread to separate stations. You can listen to everything on the air from .54 MC to 43 MC (7 meters to 555 meters), foreign, domestic, amateur and commercial, broadcasts and code! Model 430 is now used by thousands of amateur stations, aeroplanes, ships, forest patrols, police, armies and navies the world over. *For \$12.50 additional the new model 610 DC power supply now makes the 430 communication receiver available for use in your home on 110 volts AC and you can use it on six-volt storage battery operation for portable and emergency use; on your Summer vacation; camping, Marine or pleasure boat use. The model 430 also makes a dandy mobile receiver for the popular 10 meter band, for auto and trailer installation.

Here's the greatest value in the communication field for only \$29.95! A hand-built Howard with the custom parts, fine engineering and spectacular performance; features of communication receivers selling for twice the price or more. Check these outstanding features: 4 Bands—broadcast to 7 meters inclusive. Ceramic Coils, Iron Core H.I. Q. I.F. Transformers, Electrical Band Spread, Excellent Ultra-High Frequency, and eleven additional communication features.

*Pacific Coast and Export Prices Slightly Higher
America's Oldest Radio Manufacturer

Free Send Coupon for Technical Data and Name of Nearest Parts Jobber

HOWARD RADIO COMPANY
1731-35 W. Belmont Ave., Chicago, Ill.
 Please send me data on Models 430, 438 and 451A
 I desire demonstration of Model 430.
Name
Address
City State

121

CLASSIC GOLDEN AGE RADIO

HOWARD EXPLORER MODEL W DELUXE 19 TUBE ALL-WAVE SUPER.

(Uses single-purpose tubes to secure extreme circuit stability; wavelength range, 13.6 to 2,142 meters; provides for either inverted-L or doublet antenna; neon resonance indicator; zero-beat oscillator; variable Q A.V.C.; tone control; variable A.V.C. parallel push-pull output 245c.)

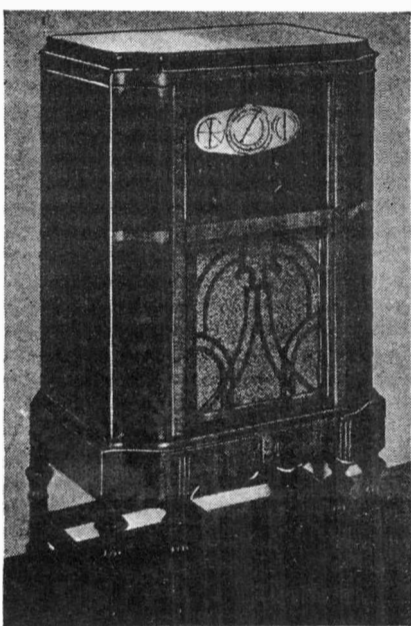

A 19 tube radio receiver in its home. Airplane-type dials are used; only the tuning dial sector of the band in use is illuminated, as the band switch is turned.

Schematic circuit of the A.F. amplifier and power pack chassis. There are 9 tubes in this section of the instrument. A "theatre"-type dynamic speaker is used.

Until very recently the general practice has been to utilize the new tubes at their maximum capabilities. Consequently, a slight change in characteristics would greatly affect the operation of the complete receiver. However, this 19 tube set is designed to utilize its tube complement very conservatively, with the result that great stability has been achieved which, after all, is a major factor in securing satisfactory reception, especially on the short waves.

Note: it is inadvisable to attempt to realign the set except as a last resort. The recommended procedure, only to be used by expert radio Service Men, is as follows:

To align the I.F. circuits feed the I.F. service oscillator test signal into the control-grid of V2.

When aligning R.F., I.F., or oscillator circuits turn A.V.C. adjustment (slotted shaft) to extreme left. The I.F. trimmers are very critical, greatly affect the performance of the set, and must be carefully resonated.

Aligning R.F. and Oscillator Circuits

Adjust A.V.C. control to extreme left position. It is unnecessary to remove the set oscillator tube. Align the circuits only in the sequence given.

To align the set oscillator turn its trimmer all the way out and then select the strongest signal when turning it in; set insensitivity near the center of the dial will result if the wrong oscillator signal is used.

Bend the variable condenser plates for kc. dial alignment only in the broadcast band. Before adjusting any band, make certain that the pointer of the station indicator is set on the last black line when the dial is turned all the way to the left on the broadcast band just above .55 (Maximum capacity of the variable condenser).

Long-Wave Band

Turn the band indicator to .15-.35, set the dial to .35, and feed 350 kc. into the antenna post. Resonate the trimmer (not green coded on the trimmer washer) in the long-wave oscillator can. Align the R.F. and antenna stages. Reset dial to just above .17 and resonate the green coded oscillator trimmer at 175 kc. Recheck the 350 kc. setting.

Broadcast Band

It is necessary on the broadcast band only, that a metal plate with holes in line with the trimmer nuts be used so that the circuits are not detuned when the regular base plate is screwed back on.

Turn the band indicator to broadcast .55 to 1.5, set the dial to 1.4, and feed in 1,400 kc. Resonate trimmer 13, R.F. trimmer 7 and antenna trimmer (knurled knob extending from top of antenna coil can). Now rotate dial to .55 and resonate trimmer 10 at 550 kc. Recheck the setting at 1,400 and bend plates of variable condenser at 950 and other points where necessary to secure kc. reading on dial.

Short-Wave Band No. 1

Turn band indicator to 1.5 to 3.5, set dial to 3.5, and feed in 8,500 kc. service oscillator signal. Resonate trimmer 13, R.F. trimmer 6 and antenna trimmer 3. Rotate dial to .55 on broadcast band. (The short-wave dial calibration may be inaccurate at this point and the .55 figure corresponds to 1.5 on short-wave band No. 1.) Feed in 1,500 kc. and resonate trimmer 9. Recheck at 8,500 kc.

Short-Wave Band No. 2

Turn band indicator to 3.5 to 9, set dial to about 8.9 (due to off-calibration this corresponds to 8.5), and feed in 8,500 kc. Resonate trimmer 12, R.F. trimmer 5 and an-

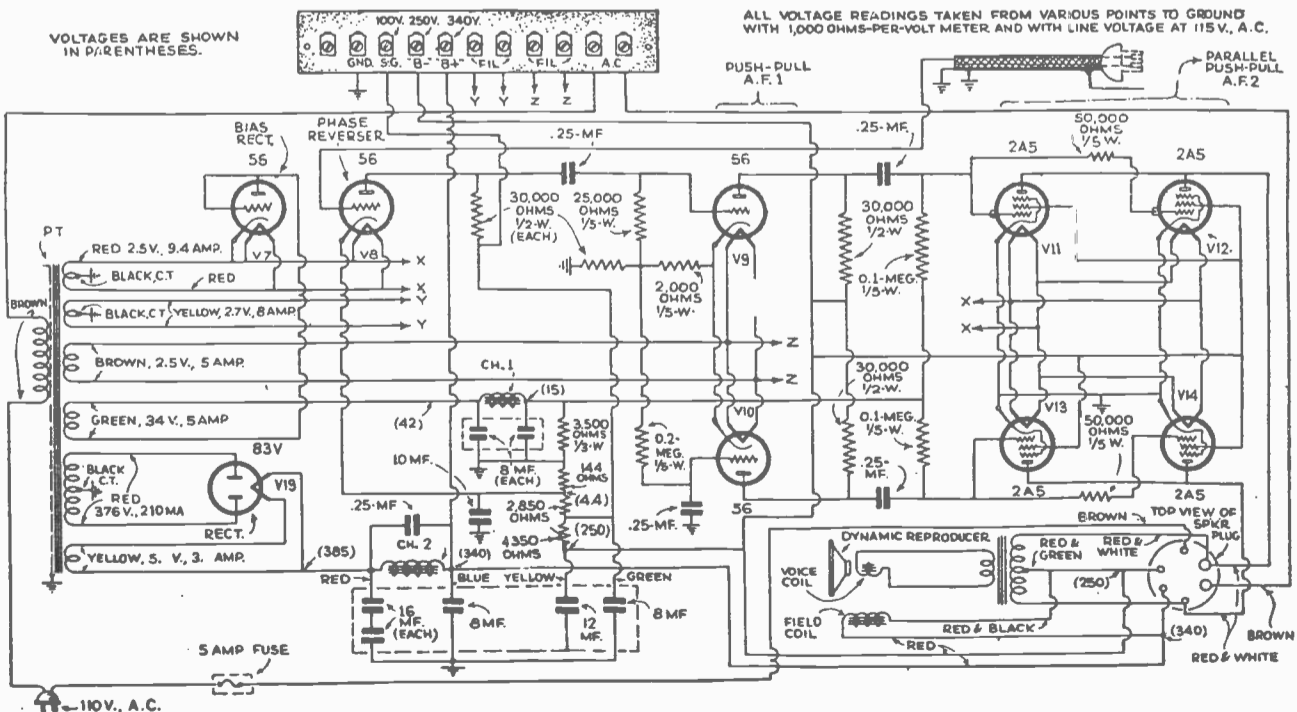

note

McMurdo Silver

Early biography of the "youth" behind the Silver-Marshall and McMurdo Silver radios

By A. Henry

HAVE you ever sat in one of the skyscraping stadiums which now dot the land and watched a famous football team in action—and then, later in the game, had an opportunity to stand close by the side-lines and see that team rush past you, literally shaking the ground as it bucked the line of its adversaries with speed "faster than the eye can follow?" That is, perhaps, a feeble suggestion of the impression one gets from meeting the newest and youngest among those radio manufacturers who hold the coveted "RCA license." He is one of the most remarkable figures in an industry distinguished for the number of young men who have attained high places.

Yet, lest the impression be conveyed that McMurdo Silver is a superman sent to earth with some peculiar sort of silver spoon in his mouth which causes difficulties to vanish before his inspired onslaught, it had best be explained that such by no means appears to be the case. Those familiar with Silver's short but adventurous business life know that, if he is a whole football team in himself, his life has been no continual succession of marches down the field to repeated touchdowns. On the contrary, there have been times when the ball was in the enemy's hands, with the line gritting its teeth to withstand the opponents' determined rushes. But, after all, the important thing about a football game is the final score. And there is no better way of stating his score than to say that in 1924 Silver went into the radio parts business with a determination to attain leadership in that business within five years; and that the thing was done in four years instead of five—for 1928 saw Silver-Marshall at the top of the heap!

And—if further evidence is needed—1929 finds this same 26-year old executive the recipient of a manufacturer's license from the Radio Corporation of America, General Electric Company, Westinghouse Electric & Manufacturing Company, and American

Telephone & Telegraph Company, to manufacture radio receivers under the famous "pooled patents" which opened the door to large-scale radio production in the market of the middle twenties. When it is remembered that these licenses have consistently been issued only to large and long-established radio manufacturing corporations—and that a minimum payment of \$100,000 per year is required of each licensee as compensation for the use of these combined patents of the largest electrical research laboratories in America—it becomes clear that those in the high councils of electrical big business are much of the deliberate opinion that McMurdo Silver is a "good bet."

And the story of this man who is still a mere boy, is doubly interesting; for it can easily be the story of any "amateur" young man of today, if only he is willing to follow in Silver's footsteps, and work and study to fit himself—not to seize, but to do as Silver did—to make, his own opportunities.

McMurdo Silver was born on the 15th of March, 1903, in Geneva, New York—almost a St. Patrick's baby. His father was professor of ancient history at Hobart College. Both of his parents were of American stock for several centuries back, with Scotch, English and French blood behind their American ancestry. The boy's early youth was uneventful except, as this narrative may fall in the class of "success stories," it must be stated that young Silver did not run true to "success" form. He was not a leader among the boys of the town, he did not play the most devilish of practical jokes, and he was not at the head of his class—actually, he was far from the top, most of the time. Nor was he a book-worm—in fact, up to the age of nine, nothing unusual seems to have been apparent in the boy except a rather noticeable seriousness.

AS THE TWIG IS BENT

At the age of nine, "wireless" came into Silver's life. How it came, and how he assimilated it, forms an amusing anecdote. Some older members of his family, seeking to instill educational thoughts in the child's mind, one day read to him two accounts from a monthly magazine. One was of "wireless," which had come into the lime-

A young constructor, a few years back, busy with a set which its contemporaries can readily date. He has since grown up with the industry—in fact, from a business standpoint, much faster.



McMURDO SILVER

light of public attention through the sinking of the *Republic* and, just then, of the *Titanic*. At the same time an account was also read of the Mexican Rurales, a troop of mounted police recruited from criminals by the simple and masterly expedient of catching one, putting a rope around his neck, placing him upon a horse all ready to be gently stroked with a whip, and asking the individual so situated if he wished to become a *Rurale*, or if he preferred to dismount from his steed posthaste and remain in the unenviable position of hanging by his neck to an obliging tree limb, separated from it by several feet of rope, and from the ground by several feet more. The answer, unless choked off by the culprit's emotion, or the executioner's desire for the unusual negative reply by way of a bit of extra excitement, was invariably "yes."

Strange as it may seem, these two bits of instruction stuck firmly in the young man's mind. The next day the cook, called to the back yard of the family residence by unearthly yells, beheld a strange sight. Sitting astride a saw-horse was a young Mexican boy hurriedly conscripted for the part of the convict. His hands were tightly tied, and a very heavy rope, almost thicker than his pudgy arms, connected his unwilling neck with the limb of a small tree directly above him. He was calling loudly upon all the saints known to him in a somewhat unintelligible imitation of Spanish. Next to him stood one of the "Silver Gang," asking loudly and repeatedly whether he "joined or died." The executioner, in anticipation of the reply, held the nozzle of a length of garden hose in his hand. Some distance away, in a confiscated wash-boiler, stood the instigator of this new game, holding the other end of the hose in one hand, while in the other was another piece of hose which reached back to the gibbet and terminated in the grimy grip of the assistant executioner. As the victim's pleas were uttered, the executioner shouted them into one hose, through which they were presumably transmitted to the ship at sea, represented by the wash-boiler. From there, through the other hose, the verdict was shouted in a high falsetto to the assistant executioner, who in turn put the all-important question to the prisoner.

In this way wisdom was assimilated by

the analytical mind of McMurdo; communication with ships could only be through rubber hose, since one couldn't shout several thousand miles. And to use "wireless telegraphy" one had to have a reason; which was opportunely provided by the recalcitrant son of a Mexican villager, who might even yet be reclaimed to the cause of the law by strong-rope methods and the marvels of radio.

THE TREE'S INCLINED

Having had the error of his ways physically impressed on him in no uncertain manner, the inquiring streak of Silver's mind came to the surface. He set out to find out about "wireless," and the reason for his chastisement. This he did for several years with no overpowering success. To earn money to buy the parts with which to experiment, he obtained a job that every older boy in town had had before him; and given up after a few days—or few weeks—for the job required a degree of regularity abhorrent to a small boy's soul. It was the newspaper route in the village. Every day, including Sunday, the boy had to get the New York City papers from the noon train, make up his route, and deliver papers from one end of town to the other, rain or shine. Fortunately, Silver's school hours permitted this and somehow he held the job not for a month, but for years. And so the paper route that had once been a source of emergency revenue to small boys of the town, ceased to be a source of annoyance to the methodical villagers who wanted their papers promptly on the dot, and seldom had got them. But let us not give young Silver credit for too much perseverance. Two factors held him on the job, rain or shine, winter or summer. The first was a parent anxious for his daily paper to arrive promptly and regularly, and the second was a similar determination on the part of the no-longer harassed proprietor of the route, which manifested itself in a much more substantial manner than parental orders.

All the money gained does not seem to have given him a "wireless" that was ever the talk of the town, but the foundation was being laid; he was reading and studying "wireless" to a point where his school studies suffered badly. Early in 1916 Professor Silver died, and the young man moved to New York City with his mother. By this time he had managed to squeeze out of grammar school, from which he never did graduate, and into high school; and for three successive years he was the discouragement of his instructors, all of whom finally gave him up as hopeless, and firmly threw him out of school.

So on a memorable Armistice Day of November 11, 1918, while Wall Street was covered from top and bottom with paper and ticker tape, and the world was terribly jubilant at the prospect of peace after the long repression of the war years, young Silver started to work in earnest to help support his family. And had Professor Silver been alive, it is doubtful if he would have been greatly grieved at the failure of his son to acquire an academic education; for the liberal-minded father had always felt from his years of experience that for a young man so uninterested in a college training as not to desire it, or to be unable, through lack of interest, to assimilate it, its loss was no real loss.

But this time the secret of Silver's success could be seen, but by most parents it

Continued on page 8



Automotive Radio

RADIO-CRAFT

May, 1932

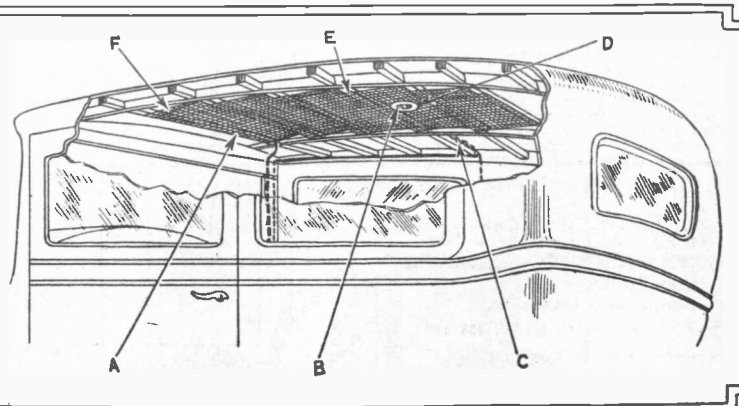
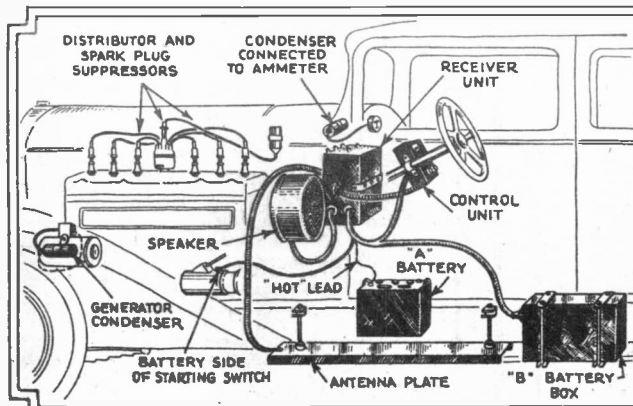

At the left is shown a typical car installation and at the right is shown a typical car antenna. At A are shown stagger tacks to permit listings on head lining, to be tacked over screen; at B, dome-light; at C, dome-light wiring; at D, a hole which is cut to clear the dome-light—the edges of the screen are soldered; at E, the antenna screen—use bright copper or bronze wire only; at F, edges of screen—they must be soldered.

SILVER

would not have been recognized. He was a failure at school; yet at the age of thirteen, in 1916, he had written, and had succeeded in having published in a sporting magazine of the day, an article of several thousand words on a subject in which he was deeply interested—early American firearms. This was during wartime, and as "wireless" had been prohibited to amateurs, Silver had thrown his whole interest into studying his other hobby, antique guns. His interest was so great, and he had spent his waking hours in such deep study and determined efforts to satisfy his curiosity at public libraries, museums, and in gun stores, that he possessed at the age of thirteen a more complete knowledge of early American arms than many a veteran collector or dealer. And this knowledge had enabled him to earn many hundreds of dollars in the years of 1916, 1917 and 1918 in buying, selling and trading old arms; for in this field his commercial talent first showed itself.

Interested as he was in firearms, he could not enlist, for he was but fifteen years old when the war ended. The ban was lifted from radio shortly after Armistice Day, and Silver began to experiment again, with the new vacuum tubes that had been developed during the war. Not content to work as a Wall Street messenger during the day and play with wireless at night as most boys would have been, he added the commercial element of building, buying and selling the crude "wireless" parts and sets of the day in addition to his trading in old arms. Silver was ambitious, and spent in study his every waking hour outside of a job that he seldom left before seven or eight o'clock in the evening.

WORKING INTO RADIO

The story is told that he gave himself five years to become a partner in the old, established brokerage house for which he worked and, upon finding himself advanced

only to the position of quotation-board boy after a year and a half, forsook Wall Street. At this point his life work was determined upon. Up to then "wireless" and antique arms had had his almost equal interest. The offer of a position as laboratory assistant in the tube laboratories of the Westinghouse Lamp Company at Bloomfield, New Jersey, decided his fate and radio definitely claimed him early in 1920. The work of developing the tubes that preceded the present Radiotrons so intrigued Silver that he decided to become an engineer—this lad who had failed at every scholastic study. How did the boy who had been disappointed because he could not rise to the top over night in Wall Street go about it?

His interest aroused, he set to work, blindly at first, then pointedly. First he asked—"Why can't I have an engineer's job now?" And when laughed at he persisted until he found out concretely just what he would have to do to become an engineer. Having then little money for education, he decided to take night courses in engineering at Cooper Union. But he was unable to pass the entrance examinations; for his only education was what he had absorbed from his parents and dug out of his hobbies for himself. Unable to take up an engineering course at once, he set out to lay the groundwork that would enable him to enter Cooper Union later. Starting in another night school to prepare, he soon passed his examinations at the head of one class, second in another. Such was the strength of his interest when once aroused. In the meantime, having learned all he could at the Westinghouse Laboratories without knowledge of his own, he went to work for a radio and electrical jobber in New York to broaden his experience. Not greatly interested in his work, he made no startling success, though promoted twice in eighteen months, once to head of his department, the second time to a higher department.

Continued next month



A modest start for a manufacturing industry: the second floor of a garage in a Chicago suburb was the first home of "S-M."

1932 ad

<p>Write Today for Information on This</p>	<p>AUTO-DIAL RADIO Quality, tone, selectivity, and power</p>  <p>COMPLETE \$39.20—includes set, remote control, suppressor kit, tubes and dynamic speaker. Set only \$17.65. Dealers wanted. Write today. J.-M.-P. MANUFACTURING CO., INC. 3359 Fond du Lac Ave., Milwaukee, Wis.</p>	<p>Sensational AUTO RADIO</p>
---	--	--

RADIO GERMAN

1932 COMMENT ON
A FOREIGN RADIO

Pictured below is a new receiver manufactured by Telefunken, of Germany. Now, this receiver has many good points which may well be incorporated in American sets.

First, the under-chassis view, shown to the right of the set, is so constructed as to make servicing a relatively easy matter. This, of course, is in direct contradiction to American standards.

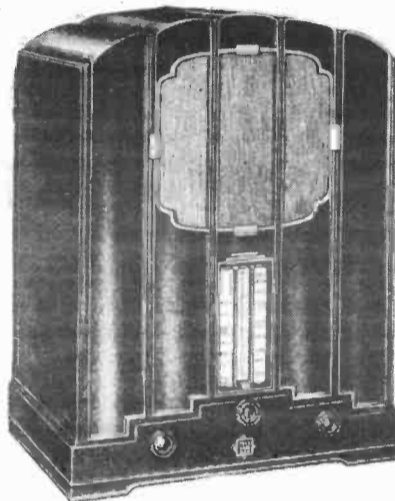

Telefunken receiver.

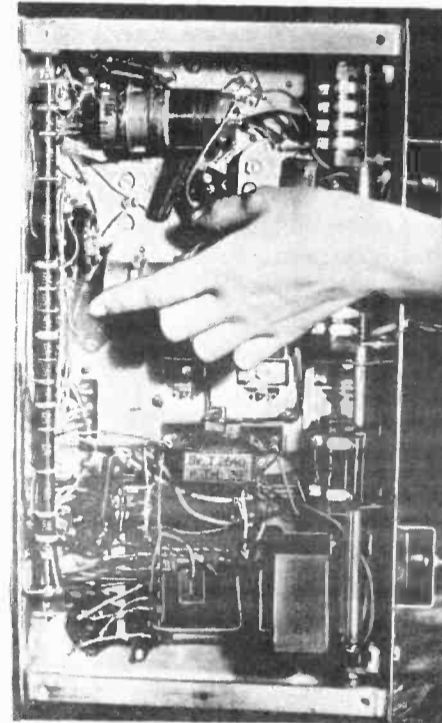

Under-chassis view of the receiver.

RADIO-CRAFT for NOVEMBER, 1932

1975 ad

**50 YEAR OLD FLAME PROOF KEY
TYPE J-7-A**
Gov't. Order No. 141082 Dated: 1921



\$12.95
PPD

In 1966 the U.S. Navy closed the hugh Brooklyn Navy Yard and the City of New York purchased the property. The J7A Keys were discovered in a warehouse where they had been stored for the past 50 years. Corrosion has been corrected, however, there is some slight paint peel. New boxes have been provided.

Both keys are of heavy duty construction with a large Navy type knob. The keying arm and dome are brass . . . the contacts are 1/4 inch coin silver. The J7A is 2 1/2 x 5 1/2 inches and the J5A is 2 1/2 x 3 1/4 inches in size. The BULB, or Lamp is NOT supplied with the J7A.

**A RARE FIND!
ORDER TODAY!** **\$12.95**
ppd

The J5A was made for the Signal Corps in 1941, and is the same type of Key except for the Dome housing the neon bulb. A real memento of WWII. Supply is somewhat limited . . . buy today!

\$11.95
ppd



Sounders
\$25.00
ppd

WALTS EMPORIUM
P. O. BOX 19406 DALLAS, TEXAS 75219
EVENINGS - 214-262-7855

SAVE FOR
COMPLETE
LIST

TWIN-DETECTOR MIDGET SUPERHET

A VARIATION in radio set design is shown by the mantel-type superheterodyne receiver illustrated in Fig. A; the diagram of connections (Fig. 1) illustrates several novel variations from orthodox design.

The input circuit includes a band selector of the inductive-coupling type. Although



Fig. A

The Radiette "Model 90" midget super.

the use of type '24 tubes is shown, the volume-control potentiometer, R1, is in the cathode circuit and, consequently, the circuit is readily adaptable to the use of type '35 variable-mu tubes; with corresponding reduction in the amount of cross-modulation. A "local-distance" switch, in the chassis, is the only other means of control. The tone control is of capacity-resistance type; C1-R2, connected from grid to grid of the push-pull '45's. The field coil of the dynamic reproducer obtains its current by being connected in the negative lead of the power pack. A jack is provided, for connection of a phonograph pickup in the cathode circuit of the twin-detectors.

This novel arrangement of a power detector circuit is the outstanding point of interest about the "Model 90." This twin-detector design, it will be noticed, is obtained by paralleling two type '27 tubes.

For the guidance of Service Men, the following data are furnished concerning the tube (average) operating characteristics: Plate potentials: V1, V2, V4, V5, V6, V7, V8, 225 volts; V3, 85 volts. Cathode potentials: V1, V4, 2 volts; V2, 7 volts; V3, 5 volts; V5, V6, 25 volts; V7, V8, 28 volts. Screen-grid potentials: V1, V2, V4, 85 volts. Voltages corresponding to the colored lead of the reproducer are as follows: red, 230 volts; blue, 160; black, 0.0; brown, 225. All potentials are thus indicated only on a high-resistance meter.

There are two 8 mf. sections of an electrolytic condenser, C2, in this chassis. This, the "Radiette Model 90" receiver, is a product of Keller-Fuller Mfg. Co., Ltd., Los Angeles, Calif.

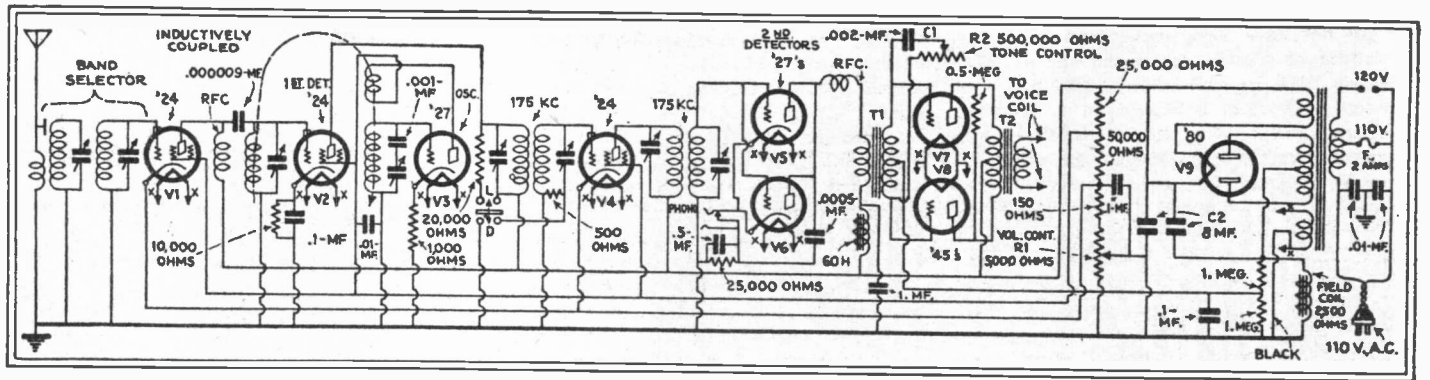

Fig. 1

Identical filament, grid and plate current and potential readings on two tubes in the detector position might come as a surprise to many Service Men; the schematic circuit of the Radiette "Model 90" receiver, above, incorporates such a twin-detector connection; each pair of the elements being connected in parallel.

RADIO-CRAFT for SEPTEMBER, 1931

CLASSIC GOLDEN AGE RADIO, continued from page 6

HOWARD EXPLORER MODEL W 19 TUBE ALL-WAVE SUPER. (Concluded)

tenna trimmer 2. Rotate dial to 8.5 and resonate trimmer 8 at 8,500 kc. Recheck at 8.5 (8.9).

Short-Wave Band No. 3

Turn band indicator to 9 to 21, set dial to 20, and feed in 20,000 kc. Resonate oscillator trimmer 11, R.F. trimmer 4 and antenna trimmer 1. The alignment at 9 is obtained by use of the fixed condensers which should not require change. To insure band sensitivity in the region of major foreign program reception, turn the dial to 12 and resonate antenna coil trimmer 1 at 12,000 kc.

Note that since all adjustments are made with the A.V.C. inactive, extreme care must be used to attenuate the input signal low enough so that there will be no overloading of tube amplifiers while making adjustments.

After these high-frequency adjustments have been made, the service oscillator setting should be advanced 980 kc. and the output signal strength considerably increased; non-reception of the image signal indicates incorrect set oscillator adjustment. For example: a service oscillator signal of 20,930 kc. should be perceptible at 20 on the dial after alignment to 20,000 kc.

Beat Oscillator Adjustments

Turn the main dial to receive a service oscillator signal of 4,800 kc., and make sure that the band on the "beat oscillator" (Frequency Meter V17) falls on 1.5 when the 2 gang condenser is at full capacity.

Turn Osc. Sw. to the right ("Mod."), and frequency dial to 4. Resonate the trimmer on the 2 gang condenser to main dial setting. Turn band indicator switch to short-wave band No. 1 (1.5 to 8.5), set main dial to where 1,500 kc. comes in, turn frequency dial to 1.5, and then resonate trimmer 15.

A.V.C. Adjustment

Connect one side of a high-resistance voltmeter to A.V.C. potentiometer terminal which connects to the "high" side of the 0.2-meg. resistor and to the 0.1-mf. fixed condenser, and the other (positive) to chassis ground.

Adjust the receiver for reception of a signal intensity of 3,000 to 4,000 microvolts, and vary for maximum voltmeter reading, in a given locality, the adjustment in the top, next to the neon adjustment, of the coil can assembly in the upper right-hand corner (facing rear of tuner).

In certain localities close to a broadcast station it may be necessary to readjust the A.V.C. (slotted shaft) control. Exactly resonate the receiver. Then, if the station's signals sound "fringy" or rough, turn the control to the right only sufficiently far to correct this condition.

Neon Tuning Indicator and Q.A.V.C.

Facing the back of the tuner chassis, extending through one of the tall shielded assemblies in the upper right-hand corner, will be found a small, black knurled knob used to adjust the neon resonance indicator. It is advantageous to be able to set this adjustment if excessive fading is experienced due to locality. Adjust the receiver dial to a powerful station during the time of day in which it is received strongest. Then turn the neon adjustment until the light just fills the opening. In arrow dial. Readjust the tuning dial of the receiver; should the light become more brilliant, leave the dial at the point of highest brilliancy and again readjust the neon indicator until it just fills the arrow opening. (This adjustment need be made only when the set is installed.)

Since the inter-station noise suppression system or Q.A.V.C. is a proportional function

of the neon light, the Q.A.V.C. system will be correctly adjusted.

Note that the neon light system is not intended to work on the short-wave stations. However, it will usually indicate resonance to more powerful signals.

Resistor X is an oscillator suppressor in short-wave band No. 3. Its value is determined by individual requirements.

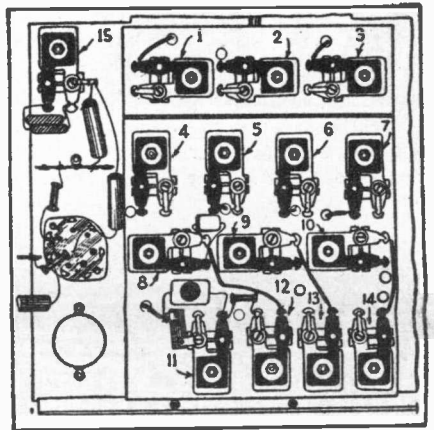

Locations of trimmer condensers in the new 19 tube all-wave superheterodyne. This illustration furnishes the necessary information to complete the data in the text.

Schematic circuit of the tuner chassis. There are 19 tubes in this unit. The 2-gang condenser mentioned in the text is located at the right of oscillator V17.

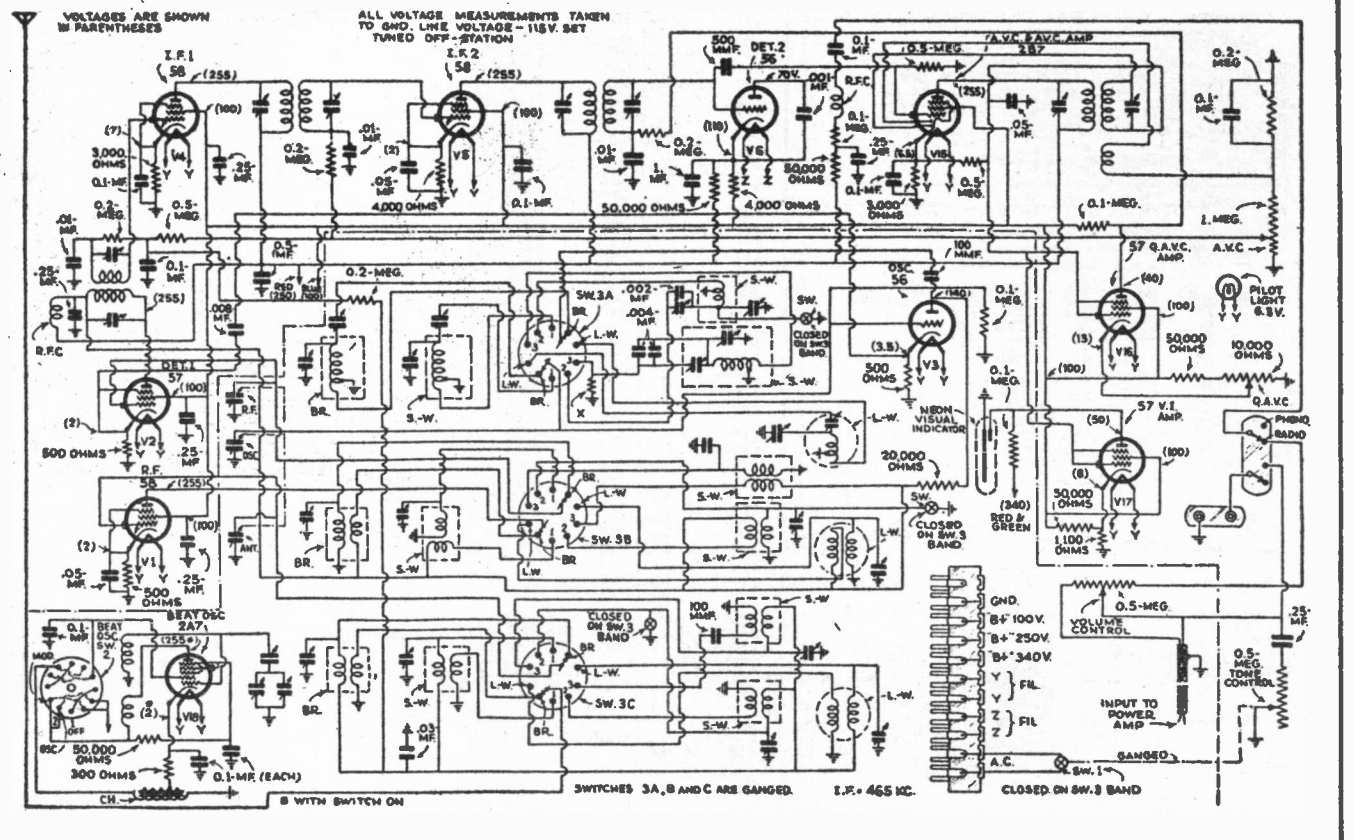

1924 ad

CRYSTAL ATOMITE
FOR **POWER VOLUME**
LOUD EVERYWHERE. A SIZABLE CHUNK—SENSITIVE ALL OVER. ATTRACTIVELY MOUNTED.
GUARANTEED
PRICE 50c POSTPAID

NION
PRICE \$1.02 POSTPAID
FIXED DETECTORS—ARE LOUD AND CLEAR.

NICKEL PLATED Especially Adapted for REFLEX DURABLE
PAT. APPLIED FOR

THE KEYSTONE PRODUCTS CO.
168 Gardonia Avenue, MICHIGAN
ROYAL OAK, MICHIGAN

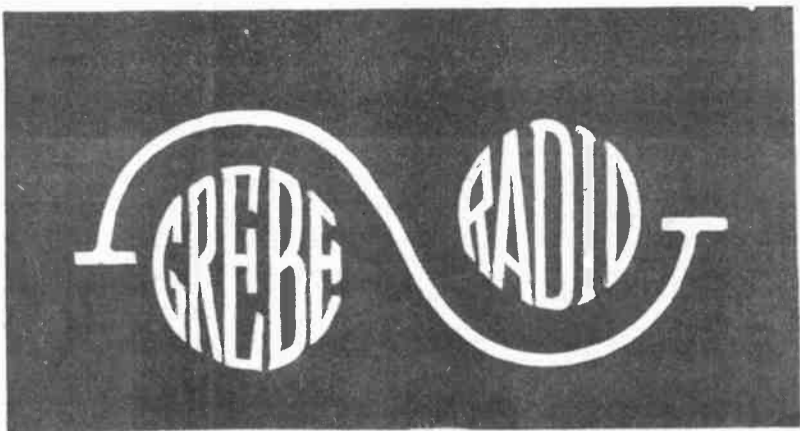

DURING SPARE MOMENTS
When not developing receiving outfits, W. F. Diehl, Chief Engineer of A. H. Grebe & Company, seeks enjoyment at Bayside, N. Y. His voice has been heard over the radiophone in nearly every state in the Union

1922

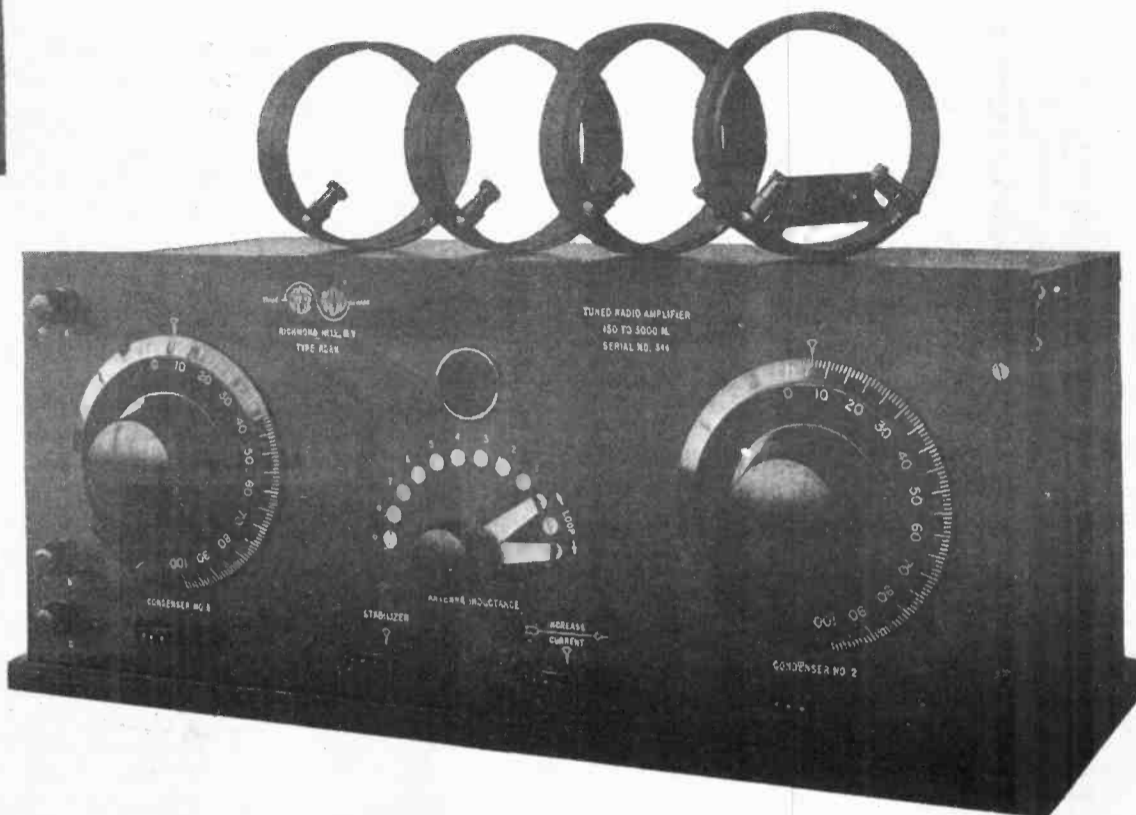

A SINGLE STAGE OF TUNED RADIO-FREQUENCY AMPLIFICATION
Is provided in this amplifier, which may be applied to any form of receiver without making special connections. Four output coils, giving a wavelength range of from 150-3000 meters, form the coupling between the radio-frequency amplifier and the receiver proper. The price of this unit and the coils is \$60.

1975 advertisement

PUETT ELECTRONICS

LIST NUMBER 10
3008 Aberton Drive Mesquite, Texas 75149

MAILING ADDRESS:
3008 Aberton Drive Mesquite, Texas 75149

HOW TO ORDER:

- ALL CHECKS OR MONEY ORDERS MUST BE MADE PAYABLE TO J.W.F. PUETT.
- Please state whether new or used tubes are desired and whether a half-price used tube is desired when a new tube is out of stock. REFUNDS are mailed with your invoice for out-of-stock tubes, or when, by customer request, a used tube is substituted for an out-of-stock new tube.
- All orders are shipped parcel post - no C.O.D. INCLUDE 15% FOR POSTAGE AND HANDLING. INSURANCE RATES ARE 30% for orders under \$50.00. TEXAS RESIDENTS ADD 5% STATE SALES TAX.
MINIMUM ORDER \$3.00

TABLE 1. OLD STYLE GLASS ENVELOPE TUBES
all are used, thoroughly tested

RADIOTRON	CUNNINGHAM	SYLVANIA	MAJESTIC
10	C32A	SY22A	G-27
UX210	CX326	SY277	G27S
UX224	C327	SY551	G35S
UX227	CX332	SY280	A.P.
UX226	CX345		
35	80	PERFORMAN	PHILCO
37	CX380	N-281	24
UX240		PA22A	26
UX245			27
71A	NATIONAL		36
UX290	UNION	ACE	37
866	W337	22A	71A
	WY22A		80
		TUNG SOL	
		2A	
		CROSLLEY	
		56	
		D227	
		WIZARD	
		245	
		226	
		SILVERTONE	
		227	

SPEED 27 \$3.

TABLE 2. SPECIALS

O1A new in original cartons (new style) \$6.00
 Cunningham CX350 used \$5.00
 Radiotron UX-200 new in original cartons \$7.00
 Westinghouse projection bulb (very old) Type T20 C13F 500 watt new \$4.00
 Western Electric WE212F used \$15.00
 Type 852 used \$15.00
 Arcturus Type 56 (blue glass) used \$5.00
 Arcturus Type 27 (blue glass) new in original carton \$7.00

ALL TUBES ARE THOROUGHLY TESTED on a mutual conductance tube checker before shipment. **CUSTOMER SATISFACTION GUARANTEED** - If you are not satisfied with your order for any reason, tubes may be returned within ten days for refund or replacement with exception of tubes which are shorted or have open filaments. It will be assumed that returned tubes with open filaments or shorts were damaged in shipment. Shipping damage claims will be handled promptly through the post office on insured orders. Puett Electronics assumes no liability for orders which are not insured, and no liability beyond that which is covered by postal insurance.

IN TABLE 3, THE SYMBOL n INDICATES THAT A TUBE IS AVAILABLE NEW AND THE SYMBOL u INDICATES THAT THE TUBE IS AVAILABLE USED.

TABLE 3. OLDER TYPE-NUMBER TUBES - prices listed for new tubes used tubes are half new price

O	u	523	nu	2.	6X75	nu	3.	14C5	n	3.	55	u	3.
1A3	n	524	nu	2.	7A4	nu	3.	14C7	n	3.	56	u	3.
1A4	nu	524	n	3.	7A5	n	3.	14F7	n	3.	57	nu	3.
1A5	nu	524	n	3.	7A6	nu	3.	14F8	n	3.	58	u	3.
1A6	n	525	n	3.	7A7	nu	3.	14J7	n	3.	59	u	3.
1A7	nu	525	n	3.	7A8	nu	3.	14J7	nu	3.	70A7	n	3.
1A8	n	525	n	3.	7A9	nu	3.	14J7	n	3.	70L7	nu	3.
1A9	n	525	n	3.	7A9	nu	3.	14J7	n	3.	75	u	3.
1B4	n	525	n	3.	7A9	nu	3.	14J7	n	3.	75	u	3.
1B5	u	525	n	3.	7A9	nu	3.	14J7	n	3.	75	u	3.
1C5	nu	525	n	3.	7A9	nu	3.	14J7	n	3.	75	u	3.
1C6	n	525	n	3.	7A9	nu	3.	14J7	n	3.	75	u	3.
1C7	u	525	n	3.	7A9	nu	3.	14J7	n	3.	75	u	3.
1D5	u	525	n	3.	7A9	nu	3.	14J7	n	3.	75	u	3.
1D8	nu	525	n	3.	7A9	nu	3.	14J7	n	3.	75	u	3.
1E5	u	525	n	3.	7A9	nu	3.	14J7	n	3.	75	u	3.
1E7	n	525	n	3.	7A9	nu	3.	14J7	n	3.	75	u	3.
1F4	n	525	n	3.	7A9	nu	3.	14J7	n	3.	75	u	3.
1G4	nu	525	n	3.	7A9	nu	3.	14J7	n	3.	75	u	3.
1G5	u	525	n	3.	7A9	nu	3.	14J7	n	3.	75	u	3.
1G6	u	525	n	3.	7A9	nu	3.	14J7	n	3.	75	u	3.
1H4	u	525	n	3.	7A9	nu	3.	14J7	n	3.	75	u	3.
1H5	nu	525	n	3.	7A9	nu	3.	14J7	n	3.	75	u	3.
1H6	nu	525	n	3.	7A9	nu	3.	14J7	n	3.	75	u	3.
1LA4	n	525	n	3.	7A9	nu	3.	14J7	n	3.	75	u	3.
1LA6	nu	525	n	3.	7A9	nu	3.	14J7	n	3.	75	u	3.
1LB4	nu	525	n	3.	7A9	nu	3.	14J7	n	3.	75	u	3.
1LC5	n	525	n	3.	7A9	nu	3.	14J7	n	3.	75	u	3.
1LC6	n	525	n	3.	7A9	nu	3.	14J7	n	3.	75	u	3.
1LD5	nu	525	n	3.	7A9	nu	3.	14J7	n	3.	75	u	3.
1LE3	n	525	n	3.	7A9	nu	3.	14J7	n	3.	75	u	3.
1LF3	n	525	n	3.	7A9	nu	3.	14J7	n	3.	75	u	3.
1LG5	n	525	n	3.	7A9	nu	3.	14J7	n	3.	75	u	3.
1LH4	nu	525	n	3.	7A9	nu	3.	14J7	n	3.	75	u	3.
1LH5	nu	525	n	3.	7A9	nu	3.	14J7	n	3.	75	u	3.
1LH6	nu	525	n	3.	7A9	nu	3.	14J7	n	3.	75	u	3.
1LH7	nu	525	n	3.	7A9	nu	3.	14J7	n	3.	75	u	3.
1LH8	nu	525	n	3.	7A9	nu	3.	14J7	n	3.	75	u	3.
1LH9	nu	525	n	3.	7A9	nu	3.	14J7	n	3.	75	u	3.
1LH0	nu	525	n	3.	7A9	nu	3.	14J7	n	3.	75	u	3.
1LH1	nu	525	n	3.	7A9	nu	3.	14J7	n	3.	75	u	3.
1LH2	nu	525	n	3.	7A9	nu	3.	14J7	n	3.	75	u	3.
1LH3	nu	525	n	3.	7A9	nu	3.	14J7	n	3.	75	u	3.
1LH4	nu	525	n	3.	7A9	nu	3.	14J7	n	3.	75	u	3.
1LH5	nu	525	n	3.	7A9	nu	3.	14J7	n	3.	75	u	3.
1LH6	nu	525	n	3.	7A9	nu	3.	14J7	n	3.	75	u	3.
1LH7	nu	525	n	3.	7A9	nu	3.	14J7	n	3.	75	u	3.
1LH8	nu	525	n	3.	7A9	nu	3.	14J7	n	3.	75	u	3.
1LH9	nu	525	n	3.	7A9	nu	3.	14J7	n	3.	75	u	3.
1LH0	nu	525	n	3.	7A9	nu	3.	14J7	n	3.	75	u	3.
1LH1	nu	525	n	3.	7A9	nu	3.	14J7	n	3.	75	u	3.
1LH2	nu	525	n	3.	7A9	nu	3.	14J7	n	3.	75	u	3.
1LH3	nu	525	n	3.	7A9	nu	3.	14J7	n	3.	75	u	3.
1LH4	nu	525	n	3.	7A9	nu	3.	14J7	n	3.	75	u	3.
1LH5	nu	525	n	3.	7A9	nu	3.	14J7	n	3.	75	u	3.
1LH6	nu	525	n	3.	7A9	nu	3.	14J7	n	3.	75	u	3.
1LH7	nu	525	n	3.	7A9	nu	3.	14J7	n	3.	75	u	3.
1LH8	nu	525	n	3.	7A9	nu	3.	14J7	n	3.	75	u	3.
1LH9	nu	525	n	3.	7A9	nu	3.	14J7	n	3.	75	u	3.
1LH0	nu	525	n	3.	7A9	nu	3.	14J7	n	3.	75	u	3.
1LH1	nu	525	n	3.	7A9	nu	3.	14J7	n	3.	75	u	3.
1LH2	nu	525	n	3.	7A9	nu	3.	14J7	n	3.	75	u	3.
1LH3	nu	525	n	3.	7A9	nu	3.	14J7	n	3.	75	u	3.
1LH4	nu	525	n	3.	7A9	nu	3.	14J7	n	3.	75	u	3.
1LH5	nu	525	n	3.	7A9	nu	3.	14J7	n	3.	75	u	3.
1LH6	nu	525	n	3.	7A9	nu	3.	14J7	n	3.	75	u	3.
1LH7	nu	525	n	3.	7A9	nu	3.	14J7	n	3.	75	u	3.
1LH8	nu	525	n	3.	7A9	nu	3.	14J7	n	3.	75	u	3.
1LH9	nu	525	n	3.	7A9	nu	3.	14J7	n	3.	75	u	3.
1LH0	nu	525	n	3.	7A9	nu	3.	14J7	n	3.	75	u	3.
1LH1	nu	525	n	3.	7A9	nu	3.	14J7	n	3.	75	u	3.
1LH2	nu	525	n	3.	7A9	nu	3.	14J7	n	3.	75	u	3.
1LH3	nu	525	n	3.	7A9	nu	3.	14J7	n	3.	75	u	3.
1LH4	nu	525	n	3.	7A9	nu	3.	14J7	n	3.	75	u	3.
1LH5	nu	525	n	3.	7A9	nu	3.	14J7	n	3.	75	u	3.
1LH6	nu	525	n	3.	7A9	nu	3.	14J7	n	3.	75	u	3.
1LH7	nu	525	n	3.	7A9	nu	3.	14J7	n	3.	75	u	3.
1LH8	nu	525	n	3.	7A9	nu	3.	14J7	n	3.	75	u	3.
1LH9	nu	525	n	3.	7A9	nu	3.	14J7	n	3.	75	u	3.
1LH0	nu	525	n	3.	7A9	nu	3.	14J7	n	3.	75	u	3.

IN TABLE 4, THE SYMBOL n INDICATES THAT A TUBE IS AVAILABLE NEW AND THE SYMBOL u INDICATES THAT THE TUBE IS AVAILABLE USED.

TABLE 4. MORE RECENT TUBE TYPES - prices listed for new tubes used tubes are half new price

0A2	n	2.	6AT6	nu	2.	12A5	nu	3.	3525	nu	2.	1629	u	3.
0A3	n	2.	6AV6	nu	2.	12A6	nu	3.	3526	nu	3.	1633	u	2.
0B3	n	2.	6AV6	nu	2.	12AT6	nu	2.	4025	n	3.	1634	u	2.
0C3	nu	2.	6BA6	nu	2.	12AT7	u	2.	4523	n	3.	1635	u	2.
0D3	nu	2.	6BE6	nu	2.	12AU6	nu	2.	4525	nu	3.	2050	nu	3.
0Y4	n	3.	6BJ6	nu	2.	12AW7	nu	2.	50R5	nu	2.	2051	nu	3.
0Z4	n	3.	6CA	nu	2.	12AV6	nu	2.	50S5	nu	2.	5686	n	2.
1L4	nu	4.	6J6	nu	2.	12BA6	nu	2.	50L6	nu	2.	5691	n	2.
1L6	n	5.	6K4	n	2.	12BE6	nu	2.	50T6	nu	3.	5703	u	2.
1R5	nu	2.	6SA7	nu	3.	12L6	nu	2.	5017	nu	3.	5749	u	2.
1S4	n	1.	6SB7	nu	3.	12SA7	nu	2.	117-	n	3.	5751	nu	2.
1S5	nu	2.	6SC7	nu	2.	12SC7	n	3.	23	nu	3.	5814	n	2.
1T4	nu	2.	6SD7	nu	3.	12SF7	n	2.	24	u	3.	5879	n	2.
1T5	nu	2.	6SE7	n	2.	12SF7	n	2.	24	u	3.	5992	u	2.
1U5	nu	2.	6SF7	n	2.	12S7	nu	3.	607	nu	5.	5881	u	2.
2C26	u	3.	6SG7	nu	3.	12SH7	u	3.	879	n	3.	5992	u	2.
2X2	n	3.	6SH7	nu	2.	12SJ7	nu	3.	884	n	5.	6080	u	2.
3A4	nu	2.	6SJ7	nu	2.	12SK7	nu	2.	930	n	3.	6842	n	2.
3A5	nu	2.	6SK7	nu	2.	12SL7	nu	3.	950	n	4.	6973	u	2.
3A8	n	3.	6SL7	nu	2.	12SN7	nu	2.	955	n	4.	6874	n	2.
3Q4	nu	2.	6SN7	nu	1.	12SQ7	nu	2.	958	u	4.	VR		

FOR SALE OR TRADE

FOR CLASSIFIED ADS

No. Words:	One Line	Two Lines	Three Lines	Four Lines
1-25	1.25	2.45	3.65	4.85
26-50	1.70	3.00	4.15	5.35
51-75	1.95	3.40	4.60	5.80
76-100	2.25	3.90	5.10	6.30
101-125	2.50	4.40	5.65	6.90
126-150	2.75	4.90	6.15	7.40
151-175	3.00	5.40	6.70	7.95
176-200	3.25	5.90	7.25	8.50
201-225	3.50	6.40	7.80	9.05
226-250	3.75	6.90	8.35	9.60
251-275	4.00	7.40	8.90	10.15
276-300	4.25	7.90	9.45	10.70
301-325	4.50	8.40	10.00	11.25
326-350	4.75	8.90	10.55	11.80
351-375	5.00	9.40	11.10	12.35
376-400	5.25	9.90	11.65	12.90
401-425	5.50	10.40	12.20	13.45
426-450	5.75	10.90	12.75	14.00
451-475	6.00	11.40	13.30	14.55
476-500	6.25	11.90	13.85	15.10
501-525	6.50	12.40	14.40	15.65
526-550	6.75	12.90	14.95	16.20
551-575	7.00	13.40	15.50	16.75
576-600	7.25	13.90	16.05	17.30
601-625	7.50	14.40	16.60	17.85
626-650	7.75	14.90	17.15	18.40
651-675	8.00	15.40	17.70	18.95
676-700	8.25	15.90	18.25	19.50
701-725	8.50	16.40	18.80	20.05
726-750	8.75	16.90	19.35	20.60
751-775	9.00	17.40	19.90	21.15
776-800	9.25	17.90	20.45	21.70
801-825	9.50	18.40	21.00	22.25
826-850	9.75	18.90	21.55	22.80
851-875	10.00	19.40	22.10	23.35
876-900	10.25	19.90	22.65	23.90
901-925	10.50	20.40	23.20	24.45
926-950	10.75	20.90	23.75	25.00
951-975	11.00	21.40	24.30	25.55
976-1000	11.25	21.90	24.85	26.10

Photo ads \$2.00 extra.

MISC.

PHONOGRAPH COLLECTORS, join the American Phonograph Society. Receive the quarterly Journal and four Newsletters. Receive free reprints and stereoscopic phonograph cards. For more information send 10¢ stamp. For one year membership, send \$6.50. The American Phonograph Society, P. O. Box 5046, Berkeley CA 94705.

WILL DUPLICATE exactly, the mutilated panel for your antique radio. Send sketch or rubbing for quotation, or will trade for antique radios of equal value. Norman A. Parsons, 22 Forest St., Branford CT 06405.

WILL REPAIR, restore, refinish, renew or rebuild your old radio. Buy, sell or trade tubes, parts and radios. Bob Lucas, 9014 Mahoning, Houston TX 77036.

FOR SALE OR TRADE

RARE RCA VICTORS: Model 7-3 Radio Record Player C1926 \$275.00; Alhambra I \$275; Early Orthophonic Credenza \$350.00; Model 9-18 Mint; Extremely Rare Model 9-25 Mint; Extremely High Quality Microphones and many early Radio Books; Grandfather clock-radio, self winding clock and Elra Radio in Pooley Cabinet cannot be told from actual Grandfather clock C1930; Rare "Monarch Special" Victor talking Machine heavily carved cabinet.

NEW OLD TUBES FOR SALE:

350.....#10; 500.....#24A;
1000.....#27; 100.....#47;
350.....#71A; 100.....#35;
50.....#81; 50.....#76
500.....#80

3000 tubes - Price \$1000.00.

Also many other hard to find tubes. Bruce Hertzberg, 343 Wagaraw Road, Hawthorne, N. J. 07506. Phone 201 423-3830.

FOR ALL your requirements in British & European vintage radio, 1920 to 1950, contact "Tudor Rees." Our full 1975 Catalogue now available, sent via airmail to the U.S.A. for two dollars. Tudor Rees, Antique Wireless Service, 64 Broad Street, Staple Hill, Bristol, BS16 5NL, Great Britain.

TRADE: Twenty-four Edison Blue Amberol four minute cylinder records in excellent condition in original containers for antique battery or AC radio equal value. Leland W. Smith, Box 38-B, Route #3, Jasper, Arkansas 72641.

WIND YOUR OWN COILS, audio transformers, etc. Stevens coil winder. Complete, counter, motor, auto brake, foot control, good condition. \$100.00 or trade for radio and wireless gear. Guy Martin, P. O. Box A, Azusa CA 91702.

TRADE: Crosley 52, Radiolas IIIA, 25 w/loop and VIII Port. 200 new tubes in boxes for early electrics. For sale by lot. SASE for tube list. Steve Meyerkorth, 2208 So. 50th Ave., Omaha, Nebr. 68106.

FOR SALE: Surplus obsolete and seldom used tubes. New, used and seconds, have 6C8, 6D6, 6N6, 7B6, 41, 47, 84 and others, 50¢ each. C. Elmer Nelson, 824 S. Pleasant St., Princeton, Ill. 61356.

EDISON CYLINDER PHONOGRAPH Ambrolla 30. Needs some repair, but in nice restorable condition \$150.00. Phone 269-8522, Glen Woody, Box 44, Mountain View, Ark. 72560.

WD11 Adaptors, use UX199, 120 VT24. No wiring changes, Radiola III's battery hook up included \$5.25 pp., 2 for \$9.25. Keith Parry, 17557 Horace St., Granada Hills CA 91344.

FOR SALE: 25 antique battery sets, etc. 201A--\$2.00, X99--\$3.50, V99--\$4.00 plus postage. Send SASE. Lane, 2301 Indep. Ave., Kansas City, MO 64124.

TUBES FOR EARLY RADIOS AND TV's. Send want list for lowest prices, trade in some types for others. Jim Farago, 247 W. Park St., So. St. Paul MN 55075.

FOR SALE: Rubber stamp with your name and address plus AK Radio and speaker \$3.00 pp. James Fred, P. C. 42, Rossville IN 46065.

TAPES OF OLD RADIO PROGRAMS: Reel-to-Reel-8 Track-Cassettes. Free list. The Radio Tape Library, P. O. Box 805, Bakersfield CA 93302.

ONE LOT PRICE: Large number of sets, horns, cone speakers, misc. parts, magazines. Also other sets and QST's. Send SASE. Brewster, 1 Concord Rd., Fishkill, N. Y. 12524.

FOR SALE: Misc. tubes and radio parts. Send SASE for list. G. B. Schneider, 6848 Commonwealth Blvd., Parma Hgts., Ohio 44130.

SELL OR SWAP: Twenties and thirties radios, tubes and books. Send SASE for list to Jack Smith, Rt. 2, Box 418, Gainesville, Fla. 32601.

WANTED

WANTED: Telegraphone, Magnecorder SD-1, pre-1946 Wire recorders; books on recording and pre-1936 television. Buy or trade. H. Leyer, AV-SFSU, 1600 Holloway, San Francisco CA 94132.

WANTED: Radiotron type UV202 tubes, Western Electric type 104D, 102G, 131D, 275A tubes with good filaments. Also one General Radio audibility meter (1920 vintage). Two early make .003 M.F.D. variable tuning condensers. LaVerne Laatz, R. R. 1, Marseilles, Ill. 61341.

WANTED: AK-Breadboards, Radios before 1926, early Disc TV's, Radio magazines before 1927, outside horn phonographs, etc. Please give prices and condition in first letter. Thanks: Charles D. Rakes, Box 445, Bentonville, Ark. 72712.

WANTED: August, October 1943 Radio News. Kennedy, DeForest headphones Kennedy Horn speaker. Escutcheon Plate, knobs for Philco 70. Greg Dockter, 1913 Kennedy, Bismarck, N. Dakota 58501.

I WILL ANSWER ALL correspondence on old Radios from 1914 to 1926. Am looking for an E. H. Scott Phantom 41. Cabinet per page 3 Oct. Horn Speaker. Charles Hammons, 460 Hill Top Rd., Covington KY 41015.

WANTED: Antique Phonograph Catalogues, all brands. Literature collections bought. All replies appreciated. I also collect machines, particularly Columbia Graphophone. Ernest Allen, 2803 Sims, Overland MO 63114.

WANTED: Swap want lists and for sale with anyone. Have many old radios, parts, tubes, speakers, etc. also records 78's cylinder etc. Wayne Wright, Pocahontas VA 24635.

WANTED: Atwater Kent variometer or variocoupler in mint or near mint condition. Advise price. E. V. Brant, 6465 Sterling Ave., Detroit, Mich. 48202.

WANTED: Scott Radios, good or parts sets, Scott News or any other literature. Also Worlds Record 8, 9, or 10. J. Clark, 1617 Roselawn, Lansing, Michigan 48915.

WANTED: Face glass, seal & schematic for 1941 Zenith Model #12S568 Chassis #12A1. Brent R. Miller, 1730 Magdalene Way, Johnstown PA 15905.

WANTED: Information about Tuska radios, schematics, etc. Bob Sullivan, Sullivan and Associates, P. O. Box 5345. Irving TX 75062

March '72
AK "Bread-
board

February '72
Marconi 106.

April '72
Tube article
by Lee DeForest

August '72
Emile Berliner
invents the Gram-
ophone

June '72
Edison Photo-
graph, 1923
radio programs

September '72
Nikola Tesla

February '73
Eagle Grapho-
phone
Echophone "1"

January '73
1887 Electric
Phonograph
Lee DeForest 1902

October '72
WRR since 1920
Amos 'N' Andy

March '73
Multiplex Phono-
graph, Armstrong
receiver

BACK ISSUES ORDER NOW!

THE HORN SPEAKER NEWSPAPER

All 10 back issues for 1973 \$5.00

January '7225¢ ea.
February '72\$1.00 ea.
March '72\$1.00 ea.
April '72\$1.50 ea.
May '7250¢ ea.
June '7250¢ ea.
August '7250¢ ea.
September '7275¢ ea.
October '7275¢ ea.
December '7225¢ ea.

All 20 back issues for 1972 and 1973,
while they last...\$10.00.

Any issue from Jan. '73 to now...50¢ ea.

MARCH

75c

THE HORN SPEAKER

1975

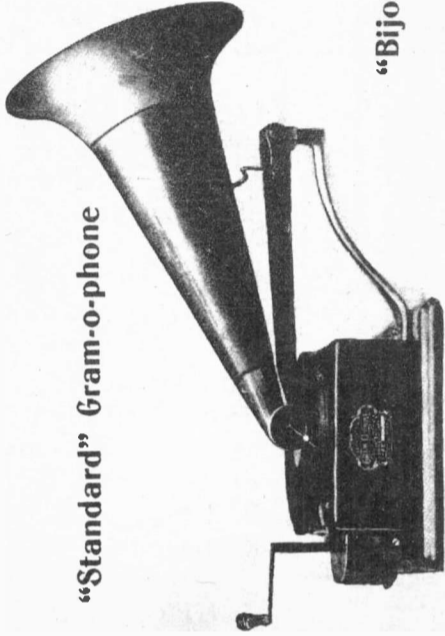

"Standard" Gram-o-phone

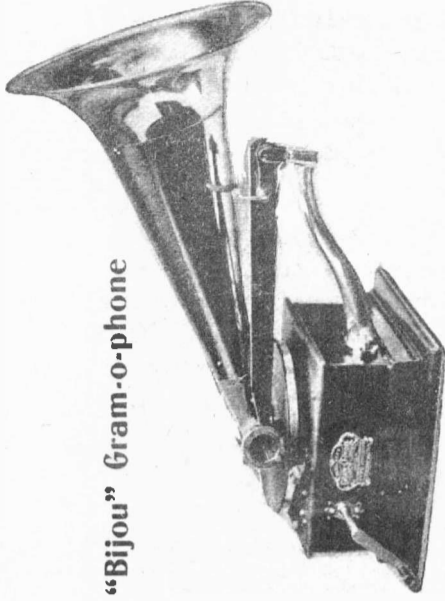

"Bijou" Gram-o-phone

Berliner

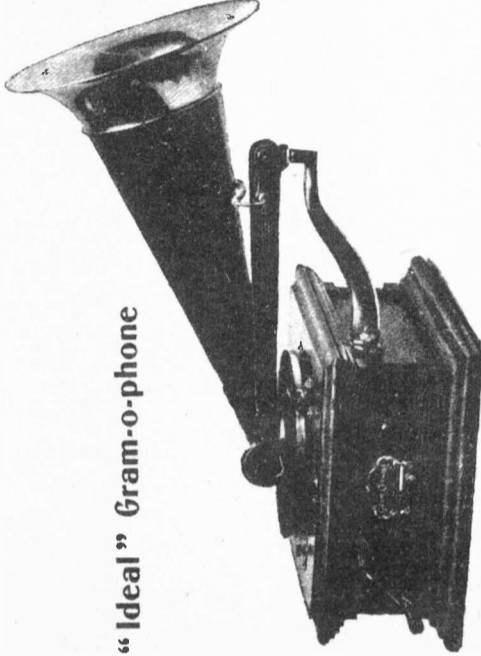

"Ideal" Gram-o-phone

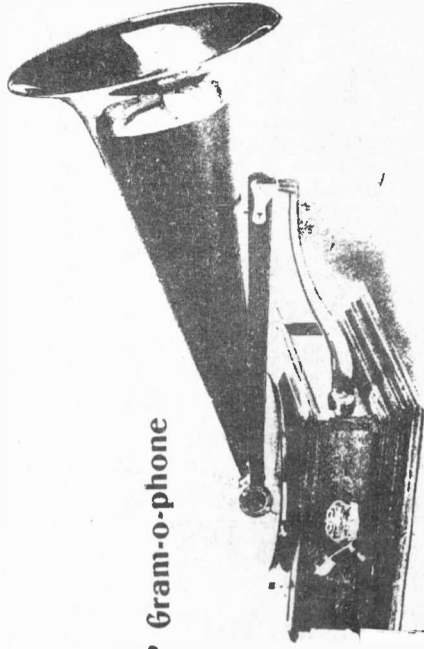

"Grand" Gram-o-phone

Mr. Gary B. Schneider
6848 Commonwealth Blvd.
Parma Hgts., Ohio 44130

5

All prepaid

The Horn Speaker

Box 12 Kleberg, Texas 75145

Send	
PLEASE PRINT	
Name _____	
Address _____	
City _____ State _____ Zip _____	
I Enclosed is \$ _____	