

HOBBY  
ELECTRONICS

# Hands-on Electronics

\$2.50 U.S.  
\$2.95 CANADA  
JULY  
1987  
48784

INCLUDING  
12-PAGE  
**GADGET**

THE MAGAZINE FOR THE ELECTRONICS ACTIVIST!

## 2 WEATHER PROJECTS YOU CAN BUILD!

Outdoor Dress Consultant—  
Know what to wear before you go out

Solid-State Barometer—  
Forecast with a new module!

- Also—
- Rip-off Capacitance Alarm
  - How to Rescue Text Files
  - Op-Amps as Electronic Building Blocks

A  
**GERNSBACK**  
PUBLICATION

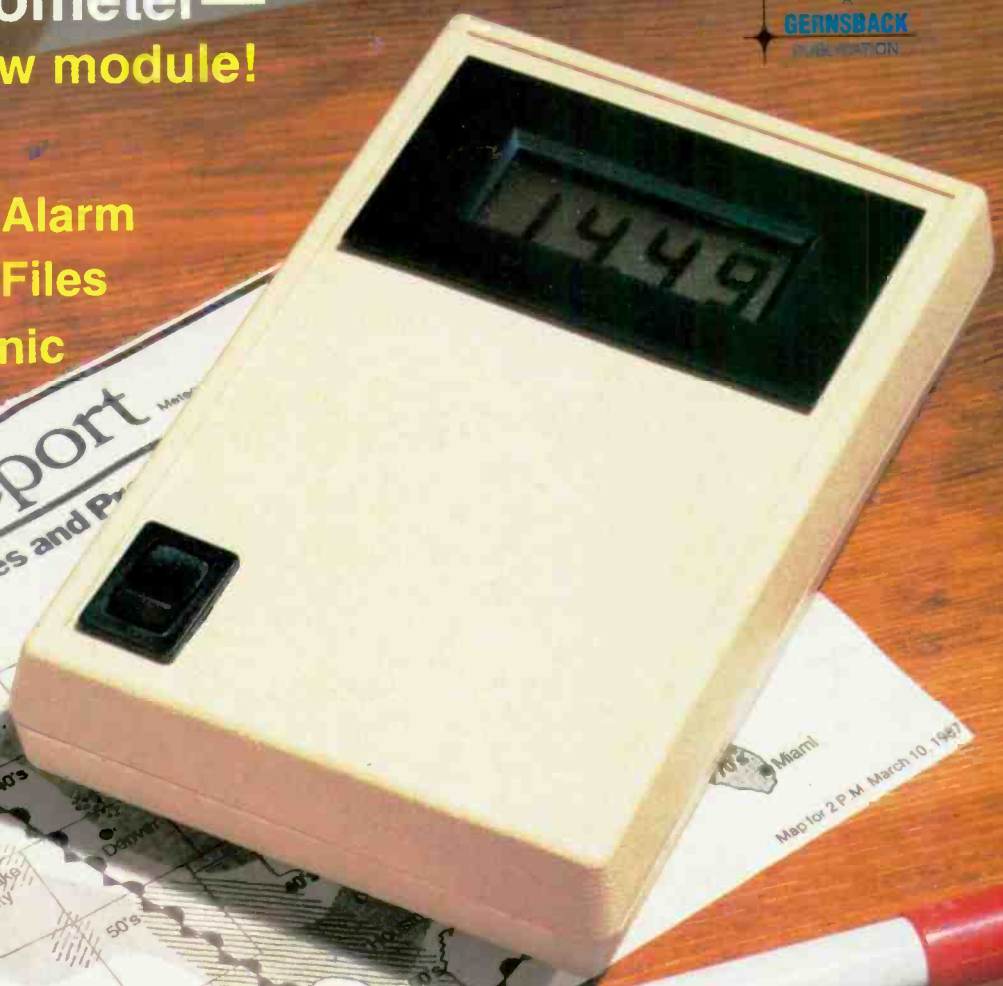

**Plus**

- Frig-Door Alarm
- Playing Old 78's
- Sound Activated Switches
- dBASE Video Tape
- and much, much more!



3 New  
FactCards  
This Issue

# NEW! Turbo Scan™ Scanners

Communications Electronics,™ the world's largest distributor of radio scanners, introduces new lower prices to celebrate our 16th anniversary.

## NEW! Regency® TS2-MA

Allow 30-120 days for delivery after receipt of order due to the high demand for this product.

List price \$499.95/CE price \$319.95  
**12-Band, 75 Channel • Crystalline • AC/DC**  
Frequency range: 29-54, 118-175, 406-512, 806-950 MHz.  
The Regency TS2 scanner lets you monitor Military, Space Satellites, Government, Railroad, Justice Department, State Department, Fish & Game, Immigration, Marine, Police and Fire Departments, Aeronautical AM band, Paramedics, Amateur Radio, plus thousands of other radio frequencies most scanners can't pick up. The Regency TS2 features new 40 channel per second Turbo Scan™ so you won't miss any of the action. Model TS1-MA is a 35 channel version of this radio without the 800 MHz. band and costs only \$239.95.

## Regency® Z60-MA

List price \$299.95/CE price \$184.95/SPECIAL  
**8-Band, 60 Channel • No-crystal scanner**  
Bands: 30-50, 88-108, 118-136, 144-174, 440-512 MHz.  
The Regency Z60 covers all the public service bands plus aircraft and FM music for a total of eight bands. The Z60 also features an alarm clock and priority control as well as AC/DC operation. Order today.

## Regency® Z45-MA

List price \$259.95/CE price \$159.95/SPECIAL  
**7-Band, 45 Channel • No-crystal scanner**  
Bands: 30-50, 118-136, 144-174, 440-512 MHz.  
The Regency Z45 is very similar to the Z60 model listed above however it does not have the commercial FM broadcast band. The Z45, now at a special price from Communications Electronics.

## Regency® RH250B-MA

List price \$699.95/CE price \$329.95/SPECIAL  
**10 Channel • 25 Watt Transceiver • Priority**  
The Regency RH250B is a ten-channel VHF land mobile transceiver designed to cover any frequency between 150 to 162 MHz. Since this radio is synthesized, no expensive crystals are needed to store up to ten frequencies without battery backup. All radios come with CTCSS tone and scanning capabilities. A monitor and night/day switch is also standard. This transceiver even has a priority function. The RH250 makes an ideal radio for any police or fire department volunteer because of its low cost and high performance. A 60 Watt VHF 150-162 MHz. version called the RH600B-MA is available for \$439.95. A UHF 15 watt version of this radio called the RU150B-MA is also available and covers 450-482 MHz. but the cost is \$439.95.

## Bearcat® 50XL-MA

List price \$199.95/CE price \$114.95/SPECIAL  
**10-Band, 10 Channel • Handheld scanner**  
Bands: 29-7-54, 136-174, 406-512 MHz.  
The Uniden Bearcat 50XL is an economical, handheld scanner with 10 channels covering ten frequency bands. It features a keyboard lock switch to prevent accidental entry and more. Also order the new double-long life rechargeable battery pack part # BP55 for \$29.95, a plug-in wall charger, part # AD100 for \$14.95, a carrying case part # VC001 for \$14.95 and also order optional cigarette lighter cable part # PS001 for \$14.95.



MODEL TS-2

MODEL HX 1500

## NEW! Scanner Frequency Listings

The new Fox scanner frequency directories will help you find all the action your scanner can listen to. These new listings include police, fire, ambulances & rescue squads, local government, private police agencies, hospitals, emergency medical channels, news media, forestry radio service, railroads, weather stations, radio common carriers, AT&T mobile telephone, utility companies, general mobile radio service, marine radio service, taxi cab companies, tow truck companies, trucking companies, business repeaters, business radio (simplex) federal government, funeral directors, veterinarians, buses, aircraft, space satellites, amateur radio, broadcasters and more. Fox frequency listings feature call letter cross reference as well as alphabetical listing by licensee name, police codes and signals. These Fox directories are \$14.95 each plus \$3.00 shipping. State of Alaska-RL019-1; State of Arizona-RL025-1; Buffalo, NY/ Erie, PA-RL009-2; Chicago, IL-RL014-1; Cincinnati/ Dayton, OH-RL008-2; Cleveland, OH-RL017-1; Columbus, OH-RL003-2; Dallas/Ft. Worth, TX-RL013-1; Denver/Colorado Springs, CO-RL027-1; Detroit, MI/ Windsor, ON-RL008-2; Fort Wayne, IN/Lima, OH- RL001-1; Hawaii/Guam-RL015-1; Indianapolis, IN-RL022-1; Kansas City, MO/ KS-RL011-2; Long Island, NY-RL026-1; Louisville/Lexington, KY-RL007-1; Milwaukee, WI/Waukegan, IL-RL021-1; Minneapolis/St. Paul, MN-RL010-2; Nevada/E. Central CA-RL028-1; Oklahoma City/ Lawton, OK-RL005-2; Orlando/Daytona Beach, FL-RL012-1; Rochester/Syracuse, NY-RL020-1; San Diego, CA-RL018-1; Tampa/St. Petersburg, FL-RL004-2; Toledo, OH-RL002-3. Regional directories which cover police, fire ambulance & rescue squads, local government, forestry, marine radio, mobile phone, aircraft and NOAA weather are available for \$19.95 each. RD001-1 covers AL, AR, FL, GA, LA, MS, NC, PR, SC, TN & VI. RD002-1 covers IL, IN, KY, MI, OH & WI. For an area not shown above call Fox at 800-543-7892 or in Ohio 800-621-2513.

## Regency® HX1500-MA

List price \$369.95/CE price \$218.95  
**11-Band, 55 Channel • Handheld/Portable**  
**Search • Lockout • Priority • Bank Select**  
**Sidelit liquid crystal display • EAROM Memory**  
**Direct Channel Access Feature • Scan Delay**  
Bands: 29-54, 118-136, 144-174, 406-420, 440-512 MHz.  
The new handheld Regency HX1500 scanner is fully keyboard programmable for the ultimate in versatility. You can scan up to 55 channels at the same time including the AM aircraft band. The LCD display is even sidelit for night use. Includes belt clip, flexible antenna and earphone. Operates on 8 1.2 Volt rechargeable Ni-Cad batteries (not included). Be sure to order batteries and battery charger from the accessory list in this ad.

## Bearcat® 100XL-MA

List price \$349.95/CE price \$178.95/SPECIAL  
**9-Band, 16 Channel • Priority • Scan Delay**  
**Search • Limit • Hold • Lockout • AC/DC**  
Frequency range: 30-50, 118-174, 406-512 MHz.

Included in our low CE price is a sturdy carrying case, earphone, battery charger/AC adapter, six AA Ni-cad batteries and flexible antenna. Order your scanner now.

### ★★★ SPECIAL SAVINGS COUPON ★★★

### ★★★ FREE DURACELL® Batteries Included ★★★

### ★★★ Free local frequency directories ★★★

Save even more with this special coupon. As long as your order is prepaid by money order, you'll get extra special pricing on items listed in this coupon. In addition, if you order a Bearcat 50XL or Regency HX1500 scanner with this coupon, you'll get a free set of Duracell batteries which we recommend for best performance. If you buy a Regency Z60 or Z45 scanner using this coupon, you'll get a free Fox frequency directory worth \$14.95. This coupon must be included with your prepaid order. Credit cards and quantity discounts are excluded from this offer. Offer valid only on prepaid orders mailed directly to Communications Electronics Inc., P.O. Box 1045 - Dept. M3, Ann Arbor, Michigan 48106-1045 U.S.A. Coupon expires July 31, 1987. Coupon may not be used in conjunction with any other offer from Communications Electronics Inc. Be sure to add shipping & handling fees listed in this ad (add \$3.00 for shipping free books or batteries).

- RH250B-M3 Regency 25 W. VHF Transceiver..... \$299.95
- RH600B-M3 Regency 60 W. VHF Transceiver..... \$388.95
- RU150B-M3 Regency 15 W. UHF Transceiver..... \$399.95
- UC102-M3 Regency 1 W. VHF 2 channel trans. .... \$119.95
- HX1500-M3 Regency 55 channel scanner..... \$217.95
- Z60-M3 Regency 60 channel scanner..... \$158.95
- Z45-M3 Regency 45 channel scanner..... \$148.95
- BC100XL-M3 Bearcat 16 channel scanner..... \$177.95
- BC800XL-M3 Bearcat 40 channel scanner..... \$278.95
- INF1-M3 Regency Informant scanner..... \$249.95
- BC210XW-M3 Bearcat 20 channel scanner..... \$168.95
- BC50XL-M3 Bearcat 10 channel scanner..... \$113.95
- RD55-M3 Uniden Radar Detector..... \$97.95

### ★★★ SPECIAL SAVINGS COUPON ★★★

## Bearcat® 800XL-MA

List price \$499.95/CE price \$289.95/SPECIAL  
**12-Band, 40 Channel • No-crystal scanner**  
**Priority control • Search/Scan • AC/DC**  
Bands: 29-54, 118-174, 406-512, 806-912 MHz.  
The Uniden 800XL receives 40 channels in two banks. Scans 15 channels per second. Size 9 1/2" x 4 1/2" x 1 1/2".

### OTHER RADIOS AND ACCESSORIES

- Panasonic RF-2600-MA Shortwave receiver..... \$179.95
  - RD55-MA Uniden Visor mount Radar Detector..... \$98.95
  - NEW/BC70XL-MA Bearcat 20 channel scanner..... \$169.95
  - BC 145XL-MA Bearcat 16 channel scanner..... \$98.95
  - BC 140-MA Bearcat 10 channel scanner..... \$89.95
  - BC 210XW-MA Bearcat 20 channel scanner..... \$169.95
  - BC-WA-MA Bearcat Weather Alert..... \$38.95
  - PC22-MA Uniden remote mount CB transceiver..... \$99.95
  - PC55-MA Uniden mobile mount CB transceiver..... \$59.95
  - NEW/R1080-MA Regency 30 channels scanner..... \$118.95
  - NEW/R1090-MA Regency 45 channels scanner..... \$148.95
  - NEW/INF1-MA Regency Informant scanner..... \$289.95
  - UC102-MA Regency VHF 2 ch. 1 Watt transceiver..... \$24.95
  - P1405-MA Regency 5 amp regulated power supply..... \$69.95
  - P1412-MA Regency 12 amp reg. power supply..... \$164.95
  - MA549-MA Drop-in charger for HX1200 & HX1500..... \$84.95
  - MA518-MA Wall charger for HX1500 scanner..... \$14.95
  - MA553-MA Carrying case for HX1500 scanner..... \$19.95
  - MA257-MA Cigarette lighter cord for HX12/1500..... \$19.95
  - MA917-MA Ni-Cad battery pack for HX1000/1200..... \$34.95
  - SMMX7000-MA Svc. man. for MX7000 & MX5000..... \$19.95
  - B-4-MA 1.2 V AAA Ni-Cad batteries (set of four)..... \$9.95
  - B-8-MA 1.2 V AA Ni-Cad batteries (set of eight)..... \$17.95
  - FB-E-MA Frequency Directory for Eastern U.S.A..... \$14.95
  - FB-W-MA Frequency Directory for Western U.S.A..... \$14.95
  - ASD-MA Air Scan Directory..... \$14.95
  - SRF-MA Survival Radio Frequency Directory..... \$14.95
  - TSG-MA "Top Secret" Registry of U.S. Govt. Freq..... \$14.95
  - TIC-MA Techniques for Intercepting Comm..... \$14.95
  - RRF-MA Railroad frequency directory..... \$14.95
  - EEC-MA Embassy & Espionage Communications..... \$14.95
  - CIE-MA Covert Intelligence. Elect. Eavesdropping..... \$14.95
  - A80-MA Magnet mount mobile scanner antenna..... \$35.95
  - A70-MA Base station scanner antenna..... \$35.95
  - USAMM-MA Mag mount VHF/UHF ant. w/ 12' cable..... \$39.95
  - USAK-MA 3/4" hole mount VHF/UHF ant. w/ 17' cable..... \$35.95
  - USATLM-MA Trunk lip mount VHF/UHF antenna..... \$35.95
- Add \$3.00 shipping for all accessories ordered at the same time.  
Add \$12.00 shipping per shortwave receiver.  
Add \$7.00 shipping per scanner and \$3.00 per antenna.

### BUY WITH CONFIDENCE

To get the fastest delivery from CE of any scanner, send or phone your order directly to our Scanner Distribution Center. Michigan residents please add 4% sales tax or supply your tax I.D. number. Written purchase orders are accepted from approved government agencies and most well rated firms at a 10% surcharge for net 10 billing. All sales are subject to availability, acceptance and verification. All sales on accessories are final. Prices, terms and specifications are subject to change without notice. All prices are in U.S. dollars. Out of stock items will be placed on backorder automatically unless CE is instructed differently. A \$5.00 additional handling fee will be charged for all orders with a merchandise total under \$50.00. Shipments are F.O.B. Ann Arbor, Michigan. No COD's. Most products that we sell have a manufacturer's warranty. Free copies of warranties on these products are available prior to purchase by writing to CE. Non-certified checks require bank clearance. Not responsible for typographical errors.

Mail orders to: Communications Electronics,™ Box 1045, Ann Arbor, Michigan 48106 U.S.A. Add \$7.00 per scanner for R.P.S./U.P.S. ground shipping and handling in the continental U.S.A. For Canada, Puerto Rico, Hawaii, Alaska, or APO/FPO delivery, shipping charges are three times continental U.S. rates. If you have a Discover, Visa or Master Card, you may call and place a credit card order. Order toll-free in the U.S. Dial 800-USA-SCAN. In Canada, order toll-free by calling 800-221-3475. FTCC Telex anytime, dial 825333. If you are outside the U.S. or in Michigan dial 313-973-8888. Order today. Scanner Distribution Center™ and CE logos are trademarks of Communications Electronics Inc. † Bearcat is a registered trademark of Uniden Corporation. † Regency and Turbo Scan are registered trademarks of Regency Electronics Inc. AD #050487-MA/M3 Copyright © 1987 Communications Electronics Inc.

For credit card orders call  
**1-800-USA-SCAN**



**Consumer Products Division**  
P.O. Box 1045 □ Ann Arbor, Michigan 48106-1045 U.S.A.  
Call 800-USA-SCAN or outside U.S.A. 313-973-8888

## CONSTRUCTION

- 32 **Dressing Consultant**—tell you what to wear by sensing weather conditions
- 38 **Solid-State Barometer**—make weather predictions with the aid of this home-brew project
- 46 **Rip Off Alarm**—a super-sensitive electronic tattletale
- 65 **Frig Door Alarm**—helps save energy by reminding you to close the door

## FEATURES

- 18 **Mr. Peepers...Peeps Back**—there's levity in electronics
- 61 **Rescue Text Files**—and save the expletives for another time
- 68 **New Sound From Old Recordings**—can be a captivating hobby
- 75 **Electronics Fundamentals**—op-amps as building blocks

## HANDS-ON REPORTS

- 45 **Sound Sender**—play your Walkman through an FM auto radio
- 63 **DUoFone**—Radio Shack's telephone/message recorder
- 67 **dBASE III Plus**—how to use a database management program
- 95 **Sound Activated Switches**—do more than just turn on lights

## SPECIAL COLUMNS

- 25 **Saxon on Scanners**—super convenience in a mobile scanner
- 27 **Jensen on DX'ing**—a direct pipeline to the happenings
- 83 **Circuit Circus**—an electronic judge takes the guess work out of calling really close races
- 86 **Carr's Ham Shack**—tune in resonance and lock out VSWR problems
- 88 **Ellis on Antique Radio**—new life for that old radio receiver
- 90 **Friedman on Computers**—mixing apples and grids
- 92 **Wels' Think Tank**—how do electronic circuits do their job

## DEPARTMENTS

- 2 **Editorial**—Buy it. Build it. Swear at it! But, enjoy it.
- 4 **Letter Box**—forum for your comments and questions
- 8 **New Products Showcase**—what's new in the marketplace
- 22 **Bookshelf**—a home shopping guide to electronic books
- 39 **Free Information Card**—a new-product information link
- 49 **Gadget**—the newsletter for grown-up kids
- 73 **FactCards**—you can't tell the players without a score card



Saxon on Scanners—page 25



Sound Sender—page 45



Rip Off Alarm—page 46



Frig Door Alarm—page 65



Ellis on Antique Radio—page 88



Carr's Ham Shack—page 86

# Hands-on Electronics®

The Magazine for the Electronics Activist!

## Buy it. Build it. Swear at it!

I read an interesting clipping from the February 3, 1987 edition of the *Los Angeles Times*. The *Times* staff writer told of a parent pair who purchased a doll stroller that came in a flat shipping carton and displayed a drawing of the three-dimensional product on one side. You all know what followed: The labor, the teeth grinding, and the minor cuts and scrapes that preceded the ultimate defeat! Eventually a consumer advocate will take up this cause.

Another story: I purchased an IBM clone computer and orchestrated its composition. I picked out the 150-watt power supply, drives, loaded it with RAM, various boards, and added serial and parallel ports plus video outputs for TTL and color monitors. When I went to pick up the parts, the obliging supplier assembled the computer and *burned* it in for 24 hours. Was I disappointed! I wanted to be the one to assemble it and be the first to power it up!

Now, there is a message here. You and I have a lot in common. We enjoy putting together things that others dread doing. There is no challenge in the assembly of a modern computer. However, as we put products and projects of this type together we become familiar with its "guts." Should a fault develop or a modification be planned, we would leap into the innards of just about any electronic device, particularly when we are familiar with what we will see. When I had to *turbo-up* my computer, I approached the modification with a small amount of fear.

The next time I purchase a major electronic or computerized item, rest assured that on a rainy Saturday afternoon I will disassemble the major sub-assemblies and reassemble the product. Should it ever fail later on, I'll be dipping my hands into an *old friend* with the confidence of a well-trained surgeon.

We are a strange breed!

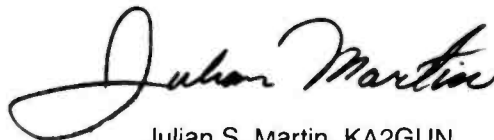

Julian S. Martin, KA2GUN  
Editor

# STAFF

Volume 4, No. 7

July 1987

Larry Steckler, EHF, CET  
Editor-In-Chief & Publisher

Art Kleiman, editorial director

Julian S. Martin, KA2GUN, editor

Robert A. Young, associate editor

Herb Friedman, W2ZLF, associate editor

John J. Yacono, associate editor

Brian C. Fenton, associate editor

Carl Laron, WB2SLR, associate editor

Byron G. Wels, K2AVB, associate editor

M. Harvey Gernsback, contributing editor

Teri Scaduto Wilson, editorial assistant

Ruby M. Yee, production director

Karen S. Tucker, production manager

Robert A. W. Lowndes, editorial  
associate

Marcella Amoroso, production assistant

Jacqueline P. Cheeseboro, circulation director

Arline R. Fishman, advertising director

## BUSINESS AND EDITORIAL OFFICES

Gernsback Publications, Inc.

500-B Bi-County Boulevard

Farmingdale, NY 11735.

516/293-3000

President: Larry Steckler

Vice-president: Cathy Steckler

## NATIONAL ADVERTISING SALES

(For Advertising Inquiries Only)

Joe Shere **MIDWEST/PACIFIC**

1507 Bonnie Doone Terrace

Corona Del Mar, CA 92625

714/760-8697

Alan Berg **EAST/SOUTHEAST**

11 Manor Drive

Marlboro, NJ 07746

212/603-9510

Larry Steckler, Publisher

500-B Bi-County Boulevard

Farmingdale, NY 11735

516-293-3000

Composition by  
Mates Graphics

Cover photography by  
Dan Muro



ABC  
membership  
applied for.



**Hands-on Electronics**, (ISSN 0743-2968) Published monthly by Gernsback Publications, Inc., 500-B Bi-County Boulevard, Farmingdale, NY 11735. Second-Class postage paid at Farmingdale, NY and at additional mailing offices. One-year, twelve issues, subscription rate U.S. and possessions \$28.00, Canada \$33.00, all other countries \$35.50. Subscription orders payable in U.S. funds only. International Postal Money order or check drawn on a U.S. bank. U.S. single copy price \$2.50. © 1987 by Gernsback Publications, Inc. All rights reserved. Printed in U.S.A.

Postmaster: Please send address changes to **Hands-On Electronics**, Subscription Dept., P.O. Box 338, Mount Morris, IL 61054-9932.

A stamped self-addressed envelope must accompany all submitted manuscripts and/or artwork or photographs if their return is desired should they be rejected. We disclaim any responsibility for the loss or damage of manuscripts and/or artwork or photographs while in our possession or otherwise.

As a service to readers, **Hands-on Electronics** publishes available plans or information relating to newsworthy products, techniques and scientific and technological developments. Because of possible variances in the quality and condition of materials and workmanship used by readers, **Hands-on Electronics** disclaims any responsibility for the safe and proper functioning of reader-built projects based upon or from plans or information published in this magazine.

# Increase your knowledge about all aspects of electronics

An absolutely no-risk guarantee.

## Select 5 Books for only \$3<sup>95</sup> and get a Free Gift!

values to \$135.70

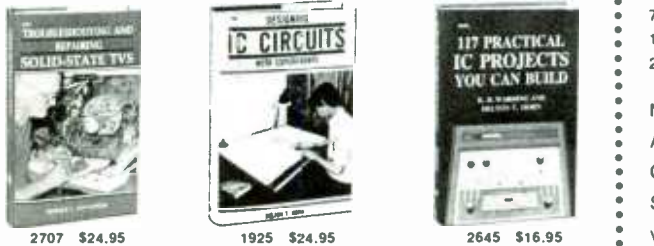
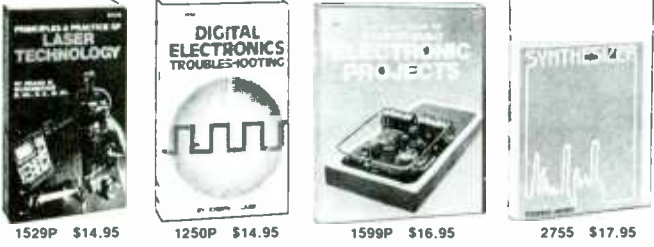
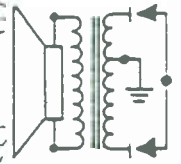

**Membership Benefits • Big Savings.** In addition to this introductory offer, you keep saving substantially with members' prices of up to 50% off the publishers' prices. • **Bonus Books.** Starting immediately, you will be eligible for our Bonus Book Plan, with savings of up to 80% off publishers' prices. • **Club News Bulletins.** 14 times per year you will receive the Book Club News, describing all the current selections—mains, alternates, extras—plus bonus offers and special sales, with hundreds of titles to choose from. • **Automatic Order.** If you want the Main Selection, do nothing and it will be sent to you automatically. If you prefer another selection, or no book at all, simply indicate your choice on the reply form provided. As a member, you agree to purchase at least 3 books within the next 12 months and may resign at any time thereafter. • **Ironclad No-Risk Guarantee.** If not satisfied with your books, return them within 10 days without obligation! • **Exceptional Quality.** All books are quality publishers' editions especially selected by our Editorial Board.

(Publishers' Prices Shown)

**FREE guide to mail order sources for electronic parts and components**

A \$6.95 Value!

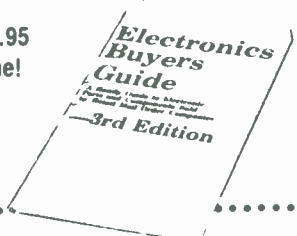

**ELECTRONICS BOOK CLUB**  
P.O. Box 10, Blue Ridge Summit, PA 17214

Please accept my membership in the Electronics Book Club and send the 5 volumes circled below, plus my FREE copy of *The Electronics Buyer's Guide* (345P), billing me \$3.95 plus shipping and handling charges. If not satisfied, I may return the books within ten days without obligation and have my membership canceled. I agree to purchase at least 3 books at regular Club prices (plus shipping/handling) during the next 12 months, and may resign any time thereafter.

728P	1199P	1250P	1370	1529P	1531P	1532P	1536	1586	1599P
1604P	1665P	1672P	1693	1775	1793	1909P	1925	1977	2635
2645	2655P	2707	2725	2753	2755	2758	2792	2795	2839

Name \_\_\_\_\_  
 Address \_\_\_\_\_  
 City \_\_\_\_\_  
 State/Zip \_\_\_\_\_ Phone \_\_\_\_\_

Valid for new members only. Foreign applicants will receive ordering instructions. Canada must remit in U.S. currency. This order subject to acceptance by the Electronics Book Club. RESP-787

© 1987 ELECTRONICS BOOK CLUB Blue Ridge Summit, PA 17214  
 All books are hardcover editions unless numbers are followed by a P for paperback

CIRCLE 6 ON FREE INFORMATION CARD

# LETTER BOX

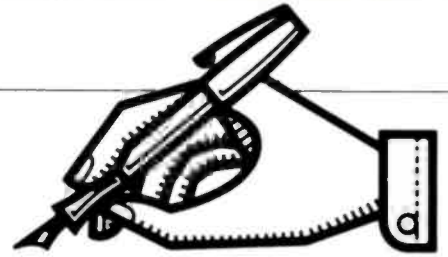

## Getting a Charge

I certainly enjoyed the article "Economy NiCd Battery Charger" in your March 1987 issue. I'm a mechanical engineer, but my hobby is electronics, and I must say that the articles are written so that those not fully skilled in the art of electronics can understand them.

When I put the circuit together, I made the following changes that other readers may wish to note: First, Fig. 1 denotes Q4 as a 2N3909 transistor, while according to the parts list Q4 is 2N3904; I used a 2N3904. It also shows R18 as 220-ohm, but in the parts list it is 22-ohm which is the value I used.

Secondly, Fig. 3 shows two R19's. I believe the vertical R19 should be R17. Resistors R8 and R9 should be switched in Fig. 3. There should be no Q9 in the figure, it should be Q4. The leads for transistor Q1 should be labeled ebc reading from left to right, not cbe.

After completing the circuit with above corrections, the only problem I had was when I connected the 100,000-ohm resistor and ammeter. The red LED stayed on, so, as the article mentions, I checked the value of R4. After increasing it to 147,000-ohm, the charger worked beautifully. Thanks for a good article.

—R.S., Copiague, NY

We're glad you got the project up and running. The errors were caused by faulty pin numbering occurring in Fig. 1. The pin marked pin 1 is really pin 14, pin 2 is pin 13, and so on. Thanks for the corrections.

## Lend Me Your Decoders

I just read your reply in April's *Hands-on Electronics* to R.M.T. of Winder, GA. After I got over the shock of realizing that not everyone knows that the Coco (alas!) doesn't have a parallel printer port, I got out the Archer Technical Data booklet on the SP0256 to see what could be done.

First, the booklet states that the SER IN pin is an 8-bit serial data input from an external speech ROM, so I don't know how well it will work with input from the printer port. The simplest thing R.M.T. can do is go down to his local Radio Shack, and get the Speech/Sound Car-

tridge, which uses the SP0256, and can also produce music simultaneously with speech. There are loader programs so the operator can type in "English" (sometimes phonetic spellings are needed) and the computer will say what's typed.

The next simplest thing to do would be to get Radio Shack's TRS-80 Color Computer Reference Manual, catalog #26-3193. That will give him the pinouts for the ROMpack cartridge port. With that, and a 40-connector (0.10-in. spacing) PC board, he could hook up something like Fig. 1. The pins are numbered rear to front with the odd numbers on the top side and the even numbers on the bottom. (It should work. Owning a Speech/Sound Cartridge, I didn't test it.)

Finally, he could get in contact with "The Rainbow" magazine, which is a CoCo-specific publication, and get the 7/84—2/85 issues. There are a series of articles on modifying the RS-DOS, which includes a parallel printer port, although that does entail opening the computer's case.

—R.R., Ft. Worth, TX

Well, R.R. there are readers, hobbyists, and friends, but you qualify as all three. We know that there are a lot of CoCo's out there and you've just given a big hand to all of them. So, for all the

speechless CoCo's out there, a hearty thank you for your research. (And to all else: be a pal and respond to your fellow hobbyists in need. It's a cold world without friends!)

## Modemize Me

For three years I've wanted to build a modem for my Apple II computer. I read your magazine and hope to find something on modems in it. I'd be grateful if you'd publish some articles on modem theory, operation, and construction. Some books or publication references would help.

I enjoy your publication and hope you'll continue the good work.

—B.E., Douglas, AK

Frankly, we'd like to present an article on modem construction, but as of yet we haven't received one. To help you get started you may want to check out the book *An Introduction to Computer Communications*, by R.A. Penfold. It costs \$5.95 (plus \$1.75 P&H) and is available from *Electronic Technology Today, Inc.*, P.O. Box 240, Massapequa Park, NY 11762-0240.

If you do build that modem, write and tell us about it. Who knows, maybe you, yourself will be the one to write the

(Continued on page 6)

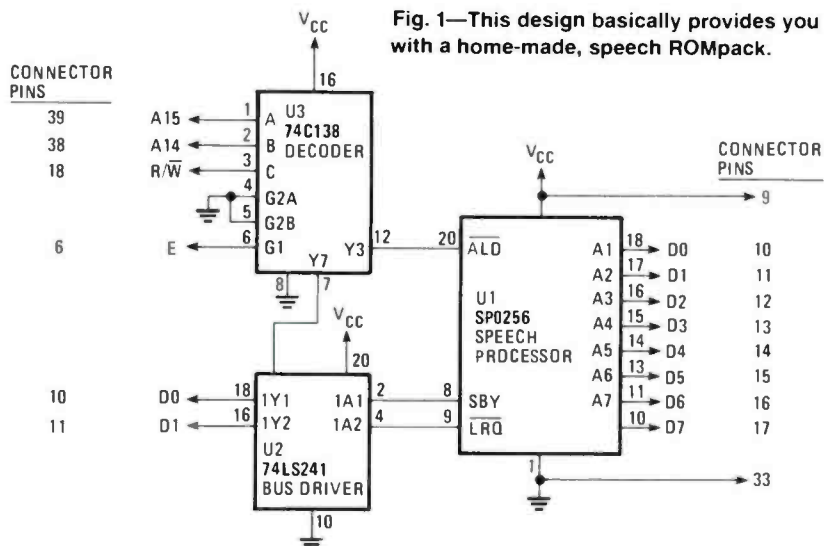

# MAKE MONEY



# TRAIN FOR ELECTRONICS

You say you're *already* trained in electronics but that you're *not* making enough money??? Well then, maybe you don't have an accredited bachelor's degree to prove that your education is *up to snuff!* Check out the Grantham Independent-Study B. S. Degree Program. It could make a *dollars and sense* difference in your electronics career.

Grantham offers this program, complete but without laboratory, to electronics technicians whose objectives are to upgrade their level of technical employment. Since the field of electronics is so enormous, opportunity for advancement is always present. Promotions and natural turnover make desirable positions available to the man who is ready to *move up*.

**Grantham College of Engineering**  
10570 Humbolt Street  
Los Alamitos, California, 90720

**This booklet  
FREE!**

This free booklet explains the Grantham B.S. Degree Program, offered by independent study to those who work in electronics.



for **FREE**  
**Booklet**  
**CLIP**  
**COUPON**  
and mail in  
envelope or  
paste on  
postal  
card.

## *Do You REALLY Want to Make More Money?*

Yes it does take *work* and a few sacrifices to climb up the electronics ladder to where the bigger money is. But, if that's where you want to be, then that's what you must do — *work harder* at learning and getting the right credentials, even if it takes a few sacrifices. A *B. S. degree* and the knowledge that rightly goes along with it can give you powerful ladder-climbing equipment in your search for *success in electronics*.

The accredited Grantham non-traditional B.S. Degree Program is intended for mature, fully-employed workers who want to upgrade their electronics careers.

## *Put Professional Knowledge and a COLLEGE DEGREE in your Electronics Career through Independent Home Study*

Study materials, carefully written by the Grantham College staff for independent study at home, are supplied by the College. Your technical questions related to these materials and the lesson tests are promptly answered by the Grantham home-study teaching staff.

## *Recognition and Quality Assurance*

Grantham College of Engineering is accredited by the Accrediting Commission of the National Home Study Council, as a degree-granting institution.

All lessons and other study materials, as well as communications between the college and students, are in the English language. However, we have students in many foreign countries; about 80% of our students live in the United States of America.

**Grantham College of Engineering** H-7-87  
10570 Humbolt Street, Los Alamitos, CA 90720

Please mail me your free catalog which explains your B.S. Degree independent-study program.

Name \_\_\_\_\_ Age \_\_\_\_\_

Address \_\_\_\_\_

City \_\_\_\_\_ State \_\_\_\_\_ Zip \_\_\_\_\_

## LETTERBOX

(Continued from page 4)  
article that you have been looking for.

### Throw Away the Key

The article entitled "Electronic Door Lock," by Marty Knight, on Page 38 of the February 1987 issue was well done and would help to produce a handy device. Although written of as an intrusion alarm, it appears it could be adapted to control an electric door latch, such as the NUTONE Model DR-1 Door Release. That device is common to apartment houses where it allows tenants to release the door remotely by pushing a button in their apartments.

There is a sense of accomplishment and pride in creating such a project and making it work, but for those who simply want results, there is a reasonably priced package available. A Digital Touch Code Lock is available from Sears Roebuck & Co. for \$39.99 (Cat. 9B53716 Spring-Summer 1986). Although intended for 24-volt circuits, the unit will work well with the NUTONE device described above when connected to a 10-volt doorbell transformer as used with the NUTONE door release.

We have had that arrangement on the front door for many years and it sure

saves a lot of fumbling with keys. The key lock does remain available in case of power failure.

You may wish to pass this along to your readers, the ones with the broken or lazy soldering irons, that is.

—D.E.H., Douglas, AL

*Most of our readers are far from lazy, but often they don't have enough time to build all of their favorite projects, so it's good to know of an already-built unit.*

### Stuck with Pins

We are hoping you could settle an argument for us. One of us thinks that pinouts on transistor packages may be different from manufacturer to manufacturer, but within a manufacturer's line that equivalent replacements will have the same pinouts. The other thinks that pinouts can vary within a manufacturer's line but that they cannot publish equivalents outside their line unless the pinouts are identical. Which of us is correct?

—D.M., Jamestown, VA

*In an effort to make electronics more interesting (and confusing), the semiconductor manufacturers in their trans-infinite wisdom produce transistors of every pinout configuration possible (six*

*in all). They do so within, and external to, their own line of products (sorry guys). They also can publish equivalence tables without regard to pinout configuration as long as a disclaimer appears in the replacement guide.*

### Bugged

I have heard about a device that scares away bugs using sound waves, and want to know if any of your staff or readers have researched it. I would also like to know if it works, and if so, see an article on how to build it. Keep up the good work.

—C.R.J., B.C., MI

*You're in luck! Our sister publication Radio Electronics ran an article on that very topic in May of 1985. If you are not an old RE subscriber, they have a reprint bookstore which you can order from by using the order form in the back pages of this magazine. All 1985 Radio Electronics reprints (excluding January) cost \$3.50 ea. (plus \$1.50 P&H). There is a wealth of information in back issues, which makes reproducing them a worthwhile service.*

Down with the insects, up with mankind! ■

# kePRO CIRCUIT MAKER

For art supplies, kits and economical equipment to produce at home professional quality print circuit boards...ask for the pro's - Kepro Circuit Systems, Inc. Kepro has been producing prototype and short run equipment, as well as providing PCB supplies to industrial companies for years. Their specialized experience and knowledge provides the home hobbyist an economical and convenient source of equipment and supplies for a professional, one-of-a-kind, printed circuit board.

Shears, etchers, sensitized and un-sensitized copperclad laminates, art supplies, kits and Keproclad...all you need to make a professional quality printed circuit board at home and at a cost you can afford.

**kepro**



Kepro Circuit Systems, Inc.

**Kepro, your one stop source for at home PCB's.**

Write or call Kepro for their catalog and price list:  
1-800-325-3878 or 1-314-343-1630 (MO)  
630 Axminster Drive, Fenton, MO 63026-2992.

## ART SUPPLIES

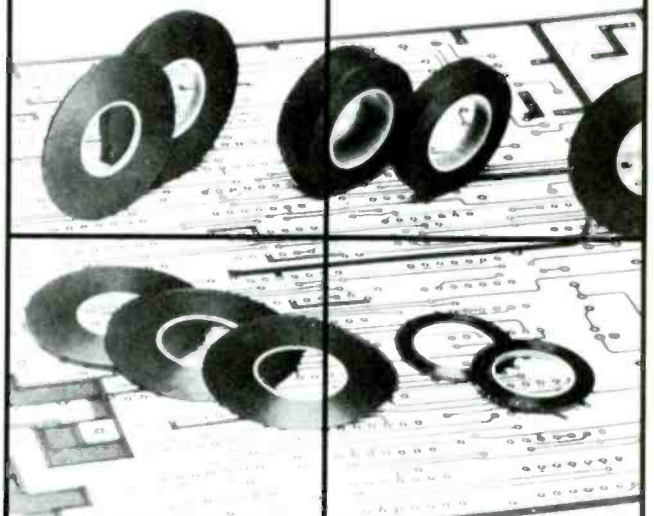

## BENCHTOP ETCHER \$765.00



## SHEAR \$390.00

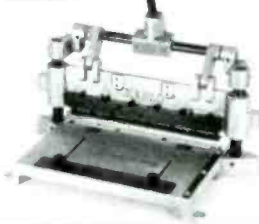

## ART SUPPLIES from \$2.79

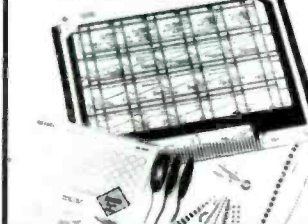

## COPPER CLAD LAMINATES



Photosensitized  
Pre-cut copper clad  
Bulk packaged copper clad  
Full sheets  
Plate-thru copper clad





**SCIENTIFIC  
ATLANTA  
UNITS**

**LOWEST  
PRICES  
ANYWHERE!**



# CABLE-TV



# BONANZA!



**WE'LL MATCH OR BEAT ANYONE'S  
ADVERTISED RETAIL OR WHOLESALE PRICES!**

ITEM	SINGLE UNIT PRICE	DEALER 10-UNIT PRICE
RCA 36 CHANNEL CONVERTER (CH. 3 OUTPUT ONLY)	29.95	18.00 ea.
PIONEER WIRELESS CONVERTER (OUR BEST BUY)	88.95	72.00 ea.
LCC-58 WIRELESS CONVERTER	92.95	76.00 ea.
JERROLD 450 WIRELESS CONVERTER (CH. 3 OUTPUT ONLY)	105.95	90.00 ea.
SB ADD-ON UNIT	109.95	58.00 ea.
<i>Call for specifics</i>		
<b>BRAND NEW — UNIT FOR SCIENTIFIC ATLANTA</b>		
MINICODE (N-12)	109.95	58.00 ea.
MINICODE (N-12) VARISYNC	119.95	62.00 ea.
MINICODE VARISYNC W/AUTO ON-OFF	179.95	115.00 ea.
M-35 B (CH. 3 OUTPUT ONLY)	139.95	70.00 ea.
M-35 B W/AUTO ON-OFF (CALL FOR AVAILABILITY)	199.95	125.00 ea.
MLD-1200-3 (CALL IF CH. 2 OUTPUT)	109.95	58.00 ea.
INTERFERENCE FILTERS — CH. 3	24.95	14.00 ea.
JERROLD 400 OR 450 REMOTE CONTROLLER	29.95	18.00 ea.
ZENITH SSAVI CABLE READY (DEALER PRICE BASED ON 5 UNITS)	225.00	185.00 ea.
<b>SPECIFY CHANNEL 2 or 3 OUTPUT</b> <i>Other products available — Please Call</i>		

Quantity	Item	Output Channel	Price Each	TOTAL PRICE
California Penal Code #593-D forbids us from shipping any cable descrambling unit to anyone residing in the state of California. Prices subject to change without notice.			<b>SUBTOTAL</b>	
			Shipping Add \$3.00 per unit	
			COD & Credit Cards — Add 5%	
			<b>TOTAL</b>	

PLEASE PRINT

Name \_\_\_\_\_

Address \_\_\_\_\_ City \_\_\_\_\_

State \_\_\_\_\_ Zip \_\_\_\_\_ Phone Number (    ) \_\_\_\_\_

Cashier's Check     Money Order     COD     Visa     Mastercard

Acct # \_\_\_\_\_ Exp. Date \_\_\_\_\_

Signature \_\_\_\_\_

**FOR OUR RECORDS:**

**DECLARATION OF AUTHORIZED USE** — I, the undersigned, do hereby declare under penalty of perjury that all products purchased, now and in the future, will only be used on cable TV systems with proper authorization from local officials or cable company officials in accordance with all applicable federal and state laws.

Dated: \_\_\_\_\_ Signed: \_\_\_\_\_

**Pacific Cable Company, Inc.**  
7325 1/2 RESEDA BLVD., DEPT. H-7 • RESEDA, CA 91335  
(818) 716-5914 • No Collect Calls • (818) 716-5140

**IMPORTANT: WHEN CALLING FOR INFORMATION**  
Please have the make and model # of the equipment used in your area. Thank You

# NEW PRODUCTS

## Multi-Application Color Monitor

What good is a compatible computer with an incompatible monitor? Well, the Diamond Scan can get along with almost any display board. The multi-application color monitor is fully compatible with the IBM MDA/CGA/EGA/PGC and Monochrome Hercules graphics boards. The monitor, designated as model AUM-1371A, has unique scanning circuitry which automatically locks onto any horizontal frequency from 15.6kHz to 35.0kHz, and any vertical frequency from 45Hz to 75Hz.

Where a range of different monitors was once required to meet diverse applications, the Diamond Scan now accommodates them all—including personal computers, NC machines, medical equipment, home automation, sophisticated CAD systems, and NTSC (TV).



CIRCLE 72 ON FREE INFORMATION CARD

Design characteristics for the Diamond Scan allow for a resolution of  $800 \times 560$  pixels. In its CGA-compatible mode, the new 13-in. color monitor has a resolution of  $330 \times 550$ ; for EGA the resolution is  $640 \times 350$ ; and in PGC operation its resolution is  $640 \times 480$ . Additionally, the Diamond Scan monitor can receive an NTSC video signal for the video overlay feature.

Other key features include a .31 dot pitch, in-line gun with multi-step focus, low power consumption, super-high contrast panel glass for improved visibility, and a Diamond mate coating for maximum glare reduction.

The Diamond Scan, measuring  $14\frac{1}{2}$ -in.  $\times$  15-in.  $\times$   $12\frac{1}{2}$ -in., carries a suggested retail price of \$889.00, the Diamond Scan is available immediately through local distributors throughout North America.

For additional information, contact Mitsubishi Electronics America, Inc., Computer Peripherals Division, 991 Knox Street, Torrance, CA 90502; Tel. 213/515-3993.

## Hybrid-Lens Projection TV

Want to watch sci-fi on a Starwars-type screen? Well, the model PTJ-4064R uses a computer-designed hybrid-lens system along with liquid-cooled tubes and optical coupling to produce a sharp, bright picture while maintaining high contrast across the face of the screen. The set uses a black matrix screen to further enhance the contrast.

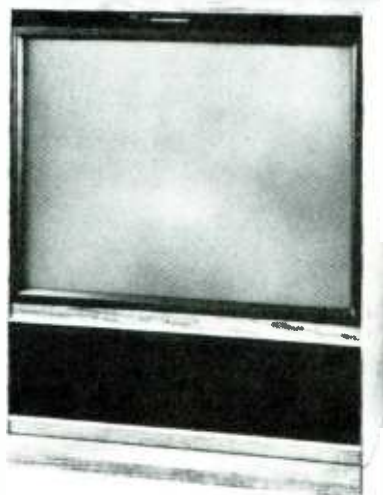

CIRCLE 73 ON FREE INFORMATION CARD

The hybrid-lens system consists of a single glass lens combined with aspherical acrylic lenses. Besides being more compact and lighter than traditional six-element lens designs, the reduced number of elements means a smaller number of surfaces in the optical path, which helps ensure color fidelity and exceptional picture brightness.

A liquid cooling system increases brightness to 250 ft./lamberts by allowing the use of higher-power electron beams in the three seven-inch CRT bulbs. Liquid ethylene glycol is used between the front faceplate of the tube and the other glass layer. The result is a bright, naturally colored picture.

The PTJ-4064R offers a 40-in. (diagonal) screen and features built-in MTS stereo reception capability. A 5-watt-per-channel amplifier delivers sound through two 6½-in. speakers and has separate bass, treble, and balance controls. Variable audio-output jacks allow connection through an external hi-fi system and provide volume control through the TV's remote control.

A 155-channel cable-compatible tuner has programmable scan and Rapid Tune. Other features include Color Pilot, three sets of audio/video inputs, two sets of audio/video outputs (including Program Out), and dual VHF antenna.

The PTJ-4064R carries a suggested retail price of \$2,700.

For more information contact Panasonic Company, One Panasonic Way, Secaucus, NJ 07094.

## Orbit Some Satellite Speakers

The Revox Piccolo-Bass system consists of two slim-profile satellite speakers plus subwoofer. The Piccolo-Bass subwoofer is engineered to radiate extremely-low bass frequencies (48 Hz to 120 Hz  $\pm$  3 dB) and will blend with any decor. Measuring  $15\frac{1}{8}$ -in.  $\times$   $14\frac{1}{16}$   $\times$   $14\frac{1}{16}$ -in., the subwoofer can be placed virtually anywhere in a room without affecting bass reproduction. It can be used as a "cube table" next to a side chair, sofa, or bed.



CIRCLE 74 ON FREE INFORMATION CARD

Complementing the subwoofer are the Piccolo satellite speakers. Each mini-speaker, which measures just  $8\frac{1}{4}$ -in.  $\times$   $11\frac{1}{16}$ -in.  $\times$   $3\frac{1}{4}$ -in., incorporates a  $4\frac{1}{16}$ -in. diameter midrange driver and  $\frac{1}{4}$ -in. dome-type speakers. Frequency response

*(Continued on page 12)*



# SATELLITE ELECTRONICS TRAINING FROM NRI!

## Now you can move into home satellite TV and commercial satellite communications with NRI's latest breakthrough in electronics training

With NRI training, you'll explore every aspect of satellite transmission and reception as you assemble, install, troubleshoot, and train with the complete TVRO system included in your course.

With today's satellite technology, a call to Paris is as clear and as easy to make as a call next door... executives use video conferencing to "meet" without leaving their offices... simultaneously, a billion people witness a single event (a soccer game, an inauguration, a benefit rock concert)... and scientists explore the mysteries of outer space without leaving their labs.

These amazing applications of satellite technology have opened up exciting, new opportunities for the technician trained to install, maintain, troubleshoot, and repair satellite communications equipment.

### Explosive opportunities in home satellite TV

In suburban backyards, alongside country farmhouses, and atop commercial buildings, satellite TV systems are continuing to expand all across the country.

Already there are over a million TVRO (Television Receive-Only) systems in place in the U.S. alone, and experts predict that the future of home satellite TV looks even brighter.

### New jobs, new careers for the trained technician

As an NRI-trained technician, you can concentrate on consumer-oriented TVRO equipment, or use your training to build a career servicing the satellite equipment that has become so vital in commercial and military communications to transmit and receive voice, data, and video signals.

### NRI brings satellite technology down to earth

NRI trains you thoroughly in basic electronics, communications, and television principles. Using the remarkable NRI Discovery Lab® and your digital multimeter, you perform critical experiments, tests, and measurements. Then, using your NRI Antenna Applications and Design Lab, you assemble and test various types of antennas and matching sections.

You then concentrate on both commercial and consumer satellite earth station equipment, putting theory to practice as you assemble, install, and test the complete satellite antenna system included in your course.

### Building your own home satellite TV system brings theory to life!

Your Drake TVRO system comes complete with 6' parabolic dish antenna system, low-noise amplifier (LNA), down converter, receiver, low-loss coaxial cable, and even a permanent polar mount.



By training with an actual TVRO system, you'll come to understand, first-hand, the function and operation of a satellite earth station. And once completed, your TVRO system will provide the best television entertainment available—direct from the satellite to your home.

### Train the uniquely successful NRI way

It's hands-on training, at home... designed around the latest state-of-the-art equipment. You discover by doing... and you do it at your own comfortable pace.

Built into your NRI training is the enormous experience of our development specialists and instructors, whose training skills and personal guidance are available to you on a one-to-one basis.

### Make your move into the future today! Send for your FREE NRI catalog

Only NRI can train you at home for an exciting and rewarding career as a satellite electronics technician. And now is the time to act. Send today for your free, 100-page catalog. It details our training methods and materials, and our more than 72 years of successful innovation in hands-on career training. If the coupon is missing, write to: NRI Schools, 3939 Wisconsin Avenue, Washington, D.C. 20016.



Complete TVRO System and electronic test equipment included with your training.

**NRI SCHOOLS**  
McGraw-Hill Continuing Education Center  
3939 Wisconsin Avenue, Washington, DC 20016

We'll give you tomorrow.

For Career courses approved under GI bill.  
 check for details.

**CHECK ONE FREE CATALOG ONLY**

<input type="checkbox"/> Satellite Electronics <input type="checkbox"/> Computer Electronics with Microcomputers <input type="checkbox"/> Robotics & Industrial Controls <input type="checkbox"/> Video Electronics Servicing <input type="checkbox"/> Electronic Design Technology <input type="checkbox"/> Digital Electronics	<input type="checkbox"/> Data Communications <input type="checkbox"/> Communications Electronics <input type="checkbox"/> Industrial Electronics <input type="checkbox"/> Basic Electronics <input type="checkbox"/> Telephone Servicing <input type="checkbox"/> Small Engine Servicing <input type="checkbox"/> Appliance Servicing	<input type="checkbox"/> Automotive Servicing <input type="checkbox"/> Air Conditioning, Heating, Refrigeration, & Solar Technology <input type="checkbox"/> Building Construction <input type="checkbox"/> Locksmithing & Electronic Security <input type="checkbox"/> Photography <input type="checkbox"/> Bookkeeping
---	---	---

Name (Please Print) \_\_\_\_\_ Age \_\_\_\_\_

Street \_\_\_\_\_

City/State/Zip \_\_\_\_\_ Accredited by the National Home Study Council 18-077

## NEW PRODUCTS SHOWCASE

(Continued from page 8)

is 80 Hz to 22 kHz,  $\pm 3$  dB. They can be wall-mounted for unobtrusive placement.

In addition to augmenting any stereo system, the new Revox subwoofer system can be added to the new stereo-television receivers. The Piccolo-Bass system can also be used as rear speakers for the extra surround-sound channel in "home theatre" applications, movie videotapes, and of course, videodiscs.

Enclosures for the compact subwoofer and satellite speakers have a similar low-resonance design used in large Revox speakers. Driver voice coils are manufactured in Revox's own factories. Tweeter diaphragms use reinforced sandwich-type construction. A proprietary acoustic lens in front of the satellite speakers' dome tweeter disperses sound frequencies evenly. All woofers use a rigid, diecast chassis for optimum performance, even at high levels of amplitudes.

In common with larger Revox speaker designs, the compact Piccolo subwoofer system exhibits low distortion. Satellite speaker harmonic distortion is 1% (HD 3 maximum, measured at a mean SPL of 91 dB and a distance of 6.6 feet) from 80 Hz to 25 kHz. For the Piccolo-Bass, similarly measured, distortion is 3%. The total system has a power-handling capacity of 50-watts-per-channel; suggested amplifier power (continuous sinewave) for the subwoofer is 20-70 watts, and the nominal impedance is 4 ohms.

The 3-piece Piccolo-Bass system carries a retail price of \$650. Individual units are also available at \$150 ea. for the mini-speakers, and \$350 for the subwoofer.

For further information contact Studer Revox, 1425 Elm Hill Pike, Nashville, TN 37210.

### Budget Tuner

Got big ears, but a small budget? Tune in to what Denon has to offer. Their PMA-250 uses high-speed power transistors ( $f_T$  of 20 MHz) with high collector power ( $P_c$  of 60 watts), large five-way binding-posts for audiophile speaker cable, and a dual-concentric volume control for high stereo separation. Expensive polypropylene, polyester film, and styrol capacitors have been selected for their sonic quality.

Internal signal routing follows Denon's "Simple is Best" philosophy for minimum degradation. For example, the CD Direct mode bypasses the function selector and tape monitor loop for the lowest possible noise, distortion, and crosstalk. Tone-control circuitry has been located in the power-amplifier section, an unusual design that further reduces noise. The PMA-250 is rated at 25-watts-per-chan-



CIRCLE 75 ON FREE INFORMATION CARD

nel, minimum RMS into 8 ohms from 20 Hz to 20 kHz with no more than 0.08% Total Harmonic Distortion.

The unit carries a suggested retail of \$200, from Denon America Inc., 27 Law Dr., Fairfield, NJ 07006.

### IBM PC's Read Apple Disks

IBM's that read Apple disks don't grow on trees. But MatchPoint-PC, which allows PC users to read from and write to Apple DOS, ProDOS, SOS, and Apple CP/M disks, is now available from Micro Solutions, Inc. It further allows users to read from and write to NorthStar hard sector CP/M disks.

The MatchPoint-PC package includes the card, software disk, users guide, and a free copy of the latest release of UniForm-PC, version 2, designed to work with the MatchPoint-PC card. The half-size card



CIRCLE 76 ON FREE INFORMATION CARD

mounts in one of the PC's expansion slots, and includes connectors and cable to connect it to the PC's floppy-disk drives. The board installs in minutes by following the step-by-step instructions provided in the Users Guide. The MatchPoint-PC software consists of five easy-to-use commands for use with Apple DOS, ProDOS, or SOS disks.

UniForm-PC makes the computer see CP/M disks as PC DOS disks, so CP/M disks can be used as though they are PC DOS disks. When used with UniForm-PC, MatchPoint-PC also allows the use of Apple SoftCard and NorthStar CP/M disks as though they were PC DOS disks. The card plugs into an IBM-PC, XT, AT (with 360K disk-drive option), or compatible. And with UniDOS users can even run 8-bit CP/M programs on their PC's.

MatchPoint-PC is available from dealers nationwide and retails for \$195.00. For the location of your nearest dealer, contact Micro Solutions, Inc., 132 W. Lincoln Hwy., DeKalb, IL 60115; Tel. 815/756-3411.

### Microphone Preamplifier

If you make recordings on the fly, you know you can't plug a mike preamp into the nearest tree, so what can you do? You get a portable like the Mic-PreEminence. It is a self-powered mike preamp useful in any application where complex analog signals tax the capabilities of current microphone preamplifiers. Ultra-low distortion of the digital medium causes distortion in analog electronics to be apparent, therefore creating a need for this type of unit. Application examples include minimizing signal flow through a console and digital sampling.



CIRCLE 77 ON FREE INFORMATION CARD

Designed to be the ultimate interface between analog microphones and digital recorders, the unit operates as an in-and-out transformerless, balanced preamp. Along with its exceptional specifications, phantom power, a useful signal indicator, and a trim control are provided. Suggested retail price is \$795.00. For further information contact: Studio Technologies, Inc., 5520 West Touhy Avenue, Skokie, IL 60077; Tel. 312/676-9177.

### Portable CD Player

Here's a CD player for you Walkman fans. The SL-XP5 is an ultra-slim portable player, which features the new FF1 laser pickup. The unit measures just 4.96-in. x 4.96-in. x .90-in.

The FF1 fine-focus, single-beam, laser pickup features a single-focus (combined colimator focus) lens that replaces several separate lenses, creating a small, lightweight pickup.



CIRCLE 78 ON FREE INFORMATION CARD

The digital accu-servo system has also been improved to attain outstanding tracking error detection, combining the fingerprint resistance of the one-beam systems and the scratch resistance of the three-beam systems.

To help avoid skipping due to jolts, a friction-free, four-wire suspension system supports the focus lens using four special metallic wires. That assembly is sup-

(Continued on page 14)

**NATIONAL SEMICONDUCTOR • PANASONIC MACHINE INC. • INTERSIL • AD EAC, INC. • J. W. MILLER • AAVD ENGINEER • F. JOHNSON • ATLANTIC SEMICONDUCTOR**

**256K (262,144 x 1) 1 DRAM 150NS \$5.70/1; \$39.95/9**

**JIDES • DIAMOND TOOL • UNGAR • ES • CW INDUSTRIES • AMDEX • G.E. IGAR • YAGEO • J. W. MILLER • LUXO SCHEMICALS • ARIES • PLESSEY**

### INTEGRATED CIRCUITS

Part No.	Description	Price
7400 TTL	74LS00 10	1.18
7401 TTL	74LS01 10	1.18
7402 TTL	74LS02 10	1.18
7403 TTL	74LS03 10	1.18
7404 TTL	74LS04 10	1.18
7405 TTL	74LS05 10	1.18
7406 TTL	74LS06 10	1.18
7407 TTL	74LS07 10	1.18
7408 TTL	74LS08 10	1.18
7409 TTL	74LS09 10	1.18
7410 TTL	74LS10 10	1.18
7411 TTL	74LS11 10	1.18
7412 TTL	74LS12 10	1.18
7413 TTL	74LS13 10	1.18
7414 TTL	74LS14 10	1.18
7415 TTL	74LS15 10	1.18
7416 TTL	74LS16 10	1.18
7417 TTL	74LS17 10	1.18
7418 TTL	74LS18 10	1.18
7419 TTL	74LS19 10	1.18
7420 TTL	74LS20 10	1.18
7421 TTL	74LS21 10	1.18
7422 TTL	74LS22 10	1.18
7423 TTL	74LS23 10	1.18
7424 TTL	74LS24 10	1.18
7425 TTL	74LS25 10	1.18
7426 TTL	74LS26 10	1.18
7427 TTL	74LS27 10	1.18
7428 TTL	74LS28 10	1.18
7429 TTL	74LS29 10	1.18
7430 TTL	74LS30 10	1.18
7431 TTL	74LS31 10	1.18
7432 TTL	74LS32 10	1.18
7433 TTL	74LS33 10	1.18
7434 TTL	74LS34 10	1.18
7435 TTL	74LS35 10	1.18
7436 TTL	74LS36 10	1.18
7437 TTL	74LS37 10	1.18
7438 TTL	74LS38 10	1.18
7439 TTL	74LS39 10	1.18
7440 TTL	74LS40 10	1.18
7441 TTL	74LS41 10	1.18
7442 TTL	74LS42 10	1.18
7443 TTL	74LS43 10	1.18
7444 TTL	74LS44 10	1.18
7445 TTL	74LS45 10	1.18
7446 TTL	74LS46 10	1.18
7447 TTL	74LS47 10	1.18
7448 TTL	74LS48 10	1.18
7449 TTL	74LS49 10	1.18
7450 TTL	74LS50 10	1.18
7451 TTL	74LS51 10	1.18
7452 TTL	74LS52 10	1.18
7453 TTL	74LS53 10	1.18
7454 TTL	74LS54 10	1.18
7455 TTL	74LS55 10	1.18
7456 TTL	74LS56 10	1.18
7457 TTL	74LS57 10	1.18
7458 TTL	74LS58 10	1.18
7459 TTL	74LS59 10	1.18
7460 TTL	74LS60 10	1.18
7461 TTL	74LS61 10	1.18
7462 TTL	74LS62 10	1.18
7463 TTL	74LS63 10	1.18
7464 TTL	74LS64 10	1.18
7465 TTL	74LS65 10	1.18
7466 TTL	74LS66 10	1.18
7467 TTL	74LS67 10	1.18
7468 TTL	74LS68 10	1.18
7469 TTL	74LS69 10	1.18
7470 TTL	74LS70 10	1.18
7471 TTL	74LS71 10	1.18
7472 TTL	74LS72 10	1.18
7473 TTL	74LS73 10	1.18
7474 TTL	74LS74 10	1.18
7475 TTL	74LS75 10	1.18
7476 TTL	74LS76 10	1.18
7477 TTL	74LS77 10	1.18
7478 TTL	74LS78 10	1.18
7479 TTL	74LS79 10	1.18
7480 TTL	74LS80 10	1.18
7481 TTL	74LS81 10	1.18
7482 TTL	74LS82 10	1.18
7483 TTL	74LS83 10	1.18
7484 TTL	74LS84 10	1.18
7485 TTL	74LS85 10	1.18
7486 TTL	74LS86 10	1.18
7487 TTL	74LS87 10	1.18
7488 TTL	74LS88 10	1.18
7489 TTL	74LS89 10	1.18
7490 TTL	74LS90 10	1.18
7491 TTL	74LS91 10	1.18
7492 TTL	74LS92 10	1.18
7493 TTL	74LS93 10	1.18
7494 TTL	74LS94 10	1.18
7495 TTL	74LS95 10	1.18
7496 TTL	74LS96 10	1.18
7497 TTL	74LS97 10	1.18
7498 TTL	74LS98 10	1.18
7499 TTL	74LS99 10	1.18
7500 TTL	74LS100 10	1.18

### INTEGRATED D. CIRCUITS

Part No.	Description	Price
4000 CMOS	4001 10	1.18
4002 CMOS	4002 10	1.18
4003 CMOS	4003 10	1.18
4004 CMOS	4004 10	1.18
4005 CMOS	4005 10	1.18
4006 CMOS	4006 10	1.18
4007 CMOS	4007 10	1.18
4008 CMOS	4008 10	1.18
4009 CMOS	4009 10	1.18
4010 CMOS	4010 10	1.18
4011 CMOS	4011 10	1.18
4012 CMOS	4012 10	1.18
4013 CMOS	4013 10	1.18
4014 CMOS	4014 10	1.18
4015 CMOS	4015 10	1.18
4016 CMOS	4016 10	1.18
4017 CMOS	4017 10	1.18
4018 CMOS	4018 10	1.18
4019 CMOS	4019 10	1.18
4020 CMOS	4020 10	1.18
4021 CMOS	4021 10	1.18
4022 CMOS	4022 10	1.18
4023 CMOS	4023 10	1.18
4024 CMOS	4024 10	1.18
4025 CMOS	4025 10	1.18
4026 CMOS	4026 10	1.18
4027 CMOS	4027 10	1.18
4028 CMOS	4028 10	1.18
4029 CMOS	4029 10	1.18
4030 CMOS	4030 10	1.18
4031 CMOS	4031 10	1.18
4032 CMOS	4032 10	1.18
4033 CMOS	4033 10	1.18
4034 CMOS	4034 10	1.18
4035 CMOS	4035 10	1.18
4036 CMOS	4036 10	1.18
4037 CMOS	4037 10	1.18
4038 CMOS	4038 10	1.18
4039 CMOS	4039 10	1.18
4040 CMOS	4040 10	1.18
4041 CMOS	4041 10	1.18
4042 CMOS	4042 10	1.18
4043 CMOS	4043 10	1.18
4044 CMOS	4044 10	1.18
4045 CMOS	4045 10	1.18
4046 CMOS	4046 10	1.18
4047 CMOS	4047 10	1.18
4048 CMOS	4048 10	1.18
4049 CMOS	4049 10	1.18
4050 CMOS	4050 10	1.18

### T.T.C. SOCKETS

Part No.	Description	Price
1000	1000 10	1.18
1001	1001 10	1.18
1002	1002 10	1.18
1003	1003 10	1.18
1004	1004 10	1.18
1005	1005 10	1.18
1006	1006 10	1.18
1007	1007 10	1.18
1008	1008 10	1.18
1009	1009 10	1.18
1010	1010 10	1.18
1011	1011 10	1.18
1012	1012 10	1.18
1013	1013 10	1.18
1014	1014 10	1.18
1015	1015 10	1.18
1016	1016 10	1.18
1017	1017 10	1.18
1018	1018 10	1.18
1019	1019 10	1.18
1020	1020 10	1.18
1021	1021 10	1.18
1022	1022 10	1.18
1023	1023 10	1.18
1024	1024 10	1.18
1025	1025 10	1.18
1026	1026 10	1.18
1027	1027 10	1.18
1028	1028 10	1.18
1029	1029 10	1.18
1030	1030 10	1.18
1031	1031 10	1.18
1032	1032 10	1.18
1033	1033 10	1.18
1034	1034 10	1.18
1035	1035 10	1.18
1036	1036 10	1.18
1037	1037 10	1.18
1038	1038 10	1.18
1039	1039 10	1.18
1040	1040 10	1.18

### 5% Carbon Film Resistors

Part No.	Description	Price
1000	1000 10	1.18
1001	1001 10	1.18
1002	1002 10	1.18
1003	1003 10	1.18
1004	1004 10	1.18
1005	1005 10	1.18
1006	1006 10	1.18
1007	1007 10	1.18
1008	1008 10	1.18
1009	1009 10	1.18
1010	1010 10	1.18
1011	1011 10	1.18
1012	1012 10	1.18
1013	1013 10	1.18
1014	1014 10	1.18
1015	1015 10	1.18
1016	1016 10	1.18
1017	1017 10	1.18
1018	1018 10	1.18
1019	1019 10	1.18
1020	1020 10	1.18
1021	1021 10	1.18
1022	1022 10	1.18
1023	1023 10	1.18
1024	1024 10	1.18
1025	1025 10	1.18
1026	1026 10	1.18
1027	1027 10	1.18
1028	1028 10	1.18
1029	1029 10	1.18
1030	1030 10	1.18
1031	1031 10	1.18
1032	1032 10	1.18
1033	1033 10	1.18
1034	1034 10	1.18
1035	1035 10	1.18
1036	1036 10	1.18
1037	1037 10	1.18
1038	1038 10	1.18
1039	1039 10	1.18
1040	1040 10	1.18

### DISC CAPACITORS

Part No.	Description	Price
1000	1000 10	1.18
1001	1001 10	1.18
1002	1002 10	1.18
1003	1003 10	1.18
1004	1004 10	1.18
1005	1005 10	1.18
1006	1006 10	1.18
1007	1007 10	1.18
1008	1008 10	1.18
1009	1009 10	1.18
1010	1010 10	1.18
1011	1011 10	1.18
1012	1012 10	1.18
1013	1013 10	1.18
1014	1014 10	1.18
1015	1015 10	1.18
1016	1016 10	1.18
1017	1017 10	1.18
1018	1018 10	1.18
1019	1019 10	1.18
1020	1020 10	1.18
1021	1021 10	1.18
1022	1022 10	1.18
1023	1023 10	1.18
1024	1024 10	1.18
1025	1025 10	1.18
1026	1026 10	1.18
1027	1027 10	1.18
1028	1028 10	1.18
1029	1029 10	1.18
1030	1030 10	1.18
1031	1031 10	1.18
1032	1032 10	1.18
1033	1033 10	1.18
1034	1034 10	1.18
1035	1035 10	1.18
1036	1036 10	1.18
1037	1037 10	1.18
1038	1038 10	1.18
1039	1039 10	1.18
1040	1040 10	1.18

### TANTALUM CAPACITORS

Part No.	Description	Price
1000	1000 10	1.18
1001	1001 10	1.18
1002	1002 10	1.18
1003	1003 10	1.18
1004	1004 10	1.18
1005	1005 10	1.18
1006	1006 10	1.18
1007	1007 10	1.18
1008	1008 10	1.18
1009	1009 10	1.18
1010	1010 10	1.18
1011	1011 10	1.18
1012	1012 10	1.18
1013	1013 10	1.18
1014	1014 10	1.18
1015	1015 10	1.18
1016	1016 10	1.18
1017	1017 10	1.18
1018	1018 10	1.18
1019	1019 10	1.18
1020	1020 10	1.18
1021	1021 10	1.18
1022	1022 10	1.18
1023	1023 10	1.18
1024	1024 10	1.18
1025	1025 10	1.18
1026	1026 10	1.18
1027	1027 10	1.18
1028	1028 10	1.18
1029	1029 10	1.18
1030	1030 10	1.18
1031	1031 10	1.18
1032	1032 10	1.18
1033	1033 10	1.18
1034	1034 10	1.18
1035	1035 10	1.18
1036	1036 10	1.18
1037	1037 10	1.18
1038	1038 10	1.18
1039	1039 10	1.18
1040	1040 10	1.18

### 7400 TTL

Part No.	Description	Price
7400	7400 10	1.18
7401	7401 10	1.18
7402	7402 10	1.18
7403	7403 10	1.18
7404	7404 10	

## NEW PRODUCTS SHOWCASE

(Continued from page 12)

ported by the high-speed, linear-motor traverse mechanism.

To help remove the unwanted harmonics of the D/A conversion process, a high-resolution digital filter is used. Double-oversampling shifts the undesirable digital noise far above the audio spectrum. That allows the analog filter section characteristics to be gradual, producing smooth, clear sound. A high-precision, Chebyshev, active low-pass filter sweeps away any remaining artifacts.

The SL-XP5 features 18-step, random-access programmability. There is a repeat key to repeat a single track, the entire disc, or program contents. A skip key is provided for movement forward or backward, and a two-speed search is accompanied by cueing sounds.

An LCD readout shows track in play, elapsed playing time, remaining playing time, programmed track number, as well as battery check, repeat, and memory recall. There is a headphone jack with a volume control, and a high-cut filter. A soft carrying case is supplied with the unit as standard equipment.

The SL-XP5 comes equipped with a rechargeable battery pack, which provides up to five hours of continuous play on a single charge. An AC adaptor is also supplied, with a car battery adaptor being an optional accessory.

The SL-XP5 is currently available at the suggested retail price of \$300. For more information contact Technics, One Panasonic Way, Secaucus, NJ 07094.

### Compact VHS VCR

Who says bigger is better? The Samsung VR2410 VHS VCR has a compact 15-in. wide cabinet and features high-quality circuitry for virtually noise-free pictures. The VR2410 offers a 110-channel, cable-compatible, frequency-synthesized tuner, 14-day/4-event programmable timer, three-speed record and playback, convenient one-touch recording, auto rewind, and a front-loading cassette system. The 20-key/23-function wireless remote features direct-access tuning, channel up and down, and picture search in all three speeds.

The VR2410 measures 15-in.  $\times$  3½-in.  $\times$  13-in. It is available at the suggested retail price of \$379.95. Contact: Samsung Electronics America, 301 Mayhill Street, Saddle Brook, NJ 07662; Tel. 201/587-9600.



CIRCLE 79 ON FREE INFORMATION CARD

### Wrapping/Unwrapping Tool Kits

Three-piece wrapping and three-piece unwrapping tool kits may just be the thing to wrap up your tool buying. The tools in the set were selected to handle the most popular wire-wrap connections.

Jonard Quick-wrap devices make uniform, permanent and stable connections. All tools are quality-engineered, precision-made and designed for maximum efficiency. The tools require no bits, sleeves or special knowledge for the user to operate.

The KU-350 wrapping kit contains a standard .073  $\times$  .750-in. hole; a single ended, .075  $\times$  .8-in. hole; and a single ended .071  $\times$  .625 hole wrapper.



CIRCLE 91 ON FREE INFORMATION CARD

The KW-360 unwrapping kit contains a double-ended, left handed, .052/.07  $\times$  1.25-in. hole; a double-ended, left and right handed, .07  $\times$  .75-in. hole; and also a double-ended, .066  $\times$  .073 hole unwrapper.

Both kits are handsomely fitted in durable leather-finished cases for maximum protection of tools. Kit model KW-350 price \$42.00—Kit model KU-360 price \$48.00. For further information and literature, showing complete details and specifications on all tools, write: Jonard Industries Corp., 134 Marbledale Road, Tuckahoe, NY 10707.

### Packet-Radio Controller

If you're looking for packet radio solutions, don't pack it in, check out the MFJ-1274. The latest TAPR TNC-2 clone, it works not only for VHF, but also for HF, OSCAR, and other non-FM packet.

The MFJ-1274 is modem selectable for both VHF and HF operation, with a precision 20-segment LED tuning indicator, a TTL serial port, and an easily replaceable, lithium battery for memory back-up.

All you need to enjoy packet radio is an MFJ-1274, your rig, and any home computer with an RS-232 serial port and terminal program.

If you have a Commodore 64, 128, or VIC-20, you can use MFJ's optional Starter Pack to get on the air immediately. The Starter Pack includes interfacing cable,

terminal software on disk or tape, and also, the complete instructions. The MFJ-1282 (disk) and the MFJ-1283 (tape) are \$19.95 each.

Unlike machine-specific TNC's, you never have to worry about your MFJ-1274 becoming obsolete because you change computers or because packet-radio stan-



CIRCLE 92 ON FREE INFORMATION CARD

dards change. You can use any computer with an RS-232 serial port with an appropriate terminal program. If packet-radio standards change, software updates will be made available to buyers as TAPR releases them.

Also, speeds in excess of 56K baud are possible with a suitable external modem! You can also use the MFJ-1274 as an excellent but inexpensive *digipeater* to link other packet stations.

It features AX.25 Level 2 Version 2 software, hardware HDLC for full duplex, true Data Carrier Detect for HF, multiple connects, 256 EPROM, 16K RAM (expandable to 32K with an optional EPROM), simple operation, socketed IC's, plus much more.

You get an easy-to-read manual, a cable to connect your transceiver (you have to add a connector for your particular radio), a connector for the TTL serial port and a power supply for 117-VAC operation (you can use 12 VDC for portable, remote, or mobile operation).

The MFJ-1274 comes with a double guarantee. If ordered directly from MFJ, it may be returned within 30 days for a prompt refund, less shipping. The MFJ-1274 is also covered by MFJ's One Year Unconditional Guarantee. Its price is \$169.95.

To order or for more information, contact MFJ Enterprises, Inc., P.O. Box 494, Mississippi State, MS 39762; Tel. 800/647-1800; or 601/323-5869.

### Micro-Ohmmeter

If you need a low-resistance measuring meter, but don't want to buy one with a whole lot of high-tech, miscellaneous functions, then read on.

The model 510, is a low-cost, 4½-digit, micro-ohmmeter designed to measure the resistance of switch and relay contacts, transformer and motor windings, connectors, or any other low-resistance device. It has five ranges from 19,999 milliohms to 199.99 ohms, full scale, 1 micro-ohm resolution, and a basic accuracy of 0.02%.

Three measurement modes are provided. The continuous DC mode is useful for making measurements on inductive components, and the switched DC mode removes the effect of thermal voltages, the largest source of error in low-resistance measurements. A pulsed mode is provided for thermally sensitive devices such as fuses. The standard unit comes with 4-terminal, Kelvin test clips and a parallel BCD interface.



CIRCLE 93 ON FREE INFORMATION CARD

The 510A also has the important ability to assure that oxides and films on contacts aren't punctured by limiting its open-circuit voltage to 50 mV. For more critical applications, Model 510A/20 is available. That version limits its open-circuit voltage to 20 mV and is the same price as the standard unit.

Competing units with equivalent resolution and features sell for more than twice the \$895.00 price of the 510A. Options available include a large selection of clips, probes, and test fixtures, battery-operation, a limits-comparator with an RS-232 interface, and a current amplifier to extend resolution down to as little as 10 nano-ohms.

For further information contact Cambridge Technology, Inc., 2464 Massachusetts Avenue, Cambridge, MA 02140; Tel. 617/876-0891.

### Tunable Terrestrial Trap

Live near an airport. Coast Guard station, or a ham who keeps screwing up your TV reception? Well, you may not be able to trap them into admitting they're the source of the trouble, but you can trap out their interference. The tunable notch filter, Model 3217LST, removes interference at a receiver's IF section caused by microwave terrestrial interference at  $\pm 10$  MHz from the transponder center frequencies. It is available for 60 MHz (model 3217LST-60) or 80 MHz (3217LST-80).

The notch filter response is designed to be nonsymmetrical in order to preserve

the receiver's 70-MHz IF passband. The 3-dB points in the direction of the passband can be set by tuning between 0.5 MHz (shallow notch) and 1.5 MHz (deep notch). That allows optimum suppression of the undesired interference and maximum preservation of the IF bandwidth. That adjustability in both frequency and bandwidth is a useful feature since the characteristics of microwave terrestrial interference can vary depending upon the type of transmission and the traffic load on that system. The exact notch center frequency can be adjusted within  $\pm 3$  MHz of the notch center frequency.

Case size is 1 7/8-in.  $\times$  2-in.  $\times$  4 1/4-in., and connectors of type F, BNC, or SMA are available options.



CIRCLE 94 ON FREE INFORMATION CARD

Suggested retail price is \$169 and delivery is two weeks. For more information contact Microwave Filter Company, Inc., 6743 Kinne St., East Syracuse, NY 13057; Tel. 800/448-1666.

### Speed Radar Gun

If you're a sportsman, radar can be used for you as well as against you. The SR-300 radar gun is a light-weight (less than 2 pounds), compact (8-in.  $\times$  3 3/4-in.  $\times$  5 1/8-in.), radar gun designed to measure the speed of a projectile traveling between 15 and 200 mph with extreme accuracy. The SR-300 is simple to use, and its all-aluminum housing and heavy-duty components are designed to provide maximum service life even when exposed to the most severe use.

Designed like police radar guns, the SR-300 is a convenient, precise way to measure the speed of baseballs, tennis balls, golf balls, etc. That makes the unit an excellent training aid for pitchers, tennis players, or golfers, where control and speed are critical to performance. Whether you are a coach, avid sportsman, or the parent of a child that wants to train like a professional, this radar gun may be just for you.

Power is provided by a rechargeable battery pack that allows from 4 hours of continuous operation to 5 days of intermittent use. The battery is housed in a small waterproof pack, that can be worn on the users belt, or carried in a jacket pocket.

★ QUALITY PARTS ★ DISCOUNT PRICES ★ FAST SHIPPING!

**ALL ELECTRONICS CORP.**  
**ALL ELECTRONICS CORP.**

SEND FOR  
**FREE**  
1987 CATALOG  
48 PAGES!



### COMPUTER GRADE CAPACITORS

- 1,400 mfd 200 Vdc  
3" x 2" dia. \$2.00
- 6,400 mfd 60 Vdc  
4 1/4" x 1 3/8" dia. \$2.50
- 7,500 mfd 200 Vdc  
5 3/4" x 3" dia. \$4.00
- 12,000 mfd 40 Vdc  
4 1/4" x 2" dia. \$2.50
- 22,000 mfd 25 Vdc  
4 3/4" x 2" dia. \$2.50
- 48,000 mfd 10 Vdc  
3" x 2 1/2" dia. \$2.50
- 72,000 mfd 15 Vdc  
4" x 2" dia. \$3.00

**MINI-PUSH BUTTON**  
S P S T momentary normally open  
1/8" pushing 35¢ each  
Red button 10 for \$3.00

### 48 KEY ASSEMBLY FOR COMPUTER OR HOBBYIST

**NEW T.I. KEYBOARDS** Originally used on computers, these keyboards contain 48 S P S T mechanical switches. Terminates to 15 pin connector. Frame 4" x 9"  
CAT # KP-48 \$3.50 each

### 3rd TAIL LIGHT ?

Stack high-tech lamp assembly. Could be used as a third auto tail light, emergency warning light, or special-effects lamp. Red reflective lens is 2 3/4" x 5 1/2" is mounted on a 4" high pedestal with up-down swivel adjustment. Includes 12v replaceable bulb. CAT# TLB \$3.95 each

### S.P.S.T. TOGGLE SWITCH

CARLING (on-off) RATED: 10 amp @ 125 Vac. All plastic body and toggle. CAT# STS-1 \$1.00 ea. 10 for \$8.50 100 for \$75.00 LARGE QUANTITIES

### TELEPHONE COUPLING TRANSFORMER

Stancor # TTPC-6 or Trad # TY-304 P 600 ohms c t 1600 ohms c t P.C. board mount 3/4" x 5/8" x 3/4" \$1.25 each

### WALL TRANSFORMERS

all plug directly into 120 vac outlet

4 VDC @ 70 ma.	\$2.00
6 VDC @ 500 ma.	\$3.50
6 VDC @ 750 ma.	\$4.50
9 VDC @ 2.50 ma.	\$2.50
9 VDC @ 500 ma.	\$5.00
12.5 VAC @ 255 ma.	\$3.00
18 VAC @ 1.8 VA and	
4.5 VAC @ 1.28 VA	\$3.50
24 VAC @ 750 ma.	\$3.00
MULTI-VOLTAGE @ 500 ma.	
3, 4 1/2, 6, 7 1/2, 9 or 12 VDC	\$7.50

### TRANSFORMERS

120 volt primaries

5.6 volts @ 750 ma.	\$3.00
6.3 volt @ 800 ma.	\$1.75
12 V.C.T. @ 200 ma.	\$2.00
12 V.C.T. @ 400 ma.	\$3.00
12 V.C.T. @ 1 amp.	\$4.00
12 V.C.T. @ 2 amp.	\$4.85
12 V.C.T. @ 4 amp.	\$7.00
18 volts @ 650 ma.	\$2.00
24 V.C.T. @ 200 ma.	\$2.50
24 V.C.T. @ 1 amp.	\$4.85
24 V.C.T. @ 2 amp.	\$6.75
24 V.C.T. @ 3 amp.	\$9.50
24 V.C.T. @ 4 amp.	\$11.00

### POLARITY SWITCH

Designed to control an external coaxial relay on a satellite TV system IDEAL FOR THE EXPERIMENTER AS PARTS Heavy chassis box containing a 5 Vdc relay. CA 358 op amp and other parts. Catalog # RDPS \$1.75 each 10 for \$15.00

### NI-CAD CHARGER TESTER

Will charge most every size Ni-cad battery available. Cat # UNCC-N \$12.50

### RECHARGEABLE NI-CAD BATTERIES

AAA SIZE 1.25V 500MAH	\$1.85
AA SIZE 1.25V 500MAH	\$1.85
AA with solder tab	\$2.00
C SIZE 1.2V 1200MAH	\$3.50
SUB-C SIZE solder tab	\$3.50
D SIZE 1.2V 1200MAH	\$3.50

### LIGHT ACTIVATED MOTION SENSOR

This device contains a photocell which senses sudden changes in ambient light. When an object or person passes within its field of view (about 5') it beeps for several seconds then resets. Could be used as a door annunciator or modified to trigger other devices. 5 1/2" x 4" x 1". Operates on 6 Vdc. Requires 4 AA batteries (not included). Catalog # LSMH \$5.75 per unit

**TOLL FREE ORDERS**  
800-826-5432  
IN CA (800-258-6666)  
INFO • (213) 380-8000  
FAX • (213) 389-7073

QUANTITIES LIMITED  
MINIMUM ORDERS \$100  
CALIF. ADD SALES TAX  
USA \$100 SHIPPING  
NO C.O.D.  
FOREIGN ORDERS  
INCLUDE SUFFICIENT SHIPPING

CIRCLE 9 ON FREE INFORMATION CARD

## ELECTRONIC COMPONENTS



176 PAGE

### FREE CATALOG

Manufacturers of Quality Electronic Components

Serving the Nation from Texas and California

- BATTERY HOLDERS & CLIPS • COILS
- CAPACITORS • CONNECTORS • FUSES
- JACKS • KNOBS • LAMPS • PLUGS
- MICROPHONES • POTENTIOMETERS
- RELAYS • RESISTORS • SWITCHES
- TRANSFORMERS • SPEAKERS • LEDS
- SEMICONDUCTORS • RF COILS

OVER 16,000 DIFFERENT ITEMS IN STOCK!  
CATALOGS MAILED OUTSIDE USA SEND \$2.00

### MOUSER ELECTRONICS

2401 HWY 287 NORTH DALLAS, TX 75063

PHONE: 817-483-4422

CIRCLE 16 ON FREE INFORMATION CARD

## ATTENTION! ELECTRONICS TECHNICIANS

EARN YOUR  
**B.S.E.E.  
DEGREE**  
THROUGH HOME STUDY



Our New and Highly Effective Advanced-Placement Program for experienced Electronic Technicians grants credit for previous Schooling and Professional Experience, and can greatly reduce the time required to complete Program and reach graduation. No residence schooling required for qualified Electronic Technicians. Through this Special Program you can pull all of the loose ends of your electronics background together and earn your B.S.E.E. Degree. Upgrade your status and pay to the Engineering Level. Advance Rapidly! Many finish in 12 months or less. Students and graduates in all 50 States and throughout the World. Established Over 40 Years! Write for free Descriptive Literature

### COOK'S INSTITUTE OF ELECTRONICS ENGINEERING



347 RAYMOND ROAD  
P.O. BOX 20345  
JACKSON, MISSISSIPPI 39209

CIRCLE 10 ON FREE INFORMATION CARD

## NEW PRODUCTS SHOWCASE



CIRCLE 66 ON FREE INFORMATION CARD

The SR-300 with LED display in mph, or the SR-300K with kilometer readout, can be operated manually or automatically. In the automatic mode, the unit displays the speed for 5 seconds and then resets. An audio tone lets the operator know that it is ready to lock onto a new target. That mode is ideal for use as a training aid with the gun mounted on a tripod. There is also a recall button that allows the last speed to be displayed.

Suggested retail price of the SR-300 is \$495.00, from Oregon Microwave, 6775 S.W. 111th, Suite 204, Beaverton, OR 97005; Tel. 503/626-6764.

### Towerful Speakers

Rapunzel never let her hair hang off these high-tech babies before. A dual 10-inch woofer, three-way system, the RS6000 is a floor-standing model featuring the new 2-in., Polydome k midrange and Emit k high-frequency drivers.



CIRCLE 63 ON FREE INFORMATION CARD

The new Emit k tweeter features a diaphragm that weighs half as much as its predecessor, and is surrounded by rare neodymium magnets, the most powerful magnet known to man. The Emit k offers outstanding transient response and greater extension of high frequencies (to 44 kHz).

The second advanced component being introduced is the new 2-in. Polydome k

midrange driver. It features an edgewound voice coil and a new polypropylene formulation, which combines extremely low mass with very effective self-damping, resulting in a remarkably dynamic and uncolored sound.

Low frequencies are provided by two 10-inch polypropylene woofers. For extended response otherwise not possible in a relatively compact enclosure, the crossover network includes an LC resonant circuit.

The suggested retail is \$425 ea., and more information can be obtained directly from Infinity Systems, Inc., 9409 Owensmouth Ave., Chatsworth, CA 91311.

### TV-RF Signal Analyzer

You cable TV hardcore techs will appreciate this signal analyzer from Sencore. The FS73 Channelizer Jr. is much more accurate than ever before thought possible, within 1 dB accuracy for each and every channel. Sencore reports that the FS73 has a fully auto-ranging meter, performs tests not found elsewhere, is fully portable, and meets or exceeds FCC specifications.



CIRCLE 62 ON FREE INFORMATION CARD

The FS73 provides an all-channel, microprocessor-controlled tuner for checking every standard and cable-channel RF level with FCC accuracy. One-touch frequency offset allows the customer to select either normal, HRC, or ICC carrier shift. Simply dial in the channel, then read the level on the fully auto-ranging meter. That method is used to measure the RF audio and FM sound through the same input.

The FS73 can analyze the audio/video ratio. That test is automatically performed on any channel by setting the function knob to the A/V position. The customer compares his reading to the 13-dB ratio specified by the FCC.

The on-channel, automatic, signal-to-noise ratio test eliminates time-consuming signal comparison and chart readings. The test is performed on channel with  $\pm 2$  dB accuracy. The auto-ranging meter gives the result directly in decibel form, saving calculation time.

The FS73 provides an exclusive, auto-



matic, and FCC-accurate hum level test. Select the hum test position on the function knob and read the meter for the hum level percentage on any channel that you care to select.

The unit is portable and provides 3½ hours of work on one charge. It also has an auto on/off feature that turns the unit off after 15 minutes of idle-battery operation. The Channelizer Jr. is also IEEE-488 Bus compatible.

The price of the FS73 Channelizer Jr. is \$1,995. Available as optional accessories are the PA241 power adapter (\$48), BY242 battery (2 required, \$44 ea.), carrying case CC243 (\$148), SS249 Cableizer (\$298), and the IB72-IEEE 488 bus interface (\$625). Anyone interested in receiving more information or ordering the FS73 should contact Sencore, Inc., 3200 Sencore Dr., Sioux Falls, SD 57107; Tel. 605/339-0100; or 800/843-3338.

#### Purge Surges

A power surge or static electricity can play havoc with communications equipment. The Black Box Power Control Center will provide complete protection for up to six pieces of equipment by taking the edge off such voltage spikes.

Equipped with UL-listed suppression circuitry, this swivel-mounted device fits between the monitor and CPU. A static discharge bar, located beneath the power



CIRCLE 71 ON FREE INFORMATION CARD

switches, is used by touching the bar before equipment is powered up. A master control switch will turn on the computer monitor and one auxiliary device. A second switch overrides the master control switch and will turn on the computer and monitor only. Four other switches will turn on the printer and other assorted auxiliary devices.

The control center retails for \$169.50, and for more information you can write to Black Box, PO Box 12800, Pittsburgh, PA 15241.

#### Radical Loudspeaker

Being an audiophile in a small apartment can be rough, unless you don't mind eating and sleeping on top of your speakers. An interesting solution is the AM-5 speaker system. Its technology, developed during research on the Acoustic Wave Music System, is the basis of a compact three-piece loudspeaker configuration that delivers the bass, power handling, dynamic range, and spatial accuracy of a much larger system.

Called the AM-5 Acoustimass Speaker System, this new kind of loudspeaker sounds right in any room and can be totally hidden from view.

Smaller than a quart container of milk and the weight of only a standard telephone, each two-cube speaker array can literally fit in the palm of a hand. Two of these arrays and an Acoustimass module (about the size of a typewriter) comprise the entire system.

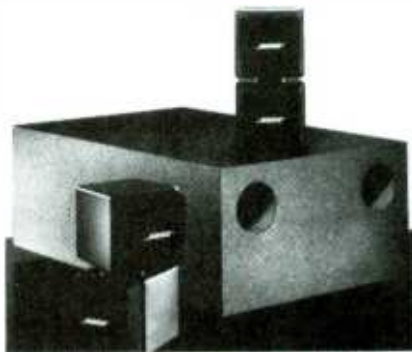

CIRCLE 61 ON FREE INFORMATION CARD

The AM-5 uses four 2½-in., wide-range drivers mounted in small, cube-shaped enclosures. Two cubes are connected to form left and right channel speakers. Each cube swivels a full 360°, to provide whatever balance of direct and reflected sound is right for the listener and the room.

Listeners can also hear stereo from virtually any location in the room, because of the even distribution of sound from the cube arrays.

The key to the AM-5 system is the new Acoustimass speaker technology. An Acoustimass module weighs approximately 20 pounds, measures 8 × 12 × 20 inches, and is designed to reproduce all the frequencies below those covered by the cube speaker arrays.

Mounted inside the Acoustimass module are two special 6-in. low-frequency drivers that fire into two internal chambers. The front of each driver cone sends sound into a ported chamber tuned to 90 Hz. The back of each driver cone fires into a second ported internal chamber tuned to a frequency of 45 Hz.

The new technology produces low-frequency energy not from the driver's cone (as with conventional woofers), but by launching into the room the mass of air contained in each chamber's port. The result is reduced cone motion and reduced harmonic distortion at music's most demanding lower octaves. Most important, the module can be placed anywhere in a room, even under furniture, while maintaining proper balance, stereo image, and extraordinary bass performance.

The AM-5 is available at better audio outlets throughout North America with a

# Our guaranteed savings plan.



**Fluke 70 Series Analog/Digital multimeters are like money in the bank.** Buy one, and you're guaranteed to save both time and money.

Money, because you get longer battery life and longer warranty coverage — 3 years vs. 1 year or less on others.

And time, because 70 Series meters are easier to operate and have more automatic measurement features.

So before buying any meter, look beyond the sticker price. And take a closer look at the new low-priced \$79 Fluke 73, the \$109 Fluke 75, and the deluxe \$145 Fluke 77. In the long run, they'll cost less, and give higher performance, too.

And that, you can bank on.

For a free brochure, and your nearest distributor, call toll-free 1-800-227-3800, ext. 229.

FROM THE WORLD LEADER  
IN DIGITAL MULTIMETERS.



© 1985 Fluke

CIRCLE 13 ON FREE INFORMATION CARD

## NEW PRODUCTS SHOWCASE

retail price of \$699.

For further information contact Bose Corp. directly, The Mountain, Framingham, MA 01701.

### Cable Conscious

If you're a supreme audiophile you know your sound system can only be as good as the cable that connects your components. That's where Interlink 400, an improved version of their popular Interlink 4 component interconnect, comes in. Designed exclusively for home audio systems, Interlink 400 improves overall sound reproduction, delivering overall greater dynamic range, increased clarity, and lower distortion.

Interlink 400 is the first Monster Cable product to employ the latest advancement in their proprietary Bandwidth Balanced technology: the new Micro-fiber dielectric insulator. Applied to the cable's inner strands, Micro-Fiber insulation provides musical dimensionality and dynamics never before available in a low priced interconnect. Interlink 400 comes

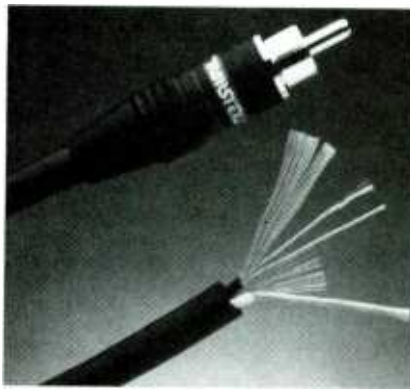

CIRCLE 88 ON FREE INFORMATION CARD

in five ready-terminated sizes, in addition to custom lengths.

Suggested retail prices: 1/2-meter pair/\$24.95; 1-meter pair/\$29.95; 1.5-meter pair/\$34.95; 2-meter pair/\$39.95; 20-foot pair/\$79.95; custom-terminated lengths at \$2.00/foot plus connectors and termination fee. Interlink Reference A connectors: \$20.00/pair.

For further information contact Monster Cable, 101 Townsend St., San Francisco, CA 94107. ■

# IT'S TIME TO GET OUT OF THE DARK.



Open your eyes and see just how many subjects are covered in the new edition of the Consumer Information Catalog. It's free just for the asking and so are nearly half of the 200 federal publications described inside. Booklets on subjects like financial and career planning; eating right, exercising, and staying healthy; housing and child care; federal benefit programs. Just about everything you would need to know. Write today. We'll send you the latest edition of the Consumer Information Catalog, which is updated and published quarterly. It'll be a great help, you'll see. Just write:

**Consumer  
Information Center  
Department TD  
Pueblo, Colorado 81009**

A public service of this publication and the Consumer Information Center of the U.S. General Services Administration

## Mr. Peepers...

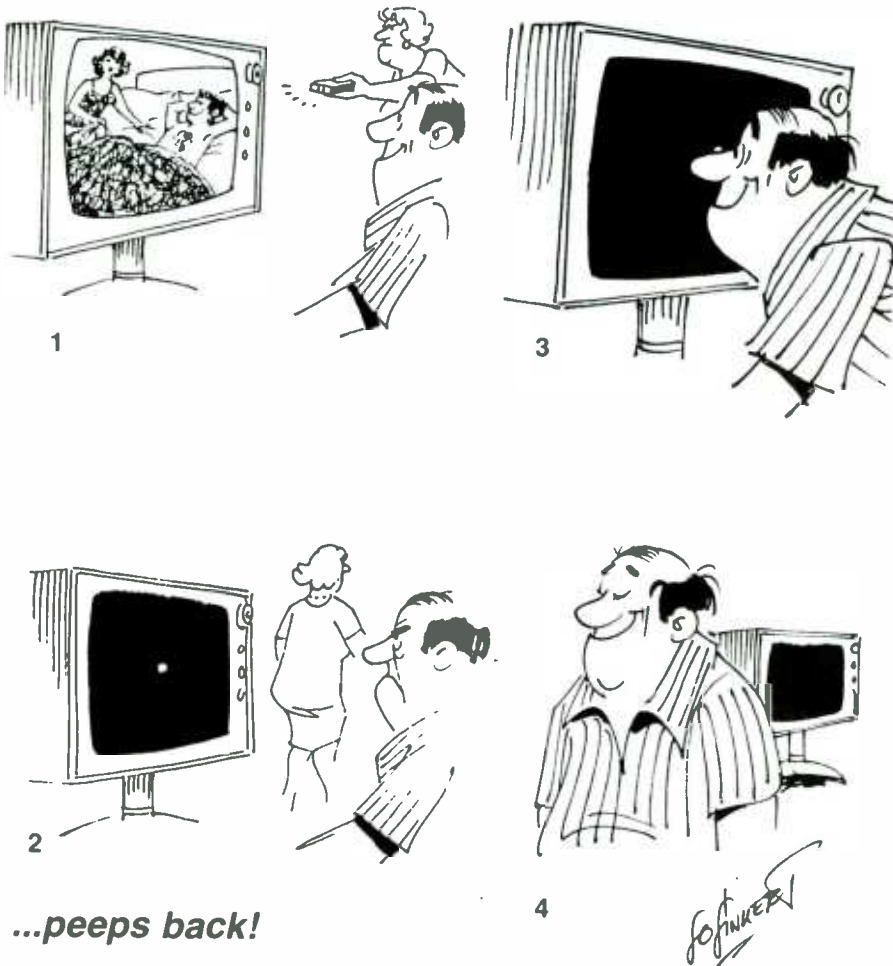

...peeps back!

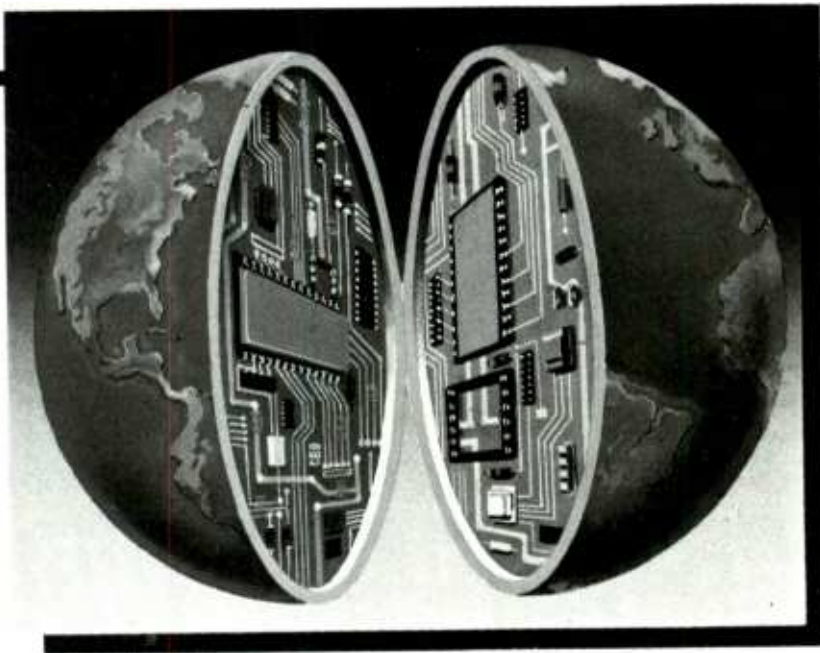

can even earn your Associate in Applied Science Degree in Electronics Engineering Technology. Of course, you set your own pace, and, if you ever have questions or problems, our instructors are only a toll-free phone call away.

## The first step is yours.

To find out more, mail in the coupon below. Or, if you prefer, call toll-free 1-800-321-2155 (in Ohio, 1-800-523-9109). We'll send you a copy of CIE's school catalog and a complete package of enrollment information. For your convenience, we'll try to have a representative contact you to answer your questions.

# CIE MAKES THE WORLD OF ELECTRONICS YOURS.

Today's world is the world of electronics. But to be a part of it, you need the right kind of training, the kind you get from CIE, the kind that can take you to a fast growing career in business, medicine, science, government, aerospace, communications, and more.

## Specialized training.

You learn best from a specialist, and that's CIE. We're the leader in teaching electronics through independent study, we teach only electronics and we've been doing it for over 50 years. You can put that experience to work for you just like more than 25,000 CIE students are currently doing all around the world.

## Practical training.

You learn best with practical training, so CIE's Auto-Programmed® lessons are designed to take you step-by-step, principle-by-principle. You also get valuable hands-on experience at every stage with sophisticated electronics tools CIE-designed for teaching. Our

4K RAM Microprocessor Training Laboratory, for example, trains you to work with a broad range of computers in a way that working with a single, stock computer simply can't.

## Personalized training.

You learn best with flexible training, so we let you choose from a broad range of courses. You start with what you know, a little or a lot, and you go wherever you want, as far as you want. With CIE, you



AHO-61

## CIE Cleveland Institute of Electronics

1776 East 17th St., Cleveland, Ohio 44114

YES! I want to get started. Send me my CIE school catalog including details about the Associate Degree Program. I am most interested in:

- |  |   |
|--|---|
| <input type="checkbox"/> computer repair     | <input type="checkbox"/> television/high fidelity service |
| <input type="checkbox"/> telecommunications  | <input type="checkbox"/> medical electronics              |
| <input type="checkbox"/> robotics/automation | <input type="checkbox"/> broadcast engineering            |
| <input type="checkbox"/> other _____         |   |

Print Name \_\_\_\_\_

Address \_\_\_\_\_ Apt. \_\_\_\_\_

City \_\_\_\_\_ State \_\_\_\_\_ Zip \_\_\_\_\_

Age \_\_\_\_\_ Area Code/Phone No. \_\_\_\_\_

Check box for G.I. Bulletin on Educational Benefits

- Veteran     Active Duty

**MAIL TODAY!**

CIRCLE 11 ON FREE INFORMATION CARD

# AMAZING SCIENTIFIC & ELECTRONIC PRODUCTS

- PLANS**—Build Yourself—All Parts Available in Stock
- LC7—BURNING CUTTING CO<sub>2</sub> LASER \$ 20.00
  - RUBA—PORTABLE LASER RAY PISTOL 20.00
  - TCC1—3 SEPARATE TESLA COIL 20.00
  - PLANS TO 1.5 MIEV 20.00
  - IOG1—ION RAY GUN 10.00
  - GRA1—GRAVITY GENERATOR 10.00
  - EML1—ELECTRO MAGNET COIL GUN/LAUNCHER 6.00

- KITS**
- MFT1K—FM VOICE TRANSMITTER 3 MI RANGE 49.50
  - VWPMSK—TELEPHONE TRANSMITTER 3 MI RANGE 39.50
  - BTC3K—250.00 VOLT 10-14" SPARK TESLA COIL 199.50
  - LHC2K—SIMULATED MULTICOLOR LASER 39.50
  - BLS1K—100,000 WATT BLASTER DEFENSE DEVICE 99.50
  - ITM1K—100,000 VOLT 20' EFFECTIVE RANGE INTIMIDATOR 69.50
  - PSP4K—TIME VARIANT SHOCK WAVE PISTOL 59.50
  - PTK1K—SPECTACULAR PLASMA TORNADO GENERATOR 149.50
  - MYPK SEE IN DARK KIT 169.50

- ASSEMBLED**
- PG7H—MULTICOLOR VARIABLE MODE PLASMA GLOBE "7" 425.00
  - BTC10—50,000 VOLT—WORLD'S SMALLEST TESLA COIL 44.50
  - LGL40—14W HeNe VISIBLE RED LASER GUN 299.50
  - TAT20 AUTO TELEPHONE RECORDING DEVICE 24.50
  - GPV10—SEE IN TOTAL DARKNESS IR VIEWER 299.50
  - LIST10—SHOOPER PHONE INFINITY TRANSMITTER 169.50
  - PPT0—INVISIBLE PAIN FIELD GENERATOR—MULTI MODE 74.50

• CATALOG CONTAINING DESCRIPTIONS OF ABOVE PLUS HUNDREDS MORE AVAILABLE FOR \$1.00 OR INCLUDED FREE WITH ALL ABOVE ORDERS.

PLEASE INCLUDE \$3.00 PH ON ALL KITS AND PRODUCTS PLANS ARE POSTAGE PAID. SEND CHECK, MO, VISA, MC IN US FUNDS

**INFORMATION UNLIMITED**  
P.O. BOX 715, DEPT. HO AMHERST, NH 03031

# BOOKSHELF

## Video Scrambling and Descrambling for Satellite and Cable TV By Rudolf F. Graf

Learn the secrets of decoding and encoding cable-TV signals by taking a peek at this book. It discusses the theory and techniques needed to understand how over-the-air and cable signals are decoded and encoded. Video, audio, and computer hobbyists, technicians, and commercial-TV personnel interested in satellite signals and programming will find this easy-to-understand book worthwhile.



CIRCLE 64 ON FREE INFORMATION CARD

Topics covered include: scrambling/descrambling techniques and basic circuitry; the SSAVI system; advanced scrambling methods—satellite techniques; political, legal, and consumer aspects of scrambling; digitizing audio and video signals; cable and satellite decoder circuitry; and also, the commercial satellite encryption systems.

*Video Scrambling & Descrambling for Satellite & Cable TV*, No. 22499, is 256 pages and retails for \$19.95, from Howard W. Sams & Co., Inc., Dept. R40, 4300 W. 62nd St., Indianapolis, IN 46268; Tel. 800/428-SAMS

## Getting the Most from Your Printer By J.W. Penfold

It is probably true that 80% of dot-matrix owners use no more than 20% of the possible features offered by their printers. That is generally due to the fact that most manuals supplied with printers are not particularly "reader friendly" and take some considerable understanding. That's why a user-

friendly book such as this, may be a good investment.

The purpose of this book is to help you to realize more of the capabilities of your dot-matrix printer, by showing exactly how to achieve given effects in word processing when printing listings, and from your own programs.



CIRCLE 65 ON FREE INFORMATION CARD

*Getting the Most from Your Printer* is written for use with home computers, especially the BBC and Acorn Electron, Amstrad, Sinclair Spectrum and OL, Commodore, Memotech, MSX, and Enterprise machines as well. It is also a useful guide and printer for users of business machines.

It contains 96 pages and retails for only \$6.95 from Electronics Technology Today, PO Box 240, Massapequa, NY 11762.

## How to Use Special-Purpose IC's By Delton T. Horn

If you've ever tried to find special applications data on many of today's special-purpose integrated circuits, you know there just hasn't been much information out there; until now.

*How to Use Special-Purpose IC's* gives you a comprehensive overview of all the newest and most useful of the vast array of special-purpose IC's. It covers practical uses for circuits ranging from voltage regulators to CPU'S, from telephone IC's to multiplexers and demultiplexers, from video IC's to stereo synthesizers, and much, much more.

Taking a hands-on approach to IC

HANDS-ON ELECTRONICS

**SUPER LONG PLAY TAPE RECORDERS**

10 Hour Model — \$95.00\*  
14 Hour Model — \$159.00\*

Modified Panasonic Slimline. high quality, AC-DC Recorders provide 5 or 7 continuous hours of quality recording & playback on each side of cassette for a total of 10 or 14 hours depending on model. Built-in features include: Voice level control, Digital counter, etc. TDK DC 180 Cassette Furnished

**PHONE RECORDING ADAPTER**

Records calls automatically. All Solid state connects to your telephone jack and tape recorder. Starts recording when phone is lifted. Stops when you hang up. \$24.50\* FCC APPROVED

**VOX VOICE ACTIVATED CONTROL SWITCH**

Solid state. Self contained. Adjustable sensitivity. Voices or other sounds automatically activate and control recorder. Uses either recorder or remote mike. \$24.95\*

\*Add for ship & hdg. Phone Adapter & Vox \$1.50 ea. Recorders \$4.00 ea. Cal. Res. add tax. Mail order. VISA, MIC, COD'S OK. Money Back Guarantee. Free data. avail... Dealer Inquiries Invited. © 9335 Lubec AMC SALES, Dept. 9335 Lubec St., Box 928, Downey, CA (213) 90241 Phone 869 8519

CIRCLE 8 ON FREE INFORMATION CARD

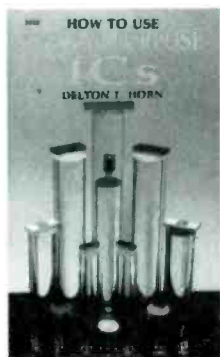

CIRCLE 67 ON FREE INFORMATION CARD

usage, Horn has avoided the temptation to become overly theoretical in his presentation. Instead, he has provided easy-to-follow explanations, supported by generous doses of drawings, diagrams, and schematics. You'll discover how and why each special-purpose IC functions and how it can be put to practical use. Focusing on everyday applications he also provides a wealth of unusual applications—idea starters that will be especially appreciated by more-advanced experimenters.

If you're a novice, you'll also be able to put the information from the

book to immediate practical use, thanks to clear, concise explanations of internal IC circuitry and the logical arrangement of IC devices by type. For example, all power-supply IC's have been grouped together as have LED drivers, sensor IC's, signal generators, radio and video IC's, digital IC's, and other IC families.

Up-to-date, and filled with practical insight into the use of IC devices, it is a sourcebook that belongs within easy reach of every hobbyist's and experimenter's workbench.

Containing 376 pages, the book sells for \$16.95 from Tab Books, Inc., Blue Ridge Summit, PA 17214; Tel. 717/794-2191.

**The Best Book of: Wordperfect By Vincent Alfieri**

It's strange to come across a document written about software used to write documents, but such strangeness is commonplace in the search for perfection.

Perfect for beginners, the book offers clear and extensive coverage of merge-printing; explores writing aids such as automatic table of contents, index generation, and user-defined macros; and contains a thorough

discussion of printer setups and laser printers. It also describes how version 4.2 of WordPerfect works.

Designed for easy reference, the chapters are arranged according to themes. It contains over 75 practical examples with screen illustrations. Topics covered include: the basics; all about printing; introduction to formatting; simple macros and file management; taking control of the page; working with multiple text columns; and document assembly.



CIRCLE 64 ON FREE INFORMATION CARD

*The Best Book of: WordPerfect, No. 46581, is 464 pages and retails for \$19.95. It's available through bookstores, or direct from Howard W. Sams & Co. Inc., Dept. R40, 4300 W. 62nd St., Indianapolis, IN 46268; Tel. 800/428-SAMS.*

For other soldering equipment, see pages 137 and 138 in Catalog #15.

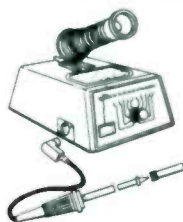

**Tenma Soldering Station**

New improved stability circuit design for more reliable operation. The temperature is adjustable from 300° F-790° F (150° C-420° C).



**Fuji Cassettes**

All Fuji cassettes have a special head cleaning leader which also features one-second internal timing marks, and a specially engineered cassette shell for low friction and long tape life.

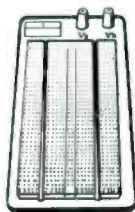

**Solderless Breadboard**

The perfect breadboard for circuit designing, testing electronic devices and educational uses.

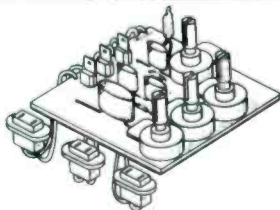

**Color Organ Kit**

The three-channel color organ gives a dramatic effect by flashing three strings of lights (each a different color) to the sound of music.

For more kits, see page 53 in Catalog #15.

For additional phono cartridges, see page 85 in Catalog #15.

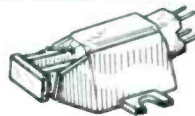

**Empire Cartridge**

All Empire cartridges are guaranteed against defects in material and workmanship for a period of two years.



**Tenma Compact DMM**

This is a compact DMM with glass epoxy PC boards, shock-mounted display and a tough thermoplastic case. Its wide angle 3 1/2 digit LCD display makes for easy and accurate reading from any angle or lighting situation.

**MCM's 156 Page Catalog #15 Is Filled With Electronic Parts**

**Call Toll Free 1-800-543-4330**

In Ohio 1-800-762-4315  
In Alaska & Hawaii 1-800-858-1849



**MCM ELECTRONICS**

858 E. CONGRESS PARK DR.  
CENTERVILLE, OH 45459  
A PREMIER Company

Source No. HO-04

CIRCLE 15 ON FREE INFORMATION CARD

## BOOKSHELF

### Mastering Expert Systems with Turbo Prolog By Carl Townsend

This book details how to design expert systems with Turbo Prolog using tutorial examples, numerous practical examples, and many program listings.

Written for the intermediate to advanced user, it provides all the design elements necessary to create an expert system from concept to actual application.

Topics covered include: fundamentals, introduction to expert systems; using turbo prolog; using rules; using data bases; controlling the

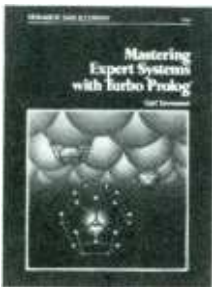

CIRCLE 64 ON FREE INFORMATION CARD

flow of execution; and special prolog application techniques.

*Mastering Expert Systems with Turbo Prolog*, No. 22568, is 272 pages and retails for \$19.95. You can buy your copy from Howard W. Sams & Co. Inc., Dept. R40, 4300 W. 62nd St., Indianapolis, IN 46268; Tel. 800/428-SAMS.

### Electronic Test Instruments: A User Sourcebook By Robert Witte

If you would like to go beyond the basics of how to operate test equipment then this may possibly be your guide.

From simple meters to spectrum analyzers, the manual offers practical techniques and shortcuts that illustrate how to use the latest digital instruments necessary for understanding, designing, or troubleshooting typical electronic circuits and systems.

This tutorial and reference book will be a constant companion for the hobbyist, experimenter, technician, or ham radio operator.

Topics covered include:

measurement theory; voltmeters, ammeters, and ohmmeters; signal sources; oscilloscopes; oscilloscope measurements; miscellaneous electronic instruments; circuits for electronic measurements; and frequency-domain instruments.



CIRCLE 64 ON FREE INFORMATION CARD

*Electronic Test Instruments: A User's Sourcebook*, No. 22483, is 272 pages and retails for \$14.95. You can order a copy from Howard W. Sams & Co. Inc., Dept. R40, 4300 W. 62nd St., Indianapolis, IN 46268; Tel. 800/428-SAMS.

### Modula-2 Primer By Stan Kelly-Bottle

Using a computer to help someone learn about software is a natural, and having a book to start you off is the way to go for most. If that makes sense to you, then read on.

This book highlights for the first-time Modula user the important features of the Modula-2 language—an increasingly vital software-development language.



CIRCLE 64 ON FREE INFORMATION CARD

It provides a tutorial approach to Modula-2 and illustrates the relationship between Pascal and Modula-2. Topics covered include: first steps; simple data types; program control structures; arrays and advanced data types; regular and function procedures; records; files and I/O; dynamic data structures; and modules.

*Modula-2 Primer*, No. 22560, is 472 pages and retails for \$19.95, from Howard W. Sams & Co. Inc., Dept. R40, 4300 W. 62nd St., Indianapolis, IN 46268; Tel. 800/428-SAMS.

(Continued on page 98)

## LOW COST PROBES FOR ALL SCOPES

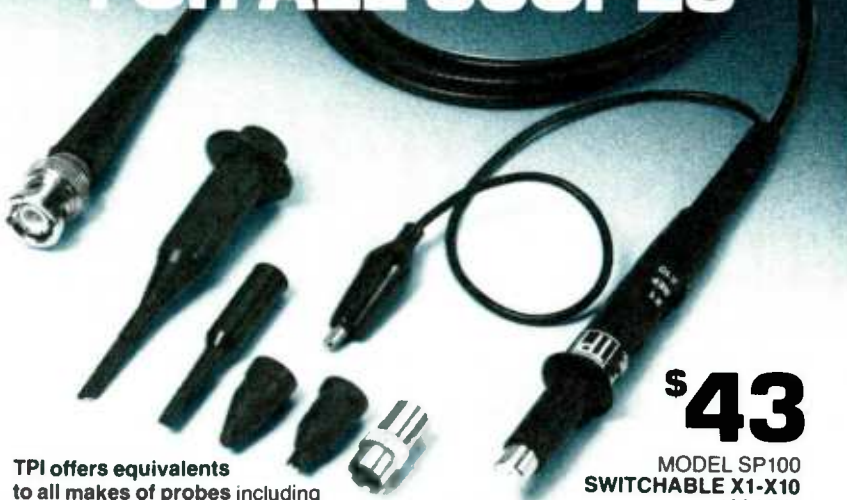

**\$43**

MODEL SP100  
SWITCHABLE X1-X10  
100 MHz

TPI offers equivalents to all makes of probes including modulars, at savings up to fifty percent. TPI probes compensate to all scopes. Slender, flexible cables are easier to handle yet more durable because of their unique center conductor. Performance is guaranteed.

FOR FAST RESPONSE CALL  
**800-368-5719**  
In Calif. 800-643-8382

**TEST PROBES, INC.** **TPI**

Your Probe Specialists  
COLINE U.S. SALES & STOCKING SOURCE

P.O. Box 2113, LA JOLLA, CALIFORNIA 92038 (619) 459-4197

CIRCLE 17 ON FREE INFORMATION CARD



By Marc Saxon

# SAXON ON SCANNERS

Here's a mobile scanner that offers convenience and affordability

HERE'S A CLEVER IDEA THAT'S JUST IN time for your motorized vacation. It's called the Regency *Informant* (officially it's the Model INF-1), a rather dramatic innovation in VHF/UHF technology. In a nutshell, it's a special mobile receiver that is pre-programmed with key state and local law enforcement frequencies for all of the 50 states.

Regency Electronics, Inc., says that "this is the world's first public information radio, a *unique* concept in public-service band receivers." (And they're probably right.)

Unlike traditional scanners, the *Informant* doesn't need to be programmed by the user; it can be operated by anyone without a prior knowledge of scanning. Designed for use in cars, trucks, and RV's, the *Informant* eliminates the need to look up frequencies and program them into the set as you move from state to state. The user-friendly receiver is pre-programmed with local, state, and national VHF/UHF police frequencies. With a single touch, the unit scans the frequencies

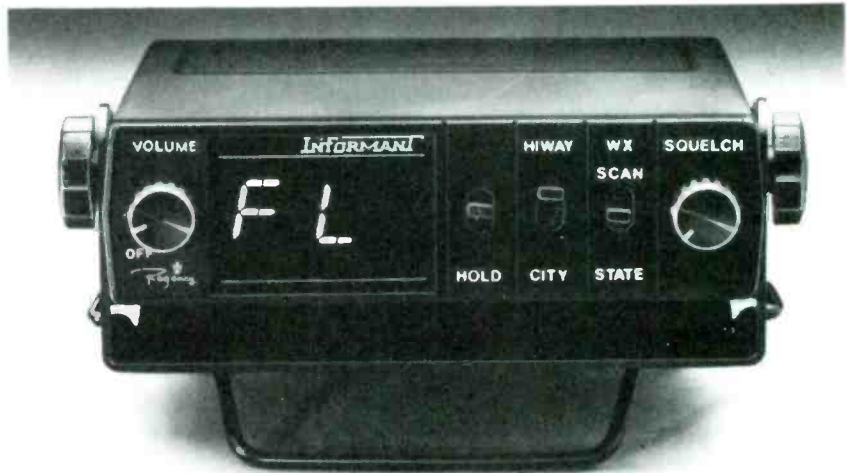

Fig. 1—Designed for use in cars, trucks, and RV's, the Regency *Informant* (Model INF-1) is a special mobile receiver that's pre-programmed with key state, local, and national police VHF/UHF frequencies for all 50 states—eliminating the need to look up frequencies and program them into the set as you travel from state to state.



This really jazzy membership certificate was issued to our esteemed Editor, Julian S. Martin, GMA of New York by *Knights of Pythias International CB Club* and displays his CB handle, *Polish Ham*. For more information about this CB club write to Eric D. Fitzpatrick, PSC, 6908 Nelson Ave., South Burnaby, BC, Canada V5J-4C1.

of a particular state you are in.

Through Regency's new *TurboScan* technology, the *Informant* scans merrily along at a rate of 50-channels per second—about four times faster than most other modern scanners. Another important feature is the unit's instant weather function. When activated, it zeros-in on the active NOAA VHF weather channel in any area and provides you with the latest weather information.

Other features include a digital display, which shows the state and type of transmission (state police, county police, etc.) being monitored; a HIGHWAY/CITY switch that lets you select local or state-wide frequencies; a top-mounted speaker, and a HOLD button that keeps the receiver on a single frequency.

Equipped with its own telescoping antenna, the *Informant* installs quickly; and may be powered by wiring it into the vehicle's electrical system, or through a cigarette-lighter plug. The *Informant* has a suggested retail price of \$369.95.

For more information on the *Informant*, contact Regency Electronics, Inc., 7707 Records Street, Indianapolis, IN 46226.

Inasmuch as we receive quite a bit of mail from CB'ers, I wanted to mention

### ARD-35 Digital Autorange Multitester



UNDER \$59.00

- Portable 3 1/2 Digit LCD, Compact Size
- Buzzer and Full Auto-Polarity Operation AC, DC Volts & Current & Resistance
- Effective Overload and Transient Protection on All Ranges
- Over-Range Indication on Each Range

### DMR-45 4 1/2 Digit Multitester

- Single 30 Position Rotary Switch with 5" High Contrast LCD • Auto-Overrange and DC Auto Polarity • Diode Test, Transistor HFE Test, Audible Continuity Test, Data Hold AC-DC Volts, AC-DC Current, Resistance • Dual Slope Integration A-D Converter Systems



UNDER \$116.00

### DM 3520 CF

- Oversize 3 1/2 digit display with 0.3% basic accuracy
- Audible continuity test, transistor HFE and diode test



UNDER \$85.00

- 35 ranges with professional carrying case and ruggedized cabinet
- 3 capacity ranges from 2000 PFD - 20 UFD
- 2 frequency ranges 20 KHz and 200 KHz
- 5 DC volt ranges from 200 MV - 1000 volts
- 5 AC volt ranges from 200 MV - 750 volts
- 6 DC current ranges from 200 UA - 20 amps
- 5 AC current ranges from 2 MA - 20 AMPS
- Resistance ranges from 20 ohm - 20 megohm

Available at your local distributor

- Single & Dual Trace Scopes
- Analog & Digital Multimeters
- Power Supplies
- High Voltage & Low Cap. Probes
- RF & Sine/Square Wave Generators
- Digital Capacity Meters

EMCO ELECTRONICS

P.O. Box 327, Plainview, NY 11803

Send for your free catalog.

CIRCLE 7 ON FREE INFORMATION CARD

## SAXON ON SCANNERS

that here at **Hands-on Electronics** we received a really jazzy membership certificate from *Knights of Pythias International CB Club* of South Burnaby, B.C., Canada. The certificate (see Fig. 1) was issued to our esteemed Editor, Julian S. Martin, and displays his own CB handle, *Polish Ham*.

### Here We Go Again

Also from western Canada comes disturbing news about renewed calls for laws relating to scanner use. This, in the wake of the murder of a Vancouver police officer by a gunman who had two scanners in his home. Certainly the murder of a policeman was a tragedy, however trying to single out scanner usage as a significant contributory factor seems (to us) to be a rather fuzzy notion. The overwhelming number of scanner owners are law abiding citizens, including many off-duty law enforcement officers.

The same logic that considers scanners to be contributory to crime and seeks their consequent control or elimination would also have to seek similar sanctions against cars, and all weapons, flashlights, tools, and virtually anything else that could be used by a criminal. You can see how illogical it is. Equipment doesn't commit crimes, criminals do.

### Join the Club

Many readers continually write to ask about joining scanner-enthusiasts clubs. Well, clubs come and go, and clubs are regional and national. A scanner club that was begun in California about 15 years ago, for instance, eventually grew to national importance and influence; but about four or five years ago, it seemed to go into a slow fade. These days it's still around, but it's only a thin shadow of its former self—a pale echo of its earlier years. Just one example of the vagaries of scanner club existence.

Two contemporary clubs do, however, presently seem both vital and on the upswing. They are the *All Ohio Scanner Club*, PO Box 2496, Springfield, OH 45501; and *SCAN*, PO Box 414, Western Springs, IL 60558.

We recommend both of those organizations as being worthy of your interest and membership. Contact them directly for information regarding membership.

### Long Distance Listening

Ivar O. Sorenson of Fergus Falls, MN, writes to say that around 42 MHz he has recently been able to hear sporadic police transmissions from stations that are apparently hundreds of miles away, maybe more. This is the best time of year for that type of distant *skip* reception throughout the 30- to 50-MHz VHF low band. The

eleven-year sunspot cycle is again giving a boost to summertime 30- to 50-MHz DX reception, and things should be constantly improving for the next few years. The peak is almost here!

Put your scanner in the search/scan mode and run through these frequencies during daylight hours this month and see what catches you can snag. From 42 to 43 MHz, there are a big batch of frequencies used exclusively by state police agencies around the nation—those stations are particularly good DX bets. The State of California uses many frequencies in the 42 to 43 MHz range and their networks have been reported from points around the world when DX conditions are right.

### Not Laughing Up His Sleeve

From the sunny climes of California comes a message from Roger deHaven. Rog says that every once in a while Washington-type VIP's pass through his city. They're always surrounded by a cordon of federal agents who seem to be wearing hearing aids and talking into their sleeve cuffs. It didn't take Roger long to decide that what appeared to be hearing aids were part of a two-way communications system, with the microphones in a wristwatch arrangement.

The next time one of those parades came through his town, Rog was there with his handheld scanner programmed for searching out UHF frequencies. He hit the jackpot when he discovered the two-way wristwatch radios operating on 407.825 and 407.875 MHz. We thank you, Roger, for passing that along to us. ■

### What's That I Hear?

Walter L. Bacon, who monitors from Florida, says that he picks up activity on 166.175 MHz. The stations announce no call signs and the communications relate to aeronautical matters. In addition, Walt observes that since he discovered that frequency (by accident) two years ago, he has heard it being used in various areas of the nation. "Can you identify what this is used for?" asks Walter.

We think so, it is a widely-used simplex and repeater frequency used by the Federal Aviation Administration (FAA) for various administrative and operations purposes. The repeater input frequency, just for the record, is 165.3375 MHz. The FAA has many stations on 166.175 MHz and readers in all areas might want to give a listen there.

Well, that's all the space that we have for this month, but we'll be looking for you the next time around. Once again, we invite you to send your photos, frequencies, questions, tips, and general scanner-related information to Marc Saxon, *Saxon On Scanners*, **Hands-on Electronics**, 500-B Bi-County Blvd., Farmingdale, NY 11735. ■

## Put Your Electronic Skills to Work in ROBOTICS NOW!

### BECOME A ROBOT VEHICLE PILOT/TECH

Financial Aid Placement Assistance



HIGH PAY HIGH TECH EXCITING CAREERS

Electronic, Hydraulic & Robotic Skills Taught.

Call or Write for FREE BROCHURE TODAY.

Ask About Our Correspondence Course (713)690-0405

UNDERWATER VEHICLE TRAINING CENTER 10046 Chickasaw, Houston, TX 77041

CIRCLE 20 ON FREE INFORMATION CARD





By Don Jensen

# JENSEN ON DX'ING

## Dx'ers have a direct pipeline to the happenings

□ "THE LAST MAJOR EVENT OF ATMOSPHERIC flight... a technological *tour de force!*" Such superlatives did not seem excessive in describing the amazing flight of the Voyager! For 9 days, 3 minutes, and 44 seconds just before Christmas, Dick Rutan and Jeana Yeager piloted their curious looking lightweight aircraft 25,012 miles around the world, non-stop and without refueling.

While millions of TV viewers caught the landing at California's Edwards Air Force Base, shortwave listeners had a better vantage point. U.S. and Canadian DX'ers followed the record-breaking flight—live and direct from the fragile craft—for at least the final three days, proving once again that the way to really stay on top of breaking events is with shortwave!

For example, was the press even aware that as the aircraft began its final leg up the Central American coast off Panama, an unknown pirate transmitter cut in on the Mission-Control frequency to give the Voyager phony course information?

Florida DX'er Terry Krueger heard the real control station cut in to warn pilot Rutan about the still unexplained, "unauthorized," transmissions.

With 7,000 pounds of fuel, more than three times the weight of the flimsy plane itself, Rutan and Yeager took off from California and headed out to sea. Beyond Hawaii, they switched to satellite communications with Mission Control in Hanger 77 at the Mojave, CA, airport.

As Voyager dodged Typhoon Marge east of the Philippines and crossed the Malaysian peninsula at 8,000 feet, they found that even with satellite relay, communications with the home base was more difficult than expected. Messages sometimes were garbled. The press back home recounted that at one point, after a third message repeat was asked by Mission Control, a tired Rutan snapped, "Get a tape recorder!"

On the fifth day they crossed Africa and then headed out into the South Atlantic. They were within range of shortwave. Rutan told Mojave control, "I'm tired and want to go to bed in California—Vector me home!"

In the U.S. SWL's began receiving the communications between the California-



The framed certificates on the wall, issued by a well-known North American listener's club, attest to Ed Kusalk's track record of hearing and verifying shortwave broadcasters from around the world. The Coaldale, Alberta, Canada listener's receiver set-up includes a Yaesu FRG7000, a Panasonic RF2800 and a military surplus Collins-made R388/VRR-51J3.

based Mission Control and Voyager 1, as Rutan identified his radio calls, on various frequencies—6,550, 8,822 or 13,312 kHz, in upper sideband mode.

Here at DX Central, I began hearing Voyager 1 at about 0430 UTC, December 21, on 8,822 kHz, USB. While not as strong as the California end of the radio link, reception was at least 80 percent intelligible.

Seventy miles off the Brazilian coast, Rutan indicated, as he described the frightening encounter a short time before with a vicious tropical squall that nearly ended the Voyager flight in disaster.

For hours, fascinated, I followed the flight homeward—shifting frequencies as Rutan did to establish the best communications with the Mojave center. I heard the routine communications, the more serious problems with navigational satellites and engines, radio chats with family members on the ground, and Rutan's superstitious request to Mission Control to avoid jinxing the craft by commenting on how well the flight was going.

"After its over we can...but don't talk

to me about it now," Rutan insisted. "Don't talk about the fat lady singing until after she sings!"

As Voyager neared home on December 22, Mitch Sams of Wichita, Kansas, heard Voyager controllers tell the aircraft's crew that they would switch communications to UHF frequencies for the last leg of the trip back to Edwards AFB.

That about ended things for North American SWL's beyond the normal range of the ultra high-frequency communications. As Krueger commented to me afterward, for DX listeners, it had been "a lot of fun," a fascinating weekend for those who know that when important things are happening, the shortwave bands are the place to be!

### Back to Basics

This month we conclude our brief review of propagation, the natural phenomena that makes it possible for radio waves to bounce back and forth between the Earth's surface and the ionized gassy belts circling its atmosphere. Thus, short-

(Continued on page 28)

You Can Be  
One Of The  
20,000 Technicians  
Certified BY ISCET



The International Society Of Certified Electronics Technicians offers permanent certification by administering the CET exam with the FCC recognized communications option for \$20. A second exam on FCC regulations for a \$10 fee is required for a Radiotelephone License. Upon passing, technicians receive both a permanent Radiotelephone Operator Certificate and a CET Certificate issued by ISCET.

### ISCET Offers License Renewal

ISCET has developed a program for registration of those who currently hold a valid Radiotelephone Operator License. By sending a completed application, a photocopy of your FCC License, and \$10 your license will be renewed with the assurance of a recognized national technicians association behind it.

For More Information Contact:  
ISCET 2708 W. Berry, Ft. Worth, TX  
76109. (817) 921-9101

### MOVING?

Don't miss a single copy of **Hands-on Electronics**. Give us:

Six weeks' notice

Your old address and zip code

Your new address and zip code

ATTACH  
LABEL  
HERE

name (please print)

address

city state zip code

Mail to: Hands-on Electronics  
SUBSCRIPTION DEPT., P.O. BOX 338,  
Mt. Morris, IL 61054-9932

### JENSEN ON DX'ing

(Continued from page 27)

wave transmissions—like a dribbled basketball—can travel round the globe.

But shortwave-reception conditions are not constant. They vary in daily, monthly, seasonal, and even longer cycles. Last month we looked at the daily, day-night variations associated with the "reflective" ionized layers. In summary though, look for shortwave signals on the lower-frequency bands when a path of darkness exists between your location and the station. On higher SW frequencies, a daylight path brings you the desired reception.

The Sun's activity greatly affects the critical ionospheric belts, so there are reception changes over roughly a month's time. The Sun rotates on its axis approximately every 27 days, showing a particular part of its surface to Earth on a regular basis. Thus, reception affected by solar activity tends to repeat itself. If you had particularly good or bad listening periods, you may experience similar conditions 27 days or so later.

Seasonally, too, there are changing reception patterns. While it's true that there are alterations in the solar effect on the ionosphere from summer to winter (it's true), as a practical matter, you will probably find better shortwave reception in the cold months because atmospheric noise—static—is appreciably lower.

Additionally, for trans-equatorial SW signals coming from the southern hemisphere, look for particularly good reception around the equinox periods, the start of spring and fall.

Finally, there is the Sunspot cycle, roughly 11 years in length. The number and intensity of solar surface eruptions varies over the years, affecting shortwave reception. The new cycle, just begun, promises improved reception, in general, over the next four or five years.

### Down the Dial

This is the corner of the column reserved for you. What are you hearing on shortwave? Drop a line, listing your most interesting SW loggings, with frequency, time and programming information. Send your data—SWL'ing questions too, if you have them—to *Jensen On DX'ing*, Hands-on Electronics, 500-B Bi-County Blvd., Farmingdale, NY 11735. Times listed are in Universal Coordinated Time (UTC, which is equivalent to Greenwich Mean Time, or GMT; EDT + 4 hours); frequencies are given in kilohertz (kHz). **BULGARIA**—11,720, *Radio Sofia* is heard on this frequency between 0000 and 0100 hours.

**BANGLADESH**—15,525, *Radio Bangladesh* tends to be the forgotten shortwave outlet of the Asian subcontinent, heard considerably less often than the stations of its neighboring countries,

### ABBREVIATIONS

<b>DX</b>	long distance (over 1000 miles)
<b>DX'er</b>	listener to shortwave broadcasts
<b>DX'ing</b>	listening to shortwave broadcasts
<b>EDT</b>	UTC + 4 hours
<b>FEBC</b>	Far Eastern Broadcasting Co.
<b>kHz</b>	kiloHertz (× 1000 cycles)
<b>SW</b>	shortwave
<b>SWL</b>	shortwave listener
<b>TV</b>	television
<b>USB</b>	upper sideband
<b>UTC/GMT</b>	Universal Time Code/ Greenwich Mean Time
<b>VHF</b>	very-high frequency

*Radio Pakistan* and *All-India Radio*. Look for this one signing on in English at 1230 hours.

**CANADA**—11,945, *Radio Canada International* offers the very popular program "Shortwave Listeners' Digest" every weekend, Saturday's on this frequency at 2130 hours; then three-and-a-half hours later at 0100, Sundays on 5,960. Easy-going Ian McFarland is the program's host-with-the-most, and you may even hear yours truly with a segment called *Don on the first weekend of July, September, and every other month*.

**GUAM**—15,300, *Adventist World Radio-Asia* should now be operating its new station, KSDA from Guam. The religious voice recently completed installation of four 100-kilowatt transmitters. On that frequency, try between 0000 and 0100 hours; or 0200-0300 on 17,855.

**URUGUAY**—9,595, *Radio Monte Carlo* in Montevideo is being heard reasonably well, at times, with all-Spanish programming during the evening hours around 0130 to 0200. With relatively few stations—compared to, say, Brazil, Columbia or Peru—Uruguay normally is not the easiest South American country to hear on shortwave.

**KIRIBATI**—14,802, *Radio Kiribati*. Kiribati is one of those exotic Pacific locations that DX geography trivia buffs love. Until independence, in 1979, the 16 atolls comprising this little country were called the Gilbert Islands. And the name doesn't even sound like you might imagine—the last syllable being pronounced "bas."

**ZAIRE**—7,204, *Radio Lubumbashi* is a central African station that for some time was missing from the air but has again been reported active. It probably is still a bit irregular, but look for it with a stringed instrument interval or tuning signal just prior to its sign on in French at 0400 hours.

\*\*Credits: Ivan Grishin, Ontario; Robert Hill, MA; David Clark, Ontario; A.C. Knutson, WI; Clay Morgan, NM; Ontario DX Association, PO Box 161, Station A, Willowdale, Ontario, M2N 5P0, Canada)

## the fourth law of robotics

A robot shall make learning fun for man and thereby improve the quality of life for mankind.



A robot is a robot is a robot... was a robot. Until HERO 2000.

HERO 2000 is much more than a robot. It's a walking, talking 16-bit computer. With 64K ROM and 24K RAM expandable to more than half a megabyte. And a fully articulated arm with five axes of motion. Yours to program. Command. Modify and expand. Total system access and solderless experimenter boards provide almost limitless possibilities. Its remote RF console with ASCII keyboard gives total control. Available with three self-study courses. Backed by Heath Company, world leader in electronic kits.

Build your own HERO 2000. Or buy it assembled. Have fun learning skills that translate directly to the world of work.



# HERO<sup>®</sup> 2000 the knowledge builder

**FREE. Send today  
for latest Heathkit Catalog.**



Mail coupon today to receive a **FREE** Heathkit Catalog featuring HERO 2000.

Mail to: Heath Company  
Dept. 107-558  
Benton Harbor, Michigan 49022

Name \_\_\_\_\_

Address \_\_\_\_\_

City \_\_\_\_\_ State \_\_\_\_\_

Zip \_\_\_\_\_

RO-141

**Heathkit<sup>®</sup>**  
Heath  
Company

A subsidiary of Zenith Electronics Corporation.

CIRCLE 14 ON FREE INFORMATION CARD

Build the...

# DRESSING CONSULTANT



**You'll always know what to wear  
with this project as a guide**

**By Tom Fox**

**W**HILE THIS PROJECT WAS ORIGINALLY DESIGNED WITH children in mind, it seems as if grown-ups enjoy it nearly as much as the cute, but noisy, undersized angels. Unlike a thermometer, (even a souped-up digital model) the Dressing Consultant takes into consideration factors such as wind, sunlight, and even rain, in addition to temperature, before it gives its judgment on the weather outside.

One of the fun things about the project is its interface between man and machine—it is amazingly down-to-Earth and can be a bit imaginative. On the front panel of the author's prototype are seven hand-painted illustrations along with a one-word description. A small light bulb mounted behind each illustration serves as a "pointer" or indicator. Six of the illustrations represent (primarily through the clothing shown in the picture) the temperature outside. For instance, when it is stifling hot outside (say above 90°F) the light bulb behind a boy in swimming trunks holding a beach ball lights up. The seventh illustration shows an umbrella. The light bulb behind the umbrella lights when it is raining. Next to the picture, a descriptive word is also included.

While the author's prototype uses illustrations and words to represent the weather outside, the reader may wish to take a different approach. For instance, one may wish to use a descriptive phrase, or even a short, vivid poem instead of an illustration. Or the reader may prefer photos to represent the weather. (Black and white prints or color transparencies can be used.)

Also, LED's may be used in place of light bulbs to indicate the weather. The primary modification for doing so is to change the values of seven resistors. Details for the modification will be given later. Except for the circuit itself, the reader should feel free to modify the project to take advantage of the reader's on-hand materials and native talents.

### The Sensor

The LM335 is a temperature-sensor IC that is inexpensive and easy to use. Its output voltage is not only exceptionally linear, but predictable as well. Basically, the LM335 functions as a Zener diode whose Zener voltage is temperature dependent. Therefore, at 77°F (which is 25°C) the output voltage is nominally 2.98 volts. A typical LM335 sensor will be within .03 volts of this nominal value. Because of such remarkable accuracy, the Dressing Consultant is calibrated with a digital voltmeter—no thermometer is required!

Normally, the LM335 is operated with a reverse current between 400 microamps and 1 mA. Current above 1 mA is not normally used because it causes significant internal heating. Nonetheless, in this project the sensor is operated with a reverse current just below its maximum rating of 10 mA. That relatively large current results in moderate internal heating, which causes the sensor to "sense" or "feel" the weather somewhat like a human body.

A healthy human body has its center heated to a temperature just under 100°C. The heat generated by the body warms a shallow layer of air immediately adjacent to the skin. In turn, that layer of air serves as an insulator helping to keep the body warm. That is one reason why wind makes one feel cooler—the wind blows away the layer of warm air, exposing the body almost directly to the outside air.

Similarly, an internally heated sensor has a shallow layer of warm air surrounding it, acting as an insulator. Wind blows away that insulation and cools the sensor. An engineer would say that moving gas (air) increases the convection-heat trans-

fer coefficient between the gas and sensor. Of course, wind does not have a cooling effect if the air temperature is higher than the body or sensor temperature—in fact, in that case wind will create a heating effect.

### Voltage and Temperature

Refer to the schematic in Fig. 1 for the following discussion. The output voltage of the sensor U5 (an LM335 IC) is doubled by U1a and its associated circuitry. So now at 25°C (77°F), the output voltage of U1a will be 2 times 2.98 volts or 5.96 volts. That output voltage (from pin 1) is then fed into four window comparators (U1c through U3b) and two regular voltage comparators (U1b and U3c). Integrated circuits U1, U2, and U3 are LM324, quad op-amps that operate quite well off a single 12-volt supply. After the circuit is calibrated, the voltages at the five TP's (test points) should be the following: TP1 = 6.12 volts, TP2 = 5.94 volts, TP3 = 5.8 volts, TP4 = 5.61 volts, and TP5 = 5.44 volts.

It is obvious from the circuit that the output of U1b will be high (close to the supply voltage) when the voltage at its noninverting input rises above 6.12 volts. The output of U1b then turns on Q1, which causes current to flow through I1 (see Fig. 2)—Bingo! The light lights! Note that 6.12 volts corresponds to a sensor voltage of 3.06 volts. That 3.06 volts corresponds to a temperature of 33°C, which, of course, is 91.4°F. In super-simple terms, the HOT light lights when the temperature of the sensor rises above 91.4°F. Similarly, when the sensor voltage drops below 2.72 volts (which causes the output voltage of U1a to drop below 5.44 volts) U3c switches on. That causes Q10 to turn on, lighting the FRIGID light. Notice that that happens at 30.2°F. Be alert to the fact that those temperatures correspond to the sensor temperature, which is several degrees warmer than the air around it when the wind is calm.

### Window Comparators

So far we have discussed standard comparator circuits, i.e. the comparator turns on when the noninverting-input voltage exceeds the inverting input voltage. We will now discuss window-comparators. Window comparators are used to detect voltages between a low limit and a high limit. There are many snazzy designs for window comparators. Some even only require a single op-amp! The type used here, however, is the standard textbook variety that uses two op-amps.

To demonstrate its operation, let us look in detail at the window-comparator consisting of U1c and U1d. Here the inverting input of U1c is set at 6.06 volts. (Actually a few thousandths of a volt less than 6.06 volts due to R27, but that difference is not significant to our discussion.) Similarly, the noninverting input of U1d is set at 5.94 volts. Also notice that the noninverting input U1c and the inverting input of U1d are connected, through 10,000-ohm resistors, to the output of U1a, whose voltage is twice that of the sensor's output. When the output of U1a is above 6.06 volts, U1c is on but U1d is off. When the output of U1a is below 5.94 volts, U1c is off but U1d is on. When the output of U1a is between 5.94 volts and 6.06 volts, both U1c and U1d are off, causing both D1 and D2 to be cut off. That causes the base of Q2 to be near ground (due to R17) and thus Q2 is shut-off. When Q2 is cut off, R18 turns on Q3, and I2 lights. So we can see that I2, the WARM light, lights when the sensor temperature is between 75.2°F and 91.4°F. The other window comparators operate similarly.

The heart of the rain-sensing circuit is National Semicon-

006  
007  
008  
009  
010  
V 011  
012  
013

Fig. 3—Use of a photographic technique of board preparation is recommended for this circuit board as it is quite complex. Note that numbers indicate the positions of the test points.

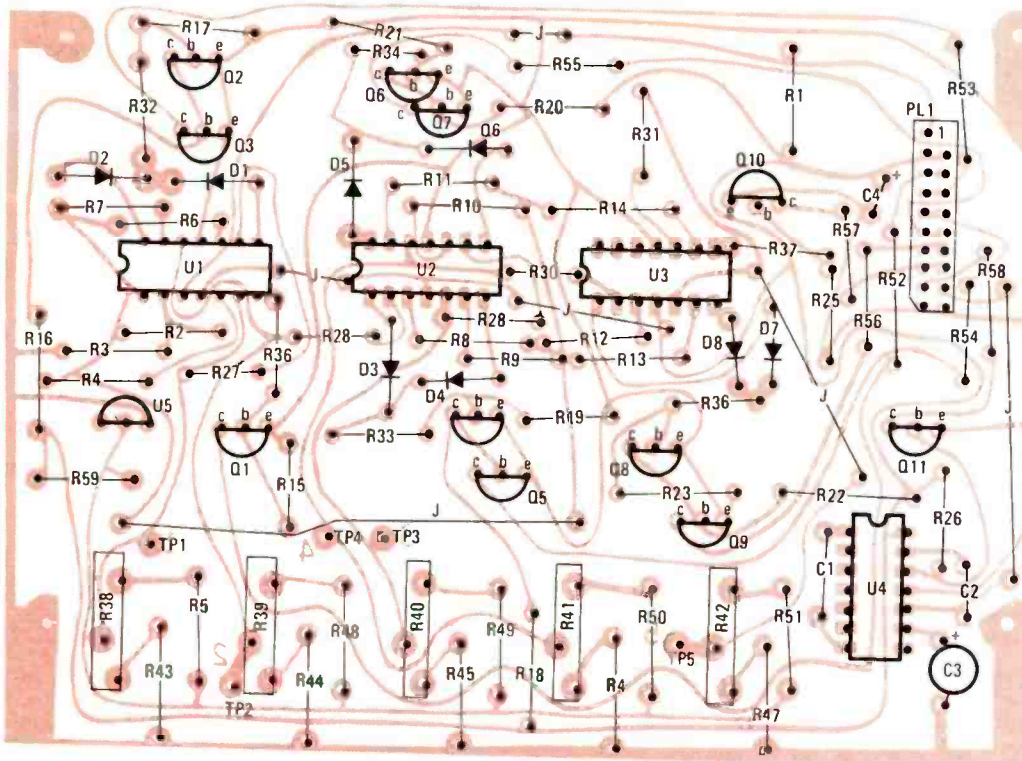
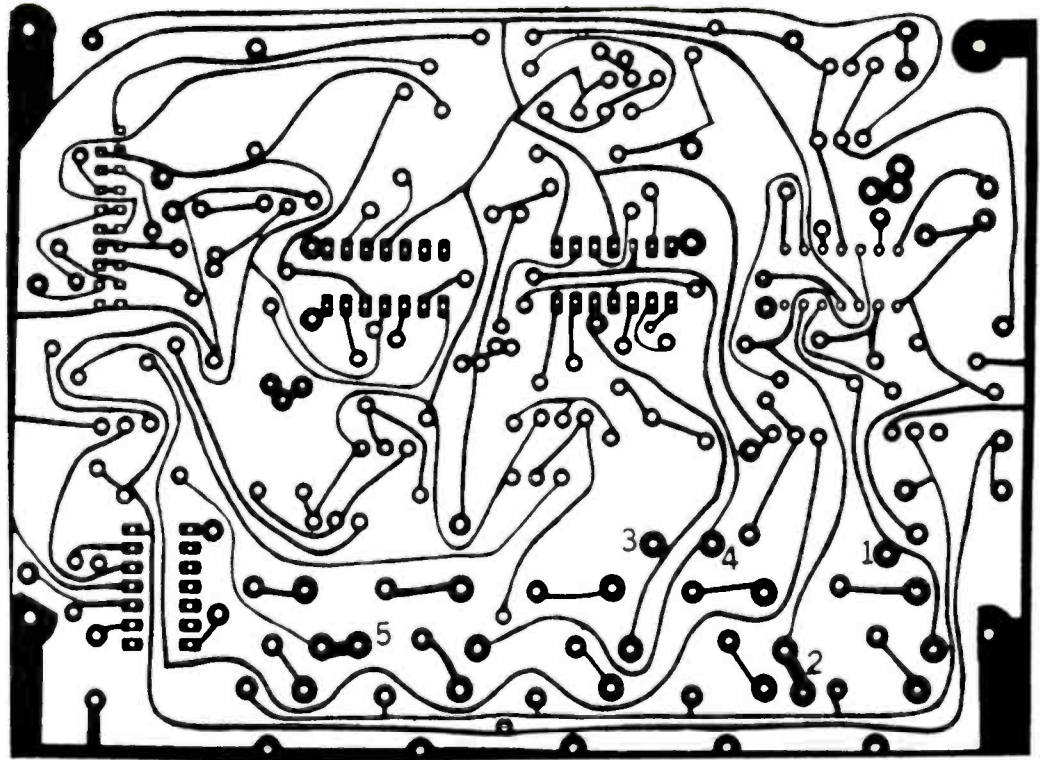

Fig. 4—Remove pin 11 from PL1 before trying to place it on the board. As you can see, there's no hole for it.

there are two things to look out for: be sure to increase the current-limiting resistors (R52-R58) from 51 ohms to 330 ohms, and make sure the LED anodes are all connected to the +12-volt output of the power supply.

### The Power Supply

It is possible to operate the project with batteries. Eight "C" or "D" cells connected in series will power the Dressing Consultant for many hours. However, with battery power, you must turn off the Dressing Consultant when not in use—that

can limit the project's usefulness. If you wish to leave the Dressing Consultant on continually, it must be powered off the AC line. Since the power requirements are small (+12 volts at less than 400 mA) and the supply doesn't have to be exceptionally well regulated or filtered, one can use a rather simple supply. For instance, a power supply consisting of a 12.6-volt, 1A transformer, a four IN4001 diode rectifier, 2000-10,000- $\mu$ F filter capacitor, and a 12-volt, 1A, voltage regulator should be sufficient. Nonetheless, the author used a surplus Coleco multi-voltage power supply. The Coleco sup-

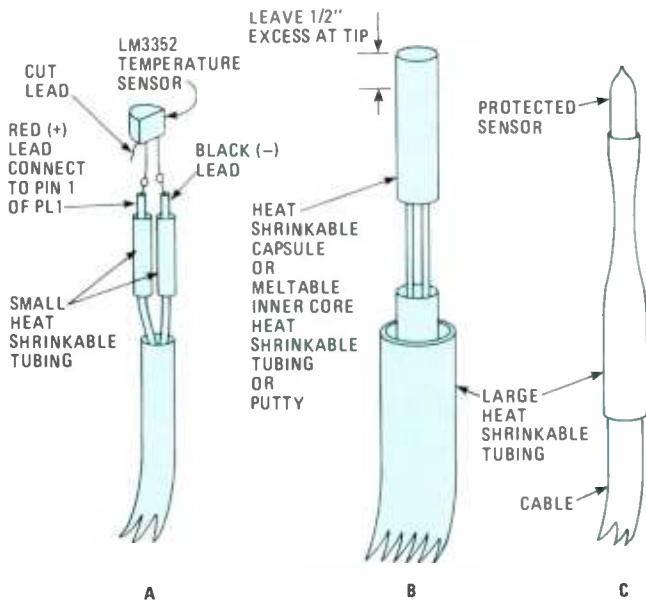

**Fig. 5**—Since the temperature sensor is to be placed outside, it must be thoroughly protected from the elements (except temperature). The leads must be not only insulated, but weather-proofed against corrosion. You may wish to use rubber silicon to totally seal the heat shrink tubing.

**Fig. 6**—This foil pattern for the rain sensor is only an example. Any pattern of two leads with a gap small enough for a rain drop to traverse will be sufficient.

ply will provide just about any voltage a hobbyist could hope for: two +12 volts, +18 volts, +5 volts, and -5 volts. It does all that at hefty amperages too! Also, its steel chassis forms the basis for an easily constructed and handsome homemade cabinet. The author has used that supply for a number of projects, including a homemade special-purpose computer, and it has performed well. See the Parts List for ordering information.

### The Cabinet Panel

We now come to the point which many new project builders become careless about—the cabinet and the proj-

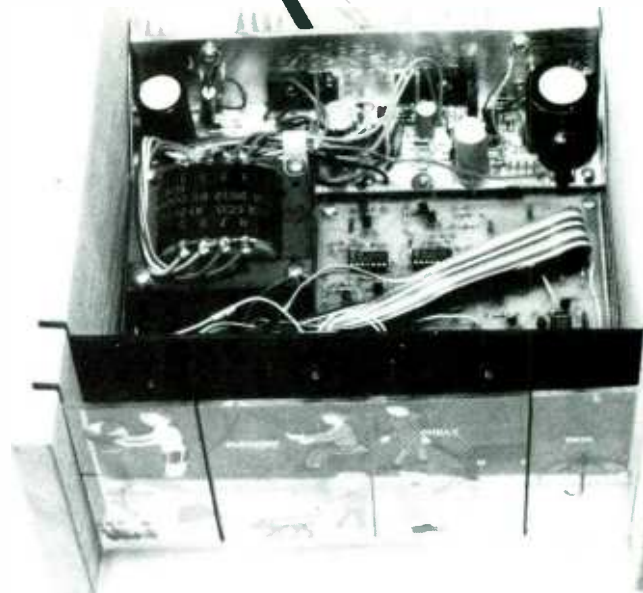

The megalithic power supply shown for the dressing consultant can be replaced by a basic power supply consisting of a transformer, full-wave rectifier, regulator, and a capacitor.

ect's external appearance. Many experimenters, especially ones building projects for the first time, will spend many delightful hours carefully wiring and testing the circuit. However, once they test it out and find that the circuit is working, their grin changes into a grimace and they throw the project together, in any available box, as fast as they can. Please, please take a little pride in your work and spend some time and effort in making a good-looking project that will be enjoyed for many years.

Figure 7 shows how the author constructed his case. As mentioned earlier, the author used the metal chassis of the Coleco power supply as the base of his case. The Dressing Consultant's circuit board is mounted directly on that metal chassis. For the sides, the author used two 11 x 5 1/2" oak boards. The oak boards are bolted to the metal chassis. With the use of a table saw, two grooves, about 3/8" deep, were cut in

*(Continued on page 98)*

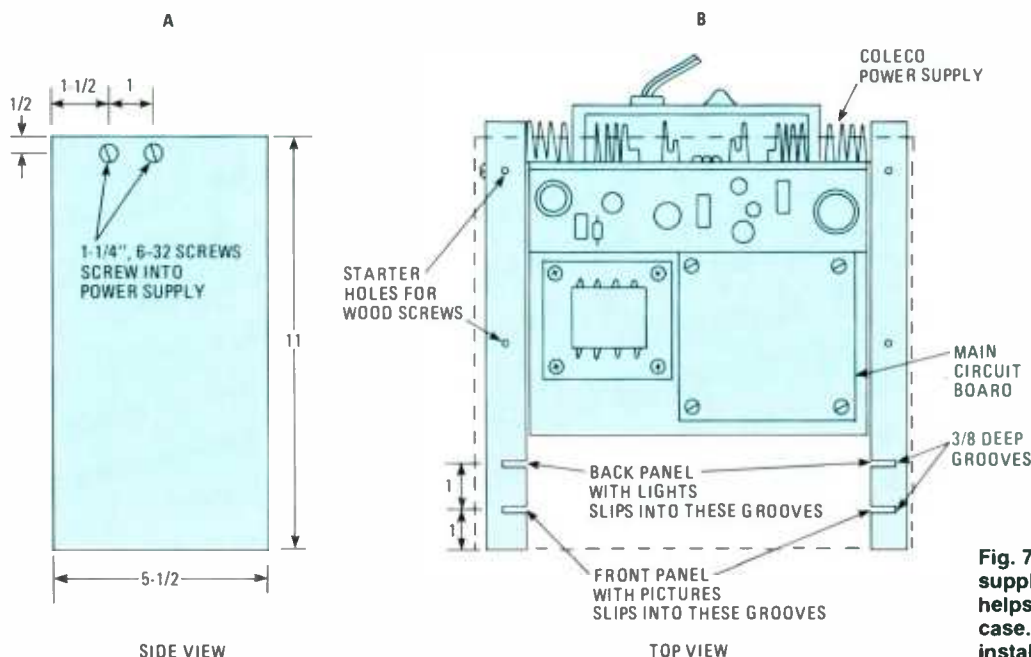
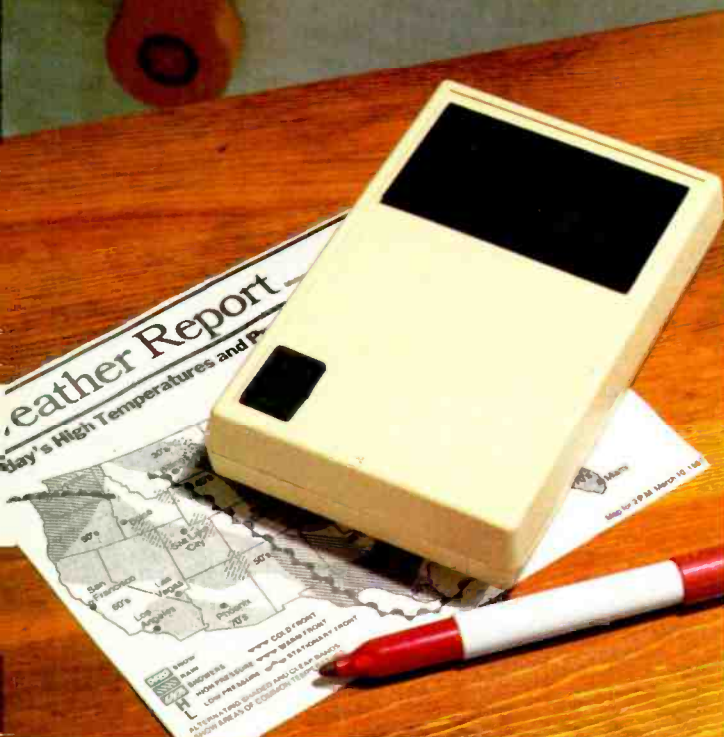

**Fig. 7**—Use of the Coleco power supply may seem a bit much, but helps provide the makings of a good case. The main circuit board can be installed right on the provided chassis.

# SOLID-STATE BAROMETER

Try your hand at weather forecasting with the aid of this home-brew barometer

By Scott Weatherwax



**T**HE MOST MISTRUSTED INDIVIDUAL IN THE RADIO AND TELEVISION media today is the weatherman. After all, even with the aid of modern technology, he seems hard pressed to make an accurate prediction as to whether it will rain or the sun will shine in the very near future. Well, here's your chance to take matters into your own hands and return to the basics of weather forecasting, with the aid of the *Solid-State Barometer*.

One of the basic ideas behind the barometer is its ability to forecast—by sensing certain atmospheric conditions—the weather wherever you are located. Therefore, the Solid-State Barometer will be compact and lightweight so that it can be used at home or on the go (say, as a portable “backpackers” unit).

Figure 1 shows a block diagram of the four basic building blocks that make up the Solid-State Barometer—a pressure sensor, the power supply, signal conditioning, and the display circuits—needed to achieve that goal. Although each block is essential to the Barometer's operation, the heart of the design is the pressure sensor.

The pressure sensor—in this case the SCX15ANC absolute sensor (from Sensym, Inc., 1255 Reamwood Ave., Sunnyvale, CA 94809)—is a device that compares the applied atmospheric (barometric) pressure to an on-board, sealed-vacuum reference and gives a proportional voltage output. A pinout diagram of the SCX15ANC (which can be operated from power supplies up to 30 volts) is shown in Fig. 2A, and its equivalent circuit is shown in Fig. 2B.

The SCX15ANC (and all sensors for that matter) have two types of errors associated with them: *offset* and *span*.

With zero pressure applied, one would expect zero volts to appear at the output of the sensor. But that is not the case. The output (for the SCX15ANC) could be as high as  $\pm 1$  millivolt, which means that the circuit must compensate for the “zero-point” offset error. The other error, span—defined as the full-scale output (FSO) voltage minus the offset—can also be as high as  $\pm 5\%$  FSO (5 mV full-scale output) and will need to be compensated for in our circuit.

## Digging Deeper

Figure 3 shows a complete schematic diagram of the Solid-State Barometer, which can be broken down into two individual sections: the signal-conditioning circuitry and the display—all of which is powered from a single 9-volt (transistor-radio type) battery.

In the signal-conditioning circuit, amplifier U1a ( $1/4$  of a LI014DN quad op-amp) is used to provide a regulated 5-volt power supply; therefore, the circuit's operation is unaffected by power supply variations, noise, or ripple. Two other op-amps, U1c and U1d, are configured as an instrumentation

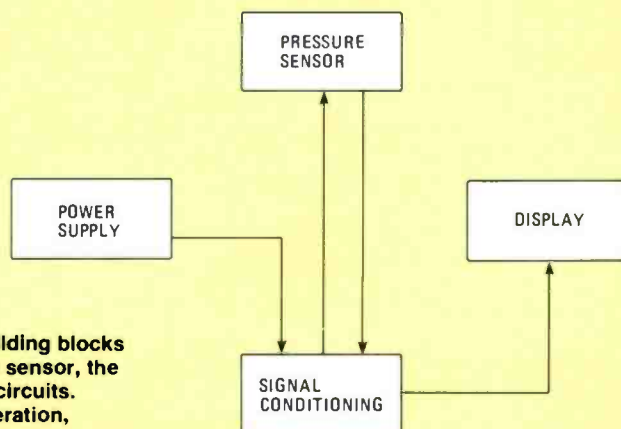

Fig. 1—The block diagram shows the four basic building blocks that make up the Solid-State Barometer: a pressure sensor, the power supply, signal conditioning, and the display circuits. Although each block is essential to the circuit's operation, the heart of the design is the pressure sensor.



# Here are your free FactCards!

Introducing Hands-On-Electronics FactCards.

Each issue, Hands-On-Electronics will present 3 new FactCards, each dealing with one of a variety of electronics topics. Some will deal with electronics basics, some will deal with discrete components, some will deal with IC's, and some will deal with circuits and applications.

All will contain the type of information electronics hobbyists need, but sometimes must search to find. With FactCards, you can find that information in a hurry.

# Clip your cards, save them, and start building your FactCards library today!

**Hands-on Electronics**

## 40 Hands-on Electronics FactCard

## SCR Circuits/ Replacement Guide

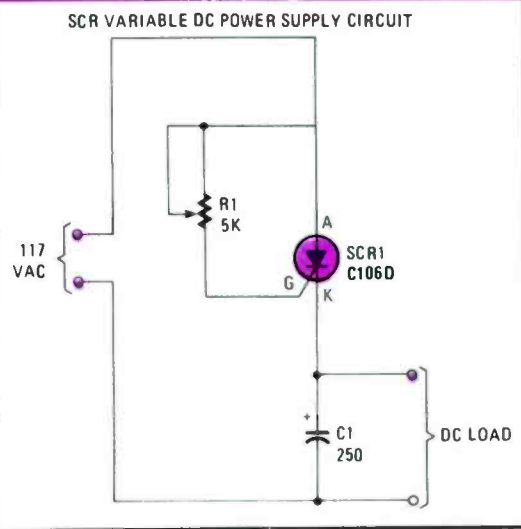
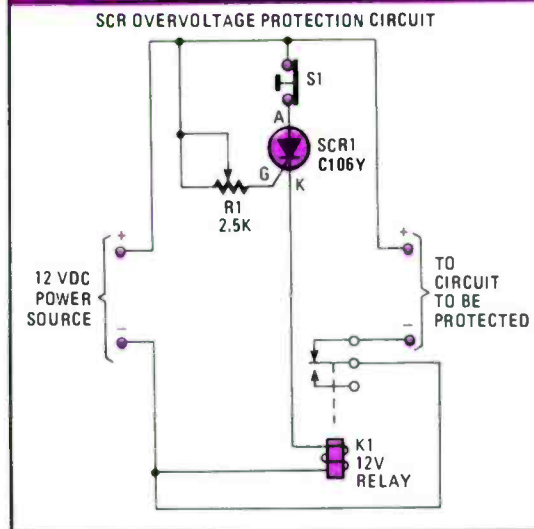

## 41 Hands-on Electronics FactCard

## 40106: Hex Schmitt Trigger

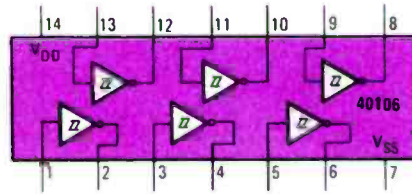

LOW POWER OSCILLATOR

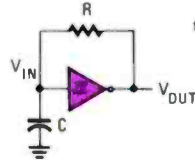

$$t_1 \approx RC \ln \frac{V_T+}{V_T-}$$

$$t_2 \approx RC \ln \frac{V_{DD} - V_T-}{V_{DD} - V_T+}$$

$$f \approx \frac{1}{RC \ln \frac{V_T+ (V_{DD} - V_T-)}{V_T- (V_{DD} - V_T+)}}$$

### Features

- Wide supply voltage range 3V to 15V
- High noise immunity 0.7 V<sub>DD</sub> (typ.)
- Lower power fan out of 2 driving 74L or 1 driving 74LS
- TTL compatibility 0.4 V<sub>DD</sub> typ
- Hysteresis 0.2 V<sub>DD</sub> guaranteed
- Equivalent to MM54C14/MM74C14
- Equivalent to MC14584B

### Absolute Maximum Ratings

V <sub>DD</sub> Supply Voltage	-0.5 to +18V
V <sub>IN</sub> Input Voltage	-0.5 to V <sub>DD</sub> + 0.5V
T <sub>S</sub> Storage Temperature Range	-65°C to +150°C
P <sub>D</sub> Package Dissipation	500 mW
T <sub>L</sub> Lead Temperature (Soldering, 10 seconds)	260°C

### Recommended Operating Conditions

V <sub>DD</sub> Supply Voltage	3 to 15V
V <sub>IN</sub> Input Voltage	0 to V <sub>DD</sub> V
T <sub>A</sub> Operating Temperature Range	-55°C to +125°C
	-40°C to +85°C

## 42 Hands-on Electronics FactCard

## 4510: BCD Up/Down Counter 4516: Binary Up/Down Counter

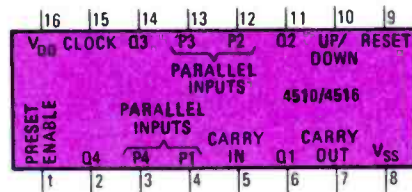

### Features

- Wide supply voltage range 3.0V to 15V
- High noise immunity 0.45 V<sub>DD</sub> (typ.)
- Low power TTL fan out of 2 driving 74L or 1 driving 74LS
- Parallel load "jam" inputs
- Low quiescent power dissipation 0.25μW/package (typ.) @ V<sub>CC</sub> = 5.0V
- Motorola MC 14510, MC14516 second source

### Absolute Maximum Ratings

V <sub>DD</sub> Supply Voltage	-0.5 to +18V
V <sub>IN</sub> Input Voltage	-0.5 to V <sub>DD</sub> + 0.5V
T <sub>S</sub> Storage Temperature Range	-65°C to +150°C
P <sub>D</sub> Package Dissipation	500 mW
T <sub>L</sub> Lead Temperature (Soldering, 10 seconds)	260°C

### Recommended Operating Conditions

V <sub>DD</sub> Supply Voltage	3 to 15V
V <sub>IN</sub> Input Voltage	0 to V <sub>DD</sub> V
T <sub>A</sub> Operating Temperature Range	-55°C to +125°C
	-40°C to +85°C

	Clock	Reset	Preset Enable	Carry In	Up/Down	Output Function
X	X	1	X	X	X	Reset to zero
X	0	0	1	X	X	Set to P1, P2, P3, P4
Pos. Trans.	0	0	0	0	1	Count up
Pos. Trans.	0	0	0	0	0	Count down
Neg. Trans.	0	0	0	X	X	No change
X	0	0	0	1	X	No change

SCR REPLACEMENT GUIDE

DEVICE	V <sub>DRM</sub>	I <sub>T</sub>	CASE TYPE	SYLVANIA ECG	RCA/SK	NTE/TCG
C122B	200V	10A	TO-220	5463	9292	5463
C122C	400V	10A	TO-220	5465	9293	5465
C155E	200V	125A	TO-83	5575	6725	—
C106Y1	30V	4A	TO-202	5452	6752	5452
C106B1	200V	4A	TO-202	5455	3597	5455
C106D1	400V	4A	TO-202	5457	3598	5457
C106F1	50V	4A	TO-202	5453	6753	5453
C106C1	400V	4A	TO-202	5457	3598	5457
C106A1	100V	4A	TO-202	5454	6754	5454
C106Q1	30V	4A	TO-202	5452	6752	5452
C135A	30V	4A	TO-202	5452	6752	5452
C135B	200V	35A	TO-48	5543	3581	5543
C180A	200V	275A	TO-93	5580	6730	—
C180N	1200V	275A	TO-93	5584	6734	—
C180E	600V	275A	TO-83	5582	6732	—
C203Y	30V	.8A	TO-92	5400	3950	5400

STATIC ELECTRICAL CHARACTERISTICS

CHARACTERISTIC	CONDITIONS			LIMIT at 25°C (TYP)	UNITS
	V <sub>D</sub> (V)	V <sub>IN</sub> (V)	V <sub>DD</sub> (V)		
Quiescent Device Current, I <sub>DD</sub>	—	0.5	5	0.02	μA
Max	—	0.10	10	0.02	
Positive Trigger Threshold Voltage	—	—	5	2.9	V
V <sub>P</sub> Max.	—	—	15	8.8	
Negative Trigger Threshold Voltage	—	—	5	1.9	V
V <sub>N</sub> Max.	—	—	15	5.8	
Hysteresis Voltage	—	—	5	0.9	V
V <sub>H</sub> Max.	—	—	10	2.3	
Input Current I <sub>IN</sub> Max.	—	0.18	18	± 10 <sup>-5</sup>	μA

CHARACTERISTIC	CONDITIONS			LIMIT at 25°C (TYP)	UNITS
	V <sub>D</sub> (V)	V <sub>IN</sub> (V)	V <sub>DD</sub> (V)		
Output Low (Sink) Current	0.4	0.5	5	1	mA
I <sub>OL</sub> Min.	1.5	0.15	15	6.8	
Output High (Source) Current	4.6	0.5	5	-1	
I <sub>OH</sub> Min.	13.5	0.15	15	-8.8	
Output Voltage	—	5	5	0	V
Low-Level V <sub>OL</sub> Max.	—	15	15	0	
Output Voltage High-Level, V <sub>OH</sub> Min.	—	0	5	5	
Output Voltage High-Level, V <sub>OH</sub> Min.	—	0	10	10	

STATIC ELECTRICAL CHARACTERISTICS

CHARACTERISTIC	CONDITIONS			LIMIT at 25°C (TYP)	UNITS
	V <sub>D</sub> (V)	V <sub>IN</sub> (V)	V <sub>DD</sub> (V)		
Quiescent Device Current, I <sub>DD</sub>	—	0.5	5	0.04	μA
I <sub>DD</sub> Max	—	0.10	10	0.04	
Output Low (Sink) Current	0.4	0.5	5	1	mA
I <sub>OL</sub> Min.	1.5	0.15	15	6.8	
Output High (Source) Current	4.6	0.5	5	-1	
I <sub>OH</sub> Min.	13.5	0.15	15	-8.8	
Input Current I <sub>IN</sub> Max.	—	0.18	18	± 10 <sup>-5</sup>	μA

CHARACTERISTIC	CONDITIONS			LIMIT at 25°C (TYP)	UNITS
	V <sub>D</sub> (V)	V <sub>IN</sub> (V)	V <sub>DD</sub> (V)		
Output Voltage	—	0.5	5	0	V
Low-Level V <sub>OL</sub> Max.	—	0.10	10	0	
Output Voltage High-Level, V <sub>OH</sub> Min.	—	0.15	15	0	
Output Voltage High-Level, V <sub>OH</sub> Min.	—	0.15	15	15	
Input Low Voltage, V <sub>IL</sub> Max.	0.5, 4.5	—	5	—	V
Input High Voltage, V <sub>IH</sub> Min.	1.9	—	10	—	
Input Low Voltage, V <sub>IL</sub> Max.	1.5, 13.5	—	15	—	
Input High Voltage, V <sub>IH</sub> Min.	0.5, 4.5	—	5	—	

For new ideas in electronics read **Radio-Electronics**

During the next 12 months

- Radio-Electronics will carry up-to-the minute articles on:
- hobby computers
  - solid-state technology
  - TV games • Video
  - color TV • stereo
  - test equipment
  - radio
  - radar detectors
  - industrial electronics
  - servicing TV-radio-stereo
  - experimenter circuits
  - exceptional construction projects

Don't take a chance on missing even one issue. Subscribe now and save!



NEW IDEAS AND INNOVATIONS IN ELECTRONICS

The newest ideas and innovations in electronics appear in Radio-Electronics. Keep up-to-date!

Subscribe Today!

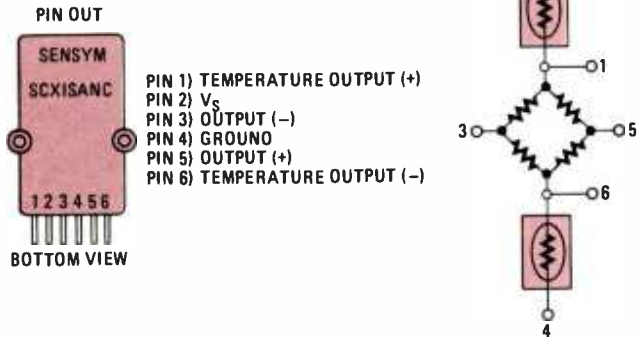

Fig. 2—The pinout diagram for the SCX15ANC absolute pressure sensor is shown in A and its equivalent circuit is shown in B.

amplifier, which boost the output of the pressure sensor. The gain of the instrumentation amplifier is given by:

$$V_{out}/V_{in} = A_v = 2(1 + R_1/R_T);$$

where  $R_1$  is 10,000 ohms, and  $R_T$  is the sum of  $R_8$  and  $R_{10}$ . The value of  $R_T$  determines the output gain and sets the Solid-State Barometer to read in mbar, psi or any other unit of measurement. That also enables us to adjust out the initial span error. Op-amp U1b, in conjunction with potentiometer  $R_4$ , provides the zero-offset adjustment.

The output of the signal-conditioning circuit is fed to the display circuitry—which consists of U2 (the heart of that section), an ICM7106 A/D converter/display driver, and a 3 1/2-digit LCD. The output of the signal-conditioning block is fed to the A/D converter (U2), which then interprets the input signal to drive the LCD.

The ICM7106 will drive the 3 1/2-digit (2000 count) LCD based on 100 microvolts input per count. A warning must be given with the A/D converter. Be sure to use the exact components recommended, as using other values can cause various errors, which can be difficult to troubleshoot.

### Assembling the Barometer

The Solid-State Barometer is built on a double-sided, printed-circuit board—a full-size template of which is shown in Fig. 4 for the true do-it-yourselfers, who would prefer to roll their own. It is recommended that the Solid-State Barometer not be built on breadboard—they have a tendency to create or amplify temperature-induced errors. Therefore, your best bet is to use perfboard or printed-circuit board (see Parts List for supplier).

If you choose to go the printed-circuit route the best way to reproduce the board is to use Lift-it film to remove the trace pattern from the page. The film can then be used with a Positive Photo-resist, pre-sensitized, printed-circuit blank to etch your own board. The next step is to purchase the components.

Try to stick with the components given in the Parts List or at least their equivalents. Using other parts may cause additional errors. If you do use different parts, be sure to do a good cross match. Once you have obtained all the parts (or the kit) assembly can begin.

Install all passive components—resistors, capacitors, jumpers, etc.—with the exception of resistors  $R_T$ , according to the layout diagram shown in Fig. 5. Resistor  $R_T$  (which is really a combination of  $R_8$  and  $R_{10}$ ) set the gain of the circuit. (The value of resistance needed will be calculated and explained in short order.) Note: The 10,000-ohm fixed resistors are not discrete components, but instead are contained within three resistor-network packages—the position of which are indicated by RN1, RN2, and RN3 in the layout diagram.

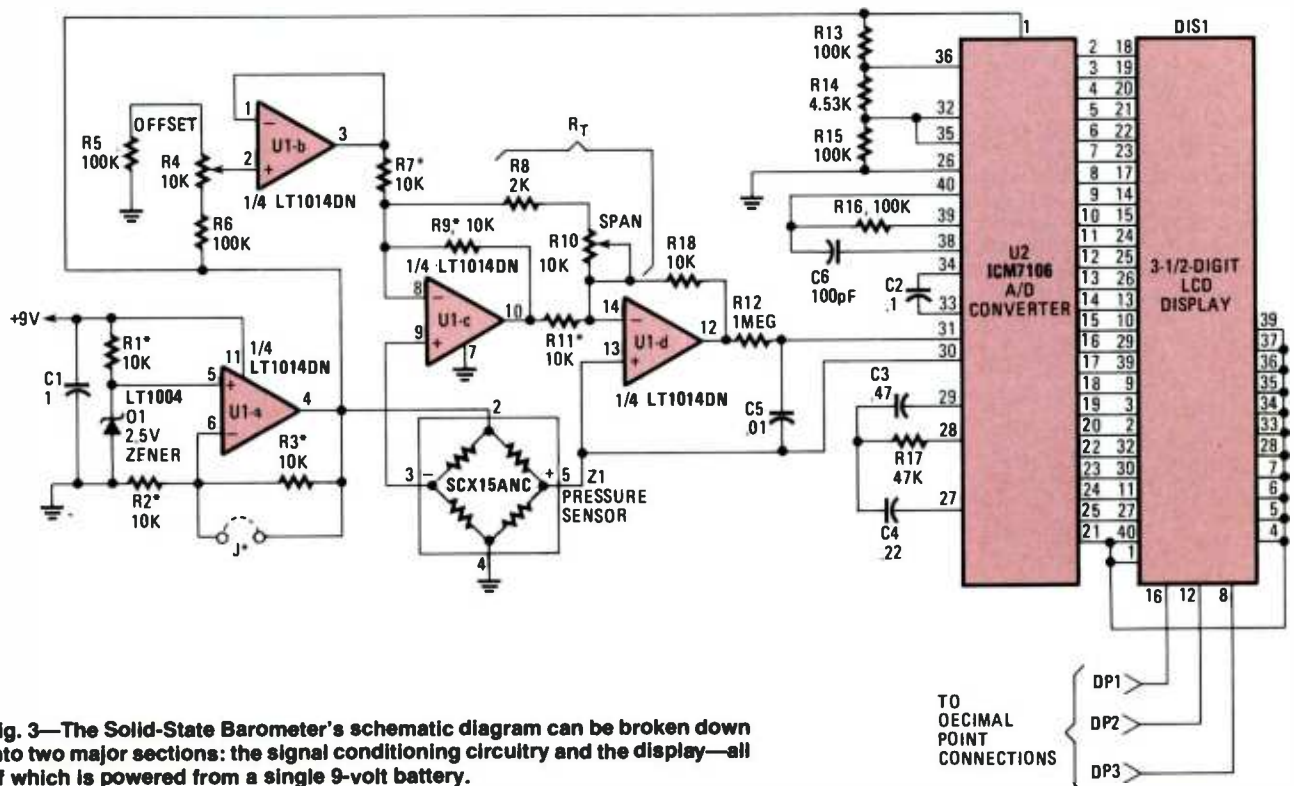

Fig. 3—The Solid-State Barometer's schematic diagram can be broken down into two major sections: the signal conditioning circuitry and the display—all of which is powered from a single 9-volt battery.

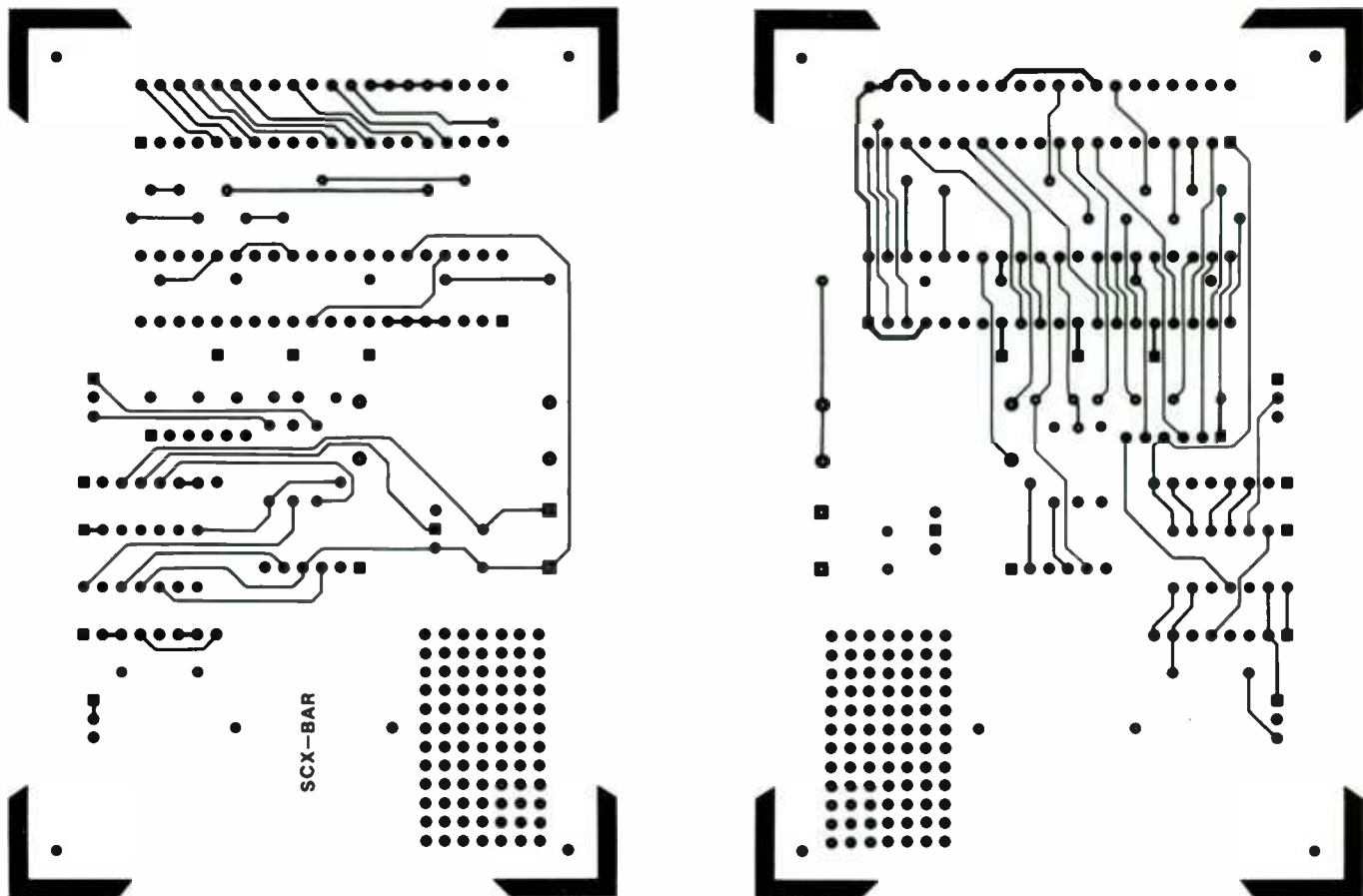
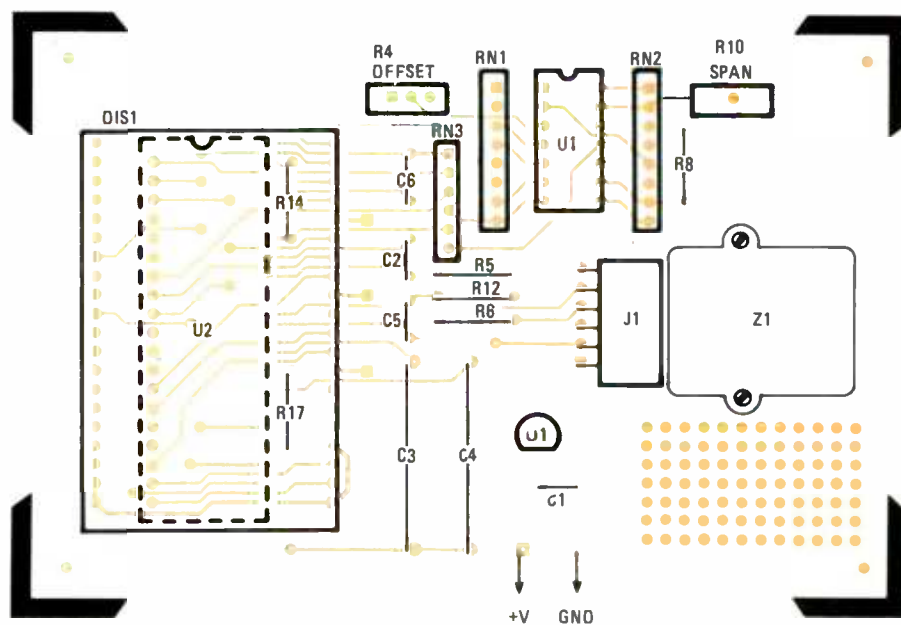

Fig. 4—A template of the Solid-State Barometer's double-sided, printed-circuit board is shown here full-size for the true do-it-yourselfers, who would prefer to etch their own board.

Fig. 5—Install all passive components—resistors, capacitors, jumper, etc.—with the exception of  $R_T$ , according to this layout diagram. Resistor  $R_T$  (a combination of R8 and R10) sets the gain of the circuit.



Install a 14-pin DIP socket for U1 and a 40-pin unit for U2. Now we come to the *Liquid-Crystal Display*. Note that the display is positioned over U2. Install a 20-pin female header on the left and right sides of U2, which will serve as a DIP socket for the display. Next place and solder the sensor at position Z1, clamping the unit to the board with screws and nuts (or self-tapping screws if you have them

on hand). Install U1 and U2 in their respective sockets.

Now install DIS1 in the header strips, making sure that the display is properly oriented. Take your time so as not to bend the pins of the display. (Pin 1 is indicated by a dot in Fig. 5.) Also, note that all the connections to the display have been made, except the decimal points. The reason for that is that some units do not require a decimal point (i.e.,

TABLE 1—CONVERSION RESISTOR VALUES

Unit	Required Gain v/v	Nominal Resistor (R <sub>T</sub> in KΩ)	Actual Resistor Values Used	
			R8 (in KΩ)	R10 (in KΩ)
PSI	4.0	10.0	7.32	5.0
mbar	2.7	28.5	27.4	5.0
cm H <sub>2</sub> O	2.75	26.5	25.5	5.0
in H <sub>2</sub> O*	2.17	117.6	113.0	10.0
mm Hg*	4.1	9.7	7.32	5.0

\*For these two types of units jumper J1 must be included in the Barometer design. In this design, 2.5 V will be supplied to the sensor so its full-scale output will be 18.8 mV.

mbar) and if need be, it can be hard wired into the circuit with little or no trouble.

Most A/D handbooks show how to accomplish the decimal-point connection using a resistor, capacitor, and about four extra soldering points. Those components are not really necessary, because there's another way to assure that the decimal point is lit: Simply connect the decimal points to an LCD segment that's always displayed. For instance, if the output is to be in psi, the decimal point connection should be tied to the 1bc segment of the MSD (Most-Significant Digit), since that segment will always be fired up under normal conditions.

### Scaling the Output

At this point, we are ready to scale the output to the particular unit needed. When we talk about scaling the output, we are really calculating the resistance of R<sub>T</sub> (the R8/R10 combination shown in Fig. 3.), which allows us to control the gain of the instrumentation amplifier, thus controlling the output to the display.

But, before we get into the mathematics of how to calculate the value of R<sub>T</sub>, let's discuss the units we want the output to represent. By using a ICM7106 A/D converter, the output is capable of displaying 199.9 millivolts or 1.999 volts full-scale. (For our application, we will be using 199.9 millivolts as a full-scale reading and each count on the display will then be 100 microvolts.) If our reading is in inches of mercury (inHg), a typical reading at sea level would be around 29.92 inHg.

Using that scale however, we will only be able to see changes in atmospheric pressure in the *tenths of inches* of

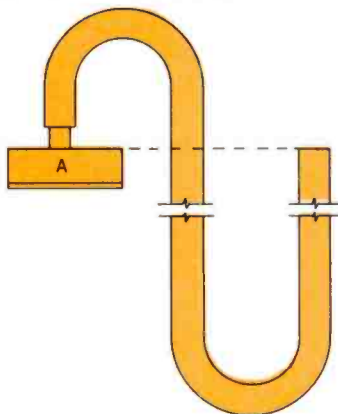

Fig. 6—To accomplish a two-point calibration, we need to produce a known pressure source by attaching a 36-inch length of 1/4-inch diameter clear, flexible tubing to port A of the SCX15ANC sensor—maneuvering the open end of the tubing until it's level with the top of the sensor.

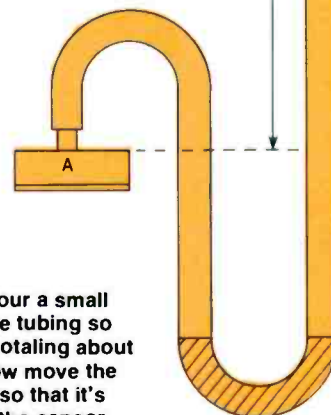

Fig. 7—Now carefully pour a small amount of water into the tubing so that a column is made totaling about six inches in length. Now move the open end of the tubing so that it's about 20 inches above the sensor.

## PARTS LIST FOR THE SOLID-STATE BAROMETER

### SEMICONDUCTORS

- D1—LT1004 2.5-volt Zener diode
- DIS1—ST P1-84 (Polytronix), ANP 0219P (Stanley), PCI M176J (PCI), T-NI1016-4211 522 (Vikay), or similar 3 1/2-digit liquid-crystal display
- U1—LT1014DN quad op-amp, integrated circuit
- U2—ICM7106 3 1/2-digit, A/D converter, integrated circuit

### CAPACITORS

- C1—1-μF, 16-WVDC miniature electrolytic
- C2—0.1-μF, ceramic disc
- C3—0.47-μF, ceramic disc
- C4—0.22-μF, ceramic disc
- C5—0.01-μF, ceramic disc
- C6—100-pF, ceramic disc

### RESISTORS

- R1—R4, R7, R9, R11—CSC06A-03-103G642, 10,000-ohm thick-film, resistor network
- R5, R6, R13, R15, R16—100,000-ohm, 1/4-watt, 5%
- R8—2000-ohm (see text), 1/4-watt, 5%
- R10—10,000-ohm (see text), thumbwheel, trimmer potentiometer
- R12—1-Megohm, 1/4-watt, 5%
- R14—4530-ohm, 1/4-watt, 5%
- R17—47,000-ohm, 1/4-watt, 5%

### ADDITIONAL PARTS AND MATERIALS

Printed-circuit board or perfboard materials, enclosure, single-pole, double-throw (power) switch, 9-volt transistor-radio battery, snap-on battery connector, wire, solder, hardware, etc.

**Note:** The Solid-State Barometer's printed-circuit board and the SCX15ANC absolute pressure sensor is available from Sensym, 1255 Reamwood Ave., Sunnyvale, CA 94089 for \$20.00. Please allow 6 to 8 weeks for delivery.

mercury. That might not give a precise-enough indication of a change in atmospheric pressure. On the other hand, if the output is in psi or millibar (14.70 psi or 1013 millibar are everyday readings), a more-sensitive reading can be measured. But don't let that discourage you from using inHg or mmHg; just be aware that by using those or other units of measurement, some sensitivity may be lost due to the 3 1/2-digit LCD.

To scale the output in psi, from the SCX15ANC data sheet we see that from a 12-volt supply the output will be 90-mV full scale. Because the output of the SCX15ANC span is ratiometric to the supply, (and remember now that we are supplying 5 volts to the SCX15ANC not 9) we find that our full-scale output is 37.5 mV. The required full-scale output span is 150 mV (for our A/D converter input) and so the voltage gain needed is about 4.

Now solving our gain equation for  $R_T$ , we find that  $R_T$  is equal to 100,000 ohms. Other values for different outputs are given in Table 1. Given that, we now know the value of all the components that are necessary to complete the circuit.

## Final Adjustments

Once the Barometer has been fully assembled, we only need to correct the offset and span errors to assure that the Barometer operates properly. To accomplish that, we'll use a two-point calibration technique. The first point, the actual barometric pressure, can be obtained from your local airport. For the second point, let's assume that we have a known 2 psi pressure reference. With two known points and some mathematics, we can eliminate the offset and span errors. The output of the sensor for a known pressure is given by:

$$V_{out} = (S \times P) + V_{os},$$

where  $V_{out}$  is the output voltage in millivolts (mV);  $S$  is the sensor's sensitivity in volts/psi;  $P$  is the applied pressure, and  $V_{os}$  is the offset error of the sensor. The sensitivity can be determined by two known pressures since it results in two equations with two unknown ( $V_{os}$  and  $S$ ), as follows: At atmospheric pressure,

$$V_{o1} = [S \times (P_{atm})] + V_{os},$$

with the additional pressure source:

$$V_{o2} = [S \times (P_{atm} + 2 \text{ psi})] + V_{os}.$$

Since  $S$  does not change as a function of the applied pressure,

$$V_{o2} - V_{o1} = (2 \text{ psi} \times S),$$

or

$$S = (V_{o2} - V_{o1}) / (2 \text{ psi}).$$

At this point, the offset voltage is known and the potentiometer  $R_4$  can be adjusted to eliminate its contribution to the error. The remaining error is due to the span (gain). That error can then be corrected by adjusting potentiometer  $R_T$ , until the digital readout agrees with the actual barometric pressure.

Unfortunately, very few of us have a known pressure source at our disposal; therefore, to accomplish a two-point calibration, we need to produce a known pressure source. That can be done by attaching a piece of  $1/4$  clear, flexible tubing (about 36 inches long) to port A of the SCX15ANC sensor—maneuvering the open end of the tubing until it's level with the top of the sensor as shown on Fig. 6.

Now carefully pour a small amount of water into the tubing such that a column is made totaling about six inches in length. Now move the open end of the tubing so that it's about 20 inches above the sensor (as shown in Fig. 7). Be sure not to let any water go into the sensor, as that may cause permanent damage to the sensor element. At 20 inches above the

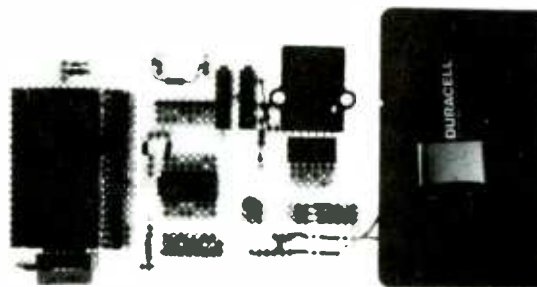

The author's prototype of the Solid-State Barometer was built on plain-Jane perboard, with self-adhering copper traces added to the board to which the components are secured. But for ease of construction and less chance of error, it's recommended that a printed-circuit board be used for the project.

sensor, we have added 0.72 psi (there are 27.68 inH<sub>2</sub>O per psi) to the barometric pressure. That 0.72 psi will be used as our second pressure source. By using the mathematical model shown earlier, we can adjust out the span and offset errors of the circuit.

If you don't want to attempt the two-point calibration, put the nominal-value fixed resistor in the circuit for  $R_T$ , and do not worry about the residual span error. Then simply adjust  $R_4$  so that your reading agrees with that at the airport. Although not the best solution, that will generally suffice for weather prediction applications.

With your Solid-State Barometer now complete and calibrated correctly, put the unit in some kind of housing to protect the circuitry. Pac Tec makes many kinds of small plastic boxes that are very useful, but any type will do the trick. The plastic box also allows your Solid-State Barometer to be fully portable.

## Interpreting Barometric Pressure

The final requirement for making weather predictions using the Barometer is knowing how to interpret the pressure readings. High pressure cells generally bring fair weather. The temperature can be warm or cold, but will remain constant for relatively long periods of time. Low pressure cells, on the other hand, generally bring cloudy weather, with rain or snow depending upon the temperature.

A steady barometer usually indicates unchanging weather for one or two days. Any rapid barometric change in pressure—meaning a 0.05 psi change over the span of a few hours—indicates that unstable weather is on its way.

In order to determine change over long periods of time, I suggest that you interface the Solid-State Barometer with a computer. That would allow you to chart the changes in barometric pressure over a period of time and compare your readings with actual weather conditions (and, of course, the predictions of your local weatherman). And if you really want to get professional about it, break out the weather map (you can find one in almost any newspaper) and chart the course of changing weather conditions.

Well there you have it. Hopefully, you'll do better than the weatherman at predicting the weather. Even if your Solid-State Barometer can't indicate the exact barometric pressure, remember you are only interested pressure change over a few hours. Good luck. ■



# Sound Sender Mobile Radio Adapter



**A wireless way to play your Walkman through an FM auto radio**

IF YOU USE A WALKMAN TAPE PLAYER, it's probably because you prefer your tape collection to what's available on radio. But what do you do when you're driving? Unless your car, truck, or RV has an AM/FM/cassette radio, you're probably stuck with listening to commercials interspersed with music and talk that you would rather not hear. Fact is, the way FM programming has deteriorated, it's not any better than AM, it's just in stereo.

But if you use a *Sound Sender* Mobile Audio Adapter, instead of the endless commercials and the irritating chit-chat of radio personalities, your FM auto radio will play your *Walkman*. That's right, you pop a tape into the *Walkman*, and instead of wearing headphones, you hear the tape from the FM radio.

What's that? You say you haven't the ability or the technical know-how to rewire your vehicle's electrical system just to play your *Walkman* through the car radio. Forget about wiring. The *Sound Sender* simply plugs into the vehicle's cigarette lighter and the *Walkman*—and that's the whole installation in a condensed nutshell.

## Transmitter in Disguise

The *Sound Sender* consists of a plastic housing that looks like an oversize cigarette lighter. From the back of the unit a

short, shielded cable leads to a conventional miniature phone plug; the kind used by the stereo headphones that go with your *Walkman*.

The only operating control is a small knurled wheel labeled *Tune*, and marked with the frequency limits of 105 and 107 MHz. As you've probably surmised, inside the housing is a small monophonic FM transmitter—actually a single-transistor oscillator—that is automatically turned on when the device is inserted into the cigarette lighter's socket. The stereo from the *Walkman* is converted to a mono signal before it modulates the RF oscillator circuit.

To listen to the *Walkman* through the car radio, you simply tune it to a "dead spot" between 105 and 107 MHz, and then move the *Stereo Sender's* tuning knob until the cassette is heard clearly from the car radio's speaker(s).

The entire FM transmitter is assembled on a small printed-circuit board. The tuning is actually done by adjusting the slug of the oscillator tuning coil (indicated by the pencil in the photograph). When the transmitter is installed in its housing, a small tuning shaft affixed to the tuning knob slides into the tuning slug. Small projections on the tuning knob prevent it from being adjusted much beyond the range of 105-107 MHz.



## Surface Mounting

SMD (Surface-Mounted Device) technology is what makes it possible to cram an entire transmitter and its filtering circuits into a housing not much larger than a cigarette lighter. (Extra filtering is needed to keep the RF hash that's normally generated by the vehicle's electrical system out of the transmitter.) As shown in the photographs, the SMD components are so small they almost disappear into the traces on the underside of the printed-circuit board. For example, in the photo of the top of the PC-board showing the tuning coil you'll note that the coil and electrolytic capacitors are conventional sizes. But in the photo of the trace side, the small "blip" at the end of the pencil—no larger than the tip of the lead itself—is the SMD transistor used for the FM oscillator. The other "blips," which are even smaller, are SMD capacitors and filter devices. The slightly larger rectangles having what appear to be numerals printed on top are SMD resistors.

## How it Works

With all the RF filtering of the device's internal connections, you're probably itching to know how the RF from the oscillator ever makes it out of the *Sound Sender* and past all the filters used in a car radio that're specifically designed to reject any kind of RF signal generated by the vehicle's equipment, such as the alternator, spark plugs, computer, etc. Figure that any kind of RF on the primary electrical circuit should be filtered before it ever gets into the radio.

The truth of the matter is that the filtering only reduced the hash below an interference-causing level. We have heard a high-tech explanation (today, everything

*(Continued on page 107)*

The pencil points to the slug of the oscillator's tuning coil. Adjusting that slug through the tuning knob's shaft sets the output frequency.

# RIP.

Here is a super



THE STRUGGLE BETWEEN THE HONEST INDIVIDUAL TRYING to keep his belongings and the evil individual looking for an easy way to take them from him, goes on and on. Finding a single alarm that will protect all your property by a single method is impossible. One type of alarm available today needs to be located in the protected area, and is only activated after the protected area is entered. Often, pets moving about the area or wind-blown drapes and curtains can trigger false alarms. That type of alarm also gives the intruder as much time as he needs to break into the home or office and reach the protected area.

Door and window switches give the intruder the choice of either breaking a window or cutting a hole in the glass so he can reach in and short the switch or metal foil, thus entry can be made without setting off the alarm. Both of these types of alarms give the fiend adequate time to break and enter. An alarm unit that impedes them before they can even get close seems to be the best approach. Especially if you don't enjoy cleaning up glass.

A perimeter alarm that can warn you before the area is even approached is what is needed. One of the application modes of this unit is just such a perimeter alarm. A small-gauge insulated wire up to a few hundred feet can be stapled along the top of a wooden fence. The sensor lead can then be connected to the wire and the unit adjusted. An intruder

placing his hand on the top of the fence, even if he is wearing gloves, will set the alarm off. With proper tuning, neither birds nor cats sitting or walking on the fence will have no effect on the sensor because they are separated from the Earth's grounding effects.

As an entrance alarm or door annunciator, a small-gauge wire strung around the door frame, connected to the sensor lead, and tuned, will trigger the alarm each time a body walks through the door. Attached to the inside of the door knob, it will trigger each time a hand even comes within a few inches of the outside door knob.

The unit can also protect large, ungrounded, metal filing cabinets, desks, safes, wall lockers, or tool boxes. One way the unit was recently used was to alert a salesperson when small jewelry items were picked up from a display table. The table was prepared by putting a 2 x 8 ft. metal window screen on the table top. The screen was then connected to the sensor wire. The screen was then covered with a table cloth and the small jewelry items were laid out for display on top of it. A muted, single-tone door chime was used as the alarm and plugged into the unit. After the unit was adjusted, the chime sounded every time a piece of jewelry was picked off the table, thus alerting the sales person. The builder will probably find many other applications for this unit after using it. All it takes is a little creativity.

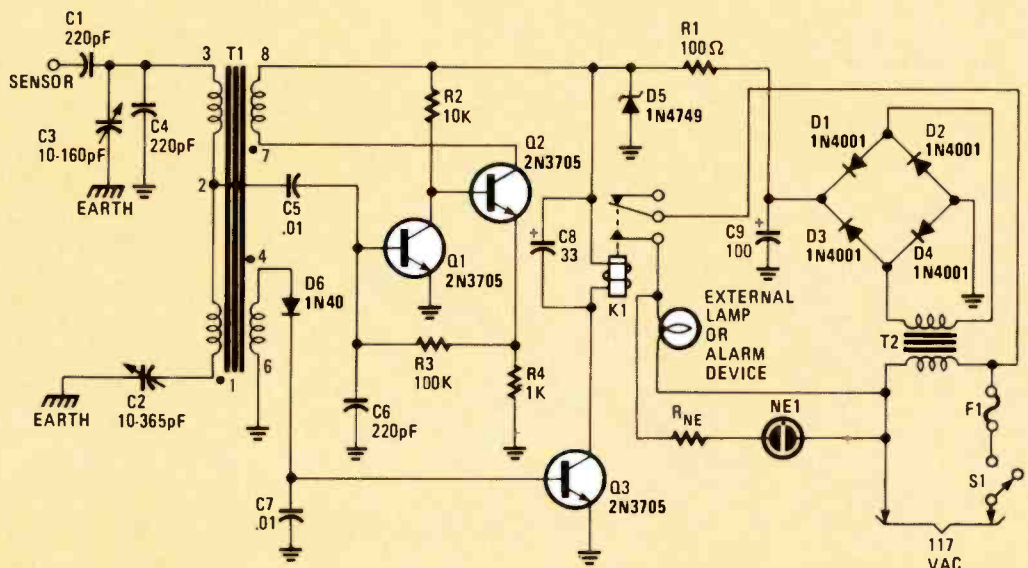

Fig. 1—The current ratings of the fuse, F1, switch S1, and relay K1, are dependent on the current draw of the alarm. An AC socket can be used in place of the lamp shown to facilitate the use of any AC signaling device. Current-limiting resistor  $R_{NE}$  may be necessary for use with some neon bulbs.



# OFF RETARDER ALARM

By W. Schopp

sensitive capacitive sensor alarm that can be used to spoil a burglar's night

## How It Works

The unit is constructed around a balanced-bridge circuit using both capacitance and inductance (see Fig. 1). The bridge consists of capacitors C2 and C3, and the center-tapped winding of T1. One end of the bridge is coupled to ground by C4, while capacitance changes are introduced through C1. A small capacitance change unbalances the bridge and produces an AC signal at the base of Q1. Transistors Q1 and Q2 are connected to form a modified-Darlington amplifier. The collector load for Q2 is a separate winding of T1 that is connected out of phase with the incom-

## PARTS LIST FOR THE RIPOFF RETARDER

### SEMICONDUCTORS

D1-D4—1N4001 1A, 50PIV power diode  
D5—1N4749, 24-Volt Zener diode  
D6—1N40, small-signal, germanium diode  
Q1-Q3—2N3705 NPN transistor (or equivalent such as 2N2219)

### CAPACITORS

C1, C4, C6—220-pF ceramic disc  
C2—10-365-pF miniature AM-radio tuning type  
C3—10-160-pF trimmer  
C5, C7—.01- $\mu$ F ceramic disc  
C8—33- $\mu$ F, 35-WVDC electrolytic  
C9—100- $\mu$ F, 35-WVDC electrolytic

### RESISTORS

(All resistors are 1/4-watt, 10% units unless otherwise specified.)

R1—100-ohm, 1/2 watt  
R2—10,000-ohm  
R3—100,000-ohm  
R4—1000-ohm

### ADDITIONAL PARTS AND MATERIALS

F1—Fuse (current rating determined by alarm device used)  
K1—24-VDC relay (current determined by the alarm device used)  
NE1—110-volt neon indicator (with resistor)  
PL1—AC power plug and cord  
SO1—AC power socket  
S1—SPST switch, (type unimportant)  
T1—Pulse transformer  
T2—Power transformer; 117-VAC primary; 24-VAC secondary

Printed-circuit board or perfboard, alligator clip, wire, solder, metal enclosure, etc.

The transformer T1 can be purchased as part #6182 from Pulse Engineering, PO Box 12235, San Diego, CA 92112. The 10-365-pF variable capacitor can be purchased from Custom Components, Box 153, Malverne, NY 11565, for \$5 plus \$1 shipping and handling/total order.

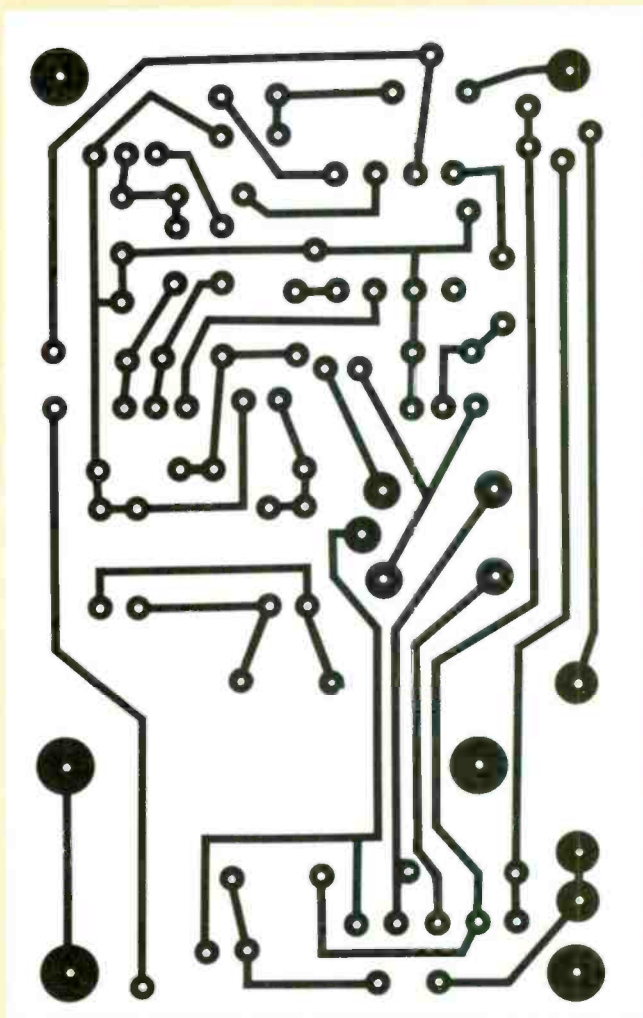

Fig. 2—This foil pattern is provided for you hardcore hobbyists who love to play with chemicals. Those less enthusiastic can place the circuit on perfboard without worry.

ing AC signal. That produces a large, distorted signal each time the bridge is unbalanced.

The distorted signal is taken from the bridge circuit by a third winding of transformer T1. That signal is then rectified by D6 and applied as a DC signal to the base of Q3. The applied signal energizes the relay, K1, as soon as the unbalanced condition occurs, and the relay drops out as soon as the circuit balance is restored. Of course, for normal alarm use, the relay should be made self latching so that the alarm condition remains in effect until the system is reset.

An audible alarm, such as a bell or klaxon horn, can be operated from the relay. If a silent alarm is needed, a light bulb can be used.

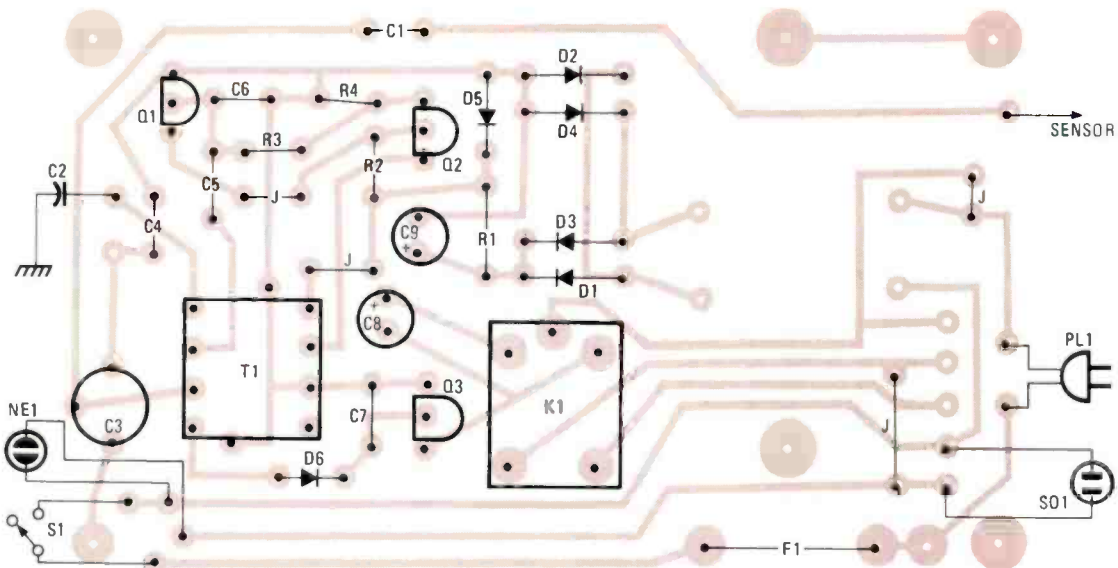

Fig. 3—The order of parts placed on the board is unimportant, however, check for proper polarity where necessary before soldering. Note the extra traces for normally-closed operation as would be useful for burglar alarms.

### Construction

The circuit is fairly simple and parts selection is not critical. Almost any general-purpose NPN transistor will operate in the circuit. One important detail is to make certain that proper phasing of the transformer is observed for correct operation of the circuit. Most transformers indicate the phase relation of the windings by the little dot shown at one terminal of a winding. It should also be noted that there are two grounding points shown on the schematic. One is the power-supply ground and the other is the chassis ground, which is an actual connection to the metal enclosure or cabinet.

The transformer used was a small-pulse transformer with the proper winding configuration, but any transformer that has three windings with one of them center-tapped can be made to work with proper tuning. A Stancore P8361 was used successfully before it was decided to select another to reduce the overall size of the unit. If that transformer is used, the primary windings are not to be connected. The complete circuit can be built on a small piece of perfboard or the circuit can be laid out for printed-circuit board use (see Fig. 2).

### Operation

Once the unit is constructed (see Fig. 3), clip the sensor lead to a metal object, such as a typewriter or lamp base. Set the tuning capacitor on the front panel, C2, to the center of its travel. Adjust C3 to the point where the relay clicks on and off. You can call C3 a range-adjusting capacitor or coarse

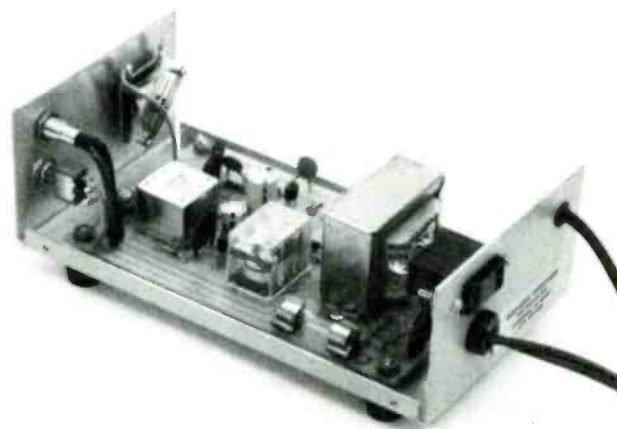

tuning. It brings the usable range of the capacitance change within the range of the front-panel tuning capacitor. If you wish to use a capacitor from your junk box in place of the one shown for C2, then adjust C3 to help set a suitable range for the replacement capacitor.

Turn the front-panel mounted capacitor fully counterclockwise, or to its maximum capacitance value. Connect the sensor lead to another metal object and advance C2 slowly clockwise until the relay clicks on. Back it off until the relay just drops out and the unit is balanced. The closer that this transition point is set, the more sensitive the circuit will be. Be very careful not to be too close to the unit while making that adjustment, since it can respond to a hand placed within six inches of the protected object. With proper application, this unit can really spoil a burglar's night, and protect your own. ■

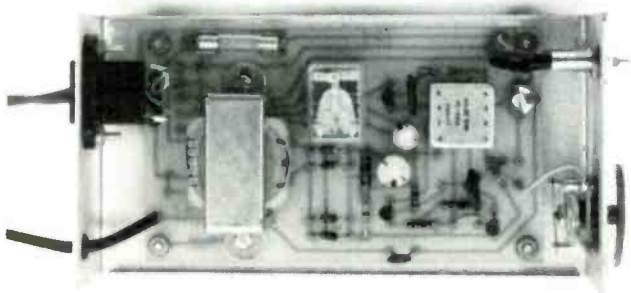

This top view reveals the socket for an external device such as a lamp or chime. By switching the leads on the socket to the unused traces, a normally-closed device can be used.

# GADGET

JULY 1987

THE NEWSLETTER FOR GROWN-UP KIDS

VOLUME XII/NUMBER V

## What's Inside . . .

**Video Game Verite:  
The Sega Master  
System** 2

**Close Shaves: Braun's  
1-2-3, The Freedom  
Blade** 3

**Expandably Yours: New  
Pioneer and Shure  
Amplifiers** 4

**A Personal Copier?:  
Silver Reed's  
Copy Pro** 5

**"Kidtronics": 84th  
Annual Toy Fair** 6



**Engineered Smile: The  
Interlak** 8

**The Jukebox's Return:  
Laser Video Music  
System** 12

## Pocket Power

**PSION ORGANISER II (Model CM).**  
Distributed by: XEC Products, 13575  
58th St. N., P.O. Box 123, Clearwater,  
FL 33520. Price: \$199.95.

At the risk of offending the American computer industry's pride and patriotism, it appears from a distance that Great Britain has done a better job of integrating the computer into everyday life than this country has. To put it plainly, the British don't seem nearly as afraid of the computer as Americans do.

With all of our talk about "computer literacy," there seem to be two classes of users in the U.S. There are the buffs and hackers, and those who, on the job or elsewhere, can "use" the machines as long as the task is laid out step-by-step.

In contrast, Great Britain's citizens seem very much at home with the computer. This spring, for example, the weekly *Observer* (founded 1791) announced a daily news service to be carried by British Telecom's Videotext system. The service isn't a pilot project or an experiment; it already has some 70,000 subscribers and an estimated 400,000 users. The *Observer* news service, according to the announcement costs "the same as a three-minute local telephone call" for each daily report.

Another example of British computer adaptation is the *Psion Organiser II*, designed and built in the U.K. and distributed here by XEC Products. Its predecessor, the *Psion Organiser* (GADGET, June 1986, p. 5) sold more than 40,000 units in its homeland.

With the *Psion Organiser II*, Britain has actually done what only gets talked about in this country. In this case, the Brits have designed a practical, efficient pocket computer which builds its user's computer literacy instead of demanding a high level of skills to begin with. GADGET's brief examination of the new *Organiser* suggests that this is really a product unlike anything else on

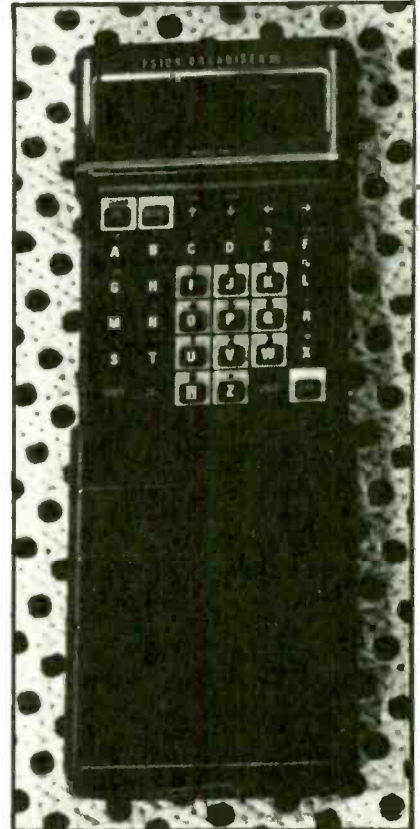

the U.S. market.

More than a hand-held calculator, though less than a full-fledged PC (but not by much), the *Psion II* is comparatively simple to operate, yet broad in its applications. The unit's pre-programmed menu includes clock and calendar functions, diary files, an alarm clock (capable of eight separate settings), a sophisticated data file with cross-reference capabilities and a powerful calculator.

The system also contains a "powerful but easy to use programming language," dubbed OPL, which can be stored in the built-in memory or in the *Organiser's* unique Datapak expandable memory. Finally, the *Psion Organiser II* can supply "a status report at any time on the amount of data and diary information stored in the ma-

(Continued on page 9)

## Round Two

**THE SEGA MASTER SYSTEM.** Manufactured by: Sega of America, Inc., 573 Forbes Blvd., South San Francisco, CA 94080. Price: \$160.

The commercial resurrection of video games potentially rates as one of the more amazing comebacks in consumer electronics. Admittedly, they're not (yet) the obsession they became first time around for both players and investors.

These electronic games most likely have begun re-establishing themselves thanks to the appearance of a new generation of consumers, too young to have overdosed during the video game craze at the end of the '70's.

Improved technology has also played a role, with the new wave of video games more complex, involving and, at their best, ingenious than the noisy and repetitive products of the first boom. Certainly among the leaders in this market comeback is *Sega*. The firm's *Sega Master System* games are being promoted as the "first-ever series of three-dimensional games for the home," with some 16 "new arcade-quality games," on "Mega Cartridge and Sega Card formats."

Even out of the box, it's clear that *Sega* is aiming for variety, and expandability in its array of electronic contests and battles. Besides sixteen games released so far, the *Sega Master System* offers three different controllers. In our tests, *Sega's* games were noticeably faster than earlier video systems, not only in their on-screen aspects, but as controlled with any of the *Sega* options available.

The *Master System* itself includes two control pads, which can be further modified with a "mini" joystick, for use with games demanding steering skills, like "World Grand Prix." Our tester had high praise for the games' graphics, calling them "the most realistic" he's seen on a home system.



Each of the system's "combo cartridges," he reported, contains two games, while the "Mega" cartridges contain only a single contest. These games on *Sega* cards are slightly less complex than their cartridge counterparts, but they also carry a lower retail tag (\$30).

Besides the supplied control pads, *Sega* offers two optional controllers. The Sports Pad (\$60), which combines a roller ball (*Sega* calls it, "the ultimate ball controller") and fire buttons for "quick maneuvers" and "near-instantaneous reaction to movements by on-screen competitors." The optional Light Phaser (\$35) is a pistol-style controller which figures in various interactive contests, aimed at the on-screen video images.

Our *Sega* gamesman devised the ultimate one-on-one, between *Sega* and another active video game innovator, Nintendo. According to him, "everyone

who tested these two games preferred *Sega's* 'Black Belt' to Nintendo's similar 'Kung Fu.'" Further underscoring *Sega's* pursuit of variety, the *Master System* offers a second martial skills game, "Ninja," and, covering further bases, a TV wrestling contest.

During their big sleep, video games probably lost scores of potential customers, and players, to competing forms of electronic (and other) entertainments. Getting them back, at least at first, won't be hard. Our tester, a video game veteran, found the *Sega System's* speed and graphics praiseworthy and a definite improvement over the earlier wave's standards in both areas.

But whether *Sega's* variety-targeted design can avoid the last video round's eventual over-exposure, over-saturation and over-kill would be hard to predict. Getting the new players should be easy, keeping them is the important challenge. —G.A. (research by Jordan Goldstein)

**Publisher:** Al Goldstein **Editor:** George Arthur **Senior Editor:** Gil Reavill **New Products Editor:** Christine Stevens **Art Director:** Kevin Hein **Associate Art Directors:** D. Devins, C. Giordano, Rob Weisberg **Production:** Bill Mudie **Administration:** Bonnie Keystone **Reader Service:** Kathryn Hartman **Technical Consultants:** Ken Schaffer, Bob Bishop **Contributing Editors:** Philip Eisenberg, Alan Freedman, Jordan Arl Goldstein, Steve Gruberg, April Guarino, John Kois, John Swenson, Ken Swisher, Aaron C. Zimmerman.

GADGET is published by A.G. Consultants, Inc., 116 W. 14th Street, New York, NY 10011, (212) 989-8001. Copyright © 1987 by A.G. Consultants, Inc. GADGET is a registered trademark of A.G. Consultants, Inc. GADGET is published 12 times a year and appears as an insert in Hands-On Electronics, published by Gernsback Publications, Inc., Farmingdale, NY 11735. For information on subscriptions to Hands-On Electronics, please see the magazine's editorial page. Letters intended for GADGET's editorial staff should be sent to the newsletter's address as shown here.

GADGET's sole commitment is to its readers. In order to avoid even the appearance of a conflict of interest, GADGET does not accept advertising nor does GADGET solicit gifts or other benefits from manufacturers and retailers who may be mentioned in reviews.

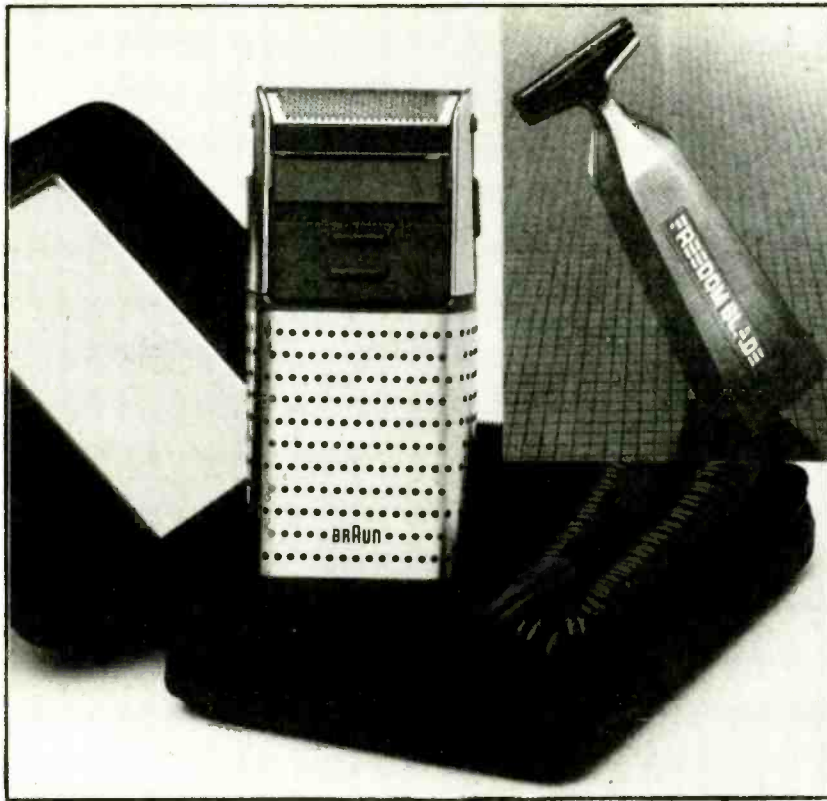

## Little Shavers

**SYSTEM 1-2-3 RECHARGEABLE SHAVER (model 3525).** Manufactured by: Braun, Inc., 66 Broadway, Route 1, Lynnfield, MA 01940. Price: \$55. **FREEDOM BLADE ELECTRIC RAZOR.** Manufactured by: Freedom Enterprises, Inc., P.O. Box 4987, Monroe, LA 71211. Price: \$39.95.

An encyclopedia entry says that razors represent "the earliest precision tools made by man." Despite a history dating back to the Egypt of 5,000 years ago, improvements in shaving implements are still being claimed and new products launched. At the same time, many are still using razors, the design of which dates back to the 19th century.

Given the subjectivity inherent in deciding what constitutes a close shave, and the endless variations in skin condition, beard condition and the like, it's not surprising that so many different styles of shaving tools coexist. The persistence of "new developments" in the field reflects the continuing dissatisfaction of thousands with their shaving experience, as does the periodic increase in the number of men wearing beards.

Germany's Braun has been in the razor business for decades. The company's recently introduced model 3525,

the *System 1-2-3 Rechargeable Shaver*, is a fairly typical electric razor in its cutting head design. However, Braun says the difference comes in the ultra-precision with which the instrument is engineered and fabricated.

"The Braun system," a sales brochure croons, "optimizes the interaction between the micro-thin foil and oscillating ice hardened steel blades. Diamond cut stainless steel blades are perfectly synchronized with the foil geometry to give the largest possible active shaving area."

Striking in its design, the *1-2-3 System* derives its name from its unique three-position shaving head. Position one is for ordinary beard cutting. A slight upward pressure on the razor's side moves the head into position two, "combination shaving, longer hairs in awkward areas," as well as ordinary whiskers. Finally, position three fully extends the razor's built-in beard, moustache and sideburn trimmer.

As a rechargeable razor, the *Braun 1-2-3* fully "recharges in only one hour—3 minute cordless shave after 5 minute recharging." Also included, an "automatic worldwide voltage adjustment, 12 volt car/boat charging." It's an altogether elegant shaving tool, handsome, well-balanced, lightweight and equipped with a mirrored carrying case.

In our tests, we found the *1-2-3* shaved exceptionally close. Braun's

precision fussiness (the cutting foil, coated with platinum, for example, features hexagonal instead of round holes) suggests that this instrument will retain its cutting edge for many shaves to come. In its class of electric razors, the *Braun 1-2-3* is near the top in quality fabrication and well-thought-out engineering and design.

According to one source, however, only about 20 percent of American males use a standard "dry" electric razor. The rest of the market belongs to the modern safety razor (safe, that is, in comparison with the straight razors it replaced around 1900), especially the low-cost, throwaway models. The *Freedom Blade* aims at capturing a good portion of the "wet shave" market and, given the buzz the product has created among shaving consumers, it might well succeed.

Not much different from a modern safety razor in appearance, the *Freedom Blade* has a built-in motor which vibrates the razor blade (it uses standard twin-blade, disposable cartridges), causing it to "sever the hairs with many tiny, rapid movements."

Despite its electrical components, the *Freedom Blade* is used with lather or cream and is fully immersible in water. An overnight charge delivers "approximately 15 shaves."

In our first use of it, we managed to cut ourselves—not the fault of the *Freedom Blade*, but rather the result of not realizing just how close this instrument cuts. After that first session, getting the hang of this razor was no trouble at all.

However, tender skin might warrant use of a pre-shave conditioner in addition to the lather or cream usually used. Despite our experience, *Freedom Blade's* manufacturer maintains the product "virtually eliminates skin irritation as well as nicks and cuts commonly caused by a conventional blade." More impressively, *Freedom Blade* backs the claim with a money-back offer. "You will experience the closest, most comfortable shave imaginable," promises a sales brochure, "or return it for a prompt and courteous refund."

Final judgments on razors and shaving methods are nearly impossible to deliver, for reasons already outlined here. We were interested to note, for example, that *Consumer Reports* hasn't done a comprehensive report on shavers, of any kind, since 1979. Still, if you're among those perpetually dissatisfied with your shaving tool, both the *Braun* and the *Freedom Blade* merit your attention. In terms of innovation, however, our nod goes to the *Freedom Blade*.—G.A.



Shure Video/Hi-Fi Expander

## Dept. of Amplification

**PIONEER VSX-5000 AUDIO/VIDEO STEREO RECEIVER.** Manufactured by: Pioneer Electronics, 5000 Airport Plaza Drive, P.O. Box 1720, Long Beach, CA 90801-1720. Price: \$569.95. **SHURE AVC20 VIDEO/HI-FI EXPANDER.** Manufactured by: Shure Electronics, 222 Hartrey Avenue, Evanston, IL 60202-3696. Price: \$599.

If one is to judge from industry market reports, American consumers have recently taken a long, hard look at their home entertainment centers and found them wanting. They are turning to more sophisticated "umbrella" units to pull all the various audio-video components together. GADGET recently conducted a head-on test of two such amplifiers, Shure's AVC20 "system expander" and Pioneer's VSX-5000.

Both units take as their centerpiece stereo "surround-sound," a method of delivering stereo sound from four speakers instead of two, with the resulting versatility exploited by adjusting speaker levels. For example, a "spatial" or "stadium" sound is obtained by delivering both direct stereo from the front speakers and support from back speakers: "studio" or "concert" sound is arrived at by relying primarily on the front speakers. Effects such as these have been used in movie theatres for years, complete with Dolby (which both products also feature).

Added to this basic surround-sound capability are a host of sophisticated technological innovations, aimed at ei-

ther combining input from many different sources (e.g., CDs, tape players, phono, etc.) or "enhancing" that input in various ways. Control is the byword here, and both units offer it to the consumer in fairly commensurate ways. The AVC20 and VSX-5000 may be seen as switching houses for the increasingly congested audio-visual railroad.

The surround-sound of these meta-amplifiers is similar but not quite identical. Using a basic four-speaker arrangement, two in front and two in back, they use various combinations to achieve different effects. For watching sporting events, all four speakers are kicked in for an ambient spaciousness difficult to obtain in a two-speaker setup. Concerts or music recordings demand a more direct, "wall-of-sound" approach, with the front speakers providing the bulk and the back speakers

supplying reverberatory coloring. One can also reproduce recent movies recorded in Dolby Surround, a method of sound encoding especially designed for systems such as these.

For ease of operation and supremely ergonomic—"user-friendly"—controls, the Shure AVC20 seems to have the edge in the complicated business of choosing surround-sound effects. A square LED indicator graphically illustrates the exact configuration of the sound, while next to it on the attractive front panel is a square volume and balance control. It is fun and instructive to "walk" the sound around the room using this four-way button.

The Pioneer's claim to dominance rests primarily on its higher power output: 70 watts per channel in surround mode, as opposed to Shure's 30 watts

(Continued on page 9)

### PERFECTION ATTAINED?

Stereo amplifiers have apparently reached a level of perfection equal to the dreams of every stereo buff—sort of. The *Consumer Union News Digest* (Box 2029, Norwalk, CT 06852) reports that *Stereo Review* has thrown up its hands at the prospect of quantifying any important differences in the audio performance of stereo amplifiers.

The audio monthly approached a consultant about designing a test to bring out the elusive subtleties in the performance of various amps. In its January issue, *SR* reported, "the evidence would seem to suggest that distinctive amplifier sounds, if they exist at all, are so

minute that they form a poor basis for choosing one amplifier over another. Certainly, there are still differences between amps, but we are unlikely to hear them."

The main differences to be "heard" are the various claims made on behalf of competing brands of amplifier equipment.

*Consumer Union's News Digest* is a biweekly compendium of significant consumer news and information, much breezier than its sometimes ponderous parent publication, *Consumer Reports* magazine, minus *CR's* exhaustive, scientific evaluation of products. Subscriptions are \$48 a year.

## The New "PC"

**COPY PRO DESKTOP COPIER.**  
Manufactured by: Silver Reed America, Inc., 19600 S. Vermont Ave., Torrance, CA 90502. Price: \$449.95.

Some products seem impervious to the much-heralded consumer electronics revolution. Regardless of demand or brand competition within the product field, prices seem not to come down.

Such has been the case with modern-day copiers. Although there are scores of consumers who might be eager to have a copier in a home office or workroom, these remain among the priciest of electronic office tools. Or they were until recently.

Canon has aggressively marketed its line of "personal copiers" (GADGET, January). Now, Japanese-owned *Silver Reed America* has introduced its first "personal desktop copier," the *Copy Pro*.

The *Silver Reed* product seems an accommodation to the economic realities of copier manufacturing. Designed for the "student, home and small office market," the *Copy Pro* weighs just under 17 lbs. and can produce six 8½" by 11" copies per minute, or "one in less than 10 seconds." As with the company's hand-held *Porta Copy* (GADGET, May), the *Copy Pro* uses thermal copying technology (a heat transfer process) in tandem with a charge-coupled-device image scanner.

The resulting duplicated images are clearly superior to what thermal copy processes were capable of in their pre-Xerox heyday. This unit pretty much lives up to its "desktop" marketing designation. The device's measurements are a compact 16" x 14½" x 4½", although the user will need to clear an area longer than the *Copy Pro*'s chassis in order to accommodate the copy tray's forward and backward motion.

This component of the *Copy Pro* suggests how dollars have been shaved off its retail price. It's no big deal, but the copy tray must be positioned by hand. There's no motor to move it back after completing a copy.

The unit's thermal copying paper comes in rolls (98' long and retailing for \$7.95) and can be loaded into the machine in just seconds. Thermal paper, it should be noted, isn't at all like Xerox paper or ordinary bond. It has the shiny, smooth surface of the chemically treated material it is.

One touch *Silver Reed* seems especially proud of is "a built-in adjustment feature" which allows the user to



copy the exact length (but not width) of an original. What this comes down to are guide marks scored into the surface of the copy tray. In adjusting the tray by hand, a user merely lines up the edge of the to-be-duplicated material with any of the three guide marks, then lines up the selected mark with the unit chassis' "start position" mark.

Controls are basic. There's a power switch, a "copy intensity" dial and a "start" button. Included with the *Copy Pro* is a "head cleaner," rather resembling a ballpoint pen. The "silver thermal head" is mounted above the paper roll compartment, accessed via a release switch and a lift-up door.

Oddly, although there's an illustration in the user's manual showing the head cleaner being used, there is no reference to the maintenance tool (that we could find) in the instructions' text. Instead, the "If You Have Problems" section merely says to "wipe the thermal head with a soft cloth or cotton swab to remove any dirt or dust"—this next to the illustration showing the head cleaner being welded by a pair of disembodied hands.

Let's not forget why it was that office thermal copiers went the way of the wax cylinder dictation machine and the rolltop desk. The *Copy Pro* instructions have a nine-point list of "don'ts" under the heading "Storing Copies."

Storage in any folders, etc., with vinyl chloride in their composition will quickly fade thermal paper copies. Likewise, "when pasting copies, avoid using glue or tape containing solvents," and "do not write on copies with ink that contains solvents." But, most potential users aren't looking to make copies for posterity.

There's also a maintenance caution in the instructions telling users to avoid placing "heavy objects" or pressing

strongly on the copy tray. Those "heavy objects" would include oversize books or bound volumes of publications. A law student, to take one example, trying to copy pages out of a weighty law book would find this copier less than adequate.

Despite an instruction booklet reference to "many years of service from your *Copy Pro*," the device's lightweight construction gave GADGET's tester pause. *Silver Reed* offers a limited three-month labor and one-year parts warranty. But it's hard to picture this copier standing up to years of heavy, or even moderate use. Long copy runs—multiple copies of a single original—would not seem to be a specialty of this particular unit. Each copy requires a press of the "start" button; there is no multiple copy control on the machine.

For research work and the like, however, the *Copy Pro* produces a perfectly acceptable duplicate. Photos and material printed over a non-white background can even be decently duplicated, thanks to the unit's "copy intensity" adjustment. The machine's removable copy tray cover, unfortunately, is mostly a reminder of how frail the unit gives every indication of being.

Even at nearly \$450, the *Copy Pro* is cheaper than any of the standard office copiers. The most important questions that might be asked by a potential buyer are: What am I going to use it for? How many copies per week, or month, will I be making? What kind of material do I wish to copy? Pages out of hefty encyclopedias? The answers to these questions should determine whether this is *your* "personal desktop copier" or merely the newest entrant into the woefully underdeveloped consumer copier market.—G.A.

## Electronic Childhood

After years of GADGET going to the *American International Toy Fair*, the 84th edition of the event came to us, so to speak. Not literally, but in terms of the product trends evident at the annual February toy industry showcase.

The trade magazine *Toy & Hobby*, called it a "new age of electronics" in playthings, reporting, "the toy market is becoming saturated with hi-tech and animated plush items." *New York* magazine's coverage labeled the trend, "kidtronics, audio and video products that have been jazzed up and scaled down for kids."

If last year's obsession was licensing (GADGET, May 1986, p. 4), this year the toy industry movers and mavens were wrapped up in "high tech." Licensing and TV tie-ins weren't much discussed during the fair's nine-day run at New York's Toy Center, mainly because the practices have become standard for toy manufacturers and marketers. Perhaps as much as 50 percent of toy sales are generated by or associated with licensing agreements and TV promotional programming.

The toy makers' wholesale adaptation of voice-recognition technology, "laser beams" and computer chips, most often used to animate some traditional plush animal suggests a research and development effort staffed by a combination of mad scientists, the Brothers Grimm and maybe a proponent of the Reagan "Star Wars" defense plan.

This proliferation of electronic, audio and video products for the kids, thus far, is a not altogether joyful



PXL 2000 Camcorder

transformation of the toy field. Its most disappointing aspect, at least as reflected at the *Toy Fair*, was the lackluster uses this technology is being put to. Oddly enough in an industry dependent on kids, the missing ingredient too often is imagination.

A primary example would be the venerable *Erector Construction Set*, manufactured by *Ideal, Inc.* (*The Toy Center North, 200 Fifth Ave., New York, NY 10010*), itself now, "a subsidiary of View-Master Ideal Group, Inc." Seeking to update the traditional steel-girder building sets, "motorized laser modules capable of firing an invisible infrared beam" have been de-

veloped, "reflecting a military theme."

The *Erector* laser components fire infrared beams at each other from a claimed distance of 20 feet and "emit up to four distinct and well-amplified battlefield sounds."

The smaller laser equipped set sells for approximately \$30, while the larger (which has both the "LaserPlex Combat Station" and the "LaserStrike" vehicle with target) retails for around \$60.

A "military theme" is the best *Ideal* could come up with for a construction toy like the *Erector Set*, and a technology like infrared beams?

Quite possibly the most talked about

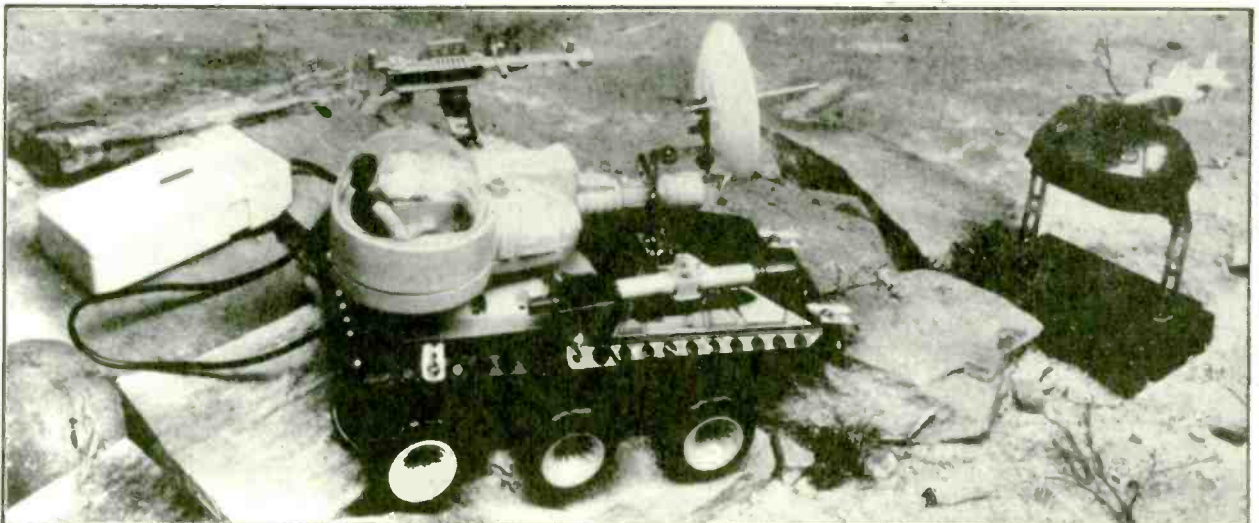

Erector LaserStrike Vehicle and Target



new toy came from another old-line industry leader, *Fisher Price* (East Aurora, NY 14052). Called the *PXL 2000*, it's "the first video camcorder system" for kids. Aimed at tykes 8 years old and up, what makes the *PXL 2000* fascinating is its technology.

It uses what's dubbed "pixelvision," in order to produce black-and-white images on a standard audio cassette. Playback requires no VCR; instead the kid vid camera is hooked up to any TV by attaching a cable supplied with the *PXL 2000*. In its deluxe version (priced at approximately \$200), the system includes a 4½" black-and-white TV. In its standard form (\$150), the unit comes equipped with TV hook-up accessories and an audio cassette.

Power is supplied by six "AA" batteries. A 90-minute audio cassette will yield an 11-minute video, 5½ minutes on each side. The image is said to be comparable to the films produced by the earliest of home movie outfits.

This is one toy we're pretty sure will be purchased by kids of all ages, if only because of its intriguing implications for the future of grown-up video.

Another video-related product was unveiled by *LJN Toys, Ltd.* (1107 Broadway, New York, NY 10010). This one, *VideoArt*, hooked up to a TV or VCR makes possible the creation of "16-color artwork on the television screen and then actually records it on a video cassette recorder." The system includes video art software which transforms the screen into a coloring book. Among cassettes available are Disney characters, Spider-Man, and of course *LJN's* own Photon and Thundercats characters. The *VideoArt* system retails for up to \$100, while each of the coloring book cassette programs costs around \$15.

*Texas Instrument* (Consumer Products, P.O. Box 655303, M.S. 8214, Dallas, TX 75265) introduced spelling and mathematical learning systems, for children 5 to 12 and 6 to 11, respectively, the *Spelling B* and *Math Star*. Both are simple computer chip units which utilize games, and contests to teach basic skills. *Math Star* is priced at \$29.95, while the *Spelling B* (with a vocabulary of over 250 words) is \$24.95.

One electronic toy with a nice sci-fi flair is the game *Perception* from *Parker Brothers* (500 Dunham Rd., Beverly, MA 01015). The company might not like this being called a game. According to the promotional literature, it is "an ESP tool," one which will "help you develop effective decision-making abilities." In performing three programs, "precognitive, tele-

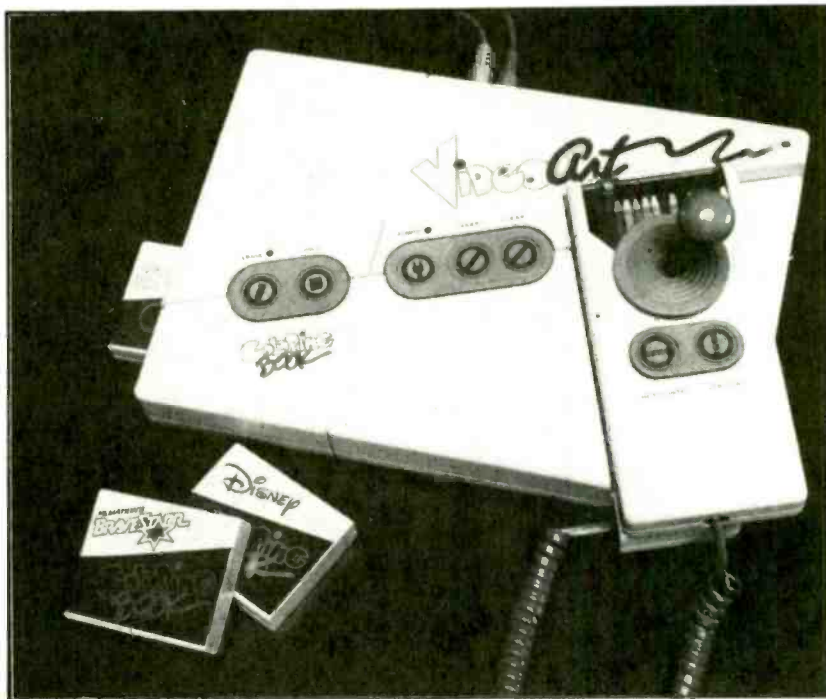

Video Art

pathic and unaided precognitive," players try to predict which of four colors the machine will display. If, as *Parker* says, "...68 percent of the adult American population believes they have some form of ESP," *Perception*, at around \$35, should do well.

This, of course, is barely the tip of the toy iceberg and GADGET will be taking an individual look at some of the new toys as the year continues. It's unfortunate that the electronification

of playthings is apparently a major factor in boosting the cost of all but the most simple of toys.

Maybe having taken a hint from the grown-up electronics industry in the area of technology, toy manufacturers will also adopt the industry's practice of gradually lowering prices as research and development and start-up costs fade. That would be one welcome by-product of the coming of "kidtronics."—G.A.



Math Star

# The Naked Tooth

**INTERPLAK HOME PLAQUE REMOVAL INSTRUMENT.** Manufactured by: Dental Research Corp., 1726 Montreal Circle, #14, Tucker, GA 30084. Price: \$99.

The toothbrush was supposedly developed in China during the 1400s. In the five centuries since, despite the electrification of toothbrushes a couple of decades ago, this basic dental hygienic tool hasn't changed much.

Dental care has improved and floss, water pics and other at-home dental care tools have, if nothing else, increased awareness of the importance of preventive maintenance. But the brush itself, especially as it's wielded by most of us, remains a weak link in the chain of dental protection.

That, anyway, was the viewpoint of the American dentist who developed the *Interplak*, a new instrument in the fight against tooth decay and gum disorders. Provisionally approved for use by the American Dental Association, the *Interplak* has been the subject of studies at a number of dental schools.

Although toothbrush-like, the *Interplak* is to the standard, manual brush what a Porsche is to a Volkswagen. Quite apart from its effectiveness as a dental tool, it's something of a marvel

of engineering and design.

The *Interplak's* unique advantage is in its powered brush head. Two rows of five tapered bristle tufts, positioned to follow the gum line, are geared so that each tuft rotates in the opposite direction of adjacent bristles and reverses direction 46 times each second. The bristle tufts each rotate at the equivalent of 4,200 rpm, reversing direction every 1.5 revolutions.

While we've gotten jaded regarding electronic miniaturization, engineering all of this coordinated rotation and counter-rotation mechanism into the head of a toothbrush—and not coming up with a finished product which weighs a few score pounds and roars like a power mower—has to be counted as a real achievement.

The precision involved in its design was responsible for a major drawback in the first *Interplaks* marketed. Each instrument demanded its own custom engineering. As a result, each user of the *Interplak* required his or her own \$99 unit, a substantial investment in dental hygiene for just about any family.

The current, improved *Interplak* is equipped with two interchangeable heads, with additional snap-on brush heads available at \$12.95 each. *Dental Research Corp.*, the manufacturer, is responsible for service and each unit is backed by a one-year warranty.

If this rather complex tool func-

tions, there seems little question that it would outclean an ordinary or electric toothbrush. Our publisher has used one for nearly a year. Besides having purchased the first, non-interchangeable model, his only negative observation is the unit's tendency to heat up in use to a rather uncomfortable degree. But as a tooth-cleaning apparatus, in his experience, the *Interplak* does a superb job.

Even in the hand of a dental delinquent, the *Interplak* would scrub more enamel and reach into more hard-to-clean areas than a desultory brushing with a stationary set of bristles. Sold with a recharging stand, dental mirror, instructions and hardware for mounting in the bathroom or elsewhere, the *Interplak* has been approved by the electrical safety-monitoring Underwriter's Laboratories and the U.S. Food and Drug Administration.

Of course, even an *Interplak* won't do any good if it's not used on a regular basis. But *Dental Research Corp.* figures that "compared with the typical one minute long manual toothbrushing," its product produces 4,200 revolutions in that minute, compared with about 160 random strokes. With this tool, that typical "one minute long toothbrushing" just might be useful time spent in dental protection, instead of the bane of dental-bill paying parents.—G.A.

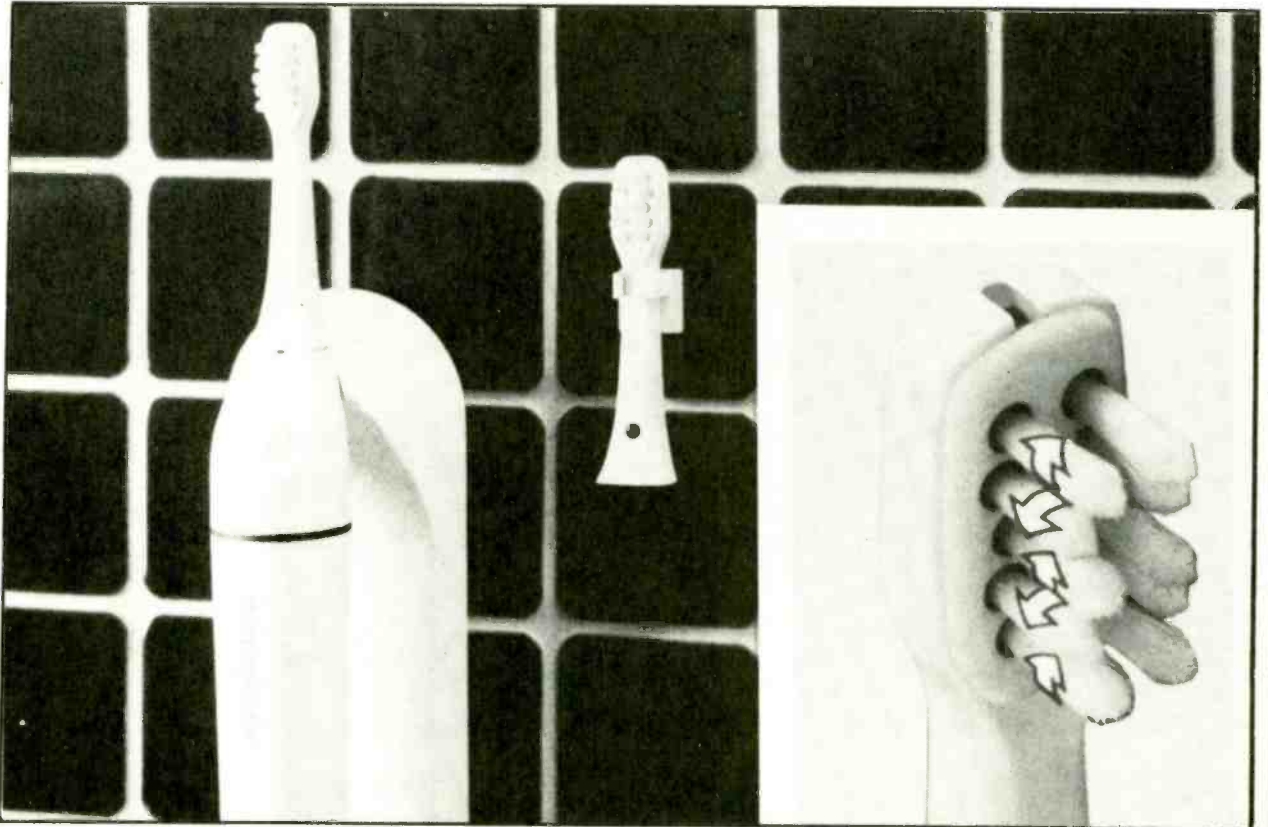

## PSION ORGANISER II

(Cont. from p. 1)

chine and on Datapaks and the quantity of internal memory still free." All of this is served up in a package weighing 10 oz. and easily palm-sized.

Its memory capacity is a feature which marks the *Psion II* as something special. Credited with 24 Bytes of ROM and 8K Bytes RAM, the model CM can carry up to 160 Kilobytes at any one time, while the heftier model XP can handle a whopping 304 Kilobytes. The key to this impressive capacity is the *Organiser's* "Datapak" system.

Similar to a desk-top computer's floppy disks in their function, each Datapak is a thumb-sized unit which slides into a slot in the back of the *Organiser*. Two units can be inserted at a time, yielding up to 64 KBytes per pack. Besides providing mass storage of data, these Datapaks can carry special programs, including three provided (as options) by *Psion*—Finance Pack (financial calculations, an expense log and bank account record-keeping, including a monthly statement), Math Pack (capable of solving

Bessel functions, polynomial equations, quadratics, Eigenvalues as well as standard statistical calculations, correlation coefficients, and more) and the Concise Oxford Spelling Checker. This Datapak allows a user to "type in the first three or four letters to define the word," with the Checker displaying "the correct spelling on the second line of the screen."

Further expanding its utility, the *Organiser II* can interface with other computers, printers and models via an optional RS232 Link communications cable (available for \$99.95). Records and files can be transferred from the *Organiser* to another computer, or from the computer to the *Organiser*. In Great Britain, it also links up with the country's "electronic mail" service.

Prices for optional data and program packs vary. An 8K Datapak retails for \$29.95, with the 64K pack priced at \$139.95. The programs described above (financial, math and spelling checker) each sell for \$49.95.

The *Psion Organiser II's* versatility (and popularity) is suggested by the British publication of a 226-page book, *Using and Programming the Psion Organiser II*, independent of the *Psion* company. According to the British

magazine, *Your Computer*, in just six months last year, *Psion* leapfrogged over other computer firms to become the world's largest producer, by unit volume, of hand-held computers.

Besides the model CM, the *Psion Organiser II* is also available as the model XP (\$249.95). With a larger memory, this unit's additional capabilities include use with a bar code and magnetic card reader and the ability to use *Psion's* 128K Datapaks.

While we'll leave it to the buffs and hackers to really explore this marvelous device in depth, GADGET was most impressed by the *Psion's* clear potential. Here is a computer designed to conform to human thinking, instead of demanding that the user learn to think like an electronic machine. If you're thinking about taking the PC plunge, the *Psion Organiser* merits careful attention as a possible alternative, particularly if you're new to the wonderful, and sometimes wacky, world of computers.

We'd also like to see American manufacturers and designers learning something from their trans-Atlantic counterparts. In the age-old contest between man and machine, *Psion* is obviously rooting for the humans.—G.A.

## AMPLIFIERS

(Cont. from p. 4)

per channel. However, since anyone venturing into this heady stratosphere of consumer gadgetry will no doubt link either of the control amps in question with other power amps, pure power primacy seems beside the point. We are left with other deciding factors, such as remote capability, design and optional features.

Both the *Shure* and the *Pioneer* units come equipped with remote control, but the latter packs many more options into its standard-size infrared unit. Basically, the *Pioneer* remote is designed to operate a whole battery of audio-visual components, as long as they are manufactured by *Pioneer* or compatible. A whole-system remote with an impressive array of 40 buttons, it nonetheless might strike all but the most fervent audiophile as a trifle over-complicated. The *Shure* remote offers dramatically reduced capability, but it does so in an immediately graspable format.

Both units also offer a video-enhancer system, a picture input treatment which has a varying effect on actually improving the image: on some older movies it works, but on some it suffers from "white-out." In addition, the *Pioneer* offers something the *Shure*

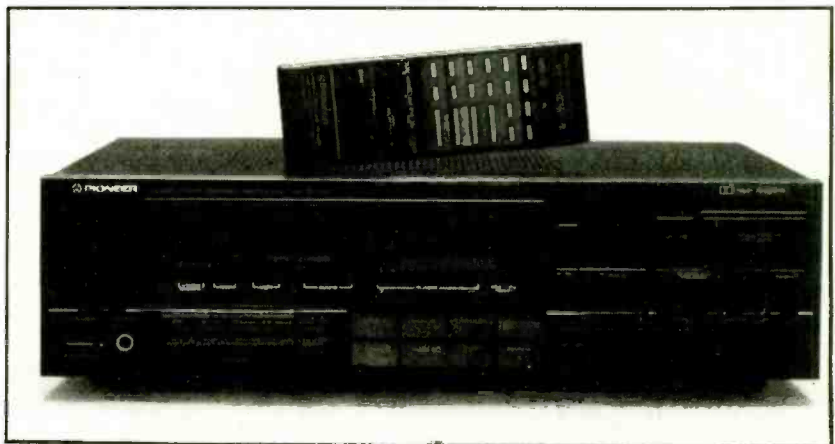

Pioneer Audio/Video Stereo Receiver

lacks, a split-screen comparison between the enhanced image and the untreated one, so the viewer may compare quality. The *Pioneer VSX-5000* also has various channel-search capabilities that the *Shure* unit does not, such as preset scanning to complement direct access tuning.

For looks, design and overall "feel," the *Shure* unit comes out slightly ahead. The controls are simply larger and easier to operate than *Pioneer's* trademark buttons. Both amplifiers are black, with the imposing front of the *Pioneer* set off with a large, lighted control window, and the *Shure* placing

several of its less-utilized controls behind an attractive glass panel.

In these realms of electronic excellence, it is moot to say one product is superior to another, and better perhaps to suggest ideal matchings of consumer with hardware. For an audio-visual maniac, especially one with several *Pioneer* units already at his command, the *VSX-5000* will pull together the system and provide the user with a single unified remote. For the more casual buyer, one who simply wants to knit various threads of his system together, the *Shure AVC20* is highly recommended.—G.R.

# Bits & Pieces



**NBA VCR Basketball Game**

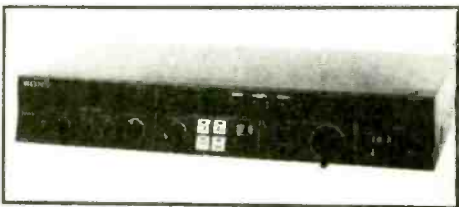

**Sony Video Multicolor Corrector**



**Technico "Instant Replay" Calculator**

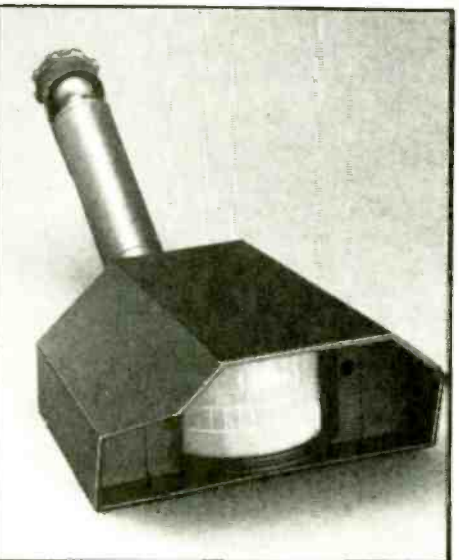

**Motion Sensor Light Control**

The video game revival, apparently, has become official. After maintaining a low profile for a couple of years, the industry is bouncing back with new games and new concepts. *VCR Enterprises, Inc.* (115 Issaquena Ave., Clarksdale, MS 38614) has introduced an **NBA VCR Basketball Game**, licensed by the National Basketball Association and making use of NBA game footage in the video cassettes included with the product. VCR Basketball is played on a board, with part of the action taking place on the screen. Players work with cards, dice, playing pieces and "a tiny basketball and miniature hoop provided for making foul shots." As the manufacturer sees it, this is a traditional board game, enhanced by the audio and visual excitement provided by the VCR. Price: \$44.

Microwave cookery is firmly established, with any doubts raised by its generation of microwaves long ago overcome in the marketplace. However, just in case you're inclined to err on the side of caution, *Brookstone* (127 Vose Farm Rd., Peterborough, NH 03458) offers a **Microwave Meter**. The device measures "dangerous leaks that can go undetected." A user passes it around the oven. A green light means safety, red means call a service representative. The meter features solid-state construction and needs no batteries. Price: \$19.95.

Among the video image enhancement devices introduced at the Winter Consumer Electronics Show by *Sony Corp. of America* (Sony Dr., Parkridge, NJ 07656) is an **XV-C700 Video Multicolor Corrector**. The unit offers a color bar generator, white balance and color/hue adjustment and "a choice of 15 wipe patterns and a background color generator for creating titles." It can also convert 35mm negatives or slides to video with the use of a film/video adapter and has audio mixing capabilities for "producing sound effects." A joystick-style controller is used for continuous correction of white balance in order to promote consistent image quality. Price: \$700.

While it's been part of broadcast football games for years, "instant replay" has just made its appearance in the world of electronic calculators. *Technico* (989 6th Ave., 7th Fl., New York, NY 10018) has introduced a non-printing **Desktop Calculator** (model PL-941) with a feature dubbed "instant replay." The unit allows the user to replay each step of a calculation. Each time the calculator's "instant replay" key is punched, "the previous entry appears on the eight-digit display." The entire calculation can be reviewed, step-by-step, for up to 32 separate entries. The PL-941 also has a continuous memory, "so once the calculation is entered into the memory, the total will remain there until cancelled, even if the calculator is turned off." Technico plans to introduce this feature later this year in credit-card, foldable, vertical and larger desktop models. The battery-operated PL-941 performs all standard functions as well as mark-up calculations. Price: \$12.95.

The past several years have seen an explosion in home security equipment. Besides widespread demand, technological change has made it possible to sell once exotic security technology at an affordable price. *Health Zenith* (St. Joseph, MI 49085) offers a **Motion Sensor Light Control** (SL-5200) which uses "passive infrared technology to turn on lights by sensing the heat of objects in motion." The control has a "detection field of 60 feet in length through a 100 degree arc," covering a total of 2,000 square feet. Its refractive lens, housed in a weather-tight case, "detects downward as well as out." The user can adjust both sensitivity and the time period during which the lights stay on. Heath Zenith suggest use in "those large areas around driveways, sidewalks and patios for convenience, safety and security." There's an optional mount available for \$10 for use with the SL-5200. Price: \$79.95.

## Bits & Pieces

No Johnny-come-lately to the telephone answering machine market, when *Code-A-Phone Corp.* (16216 S.E. 130th, Clackamas, OR 97228) says it's introducing its "lowest-ever priced TAD" ("telephone answering device"), the statement actually means something. The model 900 **Telephone Answering Machine** features variable-length announcement, voice-activated message length, last message automatic stop, message "backspace," memo recording and an LED display of number of messages received. All this and "one-button control" in a cream with burgundy accents package. There's also a power failure security capability which enables the model 900 to "remember the user's outgoing greeting and saves messages for later review" despite any power outage. Aimed at residential users, the model 900 is especially designed (and priced) for "young people." Price: \$79.95.

It's not often you find the "relaxation of Swedish massage," combined with the "invigoration of Japanese Shiatsu" in one "high-tech designer chair." If you've been looking for that elusive cross-cultural combination, the **Fuji Massage Chair** claims to be the answer. Distributed in this country by *Kinsei Shiatsu, Inc.* (551 W. 189th St., Suite R, Gardena, CA 90248), the device offers "five essential" massage functions—kneading, tapping, rolling, kneading-rolling and, as you might have guessed, tapping-rolling. The reclining armchair has two control panels, one for timing and one to select the various massage combos the Fuji is capable of. Extended use time is 30 minutes and power is supplied (at 120 volts) by an ordinary wall outlet. Price: \$1,495.

For campers, boat owners and RV fans, summer's the time for fun, but it's also the time for high temperatures, which means this **D.C. Table Fan** should find a ready market. Offered by the energy-efficient *Free Market Catalog* (1001 Connecticut Ave., N.W., Suite 638, Washington, DC 20036), this 8" oscillating fan runs on 12-volt direct current, drawing 15 watts on low and 24 watts on high speed. It also carries a one-year warranty. Price (including shipping charges): \$31.

We can't help but wonder how this product is doing in the Washington, DC market. From *Silver Reed* (19600 S. Vermont Ave., Torrance, CA 90502), it's the **Snippet Personal Shredder** (DS210). Designed to rest atop a standard office wastebasket, the little Snippet (8.5 lbs., 11.5" wide, 7.2" deep and 3.6" tall) "devours confidential notes, memos and other sensitive papers, turning them into 'curly-Q' shreds even the greatest detective couldn't piece back together(!)" That certainly goes to the heart of the device's uses. The Snippet's curly strips are only 0.16" wide and its "powerful motor shreds almost any size document," while the unit itself is "only slightly larger than a telephone." Price: \$199.95.

Carrying chests that can keep food cool, or warm, aren't new, but their design has improved in recent years. *Remington Products, Inc.* (60 Main St., P.O. Box 1101, Bridgeport, CT 06601-9967) offers a 7-lb. combo chest which can cool foods as low as 36 degrees Fahrenheit and warm them up to 185 degrees F. The **Kool Made Cooling/Warming Chest** measures 12" high by 13½" long by 9¾" wide. The unit's top has four recessed holders for beverages. The Kool Made plugs into your car's cigarette lighter or anywhere 12-volt power is available. Price: \$79.99.

Another radio aimed at the youngster market is offered by *Fun Designs* (P.O. Box 2837, 30 Tremont St., Duxbury, MA 02332) under the name **Teddy Tunes**. It's a floating radio in either AM or FM, featuring a bear who looks suspiciously like Smokey, perhaps a close relative? The Teddy Tunes speaker is mounted in the bear's belly and he floats on a yellow, red or blue raft. Its radio, of course, is waterproof. Price: AM—\$24.99; AM/FM—\$34.99.

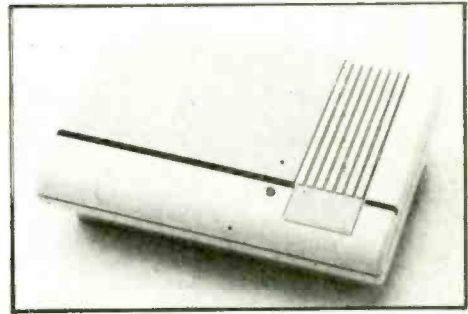

Code-A-Phone Answering Machine

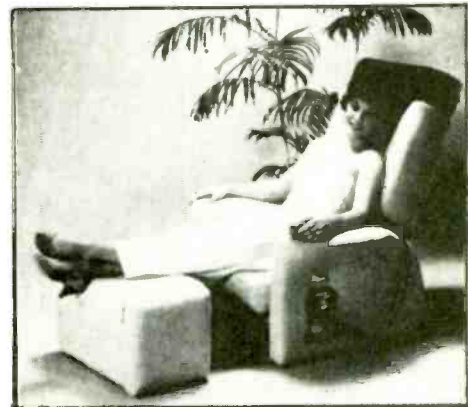

Fuji Massage Chair



Snippet Personal Shredder



Teddy Tunes Floating Radio

# Bits & Pieces



Phone Line RFI Suppressor

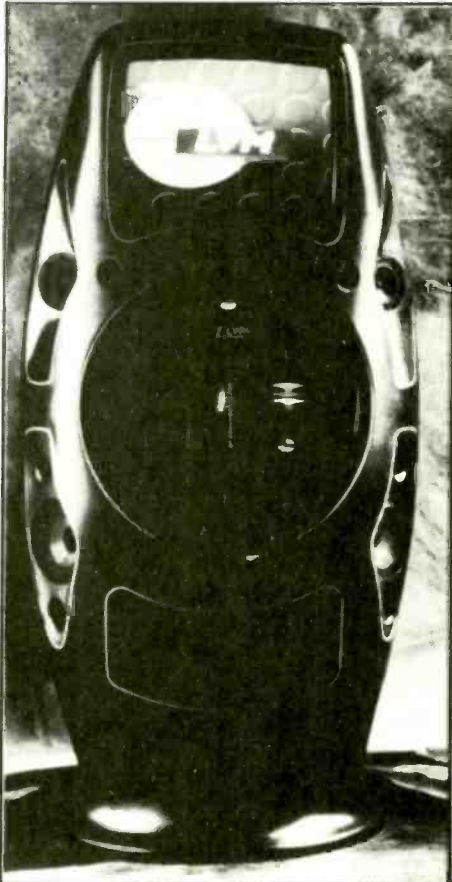

Laser Video Music System

The computer modem has reached a high level of development, but it still operates via phone lines which sometimes can allow interference with transmissions. *Electronic Specialists, Inc.* (171 S. Main St., Natick, MA 01760) has introduced a **Phone Line RFI Suppressor** to guard against this problem. Designed to protect against RFI interference emanating from area TV or radio stations, the units are also effective against police, taxi and CB interference as well as natural RFI "from lightning and other spheric discharges." The item is available with a "wide variety of connectors to accommodate all installations." Price: \$30.

Radio-equipped pillows have been around for years. Advantages are always claimed and drawbacks are just as often apparent. The **Safe & Sound FM Stereo Pillow (SS-5)** is fairly typical. Marketed by *Shoreline International Electronics, Inc.* (P.O. Box 6392, Hamden, CT 06517), its awkwardly oblong shape is complemented by clumsy access to the built-in radio's controls. Improbably, Shoreline suggests the bulky pillow can be worn around the neck like a scarf. Power is supplied by four 1.9 volt batteries or an optional AC adapter. As for the Safe & Sound's use on the beach, instructions warn "do not use near water. The stereo pillow is not waterproof or a floatation device and may present a shock hazard." These wired pillows may have their partisans, but they are unlikely to replace Walkman-stype personal stereo systems or even non-electronic pillows. Price: \$39.95.

One of the more publicized spin-off products of the early days of the U.S. space program was the Fisher Space Pen. Not developed by NASA, it was enthusiastically adopted by American, and eventually Soviet, space explorers after its development by entrepreneur and inventor, Paul Fisher. Two decades later, the *Fisher Pen Co.* (743 Circle Ave., Forest Park, IL 60130) has come up with an attention-grabbing update of its product, the **Atocha Stowaway Space Pen**. Named for a Spanish galleon which sank in 1622, each of these pens "contains gold or silver from the Atocha." Like all Fisher Space Pens, these write "at any angle, even upside down... under water, over grease, in blazing heat," and the pens "won't dry out in 100 years." Price: \$25-\$50; Collectors Series—\$300-\$1,500.

The old-fashioned mechanical-electrical jukebox has always been one of our favorite gadgets, even in its commercial decline. A company in New England, *Laser Video Music, Inc.* (60 Aberdeen Ave., Cambridge, MA 02138) has developed a new, electronic-age twist on this old warhorse which just might bring it into the 21st century. Called the **Laser Video Music Entertainment System**, this offspring of the Wurlitzer and the Capehart plays laser video discs (45 video titles per unit, some three hours of program material) as well as six minutes of commercials each hour, which doesn't sound like an improvement to us. The units contain a modem that connects them to a mainframe computer at Laser Video Music's headquarters. The home computer keeps track of when the unit is turned on, which songs are played, revenue (at 50 cents a selection) and even if it needs repairs or service. Available only on a commercial-use, lease basis, the Laser Video Music Entertainment System is a jukebox with a difference. Price: Not available.

## Coming in future issues of **GADGET** newsletter

- **Microwave Generation**—These "space age" ovens have gone from exotic accessory to everyday necessity. We use a moderately priced Toshiba to investigate the latest generation.
- **Perils of Personal TV**—Caslo's cube color tube, the TV-6000 shows promise even as the same brand's TV-2000 stumbles and falls on the slippery path of LCD technology.
- **Close Tech, The Story Continues**—With its featherweight Titanium-coated shaving foil, Panasonic's cordless shaver delivers a superior electric shave.
- **Iron Deficient?**—The Swiss-engineered Elnapress is supposed to be superior to ordinary electric irons. **GADGET** smooths out some wrinkles to discover why.

# RESCUE TEXT FILES

By **Ralph Terry**

## A BASIC program can save many hours worth of input!

□ NO MATTER HOW CAREFUL I AM ABOUT MAKING BACKUPS, SOONER or later I lose some text that took a considerable amount of time to input. That is a fairly serious disaster for a working writer, and there are ways to prevent the problem. I still don't have an answer for a failure to make backups, but floppy disk accidents can steal a backup in an instant. If it is important enough (eight or ten pages lost, perhaps), I might spend several hours with a floppy-disk zap utility and rebuild the diskette enough to salvage the critical text. Since I'm a hacker, that is fairly routine for me. (Before I learned how to do it, I used to cry a lot!) There is now a better and faster way, and you don't have to be a hacker to take advantage of it.

### The TEXTSAVE Utility

The Color Computer stores data in blocks of 2,304 bytes (nine sectors), or about 450 words of text. Most software needs a directory to find that data and keep it organized, so if a directory gets garbaged up, you lose it all. However, if the individual track and sector markers are intact, TEXT SAVE (a BASIC program) can read these sectors and save most of the data. Normally, sectors only get damaged by dirt, scratches, fingerprints, heat, and magnets, so they usually are okay. Remember two things about RSDOS: it puts the directory in the center of the diskette (track 17) and then it places files on either side of the directory, working outward as it stores data. Since the lower tracks are easier to read, they are filled first.

### How TEXT SAVE Works

No matter what error messages your word processor gives you, when trying to read a diskette, TEXT SAVE can probably read most of the sectors. Each sector is displayed on the screen as it is read, and up to nine sectors can be scanned in one pass. So, you read the diskette, one sector at a time, looking for the data you are after. It isn't as time-consuming as it sounds; although there are 603 sectors, there are only 67 data blocks. If your file is undamaged, it will start in the first sector of a block. In case of possible damage, check more than one sector in a block when searching for your file. If the first sector of a block is blank, the whole block should be.

Follow me through a typical session. Since the files are stored beginning near the center and working out, I read tracks in a search pattern to find the lowest track with data. I started with track 8, sector 1 (8,1). That one was empty, as was 9,1 and 9,10, but on 10,1 I found nine sectors used (10,1 through 10,9). That was part of the text I sought, near the end of the file. If 8,1 had been used I would have tried 6,1 or 4,1 until I found a blank sector, then searched forward from there.

Once I found a portion of the file, I moved on toward the center of the diskette, looking for more of the file. More of the file was located at 10,10, so I scanned 10,11 through 10,14. The sector at 10,14 was about half full, but I couldn't use it. That's because TEXT SAVE is designed to use only full sectors, and replace the last two bytes with an end-of-file marker. That makes the program much easier to write and faster to run than if it had to locate the true end of the file. In other words, I saved all of track 10 text except about 31 words. Back to the search!

Since I found part of the file, I saved 10,1 through 10,9 as SAVE1 and 10,10 through 10,13 as SAVE2. I then found 18 sectors on each of tracks 11, 12 and 13, and the beginning of the file at 10,10 through 10,18. Each data block was saved as I found it; I wound up with a track/sector and file list that is shown in Table 1.

The files in Table 1 are BASIC data files and must be loaded using the commands used by your particular word-processor software. TEXT SAVE generates files of the form XXXXXX/DAT; using ELITE\*WORD the file name must be given in full, followed by ";", that is, XXXXXX/DAT;. After saving those nine segments, I printed each of them to see if I had found all the text. That meant having to arrange the segments in the correct order, making a mostly complete text. I then loaded SAVE9 (the beginning text) and appended the others in the correct order. The segments fit like this: SAVE9 + SAVE5 + SAVE6 + SAVE7 + SAVE8 + SAVE3 + SAVE4 + SAVE1 + SAVE2.

I now had the reclaimed file in correct order, and it contained about 97% of the original text. However, all the embedded file formatting characters were clumps of meaningless characters, and a three-character string (";;") appeared numerous times throughout the document. That little string is an artifact of how the software handles strings longer than 255 characters. Both ELITE\*WORD and TELEWRITER have a problem with long text strings; ELITE\*WORD uses (";;") to "splice" 255-character strings together in diskette files.

TABLE 1—RESCUED TEXT FILES

Track/Sector	Number of Sectors	File Name
10, 1-9	9	SAVE 1
10, 10-18	4	SAVE 2
11, 1-9	9	SAVE 3
11, 10-18	9	SAVE 4
12, 1-9	9	SAVE 5
12, 10-18	9	SAVE 6
13, 1-9	9	SAVE 7
13, 10-18	9	SAVE 8
14, 10-18	9	SAVE 9

Some other anomalies appear in the file: (13 13), ("cr") and (cr"). TEXT SAVE replaces the last two characters in a sector with two STR\$(13) (carriage return) characters and (13 13) is how ELITE\*WORD reads them into its text buffer. The other two groups appear to be how some of the formatting commands are handled by TEXT SAVE.

The bottom line is that I spent about two hours to locate and save 3600 characters of text and do some global replace operations. For example, I replaced (","") with (), ("cr") with (\*) and (cr\*) with (\*\*). By searching for "\*\*", I located the problem areas quickly. After comparing the recovered text with my notes and outline of the original file, I could determine which characters and/or words were wiped out by the funny characters and replace them. I also had to replace the embedded printer-control characters and do a test print-out to locate other damage. That sure beats about six hours to rebuild a diskette, before beginning to repair the file itself!

TABLE 2—TEXT SAVE UTILITY

```

5 CLEAR 10000:POKE 150,18
10 DIM B$(50):DIM T$(50)
15 INPUT "DRIVE":D
20 INPUT "TRACK,SECTOR":T,S
25 PRINT"TRACK ";T;" " SECTOR ";S;
30 DSKIS D,T,S,A$,S$
35 B$(X)=A$:T$(X)=S$:X=X+1
40 PRINT"X = ";X:PRINT A$;S$
45 INPUT"MORE":Y$
50 IF Y$=""THEN S=S+1:GOTO30
55 IF Y$="P"THEN65
60 IF Y$="N"THEN80
65 INPUT"HOW MANY SECTORS":X
70 X=X-1:IF Y$="W"THEN85
75 FOR Y=0TOX:PRINT#-2,B$(Y),T$(Y):NEXT Y
80 X=0:GOTO20
85 INPUT"FILE NAME":F$:INPUT"DRIVE NUMBER":DR$
90 F0$=F$+".DAT:"+DR$
95 OPEN"O",#1,F0$
100 WRITE#1,B$(Y),T$(Y)
105 Y=Y+1:IF Y<X THEN100
110 IF Y=X THEN120
115 CLOSE 1:GOTO135
120 A=LEN (T$(X)):A=A-2:U$=LEFT$(T$(X),A)
125 Z$=STR$(13):U$=U$+Z$+Z$
130 WRITE#1,B$(X),U$:CLOSE 1
135 X=0: INPUT"ANOTHER FILE":Y$
140 IF Y$=""THEN20
145 IF Y$="D"THEN15
150 CLOSE 1:STOP

```

Depending on what kind of floppy disk accident happened, I could have lost more text from the file. In fact, one or two small (one sector or less) files were lost entirely from the diskette. The time savings may not seem like much, but consider redoing all the writing a second time. It's tough to digest a meal the second time.

### How to Run TEXTSAVE

First things first—copy the BASIC program of TEXTSAVE given in Table 2. Proof you inputting very carefully against the BASIC program in the table.

TEXTSAVE will run on a single-disk system, but is easier with two disks. With a single-disk system, swap diskettes before answering the first prompt. *Always use a freshly formatted diskette to save recovered files.* Start with "RUN TEXTSAVE (ENTER)" and swap diskettes if necessary. You will be prompted for source-diskette parameters, drive number, then track and sector.

The program responds by displaying track and sector information followed by "X—1" on the next line. The X is a sector

counter which is displayed just above the sector contents; it increments as you read more sectors. You will see the sector contents in one of five styles. A blank display indicates a never-used sector, and dots with random alphanumeric characters is probably left-over trash. A segment of text will be clearly readable, while graphics characters mixed with alphanumerics is a BASIC program. A BASIC program saved in ASCII mode will resemble a text file.

At the bottom of the display you will be prompted:

"MORE?" Press ENTER to read the next sector,  
 "P" to print on the printer,  
 "N" to choose a new track/sector combination,  
 and "W" to write to diskette.

Entering "N" brings up the track/sector prompt. Pressing (ENTER) repeatedly will scroll through the diskette sector by sector until you stop. (Remember, there are only 18 sectors per track, so if you try to do more in one pass you will get an error message.)

Be sure to examine each sector as it is displayed, to be sure you are still finding data from the correct file. You can write 18 sectors or less to the new diskette on a single pass. Entering either "P" or "W" brings up "HOW MANY SECTORS?". You can request no more than the maximum number read up to that point, or you will get an error; that many sectors will be printed on the printer or written to diskette. If "W" is chosen, you will be prompted for a file name and drive number; the /DAT extension is furnished automatically. The file will be opened, written, and closed, and you will be prompted for the next pass. Entering "D" allows you to read from another drive, while (ENTER) allows a new choice of track and sector, and any other key exits the program. If you are working on a single-disk system, be sure to keep the diskette swaps under control.

### Floppy Disk Hints

Do you get too many floppy disk errors? Review the following checklist to discover what you are doing wrong:

1. Never touch any part of the plastic media.
2. Keep the diskette in the sleeve when not in use.
3. Keep diskettes cool—never leave them in your car, or on the computer.
4. Never lay diskettes with paper clips, tools, or magnets. (Tools are often magnetized, and paper clips are often stored in magnetized holders.)
5. Don't stack diskettes near a computer or monitor—the computer chassis contain transformers which can erase data.
6. Always use VERIFYON before getting into COPY or DSKINI sessions.
7. If you suspect magnetic exposure of a diskette, save all the data you can, then use a bulk eraser on the diskette. Activate the eraser next to the diskette and keep it on while slowly moving the diskette at least 18-inches away.
8. Never use a diskette notcher to use both sides of a diskette in a single sided drive. The sleeve lining is "fuzzy" to catch dust; the diskette turns backward when flipped and, trapped dirt particles can be released onto the diskettes surface.

Remember the TEXTSAVE utility if you lose data; saving that one file made it worthwhile for me!





## Radio-Shack DUoPHONE

□ IN THE CLASSIC FILM *INVASION OF THE Body Snatchers*, beings from another planet gradually gain control of the Earth by infiltrating the minds and bodies of individual human beings. The trick is that, from the outside, those who have been taken over are indistinguishable from those who haven't.

A similar phenomenon is happening every day—right now, in fact. However, the “invaders” are not beings from another planet, but little chunks of plastic-coated silicon, otherwise known as LSI (large-scale integration) IC's. They take a multitude of forms—microprocessors, memories, television and radio sub-systems, and many more—and they're being used in more and more equipment all the time. And often it's as hard to recognize a piece of equipment that has been “invaded” by one of those chunks of silicon as a body that has been *snatched!* But only until you use it—then the difference becomes apparent.

One of the latest victims is the telephone. Sure, smart phones with memory dialing have been around for years. And, with the addition of an electro-mechanical answering machine, those smart phones could play a message to a caller and then record his response. The problem is that the electro-mechanical answering machine is expensive, unreliable, difficult to service, and therefore, expensive to service. So for years designers have been looking for ways to eliminate the mechanical components (relays, solenoids, motors, etc.) and replace them with silicon.

### The Problem

For a long time, the problem was that available LSI IC's were general-purpose

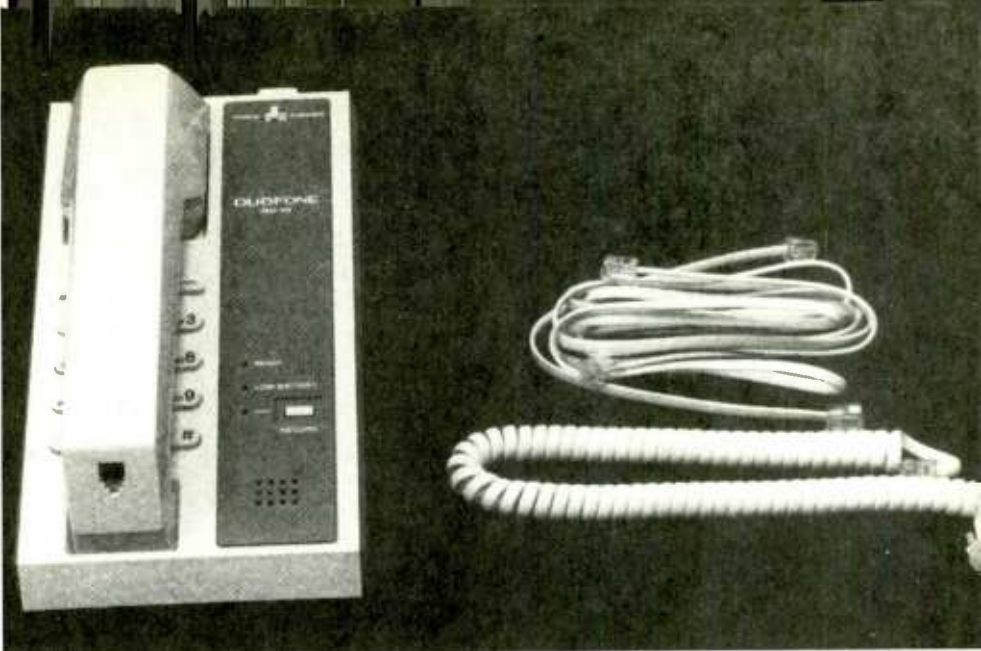

**Now you can have a multi-function telephone for a fraction of what plain-Jane units with add-ons cost**

devices (microprocessors and memory IC's), and building an answering machine with them would have been expensive, because of the circuit complexity involved, and because of the prices of some components—especially memory.

However, in the last few years, many special-purpose IC's have become available, and memory prices have fallen drastically. The dedicated IC's perform the functions of dozens of discrete IC's, so design and debugging are simpler (and less expensive) than before. In addition, fewer IC's mean smaller manufacturing costs and greater reliability, both of which increase savings for the consumer. Last, often the dedicated IC's are so powerful that functions previously only dreamt of can now be included with no extra cost. The net result is that it's now possible to build and sell multi-function telephones for a fraction of what plain-Jane units with add-ons cost just a few years ago.

### What's Out There

For example, we recently took a look at Radio Shack's DUoPHONE TAD-105 (catalog No. 43-386). The TAD-105 can do pulse and tone dialing, and last-number re-dial. Its real claim to fame, however, is its ability to record a message (as long as ten seconds) for playback only. It packs all those functions into a case about the same size and shape as a standard wall-mount telephone (see photos). The TAD-105 may be mounted on a wall or set on a desk; it looks attractive in either location.

Why would you want a telephone with a playback-only message system? There are many occasions when it's not important to record a message, but when it would be nice to at least let a caller know that you'll be back soon.

For example, at home, if you're working in the basement or outside, giving the baby a bath, or you're involved with any other activity that precludes your answering the phone, you could press a button and record a message stating that you're tied up at the moment and to please call back at 4 PM. At the office (assuming you have individual phone lines run to each desk), if you stepped out for a few minutes, you could leave a message to call back shortly. Or a business could leave a message stating “We're not open now; please call between 9 AM and 5 PM, Monday through Friday.”

### Features

Packaged in an attractive two-tone (beige and brown) slim plastic case, the TAD-105 measures 2 × 4-½ × 8½ inches and has a standard 12-key keypad—which includes the digits 0-9, and the \* and # keys. In addition, aligned in a row above the main keypad are three pushbuttons: BATT TEST, MESSAGE TEST, and REDIAL. The TAD-105 is powered by a small nine-volt, wall-plug transformer; a nine-volt battery retains the stored message should power go off. If the *low battery* LED lights when the BATT TEST button is pressed, the battery should be replaced. The unit will function with a weak battery, or none at all, but the message will not be retained if power goes off.

The MESSAGE TEST button plays the recorded message through the handset so you can hear what you've recorded. If you don't like your message—simply record over it. You'll never need a tape demagnetizer! The REDIAL button re-dials the last number called.

A switch on the upper right corner of the front panel allows you to select be-

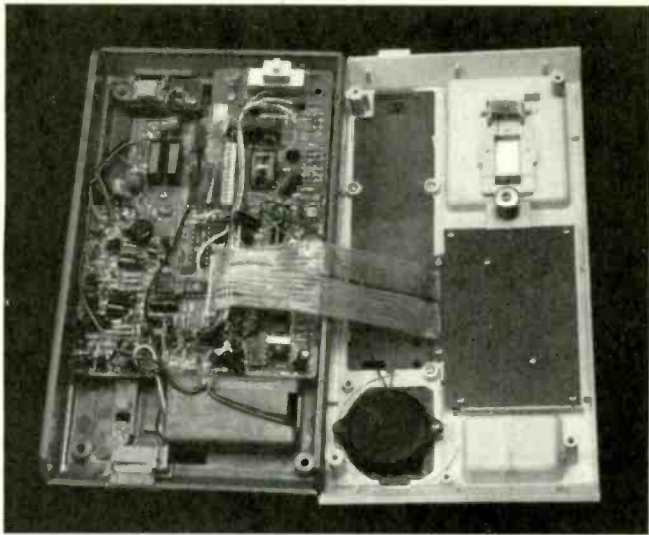

Looking into the open back of the unit, note that most of the electronics are located on a single circuit board, which is connected to the keypad by a thin ribbon cable. The circular object below and slightly left of the keypad is the microphone.

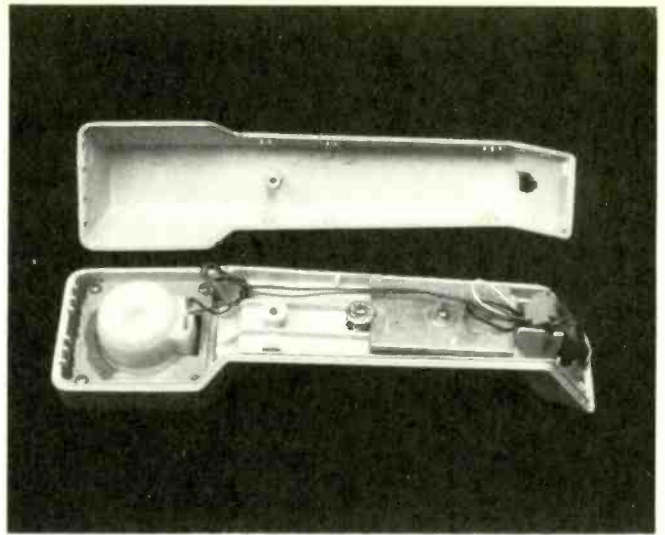

The DUoFONE's handset is almost completely void of anything electronic—in fact, other than the speaker, it contains only a modular jack and some connecting wire.

tween *phone* and *answer* modes. In the former, the TAD-105 functions as a normal telephone; in the latter, it waits for two or three rings and then plays your pre-recorded message.

The last front-panel button is the RECORD button, which when pressed, lights an LED; then, by speaking into the handset's microphone, your message is recorded. The recording time is always ten seconds; so a five-second message would be followed by five seconds of background noise.

On the right side of the unit are two slide switches: RINGER and PULSE/TONE. The latter allows you to choose pulse or tone dialing; the former allows you to set the volume level of the electronic ringer (off, low, or high).

On the bottom of the case is a connector for a standard handset coil-cord connector; on top is a jack for connecting the TAD-105 to the phone line, and another for the nine-volt transformer. The back side of the case has screw-head slots for wall mounting; screws are provided, as are complete mounting instructions. A sticker is affixed to the back side; the sticker contains FCC registration information, etc., and a notice that the phone was "Custom manufactured in Korea for Radio Shack."

There's not much to installing and operating the TAD-105. The owner's manual includes clear instructions and numerous diagrams to aid both installation and operation. Even a schematic is included. In addition, all connecting cords are included with the unit.

### How It Works

A block diagram of the circuit is shown in Fig. 1. As you can see, there are no tape cartridges or driving mechanisms; it's all

done with solid-state chips. In fact, the only electro-mechanical components are the microphone, the speaker, and the piezo-electric buzzer (see photos).

Most functions are accomplished by special IC's: dialing (U2), ringing (U1), and answering (U6 and U7). However, some functions are accomplished by discrete components: the microphone and speaker amplifiers, for example, are built using transistors and other components. In addition, not shown are the miscellaneous logic gates and counters that integrate the sub-sections.

The innovative part of the circuit, of course, is composed of U7 and U6—the speech-synthesizer and the 256K × 1 RAM IC's, respectively. The RAM is a 41256, which is used in many personal

computers. We were unable to obtain much information about speech synthesizer U7, but a block pinout diagram for the chip is shown in Fig. 2. Basically the way it works is that when pin 39 (WR) goes low, the circuit begins analyzing the signal present at pin 22 (ADI). It stores that signal in the attached RAM, U6.

The RAM has 256K *bits* of storage, which are accessible 1 bit at a time in serial fashion. How could those bits be used to *digitize* (convert to digital form) ten seconds of speech? A normal telephone line has a bandwidth of 3000 Hz. In other words, intelligible speech occurs in frequencies under 3000 Hz. To capture a 3000-Hz signal with reasonable fidelity, we must digitize it at a rate twice the

(Continued on page 104)

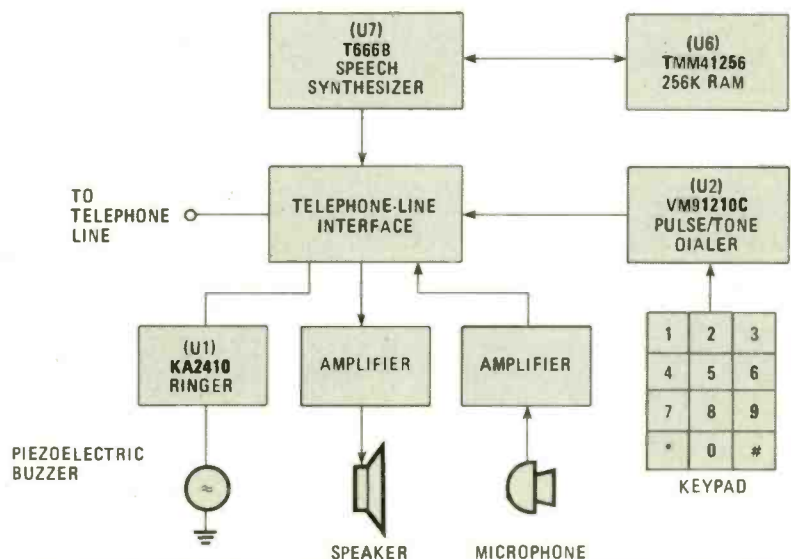
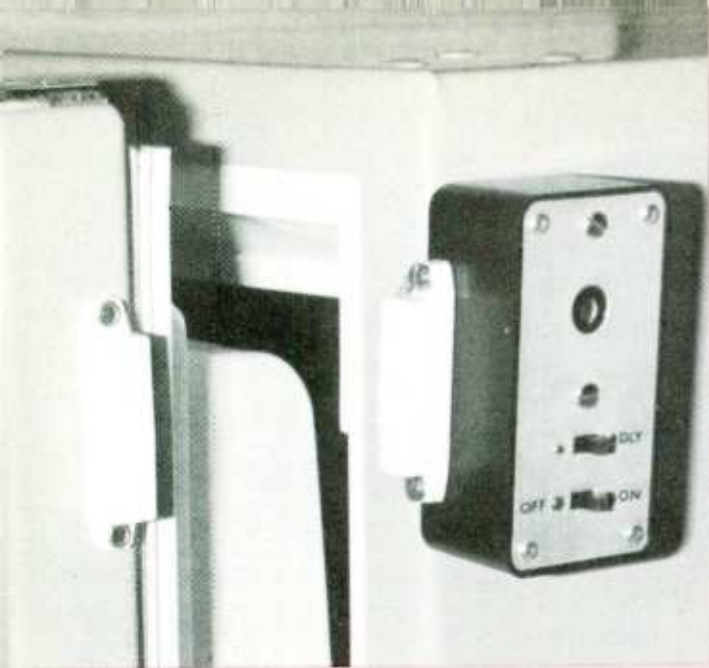

Fig. 1—The DUoFONE TAD-105 contains no tape cartridges or driving mechanisms; it's all done with solid-state IC's. In fact, the only electro-mechanical components are the microphone, the speaker, and the piezo-electric buzzer.



# Build a FRIG-DOOR ALARM

If you've got overeaters or absent-minded youngsters in the house, this project will stop them from wasting energy cold!

By Adolph A. Mangieri

□FRIG-DOOR ALARM SOUNDS OFF WHEN THE FREEZER OR refrigerator door is left ajar. A time delay built into the circuit lets you access the frig contents without sounding the alarm, but don't dally too long. The battery-operated alarm can also be used as an intruder alarm on any door to a room, closet, or cabinet.

After finding the door of my upright freezer partly ajar for more times than I care to tolerate, I decided that I needed a door alarm now wisely included in some refrigerators. A properly installed upright freezer or refrigerator is tilted backward slightly so that the door swings itself shut. As a result, one tends to let the door close itself—especially when both hands are busy. However, the door shelves may sometimes strike a parcel inside leaving the door ajar.

Do you know what happens when a freezer door remains ajar by half an inch overnight? Most, if not all, of the food on the door shelves is defrosted and must be used. Some food inside is partly defrosted raising the question of whether it is safe to refreeze it. Worse still, an *incredible* amount of frost forms on the inside the freezer. All that, plus the electricity wasted, amounts to an expensive headache.

You can purchase a simple battery-operated door alarm, which sounds immediately when the door is open or ajar. What you really need is an alarm with a time delay so that you can remove or place food in the freezer without disturbing the entire household—especially late at night.

## About the Circuit

Referring to the schematic diagram of the Frig-Door Alarm in Fig. 1, switch S1 is a magnetically operated reed switch that opens when the magnet is engaged. Switch S2 is the ON/OFF (arm/disarm) switch. Switch S3 is opened to provide a time delay before sounding if desired. Integrated circuit U1 is a 555 timer wired to begin the delay countdown when power is applied.

Let us assume that switch S2 is closed, switch S3 is open, and switch S1 is open when the door is closed. When the door is opened, switch S1 closes and applies power to the circuit. Capacitor C2 holds trigger input, pin 2 of U1, low for a brief

moment, causing U1 to begin timing. At that instant, the output voltage at pin 3 of U1 goes high. Piezo buzzer BZ1 does not sound because the voltage at pin 3 is very close to  $V_{cc}$ .

Initially discharged, timing capacitor C1 begins to charge through timing resistors R1 and R2. When the voltage across C1 reaches two-thirds of  $V_{cc}$  (in about a minute), U1 times out and the voltage at pin 3 falls low. That applies a voltage across buzzer BZ1, causing it to sound until switch S1 is opened by closing the door. If switch S3 is closed, the timing resistance consists of only resistor R2, resulting in a very small delay before the alarm sounds.

## Construction

Figure 2 shows the Frig-Door Alarm installed in a small plastic case. For rapid construction, the circuit was assembled on a perforated circuit board, but you can lay out and etch a PC board to hold the parts if you wish. The perfboard is supported on the buzzer, which is sandwiched between the board and the panel. Drill a half-inch hole in the panel to expose the opening on the buzzer.

Switch S1 consists of a reed switch with terminals, and a separate magnet, both in their own housing. I installed the reed switch on the right side of the case for a freezer door that has a handle on the left side. Install the reed switch on the plastic case using two 6-32 machine screws, which will also carry the switch connections into the case. Use a metal clip to hold the battery in the case.

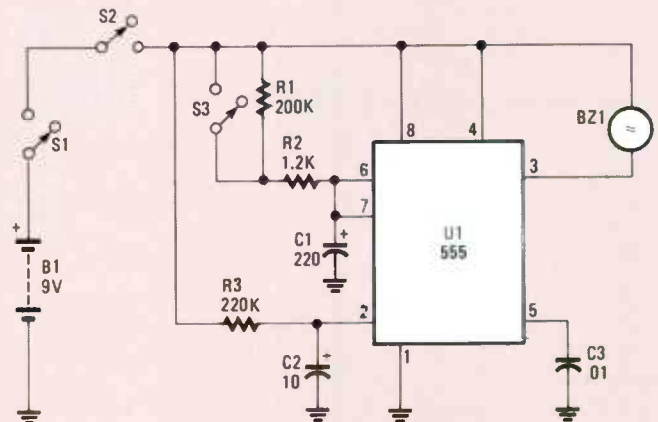
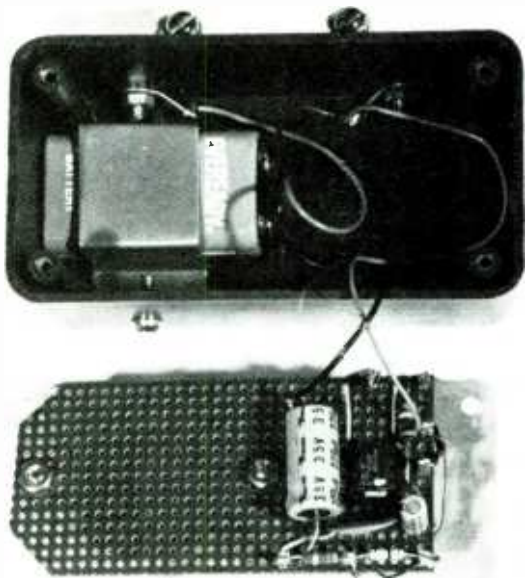

Fig. 1—Several reed switches can be paralleled to the one shown on the Frig-Door Alarm in case you want to keep tabs on both your refrigerator and freezer doors.



The metal clip acting as the battery holder was made by the author, but any that fits in the case will do the job.

Connect short wires to switches S2 and S3 before you install the circuit in the case. Wire the switches to the circuit board. Connect the battery snap connector and buzzer, paying close attention to their polarity. A wiring error can cause circuit damage.

The time delay depends on the size of resistor R1. The delay is about one minute. Doubling R1 doubles the delay. I used a 200,000-ohm resistor, but you can use larger values if you prefer a longer time delay.

To check circuit operation, turn S3 on for minimum delay. Place the magnet against the reed switch and turn S2 on. Removing the magnet should sound the alarm. Repeat the test but with S3 turned off for delayed activation to check the one-minute (or longer) delay.

If the alarm does not sound during either test, check the

#### PARTS LIST FOR THE FRIG-DOOR ALARM

##### CAPACITORS

C1—220- $\mu$ F, 25-WVDC electrolytic  
 C2—10- $\mu$ F, 25-WVDC electrolytic  
 C3—0.01- $\mu$ F ceramic disc

##### RESISTORS

(All resistors are 1/4-watt, 5% units.)  
 R1—200,000-ohm  
 R2—1200-ohm  
 R3—220,000-ohm

##### ADDITIONAL PARTS AND MATERIALS

B1—9-volt, alkaline, transistor-radio battery  
 BZ1—Piezo buzzer (Radio Shack 273-060 or equivalent.)  
 S1—Door switch (Radio Shack 49-512 or equivalent; see text.)  
 S2, S3—Miniature single-pole, single-throw slide switch  
 U1—555 timer, integrated circuit

Small case, perfboard, battery connector, battery clip, 2-sided tape, flea clips (for use with perfboard), wire, solder, etc.

circuit wiring, paying close attention to the polarity of buzzer BZ1. The circuit will not trigger if capacitor C2 is open. With the alarm sounding, move the magnet slowly towards switch S1 and the alarm should cease when the magnet is about a quarter of an inch from the reed.

#### Installation

Secure the Frig-Door Alarm to the freezer door using 2-sided adhesive-tape strips. Do not drill holes in the freezer especially in the compartment because you may damage a wire or thermal bulb element, not to mention yourself. For a larger mounting surface, the magnet can be glued with epoxy to a small flat plate, which in turn is secured to the door edge with 2-sided tape.

Turn S2 and S3 on to sound the alarm. Slowly slide the alarm case with the reed switch towards the magnet until the

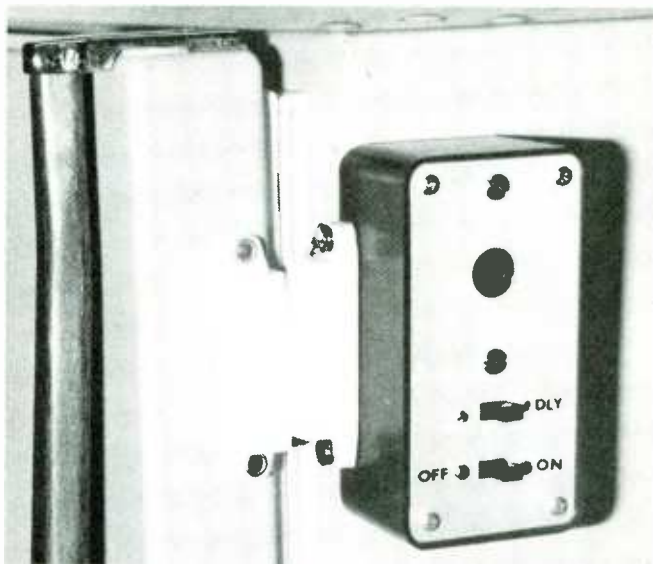

The Frig-door Alarm is shown here mounted on a left-side hinged door of a freezer. Do not drill holes in the refrigerator or in any way break the metal outer shell of the unit or door. Instead, use a water-proof glue or double-sided foam tape. The unit's reed switch can be mounted on either side of the box, so decide where the alarm will be used before mounting the switch.

alarm ceases. Using the switch specified in the Parts List, you should have about a one-quarter-inch gap between the magnet and reed switch. Now, try opening and closing the door very slowly. Move the case a bit closer if needed to stop the alarm. Strive for as much gap as possible between the magnet and switch sections. That minimizes the hysteresis effect typical of the magnet-actuated switch.

To protect a second door on the appliance, install another magnet switch on the second door and connect it in parallel with switch S1.

The Frig-Door Alarm can be used on an entrance or interior door. Install the magnet on the door at about eye level and install the alarm unit on the door jamb. Position the magnet about one-eighth of an inch from the face of the reed switch. Set switch S3 to delay and enter and close the door within a minute to avoid sounding. Turn switch S2 off to disarm the alarm when leaving the door open.

It's best to use a 9-volt alkaline battery, but you can use a zinc-carbon battery. Check the battery from time to time by closing S3 for no time delay and opening the door. Replace the battery if the sound is weak or trails off. ■

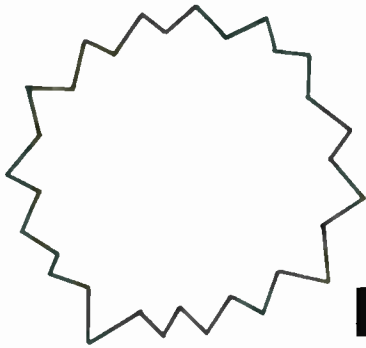

# MicroTrek dBASE III PLUS Learning System

**A video cassette and thorough manual tames programmer's fears and reduces learning time to mere hours!**

□LOOKING AT SOME OF TODAY'S FANCY AUTOMOBILES, IT'S HARD to believe that they're descended from the crotchety, finicky models of yesteryear. And so it is with personal computer software. In the *early days* (about ten years ago) keyboards and monitors were luxuries—and applications programs (word processors, spreadsheets, and database managers) were crude, if not non-existent. Of course, some of those programs improved, but not to a level where neophytes could literally dive into the program and produce excellent results almost immediately.

But that's all changed. And one product that's a living embodiment of the evolutionary process that microcomputer software has gone through is marketed by Ashton-Tate, one of the big three (also including Microsoft and Lotus Development Corporation) of microcomputer software. It's called *dBASE III PLUS*, and it's a database manager—a program that allows you to keep files of related information (names and address, inventories, accounting information, etc.). Early versions of the program ran on CP/M computers; the current version runs on the IBM-PC.

*dBASE III PLUS* is a powerful program; over the years, the major enhancements to it have been in the area of making it easier to use. In fact, the program includes several separate



but integrated systems created to help you design your database, maintain it, and print reports. But even they are not enough, especially for persons who haven't the time, the inclination, or the ability to master a fairly complex computer application.

There is a way, however, to become proficient in *dBASE III PLUS*, without earning a degree in computer science. The MicroTrek Corporation (119 West 22nd Street, New York, NY 10011) has created a group of interactive video tapes that teach a number of popular programs, including MS DOS, Lotus 1-2-3, Multimate, and, as you've probably guessed, *dBASE III PLUS*.

The course consists of three parts: a videotape (in VHS, Beta, and 3/4inch formats), a workbook, and a special data disk with sample databases and programs. The video tape itself runs about 2-1/2 hours; MicroTrek recommends that you spend a total of about six hours on the course.

It is not designed for raw PC beginners; it assumes you have knowledge of basic DOS operations, including disks, subdirectories, etc. Assuming you can format and copy disks, you should have no trouble with the material presented.

The course and the workbook are broken up into three parts: Introductory Concepts, Navigation, and How-To. Section 1 starts with some basic information about what a database is (files, records, and fields), and why it's useful. In fact, a beginner will start to plot different concepts related to his profession, hobby interests, and home that can be applied to valid *dBASE* use.

*(Continued on page 97)*



Here is an IBM-clone, desk-top PC with the *dBASE III PLUS* manuals, six floppies (left), the MicroTrek manual, and video cassette (right) waiting for the reviewer to get started.



By Marc Ellis  
Contributing Editor

# NEW SOUNDS From

**M**AYBE IT WAS AT A GARAGE SALE OR CHURCH RUMmage. Or perhaps it was in grandma's attic. You were looking for something else, but you unexpectedly came upon a collection of 78 records. Not being able to resist opening one of the dusty old albums, you started leafing through the clumsy "pages."

The colorful labels—some familiar, some strange—displayed the names of artists and selections spanning a 50-year segment of recorded history. In no particular order, you turned up a Sousa march, a Rudy Vallee hit, a *big-band* instrumental, the title song from a Crosby and Hope road picture, and arias by Tetrizzini and Caruso. Intending to spend just a moment or two, you kept turning pages, reading labels and smiling—completely losing track of time.

Most of us have had an experience like that at one time or another. But those that succumb to the lure of the old discs and take a few home to play on the family hi-fi are generally disappointed. Depending on age and condition, the venerable tracks exhibit a variety of acoustical defects that are offensive to the modern ear. Boominess, muddiness, harshness, and various degrees of the ever-present surface noise—to name some of the major problems.

If that has happened to you, don't assume that your record finds are unplayable and relegate them to the attic for another decade or two. With just a little bit of effort and resourcefulness, you can extract some remarkably good sounds from the worn old grooves. It's a rewarding process that can be carried out with a minimum of expense, and might well become the focal point of a very absorbing hobby activity.

The 78 era (roughly 1898-1948) encompassed some of the remarkable and fascinating decades of our century. And prior to the introduction of radio broadcasting in the 1920's, those discs were the only form of mass media capable of bringing

an audio message into America's living rooms.

Out there on old 78's, still waiting to be discovered, is a treasure-trove of political speeches, vaudeville acts; popular, classical, and religious music. You'll find material reflecting the customs and culture of the turn of the century, two world wars, the jazz and swing eras, and a little bit of post World-War II. Interested in playing some of those records? Here's how to get started.

## Getting the Sound Off the Records

First of all, forget your living room record player. If it's a general-purpose unit at least a few years old, it probably does have 78 speed. But don't be tempted to use that equipment. Its stylus will be ground to fit the grooves of current long-playing records (0.7 mil radius). Such a stylus will bottom out in the much coarser grooves of a 78 record, rattling around and picking up more surface noise than program material.

What type of stylus does it take to play a 78 properly? There's no simple answer to that question, though—as we'll see—there is a practical one. In the early days of 78 recording, groove design was not standardized. Every manufacturer designed his own record-cutting equipment and the geometry of the groove was a matter of individual choice. But it didn't matter because (hi-fi fans, are you ready for this?) record-playing systems were designed to rather quickly grind the fine tip of the playback stylus (or needle, as it was called) to fit the shape of the groove. Tone-arm pressures were measured in pounds rather than grams, and the shellac material forming the record contained an abrasive filler to facilitate the grinding process. Needless to say, the needles (which were commonly made of steel, thorn, or fiber) quickly wore out. And, in fact, you were supposed to discard each needle after a few playings. Your ears would tell you when.



The reproduction of vintage recordings can develop into a captivating hobby

# OLD RECORDS

Starting in the mid 1920's, when the record industry was converting from acoustical (mechanical) methods of cutting records to electrical recording, groove geometry became standardized. That made it possible for styli to be pre-shaped to fit the grooves of all manufacturers and ground to a standard radius (about 3 mils). Over the years, cartridges were designed to require less and less stylus pressure. As a result, the pre-shaped styli could be made of harder, longer-lasting materials without running the risk of tearing up the record grooves. Osmium metal came into use as a stylus material, as did diamond and sapphire. The stylus no longer had to be changed frequently—but would last for multiple playings. Your ears told you so!

## Back to the Future

Once you set yourself up with a reproducing system that uses a 3-mil stylus, you'll be able to play most post-acoustical (about post 1925) 78's with reasonable assurance that you're doing the best possible job of extracting the sound from the grooves. Since there was no groove standard prior to that period, your results will be unpredictable on the earlier records. But I've listened to many acoustical pressings with such a stylus and the results have been quite acceptable.

Where can you find a 3-mil stylus today? I thought you'd never ask! You can still purchase such a stylus for the General Electric variable-reluctance cartridge (RPX series). That cartridge appeared on the market around the time that long-playing records were introduced. It was one of the first that could reproduce the sound fidelity built into those records. Its frequency response is essentially flat from 30 to 15,000 Hz—which was a vast improvement on the crystal cartridges in general use at the time. Most people who first heard one played through a good amplifier were bowled over by the

transparent quality and extended tonal range. Those cartridges work just as well today, and have more than what it takes to bring out the best sound in your vintage 78's.

The G.E. cartridges were available in both single—and dual-stylus models. The dual-stylus version was commonly supplied with a 1-mil stylus for LP records and a 3-mil stylus for 78's. Through an unusual *turnover* feature, the spring-loaded armature holding the styli could be turned to place either the 1-mil or the 3-mil stylus in playing position. Since many hi-fi fans of that era still wanted to accommodate 78 records, the dual-stylus model was very popular.

You might be able to acquire such a cartridge from a friend who was into hi-fi in the 1950's and maintains a well-stocked junkbox. If your present record player has a 78 speed and interchangeable cartridge shells, you could conceivably set up a shell with the G.E. cartridge bridged across both stereo channels. However, the G.E. unit tracks at 6-8 grams—considerably heavier than your modern cartridge. So you'll

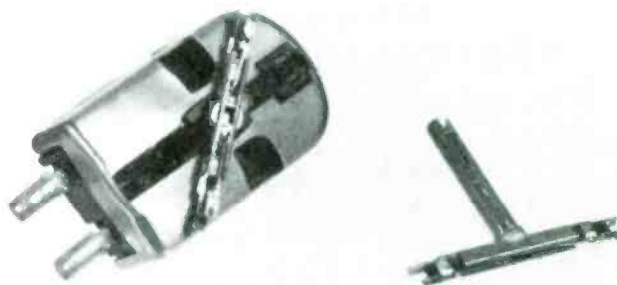

The G.E. RPX Series variable-reluctance cartridge is shown with its dual-stylus armature partly turned for better visibility. Its replacement armature is at the right.



Later model G.E. cartridge as found mounted in Garrard RC-88, bearing the designation *VRII*, takes the same replacement armature as original cartridge.

have to tape weights onto the G.E.'s shell (coins are good) to achieve the required pressure without disturbing the adjustment on your pickup arm

My own preference is to leave the living-room record player alone and set up another unit strictly for playing old records. As a matter of fact, if you can't locate a G.E. cartridge in a friend's junkbox, your best way of obtaining one is probably to purchase an entire record player from the early hi-fi era. Keep your eyes open at flea markets and rummage sales, and eventually you'll come across a fine old mid-1950's player. The Garrard RC-88 record changer was very common, as was a Garrard manual turntable called the 4 SP (4-speed). Those units almost always have a G.E. variable-reluctance cartridge installed, and you shouldn't have to pay more than a few dollars for either unit. Well-made though they are, neither has much value for playing modern records.

If you find a 4 SP, let me save you the trouble of figuring out how to turn it on! It's done by gently, but firmly, moving the tonearm to the right until you hear a click. That starts the turntable, which cuts off automatically when the stylus hits the run-out grooves at the end of the record. With the 4 SP, you should also remove the turntable and check the rubber bushings that isolate the motor platform from the turntable base. If they're dried out, your tone arm will pick up a lot of turntable rumble—but you can easily improvise sponge-rubber or foam replacements. The RC-88 is not afflicted with that problem, because it's mounted on springs. But try to find a unit that includes the accessory short spindle for using the changer in automatic-turntable mode. It can be a nuisance to thread records up and down the long record-changer spindle if you're playing them one at a time. And, unless you're careful, the practice is very likely to enlarge the spindle holes in the center of your records.



The Garrard 4 SP automatic turntable. To turn it on, the tonearm is simply moved to the right until a click is heard.

Once you've located your player and cartridge, picking up a stylus set for it is as easy as visiting your neighborhood Radio Shack store. The Radio Shack stock number is PO.1 and, while the item probably won't be in stock at the store, it can be readily ordered for you through Radio Shack's stylus/cartridge *hot line*. The styli (a 3-mil for playing 78's and a 1-mil for playing mono LP's) come already mounted on an armature which, following the included instructions, is very easy to install in place of the old armature already on your cartridge. Both of the Garrard players mentioned, by the way, have removable cartridge shells—which makes the installation procedure much more convenient.

After everything is installed on the tone arm, get out your stylus-pressure gauge and make sure that the pressure is set between 6 and 8 grams. When you've done that, the player is ready to spin your 78's. By the way, don't hesitate to play your old mono LP's on that setup (using the 1-mil stylus, of course). The stylus fits the record grooves better than the one installed on your stereo player, and you may notice a pleasant improvement in reproduction.

### A Question of Equalization

If you should now hook up your newly-refurbished record player to your hi-fi amplifier, most of your old mono LP's should sound just fine (though some may require a little tweaking of the tone controls). But reproduction of 78's will



The Garrard RC-88 changer, with a short spindle accessory for automatic turntable mode is installed. Longer spindle for record changer mode is displayed on turntable mat.

still be disappointing. They'll generally have a very thin sound, and some of the more recent electrically-recorded discs will have a greatly accentuated (boomy) base. The problem is not entirely due to the primitive recording and manufacturing techniques used to produce the discs. There is sound quality in the old grooves that is not getting to your speakers, and the reason lies in the equalization of your playback amplifier.

Prior to the introduction of magnetic cartridges to the general public well over thirty years ago, the term *equalization* (as applied to sound reproduction) was familiar only to recording engineers. But by the early 1950's, every serious hi-fi enthusiast was thoroughly familiar with the concept. Today, none but the most technically-minded hi-fi nuts (and, of course, the sound engineers) worry about sound equalization. So if we want to play 78's correctly, we must return once



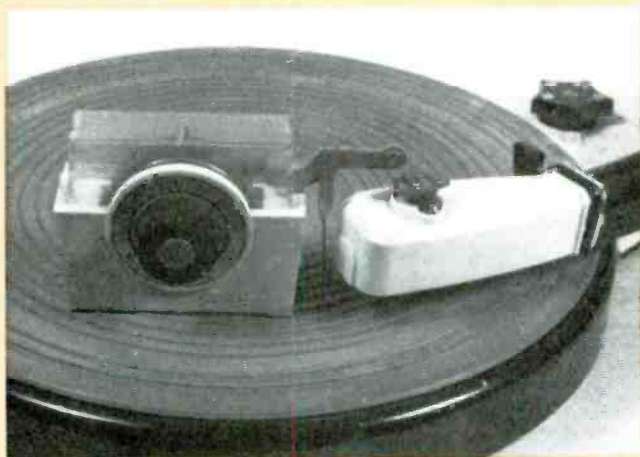

After your new styli are installed, be sure that you set stylus pressure at between six and eight grams.

again to the 1950's and reacquaint ourselves with some of the early technology.

During the cutting of a master recording, the volume of high-frequency sounds (those above 1000 Hz) is boosted. That emphasized signal is then capable of overriding needle scratch and other undesirable noises found at the high end of the audio spectrum. Conversely, the volume of low-frequency sounds (below 1000 Hz) is retarded. That's done to limit the wide swing of the record cutter at the frequencies—which would otherwise make it necessary to have wide spaces between record grooves—reducing playing time. The overall process is called equalization.

In early acoustical recordings, the equalization was done mechanically by careful placement of instruments and vocalists in relation to the recording horn. Higher-frequency sound sources (and those too weak to be picked up easily by the crude recording system) could be placed closer to the horn; lower-frequency sources (and those that were too overbearing) could be placed farther away. That kind of sound manipulation was not particularly noticeable to the listener, because of the very limited reproduction capabilities of the playback equipment.

Later, when electronic (or *electrical*, as it was first called) recording replaced acoustical techniques, the instruments

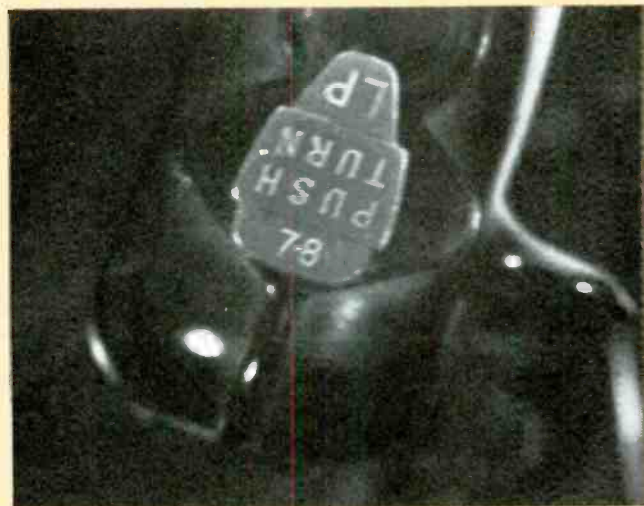

Top view of shell with cartridge installed shows tab that indicates which stylus is in playing position.

and vocalists could be left in their traditional positions. Recording equalization was handled by use of sound attenuation and boosting circuits; sound balance by multiple, individually-controlled microphones.

### Matching Playback and Record Equalizations

For many years, no special playback equalization was needed to compensate for the recording equalization. Not even when crystal cartridges and vacuum-tube amplifiers replaced the early acoustical pickups—with great increase in sound fidelity. As it happened, the natural playback characteristics of the crystal cartridge (which tended to emphasize lows and suppress highs) neatly balanced out the high-frequency boost and low-frequency attenuation introduced during the record mastering process.

But with the advent of the magnetic cartridge—whose response did not favor lows or highs, but was naturally flat—attention had to be paid to playback equalization. Especially because the availability of improved amplifying and reproducing equipment was beginning to produce a generation of very discriminating listeners. By the late 1940's, when hi-fi enthusiasts were beginning to play the new 33 $\frac{1}{3}$ -speed LP



The input selector on this mid-1950's hi-fi amplifier includes four magnetic cartridge equalization positions.

records on magnetic cartridges, the better playback amplifiers were beginning to include equalization controls. The controls were rotary switches directing resistance and/or capacitance networks designed to tailor the playback characteristics of the amplifier.

Several positions were provided, so that playback equalization corresponding to the recording equalizations used by various major record manufacturers could be selected. In other words, each equalization setting custom-tailored the characteristics of the low-frequency boost and high-frequency attenuation provided by the amplifier to complement those of the low-frequency attenuation and high-frequency boost used in the cutting of the record. The result was that the listener heard a reasonably flat reproduction of the original program material, with neither the low- or high-frequency areas of the sound spectrum either favored or attenuated.

But back then, there was no standardization of equalization curves; each manufacturer worked out his own. At one time, there may have been thirty or more different curves in use. The average amplifier could provide just a few of the most common settings (typically, AES, NARTB, RCA, DECCA). Accompanying literature usually guided the listener to the closest equalization setting available for the desired record.

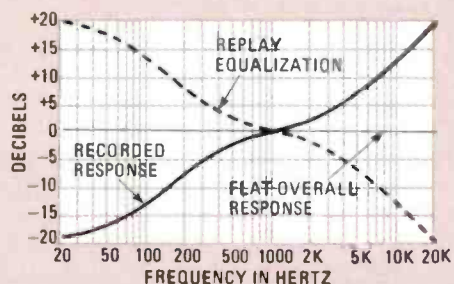

Fig. 1—Shown here is the RIAA recording and playback equalization curve that was adopted as the standard in 1953. Prior to that year, the curves were not standardized, and as a result, many variations were in use.

Any discrepancies could be made up by judicious manipulation of the tone controls.

All of that confusion came to an end when, in 1953, the record manufacturers agreed on a common standard—known as the RIAA (Record Industry Association of America) equalization. In the years since then, equalization controls slowly disappeared from hi-fi amplifiers and preamps. And today, they are very rare indeed. RIAA equalization is built into the circuitry, and that's that.

But the RIAA equalization is wrong for most 78's, except for a relatively few discs mastered during the last few years of 78 manufacture. That's why, even with the proper stylus and a good magnetic cartridge, you won't get proper reproduction on modern amplifiers. The recording and playback characteristics are too different, and the difference between them is too great to be compensated for through manipulation of the amplifier tone controls.

The most obvious way of dealing with the problem (acquiring a vintage amplifier having an equalization control) isn't necessarily the most effective. The difficulty is that a great variety of different equalization curves were used in making the early 78's, and the characteristics of many of them weren't exactly common knowledge. Equalization controls were put on amplifiers mainly with the more predictable requirements of LP playback in mind.

If you have many pre-1953 mono LP's in your collection, those settings will be very helpful to you. The proper equalization will often be found on the jackets or labels of such

recordings. Should your amplifier have a setting that matches, you'll get a much more precise reproduction than possible with a modern amp having RIAA equalization. But to get good results from 78's, you can do better than using fixed equalization settings followed by tweaking with the tone controls.



Radio Shack #32-1115 5-band mono equalizer. Even a simple unit such as this unit will be amazingly effective in adding richness and depth to your old audio tracks.

### Enter the Graphic Equalizer

We had to go back to the early days of hi-fi to find a good way of getting the sound off 78 record grooves—but present-day technology offers the best method of obtaining the proper playback equalization. What I'm talking about is the graphic equalizer. Widely available today from many different sources, and at very reasonable prices, that versatile method of sound control will allow you to massage the sound from your 78 records and make it surprisingly listenable.

Even a simple 5-band equalizer, used in conjunction with an amplifier having only the standard RIAA equalization, will make it possible for you to extract amazing tonal quality from your vintage discs. With the more sophisticated 10- or 12-band units, you can even begin to improve on the original recording process—eliminating disturbing resonances or selectively boosting thin sounds to greater audibility.

I've had great success with an inexpensive 5-band mono frequency equalizer (cat. #32-1115) that was closed out by Radio Shack about a year ago. Some stores may still have remaining stock available at attractive prices. Since that unit was designed for use with public-address systems, it has a mike-level input and output in addition to the line-level input and output normally available on a graphic equalizer.

The mike output makes a good impedance match with the G.E. magnetic cartridges and the gain characteristic of the equalizer (which is adjustable) is such that it can be used as an independent phono preamp. In that case, the line output is plugged into the amplifier AUX or TUNER input—bypassing the amplifier's internal phono preamplifier stage and whatever equalization it might have. Alternatively, the mike-level output of the graphic equalizer can be wired to the PHONO (magnetic) input of the amplifier, thus superimposing the equalization supplied by the graphic unit on that obtained from the amplifier's internal preamp.

Using the first method, I get a better idea of how I'm massaging the sound because the settings shown on the control panel of the graphic equalizer represent the actual playback equalization. On the other hand, the second method

(Continued on page 102)

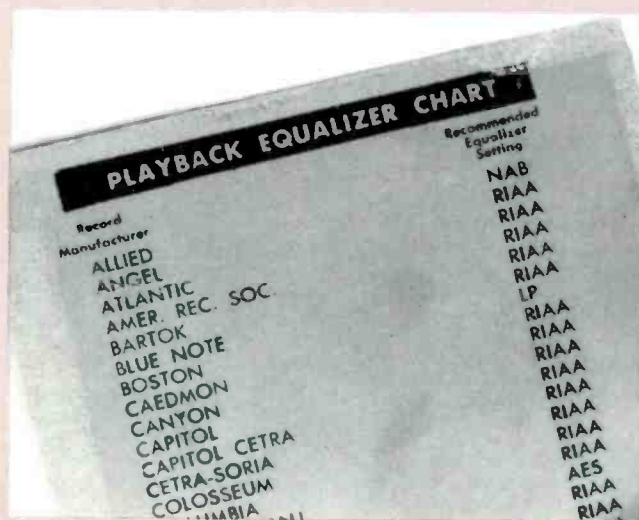

Equalization chart for late 1950's Pilot amplifier. By this time, the RIAA standard was well established, and being recommended for most records.

# Electronic Fundamentals

By Louis E. Frenzel, Jr.

## Operational amplifiers are basic building blocks.

□ OPERATIONAL AMPLIFIERS ARE CONSIDERED BASIC BUILDING blocks because often they can be used to assemble electronic circuits much in the same manner that a child would use toy blocks to construct a building, a train, a car, or a rocket ship.

A child would make his creation by piling one block on another. By using operational amplifiers—usually called op-amps—you can build electronic circuits the same way; by piling one electronic building block on another. For example, if you needed 60 dB of gain for an audio amplifier having a magnetic phono input you could go through the hassle of designing a single amplifier to do the job. Alternately, you might reach on the shelf and select three op-amp building blocks: one having 20 dB gain and equalized for a magnetic phono pickup, the other two being “flat” amplifiers with 20 dB gain.

Most likely, the output of one op-amp could simply be connected to the input of another op-amp without need for matching networks of any kind. You’d connect all three building blocks in cascade (series) and end up with a 60 dB

amplifier equalized for a magnetic phono pickup.

Notice that both equalized and unequalized op-amps have been used in the circuit. That’s the nice part about building blocks; within reason, everything usually fits together even if the building blocks are actually different kinds of circuits.

Our lesson on op-amps uses the *programmed instruction format*, whereby the information is presented to you in “chunks” called *frames*. You will read the information in each frame and then immediately answer a question based on the material by filling in a question blank(s) with appropriate words or figures. The answer to each question is given in parentheses at the beginning of the next frame in sequence.

As you progress through the lesson, use a sheet of paper to keep the frame immediately below the one you are reading covered so that you won’t accidentally see the correct answer. The easiest way to do that is to slide the paper down until it just touches the line separating the frames.

We hope you enjoy learning about electronics through programmed instruction. Please write and let us know how you like it. Start now with frame 1.

### OPERATIONAL AMPLIFIERS

1. The operational amplifier, or op-amp, is one of the most versatile and widely used amplifiers. Operational amplifiers come by their name because they were originally used in analog computers, instruments, and control systems to perform mathematical “operations” on electrical signals. Operational amplifiers are still used in such applications, but their usefulness extends well beyond that. They often replace more conventional amplifiers, and their great circuit flexibility permits them to be used as a basic building block for special amplifiers, oscillators, and a variety of signal processing and generating circuits. Low cost integrated-circuit op-amps are found in virtually every conceivable type of electronics equipment.

*Operational amplifiers are more commonly called*

2. (op-amps) Op-amps are complex multi-transistor circuits that have the following characteristics:

- Very high gain

- Direct coupling
- High input impedance
- Low output impedance
- Differential inputs

Let’s consider each in more detail.

All op-amps have very high gain. Ideally, infinite gain would be perfect, but impractical. A simple op-amp may have a gain of 1000, but more commonly the gain is tens or hundreds of thousands. The higher the gain, the better. You will hear this gain referred to as *open-loop gain*. Open-loop gain is the gain of the op-amp without feedback.

*A typical op-amp gain is:*

- 500
- 100,000
- 2,000,000

3. (b. 100,000) Integrated-circuit op-amps as a component do not have feedback. Feedback is the process of applying some output voltage back to the input. Most op-amps are



connected into circuits that use external components to provide feedback. The feedback invariably modifies some of the op-amp's characteristics, including gain and output impedance. When feedback is used, the circuit is said to be a *closed loop*.

The gain of an op-amp without feedback is called \_\_\_\_\_ gain.

4. (open loop) Op-amps are also direct-coupled circuits. There are no internal capacitors or transformers in the coupling path to block DC. Therefore, they can amplify DC as well as AC signals.

An op-amp has an input of 3 microvolts DC and a gain of 200,000. The output voltage is \_\_\_\_\_ volts DC.

5. (.6) Output is the input multiplied by the gain, or  $.000003 \times 200,000 = .6$  volts. The DC signal was amplified by the direct-coupled op-amp.

Op-amps also have a high input impedance ( $Z_i$ ). High, of course, is a relative term. In op-amp technology, *high* means more than 100,000 ohms. Op-amps having bipolar transistors at the input have input impedances in the range of 100,000 ohms to 2 megohms. Input impedances of several megohms are obtained with op-amps using field effect transistors (FET's) at the input. In practice, the higher the input impedance, the better the op-amp.

High input impedance is obtained by using \_\_\_\_\_ transistors at the input.

6. (field effect) A high quality op-amp also has very low output impedance ( $Z_o$ ). While an ideal zero-ohm output impedance is not achievable, in practice the open loop output impedance is usually in the range of 50 to 300 ohms. But with feedback,  $Z_o$  will be less than 1 ohm in most instances. The almost zero output impedance permits the op-amp to be a near ideal voltage source, thereby having the power to drive heavy loads.

With feedback,  $Z_o$  is typically less than \_\_\_\_\_ ohm(s).

7. (one) Another characteristic of op-amps is *differential input*, which means that the amplifier has two inputs and that the output is the mathematical difference between the two multiplied by the gain. If the inputs are  $E_1$  and  $E_2$  and the gain is  $A$ , then the output  $E_o$  is:

$$E_o = A(E_2 - E_1)$$

The op-amp algebraically subtracts  $E_1$  from  $E_2$ , then multiplies the difference by the gain,  $A$ .

Differential input allow op-amps to work with balanced (ungrounded) signals, and have great flexibility in processing signals.

If  $E_1 = 5$  microvolts DC, and  $E_2 = 7$  microvolts DC, and the gain is 100,000, the output is \_\_\_\_\_ volts.

8. (.2) Here is the solution:

$$E_o = A(E_2 - E_1)$$

$$E_o = 100,000(.000007 - .000005)$$

$$E_o = 100,000(.000002)$$

$$E_o = .2 \text{ volts}$$

As you can see, the op-amp is indeed performing mathematical operations. The differential input performs subtraction while the gain multiplies the signal by a constant.

Figure 1 shows the symbol used to represent an op-amp. It has two inputs and an output. The inputs are labeled with a + and a -. The + input is called the *non-inverting input*. A DC signal applied there will produce a signal of the same polarity at the output. An AC input signal at the + input will be in phase with the output.

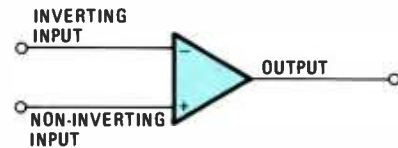

Fig. 1—This is the conventional schematic symbol used to indicate a two-input op-amp.

The - input is called the *inverting input*. A DC signal applied there will have its polarity reversed. An AC input signal will produce an output that is 180° out of phase with the input (it is inverted).

A DC signal applied to the - input will produce an output whose \_\_\_\_\_ is \_\_\_\_\_.

9. (polarity, reversed) A + DC input will produce a - DC output and vice versa.

An AC input applied to the + input creates an output that is:

- a. in phase
- b. 180° out of phase

10. (a. in phase) Op-amps are rarely used in the basic configuration shown in Fig. 1. Instead, external components such as resistors and capacitors are connected to the op-amp to modify its characteristics, improve its performance, or customize its function. Most of the external connections provide negative feedback. Feedback is an electronic technique whereby some of the output of a circuit is fed back to the input. Negative feedback means that the input and outputs have opposite phases or polarities. It is negative feedback that gives an op-amp circuit its operational characteristics.

Most op-amp circuits feed some output back to the input. This is called \_\_\_\_\_.

11. (feedback) Feedback where the output and input are out of phase is said to be \_\_\_\_\_.

12. (negative) Feedback where the output and input polarities and phases are the same is said to be positive. Positive feedback is used to produce oscillation, as you will see later.

The most common way of providing negative feedback in an op-amp circuit is to connect a resistor ( $R_f$ ) from the output back to the inverting input, as shown in Fig. 2. An input resistor,  $R_i$ , accepts the input. The + input is grounded. The resulting amplifier is an inverter whose gain is a function of the feedback and input resistors. In fact, the gain ( $A$ ) of the

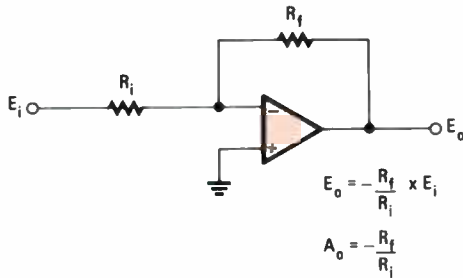

Fig. 2—An op-amp inverter circuit with finite voltage gain.

circuit is simply the ratio of  $R_f$  to  $R_i$ :

$$A = -R_f/R_i$$

The minus sign indicates inversion.

Negative feedback makes the circuit's gain dependent upon only the external component values.

The gain of the circuit in Fig. 2 is \_\_\_\_\_.

13. ( $-R_f/R_i$ ) If  $R_f = 10,000$  ohms and  $R_i = 2000$  ohms, the gain  $A$  is  $-10000/2000 = -5$ . Any input voltage will be multiplied by 5 and inverted. A 1.3 volt sinewave applied to the input will produce an output of  $1.3 \times 5 = 6.5$  volts that is  $180^\circ$  out of phase with the input.

An op-amp inverter has  $R_f = 270,000$  ohms,  $R_i = 30,000$  ohms, and the input voltage is  $-0.8$  volts DC. The output voltage is \_\_\_\_\_ volts.

14. (7.2) The gain is  $270,000/30,000 = 9$ . The output is  $-9(-0.8) = 7.2$ .

The op-amp inverter is one of the most widely used op-amp circuits. It has an input impedance that is approximately equal to the value of the input resistor,  $R_i$ . The reason for that is that the negative feedback makes the  $-$  input appear as though it is at ground potential. It isn't actually ground or zero volts because there has to be a small input voltage for the op-amp to amplify. But the voltage is so low as to be practically zero compared to the input and output. The  $-$  input is called the *summing junction* in this circuit and is said to be a *virtual ground*.

An inverter op-amp has  $R_f = 120,000$  ohms and  $R_i = 15,000$  ohms. The input voltage is 0.75. The input impedance ( $Z_i$ ) is \_\_\_\_\_ ohms.

15. (15,000) The input impedance is approximately  $R_i$ .

A popular variation of the inverter is the summing circuit shown in Fig. 3. Notice that three inputs are used. The circuit performs an algebraic addition of the three input voltages  $E_1$ ,  $E_2$  and  $E_3$ . The output voltage,  $E_o$ , is the inverted sum of the inputs; each multiplied by a gain factor. The formula below

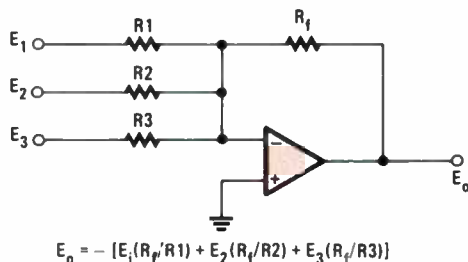

Fig. 3—An op-amp used as a voltage-summing amplifier.

expresses the output in terms of the inputs.

$$E_o = -[R_f/R_1(E_1) + R_f/R_2(E_2) + R_f/R_3(E_3)]$$

As you can see, each input is multiplied by a gain of  $R_f/R_i$ , where  $R_i$  is the associated input resistor. All the inputs are added and the sum inverted.

Here is an example:

$$\begin{aligned} R_f &= 10K & E_1 &= 3 \\ R_1 &= 1K & E_2 &= 4 \\ R_2 &= 2K & E_3 &= -6 \\ R_3 &= 5K & & \end{aligned}$$

$$\begin{aligned} E_o &= -[10K/1K(3) + 10K/2K(4) + 10K/5K(-6)] \\ E_o &= -[10(3) + 5(4) + 2(-6)] \\ E_o &= -(30 + 20 - 12) \\ E_o &= -38 \end{aligned}$$

Summing circuits are often used when two or more AC signals must be linearly mixed. An example is the mixing of audio from several microphones and musical instruments.

A summing op-amp has  $R_f = 100K$ ,  $R_1$  and  $R_2 = 20K$ ,  $E_1 = -9$  and  $E_2 = 15$ .  $E_o =$  \_\_\_\_\_ volts.

16. (-30) The solution is:

$$\begin{aligned} E_o &= -[100K/20K(-9) + 100K/20K(15)] \\ E_o &= -[5(-9) + 5(15)] \\ E_o &= -(-45 + 75) \\ E_o &= -30 \end{aligned}$$

The above example brings up an important point. The example says that the output will be  $-30$  volts. In practice, that is not usually possible. Most IC op-amps operate from two power supply voltages, usually  $+15$  and  $-15$ , or sometimes  $+12$  and  $-12$  volts. They are sometimes indicated on schematic diagrams as shown in Fig. 4. The supply voltages set the output voltage swing limits, and the output cannot exceed those levels. In the example above, the output would not be  $-30$  volts. It would be  $-15$ , the limit of the negative supply. Of course, that is a mathematically incorrect output.

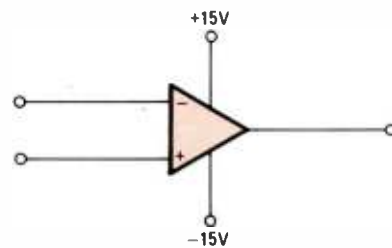

Fig. 4—These are the typical power-supply voltage connections for an op-amp.

For that reason, the inputs, gains, or both must be scaled down to keep the output within the power supply's voltage range.

Common DC supply voltages for IC op-amps are \_\_\_\_\_ and \_\_\_\_\_ volts.

17. ( $+15, -15$ ) It is possible, of course, to design op-amps with higher supply voltages and output-swing limits. Op-amps used in some big analog computers can swing in excess of  $+100$  and  $-100$  volts. In most cases, it is possible to reduce the signal levels so you can work in the available output range.

An IC op-amp inverter operates from +15/-15 volt supplies ( $\pm 15$  volts). The gain is 10 and the input voltage is a sinewave with an amplitude of 4 volts peak-to-peak (4V p-p). Draw the output waveform.

18. (See Fig. 5) The output is a sinewave with its peaks clipped. An amplifier with a gain of 10 would produce a 40-volt peak-to-peak output. But the supply voltage(s) limit the swing to +15/-15 or 30 volts p-p. Therefore, clipping or distortion occurs.

Another very popular op-amp circuit is the voltage-follower shown in Fig. 6. There are no feedback or input components. The output is tied directly back to the inverting input, thereby giving 100% negative feedback. The input is applied to the non-inverting input. The circuit is the op-amp version

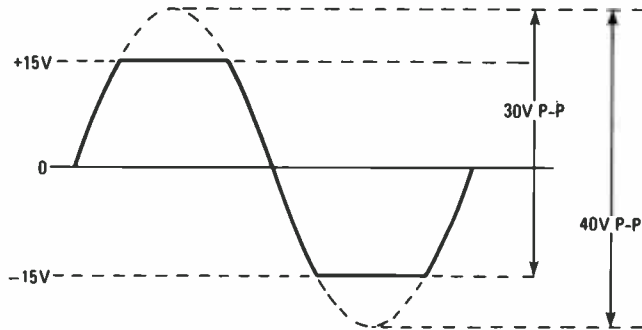

Fig. 5—Excessive sinewave signal input voltage and/or op-amp voltage gain will produce a clipped sinewave.

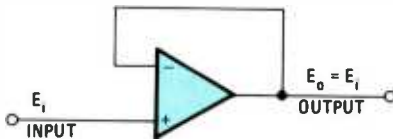

Fig. 6—An op-amp unity gain voltage follower is an unusually simple circuit to assemble.

of an emitter-follower. The circuit has a very high input impedance and an extremely low output impedance. The gain is 1—called “unity gain”—and no inversion takes place. Therefore, the output is equal to the input.

A -3 volt input is applied to an op-amp voltage-follower. The output is \_\_\_\_\_ volts.

19. (-3) The value of a voltage-follower is its ability to isolate or buffer one circuit from another. The input impedance of many megohms represents a negligible load on almost any circuit. The low output impedance lets the circuit drive heavy loads. Essentially, the voltage-follower is a power amplifier; it is used where two circuits must be coupled with minimum loading effects.

The gain of a voltage-follower is \_\_\_\_\_.

20. (+1 or unity) Sometimes a non-inverting amplifier with gain is required. That combination of qualities can be obtained with the circuit shown in Fig. 7. The circuit is similar to a standard inverter, but the input resistor ( $R_i$ ) is grounded and the input signal is applied to the non-inverting (+) input. The gain of this circuit is:  $1 + R_f/R_i$ . If  $R_f = 100K$  and  $R_i = 40K$ , the gain is  $1 + 100K/40K = 1 + 2.5 = 3.5$ .

The gain of a non-inverting amplifier where  $R_f = R_i = 10K$  is

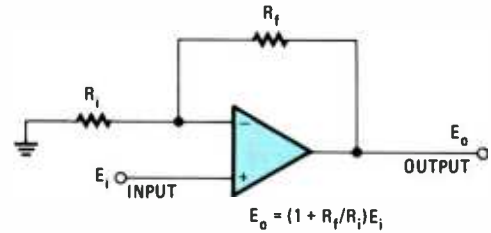

Fig. 7—This is a non-inverting op-amp having voltage gain.

21. (2) Most op-amps have a differential input. When signals are applied to both inputs the output is the difference between the two. Resistors can be connected to the op-amp to set the gains of the inputs. A typical arrangement is shown in Fig. 8. If all resistors are made equal in value, the output ( $E_o$ )

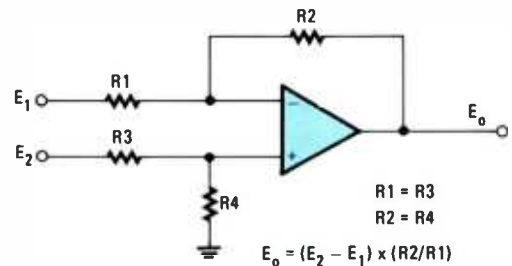

Fig. 8—A differential amplifier algebraically sums the two input signals and provides voltage amplification.

is the difference between the signals on inputs  $E_1$  and  $E_2$ :

$$E_o = E_2 - E_1$$

You can add gain to the circuit by making  $R_2$  and  $R_4$  greater than  $R_1$  and  $R_3$ . Actually,  $R_1 = R_3$  and  $R_2 = R_4$ . Under those conditions, the output is:

$$E_o = R_2/R_1(E_2 - E_1)$$

If  $R_2 = R_4 = 27K$ , and  $R_1 = R_3 = 3K$ , and  $E_1 = 7$  volts, and  $E_2 = 3$  volts, the output is:

$$E_o = 27K/3K(3 - 7)$$

$$E_o = 9(-4) = -13 \text{ volts}$$

If  $R_1 = R_2 = R_3 = R_4 = 10K$ , and  $E_1 = E_2 = 2.5$  volts, then  $E_o =$  \_\_\_\_\_ volts.

22. (0) If the inputs to a differential amplifier are equal, the output should be zero. In practice, that is basically true, but because of circuit imbalances and component differences and imperfections, the output will not be exactly zero. The quality of a differential amplifier is usually determined by how close its output is to zero with both inputs equal. That is usually expressed as the CMRR (Common-Mode Rejection Ratio). CMRR is a measure of the ability of an op-amp to cancel or reject signals that are present at both inputs. For example, a common problem with high gain, high input-impedance circuits is the pickup of stray 60-Hz powerline signals. Such signals will, of course, occur simultaneously at both inputs. If the amplifier's CMRR is good, the 60-Hz signals will be cancelled. Little or no 60 Hz will appear in the output.

A measure of a differential amplifier's ability to reject equal

signals at its inputs is called \_\_\_\_\_.

23. (common mode rejection ratio) A popular application for op-amps is active filters. Traditionally, filters are constructed of resistor-capacitor (RC) or inductor-capacitor (LC) networks. RC circuits have very high attenuation and gradual selectivity. LC filters have much less loss and greater selectivity, but inductors are larger and more expensive, especially at audio and powerline frequencies. Op-amps eliminate both the loss and expense problems. By using RC networks as input and feedback elements, an active filter with good selectivity having a gain (rather than a loss) can be constructed. Low pass, high pass, band pass and notch filters can be easily built by using an op-amp

A frequency-selective circuit having an op-amp as the main element combined with RC networks is called a(n) \_\_\_\_\_.

24. (active filter) Figure 9 shows three popular active filter configurations. A is a low-pass filter, B is a high-pass filter, C

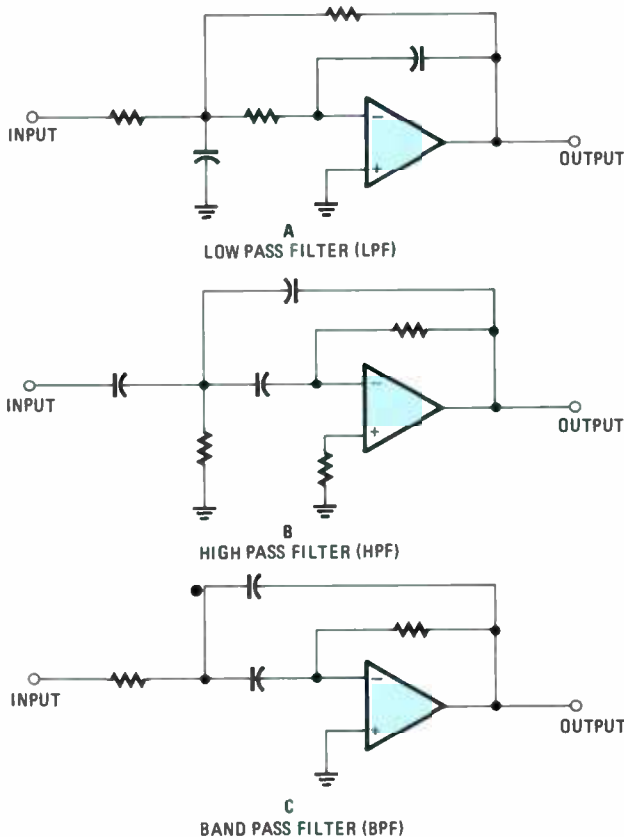

Fig. 9—These three op-amp circuits are commonly used as active, frequency-selective filters.

is a band-pass filter. Numerous other configurations are possible. Simply by selecting the right R and C values, the cut-off frequency (or center frequency on the BPF), gain, and Q (bandwidth of BPF) can be set. Such filters are highly desirable as they offer the following benefits.

- a. Small size/low weight
- b. Low cost
- c. Have gain

- d. Easy to cascade
- e. Easy to tune (frequency and Q adjustable)

Cut-off or center frequency is determined by the \_\_\_\_\_ and \_\_\_\_\_ values.

25. (R, C) Another widely used op-amp circuit is the integrator shown in Fig. 10, which performs mathematical integration. The inverter configuration is used with an input resistor (R) and a feedback capacitor (C). The output is the inverted integral of the input. For example, if the input is a sine wave, the output is a cosine wave, as shown in Figure 11A. The integral of sine is  $-\cosine$ , but the op-amp inverts this to  $+\cosine$ . If the input is a cosine wave, the output is an inverted sine wave, as shown in Fig. 11B. The integral of

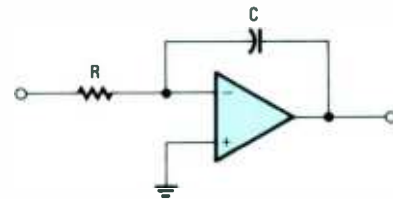

Fig. 10—An op-amp voltage integrator. It will integrate input-voltage waveforms.

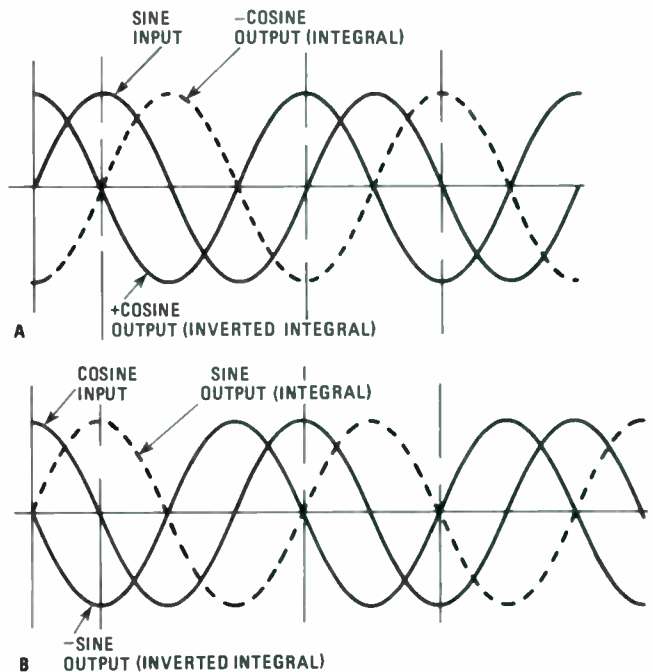

Fig. 11—This is the relationship between an integrator's inputs and outputs with sine- and cosine waves.

cosine is sine, but the op-amp inverts this to  $-\text{sine}$ . Keep in mind that sine waves and cosine waves have the same frequency and shape, but they are shifted in phase by  $90^\circ$ . The cosine wave leads the sine wave by  $90^\circ$ .

The feedback element in an integrator is a \_\_\_\_\_.

26. (capacitor)

With a sine wave input, the output of an op-amp integrator is \_\_\_\_\_. With a cosine input, the output is \_\_\_\_\_.

27. (cosine, -sine) Integrators are also used with DC and squarewave inputs. With a fixed DC input, the integrator generates a linear voltage ramp, as shown in Fig. 12. Assuming the feedback capacitor is initially discharged, when switch S1 is moved from A to B a positive voltage from power supply E (in this instance a battery) is applied to the input and

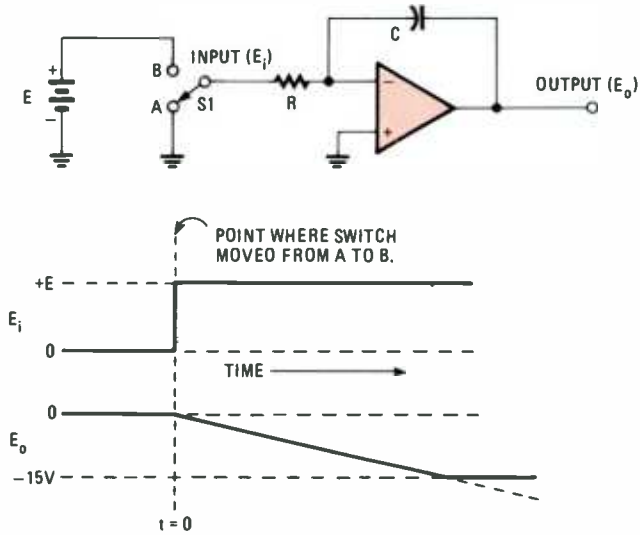

Fig. 12—Integrating a DC step-voltage will generate a linear ramp within the power supply confines.

the capacitor begins charging in a negative direction due to the inversion. The output voltage increases linearly and its value at any time t after S1 is moved to B can be computed with the formula:

$$E_o = -E_i(t)/(RC)$$

where E<sub>i</sub> is the DC input voltage, t is the time that the circuit integrates the input, and R and C are the resistor and capacitor values. Let's assume R = 100K, C = 1 μF and E<sub>i</sub> = 1 volt. If we let the circuit integrate the input for one half second, the output voltage at the end of the time period will be:

$$E_o = -(1)(.5)/(100,000 \times .000001)$$

$$E_o = -(1)(.5)(10)$$

$$E_o = -5$$

One half second after switching S1 from A to B, the output voltage will linearly ramp to -5 volts.

To produce a positive-going output ramp, an integrator must have a \_\_\_\_\_ voltage input.

28. (-DC) As long as the DC input is applied, the capacitor will charge and the output will rise. If the circuit in Fig. 12 were allowed to continue integrating the input for 10 seconds, the output would rise to:

$$E_o = -(1)(10)(10)$$

$$E_o = -100 \text{ volts}$$

Of course, you know that that cannot happen because the op-amp's output is limited by the supply voltage. Therefore, with a ±15-volt power supply(s), the output would simply rise to about -15 volts after 1.5 seconds and remain there. When choosing values for R and C or integration time t, the output voltage limitation should be taken into consideration.

An integrator circuit has the following characteristics: R = 1 megohm, C = .01 μF, E<sub>i</sub> = -2 volts. The circuit integrates for 0.3 second. The output is \_\_\_\_\_ volts.

29. (6) Here's how to make the computation:

$$E_o = -(E_i)(t)/(RC)$$

$$E_o = -(-.2)(.3)/(1/1,000,000 \times .00000001)$$

$$E_o = -(-.2)(.3)(100)$$

$$E_o = 6 \text{ volts}$$

The ramp-generating capability of the op-amp can be used to create a triangular wave made up of alternate positive- and negative-going ramps. That is done by applying a squarewave to the input. The input and output waveforms are shown in Fig. 13. When the squarewave is positive, the output is a negative ramp. When the squarewave switches to negative, the output ramp goes positive.

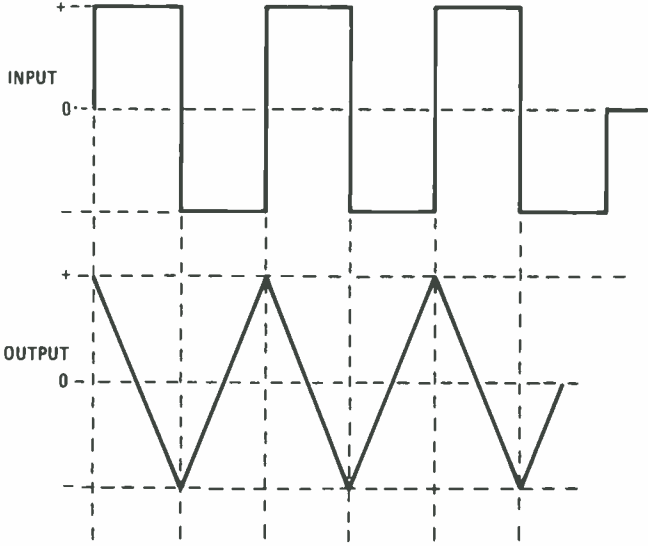

Fig. 13—Integrating a squarewave can produce a triangular or sawtooth wave.

Integrators are frequently used in wave-shaping circuits where linear ramps and triangular waves are needed. Later, we will show several generator circuits that use integrators.

To produce a triangle output wave, an integrator must have a \_\_\_\_\_ input.

30. (squarewave) One of the most useful op-amp circuits is the comparator shown in Fig. 14. When connected as a comparator the op-amp is used open loop, that is, without feedback. The comparator does what its name implies: it compares two input signals. One signal, called the reference (E<sub>ref</sub>), is applied to the - input. It is often a fixed DC voltage. The signal which is compared to the reference E<sub>i</sub> is applied to the + input. The op-amp is used in its differential configura-

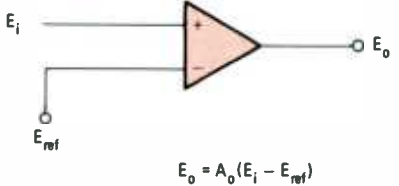

Fig. 14—A very basic op-amp comparator circuit.



tion, where the output is a function of the difference between the inputs, in this case  $V_o = A_o(E_i - E_{ref})$ , where  $A_o$  is the very high open loop gain. The output will indicate when the input signal  $E_i$  is higher or lower than the reference  $E_{ref}$ . For example, if  $E_i$  is greater than  $E_{ref}$  the output will be approximately the value of the positive supply voltage, usually +15 volts. If  $E_i$  is less than  $E_{ref}$ , then the output will be approximately the negative supply voltage, usually -15 volts. The difference between  $E_i$  and  $E_{ref}$  is amplified by the very high open loop gain. Even very small differences will produce an output high enough to force the op-amp to swing to either of its two limits.

If the output is -15 volts, then \_\_\_\_\_ is greater than \_\_\_\_\_.

31. ( $E_{ref}$ ,  $E_i$ ) Figure 15 shows some input and output waveforms that will better illustrate the operation of a comparator. The reference is a fixed DC level, as is often the case.

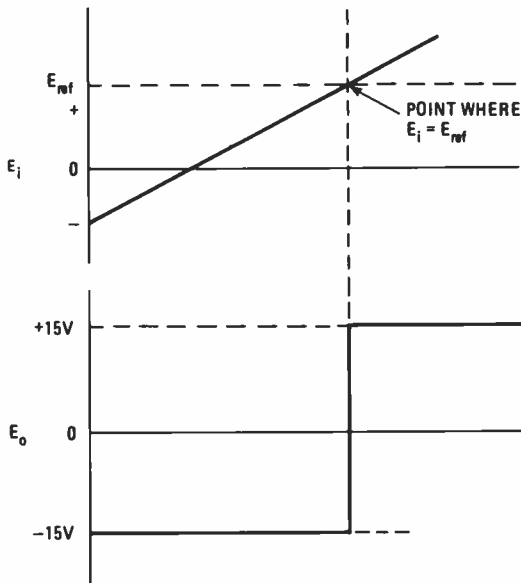

Fig. 15—These are the switching waveforms in an op-amp comparator.

The input is a positive ramp. Note the output voltage. With  $E_i$  less than  $E_{ref}$  the output is -15 volts. When  $E_i$  rises to the value of  $E_{ref}$  the output switches to +15 volts. As you can see, the switching point where  $E_o$  changes sharply from -15 to +15 volts occurs approximately where  $E_i = E_{ref}$ . Because of op-amp imperfections, switching will not occur exactly at  $E_i = E_{ref}$ , but they will usually be within a few millivolts of one another, or within microvolts if the op-amp is "very good."

The output switches when the input is approximately \_\_\_\_\_ the reference.

32. (equal to) As shown in Fig. 14, the  $E_i$  and  $E_{ref}$  can be reversed. With such a configuration the comparator inverts. If  $E_i > E_{ref}$ , the output will be -15 volts. If  $E_i < E_{ref}$ , the output will be +15 volts.

The output of the comparator is a two-state or binary signal. As a result, it can be used as a logic signal in digital circuits. But since most digital circuits use binary levels of 0 and +5 volts we must convert the -15/-5 volts to 0 and +5

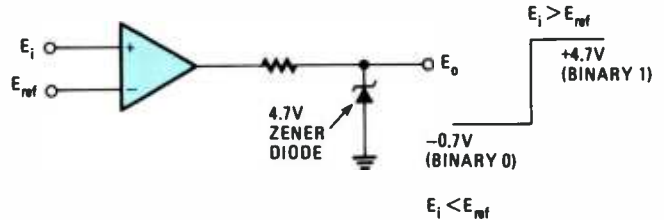

Fig. 16—A comparator output can be converted to standard digital logic levels.

volts respectively. One way to do that is shown in Fig. 16. When the op-amp output is -15, the Zener diode conducts in the forward-bias direction. Therefore, the drop across the diode is about -0.7 volts, which is near enough to zero volts that we can call it binary 0. When the op-amp output is +15 volts, the Zener conducts in the reverse direction and the voltage across it is its Zener-breakdown voltage, +4.7 volts, a value close enough to +5 volts to be a binary 1.

Refer to Fig. 17. The reference input is \_\_\_\_\_ volts. Draw the output if the input is a sine wave.

33. (zero, See Fig. 18) In Fig. 17, the reference is ground or zero volts. Therefore, the output will switch from -0.7 to +4.7, or +4.7 to -0.7 when  $E_i = 0$ . That will happen when the sinewave input varies from + to - or - to +. The circuit, therefore, converts a sinewave into a squarewave as shown in Fig. 18.

Another way to connect an op-amp as a comparator is shown in Fig. 19. The + input is grounded and two input resistors are used in a summing configuration to accept the

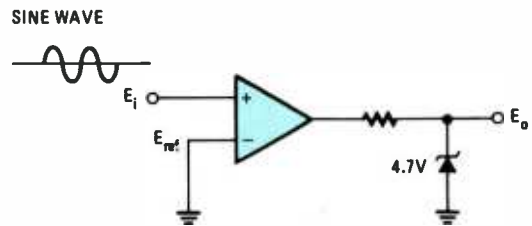

Fig. 17—This op-amp comparator's input voltage is a sinewave.

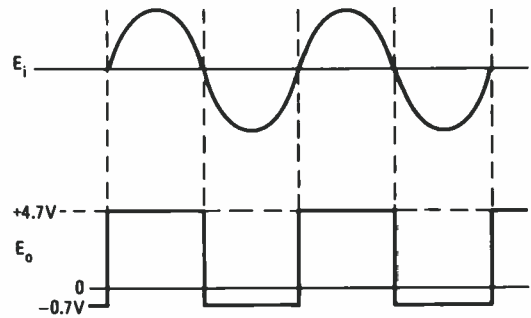

Fig. 18—These are the input and output waveforms of a comparator with  $E_{ref} = 0$ .

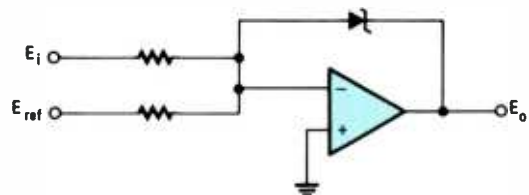

Fig. 19—An alternate comparator circuit. The polarity of  $E_i$  and  $E_{ref}$  must be opposite.

input and reference signals. A Zener diode is used as the feedback element, and as a result it will produce outputs of  $-0.7$  and  $+4.7$  volts, the same as for the circuit in Fig. 17. The only special requirement of the circuit in Fig. 19 is that the polarity of  $E_i$  and  $E_{ref}$  be opposite one another. Otherwise, the circuit switches from binary 0 to 1 or 1 to 0 when  $E_i = E_{ref}$ .

If  $E_i = +2$  and  $E_{ref} = -3$ ,  $E_o = +16$  volts.

34. (+4.7) With  $E_{ref}$  greater than  $E_i$ , the input to the op-amp is negative ( $-3 + 2 = -1$ ). Since the op-amp inverts, this forces the output toward the  $+15$  volt limit, but the Zener clamps the output to  $+4.7$  volts.

Go to Frame 35.

35. Op-amps make excellent building blocks for a wide variety of signal sources: everything from simple oscillators to sophisticated function generators. An example is the sine-wave Wien-bridge oscillator shown in Fig. 20. It produces a

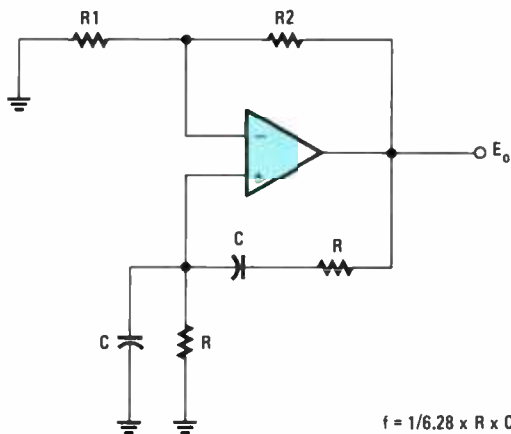

Fig. 20—This op-amp Wien-bridge oscillator circuit generates a sine-wave output.

sine-wave output at a frequency ( $f$ ) determined by the values of  $R$  and  $C$ . More specifically:

$$f = 1/6.28RC$$

If  $R = 5K$  and  $C = .01 \mu F$ , then:

$$f = 1/6.28(5000)(.00000001)$$

$$f = 1/6.28 \times .00005$$

$$f = 1/.000314$$

$$f = 3184.7 \text{ Hz}$$

The RC network produces the correct phase and amplitude of positive feedback at 3184.7 Hz to support oscillation.  $R1$  and  $R2$  provide negative feedback and set the circuit gain.

Oscillation is caused by \_\_\_\_\_

36. (positive feedback)  $R1$  in Fig. 20 is usually a light bulb with a positive temperature coefficient: Its resistance increases if the current through it increases. If the output voltage increases, the current in  $R1$  increases, thereby increasing the resistance of  $R1$ . The result is that the gain is decreased, which compensates for the original output increase. That simple AGC (Automatic Gain Control) keeps the

output sine-wave voltage constant and prevents clipping distortion. A negative temperature coefficient thermistor for  $R2$  can also be used to provide regulation of the output amplitude.

In the Wein-bridge oscillator, some form of \_\_\_\_\_ is required to keep the output voltage constant.

37. (AGC) Another way to generate sine-waves is to use an integrator circuit, as shown in Fig. 21. The circuit is called a *quadrature oscillator*. Quadrature refers to two sine-waves  $90^\circ$  out of phase. The circuit produces both sine and cosine waves. (Recall that the integral of sine is  $-\cosine$  and the integral of cosine is sine.) Also, op-amp integrators invert.

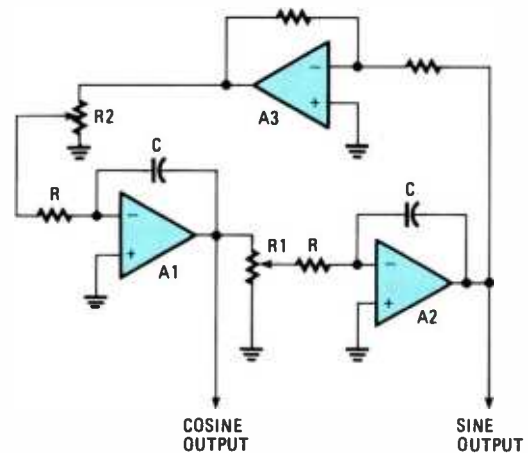

Fig. 21—A quadrature oscillator can be made with op-amp integrators.

Op-amp A1 generates a cosine wave that is integrated by A2 to produce a sine-wave. The inverter, A3, shifts the sine-wave by  $180^\circ$  to provide the  $-\text{sine}$  input to A1 to produce the cosine wave. That represents positive, or in-phase feedback, so the circuit oscillates. The values of  $R$  and  $C$  set the frequency. Potentiometers  $R1$  and  $R2$  are used to set amplitudes. In practice, some kind of AGC is used to stabilize the output amplitude.

A sine-wave generator using op-amp integrators is called a \_\_\_\_\_.

38. (quadrature oscillator) Op-amps can also be used to generate square and triangular waves. A square-wave *relaxation oscillator* is shown in Fig. 22. In that circuit, the op-amp is actually used as a comparator. Some of the output is fed back to the  $+$  input by way of the voltage divider created by  $R1$  and  $R2$ . The feedback is the reference input. The reference voltage is compared to the voltage on the  $-$  input which varies as  $C$  charges or discharges through  $R3$ . Assume that the output is initially  $+15$  volts. The voltage at the  $+$  input is about one half, or  $+7.5$  volts.  $C$  charges toward  $+15$  volts. When the voltage on  $C$  equals the voltage on the  $+$  input, the comparator's output switches to  $-15$  volts. Then  $C$  begins to discharge and then charge toward  $-15$  volts. When the charge on  $C$  equals the  $-$  voltage on the  $+$  input, the output again switches. The cycle repeats over and over at a frequency that depends upon the values of  $R1$ ,  $R2$ ,  $R3$ , and  $C$ . Zener diodes can be used to set the output to any desired level, as described. (Continued on page 97)



By Charles D. Rakes

# CIRCUIT CIRCUS

## Electronic judges take the guesswork out of calling close races

□ ONCE UPON A TIME LONG AGO, WHEN the transistor was still just a pup in the solid-state kennel, the world-famous electronic genius, professor U.P. Falloff, made the statement that any problem—no matter how impossible it might seem—could be solved with the magic of electronics. Well as a matter of fact, I didn't hear the statement first hand, but I am reasonably sure that it happened just that way, because everyone that comes to me with a problem to solve electronically can remember it well.

A good friend, who works with the Cub Scouts, came to me not long ago with a problem that cried for an electronic solution. Each year the Cub's get together with their hand-made wooden race cars and hold gravity-powered races. In some of the races the cars run in pairs; but in others, four cars race on a four-lane track.

The problem is that even when there are only two contestants, in a close race, it's difficult to determine which car came in first. And with four cars in the heat, second, third, and fourth place are even more difficult to call. It's easy to see why volunteer race Judges might be hard to find.

Naturally, I told my friend that the job

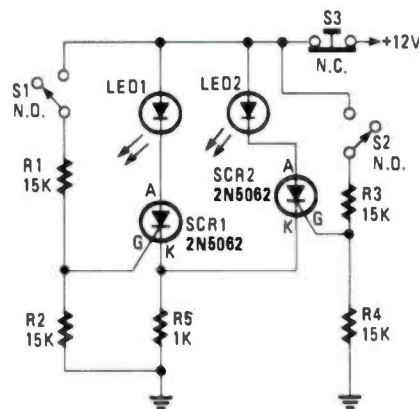

**Fig. 1—The Dual-Car Derby uses two normally-open switches (S1 and S2) connected to the gates of two low-power SCR's, each having an LED connected to its anode lead to determine the winner in a two-car race.**

seemed simple enough and I would get started on it soon—after all, it was for a good cause. Besides, what could be so difficult about determining the outcome of a simple car race? After scratching around on the surface of the problem for a

time, and drawing several circuits, I begin to fully appreciate the depth of the problem—and at the same time the animosity toward the good professor.

In the circuits for this month's Circus, you'll see the results of that labor, which will be known as the Pinewood Derby Memorandum files.

### Dual-Car Derby

The first workable solution to the problem can be seen in the basic circuit shown in Fig. 1. That circuit can be used to determine the winner in a two-car race.

Two normally-open switches, S1 and S2, are connected to the gates of two low-power SCR's, each having an LED connected to its anode lead to indicate which one turns on first. The first switch to close fires the SCR to which it is connected, lighting the LED in its anode circuit. The voltage at the cathodes of the SCR's rises to approximately 80% of the supply voltage when either one is turned on. Since both SCR's share the same cathode resistor (R5), the other SCR's gate to cathode voltage is negative; and even if its gate switch is closed, its bias remains negative, preventing its turning on. S3 (a nor-

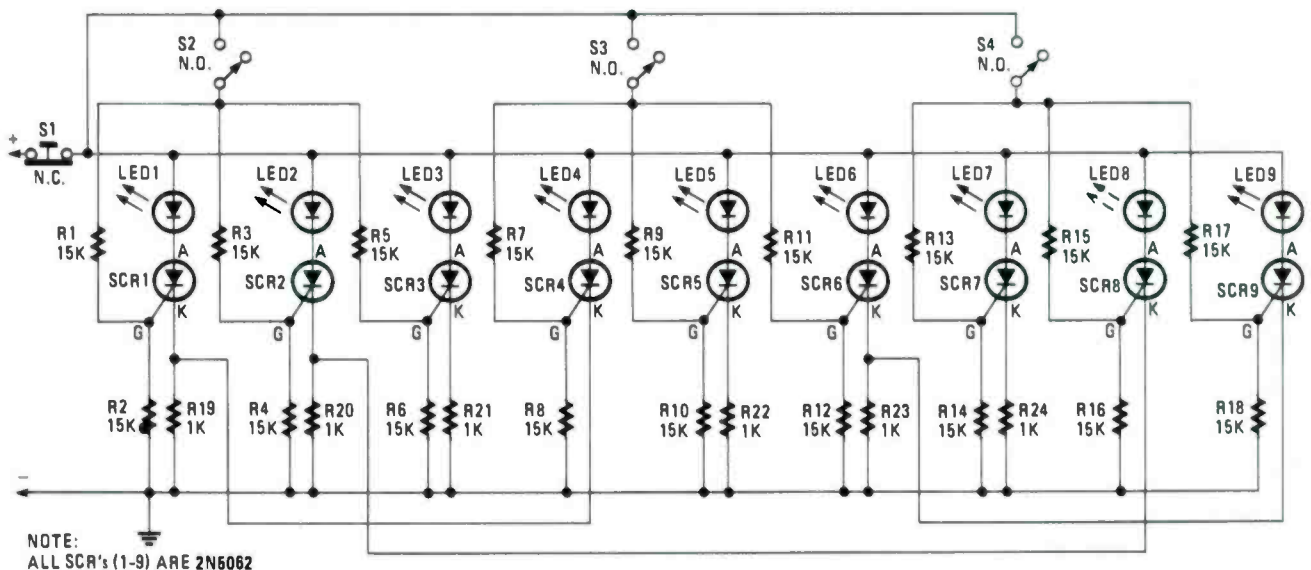

NOTE:  
ALL SCR's (1-9) ARE 2N5062

**Fig. 2—Note that with the Three-Car Derby, the component count (of the two-car circuit) increases dramatically—requiring nine SCR's to do the job of telling who comes in first, second and third.**

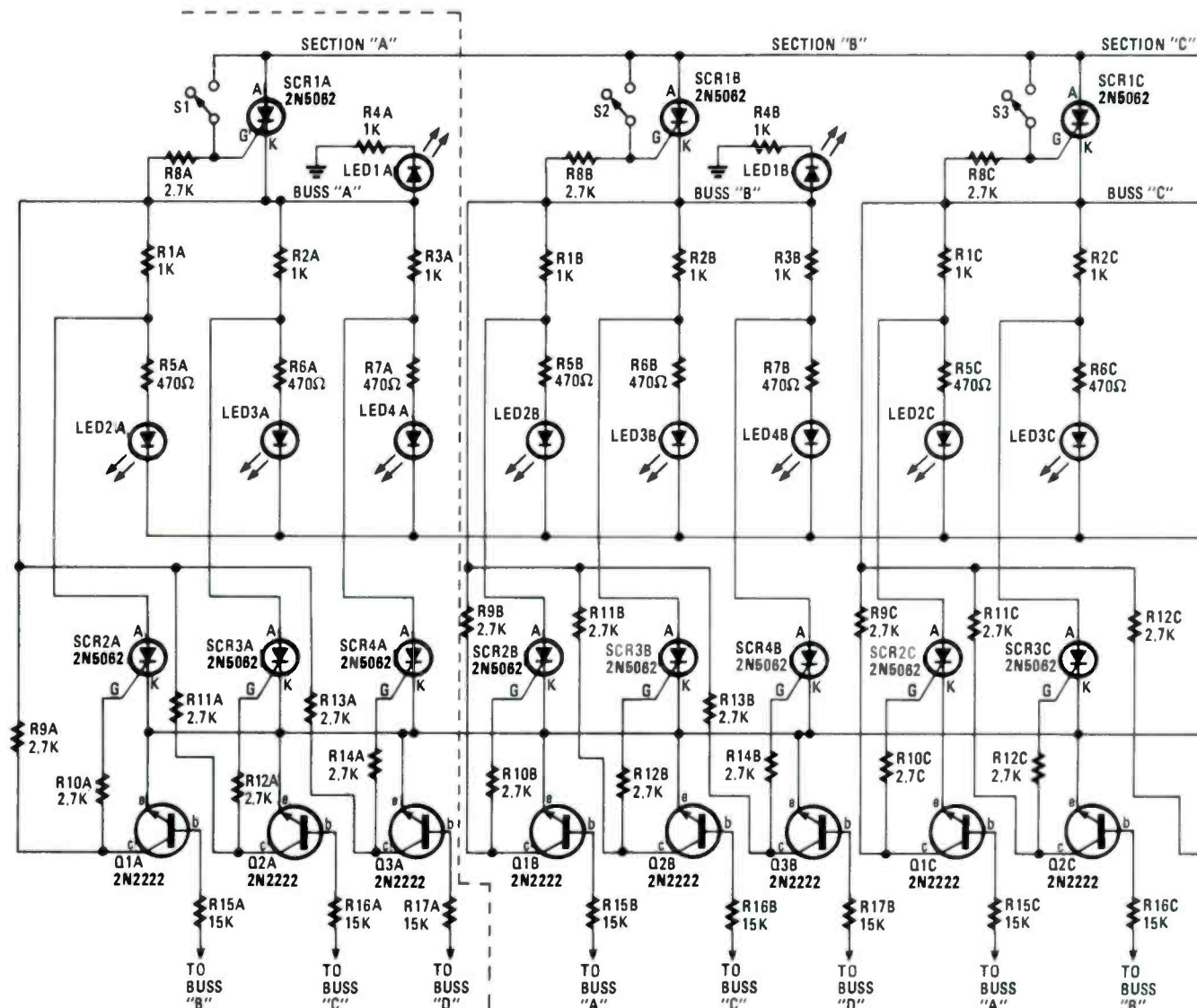

Fig. 3—Seven more SCR's are needed to make the circuit work with a fourth track—with one SCR added to each of the three existing

mally-closed switch) resets the circuit after one of the SCR's has fired.

Simple enough? With two cars, two SCR's tells who's on first. But, when the arrival of more than two contestants are to be determined, the circuit grows a bit (as shown in Fig. 2).

### Three-car Derby

Note that with three cars in the running, the component count increases dramatically—requiring nine SCR's to do the job of telling who is on first.

As an example, say that the car in lane one comes in first—switching S2 on, and momentarily turning on SCR1, SCR2, and SCR3. All three of the LED's—LED1, LED2, and LED3—would light to indicate that S2 closed first in the sequence. SCR4 shares its cathode resistor with SCR1; therefore, SCR1 is reverse-biased and can not turn on when S3 closes. SCR8 shares its cathode resistor with SCR2, so it can not be turned on

when S4 closes. In other words, the first switch to close turns on its three SCR's, sending a negative bias to one SCR in each of the other two remaining circuits. The maximum number of LED's that either of the remaining circuits can turn on is two.

If the second car comes in on lane three, making contact with S4, SCR7 turns on LED7 and SCR9 turns on LED9, but SCR8 is biased off, so only two LED's light to indicate the second-place contestant. The third car activates S3 to turn on SCR5, which in turn, lights LED5. But, at the same time, SCR4 and SCR6 are both applied with a reverse-bias voltage, which keeps them from turning on. So only one LED lights for third place.

### Four-way Derby

Seven more SCR's are needed to make the circuit work with a fourth track—with one SCR added to each of the three existing circuits, and four in the additional

input circuit for the fourth lane. The circuit, even for the four tracks, is really not that bad; but I knew that my friend was going to ask an embarrassing question. Why three lights for first place, and only one for third place? Two for second place is OK, but why can't you make a simple circuit change to make one LED light for first place, two for second, and three for third place? I could already see the waste basket filling up with reject circuits, but right is right—and it is for a good cause—so it's onward electronic solder.

If we could get only one SCR to turn on for the first race car through the gate, and somehow keep the other SCR's in the same group from lighting, the number of LED's lit would match the sequence. Of course, a signal must be sent to the other three circuits with logic information to preset each circuit for the next sequence.

The circuit in Fig. 3 handles the job quite well. The circuit's operation, when broken down into four separate (but





By Joseph J. Carr, K4IPV

# CARR ON HAM RADIO

## Tune in resonance and lock out VSWR problems

□THERE ARE A NUMBER OF MYTHS THAT are widely held among radio communications hobbyists. And amateur radio is no less infested with some of those myths than are the others (CB, for example). Twenty-five years ago, I worked in a CB shop in Virginia, and kept hearing one old saw over and over again—you can "...cut your coax to reduce the VSWR to 1" (actually, they meant 1:1 but routinely called it 1). Naturally, hoards of CB'ers have cut the coax feed-line length and watched the VSWR drop to 1:1; making it extremely difficult (if not impossible) to dispel that misconception.

Actually what we're dealing with is characteristic of the transmission line, which at a certain length, makes the VSWR appear to be 1:1. (We will address that issue in a future column.) Having done time in both the CB and amateur worlds, and "Elmered" (coached) more than a few CB'ers studying for amateur licenses, I have to admit that the *cut-the-coax* hoax seems to have cut across all lines of hobby communications (sorry, fellows, but that's my observation).

In reality, the only proper way to reduce the VSWR to 1:1 is to tune the antenna to resonance. For a center-fed, half-wavelength dipole, or a bottom-fed, quarter-wavelength vertical, the proper way to resonate the antenna is to adjust its length to the correct point. The formulas in the books and magazines only give approximate lengths—the actual antenna length is found from experimentation on the particular antenna once it's installed. And that includes commercial antennas.

On certain CB mobile antennas, for example, the trick is to raise or lower the radiator, while watching the VSWR meter. On amateur antennas, similar tuning procedures are used. Another ploy used by amateurs (including myself) is to connect an antenna-matching unit (tuner) at the output of the transmitter. For my Kenwood TS-430, I use a Heath SA-2060A to *tune-out* the VSWR presented by my Hustler 4BTV and 75-foot of coax.

The TS-430 is a solid-state rig that has finals that are not terribly tolerant of VSWR, and will shut down with a high VSWR. The purpose of the antenna tuner is to reduce the VSWR seen by the trans-

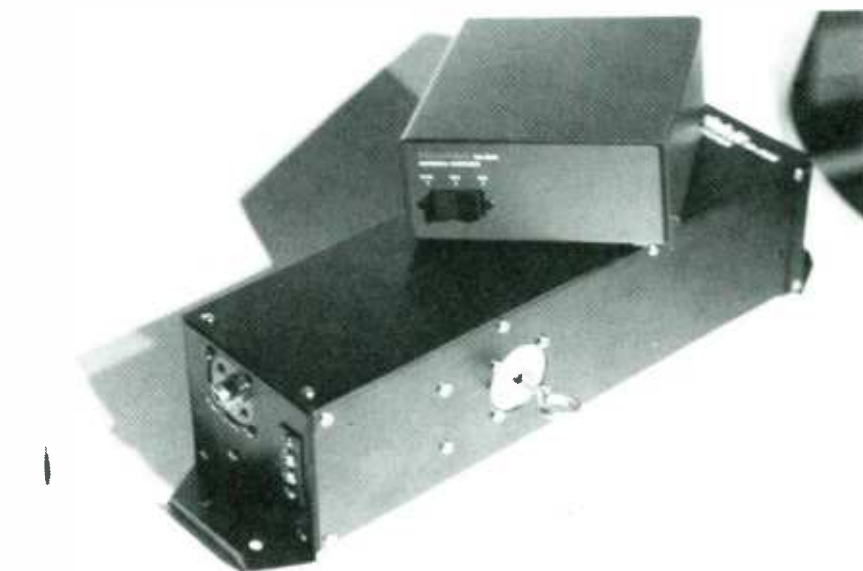

Fig. 1—The SA-2550 mast-mounted, antenna tuner's output-terminal eyelets connect to the antenna radiators. The control box is located inside the communications shack (for use by the operator) and is connected to the tuner through the transmission line. For more detailed information Circle No. 81 on Free Information Card.

mitter, and to heck with the actual antenna mismatch on the roof. The tuner also serves to reduce harmonics further, thereby, helping to prevent TVI.

The best form of antenna tuner is one that both reduces the VSWR for the benefit of the transmitter, and also resonates the antenna. That form of tuner is installed between the coaxial cable and the feed-point of the antenna. To the best of my knowledge, the new Heath SA-2550 is the only tuner on the market that really does the trick.

### A Look at the Tuner

Figure 1 shows the SA-2550 mast-mounted, antenna tuner and its control box. The large black box is mounted on the antenna mast, and its output terminals connect to the antenna radiators. The control box sits inside the shack (for use by the operator) and is connected to the mast-mounted black box through the transmission line. If your antenna does not use DC blocking capacitors, tuning capacitors or other means for blocking DC, the control voltage to the tuner can be routed through the coaxial cable.

Most antennas are designed in that

manner. But if, for any reason, your antenna or transmission line will not pass DC, then a separate control cable between the two boxes can be used. Because either scenario is possible, the SA-2550 is made more flexible.

### A Closer Look

Figure 2 reveals the internal circuitry of the SA-2550. The circuit has a large, high-voltage, 500-pF variable capacitor driven by a small (but high torque) low-voltage DC motor. The two large eyelet terminals (on either side of the tuners housing) are used to connect the antenna radiators to the box. The use of that capacitor in horizontal and vertical antennas is shown in Fig. 3.

At resonance, the feedpoint impedance of an antenna is all resistive, and it has no reactance (inductive or capacitive). As the operating frequency departs from resonance, however, the reactive components exhibit a rise in reactance, depending upon the nature of the deviation. For example, an antenna that is too long exhibits an inductive reactance.

Similarly, an antenna that is too short

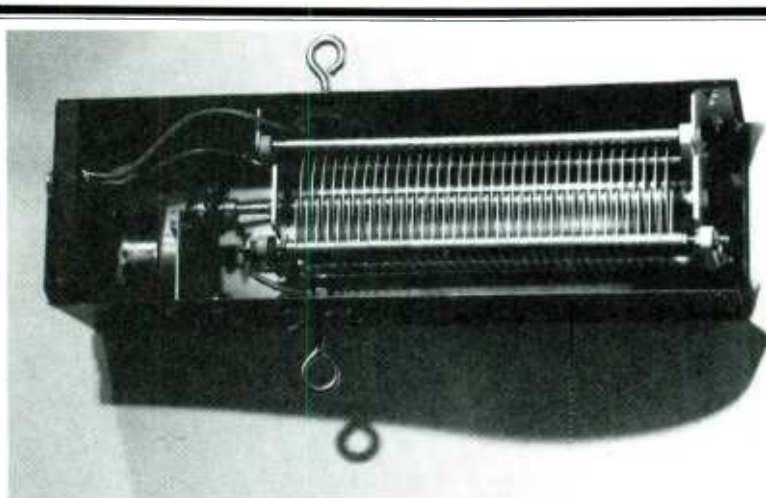

**Fig. 2—The mast-mounted portion of the SA-2550, is nothing more than a large, high-voltage, 500-pF variable capacitor driven by a small (but high torque) low-voltage DC motor.**

exhibits a capacitive reactance. For that type of antenna we insert a loading coil to provide inductance to cancel the antenna capacitance. That's the usual case for amateur and CB mobile antennas, and some vertical antennas operated on 80-meters. In the case of the SA-2550 tuner, we make the antenna radiator (L1 and L2) in Fig. 3 longer than is normally necessary, and use

the capacitor to tune out the resulting inductive reactance.

### Exploring the Possibilities

The tuner makes possible an antenna that can be set to resonate over the entire amateur band and not just at a single point. Two different antenna set-ups using the SA-2550 are shown in Fig. 4. Figure

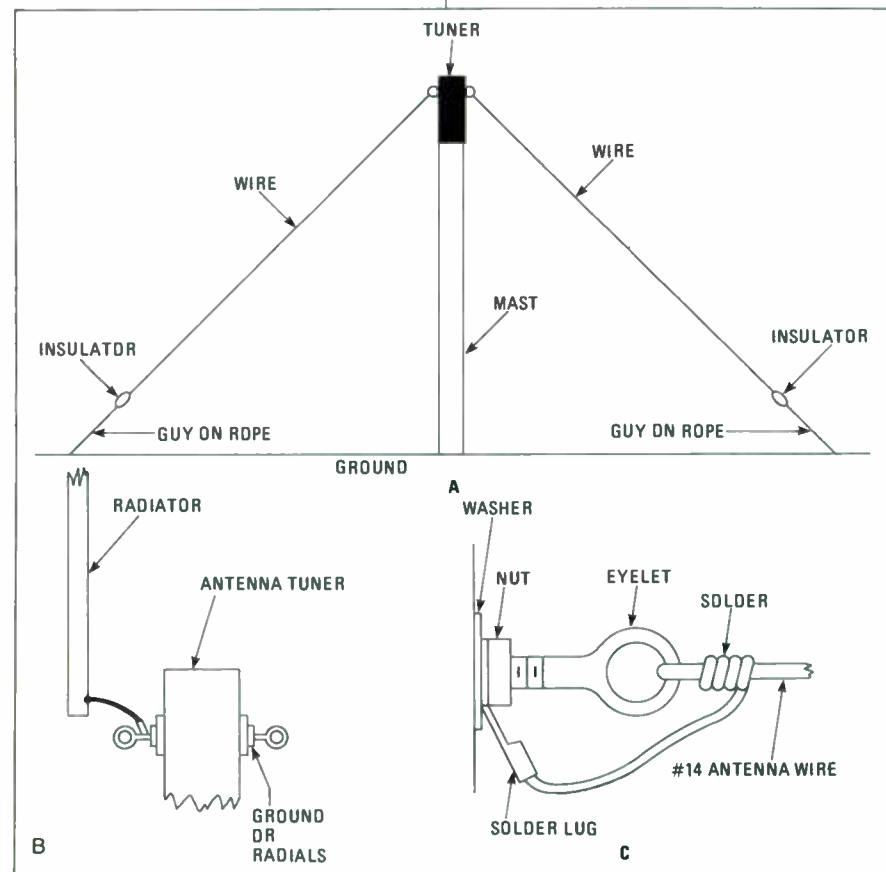

**Fig. 4—The SA-2550 tuner makes possible an antenna that can be set to resonate over the entire amateur band, whether an inverted-V type (A) arrangement or a vertical antenna (B) is used. The tuner is mounted at the top end of a mast, and the radiators connected to the tuner eyelet connections on either side of the tuner housing (C).**

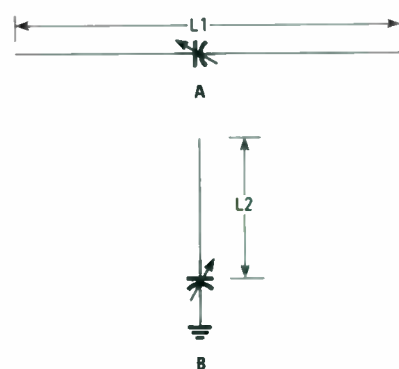

**Fig. 3—The use of the tuning capacitor along with the inductance of the wire radiator (L) act as an LC network, in horizontal (A) and vertical antennas (B). At resonance, the feedpoint impedance of an antenna is all resistive, but as the operating frequency departs from resonance, the reactive components exhibit a rise in reactance, becoming more inductive or capacitive, depending upon the nature of the frequency deviation.**

4A shows an inverted-V with radiators that are about 15-percent longer than normal inverted-V's. The tuner is mounted at the top end of a mast, and the radiators connected to the tuner eyelet connections (on either side of the tuner housing).

In the case of Fig. 4B, we see a vertical antenna. Once again, the length is 10 to 15-percent longer than most quarter wavelength verticals. One eyelet terminal is connected to the radiator, while the other is connected to the ground, or system of radials (or both, if that is how you prefer to build the antenna).

Figure 4C shows the proper method for connecting the antenna wire to the eyelet terminals. The conductor is passed through the eyelet with sufficient length to wrap back around the wire 5 to 10 times, and then to the solder lug. Although some people don't bother to solder the multi-turn section of wire, I prefer to and recommend that you do also. The purpose is not strength, but rather keeping the electrical connection's integrity once unfavorable weather conditions set in.

Building the SA-2550 is a one-evening project if you are a veteran kit builder, and you make it a long evening. Otherwise, rate this Heathkit as a weekender. Hopefully, there will be no problems in assembling the kit. Although I am wildly enthusiastic about the kit, there were a couple of aggravating problems.

First, as is true in many new products, a piece was missing. In my kit (which was a very early production model), a long metal rod used in the capacitor was missing. A quick call to Heath brought the missing part within three working days. I recommend that you inventory the parts provided to find shortages before assembly begins (that rule is not just for this kit, *(Continued on page 104)*)

By Marc Ellis



# ELLIS ON ANTIQUE RADIO

## Breathe some new life into that old-time radio receiver

□ SEVERAL MONTHS AGO, IT OCCURRED to me that it would be fun to include an ongoing series of radio receiver restoration projects as part of this column. I thought I'd occasionally pick a radio that needed some work, restore it over a period of time, and make regular progress reports to you readers. Such projects would help newcomers to the hobby get a real feel for what it takes to put an old set back into service.

At the same time, the projects would give old timers a detailed look at some sets that they might not have run across before. And if I should come up against a problem that I can't handle, maybe some of you old timers can help out!

I haven't gotten the idea off the ground until now because the development of other topics in the column hasn't left much room for new material. In addition, I hadn't yet picked out a set to start off with. Like most collectors, I have several potential projects around at all times—some as yet untouched, some partly completed; but none seemed exactly right for the kickoff.

### Resurrecting Old Radios

Recently though, at a local hamfest, I picked up a little charmer of a set that I thought would make a very-interesting restoration case history. And now that we've put the topic of electrolytic capacitors to bed, at least for a while, I have room to start something new. So meet the Echophone Commercial, a receiver for the serious—but economy-minded—shortwave listener of the early 1940's.

As I write these lines, I haven't even plugged in the set yet, so I've no idea of how much work (if any) it will take to breathe new life into that Echophone set. So let's find out together! One thing that appeals to me about the Echophone is that I can remember it from 1940's radio magazine ads, which I'd drooled over as a kid.

To my juvenile eye, it looked like a really powerful high-tech job with its snappy crackle-finished metal cabinet, business-like dial, and multiple controls. It was obviously "light-years" (or so it seemed) more advanced than the short-wave-equipped family radio I'd resorted to for my SWL activities. And with a price tag of about twenty-five dollars, it



**Here's how the little Echophone looked right after acquisition. Except for its being encrusted with grime, it's really in pretty good shape.**

almost seemed affordable. But, alas, I was never able to acquire one—that is, at least not until my fateful meeting with the present specimen at a hamfest just a few weeks ago.

The guy who sold the set to me was a former Hallicrafters employee. He told me that the Hallicrafters Company had purchased The Echophone Company in order to acquire rights to some key, RCA-circuit licenses owned by Echophone. Those licenses, he said, covered circuitry that was essential to the production of an economical and stable receiver, local-oscillator stage. Since RCA had no intention of issuing additional licenses at that

time, the only way to get one was to buy out an existing licensee.

I have no idea whether that's true, but I'd welcome comments or additional information about the set and its history. (Write me at the address shown at the end of this column and I'll share your information with your fellow readers in a future issue.)

### A Look at the Set

One thing is for sure, though. Looking at the Echophone Commercial set (see photos), there's a strong resemblance between it and the classic Hallicrafters economy shortwave unit of the mid 1940's—the famous S-38. Although the S-38's cabinet is representative of the best industrial design of its time and the Echophone is strictly utilitarian in appearance, there are more similarities than differences.

Both are essentially standard household, broadcast receivers of transformerless (AC/DC) design with shortwave coils added to allow it to also cover the standard HF spectrum (1.8 to 30 MHz). Though the frequency ranges are compressed into a very small amount of dial travel, a band-spread control helped provide a reasonable amount of station separation.

Like the S-38, the Echophone is built

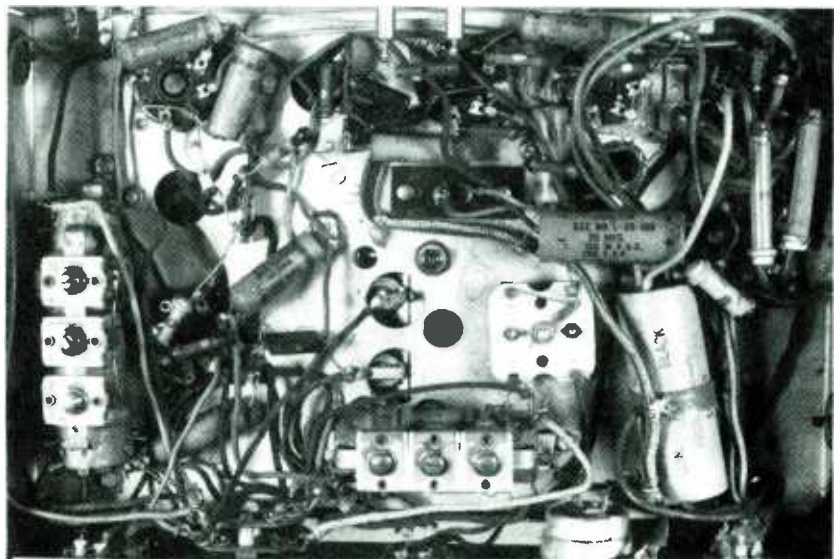

**The under-chassis wiring of the EC-1 appears to be intact, showing no clear signs of crude repairs or modifications.**



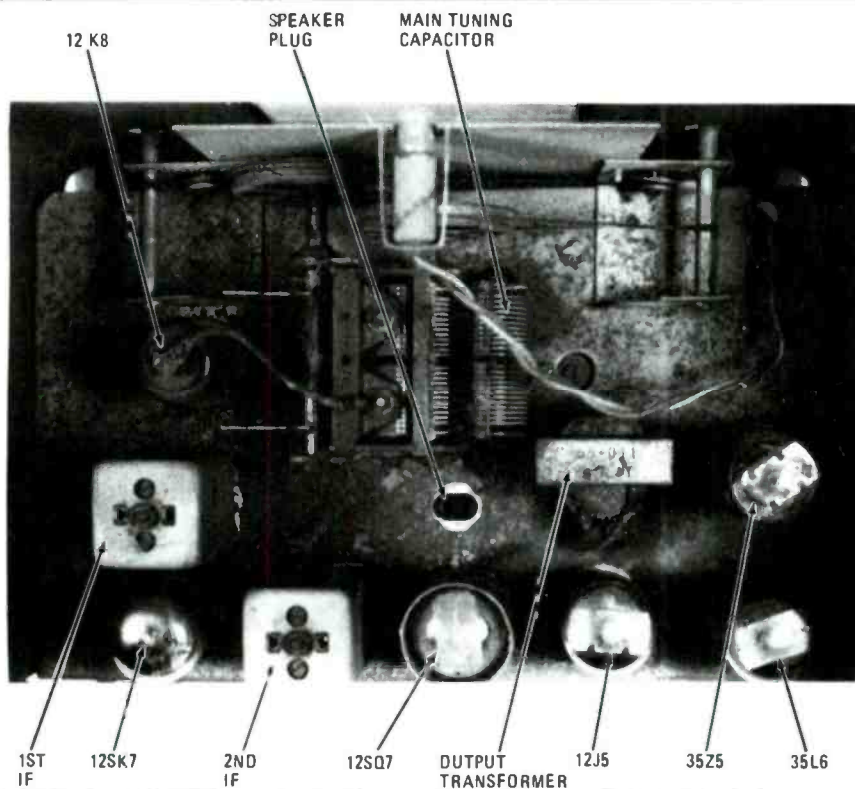

Looking into the EC-1 from the top, we see the tuning capacitor, surrounded by tubes, IF transformers, and lots of dirt and grime!

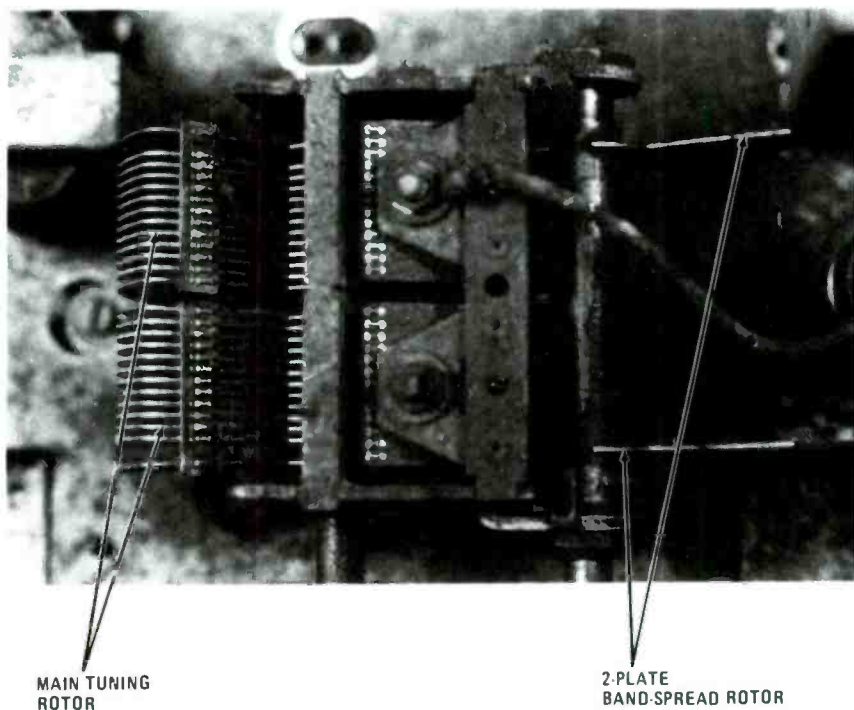

This close-up of the Echophone EC-1's tuning capacitor shows the main tuning rotor and a special, 2-plate rotor that is used for band-spreading, which allows for more accurate tuning over a broad frequency range.

into a heavy-metal case, having the following front-panel controls: MAIN TUNING, BAND-SPREAD, PHONES/SPEAKERS, OFF/VOLUME, CODE/VOICE, BAND SWITCH, and STANDBY. On the Echophone, the entire .55- to 30-MHz tuning

range (including broadcast and HF short-wave) is covered in just three bands (compared with the S-38's four).

Since separating stations on the S-38 is difficult enough, I can't imagine what it would have been like on the Echophone—

with the same frequency range covered in 25% less dial travel. But I'm quite sure that the early SWL'er using that set was very grateful to have the BAND-SPREAD control. The set's tuning range was allocated to the three bands: position 1 gave a range of from .55 to 2.1 MHz; position 2, from 2.1 to 8.0 MHz, and position 3 from 8.0 to 31.0 MHz.

As purchased at the hamfest, my Echophone looked intact and in reasonably good cosmetic condition. And though the cabinet was covered with dirt and grime, beneath it all, the paint and silk-screened lettering seemed to be in fairly decent condition. Fortunately, the celluloid dial window is also in good condition except for one relatively unobtrusive crack. That's a lucky break because, even if a replacement could be found, the present window is held in place by a riveted frame—and would be very difficult to replace.

The radio's cardboard protective back cover is broken and useless—but I have the major pieces. They'll serve as a pattern for the fabrication of a new back, having the same arrangement of ventilating holes. The cutting of those holes might be a little tedious, but it is possible.

### Digging Deeper

Both the top (which contains the speaker) and bottom of the Echophone's cabinet are easily removable, to gain access to all of the set's major components. My first official act in the restoration process was to remove those two panels, so that I could check for any obviously damaged or missing parts and find a model number, allowing me to locate the set's schematic diagram and other data.

The inside looks as nice as the outside. Though there's plenty of dirt and grime to be removed, all major parts are in place and appear to be the *real stuff* (original); there are no signs of clumsy repairs or other types of butchery.

Since I could not find a model number, I pulled the tubes and listed their types so that they could be checked against my Rider Manual index. Only one Echophone listed in the manual had a tube complement matching that of my set—the Model EC-1. That model (found in Rider Volume 14, along with its layout and other specifications) match my set perfectly. There's little doubt that the receiver now sitting on my workbench is the Model EC-1. (By the way, Rider Volume 14 came out in 1944, which obviously pegs the EC-1 as having been introduced at some prior date.)

A look at the schematic diagram reveals a basic 5-tube circuit (see photos) that was typical of the inexpensive AC/DC household, broadcast receiver in common use during the 1940's. There's a 12K8 os-

(Continued on page 108)



By Herb Friedman

# FRIEDMAN ON COMPUTERS

## Mixing Apples and Grids

□ALTHOUGH THE IBM-COMPATIBLE computer is virtually the national standard for business and what is called "serious" applications (whatever "serious" might mean), in actual fact there are two national standards. Whereas the IBM-compatible computer is virtually the standard of reference for business applications, the Apple II family of computers remains the standard for education—at least at the elementary and high school levels. Quite possibly, Apple is the educational standard because they were there "fustest with the mostest." Whatever, a goodly number of educational systems use Apples.

But what happens when the school system decides to upgrade to IBM-compatibles, or the teachers decide their personal computers must be within the mainstream

of business, which means IBM-compatible? The first thing IBM-compatible users discover is that like apples and oranges, Apples and IBMs don't mix: their programs and files can't be interchanged.

At least that's the way it used to be (as the great baseball manager Casey Stengel would put it). Finally, there is now a convenient and moderately-priced way to read AppleDOS and ProDOS/SOS, and even Apple CP/M files on your IBM-compatible computer.

The device that makes it all possible is a software-hardware package called *MatchPoint*, from Microsolutions, DeKalb, IL 60115. As shown in the photograph, the hardware is a half-slot size adapter (card) that resembles a conventional IBM disk-controller adapter, and in fact, it serves as

a transparent interpreter between the disk controller and the floppy disk drives. It is installed in any slot that can be reached by the disk drives' connecting cable, whose connector is moved from the controller to the *MatchPoint*. A supplied adapter cable is installed between the *MatchPoint* and the disk controller. So what we have, more or less, is a daisy chain, wherein the disk controller feeds the *MatchPoint*, which in turn feeds the floppy disk drives.

### It Works This Way

When the computer is running under PC/MS-DOS the *MatchPoint* is invisible; as if it never existed. When you want to read Apple disks you run the supplied MPOINT software, which sets up the *MatchPoint* so the B: drive will read and write Apple-format disks. (It won't read half-stepped "protected" disks.) Also, if you want to read Apple files that were made in CP/M you must also run the disk-interchange software called *UniForm* (which is supplied with the adapter).

But keep in mind that even though you can exchange disk files between formats, with one exception (which we'll get to shortly), you cannot run binary programs. The exchange is effective only with ASCII text files, or BASIC programs saved in ASCII format. Even then, the BASIC program must use no commands or functions that are not common to both Apple and IBM. Of course, if the BASIC listing is in ASCII it's easy enough to edit the program so it will run on either computer system. (I can hear you educators cheering.)

MPOINT sets up the software so that the B: drive can recognize both PC/MS-DOS and Apple commands. With MPOINT running, the B: drive responds to PC/MS-DOS commands. But if the MPOINT Apple commands ACOPY, ADEL, ADIR, AINIT, or ATYPE are entered, the B: drive automatically shifts gears and runs in the Apple mode. The Apple commands are self-explanatory except for AINIT, which is the same as FORMAT; it formats an Apple disk in the B: drive.

How does it work? Flawlessly. We have been using it to read Apple text files sent in by the authors of our projects (you can

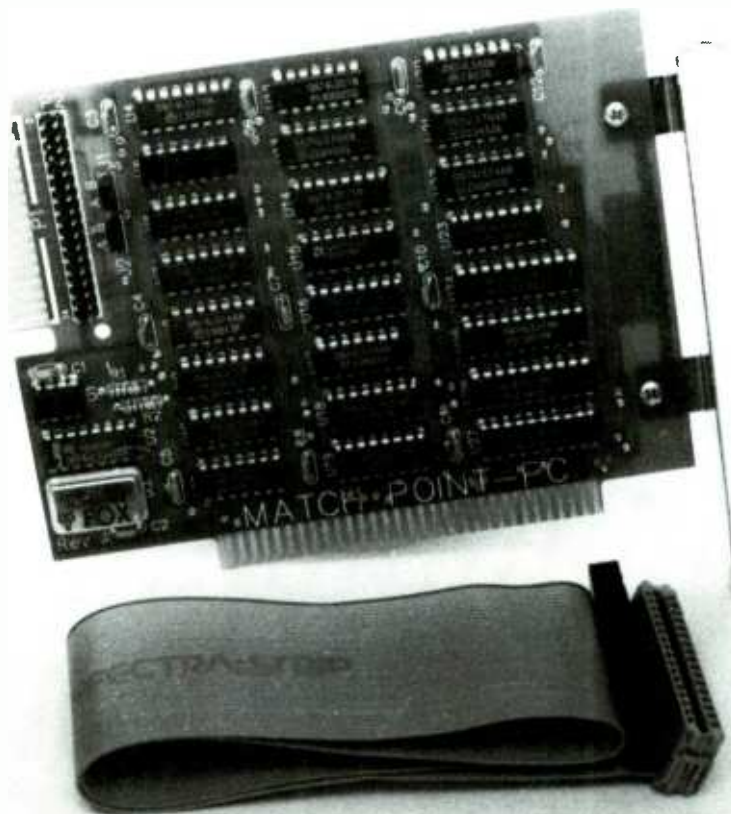

The *MatchPoint* adapter is a half-size card that takes up one slot. It connects between the disk controller and the floppy drives and is transparent to PC/MS-DOS.

also be an author), and haven't had a hitch yet. When you don't need it you don't even know it's there—it's transparent. When you do need it, it works as if Apple-compatibility was built into PC/MS-DOS.

The exception to the rule that you can't run a binary program is CP/M that originated as Apple CP/M from a *Softcard* or a similar conversion device. You can run the program on the IBM if the IBM is running a CP/M emulator program (there are several in the marketplace).

### A Sea of Grids

Our next award-winner this month is the IBM-compatible software *Grid Designer*, from The Channelmark Corp., 2929 Campus Drive., San Mateo, CA 94403. *Grid Designer* is another of those programs that after the first time you use it you won't know how you ever got along without it.

Surprisingly, the program isn't the "kitchen sink" kind of software that's becoming increasingly common, where every possible function is included to justify a higher price. *Grid Designer* costs under \$50 (you must write to Channelmark to determine the most recent price), and all it does is print grids and similar forms. Usually, if you have need for a special kind of grid paper you use the program to print a single copy and then run off a batch of additional copies on a photocopier.

The program is supplied with more than 200 styles of grids, which includes 24 varieties of standard quadrille paper, 12 accountant's formats, quadratic coordinate paper in six scales, three kinds of ruled paper, and staff paper for musicians. For programmers there is a CRT programmer's chart, FORTRAN and COBOL charts, and a flowchart. For general or family use, there's an inventory sheet, a telephone message log, and bowling, baseball, bridge, and 9-hole golf scorecards. But even more important, there's a "design your own mode" that lets you design virtually any kind of grid or chart you can think of.

Whether you design your own or use one of the "stock" grids, one or two lines of text can be printed at the top and/or bottom of the grid; positioned either left, center, or right.

A few sample grids that illustrate *Grid Designer's* versatility are shown. Some, such as the *Inventory of Parts* and the bowling league scoresheet, are "stock" templates provided with the program. The *Special Test* form peaking out from behind the bowling scoresheet was custom designed. Notice how the two-line headings specifically identify the function of the various forms and grids.

Typical of the new breed of low-cost software the packaging is "plain pipe rack;" don't expect a fancy manual or

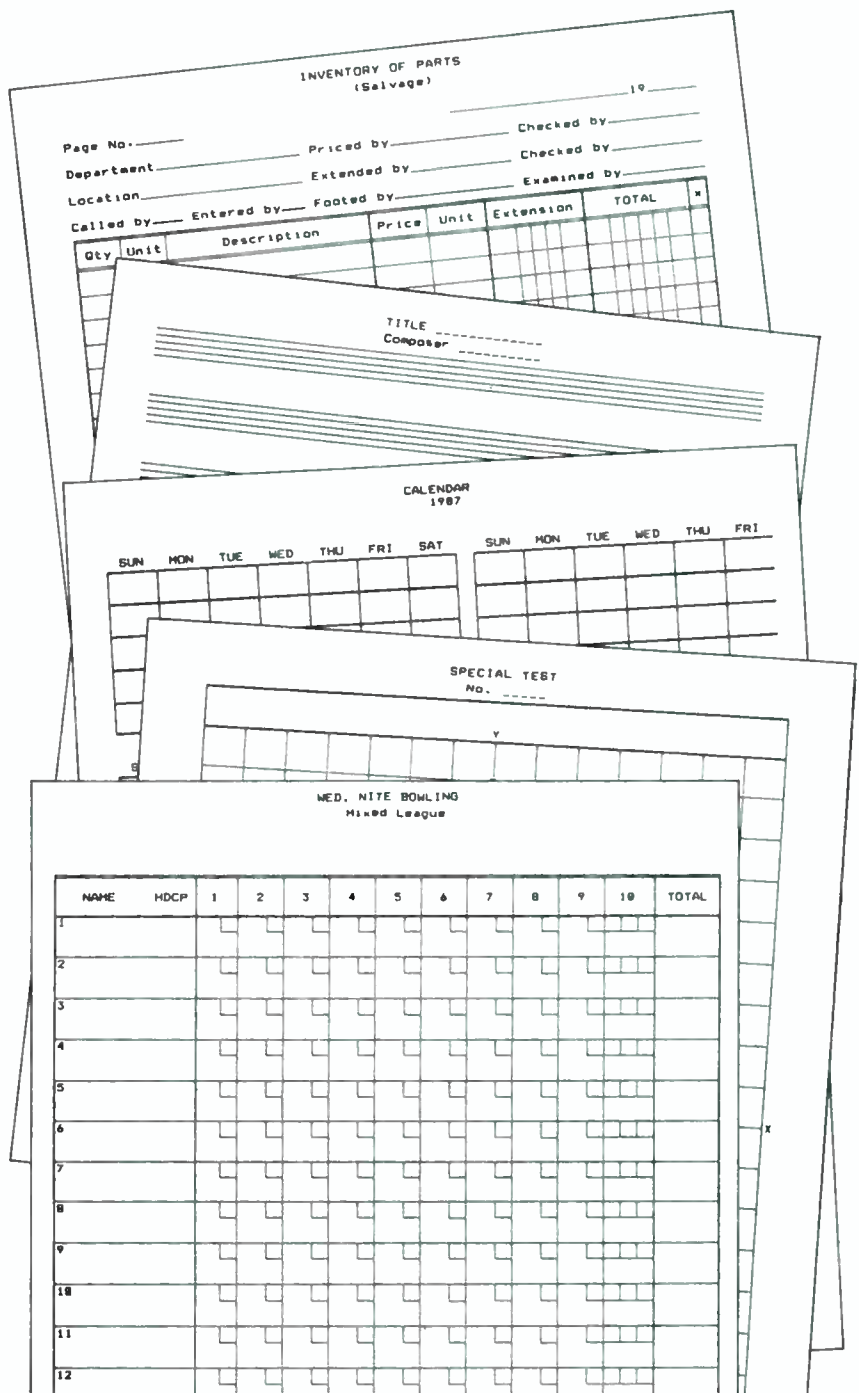

**These are just a few of *Grid Designer's* more than 200 stock grids. The user can also design, and save to disk, his own custom grid designs.**

even illustrations of the available grids. The "manual" is supplied as a disk file that you must print out before you use the program. (You could read it off the screen, but it's really confusing to follow.) If you want samples of the grids you'll also have to print them out yourself, although their description in the menu is quite good, and in most instances you'll have a very accurate idea of how the grid will look without having to bother making a test print.

The program is easy-to-use and glitch-free. Unfortunately, it comes on a protected disk that cannot be copied, although it does allow five hard disk installs on the same computer. But you can buy a single backup copy for \$5. (I really hate protected software.) The program will work with the most-popular matrix printers, but if you have a not-too-common printer, or if you have any doubts whatsoever, check with Channelmark before you purchase the software. ■



# WELS' THINK TANK

By Byron G. Wels

## How does a circuit do what it's supposed to do?

IF ASKED WHAT I THOUGHT WAS THE most interesting part of electronics hobbying, by far the answer would have to be picking up a schematic diagram and following the circuit's flow of operation—figuring out what each sub-circuit does and its effect on the section that follows. Sound kind of weird? Not really. As any electronics hobbyist knows, when you build some device from a magazine article or kit, there is no warranty covering the kit or circuit's operation upon completion. (Now do you understand my logic?) That means that you (and only you) are responsible for repairs, which includes purchasing replacement parts, installing them, and checking to make sure that the circuit works properly. And there is just no way around it; you can't repair what you don't understand.

And that brings me to the purpose of this column: To educate, as well as entertain. You'll note that along with each circuit presented, there is a brief description (we can't cover everything) of the circuit's operation included for your benefit. So, as you read these pages, remember that if you can understand the simple circuits that are shown here, you'll be prepared to tackle the more complicated ones. (Complicated circuits are really a combination of several simple sub-circuits, whose basic functions never change.)

### S-c-h-m-i-t-t

C.C., of Bloomfield, NJ asks that we settle two arguments for him. It seems that his friend says that the Schmitt in Schmitt trigger is spelled Schmidt, while C.C. says it's Schmitt. He also wants to know if you can use a 555 timer in a Schmitt trigger application.

We'll deal with the last question first. Take a look at Fig. 1, C.C. The two comparator terminals (pins 2 and 6) of the 555 oscillator/timer are connected together and used as a common signal input. When the input crosses  $\frac{2}{3} V+$ , the output falls low and remains in that state until the input drops to  $\frac{1}{3} V+$ , at which time the output reverts to a high state. Because of the internal feedback of the 555, the output change of state is fast, and independent of the input rate of change.

Now if you desire to add a *threshold* control, the toggle point can be varied.

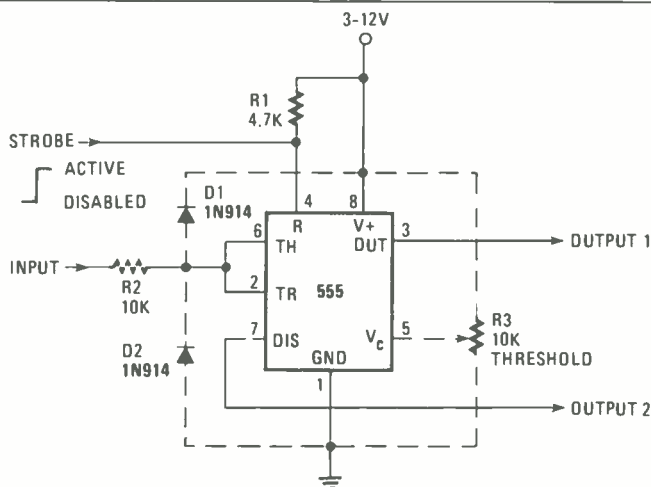

Fig. 1—The 555 timer can be applied in functions that do not necessarily involve timing. The Schmitt trigger, shown here, is typical of them. It is used to connect the two comparator inputs together and use them as a common signal input.

The necessary components to accomplish that are shown with dotted lines. With that control in place, the upper potential will be the equal of that at pin 5, while the lower threshold will be one-half that voltage.

You can select from a wide variety of 555 family types; and the CMOS versions (7555, 7556) will present a very-high input impedance, as well as a rail-to-rail output swing. And if you find that signal peaks are greater than  $V+$  or less than ground, add the components labelled R2, D1, and D2. If that doesn't happen, those components can be left out.

And you win. It's Schmitt, C.C.

### Lamp Driver

"Is there such a thing as an incandescent-lamp driver?" asks R. W., of Phoenix, AZ.

Turn your attention to Fig. 2, R.W. With logic circuits, it's often desirable to drive higher-current loads, such as LED's, incandescent lamps, or relays. Incandescent lamps can present their own special problems.

Because of the nonlinear resistance/voltage characteristics of incandescent lamps, turn-on current surges can be a lot higher than the steady-state value for a given unit. Such surges can blow a driver or even the lamp. In Fig. 2, the 322 and 3905 timers are seen in the emitter-output

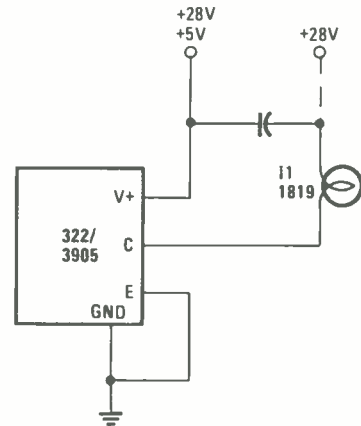

Fig. 2—To drive an incandescent lamp, the schematic shows the use of 322/3905 timers in the collector-output mode of operation. Refer to the text for a more-detailed explanation.

mode driving a 28-volt, 40-mA lamp. The supply voltage is compatible with the lamp rating.

In the example shown, a 28-volt supply is used, but any lamp rated at 50-mA or less can be used in the circuit.

### Time Delay

E.B. of Austin, TX, asks if we can provide a schematic diagram for a time-delayed relay.

Sure thing, E.B., check out Fig. 3. The

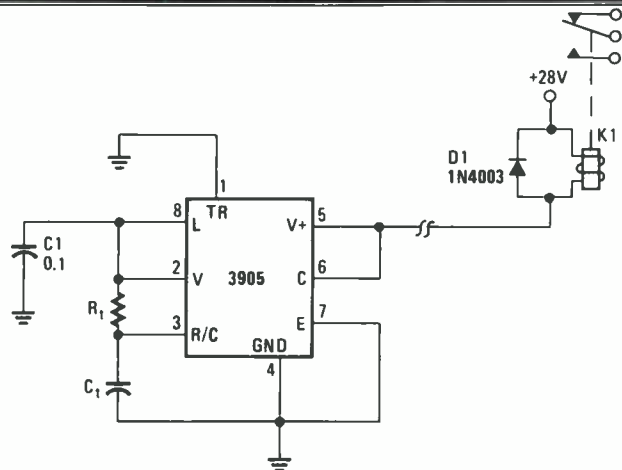

**Fig. 3**—The time-out period is determined by the formula  $R_1 \times T_c$ . The relay used is a Potter and Brumfield 24-volt DC coil rated at 40 mA with contacts to suit.

3905 timer is operated as a two-terminal switch, which after the time delay, triggers the relay. The timer and its associated components are to the left, the load is to the right. Notice that the collector (pin 6) and V+ pins of the timer are connected together, forcing the total timer current through the load.

The basis for operation of the circuit is that the standby current of the timer before time-out is low. In fact, it has to be lower than the minimum actuation current of the relay to avoid premature closure of the relay contacts. When power is applied, the timer starts to time out and during the timing interval, its output appears as a high impedance to the relay, so the relay remains open.

When the timing interval is completed, the output stage of the timer conducts and a large current flows through the relay coil, making the contacts close. The relay stays closed until power is recycled. That two-terminal timed switch can be used to drive other loads if current thresholds are kept compatible with the 322 and 3905 characteristics.

### Dark Detector

"I'm doing some important experiments for a school science project, and while I don't want to reveal too much of what I'm experimenting with, I do need an alarm to notify me when a lamp burns out. Can you help?" That's what C.J., of Groton, CT wrote.

Sure thing, C.J.—take a *gander* at Fig. 4. That circuit ought to do the trick for you. We're using a cadmium-sulphide LDR (light-dependent resistor) to sense the absence of light and to operate a small speaker. LDR1 enables the alarm when light falls below 2 footcandles.

It's interesting to note that there are basic essentials to any type of an alarm circuit. You have a trigger or detection device, control circuitry, and the noisemaker itself. With essentially the same control circuitry, you can easily vary the trigger or detection device, and also select from a variety of output or indicating devices, such as bells, horns, lights, whatever.

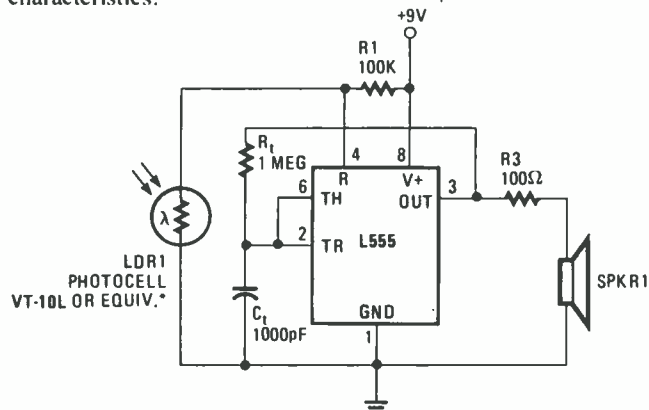

**Fig. 4**—This circuit enables you to know when a lamp goes out for any reason including a burn-out or a fuse blow. It uses a Cadmium Sulphide photocell as the detecting device, sounds a tone in a small loudspeaker to notify you of what happened.

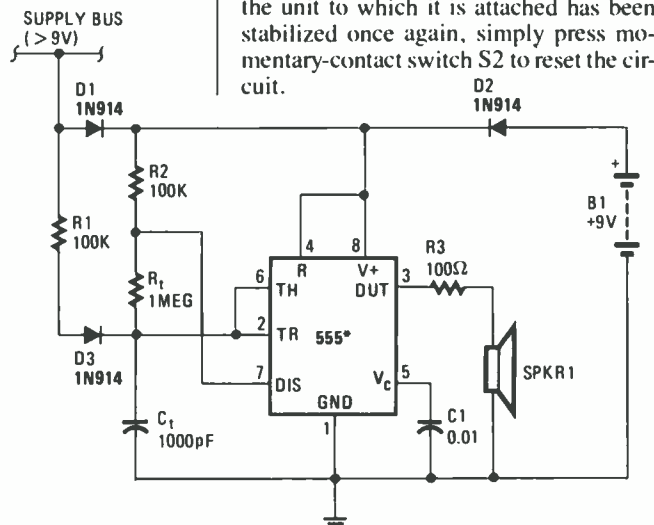

**Fig. 5**—If you want to reduce the standby current drain, simply substitute the 555 timer shown here for a low-current version, such as the TCL555 or 7555. They're physically and electrically interchangeable.

Within given circuit parameters, the control circuitry remains essentially the same. The LDR that was used in this circuit is the VT-10L from Vactec, Inc. (2423 Northline Ind. Blvd., Maryland Heights, MO 63043).

### Power Alarm

"I want to add a fairly unusual feature to my new power supply," writes K.G., of Davenport, IA. "I'd like some warning, say five minutes worth, that the fuse is going to blow." Now that one threw us for awhile, until he went on to explain. "Just kidding. But seriously, is there a way to connect a power-failure alarm that will indicate audibly that there's been a drop-out?" Well, I've heard some weird requests, but that one almost took the cake!

Well, K.G., look at Fig. 5. It uses a 555 as an oscillator biased off by the presence of line-based DC voltage. When the line voltage fails, the bias is removed, and the tone will be heard in the speaker.

R1 and D1 provide the DC bias that charges capacitor C1 to over 2/3-volt, thereby holding the timer output low. Diode D1 provides DC bias to the timer-supply pin and, optionally, charges a rechargeable battery through the dotted-line connection of RCH across D2. And, when the line power fails, DC is furnished to the timer through D2.

### Tilt!

"Remember the old pinball machines with their tilt switches?" writes S.R. of Ft. Lauderdale, FL. "I'd like to work that sort of system into an electronic-alarm circuit, but if I recall correctly, they were electro-mechanical. Is there something more electronic I can use?"

Sure, S.R. Look at Fig. 6. That circuit uses a simple glass-encapsulated mercury switch as the triggering device. And after the unit to which it is attached has been stabilized once again, simply press momentary-contact switch S2 to reset the circuit.

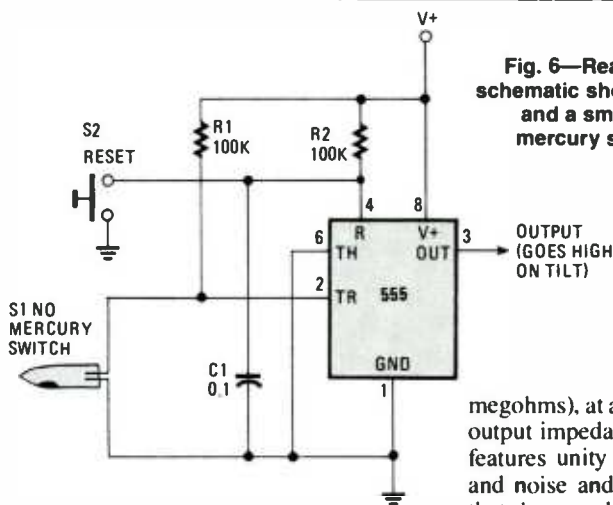

**Fig. 6—Really an alarm circuit, this schematic shows how to use a 555 timer and a small glass-encapsulated mercury switch to indicate "tilt."**

The tilt switch is actually a mercury switch that's mounted such that it is normally open, which allows the timer output to stay low, as established by C1 on start-up.

When S1 is disturbed, causing its contacts to be bridged by the mercury pool, the 555 latch is set to a high output level where it will stay even if the switch is returned to its starting position. The high output can be used to enable an alarm of the visual or aural type.

#### Buffer Needed

Hey Byron, maybe you can help me. I've got an amplifier, and when I try to add additional loading, all my audio goes down in the mud. What am I doing wrong?—J.T., San Fernando, CA

Nothing, J.T. Nothing except loading down the amplifier. What you need is a high-impedance buffer, like that shown in Fig. 1, between the amplifier and the added load. That circuit, by way of U1—an LF351 BIFET op-amp, which is easily replaced by any JFET type, such as the TL081CP—provides a very-high input impedance (typically one million

megohms), at audio frequencies and a low output impedance of only a few ohms. It features unity gain up to about 4 MHz, and noise and distortion levels so small that they can be ignored. BIFET devices also provide excellent noise and distortion performance.

The inverting (–) input of U1 is connected directly to the output so the circuit has unity gain between the non-inverting (+) input to the output. The non-inverting input is biased via R3 to half the supply potential by the voltage divider formed by resistors R1 and R2. Naturally, the output voltage is also nominally half the supply voltage. That provides the circuit with a large signal-handling capacity.

Capacitors C2 and C3 provide input and output DC blocking respectively. Because of the shunting effect of R1, R2, and R3, the input impedance of the circuit would be reduced to about 15 megohms if you didn't include bootstrapping capacitor C1, which couples the output signal to the junction of the three resistors. So any change in the voltage at the input is matched by a similar change at the junction of the three resistors.

The input signal doesn't change the voltage across R3 and doesn't cause any current to flow through that resistor. So R3 seems to have an infinite impedance to

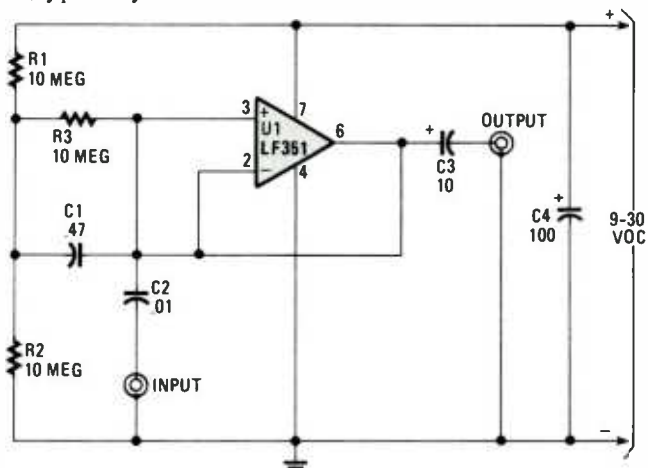

**Fig. 7—This buffer amplifier (using an LF351 BIFET op-amp), with its high input impedance and low output impedance at audio frequencies, features unity gain up to about 4MHz and low noise and distortion levels. The circuit can be powered by a 9- to 30-volt power supply and consumes only about 2mA.**

the input signal, and has no significant shunting effect on the input. In actual practice, the input impedance of the amplifier is determined by stray input capacitances and the frequency of the input signal. Since most of that will be at the input lead, be sure to use shielded cable to reduce the strays.

The circuit works well at almost any voltage from 9 to 30 volts and consumes about 2mA.

#### Quadraphonic Sound

I recently heard a quadraphonic stereo system and fell in love. Then I checked out some of the prices and got a divorce. Isn't there a less-expensive way to go than to invest all of my life savings?—S.L., Lubbock, TX

A quad system can really be expensive, of course. But there is a way that's worth looking into. Admittedly, it's a quasi-quadraphonic system, but the sound enhancement, using just two additional speakers and the circuit in Fig. 2 is really worthwhile. You might also want to try this in your car as well.

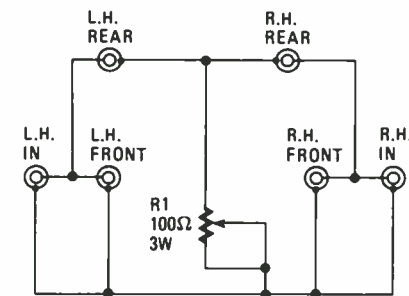
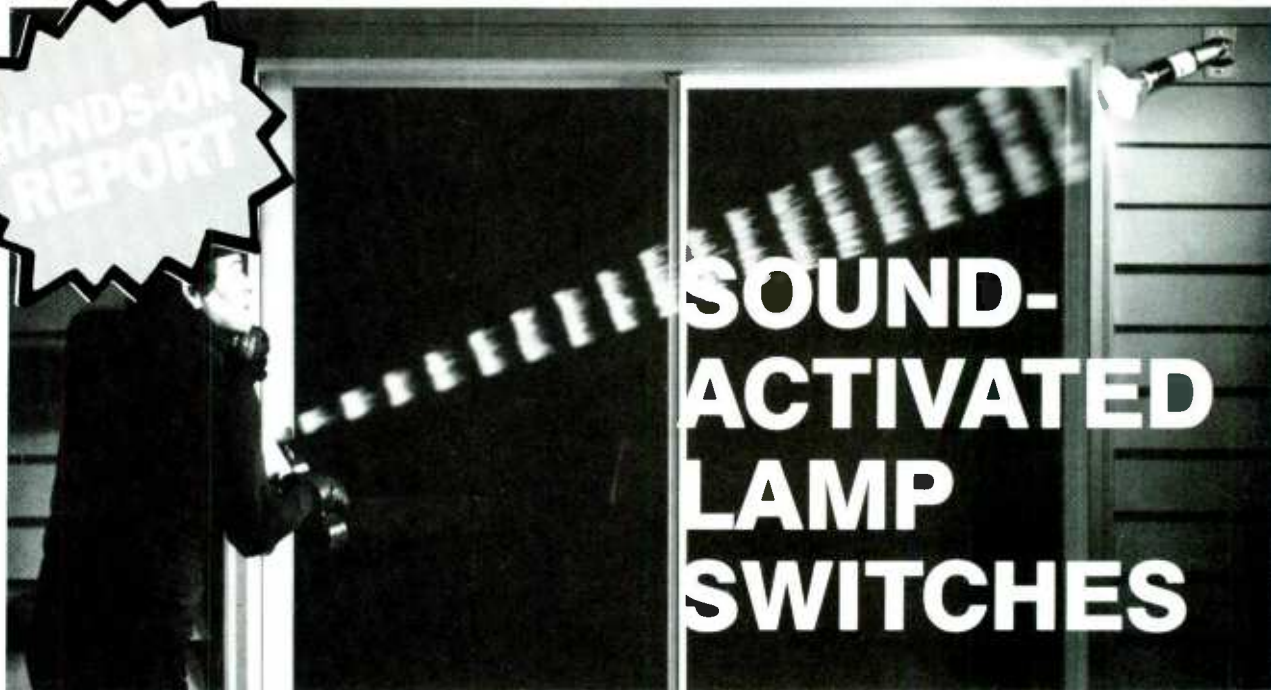

**Fig. 8—With this quasi-quadraphonic sound system, the amplifier's audio output is fed to the front-channel loudspeakers. The rear speakers are fed the difference between the front-channel (left and right) signals.**

The output from the amplifier is fed in the normal way to what are called the front (left and right) speakers. A portion of the audio signal enroute to the front speakers is diverted to the rear speakers. The rear speakers are fed the difference between the signals of the front channels. That's because signals appearing at the two front channels cause similar variations in the voltage across the rear speakers, which tend to largely or totally cancel each other out in the rear-channel audio.

The signals that appear in only one channel cause a voltage to be developed across the rear speakers in the normal way. So the general level of volume from the rear is somewhat less than that from the front or main speakers.

You'll also find ambience signals present. They are not picked up directly by the microphones, but are picked up after they have bounced off a wall or ceiling. Reproduction of those signals usually imparts a more-spacious sound to the music and provides very-realistic effects. ■



**Clap your hands for this electronic genie and it will light your way, or scare an intruder clear into the next county.**

**By Bobby-Lee Terwilliger**

**I**T WAS JUST THE KIND OF NIGHT THE cartoon character Snoopy likes to write about: dark and stormy. Behind the curtain of rain, a dark shadow edged its way to the back door of a darkened home. The rattle of the doorknob could hardly be heard over the sound of the rain—when suddenly, the house lit up like a Christmas tree. Darkened rooms glowed with light, outdoor floodlights turned night into day, and the dark shadow fled over the fence. Within minutes the lights turned off. Yet there was no one at home to turn the lights on or off: The dark shadow had itself triggered several *Intermatic Sound-Activated Lamp Switches*: noise-sensitive devices that control the electric supply to lamps, buzzers, or whatever you want.

The Intermatic Sound-activated Switches are basically compact amplifiers having a self-contained microphone, a sensitivity control, an LED sensitivity-adjustment indicator, a time delay, and a semiconductor switch. The device is normally off. When the microphone senses an unusual sound, it turns the electronic switch on, which in turn, provides a 117-volt power-line output to light a lamp. When the sound stops, the switch remains on until the delay *times out*; at which time the device resets itself to the off condition.

The triggering sound can be any medium- to high-frequency, semi-impulse noise that exceeds the ambient (background) noise level. It can be a clap, a

whistle, a click, or a bang. For example, if you place a Sound-Activated Switch over the cellar steps, you don't have to worry about making your way down in the darkness if your hands are full. A simple whistle will cause the Sound-Activated Switch to turn on the lights. Or, you could have a sound switch installed in a ground floor room so that the sounds made by a burglar attempting entry into the home would cause the lights to go on.

### Three Kinds of Sensors

There are six different types of Sound-Activated Switches; we chose to look at the three models—shown in the photographs—that we thought had the most appeal for the average home. Model X320



**The unit on the left replaces a conventional toggle-type wall switch. It can be operated like a conventional toggle switch or sound activated. The center unit is the Sound-Activated Socket, and on the right is the portable, Plug-in Security Lamp Switch.**

is a substitute for a conventional toggle-type wall switch, which it closely resembles: Toggle down is off; toggle up is on. But there is also a position between the two, and that is the sound-activated mode, which will automatically turn on the room light when it *hears* an unusual noise.

Built into the toggle-type Sound-Activated Switch are controls for both sensitivity and time-delay (how long the light remains on), and a small LED that is used as the sensitivity indicator.

Under typical ambient-noise conditions, the sensitivity control is adjusted until the LED blinks when the device senses the sound level the user wants to serve as the trigger. Sounds of lesser volume, which do not cause the LED to light, won't trigger the device, while any sound that does light the LED will trigger the light(s).

Once the light turns on, it will remain on for the period established by the time-delay adjustment, assuming that there's no other unusual noise. If the noise continues or repeats while the light is on, it will remain on and not start to *time out* until the high-level noise ceases.

Another version of the Sound-Activated Switch is the model SX530B Plug-in Security Lamp Switch; that plugs into a conventional electric outlet and contains its own controlled socket, to which a conventional table or floor lamp is connected. Unlike the toggle-type audio light, the portable model has a fixed time-delay.

(Continued on next page)

CIRCLE 77 ON FREE INFORMATION CARD

## SOUND-ACTIVATED LAMP SWITCHES

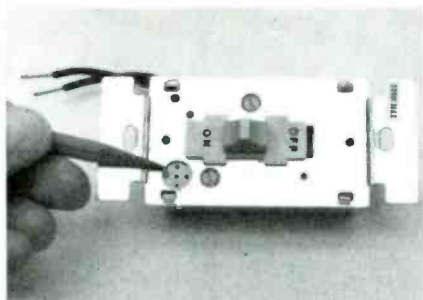

The pencil points to the microphone that's built into the toggle-type switch. The two screws allow the user to set the sensitivity and time-delay adjustments.

The third model is the X740 Sound-Activated Socket, which is primarily intended for use outdoors as part of a home's security system, although it can also be used indoors, perhaps to turn on a common table or floor lamp. (It becomes an integral part of the lamp). As shown in the photographs, the socket resembles a *photo-detector*, a gadget containing a photocell that automatically turns on a



Here's how the Sound-Activated Socket looks when equipped with a floodlight, ready for installation in a fixture.

floodlamp when darkness falls (the sun goes down). But unlike a conventional photo-detector, the X740 Sound-Activated Socket is sensitive to, and controlled by sound. A built-in light sensor only holds off the light during daylight; it does not turn on the light at night.



The Sound-Activated Socket has a photocell (under the word *AUDIOLITE*), which holds off operation during daylight.

The socket is turned on only when a sound is detected. As with the Security Lamp Switch, the light remains on for a predetermined time (about 30 seconds) and then turns off.

Like the other sound-activated switches, the socket version has a sensitivity control and an LED sensitivity indicator. (The time-delay is fixed.)

### Testing 1...2...3

We tried all three versions. While they work successfully once adjusted, getting them adjusted can be tiresome, because the light is triggered each time the sensitivity control is moved: Then you must wait for the time-delay to turn off the light so that you can check the adjustment.

There's also the problem of intermittent noise triggering. A car sounding its horn in the street triggered the socket model, which had been installed in a backyard. Normally, that isn't a problem, since it gives your home a *lived-in* appearance; but, the uncommon ambient-noise level must be considered when making the sensitivity adjustment.

There is also the problem of household pets (if you have any). If they are in the same room as a Sound-Activated Switch, the ordinary noises they create will trigger the switch.

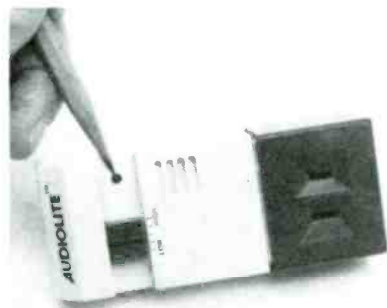

The pencil points to the LED trigger-level indicator on the plug-in lamp switch. Note the integral power outlet, and the sensitivity adjustment.

But there's a flip side to the coin. Since a Sound-Activated Switch will trigger on almost any kind of noise, if the toggle-type unit is installed in a dark area—such as near the basement steps or the entrance to a long hallway—the light can be turned on before you enter the dangerous area by simply whistling, clapping your hands, or speaking the magic words: *Lights on, sesame* (or even just *open sesame*). Imagine not having to elbow the light switch on as you approach the stairs carrying an armload of packages.

Sound-Activated Lamp Switches are available from local hardware and lighting stores. For additional information write to Intermatic, Inc., Intermatic Plaza, Spring Grove, IL 60081. ■

# Go ahead and run it.

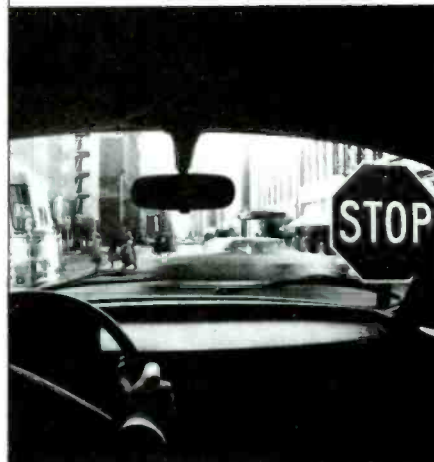

Maybe there's a car coming and maybe there isn't. Fortunately, most people figure the risk isn't worth the chance.

But oddly enough, it doesn't work that way with the warning signs of a heart attack. Most people ignore the signals. Or chalk it up to indigestion. Or wait to see what happens next.

Every year 350,000 heart attack victims die before they reach the hospital. But you don't have to be one of them.

If you feel an uncomfortable pressure, fullness, squeezing or pain in the center of your chest that lasts for two minutes or longer, you may be having a heart attack. In some cases, the sensation may spread to the shoulders, neck or arms—and be accompanied by sweating, dizziness, fainting, nausea or shortness of breath. The important thing is to get help. Either by calling the local emergency medical service (EMS) or by asking someone to drive you to a hospital emergency room.

If you ignore the signs of a heart attack, you'll have no one to blame. Not even yourself.

WE'RE FIGHTING FOR YOUR LIFE



**American Heart Association**



## LEARNING dBASE III PLUS

(Continued from page 67)

Section II covers installation and basic functions—the Assistant (the menu system), the various screen areas, and basic keys. That is where the “meat and potatoes” of dBASE III PLUS begins.

Section III shows you how to set up a working database by walking you through a step-by-step example. Section III also shows you how to sort and index information and print reports. Last, several appendices include more detailed information, including handy tips, command references, sample programs, etc.

The meat of the course is contained in Section III, the How-To section. As you create and manipulate the sample database, you try many features, mostly using the “Assistant,” the menu-driven user interface. But occasionally you’re shown how to drop into the command mode, wherein the menus are bypassed, and you type your commands directly. The workbook serves to reinforce, amplify, and restate what you learn from the videotape; it also contains quizzes (with answers) following each lesson, and additional exercises. In addition, the tape has built-in *pauses points* during which you can go through the workbook exercises at your own speed.

If you’ve never worked with a database program before, the MicroTrek tape serves as a good introduction. If you’ve

worked with other database managers or earlier versions of dBASE (as we had), the pace seems slow at times, but easier than trying to absorb the thick set of manuals Ashton-Tate provides. The tape would be useful in an educational setting, with or without the workbook, as long as each student or trainee had hands-on access to a PC. The price is rather steep for individual use (\$495), but it would be quickly recouped in any medium- to large-size organization.

The young lady who narrated the video program brought some humor to this reviewer’s viewer. As she stressed points in her delivery, her eyebrows rose and disappeared under her bangs. After a few chuckles, it was all business. Also, quality shielded cables between the television set and videotape player prevented the RF hash produced by the computer from *herringboning* the TV picture. That was not the case when we originally setup using a frayed cable at first try.

There are cheaper database managers, but if you need a solid, proven performer, dBASE III PLUS is worthy of consideration. And if you’re responsible for educating yourself or others in how to use the program, the MicroTrek Interactive Video Training Course is recommended. For more information on the MicroTrek Interactive Video Training Course circle No. 82 on the Free Information Card. Likewise, Ashton-Tate would like to send you information on dBASE III PLUS when you circle No. 83 on the Free Information Card. ■

## ELECTRONIC FUNDAMENTALS

(Continued from page 82)

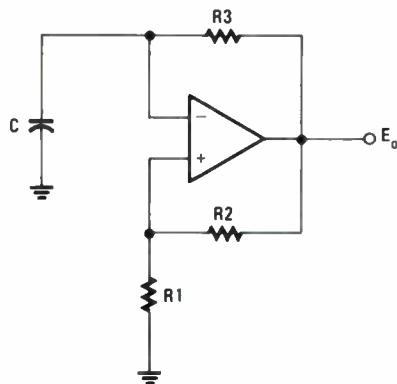

Fig. 22—A relaxation oscillator produces a squarewave voltage at the output.

A squarewave op-amp generator is called a \_\_\_\_\_.

39. (relaxation oscillator) One of the most popular op-amp oscillators is called a *function generator*. It produces both square and triangular wave outputs. Figure 23 shows a typical circuit. Op-amp A1 is an integrator while A2 is connected as a comparator with its reference set to ground, or zero volts. A1 integrates the DC output of A2 until its output equals zero, at which point the comparator output switches. The integrator then switches directions and generates a ramp in the opposite direction again until its output equals zero. The result is square and triangular waves such as those previously shown in Fig. 13. By switch-selecting various values for C, and by making the squarewave output level of the comparator variable, the output frequency can be varied over an extremely wide range.

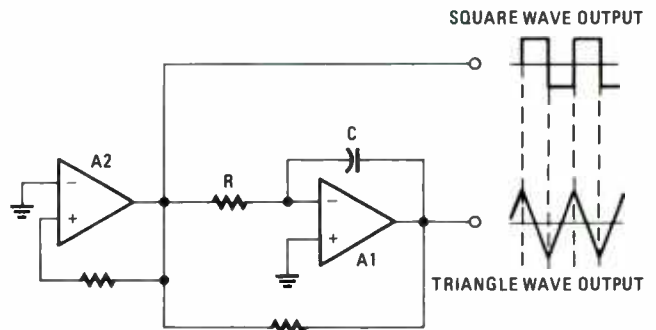

Fig. 23—A function generator produces square- and triangle - output waveforms.

A function generator produces \_\_\_\_\_ and \_\_\_\_\_ output waves.

40. (square, triangular) By using wave shaping or filtering circuits, a sinewave can be generated from the triangular wave. Thus the function generator can produce the three most commonly used types of output signals over a wide frequency range. A commercial test instrument called a *function generator* uses a similar circuit to provide those features.

### Please Write

We have come to the end of our course in *Electronic Fundamentals*. We hope it has given you a firm grasp on what electronics is all about, but hope isn’t the same thing as really knowing. We would like to know your thoughts on both the course and on our method of *programmed instruction*. Whether you find them good, bad, or indifferent, please write and tell us how you feel about them. ■

In the next issue of **Hands-on Electronics**, author Louis Frenzel will start a new series of articles. The kick-off piece will be on static RAM’s. Watch for it!

## BOOKSHELF

(Continued from page 24)

### Understanding IC Operational Amplifiers—3rd Edition By Roger Melen and Harry Garland

Want the lowdown on op-amps? In this text the op-amp is discussed in detail for the electronics hobbyist and technician. New, expanded, and updated applications include material on computer-aided design techniques



CIRCLE 64 ON FREE INFORMATION CARD

and IC op-amps in microprocessors.

Topics covered include: the ideal op-amp; IC electronics; monolithic op-amp circuitry; the integrated-circuit op-amp; linear and nonlinear applications; op-amp systems; and specialized operational amplifiers.

*Understanding IC Operational Amplifiers, Third Edition*, No. 22484, is 224 pages and retails for \$12.95. You'll find it in bookstores, electronics distributors, or you can get it from Howard W. Sams & Co. Inc., Dept. R40, 4300 W. 62nd St., Indianapolis, IN 46268; Tel. 800/428-SAMS.

### Forrest Mims' Circuit Scrapbook II By Forrest Mims

If you're a Mims fan, then this scrapbook may be a great addition to your collection. It is an exciting compilation of nearly 70 projects.

Each column explores a specific area of electronics, but assumes no prior knowledge. The book is a tutorial for students in technical schools and

universities, and can be enjoyed by technicians and hobbyists.

Topics covered include: transistor and MOSFET circuits; analog circuits; digital circuits; LED's, laser diodes, and optoelectronics; radio control; sensors and sensing systems; and circuit assembly tips.



CIRCLE 64 ON FREE INFORMATION CARD

*Forrest Mims' Circuit Scrapbook II*, No. 22552, is 272 pages and retails for \$19.95. To purchase a copy contact Howard W. Sams & Co. Inc., Dept. R40, 4300 W. 62nd St., Indianapolis, IN 46268; Tel. 800/428-SAMS. ■

## DRESSING CONSULTANT

(Continued from page 37)

each oak board. Two pieces of 1/8" plexiglass or similar material were slipped into those grooves.

The front sheet of plexiglass has seven illustrations painted on it. Each picture characterizes the particular weather conditions outside. In addition to the illustration, a one-word description of the weather is also included. If you use an acrylic paint, as the author did, be sure to also use acrylic varnish. Follow directions on the bottle. (Model paint, such as Testor's, is more durable than acrylic, but somewhat harder to work with.) An additional protective coating or plastic film is also recommended.

The other sheet was spray painted black and slips into the groove located about 1" behind the front panel. That sheet holds the seven light bulbs—the bulbs slip into grommets mounted in the plastic sheet. Table I gives a brief description of the conditions associated with each light, II through I7. The sensor's reference temperature and respective test point voltage is also included.

For the top of the cabinet the author used a 10 x 10 1/2" oak board. Four wood screws are used to fasten the top board to the two side boards.

The preceding description of the case and front panel are merely suggestions. The reader may come up with a simpler and better looking design.

### Calibration

A digital voltmeter is recommended for calibration, although a good quality analog voltmeter will suffice. Turn on the power and connect the heat sensor. Connect the negative (usually black) lead of the voltmeter to circuit ground. Referring to Fig. 4, connect the voltmeter's positive lead to TP1. Adjust R38 for a reading of 6.12 volts. Similarly, connect the

positive lead to TP2 and adjust R39 for a reading of 5.94 volts. Likewise, adjust R40 so TP3 is at 5.8 volts, R41 is at 5.61 volts, and R42 so TP5 is at 5.44 volts. Note that those voltages correspond to cutoff temperatures of 91.4°F, 75.2°F, 62.6°F, 45.5°F and 30.2°F, respectively. If you prefer other cutoff temperatures, R38 through R42 must be set differently. (Note that every .02 volts corresponds to 1.8°F. Thus, 5.46 volts corresponds to 32°F and 6.10 volts to 89.6°F.)

### Using the Dressing Consultant

Both sensors must be mounted outside; at least a foot away from the building. Do not place the temperature sensor where it will receive intense direct sunlight—filtered sunlight is recommended. Obviously, the rain sensor should not be located at a place protected from rain, e.g. under eaves or trees.

Note that the Dressing Consultant uses a heated temperature sensor. Because of that, the unit should either be left on continually or turned on for at least a minute before it is "consulted" for its sage-like advice. Stay warm and enjoy. ■

TABLE 1  
TEMPERATURE/ELECTRICAL CORRESPONDENCES

DESCRIPTION	LIGHT	CONDITIONS
HOT	11	OVER 91.4°F (33°C) TP1 AT 6.12 volts
WARM	12	BETWEEN 75.2°F (24°C) AND 91.4°F (33°C) TP1 AT 6.12 volts; TP2 AT 5.94 volts
PLEASANT	13	BETWEEN 62.6°F (17°C) AND 75.2°F (24°C) TP2 AT 5.94 volts; TP3 AT 5.80 volts
COOL	14	BETWEEN 45.5°F (7.5°C) AND 62.6°F (17°C) TP3 AT 5.80 volts; TP4 AT 5.61 volts
CHILLY	15	BETWEEN 30.2°F (-1°C) AND 45.5°F (7.5°C) TP4 AT 5.61 volts; TP5 AT 5.44 volts
FRIGID	16	BELOW 30.2°F (-1°C) TP5 AT 5.44 volts
RAIN	17	HIGH HUMIDITY

**NOTE:** The temperature is the temperature of the internally heated sensor. When the wind is calm the sensor is several degrees warmer than the air. Under windy conditions the sensor temperature is nearly the same as that of the air.

# Electronics Paperback Books

GREAT PAPERBACKS AT SPECIAL PRICES



**BP173—COMPUTER MUSIC PROJECTS** ..... \$6.95. Shows how to use your home computer to produce electronic music. Many circuits. Mostly jargon free.

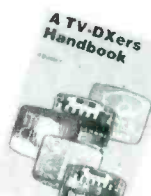

**BP176—TV DXING FOR THE ENTHUSIAST** ..... \$6.95. Practical, authoritative intro to this unusual aspect of electronics. 8 1/2 x 11 in. 144 pp.



**27051—CUSTOMIZED MICRO PROCESSOR PROJECTS** ..... \$14.95. Building instructions, detailed schematics and application programs for intriguing and useful dedicated CPU projects.



**BP141—LINEAR IC EQUIVALENTS AND PIN CONNECTIONS** ..... \$12.50. 247 pages, 7 x 10 in. Shows equivs & pin connections for popular user-oriented ICs.



**BP140—DIGITAL IC EQUIVALENTS AND PIN CONNECTIONS** ..... \$12.50. 312 pages, 7 x 10 in. Shows equivs & pin connections for popular user-oriented ICs.



**BP187—REFERENCE GUIDE TO AMSTRAD WORD PROCESSING** ..... \$14.95. Everything you need to know about using these machines.



**BP148—THE PRACTICAL BOOK** ..... \$6.95. A book on the BASIC programming for those who have not yet bought a computer as well as those who have trouble learning how to program.



**BP108—INTERNATIONAL DIODE EQUIVALENTS GUIDE** ..... \$5.75. Full interchangeability data and characteristics for diodes, including Zeners, LEDs, Diacs, Triacs and more.



**BP135—SECRETS OF THE COMMODORE 64** ..... \$5.00. Masses of useful info and programming tips not found in any user's manual.



**BP143—INTRO TO PROGRAMMING THE ATARI 600/800 XL** ..... \$5.00. Perfect complement to the Atari user's manual. Even shows how to use animated graphics.

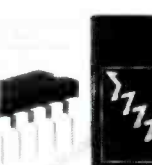

**BP148—COMPUTER TECHNOLOGY EXPLAINED** ..... \$5.00. Explanations for computer terms often encountered. A dictionary for computer lingo.



**BP131—MICRO INTERFACING CIRCUITS—BOOK 2** ..... \$5.75. Interfacing sound and speech generators, temperature and optical sensors, motor controllers, and more.



**BP105—ANTENNA PROJECTS** ..... \$5.00. Practical radio antenna designs that deliver good performance and are relatively simple and inexpensive to build.



**WHITES—WHITE'S RADIO LOG** ..... \$4.95. An up-to-date directory of AM, FM and TV stations, including a section on worldwide shortwave stations.

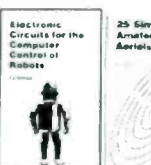

**BP144—FURTHER PRACTICAL ELECTRONICS CALCULATIONS AND FORMULAE** ..... \$9.00. Companion volume to BP53. Book carries on with new data not found in earlier edition. 450 pages.



**BP125—25 SIMPLE AMATEUR BAND ANTENNAS** ..... \$5.00. All kinds of antennas for all kinds of amateur radio reception.

**BP130—MICRO INTERFACING CIRCUITS—BOOK 1** ..... \$5.75. Practical add-ons transform your computer into control or measurement equipment.

**BP132—MICRO INTERFACING CIRCUITS—BOOK 1** ..... \$5.75. Interfacing sound and speech generators, temperature and optical sensors, motor controllers, and more.

**BP140—ANTENNA PROJECTS** ..... \$5.00. Practical radio antenna designs that deliver good performance and are relatively simple and inexpensive to build.

**BP148—COMPUTER TECHNOLOGY EXPLAINED** ..... \$5.00. Explanations for computer terms often encountered. A dictionary for computer lingo.

**WHITES—WHITE'S RADIO LOG** ..... \$4.95. An up-to-date directory of AM, FM and TV stations, including a section on worldwide shortwave stations.

**BP144—FURTHER PRACTICAL ELECTRONICS CALCULATIONS AND FORMULAE** ..... \$9.00. Companion volume to BP53. Book carries on with new data not found in earlier edition. 450 pages.

**BP125—25 SIMPLE AMATEUR BAND ANTENNAS** ..... \$5.00. All kinds of antennas for all kinds of amateur radio reception.

**BP179—ELECTRONIC CIRCUITS FOR THE COMPUTER CONTROL OF ROBOTS** ..... \$5.00. Data and circuits for interfacing the computer to the robot's motors and sensors.

## Quality Paperbacks

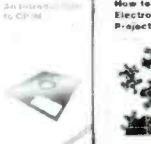

**BP183—AN INTRODUCTION TO CP/M** ..... \$5.75. To run and use programs operators under CP/M you need this book.

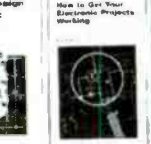

**BP127—HOW TO DESIGN ELECTRONIC PROJECTS** ..... \$5.75. How to use standard circuit elements to make custom electronic projects.



**BP110—HOW TO GET YOUR ELECTRONIC PROJECTS WORKING** ..... \$5.00. How to find the faults in your projects, repair them and get them working.



**BP121—DESIGN & MAKE YOUR OWN PC BOARDS** ..... \$5.75. Everything you need to know before you make printed-circuit boards for your projects.



**BP56—ELECTRONIC SECURITY DEVICES** ..... \$5.00. Three basic sections. Switch activated alarms, infrared & ultrasonic systems, smoke, gas, water detection.



**BP85—INTERNATIONAL TRANSISTOR EQUIVALENTS** ..... \$7.50. Locates possible substitutes for a popular user-oriented selection of modern transistors. Japanese, European and American types.

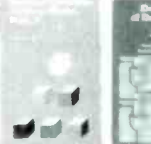

**BP117—PRACTICAL ELECTRONIC BUILDING BLOCKS, Book 1** ..... \$5.75. Build the blocks and then combine them to form almost any custom project of your choice.



**BP118—PRACTICAL ELECTRONIC BUILDING BLOCKS, Book 2** ..... \$5.75. Amplifiers for all kinds to add to the circuits from Book 1 of this series.

**BP104—ELECTRONIC SCIENCE PROJECTS** ..... \$5.75. Simple to complex, a group of projects with a strongly scientific flavor.

**BP92—CRYSTAL SET CONSTRUCTION** ..... \$5.00. A variety of crystal radio receivers for the experimenter and hobbyist.

**BP110—HOW TO GET YOUR ELECTRONIC PROJECTS WORKING** ..... \$5.00. How to find the faults in your projects, repair them and get them working.

**BP121—DESIGN & MAKE YOUR OWN PC BOARDS** ..... \$5.75. Everything you need to know before you make printed-circuit boards for your projects.

**BP56—ELECTRONIC SECURITY DEVICES** ..... \$5.00. Three basic sections. Switch activated alarms, infrared & ultrasonic systems, smoke, gas, water detection.

**BP85—INTERNATIONAL TRANSISTOR EQUIVALENTS** ..... \$7.50. Locates possible substitutes for a popular user-oriented selection of modern transistors. Japanese, European and American types.

**BP117—PRACTICAL ELECTRONIC BUILDING BLOCKS, Book 1** ..... \$5.75. Build the blocks and then combine them to form almost any custom project of your choice.

**BP118—PRACTICAL ELECTRONIC BUILDING BLOCKS, Book 2** ..... \$5.75. Amplifiers for all kinds to add to the circuits from Book 1 of this series.

## Affordable Prices

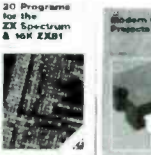

**BP128—20 PROGRAMS FOR THE ZX SPECTRUM & 16K ZX81** ..... \$5.75. All programs run on both machines. Include flow charts and info on how to modify to run on other computers.



**BP106—MODERN OP-AMP PROJECTS** ..... \$5.00. Includes a Slide Trigger, AF Signal Gen, Make Pre-amp, Scratch Filter, and much more.

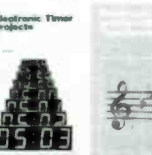

**BP59—SECOND BOOK FOR CMOS IC PROJECTS** ..... \$5.00. Multivibrators, amplifiers; Triggers & gates; special devices including reaction timer, simple electronic organ, and more.

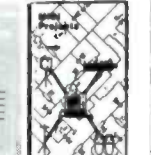

**BP182—MIDI PROJECTS** ..... \$6.95. Details of how to interface many popular home computers with MIDI music systems.



**BP85—SINGLE IC PROJECTS** ..... \$4.95. All projects in this book are based on one IC and are simple to construct. Great way to get started with ICs.

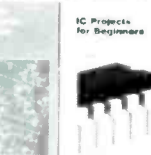

**BP48—POPULAR ELECTRONIC PROJECTS** ..... \$5.50. A collection of a wide range of electronic projects and circuits for the experimenter.

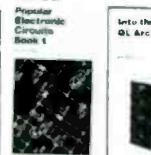

**BP97—IC PROJECTS FOR BEGINNERS** ..... \$5.00. Written especially for the less experienced experimenter. Complete parts layouts and wiring diagrams.



**BP169—INTO THE QL ARCHIVE** ..... \$5.95. Presents the powerful database for the Sinclair QL. Step-by-step approach includes practical examples.

**BP51—ELECTRONIC MUSIC AND CREATIVE TAPE RECORDING** ..... \$5.50. Shows how you can make electronic music at home with simple and inexpensive equip.

**BP185—ELECTRONIC SYNTHESIZER CONSTRUCTION** ..... \$5.95. Shows how to build a monophonic synthesizer; section by section. Replaces BP81.

**BP128—20 PROGRAMS FOR THE ZX SPECTRUM & 16K ZX81** ..... \$5.75. All programs run on both machines. Include flow charts and info on how to modify to run on other computers.

**BP106—MODERN OP-AMP PROJECTS** ..... \$5.00. Includes a Slide Trigger, AF Signal Gen, Make Pre-amp, Scratch Filter, and much more.

**BP59—SECOND BOOK FOR CMOS IC PROJECTS** ..... \$5.00. Multivibrators, amplifiers; Triggers & gates; special devices including reaction timer, simple electronic organ, and more.

**BP182—MIDI PROJECTS** ..... \$6.95. Details of how to interface many popular home computers with MIDI music systems.

**BP85—SINGLE IC PROJECTS** ..... \$4.95. All projects in this book are based on one IC and are simple to construct. Great way to get started with ICs.

**BP48—POPULAR ELECTRONIC PROJECTS** ..... \$5.50. A collection of a wide range of electronic projects and circuits for the experimenter.

## CHECK OFF THE BOOKS YOU WANT

**ELECTRONIC TECHNOLOGY TODAY INC.**  
 P.O. Box 240, Massapequa Park, NY 11762-0240

Name \_\_\_\_\_  
 Address \_\_\_\_\_  
 City \_\_\_\_\_ State \_\_\_\_\_ Zip \_\_\_\_\_

H787

**SHIPPING CHARGES IN USA & CANADA**

\$0.01 to \$5.00	..... \$1.00
\$5.01 to \$10.00	..... \$1.75
\$10.01 to \$20.00	..... \$2.75
\$20.01 to \$30.00	..... \$3.75
\$30.01 to \$40.00	..... \$4.75
\$40.01 to \$50.00	..... \$5.75
\$50.01 and above	..... \$7.00

**OUTSIDE USA & CANADA**

Multiply Shipping by 2 for sea mail  
 Multiply Shipping by 4 for air mail

Total price of merchandise ..... \$ \_\_\_\_\_  
 Sales Tax (New York State Residents only) ..... \$ \_\_\_\_\_  
 Shipping (see chart) ..... \$ \_\_\_\_\_

**All payments must be in U.S. funds**

Number of books ordered

Total Enclosed ..... \$ \_\_\_\_\_

**NEW SOUNDS FROM OLD RECORDS**  
(Continued from page 72)

offers more sound control because the internal preamp does most of the work of shaping the required equalization. That means that greater departures from "normal" can be made through use of the graphic unit.

There's a nice advantage in being able to insert the graphic equalizer between the phono pickup and the amplifier input (either method above). You can then make a tape recording of your equalization playback using the amplifier's TAPE OUT jack while listening to the equalized sound through the amplifier's speaker output.

Equalizers having only line-level input and output have to be connected between the amplifier's TAPE OUT jack and the line input of your tape recorder. That means (1) that the RIAA equalization from the phono preamp is always superimposed on the equalization from the graphic unit (similar to the first method mentioned above) and (2) that the sound from the speaker connected to the amplifier is not equalized and therefore cannot be used to monitor the results of your sound shaping. You'll have to use the monitor function of your tape recorder instead.

Some of the more-modern amplifiers have provisions for delivering a line-level signal to an equalizer for processing—then accepting the line-level equalizer output ahead of the TAPE OUT jacks. That eliminates the second difficulty. You could also get around it by purchasing an outboard phono preamplifier. Intended to provide magnetic-cartridge inputs for amplifiers lacking them, such preamps are available inexpensively from Radio Shack or other electronics parts distributors. Connect the output of your magnetic cartridge to the preamp's line input; wire the preamp's line output to the amplifier's AUX or TUNER input.

The Radio Shack #32-1115 graphic equalizer provides boosts or cuts up to 12 dB in frequency bands centered on 60, 240, 1,000, 3,500, and 10,000 Hz. When using it to modify existing RIAA equalization, I generally make cuts at 60 and

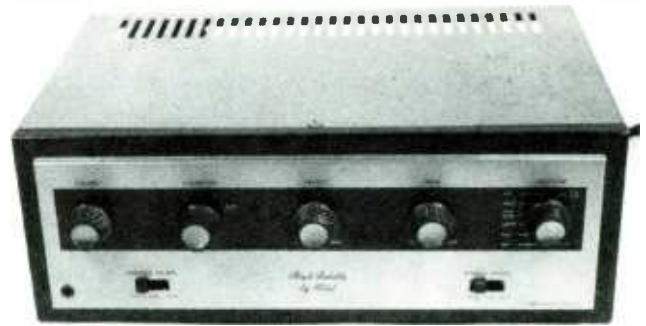

This mid-1950's hi-fi amplifier (Pilot AA-920B) was acquired for the sole purpose of playing back vintage recordings.

10,000 Hz (amount depends on individual recording). That gets rid of boominess and cuts down the sound of record scratch. The three midrange controls receive varying amounts of boost to overcome the usual *thin* reproduction and add transparency and depth.

To get a graphic equalizer having more bands (which will allow you to do even more sophisticated sound-shaping), you'll probably have to buy a stereo unit—which will have two sets of frequency controls—one for each channel. You'll only need one of those for your work with vintage recordings.

Rather than adapt the living room stereo amplifier for that essentially mono job, I've acquired a mid-1950's hi-fi unit for vintage record playback. Those old amplifiers are available reasonably priced (I picked mine up for three bucks at a church rummage) and can prevent you from having to rearrange the wiring on the back of the family set. Such rewiring can be difficult and frustrating when (as mine is) your set is built into a cabinet or bookcase.

Having a separate amplifier and record player for your 78 work also allows you to confine your experimental wiring hookups and stacks of discs to the basement or utility room. That will make the family a whole lot more tolerant should your work with old recordings turn into a full-time hobby! ■



**\$350**

**NEW IDEAS**

**42 PROJECTS  
COMPLETE PARTS LISTS  
ONE-EVENING PROJECTS  
EASY TO BUILD**

■ NEW IDEAS is packed with 42 practical circuits for the Electronics Experimenter and Project Builder. In addition to the headlight alarm, the voltage freezer, and the remote telephone ringer, you get complete plans for a simple Tesla coil project that can generate 25,000-volts AC and draw one-inch sparks. Other interesting projects are: a sound-effects generator, a crystal tester, a stereo remote control, and much, much more! Each project was selected for its low cost of parts!

■ WANT TO EXPAND your knowledge of electronics? Build gadgets that only you can have on your block? Acquire a library of projects? NEW IDEAS is the gold mine of circuits you should own and read. You could start the first night building a project that will have others praising what it can do and admiring you for building it.

■ THERE ARE PROJECTS for everyone—automotive, household, test equipment, audio and hi-fi, and projects just for fun.

**NEW IDEAS—Circuits for Experimenters and Project Builders!**

Please send one copy of NEW IDEAS at \$3.50. First Class postage and handling \$1.00 (U.S. and Canada only). All other countries: \$2.00 for sea mail, \$3.00 for air mail.

Please send \_\_\_\_\_ copies of New Ideas. Total cost is sum of copy price and First Class postage and handling cost multiplied by number of issues ordered.

Please print

Allow 6-8 weeks for the material to arrive.

(Name) \_\_\_\_\_

Detach and mail today:  
HANDS-ON ELECTRONICS  
Reprint Department  
500-B Bi-County Boulevard  
Farmingdale, NY 11735

(Street Address) \_\_\_\_\_

(City) \_\_\_\_\_

(State) \_\_\_\_\_

(Zip) \_\_\_\_\_

H787

All Payment must be in U.S. Funds!



**NOW**  
**Hands-on Electronics**  
**Every Month!**

■ IF YOU'RE THE KIND OF READER that doesn't want to wait, you can order your next copy of **Hands-on Electronics** now. **Hands-on Electronics** is crammed full of electronic projects that you won't be able to wait to build for yourself. You can expect top-notch digital projects, fun-to-play electronic games, valuable add-on computer projects, BCB and shortwave receivers, photographic/darkroom gadgets, devices to improve your car's performance, test equipment ideas, and more in every issue of **Hands-on Electronics**.

■ YOU CAN HAVE THE NEXT TWELVE ISSUES of **Hands-on Electronics** delivered to your home for only \$28.00 — a savings off the single copy price of \$2.50 per issue! Or you can order 7 issues for only \$16.97 and still save off the single copy price of \$2.50 per issue!

■ EVERY ISSUE OF **Hands-on Electronics** will continue to contain a variety of construction articles to suit every taste. In addition, feature articles on electronics fundamentals, test equipment and tools will round out each issue. Of course, **Hands-on Electronics** will continue to provide new product and literature listings to keep you up to date on the latest developments in electronic technology.

■ GET IN ON THE ACTION! Order your next issue of **Hands-on Electronics** today. Use the convenient order coupon below. Be sure to send check or money order—no cash!

## Hands-on Electronics SUBSCRIPTION

I want to be sure I don't miss any issues. Send me ONE FULL YEAR — twelve issues — of **Hands-on Electronics** for \$28.00 (Canada \$33.00 U.S. Funds).

I want to SAVE OFF THE SINGLE COPY PRICE of \$2.50 per issue. Send me 7 issues of **Hands-on Electronics** for \$16.97 (Canada \$19.89 U.S. Funds).

Payment Enclosed

Please charge my

Visa

Mastercard

Signature \_\_\_\_\_

Bill Me Later

Acct. # \_\_\_\_\_

Exp. Date \_\_\_\_\_

Allow 6-8 weeks for the first issue to arrive. Offer valid in U.S. Funds Only.

Please print

\_\_\_\_\_  
 (Name)

\_\_\_\_\_  
 (Street Address)

\_\_\_\_\_  
 (City)

\_\_\_\_\_  
 (State)

\_\_\_\_\_  
 (Zip)

Detach and mail today  
 to:  
 HANDS-ON  
 ELECTRONICS  
 SUBSCRIPTION DEPT.  
 P.O. BOX 338  
 MOUNT MORRIS, IL  
 61054

AHOG7

## RADIO SHACK DUOFONE

(Continued from page 64)

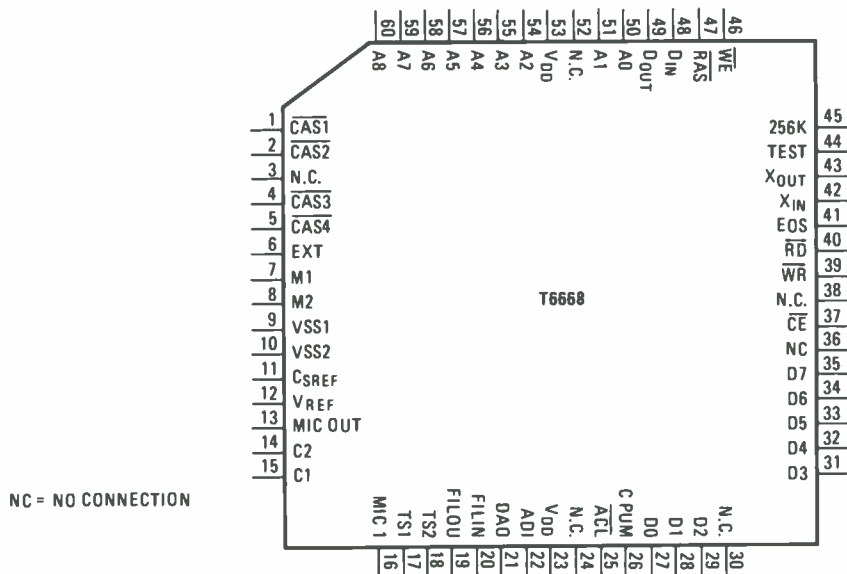

Fig. 2—Unlike mechanical telephone-answering machines, the TAD-105 uses a speech-synthesizer, controlled by a 41256 256K × 1 RAM IC—which is used in computers.

desired bandwidth (in this case, 6000 times per second). So, in order to capture ten seconds of speech, we need about 60,000 samples.

Dividing 256,000 by 60,000 gives about four—so each sample can be represented by four bits in the RAM IC. Four bits can be combined in sixteen different ways, so each sample can have one of sixteen different voltages. That's not really very many; high-fidelity digital recordings are often made with sixteen or eighteen bits for each sample. Sixteen bits yield 65,536 different voltage levels, and eighteen bits, 262,144 levels.

If we settled for a bandwidth of, say, 2.5 kHz, we could get five bits of resolution, which would yield 32 different voltages. The trade-off is that, although each sample would be a more accurate representation of the voltage at that instant, higher frequencies would be lost, or would appear as noise. Six bits would give a maximum frequency of about 2.2 kHz, seven bits, 1.9 kHz, and eight bits, 1.6 kHz.

Radio Shack's literature does not specify the sample rate used, nor the number of bits per sample. But the preceding analysis shows how the circuit works, and the kind of performance various values would give.

### Our Impressions

However many bits are used, fidelity of the recorded message is surprisingly good—it's as good as most low- to medium-cost magnetic-tape-based answering machines. The TAD-105 has a good "feel," unlike many inexpensive modern phones. The handset is light, but not too light, and sound reproduction through the handset speaker is good, as is the sound

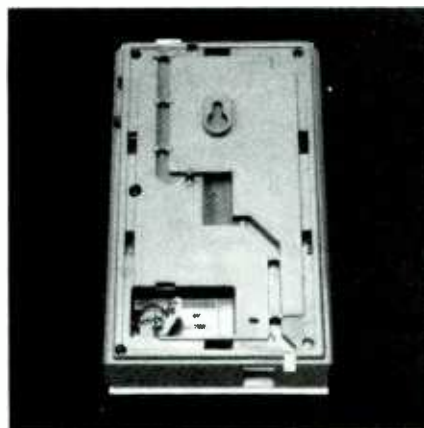

The inlet on the rear of the unit allows easy wall mounting. A compartment is provided on the back of the base unit for a 9-volt battery—a back-up power source.

transmitted by the microphone. The warbling "ring" tone is not unpleasant, unlike that of some of the inexpensive electronic phones.

We do have a few "nits" to pick. For one, you can't set the number of rings after which the phone will play the pre-recorded message. And the PHONE/ANSWER switch could work better. It would be nice if, in the answer-only mode, it would answer all the time after a user-settable number of rings; in the other mode, it would only answer if the user hadn't picked up the handset after a preset number of rings. That way, every caller would get some response. A blinking LED when in answer mode would help you remember to put the unit back in phone mode.

The back-up battery is a standard nine-volt type, which is installed in the under-

side of the case (see photos); a rechargeable type (that is trickle-charged) would make the phone maintenance-free. The RECORD button has no interlock, electrical or mechanical, so it's easy to press it and accidentally wipe out your message.

In addition, it would be great to have ten or more dialing memories and the ability to record messages—in electronic memory, of course. In fact, by using a microprocessor and 16 megabytes of memory, you could record 64 ten-second messages...but those are wish-list items, not faults.

All in all, the TAD-105 is a heck of a phone—especially when you consider that it costs only \$49.95. Visit your local Radio Shack for a demonstration or more information. ■

## HAM RADIO

(Continued from page 87)

but all kits by all manufacturers).

The second problem was in trying to make the capacitor fit together. The SA-2550, like the other Heath amateur-radio antenna tuners, requires that you build the tuning capacitor from bits and pieces. You'll receive a bag of stator plates, a bag of rotor plates, and a couple of bags of spacers and other bits of hardware. There is a lengthy assembly procedure for the capacitor.

I have built four Heath antenna tuners, and all used the same type *roll-your-own* capacitors. While the idea of assembling a variable capacitor may seem frightening to an inexperienced builder, it is actually relatively easy. I've never had any problem with the capacitors in the first three tuners. But in the SA-2550, I had a dickens of a time making it work. The problem was that the spaces between plates were not even, either between any two plates or from plate-to-plate over the length of the capacitor.

After a lot of *spritzing and fussing*, the capacitor finally went together (my kids may have learned a couple of new words that my wife doesn't appreciate). I believe that Heath needs to look at either the tolerancing of the capacitor parts, or the instructions to determine whether that's a real problem, or whether ol' Joe's hands ain't what they use to be.

It should be pointed out, however, that only ordinary mechanical skills normally associated with all forms of electronic kit construction are needed to assemble the capacitor—the only added ingredient is a little more patience than is required to assemble similar capacitors on earlier model Heath Kit tuners. The earlier capacitors went together exactly as shown in the Heath assembly manuals.

If you want to build either a vertical or inverted-V antenna that can be tuned to resonance across an entire HF amateur band, then I recommend the SA-2550. ■

This will be coming to you when you subscribe to **Radio-Electronics**

- **HELPFUL CONSTRUCTION ARTICLES...**
  - Test Equipment
  - Hi-Fi Accessories
  - Telephone Accessories
  - Music Synthesizers
  - Computer Equipment
  - Automotive Equipment
  - Intruder Alarms-Home & Car
  - Video Accessories
- **NEWS ON NEW TECHNOLOGY**
  - Computers
  - Microprocessors
  - Satellite TV
  - Teletext
  - Automotive Electronics
  - Speech Synthesizers
  - IC Applications
- **FASCINATING "HOW TO DO IT" ARTICLES...**
  - Build Your Own Projects
  - Make Your Own PC Boards
  - Wiring Techniques
  - Soldering and Desoldering
  - Design and Prototyping

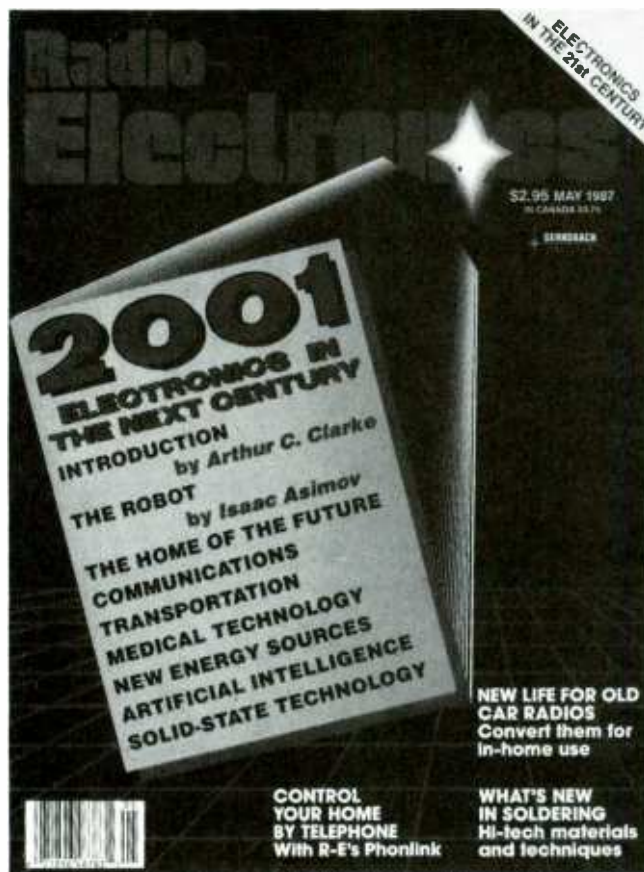

- **HOW YOU AND THE COMPUTER CAN BE FRIENDS...**
  - Getting Started
  - Programs, Circuit Design, Games
  - A/D-D/A Interfacing
  - Peripheral Equipment
- **NEW AUDIO DIMENSIONS FOR YOUR PLEASURE...**
  - Noise-Reduction Devices
  - How to Connect that Extra Add-On
  - Hi-Fi Accessories
  - New Technology
- **TV WONDERS FOR YOUR FUTURE...**
  - Latest Receivers and Circuits
  - The Home Entertainment Center
  - Projection TV
  - Satellite TV Receivers
  - Jack Darr's Monthly Service Clinic
  - Service Problems and Solutions
- **REGULAR MONTHLY FEATURES**
  - DESIGNERS NOTEBOOK by Robert Grossblatt
  - HOBBY CORNER by "Doc" Savage, K4SDS
  - STATE-OF-SOLID-STATE by Bob Scott
  - WHAT'S NEWS, new products, stereo news and NEW IDEAS, STEREO PRODUCTS, NEW COMPUTER PRODUCTS FOR HOME/JOB and MUCH MORE!

Radio-Electronics covers all aspects of the fast moving electronics field...featuring **COMPUTERS • VIDEO • STEREO TECHNOLOGY • SERVICE COMMUNICATIONS • PROJECTS**

# Get it all!

Subscribe today to Radio-Electronics! Don't miss a single issue and...see subscription card in back of this issue for big savings.

When you select one of the subscription offers listed on the handy coupon—you'll be assured of having your copy reserved, even if it sells out on the newsstand. Make sure you get all the excitement in every issue of Radio-Electronics, every month, by filling in and mailing your subscription card today.

# HANDS-ON MARKETPLACE

## FOR SALE

**LASERS:** Surplus parts, and units, "the source for laser surplus!" Free catalog. **MEREDITH INSTRUMENTS**, P.O. Box 1724, Glendale, AZ 85311.

500 parts \$12.00. Mixed resistors, capacitors, diodes, inductors, etc. Good stuff. No junk. 5 free power transistors with each \$24.00 order. We pay shipping in U.S.A. Add \$2.00 if C.O.D. **BARGAIN CITY**, P.O. Box 121H, Glen Miss. 38846.

## CLASSIFIED AD ORDER FORM

To run your own classified ad, put one word on each of the lines below and send this form along with your check to:

**Hands-on-Electronics Classified Ads**, 500-B Bi-County Boulevard, Farmingdale, N.Y. 11735

**PLEASE INDICATE** in which category of classified advertising you wish your ad to appear. For special headings, there is a surcharge of **\$10.00**.

( ) Plans/Kits ( ) Business Opportunities ( ) For Sale  
( ) Education/Instruction ( ) Wanted ( ) Satellite Television  
( )

Special Category: \$10.00

### PLEASE PRINT EACH WORD SEPARATELY, IN BLOCK LETTERS.

(No refunds or credits for typesetting errors can be made unless you clearly print or type your copy.) Rates indicated are for standard style classified ads only. See below for additional charges for special ads. **Minimum: 15 words.**

1	2	3	4	5
6	7	8	9	10
11	12	13	14	15 (\$21.00)
16 (\$22.40)	17 (\$23.80)	18 (\$25.20)	19 (\$26.60)	20 (\$28.00)
21 (\$29.40)	22 (\$20.80)	23 (\$32.20)	24 (\$33.60)	25 (\$35.00)
26 (\$36.40)	27 (\$37.80)	28 (\$39.20)	29 (\$40.60)	30 (\$42.00)
31 (\$43.40)	32 (\$44.80)	33 (\$46.20)	34 (\$47.60)	35 (\$49.00)

We accept MasterCard and Visa for payment of orders. If you wish to use your credit card to pay for your ad fill in the following additional information (Sorry, no telephone orders can be accepted.):

Card Number \_\_\_\_\_ Expiration Date \_\_\_\_\_

PRINT NAME \_\_\_\_\_

SIGNATURE \_\_\_\_\_

**IF YOU USE A BOX NUMBER YOU MUST INCLUDE YOUR PERMANENT ADDRESS AND PHONE NUMBER FOR OUR FILES. ADS SUBMITTED WITHOUT THIS INFORMATION WILL NOT BE ACCEPTED.**

**CLASSIFIED COMMERCIAL RATE:** (for firms or individuals offering commercial products or services) \$1.40 per word prepaid (no charge for ZIP code)...**MINIMUM 15 WORDS**. 5% discount for same ad in 6 issues within one year; 10% discount for 12 issues within one year if prepaid. **NON-COMMERCIAL RATE:** (for individuals who want to buy or sell a personal item) \$1.15 per word, prepaid...no minimum. **ONLY FIRST WORD AND NAME** set in bold caps at no extra charge. Additional bold face (not available as all caps) 25¢ per word additional (20% premium). Entire ad in boldface, add 20% premium to total price. **TINT SCREEN BEHIND ENTIRE AD:** add 25% premium to total price. **TINT SCREEN BEHIND ENTIRE AD PLUS ALL BOLD FACE AD:** add 45% premium to total price. **EXPANDED TYPE AD:** \$1.85 per word prepaid. All other items same as for STANDARD COMMERCIAL RATE. **TINT SCREEN BEHIND ENTIRE EXPANDED TYPE AD:** add 25% premium to total price. **TINT SCREEN BEHIND ENTIRE EXPANDED TYPE AD PLUS ALL BOLD FACE AD:** add 45% premium to total price. **DISPLAY ADS:** 1" x 2 1/4" — \$160.00; 2" x 2 1/4" — \$320.00; 3" x 2 1/4" — \$480.00. **General Information:** Frequency rates and prepayment discounts are available. **ALL COPY SUBJECT TO PUBLISHERS APPROVAL. ADVERTISEMENTS USING P.O. BOX ADDRESS WILL NOT BE ACCEPTED UNTIL ADVERTISER SUPPLIES PUBLISHER WITH PERMANENT ADDRESS AND PHONE NUMBER.** Hands-on Electronics is published monthly, therefore copy to be in our hands for Aug. 87, 4/19; Sept. 87, 5/19, Oct. 87, 6/19.

**LINEAR parts—Transistors:** MRF454 \$15, MRF455 \$12, MRF477 \$11, MRF492 \$16.75, MRF421 \$22.50, SRF2072 \$13, SRF3662 \$25, 3800 \$18.75, 2SC2290 \$19.75, 2SC2879 \$25. **Tubes:** 6KD6 \$10.50, 6LQ6 \$9.75, 6LF6 \$9.75, 8950 \$16.75. Best prices on Palomar Road Noise Mics, Ranger AR3300. New 16 page catalog listing radio/amplifier tricks—channel modification, PLL-Sliders, peaking for range, hard-to-find linear parts—mail \$1.00 to: **RFPC**, Box 700, San Marcos, CA 92069. For same day parts shipment, call (619) 744-0728.

**TUBES** 59 cents. Year guarantee. Free catalog. Tube Tester \$8.95. **CORNELL**, 4219 University, San Diego, CA 92105.

**CABLE-TV converters.** Scientific Atlanta, Jerrold, Oak, Zenith, Hamlin. Many others. "New" **VIDEO HOPPER** "The copy killer". Visa, M/C & Amex accepted. Toll free 1-800-826-7623. **B&B INC.**, 10517 Upton Circle, Bloomington, MN 55431.

**OSCILLOSCOPES** and test equipment. Tektronix, H.P., Fluke, etc. Free catalog. **CAL-SCOPE**, 1030 W. Maude Ave. #505, Sunnyvale, CA 94086 (408) 730-4573.

**TUBES**—over 2000 types, including early and hard-to-find. Parts and literature for antique radio restorations. Send \$2.00 for 20 page catalog to **ANTIQUE ELECTRONIC SUPPLY**, 688-C West First Street, Tempe, AZ 85281.

**OLD** radio tubes. Send \$1.00 for lists. Refundable. **DIERS**, 4276 North 50, Milwaukee, WI. 53216.

**IS it true you can buy jeeps for \$44 through the U.S. government? Get the facts today! Call 1-312-742-1142 Ext. 1717.**

**NIGHT vision** equipment, lasers, computer parts and surplus electronic equipment. 68 page picture catalogue \$1.00. **MESHNA, INC.**, Nahant, MA 01908.

## SATELLITE TV

59 degree brand name LNA's! LNB's! Ku-Band LNB's! Discount pricing! Catalog \$1.00 (Refundable): **LNA-HI**, 201 E Southern, Suite 100, Tempe AZ 85282.

## PLANS/KITS

**BUILD** this five-digit panel meter and square wave generator including an ohms, capacitance and frequency meter. Detailed instructions \$2.50. **BAGNALL ELECTRONICS**, 179 May, Fairfield, CT 06430.

**CRYSTAL** radio sets, plans, parts, kits. Catalog \$1.00. **MIDCO**, 660 North Dixie Highway, Hollywood, FL 33020.

**STRANGE** stuff. Plans, kits, items. Build satellite dish \$69.00. Descramblers, bugs, adult toys. Informational photo package \$3.00, refundable. **DIRIJO CORPORATION**, Box 212-H, Lowell, NC 28098.

**COLOR** computer, security devices. Temperature, sound, intrusion alarm. Plugs into cassette and joystick sockets. Plans, programs cost \$10.00. **BROWN'S**, 119 Skyline Drive, R.H., Granbury, TX 76048.

**SATELLITE DISH PACKAGE** make your own dish with inexpensive and easily available basic materials. Solid construction, less than 17 hours labour. Templates included. Specify diameter. \$9.25 plus \$2.00 shipping and handling. Cheque or money order. **NATIONAL SUPPLY**, Box 370 PortHope Ontario L1A 3Z2 Canada.

**UPGRADE** kit for line zappers \$19.95. Stops negative pictures, improves clarity. Complete with add-on board. Complete kits available. **C&C SPECIALTIES**, 1432 Heim, Orange, CA 92665. (714) 998-6866.

**AMPLIFIER plans**—Totally new technology. Quieter, freer from distortion, easier to construct audio amplifiers. Plans, all wattages, \$15. **AMPLIFIERS UNLIMITED**, Rt 2, Box 139, Highmore, SD 57345.



**EXPANDABLE** digital panel meter—Modular construction allows the basic DMS to take on the appearance and function of many devices by simply attaching standard, custom or do-it-yourself add-on modules. The Basic DMS as shown in Aug. '86 Modern Electronics \$31.95 (kit); Tachometer add-on module (Oct. '86 ME) \$29.95. Add 2.50 P&H each. Other kits available. Free brochure. Call (404) 979-5900. **BALLCO INC.**, 148 South Clayton St., Suite 131, Lawrenceville, GA 30245.

**CATALOG:** Hobby circuits, licensed/unlicensed broadcasting, transmitters, antennas, books, scramblers, bugging devices, science projects, more! **PANAXIS**, Box 130-H07, Paradise, CA, 95967.

## WANTED

**INVENTORS!** AIM wants ideas, inventions, new products, improvements on existing products. We present ideas to manufacturers. Confidentiality guaranteed. Call toll free 1-800-225-5800 for information kit.

## DO-IT-YOURSELF TV REPAIR

**NEW...Repair any TV...easy.** Retired serviceman reveals secrets. Write, **RESEARCH**, Rt. 3, Box 601BH, Colville, WA 99114.

## CABLE EQUIPMENT

**CABLE-TV Secrets**—the outlaw publication the cable companies tried to ban. HBO, Movie Channel, Showtime, descramblers, converters, etc. Suppliers list included, \$8.95. **CABLE FACTS**, Box 711-H, Pastaskala, OH 43062.

**JERROLD** equipment including new Jerrold Tri-Mode and Drzin systems, Hamlin, SB-3, N-12, Mini-code, Zenith, Z-Tac and more. All products enable you to pick up most cable stations. Best prices around! For information, send \$1.00 plus S.A.S.E. or call (312) 658-8643. **SWENSENS ELECTRONICS**, 518 North Harrison St., Suite C, Algonquin, IL 60102. No Illinois orders accepted!

## BUSINESS OPPORTUNITIES

**CASH in on Army surplus sales.** Buy directly from government. No middlemen. Book \$4.50. Shipping and handling included. Cheque or money order. **NATIONAL SUPPLY**, Box 370, PortHope Ontario L1A3Z2 Canada.

## BEST JOBS/HIGHEST PAY

**NEW easy method.** Guaranteed. Free report reveals secrets, tells how. **NOVA SYSTEMS**. 6901-B North Lamar, Austin, TX 78752.

## CELLULAR PHONES

**WIRING up Cellular phones.** 20+ pages. Most brands covered. Bonus, making briefcase phones. All for \$6.95 plus \$1.50 ship/hdlg to: **EVERGREEN RESOURCES**, 1321-N S.E. Everett Mall Way, #273, Everett, WA 98204.

# GET OUT OF THE DARK.

The Consumer Information Catalog will enlighten you with over 200 federal consumer-oriented publications. Many are free and all are helpful. Get your free copy by writing—

**Consumer Information Center  
Dept. TD, Pueblo, Colorado 81009**

U.S. General Services Administration



**Now paying 10.94%.**

U.S. Savings Bonds now pay like money market accounts! At the current rate—10.94%—you could double your money in less than seven years. Just hold Bonds for five years and you get the new higher variable rates. Plus, you get a guaranteed return. That's the kind of change anyone can appreciate.

But some of the best things about Bonds haven't changed. Savings Bonds are still as safe as ever. They're still exempt from state and local income taxes. And since Bonds cost as little as \$25, they're as affordable as ever. What's more, Bonds remain a great way to keep our country strong.

You can purchase Bonds almost anywhere. At neighborhood banks, savings and loans and credit unions. Or easier still, right through the Payroll Savings Plan where you work.

For your free booklet, write: "50 Q&A," U.S. Savings Bonds Division, Washington, DC 20226.

**U.S. SAVINGS BONDS**  
Paying Better Than Ever

Variable rates apply to Bonds purchased on and after 11/1/82 and held at least 5 years. Bonds purchased before 11/1/82 earn variable rates when held beyond 10/31/87. Bonds held less than 5 years earn lower interest.

A public service of this publication.

## SOUND SENDER

(Continued from page 45)

is high-tech, nothing is simple) of how the Sound Sender gets around all the RF filtering, but quite frankly we're not ready to buy the explanation provided at this time. More likely, we think it works this way:

The oscillator puts out a strong RF signal of several volts. By the time it gets past its own internal filtering used to keep the auto's own hash out of the modulation, the desired RF has been knocked down to a few milliwatts, which is fed into the car's electrical system through the cigarette lighter's wiring.

The RF flows to the radio where the spark plate (a capacitor), and possibly an RF choke, squash the RF down to just a few microvolts, which literally float around the internal wiring of the radio—the wires now function as a transmitting antenna. Since an auto radio needs just a few *microvolts* (typically between 3- and 10- $\mu$ V) for good FM reception, the few microvolts from the Sound Sender that got past the filtering is enough to provide decent FM reception.

### Testing, 1...2...3

Surprise, surprise! We tried the Sound Sender in two different makes of car and the Sound Sender worked just as claimed. The signal was received with a signal-to-noise ratio comparable to what we got from moderate-level FM stations: perfectly satisfactory. The tuning held—requiring no adjustment—from a start-up temperature of 26°F to 87°F with the heater going full blast. Somewhere along the way, we had to trim the tuning once for best sound, but we also have to do that with conventional FM listening.

Since the Sound Sender has no automatic volume control, it has to be "ear-balled." First, you tune a conventional—not hard-rock—FM station and note its volume level. Then you tune in the Sound Sender and adjust the volume control of the *Walkman* until its signal sounds a shade weaker than the regular station; the result is *Walkman* sound having minimum distortion.

About the only complaints you're likely to have are that the *Walkman* is heard in mono, and it's frequency response isn't hi-fi: it's just about what you'd get from an AM station. Of course, you can boost the



**SMD components are so small you can barely see them. The small "blip" at the end of the pencil isn't a dirt speck on the picture, it's a transistor.**

highs somewhat through the radio's tone control(s), or the equalizer found on some portable tape players. But even not too hi a fi is better than nose.

The Sound Sender will fit all vehicles except late-model Ford LTD's and Thunderbirds (which is a funny claim because our test unit performed the same in a late model LTD as it did in a Plymouth, although the LTD was equipped with a Radio Shack AM/FM radio). The device is list priced at \$29.95, but has been purchased in auto-accessory stores for \$19.95. For information see your local auto-accessory dealer or write to Hartzell Mfg. Inc., 2516 Wabash Ave., St. Paul, MN 55114, or circle No. 80 on the Reader's Free Information Card. ■

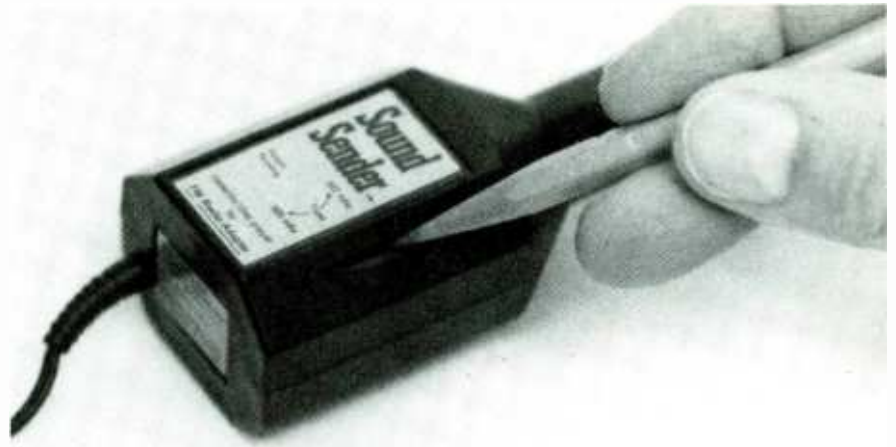

The pencil points to a small, knurled knob that sets the output frequency. It's the only control on the unit, all else is controlled by the radio and tape deck.

## ELLIS ON ANTIQUE RADIO

(Continued from page 89)

cillator/mixer, 12SK7 IF amplifier, 12SQ7 detector/amplifier, 35L6 output amplifier, and 35Z5 rectifier. The only obvious features that mark the set as a communications receiver (albeit, a very rudimentary one) are one extra tube—a 12J5 that's used as a BFO (beat-frequency oscillator)—and the band-switched coil-sets in the RF and circuits. It's truly a no-frills receiver. Once running, it should be interesting to see how it performs.

### Plan of Attack

Having found out that much, I was really tempted to plug in the set and give it a try. But I gave up on that idea for a couple of reasons. First of all, I thought I should take my own advice and try to preserve the electrolytic capacitors by applying a lower-than-normal line voltage when first turning on the set. I'm not set up to do that conveniently yet, but am building up a little control console for the purpose of using a Fair Radio Sales trans-

former, to make working on the radio a lot safer. The transformer effectively insulates the set from the AC line.

The other reason for delaying the *test flight* is the filth encrusting much of the set's innards. Even if the EC-1 were to take off on the first try, its operation would probably be noisy and erratic until the dirt and corrosion is removed—especially from the tuning capacitor (see photos), volume control and control switches. And right now, because of the grime covering the inside of the celluloid window, it's even a chore to read the tuning dial.

The next step, then, in bringing the EC-1 back to life will be further disassembly followed by deep cleaning. Tune in next month for more details!

### The Fair Radio Transformer

In a previous column, I reported on a surplus isolation transformer being offered by Fair Radio Sales, 1016 E. Eureka St., Lima, OH 45802. The transformer—part number P-126J875, listed in catalog WS-86 at \$7.95, plus shipping—comes with a switch-tapped primary that, when

operated from a 117-volt input, provides 69-, 78-, 100-, 122- and 147-volt open-circuit secondary voltages, rated at a hefty 1-ampere.

The transformers are all used units, and the one supplied to me had a defective tap switch, but was otherwise fine. By next month, I should have it wired into a control console that will really promote the process of set start-up and testing.

If you have any information to share on the Echophone EC-1 please write to me C/O Hands-on Electronics, Gernsback Publications, Inc., 500-B Bi-County Boulevard, Farmingdale, NY 11735. ■

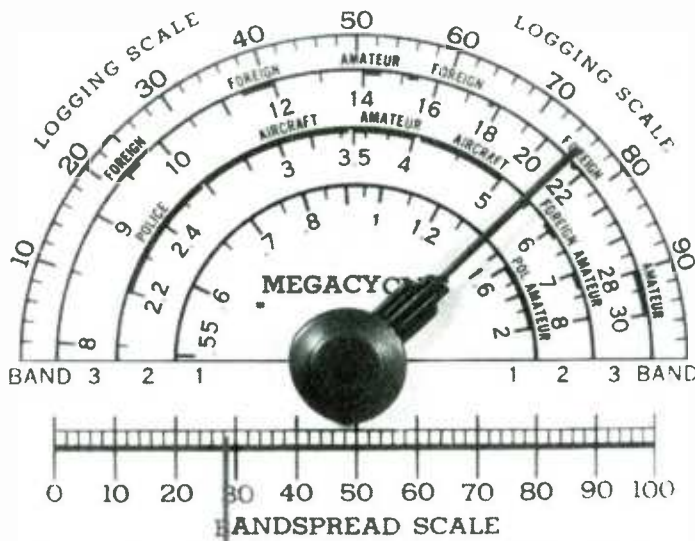

Here's a good look at the Echophone's tuning dial. Set was removed from cabinet so camera wouldn't have to look through a grimy celluloid window.

## ADVERTISING INDEX

HANDS-ON ELECTRONICS magazine does not assume any responsibility for errors that may appear in the index below.

Free Information No.	Page
8	AMC Sales . . . . . 22
9	All Electronics . . . . . 15
—	Amazing Devices . . . . . 22
11	C.I.E. . . . . 21
21	Communications Electronics . CV2
10	Cooks Institute . . . . . 16
12	Digi-Key . . . . . 13
—	Electronic Tech. Today . CV3, 101
6	Electronics Book Club . . . . . 3
7	Emco . . . . . 26
13	Fluke Manufacturing . . . . . 17
—	Grantham Col. of Engineering . . 5
14	Heath . . . . . 31
—	ISCET . . . . . 28
18	Kepro Circuit Systems . . . . . 6
15	MCM Electronics . . . . . 23
16	Mouser . . . . . 16
—	NRI . . . . . 11
—	Pacific Cable . . . . . 7
17	Test Probes . . . . . 18
19	Trio Kenwood . . . . . CV4
20	UVTC . . . . . 26

## BUY BONDS

# Electronics Paperback Books

EVERY BOOK IN THIS AD \$6 OR LESS!

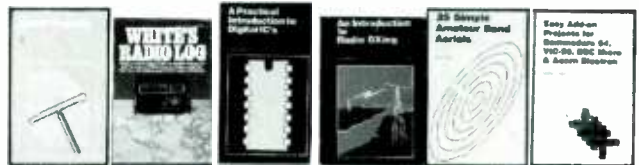
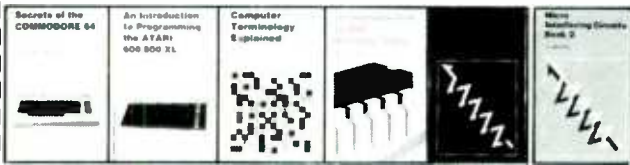

- BP125—25 SIMPLE AMATEUR BAND ANTENNAS.....\$5.00.** All are inexpensive to build, yet perform well. Diodes, beams, triangle and even a mini rhombic.
- BP128—20 PROGRAMS FOR THE ZX SPECTRUM AND 16K ZX82.....\$5.75.** Included with each program is a flow chart and a description of what happens. Notes for converting programs for use on other computers are also included
- 160—COIL DESIGN & CONSTRUCTION MANUAL.....\$5.95.** How the hobbyist can build RF, IF, audio and power coils, chokes and transformers. Covers AM, FM and TV applications.
- 208—PRACTICAL STEREO & QUADROPHONY HANDBOOK.....\$3.00.** A reference book for all interested in stereo and multichannel sound reproduction.
- BP99—MINI-MATRIX BOARD PROJECTS.....\$5.00.** Here are 20 useful circuits that can be built on a mini-matrix board that is just 24 holes by ten copper-foil strips.
- BP157—HOW TO WRITE ZX SPECTRUM AND SPECTRUM+ GAMES PROGRAMS.....\$5.95.** A crystal-clear step-by-step guide to writing your own graphics games programs.
- BP117—PRACTICAL ELECTRONIC BUILDING BLOCKS—Book 1.....\$5.75.** Oscillators, Timers, Noise Generators, Rectifiers, Comparators, Triggers and more.
- 219—SOLID-STATE NOVELTY PROJECTS.....\$4.95.** Fun projects include the Optomin, a musical instrument that is played by reflecting a light beam with your hand, and many more.
- BP179—ELECTRONIC CIRCUITS FOR THE COMPUTER CONTROL OF ROBOTS ..... \$5.00.** Data and circuits for intercing the computer to the robot's motors and sensors
- BP126—BASIC & PASCAL IN PARALLEL.....\$4.95.** Takes these two programming languages and develops programs in both languages simultaneously.
- 224—50 CMOS IC PROJECTS.....\$5.25.** Includes sections on multivibrators, amplifiers and oscillators, trigger devices, and special devices.
- 225—A PRACTICAL INTRODUCTION TO DIGITAL IC'S.....\$4.95.** Mainly concerned with TTL devices. Includes several simple projects plus a logic circuit test set and a digital counter timer.
- BP170—INTRODUCTION TO COMPUTER PERIPHERALS.....\$5.95.** Shows how to use a variety of co computer add-ons in as non-technical a way as possible.
- 227—BEGINNERS GUIDE TO BUILDING ELECTRONIC PROJECTS.....\$5.00.** How to tackle the practical side of electronics so you can successfully build electronic projects.
- BP169—HOW TO GET YOUR COMPUTER PROGRAMS RUNNING.....\$5.95.** Shows how to identify error in program and what to do about them.
- 123—FIRST BOOK OF PRACTICAL ELECTRONIC PROJECTS.....\$3.75.** Projects include audio distortion meter, super FET receiver, guitar amplifier, metronome and more.
- BP24—52 PROJECTS USING IC 741.....\$5.25.** Lots of projects built around this one available IC.
- BP110—HOW TO GET YOUR ELECTRONIC PROJECTS WORKING.....\$5.00.** How to find and solve the common problems that can occur when building projects.

- BP33—ELECTRONIC CALCULATOR USERS HANDBOOK.....\$5.75.** Invaluable book for all calculator owners. Tells how to get the most out of your calculator.
- BP36—50 CIRCUITS USING GERMANIUM, SILICON & ZENER DIODES.....\$5.00.** A collection of useful circuits you'll want in your library.
- BP37—50 PROJECTS USING RELAYS, SCR'S & TRIACS.....\$5.00.** Build priority indicators, light modulators, warning devices, light dimmers and more.
- BP183—AN INTRODUCTION TO CP M.....\$5.75.** To run and use programs operating under the CP/M operating system you will find this book extremely useful.
- BP42—SIMPLE LED CIRCUITS.....\$5.00.** A large selection of simple applications for this simple electronic component.
- BP127—HOW TO DESIGN ELECTRONIC PROJECTS.....\$5.75.** Helps the reader to put projects together from standard circuit blocks with a minimum of trial and error.
- BP122—AUDIO AMPLIFIER CONSTRUCTION.....\$5.75.** Construction details for preamps and power amplifiers up through a 100-watt DC-coupled FED amplifier.
- BP92—CRYSTAL SET CONSTRUCTION.....\$5.00.** Everything you need to know about building crystal radio receivers.
- BP45—PROJECTS IN OPTOELECTRONICS.....\$5.00.** Includes infra-red detectors, transmitters, modulated light transmission and photographic applications.
- BP48—ELECTRONIC PROJECTS FOR BEGINNERS.....\$5.00.** A wide range of easily completed projects for the beginner. Includes some no-soldering projects.
- BP49—POPULAR ELECTRONIC PROJECTS.....\$5.50.** Radio, audio, household and test equipment projects are all included.
- BP51—ELECTRONIC MUSIC AND CREATIVE TAPE RECORDING.....\$5.50.** Shows how you can make electronic music at home with the simplest and most inexpensive equipment.
- BP56—ELECTRONIC SECURITY DEVICES.....\$5.00.** Includes both simple and more sophisticated burglar alarm circuits using light, infra-red, and ultrasonics.
- BP59—SECOND BOOK OF CMOS IC PROJECTS.....\$5.00.** More circuits showing CMOS applications. Most are of a fairly simple design.
- BP72—A MICROPROCESSOR PRIMER.....\$5.00.** We start by designing a small computer and show how we can overcome its shortcomings.
- BP74—ELECTRONIC MUSIC PROJECTS.....\$5.95.** Provides the experimenter with a variety of practical circuits including a Fuzz Box, Sustain Unit, Reverberation Unit, Tremolo Generator and more.
- BP91—AN INTRODUCTION TO RADIO DXING.....\$5.00.** How you can tune in on those amateur and commercial broadcasts from around the world in the comfort of your home.
- BP94—ELECTRONIC PROJECTS FOR CARS AND BOATS.....\$5.00.** Fifteen simple projects that you can use with your car or boat. All are designed to operate from 12-volt DC supplies.

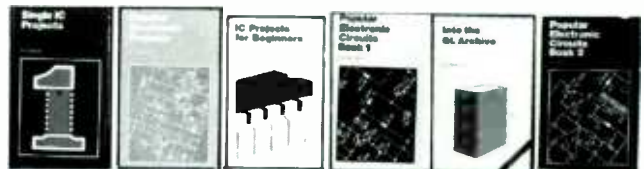

**ELECTRONIC TECHNOLOGY TODAY INC.**  
P.O. Box 240, Massapequa Park, NY 11762-0240

SHIPPING CHARGES IN USA & CANADA

\$0.01 to \$5.00 . . .	\$1.00
\$5.01 to \$10.00 . . .	\$1.75
\$10.01 to 20.00 . . .	\$2.75
\$20.01 to 30.00 . . .	\$3.75
\$30.01 to 40.00 . . .	\$4.75
\$40.01 to 50.00 . . .	\$5.75
\$50.01 and above . . .	\$7.00

**OUTSIDE USA & CANADA**

Multiply Shipping by 2 for sea mail  
Multiply Shipping by 4 for air mail

Total price of merchandise . . . . . \$ \_\_\_\_\_  
Sales Tax (New York State Residents only) . . . . . \$ \_\_\_\_\_  
Shipping (see chart) . . . . . \$ \_\_\_\_\_

**All payments must be in U.S. funds**

Number of books ordered  \_\_\_\_\_  
Total Enclosed . . . \$ \_\_\_\_\_

Name \_\_\_\_\_  
Address \_\_\_\_\_  
City \_\_\_\_\_ State \_\_\_\_\_ Zip \_\_\_\_\_

H787

# KENWOOD

...pacesetter in Amateur radio

NEW

## Hear it All!



## R-5000

### High performance receiver

**THE** high performance receiver is here from the leader in communications technology—the Kenwood R-5000. This all-band, all mode receiver has superior interference reduction circuits, and has been designed with the highest performance standards in mind. Listen to foreign music, news, and commentary. Tune in local police, fire, aircraft, weather, and other public service channels with the VC-20 VHF converter. All this excitement and more is yours with a Kenwood R-5000 receiver!

- **Covers 100 kHz-30 MHz in 30 bands, with additional coverage from 108-174 MHz (with VC-20 converter installed).**
- **Superior dynamic range.** Exclusive Kenwood DynaMix™ system ensures an honest 102 dB dynamic range. (14 MHz, 500 Hz bandwidth, 50 kHz spacing.)



- **100 memory channels.** Store mode, frequency, antenna selection.
- **Voice synthesizer option.**
- **Computer control option.**
- **Extremely stable, dual digital VFOs.** Accurate to  $\pm 10$  ppm over a wide temperature range.
- **Kenwood's superb interference reduction.** Optional filters further enhance selectivity. Dual noise blankers built-in.
- **Direct keyboard frequency entry.**

- **Versatile programmable scanning, with center-stop tuning.**
- **Choice of either high or low impedance antenna connections.**
- **Kenwood non-volatile operating system.** Lithium battery backs up memories; all functions remain intact even after lithium cell expires.
- **Power supply built-in.** Optional DCK-2 allows DC operation.
- **Selectable AGC, RF attenuator, record and headphone jacks, dual 24-hour clocks with timer, muting terminals.**

### Optional Accessories:

- VC-20 VHF converter for 108-174 MHz operation
- YK-88A-1 6 kHz AM filter
- YK-88S 2.4 kHz SSB filter • YK-88SN 1.8 kHz narrow SSB filter
- YK-88C 500 Hz CW filter
- YK-88CN 270 Hz narrow filter
- DCK-2 DC power cable
- HS-5, HS-6, HS-7 headphones
- MB-430 mobile bracket
- SP-430 external speaker
- VS-1 voice synthesizer
- IF-232C/IC-10 computer interface.

More information on the R-5000 and R-2000 is available from Authorized Kenwood Dealers.

**R-2000** 150 kHz-30 MHz in 30 bands  
• All modes • Digital VFOs tune in 50 Hz, 500 Hz, or 5 kHz steps • 10 memory channels  
• Programmable scanning • Dual 24-hour digital clocks, with timer • 3 built-in IF filters (CW filter optional)  
• All mode squelch, noise blanker, RF attenuator, AGC switch, S meter • 100/120/220/240 VAC operation • Record, phone jacks  
• Muting terminals • VC-10 optional VHF converter (118-174 MHz)



# KENWOOD

TRIO-KENWOOD COMMUNICATIONS  
1111 West Walnut Street  
Compton, California 90220

Specifications and prices are subject to change without notice or obligation.

CIRCLE 19 ON FREE INFORMATION CARD