

Hobby  
Electronics

\$2.50 U.S.  
\$2.95 CANADA  
APRIL  
1987

48784

# Hands-on Electronics

INCLUDING  
12-PAGE  
**GADGET**

THE MAGAZINE FOR THE ELECTRONICS ACTIVIST!

## TOUCH LAMP DIMMER

A touch and it's on—  
A touch and it's off—  
Dally for a moment  
and the lamp  
brightens or  
dims!

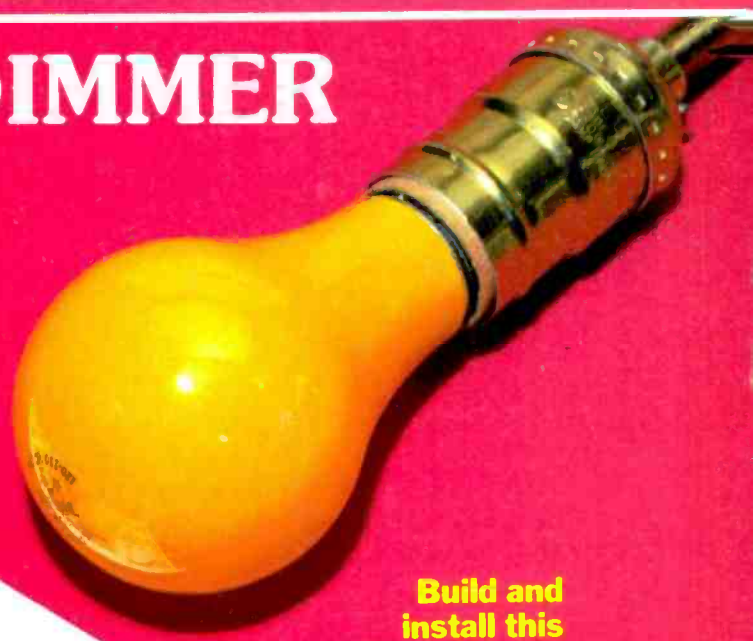

Build and  
install this  
simple device  
in one evening.



### Build a BINAURAL MIKE SET

Record stereo sound  
as your ears hear it!

### BUILD TEST-A-MATIC

Ring out your home's and office's  
telephone with this goof-proof device

### TOUCH SCREEN TECHNOLOGY

Let your fingers do the picking  
and your computer do the thinking!

### HOW JOYSTICKS WORK

Discover their inner workings, what can  
go wrong, and how to fix them

### UNIQUE ELECTRONICS

How one man converted his hobby  
into a thriving business

DECIBIT  
Compute

NY 13760  
INDICOTT  
326 STEIN DR  
JCE 02VOLD  
DIR  
017  
13760V0326SE00N RESP  
DEC 1987

### OUND ACTIVATED WITCHES

They are cheaper to buy than build  
very easy to install!



FactCards  
This Issue

A  
GERMSBACK  
PUBLICATION

# How to beat the high cost of cheap meters.



You get what you pay for.  
**So get the Fluke 70 Series.**

You'll get more meter for your money, whether you choose the affordable 73, the feature-packed 75 or the deluxe 77.

All of them will give you years of performance, long after cheaper meters have pegged their fishhook needles for the last time.

That's because they're built to last, inside and out. So they're tough to break. They don't blow fuses all the time. You don't even have to replace batteries as often.

And they're backed by a 3-year warranty. Not the usual 1-year.

Of course, you may only care that the world-champion 70 Series combines digital and analog displays with more automatic features, greater accuracy and easier operation than any other meters in their class.

You may not care that they have a lower overall cost of ownership than all the other "bargain" meters out there.

But just in case, now you know.

For a free brochure or your nearest distributor, call toll-free **1-800-227-3800, ext. 229.**

**FROM THE WORLD LEADER IN DIGITAL MULTIMETERS.**



**FLUKE 73**

\$79\*  
 Analog/digital display  
 Volts, ohms, 10A, diode test  
 Autorange  
 0.7% basic dc accuracy  
 2000+ hour battery life  
 3-year warranty



**FLUKE 75**

\$109\*  
 Analog/digital display  
 Volts, ohms, 10A, mA, diode test  
 Audible continuity  
 Autorange/range hold  
 0.5% basic dc accuracy  
 2000+ hour battery life  
 3-year warranty



**FLUKE 77**

\$145\*  
 Analog/digital display  
 Volts, ohms, 10A, mA, diode test  
 Audible continuity  
 "Touch Hold" function  
 Autorange/range hold  
 0.3% basic dc accuracy  
 2000+ hour battery life  
 3-year warranty  
 Multipurpose holster

\* Suggested U.S. list price, effective November 1, 1985  
 \*\* Patent pending



## SPECIAL FEATURES

- 39 Use That Old Computer—a new life for that golden oldie Little
- 44 Get NLQ From Old Printers—put that printer back on line
- 59 The Arabs Have a Word for It—a Language Interpreter for PC's
- 60 The Cold Virus is in a Bind—what researchers have discovered
- 66 Compute dB in Your Head—put the world's first computer to work
- 68 Unique Electronics—transform your home into your dream house

## FEATURETTES

- 23 To Sleep, To Dream—fiction or not?
- 73 Magic Paperweight—holds on to important documents
- 74 Three-mile Hole—to discover more about earthquakes

## THEORY AND CIRCUITS

- 63 How Joysticks and Trackballs Work—they are a nightmare to repair
- 34 Touch Screen Technology—get the feel of it
- 75 Electronic Fundamentals—what you need to know about solid-state components

## CONSTRUCTION

- 26 Touch Light Dimmer—why buy one when you can build one?
- 30 Sound-Activated Switches—are not just for turning on lights
- 42 Binaural Mikeset—lets you record life-like audio
- 61 Test-A-Matic—lets you save on telephone repair

## SPECIAL COLUMNS

- 22 Saxon on Scanners—handheld competes with base stations
- 84 Jensen on DX'ing—looking to the future
- 86 Carr's Ham Shack—the advantages of limited—space antennas
- 88 Circuit Circus—homebrew projects that teach as well as entertain
- 90 Ellis on Antique Radios—thanks for the memories
- 92 Wels' Think Tank—how did you get started in electronics?
- 96 Friedman on Computers—software created on the kitchen table

## DEPARTMENTS

- 2 Editorial—there's nothing new under the sun....or is there?
- 4 Letter Box—we respond to your inquiries
- 8 New Products Showcase—moves with the marketplace
- 16 Bookshelf—what's new in electronics literature
- 37 Free Information Card—all you want to know from those who know it best
- 47 Gadget—the newsletter for grown-up kids
  - GE mini portable telephone—Toshiba portable CD player—Braun handheld blender—VP 700 voice messenger and more!
- 71 FactCards—a storehouse of knowledge at your fingertips

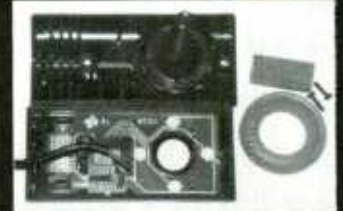

Joysticks, Trackballs page 63



Unique Electronics—page 68



Binaural Mikeset—page 42

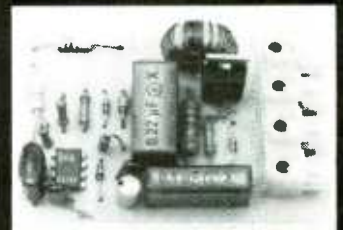

Touch Light Dimmer—page 26



Touch Screen—page 34



Test-O-Matic—page 61

### *There's nothing new under the sun, except...*

April comes but once a year just as the other months do. Editors sometimes get the urge to do some special effort on behalf of the spirit of the first of that month and this editor is no exception.

One good ploy was to spoof the time-honored decibel, but John, our budding new editor, mentioned that we have a hot story on how to figure out dB's without a scientific calculator or tables. So I left Bell's baby alone.

The next gimmick I came up with was a play on how some exotic language can be learned by placing an EPROM in a subject's brain. Bob, my main construction man, said that I was a bit late. A company just came up with software and chip to translate Arabic to French and English. In fact, Bob noted that the program handles the Latin languages without a chip. So down went another idea.

So I came up with the ultimate idea, a story on a company that makes electronic gadgets do the work we don't like to do. Herb, my ace troubleshooter, pipes up that I read his latest feature story on how this California ex-pilot converted a hobby into a full-time business; and it wasn't fair of me to peek at his copy until he finished with the editing.

Well, I had it! I had one idea left, and I went ahead with it. It's in the issue and I hope you enjoy it. Should you not spot it, then maybe I did too good a job!



Julian S. Martin, Editor

Composition by  
Mates Graphics

Cover photography by  
Walter Herstatt

## STAFF

**Larry Steckler, EHF, CET**  
Editor-In-Chief & Publisher

**Art Kleiman**, editorial director

**Julian S. Martin, KA2GUN**, editor

**Robert A. Young**, associate editor

**Herb Friedman, W2ZLF**, associate editor

**John J. Yacono**, associate editor

**Brian C. Fenton**, associate editor

**Byron G. Wels, K2AVB**, associate editor

**Carl Laron**, associate editor

**M. Harvey Gernsback**, contributing editor

**Teri Scaduto Wilson**, editorial assistant

**Ruby M. Yee**, production director

**Karen S. Tucker**, production manager

**Robert A. W. Lowndes**, editorial  
associate

**Geoffrey S. Weil**, production assistant

**Jacqueline P. Cheeseboro**, circulation director

**Arline R. Fishman**, advertising director

### BUSINESS AND EDITORIAL OFFICES

Gernsback Publications, Inc.  
500-B Bi-County Boulevard, Farmingdale, NY 11735.  
516/293-3000

President: Larry Steckler

Vice-president: Cathy Steckler

### NATIONAL ADVERTISING SALES

(For Advertising Inquiries Only)

**Joe Shere MIDWEST/PACIFIC**

1507 Bonnie Doone Terrace  
Corona Del Mar, CA 92625 714/760-8697

**Alan Berg EAST/SOUTHEAST**

11 Manor Drive  
Marlboro, N.J. 07746 212/603-9510



ABC  
membership  
applied for.

**Hands-on Electronics**, (ISSN 0743-2968) Published monthly by Gernsback Publications, Inc., 500-B Bi-County Boulevard, Farmingdale, NY 11735. Second-Class postage paid at Farmingdale, NY and at additional mailing offices. One-year, twelve issues, subscription rate U.S. and possessions \$28.00, Canada \$33.00, all other countries \$35.50. Subscription orders payable in U.S. funds only. International Postal Money order or check drawn on a U.S. bank. U.S. single copy price \$2.50. © 1987 by Gernsback Publications, Inc. All rights reserved. Printed in U.S.A.

Postmaster: Please send address changes to **Hands-On Electronics**, Subscription Dept., P.O. Box 338, Mount Morris, IL 61054-9932.

A stamped self-addressed envelope must accompany all submitted manuscripts and/or artwork or photographs if their return is desired should they be rejected. We disclaim any responsibility for the loss or damage of manuscripts and/or artwork or photographs while in our possession or otherwise.

As a service to readers, **Hands-on-Electronics** publishes available plans or information relating to newsworthy products, techniques and scientific and technological developments. Because of possible variances in the quality and condition of materials and workmanship used by readers, **Hands-on-Electronics** disclaims any responsibility for the safe and proper functioning of reader-built projects based upon or from plans or information published in this magazine.

# Increase your knowledge about all aspects of electronics

An absolutely no-risk guarantee.

Select 5 Books for only \$2<sup>95</sup> and get a Free Gift!

values to \$126.75

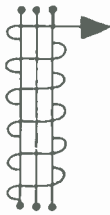
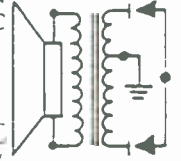

1536 \$14.95



2665 \$17.95



1825 \$15.95



1553 \$15.95



1587P \$13.95



1992 \$14.95



1277P \$15.95



1498P \$11.95

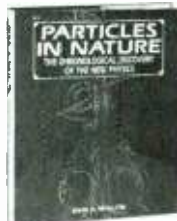

2616 \$23.95



1858 \$16.95



1909P \$14.95



1529P \$14.95

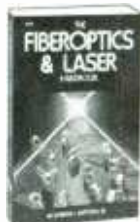

1671P \$16.95



1632P \$12.95



1665P \$17.95



1199P \$16.95

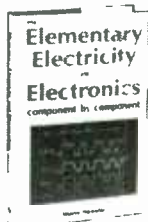

2753 \$23.95



2635 \$19.95



1604P \$15.95



1870 \$19.95



1532P \$14.95



2609 \$26.95

## TROUBLESHOOTING & REPAIRING



1977P. Troubleshooting and Repairing Satellite TV Systems Paper \$18.95

1503P. Maintaining and Repairing Videocassette Recorders Paper \$15.95

1897P. Beginner's Guide To TV Repair—3rd Edition Paper \$12.95

1250P. Digital Electronics Troubleshooting Paper \$14.95



## EXCITING PROJECTS

1672P. Electronic Design and Construction of Alternate Energy Projects Paper \$12.95

1599P. GIANT Book of Easy-to-Build Electronic Projects Paper \$16.95

1586. 25 Silicon-Controlled Rectifier Projects \$17.95

## AUDIO



1964P. Designing, Building and Testing Your Own Speaker System . . . with Projects—2nd Edition Paper \$10.95

2728. Demystifying Compact Discs: A Guide to Digital Audio \$15.95

2675. Microphones—3rd Edition—Covers equipment and techniques. \$22.95

2655P. The Complete Shortwave Listener's Handbook—3rd Edition Paper \$16.95

## REFERENCE & THEORY



1625. Master Handbook of Electronic Tables & Formulas—4th Edition \$24.95

1370. The Master Handbook of IC Circuits \$26.95

(Publisher's Prices Shown)

**Membership Benefits • Big Savings.** In addition to this introductory offer, you keep saving substantially with members' prices of up to 50% off the publishers' prices. • **Bonus Books.** Starting immediately, you will be eligible for our Bonus Book Plan, with savings of up to 80% off publishers' prices. • **Club News Bulletins.** 14 times per year you will receive the Book Club News, describing all the current selections—mains, alternates, extras—plus bonus offers and special sales, with hundreds of titles to choose from. • **Automatic Order.** If you want the Main Selection, do nothing and it will be sent to you automatically. If you prefer another selection, or no book at all, simply indicate your choice on the reply form provided. • **Ironclad No-Risk Guarantee.** If not satisfied with your books, return them within 10 days without obligation! • **Exceptional Quality.** All books are quality publishers' editions especially selected by our Editorial Board.

FREE when you join  
A Handy, Pocket-Sized  
Resistor and Inductor  
Color Code Calculator



## ELECTRONICS BOOK CLUB

P.O. Box 10, Blue Ridge Summit, PA 17214

Please accept my membership in the Electronics Book Club and send the 5 volumes circled below, plus my FREE Resistor & Inductor Color Code Calculator, billing me \$2.95 plus shipping and handling charges. If not satisfied, I may return the books within ten days without obligation and have my membership canceled. I agree to purchase at least 4 books at regular Club prices (plus shipping/handling) during the next 12 months, and may resign any time thereafter.

1199P 1250P 1277P 1370 1498P 1503P 1529P 1532P 1536 1553 1586  
1587P 1599P 1604P 1625 1632P 1665P 1671P 1672P 1825 1858 1870 1897P 1909P  
1964P 1977P 1992 2609 2616 2635 2655P 2665 2675 2728 2753

Name \_\_\_\_\_

Address \_\_\_\_\_

City \_\_\_\_\_

State/Zip \_\_\_\_\_ Phone \_\_\_\_\_

Valid for new members only. Foreign applicants will receive ordering instructions. Canada must remit in U.S. currency. This order subject to acceptance by the Electronics Book Club. RESP-387

# LETTER BOX

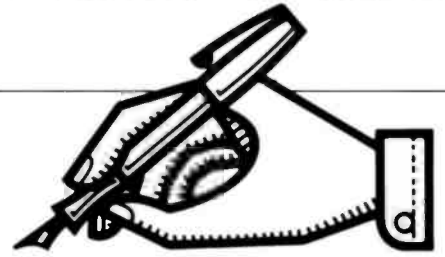

## Under the Table

In *Hands-on Report of the Checkman Mini Pocket DMM*, December 1986, the author refers to Table 1, but there was no table in the article! Since the missing table contains all the results on the meter, the entire reason for the article disappears along with the table.

I hope you will publish these test results soon, and if there is any way you could send me a copy of the table before your next issue, I would appreciate it. I am considering it as a Christmas present and hesitate to buy a new product blind via mail order.

I enjoy your publication and buy it regularly. I very much appreciate the electronics design computer programs and the broad range of construction projects. I have an old Timex 1000 computer and intend to install the TI keyboard as per your article in that issue.  
K.B.S., Lansing MI

TABLE 1—COMPARISON TESTS

Resistance—Marked Value (Ohms)	Value Measured on Service Meter (Ohms)	Resistance Measured on Checkman Mini (kOhms)
1	1.01	.001
68	68.1	.069
10k	9.93k	9.95
150k	147k	143
750k	850k	840
910k	965k	965
820k	808k	808
AC Voltage on Service Meter		AC Voltage on Checkman Mini
10.2		10.3
20.6		20.4
31.4		31.4
71.3		72.6
120.7		120.5
145.0		144.8

*By golly, by gosh, by gum; you're right! Well, there's no use in hiding under the table (or hiding the table), so here's Table*

*1 for everyone to view. (Don't be concerned, we sent K.B.S. his copy before the holidays.)*

## Doubled Over

I was very dismayed to discover a couple of years ago that the entire electronic hobby-magazine market had forsaken non-computer electronics, giving almost complete devotion to computers, with an unnatural religious fervor that left all true technicians out in a cold, unfamiliar waste land that was once flooded with projects we could build and use. Computers are nice in their place, but if they're going to replace all other electronics interests, who needs them?

I noted with great pleasure the recent return to construction projects and non-computer articles like in the days of old. You seem to be leading the pack. I'm thinking seriously about subscribing again; however, when I received a subscription card it said \$28.00 for 1 year. I compared it to the one I'd been sitting on from last year (in hopes that, soon, computers would loose their death grip on the market) and I did a double take; or your doing a double take, I should say. Last years price was \$14.00. What's up besides price and a return to the old way of doing things?

—B.J., Paris, NY

*Well for one thing, we have gone*

*monthly. So now we are not only one of the few magazines left in our portion of market, we are cranking out twice as many projects as last year! I'm sure an avid hobbyist (and lobbyist) such as yourself will find that doubly enjoyable.*

## Nothin' But a Hounddog

I am trying desperately to construct a good metal detector that cancels out not only ferrous metals but also aluminum in favor of gold and silver, but, due to the blackout on electronic articles and projects in the computer age, I am having difficulty finding anything useful. I've even been buying old dog-eared issues of the now defunct *Popular Electronics* at garage sales.

One of about 10 *Bottle-cap Finders* that I've built over the last year (all of which claimed to be the answer to finding coins and treasure at the exclusion of all else) is the *Hounddog* from 1981 *Electronics Hobbyist* page 32.

The original circuit was very unstable, ate batteries at an unbelievable rate, and found iron superbly. But the only way it would find non-ferrous metals was to adjust it so the piezo buzzer was turned on all the time then non-ferrous metals es-

pecially aluminum will stop it from buzzing.

I've tried everything from changing the power supply to adding new sensitivity ranges, and still pick up ferrous metals like crazy and precious metals hardly at all.

Can you help me improve this one or to find one that really works as advertised: to find "Treasure Not Trash."  
—D.A., Key West, FL

*If I could make make a cheap detector for precious metals only, I would cash in on it (and big) and get that yacht I've had my eye on! Inductive probes detect changes in inductance due to metals particularly susceptible to ferro-magnetism (such as iron). This is the kind you have built. Capacitive detectors, while capable of detecting non-ferrous metals, are affected by everything else as well.*

*The only thing I can suggest is try alchemy. At least it has not been as categorically denied by science as inexpensive electronic dowsing has.*

## Silent CoCo

Regarding your article: *Computer*  
(Continued on page 6)



**SCIENTIFIC  
ATLANTA  
UNITS**

**LOWEST  
PRICES  
ANYWHERE!**



# CABLE-TV



**WE'LL MATCH OR BEAT ANYONE'S  
ADVERTISED RETAIL OR WHOLESALE PRICES!**

ITEM	SINGLE UNIT PRICE	DEALER 10-UNIT PRICE
RCA 36 CHANNEL CONVERTER (CH. 3 OUTPUT ONLY)	29.95	18.00 ea.
PIONEER WIRELESS CONVERTER (OUR BEST BUY)	88.95	72.00 ea.
LCC-58 WIRELESS CONVERTER	92.95	76.00 ea.
JERROLD 450 WIRELESS CONVERTER (CH. 3 OUTPUT ONLY)	105.95	90.00 ea.
SB ADD-ON UNIT	109.95	58.00 ea.
<b>BRAND NEW — UNIT FOR SCIENTIFIC ATLANTA</b>	<i>Call for specifics</i>	
MINICODE (N-12)	109.95	58.00 ea.
MINICODE (N-12) VARISYNC	119.95	62.00 ea.
MINICODE VARISYNC W/AUTO ON-OFF	179.95	115.00 ea.
M-35 B (CH. 3 OUTPUT ONLY)	139.95	70.00 ea.
M-35 B W/AUTO ON-OFF (CALL FOR AVAILABILITY)	199.95	125.00 ea.
MLD-1200-3 (CALL IF CH. 2 OUTPUT)	109.95	58.00 ea.
INTERFERENCE FILTERS — CH. 3	24.95	14.00 ea.
JERROLD 400 OR 450 REMOTE CONTROLLER	29.95	18.00 ea.
ZENITH SSAVI CABLE READY (DEALER PRICE BASED ON 5 UNITS)	225.00	185.00 ea.
<b>SPECIFY CHANNEL 2 or 3 OUTPUT</b> <i>Other products available — Please Call</i>		

Quantity	Item	Output Channel	Price Each	TOTAL PRICE
			<b>SUBTOTAL</b>	
			Shipping Add \$3.00 per unit	
			COD & Credit Cards — Add 5%	
			<b>TOTAL</b>	

California Penal Code #593-D forbids us from shipping any cable descrambling unit to anyone residing in the state of California.  
Prices subject to change without notice.

PLEASE PRINT

Name \_\_\_\_\_  
 Address \_\_\_\_\_ City \_\_\_\_\_  
 State \_\_\_\_\_ Zip \_\_\_\_\_ Phone Number ( \_\_\_\_\_ ) \_\_\_\_\_  
 Cashier's Check     Money Order     COD     Visa     Mastercard  
 Acct # \_\_\_\_\_ Exp. Date \_\_\_\_\_  
 Signature \_\_\_\_\_

FOR OUR RECORDS:

**DECLARATION OF AUTHORIZED USE** — I, the undersigned, do hereby declare under penalty of perjury that all products purchased, now and in the future, will only be used on cable TV systems with proper authorization from local officials or cable company officials in accordance with all applicable federal and state laws.

Dated: \_\_\_\_\_ Signed: \_\_\_\_\_

**Pacific Cable Company, Inc.**  
 7325 1/2 RESEDA BLVD., DEPT. H-4 • RESEDA, CA 91335  
 (818) 716-5914 • No Collect Calls • (818) 716-5140

**IMPORTANT: WHEN CALLING FOR INFORMATION**  
 Please have the make and model # of the equipment used in your area. Thank You

★ QUALITY PARTS  
★ DISCOUNT PRICES  
★ FAST SHIPPING!  
**ALL ELECTRONICS CORP.**  
905 S. VERMONT • P.O. BOX 20406 • LOS ANGELES, CA 90008

SEND FOR  
**FREE**  
48 PAGES!

**ULTRA-MINIATURE  
5 VDC RELAY**

Fujitsu #  
FBR211NED005M20  
High sensitivity  
Coil: 120 ohms \$1.25 each  
CONTACTS: 1 amp 10 for \$10.00  
Mounts in 14 pin DIP socket

**D.R.S.T. LIGHTED  
ROCKER SWITCH**

115 vac lighted rocker  
snap mounts in  
¾ x 1 1/8" hole  
Orange lens 16 amp  
contact \$1.50

**MINIATURE TOGGLE SWITCHES**  
ALL ARE RATED 5 AMPS @ 125 VAC

**S.P.D.T.  
(on-on)**

PC style  
non-threaded  
bushing  
75¢ each  
10 for \$7.00

**S.P.D.T.  
(on-on)**

Solder lug  
terminals  
\$1.00 each  
100 for \$80.00

**S.P.D.T.  
(on-off-on)**

Solder lug  
terminals  
\$1.00 each  
100 for \$80.00

**13.8 VDC REGULATED POWER SUPPLY**



These are solid state, fully regulated 13.8 vdc power supplies. Both feature 100% solid state construction, fuse protection, and L.E.D. power indicator U.L. listed

2 amp constant, 4 amp surge \$20.00 each  
3 amp constant, 5 amp surge \$27.50 each

**COMMODORE PRINTER/PLOTTER**

Commodore Model # 1520  
Four color X-Y plotter Standard VIC  
serial interface allows easy connection  
to Commodore 64 computers Up to 80  
characters per line (upper and lower case)  
in four sizes CAT # COM-1520 \$49.95 each  
EXTRA pen sets \$1.50 per set



**COMPUTER  
GRADE  
CAPACITORS**

2,000 mfd. 200 Vdc  
1 3/4" x 5" high \$2.00  
6,400 mfd. 60 Vdc  
1 3/8" x 3 3/4" high \$2.50  
9,700 mfd. 50 Vdc  
1 3/8" x 4 1/2" high \$3.00  
31,000 mfd. 15 Vdc  
1 3/4" x 4" high \$2.50  
50,000 mfd. 40 Vdc  
3" x 5 3/4" high \$4.50  
66,000 mfd. 15 Vdc  
3" x 3 3/4" high \$3.00  
60,000 mfd. 40 Vdc  
3" x 5 high \$3.50  
86,000 mfd. 30 Vdc  
3" x 5 1/4" high \$3.50

**EDGE  
CONNECTORS**  
ALL ARE .156 SPACING.

22 EDGE CONNECTOR \$1.25 ea  
solder lug style 10 for \$11.00  
22/44 EDGE CONNECTOR  
\$2.00 ea PC style 10 for \$18.00  
22/44 EDGE CONNECTOR  
solder lug style \$2.50 each  
28/56 EDGE CONNECTOR  
\$2.50 ea PC style 10 for \$22.00  
36/72 EDGE CONNECTOR  
PC style \$3.00 each  
43/86 EDGE CONNECTOR  
PC style \$4.50 each

**TI SWITCHING POWER SUPPLY**

Compact well-regulated switching power supply  
designed to power Texas Instruments computer  
equipment

INPUT 14 - 25 vac @ 1 amp  
OUTPUT • 12 vdc @ 350 ma  
5 vdc @ 1.2 amp  
- 5 vdc @ 200 ma  
SIZE 4 1/4" x 4 1/4" x 1 1/4" high

**SPECIAL  
PRICE**

each

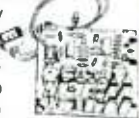

**RECHARGEABLE  
NI-CAD BATTERIES**

AAA SIZE 1.2v 500mAh \$1.85  
AA SIZE 1.2v 500mAh \$1.85  
AA with solder tab \$2.00  
C SIZE 1.2v 1200mAh \$3.50  
SUB-C SIZE solder tab \$3.50  
D SIZE 1.2v 1200mAh \$3.50

**UNIVERSAL CHARGER**

Will charge 4 AA, C, D, or AAA  
ni-cads or one 9 volt ni-cad at  
one time \$11.00 per charger.

**10 AMP SOLID STATE  
RELAY**

CONTROL 3 32 vdc  
LOAD 140 vac 10 amp  
SIZE 2 1/2" x 1 1/4" x 1 1/8"

\$9.50 EACH 10 FDR \$90.00

**PHOTO-FLASH  
CAPACITORS**

70 ml 330v  
75¢ ea.  
CAT# PPC-170  
400 ml 330v  
CAT# PPC-400 1.00 ea.  
800 ml 330v  
CAT# PPC-800 1.35 ea.

**STANDARD JUMBO  
DIFFUSED T 1 3/4**

RED 10 for \$1.50  
100 for \$13.00  
GREEN 10 for \$2.00  
100 for \$17.00  
YELLOW 10 for \$2.00  
100 for \$17.00

**LED HOLDERS**

Two piece holder  
for jumbo LED  
10 for 65¢ 100 for \$5.00

**TELEPHONE  
COUPLING  
TRANSFORMER**

Stancor # TTPC-8 or  
Tnad # TY-304 P  
600 ohms c 1  
10 600 ohms c 1  
P.C. board mount  
each \$1.25

**TOLL FREE ORDERS**  
• 1-800-826-5432  
(IN CA: 1-800-258-8668)  
INFO • (213) 380-8000  
TWX - 5101010163 ALL ELECTRONIC

QUANTITIES LIMITED  
MINIMUM ORDER \$10.00  
USA \$3.00 SHIPPING  
NO C.O.D.  
FOREIGN ORDERS  
INCLUDING SUFFICIENT  
SHIPPING

**LETTER BOX**

(Continued from page 4)

*Controlled Voice Synthesizer* (December 1986 *Hands-on Electronics*), I can't figure how to connect this project to my computer. I have a Radio Shack Color Computer II 64K. Please, can you help me? As this is a very popular computer I'm sure many of your readers would also be interested in this modification. I have already acquired all the necessary components, I need help!  
—R.M.T., Winder, GA

*I can certainly understand the frustration of trying to adapt the Voice Synthesizer to your particular computer. However, it's really quite simple: First get a copy of your computer's parallel printer I/O port connections. Then, as stated in the article, wire a cable to connect like bits: A1, to A1, A2 to A2, and so on. Or, as in my case, A1 (on the synthesizer) to bit 1 of the computer, A2 to bit 2, and so on down the line.*

*However, if your computer has a serial port, you have two options: either devise a circuit, most likely using a UART, to convert the serial port signal to parallel; or, you can simply redesign the circuit board to accept serial port data at pin 21 of U1 (see pinout diagram of the synthesizer chip). Well that about covers it. Good luck!*

**What a Head on Fred!**

The January cover is the greatest. Fred the Head is an exceptionally good project, but what a head! It looks like my mother-in-law before she shaves. Thanks for being what you are—a great hobby fun-book!  
—H.Y., Hollywood, CA

*Thanks for expressing your enjoyment of Fred the Head. I bet your mother-in-law is a lovely person, and the two of you are great friends. With Fred the Head you'll have a great trio.*

**That's Life!**

I read in "Computer Basics"—a Life book—that PE's (Popular Electronics) arch rival was Radio Electronics! I didn't know that.  
—M.B., New York, NY

*Radio Electronics is our sister publication and the editors never considered any magazine an arch rival. In fact, the editorial staffs of those magazines met frequently at press conferences and broke bread together. Sometimes writers let their imaginations run away from themselves when they recall history.*

**Enlighten Me**

I highly encourage the editorial selection of more articles developed and

presented in the easy-to-understand, detailed fashion of *Solar-powered House Numbers*. Congratulations to the author and the editors for the selection of it. However, how many houses are numbered with just two numbers? In my metropolitan area, four numbers are common, and five not uncommon. What a practical device this could have been for police and fire assistance. How disappointing to find this an apparent classroom exercise without much practical application. How about an update article and circuit for displaying at least four numbers. Or do we have to build separate units for every two numbers? Get that addendum to this article coming!

Keep the good articles coming. I do enjoy the magazine.  
—C.H., Coral Gables, FL

*All you really need do is wire the extra digits as in the article, and if more current is required to charge the battery, hook further solar cells in parallel. We would do an addendum if only it wouldn't sound redundant.*

**Text Tease**

In Fig. 1 on page 22 of the December '86 issue, no value is given for L2. Instead it says "see text," unfortunately the text says nothing about it. What should the value be?  
—D.S., Tallahassee, FL

*Sorry about the "inductor, inductor, who's got the inductor?" game. It should have been printed as 2µH for the described frequency.*

**Get Sassy!**

*All you wonderful readers that send us mail, be sure to include a SASE (that's self-addressed, stamped envelope—not a call for chaos) with your letters. That allows us to quickly respond to your requests for information, whether they appear in this column or not.*



*I know you are a genius, my Master, but the computer printout says Melvin shouldn't have eleven toes.*



AK, Puerto Rico - 218-681-6674 Telex - 62872914 FAX - 218-681-3380 TWX - 9103-08982 DIGI KEY CORP



NATIONAL SEMICONDUCTOR • PANASONIC MACHINE • EWC, INC. • INTERSIL • AD EAC, INC. • J. W. MILLER • AAVDI ENGINEER • E. F. JOHNSON • ATLANTIC SEMICONDUCTOR

**256K (262,144 x 1) DRAM 150NS \$5.70/1; \$39.95/9**

DIODES • DIAMOND TOOL • UNGAR • ES • CW INDUSTRIES • AMDEK • G.E. IGAR • YAGEO • J. W. MILLER • J. J. SCHEMICALS • ARIES • PLESSEY

Factory Firsts

7400 TTL		4000 CMOS		TI I.C. SOCKETS	
7400	1.00	4000	1.00	TI I.C. SOCKETS	
7401	1.00	4001	1.00		
7402	1.00	4002	1.00		

74500 TTL		4000 CMOS		TI I.C. SOCKETS	
74500	1.00	4000	1.00	TI I.C. SOCKETS	
74501	1.00	4001	1.00		
74502	1.00	4002	1.00		

74LS00 TTL		4000 CMOS		TI I.C. SOCKETS	
74LS00	1.00	4000	1.00	TI I.C. SOCKETS	
74LS01	1.00	4001	1.00		
74LS02	1.00	4002	1.00		

74LS00 TTL		4000 CMOS		TI I.C. SOCKETS	
74LS00	1.00	4000	1.00	TI I.C. SOCKETS	
74LS01	1.00	4001	1.00		
74LS02	1.00	4002	1.00		

74LS00 TTL		4000 CMOS		TI I.C. SOCKETS	
74LS00	1.00	4000	1.00	TI I.C. SOCKETS	
74LS01	1.00	4001	1.00		
74LS02	1.00	4002	1.00		

74LS00 TTL		4000 CMOS		TI I.C. SOCKETS	
74LS00	1.00	4000	1.00	TI I.C. SOCKETS	
74LS01	1.00	4001	1.00		
74LS02	1.00	4002	1.00		

**SOLDER TAIL DIP SOCKETS**

- Single lead
- Lead profile
- YOUR CHOICE 1/4" OR 5/16"

**TIN PLATED SOLDER TAIL**

Part No.	Description	Phi.	1	10	100
CS1A	14 pin solder tail	1.27	1.00	1.00	1.00
CS1B	16 pin solder tail	1.27	1.00	1.00	1.00

Part No.	Description	Phi.	1	10	100
CS2A	14 pin solder tail	1.27	1.00	1.00	1.00
CS2B	16 pin solder tail	1.27	1.00	1.00	1.00

Part No.	Description	Phi.	1	10	100
CS3A	14 pin solder tail	1.27	1.00	1.00	1.00
CS3B	16 pin solder tail	1.27	1.00	1.00	1.00

**WIRE WRAP DIP SOCKETS**

- Standard profile
- Undermounting and top layering capability
- Contains accommodations for round pins in big leads
- Wire wrap points lead to precision of 0.01" pin

Part No.	Description	Phi.	1	10	100
CS4A	14 pin wire wrap	1.27	1.00	1.00	1.00
CS4B	16 pin wire wrap	1.27	1.00	1.00	1.00

Part No.	Description	Phi.	1	10	100
CS5A	14 pin wire wrap	1.27	1.00	1.00	1.00
CS5B	16 pin wire wrap	1.27	1.00	1.00	1.00

Part No.	Description	Phi.	1	10	100
CS6A	14 pin wire wrap	1.27	1.00	1.00	1.00
CS6B	16 pin wire wrap	1.27	1.00	1.00	1.00

Part No.	Description	Phi.	1	10	100
CS7A	14 pin wire wrap	1.27	1.00	1.00	1.00
CS7B	16 pin wire wrap	1.27	1.00	1.00	1.00

Part No.	Description	Phi.	1	10	100
CS8A	14 pin wire wrap	1.27	1.00	1.00	1.00
CS8B	16 pin wire wrap	1.27	1.00	1.00	1.00

Part No.	Description	Phi.	1	10	100
CS9A	14 pin wire wrap	1.27	1.00	1.00	1.00
CS9B	16 pin wire wrap	1.27	1.00	1.00	1.00

Part No.	Description	Phi.	1	10	100
CS10A	14 pin wire wrap	1.27	1.00	1.00	1.00
CS10B	16 pin wire wrap	1.27	1.00	1.00	1.00

Part No.	Description	Phi.	1	10	100
CS11A	14 pin wire wrap	1.27	1.00	1.00	1.00
CS11B	16 pin wire wrap	1.27	1.00	1.00	1.00

Part No.	Description	Phi.	1	10	100
CS12A	14 pin wire wrap	1.27	1.00	1.00	1.00
CS12B	16 pin wire wrap	1.27	1.00	1.00	1.00

Part No.	Description	Phi.	1	10	100
CS13A	14 pin wire wrap	1.27	1.00	1.00	1.00
CS13B	16 pin wire wrap	1.27	1.00	1.00	1.00

Part No.	Description	Phi.	1	10	100
CS14A	14 pin wire wrap	1.27	1.00	1.00	1.00
CS14B	16 pin wire wrap	1.27	1.00	1.00	1.00

Part No.	Description	Phi.	1	10	100
CS15A	14 pin wire wrap	1.27	1.00	1.00	1.00
CS15B	16 pin wire wrap	1.27	1.00	1.00	1.00

Part No.	Description	Phi.	1	10	100
CS16A	14 pin wire wrap	1.27	1.00	1.00	1.00
CS16B	16 pin wire wrap	1.27	1.00	1.00	1.00

Part No.	Description	Phi.	1	10	100
CS17A	14 pin wire wrap	1.27	1.00	1.00	1.00
CS17B	16 pin wire wrap	1.27	1.00	1.00	1.00

Part No.	Description	Phi.	1	10	100
CS18A	14 pin wire wrap	1.27	1.00	1.00	1.00
CS18B	16 pin wire wrap	1.27	1.00	1.00	1.00

**DISC CAPACITORS**

- Max. Working Voltage: 200V to 350V
- Operating Temp. Range: 55°C to 125°C

Part No.	Value	Phi.	1	10	100
DC100	100 pF	1.00	1.00	1.00	1.00
DC101	100 pF	1.00	1.00	1.00	1.00

Part No.	Value	Phi.	1	10	100
DC102	100 pF	1.00	1.00	1.00	1.00
DC103	100 pF	1.00	1.00	1.00	1.00

Part No.	Value	Phi.	1	10	100
DC104	100 pF	1.00	1.00	1.00	1.00
DC105	100 pF	1.00	1.00	1.00	1.00

Part No.	Value	Phi.	1	10	100
DC106	100 pF	1.00	1.00	1.00	1.00
DC107	100 pF	1.00	1.00	1.00	1.00

Part No.	Value	Phi.	1	10	100
DC108	100 pF	1.00	1.00	1.00	1.00
DC109	100 pF	1.00	1.00	1.00	1.00

Part No.	Value	Phi.	1	10	100
DC110	100 pF	1.00	1.00	1.00	1.00
DC111	100 pF	1.00	1.00	1.00	1.00

Part No.	Value	Phi.	1	10	100
DC112	100 pF	1.00	1.00	1.00	1.00
DC113	100 pF	1.00	1.00	1.00	1.00

Part No.	Value	Phi.	1	10	100
DC114	100 pF	1.00	1.00	1.00	1.00
DC115	100 pF	1.00	1.00	1.00	1.00

Part No.	Value	Phi.	1	10	100
DC116	100 pF	1.00	1.00	1.00	1.00
DC117	100 pF	1.00	1.00	1.00	1.00

Part No.	Value	Phi.	1	10	100
DC118	100 pF	1.00	1.00	1.00	1.00
DC119	100 pF	1.00	1.00	1.00	1.00

Part No.	Value	Phi.	1	10	100
DC120	100 pF	1.00	1.00	1.00	1.00
DC121	100 pF	1.00	1.00	1.00	1.00

Part No.	Value	Phi.	1	10	100
DC122	100 pF	1.00	1.00	1.00	1.00
DC123	100 pF	1.00	1.00	1.00	1.00

Part No.	Value	Phi.	1	10	100
DC124	100 pF	1.00	1.00	1.00	1.00
DC125	100 pF	1.00	1.00	1.00	1.00

Part No.	Value	Phi.	1	10	100
DC126	100 pF	1.00	1.00	1.00	1.00
DC127	100 pF	1.00	1.00	1.00	1.00

Part No.	Value	Phi.	1	10	100
DC128	100 pF	1.00	1.00	1.00	1.00
DC129	100 pF	1.00	1.00	1.00	1.00

Part No.	Value	Phi.	1	10	100
DC130	100 pF	1.00	1.00	1.00	1.00
DC131	100 pF	1.00	1.00	1.00	1.00

Part No.	Value	Phi.	1	10	100
DC132	100 pF	1.00	1.00	1.00	1.00
DC133	100 pF	1.00	1.00	1.00	1.00

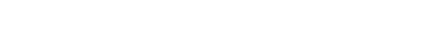
**ASSORTMENT OF 15 POPULAR CAT NO. #5495****3 AMP SILICON RECTIFIERS****1% Metal Film Fixed Resistors****310 DISC CAPACITORS**

The Digi Key volume discount and service charges are simple to apply. Most items sold by Digi Key may be combined for a volume discount. Items that are not discountable are identified by the suffix "NET" following the part number. Also, we offer a quantity discount on all orders. Items that are not discountable are marked. They add the service charge. We pay shipping and insurance to addresses in the U.S.A., Canada and Mexico when check or money order accompanies order. Digi Key only ships orders within the continental U.S., Alaska, Hawaii, Canada and Mexico.

WHEN ORDERING BY PHONE, CALL 1-800-344-4533 (AK, call 218-681-6674). BY MAIL SEND YOUR ORDER TO: DIGI KEY, P.O. Box 877, Thief River Falls, MN 56701.

You may pay by check, money order, Master Charge, VISA or C.O.D. **DIGI KEY GUARANTEE:** Any parts or products purchased from Digi Key that prove to be defective will be replaced or refund of \$ returned within 90 days from receipt with a copy of your invoice. **NEVER SUBJECT TO CHANGE WITHOUT NOTICE.**

CIRCLE 13 ON FREE INFORMATION CARD

**SERVICE CHARGES VOLUME DISCOUNT**

0.00 - 9.99	42.00%	0.00 - 99.99	NET
10.00 - 99.99	40.00%	100.00 - 249.99	NET
100.00 - 249.99	35.00%	250.00 - 499.99	NET
250.00 - 499.99	30.00%	500.00 - 999.99	NET
500.00 - 999.99	25.00%	1000.00 - 2499.99	NET
1000.00 & Up	No Charge	2500.00 & Up	Less 25%

APRIL 1987

# NEW PRODUCTS

## Driving Driver

If you thought the car loudspeaker couldn't get more complex, then the Mobile Sound Division of Nakamichi has something to change your mind. The new driver—designated the SP-40—uses a 10-cm, carbon-graphite reinforced, polypropylene main cone, with a mechanical crossover to a 4.3-cm, high-frequency subcone. Special care has been taken in designing the magnet structure and cone configuration to ensure natural reproduction of the entire audible frequency range. The compact dimensions of the new driver—especially *vis-a-vis* depth—permit it to be installed in the door frame of most cars very easily. Thus, the SP-40 can be used both as a full-range speaker for low-cost installations, and as a bass/midrange driver in two-way systems where the Nakamichi SP-50 might not fit.



CIRCLE 65 ON FREE INFORMATION CARD

Polypropylene is immune to the heat and humidity experienced in a car, and it has excellent damping to prevent the ringing, harsh sound that characterizes other environmentally safe materials. The polypropylene is reinforced with carbon-graphite fibers that add negligible mass, have no effect on damping, but do strengthen the cone to prevent cone break-up and the resulting sound coloration. The cone is suspended by a urethane surround that suppresses edge vibration and permits long-throw motion for powerful bass reproduction.

In the SP-40, eddy-current distortion has been virtually eliminated by shielding the center pole of the magnet with a copper cap. Eddy-current flow is thus confined to the low-resistance copper cap and, since current flow in copper is inherently linear, the composite magnetic drive is linear as well. As a result, high-frequency, third-harmonic distortion is drastically reduced and the sound is

noticeably more musical. The copper cap also reduces voice-coil inductance and so produces uniform impedance into the high-frequency region. That permits the speaker to draw the same power from the amplifier at all frequencies and results in an unusually broad and uniform frequency response.

The SP-40 retails for \$115 per pair. For ordering and sales information call 800/223-1521 inside CA; and call 800/421-2313 from all other states.



CIRCLE 63 ON FREE INFORMATION CARD

## Super Disk-Filing System

Some spend time trying to develop a better mouse trap—making a good thing better—and M & R Distributing has made disk filing excellent with their 5-1/4" "Pic-A-Disk" system.

That system is a major improvement in disk storage. The unique design and color coding of the disks and the residential slot feature, make instant disk retrieval, identification, and replacement a reality.

Pic-A-Disk also serves as a filing system and organizer, thereby eliminating the possibility of misplacing a disk. It is now virtually impossible to misfile disks when using the patented color-coded system.

Pic-A-Disk holds and stores 50 disks in a desktop storage tray at an easy viewing

angle making each and every disk visible. The flip-top lid features a carrying handle and latching mechanism which provide a dust- and moisture-resistant environment.

It retails for \$19.95. For further information, or to place an order, write or call: M & R Distributing Co., Inc., PO Box 190, Oceanside, NY 11572; Tel. 516/678-3334.

## Static-Control Floor Finish

If you work with CMOS chips by yourself or for a company then your ESD problems could disappear with the your next floor resurfacing. A new video tape describing the use and application of Statguard Floor Finish, an alternative to floor mats and tiles for eliminating ESD problems, is being offered by Charleswater Products, Inc. of West Newton, MA.

The Statguard Training Video Tape features a demonstration of the proper application of the conductive floor finish for a complete ESD program. Covering approx. 2,000 sq. ft. per gallon, the high-gloss floor wax dissipates static charges and prevents further charge generation from walking for up to 60 days.



CIRCLE 75 ON FREE INFORMATION CARD

Complete with maintenance procedures and ESD measurement tips for the UL-classified antistatic floor treatment, the Statguard Training Video Tape is available in popular VHS and Beta formats. Playing time is approximately eight minutes. The Statguard Training Video Tape is available on loan, at no charge.

(Continued on page 12)

# Train with NRI for a high paying career servicing computers.



**DIGITAL MULTIMETER**—Professional test instrument for quick and easy measurements.

**LESSONS**—Clear, well illustrated texts build your understanding of computers step-by-step.

**DISK SOFTWARE**—including MS-DOS, GW BASIC, WordStar, and CalcStar.

**SANYO COMPUTER**—8088 CPU double-sided disk drive, 256K RAM, 4.77 MHz and 8 MHz turbo speed.

**MONITOR**—High resolution, green screen displays, crisp text and graphics.

**TECHNICAL MANUALS**—with complete specs on Sanyo computer and professional programs.

**DISCOVERY LAB**—Using it, you construct and test circuits like those used with computers.

**DIGITAL LOGIC PROBE**—Simplifies analyzing digital circuit operation.

## Get started now by building this fully IBM PC compatible computer

Now you get it all... training for America's fastest growing career opportunity... training to service all computers... training on the newest total computer system, the Sanyo 880. Only NRI can give you the well-rounded training you need, because only NRI gives you a complete computer system... computer, monitor, disk drive, software, even test instruments like a digital multimeter and logic probe to work with and keep. It all adds up to training that builds the knowledge, competence, and ability you need to succeed as a computer service specialist.

### Get inside the newest, fully IBM PC compatible Sanyo Microcomputer

As an NRI student, you'll get total hands-on training as you actually build your own latest model Sanyo 880 Series computer from the keyboard up. It's fully IBM PC compatible and, best of all, it runs programs almost twice as fast as an IBM PC. As you assemble the Sanyo 880, you'll perform demonstrations and

experiments that will give you a total mastery of computer operation and servicing techniques. You'll do programming in BASIC language—even run and interpret essential diagnostic software.

### Understanding you get only through experience

You need no previous knowledge to succeed with NRI. You start with the basics, rapidly building on the fundamentals of electronics with bite-size lessons. You perform hands-on experiments with your NRI Discovery Lab and then move on to master advanced concepts like digital logic, microprocessors, and computer memories.

### Learn at home in your spare time

You train in your own home at your own convenience, backed at all times by your own NRI instructor and the entire NRI staff of educators and student service support people. They're always ready to give you guidance, follow your progress,

and help you over the rough spots to keep you moving toward your goal.

### 100 page free catalog tells more... send today

Send the postage-paid reply card today for NRI's 100 page catalog that gives all the facts about computer training plus career training in robotics, data communications, TV/audio/video servicing, and many other fields. If the card is missing, write to NRI at the address below.

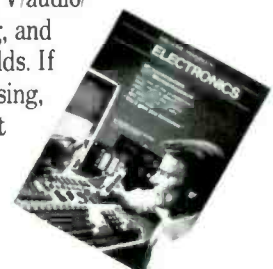

# NRI

 SCHOOLS

McGraw-Hill Continuing Education Center  
3939 Wisconsin Avenue  
Washington, DC 20016

We'll give you tomorrow



For more information contact: Charleswater Products, Inc., Pauline Bendana, Marketing, 93 Border St., West Newton, MA 02165; Tel. 617/964-8370.

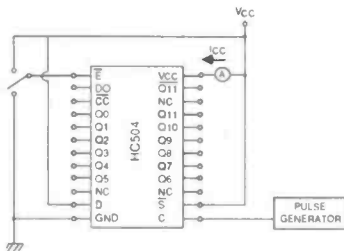

CIRCLE 74 ON FREE INFORMATION CARD

### 35-MHz SAR Chip

Our technology is speeding up our lives every day, so it comes as no surprise that technology is speeding itself up to meet the demands of we electronics-minded people. A good case in point is the high-speed successive approximation register (SAR) produced by Hirel Co. as a direct replacement for the 2504 and 25L04 bipolar devices. Developed on 1.5 micron n-well technology, the chip consumes less than 4 mA at its guaranteed maximum operating point of 25-MHz.

The Zy25HCT04 SAR is primarily used in analog-to-digital converters. With its ability to be clocked at 35 MHz, it can

be used in converters capable of 1- to 5-million conversions per second. The actual conversion rate will be a function of the other components in the converter. The combination of CMOS technology and tight design rules keep the current consumption very low. With a 5-volt supply, and at 1 MHz, the device will consume less than 100  $\mu$ A; and at 25 MHz the current increases to less than 4 mA.

Although the part is mainly used in A/D converters it also has applications in ring counters and serial-to-parallel converters.

The Zy25HCT04 is available in chip form and in plastic, dual in-line packages. The price for the chips (100pc. price) is \$4.80 and in plastic DIP it is \$5.50. Write or call Zyrel Inc., 1900 McCarthy Blvd., Suite 201, Milpitas, CA 95035; Tel. 408/433-0488.

### 10-MHz Sweep/Function Generator

If you're a test-bench equipment nut, then hold onto your hat! The LFG-1310 is a feature-packed sweep/function generator designed for a variety of research and development, service, design and educational applications. Outputs include every required waveform: sine, square, triangle, ramp, and pulse.

Five different operating modes enable the LFG-1310 to be used as a source for

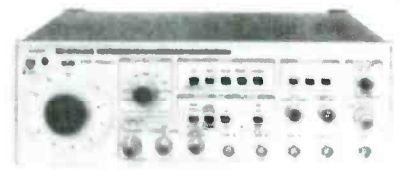

CIRCLE 76 ON FREE INFORMATION CARD

both general and specialized measurement techniques such as frequency response analysis, noise-reduction circuit work, and loudspeaker testing. Versatile output controls enable all types of signal conditions to be established including different bias levels for amplifier work. The output may also be frequency or amplitude modulated by an external signal.

The frequency range starts at .01 Hz and goes to 10 MHz in 9 overlapping steps. The distortion on the sinewave up to 50 KHz is less than 0.5%; beyond that it's 25 dB or more down from the harmonic. The squarewave rise/fall time is less than 25 ns at maximum output.

The output modes include CW, sweep (linear or logarithmic from 1 ms to 10 s), gate, burst, and trigger with a variable trigger point.

The unit retails for around \$1100 dollars, and to find the number of the Leader distributor nearest you, call 800/645-5104.

# Attention Electronic Enthusiasts!

### Tenna Soldering Station

- Adjustable temperature range of 150°-420° C (300°-790° F)
- Grounded
- Overheat protection with closed loop temperature control
- Heat resistant soldering iron cord
- Auxiliary ground terminal
- Built-in tray with cleaning sponge
- Improved circuit design for greater temperature stability



#21-147 **\$4480**  
\$49<sup>95</sup> (1-3) (4-up)

### Tenna Compact DMM

- 3½ digit shock mounted display
- Five DCV ranges
- Five DCA ranges
- Two ACV ranges
- Five resistance ranges
- 1Mohm input impedance



#72-060 **\$2995** (ea.)

1 Year Limited Warranty

### Solderless Breadboard

- The perfect breadboards for circuit designing, testing electronic devices and educational uses
- Red and black binding posts included for easy voltage connection
- 4" (W) x 8½" (L) x ¼" (D)

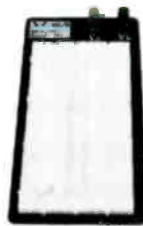

#72-340 **\$1780**  
\$19<sup>95</sup> (1-9) (10-up)

### Tenna 6.5MHz Oscilloscope

- This model is equally at home on the test bench or in the classroom. Features:
- High brightness CRT
- Alligator clip test leads
- External sync input
- Carrying handle
- 90 day warranty
- See MCM Catalog #14 for more information

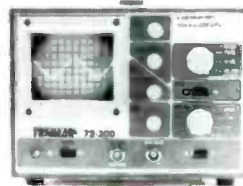

#72-300 **\$15880** (ea.)

### Tenna 5 Amp Regulated Power Supply

- Output: Regulated 13.8VDC
- Input: 120VAC
- Fuse protected
- Heavy duty binding posts
- Output current: 5 amp one minute on, three minutes off; 3.5 amp continuous



#72-280 **\$2995** (ea.)

### Rocket General Purpose 9V Battery

- Zinc chloride dry cell
- Minimum order quantity of five



#29-300 **38c** (5-9) (10-up)

Be Sure To Call For Your FREE Catalog! Over 7,000 Items!



- Terms:**
- \$10 minimum order. \$1.00 charge for orders under \$10
  - \$20 minimum charge card order
  - Orders shipped UPS C.O.D.
  - Most orders shipped within 24 hours.
  - Sales office open 8:30 am to 7:00 pm Saturdays 10:00 am to 3:00 pm EST
  - For prepaid orders add \$2.75 for shipping and handling.
  - Should shipping and handling charges exceed \$2.75, the balance due will be sent C.O.D.



Call Toll Free 1-800-543-4330 (In Ohio 1-800-762-4315 In Alaska and Hawaii 1-800-858-1849)



**MCM ELECTRONICS**  
858 E. CONGRESS PARK DR.  
CENTERTVILLE, OH 45459  
A PREMIER Company

© 1987, MCM Electronics  
SOURCE NO. HO-01

### the fourth law of robotics

A robot shall make learning fun for man and thereby improve the quality of life for mankind.



A robot is a robot is a robot... was a robot. Until HERO 2000.

HERO 2000 is much more than a robot. It's a walking, talking 16-bit computer. With 64K ROM and 24K RAM expandable to more than half a megabyte. And a fully articulated arm with five axes of motion. Yours to program. Command. Modify and expand. Total system access and solderless experimenter boards provide almost limitless possibilities. Its remote RF console with ASCII keyboard gives total control. Available with three self-study courses. Backed by Heath Company, world leader in electronic kits.

Build your own HERO 2000. Or buy it assembled. Have fun learning skills that translate directly to the world of work.



# HERO<sup>®</sup> 2000

the  
knowledge  
builder

**FREE. Send today for latest Heathkit Catalog.**



Mail coupon today to receive a **FREE** Heathkit Catalog featuring HERO 2000.

Mail to: Heath Company  
Dept. 107-528  
Benton Harbor, Michigan 49022

Name \_\_\_\_\_

Address \_\_\_\_\_

City \_\_\_\_\_ State \_\_\_\_\_

Zip \_\_\_\_\_

RO-141

**Heathkit<sup>®</sup>**  
Heath  
Company

Heath Electronics Corporation.

PLEASE PRINT ON FREE INFORMATION CARD

### Test and Re-wire RS-232 Interfaces

If you're tired of fiddling with wires for your break-out box then B & B may have just what you want. The MAB Budget Break-Out Box has all the necessary features to open signal lines, monitor RS-232 signals, and re-wire lines.

Nine 2-color LED indicators monitor transmit data, receive data, request to send, clear to send, data-set ready, carrier detect, and data-terminal ready. And two additional LED indicators are spares for testing any signal line. LED's turn green

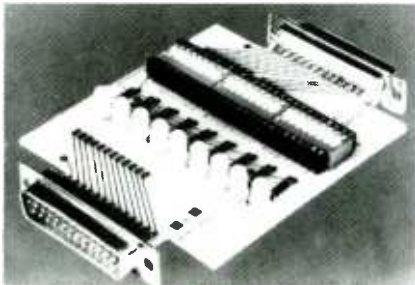

CIRCLE 62 ON FREE INFORMATION CARD

for "high" (space), red for "low" (mark) and off for "open".

The MAB Budget Break-Out Box performs all the functions of more expensive models, but the open-frame construction, only 4" x 3", keeps manufacturing costs down, and the savings are passed on directly to the customer. The retail price is only \$59.95, which includes one male and one female RS-232 connector. The unit does not require AC power or batteries.

Write or call for more information on B & B's MAB Budget Break-Out Box Model 232MAB and a free B & B catalog, at B & B Electronics Manufacturing Co., 1500 Boyce Memorial Drive, Ottawa, IL 61350; Tel. 815/434-0846.

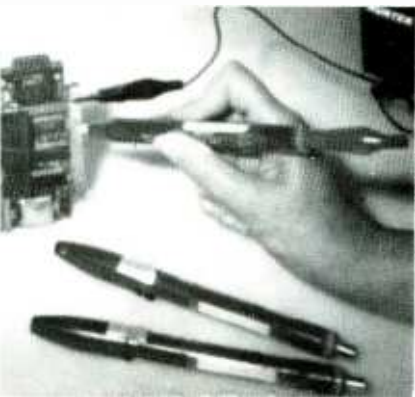

CIRCLE 70 ON FREE INFORMATION CARD

### Plating Pens

If you're looking for a way to electroplate your card edge connectors, phono plugs, or whatever, with gold for high conductivity, then you may find this system appealing. It has been developed specifically to provide a simple and conve-

nient electro-plating capability for such applications as scientific and engineering development, electronic repairs, specialized production, dental work, special art-work, and restoration. Completely self-contained and portable, it is equally useful in the lab, office, or shop. Utilizing special disposable cartridge-pens (13 in all), the system permits an instantaneous selection from a wide variety of plating possibilities without the necessity for expending time, effort and expense in preparing a special plating solution. Above all, it is simple to use with no special skill required!

A complete selection of pens is available for a wide variety of plating requirements. Power can be supplied by your own variable D.C. supply capable of supplying up to 12 volts at 0.1 amp or our variable voltage power supply.

The various pens, power supply, absorbents and such can be bought separately, unless you would prefer a kit consisting of the power supply, connector cables, and the following pens: absorbent, silver, gold (24K), nickel chrome color, and copper for \$325. Available from Hunter Products, Inc., 792 Partridge Drive, Bridgewater, NJ 08807; Tel. 201/526-8440.



CIRCLE 71 ON FREE INFORMATION CARD

### Light Pulse Generator

You high-tech optical wizz's will love this new pulse generator designed to trigger external equipment. The Model 6020 is a fast light-pulse generator with built-in power metering. It brings to the Electro-Optics field a means of controlling light with a precision and ease unattainable previously.

The 6020 operates at frequencies over 250 MHz, has half-nanosecond risetimes, and generates impulses 500 ps wide. Basically, the 6020 converts electronic signals into light. The user can vary pulse delays and widths, generate single or double pulses, externally trigger or modulate the light output, determine optical output power, and more. The instrument serves as a low-jitter, calibrated light source that digitally displays pulse baseline and peak power level, both adjustable with 0.1% resolution. It employs special control circuitry to provide the user with a stable, high performance optical generator. A laser diode is the internal light-emitting source. The laser-generated light is steadily monitored and regulated with sensing and feedback circuits that keep the instru-

ment's light intensity under constant control.

Additional to the light output, is an electronic output coincident with light pulse timing that can be used to trigger other equipment, such as an oscilloscope.

The generator runs for \$8250 (fob Berkeley, CA), from Berkeley Nucleonics Corp. 1198 Tenth St., Berkeley, CA 94710; Tel. 415/527-1121.



CIRCLE 72 ON FREE INFORMATION CARD

### Anti-Static Caplugs

What good is it to build a static-sensitive project with great care, only to have it ruined by a static discharge entering through an unprotected connector? Well, there is a two-page, illustrated product bulletin (AS-986), presenting new anti-static connector caps and plugs for both electrostatic discharge (ESD) and physical protection that has just been issued by the Caplugs Division of Protective Closures Co., Inc.

The bulletin describes the Series EC Caps and Series EP Plugs as being molded from pink, anti-static, low-density polyethylene #78. The material, according to the bulletin, gives excellent ESD protection and is compatible with clean-room processing of components as well. Anti-Static Caplugs meet the static-decay test requirements of MIL-B-81705B.

Specifications, accompanied by dimensional drawings, show that the Series EC Caplugs are available to cap nominal thread sizes from 1/4" through 3", and that the Series EP Caplugs will plug listed thread sizes from 1/2"-28 through 2-1/2"-16. A price list for standard carton quantities and for anti-static, poly-bagged "Mini Paks" containing 1/5 the full carton quantity is included in the bulletin.

A copy of Product Bulletin AS-986, together with a free sample-assortment of the new Anti-Static Caplugs, are obtainable from Caplugs Division, Protective Closures Co., Inc., 2150 Elmwood Ave., Buffalo, NY 14207. ■

# Where's Your **ELECTRONICS** Career Headed?

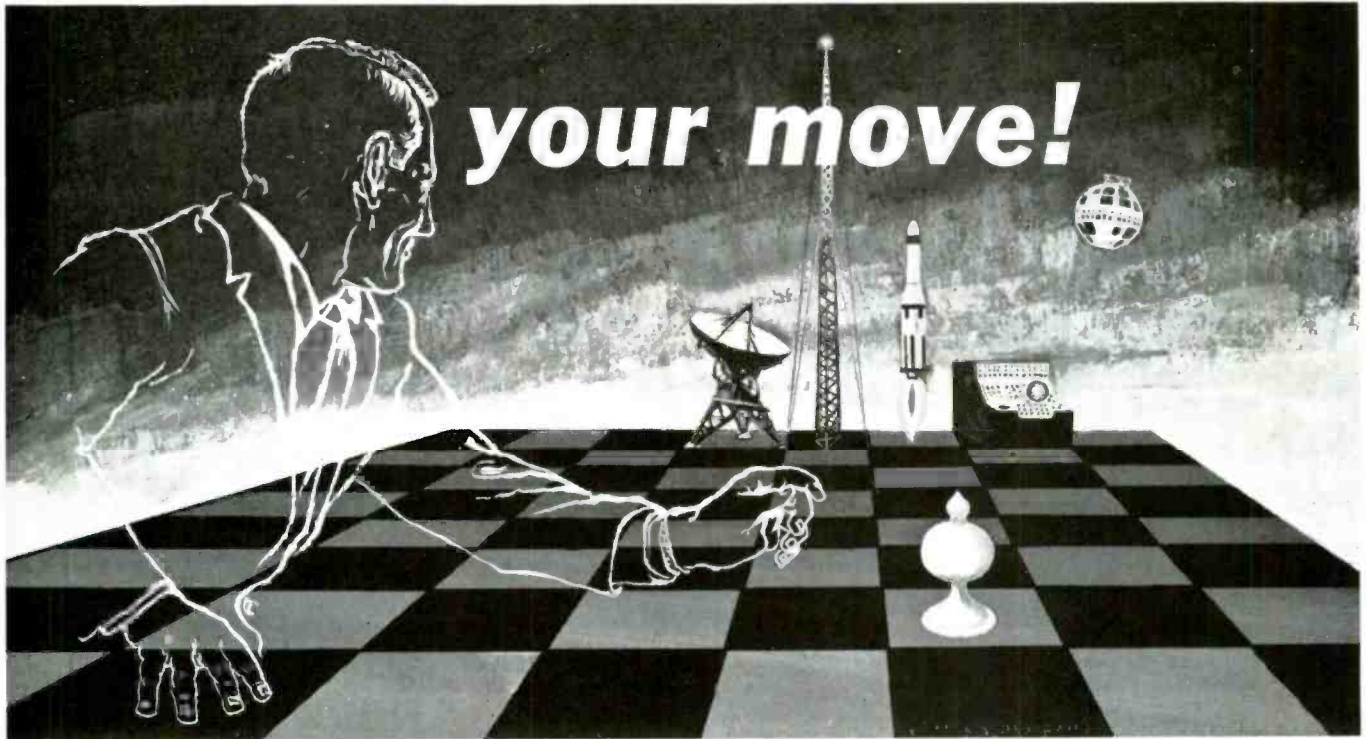

## The Move You Make Today Can Shape Your Future

Yes it's your move. Whether on a chess board or in your career, you should plan each move carefully. In **electronics**, you can *move ahead* faster and further with a

## **B. S. DEGREE**

Put professional knowledge and a **COLLEGE DEGREE** in your electronics career. Earn your degree through independent study at home, with Grantham College of Engineering. No commuting to class. Study at your own pace, while continuing your present job.

The accredited Grantham non-traditional degree program is intended for mature, fully employed workers who want to upgrade their careers . . . and who can successfully study electronics and supporting subjects through

### **INDEPENDENT STUDY, AT HOME**

Free Details Available from:

**Grantham College of Engineering**  
10570 Humbolt Street  
Los Alamitos, California 90720

### **Independent Home Study Can Prepare You**

Study materials, carefully written by the Grantham staff for independent study at home, are supplied by the College, and your technical questions related to those materials and the lesson tests are promptly answered by the Grantham teaching staff.

### **Recognition and Quality Assurance**

Grantham College of Engineering is accredited by the Accrediting Commission of the National Home Study Council.

All lessons and other study materials, as well as communications between the college and students, are in the English language. However, we have students in many foreign countries; about 80% of our students live in the United States of America.

**Grantham College of Engineering** H-4-87  
10570 Humbolt Street, Los Alamitos, CA 90720

Please mail me your free catalog which explains your B.S. Degree independent-study program.

Name \_\_\_\_\_ Age \_\_\_\_\_

Address \_\_\_\_\_

City \_\_\_\_\_ State \_\_\_\_\_ Zip \_\_\_\_\_

# BOOKSHELF

## 1-2-3 Macro Library—2nd Edition By David Paul Ewing

Holy Marco! Most user's guides give you information on the software, but how many give full-length, ready-to-run macros? Well, *1-2-3 Macro Library* offers a collection of macros that will decrease the time spent in creating, changing, and printing worksheets. More complete than the first edition, the 2nd Edition is designed for all 1-2-3 macro users, including Release 2 users.

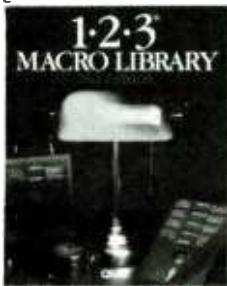

CIRCLE 85 ON FREE INFORMATION CARD

Ready-to-run macros can be immediately applied to existing worksheets or modified for specialized tasks. In addition, users will find valuable hints for creating and applying their own macros to 1-2-3 spreadsheets, databases, and graphs.

Users will learn how to create, edit, and use 1-2-3 Macros, beginning with simple keyboard-alternative macros to complex macros that require special programming commands—commands from the command language and /x commands. All macro commands are defined and explained, including the 40 commands from 1-2-3's command language. Also included is a complete introduction to /x commands.

A convenient companion disk, sold separately for \$39.95, is available. The disk enables users to avoid the delay and inconvenience of manual entry, while ensuring that each macro line is accurate.

The book contains 354 pages, costs \$19.95, and is available in most bookstores and computer stores throughout North America. To order directly from Que Corp., call 800/428-5331 and ask for a sales representative.

## Desk Top Publishing From A To Z By Bill Grout, Irene Athanasopoulos, and Rebecca Kutlin

As a desktop publisher, you can create your own newsletters, catalogs, conference brochures, news releases, and more. But how do you get started? Ironically, by reading what someone else has published!

*Desktop Publishing From A to Z* helps you choose the software, equipment, and procedures you need to achieve professional results. You'll find out about software and hardware—from project-management programs, to page-makeup programs, from the Macintosh and the IBM PC, to the LaserWriter printer. With the book, you'll learn how to establish a publishing plan; control costs and profits; handle printing and binding, and promote and distribute your publication.

*Desktop Publishing From A to Z* shows you how to publish whatever is important to you, and make it look important to others.

The book, a 214 page paperback, retails for \$17.95 from McGraw-Hill, 2600 10th St., Berkeley, CA 94710; Tel. 800/227-0900 or 800/772-2531.



CIRCLE 86 ON FREE INFORMATION CARD

## Commodore 128 Assembly Language Programming By Mark Andrews

Assembly language is to the human/computer interface as a hug is for parent/child interaction; it is simple and fundamental to the growth and development of all involved. So, if you want your computer to be more embracing, check out this text. It concentrates on 128 assembler

programming uses for its many features, and details its unique memory configuration.



CIRCLE 87 ON FREE INFORMATION CARD

This language is more specific than BASIC and provides a programmer with a more sophisticated vehicle to access hardware features.

Topics covered include: review of 6510/8502 assembly language; mapping the Commodore 128; C-128 assemblers and monitors; 40- and 80-column text and text graphics; 40- and 80-column, high-resolution graphics; C-128 file management and the 1571 disk drive; C-128 music and sound; C-128 I/O; programming the C-128 in its C-64 and CP/M modes.

A 300-page guide, *Commodore 128 Assembly Language Programming* retails for \$15.95 from Howard W. Sams and Co., Dept R40, 4300 62nd St., Indianapolis, IN, 46268; Tel. 800/428-SAMS.

## Fun Way Into Electronics By Dick Smith

If you have kids at home interested in electronics, or perhaps you're a beginner yourself, you may like to take a look at this three-volume series.

*Fun Way Into Electronics* features 50 introductory projects for beginning electronics enthusiasts. Starting with Volume 1 and continuing through the series, each project is designed as an instructional building block allowing the beginner to progress to more sophisticated projects.

Each book features easy-to-understand, concise construction methods and descriptions, providing a learning program.



Topics covered include: Volume 1—20 introductory projects, basic materials and tools, component descriptions, component codes, guide to successful projects, component listing, and projects. Volume 2—20 projects, soldering to a professional printed-circuit board, using a multimeter, reading circuit diagrams, basic circuit laws, milestones in electronics, and more. Volume 3—advanced projects, investigating integrated circuits, constructing PC boards, building a mini synthesizer and a mini stereo amplifier, and understanding the binary system.

Each volume retails for \$9.95 and is available through bookstores, educational institutions, computer retailers, electronics distributors, or directly from Howard W. Sams and Co., Dept. R40, 4300 W. 62nd St., Indianapolis, IN 46268; Tel. 800/428-SAMS.

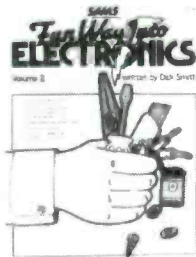

CIRCLE 91 ON FREE INFORMATION CARD

### Your IBM PC Made Easy By Jonathan Sachs

If you dislike the formality of your user guides, or you want to increase your knowledge of your PC, this book is what you need. *Your IBM PC Made Easy* covers the fundamentals of your system, and details major features of your PC, including coverage of DOS 2.0 and the PC XT.



CIRCLE 90 ON FREE INFORMATION CARD

Step-by-step operating instructions allow you to tap into your PC's capabilities quickly and easily. Equally important, a guide to resources tells you what you need to know about dealers, hardware, software, services, and accessories for your PC.

In addition, a reference guide for

# Free Famous hi-tech catalog

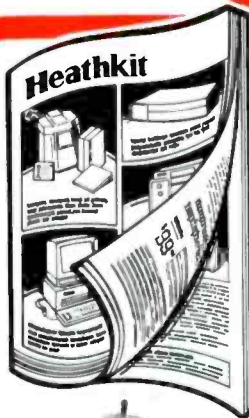

**A very special computer & electronics guide that shows you what the exciting world of kitbuilding can do for you.**

Challenge. Knowledge. Achievement. Enjoyment. All of these things are yours when you build a Heathkit high-quality product. Our colorful, informative catalog reflects the years of experience and technological expertise that make these things happen for you.



HERO® 2000 Educational Robot and Courseware

IBM-PC Compatible Expandable Computers

Amateur Radio Terminal Node Controller

Precision Test Instruments

Electronic Keyless Doorlock

In our catalog you'll find over 450 interesting and useful items – from computer hardware and software to robots and test instruments, and from home security systems to color tv's and amateur radio equipment.

But what makes Heath Company unique is that we offer you the confi-

dence and pride that you can only get by building a state-of-the-art product yourself. And you're backed by our promise, "We won't let you fail!"

The Heathkit Catalog is a simple – and FREE – first step toward this excellent opportunity.

**Send NOW for your FREE Heathkit Catalog**



**Yes!** I want to see what kitbuilding can do for me. Please send me the latest Heathkit Catalog Free.

Send to: Heath Company, Dept. 107-522  
Benton Harbor, Michigan 49022

Name \_\_\_\_\_

Address \_\_\_\_\_

City \_\_\_\_\_

State \_\_\_\_\_

Zip \_\_\_\_\_

CL-787R1

**Heathkit®**  
Heath  
Company

A subsidiary of Zenith Electronics Corporation

CIRCLE 18 ON FREE INFORMATION CARD

## HOT BOOKS FOR HOBBYISTS



**2617T—BUILD A REMOTE-CONTROLLED ROBOT FOR UNDER \$300....\$9.95.** Foot-proof instructions for putting together your own full-size robot



**2735T—62 HOME REMOTE CONTROL AND AUTOMATION PROJECTS....\$12.95.** A fascinating collection of projects to make your life safer, more convenient, and more fun

### BUILD A REMOTE-CONTROLLED ROBOT....FOR UNDER \$300

**2617T**—If you're fascinated by the home robots increasingly available on today's market .... but are stopped by their price tags .... here's your solution. Build your own home robot—and a full size unit at that—for less than \$300. No advanced electronics or computer skills are needed to put together "Questor", a robot butler especially designed to be both affordable and easy-to-build. — Order your copy for \$9.95 plus \$1.75 shipping.

### 62 HOME REMOTE CONTROL AND AUTOMATION PROJECTS

**2735T**—A device that automatically dims the lights when you turn on your stereo ... an automatic guest greeter ... sensors that keep your air-conditioning at ideal levels automatically ... voice-operated transmitters, door and window controllers and more. Complete instructions, wiring diagrams, and show-how illustrations for each device. \$12.95 plus \$2.75 shipping.

Send 40-page catalog—FREE with order.  
 I've included \$2.00 Send catalog and coupon good for \$2.00 on first order.

**Electronic Technology Today**  
 P.O. Box 240  
 Massapequa Park, NY 11762

operations and troubleshooting common computer problems helps you keep your system up and running.

Comprehensive and easy to understand, *Your IBM PC Made Easy* is written for both the beginning or experienced IBM PC user.

Retailing for \$14.95, the 431 page paperback is available from McGraw-Hill, 2600 10th St., Berkely, CA 94710; Tel. 800/227-0900, or 800/772-2531.



CIRCLE 94 ON FREE INFORMATION CARD

### 30 Customized Microprocessor Projects

By Delton T. Horn

At last—here is an electronics project guide that is a complete sourcebook on designing and building special purpose computer devices around the Z80 microprocessor!

*30 Customized Microprocessor Projects* directs attention to the use of dedicated CPU's. He shows how those relatively inexpensive devices can be used where computer control is desirable, but where use of a full microcomputer would be both wasteful and impractical.

The book leads off with a thorough refresher course on the basics of circuit design and digital technology. CPU commands and data, computer components, and the Z80 microprocessor are examined and there's a complete look at semiconductor memory—RAM, ROM, PROM, EPROM, and other memory devices. Next, you move into the fundamentals of interfacing including use of memory mapped I/O's and direct I/O's, Z80 interface timing, bus interface circuitry, and interfacing of analog signals.

Instructions for building a CPU breadboard, an EPROM programmer with supplemental power supply, an AC timer/automation system, several types of security sensors and systems, and a variety of test equipment units round out the text. Included are computer programs to make the projects work and a quick-reference listing of the Z80 instruction set and hexadecimal codes.

The book, 297 pages in length, retails for \$14.95. Published by Tab Books, Inc., Blue Ridge Summit, PA 17214; Tel. 717/794-2191.

### How to Design and Build Electronic Instrumentation

By Joseph J. Carr

*How to Design and Build Electronic Instrumentation* is a sourcebook that contains practical design and construction guidance; it shows how to put together a huge range of useful electronics instruments—ranging from relatively simple circuits to amazingly sophisticated microprocessor devices.



CIRCLE 95 ON FREE INFORMATION CARD

Avoiding too-technical explanations and overly complex mathematical formulas, Carr (an author whose byline frequents the pages of this magazine) provides a practical approach to design and construction techniques and to putting circuitry to work in the real world. Plus, he provides scores of detailed schematic diagrams and construction diagrams as well as three computer programs to help the reader design his own circuits for specific applications.

Providing background on operational amplifiers, digital electronics, special IC devices, and power supply design principles, Carr guides the reader through the use of single-ended DC amplifiers, AC amplifiers, DC differential amplifiers, and other useful digital and analog circuitry. He covers transducers, bridge and carrier amplifiers, temperature measurement, IC waveform generators, data converters, optoelectronics, instrumentation techniques, and the use of active filters. Proper construction techniques and the fundamentals of circuit design are fully explained with practical example circuits and microcomputer design programs.

The book comes in paperback (\$17.45) and hardcover (\$26.95) forms, and is 518 pages. It's available from TAB Books Inc., Blue Ridge Summit, PA 17214; Tel. 717/794-2191.

## AMAZING DEVICES

**PHASORS**

**PLANS**—All Parts Available in Stock

- LC5 BURNING CUTTING CO2 LASER ... \$20.00
- RUB3 RUBY LASER RAY PISTOL ... 20.00
- BTC5 1.5 MILLION VOLT TESLA COIL ... 15.00
- PTG1 PLASMA TORNADO GENERATOR 10.00
- GRA1—GRAVITY GENERATOR 10.00
- MAGNETIC CANNON PROJECTOR 10.00

**LASERS**

**KITS**—Includes Plans and Parts

- LHC2K SIMULATED RED/GRN/YEL LIGHT LASER 34.50
- BTC3K 250,000 VOLT TESLA COIL ... 159.50
- 10G1K ION RAY GUN 109.50
- PSP3K PHASOR SHOCK WAVE PISTOL 49.50
- STG1K—STUN/PARALYZING GUN ... 39.50
- INFIK INFINITY TRANSMITTER 134.50
- MFT1K 2-3 MILE RANGE FM VOICE XMTR PC BOARD 49.50

**SECURITY**

**ASSEMBLED AND TESTED PRODUCTS**

- LGU30 RED 1MW PORTABLE HENE LASER 349.50
- TCL30 SOLID STATE TESLA COIL 35KV 84.50
- IPG50 POCKET PAIN FIELD GENERATOR 64.50
- BLS10 BLASTER DEFENSE WEAPON ... 89.50
- ITM10—100KV SHOCK AND STUN GUN 99.50
- PPF10 PHASOR PAIN FIELD PORTABLE 249.50
- SNP20 SECURITY PHONE LISTENER ... 99.50

• CATALOG CONTAINING DESCRIPTIONS OF ABOVE PLUS HUNDREDS MORE AVAILABLE FOR \$1.00 OR INCLUDED FREE WITH ALL ABOVE ORDERS

PLEASE INCLUDE \$3.00 PH ON ALL KITS AND PRODUCTS. PLANS ARE POSTAGE PAID. SEND CHECK, MO, VISA, MC TO

**INFORMATION UNLIMITED**

P.O. BOX 716, DEPT. HO AMHERST, NH 03031

CIRCLE 5 ON FREE INFORMATION CARD

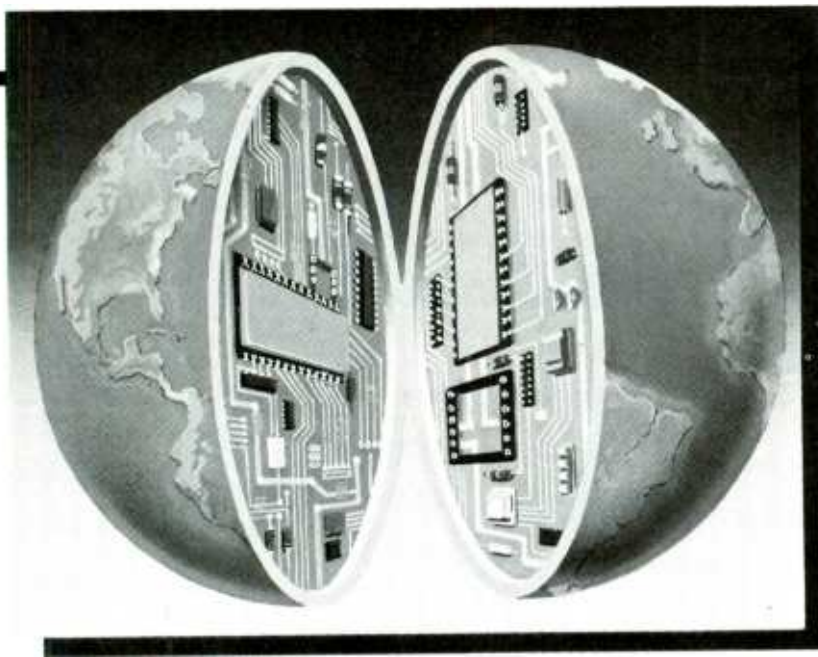

can even earn your Associate in Applied Science Degree in Electronics Engineering Technology. Of course, you set your own pace, and, if you ever have questions or problems, our instructors are only a toll-free phone call away.

## The first step is yours.

To find out more, mail in the coupon below. Or, if you prefer, call toll-free 1-800-321-2155 (in Ohio, 1-800-523-9109). We'll send you a copy of CIE's school catalog and a complete package of enrollment information. For your convenience, we'll try to have a representative contact you to answer your questions.

# CIE MAKES THE WORLD OF ELECTRONICS YOURS.

Today's world is the world of electronics. But to be a part of it, you need the right kind of training, the kind you get from CIE, the kind that can take you to a fast growing career in business, medicine, science, government, aerospace, communications, and more.

## Specialized training.

You learn best from a specialist, and that's CIE. We're the leader in teaching electronics through independent study, we teach only electronics and we've been doing it for over 50 years. You can put that experience to work for you just like more than 25,000 CIE students are currently doing all around the world.

## Practical training.

You learn best with practical training, so CIE's Auto-Programmed® lessons are designed to take you step-by-step, principle-by-principle. You also get valuable hands-on experience at every stage with sophisticated electronics tools CIE-designed for teaching. Our

4K RAM Microprocessor Training Laboratory, for example, trains you to work with a broad range of computers in a way that working with a single, stock computer simply can't.

## Personalized training.

You learn best with flexible training, so we let you choose from a broad range of courses. You start with what you know, a little or a lot, and you go wherever you want, as far as you want. With CIE, you



HO-55

## CIE Cleveland Institute of Electronics

1776 East 17th St., Cleveland, Ohio 44114

YES! I want to get started. Send me my CIE school catalog including details about the Associate Degree Program. I am most interested in:

- |  |   |
|--|---|
| <input type="checkbox"/> computer repair     | <input type="checkbox"/> television/high fidelity service |
| <input type="checkbox"/> telecommunications  | <input type="checkbox"/> medical electronics              |
| <input type="checkbox"/> robotics/automation | <input type="checkbox"/> broadcast engineering            |
| <input type="checkbox"/> other _____         |   |

Print Name \_\_\_\_\_

Address \_\_\_\_\_ Apt. \_\_\_\_\_

City \_\_\_\_\_ State \_\_\_\_\_ Zip \_\_\_\_\_

Age \_\_\_\_\_ Area Code/Phone No. \_\_\_\_\_

Check box for G.I. Bulletin on Educational Benefits

- Veteran     Active Duty

**MAIL TODAY!**

CIRCLE 12 ON FREE INFORMATION CARD

By Marc Saxon



# SAXON ON SCANNERS

## A handheld scanner that competes with base units

HERE'S A CHEERFUL LITTLE EARFUL: The latest 55-channel handheld scanner from Regency—the HX-1500—is the heir to the earlier HX-1200 and those that went before it.

Scanners that can be held in the hand or clipped to the belt are perfect for field use. Sadly, some of those small scanners have had to trade off performance for size when it comes to frequency coverage and product features. The HX-1500, however, takes a back seat to no other scanner, even a sophisticated base station. With its 55-channel scanning capacity, it manages to beat out many desk-top scanners!

The Regency HX-1500 covers over 18,000 frequencies from a huge chunk of the spectrum: 29 to 54 MHz, 118 to 174 MHz, and 406 to 512 MHz; including four ham bands, the VHF aero band, the VHF high/low/UHF/UHF-T public service, federal, and industrial bands; and even frequencies used by some weather and space research satellites. Not bad; not bad at all.

A snap to program, the HX-1500 has a sealed rubber keypad that *beeps* each time a key is pressed. The LCD display shows the frequency entered, and blinks little programming prompt-messages to you to make things as simple as possible. For added monitoring convenience, the scanner also is the first handheld unit to feature selectable scanner banks. Channels can be grouped into any of four banks for faster and easier access. You might group federal channels in one such bank, police in another, aero in the third bank, etc.

Quite a bit of planning has been done to make the HX-1500 convenient to use. For instance, there are two scan-control buttons, one on the front and one on the top. The topside button makes it easy to start the set scanning when you've got it clipped to your belt. The advanced memory system holds your frequencies even when the batteries are worn out. Other fancy features include dual scan speeds, a priority channel, direct channel access, and a die-cast aluminum chassis for rugged durability.

The HX-1500 carries a price tag of \$369.95 (suggested retail) and comes with a rubber duckie-type antenna, belt clip, earphone, and you can use optional rechargeable batteries if you like (it takes



The HX-1500, 55-channel handheld scanner features dual scan-speeds, a priority channel, direct-channel access, and a memory system that holds your frequencies even when the batteries are shot.

eight AA-type batteries). An optional carrying case and battery charger are also available.

Give the Regency HX-1500 the *eyeball* at your nearest Regency dealer, or check directly with Regency Electronics Inc., 7707 Records Street, Indianapolis, IN 46226.

### Captured by Radio

One novel use of a handheld VHF radio was reported recently and you might find it rather dramatic. In New York City, a 200-pound female prisoner was being transported to court to face a murder charge. At some point she decided that she'd really rather be someplace else, and thereupon, managed to slip out of her handcuffs (she had been handcuffed to another prisoner) and ran from the van

when it pulled up to the courthouse entrance.

Heading down the street as fast as she could go, she was being chased by a phalanx of court officers and correction officers. She had gotten about a block from the van through streets too crowded to fire any shots, and also too congested to permit a reasonable chase. That's when one of the court officers threw his handheld radio at her. He scored a direct hit on the prisoner's back, causing her to slip and fall. Within seconds, she was back in custody and on the way (again) to face the judge.

### Everyone's into Radio

Your columnist has been finding some interesting frequencies used by manufacturers of aircraft. Test pilots appear to use these frequencies to communicate with other aircraft and with the ground. Inasmuch as some of the aircraft (military and civilian) achieve very impressive altitudes, the radio transmission range can be well over 200 miles.

Sometimes the conversations get extremely animated and interesting. You might want to see if you can pick up any activity on these channels. Try listening on: 36.90, 123.125, 123.15, 123.175, 123.2, 123.225, 123.25, 123.275, 123.325, 123.35, 123.375, 123.4, 123.425, 123.45, 123.525, 123.55 and 123.575 MHz. (Speaking of aircraft, a reader stationed at Wright Patterson Air Force Base in Ohio, writes to say that the famous Air Force Museum located there uses 413.375 MHz for its communications needs.)

Officially and theoretically, search and rescue aircraft operate on 123.1 MHz, however that frequency seldom reveals very much activity. Here are some little-known frequencies, however, that have produced some worthy communications for those within range of several U.S. Naval Air Stations.

They are the VHF channels used for something known as FACSFAC (Fleet Area Control and Surveillance). The mission of FACSFAC is to provide scheduling, communication links, control, containment, coordination, search and

(Continued on page 105)

# To sleep, to dream... Calling CQ Earth... SWL fiction or not!?

By Vince Luciani

□ RECENT REPORTS OF METAPHYSICAL experiments, which claim spiritual communications with departed souls via shortwave radio, have met the expected rejections of most people, myself included. Yet, from the experience I am about to describe, I can no longer be so closed-minded. Shortwave communications in the psychic realm may, in fact, be no further distant than the closing of one's eyes.

Shortwave listeners—SWL's—enjoy a direct insight into the cultures of societies from all over the world; have you ever thought of SWL'ing as such? Also, the process of joining this fascinating hobby comes without technical training. Aficionados, of which there may be a few million on earth know, too, the surprising degree of relaxation and stress release this hobby offers.

It should not surprise you, then, to learn that I'm an active SWL and often carry my favorite little Sony shortwave portable with me. You see, I simply never tire of listening to what they, out there, wish to tell all of us about themselves, and they do this via their shortwave broadcasts, available to all who care. I care.

So it was, Sony and all, the evening I had finished reading a rather absorbing book whose contents I shall not divulge at this time so that distracting inferences might not be drawn.

Tilted fully back on my favorite reclining chair, the Sony perched near my ear, the book on my lap, and the spirits of the book's subject matter still quite lively in my mind, I closed my eyes but for a moment that I might meditate...and as though by command, I was instantly asleep.

Scarcely had I transitioned from the awake state than had I become aware of being in a dream in which I walked the cobblestoned streets of what I was quick to recognize as the city of Philadelphia. I was at 12th and Market Streets; I know, I have been there often.

But this was not the Philadelphia of today. No, it was obviously the Philadelphia of a past age; the *revolutionary period*, as gauged from the attire of those walking by who stared at my own clothing as though I were from another world...which, of course, I was.

Fortunately, I spied a print shop in

whose window hung the front page of a newspaper. Hurriedly scanning it for a date, I was pleasantly shocked to learn it was July 4, 1776! Further, my awareness of the dream state now brought me to the realization of a long sought-after ambition—I was in a lucid dream!

To explain, lucid dreams are those in which the dreamer is quite aware of the dream and of one's presence in it. Hence, the status of the dream can take many turns as sometimes dictated by the alert dreamer. After all, a dream—any dream—can be said to be a subconscious stage production in which the dreamer is simultaneously author, producer, cast, and audience to all that takes place in the dream.

What, then, to do for the best realization of my sudden good fortune? Of course the signers of the Declaration of Independence were but a few blocks from where I stood on this date: George Washington, Thomas Jefferson, Benjamin Franklin, John Hancock...exciting? Very much so. Imagination? Perhaps, perhaps not.

Ignoring the stares of those about me, I set off toward Independence Hall at 5th and Chestnut Streets, walking along Market Street, anxious that I could soon actually see, hear, meet, and touch those famous giants of American history. My steps quickened.

But not so quickly that they could not be brought to a halt by the extraordinarily tantalizing aroma of freshbaked breads. Ah, the sense of smell in a dream, you ask? Yes, and quite acutely so in special circumstances.

The bakery was located on 6th Street, hardly out of my way. Quickly, now, eager to experimentally evaluate my senses of both smell and taste, while in a lucid dream, I ordered a loaf—three cents—and reached to my right pocket for the change, transferring the Sony to my left hand in the process...my God! The Sony! I had my shortwave radio with me!

That you might better share my excitement of the moment, try to see things from my standpoint. Here I was, temporarily existing in a world that was dated two centuries prior to the invention of the marvelous radio I held in my hand; in fact, the year was several generations short of Marconi's demonstrations of wireless

## ATTENTION! ELECTRONICS TECHNICIANS

### EARN YOUR B.S.E.E. DEGREE



#### THROUGH HOME STUDY

Our New and Highly Effective Advanced-Placement Program for experienced Electronic Technicians grants credit for previous Schooling and Professional Experience, and can greatly reduce the time required to complete Program and reach graduation. No residence schooling required for qualified Electronic Technicians. Through this Special Program you can pull all of the loose ends of your electronics background together and earn your B.S.E.E. Degree. Upgrade your status and pay to the Engineering Level. Advance Rapidly! Many finish in 12 months or less. Students and graduates in all 50 States and throughout the World. Established Over 40 Years! Write for free Descriptive Literature.

### COOK'S INSTITUTE OF ELECTRONICS ENGINEERING

347 RAYMOND ROAD  
P.O. BOX 20345  
JACKSON, MISSISSIPPI 39209

CIRCLE 10 ON FREE INFORMATION CARD

## Need Quick Turnaround on CRYSTALS?

### Try Our E.O.D. (Emergency Order Dept.)

and get

### JAN QUALITY and STABILITY PLUS Low Prices!

## JAN CRYSTALS

You benefit from 21 years of manufacturing quality crystals for industry, military services, radio amateurs, citizen band and experimenters.

To Get Free Catalog  
Call or Write

**JAN CRYSTALS**  
P.O. Box 06017  
Ft. Myers, FL 33906  
(813) 936-2397

VISA

MasterCard

CALL 1-800-237-3063  
FREE (Except Florida)

CIRCLE 16 ON FREE INFORMATION CARD

# SUPER LONG PLAY TAPE RECORDERS

10 Hour Model — \$95.00\*  
14 Hour Model — \$159.00\*

Modified Panasonic Slimline high quality AC-DC Recorders provide 5 or 7 continuous hours of quality recording & playback on each side of cassette for a total of 10 or 14 hours depending on model. Built-in features include • Voice level control • Digital Counter etc. TOK DC 180 Cassette Furnished



## PHONE RECORDING ADAPTER

Records calls automatically. All Solid state connects to your telephone jack and tape recorder. Starts recording when phone is lifted. Stops when you hang up.

\$24.50\*

FCC APPROVED

## VOX VOICE ACTIVATED CONTROL SWITCH

Solid state Self contained. Adjustable sensitivity. Voices or other sounds automatically activate and control recorder. Uses either recorder or remote mike.

\$24.95\*

\* Add for ship & hdg. Phone Adapter & Vox \$1.50 ea. Recorders \$4.00 ea. Cal. Res. add tax. Mail order VISA MIC. COD's OK. Money Back Guarantee. Qty. disc. avail. Dealer Inquiries invited. Free data. **AMC SALES, Dept. 9335 Lubec St., Box 928, Downey, CA 91746** (213) 902-4111 Phone 869-8519

CIRCLE 9 ON FREE INFORMATION CARD

communications. All my energies were encapsulated into one burning question: Were there any shortwave broadcasts filling the high-frequency bands back in 1776?

Judge not too quickly nor harshly, my friends. You see, I have been involved with radio communications since my days as a kid radio officer in World War II; I know my way around this field. I am also blessed with a prayerlike curiosity of all things unique to our earthly existence, of which radio communications is but one. Is radio propagation a permanent attachment to the planet, or is it a passing phenomenon? Ridiculous, you say? Then check the ascending-descending curve of solar flux maxima from 1900, on.

More pertinent to the matters of my dream, however, was the question of whether we 20th-century earth-walkers were the very first in the universe to have radiated signals into space. Can we seriously believe ourselves to be the only lifeforms in the universe to have broadcasted radio signals? Were there others who had perhaps ceased their own transmissions, for whatever reasons, coincident to our earth discovery of radio? Allow your speculative nature to consider those questions.

Back to the dream...I dashed outside of the bakery so as not to startle the young clerk further; could you imagine his reac-

tion had I energized the Sony in his presence it's speaker hissed aloud!

Once outside, I raised trembling hands to the power switch, hesitated a moment, and turned the set on.

Instantly, there were sounds of proportions so strange that I have never since been able to reconstruct them in my mind, not now. Immediately, I was gone from that place, rudely thrust back to the present. I screamed an agonized scream of protest!

What had happened? Dream researchers say it was a safety release, the dream's sudden termination, in which my logical left brain had overridden my imaginative right brain to remove me from a danger that my total mind fully knew I could not assimilate. Yes, there are dangers to lucid dreams.

Those mysterious sounds. Understand, I am absolutely certain they were neither static, nor low-battery squeal, nor any other common radio sound—they were broadcasted signals; I simply do not consciously know their details.

Often, since then, have I read and re-read that book on the drafting of the Declaration of Independence—the book with which I had fallen asleep, into the dream—in hopes I might retrace my earlier path, but without luck. I have accepted hypnotic regressions but here, too, there is no help, for each time a substantial block develops, which I am apparently unable to skirt. I suppose there may be an incomprehensible scheme somewhere out in eternity by which we get one time and only one time to experience such splendid occurrences. How sad.

And what about those sounds that I'd heard on my radio in the year 1776? Well, I have an intuitive belief that there are readers out there who know and understand. I wish to hear from them.

Please write, and please understand that they won't let me answer your letters!

## Employers

Willing workers available now at as little as 1/2 your usual cost.

This is your chance to get help you've needed, but thought you couldn't afford.

No business too large or too small. Call your private industry council or write National Alliance of Business, P.O. Box 7207, Washington, D.C. 20044

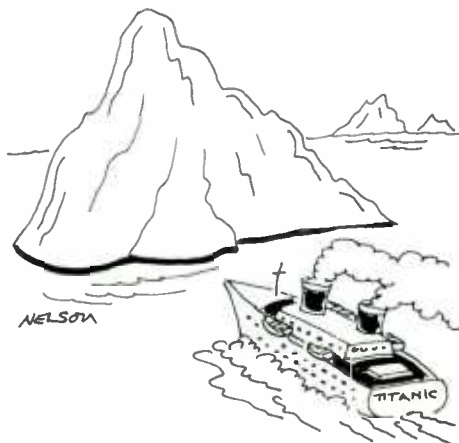

According to our computer we should be able to smash right through it!

A Public Service of The Publication **Ad Council**

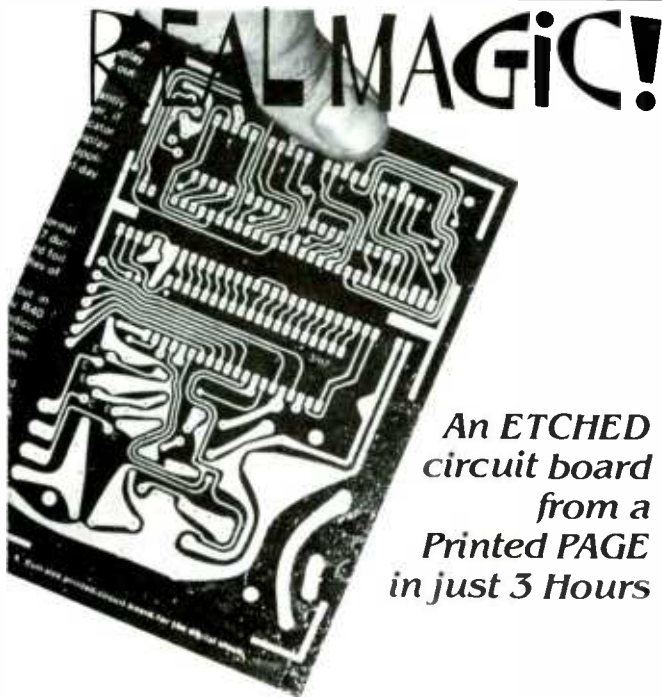

An ETCHED circuit board from a Printed PAGE in just 3 Hours

The ER-4 PHOTO ETCH KIT gives you the tools, materials and chemicals to make your own printed circuit boards. The patented Pos-Neg™ process copies artwork from magazines like this one without damaging the page. Use the circuit patterns, tapes and drafting film to make your own 1X artwork. Or try the Direct Etch™ system (also included), to make single circuit boards without artwork. The ER-4 is stocked by many electronic parts distributors, or order direct, postpaid.

ER-4 PHOTO ETCH KIT (NJ and CA residents add sales tax) . . . . \$37.00

DATAK'S COMPLETE CATALOG lists hundreds of printed circuit products and art patterns. Also contains dry transfer letter sheets and electronic title sets for professional looking control panels. WRITE FOR IT NOW!

The DATAK Corporation • 65 71st Street • Guttenberg, NJ 07093

CIRCLE 6 ON FREE INFORMATION CARD

# Electronics Paperback Books

GREAT PAPERBACKS AT SPECIAL PRICES



**BP173—COMPUTER MUSIC PROJECTS** ..... \$6.95. Shows how to use your home computer to produce electronic music. Many circuits. Mostly Jargon free.



**BP170—AN INTRODUCTION TO COMPUTER PERIPHERALS** ..... \$5.95. Describes and explains how to use a variety of different computer equipment in a way as non-technical as possible.



**27051—CUSTOMIZED MICRO-PROCESSOR PROJECTS** ..... \$14.95. Building instructions, detailed schematics and application programs for intriguing and useful dedicated CPU projects.



**BP141—LINEAR IC EQUIVALENTS AND PIN CONNECTIONS** ..... \$12.50. 247 pages, 7 x 10 in. Shows equivs & pin connections for popular user oriented ICs.



**BP140—DIGITAL IC EQUIVALENTS AND PIN CONNECTIONS** ..... \$12.50. 312 pages, 7 x 10 in. Shows equivs & pin connections for popular user oriented ICs.



**BP187—REFERENCE GUIDE TO AMSTRAD WORD PROCESSING** ..... \$14.95. Everything you need to know about using these machines.



**BP108—INTERNATIONAL DIODE EQUIVALENTS GUIDE** ..... \$5.75. Full interchangeability data and characteristics for diodes, including Zeners, LEDs, Diacs, Triacs and more.



**BP135—SECRETS OF THE COMMODORE 64** ..... \$5.00. Masses of useful info and programming tips not found in any user's manual.



**BP143—INTRO TO PROGRAMMING THE ATARI 600/800 XL** ..... \$5.00. Perfect complement to the Atari user's manual. Even shows how to use animated graphics.



**BP131—MICRO INTERFACING CIRCUITS—BOOK 1** ..... \$5.75. Practical add-ons transform your computer into control or measurement equipment.



**BP131—MICRO INTERFACING CIRCUITS—BOOK 2** ..... \$5.75. Interfacing sound and speech generators, temperature and optical sensors, motor controllers, and more.



**BP152—INTRO TO Z-80 MACHINE CODE** ..... \$5.95. Speed up your programs. They may be harder to write, but it's worth learning how. Some demo programs are included.

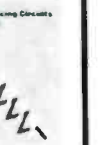

**BP105—ANTENNA PROJECTS** ..... \$5.00. Practical radio antenna designs that deliver good performance and are relatively simple and inexpensive to build.



**WHITES—WHITE'S RADIO LOG** ..... \$4.95. An up-to-date directory of AM, FM and TV stations, including a section on worldwide shortwave stations.



**CONFID—CONFIDENTIAL FREQUENCY LIST, 6th edition** ..... \$15.95. Latest info on unusual and exotic shortwave broadcast stations.



**BP125—25 SIMPLE AMATEUR BAND ANTENNAS** ..... \$5.00. All kinds of antennas for all kinds of amateur radio reception.



**BP134—EASY ADD-ON PROJECTS FOR COMMODORE 64** ..... \$6.95. Picture dig, timer, light pen, model controller and more.



**BP179—ELECTRONIC CIRCUITS FOR THE COMPUTER CONTROL OF ROBOTS** ..... \$5.00. Data and circuits for interfacing the computer to the robot's motors and sensors.

## Quality Paperbacks



**BP39—50 FET PROJECTS** ..... \$5.50. Projects include rf amplifiers & converters, test equipment, receiver aids, tuners, receivers and more.



**BP127—HOW TO DESIGN ELECTRONIC PROJECTS** ..... \$5.75. How to use standard circuit elements to make custom electronic projects.



**BP110—HOW TO GET YOUR ELECTRONIC PROJECTS WORKING** ..... \$5.00. How to find the faults in your projects, repair them and get them working.



**BP121—DESIGN & MAKE YOUR OWN PCB BOARDS** ..... \$5.75. Everything you need to know before you make printed-circuit boards for your projects.



**BP56—ELECTRONIC SECURITY DEVICES** ..... \$5.00. Three basic sections: Switch activated alarms, infrared & ultrasonic systems, smoke, gas, water detection.



**BP85—INTERNATIONAL TRANSISTOR EQUIVALENTS** ..... \$7.50. Locates possible substitutes for a popular user-oriented selection of modern transistors, Japanese, European and American types.



**BP117—PRACTICAL ELECTRONIC BUILDING BLOCKS, Book 1** ..... \$5.75. Build the blocks and then combine them to form almost any custom project of your choice.



**BP118—PRACTICAL ELECTRONIC BUILDING BLOCKS, Book 2** ..... \$5.75. Amplifiers for all kinds to add to the circuits from Book 1 of this series.

## Affordable Prices



**BP126—20 PROGRAMS FOR THE ZX SPECTRUM & 16K ZX81** ..... \$5.75. All programs run on both machines. Include flow charts and info on how to modify to run on other computers.



**BP106—MODERN OP-AMP PROJECTS** ..... \$5.00. Includes a Slide Timer, AF Signal Gen, Mike Pre-amp, Scratch Filter, and much more.



**BP59—SECOND BOOK FOR CMOS IC PROJECTS** ..... \$5.00. Multivibrators, amplifiers, triggers & gates, special devices including reaction timer, simple electronic organ, and more.



**BP182—MIDI PROJECTS** ..... \$6.95. Details of how to interface many popular home computers with MIDI music systems.



**BP65—SINGLE IC PROJECTS** ..... \$4.95. All projects in this book are based on one IC and are simple to construct. Great way to get started with ICs.



**BP49—POPULAR ELECTRONIC PROJECTS** ..... \$5.50. A collection of a wide range of electronic projects and circuits for the experimenter.



**BP97—IC PROJECTS FOR BEGINNERS** ..... \$5.00. Written especially for the less experienced experimenter. Complete parts layouts and wiring diagrams.



**BP80—POPULAR ELECTRONIC CIRCUITS, Book 1** ..... \$5.00. More circuits for hobbyists. Audio, radio, test music, household and more.



**BP98—POPULAR ELECTRONIC CIRCUITS, Book 2** ..... \$5.95. Have you ever written your own programs only to find that they do not work? This book shows you how to find errors.

CHECK OFF THE BOOKS YOU WANT

ELECTRONIC TECHNOLOGY TODAY INC.  
P.O. Box 240, Massapequa Park, NY 11762-0240

Name \_\_\_\_\_  
Address \_\_\_\_\_  
City \_\_\_\_\_ State \_\_\_\_\_ Zip \_\_\_\_\_

SHIPPING CHARGES IN USA & CANADA

\$0.01 to \$5.00	..... \$1.00
\$5.01 to \$10.00	..... \$1.75
\$10.01 to 20.00	..... \$2.75
\$20.01 to 30.00	..... \$3.75
\$30.01 to 40.00	..... \$4.75
\$40.01 to 50.00	..... \$5.75
\$50.01 and above	..... \$7.00

OUTSIDE USA & CANADA  
Multiply Shipping by 2 for sea mail  
Multiply Shipping by 4 for air mail

Total price of merchandise ..... \$ \_\_\_\_\_  
Sales Tax (New York State Residents only) ..... \$ \_\_\_\_\_  
Shipping (see chart) ..... \$ \_\_\_\_\_

All payments must be in U.S. funds

Number of books ordered

Total Enclosed .. \$ \_\_\_\_\_

H487

# Touch Light

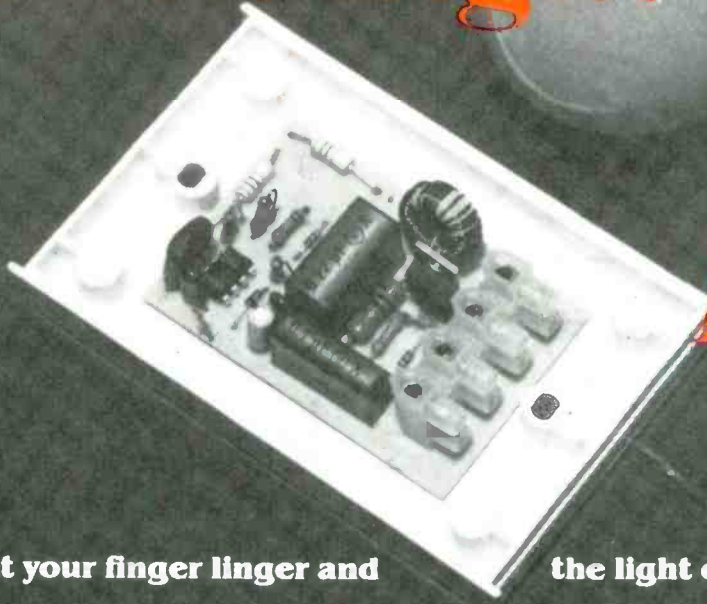

# Dimmer

By Marty Knight

Let your finger linger and

the light doesn't go out, it dims!

□ THE FM WAS PLAYING A FORTY'S GLENN MILLER BALLAD, the dinner was gourmet, and it was time for lights to go out! The mood was just right, and...snap! The wall switch sounded like a rifle shot and the room plunged into darkness. "Whaaaaa!" Darn it, Junior woke up! "Honey, warm up a bottle."

That domestic scene would have had a happier ending if a *Touch Light-Dimmer* were installed where the wall switch was! Just a touch of its metallic plate will turn the lights off, and longer contact would slowly dim the light without a harsh transition. Maybe it's time you installed a *Touch Light-Dimmer*. We will tell you how it works and how to put one together in one evening.

## The Ups and Downs of Lighting

The *Touch Light-Dimmer* uses a novel integrated circuit and a triac that turns lamps on and off when you touch a wall plate instead of using the light switch! Additionally, overhead lamps can be dimmed or brightened to any level by touching the panel for one or two seconds. It's that extra *touch* that makes this circuit a winner! Ordinary touch and "clap-sound" switches now on the market reverse the state of the lamp from on to off and off to on; but none of them offer gradual dimming nor brightening!

Should the original switch control wall outlets, the *Touch Light-Dimmer* can operate table and floor lamps plugged into those outlets, but be sure that only a purely resistive load is used. Motor-driven devices and fluorescent lamps are taboo!

The *Touch Light-Dimmer* has built-in noise suppression and optional remote sensing for two-way or multi-way lamp switching. You can use the dimmer in the same room you listen to shortwave radio in, without undue noise from the dimmer. Optional remote sensing permits additional touch-plates to be used where multi-way switching existed before.

The *Touch Light-Dimmer* circuit is mounted on a small printed-circuit board behind a blank plastic faceplate, which has the standard mounting holes of common metallic switch-plates. A decorative metallic plate (that serves as the touch plate) clips onto the plastic plate.

## The Triac Is Not Shiftless!

As with all other dimmer circuits, the *Touch Light-Dimmer* uses a triac. It is controlled by a new Siemens light-dimmer integrated circuit, the S576A.

The triac is an AC power-control device that behaves like a bi-directional thyristor (SCR) that can be triggered into conduction for both voltage polarities by a signal applied to its gate. The triac continues to conduct until the AC voltage decreases to zero—then the triac turns off. A triac can be triggered into conduction at any point on either half of the line-voltage waveform. Triggering occurs whenever a low-voltage of either polarity exists across the gate and terminal 1 of the triac. For a full discussion on how an SCR and triac works, refer to the article "All About SCR's, Triacs, Diacs, and Quadracs," page 37 in the March, 1987 issue of **Hands-on Electronics**.



The triac is a semiconductor switching device which is either on (conducting) or an open circuit. The average power passed by the triac is controlled by firing the triac at the proper times during each half-wave cycle; a triggering technique called *phase control*. A graphic description of that technique is shown in Fig. 1. Should the triac be switched on early in the AC cycle, the *on* time of the lamp is large and the lamp will appear to be almost fully on.

To trigger the triac at the required time in the AC cycle, some form of phase detection of the line voltage is necessary as well as a trigger signal to fire the triac. To do the job, we call upon the light-dimmer integrated circuit, the Siemens S576A dimmer/switch IC.

### Putting the S576A to Work

When a signal from the touch plate is sent to the Siemens S576A IC, an analysis of the signal by the chip is begun. Signals shorter than 50 mS (milliseconds) are discarded by the circuit as noise; signals between 50 and 400 mS in duration are recognized as on/off controls; and signals which last longer than 400 mS are recognized as up/down dimming commands.

Figure 2 shows a schematic diagram of the Touch Light-Dimmer that includes the S576A dimmer/switch integrated circuit, U1. The chip provides the logic to decide whether on/off or dimming is required, and maintains the brightness level previously set by dimming.

A digital up/down brightness counter in U1 provides information for controlling the phase angle for the gate pulse applied to triac Q1. The on signal sets the phase angle for maximum brightness; and the off signal, minimum phase angle. The up/down dimming signal starts the brightness counter in the S576A cycling through the dimming cycle of dark-to-bright-to-dark phase angle. Using the switch to dim/brighten the lamp will cause the triac, Q1, to fire later/earlier in the AC line's half-cycle period.

A portion of the AC line-voltage is sent to the sync input of U1, pin 4, which provides a synchronization signal. A phase-locked-loop circuit in U1 is used to obtain a frequency of 102.4 kHz, which is ultimately used to clock the circuit so

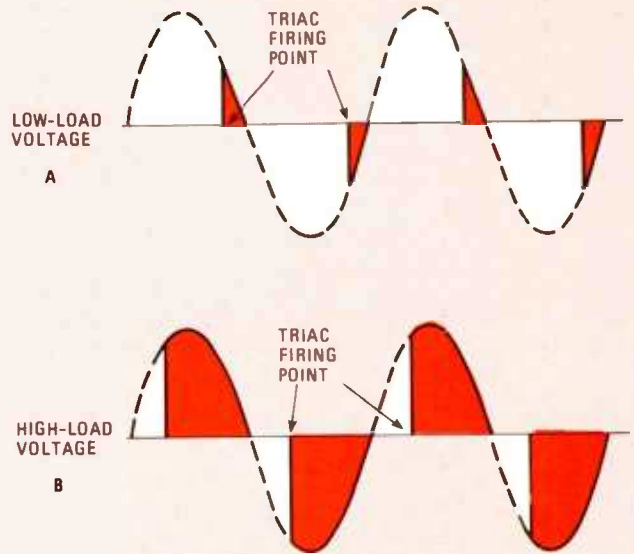

Fig. 1—Phase-control firing of a triac requires controlling the time that a triac is fired at each half cycle of the AC powerline voltage. In A, the triac firing point is close to the end of a half cycle, so that only a small portion of the time is allotted for current passing through the triac. In B, the firing point is closer to the starting point of the half cycle so that a larger portion of the time the load is connected to the AC powerline by the triac. The total average power of B is several times larger than that of A.

that the VCO output (U1, pin 8) is always in sync with the line. Much has been said about U1 in Fig. 2. Now let's get into the total circuit.

The triac, Q1, is connected between the hot line from the 117-VAC line, and the common via the controlled lamp and a toroidal, solid-core 100- $\mu$ H choke (L1). Choke L1 and capacitor C1 suppress troublesome electromagnetic interference (EMI) produced by the fast switching of triac Q1.

The triac's power rating can handle 300-watt, resistive (lamp) loads without the need of a heat sink. Do not exceed the 300-watt rating or use inductive loads.

A low-voltage supply for U1 is derived directly from the

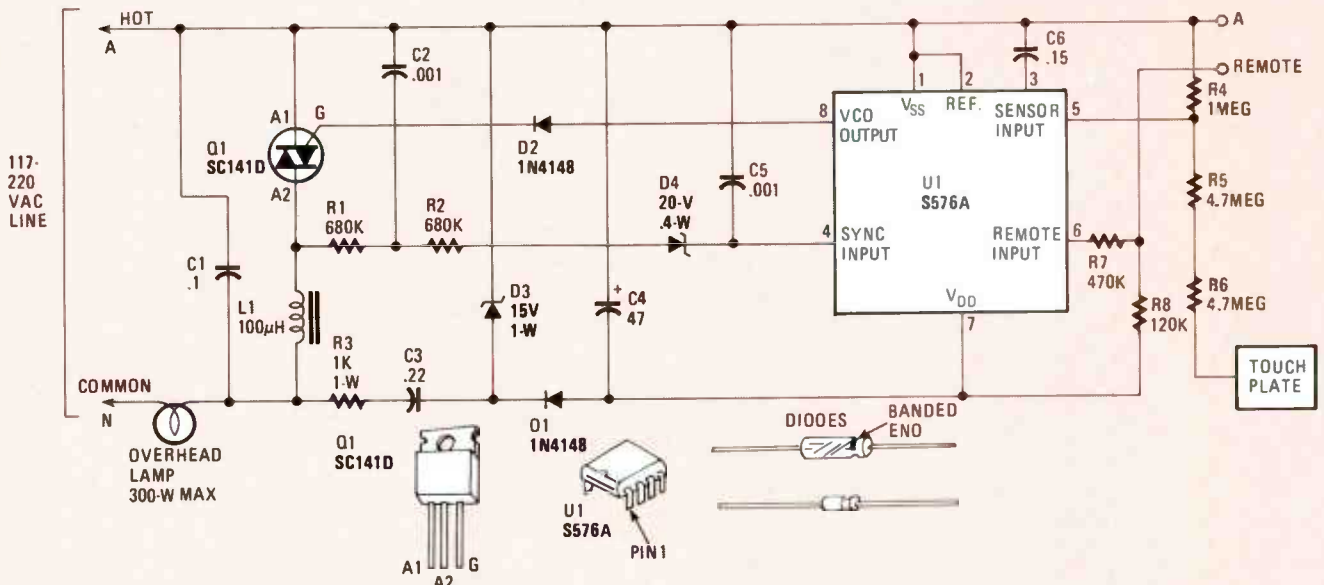

Fig. 2—In this application the polarity of Q1 is important, so make sure the anodes are properly oriented or U1 will trigger it improperly. Note that the project can be used on either 117-VAC or 220-VAC (European) lines safely.

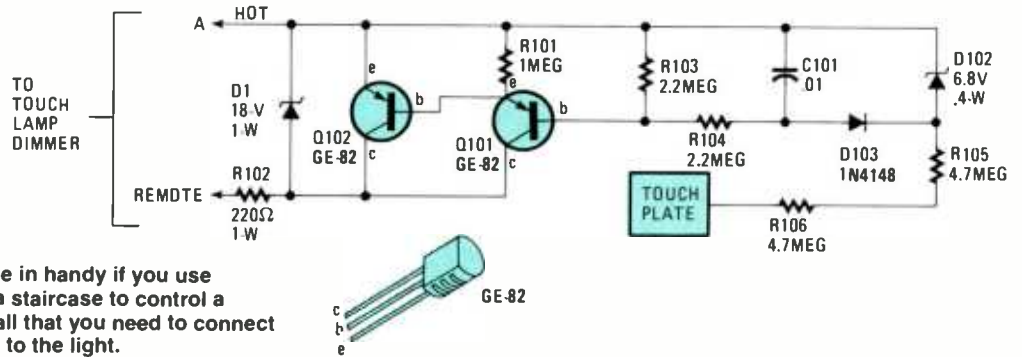

Fig. 3—The remote switch will come in handy if you use switches at the top and bottom of a staircase to control a single light. The existing wiring is all that you need to connect both the main and remote modules to the light.

AC line via current-limiting capacitor C3 and resistor R3. By using the capacitor's reactance to limit current rather than just a dropping resistor, heat dissipation is greatly reduced. Diodes D1 and D3 operate in conjunction with the C3 to charge C4. Zener diode D3 also limits the supply voltage to about 15-volts DC.

Pin 8 of U1 provides negative gate-triggering for triac Q1. Diode D2 reduces positive voltage-spikes which can be produced at the gate of U2 when being triggered by U1.

The PLL sync input to U1, pin 4, is derived from the A2 terminal of Q1 via R1, R2, and a 20-volt Zener diode, D4, in conjunction with capacitors C2 and C5. That circuit is a filter that eliminates possible dimming or flickering of the external lamp caused by AC phase and voltage variations which sometimes occur in the AC powerline.

Resistors, R4, R5, and R6, isolate the touch plate from the AC powerline, but provide sufficient connection to the sensor input of U1 to activate the chip when touched by a finger.

Touch-plate operation relies on the resistance of the body to ground. (Some will argue that the operation relies on the discharge of electrons from the plate into the body.) Normally the sensor input, pin 5 of U1, is held at active potential (120-volts AC) until the touch plate is touched, bringing it to a lower level, and thereby triggering U1. The total series resistance to the AC powerline limits the current to an undetectable, safe level. The subject would be safe even while standing in salt water—but don't try it!

Power conservationists and bill payers will find that the power used by the circuit is about 0.25 watt—a very small price to pay for the service received. Of course, the power expended by the incandescent lamp when illuminated is greater.

### Remote-Switch Circuit

The remote-switch circuit shown in Fig. 3 was designed to connect to the remote terminal of Touch Light-Dimmer circuit. If that terminal is brought to hot-line potential, the extension input, pin 6 of U1 (see Fig. 2), will activate the chip. That is necessary because remote operation could not be achieved by extending a lead from pin 5 of U1 or any other point in the touch-plate circuit. The added capacitance of the circuit would pick up false trigger signals, causing the lamp to come on when a neighbor turns on a vacuum cleaner, or lightning strikes a power line in the next state.

When the remote touch-plate is touched, the voltage drop at that input to the remote circuit charges C101 (Fig. 3) until the voltage reaches the Zener voltage of D102 (6.8-volts) minus the voltage drop across D103. Transistor Q101 is switched on due to the base current through resistor R104 that is connected to C101. Transistor Q101 switches on transistor Q102, setting the remote input high.

When the hand is removed from the remote touch plate, capacitor C101 discharges via resistors R103 and R104, base current to transistor Q101 is removed, which in turn removes the base drive to Q102. Base resistor R101 of transistor Q102 ensures that the transistor will be cut off. The response time of the circuit is not as fast as you would expect in an electronic circuit. The delay is dependent upon C101 and the associated resistors. It takes about 2 ms to switch the transistor on after touching the sensor input (not a bad delay), and about 30 ms to switch it off after contact ceases. (Your eye may spot that delay.)

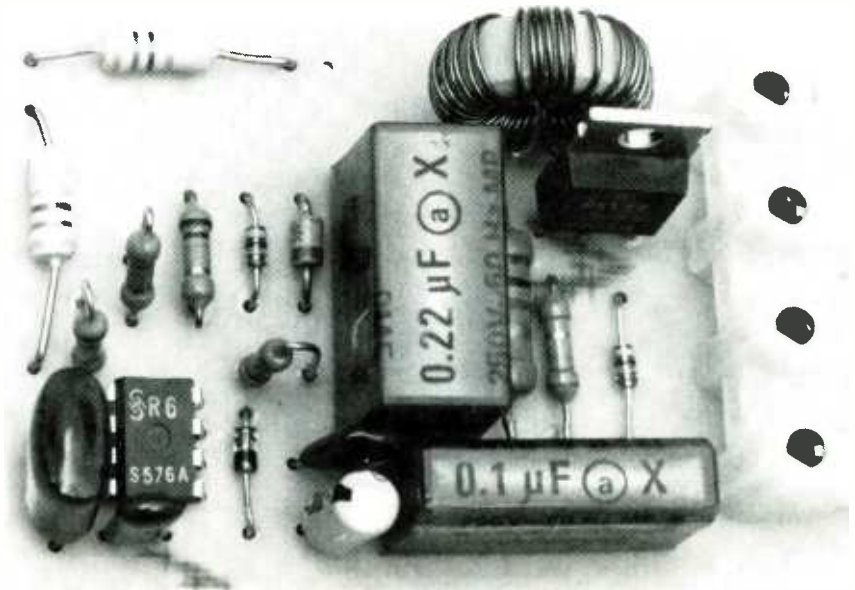

For this project it is particularly important to check the placement of polarized parts. This includes not only the capacitors, but the triac as well because improper placement will cause it to fire at the wrong halfcycles.

Zener diode D101 and resistor R102 protect transistor Q102 in the event that connections A and Remote (Figs. 2 and 3) are mistakenly reversed. Zener diode D102 is forward-biased and serves as a signal diode, and also protects transistors Q101 and Q102 against excessive collector-emitter voltages.

### Construction is a Snap

First off, acquiring the parts is simple! One-stop mail-order shopping via telephone makes it easy. The Touch Light-Dimmer comes in kit form (K6319) from Altronics Distributors. The kit contains all the parts and materials you will require to build and install the project. A printed-circuit board holds all of the circuit components; it fits snugly under a plastic face plate in place of your present wall switch.

(The average experimenter will have trouble acquiring the Siemens S576A integrated circuit locally or through the mail. It is not stocked by many industrial distributors, nor will those distributors sell single units.)

Follow the parts layout shown in the photographs and Fig. 4 when wiring the dimmer. Be sure that all polarized parts (capacitors, diodes, triac, IC, etc.) are positioned correctly before soldering them in place.

The four-way insulated terminal block is secured to the printed-circuit board using short lengths of leads salvaged from snipped resistor leads.

The coil on the toroid is wound with 37 turns of 0.5-mm, enamelled copper wire. Wind each turn tightly so that each turn touches the previous turn at the inside diameter. When winding is complete, twist the two ends of the copper wire together leaving about  $\frac{3}{4}$ " excess. Clean each end of the wire with a knife or razor blade to remove the enamel, and tin the ends.

The toroid coil, L1, is tied to the printed-circuit board by a short piece of nylon thread. You could use a piece of thin diameter copper wire since the holes provided on the board have solder pads. Be careful not to make a continuous loop—which would become a shorted turn loading the coil unnecessarily thereby reducing its ability to eliminate noise from the AC powerline.

Safety of the circuit can be jeopardized by incorrect components inserted in the touch-plate's resistor-string circuit. Before you proceed after wiring the kit, look to see that the two 4.7-Megohm resistors (R5 and R6) are soldered in place. Also, that the lead to the touch plate is soldered to the board at the correct solder pad.

Carefully check the work that you have done. Be sure that parts are correctly located and polarized units are properly positioned on the board. Inspect for poor solder joints and solder bridges. Look for anything that will cause the circuit to fail or shock someone. Correct the faults you find.

Now comes the time when the touch plate is connected to the printed-circuit board. Position the board on the touch-plate's plastic at about its center area. Mark a hole where the solder pad for the connection is made on the plastic. Remove the metal touch plate and drill a small hole for a thin wire to pass through. Connect a four-inch length of thin, solid, copper wire to the touch-plate terminal. Pass the touch-plate wire through the hole from the rear of the plate, and center the printed-circuit board on the rear of the plastic. You may have to snap off some "plastic bumps" that are used in some models to hold the mounting screws during shipment.

Cement the printed-circuit board to the touch-plate's plastic form using RTV cement. (You may prefer to work with

### PARTS LIST FOR THE TOUCH LAMP DIMMER

#### SEMICONDUCTORS

D1, D2—1N4148 or 1N914 silicon diodes  
D3—Zener diode, 15-volt, 1-W  
D4—Zener diode, 20-volt, 400-mW  
Q1—SC141D 6A triac  
U1—S576A light dimmer/switch integrated circuit

#### CAPACITORS

C1—1- $\mu$ F, 50-WVDC, metallized dielectric  
C2, C5—.001- $\mu$ F, metallized polyester  
C3—0.22- $\mu$ F, 250-WVDC disc  
C4—47- $\mu$ F, 16-WVDC, electrolytic  
C6—.15- $\mu$ F, metallized polyester

#### RESISTORS

(All resistors are  $\frac{1}{2}$ -watt, 5% units unless otherwise noted.)

R1, R2—680,000-ohm  
R3—1000-ohm, 1-watt  
R4—1-Megohm  
R5, R6—4.7-Megohm (Philips CR52 or VR37)  
R7—470,000-ohm  
R8—120,000-ohm

#### ADDITIONAL PARTS AND MATERIALS

L1—100- $\mu$ H choke made from 4 ft. of .5-mm, diameter enamelled copper wire, and an iron power-transformer ring (toroid) core (Neosid 17-132-10 or equivalent)  
Printed-circuit board, touch plate (decorator blank switch plate with blank, metallic-finish cover plate), 4-post terminal block, solder, epoxy or RTV cement, etc.

A kit for this project (order number K-6319) is available for \$35.00 (plus \$3.00 shipping and handling), from Imtronics Industries Ltd., 11930 31st Court N., St. Petersburg, FL 33702.

epoxy.) After the cement dries the dimmer can be tested and wall-mounted. The excess wire from the touch-plate terminal will be taken care of later.

### Check It Out!

The project should be carefully checked to ensure that there is a high resistance between the touch plate and both sides of the AC powerline before the device is connected to a circuit. Use either an analog or digital ohmmeter set at the highest range so that the scale can accurately indicate 10-Megohms resistance. The resistance between the AC terminal of the circuit and the touch-plate should be in the region of 10 Megohms. If not, you may receive an electrical shock that could injure or kill you.

If the resistance is dangerously low, inspect the unit very carefully for faults caused by excessive solder, faulty or damaged parts, or incorrect parts location.

### Wall Mounting

By now you must have considered where the Touch Light-Dimmer is to be installed. Don't rush into the job throwing caution to the wind. You will be working on AC powerlines that, when powered, can kill you and still have enough *oomph* left to light up the house. Don't take chances—disconnect the power to the lamp circuit. First, get the help of someone else in the house. You really don't need help, but it is wiser to have someone else around, who knows what you are doing, to shut off the fuse panel or circuit-breaker box.

(Continued on page 105)



# SOUND- ACTIVATED SWITCH

ONE OF THE MOST MAGICAL IF NOT CONVENIENT forms of remote control is the *sound-activated switch*; a controller device that responds to some form of user-generated noise: a whistle, a clap, even a cough. Clap and the lights turn on, or off, or dim. Clap again and the hi-fi starts up, or turns off; or whatever you want to happen, happens. It's almost as good as having a personal genie, although it can't give you three wishes.

There are basically two kinds of sound-activated switch: *latching* and *timed*. The latching type responds (switches) and maintains its status until deliberately reset by a second sound, or a sequence of sounds. The timed type responds and maintains its status for a programmed amount of time, after which the device automatically resets and waits for a new trigger command (sound). Selecting the switching mode is a matter of personal desire.

To make certain that you always have the function that's needed, our sound-activated switch has both latched and timed outputs. With the latched output the load changes state each time a noise is produced. Latching can be used to turn an appliance on or off with a snap of the fingers, or even a whistle.

But flip a switch and you can operate the sound-activated switch in the timed mode. Then it can be used to keep a room

light on as long as you're making a small amount of continuous or intermittent noise.

## How it Works

The sound-activated switch uses a variety of linear and digital integrated circuits to achieve the desired functions. The trigger is the audio signal from condenser microphone MIC. The microphone's audio signal is amplified by U1, a dual op-amp, which has both sections wired as inverting amplifiers connected in cascade (series).

Resistors R3 through R6 provide a "centertap" bias so the op-amps will operate with a single-ended power supply. The gain of the first stage is controlled by the ratio of resistor R2 to R7.

The output (pin 1) of the first stage is capacitively-coupled to the inverting input (pin 6) of the second op-amp, whose gain is determined by the setting of potentiometer R10. In effect, R10 determines the sensitivity of the sound-activated switch.

The output (pin 7) of the second op-amp has enough amplitude to drive the input of U2, a 4047 that is wired as a retriggerable monostable multivibrator. The 4047 was chosen because its output will remain *on* without toggling *off* as long as sounds are present in a room. During silence, the monosta-

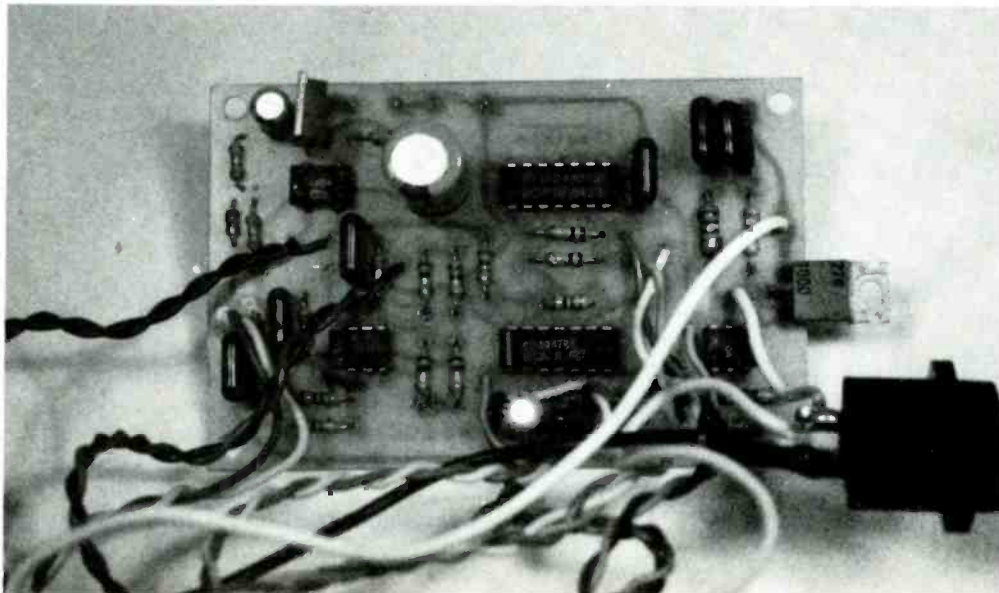

The connections to the cabinet-mounted components don't necessarily originate along the edges of the printed-circuit board. To avoid mistakes, twist together each pair of wires that connect to non-board components.

**Be like the great magicians of antiquity:  
Two hand claps will make this  
electronic genie do your on/off bidding.**

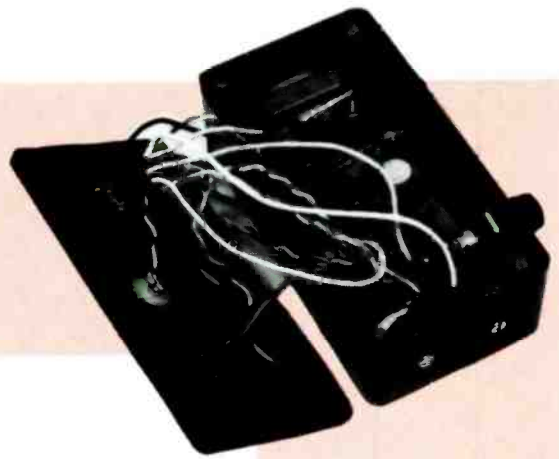

**By Rich Hampton**

ble will time out in 6 to 60 seconds, depending upon the setting of potentiometer R14.

Resistor R13 and capacitor C6 also regulate the firing time. Switch S1a connects C6 when in the timed mode and C5

when in the latched mode. C5 is smaller so there will be a short pulse at the output when in the latched mode.

The Q output (pin 10) of U2 is connected either to the flip-flop (U3) or to the output circuit, depending on the setting of

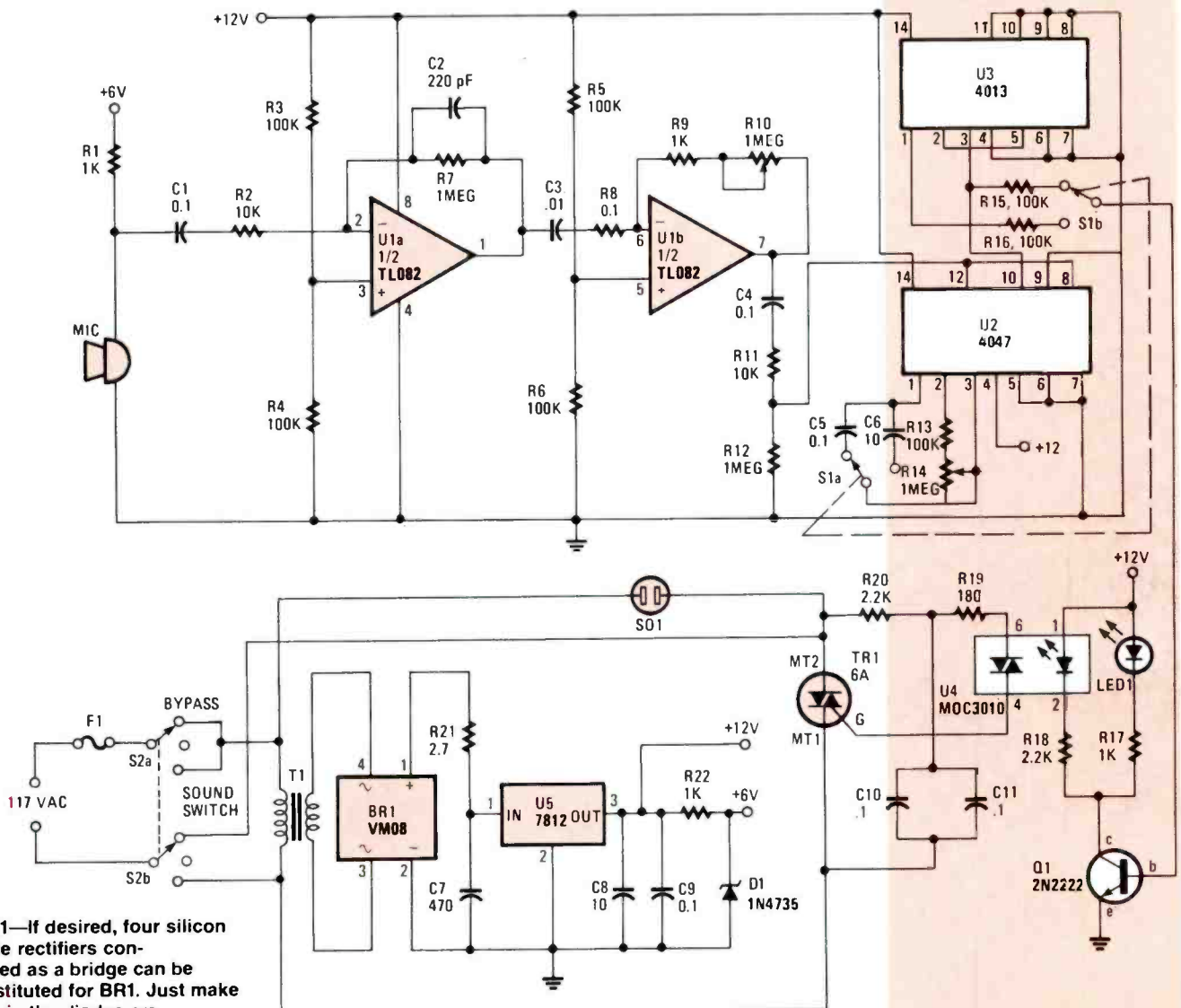

**Fig. 1—If desired, four silicon diode rectifiers connected as a bridge can be substituted for BR1. Just make certain the diodes are rated at least 50V, 1A.**

## PARTS LIST FOR THE SOUND-ACTIVATED SWITCH

### SEMICONDUCTORS

BR1—VM08 bridge rectifier, 50-V, 1A  
D1—1N4735 Zener diode, 6-V, 1-watt  
LED1—Light-emitting diode, red  
Q1—2N2222 NPN transistor  
TR1—Triac, 400-V, 6-A  
U1—Dual op-amp, TL082  
U2—CD4047 monostable multivibrator integrated circuit  
U3—CD4013 dual D flip-flop integrated circuit  
U4—MOC3010 opto-coupler (opto-isolator)  
U5—7812 12-volt regulator integrated circuit

### CAPACITORS

C1, C3, C4, C5, C9, C10, C11—0.1- $\mu$ F, 250-WVDC, Mylar  
C2—220-pF, ceramic disc  
C6, C8—10- $\mu$ F, 25-WVDC, Electrolytic  
C7—470- $\mu$ F, 25-WVDC, electrolytic

### RESISTORS

(All fixed resistors are 1/4-watt, 5% units unless otherwise noted.)  
R1, R8, R9, R17, R22—1000-ohm  
R2, R11—10,000-ohm  
R3, R4, R5, R6, R13, R15, R16—100,000-ohm

R12—1-Megohm  
R7—1-Megohm  
R10, R14—1-Megohm potentiometer  
R18—2200-ohm  
R19—180-ohm, 1/2-watt  
R20—2200-ohm, 1/2-watt  
R21—2700-ohm, 1/2-watt

### ADDITIONAL PARTS AND MATERIALS

F1—Fuse rated to match load  
MIC—Condenser microphone  
T1—Transformer: AC-line, step-down, power; 12.6-volt, 300-mA secondary winding  
S1—DPDT, toggle switch  
S2—DPDT, center-off, toggle switch  
SO1—117-VAC line socket  
Fuse Holder, printed-circuit materials, wire, solder, cabinet

### PRINTED CIRCUIT BOARD AVAILABLE

An etched, drilled, and plated printed-circuit board is available from Richard Hampton, 17005 E. 4th St. South, Independence, MO 64056. Price is \$9.50 postpaid (includes postage, handling, and insurance). Missouri residents add 54-cents sales tax.

S1b. If S1 is in the latched position the output of U2 is connected to the input (pin 3) of U3 (4013), a D flip-flop.

U3 is wired with its Q (pin 5) connected to its D (pin 2) so it will toggle each time an input is received. Pin 1 of U3, the latched output, is connected to output-driver transistor Q1 via S1b if the switch is set to the latched mode.

When the voltage from S1b goes high, Q1 is turned on, and it supplies current to the opto-isolator's (U4) LED through current limiting resistor R18. Q1 also supplies current to indicator LED1. Triac TR1 gets its gate current from the opto-isolator's output. Select a triac for TR1 that will carry the amount of current you plan to use.

### The Power Supply

The power supply provides the 12 volts needed for the main circuits, and the 6 volts required by the condenser micro-

phone (MIC). The AC line voltage is applied to T1, whose output is rectified by bridge-rectifier BR1. BR1's pulsating output voltage is filtered by capacitors C7 and C8. Output voltage regulation is provided by U5, a 12 volt, 3-terminal fixed regulator. U5's 12 volt output is reduced to the 6 volts needed for condenser microphone MIC by the combination of Zener diode D1 and R22.

Switch S2 is wired so as to provide a bypass for the sound-activated switch. If you also want power control of the sound-activated switch, as shown in Fig. 1, then S2 must have a center-off position.

### Construction

The sound-activated switch should be assembled in a plastic cabinet. The unit shown in the photographs uses a plastic experimenter's box approximately 6-in.  $\times$  3-in.  $\times$  1-3/4-in.. The main circuit is assembled on a printed-circuit board which is mounted in the bottom of the box.

A full-scale template of the board is shown in Fig. 2. (If, for some reason, you cannot make the board yourself, it can be purchased from the source given in the parts list.)

Figure 3 shows the parts layout for the printed-circuit board. Make certain you install electrolytic capacitors C6 and C8 with the correct polarity. Also, double-check the polarity of LED1.

Temporarily set the finished printed-circuit board aside and install the panel-mounted components and transformer T1 in the cabinet.

T1 is mounted in the bottom of the cabinet, so make certain you leave sufficient room for the printed-circuit assembly.

**It's a careful and tight squeeze to get everything into the suggested plastic cabinet. In particular, take extra care that wires and parts carrying 117 volts don't short-circuit to adjacent connections. If it looks as if the wiring will be tight, use a larger size cabinet.**

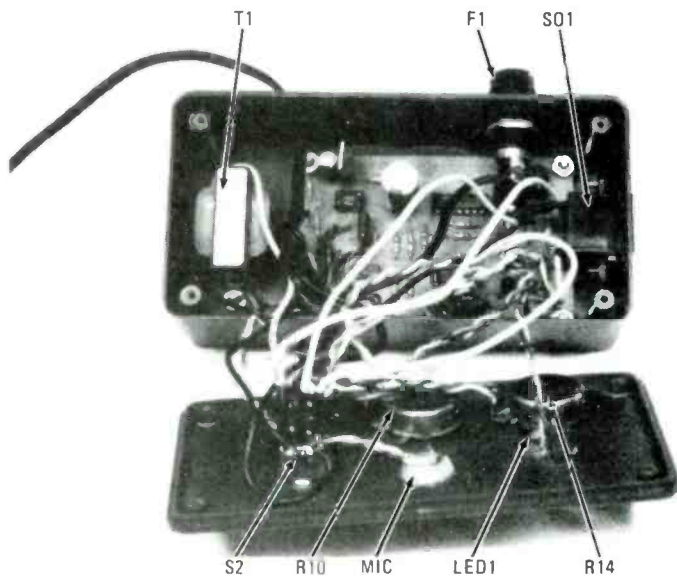

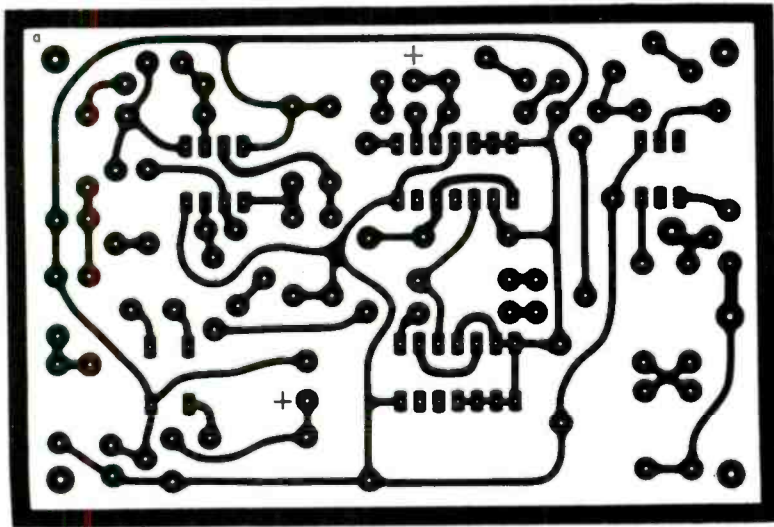
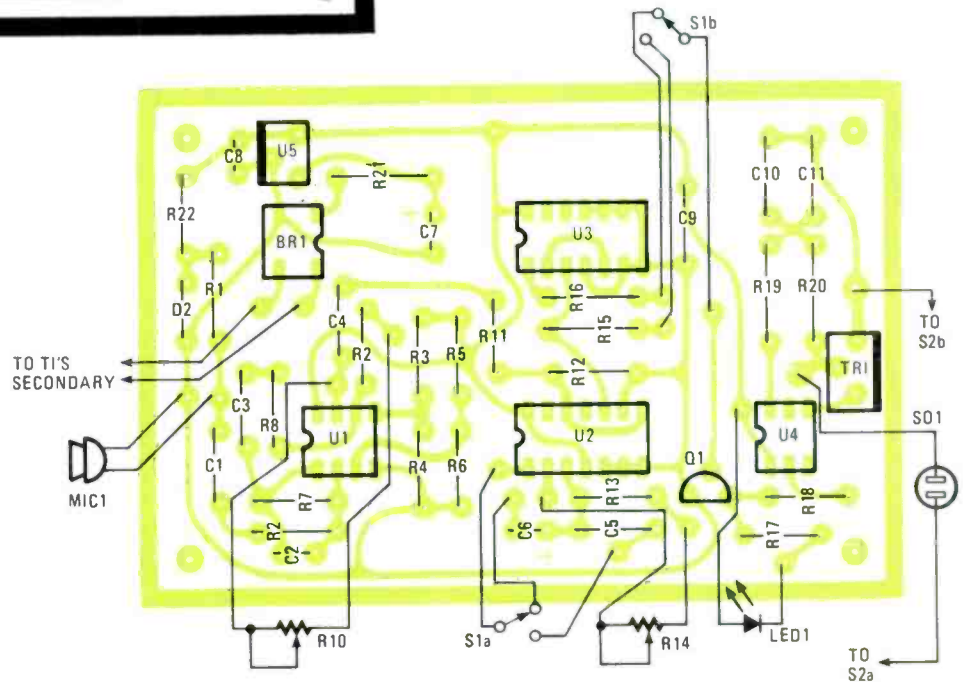

Fig. 2—This is a full-scale template for the printed-circuit board. Make the board itself from a photocopy or use a perfboard layout!

Fig. 3—There's no particular order to stuffing the parts on the printed-circuit board. But take extra care that U5 and TR1 aren't reversed. The heavy line on their outline indicates their metal mounting tab.



Also, check the location of socket S01. It carries 117 volts, so be sure no front panel component touches an S01 terminal when the panel is installed.

In fact, be extra careful when routing the AC power and its associated wiring. Always insulate the AC connections with tape or heat-shrink tubing to avoid accidental short circuits; and make sure there are no exposed strands on bypass switch S2, because it's connected to the powerline.

### High Power

Triac TR1 should have a heat sink installed if high-wattage loads will be used. However, don't use an external heat sink if the triac doesn't have an *insulated tab* because an uninsulated tab would place the heat sink at a line-voltage potential, which could be a hazardous situation depending on the particular assembly of your unit.

### Testing and Operation

Connect a suitable load such as a 60-watt lightbulb to S01, set switch S2 to the center position, and then connect the sound-activated switch to the powerline. If S2 is set to its *bypass* position the lightbulb should turn on. When S2 is set to its *sound-switch* position the unit should go into its sound-

activated mode and the lightbulb should be out.

The sound-activate operation will depend on the setting of the function switch S1, the adjustment of sensitivity control R10, and the adjustment of delay control R14.

If the latched mode is selected, the unit should toggle each time a noise is produced. It may be necessary to adjust the sensitivity potentiometer to get the proper on-off operation.

The delay control will have little effect on the latched mode because a small capacitor (C5) is switched into the monostable multivibrator circuit.

When the timed mode is selected, the delay control will determine how long the load stays on. Keep in mind that the monostable is retriggerable. If there is continuous input (noise) the output will remain on until there is silence. In silence, the monostable times-out after a period of time determined by the setting of the delay control.

If you have difficulty in operating the unit, start troubleshooting by testing the power supply. Then follow the signal as it passes through the integrated circuits. DC levels should be observed at S1b.

Use the sound-activated switch for your convenience or to amaze your friends. It may be used on any load that does not exceed the current rating of the triac. ■



**We do more than  
just touch on the subject!**

# TOUCH SCREEN TECHNOLOGY

By Jeff Holtzman

□FOR MANY PEOPLE, INTERACTING WITH A COMPUTER IS about as much fun as going to the doctor; it's to be avoided except when absolutely necessary. But there are times, of course, when going to the doctor is necessary. Similarly, there are times when interacting with a computer is necessary. As the microprocessor continues to invade all areas of life, you may not even realize that it is controlling devices ranging from automobiles to VCR's, to electric dishwashers.

In fact, one of the biggest areas in computer-system design now concerns the ways in which the average non-technical person can manipulate the computer to accomplish a task or obtain information—all the while maintaining the illusion that the computer is not computerish.

One 15-year-old technology is making great strides in improving what designers refer to as the *man-machine interface*. It's called *touch technology*, and already it is revolutionizing the way that we obtain information, order consumer products, control the operation of automobiles and aircraft, and keep track of factory inventory, etc. It will even affect the way wars will be fought.

In this article, we'll take a brief look at the history and philosophy of touch-system design, and go on to examine the underlying technology of several types of touch systems. Along the way, we'll illustrate many current and planned applications of touch technology.

## What Is Touch?

Twenty years ago, if you asked a member of the general public what came to mind when the word "computer" was mentioned, you probably got a description of a huge machine surrounded by hundreds of data-entry clerks pounding furiously on keypunch machines—all for the purpose of printing incorrect utility bills.

Computer-system designers realized that if the computer were ever to be given a chance to do the things the designers knew it could do, the image just described would have to change—drastically and rapidly. So they began to think of more effective (more intuitive) ways of interacting with the computer.

They immediately realized several things. Batch operations (loading a computer with several jobs at once) and keypunch machines would never captivate the public. The interactive display terminal was a definite improvement, but, because the average user is not a touch-typist, the terminal was not really a solution.

Finally, in the early 70's, just as the first microprocessors were coming to market, several bright people realized that, by doing away with the keyboard, one large impediment to widespread computer use would be removed.

Without a keyboard, though, how would anyone—technical or non-technical—operate the computer? A *human-factor* breakthrough occurred when someone came up with the idea of using the display screen for both output and input. That way, a user could literally point at images on the screen and cause things to happen.

The light pen was an early implementation of the *point-and-shoot* method of computer-human interaction. There are several problems with the light pen, however. One has to do with hardware, and the other—once again—with human interaction. The hardware problem is this: In order for the computer to know where a light pen is pointing, it must know the position of the electron beam inside the CRT (Cathode Ray Tube) at all times. That's not as much of a problem today, with our single-IC CRT controllers, as it was back then.

The real problem remained the same: the man-machine interface. The light pen, in some ways, is superior to the



standard keyboard, but it is still a mechanical intermediary between the mind of the person using it and the "mind" of the computer; and all along, the design goal has been to bring about a meeting of those minds. Also, the light pen, with its "umbilical cord," is subject to damage.

### The Touch Screen

Eventually it was realized that, by eliminating the mechanical intermediary and using special sensors, the screen itself could at least be made to appear to be the input device: Thus, the *touch screen* was born.

There are two major types of touch screens: IR (infrared) and overlay; the latter may be divided into resistive and capacitive types. A fourth type, SAW (surface acoustic wave) has been demonstrated in the laboratory, but is not yet commercially viable.

The IR touch screen is composed of a frame of infrared LED's and phototransistors arranged in a rectangular shape that is mounted in front of a CRT screen. As shown in Fig. 1, the overlay type consists of several layers of special clear plastics that are affixed directly to the CRT's viewing screen.

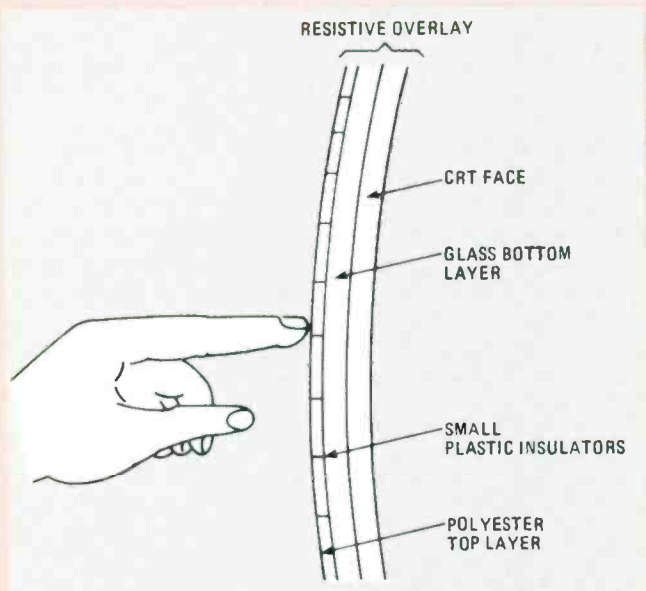

Fig. 1—The resistive-overlay touch sensor consists of a glass bottom layer and a polyester top layer separated by thin plastic insulators. Touching the screen completes a DC circuit, allowing an A/D converter to provide positional information about where the screen was touched.

The IR touch screen works as follows: All LED's start off dim; each one is illuminated in turn. The state of the phototransistor opposite that LED is then checked. If it's receiving a signal, then nothing is blocking the light path. If it's not receiving a signal, then something is blocking the path.

A microprocessor controls scanning. It also provides diagnostics, by checking to make sure that each LED can transmit and that each phototransistor can receive. The microprocessor also communicates with the computer controlling the overall system, telling it when a touch occurs, and where.

The resistive-overlay type of touch screen works by applying analog voltages to the X and Y planes of the bottom layer (the one closest to the CRT) of the touch screen. When the top layer contacts the bottom layer (by someone's touching the top layer), X and Y DC voltages may be read. The values of those voltages are both proportional to the position at which



Ready-to-go systems for retrofitting several popular computer monitors are available from Carroll Touch.

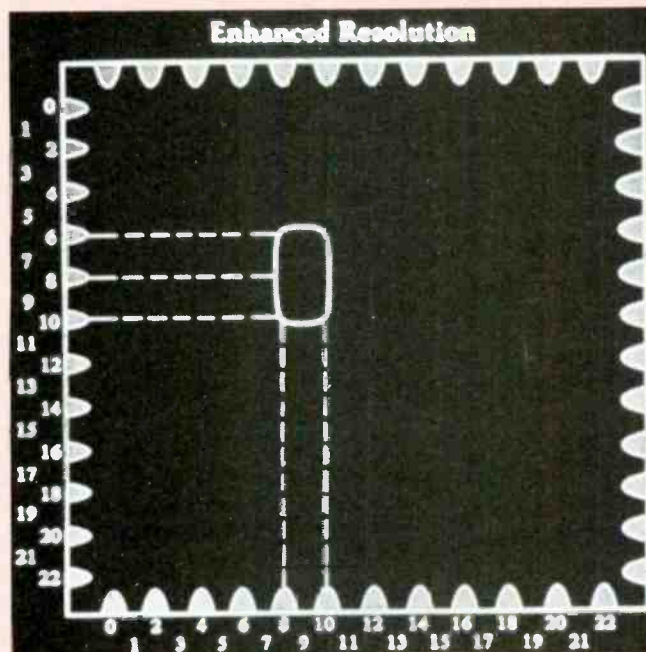

The infrared touch screen is composed of an array of LED's and phototransistors. To scan the screen array, one light-emitting diode at a time is turned on, and the state of the corresponding phototransistor is checked.



Think that touch technology is just another passing fad? IBM doesn't—the cover of the 1985 annual report shows an automotive technician using an IBM touch-based system for diagnosis.

the touch occurred. An ADC (Analog-to-Digital Converter) then provides a digital representation of those voltages for the controlling computer to process.

The capacitive touch screen works similarly, except that touching the screen provides a change in capacitance that affects the frequency of an oscillator. It's then a simple matter to measure and interpret that change to provide information



AT&T's WorldKey Information Center in Disneyworld proves that touch technology can bring the benefits of computers to all.



Touch technology is useful in battle for determining enemy positions and directing strikes against those positions.

about the location that was touched.

Whatever technology is used, it's still up to the controlling computer to respond intelligently to the touch controller's information. For example, if the touch-screen electronics send a message that the screen was touched at position (X, Y), the control computer's program must know how to interpret that message. It might know, for example, that any touch between positions (X1, Y1) and (X2, Y2) means "end program."

Other screen regions might indicate other actions such as "decrement inventory count of part number 1124321 by one" or "total the selected items, add sales tax, and print a ticket."

### Advantages and Disadvantages

Resistive-overlay touch screens are usually less expensive than the other types, especially the IR. In addition, the resistive type is easier to install. After removing the CRT's bezel, the overlay is affixed to the screen with a special adhesive. Then the bezel is replaced, and the display is reassembled. It's also easy to adapt overlay sensors to CRT's of different sizes and shapes. The plastic layers need merely be cut in the desired manner.

The Buick Riviera has a touch-screen system that allows you to track and control gasoline supply, climate, time, etc.

The main disadvantage is that the overlay reduces the intensity of light emitted by the CRT, although transmissivity has improved greatly in recent years to about 80% for the best devices. In addition, the plastic surface of the overlay may be vandalized, thereby impairing use of the device. Again, though, advances in what is called hard-coating have made it increasingly difficult to do significant damage to the overlay.

In large quantities (10,000 or so), a typical resistive overlay sensor for a 12-inch CRT costs about \$160.

On the other hand, the biggest advantage of the IR touch screen is that it does not obstruct the CRT; no image brightness, contrast, or detail is lost. In addition, it's nearly vandal-proof.

Other advantages include the following: It works well in harsh environments, is very reliable, and resists environmental contaminants (dust, dirt, chemicals, and moisture, etc.). Its main disadvantage is the fact that a new PC-board/frame must be designed for each new CRT system. In large quantities that's not a problem, but it makes prototyping difficult and expensive.

The IR sensor also takes more space than the overlay type, so it may be difficult to integrate it with existing installations. Last, the IR sensor is somewhat more expensive, at about \$190 in OEM (original-equipment manufacturer) quantities.

### Conclusions

A new technology is often greeted with either ballyhoo or boos, regardless what that technology is. Touch screens, however, have been sneaking up on us slowly. Designers have quietly used them to solve problems ranging from giving directions at Epcot Center in Disneyworld, to controlling automobiles and automatic teller machines, to providing up-to-the-minute battle reports. However, they still haven't found a way to get the bugs out of printing correct phone bills.

We'd like to thank Carroll Touch, a subsidiary of AMP, Inc. for much of the technical background and illustrations for this article. For more information, contact Michele Higdon at P. O. Box 1309, 2800 Oakmont Drive, Round Rock, TX 78680; Tel. 512/244-3500. ■



# Here are your free FactCards!

Introducing Hands-On-Electronics FactCards. Each issue, Hands-On-Electronics will present 3 new FactCards, each dealing with one of a variety of electronics topics. Some will deal with electronics basics, some will deal with discrete components, some will deal with IC's, and some will deal with circuits and applications.

All will contain the type of information electronics hobbyists need, but sometimes must search to find. With FactCards, you can find that information in a hurry.

# Clip your cards, save them, and start building your FactCards library today!

**Hands-on Electronics**

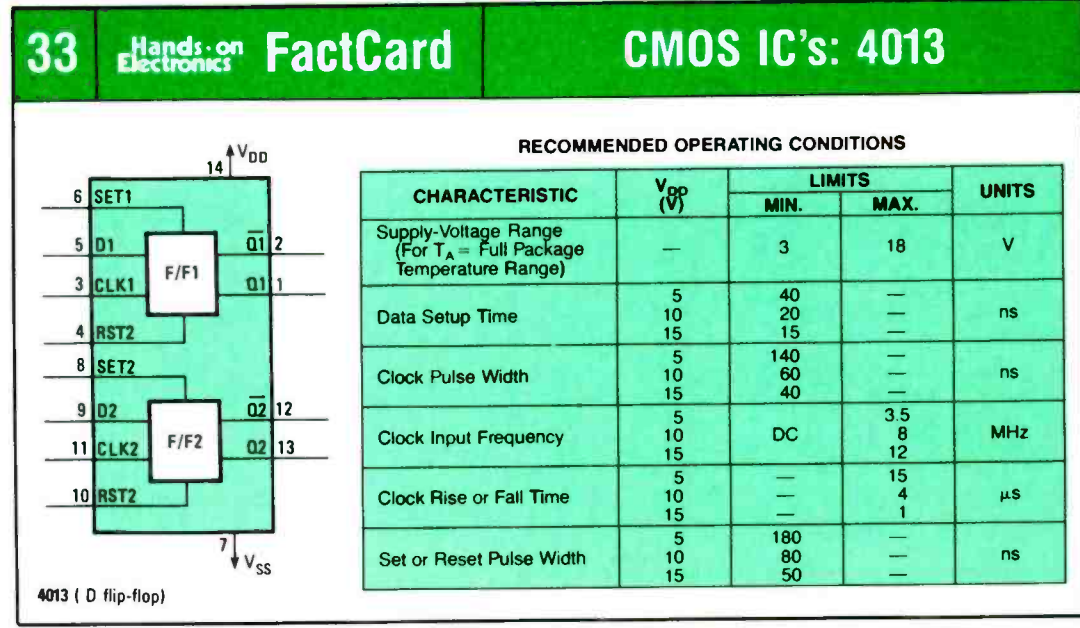
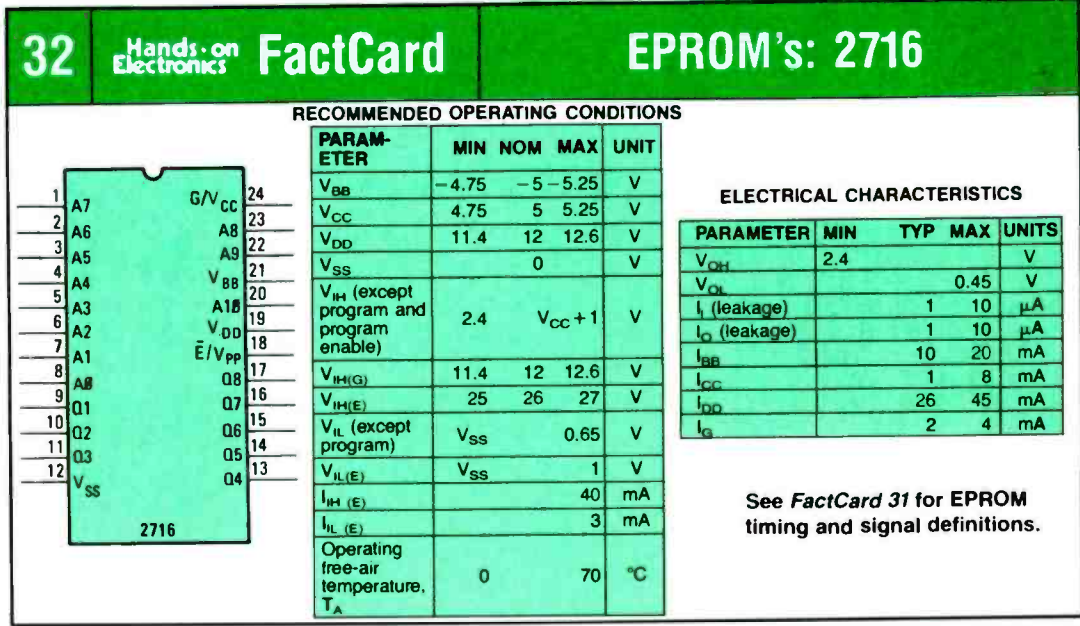
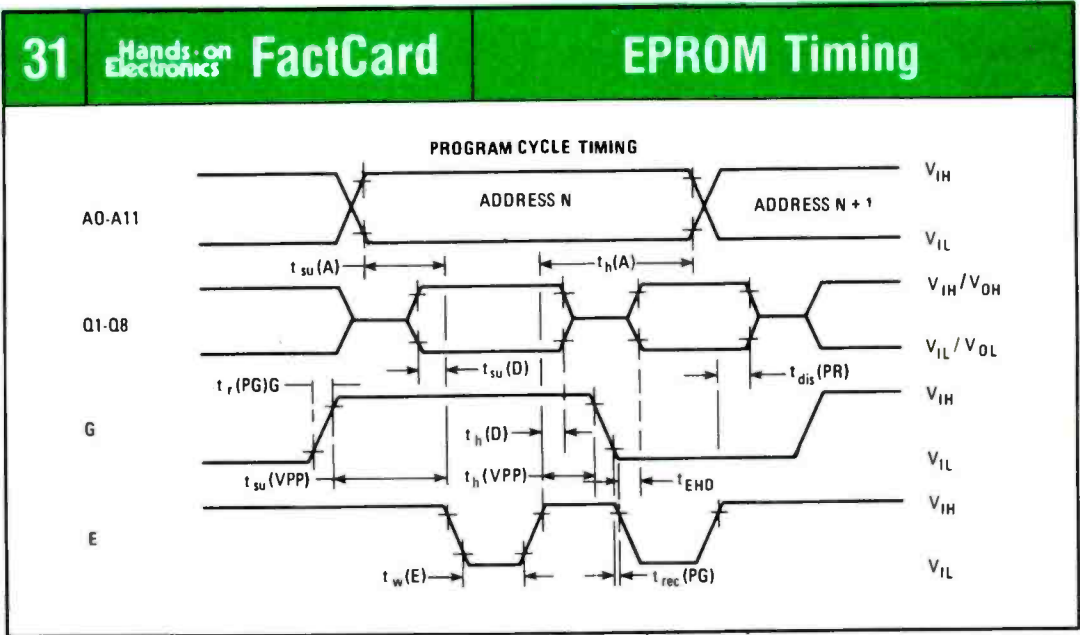

# 31 Hands-on Electronics FactCard

# EPROM Timing

### EPROM DATA DEFINITIONS

$V_{PP}$	Programming voltage
$V_{IH}$	High-level input voltage
$V_{IL}$	Low-level Input voltage
$V_{OH}$	High-level output voltage (verify)
$V_{OL}$	Low-level output voltage (verify)
$I_I$	Input current (all inputs)
$I_{IH}$	High-level Input current
$I_{IL}$	Low-level input current
$t_{dis}(PR)$	Output disable time
$t_w(E)$	E pulse duration
$t_{su}(A)$	Address setup time
$t_{su}(D)$	Data setup time
$t_{su}(V_{PP})$	Vpp setup time
$t_h(A)$	Address hold time
$t_h(D)$	Data hold time
$t_h(V_{PP})$	Vpp hold time

### READ CYCLE TIMING

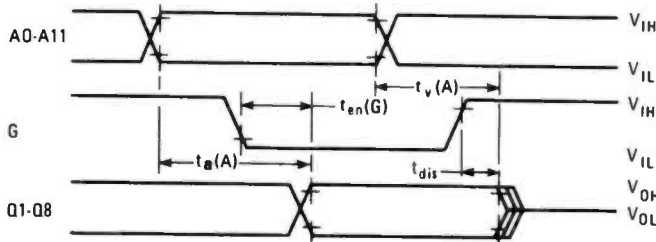

$t_{rec}(PG)$	$V_{pp}$ recovery time	
$t_r(PG)G$	G rise time during programming	$t_{dis}$ Output disable time from E or G, whichever occurs first
$t_{EHD}$	Delay time, data valid after E low	$t_v(A)$ Output data valid time after change of address, E, or G, whichever occurs first
$t_a(A)$	Access time from address	
$t_a(E)$	Access time from E	
$t_{en}(G)$	Output enable time from G	

# 32 Hands-on Electronics FactCard

# EPROM's: 2716

### SWITCHING CHARACTERISTICS

PARAMETER	MIN	MAX	UNIT
$t_{su}(A)$		450	ns
$t_{en}(G)$		120	ns
$t_v(A)$	0		ns
$t_{dis}$	0	120	ns
Read Cycle time	450		ns

### PROGRAM CHARACTERISTICS

PARAMETER	MIN	MAX	UNIT
$t_w(E)$	0.1	1	ms
Transition times (except program pulse)		20	ns
Transition times, program pulse	50	2000	ns
$t_{su}(A)$	10		$\mu$ s
$t_{su}(D)$	10		$\mu$ s
$t_{su}(V_{PP})$	10		$\mu$ s
$t_h(A)$	1000		ns
Address hold time after program input data stopped	0		ns
$t_h(D)$	1000		ns
$t_h(V_{PP})$	500		ns
$t_{EHD}$	0		ns

### ABSOLUTE MAXIMUM RATINGS

$V_{CC}$	-0.3 to 15V
$V_{DD}$	-0.3 to 20V
$V_{SS}$	-0.3 to 15V
All input voltage (except $V_{PP}$ )	-0.3 to 20V
$V_{PP}$	-0.3 to 35V
Output voltage (operating, with respect to $V_{SS}$ )	-2 to 7V
Operating free-air temperature	0°C to 70°C
Storage temperature range	-55°C to 125°C

For new ideas in electronics read **Radio-Electronics**

During the next 12 months

- Radio-Electronics will carry up-to-the-minute articles on:
- hobby computers
  - solid-state technology
  - TV games • Video
  - color TV • stereo
  - test equipment
  - radio
  - radar detectors
  - industrial electronics
  - servicing
  - TV-radio-stereo
  - experimenter circuits
  - exceptional construction projects

Don't take a chance on missing even one issue. **Subscribe now and save!**



NEW IDEAS AND INNOVATIONS IN ELECTRONICS

The newest ideas and innovations in electronics appear in **Radio-Electronics**, Keep up-to-date!

Subscribe Today!

# 33 Hands-on Electronics FactCard

# CMOS IC's: 4013

### STATIC ELECTRICAL CHARACTERISTICS

CHARACTERISTIC	CONDITIONS			LIMIT at 25°C (TYP)	UNITS
	$V_O$ (V)	$V_{IN}$ (V)	$V_{DD}$ (V)		
Quiescent Device Current	—	0.5	5	0.02	$\mu$ A
Current	—	0.10	10	0.02	
$I_{DD}$ Max.	—	0.15	15	0.02	
Output Low (Sink) Current, $I_{OL}$ Min.	0.4	0.5	5	1	mA
Current	0.5	0.10	10	2.6	
$I_{OL}$ Min.	1.5	0.15	15	6.8	
Output High (Source) Current, $I_{OH}$ Min.	4.6	0.5	5	-1	
Current	2.5	0.5	5	-3.2	
$I_{OH}$ Min.	9.5	0.10	10	-2.6	
$I_{OH}$ Min.	13.5	0.15	15	-6.8	
Input Current, $I_{IN}$ Max.	—	0.18	18	$\pm 10^{-5}$	$\mu$ A

CHARACTERISTIC	CONDITIONS			LIMIT at 25°C (TYP)	UNITS
	$V_O$ (V)	$V_{IN}$ (V)	$V_{DD}$ (V)		
Output Voltage: Low Level, $V_{OL}$ Max.	—	0.5	5	0	V
Output Voltage: High-Level, $V_{OH}$ Min.	—	0.10	10	0	
Output Voltage: High-Level, $V_{OH}$ Min.	—	0.15	15	0	
Input Low Voltage, $V_{IL}$ Max.	0.5, 4.5	—	5	1.5	V
Input High Voltage, $V_{IH}$ Min.	1.9	—	10	3	
Input High Voltage, $V_{IH}$ Min.	1.5, 13.5	—	15	4	
Input High Voltage, $V_{IH}$ Min.	0.5, 4.5	—	5	3.5	
Input High Voltage, $V_{IH}$ Min.	1.9	—	10	7	
Input High Voltage, $V_{IH}$ Min.	1.5, 13.5	—	15	11	

By Lou Hinshaw

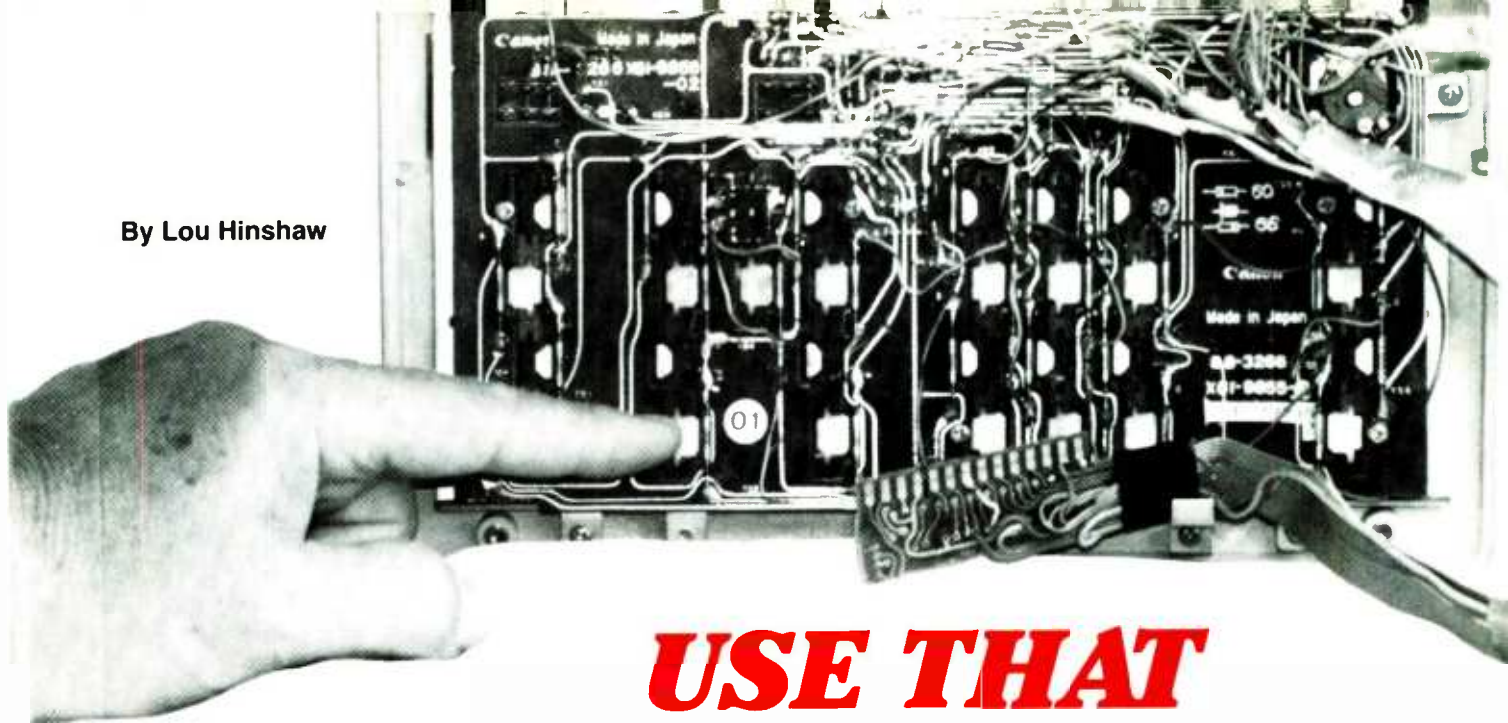

# USE THAT LITTLE OLD COMPUTER

**Just because you've got a new computer doesn't mean your old one should be sent to the dumps. It can still serve a useful purpose**

□ SOME OF THE SMALL COMPUTERS WE HAVE LAYING around in our closets are still very powerful tools at times when using a new, fancy machine may not be justified. Remote sensing, for example, could be accomplished by connecting each key of the keyboard to a sensor. When a sensor is tripped, the sensor closes the switch as though a key had been depressed. That causes the keyboard to generate the corresponding key code to the computer, which then processes the character corresponding to that key.

The Commodore VIC-20, for instance, has *fifty* keys that can be used as single-pole, single-throw switches. If you don't have such a small computer, you may find one at a very low price. In the Tulsa area, they often go for \$20 to \$35. With a little mathematics you'll see that the you can hook up 50 external switch points for less than a dollar each.

All you have to do is add a keyboard jack to the rear of the VIC-20, and connect the switches where the keys were. Get a simple program to command the machine (there's a short one in this article), add a printer, and you'll have a dedicated MPU sensor, which can print out data or, make the switches parallel with the keys and use them as a local entry point.

We wired in a socket (jack) for parallel switches on a VIC (see photo 1). We used the jack for a ten-key keypad, but you can use it for anything you can imagine. A traffic survey in your offices, for instance.

But first, let's get the jack installed.

## How To Do It

Read this article all the way through before you do any of the things described here, and make a list of what you will need. The following techniques will work on most computers.

You will need a soldering iron, an ohmmeter, a pair of

tweezers, needle-nose pliers, a utility knife, and a phillips screwdriver or nutdriver for this project. Also, you need some knowledge of soldering small connections. This is not a project for rank beginners, but it doesn't call for an expert technician either. You will not need to bother any IC chips, so if you use care in opening and closing the computer case, you shouldn't have any malfunctions.

## A Source of Switches

Reed switches are reliable and inexpensive little *goodies*, enclosed in glass, that close when they get near a magnet. They're very common. We found a 99-cent calculator with a reed-switch keyboard at a garage sale.

On the underside of the keyboard, look for little glass matchsticks a half-inch long. Each one has wire sticking out of each end, and a magnetic tab next to it that sticks out from the board when we tap its key. If you see them and want to use magnetic sensors, then buy the calculator. Newer calculators may not have reed switches, so it's best to check. Get permission before you open the case, though.

Reed switches can also be used to monitor doors, or anywhere that a magnet can be swung near the switch.

Our keypad had 28 reed-switch keys and 4 additional switches, all of which we will use—someday. Our junkbox yielded some left-over cable, and the match board from the calculator gave us a plug to hook it to the computer keyboard.

## Dismantle Time

The process is simple in theory, but tedious in practice. While there are 65 keys on the C-84, there are fewer than 20 wires leading from the keys to the computer board. Obviously, the keys are matrixed. Never mind the logic involved; if it works, it works. The thing to do is wire the

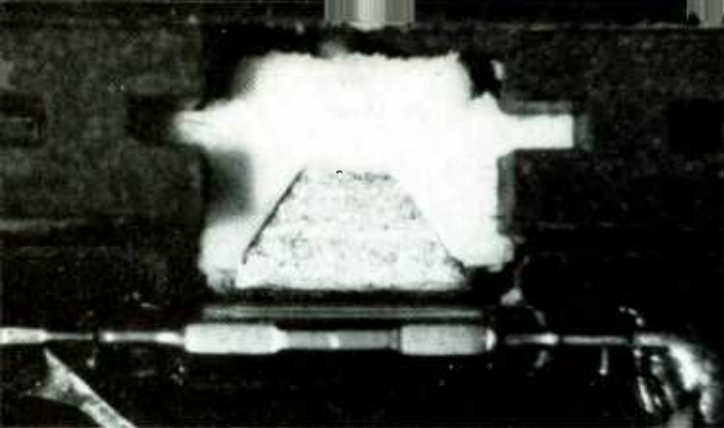

The blue-glass slender thing in the center of the photograph is a reed switch, and the gray wedge in the holder beside it is the activating permanent magnet.

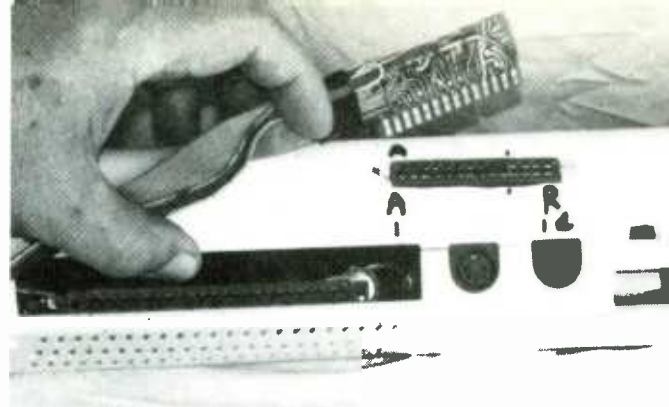

Here is the card-edge connector installed in the rear of a computer (VIC-20) case. The external cable attached to the card-edge to be plugged into the computer, is for the keyboard.

keyboard with an external plug for your external keypad, sensors, or whatever.

If your guarantee is up, or if you are willing to trash the guarantee, get ready to take the top off your computer. Have a clear space in which to work, and a bowl for the screws so they can't run off. (My wife, who is a radio amateur, says carpets like to eat small electronic parts, and sing songs to lure the screws, and other hardware. They're never seen again.) Use a soldering iron of the correct power, about 30 watts, and have some burn medicine or an aloe plant nearby.

If the computer and the keyboard are housed separately, then follow the instructions below as though the computer case being discussed was the keyboard case.

Take the screws out of the computer case and put them in the bowl. Lay the computer on the work area right side up with its front edge toward you. Gently open the case like opening a suitcase. As you lift open the case, you will see the cable(s) that connect the keyboard to the computer. Make a note of the way the plugs are aligned. If you put them back wrong, the computer will not work. Then, unplug the keyboard from the rest of the computer, and fold the top back until you disengage the hinges, if any, at the back. Set the bottom half of the computer out of the way.

### Now Mount the Plug

Get a socket that is small enough to fit in the back rim of the top (keyboard) half of the case, but large enough to handle

all the wires you need to use. We got ours from the same calculator we got the keypad from. We cut out the edge connector and its mating jack and used the card edge connector for a male plug on the cable.

If the wires on your jack (female plug) are long enough to reach from the place where the jack is to be mounted, to the place where they are to be soldered to the existing cable, then leave them on the plug and trim them to fit when you need them. That will save work. Be sure that all wires from the main keyboard to the new jack will be out of the way when you put the computer back together.

Carefully cut a hole in the plastic case. Use the hot soldering iron to melt the plastic out of your way. Be sure that you have adequate ventilation in your work area for this step, to protect your eyes and lungs, and decrease the smell. Make any bolt holes that you need the same way. Clean the plastic from the soldering iron before using it for soldering. Mount the jack in the hole. It may not fit, so use a utility knife to remove any globs of plastic from the edge of the hole, and trim as needed.

### Wire the Jack

Carefully look at the wires of the large cable where they go into the back of the keyboard. With a pair of tweezers and the soldering iron, heat the insulation on the wires and skin each wire back about an eighth of an inch. Be careful not to get the wire too hot or the solder will melt. Also the insulation will crawl back too far if it takes too long to cool.

If the jack doesn't have wires on it, use some wire the size of the wire in the regular cable. Skin the end of a piece of wire, and carefully solder it to the first connector on the jack. Now solder the other end of the wire to the bare spot on one of the cable wires at the point where it goes into the keyboard. Make sure that you haven't allowed the original wire to become disconnected.

Carelessness may not be the best way to ruin the keyboard, but it is as good a way as any I know, and takes less effort than most. Use as little heat and as little solder as you can get by with and still have a good joint. A sharp, clean, well-tinned point on the iron is a must. Now solder another new wire to another of the original wires in the keyboard, and run it to the jack in the case. Keep doing that until all the wires in the cable have been connected to the jack as well as the main keyboard. As you make each solder joint, check it for cold solder, shorts, etc.

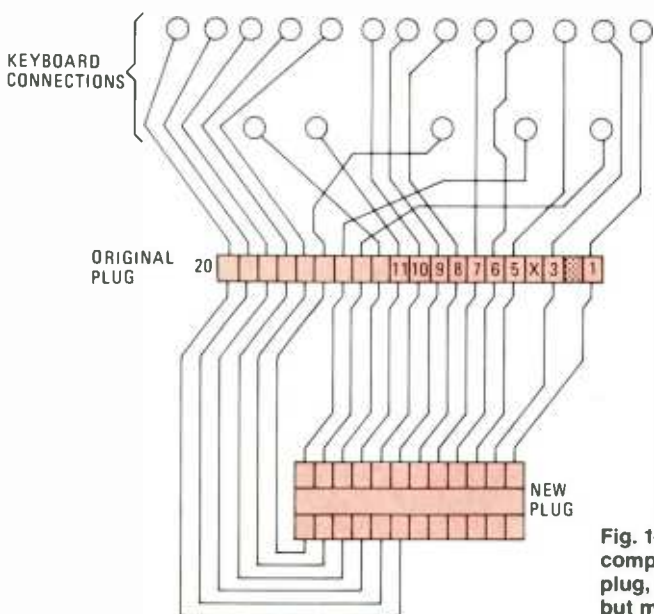

Fig. 1—A schematic diagram of the wires between the computer plug, keyboard connections, and the new plug, is not necessary with a complete pin chart, but may be useful when planning future modifications.

Now for the administrative part. Draw a small chart, or table, using three columns like Table 1. Those are not actual pin arrangements, just an illustration of the table. Make your own.

**TABLE 1  
PIN-TO-KEY CONNECTIONS**

Pin	Key	Pin
1	4	18
1	Q	12
1	V	9
2	5	17
2	W	13

Label the columns pin, key, and pin. Number the first column with a 1. Use an ohmmeter to see which pin has continuity with (is connected to) pin 1 through which key.

(In case of a specific computer, such as the VIC-20, you may wish to save time, and get the info from a book. I got mine from *VIC Revealed* by Nick Hampshire, published by Hayden.)

The fastest way to make the test is to hook one lead of the ohmmeter onto pin 1 of the jack, hold down a key, and gently rake the other ohmmeter probe over the rest of the pins of the jack. Some jacks are recessed, so you will need to find a way to reach them. A jiggle of the meter needle will signal the place of continuity. If no such jiggle happens, depress the next key in order and try again. Keep at this until you find the key(s) and other pin(s) that make up that set. Note them on the table and move the clip from pin 1 to pin 2, and repeat the process. Continue until the chart is complete.

Next, make a diagram of the keyboard where the wires are connected. Try to draw it just as it looks on the keyboard. Number each point for the place on the new jack where the wire hooks onto the regular plug (See Fig. 1).

### A Keyboard, for Instance

Now you need only to see that the keys in your keyboard (or the door counters) are wired so that they connect to the

```

10 rem sensor-counter-printer program.
20 LET B$=""
25 LET C=0
30 GET A$
35 IF A$ <> "" THEN 30
40 B$=B$+A$
45 LET C=C+1
50 IF C => 40 THEN 70
60 GOTO 30
70 OPEN 4, 4, 2
75 PRINT# 4, B$
80 CLOSE 4
90 GOTO 20
100 END

```

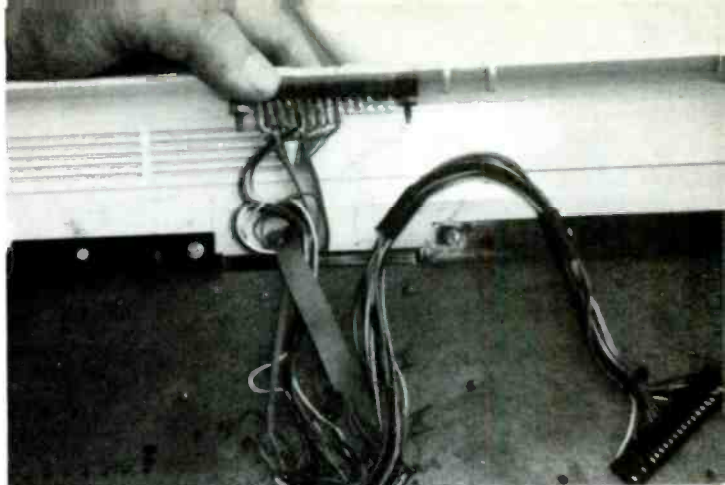

An ant's eye view of the keyboard from the bottom shows the original and new cables connected together, in parallel. The soldering was done at the keyboard end of the cable to facilitate flexibility

proper pins. Look at the underside of your new keypad. Find the traces (little copper or solder stripes) on the board that lead to key #1 on the keypad. Bear in mind that when you wire up one key to the mating plug, that wire will be used by more than one key. For instance, in a Vic-20, the keys 3, 5, C, and D all share a common lead. You may wish to see if the traces on your keypad go to the other keys you want.

If you're wiring an alternate entry keypad, don't cut any traces on it until you have wired the keys in, or until you encounter a place where two keys conflict.

You may wish to buy a piece of ribbon cable at an electronics supply store. It should not cost much, but if you wish, you can make a cable out of wires from a junked-out TV set. We have often done so. Just watch that your ten-key (or more) pad is connected to the same wires as the mating keys on the main keyboard. Test for that by clipping the ohmmeter on the proper pins in the jack, and pressing the matching keys on each board. Inspect carefully to see that no extra keys are wired to any circuit. Double check your work.

### Closing Time

Now unplug the new keypad from the main keyboard and put the computer case back together the way *porcupines smooch*: with great care. Check your notes and be sure all internal plugs are properly aligned. When the plugs are reconnected, put the top half onto the bottom half slowly. Be sure that you are not forcing the case or it may break.

Reinstall the screws and test the computer by hooking it up to the monitor, new keypad, and power. Now turn it on, and press keys on both the main keyboard and the new keypad. Each key on the new pad must do exactly what the same key on the main keyboard does. If they do, then you are ready to reassemble your system, and enjoy, enjoy.

### Control Program

The program in Fig. 2 is for the VIC-20, but I made it as nearly universal as I could. The program will just print out any letters that have been "typed" by opening a door, stepping on a switch, etc. or from the keyboard. It will absorb forty letters, and print them on one line. You may wish to expand the program for time keeping, counting the totals of individual keys, etc. ■

Fig. 2—This program will keep track of the letters typed in and place them in a file 40 characters at a time.



By Thomas Krehbiel

□ NO MATTER HOW MUCH WE EQUALIZE, EXPAND, TIME align, or otherwise tweak our stereo systems, the instant we start the music playing our ears tell us that we are hearing reproduced rather than live sounds. Stereophonic reproduction seldom delivers the illusion of reality that it promises. Binaural sound, stereo's often-overlooked first cousin, can come much closer to fooling our hearing; so close in fact, that more often than not, the sound is truly lifelike.

Binaural recordings are made with two microphones that are positioned to simulate a pair of human ears. That is a somewhat different than a stereo recording, which can be made from two mikes in separate rooms. The signals from the binaural mikes are recorded on a standard two-channel (stereo) tape recorder or deck. When the recording is played back through headphones the listener is effectively transported through space and time to where and when the original sound occurred. That happens because the sounds that arrived at the mike's electronic ears are fed directly into the listener's auditory system.

It's an effect that must be experienced to be fully appreciated and understood, but there are very few binaural recordings available commercially. The most practical way to become familiar with the capabilities of binaural reproduction is to make some binaural recordings yourself.

### Binaural Microphones

Anyone who owns a stereo tape recorder and a pair of stereo headphones has two out of the three parts that make up a complete binaural recording and reproducing outfit. The third requirement is the binaural microphone set which serves as a surrogate listener.

There are two commercially-produced binaural microphone configurations. In the more common, the microphones are mounted in place of the ears in a dummy head. In the

# Build a BINAURAL MIKESSET

**For true, lifelike reproduction, the recording must be binaural rather than stereo. Here's how to make your own binaural mikeset.**

other, the mikeset takes the form of a pair of headphones which the user places on his or her own head.

A headphone-style mikeset is handy for recording on-the-go, or for obscuring the fact that a recording is being made. (These days, most people take little notice of someone wearing headphones.) The primary problem with having the microphones built into a headset is that their placement changes whenever the wearer moves his or her head. If the wearer turns left the sound will be favored in the right microphone, and vice-versa.

Dummy-head mikesets are generally used in formal recording circumstances because they avoid the unusual effects that may occur when a binaural mikeset changes position during a recording.

Since both kinds of mikesets have their adherents, we'll show how to build both types of binaural mikesets using electret condenser-microphone capsules; the same kind of microphones usually built into portable cassette recorders. Although relatively inexpensive, the capsules are easy to obtain, have good frequency-response characteristics, and require only a simple power supply.

### Construction

The first step is to build the power supply. For this you'll need a box large enough to hold a 9-volt battery, a terminal strip, two resistors, and input and output jacks. If you don't have anything suitable lying around the shop, use a Radio Shack model 270-231 Plastic Project Box.

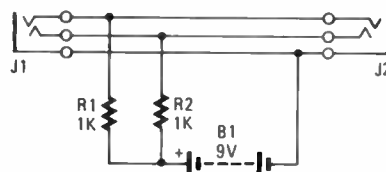

Fig. 1—A 9-volt battery and two resistors are all that are needed for the microphone power supply. Jacks J1 and J2 can be any kind of miniature or standard stereo phone jack.



## PARTS LIST FOR BINAURAL MIKESSET

B1—9-volt transistor-radio battery  
 J1, J2—Stereo phone jack (see text)  
 MIC1, MIC2—Electret microphone capsule, Radio Shack 270-090  
 P1—Stereo phone plug (see text)  
 R1, R2—1000-ohm, ¼-watt, resistor  
 Misc.—Styrofoam wig stand or miniature stereo headset (or both), battery holder, plastic project box, two-lug terminal strip, miniature shielded cable, hookup wire

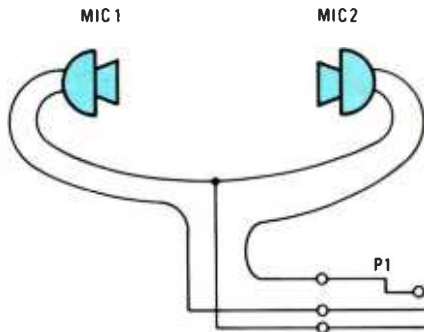
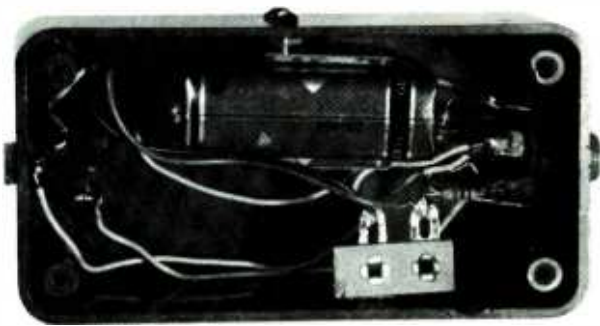

Fig. 2—Whether the microphones are installed in a headset or a dummy head, the wiring is the same. Make certain the common connection is wired to P1's sleeve.

Start by drilling appropriate holes in each end and then mount the input and output jacks. I used three-conductor phone jacks, one miniature and the other standard-sized, because that's what I had in stock. It really makes no difference whether standard or miniature jacks are used.

Mount a battery holder and a 2-lug terminal strip along the sides of the box. Connect the red wire from a battery clip to one of the terminal lugs; then connect one end of resistors R1 and R2 to that same lug. The other ends of the resistors go to the signal-carrying contacts of one of the jacks. It doesn't matter which one; use whichever one is easier to reach.

The black battery wire goes to the remaining terminal strip lug, and a length of wire runs from there to either J1 or J2's grounding lug. Next, run three wires from each of the lugs of one jack to the corresponding lugs of the other and solder all connections. Clip a 9-volt battery in place and close up the box.



Nothing is critical about the power supply; use any layout and any kind of suitable cabinet. The two-lug terminal strip serves only as a power source for the resistors.

There is no need for an on-off switch since the battery is disconnected when nothing is plugged into either jack.

It is also not necessary to identify one jack as *input* and the other as *output* because the power module is symmetrical.



A microphone capsule fits neatly into the space that's left when the speaker element is removed from the earpiece of a miniature (lightweight) stereo headset.

Either jack may be used for the mikeset: the remaining jack connects to the recorder.

### Installing the Capsules

(Note, the parts values shown are those required by the Radio Shack capsule given in the parts list. Other microphone capsules may require additional parts, different resistor values, or different battery polarity. If you substitute for the recommended capsule, be sure to follow its manufacturer's recommendations.)

Now you're ready to mount and wire the microphone capsules. To make the dummy-head version, you'll need a plastic-foam wig head to hold the mikes. A new one is fine, but you can find serviceable used heads at many thrift and second-hand stores at very low prices. A coat of flat-black spray paint gives a fresh appearance and covers minor scrapes.

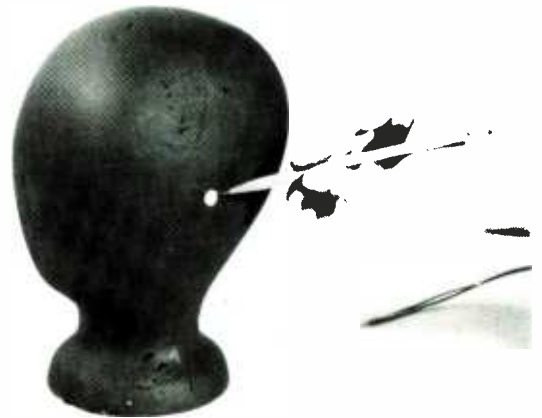

The white dot pointed to by the pencil is actually one of the small electret microphones which is mounted on the sides of the dummy head. A corresponding microphone is mounted on the opposite side of the foam form.

To prepare the wig head to receive the mikes, start by using a ¼-in. twist-drill bit to ream holes at ear level on both sides of the head. Do this by hand. If you make the holes just a bit smaller than the microphone capsules the capsules will be held in place securely without adhesives (by friction).

Solder a suitable length of flexible shielded cable to each of the capsules. Be sure to observe polarity.

(Continued on page 102)

# NEAR LETTER QUALITY FROM OLD PRINTERS

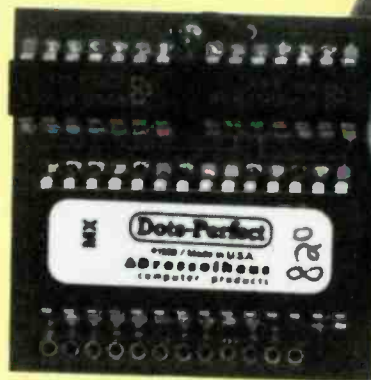

**If you don't have the nerve to use old-fashioned dot-matrix draft-quality printing for business documents and letters, here's how to upgrade your printer to NLQ—Near Letter Quality—and get printing that looks almost as if it was produced by a conventional office-quality typewriter.**

By Herb Friedman

□HEY THERE BUNKY! ARE YOU PUTTING OFF UPGRADING that old home-and-family computer because you can't afford a new printer and can't see spending *big bucks* if your printouts will still look like they were chiseled in stone? Or have you splurged for the latest IBM-clone and found that all those cute graphic symbols on the screen come out on your prints as only "heaven-knows-what?" Or have you spent months researching, and days writing, the definitive report on the meaning of life, and find your boss, instructor, or teacher would rather read something written in ink on a brown lunch bag than strain his or her eyes deciphering the small black holes you're trying to pass off as printing? Well then, as *The Old Philosopher* would say, "You're in the right place Bunky, because we might have the answer to your problems."

Although it's open to some debate, because of its reliability and convenient-to-use features, the EPSON MX-80 and its derivatives were the most popular printers for early computers, going back as far as the Radio Shack TRS-80 Model I, for which the MX-80 printer was specifically tailored.

The MX-80 printer achieved so high a reputation that it was selected by IBM to be used as, first, its conventional printer, then later, as IBM's graphics printer. It is quite likely that whether you started out with one of the early home-and-family computers, or jumped right in with an IBM-compatible, that your printer is MX-80 derived, or one of the later FX, JX, or RX series of matrix printers.

## Wrong Guess

Unfortunately, both EPSON and IBM made a wrong guess on the typeface. (The way the characters appear when printed.) Perhaps it was because conventional office typewriters were getting away from what *yuppies* considered to be old-fashioned, by using modern, sans-serif typefaces; or maybe EPSON and IBM specifically wanted their printing to

have the computer-look. Whatever, they opted for sans-serif, straight-line characters.

## Tiny Lines

For those of you unfamiliar with the term *sans-serif*, we'll explain. Serifs are a thin or small line used to finish off the main stroke(s) of a letter, as at the top and bottom of the letter M. If a typeface doesn't have the line(s) it is called *sans-serif*. For example, Fig. 1A is a sans-serif dot-matrix typeface; Fig. 1B is a serif typeface produced on the same dot-matrix printer.

Fig. 1A

This is an example of non-serif draft-quality dot-matrix printing.  
This is the same non-serif font "emphasized" for appearance.

Fig. 1B

This is an example of NLQ printing using serif characters.  
It was made with the same printer used for Fig. 1A.  
This is the same serif font "emphasized" for density.

**Fig. 1—Notice how different the type faces of the sans-serif (1A) and serif characters (1B) are. It may be an interesting historical note that as mankind advances, it uses technology to recapture simpler times.**

At first, with typewriters and computers, the modern sans-serif typefaces were all the rage: Everyone wanted to show that they were "with it;" that they weren't tied to old conventions and thought, and they tried to project such an image by using sans-serif typeface. Eventually, modern typefaces became so outlandish it was hard to distinguish between the upper and lower case (capital and small letter) characters. Since most people like beauty—which is the reason we decorate everything from dinnerware to buildings—the old-

fashioned serif typefaces quickly resumed their desirability. So much so, that the term NLQ—meaning Near Letter Quality—is used to describe a matrix-printed character that so closely resembles a serif character printed by a conventional typewriter it is often assumed to be a typewritten character: what is called *letter quality*. (*Letter quality* means a fully-formed character such as produced by a conventional office typewriter. The terms NLQ and *correspondence-quality* means a matrix-printed character—made from closely-spaced dots—that almost resembles letter-quality printing.)

So problem number one with most of the popular matrix printers is that the so-called modern, data-processing style, sans-serif typeface is generally not desired in commerce or personal correspondence; and more important, it cannot be read by a moderately-priced optical scanner, which is the way most large organizations “read” documents into their computers.

### Graphics Characters?

Problem Number two for the older printers is the IBM graphics character set, which is accessed by the ASCII codes above 127. Among many other “special” characters and graphics symbols, the high-ASCII codes provide the  $\Omega$  (omega), the  $\infty$  (infinity), the Ñ (Ninyo), and the  $\sqrt{\quad}$  (square root). While below ASCII 32,—an area reserved for control codes—the IBM character set also provides the four playing card suits, faces, and the international male and female symbols, among others.

Until recently, no printer other than IBM’s own Graphics Printer provided the full IBM graphics-character set. The only way to get it other than by purchasing an IBM printer was through special software programs, which didn’t always work.

It is quite likely that if you have the original IBM printer, which is really a conventional MX-80, you can’t print the characters you see on the screen, nor can you print the characters if you have recently upgraded to an IBM or an IBM clone, but cannot afford to replace your original printer.

### Dots-Perfect

But if your printer is MX-80 derived or IBM, or an FX or a JX, there is a simple and relatively inexpensive solution to both problems: it’s called *Dots-Perfect*.

Dots-Perfect is an easy-to-install retrofit kit that replaces the original ROM’s in the printer. The retrofit provides NLQ print and the complete IBM Number 2 character set (having no character omissions that we can find). Originally, there were two IBM graphics-character sets that were accessed through a BASIC routine. The Number 2 set is now standard. (The difference that there is more graphics characters in the Number 2 set.)

Dots-Perfect also provides a host of features not usually found on the MX/FX/JX/IBM printers. For example, with Dots-Perfect the printer will print the slashed-zero or the conventional (unslashed) zero using the same ASCII code; it is pre-programmed from front panel switches rather than by a BASIC program. To keep things short, we’ll simply list all the features available by touching what is normally the *on-line*, LF (linefeed), and FF (formfeed) pushbuttons on the printer’s control panel. The directly-programmed functions are: NLQ or conventional draft-mode characters, Condensed characters, Double-Wide characters, Emphasized characters, Double-Strike, Perforation Skipover, ½-in. left margin, Ital-

ics, Fine Print (microtype characters), 8 Lines/inch, Slash Zero, 8½-in. wide paper, and Print color (JX only).

As well as turning each function on or off through the control panel’s pushbuttons, the majority of the functions that are normally selected or ganged through a BASIC program, or even through internal switches, can be ganged or selected through the LF and FF pushbuttons.

For example, pressing the FF pushbutton twice programs the Double-Wide character mode. Pressing once more adds emphasis to the Double-Wide characters. Pressing once more adds double-strike. Pressing three more times would provide italic, Double-Wide, emphasized, double-strike characters. Pressing four more times would cause the italic, Double-Wide, emphasized, double-strike characters to print with a slashed zero.

### Internal Switches or a Basic Program

Many of the functions, such as the IBM graphics or italics as the normal “high-ASCII” mode, can be programmed as the default through internal switches. Similarly, just about anything can be programmed through a short BASIC routine. Or, one can use the *Disk Wiz* software covered elsewhere in this issue, which controls any printer or Dots-Perfect function directly from the computer’s keyboard without any kind of BASIC or pushbutton programming.

### Making the Retrofit

The photographs show the most popular retrofit, that for the MX-80, the IBM Printer, and the IBM Graphics Printer. Although the internal hardware for the MX-80 and IBM printers vary slightly, the area where the retrofit is made is the same for all versions.

The Dots-Perfect module is supplied as a factory-wired module containing three integrated circuits and a wire lead with a miniature hook-probe. The module snaps directly into one of the sockets that may or may not be used for an original printer ROM. The hook-probe connects to one of the printer’s original resistors.

The retrofit starts by removing the printer’s paper guide and the paper-feed knob (pull it straight out and off). Then remove the the four screws on the bottom of the printer, which secure the cover. Rather than pivoting the cover out of the way, in which case it will simply fall back at the most critical moment, remove the cover. If you look carefully, you will find that the wires that appear to lead to the panel-mounted *on-line*, FF, and LF pushbuttons actually terminate in a connector. (Look again, it’s really a connector.) Carefully slide

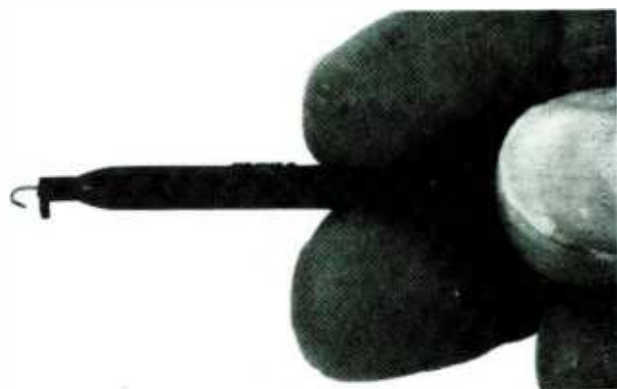

The wire leading from the Dots-Perfect module terminates in a miniature hook-probe that clips to an existing resistor.

the connector straight out and off the terminals, and using a pencil, a piece of tape, or whatever, mark the connector so that you can get it back correctly when you replace the cover.

Out in the clear, easy to see, are three large sockets labeled 1B, 2B, and 3B. The sockets are for ROM's, and one or two might be empty depending on the particular printer. You don't care how many are used or empty because you must remove all ROM's so that all three sockets are empty. The retrofit will be installed in socket 3B (Photo D).

If a ROM had been factory-installed in sockets 2B and 3B, there is a *very thin* pin guide between the ROM and the socket that stays in place when the ROM is removed. You must

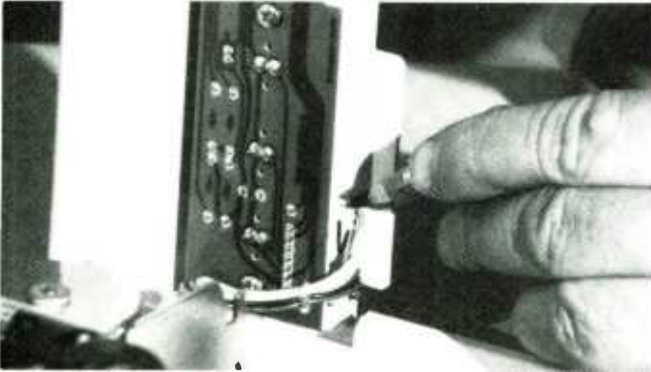

The author points to what appears to be a plastic block in which all the wires to the printer's control panel terminate. The block is actually a connector. Separating the connector allows the cover to be completely removed.

remove the pin guides, or else there won't be sufficient clearance for the Dots-Perfect module. Take extreme care that you are removing the pin guide and not breaking the socket.

The ROM's can be removed by slipping the edge of a medium size screwdriver between the ROM and the socket and gently rocking until the ROM just moves. Alternate several times between both sides of the ROM until it literally pops free. There isn't much room on the side of the ROM nearest the center of the printed-circuit board and you will probably need a very short screwdriver, or an *offset screwdriver* (one shaped like the letter L). The offset screwdriver makes an excellent pry-bar for lifting large integrated circuits out of a socket.

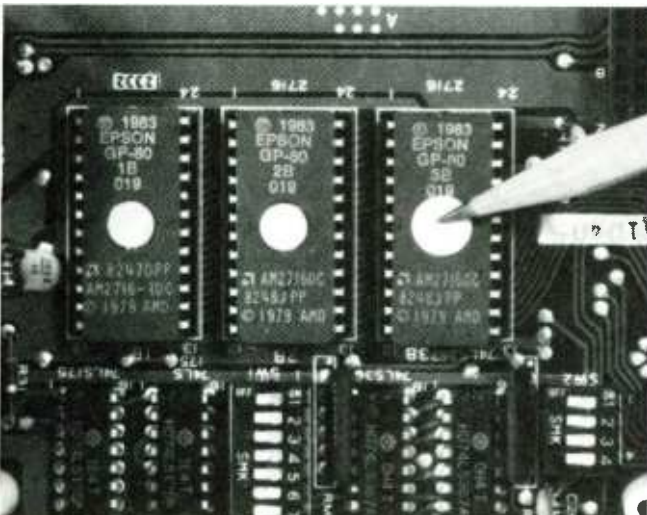

The pencil points to the ROM in socket 3B. ROM's may or may not be present in the two adjacent sockets, 1B and 2B. All must be removed. The Dots-Perfect is installed in socket 3B.

Take extreme care that you don't get the screwdriver between the socket and the printed-circuit board—which is easy to do. If in doubt, use a flashlight and a magnifying glass so that you can really see what you're doing.

Carefully position the retrofit module over socket 3B (Photo E) and press it down into the socket. Keep in mind that although the module fits in socket 3B, it will not seat properly unless the pin guide is also removed from socket 2B. Unfortunately, the 2B pin guide removal is not clear in the Dots-Perfect instructions.

Finally, secure the hook-probe to the indicated resistor; which sounds a lot easier than it is. The resistor is directly under the platen mechanism and might take some convoluted wiggling to seat the hook. Whatever you do, don't force the hook on the resistor—that might cause the resistor to break. Just take your time, twist and position the probe, and suddenly it will be hooked on.

Finally, you might have to cut open a wire loop that's on the printed-circuit board. The loop is out in the clear and the

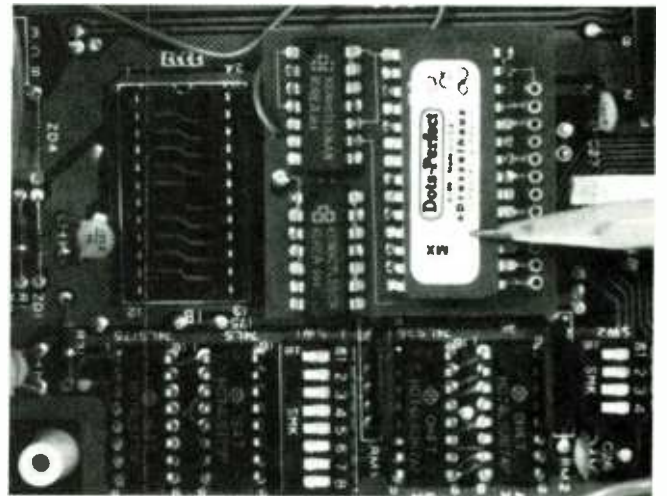

Here's how it looks when the Dots-Perfect module is installed. Notice that the module also overlaps socket 2B. The pencil indicates the large ROM, which is over 3B.

Dots-Perfect instructions clearly indicate its position, so there's no problem in cutting the loop. Cutting, or simply checking that the loop doesn't exist is the last step in doing the retrofit. (Total time should be under 20 minutes, even if you're extra slow and careful.)

### Default Programming

Directly below the module is an eight-position dip switch (Photo F). To the bottom-right of the module is a 4-position DIP switch (Photo G). Both switches are used to program the defaults, which are different from those of an unmodified printer. (Don't use the DIP-switch instructions that came with the printer.) You must program the defaults before you close up the printer.

The eight-position DIP switch provides: Fixed or not-fixed printer selection; Slashed or not-slashed zero; Internal buzzer on or off; Emphasized characters on or off; Italics on or off; Paper-out sensor active or disabled; IBM or Epson character set; Compressed characters on or off.

The four-position DIP switch provides: 1-in. perforation skipover on or off; Auto LF with CR, or LF from computer; NLQ or draft print mode; and 8-1/2-in. or 13 1/2-in. paper width.

(Continued on page 103)

# GADGET <sup>©</sup>

APRIL 1987

THE NEWSLETTER FOR GROWN-UP KIDS

VOLUME XII/NUMBER II

## What's Inside . . .

**Announcing Your  
Absence: The VP-700  
Voice Messenger 2**

**An Office in Your Lap:  
NEC's "Starlet" PC 3**

**Practical Multipractic:  
Braun's Hand-Held  
Blender 4**

**Toshiba's Flying  
"Wedge": Deluxe  
Portable CD Player 6**



**Smaller Still:  
Samsung's 4mm  
Camcorder 8**

**Discman Redux:  
Sony's New D-10 10**

**Duplication on the  
Run: Sharp's New  
Handy Copier 12**



## Mini Portable, Mini Service

**GE MINI PORTABLE CELLULAR TELEPHONE.** Manufactured by: General Electric Mobile Communications Division, Lynchburg, VA 24502. Price: \$3,000.

Watching one of America's corporate behemoths crash into a new product area is not without its humorous aspects. Even when they avoid the marketing pratfalls which can doom a new product or service, as a rule the Fortune Five Hundred boys aren't distinguished by either their finesse or innovative technique. Just like the generals who are said to always fight the last war, corporate marketers tend to use the methods they developed for a previous new product introduction in their current campaigns.

We don't know what *General Electric* thinks it's selling with its new line of cellular telephones—a *Mini Portable* and the vehicular "Carfone"—

but we do know their corporate sense of the cellular market is a tad underdeveloped. In the technical aspects of cellular design, however, *GE* thankfully has a surer touch.

A news release from the firm says the *GE Mini Portable* is "a full featured cellular telephone which will fit in an inside suitcoat pocket," while a mail-order firm says it slips "into your pocket to go wherever you go." If that's how you're planning to use this phone, may we suggest a visit to a tailor before taking delivery of the unit? You'll want to strengthen, and possibly enlarge, your pocket before "slipping" this 1.88-lb. instrument into it.

We were amused to notice that in its promotional material, venerable *GE* was uncertain of what to call the instrument. The preferred term appears to be "radio" telephone, a designation most cellular customers would find confusing. *GE* also neglected to introduce a carrying case for the instrument, something nearly standard with competing brands. Although the company says by the time you read this a case for the *Mini Portable* will be available, at a price yet to be determined.

However, this is an impressively compact unit by current industry standards and in its design, the *Mini* exhibits some refinements which suggest learning from other manufacturers' mistakes. The keypad and LCD configuration are simple and straightforward. The phone is turned on by a switch mounted on the instrument's side. In order to transmit a call, two keys are pushed simultaneously; the LCD then signals that a call can be placed. The keypad is also backlit, telling the user with a glance if the phone is turned on.

The *Mini's* slim-line nickel cadmium battery slides in beside the phone's keypad, adding to both the weight and width of the instrument.

One innovation is an "A/B" switch which allows the user to move between a city's two cellular systems. In lan-

(Continued on page 5)



## Chip Thrill

**VOICE MESSENGER (VP-700).** Manufactured by: Colonial Data Technologies Corp., 80 Pickett District Road, Milford, CT 06776. Price: \$54.95.

The sales demographics for phone answering machines are exploding upwards, and it's only natural that technology is racing to keep pace with the market. The *VP-700 Voice Messenger* represents not so much a giant step forward for answering devices, but a giant step sideways. It uses digital encoding

to simplify answer-only telephone response, in cases where there is no need for the machine to record incoming messages from callers.

Receiving and recording incoming messages is, to be sure, a main reason for telephone answering machines to exist, and represents their primary utility in the mind of the public. The *VP-700*, therefore, comes with that major caveat: It is not a device whereby you leave a cutesy little message in your best Groucho Marx or W.C. Fields voice, and then play back the responses from your friends when you return home.

This said, however, you have to ad-

mire the *VP-700* for what it does do. It answers your phone with a clear, round-toned message that you record yourself, and it does this with a speed and simplicity which is marvelous. Stripped of the cumbersome analog system of audio recording, with its problematical cassettes and wear-intensive technology, the *VP-700* points to the wave of the future in answering devices.

That wave, in a word, is "digital." The *VP-700* uses a digital voice chip to encode any phone message of up to 16 seconds duration. Messages can be replaced and rerecorded with no rewind or fast-forward, no wear and tear on the machine, no distortion due to degenerating tape quality. The solid-state digitizes rather than synthesizes the voice of the user, and the quality is much higher as a result.

One bonus side effect of the digital approach is the unit's compact size—6½" x 3¾" x 1½". These smaller-than-a-breadbox dimensions allow discreet wall mounting, for example, and even portability. Installation is so simple—just two plug-ins with modular phone jacks—that taking the *VP-700* on the road is a real possibility.

Business use is the obvious target for the *Voice Messenger*, since most home users will want the incoming-message record capability that the unit lacks. For answering repetitive calls for easily encapsulated information—a schedule at a movie house, for example—the *VP-700* is ideal. The only limitation is the 16-second time limit, since the message can be changed as often as needed.

The controls on the *VP-700* are easily accessible. There is a power button, with battery back-up to preserve the message already digitized. The AC adapter (included) plugs into a wall jack, and the 9-volt alkaline battery for back-up (also included) fits into the back. There is also a single button for message recording and testing, and one other control to turn off the machine and allow calls to come through.

Since normal operation of the phone

*(Continued on page 6)*

**Publisher:** Al Goldstein **Editor:** George Arthur **Senior Editor:** Gil Reavill **New Products Editor:** Christine Stevens **Art Director:** C. Giordano **Associate Art Directors:** Kevin Hein, Rob Welsberg **Production:** Bill Mudie **Administration/Reader Service:** Kathryn Hartman **Contributing Editors:** Philip Eisenberg, Alan Freedman, Jordan Ari Goldstein, Steve Gruberg, Aprille Guarino, John Kois, John Swenson, Ken Swisher.

GADGET is published by A.G. Consultants, Inc., 116 W. 14th Street, New York, NY 10011, (212) 989-8001. Copyright © 1987 by A.G. Consultants, Inc. GADGET is a registered trademark of A.G. Consultants, Inc. GADGET is published 12 times a year and appears as an insert in Hands-On Electronics, published by Gernsback Publications, Inc., Farmingdale, NY 11735. For information on subscriptions to Hands-On Electronics, please see the magazine's editorial page. Letters intended for GADGET's editorial staff should be sent to the newsletter's address as shown here.

GADGET's sole commitment is to its readers. In order to avoid even the appearance of a conflict of interest, GADGET does not accept advertising nor does GADGET solicit gifts or other benefits from manufacturers and retailers who may be mentioned in reviews.



## Starlet Letters

**STARLET PORTABLE COMPUTER (PC-8401A-LS).** Manufactured by: NEC Electronics, U.S.A., 1255 Michael Dr., Wood Dale, IL 60191. Price: \$999.

The portable computer is one of the more revolutionary technological advances of this super-hyped era of electronic information storage and retrieval. Properly mastered and used, it allows you to carry around a typewriter, filing system, library, notebook and business ledger, as well as providing an opportunity to hook your own portable databank into larger systems virtually anywhere you find them. In this sense the PC truly is a "portable office." Its value to writers, business people, researchers, students and teachers is potentially limitless.

The *NEC Starlet* is a most impressive PC. Its claim to be a "sophisticated yet easy to use productivity tool" is born out in all of its functions. In fact the PC is so versatile, the average user will likely never utilize the full

range of its features and capabilities.

The heart of the *Starlet* is its word-processing program, a variation on the popular WordStar program called WordStar-To-Go. In this program, the user can work on a number of files more or less at the same time with a full range of editing capabilities.

All the WordStar techniques and capabilities of 360-degree cursor movement, copy editing, block copy movement, text format and even page design are available by simply pressing one or a combination of the *Starlet's* keys.

A writer can use WordStar-To-Go to work on half-a-dozen standard-length magazine articles or a medium-sized book manuscript without exhausting the program's memory capacities. Even then, the PC can be augmented by discs, thus increasing the electronic memory ad infinitum (while, of course, reducing the unit's portability to some extent).

The *Starlet* has a working file memory of 64K RAM. For those of you not computerized, RAM is "Random Access Memory," an area of the PC databank in which information can be read or written. The 64K RAM of *Starlet* translates to 65,536 bytes of Random

Access Memory.

*Starlet's* writing functions are superior to those of most other portable computers. The keyboard is well defined and easy to figure out; the individual keys are large enough to allow for comfortable typing.

The LCD work screen is another extremely useful feature which gives *Starlet* a tremendous working advantage over smaller, harder-to-read screens like the standard Radio Shack PC. The screen is an 80-column x 16-line display with clear, easy-to-read characters. The scrolling feature makes it possible for you to keep your place in the copy at all times. A drawback is that the screen cannot be read from every angle, so in folding it back you have to be careful to adjust it to the correct viewing angle for your situation.

The *Starlet* comes with a tremendous volume of reading matter in several instructional booklets. It may take you some time to wade through all of this material, but, if you read it carefully and apply the instructions to the computer as you go along, it answers every question you may come up with. Even someone who has never touched a computer before can pick up the *Starlet* and with these instruction booklets, start editing, storing and retrieving files the first day of use.

One manual covers WordStar-To-Go, another describes the Calc-To-Go spreadsheet program, while a third explains the operation and application of telecommunications (*Starlet* has a built-in modem unit that allows you to communicate via telephone hookup with other computers or databanks) and personal file features.

*Starlet* also comes with a general overview manual, the "User's Guide for the Portable Office," which explains all the basic functions of the computer and how the various programs relate to each other. This is must reading, especially for the neophyte user, because it spells everything out in meticulous detail.

As if that wasn't enough, you also get a smaller "Quick Guide for the Portable Office," which summarizes the commands needed to operate each of the computer's programs. Once you've read the other manuals for contextual understanding, the Quick Guide assembles all of the crucial information into one small, easy-to-follow package.

One word of caution: If you are not computer-literate, don't try to jump immediately to the Quick Guide or you're liable to become hopelessly confused. Take it step-by-step, and the *Starlet* will reveal itself as an invaluable tool.—J.S.

## Practic Makes Perfect

**MULTIPRACTIC HAND BLENDER.**  
Manufactured by: Braun, Inc., 66  
Broadway, Route 1, Lynnfield, MA  
01940. Price: \$33.50.

Does anyone remember what it was the kitchen blender replaced? Was it the hand-held electric mixer? Of course, the blender itself has been superseded by various European-style culinary machines in the never-ending cavalcade of consumer marketing.

Germany's *Braun* has come up with a new replacement for the blender and while it's not really competition for the gourmet devices which have made a home for themselves in American kitchens, it is a handy, well-designed, if limited, culinary tool.

Called the *Multipractic* and fabricated in Spain, the differences between this and a hand-held electric mixer begin with its shape and appearance. Some 14.5" long, its six-setting speed adjustment and on-off control are built into the handle-motor assembly. A graceful curve in the upper handle (an example, we'd guess of "ergonomic design") makes the *Multipractic* easy to maneuver. During mixing, we tended to wield it like an over-sized, electric-powered spoon.

As if embarrassed by the *Multipractic's* essential simplicity, *Braun* has outfitted it with an impressive array of accessories—a blending beaker, a mixing bowl and a compact storage rack for mounting on the kitchen wall. There's also a filter, and egg white separator (a handy enough gadget in its own right), a spatula and a whisk attachment. Also included, a sauce and drink recipe booklet in four languages (no less).

The key to this device's success would seem to be its limited uses. Among tasks suggested in the instruction booklet are blending soups, sauces, mayonnaise, purees, desserts, mixed drinks, baby and dietary foods, egg whites and whipped cream.

Although we did use it as a hand mixer, we suspect that prolonged use for blending thick batters and the like would give this item a short life. The unit's Underwriters Laboratory sticker carries the cryptic statement, "for intermittent use only." The directions elaborate, "maximum operating time: 5 minutes. Then allow blender to cool off at least 3 minutes before using again."

The business end of the *Multipractic* at first glance seemed a bit underdeveloped: two dinky, metal blades. But they blended as efficiently as the two dinky metal blades found at the bottom of most conventional blenders, and being in the open were easier to clean. The whisk attachment (which looks like the safety cage on an automotive drop light) harnesses the blades to turn its plastic whisk, inside the piece's non-moving plastic cage.

In GADGET's test, we found this handy to use, easy and quick to clean and seemingly as fast and efficient as any ordinary blender. We also found it advertised at retail prices substantially lower than *Braun's* suggested retail tag.

The proof, of course, is in the mixing. If your culinary routine includes the blending and mixing for which the *Multipractic* was designed, this is a kitchen gadget worth looking at.—G.A.





## GE MINI PORTABLE PHONE

(Cont. from p. 1)

guage which recalls the chronic overload problems of the old "improved mobile transmission system" which cellular superseded, the instruction manual explains, "when you contract for service," a supplier of cellular service "is designated as the preferred service and that unique system identification is stored in the radio. . . . The normal mode of operation is to seek service on the preferred system.

"If for any reason the radio does not acquire preferred service, it can switch over to the non-preferred system to seek service." A handy feature in those cities which actually have two, competing cellular suppliers in place.

Another nice feature is the timer function of the LCD. During call transmission, it shows the seconds passing, important given the high rates charged by the cellular telephone industry. GE also lists as features some near-standard capabilities like a "noise cancelling microphone," electronic lock, vehicular adapter, 30-number memory and a volume control.

The *Mini* is available in three different configurations. The *GE Mini Portable*, the one GADGET purchased, includes the phone, a desk-top charger and a spare battery. The *GE Mini "Convertible"* package includes a remote handset and cradle, a 12-volt vehicular charger and a mount. Finally, the "VersaMobile" also includes a 3-watt power booster amplifier and a hands-free speaker/microphone.

Although the instruction manual is dim on the question of recharging, a call to a GE 800 number supplied some important information regarding the recharging of the phone. The desktop charger has two compartments—one for the phone with battery and the second for quick charge of the battery alone.

The battery-alone quick charge takes an hour and a half. An LCD indicator on the front of the charger indicates when the battery has returned to normal energy level. However, the battery-with-phone charge takes a maximum of 16 hours.

According to GE, in the interest of longer battery life, at least once a month the user should put the phone and battery through the long recharge. Further, every couple of months, users should allow the battery to discharge completely, simply by turning on the phone and letting it use up the stored energy. This is useful (if not mandatory) according to GE in order to "equalize the charge" and lengthen



GE's Line of Cellular Equipment

the useful life of the battery. As the GE employee put it, "when you have to buy a replacement battery [priced at around \$60] you'll understand why you should try to make those units last."

Despite the touted "dual antenna system" (a telescoping external and an internal antenna are supposed to "provide improved performance for weak signal areas"), GADGET's publisher has had his share of frustrations using the *GE Mini Portable*. In Manhattan, its performance is erratic at best.

According to a second GE employee with whom we spoke, this is a result of the canyon-like cityscape of Manhattan and, he intimated, an inescapable characteristic of portable cellular phones because of their necessarily lesser power output. Something, of course, not mentioned in sales literature for what a GE press release calls "the ultimate cellular telephone in a portable configuration."

On a weekend trip to Tampa, Florida, our publisher was unable to use the phone on "roaming" status. That is, use the New York-registered phone in another cellular service area.

Tampa's GTE Mobile Net was perfectly willing to sign us up for a weekend of service away from home territory (still, by the way, an irritating rigamarole to go through for a simple transfer of phone service), but was unable to actually provide any service.

Mr. Goldstein was unable to call anywhere, either in Florida or long distance, and the GADGET office was unable to reach him by dialing the 11 number plus home system area code plus instrument number required by

the Tampa system for the "freedom" of "roaming."

Once again, GE insisted that any problems belonged to the cellular system, that their phone was not the source of service difficulties. "The smaller the market, the worse the service" was the cellular wisdom imparted. A small market means fewer cellular subscribers which means less income which means fewer cellular transmitting stations and, hence, poorer service.

So that promised golden era of wireless cellular communications remains, apparently, elusively off in the future. In the case of portable cellular phones, this would seem to create some marketing problems.

Especially as car phone installations work better and cost less. The GE "Carfone," introduced with the *Mini Portable*, retails for less than half of its non-vehicular counterpart, the \$3000 *Mini*. If you're interested in a fully portable instrument from GE, perhaps the optional power booster should be part of your purchase.

Marketing considerations, however, are the least of consumer worries. With federal regulation essentially dismantled, what spur is there to improvement of cellular system service? Not much really, beyond vigilant individual consumers, willing and able to express their complaints to suppliers.

Depending on mystical "market forces" to bring improvements in cellular service probably means our grandchildren can look forward to glitch-free wireless phone transmission. In the meantime, cellular consumers are stuck. —G.A.

## VOICE MESSENGER

(Cont. from p. 2)

is impossible when the *VP-700* is in operation, there is no way to use it to "screen" incoming calls: The phone does not ring, and there is only a small LCD signal on the front of the unit to indicate there is a call coming in. Answering machine market research indicates, however, that only 4 percent of consumers cite call-screening as a primary reason for purchasing an answer-

ing machine.

The next logical step in answering machine development will be to extend the digitized voice recording concept to incoming calls—to give callers memory chips of their own, in other words. While this would probably increase the dimensions of the device beyond the *Voice Messenger's* almost palm-sized compactness, the added versatility would be worth it. Market research has also found that price is the most sensitive determining factor for consumers in buying an answering machine, and

for this reason, also, the *Voice Messenger* seems to be positioned ideally in the market. With an estimated 15 million households now indicating they expect to buy an answering machine sometime in the near future, this is a booming sector of electronic sales.

Given its limitations, the *VP-700* cannot be said to answer the needs for the entire market. However, for the people who need an efficient phone answering device and don't care or need to record incoming calls, the *VP-700* is ideal. —G.R.

## CD Character

**COMPACT DISC DIGITAL AUDIO PLAYER (XR-P9RC).** Manufactured by: Toshiba Corp., 82 Totowa Rd., Wayne, NJ 07470. Price: \$300.

Compact disc players, the wave of the future, are storming into the present. One of the finest to wash up on our shores here at GADGET is the *Toshiba XR-P9RC*, a single unit which combines the finest features of portable and home compact disc play.

The leading attraction of this *Toshiba* CD is its remote capability. In such a modestly priced product, having a separate, sleekly designed infrared remote control is a pure bonus, an added dollop of "gravy" that makes the package as a whole more attractive. Another plus is the unit's wedge-shaped or "pyramid power" design—when in home use, the CD player is attached to a triangular AC adapter power-pack, and presents a 45-degree angled face to the user. This improves access, although there is some concomitant increase in the amount of space occupied by the unit.

The *XR-P9RC's* other life begins when you slip off the AC adapter, connect the battery pack and slide the now-portable CD into its carrying case. As a personal stereo, while a bit bulkier than other CDs and of course minus its at-home remote capability, the *Toshiba* points up the strengths of the CD format. Some of the compact disc's drawbacks come through, too: The *XR-P9RC* isn't as skip-prone as some other portable players, but it still isn't suitable for use while jogging or indulging in any other shock-producing physical activity.

Other quibbles: The battery pack (for six "C" batteries) is more cumbersome than the standard, rechargeable Sony-style pack. This contributes to the slightly oversized feel of the "portable" incarnation of the *XR-P9RC*. It



is one of the larger portable CD players on the market, toeing the tape at 5" by 7" by 1½"—not big enough to call in the Sherpas, by any means, but still bigger than the veritable wafers some companies are currently marketing. Also, in home use, the remote capability turns out to be not all that capable—no fast forward or reverse and no programming the unit's memory from across the room.

But that's just what those two caveats are, quibbles. All told, and especially for its price, the *Toshiba* unit weighs in as a marvel born of the modern-day marriage of engineering and marketing. It is currently the only portable player with remote capability, and it is certainly one of the finer portables when it comes to conversion to home use.

The *XR-P9RC's* sound has that clar-

ion-clear, pristine-pure, almost scary immediacy that is most arresting to those who've spent their formative listening years suffering the slings and arrows of the LP. *Toshiba* has wisely forgone including the headphones necessary for portable use. These are often, in GADGET's experience, the weak link in the CD sound chain and thus consumers are often better off selecting their own. Hooked up to an amplifier in a component system, the *XR-P9RC* makes you realize what that "aux" channel button is all about.

Again, for the price and for the versatility a user gets for his or her money, the *Toshiba* portable CD player is hard to beat. As an introduction to the joys of the compact disc—both at home and in transit—we can give the *XR-P9RC* the imprimatur of GADGET's highest recommendation.—G.R.

## Bits & Pieces

If you're the owner of a Beta or 8mm VCR, and do a lot of recording and erasing, you may already know about the **Eraser-Winder** from *Sony Corp.* (Sony Drive, Park Ridge, NJ 07656). The compact unit completely rewinds a standard L500 Beta videocassette in just two minutes (half the time it takes on a VCR). The separately activated "erase" capability eradicates all previously recorded video or audio signals while the unit rewinds. A built-in safety tab detector prevents accidental erasing. The Eraser-Winder also cuts down, or so the marketers say, on wear and tear of your VCR's heads, and you'll be able to use your home unit while another tape is being rewound. The device is available in both Beta and 8mm formats. Price: \$145.

For centuries, Scandinavians have used the sauna, making its hot, dry "bath" a daily ritual of relaxation. Now, *Helo, Inc.* (28 Fahey St., Stamford, CT 06907) has introduced what it calls "a genuine **Scandinavian sauna**" large enough for two people, but small enough to fit into a bathroom or even walk-in closet. Made of redwood or cedar, the *Helo Duette* measures 4' by 4' by 6'6" and features a tempered glass window in its door. It comes equipped with a heater and Finnish "Konno lava rocks," over which water is poured to generate steamy hot air. Best of all, no special plumbing is necessary and the unit uses a regular 110-volt wall outlet. In use, the *Duette* reaches temperatures of 180 degrees Fahrenheit and, according to the manufacturer, can be assembled in "less than an hour." Price: \$1,995.

Last year's CD breakthrough, a disc changer for multiple-CD play, has become part of today's standard product line. *Sanyo Consumer Electronics* (1200 W. Artesia Blvd., Compton, CA 90220) has become the latest firm to introduce a **CD player with changer**, the **CPM1000**. The unit accepts as many as 10 discs and offers 32-selection programming. The company proudly calls it, "the top of the line in Sanyo's CD player offering." Besides a three-beam laser pickup, the **CPM1000** features an index function, introscan selection to preview selections on a disc and forward and reverse selection skip. Price: \$469.95.

Among the most common of telephone accessories, the answering machine has spawned an accessory of its own, designed to keep the device out of the reach of small children in the home or unclutter a desktop at work. Called the **Wall-Mountie**, it's a clear Lucite holder which fits most major brands of telephone answering machines, including Code-a-Phone, Panasonic and Sanyo, and can support up to 15 lbs. of weight. Easily installed with two screws, the holder can be adjusted vertically and horizontally. The **Wall-Mountie**, however, won't fit machines with a built-in telephone or any that are less than 6" in length. Available at a number of outlets in New York, it can be ordered from the *Fone Booth* (12 E. 53rd St., New York, N.Y. 10022), which will ship it UPS. Price (exclusive of UPS charges): \$20.

One aspect of the new federal tax laws is the need for even more detailed records of business expenses. The **Telko Expense Tabulator** seems to have been designed with the new tax code revisions in mind. Sold by *Impact 2000* (60 Irons St., Toms River, NJ 08753), the **Telko** can keep track of up to 1,400 separate expenses, by date, while providing a running total and daily subtotals for any of 16 expense categories, including hotel, food, phone, taxi, bus, mileage, parking, tips, etc. It can also convert foreign currency to the U.S. equivalent and serve as a "portable, compact calculator with 8-digit display, math and percentage functions, memories and automatic shut-off." The **Telko** includes both an electronic thermal printer and the batteries to power both the tabulator and the print-out unit. Sold with 5 rolls of thermal paper, there's also an optional AC adapter and vinyl carrying case. price: \$149.95.



Sony Eraser-Winder



CPM1000 CD Player With Changer



Telko Expense Tabulator

# Bits & Pieces



**Endless Energy Battery Kit**

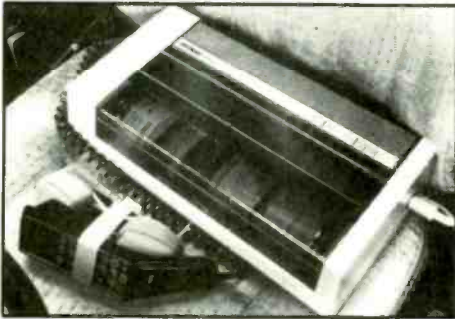

**Portafax Portable Facsimile Machine**



**Samsung 4mm Camcorder**



**NoLabel Cassette Label System**

In an attempt to establish itself in the consumer market, *TNR Technologies, Inc.* (45 Jefryn Blvd., Deer Park, NY 11729) has introduced a line of rechargeable Nickel Cadmium batteries which are guaranteed "forever." Called the **Endless Energy Rechargeable Battery System**, this new product line can be purchased as a system, which includes both battery and recharger, or separately—just the energy cells. The company also says "Endless Energy chargers and batteries can be used interchangeably with General Electric, Eveready and Panasonic." Prices vary depending on voltage and battery type. What the company calls the "deluxe value kit" includes two "C," two "D" and four "AA" batteries, plus a charger. Price: \$49.95.

If Calvin Coolidge were still alive, he might have to amend his famous dictum, "the business of America is business," to "the business of America is increasingly portable and on-the-go." That's certainly an observation that *Medbar Enterprises, Inc.* (71-08 51st Ave., Woodside, NY 11377) could get behind. The reseller, dealer and developer of various office products has just introduced a **portable facsimile machine**, the **Portafax**, small enough for a briefcase. Weighing 7.5 lbs., the device can transmit or receive documents over any home, car, pay or business phone. Battery powered, the Portafax can be powered by a car lighter or a standard outlet with the addition of optional adapters. The unit offers resolution of 100 lines per inch and takes three minutes to send or receive a standard letter-size page. The Portafax uses electro-sensitive paper. Price: \$1,495.

If after careful study and comparison, you've finally made a choice between VHS, Beta and 8mm video formats, you won't want to know about the world's first **4mm camcorder**, developed by *Samsung Electronics* (301 Mayhill St., Saddle Brook, NJ 07662). Called the SVC41, the unit is smaller than either 8mm or VHS-C camcorders, yet according to its developers, "offers most features of these larger models, plus a VHF-UHF tuner for viewing and recording TV programs." The unit is equipped with a 2.5" LCD color screen which serves as a viewfinder and record and playback capacity of up to 80 minutes. Shown at the winter Consumer Electronics Show, the SVC41 is expected to go on the market in Korea next summer, with plans for its introduction to the U.S. still unformulated. Price: \$1,300.

A new environmental worry has joined those already established recently, deadly radioactive radon gas. Radon is a colorless, tasteless, odorless gas which emanates from uranium deposits in rock and soil. In a report last year, the Environmental Protection Agency blamed exposure to radon for approximately 5,000 to 20,000 lung cancer deaths in this country each year. *The Free Market Bright Ideas Catalog* (1001 Connecticut Ave. N.W., Suite 638, Washington, DC 20036) lists a low-price **radon home testing kit**. Buyers are responsible for properly exposing them for four to six days as specified in the instructions. Then the test samples are mailed to a laboratory and test results are returned by mail. The entire process takes a month or so. Price: \$16.95.

Active videotapers might be interested in a new system for identifying their cassettes. From *Weber & Sons, Inc.*, (NLS-Video Dept., 3468 Highway 9, Freehold, NJ 07728), the system is called **NoLabel**. Instead of sticking little paper labels onto the cassettes, then tearing them off or papering them over with another little paper label, the Weber system uses a clear plastic pocket, affixed to the cassette, that allows the user to slide in a card on which the relevant information is entered. When the cassette label is changed, the card is removed and a new one put into the see-through pocket. Insert cards are available in both white and assorted colors, allowing the consumer to "color code" cassettes, red for sports programs, for example, or blue for music videos, etc. The NoLabel System kit includes 100 plastic pockets in two sizes, 100 printed white cards and 100 color ones. There are sizes for use with both VHS and Beta. Price: \$22.45.

There's a frantic scramble going on in the electronics industry as manufacturers vie to establish themselves in the exploding desktop publishing field. Latest out of the starting gate is *Epson (2780 Lomita Blvd., Torrance, CA 90505)*, with its new "ultra low-cost" **Image Scanner Option Kit**. An accessory for the company's EX-800, EX-1000 and LQ-2500 dot-matrix printers, the scanner reads and converts hard copy images such as photographs, graphics, maps or clip art into bit image data. Those images are then transmitted to a host computer for storage. The user can then call up the images and integrate them into "most advanced word processing and spreadsheet packages" via the American Programmer's Guide bundled INSET software package. The Image Scanner Option Kit includes the scanner mechanism, an identity cartridge, a diskette with Epson's Scanner utility and INSET software and a user's manual. The unit will work with IBM PCs, XT and AT or compatible computers. Price: \$299.



**Image Scanner Option Kit**

The vacuum cleaner is one of the oldest consumer appliances, but manufacturers still come up with variations on this old household theme. Like the new VC-31 **Cordless Rechargeable Vac** from *Toshiba (82 Totowa Rd., Wayne, NJ 07470)*. Lightweight, the VC-31 features a two-speed control, easy dust disposal and a reusable cloth filter. It also comes equipped with an adapter for use with a standard wall outlet. Recharging takes five hours for up to 30 minutes of cordless operation. Price: \$45.

Here's yet another cordless, handheld vacuum cleaner. What makes this one special is its ability to pick up both solids and liquids. Called the **Aqua Sweep**, and available from *Impact 2000 (60 Irons St., Toms River, NJ 08753)*, this 2-lb., 20" long mini-vac comes with a mounting bracket which incorporates the recharger for the Sweep's batteries. Both dust box and filters are washable and rated dishwasher-safe. Price: \$44.95.

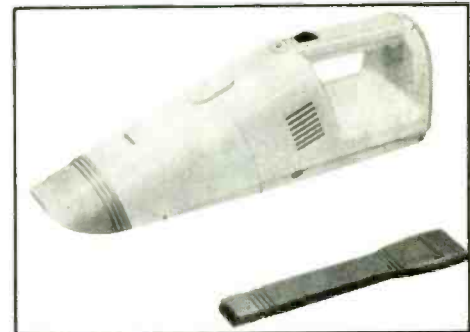

**V-31 Cordless Rechargeable Vacuum**

It's being called "the best of both worlds," at least in the press releases, but the new **X'Press 16** home computer from *Bondwell (47358 Fremont Blvd., Fremont, CA 94538)* really does seem to be an interesting advance, if only because of its low price. Featuring an advanced video display processor, 256K RAM, enhanced audio output (this season's PC industry favorite feature) and built-in disc drive, the X'Press 16 is touted as "an advanced game machine for the home and powerful computer that can run business software packages." Bondwell is also proud of its screen's "outstanding color resolution," credited to the system's video display processor. As with most of this firm's products, this PC is an IBM compatible. Price: \$499.



**X'Press 16 Home Computer**

Childhood can seem a perilous time, especially to parents. That's why we thought readers might be interested in something the famed Dr. Benjamin Spock says should be purchased by "every parent." The **Childwise Catalog** is billed as "a consumer guide to buying the safest and best products for your child" through the age of 5. According to Dr. Spock, "it covers all conceivable products and services for children from baby shampoos and adoption services to health foods and unsafe toys." This comprehensive guide, authored by Jack Gillis and Mary Ellen R. Fise, is available from the *Consumer Federation of America (1424 16th St., N.W., Washington, DC 20036)*. Price (including postage and handling): \$7.95.

The Munchkins are here. Not the sawed-off extras from the famed "Wizard of Oz," but what *Sharp Electronics (Sharp Plaza, Mahwah, NJ 07430)* says are "America's smallest **microwave ovens**." Available in two models—The **R-3280** and the **R-3980**—these .3 cubic-foot ovens are designed for "reheating single-serving meals" and come in a variety of designer hues, including metallic silver, brick red and fauxgranite or pastel yellow, ivory and red. What, no avocado? Both the top-of-the-line R-3980 and its companion model feature "space-saving under-the-cabinet" designs. In addition, the R-3980 has "automatic defrost, Sharp's one-minute key, clock, digital display and two power settings." Price: R-3980—\$179; R-3280—\$149.

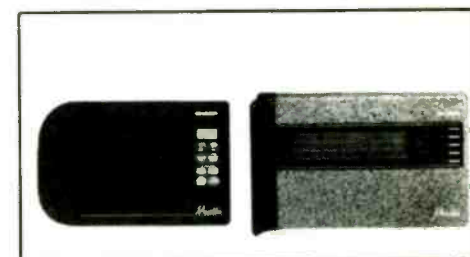

**Mini-Size Microwave Ovens**

# Bits & Pieces



**My Cafe Coffeemaker**



**Hewlett-Packard Infrared Printer**



**Telephone Voice Security Terminal**

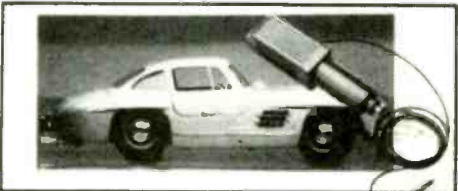

**FM Car Communicator**



**Portable CD Player**

Among the more popular automatic coffee makers is the **My Cafe** from *Toshiba* (82 Totowa Rd., Wayne, NJ 07470). This compact appliance grinds and brews coffee and now a new model is available at a slightly lower price, an eight-cup unit, the HCD-701. Featuring a beige and brown color scheme, this My Cafe features a permanent stainless steel filter, a warmer and a "calibrated water window to indicate the number of cups of coffee being made." The unit also offers three settings—regular, dark and demitasse. Price: \$90.

Those new Business Consultant calculators from *Hewlett-Packard* (P.O. Box 10301, Palo Alto, CA 94303-0890) now have an **infrared printer** to go with them, the battery-powered 822240A printer. The unit used thermal technology to print a 24-character line in just under a second. Powered by four "AA" batteries (or an optional AC adapter), the printer can be situated up to 18 inches away from the calculator within a 60-degree arc. Previously used in remote-control systems for home entertainment equipment, Hewlett-Packard says this is the first time "the technology has been used to link a handheld calculator and printer." Price: \$135.

Another gadget for the seriously paranoid among us, this one to keep telephone calls absolutely private and unmonitored. The new **SVX-1000 Telephone Voice Security Terminal** from *Motorola* (Communications Sector, SHS, 1301 E. Algonquin Rd., Schaumburg, IL 60196), "protects voice communications... by converting normal speech into a digital format and encrypting it with a complex coding algorithm." That sounds like enough to discourage all but the most highly motivated of espionage agents. The SVX-1000 features a built-in CVSD voice digitizer and a twelve-bit modem and even works with mobile or portable phones. The terminal weighs 6.5 lbs., fits easily on a desk or in a briefcase and "requires no special training to use." Installation is simple, using modular phone connectors and an ordinary AC power outlet. Price: \$3,000.

Although originally aimed at the hospital and health care market, the prepackaged, **sanitized telephones** marketed by *Mini-Phones, Inc.* (Box 914, Midland, TX 79702) are really for anyone looking for a low-cost, simple instrument. A spokesman for the firm says that although hospitals dispose of the phones, or send them home with the patient, Mini-Phones instruments aren't necessarily "throwaway phones," although they're cheap enough to be. Anyone out there have a non-hospital use for a phone you can afford to toss out if you want to? Price: \$7 to \$15.

We're not really sure this product has much in the way of widespread appeal, nonetheless, we know there's someone out there who could probably put the **Call-Mate FM Car Communicator** to good (or at least some) use. Available from *Impact 2000* (60 Irons St., Toms River, NJ 08753), the system plugs into a car lighter and includes antenna cord which is fastened to the vehicle window via a suction cup. Then the driver in each car so equipped turns on the FM radio to the frequency specified for the Call-Mate and two-way communication is established, up to two miles away. Sold, naturally, in pairs. Price: \$59.95.

Not quite a year after introducing the D-7 "Discman" portable CD player, *Sony* (Sony Drive, Parkridge, NJ 07656) has introduced a new model, the **D-10 portable CD player**. The firm says it's 40 percent smaller than the D-7 but includes features and capabilities usually found only in home players. In addition to the earlier model's "AMS," automatic music sensor for "selection of up to 99 tracks in forward or reverse search," Sony offers an optional infrared remote control, "for the ultimate convenience during stationary listening." The remote control, in addition to providing access to the unit's AMS feature, can also "provide 10-key direct music selection of any track." Sony's roll-out of the D-10 spotlighted a host of separately priced gimmicks and gadgets, including power options which include batteries, an AC adapter or a car cassette adapter (CPA-1). Price: \$349.95.

## Bits & Pieces

With more than a century of watchmaking behind it and a carefully nurtured reputation for precision stopwatches and sports chronographs, you might expect *Tag-Heuer* (960 S. Springfield Ave., P.O. Box 420, Springfield, NJ 07081) to be a tad staid in the design department. Quite the contrary, in its use of unconventional materials, the firm is downright visionary. Take its new **Formula 1 diving watch** with analog dial. With Swiss quartz mechanism, and rated water-resistant to a depth of 200 meters, the Formula 1 features a steel and fiberglass case and a band made of a "special tough plastic" which can be cut to fit individual wrist sizes. There's also the characteristic Tag-Heuer timing bezel, designed for safety's sake to move in only a counter-clockwise direction. The watch, with a one-year warranty, comes in an unusual oblong plastic case. Price: \$145.



Formula 1 Diving Watch

"It's no secret that employee pilferage is an on-going problem," says the promotional material for the **FEAR security system** from *Apco* (478 11th St. Palisades Park, NY 07650). But what's not so clear is why this device is such a house-afire deterrent to theft and pilferage. According to Apco, "FEAR is an electronic system that non-discriminately, randomly selects exiting employees for closer personal inspection." Management selects one of ten settings, each representing a percentage. The employee steps on a pressure sensitive pad which activates the unit to flash either a red or green light. It sounds like psychological mumbo-jumbo to us—"the true essence of FEAR is its most effective psychological deterrent to every employee. No one really knows when the red alarm will be activated." Un-huh, now where's the unit designed to catch dishonest or pilfering employers? Price: \$175.

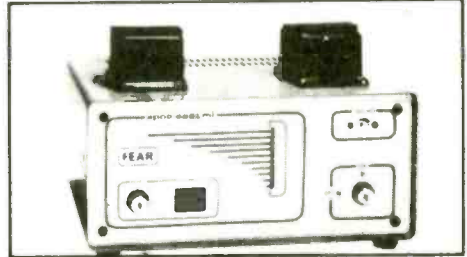

FEAR Security System

Retro-styling is very big nowadays in just about every field except electronics. Naturally, the marketers of life in the future are slightly reluctant to celebrate the past, but *Sharp* (Sharp Plaza, Mahwah, NJ 07430) had such luck with its pseudo-'50's QT-50 audio products, that it's introduced a companion line, the **QT-F40 AM/FM Stereo Cassette Portables**. Brightly colored, the QT-F40's feature a unique removable top cover which protects and conceals controls and a folding antenna. The units are also impressively compact. Price: \$79.95.

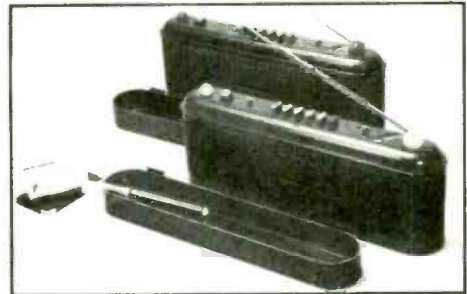

AM/FM Stereo Cassette Portable

Another approach to erasing videocassettes is represented by what *Herrington* (10535 Chillicothe Rd., Kirtland, OH 44094) calls this "studio quality eraser" which "restores tape purity," no less. The hand-held unit is moved over the videocassette and will "guarantee a perfect copy every time you re-record a videotape." The "beautifully contoured housing" is made of "indestructible Lexan" (whatever that is). This eraser also works with audio cassettes. Price: \$69.95.



Audio and Video Tape Eraser

The **Robotic Society of America** (190 Waverly Rd., P.O. Box 54-H, Scarsdale, NY 10583) is dedicated to "the study, experimentation, creation and advancement of Robotics and other artificial life forms." We suspect members also manage to have some fun while advancing on those fronts. In a drive to increase membership, the group says it is "giving away an experimental sound-activated robot in kit form to each new member." The society also publishes a newsletter and a reference work entitled "The Robotic Sourcebook." Annual dues are \$50. For further information, contact the Robotic Society of America.

Current controversy regarding smoking and smokers has put one old reliable gift item somewhat in the shade, the **cigarette lighter**. But the industry continues to introduce new models, even if under a slight cloud. *Te-Amo Geryl, Inc.* (P.O. Box 187, 207 Moonachie Rd., Moonachie, NJ 07074) has a new line of lighters, including "designer" units, each one guaranteed for five years or 50,000 lights (whichever comes first). Our favorite is the model 700, the **Gat**, meaning of course that this item is designed to look like a firearm. Or, as Te-Amo puts it, "here is 'firepower' at the touch of the trigger." The Gat is available in red, white or black. Price: \$16.95.

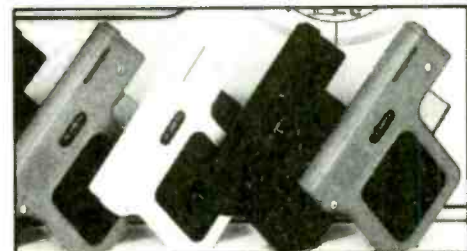

Te-Amo "Gat" Electronic Lighter

# Bits & Pieces

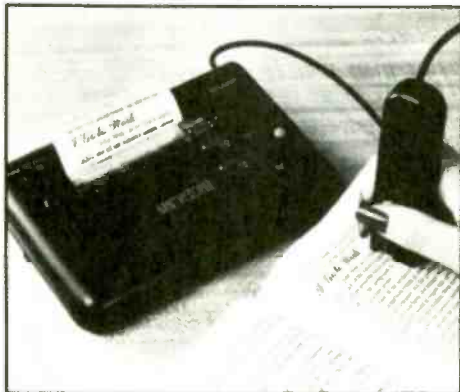

Sharp Handy Copier

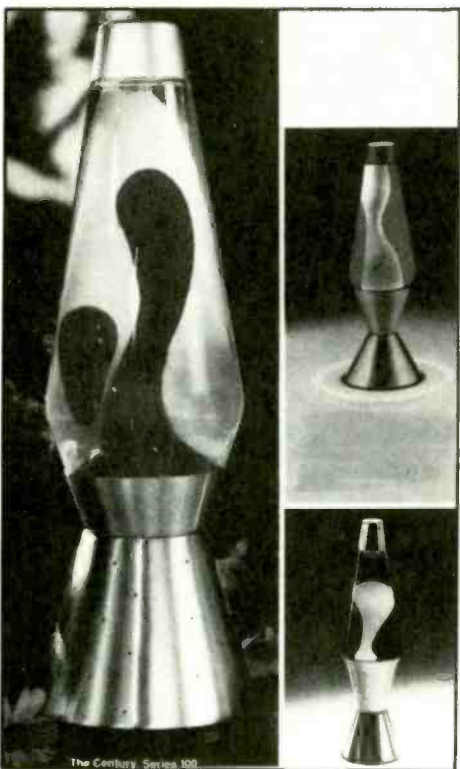

The Lava Lite

When photo copiers appeared, they must have seemed to the first users like the handiest device to come along since the invention of carbon paper. But over the decades, various limitations have become apparent. Enter the **Handy Copier (Z-HC1)** from *Sharp Electronics (Sharp Plaza, Mahwah, NJ 07430)*. Instead of the user taking a document to the copier, this device allows the copier to be taken to the material to be duplicated. A miniaturization of the familiar thermal copier, the Handy Copier wand scans the material to be copied, while a slightly larger-than-palm-sized printer copies it onto standard 3"-width thermal paper. The product would seem ideal for copying single-line text from newspapers, books, etc., a real boon for students and various researchers. Price: \$189.95.

According to some estimates, as many as 20,000 people around the world now live in solar-powered homes. If energy from the sun strikes you as practical alternative to standard electrical sources, you may want to send for the **Solar Electric Home Kit** from *The Free Market Bright Ideas Catalog (1001 Connecticut Ave. N.W., Suite 638, Washington, DC 20036)*. The kit includes a copy of the "Guide to the Photo-voltaic Revolution" by Paul Maycock, a question and answer worksheet on making your home solar-powered and a newsletter. In addition, you'll be contacted by a professional consultant who will "work with you on designing your system." The price of the Solar Electric Home Kit will be credited toward your first purchase of any photovoltaic equipment from the FREE catalogue. Price: \$35.

As computer progress, this doesn't hold a candle to the development of, say, the microchip, but we're sure there are PC owners who would jump at the chance to purchase "**designer covers** for protecting computers, VCRs and typewriters." From *Designer Products, Inc. (6585 S. Yale, Suite 1050, Tulsa, OK 74136)*, these fabric covers are marketed under the name "Designer Software," and come in an even dozen colors. Made of either plain or patterned Ultrasuede, water-repellent denim or Versatech, a new synthetic fabric, these covers fit all major PC lines and their peripherals and protect the equipment from dust, liquid or other foreign matter. These machine-washable covers allow ventilation and can be special ordered with monograms, logos or other designs. Price: \$9.99 to \$100.

What's the Aquarian Age knicknack with a "motion for every emotion?" It's that psychedelic accessory par excellence, of course, the **Lava Lite**. Media coverage last winter hailed "the return of the Lava Lite," but when we contacted *Lava Simplex Internationale (1656 N. Besley Court, Chicago, IL 60622)*, we discovered they'd never gone away. Sales, however, have been booming for the glowing, gobbing decorator item in recent months. Lava Simplex Internationale offers no fewer than five different lines of this "decorator lite of a million moving shapes," with names like, "The Aristocrat," "The Century" and "The Enchantress." Price: \$43 to \$55.

## Coming in the May **GADGET** newsletter

- **The Sure Shot Tele Quartz Date**—Canon's new camera with a built-in calendar, and a host of other innovative features, brings the art of the snapshot to new levels of sophistication.
- **1-2-3 Heart Rate**—The manufacturer calls this heart rate monitor, "the speedometer of Aerobic Exercise." GADGET gives it a consumer check-up.
- **Realistic Linear-Tracking, Front-Loading Turntable**—formerly high-priced features in a moderately priced package.

Also in the next GADGET—The return of the dual-deck VCR, cooling out with the "Cool Sounds" combination beverage pack and AM/FM radio, Samsonite's "System Four," Bio-feedback from Thought Technology, Ltd. and much, much more.



# The Arabs Have a Word for It!



## Arabic/English/French word-processor program makes your PC an almost United Nations interpreter!

By J. Sienkiewicz

□THE HEAD BUYER IS RUNNING ABOUT THE OFFICE RAISING havoc while waiting for an outside interpreter to translate two letters, one each in French and Arabic. A big cash deal hinges on immediate response provided the translation is accurate!

Across town in a university dorm, a sophomore is stumbling through his last semester of French—if only he can translate a travel thesis into good German, he would be eligible to play varsity basketball during his junior year!

In an attic room in the suburbs, a shortwave listener struggles with a letter with too-frequent references to a Norwegian-English/English-Norwegian dictionary, all this effort for a favorable QSL card from his reception report!

Those isolated cases with one common barrier—second-language comprehension—do not occur as infrequently as you would imagine. Those people communicating in two or more languages also include: Export-importers, shippers, scientists, health-care professionals, the military, scholars, travel agents, financial institutions, and many others.

### The Need for Multilingual Word Processing

Computers, communications, and technology are rapidly uniting countries and cultures. Corporations, diplomatic posts, government offices, information services, and others active internationally have needed software programming that would provide fast, effective multilingual word processing to close the gap.

Present PC/DOS word-processing software will not generate (with an operator) professional-quality text in more than one language within a single document. *Interword*, a multilingual word-processing system, was developed to permit switching from language to language within a PC program.

Software that converts an IBM-PC or compatible personal

computer into an advanced Arabic/English/French word processor with graphics capabilities has been marketed by Computers Anywhere, Inc. under the "Interword" trademark.

Arabic/English/French Interword software lets users write in either language or combine all three on-screen or printed page—even in a single paragraph or line. It also can enhance a document with straight-line graphics. Switching between languages is done with a single keystroke, without changing diskettes. Farsi/English/French versions, select automatically the correct form of Arabic or Farsi letters.

### Graphics Capabilities

By touching a function key, Interword software turns PC/DOS computers into graphics machines, permitting the addition of graphics characters to the text of any language or language combination. Press the F9 function key and any other key touched will display a graphic character.

Interword software can create simple and shaded bar charts and line graphs; horizontal and vertical rules and dividers; linear frames and outlines for columns, sections, and blocks of copy; and tables based on lines and rectangles.

### Printed Output

For type variations, Interword software can direct a dot-matrix printer to produce type in small, medium, large, double-width, or condensed fonts or underlined text.

Interword's printing routines are compatible with dot-matrix, laser, and Daisywheel printers. Full use of Interword's

The above monitor screen shot shows linear graphics combined with English, French, and Arabic text displayed by "Arabic/English/French Interword." For more information circle No. 81 on the Free Information Card.

Interword's claim to the making of simple charts and graphs is understated—much can be done with the graphics provided to make the dullest report fact-filled with solid graphics.

features requires a printer with downline, loadable, character capability or Daisywheel compatible with Interword's ASCII code table.

### Hardware Requirements

Arabic/English/French and Farsi/English/French Interword software is designed to run on an IBM-PC, XT, or AT or compatible MS/DOS computer with 128K memory, two disk drives or a hard-disk system. Also required is a color or monochrome monitor driven by a board having a character generator compatible with one of Interword's character generators.

An EPROM computer chip enclosed with the Interword software package must be installed on the IBM-PC or compatible in order to use the Arabic/English/French, Arabic/Farsi/French, Arabic/Russian or Multilingual versions of Interword.

Each Interword package (except Latin languages) contains a program diskette, printer routines diskette, keyboard overlays, English user's manual, and EPROM chip programmed with the proper English, foreign language, and graphics characters. An Arabic manual is provided with the Arabic/English/French version. Suggested retail price for the software and EPROM is \$495.00.

Latin Language Interword has a program diskette, keyboard overlays, and English user's manual. Suggested retail

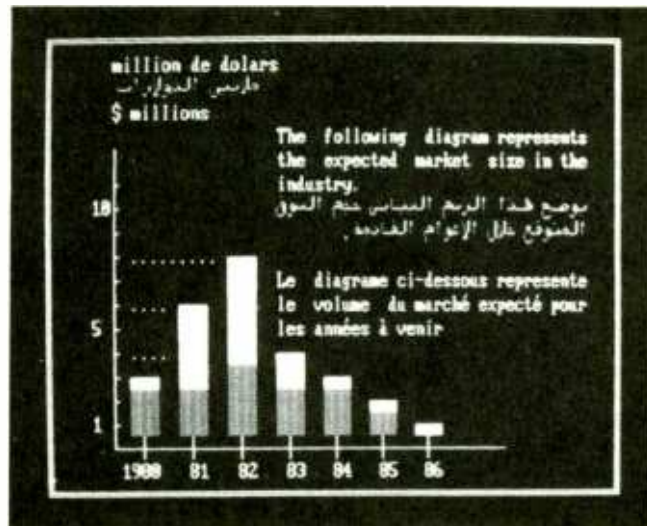

price is for the software (EPROM not needed) \$395.00.

Future Interword software products planned by Computers Anywhere include multilingual word-processing for additional language combinations, a spreadsheet, and multilingual database applications.

Considering that students throughout the world will be asking, "Where can I get the Interword package for the *so-and-so* language, the following recommendation is made: Write for more information on Interword products to Computers Anywhere, Inc., 8200 Greensboro Drive, #304, McLean, Va 22102, or by circling No. 81 on the Free Information Card. ■

## THE COLD VIRUS IS IN A BIND

□ RESEARCHERS AT PURDUE UNIVERSITY have pinpointed the site where antiviral agents bind on a common cold virus and prevent the spread of infection. What has that to do with electronics? The answer is: The work could not have been attempted were it not for the use of computers and computer graphics.

The researchers said that they have determined graphically, in atomic detail, the site where two antiviral compounds bind on a human rhinovirus, one of many viruses that cause colds in humans. The compounds, developed by Sterling Drug Inc., of New York, render the virus helpless by preventing it from opening up to release its infectious materials.

The Purdue group was headed by Dr. Michael G. Rossmann who was the first to map the structure of a cold virus graphically. That was in 1985. The computer played an important part in that research. The generation of viral graphics made it possible to think and plan successful drug attacks on a virus before the drug is applied to a human.

### How They Did It

By examining in detail the location where those compounds bind, and learning more about the specific agents used in

the binding process, scientists may be better able to target drugs against the viral structure.

The study provides the first glimpse of how antiviral agents work within the structure of a virus. In tracing the paths used by the compounds to enter the virus, Dr. Rossmann's group used techniques that they developed in their pioneering studies on the structure of human rhinovirus-14.

In their report, the group describes the site, which is located on one of the four virus proteins that intertwine to create the 20-sided structure of the cold virus. The compounds enter through pores and bury themselves inside a "barrel" made up of amino acids. The compound alters the position of a few amino acids and nestles itself right into the barrel.

The binding effect of the compound works to prevent the outside shell of the virus from breaking apart and releasing the internal ribonucleic acid or RNA. Without RNA to direct the synthesis of more viral proteins, the virus cannot replicate itself and cause infection.

### Drug Industry Contribution

The compounds used in the study were selected on the basis of their biological

activity against the virus, according to Mark McKinlay, director of microbiology at the Sterling-Winthrop Research Institute, a branch of Sterling Drug Inc.

"We knew the compounds blocked the uncoating process, but we did not know how or why this occurred. Professor Rossmann's research has brought us to a unique position by showing how the compound interacts at the molecular level," he said.

The Purdue research team now is working with Sterling to analyze a series of new compounds with slightly different properties.

Knowing how and where the drugs interact with their viral target may help the company develop more effective compounds, McKinlay said. He added that researchers are still far from offering a cure for the common cold.

Dr. Rossmann said that the research will provide fundamental knowledge of how virus structures unfold and infect host cells. That knowledge is now based on the contribution of computer science, and the magnitude of that contribution will expand manifold as scientists use computers and computer graphics as a painless and safe investigatory tool. Look out, virus, here come the computers! ■

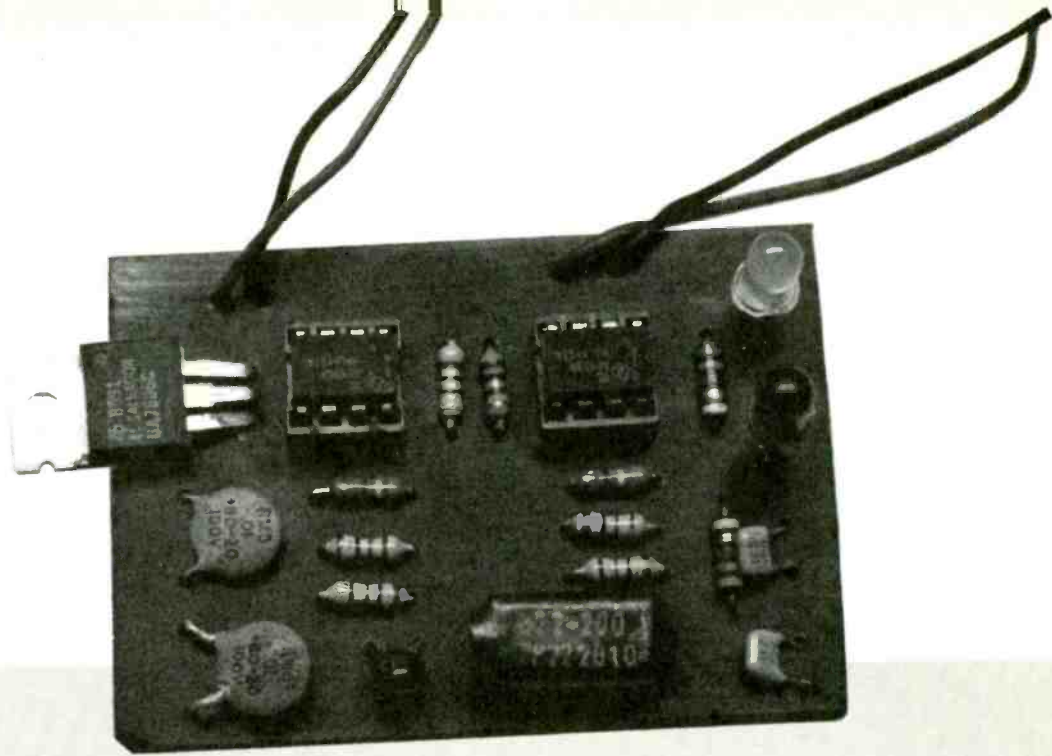

# THE TEST-A-MATIC

**If you're hung-up on telephone-cable sorting,  
then here's a project guaranteed to ring your bell!**

By Bob Grossblatt

□ ONCE UPON A TIME, THE ONE THING YOU DIDN'T DO WAS to mess around with the phone company—no matter what. All the telephone stuff in your house was only there temporarily. The phones, cable, even your number, was rented from Ma Bell. You were allowed to use it; but if they caught you just looking at it with a screwdriver in your hand, you had a good chance of losing your contact with the outside world.

## A Brave New World

Well, things have changed. Extension cables, extra phones, modems, and a huge aftermarket of telephone add-ons, have been created as a result of forced divestiture and other legislation. As things stand now, the phone company will provide you with a line, a number, and permission to hang just about anything you want on the telephone outlet. The days of expensive buffer boxes and protective adapters are over. After 50 years, Ma Bell has finally realized that even if you plug the phone line into a 117-volt AC socket, the only damage will be to yourself.

Even though a whole slew of new standards have emerged for wire, plugs, and jacks, it's still necessary to ring out the lines and be sure of maintaining correct polarity. The former is important when you're running several lines together; and the latter is needed if the accessories you're connecting draw operating power directly from the phone line.

## What Is Needed?

With new things to test, you can well expect new test equipment to be born. For the new need, the Test-A-Matic

was designed and made to *ring out* the telephone lines you install in your home, office, and shop. The Test-A-Matic is, among other things, nothing fancy. None of the parts are the least bit exotic, the layout isn't critical, and you can use any construction method you like. The circuit will work just as well if it's neatly laid out on a printed-circuit board or spread all over the room with alligator clips. But before we get into the circuit itself, let's take a look at what it will do for you.

There are two basic line tests that you can perform with the Test-A-Matic—line identification and polarity test. The line tester will actually do double duty, since it will indicate continuity. Checking the integrity of the copper is only half the job; you have to watch the polarity as well. In the old days of rotary dials, polarity wasn't a big deal—but DTMF phones are powered off the phone line and won't work unless you maintain the proper polarity. The Test-A-Matic is an easy and convenient way to make sure that you've wired everything properly before you actually connect any equipment to the line.

## Operation

The complete schematic diagram is shown in Fig. 1. If you're already familiar with the 555, you won't have any trouble understanding how the circuit works. Both the 555's are set up as astable timers, and U1 is used to modulate the frequency of U2. Resistors R3 and R4, and capacitor C3 are chosen to generate a frequency of about 4 Hz for U1. The low frequency of U2 (determined mathematically by the values of R7, R8, and C4) is about 733 Hz; but the measured frequency

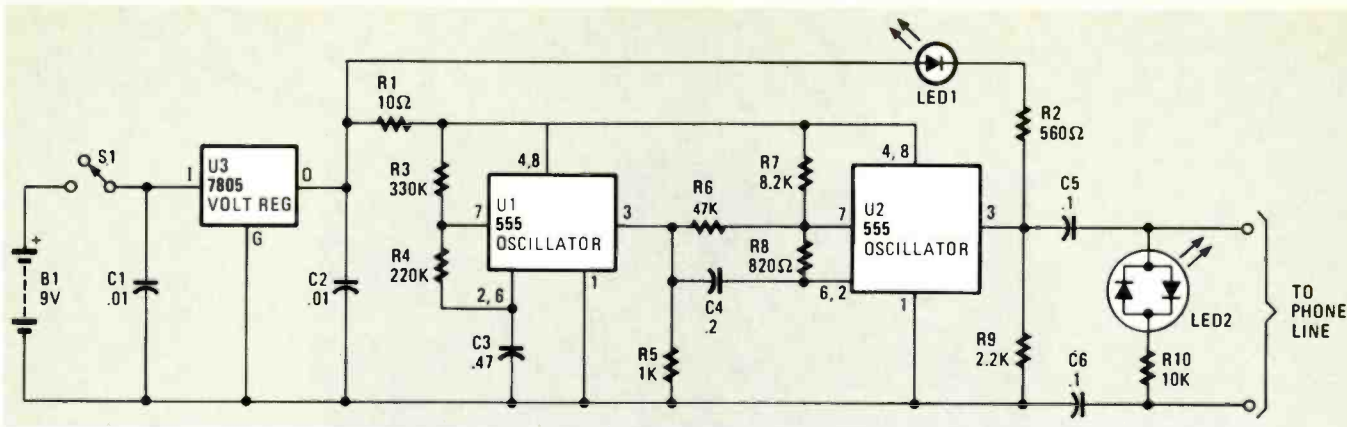

Fig. 1—If the use of a voltage regulator seems a bit drastic to you, try using a Zener diode rated close to five volts in parallel to the circuit, and a current-limiting resistor in series with the battery.

is higher, since the timing capacitor (C4) is set to discharge to the output of U1 rather than ground. Without going through the math, that has the effect of changing both U2's high and low frequencies by a factor related to the duty cycle of U1—about 3.

By having the output of U1 modulate the discharge threshold of U2, the output frequency of the Test-A-Matic will switch back and forth between approximately 710 and 2100 Hz at a 4-Hz rate. The result of all that is a very distinctive signal that can be easily identified when you're trying to ring out lines. Light-emitting diode LED1 is really only in the circuit to show that it's working. (If there's no speaker on the line, it's nice to be able to have an indication that the unit is working.)

The Test-A-Matic uses two separate 555's but you can cut down on the number of parts by replacing both of them with one 556 dual timer. All the rest of the components will remain the same. The circuit has to be powered by 5 volts; and one way to do it is, as shown in the schematic diagram (Fig. 1), by feeding a 7805 regulator chip with a nine-volt battery. When the circuit is operating it will draw about 100 milliamperes. That is much too much current to get directly from the phone line. If you want to power the Test-A-Matic from the phone line, replace the two 555's with 7555's, the CMOS version of the chips. That will cut the amount of operating current down to a maximum of about 15 milliamps—well within the phone line's capacity.

**PARTS LIST FOR THE TEST-A-MATIC**

**SEMICONDUCTORS**

- LED1—Light-emitting diode, jumbo red
- LED2—Light-emitting diode, tri-color
- U1—7805 5-volt regulator, integrated circuit
- U2, U3—555 timer integrated circuit

**CAPACITORS**

- C1, C2—.01-μF, ceramic disc
- C3—.47-μF, Mylar
- C4—.2-μF, ceramic disc
- C5, C6—.1-μF, ceramic disc

**RESISTORS**

- (All resistors are ¼ watt, 10% units.)
- R1—10-ohm
  - R2—560-ohm
  - R3—330,000-ohm
  - R4—220,000-ohm
  - R5—1000-ohm
  - R6—47,000-ohm
  - R7—8200-ohm
  - R8—820-ohm
  - R9—2200-ohm
  - R10—10,000-ohm

**ADDITIONAL PARTS AND MATERIALS**

- S1—SPST, slide or toggle switch
- B1—9-volt, transistor-radio battery
- Battery clip, hookup wire, alligator clips, modular plug (see text), solder, etc.

While it may seem slicker to have the Test-A-Matic line powered, it turns out to be less than terrific in actual practice. By building the unit as shown, you can use it for things other than phone lines. As a matter of fact, it's nice to be able to ring out lines *before* they're tied into an active phone line.

Using tri-colored light-emitting diodes (LED2) is a handy way to make sure that the polarity of the phone line is correct. Since it's connected in the circuit after the two decoupling capacitors C5 and C6, it will be powered only by the voltage on the phone line. That means the Test-A-Matic can be turned off and you'll still be able to check line polarity.

**Construction**

When you assemble the Test-A-Matic, you should make sure that the tri-color light-emitting diode, LED2, is wired to be green when the polarity is correct and red when it's reversed. That isn't a hard and fast rule, but it's a lot easier to remember that green means correct, or "go." The easiest way

(Continued on page 100)

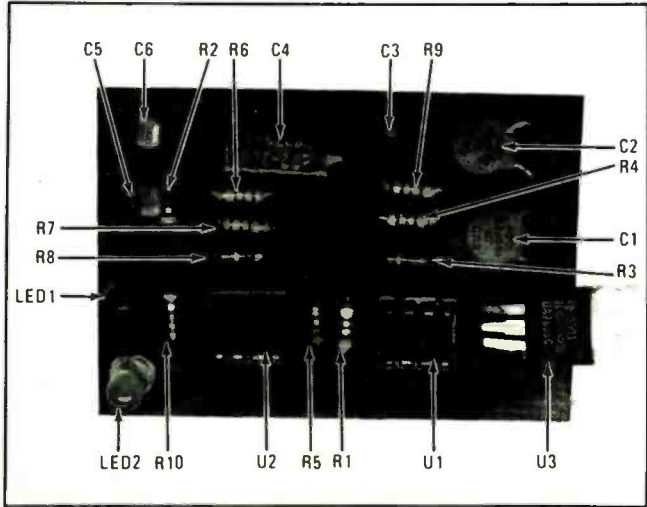

Parts location for the Test-A-Matic layout used by the author.

# JOYSTICKS & TRACKBALLS

**Although most joysticks and trackballs look alike, internally they can be as different as night and day—and no joy to fix if you don't know what to look for.**

By Victor Meeldijk

**V**IRTUALLY EVERY COMPUTER, FROM THE SIMPLE ONES intended for home-and-family use to those intended for the business office, make provision for some kind of joystick or trackball controller. Although there are only a few trackball models generally available, there are several varieties of joysticks, which differ not only in the way they are wired—some for Commodore, Atari, or the TI 99/4A Computer—but in their internal and external construction.

There are two common types of joysticks. One is simply a collection of 5 switches: One switch for each movement of *up*, *down*, *left*, *right*, and *fire* (an additional switch is added if an extra *fire* button is provided). It's the kind of joystick used for the Atari, Commodore, and TI 99/4A computers.

The other design uses center-tapped variable resistors or potentiometers to cause resistance changes when the joystick is operated. It is used for such computers as the Radio Shack TRS-80's. Because of the limited application of the variable-resistance joystick, we'll concentrate on the more prevalent kind—those employing switching systems.

Photos 1 and 2 show the TI joystick. The switch is made up of the conductive fingers on a flexible circuit card and a conductive spot on the joystick housing. As the joystick's lever arm is moved, the rim of the lever presses on a piece of foam which shorts the conductive fingers via the spot on the housing. Depending on how the joystick is moved, the switches short an *ENABLE* line to different circuits in the TI computer.

Diodes in series with the switches are used to prevent unusual computer operation in case two TI joysticks are activated at the same time.

Photo 3 and 4 show a unit similar to the one supplied with Atari computers. The switches are the *snap-dome* kind, which is the type used for key-switches in most better-quality calculators. When the metal dome is depressed by a plastic assembly inside the handle, it shorts conductive traces on a printed-circuit card. Although both the TI and Atari joysticks

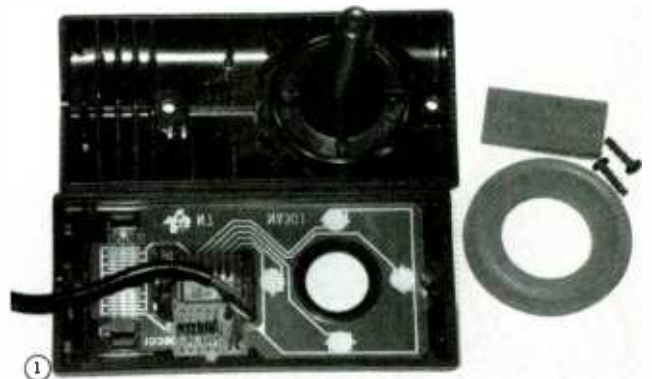

The TI joystick employs a flexible printed circuit for the switch contacts (the large pads arranged in a diamond shape).

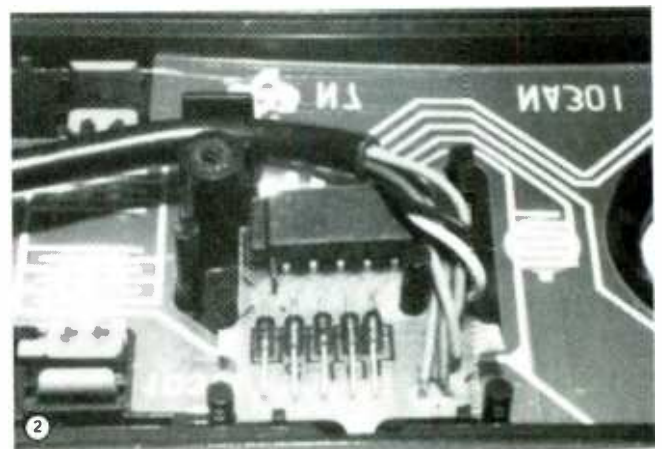

Diodes built into the TI joystick prevent interaction with the contacts of a second joystick, if one is used.

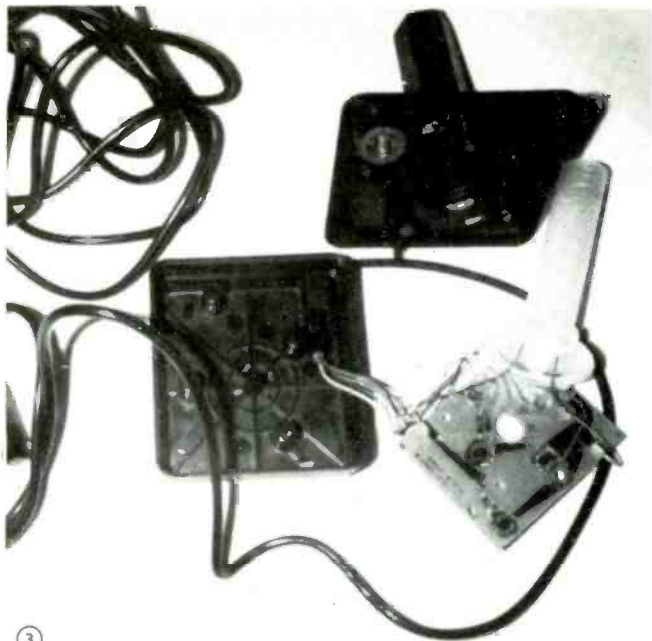

3

Atari type joysticks use a simple form of construction which is made possible by a "bubble switch."

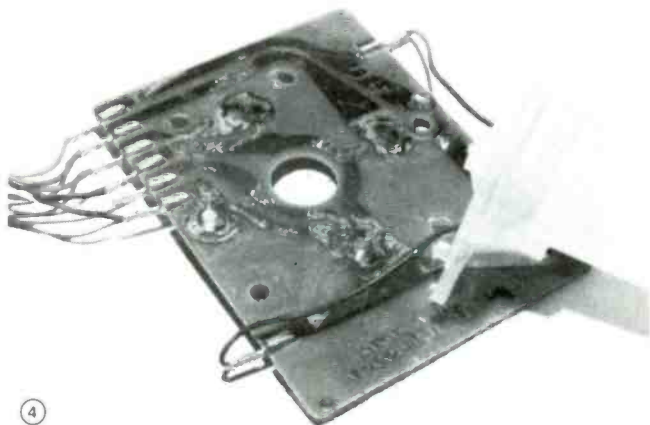

4

The bubble switch is simply a metal dimple that straddles printed-circuit foils. When pressed down by the handle, the bubble shorts-circuits the foil "switch."

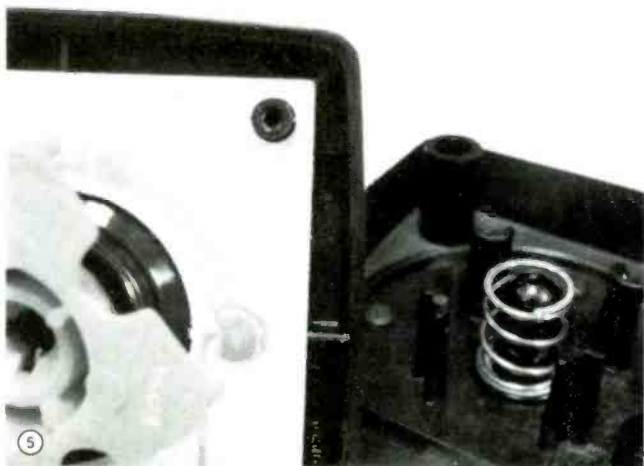

5

More expensive joysticks provide a better "feel" by using a spring to load the handle. The spring tends to snap the handle back to its centered position.

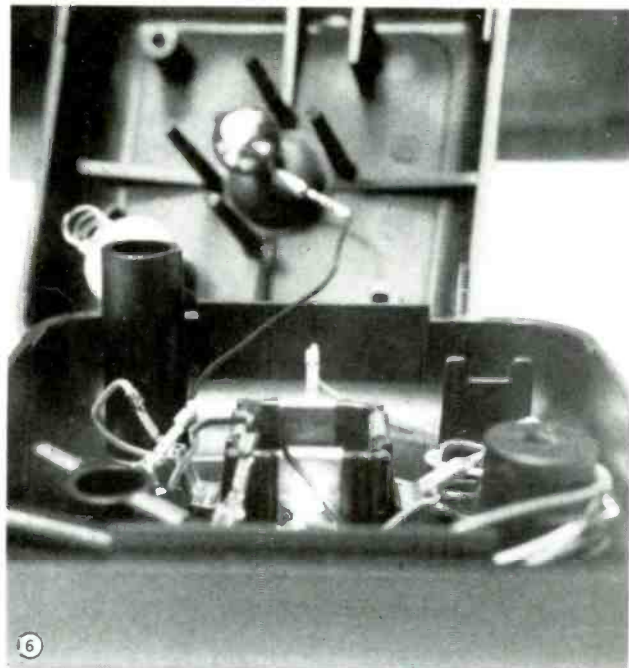

6

The ball-and-plate joystick is unusual but fast-acting. Four metal plates are folded over an insulating box, with a metal ball suspended in the center of the box. Moving the handle just a bit shorts the ball against a switchplate.

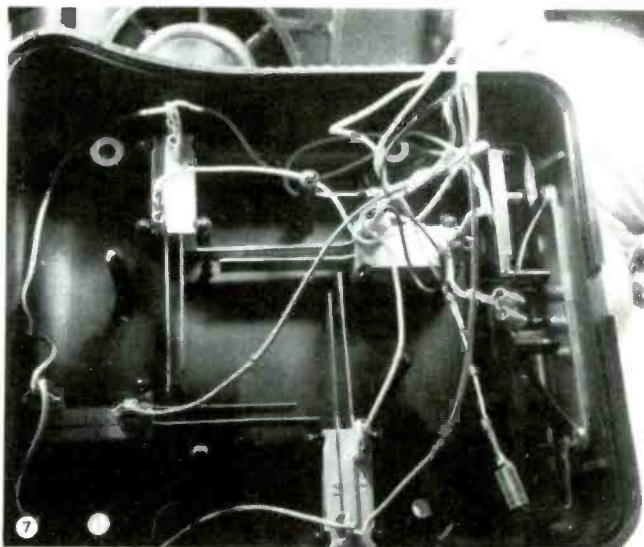

7

Four leaf switches arranged in a box also provide joystick action. The handle is positioned in the center. Moving the handle causes a set of leaf contacts to close.

use switching, the Atari-type electrical design is used to short various circuit connections to ground, rather than to activate ENABLE lines.

Photo 5 is the *Pointmaster* joystick by Discwasher, a design that also uses snap-dome switches. However, a spring has been added to enhance the "feel" of the joystick lever.

Other contact methods used for joysticks include a metal ball attached to the joystick handle, which touches metal plates (Photo 6) arranged in a box-like formation. The design is used in the *Starfighter-Ultimate Joystick* by Suncom Inc.

Metal strips forced together by a plastic hub inside the joystick handle (Photo 7) are used in the *TRI-FIRE PROS-TICK III* by the Newport Controls Division of CAL-TRON.

## Trackballs

The trackball is generally a more precise alternative to the joystick because it permits incremental or semi-incremental adjustments. Photo 8 shows a unit that simulates opening and closing of switches by using LED's and photodetectors. As the trackball is rotated, a plastic assembly moves to allow only one photodetector to be activated for either up/down or left/right movements. Behind this assembly is a slotted disk which spins as the trackball is rotated, constantly interrupting the light falling on the selected photodetector. When light hits the photodetector its resistance drops, simulating a switch closure. The "switch" opens when the light is interrupted.

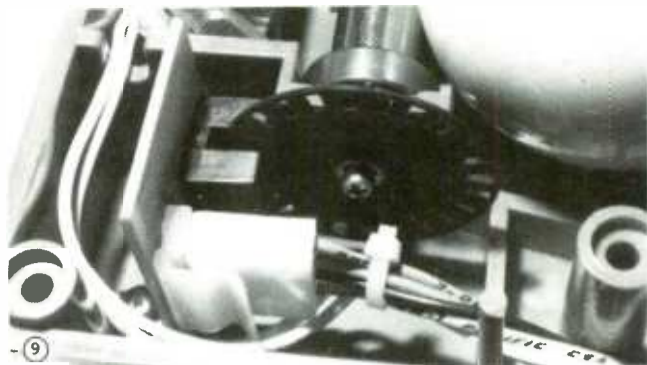

A variation on trackball design also uses two shutters, but the sensing devices are integrated photodetectors, which produce squarewave quadrature waveforms.

### PHOTODETECTOR

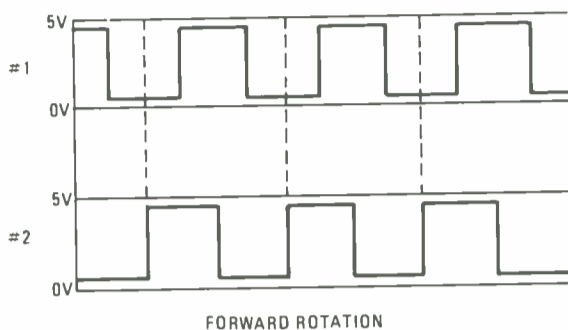

FORWARD ROTATION

### PHOTODETECTOR

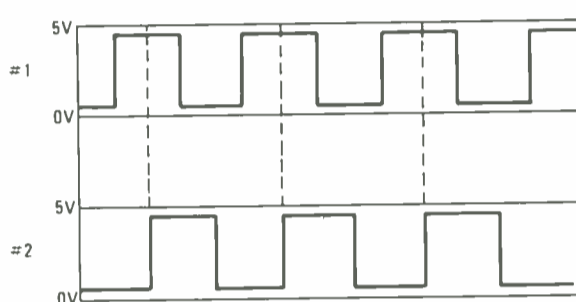

BACKWARD ROTATION

Fig. 1—The quadrature waveforms produced by the electronic trackball depend on the rotation of the ball. Changing the direction of rotation displaces the waveform from the No. 1 detector by 180°.

output provides either a low logic level (as in the case of Atari/Commodore WICO units), or an analog voltage created using a digital-to-analog-converter circuit (ie., the WICO TI 99/4A compatible unit).

Trackballs for industry are also available with interface options such as RS232, serial, parallel, balanced line-driver, or analog voltage output. Also, when precision positioning is needed, the number of pulses or squarewaves produced per ball-revolution is reduced so that it takes many revolutions to represent a small movement.

As a general rule however, when it comes to personal computers you're more likely to come across the conventional trackball designs, which function primarily as "better quality" substitutes for joysticks.

Many joysticks, replacement cords, PC-boards, etc., are available from MCM Electronics; in OH Tel. 800/762-4315, in AL and HA Tel. 800/858-1849, for all else Tel. 800/543-4330.

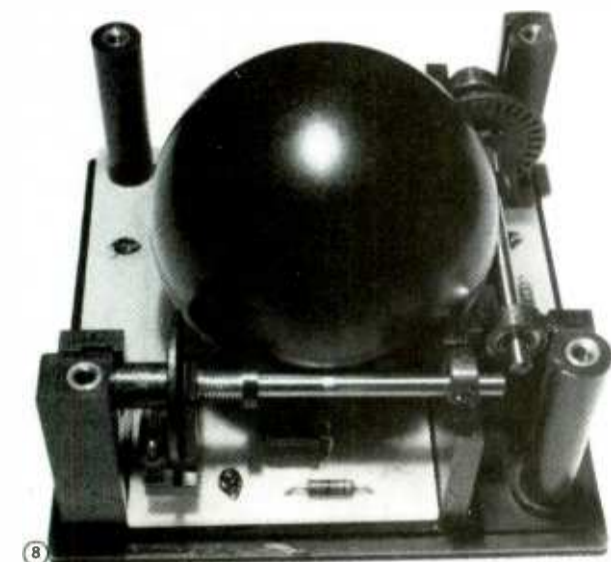

Take the cover off a trackball and it really looks different (top). The ball actually rotates two shutter mechanisms. A close look at a shutter (bottom) shows that it provides an on-off switching action by interrupting the light from an infrared LED that falls on a photodetector.

A similar unit which uses electronics to distinguish up from down and left from right movements is the WICO trackball shown in Photo 9. In that unit, photodetectors produce quadrature waveforms to indicate the direction of travel. A typical pattern used to distinguish the various movements is shown in Fig. 1.

Rather than simulating a switch closure, the trackball

Step 1—Break the power ratio down into factors which appear in the table:

$$32 = 10 \times 3.2$$

Step 2—Add the factor's decibel equivalents:

$$10 \text{ dB} + 5 \text{ dB} = 15 \text{ dB}$$

**Example 5.** What is the gain in decibels if the voltage ratio is 8.0?

Step 1—Change the voltage ratio into the power ratio:

$$\text{Power ratio} = (\text{Voltage ratio})^2$$

$$8^2 = 64$$

and proceed as previously:

$$64 = 10 \times 6.4$$

$$10 \text{ dB} + 8 \text{ dB} = 18 \text{ dB}$$

The next two examples should be used to check your knowledge. Please do them by yourself, then check your answers against the solutions.

**Example 6.** What are the power and voltage ratios of some amplifiers that have gains of: a. 45 dB; b. 32.5 dB; c. 23.7 dB; d. 17.3 dB; e. 12.2 dB.

a. 45 dB = 40 dB + 5 dB

$$\text{Power Ratio} = 10^4 \times 3.2 = 32,000$$

$$\text{Voltage Ratio} = \sqrt{32,000} = 179$$

d. Power Ratio = 2097

$$= 1000 \times 2.09 = 1000 \times 2 \times 1.04$$

$$\text{Gain dB} = 30 \text{ dB} + 3 \text{ dB} + 0.2 \text{ dB} = 33.2 \text{ dB}$$

Before ending, I want to remind you that, you can make the dB-power ratio table containing the voltage as well as the power ratios (see Table 2). That will help in times when you know the voltage rather than the power ratio for a circuit.

Well now that you know how to be calculating, get out there and design away (or at least surprise your friends). ■

TABLE 2  
DECIBELS WITH POWER  
AND VOLTAGE RATIOS

dB	Power Ratio	Voltage Ratio
0	1	1
0.1	1.01	1
0.5	1.12	1.05
0.9	1.23	1.1
1	1.25	1.12
5	3.2	1.78
7	5.0	2.23
10	10.0	3.16
20	10 <sup>2</sup>	10
30	10 <sup>3</sup>	31.6
40	10 <sup>4</sup>	100
80	10 <sup>8</sup>	10,000

# COMPUTING DECIBELS-THE

**You don't have to have the IQ of Einstein to compute dB's without a scientific calculator. Here's a technician's trick everyone should know!**

□ IF YOU'RE A DX'ER, OR A HOBBYIST DESIGNING AN AMPLIFIER or oscillator circuit, and you need to figure out the dB's of gain in the circuit, what do you do? Most would run for the nearest multi-function calculator, and a few to the nearest computer. Wouldn't you rather do it without running anywhere if you could without risking a migraine? Well you can with this simple method, so let's get started.

To refresh your memory, decibels are computed with an equation using a ratio of two powers or voltages. For example, the gain measured in dB's is ten times  $\log_{10}$  of the ratio of

dB is equivalent to a voltage ratio of 10, ( $\sqrt{10^2} = 10$ ); 30 dB gives a 31.6 voltage ratio, ( $\sqrt{10^3} = 31.6$ ), and so on.

First I'll show you how to use that table to convert decibels into their ratios. Secondly, you'll learn how to generate the table anytime you wish without a calculator. And finally, you'll see how to convert either ratio into decibels. Some things to remember: Voltage ratio =  $\sqrt{\text{Power ratio}}$ ; Power ratio = Voltage ratio<sup>2</sup>; adding decibels is like multiplying regular numbers, so break decibels down into additions of their digits; multiplying regular numbers is like adding deci-

## UNIQUE ELECTRONICS

**Television sets that rise from tables, rooms that rotate, and secret panels aren't just in Hollywood movies. This wizard-of-wiring will build them into your own home or office.**

By Jeff Rowe

□ AT THE VENUTO FAMILY HOUSE IN ORANGE COUNTY, Calif., turning on the television set recently became an electronic process in itself.

After opening the wooden doors on a custom-made cabinet to expose a seven-foot diagonal screen, the viewer depresses a button and a platform holding the television projector lowers itself silently from the ceiling. Next, the family selects from among the 150 channels that their satellite dish can receive.

The television project is just part of an integrated electronic package that includes intercoms and sound systems throughout the house, and electronically-controlled gates that can be operated through the telephone system.

All the unique high-tech gadgetry is the work of a Mission Viejo, Calif. company that specializes in electronic wizardry for houses and offices.

Rooms that rotate, secret panels, television sets that rise from tables, closed-circuit television intercoms, and voice-activated bookcases that rotate into bars are just a few of the creations of *Unique Electronics*, a company that owner and chief technician Jim Walin has nurtured from a hobby into a \$1-million business.

"James Bond stuff, that's what we do," said Walin.

As he recalls, the inclination to tinker with electronics began before he started school. "At an early age I was building Rube Goldberg contraptions," said Walin, who after college worked his way up the aviation ladder to a career with Continental Airlines, where he spent 12 years hauling passengers.

But even when Walin was a jumbo-jet pilot, Rube Goldberg continued to walk in his shoes; by 1975, his hobby had grown into a \$15,000-a-year garage business, and Walin—along with two associates—rented some workshop space. When Continental declared bankruptcy in 1983, Walin turned his hobby-job into his new career.

### Anything is Possible

"Given enough time and a deep enough budget, there is no electronic gizmo that Unique cannot make," Walin said.

For example, an Orange County businessman wanted a glass-walled room in his custom-designed house that would rotate so he could gaze across Newport Harbor and then, without getting up or moving the furniture, look at the *media wall*, which includes a large television projection-screen and a stereo system.

Walin designed the room to rotate on a bed of rubber wheels that are driven by an electric motor coupled to a three-speed transmission.

Then there was a record producer who wanted a television set that would drop by the foot of his bed and then tilt to the perfect angle for the weary executive to watch while propped up with pillows.

Making the device that would tilt the set once it deployed was a "fun challenge," Walin recalled; and \$5,300 later, the device worked as the executive wanted.



Even the doorbell and intercom at the front gate to the house are rigged into the house's electronic network.



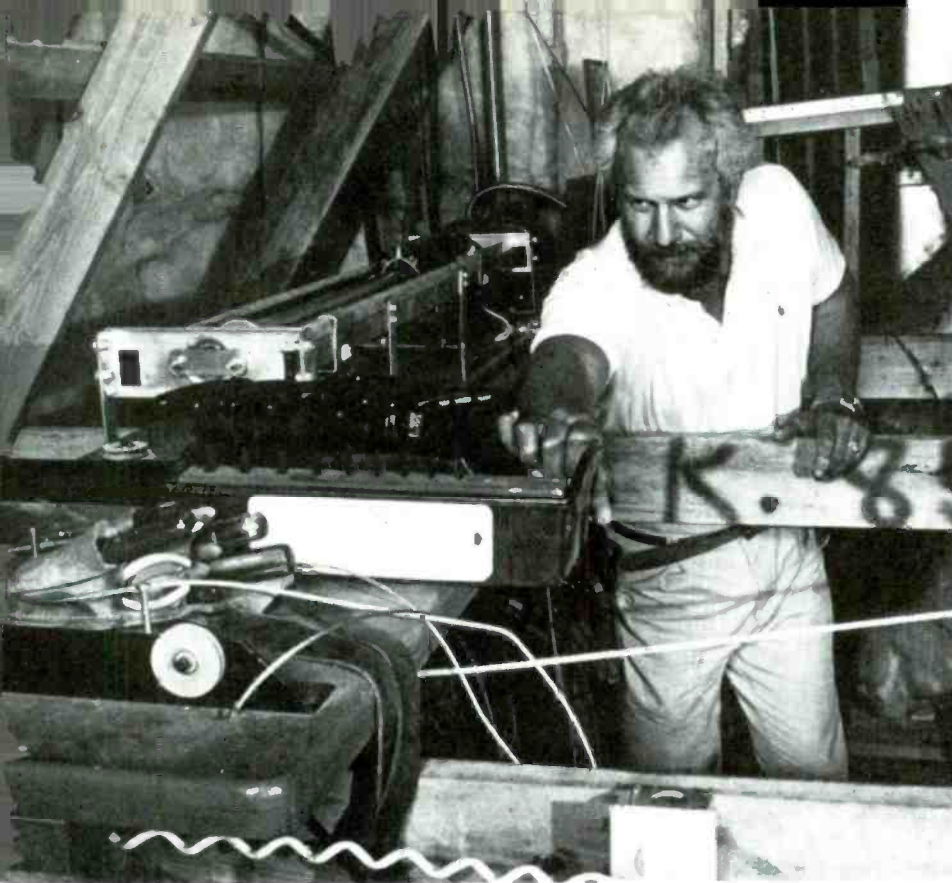

It takes a number of pulleys, wheels, and electric motors to make a platform for a television projector that will descend from the ceiling. Jim Walin makes the final adjustments on such a device in the ceiling of the Venuto family's house in Laguna Niguel.

A circuit panel is the center of the diverse systems in the electronically-controlled house. The intercoms, music and television systems, the electronic gates, and the other electronic gadgets and gizmos are interconnected and wired through the panel.

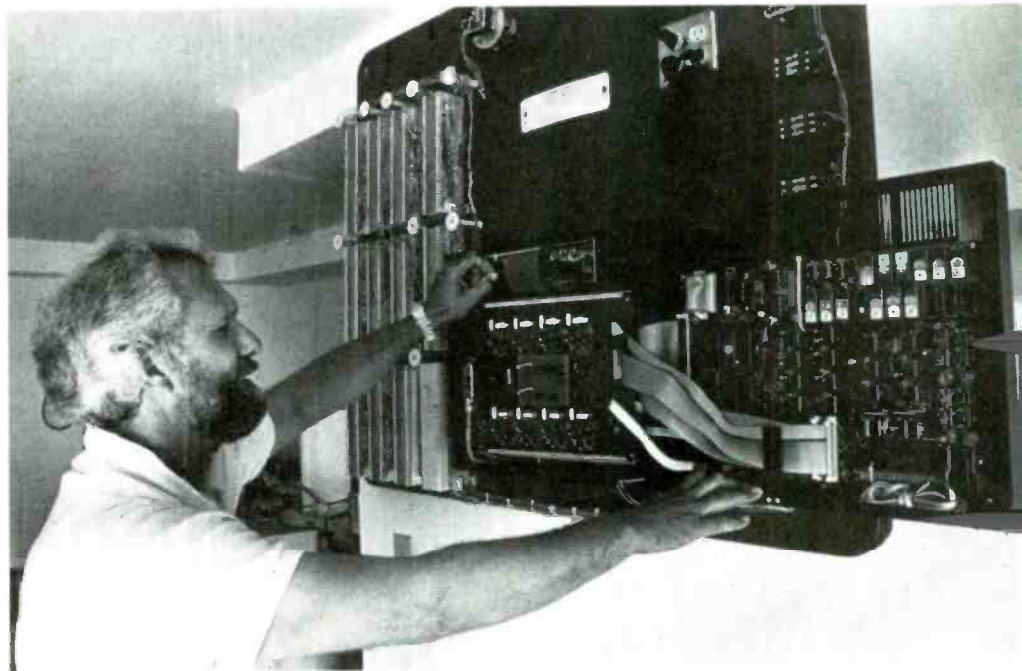

Businesses apparently also like electronic gadgetry.

A current project involves rigging a 6-foot by 4½-foot piece of artwork in a company's corporate offices so that, at the push of a button, it will roll into the ceiling, thus revealing a closed-circuit monitoring system.

A local mortgage company recently commissioned Walin to install two secret doors that, when opened, reveal a bar and an audio-visual center. Then, at the push of a remote-control button, the equipment stows itself, turns out the lights and closes the doors.

Such devices appeal to "neatness freaks," Walin said.

Another neatness nut wanted an uncluttered desk and hired

Walin to do it electronically, without a broom.

No problem, Walin said.

He crafted a device that lifts a computer screen out of the customer's desk when the keyboard is exposed. In another corner of the desk, a television set and a videotape recorder also rise and disappear at the command of a switch.

A mortgage banker had his office rigged with secret doors that open electronically to expose a wet bar and a television set.

Another businessman wanted an automated desk, and so Walin fabricated a system that elevates a computer terminal from the desk top.

Walin and his assistant fit the television projector platform into the ceiling at the Venuto house. It will be raised and lowered by a pulley system.



"They're toys," Walin said. "People like trick electronics."

But unique "toys" can be costly.

### They Take Time to Build

Most systems take about three months to design, build, and install. Unique has nine full-time employees, and uses several subcontractors to do specialized computer, telephone, wood, and metal work.

Television deployment systems generally carry a price tag of from \$3,800 to \$5,300, and it costs \$30,000 to \$50,000 to complete the typical electronically-rigged house: It would have a hidden television set, intercom systems, stereo systems in each room, and specialized cable and telephone systems. All of the systems are integrated through a main computer center.

However, it can cost twice that to really outfit a house with

the finest electronics. Such a house would have satellite-television systems, touch-operated heat, light and security systems; and special effects, such as a secret door or two.

Walin's biggest project came in 1982 when the company outfitted a house with voice-activated systems that control every door and window, environmental controls activated by touch and speech, and remote-control devices to control the array of systems in the house. The complete project cost nearly \$200,000.

Rather than being just a lark for rich people, Walin reckons "smart houses" will become more and more common.

"In the next five to ten years we'll see whole tracts built that will have lighting and heating control on a room-by-room basis," he said. "The energy savings alone would pay for the system in a year or two." In addition, such houses will have security systems. The systems will probably be voice-, keypad-, and touch-activated, and so it would be only natural to connect the appliances to such a switching system, thus creating a house that would put Epcot Center to shame. Unfortunately, voice recognition systems are not so advanced that they can provide adequate security or efficient service in burglar alarm systems, so digital keypads and hidden touch points will dominate the technology for a while.

Hidden touch points are interesting in that you don't have to remember a different combination for each appliance or room, just touch a certain spot and the appliance is activated or deactivated (armed or disarmed for an alarm system). However, touch points cannot be changed as easily as a digital combination, and once someone has seen you operate the device they can do the same, thus while touch-point technology is great for general appliance use, digital-locks are superior for security systems.

Following along with the James Bond theme, such systems will include radar, ultrasonic, infrared, and proximity detection devices, not to mention closed circuit television systems, now that almost everyone has a VCR. Such systems will even dial the police in the event of a break-in, and keep dialing in case they're out at Dunkin' Doughnuts. With such an arsenal not even the Pink Panther would take a shot at your house.

A likely offshoot of this maze of wires, is remote-sensor fire detection. Various detectors throughout the house could be connected to a central power-supply and readout. The readout display could be placed on the outside of the house and contain a map of the house with LED's indicating where the fire is raging within. In this way, the firemen could quickly locate the trouble areas, know how to attack the blaze, plot rescue routes, and how to enter and leave the house in maximum safety. You can talk about monetary security all you want, but a fire detection system like that is what would make me sleep better, not to mention safer.

Despite the prices, the demand for household and office electronics apparently is on a growth curve, Walin said, and he forecasts that the company's revenue will be 30% higher than last year. ■



# Dirijo Corp. Magic Paperweight



**Its mysteries are based on a firm physical concept!**

□ ONCE EVERY GENERATION A PRODUCT appears in the marketplace that captures the imagination of all those who come in contact with it. Sold under the commercial name of Magic Paperweight, the device is essentially the Newton force-field levitation demonstrator that has been the talk of scientists in physics laboratories throughout the world. Used as a curio item, the Magic Paperweight has been the centerpiece of classical Newtonian low-energy field discussions ever since that eventful day a falling apple had the good fortune to *zonk* the originator of gravitation theory.

## Testing by Use

The best way to explain the Magic Paperweight is to describe its use and other varied applications as performed in our testing laboratories. Testing began by following the manufacturer's activation instructions.

The suspensor unit has two operating modes—G-POS and G-NEG. To prevent

possible damage during shipment, the G-POS mode was selected at assembly time. To activate the more desirable G-NEG mode, first remove the suspensor unit's (Fig. 1) elastometer limit stop (if present).

Next, grasp the base in the left hand, the suspensor unit with the right fingers, and remove the elastometer limit stop from the power-guide riser rod with an upward motion. Carefully invert the suspensor unit (thus selecting G-NEG mode), and replace it on the power-guide riser rod. It should now levitate above the truncated-pyramid power base. The details of the Z field cannot be discussed at this academic level, however it can be stated that the force field is at least 10 milli-microgauss.

The suspensor unit elastometer limit stop (if provided) may now be replaced (if desired). The unit is now fully armed to perform its designed and other varied functions.

The testing process continued by performing the normal operational modes.

The Magic Paperweight itself has two main modes of operation, thereby allowing its use on both friendly and unfriendly paper. Examples of friendly paper are money, checks made out to you, notes of admiration from the opposite sex, and any other desirable paper objects. Examples of unfriendly paper are unexpected letters from the I.R.S., bills, pictures of your mother-in-law, junk mail designed to look like big checks, etc.

The friendly holding surface (surface "A") and the aggressor point are clearly shown on Fig. 1 and should be used as directed in the instructions.

Friendly paper may be weighted by placing the item to be held on a flat surface, and then positioning surface "A" of the truncated-pyramid power base upon it. After removing the suspensor unit, unfriendly paper should be violently impaled upon the aggressor point thus venting potentially harmful anger.

**CAUTION! Do not impale hand, posterior, or any other body part on the aggressor point when using the unfriendly mode.**

The suspensor unit may then be replaced in the desired G-NEG or G-POS mode. Periodic observation of the ratio of unfriendly to friendly paper is an excellent indicator of how your day, week, or year is going.

## Optional Functions

In addition to its designed purpose, there are other uses for the device. A few of them are listed below:

*Executive Tranquilizer—Finger Drop:* Grasp suspensor unit, raise to top of power-guide riser rod, release, then attempt to squarely grasp the bouncing suspensor unit.

*Executive Tranquilizer—Knee Bounce:* Place truncated-pyramid power base on knee (suspension unit in G-NEG position—limit stop removed). With rhythmic vertical motion of lower leg and knee, see how long suspensor unit can be kept on power-guide riser rod at maximum bounce. Long-term success at this exercise has been said to indicate great prow-

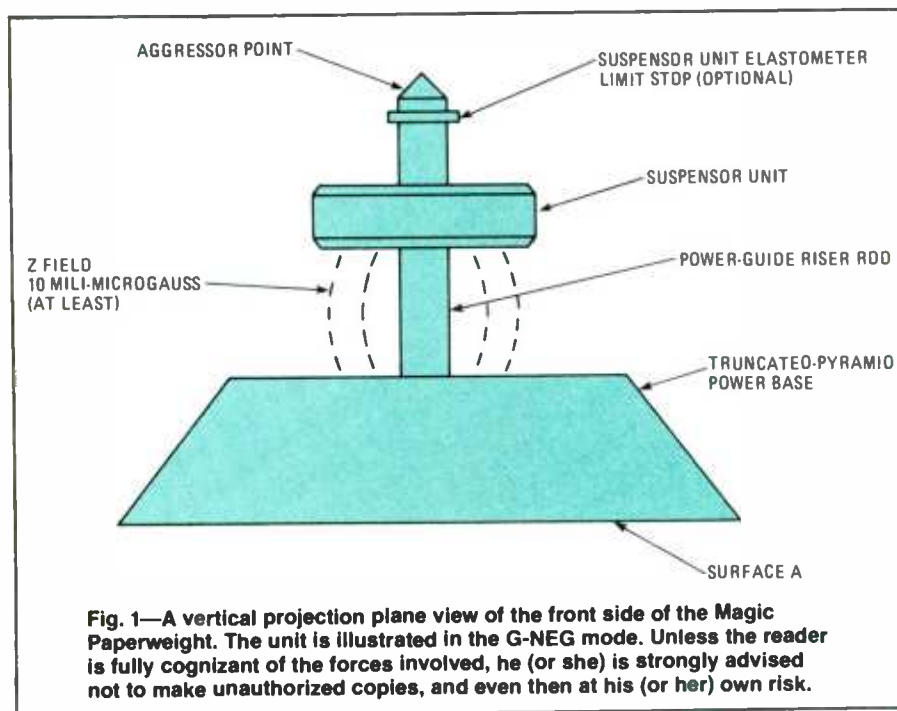

ess for stomping on bugs, bouncing grand children, and other more satisfying activities.

(The user should exercise some caution when attempting the above optional functions. The Executive Tranquilizer exercises may induce a trance-like state similar to "runner's high." If job loss results, set the unit to G-POS and use it to hold down job-application forms, clipped want advertising and resumes.)

**Enthusiastic Motorist Aid:** Unit should be securely and safely mounted on auto dashboard. Remove limit stop and select G-NEG mode for suspensor unit. Observe suspensor unit frequently. If suspensor unit is seen to have left the power-guide riser rod and is sticking to upper portion of windshield trim, two conditions are possible: The last hill was crested too rapidly, or the auto is inverted. Observe the state of the outside world to determine which of foregoing has occurred.

**Patience Enhancer:** Select G-POS mode for suspensor unit. Holding suspensor unit at top of power-guide riser rod, place drop of sugar water or similar sub-

stance on flat upper surface of truncated-pyramid power base near where the power-guide riser rod protrudes. Await first insect. When insect is located beneath suspensor unit, release same, squishing insect. (The technique is a high-tech version of catching a housefly with chopsticks.) Success at that exercise is highly esteemed and indicates the ability to overcome all obstacles in life.

**Broken Pull-Tab Beverage Rescuer:** Remove suspensor unit and all unfriendly paper. Grasp truncated pyramid with surface "A" against your palm. Position can on flat surface and strike with aggressor point, thus forming a drinking hole. Note that the flat, upper surface of the truncated pyramid deflects the resulting spray horizontally, thus cooling your belly on the outside as well.

The above optional uses of the Magic Paperweight are but just a few of the many that can be thought of by a serious researcher and verified in a laboratory. (Should you come up with an outstanding application for the Magic Paperweight, write to the Letters Editor and present your case.)



This photo illustrates the success one can expect when using the Magic Paperweight in the optional Broken Pull-Tab Beverage Rescuer Mode. The technique works equally as well on the new Coke, Pepsi, and RC, as it does on non-cola drinks. Coke, Pepsi, RC, and maybe non-cola drinks are registered trade marks.

TABLE 1—MAGIC PAPERWEIGHT MODE PERFORMANCE RATINGS

Operational Function	Rating
Friendly paperweight	10
Unfriendly paperweight	10
Executive tranquilizer:	
Finger drop	8*
Knee bounce	5*
Enthusiastic motorist aid:	**
Patience Enhancer	10
Broken pull-tab beverage rescuer	2***

\* Lab technician may have had poor coordination.

\*\* Lab technician did not volunteer his car.

\*\*\* Can tipped and soda spilled 3 out of 4 tries.

### Conclusions

The editors can find no fault with the product's design, manufacturer, or application of intended and optional uses, which have been rated and documented in Table 1. A rating scale of 1 (lowest or unsatisfactory) to 10 (highest or excellent) was used.

Further laboratory investigation revealed that the Magic Paperweight was manufactured by American craftsmen in North Carolina. It comes with a lifetime, limited warranty as follows: If the suspensor unit ever fails to levitate due to loss of power in either the truncated-pyramid

power base or said suspensor unit, simply return the complete Magic Paperweight to the manufacturer and he will replace it free of charge. This warranty is limited to power loss only and is void in the case of physical damage to truncated-pyramid power-base assembly or suspensor unit. There is no warranty, implied or otherwise, on the elastometer limit stop.

If you are aroused to purchasing the Magic Paperweight on the strength of this Hands-on Report, you can do so by writing to Dirijo Corporation, P.O. Box 212, Lowel, NC 28098. The price is \$4.95 plus \$2.00 for shipping and handling. The Magic Paperweight makes an excellent April Fool gift. ■

## THREE-MILE HOLE TO DISCOVER MORE ABOUT EARTHQUAKES

□ SCIENTISTS ARE DRILLING A THREE-mile hole near the San Andreas fault in California to try to resolve a paradox that has puzzled researchers for many years—why the surface heat flow measured there doesn't correlate with that predicted by all models of the fault.

The drilling project will enable scientists and engineers to test and sample environments near zones where active forces deform—crush and stretch—the rocks. The 16,000-foot hole, equipped with ultra-sensitive instruments, will be established as a deep earth observatory to monitor the San Andreas fault for the next several decades.

Drilling enables scientists to sample directly and test the structure and physical properties of the earth's crust where it has been deformed, indicating that an earthquake could follow. Once cause of earthquakes, scientists believe, is the sudden release of energy that has been built up

when large segments of the earth's crust, called plates, become dislocated as they rub against each other.

The drill site is near Cajon Pass in California about 60 miles northeast of Los Angeles and about three miles northeast of the San Andreas Fault, the most seismically active system in the United States. The fault passes within a few miles of two of this country's largest metropolitan areas, Los Angeles and San Francisco, posing a continual earthquake threat. The drill site is not located directly on the fault zone because the rocks there are too crushed and broken from the fault motion to permit the required drilling and downhole stress testing.

Scientific studies indicate that movement along the fault has been extraordinarily constant over the past thousand years. Major earthquakes have occurred regularly in the Cajon Pass area about every 140 years. Intermediate-size quakes

occur with even greater regularity along the central portion of the fault.

Those observations suggest that well-designed experiments in drill holes can develop a degree of predictability of fault motion. To do so, it is necessary to penetrate into the earth's crust and determine actual downhole temperature, the magnitude and orientation of subsurface forces, and rock and fluid properties which control rock deformation and failure. In addition, drilling provides a record of changes over millions of years of geologic time; data that laboratory experiments cannot provide.

Drilling at Cajon Pass, which began last December, is the first of major drilling activities to be conducted by Deep Observation and Sampling of the Earth's Continental Crust, Inc. (DOSECC), a corporation headquartered in Washington, D.C. and formed by a consortium of universities. ■

# Electronic Fundamentals

By Louis E. Frenzel, Jr.

**Unlike passive components which simply react to externally applied voltages and currents, active devices amplify, rectify, control, or in some other way modify a voltage or current.**

□ ONE OF THE INTERESTING THINGS ABOUT SOLID-STATE devices—in particular, transistors—is that you can *guesstimate* parts values based on your previous experience with the device and come up with a circuit that will work. It might not be the most efficient circuit, nor the most effective for a particular use, but it *will* work. At the very minimum, the *guesstimated* values won't cause anything to burn up.

But for critical operation—when you want or need maximum efficiency or performance—circuits must be designed within the parameters of a specific device; and to do that, you have to understand how the device works.

To help you squeeze the most performance from solid-state components, this month's lesson covers those types most commonly used: bi-polar transistors and the FET family.

Our lesson uses the *programmed instruction format*, whereby the information is presented to you in chunks called *frames*. You will read the information in each frame and then immediately answer a question based on the material, by filling in a question blank(s) with appropriate words or figures. The answer to each question is given in parentheses at the beginning of the next frame in the sequence.

As you progress through the lesson, use a sheet of paper to keep the frame immediately below the one you are reading covered, so that you won't accidentally see the answer. The easiest way to do that is to slide the paper down until it just touches the line separating the frames.

We hope that you enjoy learning about electronics through programmed instruction. Start now with frame 1.

## Diodes and Transistors

1. The components we have discussed so far in this series—resistors, inductors, transformers, and capacitors—are referred to as *passive components*. Passive components simply react to any externally applied voltage or current. They neither amplify signals nor create new energy. Passive components are used to make passive circuits with similar characteristics.

*Inductors and capacitors that simply respond to external signals are called \_\_\_\_\_ components.*

2. (passive) Another type of component is the *active device*. An active device amplifies, rectifies, or switches. It has gain, or it controls or modifies a signal in some way. It creates new energy. Typical active components are diodes, transistors, and tubes. Active circuits are formed when active devices are combined with passive components.

\_\_\_\_\_ components amplify or control electrical signals

3. (active)  
Common active components are \_\_\_\_\_, and \_\_\_\_\_.

4. (diodes, transistors, and tubes) In this lesson, we discuss common semiconductor active devices including diodes, bipolar transistors, and FET's (field-effect transistors). Virtually all electronic circuits, discrete components, or integrated circuits, are made up of a combination of those components.

Go to frame 5.

## Semiconductors

5. Diodes and transistors are made of semiconductor materials having a resistance that is somewhere between that of a conductor and an insulator. A good conductor, such as copper or silver, has a very low resistance and electrons flow through it readily. An insulator, such as glass, ceramic, or plastic, has a very high resistance and effectively prevents electron flow. Semiconductors are certain types of materials that have been "doped" so that their resistance or conductivity is carefully controlled. Electrons flow readily, but with some opposition that can be controlled.

*Fill in the blanks below with the material that best fits the description.*

High resistance \_\_\_\_\_.

Low resistance \_\_\_\_\_.

\*This article was derived from the soon-to-be published book *Crash Course in Electronics Technology* by Louis E. Frenzel, Jr. Its use is by the courtesy of the publisher, Howard W. Sams and Co. (Macmillan).

Intermediate resistance \_\_\_\_\_.

6. (insulator, conductor, semiconductor) Some typical semiconductor materials are germanium and silicon. Most early diodes and transistors were germanium devices, but today most semiconductor devices are made of silicon. A newer type of semiconductor material made of gallium and arsenic is called gallium *arsenide* and is abbreviated GaAs. It is used to make light-emitting diodes (LED's) and very high frequency transistors and diodes.

Most diodes and transistors are made of \_\_\_\_\_.

7. (silicon)

Very high frequency semiconductor devices are made of \_\_\_\_\_.

8. (GaAs) There are two basic types of semiconductor material: P-type and N-type. Silicon or GaAs is combined with other substances to form both types. One type of impurity is added to pure silicon to form P-type, while another type of impurity is added to form the N-type. As a result of the "doping," the N-type material has an excess of free electrons, meaning that the majority current-carriers are electrons. In P-type material, the doping causes the majority current-carriers to be *holes*. A hole is the absence of an electron in the atomic structure of P-type silicon material. A hole acts like a positive charge. P-type semiconductor material has an excess of holes to support current flow. Both P- and N- type semiconductors contain both holes and electrons, but only one type of current-carrier predominates in each.

The two types of semiconductor materials are \_\_\_\_\_-type and \_\_\_\_\_-type.

9. (P-type, N-type)

Current flow in N-type silicon is by \_\_\_\_\_.

10. (electrons)

Current flow in P-type material is by \_\_\_\_\_.

11. (holes)

A hole is the \_\_\_\_\_ of an electron in the atomic structure of P-type semiconductors. Holes have a \_\_\_\_\_ charge.

12. (absence, positive) Transistors, diodes, integrated circuits, and other devices are formed by combining P- and N-type semiconductors in various ways. Let's see how.

Go to frame 13.

## Diodes

13. A diode is created by joining P-type and N-type semiconductors, as shown Fig. 1. The P-type element is called the *anode* while the N-type element is called the *cathode*. The

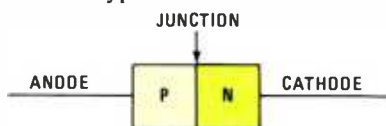

Fig. 1—A junction diode is formed by joining P- and N-type semiconductor materials.

area where the two elements come together is referred to as a *PN junction*. Diodes made that way are called *junction diodes*. Figure 2 shows the symbol used to represent a PN junction diode in schematic diagrams.

The contact surface between the P- and N-type materials is called the \_\_\_\_\_.

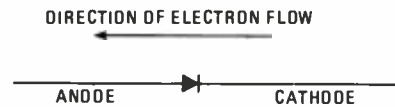

Fig. 2—This is the symbol that is generally used to represent a diode in schematic diagrams.

14. (junction) Most diodes are packaged in a small plastic or glass cylinder with wire leads, as shown in Fig. 3. A band around one end of the cylinder marks the cathode lead.

The lead opposite the banded end is the \_\_\_\_\_.

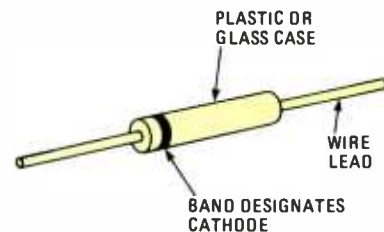

Fig. 3—This is the typical diode package. The cathode end is always marked by a band or symbol.

15. (anode) A junction diode has unilateral characteristics, which means that current will flow through it easily in one direction, but will be blocked in the other direction.

Assume that we apply a DC voltage to the junction diode, as shown in Fig. 4A. The voltage is called *bias*. Series-resistor R1 limits the current to a safe value. Electrons flow from the negative terminal of the battery into the N-type material. If the battery voltage is high enough to overcome an inherent potential *barrier* associated with the junction, the electrons will cross the junction and fill the holes in the P-type material. As the holes are filled, new holes are formed as electrons are pulled from the P-type material by the positive

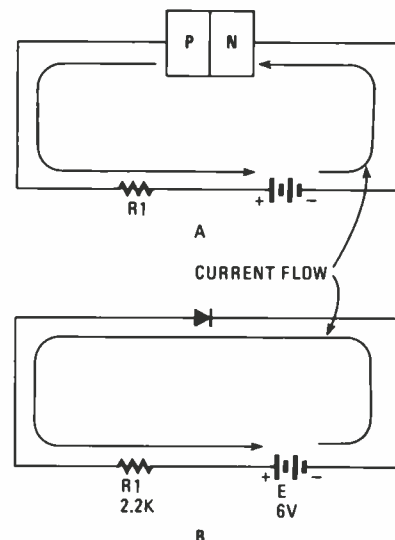

Fig. 4—Current flows in the circuit when a forward bias is applied to a junction diode.

terminal of the battery. The result is a continuous current flow through the diode. The condition that permits the current flow is known as *forward bias*.

Refer to Fig. 4B. To bias a junction diode into conduction, the anode (P) must be connected to the \_\_\_\_\_ terminal of the battery and the cathode of the diode is connected to the \_\_\_\_\_ battery terminal.

16. (positive, negative) When a PN junction diode is forward-biased, a continuous flow of current passes through the device. The current is effectively limited by the external circuit resistance. A voltage drop of approximately .7 volts occurs across a forward-biased silicon diode. The voltage drop is essentially constant regardless of the amount of current flow. The drop across a conducting germanium diode is approximately .3 volt.

In the circuit of Fig. 4B, the current is \_\_\_\_\_ mA.

17. (2.4) The diode in Fig. 4B is forward-biased because the polarity of the applied voltage is correct, so current flows. The amount of current flow is determined by the resistance, the battery voltage, and the diode's voltage drop. Assuming a silicon device, the diode drop is .7 volt. As a result, the voltage drop across the resistor is 6 - .7, or 5.3 volts. The current (I) is found by Ohm's law:

$$I = E \div R = 5.3 \div 2.2K = 5.3 \div 2200 \\ = .0024 \text{ amp} = 2.4 \text{ mA}$$

The voltage that causes current to flow in a PN junction diode is called \_\_\_\_\_.

18. (forward bias) A forward-biased diode acts like a very low resistance, therefore, current flows through it freely. But, if the polarity of the applied voltage is reversed, no current flows. The condition is called *reverse bias*.

Refer to Fig. 5. The electrons on the negative terminal of the battery attract holes away from the junction and fill them in the P-type material. The excess electrons in the N-type material are drawn away from the junction by the positive

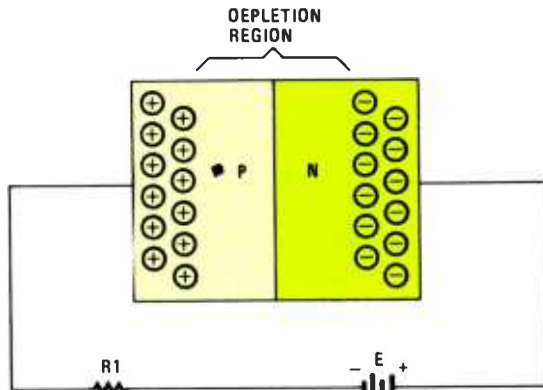

Fig. 5—No circuit current flows when a PN junction is reverse-biased because electrons move away from the junction.

terminal of the battery. The current carriers in the device are drawn away from the junction so there are none to support current flow. (The area around the junction is called the *depletion region*). Therefore, the diode acts as an open circuit. Actually, a small current—called the *leakage current*—does flow across the junction in most diodes. In a good silicon device, leakage current is very low, usually in the nanoam-

per range. For most applications, the leakage is negligible and can be assumed to be zero.

To reverse-bias a diode so that no current flows through it, the anode (P) must be \_\_\_\_\_ with respect to the cathode (N).

19. (negative) If the anode is negative with respect to the cathode, the diode is reverse-biased and no current flows. Refer to Fig. 6. The diode is \_\_\_\_\_-biased. Therefore, current \_\_\_\_\_ (does or does not) flow.

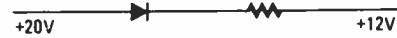

Fig. 6—Bias with only positive voltages applied. The diode will conduct because the cathode is less positive than the anode. We can say the cathode is "negative."

20. (forward, does) The question isn't intended to be tricky, or to trip you, because it is possible for a diode to be biased in that way. In Fig. 6, the anode is more positive than the cathode by 8 volts, so the cathode is negative with respect to the anode; so, forward bias exists and current flows.

Refer to Fig. 7. The diode is \_\_\_\_\_-biased. Current \_\_\_\_\_ (does, does not) flow.



Fig. 7—Bias with only negative voltages applied. No current flows because the cathode is positive to the anode.

21. (reverse, does not) In Fig. 6, both elements have negative voltages on them, but the anode is more negative than the cathode so reverse bias exists and no current flows. Look for similar conditions in other circuits.

Diodes are widely used in electronic circuits. They are used in power supplies as rectifiers to convert AC to DC. They are used in logic and control circuits as switches. They demodulate AM and FM signals in detector circuits. LED's (Light-Emitting Diodes) generate light, and Zener diodes regulate voltages. You will find a diode in virtually every electronic circuit.

. Go to frame 22.

## Bipolar Transistors

22. A transistor is a three-element semiconductor device used for controlling a large current with a smaller current.

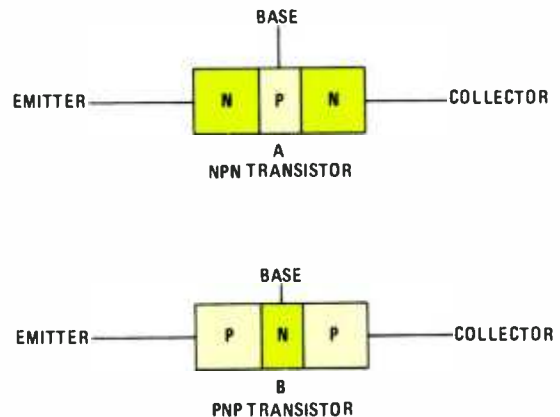

Fig. 8—The two types of bipolar transistors are the NPN, shown in Fig. A, and the PNP shown in Fig. B.

Transistors are used primarily as amplifiers, but are also used as switches. There are two basic types of transistors, *bipolar* and *field effect*. We will discuss bipolars first, the field-effect types will be covered later.

Bipolar transistors are made by combining P- and N-type materials to form two junctions. Figure 8 shows the two types of transistors that can be made. The device in Fig. 8A is an NPN transistor and the device in Fig. 8B is a PNP transistor. The three transistor elements are called the *emitter*, *base*, and *collector*.

In practice, transistors do not have the exact physical geometry shown in Fig. 8, which is just a convenient way to show the general structure; so we will continue to use it here. In reality, the actual physical structure looks more like the one shown in Fig. 9, the arrangement for an NPN transistor.

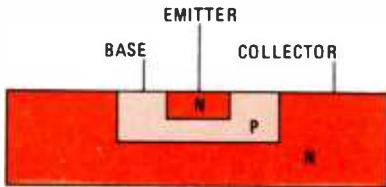

Fig. 9—This is the actual geometry of a transistor.

A bipolar transistor has \_\_\_\_\_ PN junctions.

23. (two) Both NPN and PNP transistors have two PN junctions. Alone, each junction acts like a diode.

The symbols used to represent the two types of transistors in schematic diagrams are shown in Fig. 10. The only difference between the two symbols is the direction of the arrow on the emitter.

The three elements of a transistor are \_\_\_\_\_ and \_\_\_\_\_.

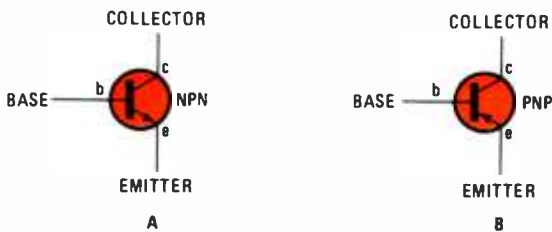

Fig. 10—These are the symbols commonly used to represent NPN (A) and PNP (B) transistors.

24. (emitter, base, collector) Transistors are packaged in a variety of housings. Some of the more common ones are shown in Fig. 11. The TO-5, TO-18, and TO-92 packages are for small-signal applications, while the TO-3 and TO-220 packages are used in high-power applications.

Transistor housings are made of \_\_\_\_\_ or \_\_\_\_\_.

25. (plastic, metal) Current flows through a transistor from the emitter through the base to the collector. Current is holes in a PNP transistor and electrons in an NPN transistor. The presence, absence, or magnitude of the emitter-collector current is dependent upon the existence or magnitude of the base current. The base current controls the emitter-collector current.

The control element in a transistor is the \_\_\_\_\_.

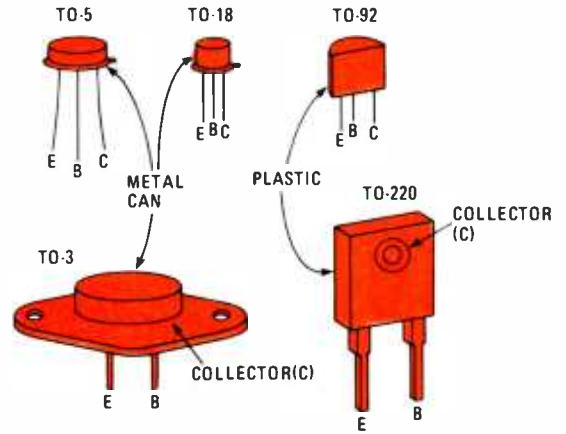

Fig. 11—Transistors use various packaging. These are among the types most commonly used.

26. (base) In order for a transistor to operate, the emitter-base (E-B) and base-collector (B-C) junctions must be properly biased. The transistor will perform correctly when the E-B junction is forward-biased and the B-C junction is reverse-biased.

Refer to Figure 12. The PNP transistor shown is properly biased. True or False? \_\_\_\_\_.

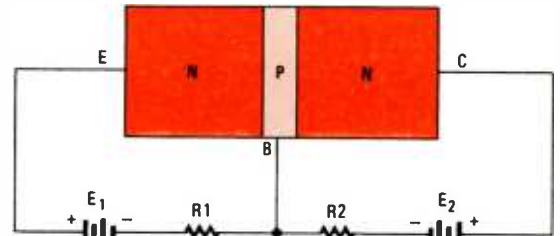

Fig. 12—This is how bias can be applied to both junctions of an NPN transistor using two power sources.

27. (False) The B-C junction is properly reversed-bias (+ to N and - to P), but the E-B junction is reversed-bias. The transistor is cut off and does not conduct current. To forward-bias it, the polarity of battery E1 must be reversed.

Refer to Figure 13. Is the PNP transistor correctly biased? Yes or No? \_\_\_\_\_

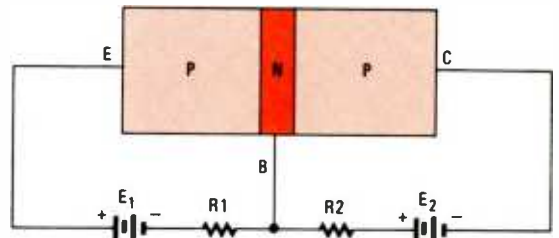

Fig. 13—This is how you bias both junctions of a PNP transistor using two power sources.

28. (Yes) The E-B junction is forward-biased (+ to P and - to N) and the B-C junction is reverse-biased (+ to N and - to P). With that arrangement, emitter-collector current will flow.

In practice, you can measure the voltages and polarities at each transistor element to determine if the transistor is conducting or cut off.

Using what you've learned about bias, determine the status of the transistor in Fig. 14A.



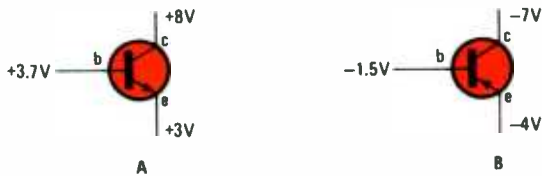

Fig. 14—The status of a transistor can be determined from voltage measurements on the various terminals.

The transistor is an \_\_\_\_\_ and it is \_\_\_\_\_.

29. (NPN, conducting) The base is more positive than the emitter so the E-B junction is forward-biased. Note that the voltage between the emitter and base is .7 volts. The value is the forward voltage drop of a silicon diode. The base is less positive or more negative than the collector by 8 - 3.7, or 4.3 volts; therefore, the B-C junction is reverse-biased. The transistor conducts.

Refer to Fig. 14B. The transistor is a \_\_\_\_\_ and it is \_\_\_\_\_.

30. (PNP, cut-off) Both the E-B and B-C junctions are reverse-biased so the transistor does not conduct.

The actual path for current (electron) flow in a properly biased NPN transistor is shown in Fig. 15. The resistors control the current level.

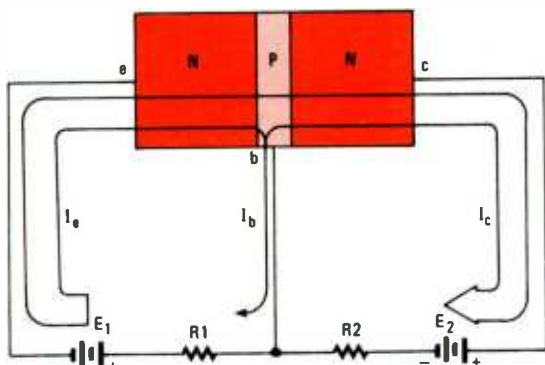

Fig. 15—This is the current (electron) flow in a correctly-biased NPN transistor.

A large emitter current ( $I_e$ ) flows into and through the emitter. It passes into the base and on to the collector. A small amount of emitter current divides off and flows out of the base. The current flow out of the base is the E-B junction forward-bias current, called the *base current* ( $I_b$ ). Its magnitude is usually considerably less than that of the emitter current. The remaining current flows out of the collector. It is called *collector current* ( $I_c$ ).

In Fig. 15, the collector current is:

- a. less than
- b. equal to
- c. greater than

the emitter current.

31. (a. less than) The collector current ( $I_c$ ) is very nearly equal to the emitter current ( $I_e$ ), but is less than the emitter current by an amount equal to the base current ( $I_b$ ). The exact relationship is expressed as:

$$I_c = I_e - I_b$$

Another way to look at it is that the base current splits off from the emitter current, leaving the collector current. Therefore, the base current is the difference between the emitter and collector currents or:

$$I_b = I_e - I_c$$

Since  $I_e$  is made up of  $I_b$  and  $I_c$ , we can say that:

$$I_e = I_c + I_b$$

In a transistor, the smallest current is \_\_\_\_\_ and the largest current \_\_\_\_\_.

32. ( $I_b$ ,  $I_c$ ) You would normally expect current to flow in the E-B circuit because the junction is forward-biased. However, you would not expect current to flow in the collector because the B-C junction is reverse-biased. The electrons flowing in the emitter pass into the base. Some of the electrons combine with holes in the P-type base and create the base-current flow. But most of the electrons pass through the base into the collector because the base is extremely thin and has only a few holes to support current flow. The electrons passing through the base are heavily attracted by the positive charge from the battery on the collector.

Most of the \_\_\_\_\_ current passes through the transistor to become \_\_\_\_\_ current.

33. (emitter, collector) Now let's examine the operation of a PNP transistor. The current flow in a properly biased PNP transistor is as shown in Fig. 16. Remember that the current flow inside a PNP transistor is holes. But in the external circuit the current is electron flow, as indicated by the dashed lines.

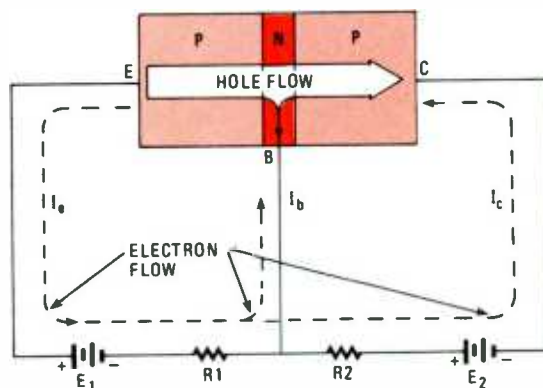

Fig. 16—This is how electrons and holes flow in a correctly-biased PNP transistor.

Inside the PNP transistor, the holes flow from positive to negative. The internal hole currents have the same relationship as electron flow in an NPN transistor:

$$I_c = I_e - I_b$$

The electron flow external to the transistor is best expressed as:

$$I_e = I_c + I_b$$

If the emitter current is 2 mA and the collector current is 1.95 mA, then the base current is \_\_\_\_\_.

34. (.05 mA, or 50  $\mu$ A) The base current is the difference between the emitter and collector currents, or:

$$I_b = I_c - I_e$$

Hence,  $I_b = 2 - 1.95 = .05 \text{ mA}$ , or  $50 \mu\text{A}$

The ratio of the collector-to-emitter current is called the *forward current gain* ( $\alpha$  or *alpha*).

$$\alpha = I_c \div I_e \approx 1: \text{ since } I_c \approx I_e$$

(where the character “ $\approx$ ” means *approximately equal to*)

Values of *alpha* for a practical transistor are in the .95 to .99 range. The higher the gain, the better.

Using the values in the previous example ( $I_e = 2 \text{ mA}$ ,  $I_c = 1.95 \text{ mA}$ ) the current gain “*alpha*” is \_\_\_\_\_.

35. (.975)  $\alpha = I_c \div I_e = 1.95 \div 2 = .975$

Now let's take a look at another way of connecting the bias to a transistor. Refer to Fig. 17.

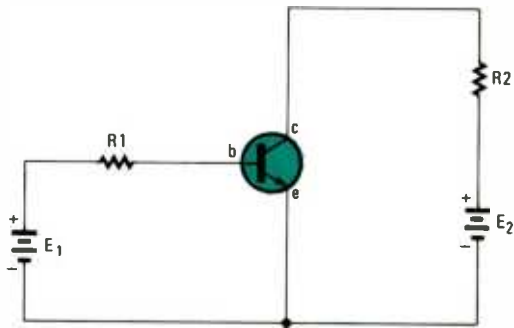

Fig. 17—This is the more commonly-used way to show biasing of an NPN transistor.

Note that the emitter, rather than the base, is the common element for the supply voltages. Look back at Fig. 15 to verify how we used the base as the common element. The circuit in Fig. 15 is called a *common base circuit*, while the circuit in Fig. 17 is referred to as a *common emitter circuit*

The transistor in Fig. 17 is properly biased for conduction. True or False? \_\_\_\_\_

36. (True) Figure 18 shows how current flows. The e-b junction is forward-biased and the b-c junction is reverse-biased. The reverse bias on the b-c junction can be more readily seen if you first consider the voltage on the base. The base is .7 volts more positive than the emitter because of the voltage drop across the forward-biased e-b junction. The

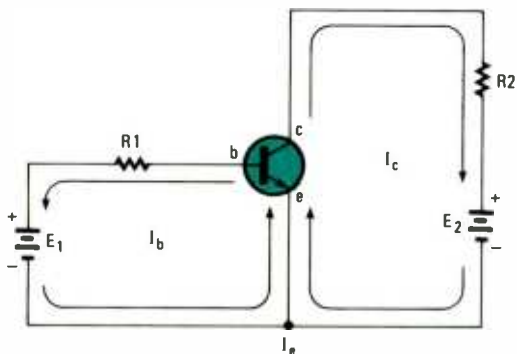

Fig. 18—There are two current loops in a common-emitter circuit that uses an NPN transistor.

collector is more positive than the base with respect to the emitter because E2 is higher than .7 volts. Hence, the base is less positive, or negative, with respect to the collector. The

condition is called *reverse bias*.

Which expression below best describes the relationship between the currents in Figure 18?

- a.  $I_c = I_e + I_b$
- b.  $I_c = I_b + I_e$
- c.  $I_e = I_c + I_b$

37. (c.  $I_e = I_c + I_b$ ) The base and collector currents combine at the emitter to form the emitter current.

Since both bias voltages (E1 and E2) in Fig. 18 are positive with respect to the emitter, they can be replaced by a single battery. (See Fig. 19.) Such an arrangement greatly simplifies the power supply requirements.

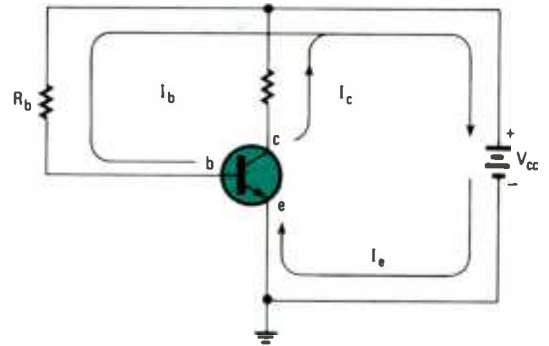

Fig. 19—Resistor  $R_b$  permits a single voltage supply to bias an NPN transistor.

The values of  $R_b$  and  $R_c$  are adjusted to provide the desired bias current. The bias voltage is usually labeled  $V_{cc}$  and is called the *collector supply*.

Refer to Fig. 19. Which expression is correct?

- a.  $I_b < I_c$
- b.  $I_b = I_c$
- c.  $I_b > I_c$

(Note: the symbol “ $>$ ” means “greater than,” while “ $<$ ” means “less than”)

38. (a.  $I_b < I_c$ ) The base current is always less than the collector current, much less.

The *ratio* of the collector current to base current is another way of expressing the gain of a transistor. The ratio is called the *DC forward current gain*: designated as  $\beta$  (beta), or “ $h_{fe}$ .”

$$h_{fe} = \beta = I_c \div I_b$$

The higher this ratio, the higher the gain and the better the transistor.

If  $I_c = 1.95 \text{ mA}$ , and  $I_b = .05 \text{ mA}$ , then beta is \_\_\_\_\_.

39. (39)  $h_{fe} = I_c \div I_b = 1.95 \div .05 = 39$

The current-gain figure actually tells us how much control the base current has over the collector current. Recall that if no base current flows due to a lack of forward bias on the e-b junction, then no collector or emitter current flows: the transistor is cut off. The amount of collector current flowing actually depends upon the amount of base current. The collector current is directly proportional to the base current. Beta is essentially constant for a given transistor, so increasing  $I_b$  increases  $I_c$  by a factor equal to beta.

The forward current gain of a transistor is called \_\_\_\_\_.

40. (beta, or  $h_{fe}$ )

In a common-emitter circuit, if the base current is decreased, the collector current will \_\_\_\_\_.

41. (decrease) Varying the base current causes the collector current to vary in the same way. Because of the transistor's gain, a small base current can control a large collector current. Small-controlling-large is the essence of amplification.

As you vary the base current to control the collector current, the transistor acts like a variable resistor. A low collector current means a high emitter-to-collector resistance, and a high collector current represents a low emitter-to-collector resistance.

A decrease in base current causes the emitter-collector resistance to \_\_\_\_\_.

42. (increase) Decreasing  $I_b$  decreases  $I_c$  so that the transistor conducts less and appears as a higher resistance.

When a transistor is used as an amplifier, a small AC signal varies the base current to produce a larger collector-current variation of the same shape.

Varying the base current causes the transistor to act as a \_\_\_\_\_.

43. (variable resistance) The transistor can also be used as an on-off switch. If no base current is applied, no collector current flows so the transistor is cut off: It acts as an open switch. If a high base current is applied, the transistor conducts and acts like a very low resistance: The transistor appears to be a closed switch. Such transistor switches are used in control circuits and are the basis for many digital logic circuits.

Go to frame 44.

## Field-Effect Transistors

44. The other major type of transistor is the FET (field-effect transistor). Like bipolar transistors, FET's are also made of N and/or P-type semiconductor materials. They are also three-terminal devices in which the resistance or conductance between two terminals is controlled by the voltage on a third terminal. However, the operation of an FET differs completely from the operation of a bipolar transistor. Most FET's are silicon devices, but special FET's for microwave amplification and high speed digital applications are made of gallium arsenide (GaAs).

In a FET, one terminal controls the \_\_\_\_\_ between the two other terminals.

45. (resistance or conductance) There are two basic types of FET's: junction FET's or JFET's; and insulated-gate FET's (IGFET's). Let's begin our discussion with JFET's; we will cover IGFET's later.

A JFET consists of a bar of N-type or P-type semiconductor material. Figure 20 shows a bar of N-type material to which has been connected a 12-volt DC power supply. Resistor R1 sets the current level. The negative end of the bar is called the *source* (S), while the positive end is called the *drain* (D). They are the two main terminals of the JFET.

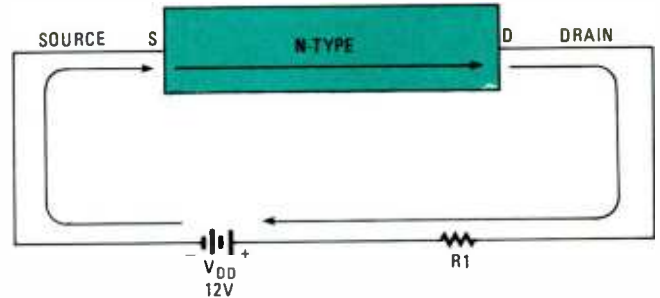

Fig. 20—This is the basic structure of an N-type FET.

Current flows from source to drain, the bar forming a channel for electrons. The supply voltage, called the *drain voltage*, or  $V_{DD}$ , is distributed or dropped evenly along this bar. Halfway down the bar the voltage would be +6 volts with respect to the source. The bar of an N-type semiconductor, called an N-channel, has a resistance whose value is a function of the bar's length, cross-sectional area, and the amount of doping. The resistance value determines the amount of current. Current flow through the bar is electrons as that is the excess current carrier in N-type semiconductors.

In an N-channel JFET, electrons flow from \_\_\_\_\_ to \_\_\_\_\_.

46. (source, drain) To control the source-drain (S-D) current, a third element called a *gate* is added to the bar (as shown in Fig. 21). P-type semiconductor material is diffused into the N-channel bar, forming a PN junction. In Fig. 21, it appears as though two PN junctions exist, but because the two P-type areas are electrically connected, only one junction

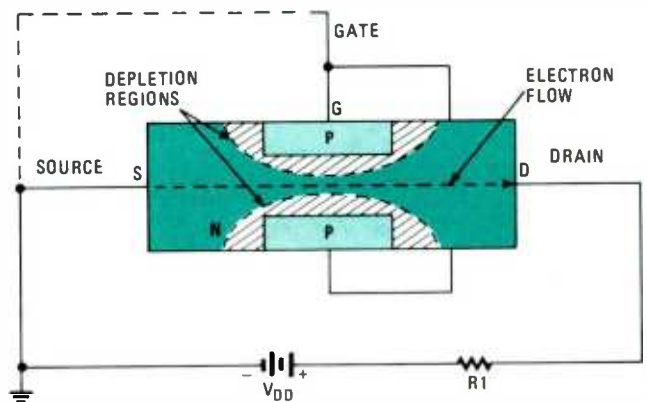

Fig. 21—The gate element of a field-effect transistor controls the source-to-drain current.

exists; thus the name, *junction FET*. The amount of voltage applied between the bar and the source determines the conductance of the FET.

The \_\_\_\_\_ element of a FET controls the \_\_\_\_\_ between source and drain.

47. (gate, resistance or conductance) If the gate is connected to source (ground), the PN junction is reverse biased. The reason it is reverse biased is because the P-type gate is negative while the N-type channel adjacent to the gate is positive due to the distribution of the supply voltage along the N-type bar. The reverse bias sets up a depletion region in the N-type bar that effectively narrows the channel for electron flow, thereby increasing the resistance between source and drain.

The source-to-gate \_\_\_\_\_ controls channel resistance.

48. (bias or voltage) Connecting a voltage (bias) source between the source and gate so that the gate is negative (as shown in Fig. 22) increases the depletion region, narrowing the channel and further increasing its resistance. Increasing the bias voltage increases the resistance, and, of course, reduces the source-drain current, usually called the *drain*

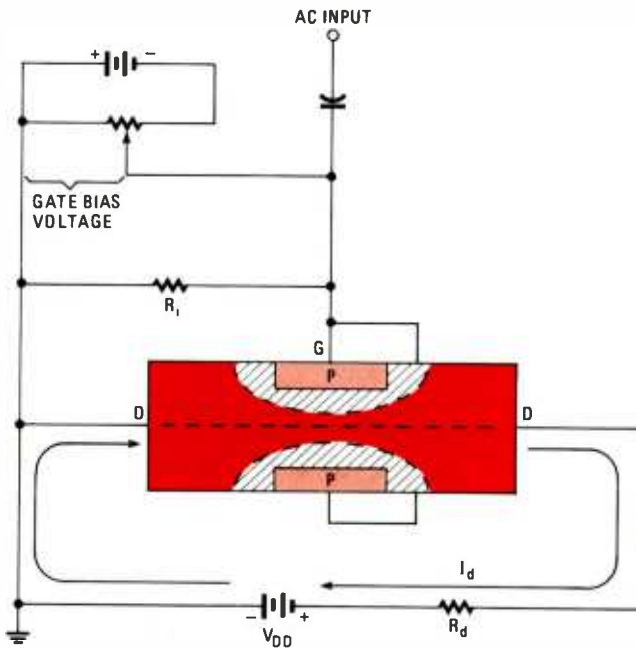

Fig. 22—Varying the gate bias controls the drain current.

current ( $I_d$ ). Decreasing the amount of bias decreases the depletion region, thereby increasing channel width, decreasing the source-drain resistance, and increasing current flow. The more negative the gate bias, the \_\_\_\_\_ the source—drain resistance and the \_\_\_\_\_ the current.

49. (higher, lower) An important point here is that since the source-to-gate junction is reverse-biased, no current flows in the gate circuit. But the amount of gate voltage does control the channel resistance.

In most JFET applications, an AC input voltage is connected to the gate along with the DC bias. The AC rides (is superimposed) on the DC bias, as shown in Fig. 23. Therefore, the channel resistance and current varies in accordance with the AC input. In that way, a small input voltage can control the larger source-drain current. Once again, small is controlling large, so it is the principle of amplification in a JFET.

A small AC input voltage controls the larger drain current producing \_\_\_\_\_.

50. (amplification) Because the gate junction is reverse-biased, the small AC input sees a very high input impedance. In fact, the input impedance is the value of the input resistor ( $R_1$  in Fig. 22), which is usually made very high: 1 megohm or greater. In a bipolar transistor, the input signal is applied to the base. Since base current flows, the AC signal sees a low input impedance, which is a disadvantage.

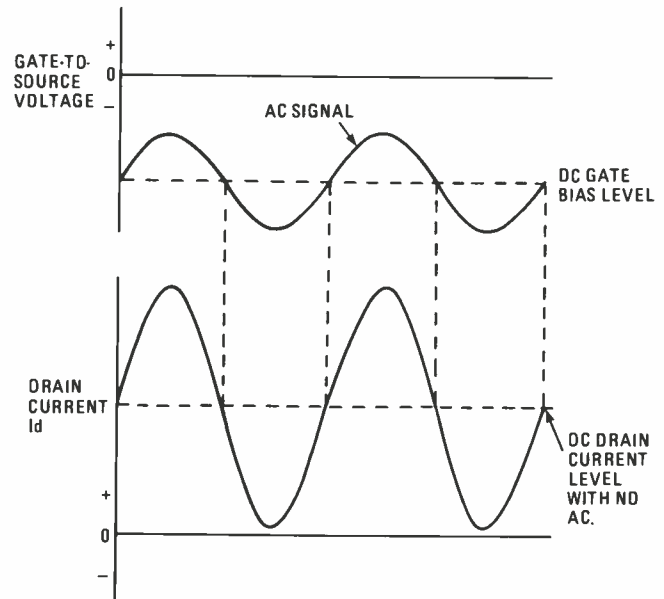

Fig. 23—Variations in a JFET's input voltage translates as a variation in drain (output) current.

A benefit of an FET over a bipolar transistor is \_\_\_\_\_ input impedance.

51. (high) The physical arrangement of the elements of a JFET (shown in Fig. 22) is not used in practice. Instead, a practical JFET has a geometry similar to that shown in Fig. 24. The symbol generally used to represent a FET in schematic diagrams is shown in Fig. 25.

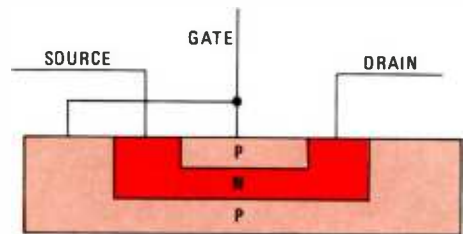

Fig. 24—This is the practical geometry of an N-channel JFET.

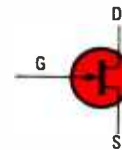

Fig. 25—This is the generally-used schematic symbol for an N-channel JFET.

In Fig. 24, the center element is the \_\_\_\_\_.

52. (gate) It is also possible to make a P-channel FET. A P-type bar of semiconductor material is used and an N-type gate is diffused into it, as shown in Fig. 26. The supply voltage is connected as shown: in that case the drain is negative with respect to the source. Current flow through the P-channel is holes with the direction indicated. In the external circuit, current flow is by electrons. The gate junction is reverse-biased by making it positive with respect to the source (as shown), creating the depletion region which removes carriers (holes), thereby increasing channel resistance.

The symbol for a P-channel JFET is shown in Fig. 27. Note the direction of the arrow compared to the N-channel symbol

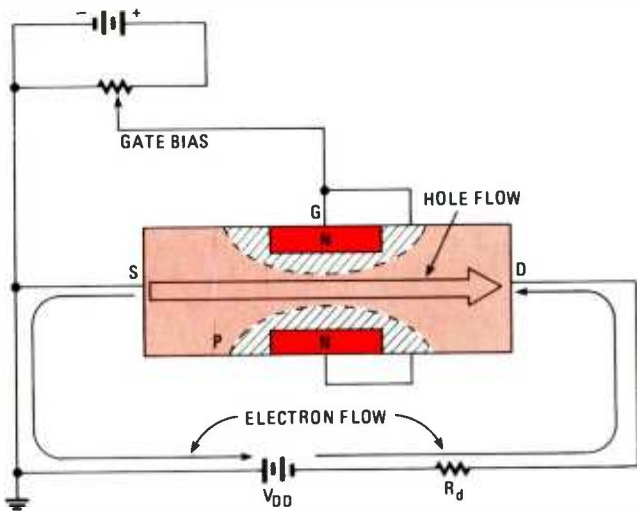

Fig. 26—A P-channel JFET looks as though it's an N-channel with everything reversed.

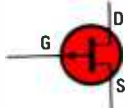

Fig. 27—This is the schematic symbol for a P-type JFET.

in Fig. 25.

Current flow in a P-channel JFET is \_\_\_\_\_ that move from \_\_\_\_\_ to \_\_\_\_\_.

53. (holes, source, drain) Now let's talk about insulated-gate FET's. While their name gives a clue to their structure, they are more widely known as metal-oxide semiconductor FET's, or MOSFET's. MOSFET's are the basic element in most large and very-large scale digital integrated circuits. But, of course, discrete component MOSFET's are also widely used in TV sets, radio transmitters and receivers, and other analog circuits.

An IGFET is better known as a \_\_\_\_\_ FET.

54. (metal-oxide semiconductor) The basic structure of a MOSFET is shown in Fig. 28. Two closely spaced N-type elements are diffused into a P-type substrate (or base) form-

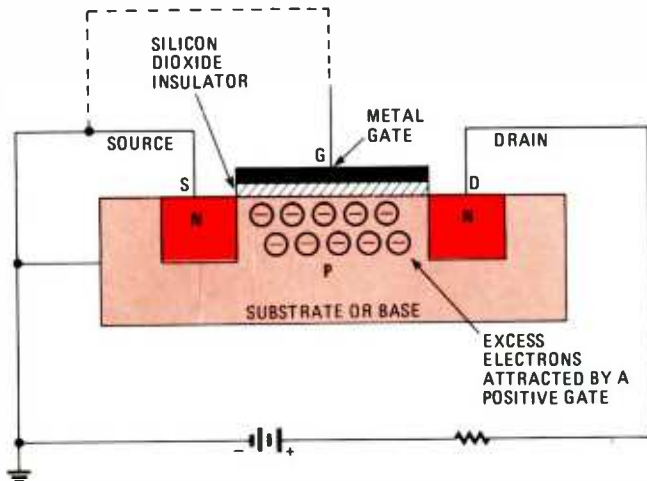

Fig. 28—The basic structure of an N-channel MOSFET. The excess electrons are attracted by a positive gate from a channel between the source and the drain.

ing two PN junctions: the source and the drain. A thin insulating layer of silicon oxide is grown over the substrate between the source and drain. On top of the layer is deposited a small metal plate. The plate is the gate that controls the current flow between the source and drain. The gate is electrically isolated from the substrate and does not form a PN junction with it. Instead, the metal gate and the substrate form a tiny capacitor with the silicon oxide acting as the dielectric.

The gate and substrate form a \_\_\_\_\_.

55. (capacitor) It is the electric field between the gate and substrate that controls current flow. As in other FET's, a voltage is applied between source and drain as indicated in Fig. 28. The substrate is connected to ground. Assume initially that the gate is also grounded. No current flows because the two PN junctions are reverse-biased. As you can see, that is different from a JFET in which source to drain current flows when gate voltage is zero.

If a positive voltage is applied to the gate, the gate-substrate capacitor will charge. The positive charge on the gate attracts electrons in the P-type substrate. The higher the gate voltage, the greater the number of electrons that flow toward the gate. The electrons accumulate between the source and drain near the gate. The excess of electrons makes the P-type substrate act like N-type material, thus forming a channel for electron flow from source to drain.

The gate voltage causes a conducting \_\_\_\_\_ to form between \_\_\_\_\_ and \_\_\_\_\_.

56. (channel, source, drain) The kind of MOSFET operation in frame 55 is known as the *enhancement mode*. As the gate voltage is increased, the channel begins to form. At some gate voltage, called *the threshold*, the channel is completely formed so that current flows from source to drain.

Increasing the gate voltage farther increases the channel and the current flow. Superimposing an AC signal on the DC gate bias voltage will cause the source-to-drain current to follow the AC.

Note that no gate current flows because of the oxide insulation, making for a super-high input impedance that virtually eliminates any load on the driving circuit. The super-high input impedance is a major benefit of a MOSFET.

A MOSFET that conducts after the gate reaches a threshold value is called an \_\_\_\_\_ MOSFET.

57. (enhancement mode) A P-channel MOSFET can be formed by diffusing P-type source and drain elements in an N-type substrate. The insulating oxide and gate are formed on top of the substrate. The source-to-drain supply voltage is applied so that the drain is negative. A negative bias voltage is applied to the gate. Making the gate more negative causes holes in the N-type substrate to collect between source and drain under the gate, forming a conducting channel of holes. Therefore, holes flow from source to drain when the gate-threshold voltage is exceeded. Electrons flow in the external circuit.

The conducting channel in a P-type MOSFET is \_\_\_\_\_.

(Continued on page 106)



By Don Jensen

# JENSEN ON DX'ING

## What's new, and what's coming?

□KVOH. THE STATESIDE STATION OF THE High Adventures Ministries, has been on the air now from Rancho Simi in California since late last year. It had been scheduled to hit the airways earlier in 1986, but problems developed with the transmitter manufacturer. So, the religious organization turned to longtime missionary broadcaster HCJB, the *Voice of the Andes*. The Quito, Ecuador station sold KVOH a 19-year-old, 100-kilowatt RCA shortwave transmitter.

The California-based station is scheduled to broadcast from 1400 to 0800 UTC. Frequencies to try—with a single transmitter, of course (they can only use one at a time)—include 6005, 9525, 9852.5, 11930, 11940, 15250 and 17775 kHz. The station also has operated the shortwave *Voice of Hope* for a number of years from southern Lebanon.

Expected to be operating soon from a transmitter site near Bangor, Maine, is the 500-kilowatt shortwave voice of the well-known Christian Science Monitor newspaper.

The station also has purchased KYOI on the island of Saipan in the Pacific. KYOI formerly broadcast commercial pop-music programs to audiences in Japan.

### Expanding Broadcasts

The *Voice of America* will be adding two new overseas relay transmitter complexes. On Sri Lanka, the Asian island nation off the southern tip of India, the VOA will be setting up shortwave operations near Puttalam.

Last year, the Sri Lankan government asked Voice officials to shift the site of the relay facility from one at Iranawila, near Chilaw, to permit the expansion of teak plantation projects and to avoid having to relocate 200 families at what had been the first-choice site of the VOA engineers.

An even bigger VOA shortwave-relay

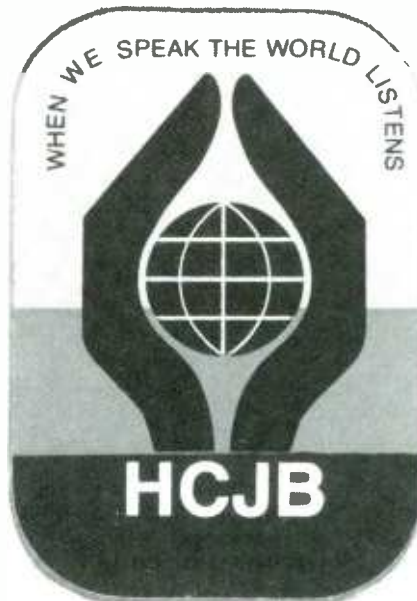

This attractive—in red, white, blue, yellow, and black—sticker is sent to listeners by HCJB (Quito, Ecuador), the pioneer *Voice of the Andes*.

center, with 16 huge, 500-kilowatt transmitters, is to go up in Israel's Negev desert. That installation also will be used by US-operated *Radio Free Europe* and *Radio Liberty*, which direct programming to eastern Europe and the Soviet Union, respectively.

### Station Profile

Broadcasting in Israel dates back to the pre-independence days of 1936, when, under British Mandate, the official *Palestine Broadcasting Service* was established. For that reason, Israeli Radio last year celebrated its 50th anniversary.

While PBS was the official radio, simultaneously there also was a Hebrew underground radio—claimed to be the world's first clandestine broadcaster—serving Palestine's Jewish community from as early as 1938.

Today, the Israeli broadcasting operations use six separate networks, around the clock, with programs on AM and FM radio and TV.

One of those networks is the international shortwave voice, *Kol Israel*—the *Voice of Israel*. It is as old as its home-

land, born on May 14, 1948. Its first live broadcast was the Declaration of Independence of the State of Israel.

Then, however, the overseas programming was identified as *Kol Zion*, and was under the direction of the Jewish Agency. Its programs were intended for the Diaspora—Jews living outside the homeland.

In 1965, though, the foreign radio became part of the Israeli Broadcasting Authority, an independent corporation responsible for all radio broadcasts. Since then, its mission has expanded. *Kol Israel* transmits in 16 languages, including Russian and several other Soviet languages. Those programs, since 1970, have been jammed; but still the station says it has some two-million listeners a week in the USSR.

Nightly English language programs to North America began in the late 1970's. *Kol Israel* uses powerful 50-, 100-, and 300-kilowatt transmitters, broadcasting from a shortwave center on the shores of the Mediterranean.

It has a staff of 100, which prepares the news broadcasts, interviews political leaders and other personalities; and reports on Israeli arts, science, tourism, sports, youth, immigration, and religion. There also are special broadcasts by *Kol Israel* for the religious holidays and the Sabbath.

*Kol Israel* receives about 2000 letters a month from its listeners around the world. Israel Radio broadcasts in English eight times daily, with each transmission kicking off with 10 to 15 minutes of news from Israel and the Middle East.

The programs for North America begin at 0000, 0100, 0200, and 0500 UTC/GMT (equivalent to 7, 8, 9 pm, and midnight, EST). At the time of this writing, the frequencies used for the first three transmissions are 5885, 7465, and 9435 kHz. The late show, intended especially for the west coast, uses 9009, 9435, 11605, and 13725 kHz. To other parts of the world, the station airs broadcasts in English at 1100, 1800, 2000, and 2230 UTC/GMT.

You may send your letters and reception reports to *Kol Israel*, External Services, PO Box 1082, 91010 Jerusalem, Israel.

\* (CREDITS: Dan Sheedy, California; Mike Nikolich, Illinois; John Tuchscherer, Wisconsin; Ori Siegel, Ontario; Tom Manley, Harold Sellers, Ron Hopkins, and David Clark, all of Ontario; North American SW Association, 45 Wildflower Road, Levittown, PA 19057; Ontario DX Association, P.O. Box 161, Station A, Willowdale, Ontario, Canada M2N 5P0)

## Back to Basics

Listeners identify stations by their announcements, of course. But most international broadcasters also use what are called tuning or interval signals.

**Interval signals**—IS, to radio listening hobbyists—may be fragments of a melody, horns, drum beats, chimes, electronic tones, even bird calls. One African station uses a cacophonous collection of barnyard sounds. Each interval signal is distinctive to a particular station, and therefore is useful for identification.

An IS can be heard before a station's sign on or preceding each scheduled transmission. It can be heard between programs, at station-break time. For the Voice of America, the musical signature from Yankee Doodle serves as the IS. *Radio RSA* in South Africa features the call of a native bird, the Bokmakierie, combined with a few bars of a folk melody played on a guitar.

*Voice of Nigeria* has as its tuning signal, the famous *talking drums*. *Vatican Radio* uses the melody, "Christus Vincit," played on the bell-like celeste, with orchestra. Also using a celeste IS, though playing an old Dutch folk song, is *Radio Nederland*.

*Radio Finland* begins its foreign service shortwave programs with a theme from the Karelia Suite by the Finnish composer, Jan Sibelius.

And on the *British Broadcasting Service World Service*, before the start of programs each hour, you'll hear the famed Bow Bells.

The list of interval signals used by the world's broadcasters is long and varied. If you aren't familiar with many of them by now, with a little bit of listening, you soon will be.

## More Basics

Beginning shortwave listeners sometimes are confused by the terms *frequency* and *wavelength*. Both are ways of expressing the same essential information about where to tune for a station.

**Wavelength**—measured in meters—refers to the length of a particular radiowave. These days, however, it survives as a term mostly reserved for references to a particular band of shortwave frequencies, as in 31 meters.

**Frequency**, usually measured in kilohertz today, describes the number of wave cycles-per-second. A shortwave frequency of 9,500 kilohertz (kHz) means that the wave is repeated 9,500 thousand times-per-second. An older term for the same unit is kilocycles per second, or kc/s.

One thousand kHz equals a megahertz (MHz), which may be used interchangeably: 9,500 kHz = 9.5 MHz.

The formulas for converting frequency to wavelength, and vice versa, are: Wavelength ( $\lambda$ ) in meters =  $300,000/\text{kHz}$   
Example:  $300,000/9,500 = 31.68$  meters

Frequency in kHz =  $300,000/\lambda$   
Example:  $300,000/49.0 = 6,122$  kHz

## Down the Dial

These are some of the shortwave stations your fellow DX'ers are hearing. If your reports aren't included, they could be if you drop us a note with information on the stations you are hearing. Times are listed in Universal Coordinated Time (UTC, also known as GMT) and frequencies are in kilohertz (kHz).

**GUATEMALA**—3330. *TGNA, Radio Cultural*, Guatemala City, is a religious broadcaster heard with English language programs—other times it broadcasts in Spanish—about 0315 hours.

**Cameroon**—4850. *Radiodiffusion National* in the Yaounde, is heard with good signals broadcasting its English language news at 5030 hours.

**Haiti**—4930. 4VEH. Cap Haitien, another religious station, turns up here occasionally during the early mornings. You may hear French news at 1100 hours.

**Chad**—5288. Moundou, a provincial city in this west African country has a domestic broadcaster that can be heard on this frequency at about 0500 hours, broadcasting mostly local African and French music.

**Vatican**—6030. *Vatican Radio* follows up its French programming with a brief English program at 0050 hours, which was formerly heard on 6015.

**Spain**—6125. *Radio Espana Exterior* from Madrid is the foreign service of the Spanish national radio. Try tuning this one in at 0100 hours.

**Australia**—6150. *ABC Melbourne*, broadcasts from transmitters at Lyndhurst. The programs, noted around 0830 hours, are intended for Aussie listeners in the inland "outback" and are separate and distinct from the overseas programming of *Radio Australia*.

**Solomon Islands**—S.I.B.S. has been heard at 0800 hours with its interval signal—played on bamboo pipes, but sounding like a horn—and news in the local pidgin language.

**Thailand**—9654. *Radio Thailand* has been noted in the mid-west US at 1135 hours broadcasting its interval signal, with multilingual identifications, and English languages sign on.

**India**—9910. *All India Radio*, Delhi, has English news read by a woman at 2045, followed by Indian music.

**Bangladesh**—13695. *Radio Bangladesh* is India's next door Asian neighbor. Its programming can be noted around 1415 to sign off at 1500. Look for Asian subcontinental music and announcements in the Urdu language.

**South Korea**—*Radio Korea*, Seoul, which recently marked its 33rd anniversary on the air, can be heard in English around 1430 hours.

## ABBREVIATIONS

EST	UTC +5 hours
HCJB	Voice of the Andes (Quito, Ecuador)
IS	Interval signals
KHz	kiloHertz (1000 Hertz or cycles)
PBS	Palestine Broadcasting Service
RSA	Radio South Africa
SIBS	Solomon Islands Broadcasting Service
USSR	Russia (Union of Soviet Socialist Republics)
UTC/GMT	Universal Time Code/ Greenwich Mean Time
VOA	Voice of America
VON	Voice of Nigeria
WWII	World War II (1939-1945)

**Ghana**—4,915 kHz, the *Ghana Broadcasting Corp.* station in the West African city of Accra has been heard here with English news at 2250.

**Antigua**—6,195 kHz, the powerful signal of the *British Broadcasting Corp.* on this frequency, heard both early mornings and evenings, comes from a relay transmitter on this West Indian island.

**Vanuatu**—7,260 kHz, this Pacific island used to be called New Hebrides. *Radio Vanuatu* has been logged from around 1100 until 1125 sign off. It has a parallel, but weaker signal on 3,945 kHz.

**Portugal**—9,680 kHz, *Radio Portugal's* nightly program has been heard starting at 0030. During the half hour that follows, you'll hear some pleasant music and English news.

**North Korea**—9,750 kHz. *Radio Pyongyang's* English language service signs on at 1100. Lots of party-line propaganda here.

**Argentina**—15,000 kHz, *LOL*, the Argentine standard time and frequency stations, rarely can be heard when interference from the U. S. counterpart, WWV on the same channel allows. *LOL* identifies in morse code with voice announcements in Spanish.

Drop me a line and tell me what stations you're logging, their programming, the frequency, and time. Send your info to *JENSEN ON DX'ING, Hands-on Electronics*, 500-B Bi-County Blvd., Farmingdale, NY 11735. ■





By Joseph J. Carr, K4IPV

# CARR ON HAM RADIO

## If the antenna doesn't fit, use a limited-space design

□ FOR ALL BUT A LUCKY FEW, LIVING space costs a bundle. Modern housing is crowded into small city and suburban lots, townhouse developments, and apartment houses. Even where available, the large, expansive, semi-farmette, suburban lot of earlier generations is simply not affordable anymore. So what's the amateur to do? He or she usually needs a lot of room to stretch a VHF sky hook, so how does the townhouse dweller, the row houser, or the small-lot ham operator put up an antenna that will get out?

First, find out if outdoor antennas are even allowable in your community. Almost without exception, outdoor antennas work better than indoor antennas. Not because wood attenuates signals or detunes antennas (it does, but that's not the problem), but because outdoor installations are typically easier to make conform to orthodox designs.

Almost all townhouse communities, and a surprisingly large number of newly-built single-family communities, have restrictive covenants in the deed that sound as if they were written by a lawyer whose cheap TV set receives single-sideband better than it receives the National Football League broadcasts. In those cases, you have fewer options than the operator with no restrictive covenants.

In rare instances it's possible to get around covenants that restrict outdoor antennas. For example, in my home town there was the case of a guy who put up a satellite dish to receive TV signals. After a vigorous court fight, he received permission to put up the antenna if it was disguised. But don't count on lightning striking twice in your town.

### Verticals

The classic limited-space antenna is the vertical, but it can only be used by those who can put up outdoor antennas. My present antenna is a 40 through 10 meter vertical, mounted on a wooden support on the back of my house. Although a vertical antenna appears to take up more space than is needed because of its system of radials, the vertical can be put up in places where other forms of antenna are less than easy...Or impossible. For ground-mounted verticals, we don't destroy backyard living space with radials because we

can bury the radial wires underground.

### Scrunched Dipoles

You've heard of *folded* dipoles? Well I'm going to show you several *scrunched* dipoles for limited space installations, both indoor and outdoor.

The ordinary dipole is a half wavelength radiator that is fed at the center, usually with 75-ohm coaxial cable. The ends of the dipole are supported at some altitude above the ground. The overall length of the dipole, if it is far above the surface of the Earth, is given by the formula:

$$L = 492/F$$

where L is in feet, and F is in megahertz. Because of certain problems however, the practical formula for dipoles close to the Earth's surface have a length of:

$$L = 468/F$$

Even that figure is not totally and always accurate, and some trimming is usually necessary. For the scrunched dipole, the 468/F formula is a starting point for the length.

Figure 1 shows a sloped dipole; a type of antenna used in yards that are too short for a half-wavelength antenna plus support ropes. One end of the dipole is supported at some altitude typical of dipoles; for example, the eaves of your house or a nearby tree (which could also be used to hang the lawyer who wrote the restrictive covenants). The other end of the dipole is tied to the ground. The antenna is a cross between a horizontal dipole and a vertical dipole.

The classic scrunched dipole is shown in Fig. 2. In that case, we see that the radiator is angled in different directions in order to fit it into the available space. Almost any scrunching angle is acceptable, with the understanding that performance is not up to that of the standard dipole. As you can see in Fig. 3, the bent radiators of Fig. 2 can be indoors or outdoors. In the case of Fig. 3, the dipole is mounted inside the attic, and is tacked along the roof beam and the edges of the roof. That approach is usable by most townhouse dwellers.

Scrunched dipoles do not perform as well as a properly installed full-size dipole; but don't worry too much about that fact, however, because the trade-off is hor-

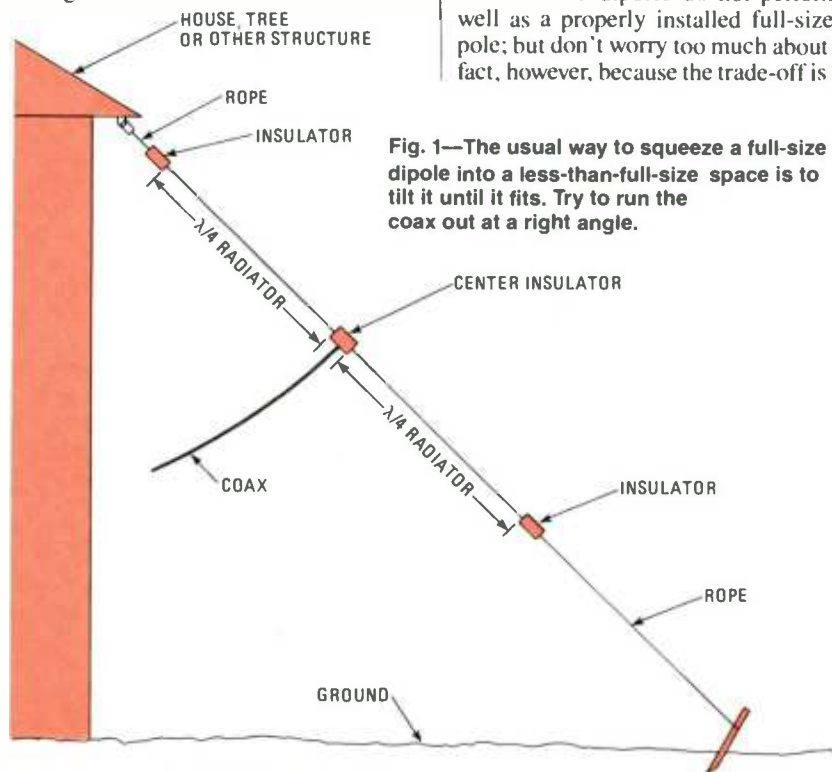
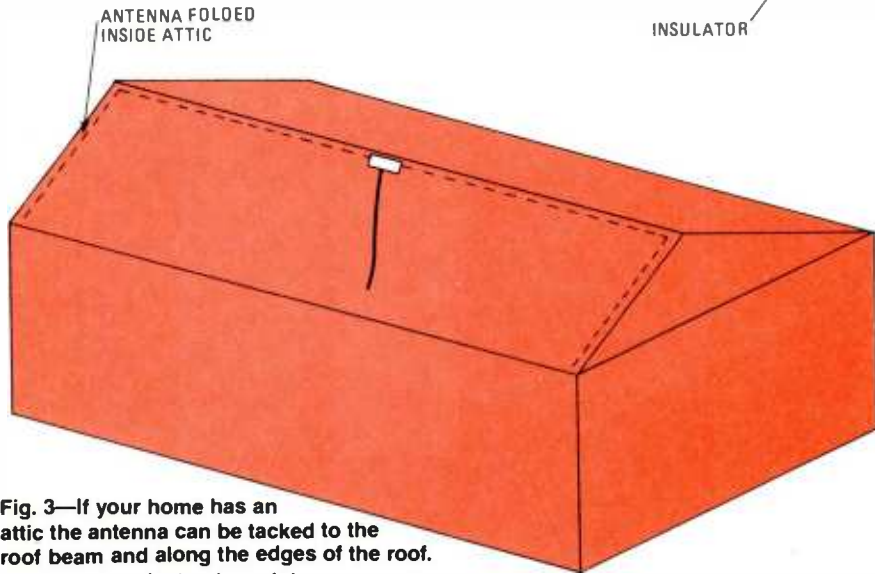
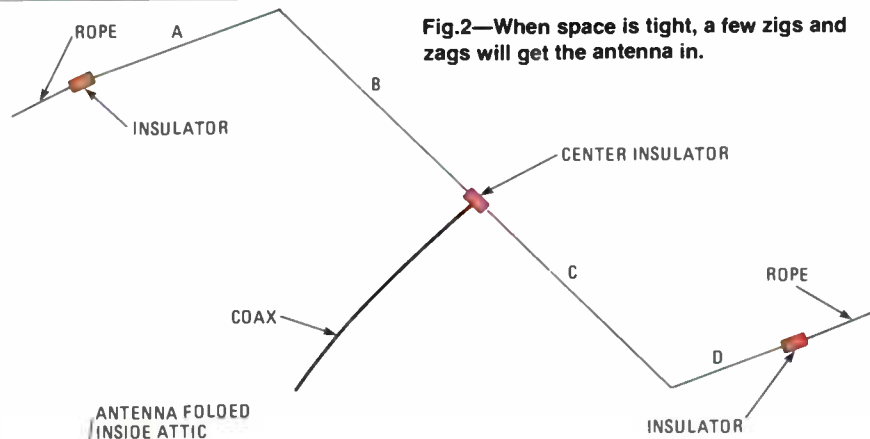

Fig. 1—The usual way to squeeze a full-size dipole into a less-than-full-size space is to tilt it until it fits. Try to run the coax out at a right angle.



**Fig. 2—When space is tight, a few zigs and zags will get the antenna in.**



**Fig. 3—If your home has an attic the antenna can be tacked to the roof beam and along the edges of the roof. An advantage is that it can't be seen.**

rible and too ghastly to contemplate: Going off the air!

Be aware that the feedpoint impedance may not be exactly 75 ohms as the textbooks tell us. But then again, dipole impedance is rarely 75 ohms because it depends in part upon height of the antenna above ground. There are two approaches to the problem. First, buy or build an antenna tuner or transformer that will match the antenna's impedance to either 50-ohm or 75-ohm coaxial cable. Second, ignore it. Unless your rig has solid-state final amplifiers, it won't mind an SWR of 2:1, or even 2.5:1. For example, suppose the feedpoint impedance is 30 ohms, which is not an unreasonable figure; I measured one such dipole at that impedance once. If you use 50-ohm coaxial cable the VSWR is 50:30, or 1.7:1. Even most solid-state final amplifiers will tolerate a 1.7 VSWR.

**Long- and Short-wire Antennas**

Not everyone finds it convenient to put up a scrunched dipole. For those we offer other designs. In Fig. 4 we see a long-wire antenna, and in Fig. 5 a short-wire antenna. The long-wire antenna uses a radiator that is a random length, but is more than a

quarter wavelength. Typically, those antennas are 75 to 100 feet long, and are installed wrapped around backyards. An L-section coupler is used to match the wire's feedpoint impedance to that of the coaxial cable.

The short-wire antenna is merely a 4- to 12-foot length of aluminum pipe or wire hanging out the window. I used one of these in college for a couple of years, and in our first house for a few months. Again, an L-section coupler is used to match the impedances. In most cases, a series coil is

**Fig. 4—An antenna can be electrically lengthened by an L-section tuner.**

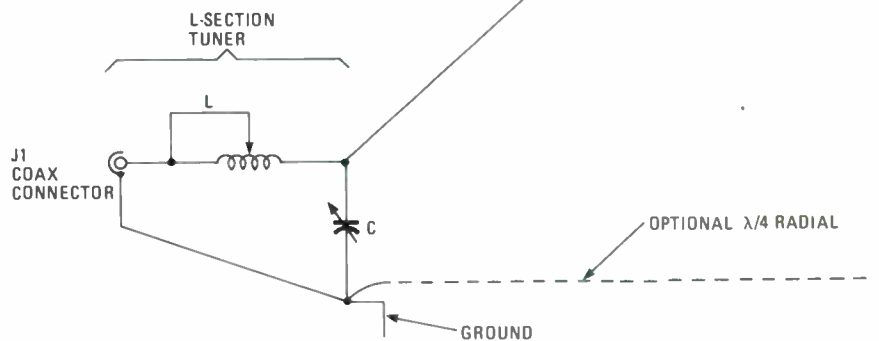

placed at the feed end of the pipe to make up the lost length. (The ARRL handbook has tables for finding the size of a coil needed for specific lengths of pipe.)

The antennas shown in Figs. 4 and 5 both depend upon "...a good ground" to work. Unfortunately, the very factors that make these "apartment-dwellers specials" necessary in the first place also make it impossible to obtain "...a good ground." I found the very concept of "...a good ground" absurd in my third-floor walk-up student boarding-house room. But there was still hope. You can use a single (more works better, but one is OK) quarter wavelength radial to form a counterpoise groundplane. In my case, it was possible to sneak the radial down the outside of the clapboard house. Other students I knew tacked the radial to the baseboard in their rooms (be careful of the far end: it's at a high RF voltage).

The best "apartment dwellers special" that I ever owned, one on which I worked a lot of DX using only 100-watts, was a mobile antenna (Fig. 6) mounted on the window sill. I used a Hustler mobile antenna with three loading coils (15-m, 20-m and 40-m). The 15-m worked best, but I got surprisingly good results on the two lower bands also. Again, one or two quarter wavelength radials work wonders. On my 33 x 75 foot starter-house-lot I first used a short-wire pipe antenna, and then got a "real" antenna: the Hustler with three loading coils mounted on the same shaft. I used two radials each on 15-m and 20-m, and one radial on 40-m (which may explain in part why it didn't work as well on 40).

*(Continued on page 103)*



By Charles D. Rakes

# CIRCUIT CIRCUS

## Home-brew projects teach, as well as entertain

□ THE SIMPLE, UNCOMPLICATED, useful, inexpensive, interesting, and just plain fun. All of those words help to describe this month's collection of circuits, because they're designed for the experimenter who likes to expand, change, modify, and create their own version of a circuit or project.

The heart of the experimental circuits is a home-made two-terminal solid-state component that offers a negative resistance characteristic. So far, that doesn't sound too simple, does it; but once we wade through a minimum of circuit theory, the actual use of the device is true simplicity in itself.

Our home-made, diode-like device can be turned into a voice transmitter, a tone-modulated transmitter, a simple BC (broadcast) receiver, an automatic telephone transmitter, or you can devise your own circuits with a minimum of additional components.

### Home-brew Diodes

The schematic diagram in Fig. 1 shows how our two terminal device is constructed from two JFET transistors: an N-channel and a P-channel unit. The JFET pair is interconnected so that only two leads extend out into the real world. Somewhat like a diode, one lead is referred to as the anode (positive terminal) and the other lead the cathode (negative terminal).

Our two-terminal device exhibits a negative resistance characteristic when certain voltages are applied across its leads. That simply means that as the voltage across the device is increased, the current through it is decreased. After the voltage has increased to a level determined by the two JFET's specifications, the current flow through the pair drops to almost zero and remains at near-cut-off until the voltage is increased to the point where one of the JFET's gate junctions breaks down.

At breakdown, the current through the device increases and should be limited by a series resistor. For all of our circuit experimenting, the device is operated well below the breakdown area, but it's an area where additional experimenting can be performed.

Silicon Valley we're not, but building

your own special diode is no problem. Take a pair of complementary JFET transistors and connect them together as shown in Fig. 1. We used Radio Shack's N-channel (276-2035) and P-channel (2N4342) JFET's to make the diode.

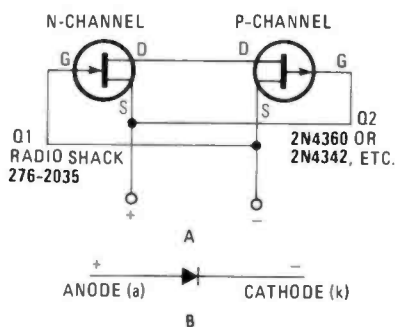

Fig. 1—Home Brew Diode.

### PARTS LIST FOR THE HOME-BREW DIODE

- Q1—N-channel JFET, RS #276-2035, ECG 312 or similar
- Q2—P-channel JFET, 2N4360, 2N4342, or similar

### Audio Transmitter

The circuit in Fig. 2 might be billed as one of the simplest voice-transmission circuits that can be built. Take an L/C tank circuit, couple it with a mike, add our active two-terminal device, and *bingo* a broadcast transmitter is magically produced. If a tunable loopstick is used for

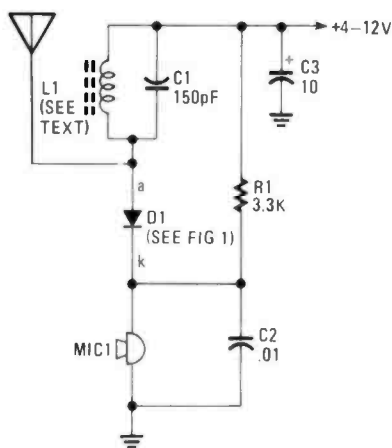

Fig. 2—Audio Transmitter.

### PARTS LIST FOR THE AUDIO TRANSMITTER

- C1—150-pF, 100-WVDC ceramic disc capacitor
- C2—.01- $\mu$ F, 100-WVDC Mylar or similar capacitor
- C3—10- $\mu$ F, 16-WVDC electrolytic capacitor
- D1—(See text and Fig. 1)
- L1—Tunable loopstick ferrite broadcast antenna coil
- MIC1—Telephone carbon microphone element
- R1—3300-ohm  $\frac{1}{4}$ -watt resistor
- Batteries (or plug-in power supply), pull-up antenna, enclosure, wire, solder, etc.

L1, the transmitter can be tuned to any frequency in the broadcast band; and if the high frequency end of the band cannot be reached, just reduce the value of C1.

Any not-in-use telephone, carbon microphone-element can be used for the transmitter's audio pick-up (MIC1) and any DC power source of 4- to 12-volts at a few milliamps will do for power. A handy method to use in selecting the proper voltage range for the two-terminal device is to build and use the variable voltage-control circuit shown in Fig. 6.

The best operating range for all of the circuits is on the downhill side of the volt-

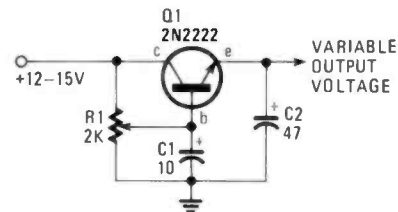

Fig. 6—Variable Power Supply.

age/current negative resistance curve; the exact operating voltage is non-critical, and usually a voltage of 2 to 6-volts will power all of the circuits shown.

### Tone-modulated Transmitter

Build the tone-modulated transmitter circuit shown in Fig. 3, and use it as a hidden transmitter for the kids to track down with any portable transistor BC (broadcast) band radio, or use the circuit

### FOR THE VARIABLE POWER SUPPLY

- C1—10- $\mu$ F, 16-WVDC electrolytic capacitor
- C2—47- $\mu$ F, 16-WVDC electrolytic capacitor
- Q1—2N2222A NPN (or similar) transistor
- R1—2000-ohm, potentiometer
- DC input source of 12 to 15 volts at 25 mA or more
- Printed circuit or perfboard materials, wire, solder, etc.

as a wireless code-practice oscillator. The RF tank circuit (L1/C2) oscillates within the BC band and the combination of C1 and the 1000-ohm winding of T1 makes up an audio tuned circuit that also oscillates at the same time, producing a tone-modulated RF carrier from a single

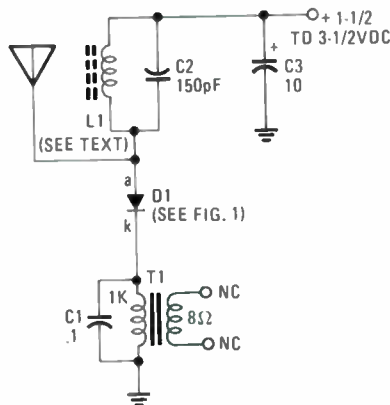

Fig. 3—Tone-modulated Transmitter.

two-terminal active device. The current requirement is so low for the oscillator circuit that a pair of AA cells should power the circuit for days. To change the audio-tone frequency, vary the value of C1, and if a different RF range is desired change the value of L1 and C2 to resonate at the new frequency.

As simple as the basic circuit might seem, you can spend many hours experi-

### PARTS LIST FOR THE TONE MODULATED TRANSMITTER

- C1—.1- $\mu$ F, 100-WVDC Mylar capacitor
- C2—150-pF, 100-WVDC ceramic disc capacitor
- C3—10- $\mu$ F, 16-WVDC electrolytic capacitor
- D1—(See text and Fig. 1)
- L1—Tunable Broadcast ferrite loopstick
- T1—1000-ohm to 8-ohm miniature output transformer
- Printed-circuit or perfboard materials, batteries or plug in power supply, pull-up antenna, enclosure, wire, solder, etc.

menting with the circuit. You might try replacing L1 and C2 with another transformer like T1 and tune it to another audio frequency and see if a two-tone audio generator can be produced.

### BC Receiver

My favorite twin lead circuit is shown in Fig. 4A, which is an ultra simple BC-band, super-regenerative receiver that's capable of picking up a number of local stations, using nothing more than a two foot *hank* of hook-up wire. The incoming radio signal is selected by the tuned circuit made up of L1 and C1, while L2 and C2 form another tank circuit that oscillates and interrupts the oscillation produced by the RF (L1/C1) tuned circuit.

The circuit is a self-quenching type of super-regenerative detector that can offer the experimenter and radio builder an excellent challenge in building and improving the basic circuit. An alternate detector circuit is shown in Fig. 4B. Diode D2 and capacitor C3 are removed from the basic

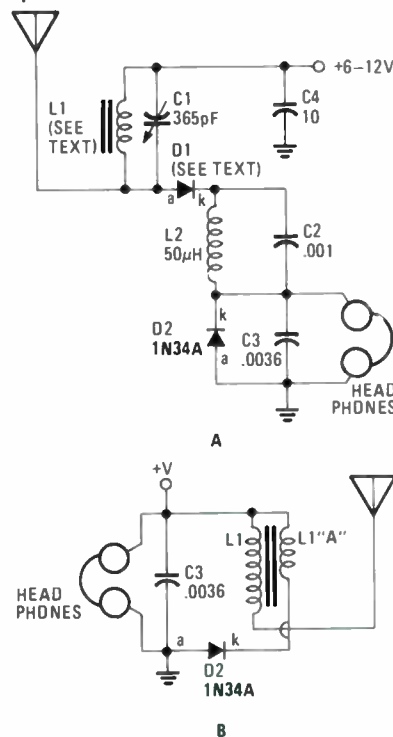

Fig. 4—BC Super-regenerative Receiver.

circuit, and the bottom end of L2 and C2 are connected to ground. A ten turn winding is added to the cold end of L1 (the side that is connected to the positive supply) and connect one end of the coil to the battery positive circuit and the other to the cathode of D2. The headphones and capacitor C3 connect to the circuit as shown in Fig. 4A.

Try each of the detector circuits to determine which one works best for you.

### Telephone Transmitter

Build the circuit shown in Fig. 5 and let

### PARTS LIST FOR THE BC SUPER-REGENERATIVE RECEIVER

- C1—365- $\mu$ F, tuning capacitor
- C2—.001- $\mu$ F, 100-WVDC Mylar capacitor
- C3—.003- $\mu$ F, 100-WVDC Mylar capacitor
- C4—10- $\mu$ F, 16-WVDC electrolytic capacitor
- D1—(See text and Fig. 1)
- D2—1N34A Germanium diode
- L1—Tunable broadcast ferrite loopstick
- L2—50 $\mu$ H, inductor
- Headphones (2000-ohm), battery (or plug-in power supply), short wire antenna, perfboard, pins, etc.

the kids monitor Grandma's telephone calls on any transistor radio. L1 and C2 set the transmitter's frequency, and the audio present on the phone lines modulates the transmitter's carrier. When the telephone is in the on-hook condition, the voltage applied to the telephone transmitter is nearly 48-volts DC.

Under those circuit conditions, our special (home-brew) diode goes into cut off, drawing almost zero current from the phone circuit. However, when the phone is taken off-hook, the voltage across the phone lines drops to about 4- to 8-volts DC. At that voltage level, the little transmitter automatically turns on to broadcast whatever comes down the phone lines. Need we say more.

That's only a small example of what can be accomplished with a simple homemade two terminal solid-state device. Experiment on your own and see if you can improve those circuits. ■

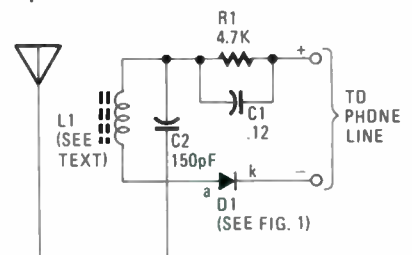

Fig. 5—Telephone Transmitter.

### PARTS LIST FOR THE TELEPHONE TRANSMITTER

- C1—.12- $\mu$ F, 100-WVDC Mylar capacitor
- C2—150-pF, 100-WVDC ceramic disc capacitor
- D1—See Fig. 1 and text
- L1—Tunable broadcast ferrite loopstick
- R1—4700-ohm 1/4-watt, 5% resistor
- Printed-circuit or perfboard materials, small antenna, wire, solder, etc.



By Marc Ellis

# ELLIS ON ANTIQUE RADIO

## Vacuum tube wrap-up

IN THE LAST FEW COLUMNS, WE TOOK A leisurely look at the development of vacuum tubes through about 1927. Starting with the battery-operated types that were first used in home broadcast receivers, we progressed to the first tubes that were designed specifically for AC-operated (plug-in) radios. The emphasis was on how the tubes operated, how they evolved, and how they influenced receiver design.

Before leaving the subject of tubes for a while, I think it would be very useful to take another look at tube development for the period in question—this time stressing chronology rather than function. What I'm after is to organize the information in such a way that you can pick up a tube of that period and, from its type and certain physical characteristics, make a pretty good guess about when it was manufactured. Out of necessity, our chronology will be presented in semi-outline form and contain both new material and a re-hash of information from previous columns. To give yourself the best possible background, it would help to re-read *Ellis On Antique Radio* for February and March 1987.

Since the tube chronology won't take up all of this month's column space, I'll also take the opportunity to share with you some of the reader mail that has begun to come in. Prior to this writing (just before Thanksgiving) only two issued of the column had appeared on the stands. Nevertheless, several people have contacted us—and I hope to hear from many more as the column becomes more widely known.

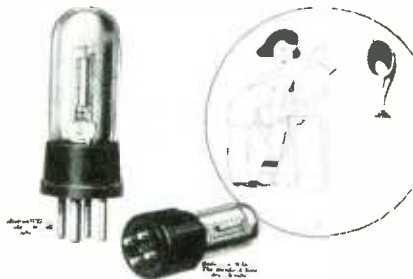

Detail from an early tube ad provides a good look at the WD-11 (upright) and WD-12 tubes. Note the fat contact pin (plate connection) on the WD-11.

### Tube Chronology

#### • 1920

RCA introduces types UV-200 (detector) and UV-201 (amplifier), the first receiving tubes produced for the mass market. Their 5-volt filaments were designed for storage-battery operation.

#### • 1922

Westinghouse releases the WD-11. Designed for portable operation, its filament was powered from a single 1.5-volt dry cell. Its unique base design was not compatible with any other type.

#### • 1923

RCA released three new types: the UV-201A (an improved version of the UV-201, requiring only 25% of the filament current); the UV-199 (filament operated by three 1.5-volt dry cells); the WD-12 (a version of the WD-11 having a standard UV-type base).

The high-efficiency thoriated tungsten filaments in the UV-201A and UV-199 tubes make necessary the use of a *getter* to remove all traces of oxygen from the bulb. The getter is typically a magnesium pellet *fired off* as the bulb is being evacuated—burning the oxygen and leaving a silvery deposit on the inside of the glass. An earlier getter compound, used only briefly, left a rainbow-colored deposit. (Rainbow tubes are prized by collectors.)

Westinghouse and RCA agree that Westinghouse broadcast-radio products, including the WD-11 and WD-12 tubes, will be sold only under RCA's (Radiotron) brand name.

#### • 1924

The pointed *tip seal* began to disappear from the top of UV-200, -201 and -201A bulbs. But the bulbs retained their original pear shape.

The WD-11 bulb became narrower in diameter, but retained its tubular shape.

A bakelite base replaced brass for all types except WD-12.

#### • 1925

The long-pin UX-type base (designed for push-in sockets) replaced the short-pin UV-type base (designed for bayonet-mount sockets). But the horizontal *locating and locking* pin was retained so that new tubes could still be bayonet-mounted into older sockets.

The WD-11 and WD-12 bulbs shed their pointed tip-seals, and magnesium

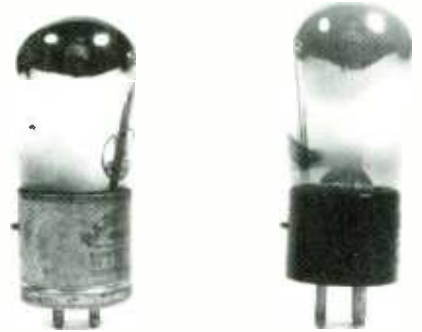

Pre-1925 (left) and post-1925 versions of the '01A-type tube. The modern version has no tip and uses a bakelite base instead of brass. Long-pin UX-type base, which retained the horizontal locating and locking pin, replaced the short-pin UY-version.

gettering was added so that the bulbs were silvery inside rather than clear.

The WD-12 tubular bulb was reduced in diameter to match the 1924 change in WD-11 bulb, and its base was changed from brass to bakelite.

New tube types introduced included: WX-12 (same as WD-11 and WD-12, but with UX-type base); UX-112, 120, 210 (power amplifiers); UX-213 (full wave rectifier).

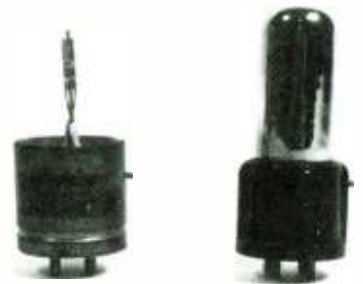

In 1925, the WD-12 (left) was replaced by the newer version (right), which unlike the earlier version had no tip. Also, the brass base of the earlier version was replaced by bakelite base, and magnesium gettering caused the bulb to be silvery instead of clear.

● 1926

New tube types introduced include: UX-200A (improved version of UV-200 having thoriated filament, long-pin base); UX-171 (power amplifier).

● 1927

New tube types introduced include: UX-226 and UY-227 (AC-filament amplifiers); UX-112A and UX-171 (improved versions of UX-112 and UX-171 power amplifiers); UX-280 (heavy-duty, full-wave rectifier).

● 1930

Horizontal locating and locking pins began to vanish from tube bases, which meant that the new generation of tubes would no longer fit the old UY-style sockets. At the same time, type numbers are simplified by dropping the old prefixes. For example: the UX-201A became the O1A, and the UY-227 became the 27.

● 1932

The pear-shaped bulbs used on most tubes up to that time began to disappear, to be replaced by taper-top (sometimes known as *dome-top*) style.

That wraps up our tube chronology for now, so let's open the mailbag and see what some of the readers have had to say!

#### The Mailman Cometh

Bob La Morgese (8 Manor Ct., New City, N.Y. 10956) is looking for schematic diagrams of vintage radio circuits using modern tubes and parts. Anyone want to send Bob some ideas?

One reader who might be able to help is Dan Damrow (5331 West 79th St., Burbank, IL 60459). Dan's special interest is restoring old sets, and making his own new parts as needed. The pictures he sent show not only a restored 1930's crystal set, but also a 1940's ham receiver and transmitter being built from scratch—ap-

parently with a mixture of old and new parts. Nice work, Dan!

Claude Jordan (3010 Acorn Rd., Augusta, GA 30906) writes that he's looking for a copy of *Radio Servicing Made Easy Volume 2*—Gernsback Library Book No. 107 (he already has Volume 1). He'd also like to find schematic diagrams of easy-to-build test equipment (including capacitor and tube checkers, signal tracers, VTVM's, etc.).

Harold Guenther (17934 Toepfer, East Detroit, MI 48021) likes *old* test equipment, and would like to see some in the column. We'll try to oblige in future issues, Harold!

Is there anyone out there who's in possession of a spare ELL80/6HU8 tube? If so, contact Keith Irtenkauf (26188 Springfield, Farmington Hills, MI 48018). He needs one to get a 1967 Grundig set operating again.

Jess Sandison (5757A Underwood Rd., Pasadena, TX 77507) has a problem with missing knobs. He needs some for restoration of a 7-3232 Zenith (about 1938), and wonders how other collectors deal with the problem of identifying what style is needed, and how they go about locating reproductions.

Three readers are looking for information on old sets: Douglas M. Rinaldi (Rt. 8 Box 117, Caldwell, ID 83605) would like to know when his Webster-Chicago Model 80-1 wire recorder was manufactured and if the set has any antique value. It's complete with 18 spools of wire and the original instruction book.

Jose C. Gutierrez Deciga (A. Postal 910, Morelia, Mich. 58000 Mexico) needs information on the RCA Radiola III and is looking for a couple of WD-11 tubes to make it operational. He also wonders if anyone has data on *Ayrola* brand radio

sets. Jose has a nice one with broadcast and shortwave bands, and a *magic-eye* tuning indicator—but needs some service information.

Elizabeth Wendling is looking for schematic diagrams for a 1939 Zenith Model R-831062—but, unfortunately, I don't have her address. Elizabeth, if you see this write again; but this time put your address on the letter as well as the envelope! Sometimes envelopes get separated from their letters in the forwarding process.

Finally, how about a plug for the columnist himself? I'd like to trade for, or purchase, Rider Manual No. 21 and a complete Rider index. I have available for trade the following seven Rider Manuals: 10 to 13 and 15 to 17. Contact me C/O **Hands-on Electronics** at the address below.

Just a few final words, now, on how I'd like to handle reader comments and queries. First of all, be assured that your letters are *most* welcome at any time. Regrettably, circumstances won't permit me to make individualized, personal replies. But I plan to use your letters in the column from time to time as space permits.

Most of the letters that have come in so far are from readers who need parts, help, or information of one kind or another—and that's fine. But I'm also interested in hearing from those who (like Dan Damrow) have accomplishments to share. Have you found a rare or unusual set?; solved a difficult restoration problem?; amassed an interesting collection? Let me know and, if possible, send a picture.

I'm including the return addresses of all the people whose letters appear in this column so that anyone who would like to share information or ideas can get in touch with them directly. If this column were used as a clearing house for forwarding answers to queries, I'd be introducing several months of delay. For example, we work so far ahead of the current issue in putting together **Hands-on Electronics** that the words that appear this month were written in late November.

Were someone to send the answer to queries in this column, it might be a month or two before I could find the space to include it—and then several more months before the column containing the answer hits the newstands.

However if you are answering a question for a reader and feel that others might be interested, send us a copy too! We'll print it at the earliest opportunity.

So keep the letters coming, friends! I'm looking forward to opening the mailbag again and having another session on reader needs, problems, and accomplishments. Send your correspondence to Marc Ellis, C/O **Hands-On Electronics**, 500-B Bi-County Blvd., Farmingdale, NY 11735. ■



Dan Damrow's restored 1930's crystal set



# WELS' THINK TANK

By Byron G. Wels

## Can you remember how you got started in electronics?

□ MOST OF US WHO ARE DEEPLY INVOLVED in electronics actually got started at a very tender age. I remember, in my own case, that I had a date with a pretty girl who was totally lacking in the brains department. (To make my point, I can remember a group of us talking outside school one day, and a friend said "All girls like flattery." This genius asked "Who's Flattery?")

Anyway, upon arriving at her home, I was introduced to her older brother, who was an amateur radio operator. That's where it all started. Needless to say, we never made it to the movies that night. Long after she'd given up on the movies and gone to sleep, her brother and I continued to talk. It wasn't long after that I got a ham license of my own. Later in life, the military took advantage of my interest in radio and radar, and handed me a career. That brings us just-about up to date, and in the nick of time to start this month's column!

### Car-Wiper Control

When I bought my car, they didn't offer a controlled timer for my windshield wipers. But now, I'd like to add it myself—inexpensively, of course—if that's at all possible. Can you help?

—M.H., Brooklyn, NY

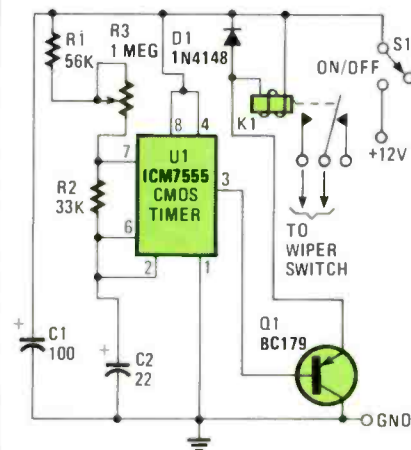

Fig. 1—The Wiper-Control circuit is built around an ICM7555, a CMOS version of the 555 timer, which is configured for standard astable operation, providing a form of relaxation oscillator.

Check out Fig. 1, M.H. As you can see, the circuit is built around a CMOS version of the ubiquitous 555 timer (ICM7555), which can operate on any supply voltage between 2 and 18-volts DC. And since it isn't unknown for a car to exceed the 12-volt supply, the added safety afforded by the chip is a good idea. If you don't have a 7555 around, don't worry; the 555 will handle up to 16 volts.

In Fig. 1, U1 is configured to operate in the standard astable mode, providing a form of relaxation oscillator. When power is applied, C2 initially charges through R1, R2, and R3 to two-thirds of the supply voltage. At that point, U1 senses that its threshold voltage at pin 6 has been reached, and triggers the timer, causing its output at pin 3 to go high. That high, applied to the base of Q1, keeps the transistor in the off state.

Now C2 begins to discharge through R2 to pin 7 of U1. When C2 has discharged to about one-third of the supply voltage, U1 is toggled back to its original state. C2 starts to charge again, as pin 3 of U1 goes low. The low at pin 3 causes Q1—which serves as an emitter-follower buffer stage—to turn on, allowing current to flow through the coil of relay K1. That, in turn, causes K1's contacts to close, applying power to the wipers.

The charge time of capacitor C2 is determined by the setting of potentiometer

R3. Capacitor C2 should be a tantalum type, and actually, almost any 12-volt coil relay with sufficiently heavy contacts should serve well.

### Courtesy Lamp Timer

My friend's new car has a neat feature: The inside courtesy light stays on for a while after he's closed and locked the door. In fact, that show-off and I drove to the local diner, got out, and I told him the lights were still on. He turned back to the car, snapped his fingers, and the lights went out! Can I do that?

—S.R., Pompano Beach, FL

Sure you can! See Fig. 2. The circuit shown is for a negative-ground system, but if your car has a positive ground, simply reverse the positive and negative connections—the +12 V connection becomes a positive ground, while the GND connection goes to the negative supply. The timer is connected in parallel with the lamp. The circuit closes a set of normally-open relay contacts when the courtesy light is switched on. That only lasts for thirty seconds and then switches off the relay (and the lamp). It's an add-on unit that requires no modifications to existing car wiring.

In Fig. 2, a potential roughly-equaling two-thirds of the supply voltage is fed to the non-inverting input of U1—an LF351 op-amp, set up as a voltage comparator—

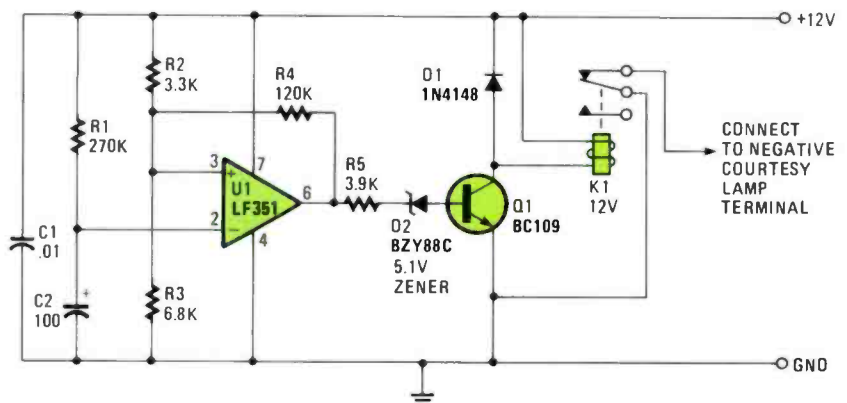

Fig. 2—The Courtesy-Lamp Timer (as presented) is intended for use in vehicles with a negative-ground system, but if your car has a positive ground, simply reverse the positive and negative connections—the +12 V connection becomes a positive ground, while the GND connection goes to the negative supply.

at pin 3 through R2 and R3. U1's inverting input at pin 2 is fed from the supply lines through an R/C network consisting of R1 and C2. The output state of U1 depends on the comparative input voltages, rather than on what voltages happen to be present.

Initially, C2 is not charged, resulting in the non-inverting input at pin 3 being at a higher potential than that at pin 2. The imbalance between the two inputs cause U1's output at pin 6 to go high. That high is fed to the base of Q1 through R5 and D2, biasing the transistor into conduction, which then activates relay K1.

However, as C2 charges via R1, the potential across it (which is fed to pin 2) exceeds that at pin 3, causing the output of U1 at pin 6 to go low. The positive feedback provided by R4 makes U1's output low, cutting off Q1 and deactivating the relay. Diode D1 is included in the circuit to ensure that Q1 cuts off when the comparator's output goes low. Since there will actually be about 1.5 volt at the output of U1, without the drop through D2, there might just be enough current flowing into the transistor to keep it switched on.

You can adjust the nominal time delay by changing the value of R1. Make sure you spend a bit of money to get the best capacitor you can for C2. It should be a good-quality unit with a low level of leakage, or you might find the time delay a lot longer than you'd like, or the lights might not go off at all!

### Voltage Monitor

My car battery just died, and the only warning I had was when I tried to start it, and it wouldn't turn over. Please go through your vast storehouse of knowledge and come up with a solution to the problem. Oh yeah: Keep it inexpensive and simple to construct!

—M.R., Glen Cove, NY

Thanks for the compliment M.R., but my storehouse of knowledge is only half-vast! Anyway, take a peek at Fig. 3. We're using eight inexpensive components. If the battery voltage exceeds about 11 volts, current flows through R1, D1, and R2. The voltage produced as a result of current flow through R2 is sufficient to bias transistor Q1 into conduction. That places the collector voltage of Q1 virtually at ground. So Q2, driven from the collector of Q1, is cut off. LED1 and current-limiting resistor R4 are connected in the collector circuit of Q2. In the cut off state, the LED does not light.

Should Q1's base voltage drop below 0.6 volts or thereabouts, Q1 turns off, biasing Q2 on and illuminating LED1 to indicate that the battery voltage has fallen below the 11-volt threshold level. Naturally, the threshold will not be precisely 11 volts because of component tolerances.

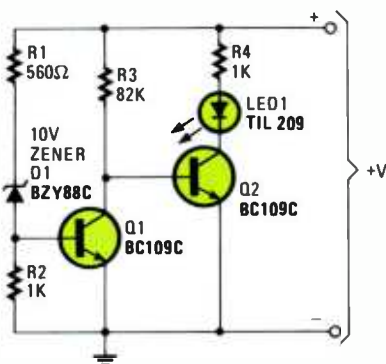

**Fig. 3—As long as the battery voltage is about 11 volts or more, Q1 is biased on, Q2 is turned off, and LED1 is extinguished. But, if the voltage drops 0.6 volt or so below 11 volts, LED1 lights.**

The circuit doesn't incorporate triggering so that LED1 will not be switched hard on or off. It can take up an intermediate state. That is no problem however, as there is a reasonably abrupt switchover as the battery falls through the threshold potential. Installation is no problem either. Simply connect the device across the battery.

### Power On the Go

My car has a radio but no cassette deck. I am aware that there are several options: I can go broke buying batteries for my home cassette; or get an inverter that does fine for an electric shaver, but produces more noise than electricity for a portable cassette player/recorder. Can I find a way to properly drop the car's 12 volts to a useable supply?

—J.B., Houston, TX

Start by looking at Fig. 4. What you have here is essentially a series voltage regulator. Note that U1, an LF351 op-amp, feeds two transistors (Q1 and Q2), which are connected as a discrete emitter follower, Darlington buffer stage. While they provide only about unity voltage

gain, they are capable of a very-high current gain; thus, the circuit can supply the high current required by most cassette players. If not for the motors, a cassette player would normally demand no more current than a similar-sized transistor radio.

A 100% negative feedback loop (via Q3) provides degenerative feedback to U1's inverting input at pin 2; thereby, providing unity voltage gain at pin 6 of U1. So if the non-inverting input is stabilized at 7.5 volts, the output will be stabilized at the same potential. R1 and D1 form a simple shunt Zener regulator that sets the output potential at the desired level. D1 should be changed to a 6.2-volt Zener if you need six volts, or 9.1 volts for an output of 9 volts.

Output current limiting is handled by Q3 and R2. Ordinarily, the output current (hence, the current through R2) would produce a voltage across R2 of insufficient magnitude to bias Q3 into conduction. The current-limiting circuitry, therefore, has little effect, as the negative-feedback action compensates for the small voltage drop that does occur. At output currents of around 500 mA, the voltage produced across R2 is sufficient to bias Q3 into conduction. That results in some of U1's output current being diverted to the negative supply by Q3 and the output load, pulling the output voltage even lower.

The greater the overload on the output, the harder Q3 conducts, pulling the output voltage lower—thereby limiting the rise in output current. Even with a dead short across the output, current is limited to about 520 mA, because Q3 reduces the output voltage almost to zero. Capacitors C1, C2, and C3 serve to reduce noise on the output and provide circuit stability. While the circuit is designed for cars with negative grounds, it can serve as well in positive-ground vehicles—provided that

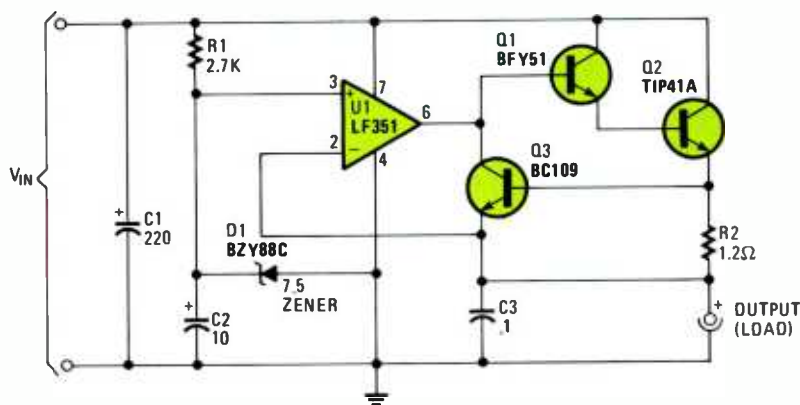

**Fig. 4—In our circuit, which is essentially a series voltage regulator, U1 feeds transistors Q1 and Q2, which are connected as a discrete emitter-follower. R1 and D1 form a simple shunt Zener regulator that sets the desired output-voltage level.**

## WELS' THINK TANK

both negative and positive outputs are isolated from the car's chassis or frame.

### Lights Timer

I've seen cars that, when you get out and lock the door, the headlights stay on for awhile and then shut themselves off. That's not just a nice thing to have, but has a lot of practical application if you have to fish around in the dark looking for keys. Can I add that feature to my car?

—S.T., San Diego, CA

Sure you can. S.T., and it isn't a difficult or costly addition either. See the schematic diagram in Fig. 5. The circuit, built around a CMOS version of the 555 timer (U1) set up for astable operation, provides a positive output pulse whose duration is dependent upon the values of C2 and R1. Pulse duration (in seconds) is given by

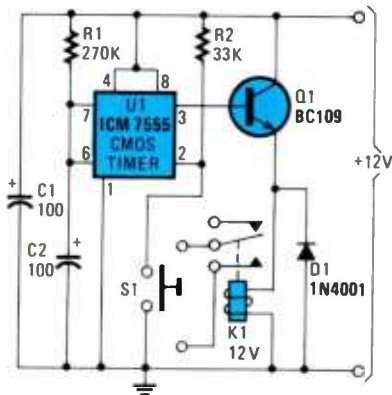
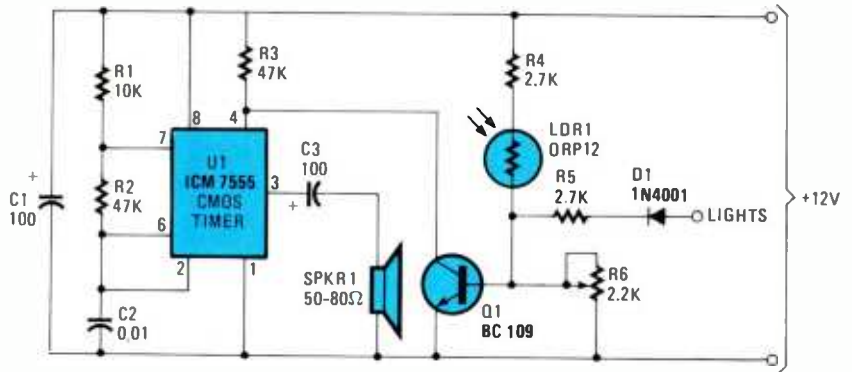

**Fig. 5—The Headlight Timer is a simple clock circuit that's used to remove power from the headlights by opening the contacts of a relay after a preset period.**

$1.1RC$  seconds. For the values shown, that works out to about 30 seconds. If you need a longer time period, simply increase the value of R1 accordingly. Make certain that the capacitor selected for C2 is of good quality.

Resistor R2 takes the trigger input from U1 pin 2 to the high state under normal conditions. However, pressing S1 takes pin 2 low and triggers the timer. The output of U1 is fed to the base of Q1 (an emitter follower buffer stage), which when biased on, activates relay K1, a normally-open unit. D1 serves as a protective diode.

When you're installing the circuit, think for a minute! You *must* connect the circuit directly to the car's battery. Take the usual precaution of connecting it to the hot side of the ignition. Connect the relay contacts across the headlight switch. Of course, when you turn the ignition off, you'll be disabling the circuit! Such a circuit might also be coupled with an LDR to make an automatic porch light.



**Fig. 6—This twilight-triggered circuit is activated by the lack of light falling on a cadmium-sulfide LDR. As dusk begins to fall, LDR1 operates a small horn to provide an audible reminder that it's time to turn on your headlights.**

### Twilight Time

Just what am I supposed to do? It's a long drive from my home to work, and an even longer one going home! I leave work while it's still daylight, and dusk falls while I'm on the road. Last night some speed nut nearly creamed me and yelled "Turn on yer lights, idiot!" Is there an electronic way to remind me to turn on my headlights and avoid getting killed?

—J.B., Reno, NV

Guess what! Look at Fig. 6. It's one of those *one-evening projects*, that you'll wonder how you ever lived without. As dusk begins to fall, the sensor (in this case, a cadmium-sulfide light-dependent resistor or LDR) operates a small horn to provide an audible reminder that it's time to turn on your lights. And guess how you turn the circuit off—simply turn your headlights on, and the noise stops.

You'll note that once again, we're using a CMOS 7555 in the astable mode. The timing components (R1, R2, and C2) establish an output frequency of about 1 kHz, which is capacitively coupled by C3 to SPKR1, a high-impedance loudspeaker (ranging between 50 and 80 ohms). Pull-up resistor R3 takes pin 4 of U1 virtually to the positive supply rail, causing the circuit to oscillate in the normal way. Transistor Q1 (with its collector connected to pin 4 of U1) mutes the oscillator when turned on.

The base of Q1 is fed through a voltage divider formed by R4, LDR1—a light-dependent resistor with an internal resistance of about 100 ohms under bright-light conditions and about 10 megohms in total darkness—and potentiometer R6. Q1's base voltage depends on the light level received by LDR1 and the setting of R6. If LDR1 detects a high light level, its resistance decreases, thereby providing a greater base current for Q1, causing it to conduct.

When Q1 conducts, pin 4 of U1 is pulled to near ground potential, muting the oscillator. If, on the other hand, LDR1

detects a low light level, its resistance increases (reducing base current to Q1), cutting off the transistor and enabling the oscillator. In actual practice, you set R6 so that at a suitable light level (dusk), the oscillator will sound.

The anode of diode D1 connects to the light switch, where it connects to the vehicle's parking lights. With the lights switched off, that point is connected to the negative chassis by way of the parking lamp. That has no effect on the circuit, as D1 blocks any current flow to ground from Q1's base via R6 and the sidelight lamps.

When the lights are switched on, the anode of D1 is connected to the positive supply via the parking lamp switch, thereby applying a voltage to the base of Q1, biasing it into conduction. With Q1 conducting, pin 4 of U1 is pulled virtually to ground, disabling the oscillator even though LDR1's resistance is not enough to do so.

### Directionals Warning

OK, admit it: You've left your directionals on and driven all the other drivers crazy, waiting for you to make your turn! Can't we do something about that?

—J.P., Wantagh, NY

J.P., you sound like a man on a mission. And you're right. Directionals have flash-

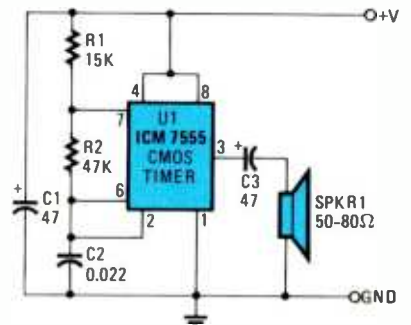

**Fig. 7—This audio oscillator (based on the ICM7555 CMOS oscillator/timer) can be used to provide an audible tone to warn you that your turn signal has been left on.**



ing lights, *clickers*, and all sorts of other devices that are used to call attention to a particular condition. But when you're watching the road and listening to the radio, it's sometimes hard to notice that the last easy curve wasn't quite enough to turn off your self-cancelling directionals. And so, there you go tooling down the highway with the directionals battling away like mad.

Figure 7 is a schematic diagram of a circuit that will provide an additional audible tone. The circuit (an audio oscillator built around the ICM7555 CMOS oscillator/timer set up for astable operation) is capacitively coupled to a high-impedance loudspeaker, SPKR1. With the specified components, the circuit oscillates at a few hundred Hertz, and its output volume is enough to alert you to the fact that your directionals are operating, but not enough to scare you into an accident.

You can get as fancy as you like with this one; however, perfboard construction is usually sufficient. It will work with either positive or negative ground vehicles—either 6- or 12-volt systems. You'll find a marked reduction in volume however, if you use it with a 6-volt car.

#### Immobilizer

I know there are all sorts of fancy doodads to protect cars, from sirens to horn blowers. But since a car depends on electricity, you'd think there might be some electronic means to sense the presence of an intruder and just disable the car by cutting off the electrical supply.

—P.J., Pueblo, CO

P.J., I was once deeply involved in the security industry, and we once interviewed a convict whose thing was walking down residential streets and looking into car windows. When he saw a vehicle with some change on the dashboard (which the driver probably kept for tolls), he'd try to break in and steal it. If he couldn't break in any other way, he'd pick up a rock and smash the glass! We explained that while he might get twenty-five or fifty cents, replacing that glass could cost the owner up to \$75! His answer was, "What do I care? It's not my car!"

Looking at Fig. 8, we have the electronic solution to the dilemma. A flip of S1 puts the circuit into action. Power for the circuit is picked up from the ignition switch, and the circuit receives no power until the ignition switch is closed. When power is turned on, capacitor C1 is not charged and the emitter-follower Darlington pair (formed by Q1 and Q2) are cutoff, thus no power is applied to the relay (K1), which serves as Q1's emitter load.

The relay's normally-open contacts are connected across the vehicle's points. (At this time, the relay contacts are open and have no effect on the ignition system.) C1 charges by way of R1, causing the voltage

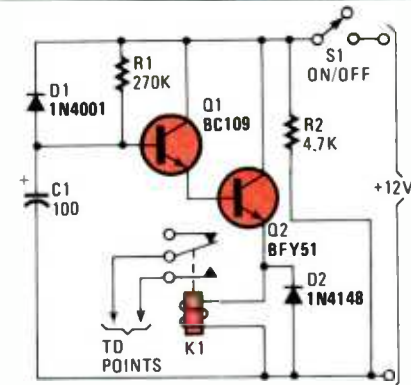

**Fig. 8—When power is applied to the car immobilizer circuit, Q1 is biased on, which in turn, turns on Q2 and energizes the relay. That, in turn, causes K1 to open, removing power to the points.**

at the base of Q1 to rise steadily. That creates a similar rise in the voltage at the emitter of Q2. A Darlington pair is used to provide a high input-impedance, buffer stage so that the voltage across C1 is free to rise almost to the full supply potential.

Loading effects do not limit the charge potential to just a few volts. So pretty soon, the voltage applied to the relay becomes sufficient to activate it. The contacts close and short out the points. The ignition system now doesn't act properly and the vehicle is disabled. If the ignition is switched off, power is removed from the circuit and diode D1, which was previously reverse-biased, is now forward biased by the charge on C1. D1 allows C1 to rapidly discharge through R2 (and any other DC paths across the supply lines). The circuit is ready to operate when the ignition is again turned on. The engine will operate, but not for very long.

The values of R1 and C1 provide a delay of about 25 to 30 seconds. Increase R1's value to provide a longer delay.

#### Depth Sounder

I've got a small boat and while it is a lot of fun, I don't want to go broke outfitting it. I've got a depth indicator that tells me how deep the water is under my keel, but it requires somebody's attention. Can I add an audible alarm to signal when the water gets too shallow? My wife says a boat is a hole in the water surrounded by wood, into which you throw all your money! Being an electronics hobbyist, I'd like to *roll my own* and save some bucks. Got anything for me, Byron?

—P.D., Freeport, NY

Sure do, P.D!—take a look at Fig. 9. We're presupposing that your present depth sounder is not one of the digital types, but instead, the more-common gadgets that use a light that flashes at the depth indicated on a scale. One of the nice things about the circuit is that it doesn't require that you dig into the existing sounder.

You'll find that the schematic uses two main sections: A bistable multivibrator, better known as a flip-flop (consisting of Q1, Q2, and R2 to R5), and an audio oscillator (built around a ICM7555 set up for astable and controlled by the output of the flip-flop). At turn-on, the flip-flop goes to the state where Q1 is switched on and Q2 is off, or the flip-flop can be manually set to that state by operating switch S1.

Under normal conditions, Q2 is switched on and pin 4 of U1 is virtually at zero volts; thereby, muting the oscillator, so that a tone is heard at the loudspeaker.

A 2N5777 photo-Darlington transistor (Q3), which offers high sensitivity and a moderately-fast response time, is used as a sensitive photoresistor. The collector-emitter impedance of Q3—which is connected in series with R8 to make a voltage

(continued on page 100)

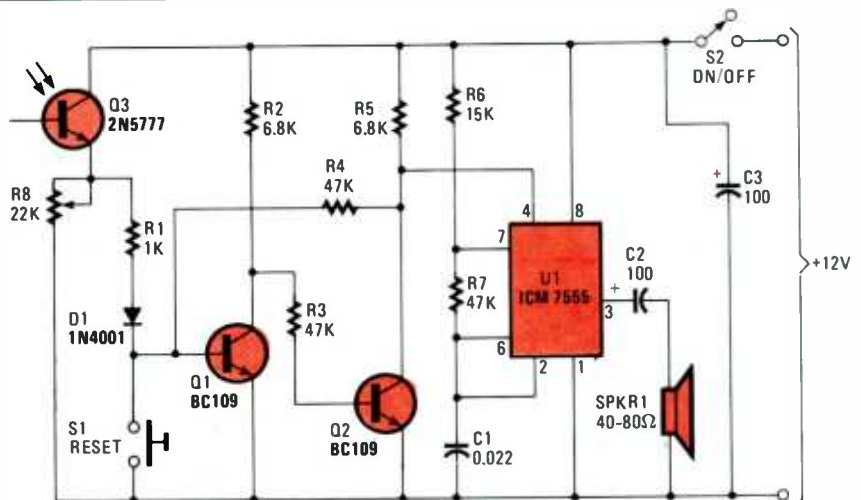

**Fig. 9—The depth-sounder alarm circuit can be viewed as two separate circuits: A flip-flop (consisting of Q1, Q2, and R2 to R5) and an audio oscillator (based on an ICM7555 set up for astable operation and controlled by the output of the flip-flop).**



# FRIEDMAN ON COMPUTERS

## Some really outstanding software is created on the kitchen table

IT IS OFTEN IMPLIED THAT MUCH OF THE best-known software are *on-going legends*, or that they made personal computing what it is today. Except for VisiCalc, ProFile, and WordStar, such claims are simply not true. Personal computing was made possible by programmers working on their kitchen tables, because the best they could afford in the way of advertising was a teeny-tiny advertisement in what were then the only major computer magazines: *80 Micro* and *Byte*.

How well I remember calling "Software Distributors" for review copies only to be told by a pre-school voice that "My brother doesn't come home from *high school until two-thirty*;" or "*Daddy comes home from work at six*," or "*Mommy isn't home*."

Today, it's even harder for *cottage programmers* to sell their stuff because they simply haven't got the money to compete with four-color, full-page ads; and very few computer publications review software that isn't sold by their advertisers.

But a lot of notably good—particularly, unusual—software is still being written on and sold from the kitchen table; and this month I'm going to tell you about two small PC/MS-DOS programs that I frequently use. I believe that they are the kind of stuff you would probably want, and there are strong odds against you hear-

ing about them any other way.

### The Disk Wiz

The *Disk Wiz*, \$25.00, plus \$3.00 postage, from Computer Creations, 3538 Walker Ave., Memphis, TN 38111 (901/327-9210), is a collection of menu-driven operating aids that I've wanted since I got my first PC in 1976. Its outstanding feature is that it loads into RAM and remains in the background until called up at the touch of a key. You can break into word processing, spreadsheeting, whatever, have it do its thing, and instantly return to what you were doing.

Typically, there's a lot of *kitchen sink* stuff thrown in that I can't imagine anyone needing, so I'll hit the highlights. For me, the most important function is *instantaneous* programming of the printer by up to 20 (yes, 20) user-pre-programmed printer codes, and a wild-card (number 21) that can be programmed on the fly. Each code can consist of up to five individual codes. For example, I can instantly switch in the middle of a spreadsheet to double-strike compressed type, and return to emphasized NLQ—using only a touch of the key for each.

Figures 1 and 2 illustrate the user programming available with the supplied configuration program. Figure 1 is the way that it comes from the factory, pre-pro-

grammed for an EPSON code-compatible printer. But my printer has the IBM character set, which I want to use instead of the italics mode, so I will reprogram the *Disk Wiz* for IBM print type.

Note that on the bottom of Fig. 1, I've indicated that item F should read "IBM +" (on) and have entered the code 23/3/0/0/0. (No entry for a byte is zero.) Look at Fig. 2. Note that item F now reads "IBM +" with the new code. At the bottom of the screen, you'll see my next entry, which changes item G to read "IBM +-" (IBM off, return to italics), and printer code 27/4/0/0/0. When the RETURN key is pressed, the entry will replace the one for "Ital +."

The actual *operating menu* shows only the individual functions that are highlighted, not the codes; Codes are displayed only during the user's configuration.

The function labeled "K Other" is a real winner. It can be programmed on-the-fly (meaning, at any time) with a temporary printer-control code; so if something comes up for a feature not included in the 20 pre-programmed codes, you simply select "K Other" and key it in directly.

### IBM Graphics

Another great *Disk Wiz* feature is an on-screen display of the entire IBM-com-

(Continued on page 99)



Fig. 1—The *Disk Wiz* customizing program allows you to pre-program up to 20 printer control codes that are sent to the printer at the touch of a single key. At the bottom, the screen shows we want to change The "Ital +" to read "IBM +," and we will program a new printer code for IBM of 23/3/0/0/0.



Fig. 2—The first change is made! Note that item F now reads "IBM +," and that the printer code is changed. The bottom of the screen shows the programming for "IBM -" is ready for entry.

## FRIEDMAN ON COMPUTERS

(Continued from page 96)

patible character set for ASCII 0 through 244. Let's assume that you're writing a computer program, or preparing a document, and you want to show the value 50 Ω (50 ohms).

You can enter ASCII codes in your program or word processor, but what's the code for the Ω symbol, or the code for Σ? Simple, touch a key and the Disk Wiz produces the full IBM ASCII code on-screen, as shown in Fig. 3.

### Much More

Disk Wiz has a set of utilities that includes the usual *bulk* erase, copy, rename, etc. The two that I like the most automatically strip the eighth bit on a screen display of a disk file (it will convert WordStar files to a readable screen display), and print any disk file as ASCII characters.

One feature that gets a lot of use is a very simple typewriter mode. Key-in a line of type—even in the middle of another program—and the line gets printed when you press RETURN. You can edit, insert, and delete on each line before it's printed, and the computer beeps automatically at 65 characters (so you don't keep typing past the end of the printer.) You can also make the cursor larger (although some software will cause it to immediately return to original size). It will make a small text file, toggle the sound, even change screen colors and create electronic music. (See, I told you that cottage software throws in the kitchen sink.)

Finally, Disk Wiz really takes the hassle out of managing hard-disk files, because you can step directly to any directory or file. All in all, it's a lovely program that sneaks up on you. First, you use it every now and then, then more frequently; finally, it ends up in the AUTOEXEC.BAT file because you can't do without it. (Yes, Disk Wiz can be used as a stand-alone program rather than memory-resident, but it's just not the same.)

### MACE +

MACE +, \$69.95, from Paul Mace, 206 Alicia Ave., Ashland, Oregon 97520, is a set of utilities primarily intended to recover hard-disk *crashes* and deleted

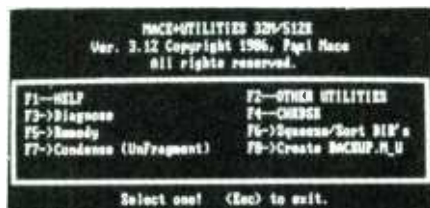

Fig. 4—The main menu for MACE + is simple enough to understand. In fact, you can run the entire program just from the menu. F2 calls up a submenu that provides the undelete, reclaim, boot restoration, and CHKDSK operations.

- Disk Wiz - Disk Drive Access & Utilities, V1.08 1/1/87 8:1  
© 1986 Computer Creations, 3538 Walker Ave., Memphis, TN 38111

PC Character Set  
Special ASCII Chars: 7=Bel 10=LF 12=FF 13=CR 27=ESC 32=Space

	0	1	2	3	4	5	6	7	8	9	0	1	2	3	4	5	6	7	8	9	
0																					
20	W	U	S	T	I	+	+	+	+	+	+	+	+	+	+	+	+	+	+	+	+
40	(	)	*	+	-	/	/	/	/	/	/	/	/	/	/	/	/	/	/	/	/
60	<	=	>	?	@	A	B	C	D	E	F	G	H	I	J	K	L	M	N	O	P
80	Q	R	S	T	U	V	W	X	Y	Z	[	\	]	^	_	~	!	"	#	\$	%
100	A	a	F	f	H	h	I	i	J	j	K	k	L	l	M	m	N	n	O	o	P
120	x	y	z	(	)	*	+	-	/	/	/	/	/	/	/	/	/	/	/	/	/
140	T	I	W	A	E	Z	B	G	B	0	U	U	C	E	T	H	F	F	F	F	F
160	A	I	O	U	R	H	T	A	L	L	L	L	L	L	L	L	L	L	L	L	L
180	L	L	L	L	L	L	L	L	L	L	L	L	L	L	L	L	L	L	L	L	L
200	L	L	L	L	L	L	L	L	L	L	L	L	L	L	L	L	L	L	L	L	L
220	L	L	L	L	L	L	L	L	L	L	L	L	L	L	L	L	L	L	L	L	L
240	L	L	L	L	L	L	L	L	L	L	L	L	L	L	L	L	L	L	L	L	L

Fig. 3—This is the Disk Wiz's screen presentation of the complete IBM graphics character set. The ASCII code for each character is the row number plus the column number. For example, the letter "E" is 60 + 9, or ASCII 69.

## Hands-on Electronics

## REPRINT BOOKSTORE

- SP4 Special Projects #4 (Summer 1982) ... \$5.50
- SP5 Special Projects #5 (Winter 1983) ... \$5.50
- SP6 Special Projects #6 (Spring 1983) ... \$5.50
- SP7 Special Projects #7 (Summer 1983) ... \$5.50
- SP8 Special Projects #8 (Fall 1983) ... \$5.50
- SP9 Special Projects #9 (Winter 1984) ... \$5.50
- SP10 Special Projects #10 (Spring 1984) ... \$5.50
- 111 Hands-On Electronics #1 ... \$4.50
- 112 Hands-On Electronics #2 ... \$4.50
- 113 Hands-On Electronics #3 ... \$4.50
- 114 Hands-On Electronics #4 ... \$4.50
- 115 Hands-On Electronics #5 ... \$4.50
- 115A Hands-On Electronics #6 ... \$3.50
- 116A Hands-On Electronics (Jan-Feb '86) ... \$3.50
- 116B Hands-On Electronics (Mar/Apr '86) ... \$3.50
- 116C Hands-On Electronics (May/Jun '86) ... \$3.50
- 116D Hands-On Electronics (Jul/Aug '86) ... \$3.50
- 116E Hands-On Electronics (Sep/Oct '86) ... \$3.50
- 116K Hands-On Electronics (Nov '86) ... \$3.50
- 116L Hands-On Electronics (Dec '86) ... \$3.50
- 117 Hands-On back issues ... \$3.50  
Write in issues desired.
- 152 8-Ball Satellite TV Antenna ... \$5.00
- 106 Radio-Electronics back issues (1986) ... \$3.00  
Write in issues desired.
- 105 Radio-Electronics back issues (1985) ... \$3.50  
(Jan. 85 not available)  
Write in issues desired.
- 104 Radio-Electronics back issues (1984) ... \$4.50  
(December 1984 issue is not available)  
Write in issues desired.
- 103 Radio-Electronics back issues (1983) ... \$5.00  
(Jan., Feb., May are not available)  
Write in issues desired.
- 102 Radio-Electronics back issues (1982) ... \$5.50  
(January 1982 is not available)  
Write in issues desired.
- 101 Radio-Electronics back issues (1981) ... \$6.00  
(Issues available: July, Aug. Sept. Nov.)  
Write in issues desired.
- 153 Etch your own PC boards ... \$3.00
- 154 How to Repair VCR's ... \$3.50
- 155 IBM Typewriter to Computer ... \$3.00
- 125 Radio-Electronics Annual 1985 ... \$3.50
- 126 Radio-Electronics Annual 1986 ... \$2.50
- 156 How to Make PC Boards ... \$2.00
- 157 All About Kits ... \$2.00
- 158 Electro Importing Co. Catalog (1918) ... \$5.95
- 159 Low Frequency Receiving Techniques  
Building and using VLF Antennas ... \$6.00
- 160 New Ideas - 42 Circuits ... \$3.50
- 161 Descrambling (Feb., 1984) ... \$2.00
- 162 Build Your Own Satellite TV Receiver \$7.00
- 163 Receiving Satellite TV ... \$7.00
- 164 Modern Electrics (April, 1908) ... \$3.00
- 165 How to Repair CD Disc Players ... \$5.00
- 166 Collected Works of Mohammed Ulyses Fips  
(62 pages, April Fools Collection) ... \$10.00
- 167 Designing With IC's ... \$4.00

To order any of the items indicated above, check off the ones you want. Complete the order form below, include your payment, check or money order (DO NOT SEND CASH), and mail to Hands-on-Electronics, Reprint Department, P.O. Box 4079, Farmingdale, NY 11735. Please allow 4-6 weeks for delivery.

If you need a copy of an article that is in an issue we indicate is unavailable you can order it directly from us. We charge 50¢ per page. Indicate the issue (month & year), pages and article desired. Include payment in full, plus shipping and handling charge. Make checks payable to Gernsback Publications, Inc.

ARTICLE	MONTH	YEAR	TOTAL PRICE
PAGES			
TOTAL PAGES	(@ 50¢ each)		

MAIL TO: Hands-on-Electronics  
Reprint Bookstore, P.O. Box 4079, Farmingdale NY 11735

All payments must be in U.S. funds

\$0.01 to \$5.00	\$1.00	\$30.01 to 40.00	\$4.75	<b>OUTSIDE USA &amp; CANADA</b> Multiply Shipping by 2 for sea mail Multiply Shipping by 4 for air mail
\$5.01 to \$10.00	\$1.75	\$40.01 to 50.00	\$5.75	
\$10.01 to 20.00	\$2.75	\$50.01 and above	\$7.00	
\$20.01 to 30.00	\$3.75			
Total price of merchandise			\$	
Sales Tax (New York State Residents only)			\$	
Shipping (see chart)			\$	

Name \_\_\_\_\_ Total Enclosed \_\_\_\_\_ \$ \_\_\_\_\_  
 Address \_\_\_\_\_  
 City \_\_\_\_\_ State \_\_\_\_\_ Zip \_\_\_\_\_

HB487

disk files; it can also salvage damage to floppy discs.

If you have ever had a hard-disk crash, or tried to recover an erased disk file, you've probably cursed all the software ever written. What should be an easy recovery turns into a nightmare because most recovery software have the most convoluted menus imaginable. One, in fact—the most famous of all—simply left an instruction off the screen; the program is almost impossible to use if you're not a *hardware hacker*, yet it has been hailed far and wide. (I often wonder if anyone ever tries the stuff.)

Well, MACE+ is different; the manual

is almost incomprehensible—because once again, it's written by a hacker for other hackers—but the program itself is a gem, and it runs beautifully from menus even if you can't understand the documentation. When you load MACE+, you get the main menu shown in Fig. 4, from which everything is operated. The screen is almost self-explanatory.

#### Recover from FORMAT

But perhaps most important of all, MACE+ will recover from an accidental formatting of the hard disk—which is usually instant death to everything on the disk. Except for ATT and Burroughs MS-

DOS 2.11 and COMPAQ MS-DOS 3.11, MACE+ will restore a hard disk if you should have accidentally formatted, or had even just started to format, shrieked *Whoops!*, and tried to bail-out with a control-C. (There is no bail-out from FORMAT, the instant it starts the disk data is *dead*.)

There are other MACE+ goodies, but once again I've touched on what I consider the highlights because this isn't intended as an in-depth review. Rather, it's just an example of the kind of high-performance *cottage-industry* software that's available at reasonable prices. Although a lot of cheap stuff is garbage, there's a lot of gold to be found on a kitchen table. ■

### WELS' THINK TANK

(continued from page 95)

divider across the supply—falls as the light level it receives is increased. The voltage at the junction of Q3's emitter and the wiper arm of R8 will rise and fall with the light level received by Q3.

Resistor R8 is adjusted so that under normal operating conditions, the input of the flip-flop from Q3 (through diode D1 and current-limiting resistor R1) is insufficient to switch on Q1 and trigger the flip-flop to the other state. It is sufficient to do so if Q3 gets light from the scale indicator lamp. With the flip-flop triggered into the

other state, the collector of Q2 goes high and activates the audio alarm. Because of the presence of diode D1 at the input of the flip-flop, the Q3 can switch Q1 on, but cannot turn it off. It must be manually reset by pressing switch S1.

Position the phototransistor over the scale of your depth indicator, with the photocell placed to receive the flashing light. For added accuracy, you can mount the photocell in a small, black cardboard tube positioned directly over the scale.

Sad to say, we've used all the allocated space for this month. I want to thank all those who have written in, and promise

that we'll be getting the answers out as rapidly as time and/or space allow. And even if you haven't any questions, drop a line just to say "hello!" I'm looking forward to hearing from you. Write to By Wels, *Wels' Think Tank, Hands-On Electronics Magazine*, 500-B Bi-County Blvd., Farmingdale, NY 11735. ■

Schematics for this month's column were taken from Electronics Projects for Cars and Boats, By R.A. Penfold, Published by Bernard Babani Publishing, Ltd. You can order this book for \$5.00 from Electronic Technology Today Inc., PO Box 240, Masapequa Park, NY 11762-0240

### THE TEST-A-MATIC

(Continued on page 62)

to identify the positive side of the phone line is with a voltmeter set to a scale capable of measuring at least 50 volts. Once you're sure which is the plus side of the line, connect the tri-color LED. If it lights green, you're in business; if it's red, just flip it.

It may seem to you that R10 is a bit large for a current-limiting resistor, but remember that there's 50 volts on the line. Making R10 smaller won't increase the output of the tri-color LED, but may lower the line voltage enough to trigger an off-hook condition. That will drop the line voltage to about 5 volts. It's nothing to worry about—but since it's avoidable, why not bother?

Building the Test-A-Matic is even easier than using it. Nothing is critical and you can use any method you prefer. If you want to change any of the frequencies, use the standard 555 formulas to work out new values to alter either the warble rate or frequency. Just remember that the former is set by U1 and the latter by U2. There are some components you should leave alone. R1 holds the operating current at about 100 milliamps and R9 provides U2 with a resistive load to make sure that the circuit will always start.

#### Ringling the House Down

Once you have the Test-A-Matic up and operating, clip it onto the phone line and turn it on. LED1 should be pulsing on and off and LED2 should be either red or green. If it's not working, check your circuit connections, make sure there's power going to the 555's, and so on. Because the circuit is so simple, possible problems are simple as well.

There's only one *no-no*, but it's an important one. Al-

though 555's can operate over a wide range of supply voltages, the Test-A-Matic is designed to work properly with a 5-volt supply. You won't blow anything up if you feed it 9 volts—but it won't work, either. It's very important to use U3, the 7805. If the circuit is powered by anything more than 5 volts, it's operation will be erratic at best. Not only that, but you'll have trouble trying to figure out what's wrong.

Using the Test-A-Matic is straightforward. Just clip the leads to the line and turn it on. The warble produced has a lot of *oomph* behind it and, because of its distinctive sound, you'll be able to recognize it easily at the other end of the line. If you're using it to ring out live phone lines, the tri-color LED will immediately show you if you have the proper polarity. The only addition that you might want to make to the circuit is to parallel another cable with the test leads. It's sometimes handy to have the Test-A-Matic's output connected to a modular connector so that you can easily plug it into a telephone wall outlet.

#### A Word to the Wise

A word of warning is in order: It only takes one break in the standard to throw the conventions out the window. It often happens that someone (even a phone-company installer), won't pay attention to the red and green standards so your modular pigtail won't give a true indication of the line. When in doubt, use the clip leads.

It doesn't take much in the way of time, energy, or money to put a Test-A-Matic together. You should be able to knock one off in a few hours without spending more than a couple of bucks. The amount of brain damage it can save you, however, is beyond measure. Take a little bit of time and build one. If you only use it once a year, it will be more than worth the effort. ■

This will be coming to you when you subscribe to **Radio-Electronics**

• **HELPFUL CONSTRUCTION ARTICLES...**

Test Equipment  
Hi-Fi Accessories  
Telephone Accessories  
Music Synthesizers  
Computer Equipment  
Automotive Equipment  
Intruder Alarms-Home & Car  
Video Accessories

• **NEWS ON NEW TECHNOLOGY**

Computers  
Microprocessors  
Satellite TV  
Teletext  
Automotive Electronics  
Speech Synthesizers  
IC Applications

• **FASCINATING "HOW TO DO IT" ARTICLES...**

Build Your Own Projects  
Make Your Own PC Boards  
Wiring Techniques  
Soldering and Desoldering  
Design and Prototyping



• **HOW YOU AND THE COMPUTER CAN BE FRIENDS...**

Getting Started  
Programs, Circuit Design, Games  
A/D-D/A Interfacing  
Peripheral Equipment

• **NEW AUDIO DIMENSIONS FOR YOUR PLEASURE...**

Noise-Reduction Devices  
How to Connect that Extra Add-On  
Hi-Fi Accessories  
New Technology

• **TV WONDERS FOR YOUR FUTURE...**

Latest Receivers and Circuits  
The Home Entertainment Center  
Projection TV  
Satellite TV Receivers  
Jack Darr's Monthly Service Clinic  
Service Problems and Solutions

• **REGULAR MONTHLY FEATURES**

DESIGNERS NOTEBOOK by Robert Grossblatt  
HOBBY CORNER by "Doc" Savage, K4SDS  
STATE-OF-SOLID-STATE by Bob Scott  
WHAT'S NEWS, new products, stereo news and NEW IDEAS, STEREO PRODUCTS, NEW COMPUTER PRODUCTS FOR HOME/JOB and MUCH MORE!

Radio-Electronics covers all aspects of the fast moving electronics field...featuring  
**COMPUTERS • VIDEO • STEREO TECHNOLOGY • SERVICE COMMUNICATIONS • PROJECTS**

# Get it all!

Subscribe today to **Radio-Electronics**! Don't miss a single issue and...see subscription card in back of this issue for big savings.

When you select one of the subscription offers listed on the handy coupon—you'll be assured of having your copy reserved, even if it sells out on the newsstand. Make sure you get all the excitement in every issue of **Radio-Electronics**, every month, by filling in and mailing your subscription card today.

## BINAURAL MIKESSET

(Continued from page 43)

Insert each cable into an ear hole and fish them both out the bottom. (Most wig heads have a tapering cavity inside. If yours doesn't, you'll have to provide the exit.) Make a hole at the back just above the base to feed the cables through so the set will sit nicely on a flat surface.

Press the capsules firmly into the ear holes until they are flush with the sides of the head. Strip the free ends of the wires, twist the shields together, and connect the wires to a plug that matches the jack arrangement at one end of the power supply box. That's all there is; the dummy-head mikeset is ready for use.

## Headphone Mikeset

A handy way to make a headphone-type binaural mikeset is to rebuild a pair of miniature headphones. If you keep your eyes open you should be able to pick up a suitable pair for under \$5.00. All you have to do is remove the speaker elements and substitute mike capsules. Even a defective pair of phones will serve this purpose as long as the wiring harness and plug are still intact.

First, remove the foam covers from the earpieces. Gently stretch the foam and lift it away from the tiny teeth that hold it in place. Pry out the speaker elements and snip the wires attached to them.

Using a small, sharp knife, cut an opening in the plastic body of each earpiece to receive a mike capsule. The openings should be located so that the mikes will face forward when the set is placed on the head. Solder the original headphone wires to the microphone capsules, then secure the capsules in the earpiece openings with a dab of glue and replace the foam covers.

If you make a headphone mikeset, be sure to select a miniature three-conductor jack for at least one end of the power supply to match the plug supplied on the headset.

To use the mikeset, simply plug it into one end of the power

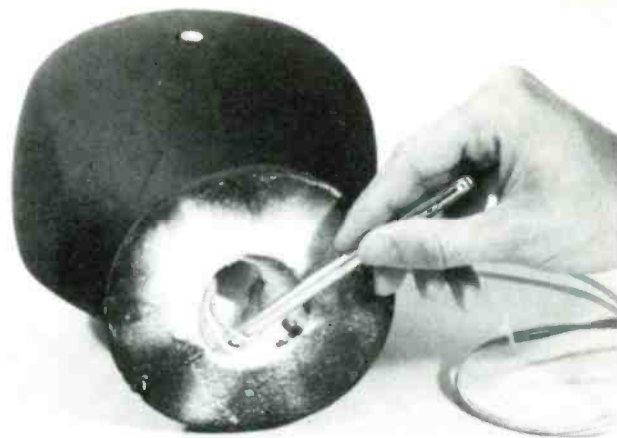

The wires from the microphone pass through the hollow center of the head. If your head doesn't have the space, you'll have to carve it out yourself with a long, thin knife.

supply box and feed the output from the other end into the mike inputs of your stereo tape recorder. For your first binaural experiment, I recommend taping household conversation and noise with the mikeset located at a usual seating location. After getting a number of minutes of sound on tape, listen to what you recorded through a pair of stereo headphones while seated right where the mike was placed.

You will also find that binaural sound is unsurpassed for making intelligible recordings of speech and conversation under difficult acoustic conditions. Try it at a conference, a lecture, or a party.

When you record live music, using a binaural mike eliminates any need for multiple mikes, mixers, and the like. Place the mikeset at a good location for live listening and tape the two channels. If you can, position the mikeset in "the best seat in the house." That would be wonderful, but you can make a realistic binaural recording even at lesser locations.

Recording music and speech is only scratching the surface. Other interesting binaural applications might be recording realistic sound effects, creating lifelike dramatic performances on tape, or (with the headphone-style mike and a battery-operated portable recorder) documenting a stroll down a city street or through the countryside.



\$350

## NEW IDEAS

42 PROJECTS  
COMPLETE PARTS LISTS  
ONE-EVENING PROJECTS  
EASY TO BUILD

■ NEW IDEAS is packed with 42 practical circuits for the Electronics Experimenter and Project Builder. In addition to the headlight alarm, the voltage freezer, and the remote telephone ringer, you get complete plans for a simple Tesla coil project that can generate 25,000-volts AC and draw one-inch sparks. Other interesting projects are: a sound-effects generator, a crystal tester, a stereo remote control, and much, much more! Each project was selected for its low cost of parts!

■ WANT TO EXPAND your knowledge of electronics? Build gadgets that only you can have on your block? Acquire a library of projects? NEW IDEAS is the gold mine of circuits you should own and read. You could start the first night building a project that will have others praisling what it can do and admiring you for building it.

■ THERE ARE PROJECTS for everyone—automotive, household, test equipment, audio and hi-fi, and projects just for fun.

### NEW IDEAS—Circuits for Experimenters and Project Builders!

Please send one copy of NEW IDEAS at \$3.50. First Class postage and handling \$1.00 (U.S. and Canada only). All other countries: \$2.00 for sea mail, \$3.00 for air mail.

Please send \_\_\_\_\_ copies of New Ideas. Total cost is sum of copy price and First Class postage and handling cost multiplied by number of issues ordered.

Please print

Allow 6-8 weeks for the material to arrive.

Detach and mail today:  
HANDS-ON ELECTRONICS  
Reprint Department  
500-B Bi-County Boulevard  
Farmingdale, NY 11735

(Name) \_\_\_\_\_

(Street Address) \_\_\_\_\_

(City) \_\_\_\_\_

(State) \_\_\_\_\_

(Zip) \_\_\_\_\_

All Payment must be in U.S. Funds!

H487

## NEAR LETTER-QUALITY FROM OLD PRINTERS

(Continued from page 46)

Remember, the switches set only the default mode; it can be changed through software, the printer's panel controls, or the Disk Wiz. For example, a BASIC CHR\$(27)"x1" overrides the default setting or the panel switch selection and turns NLQ on; a CHR\$(27)"x0" turns NLQ off.

Software always overrides hardware defaults or settings (made through the LF and FF pushbuttons).

The final step after installing the cover is to apply a supplied programming sticker to the front panel. The sticker shows the number of times the on-line, FF, and LF pushbuttons must be pressed to turn a specific function on or off, or to reset the printer to the normal dot-matrix draft mode.

### Tricks

Keep in mind that the panel controls can be used along with another program. For example, if you're printing a word-processed document and you want some words italicized but your word processor won't send printer control codes from within a document, simply program the word

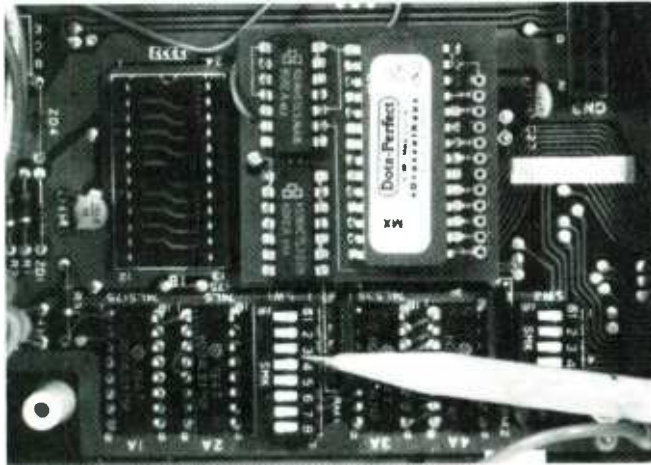

The pencil indicates the location of the 4-position DIP switch, which also must be set for the power-up defaults.



The pencil indicates the location of the 8-position DIP switch, which must be set for the normal power-up defaults.

processing to pause the printing, change to italics with the LF and FF pushbuttons, print what must be italicized, pause, switch the printer back to "normal," and resume printing again. It's all that easy!

### Different Modules

There are three versions of Dots-Perfect: Dots-Perfect/MX for MX-80/100 and IBM PC/Graphics, Dots-Perfect/RX for Epson RX-series printers, and Dots-Perfect/FX for Epson FX-80/100 and JX-80.

All give NLQ quality. The MX and FX models also give the IBM Graphics character set. The FX model can be set to Apple Imagewriter emulation for use with a Macintosh. All versions are priced at \$79.79 and may be ordered direct from Dresselhaus Computer Products, Glendora, CA, via their toll free number: 800/368-7737. ■



The final step in the retrofit is to apply the decal (label) that shows the programming provided by the printer's on-line, LF and FF panel controls.

## CARR ON HAM RADIO

(Continued from page 87)

### A Directional Limited-space Antenna

Although several companies make small beam antennas that work from not-at-all to well enough, we can make a directional dipole from a pair of back-to-back mobile antennas. I first tried that system with relatively flexible mobile antennas made of fiberglass, but it didn't work; The ends were too droopy. The hard metal shaft of Hustler-type antennas worked best. In fact, several years ago an engineer at the Hustler factory sent me a drawing showing two of their antennas back-to-back, as in Fig. 7. The antennas tend to have a high-Q, that is, a narrow bandwidth. But over a limited range, or with a proper tuner at the feedpoint, that problem can be overcome. The antenna can be rotated either by hand or with a simple TV-style rotor.

The engineer I talked to told me that

some users had claimed that it worked best when the two antennas were tuned to slightly different frequencies. He couldn't exactly explain why, but pointed out that the problems would show up as VSWR. When I built one of those just for kicks (I kept it up only a week), it didn't seem to matter a whole lot that the two mobile antennas were tuned to the same frequency. The feedpoint impedance,

however, is lower than for regular dipoles, a problem that can be handled with either  
(Continued on page 105)

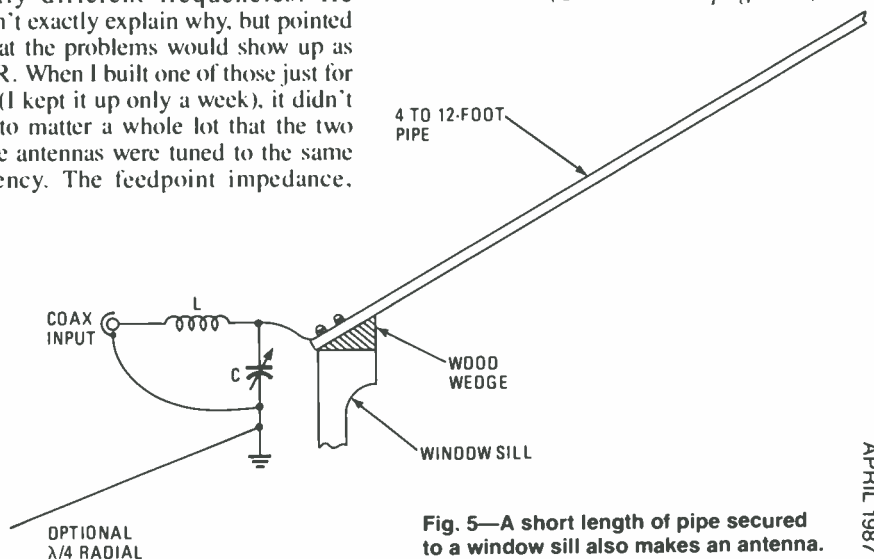

Fig. 5—A short length of pipe secured to a window sill also makes an antenna.

# HANDS-ON MARKETPLACE

## SATELLITE TV

SATELLITE receivers without downconverters. Some have minor scratches. All new \$35.00. **SATELLITE VISIONS**, RE 1, Box 22, Marshall, OK 73056.

**DESCRAMBLER**. Unscramble the video portion of Videocipher II, satellite TV signals with low cost decoder. Uses only three 556 timers. Order PC board and instructions \$35.00. **VALLEY MICRO-WAVE ELECTRONICS**, Bear River, Nova Scotia, Canada BOS-1B0.

## FOR SALE

PICTURE flyer lists quality surplus electronics at low prices. Since 1970. Send for the last 3 issues. **STAR-TRONICS**, Box 683, McMinnville, OR 97128.

**LASERS**: Surplus parts, and units, "the source for laser surplus"! Free catalog. **MEREDITH INSTRUMENTS**, P.O. Box 1724, Glendale, AZ 85311.

**LINEAR parts**—Transistors: MRF454 \$15, MRF455 \$12, MRF477 \$11, MRF492 \$16.75, MRF421 \$22.50, SRF2072 \$13, SRF3662 \$25, 3800 \$18.75, 2SC2290 \$19.75, 2SC2879 \$25. Tubes: 6KD6 \$10.50, 6LQ6 \$9.75, 6LF6 \$9.75, 8950 \$16.75. Best prices on Palomar Road Noise Mics, Ranger AR3300. New 16 page catalog listing radio/amplifier tricks—channel modification, PLL-Sliders, peaking for range, hard-to-find linear parts—mail \$1.00 to: **RFPC**, Box 700, San Marcos, CA 92069. For same day parts shipment, call (619) 744-0728.

**TUBES** 59 cents. Year guarantee. Free catalog. Tube Tester \$8.95. **CORNELL**, 4219 University, San Diego, CA 92105.

**CABLE-TV** converters. Scientific Atlantic, Jerrold, Oak, Zenith, Hamlin. Many others. Visa & MC accepted. Toll free 1-800-826-7623. **B&B INC.**, 10517 Upton Circle, Bloomington, MN 55431.

## CLASSIFIED AD ORDER FORM

To run your own classified ad, put one word on each of the lines below and send this form along with your check to:

**Hands-on-Electronics Classified Ads**, 500-B Bi-County Boulevard, Farmingdale, N.Y. 11735

**PLEASE INDICATE** in which category of classified advertising you wish your ad to appear. For special headings, there is a surcharge of \$10.00.

( ) Plans/Kits ( ) Business Opportunities ( ) For Sale  
( ) Education/Instruction ( ) Wanted ( ) Satellite Television

Special Category: \$10.00

### PLEASE PRINT EACH WORD SEPARATELY, IN BLOCK LETTERS.

(No refunds or credits for typesetting errors can be made unless you clearly print or type your copy.) Rates indicated are for standard style classified ads only. See below for additional charges for special ads. **Minimum: 15 words.**

1	2	3	4	5
6	7	8	9	10
11	12	13	14	15 (\$18.75)
16 (\$20.00)	17 (\$21.25)	18 (\$22.50)	19 (\$23.75)	20 (\$25.00)
21 (\$26.25)	22 (\$27.50)	23 (\$28.75)	24 (\$30.00)	25 (\$31.25)
26 (\$32.50)	27 (\$33.75)	28 (\$35.00)	29 (\$36.25)	30 (\$37.50)
31 (\$38.75)	32 (\$44.00)	33 (\$41.25)	34 (\$42.50)	35 (\$43.75)

We accept MasterCard and Visa for payment of orders. If you wish to use your credit card to pay for your ad fill in the following additional information (Sorry, no telephone orders can be accepted.):

Card Number

Expiration Date

PRINT NAME

SIGNATURE

**IF YOU USE A BOX NUMBER YOU MUST INCLUDE YOUR PERMANENT ADDRESS AND PHONE NUMBER FOR OUR FILES. ADS SUBMITTED WITHOUT THIS INFORMATION WILL NOT BE ACCEPTED.**

**CLASSIFIED COMMERCIAL RATE:** (for firms or individuals offering commercial products or services) \$1.40 per word prepaid (no charge for ZIP code)...**MINIMUM 15 WORDS**. 5% discount for same ad in 6 issues within one year; 10% discount for 12 issues within one year if prepaid. **NON-COMMERCIAL RATE:** (for individuals who want to buy or sell a personal item) \$1.15 per word, prepaid....no minimum. **ONLY FIRST WORD AND NAME** set in bold caps at no extra charge. Additional bold face (not available as all caps) **25¢ per word additional (20% premium)**. Entire ad in boldface, add 20% premium to total price. **TINT SCREEN BEHIND ENTIRE AD: add 25% premium to total price. TINT SCREEN BEHIND ENTIRE AD PLUS ALL BOLD FACE AD: add 45% premium to total price. EXPANDED TYPE AD: \$1.85 per word prepaid.** All other items same as for STANDARD COMMERCIAL RATE. **TINT SCREEN BEHIND ENTIRE EXPANDED TYPE AD: add 25% premium to total price. TINT SCREEN BEHIND ENTIRE EXPANDED TYPE AD PLUS ALL BOLD FACE AD: add 45% premium to total price. DISPLAY ADS:** 1" x 2 1/4"—\$160.00; 2" x 2 1/4"—\$320.00; 3" x 2 1/4"—\$480.00. **General Information:** Frequency rates and prepayment discounts are available. **ALL COPY SUBJECT TO PUBLISHERS APPROVAL. ADVERTISEMENTS USING P.O. BOX ADDRESS WILL NOT BE ACCEPTED UNTIL ADVERTISER SUPPLIES PUBLISHER WITH PERMANENT ADDRESS AND PHONE NUMBER.** Hands-on Electronics is published monthly, therefore copy to be in our hands for May 87, 1/19; June 87, 2/19; July 87, 3/19.

## PLANS/KITS

**BUILD** this five-digit panel meter and square wave generator including an ohms, capacitance and frequency meter. Detailed instructions \$2.50. **BAGNALL ELECTRONICS**, 179 May, Fairfield, CT 06430.

**CRYSTAL** radio sets, plans, parts, kits. Catalog \$1.00. **MIDCO**, 660 North Dixie Highway, Hollywood, FL 33020.

**JERROLD** gated pulse theory. Twelve information packed pages covering DI & DIC converter operation. Includes introduction to trimode system. \$6.95 plus \$1.50 postage and handling. **ELEPHANT ELECTRONICS INC.**, Box 41865-H, Phoenix, AZ 85080. (602) 581-1973.

**STRANGE stuff**. Plans, kits, items. Build satellite dish \$69. Descramblers, bugs, adult toys. Informational photo package \$3.00, refundable. **DIRIJO CORPORATION**, Box 212-H, Lowell, NC 28098.

**DESCRAMBLE** the latest video cassette copy protection scheme. Our simple Line Zapper circuit takes the jitter out of your picture. Complete plans and theory only \$9.95 plus \$1.50 postage and handling. PC board & completer kit also available. **ELEPHANT ELECTRONICS INC.**, Box 41865-H, Phoenix, AZ 85080. (602) 581-1973.

**PROJECTION TV**...Convert your TV to project 7 foot picture...Results comparable to \$2,500 projectors...Total cost less than \$30.00... Plans and 8" lens \$21.95... Illustrated information free. **MACROCOMA-HG**, Washington Crossing, PA 18977. Creditcard orders 24 hours, (215) 736-3979.

**FM** transmitter kit, matchbox size, super sound sensitivity, adjustable frequency/gain. Board, parts, educational instructions, \$19.95. **PERSHING TECHNICAL**, P.O. Box 1951, Fort Worth, TX 76101.

**REMOVE** vocals from records! Detailed theory and schematics, \$7.95. **RODALE ELECTRONICS**, 1035A Jefferson, Indianapolis, IN 46201.

**STEREO** image magnifier, 3-D snapshot viewer, plus many more fascinating plans/kits. Send today for free catalog plus complimentary plan. **QUANTUM RESEARCH**, 17919-77 Ave., Edmonton, AB T5R-2S1.

**SCHEMATIC** and theory for third brake light. Send \$2.00 to **BILL SHAFER**, P.O. Box 107, Gas City, IN 46933.

**Free Federal Consumer Information Catalog.**

Dept. TD, Pueblo, Colorado 81009



**VOICE** disguisers! FM bugs! SWL active antenna! Receivers! More! Catalog \$1.00 (refundable): **XANDI**, Box 25647, Dept. 32A, Tempe, AZ 85282.

**SAVE 75%**. Build your own IBM PC/XT compatible computer—easy—free details. **DIGATEK CORP.**, Suite 850, 2723 West Butler Drive, Phoenix, AZ 85051.

**PROGRAMMABLE** power supplies. Schematics and well written details are provided on several digitally programmable power supplies. Easy interface to PC. Ideal for Robotics applications. \$10 PPd. **BELL**, 416 Dale Terrace, Clarksville, TN 37042.

**BUILD** this one! Simple circuit and oscilloscope displays semiconductor junctions, resistance, capacitance, more...Both component and "in circuit" tests. Manual only \$5. **MARTY'S BOOK CONNECTION**, Box 37018, Fort Worth, TX 76117.

### FREE CATALOG

**FREE** semiconductors catalog gift with purchase. **C.M. ELECTRONIQUE**, Dept. HQ, P.O. Box 243, Laprairie, Quebec, Canada J5R 3Y3.

### WANTED

**INVENTORS!** AIM wants ideas, inventions, new products, improvements on existing products. We present ideas to manufacturers. Confidentiality guaranteed. Call toll free 1-800-225-5800 for information kit.

### DO-IT-YOURSELF TV REPAIR

**NEW...Repair any TV...easy.** Retired serviceman reveals secrets. Write, **RESEARCH**, Rt. 3, Box 601BH, Colville, WA 99114.

### CABLE EQUIPMENT

**CABLE** -TV Secrets—the outlaw publication the cable companies tried to ban. HBO, Movie Channel, Showtime, descramblers, converters, etc. Suppliers list included, \$8.95. **CABLE FACTS**, Box 711-H, Pataskala, OH 43062.

### EPROM PROGRAMMING

**FREE** catalog. Your software/data installed in (E)PROM of your choice. Fast, low cost service. Write/call: **ROMULUS MICROCONTROL**, Dept. B, Box 8669, Rockville, MD 20856; (301) 540-8863.

## ADVERTISING INDEX

**HANDS-ON ELECTRONICS** magazine does not assume any responsibility for errors that may appear in the index below.

Free Information No.	Page
—	"2001" ..... CV3
9	AMC Sales ..... 24
8	All Electronics ..... 6
5	Amazing Devices ..... 18
12	C.I.E. .... 11
10	Cooks Institute ..... 23
13	Digi-Key ..... 7
7	Electronic Book Club ..... 3
—	Electronic Tech. Today ..... 18,25
19	Fluke Manufacturing ..... CV2
—	Grantham Col. of Engineering .. 15
—	HO Reprint Bookstore ..... 99
17, 18	Heath ..... 13, 17
16	Jan Crystals ..... 23
20	MCM Electronics ..... 12
—	NRI ..... 21
—	Pacific Cable ..... 5
6	The Datak Corporation ..... 24
14	Trio-Kenwood ..... CV4

(Continued from page 103)

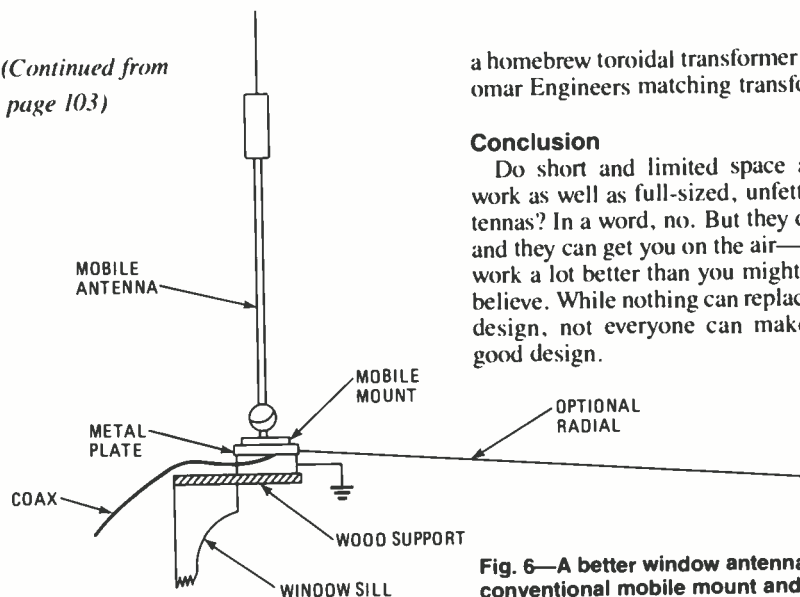

a homebrew toroidal transformer or a Palomar Engineers matching transformer.

### Conclusion

Do short and limited space antennas work as well as full-sized, unfettered antennas? In a word, no. But they do work, and they can get you on the air—and they work a lot better than you might initially believe. While nothing can replace a good design, not everyone can make use of good design. ■

Fig. 6—A better window antenna is a conventional mobile mount and antenna.

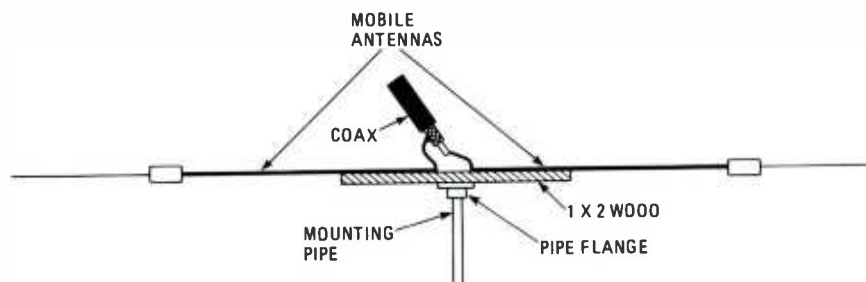

Fig. 7—A rotatable (directional) sky-hook can be made from two mobile antennas.

### SAXON ON SCANNERS

(Continued from page 22)

rescue, and a variety of other services to all military and civil aircraft operating in military-warning areas and offshore operating areas along the east, west, and gulf coasts.

Listen for FACSFAC operations as follows: Virginia Capes, VA (ID is *Giant Killer*) on 127.65, 135.225, 135.725, 135.875 MHz. The Jacksonville, FL operation—dubbed *Sealord*—can be found on 120.95, 134.65, 135.925 MHz. The Pensacola, FL installation (known as *Seabreeze*) can be heard on 118.425 MHz. San Diego, CA (*Beaver*) can be picked up on 118.65, 120.85 MHz.

Those are, of course, only the VHF frequencies associated with FACSFAC. There are also FACSFAC communications taking place in the HF and UHF aero bands.

We continually receive requests for in-

formation on two main topics: sources of scanner frequency information and how to get information on identifying and removing interference. A fine publication entitled *Interference Handbook* is available from the Superintendent of Documents, U.S. Government Printing Office, Washington, DC 20402-9325. The 64-page illustrated book is only \$2.50. Ask for book S/N 004-000 00450 7 when ordering.

A large selection of frequency directories for all bands (scanner, broadcast, shortwave, etc.) is available from CRB Research, P.O. Box 56-GP, Commack, NY 11725. Their catalog is sent free upon request.

Now it's our turn: Our request is that readers continue to furnish us with frequencies, questions, and other information relating to scanner monitoring. Write to: Marc Saxon, *Saxon on Scanners*, *Hands-on Electronics*, 500-B Bi-County Blvd., Farmingdale, NY 11735. Let's hear from you! ■

### TOUCH SWITCH DIMMER

(Continued from page 29)

When you are ready to mount the Touch Light-Dimmer to a wall box, you are in for a surprise or two. First, the holes in the plastic wall plate are 3 7/8 inches apart, and the North American standard is 3-5/16 inches apart. No, you don't have to drill new holes or enlarge the old ones. Inspect the plastic care-

fully; you'll discover two pop-out bushings that provide countersunk holes underneath that match the metallic or plastic electrical box in the wall.

The next discovery will be that the screws provided are *too wide*—the screws may be metric standard. Do not use those screws, because they will destroy the threaded holes in the

(turn page)

electrical box, and future replacement with North American products will have screws that do not catch the thread in the box. To avoid the problem, use the screws that held the wall switch in place, or similar screws. They need to be about 1" long in most cases. Be sure to sink the screwheads below the plastic surface so that the screws will not come in contact with the touch plate when it is installed.

Once the power is off, remove the old switch. Save it—it's still good! The Touch Light-Dimmer mounted on its plastic plate is about the same size as the switch that was removed and its corresponding metal plate. It should fit easily into the recess of the wall box. The leads that were connected to the wall switch are now connected to the dimmer. Connect the hot lead to the A terminal and the lamp lead to the N terminal. The hot lead is the lead that reads 117-VAC when the circuit is powered. If you don't know which lead is hot before you remove the wall switch, use an AC voltmeter between a good electrical ground and the lead under test. A 117-VAC reading indicates the hot line.

If you'd like to guess which lead is the hot lead, go ahead and connect the Touch Light-Dimmer. If it works, you did it correctly (and luckily); otherwise, power down and reconnect by switching the leads—the unit will not be damaged.

The two screws will hold the plate in place. Lay the touch plate lead straight down to the bottom of the plastic plate. Snap the metallic plate, which will electrically connect to the bare wire lead, onto the plastic plate. Should any part of the lead protrude, snip it off.

## Going Remote

Figure 4 shows the wiring normally used for two-way switches (Fig. 4A) and the equivalent wiring for the Touch Light-Dimmer and remote switch (Fig. 4B). Note that the unused hot AC powerline terminal on the Touch Light-Dimmer may be used for bridging or connections to additional remote switches. Also note that you can have as many remote switches as you like—all you have to do is wire them in parallel, but be careful not to transpose the hot and common lines.

After some time the touch plate may collect dust and an oily film on the polycarbonate plate. That can decrease the resistance between the touch plate and ground causing false triggering of the dimmer. Wiping the surface with a clean cloth will remedy that. If the trouble persists, remove the metallic plate and carefully wipe the plastic surface and the plate itself. That should do it.

OK, you have it all now. Plan to replace that snappy toggle switch with the Touch Light-Dimmer. We didn't get deep into the construction of the remote control for two good reasons. They are: Not everyone who assembles the Touch Light-Dimmer will want remote-control operation; and if you can put together the Touch Light-Dimmer, you'll have no trouble with the remote control. Details for purchasing a kit of parts for both devices are given in the Parts List.

Now, with the Touch Light-Dimmer installed, you can fantasize during the late evening movie and dim the lights. "Ah, mon cheri..."

## ELECTRONIC FUNDAMENTALS

(Continued from page 83)

58. (holes) The symbols generally used to represent enhancement MOSFET's in schematics are shown in Figs. 29A and 29B. A simplified symbol sometimes used in integrated-circuit diagrams is shown in Fig. 29C.

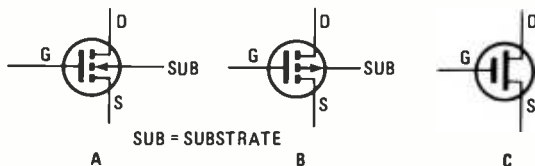

Fig. 29—The generally-used schematic symbols that are used for enhancement mode MOSFET's: A) N-channel; B) P-channel; C) simplified.

Another kind of MOSFET is the depletion-mode type shown in Fig. 30. In addition to the source and drain, a channel is also diffused into the substrate between them. The oxide and gate are formed over the channel as before. Since there is a continuous path from source to drain as in a JFET, current flows when the gate voltage is zero.

A normally-conducting MOSFET (gate voltage = 0) operates in the \_\_\_\_\_ mode.

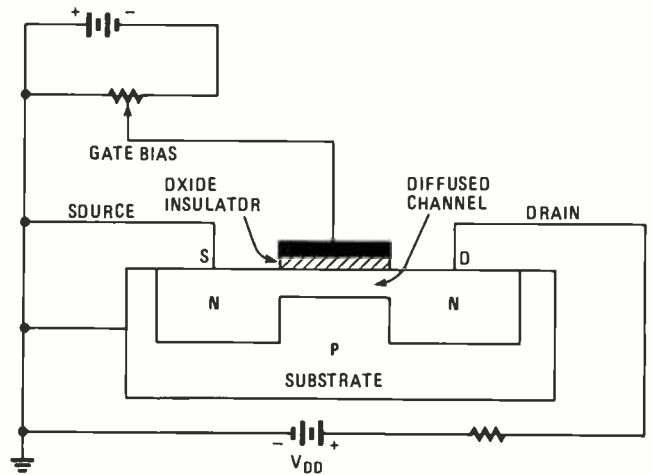

Fig. 30—An N-channel depletion mode MOSFET.



Fig. 31—The generally-used schematic symbols that are used for depletion mode MOSFET's: A) N-channel; B) P-channel.

59. (depletion) To control the source-drain current in an N-channel depletion mode MOSFET, a negative gate voltage is applied, which repels or depletes the number of electrons in the channel—increasing its resistance. Applying AC to the gate causes the channel resistance and current to vary accordingly.

To decrease the current in an N-channel MOSFET, a \_\_\_\_\_ gate voltage must be applied.

60. (negative) A P-channel depletion mode MOSFET has a continuous P-type source, channel, and drain diffused into an N-type substrate. Current flows with zero gate voltage. A positive gate voltage depletes the channel of holes, increasing its resistance and decreasing current flow. Figure 31 shows the symbols generally used to represent depletion mode MOSFET's.

# 2001 IS COMING IN MAY



An electronics revolution is in the making, but you don't have to wait until 2001 to find out how it will change your life in the 21st century. Radio-Electronics will forecast the coming changes and how they will affect you in the May 1987 issue!

Created by a special editorial task force—two years in preparation—this unique issue, 2001, takes you into the research laboratories of Westinghouse, Texas Instruments, Ford and Bell Labs where the future is being invented today!

You'll get an advance look at what's coming in artificial intelligence... new cars and highways (clearer, quieter and more efficient)... futuristic energy sources like magneto-hydrodynamic and particle-beam generators... personal communications systems that will give you instant access to anyone, anywhere... super computers and teaching breakthroughs that will multiply your capacity to learn!

Arthur Clarke introduces 2001. Isaac Asimov explores the marvels of robotics. But this is not science fiction. Rather it is

emerging technology with a solid foundation in current research and development.

And its impact will be enormous. It will change the way you work... the way you think... the way you live!

2001 is the kind of special publishing event that can only happen once in any magazine's lifetime and it will happen to Radio-Electronics in May, 1987.

With extra features and extra pages, 2001 will bear a premium cover cost, but you can reserve your copy now at less than the regular cover cost by mailing any one of the subscription orders in this issue.

2001 is coming in May. Make sure now that you don't miss it!

**Radio-  
Electronics**<sup>®</sup>

# KENWOOD

...pacesetter in Amateur radio

NEW

## Hear it All!



## R-5000

### High performance receiver

**THE** high performance receiver is here from the leader in communications technology—the Kenwood R-5000. This all-band, all mode receiver has superior interference reduction circuits, and has been designed with the highest performance standards in mind. Listen to foreign music, news, and commentary. Tune in local police, fire, aircraft, weather, and other public service channels with the VC-20 VHF converter. All this excitement and more is yours with a Kenwood R-5000 receiver!

- Covers 100 kHz-30 MHz in 30 bands, with additional coverage from 108-174 MHz (with VC-20 converter installed).
- Superior dynamic range. Exclusive Kenwood DynaMix™ system ensures an honest 102 dB dynamic range. (14 MHz, 500 Hz bandwidth, 50 kHz spacing.)



- 100 memory channels. Store mode, frequency, antenna selection.
- Voice synthesizer option.
- Computer control option.
- Extremely stable, dual digital VFOs. Accurate to  $\pm 10$  ppm over a wide temperature range.
- Kenwood's superb interference reduction. Optional filters further enhance selectivity. Dual noise blankers built-in.
- Direct keyboard frequency entry.

- Versatile programmable scanning, with center-stop tuning.
- Choice of either high or low impedance antenna connections.
- Kenwood non-volatile operating system. Lithium battery backs up memories; all functions remain intact even after lithium cell expires.
- Power supply built-in. Optional DCK-2 allows DC operation.
- Selectable AGC, RF attenuator, record and headphone jacks, dual 24-hour clocks with timer, muting terminals, 120/220/240 VAC operation.

#### Optional Accessories:

- VC-20 VHF converter for 108-174 MHz operation
- YK-88A-1 6 kHz AM filter
- YK-88S 2.4 kHz SSB filter
- YK-88SN 1.8 kHz narrow SSB filter
- YK-88C 500 Hz CW filter
- YK-88CN 270 Hz narrow filter
- DCK-2 DC power cable
- HS-5, HS-6, HS-7 headphones
- MB-430 mobile bracket
- SP-430 external speaker
- VS-1 voice synthesizer
- IF-232C/IC-10 computer interface.

More information on the R-5000 and R-2000 is available from Authorized Kenwood Dealers.

### R-2000

- 150 kHz-30 MHz in 30 bands
- All modes
  - Digital VFOs tune in 50 Hz, 500 Hz, or 5 kHz steps
  - 10 memory channels
  - Programmable scanning
  - Dual 24-hour digital clocks, with timer
  - 3 built-in IF filters (CW filter optional)
  - All mode squelch, noise blanker, RF attenuator, AGC switch, S meter
  - 100/120/220/240 VAC operation
  - Record, phone jacks
  - Muting terminals
  - VC-10 optional VHF converter (118-174 MHz)



# KENWOOD

TRIO-KENWOOD COMMUNICATIONS  
1111 West Walnut Street  
Compton, California 90220  
CIRCLE 14 ON FREE INFORMATION CARD