

PRICE—TWENTY-FIVE CENTS

FM

SEPTEMBER

1941



POLICE SERVICES
PREFER 3-WAY FM.

THE COMPLETE AND AUTHORITATIVE SOURCE OF INFORMATION
ON FREQUENCY MODULATION ★ ★ *Edited by M. B. SLEEPER*

REG. U.S. PAT. OFF.

World Radio History

FEWER PARTS -- FEWER TUBES

when you choose G.E.'s
SIMPLIFIED CIRCUIT

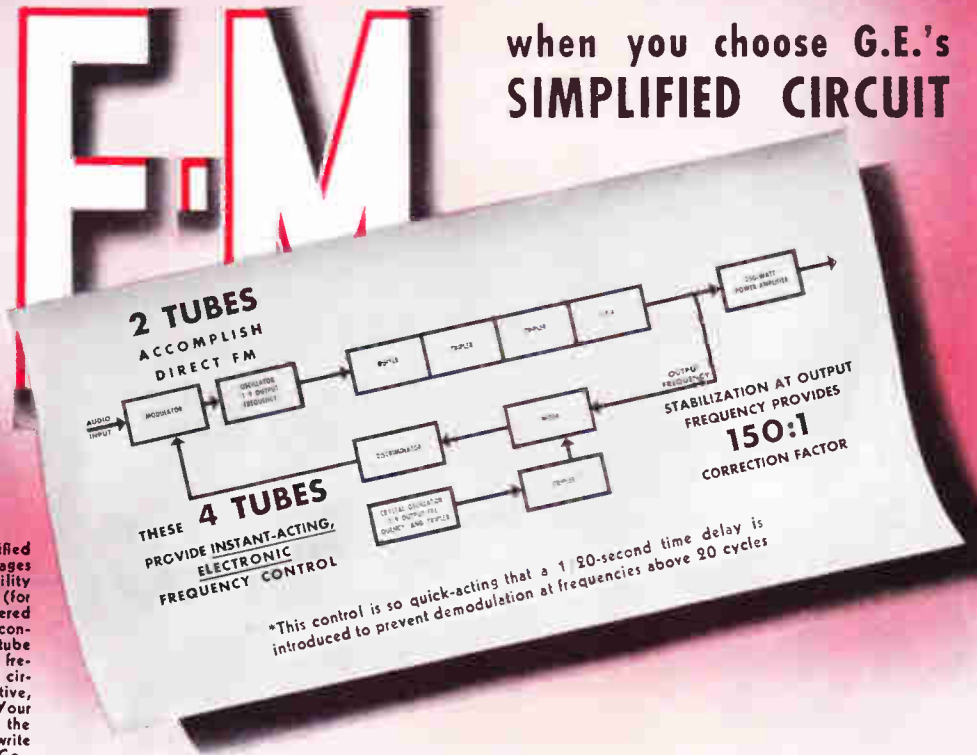

Inherent in this simplified circuit are the advantages of complete accessibility without disassembly (for every tube and soldered joint), low power consumption plus low tube replacement cost. The frequency stabilization circuit is simple, positive, and fast in action. Your nearby G-E man has the complete story. Or write General Electric Co., Schenectady, N. Y.

Engineers, look at this performance!

GUARANTEED PERFORMANCE CHARACTERISTICS

MEASUREMENTS ON TYPICAL PRODUCTION TRANSMITTERS

FREQUENCY STABILITY

±1000 cycles over a normal room temperature.

For weeks Station W2XOY, General Electric's FM proving ground, has operated 10 hours a day within ±200 cycles. Stability was measured *every hour*, using G.E.'s primary laboratory standard.

FM CARRIER NOISE LEVEL

Down 70 db at 100% modulation.

Production transmitters average 72 db down at 100% modulation.

HARMONIC DISTORTION

At 100% modulation less than 1% for modulating frequencies between 30 and 7500 cycles.

Actual performance based on units built to date indicates, at 100% modulation, less than 1% harmonic distortion for modulating frequencies between 30 and 16,000 cycles; less than 0.75% at 50% modulation; and less than 0.5% at 25% modulation.

AUDIO- FREQUENCY RESPONSE

The a-f characteristic from 30 to 16,000 cycles is within ±1 db, with or without pre-emphasis.

Without pre-emphasis, about -0.3 db from 30 to 16,000 cycles; with pre-emphasis, about -0.8 db.

The performance values on the right are not to be construed as G-E guarantees. They represent typical measurements made on stock transmitters and, as such, reflect General Electric's conservative guarantee policy.

GENERAL  ELECTRIC

World Radio History

160-15-B-6914

The Only One They Carry Off Is FM MAGAZINE



5. If you go to call at the REL factory in Long Island City, you will see that there is a magazine rack at the entrance, where you will find various radio publications, generally looking worn and weary, as magazines do when they have been picked up and put back many times.

You may not see a copy of *FM MAGAZINE* among them, but if you do, it will be a bright new copy, standing very erect!

Twice a month, when I call at REL, I put a new copy of *FM MAGAZINE* in that rack, and yet, the next time I go there, it's gone! That hasn't happened just three or four times. It has been going on for practically a year!

Finally, I asked the telephone operator about it. She said: "They must find it so interesting that they want to carry it off."

"Who do you suppose these men are who find *FM MAGAZINE* so interesting?" I asked.

"Oh," she said, "there's a constant stream of officials and engineers coming in here from broadcast stations, public utilities, and police departments, beside the Army officers and Government officials."

This incident is significant to radio advertisers because it is only one of a constant succession which has made *FM MAGAZINE* known as *the engineering publication of greatest interest to the executives and engineers in all branches of the radio business.*

M. B. SLEEPER, *Editor and Publisher*

To Those Who Have Friends in the Armed Forces



You have at least one friend who is serving in the Armed Forces as a radio officer, technician, instructor or operator. Radio literature, other than the service manuals, is scarce and difficult for him to obtain.

Those of us who were in the last war remember how completely we were cut off from outside news of engineering progress and developments.

Any radio man you know who is now in the service will be everlastingly grateful to you if you will have **FM MAGAZINE** sent to him from month to month. So will his friends, for the few radio magazines which reach the camps and schools are shared by many.

For our part, we'd like to share the cost with you. Accordingly, we have established a half-price rate of \$1.50 for a year's subscription addressed to any man in the U. S. Army, Navy, or Marine Corps.

The cost to you is small. The value to those you will benefit is great. Your thoughtfulness will be long remembered. — Act on this suggestion **TODAY!**



Half-Price Military Subscriptions

Should be Addressed to:

FM MAGAZINE

Readers' Service Department
112 East 36th Street, New York City



POLICE PREFER FM

THE most important subject to be discussed at the police officials APCO convention in September will be 3-way FM equipment.

Until Major Armstrong's invention was applied to emergency communications service, the widespread use of 2-way or 3-way systems remained in the realm of ideas which would be marvelous if they had the degree of dependability required of all equipment used in the protection of life and property.

One-way AM systems, valuable as they have proved to be in thousands of instances, are still limited in usefulness to the extent that in many emergencies they are totally inadequate.

In fact, the need for talking back from patrol cars was not generally appreciated until FM came into the police picture, and added the third dimension of car-to-car or 3-way communication.

During more than a year of service, FM has demonstrated that essential characteristic of absolute certainty which has won for it the confidence of police officials throughout the United States.

The resulting demand for FM equipment has been accelerated by the needs of National Defense. This month's cover photograph was taken in the factory of Link Radio Corporation, one of the Armstrong licensees. It shows some of the daily production of FM transmitter units coming out of final inspection, ready for packing and shipping.



THE RADIO ENGINEERING NEWS JOURNAL OF BROADCASTING, COMMUNICATIONS & TELEVISION

VOL. 1 SEPTEMBER, 1941 NO. 11

COPYRIGHT 1941 M. B. SLEEPER

CONTENTS

EMERGENCY TRUCK FOR STATE-WIDE FM SYSTEM <i>by Sydney E. Warner</i>	5
HOW W47A DID IT <i>by William F. Marquet</i>	7
FM IS MUSIC SHOW FEATURE	14
ANALYSIS OF MARKETS FOR FM <i>Compiled by FM Magazine</i>	16
WHAT THE FM BROADCASTERS HAVE TO SAY <i>A Statement by Louis Allen Weiss</i>	22
ZENITH A-FM PIANO DATE <i>From Official Service Manual</i>	23
B.B.B. ASKS FM QUESTIONS <i>by M. B. Sleeper</i>	27
THE MANUFACTURERS SAY: <i>A Statement by Fred M. Link</i>	30
FM SPOT NEWS	32
NEWS PICTURE <i>Station W451</i>	33
REL IN FM EMERGENCY FIELD <i>by Col. Gustavus Reiniger</i>	35
50,000-WATT FM TRANSMITTER <i>by W. R. David</i>	37

THE COVER DESIGN AND CONTENTS OF FM MAGAZINE ARE FULLY PROTECTED BY U. S. COPYRIGHTS, AND MUST NOT BE REPRODUCED IN ANY MANNER OR IN ANY FORM WITHOUT WRITTEN PERMISSION

★ ★ ★ ★ ★

M. B. SLEEPER, *Editor and Publisher*

Published by: FM COMPANY

Editorial and Advertising Office:

112 East 36th Street, New York City, Tel. LE 2-8070

FM Magazine is issued on the 20th of each month. Single copies 25c — Yearly subscription in the U.S.A. and foreign countries \$3.00. Subscriptions should be sent to FM Company, 112 East 36th St., New York City.

The publishers will be pleased to receive articles, particularly those well illustrated with photos and drawings, concerning all phases of FM developments. Manuscripts should be sent to the publication office, at New York City. Contributions will be neither acknowledged nor returned unless accompanied by adequate postage, packing, and directions, nor will FM Magazine be responsible for their safe handling in its office or in transit.

Advertising correspondence, copy, and cuts should be addressed to the advertising office at New York City.

PLEASE NOTE FM MAGAZINE'S NEW ADDRESS: 112 E. 36 ST., NEW YORK CITY

FM COMPANY

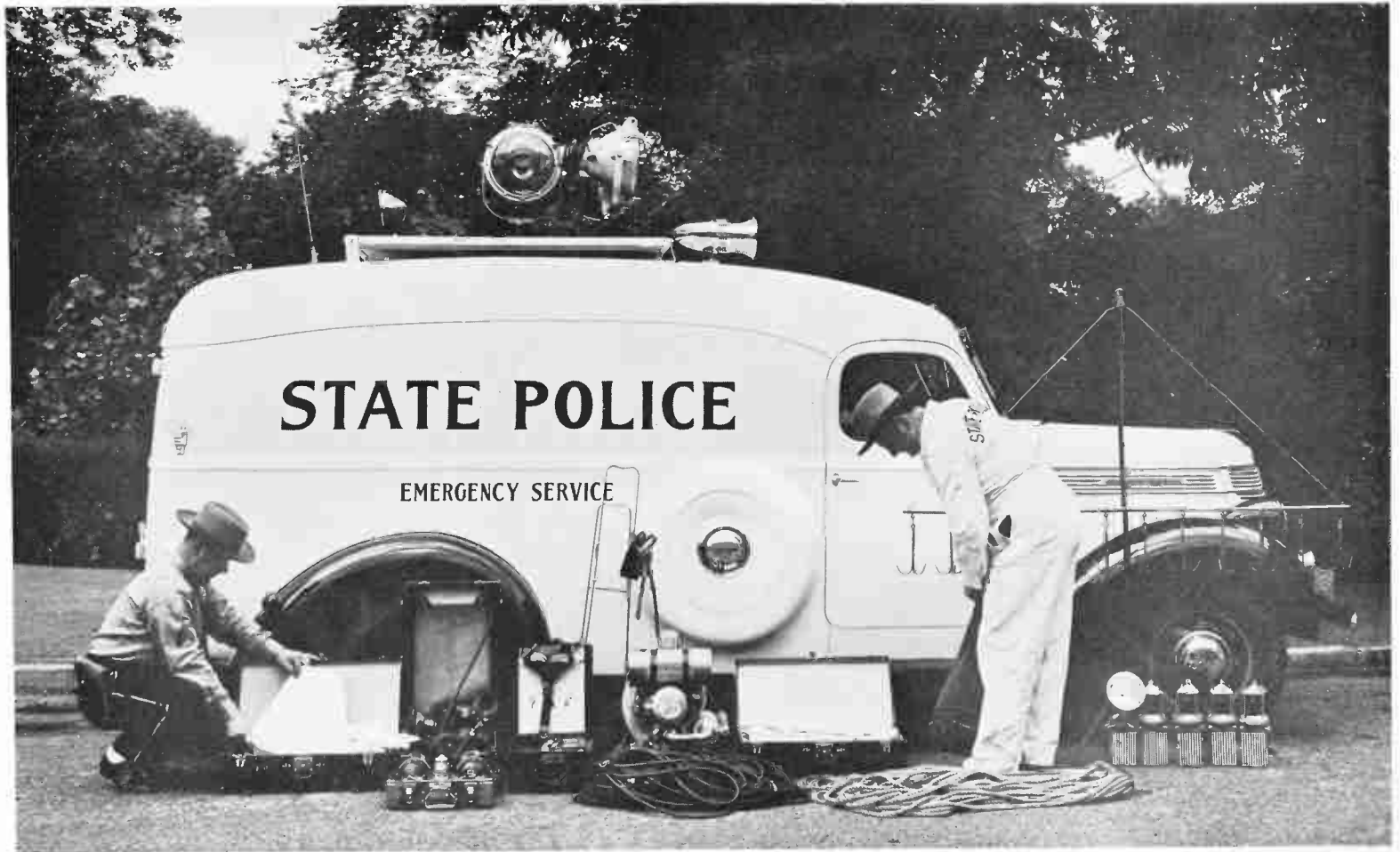

SGT. NORMAN LOWERY AND OFFICER HUBERT SPENCER STOW AWAY SOME OF THE EQUIPMENT CARRIED IN THE EMERGENCY SERVICE TRUCK

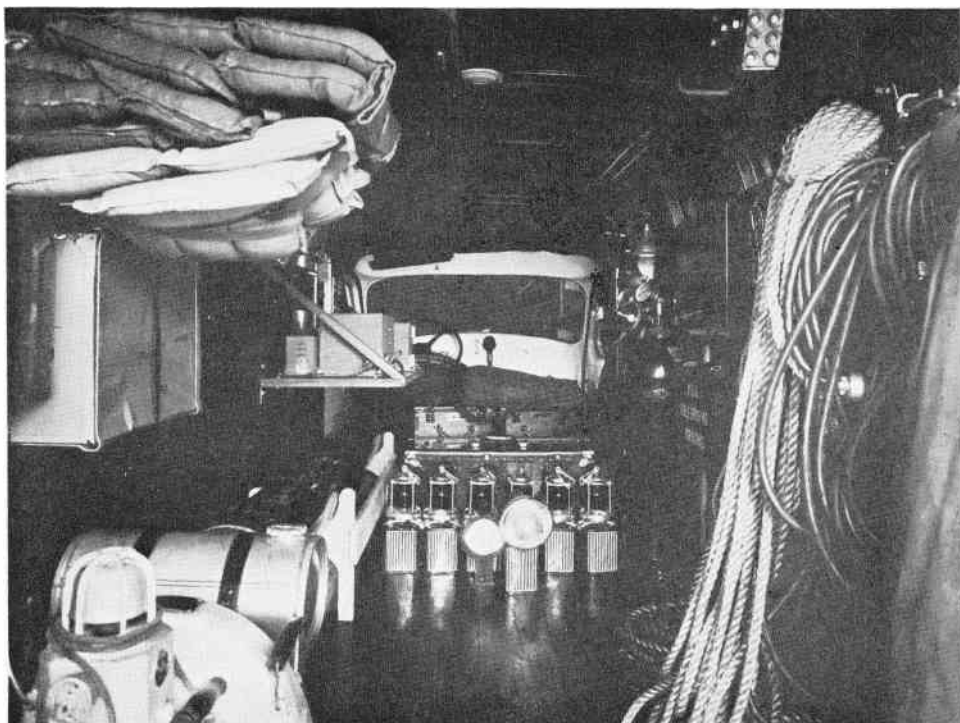

INSIDE THE EMERGENCY TRUCK. THE 3-WAY RADIO IS MOUNTED ON A SHELF AT THE LEFT

Emergency Truck to Supplement **STATE-WIDE FM SYSTEM**

Connecticut Has Emergency Truck Which Can be Sent to Any Disaster to Clear Special Message Traffic

BY SYDNEY E. WARNER *

AS A part of our State Police communications system, Commissioner Edward J. Hickey planned to equip a special truck for emergency service and which could be dispatched to the scene of any disaster to handle the extra load of resulting message traffic.

This truck, shown in the accompanying illustrations, has now been fitted out and put into service. The list of equipment, selected from experience with emergency needs, is given here in the hope that it may be useful to others planning to outfit trucks for a similar purpose:

- 1—Complete Link mobile FM apparatus
- 1—Electric generator, 1,500 w.

- 3—Flood lights, 750 w.

Cable for this equipment, 1,000 ft.

- 1—Davis inhalator
- 2—Davis gas masks
- 2—Asbestos suits
- 4—Complete sets of boots, raincoats, hats and gloves
- 4—Complete sets of working jumpers
- 4—Sets of asbestos gloves
- 2—Sets of grappling hooks
- 3,000 ft. of rope
- 1—Set block and tackle to move 40 tons
- 2—Hydraulic jacks up to 40 tons
- 4—Life saving jackets
- 2—Foamite fire extinguishers
- 1—Complete welding and burning outfit
- 4—Complete first aid outfits

* Radio Supervisor, Connecticut State Police, Hartford, Conn.

1—Complete first aid outfit for burns
 2—Stretchers
 1—Gas stove
 1—2-qt. thermos bottle for sterile water
 Flashlights, saws, hammers, pick axes, axes, sledge hammers, bolt cutters, blinking red lights, steady red lights, hand searchlights, both dry and wet batteries.

The radio installation can be seen in the illustration showing the inside of the truck. This is a standard Link assembly, connected to a spring-mounted whip antenna located on the roof of the truck, in accordance with our standard practice.

The Link equipment provides 3-way communication, and therefore can become a local headquarters for talking to other cars by switching the transmitter to the main-station frequency. This system of 3-way communication was outlined in my article¹ in *FM Magazine*, January, 1941.

Experience has shown that if any one of our 10 main stations should be disrupted, the emergency truck can be sent to high ground in the vicinity of the transmitter affected, and its traffic handled by the truck without any interruption.

This addition to the facilities of the Connecticut State Police is of great value because of the increasingly important service which our

state-wide radio system is furnishing. Now, of course, new responsibilities connected with National Defense put a greater load on our Department, and the radio traffic has increased correspondingly.

Consequently, 43 civilian employees and 50 State policemen are being added to our force. The civilians will take over radio dispatching, teletype operating, and office routine, releasing a corresponding number of State policemen for active field duty.

In step with this expansion, 60 more Link 3-way FM units are being added for these new men. By fall, we shall have 285 mobile FM units, so that all Connecticut State Police officers, totalling 275, will be in constant contact with their headquarters. I believe this is the largest 3-way installation anywhere, and it has been made possible by Frequency Modulation.

It is interesting to note that, after more than a year of operation, the maintenance problem is very satisfactory. We maintain the entire system of ten 250-watt fixed stations and the 285 car units with a staff of 5 men. Such an arrangement is possible and practical only with equipment that requires little attention.

¹ Police FM Performance, by Sydney E. Warner, *FM Magazine*, January, 1941. See also State-Wide FM System, by State Police Commissioner Edward J. Hickey, in the same issue.

FM MAGAZINE OFFICES MOVED TO NEW YORK CITY

ON August 25th, the *FM Magazine* editorial and advertising office at Newton, Mass., and the circulation office at South Norwalk, Conn., were moved to 112 East 36th Street, New York City. All correspondence should now be addressed to the New York office. The Magazine will be printed by Rumford Press, as in the past.

Moving the offices to New York City is a part of plans to expand the activities of *FM Magazine* and to make this publication of greater usefulness to both readers and advertisers. No. 112 East 36th Street is in the Murray Hill section of the City, just six blocks straight down Park Avenue from the Grand Central Station, in the heart of the Nation's radio activities.

From the first issue, November 1940, *FM Magazine* has pioneered with the pioneers of Frequency Modulation. When this publication started, the only broadcast stations were still operating with experimental licenses. At that time, even Yankee Network's Paxton station was only using what was left of the original antenna that was blown down the previous spring and Major Armstrong's station at Alpine had not begun a full, regular program schedule.

World War 2 was only in its first year when plans were being made to get *FM Magazine* under way,

and U. S. radio set manufacturers, with the most profitable year since 1929 behind them, were making still bigger preparations for the 1940-41 radio season.

With the October issue, *FM Magazine* completes its first year of service to the radio engineers, executives and merchandisers—a year which, concurrently with the nation-wide establishment of Frequency Modulation broadcasting, has brought more changes and modifications to the radio industry than have taken place in any year since all unfilled government contracts were cancelled in 1918!

Looking ahead to *FM Magazine's* second year—this will undoubtedly see many further adjustments on the part of radio broadcasters, manufacturers, and the trade, made in response to the needs of National Defense. Fortunately, plans to erect new FM stations are being carried out and this activity will be accelerated as soon as the FCC's newspaper-radio investigation is over, and the broadcast station executives can get back to their jobs of serving public interest, convenience and necessity.

All present indications promise sufficient production of A-FM receivers to keep pace with growing public demand where FM stations are in operation, and in other areas where stations are preparing to go on the air. Receiver production has never been stopped in England. With our greater resources and resourcefulness, there is every reason to expect American manufacturers to maintain their position of radio leadership among all nations.



W47A TRANSMITTER HOUSE TOPS MT. PINNACLE, 1,600 FT. HIGH, NEAR ALBANY, N. Y.

HOW W47A DID IT

The Inside Story of the Planning That Put the Capitol Broadcasting Company in the Black from Its First Day on the Air

BY WILLIAM F. MARQUET*

AMERICA'S first independent commercial FM station, W47A, is on the air. Its inaugural ceremonies, on the night of July 17th, brought to fruition a dream born six years ago. Located in the heart of the economically fertile Tri-City triangle formed by the cities of Schenectady, Albany, and Troy, Station W47A commands the FM waves which blanket a population of almost a million people inhabiting the 6,589 square miles covered by the new up-State FM outlet.

To the casual onlooker attending the inaugural program, it might have appeared that Station W47A, like some Olympian deity of mythology, had sprung full-grown at the instant of birth. Only the insider looking out would have known that over five years had elapsed from the time W47A was conceived as

a vision until it attained actuality. Credit for the long, upgrade pull that finally put the station on the topmost site of Pinnacle Point in the Helderberg Mountains goes to Leonard L. Asch, President of the Capitol Broadcasting Company, Inc., which operates W47A.

Probably unique in the history of broadcasting is W47A's feat of commencing commercial operations on the very first day with a schedule of programs sufficient to just meet operating expenses, exclusive of capital costs. Most of the station's present thirty-six contracts were signed in advance of the July 17th debut. All accounts at present are local sponsors; all are for thirteen weeks' duration.

The logical question arises: "How was it done?"

First, a realistic approach to the "circulation" or FM set problem dictated the adoption of an unorthodox rate card. Time rates were

*News Editor, Capitol Broadcasting Company, Inc., Schenectady, N. Y.

established on the basis of the cost of a direct mail campaign per FM listener-home. The fact that FM homes constantly were increasing in the W47A area, plus the fact that time cost would remain constant for the contract period, enabled the station to sell the idea of a less than direct mail cost equivalent.

The results of these tactics, so far as national advertisers were concerned, were disappointing. No definite commitments for time have been secured yet from national agencies.

With local establishments, however, the situation was eminently gratifying. Merchants responded to the direct mail sales angle and admitted the tariff had been calculated on a reasonable initial basis. In some instances, farsighted businessmen who spotted the future opportunities of FM asked to have contracts made on a two- or three-year basis. All such offers, naturally, were declined with thanks.

Even prior to actual solicitation of accounts, the management of W47A took the position that, for some time to come, considerable attention would have to be paid to assisting all elements in the radio distribution field to sell their FM sets and translators. Accordingly,

during the last two months of last year and the first month of 1941, W47A launched a receiving set merchandising campaign, with the valuable co-operation of FM Station W2XOY and the General Electric Company's merchandising department.

During that three-months' period, W47A assisted directly in placing approximately 600 more FM radios in the station's area. Specific activities included the use of co-operative newspaper advertising, radio dealer and department store window displays, the use of dealer and theater tie-ups, and the like. Incidentally, W47A, in co-operation with dealers and department stores, sponsored an FM radio training institute which enrolled radio salesmen to teach them the fundamentals of frequency modulation, during the mornings, and left them free in the afternoons and evenings to solicit FM prospects. Since this set-selling campaign was instituted late last year, slightly over 2,000 FM homes have been added in the territory serviced by W47A.

A third major factor which promoted the sale of radio time was in stressing the program versatility of W47A. Clients and prospects were

PROGRAM MANAGER GILBERT BAYEK IS AT THE FM STUDIO MICROPHONE, WHILE D. S. HOAG MANIPULATES THE CONTROLS OF THE CONSOLETTA, DURING A W47A BROADCAST





DWELLE S. HOAG, W47A CHIEF ENGINEER, WATCHES FOR A SIGNAL FROM THE STUDIO. NOTE THE COMPACT "ARM'S LENGTH" ARRANGEMENT OF CONSOLE AND TURNTABLES

told that, in addition to benefiting from the well-known superior audio characteristics of FM, they would receive both Mutual and Yankee Network programs, plus ASCAP and BMI music, MacGregor dramatic transcriptions, Associated Press radio processed news service, and several distinctive station-sponsored features. Capital was made, also, of the fact that W47A would operate on a somewhat longer schedule than other comparable stations. The station is on the air full time from 8:30 in the morning to 1 o'clock the following morning on weekdays, and from 8:30 Saturday morning to 3 o'clock Sunday morning, providing a "night club of the air" program from 1 to 3 A.M., Sunday. W47A at the moment is the only station in the Tri-City area which continues broadcasting after the usual 1 o'clock sign-off period on Sunday morning.

High on the station's agenda is the objective of keeping in close, constant touch with the radio dealers in the territory served by W47A. Names and addresses of all purchasers of FM and FM combination sets are obtained from dealers and distributors. Letters welcoming the radio set purchasers to W47A's channel are mailed regularly, urging them especially to

send in their comments and suggestions. The letters endeavor to stress the note of friendliness and informality, and are intended to make each FM listener feel more like a participant in the programs than an inactive member of the radio audience.

A continuing flow of fan mail is encouraged by periodic announcements that Pioneer Listener Certificates are being sent to all listeners who send in their comments. Emphasis is placed on the undeniable fact that such pioneer listeners are participating in research and development of radio's newest art by volunteering helpful and practical information on program reception.

Turning for a moment to the topic of how the station came into being, it will be recalled that mention was made above of the fact that Mr. Asch's struggles for a radio outlet covered almost six years, long before frequency modulation became a household word. Mr. Asch, while still a member of the merchandising strategy staff of General Electric, was bitten by the radio bug. He made several attempts, without success, to obtain an AM license.

Then FM, with its multiplied opportunities for licenses, swept onto the horizon, and im-

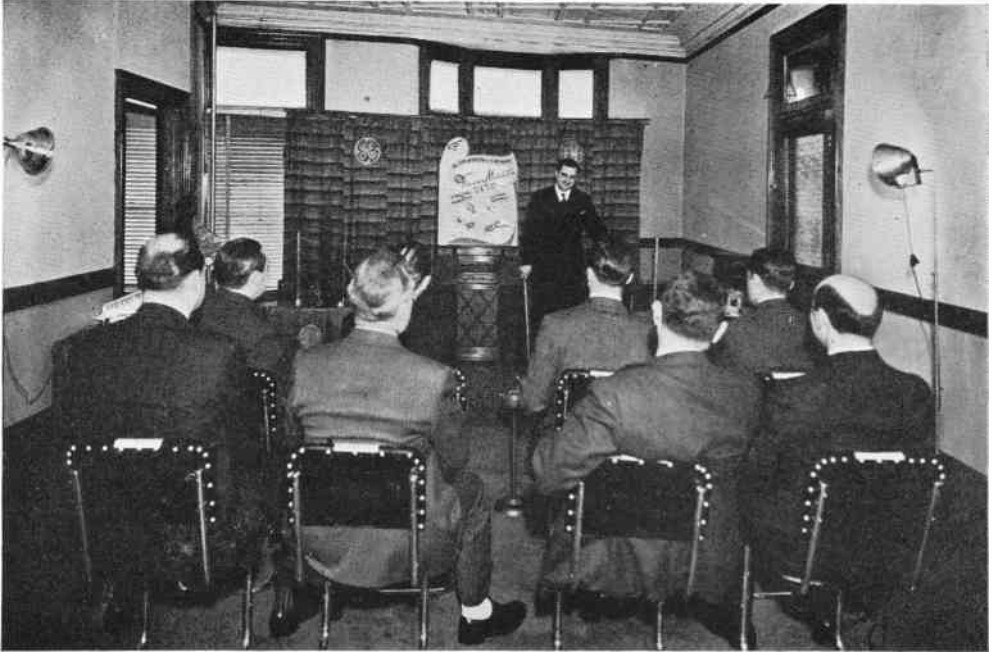

ENGINEER A. N. RUSCITTO PUT ON A TRAINING COURSE FOR FM RECEIVER SALESMEN

mediately Mr. Asch said, "From now on, it's FM for me." Late in 1939, James E. Cushing, one of Schenectady's most prominent business leaders, Harold E. Blodgett, former State As-

DR. W. R. G. BAKER DELIVERED ONE OF THE PRINCIPAL ADDRESSES AT THE W47A INAUGURAL



semblyman and president of the Schenectady County Bar Association, and Mr. Asch agreed that an FM station in the Schenectady area had the possibilities of a bright business future. They formed the Capitol Broadcasting Company, Inc., and, with the aid of Paul G. Fritschel, as consulting engineer, dispatched to Washington the original-style 42-page application on August 7, 1940. The Federal Communications Commission granted a construction permit October 31, 1940.

Perhaps it is merciful to skip over most of the early difficulties experienced by W47A, especially since they have been duplicated, with variations, by almost all other pioneer FM stations. But one difficulty surmounted may deserve special mention — that of transmitting programs from the studios in mid-town Schenectady to the mountain top transmitter, twelve miles away by airline flight. The attempt to solve the difficulty by leased telephone wire resulted in obtaining a quotation of \$15,634.50 as installation cost, with a monthly rental of \$118.50. The quotation also contained the provision that, "transmission characteristics of proposed facilities indicated that they are capable of transmitting a band of frequencies from 30 to 15,000 cycles at ± 1 db., and that the noise level is about - 33 db. above reference noise level. . . . I would like to point out that transmission available is based upon existing power conditions and cannot be guaranteed against future changes in these conditions."



LEONARD L. ASCH, PRES., HAROLD E. BLODGETT, VICE-PRES., JAMES E. CUSHING, CHAIRMAN

Armed with this quotation and with the aid of FMBI, hearings were arranged in Washington, and the FCC authorized the use of a relay transmitter for a studio-transmitter link. The Capitol Broadcasting Company subsequently received STL Number 1 construction permit to operate on the 331,000 kilocycle range.

As no equipment of that character was available, the management of W47A decided to install temporary studios in the mountain top transmitter house, so as to begin operations promptly, rather than await the delivery of the relay transmitter sometime this fall. The plan of incorporating additional space in the transmitter house to provide room for television equipment in the future bore immediate fruit in that it permitted the allocation of that space for the temporary FM studios.

The transmitter house is equipped with a General Electric 1-kw. FM transmitter, operating at 44.7 mc. Two RCA velocity microphones and one Western Electric cardioid microphone are used. The control equipment consists of an RCA consolette, with a General Electric monitor loud speaker and amplifier, type JCP-10, and two RCA turntables, with combination vertical and lateral sound pickups. A G.E. frequency monitor has been ordered and is expected to be delivered soon. Meanwhile, monitoring is done weekly by the G.E. Laboratory.

Defense priorities have delayed delivery of the steel mast and turnstile, necessitating the

design and FCC approval of a temporary antenna, consisting of a 65-ft. wooden pole with a special "lazy-H" type antenna.

Permanent studio facilities will be available

TELFORD TAYLOR, GENERAL COUNSEL OF FCC, SPEAKING ON FIRST W47A PROGRAM





LEFT: THE TEMPORARY WOODEN MAST CARRIES A "LAZY-H" ANTENNA. THIS WILL BE REPLACED UPON DELIVERY OF PERMANENT STEEL ANTENNA MAST



RIGHT: ENGINEERS AND ANNOUNCERS AT THE ENTRANCE OF THE TRANSMITTER HOUSE. L. TO R., EARL STRICKLAND, A. N. RUSCITTO, ROBERT HENRY, GRANGER TRIPP, AND CHIEF ENGINEER D. S. HOAG

in Schenectady by early October, provided that the relay transmitter is received by then.

Temporary arrangements have been made to pick up programs from Paxton, Mass., by radio for rebroadcasting over W47A. For this purpose, a dipole and receiving set have been set up approximately 1,500 ft. from the transmitter house and 100 ft. higher. A shielded receiving set, with an RF stage added, is used for that purpose.

The staff of W47A now comprises a program manager, chief radio engineer, three announcers and three assistant engineers. Gilbert Bayek, formerly of WDRC in Hartford, is

program manager. Chief engineer is Dwelle S. Hoag, formerly with WGNV in Newburgh. He is assisted by A. N. Ruscitto, Norman Peterson and Robert Henry. Granger Tripp, William Van Steenburgh and Nelson M. Griggs constitute the announcing staff.

Publicity, inevitably, has played a conspicuous role in promoting the destinies of W47A. Public relations have been handled by the writer, engaged on a full-time basis as news editor. As an example of the part played by publicity, the advent of W47A on the air waves was greeted by five pages of promotional material in one Schenectady paper, six pages in

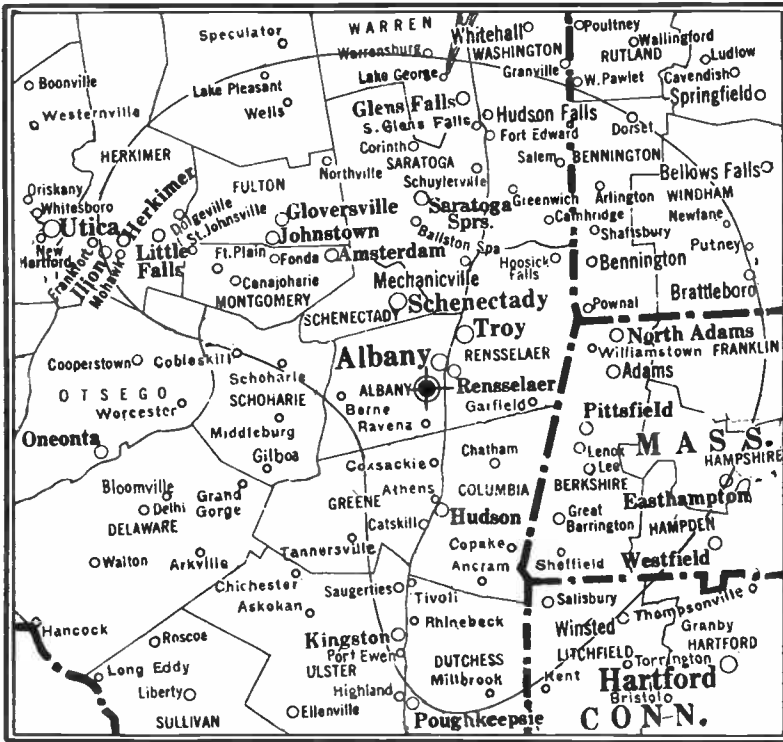

50-MICROVOLT CONTOUR COVERS 6,589 SQUARE MILES, 967,733 POPULATION, 264,090 HOMES WITH RADIOS. MAP SCALE, 35 MILES PER INCH

the other Schenectady daily, and by two pages each in the Albany and Troy papers.

The problem of earning a reputation among both sponsors and the listening public for "class," without falling into the error of becoming a "snob" station, has required some ticklish maneuvering. Offers of programs from so-called "borax" houses and other opportunistic high-pressure merchandisers have been declined as tactfully as possible, in keeping with the high standards established for all Frequency Modulation broadcasting. It is believed that the temporary loss of immediate revenue will be compensated by an increasing public recognition of the worthwhileness of those sponsors whose programs are acceptable.

In keeping with the policy of building public acceptance from the top, W47A has followed the practice of promoting demonstrations and explanatory talks with such organizations as the Rotary, Kiwanis, Zonta and other service clubs. The nature of the questions asked, the type of intelligent interest shown and the follow-up by station solicitors have proved be-

yond question that the practice is sound and feasible — at least for W47A.

In an effort to build a speedier and more widespread acceptance for FM from the so-called "general public," Station W47A already has laid plans for continuing its demonstrations and get-acquainted-with-FM-programs in the Schenectady, Albany and Troy schools. To dramatize more convincingly the merits of Frequency Modulation transmission, W47A is planning to ask school administrators and groups to produce some of their more ambitious dramatic projects over W47A. Simultaneously with each such demonstration, the station will make sure that interested neighborhood dealers are informed of the impending educational projects so that they will have ample opportunity to capitalize on these actual "live talent" demonstrations.

EDITOR'S NOTE: This information, presented by Mr. Marquet, was supplied in response to a request directed to the Capital Broadcasting Company for an account of their policies, methods, organization, and technical facilities. Their remarkable success should serve as encouragement to those who have been considering the operation of FM stations in comparable cities.

RIGHT: LLOYD SPENCER, LEFT, OF STROMBERG-CARLSON, WAS ONE OF THE BUSIEST SALES EXECUTIVES, AND ONE OF THE MOST ENTHUSIASTIC ABOUT FM.

BELOW: ONE OF THE NEW CABINETS HOUSING THE NEW PILOT CONQUEROR CHASSIS. THIS FEATURES LONG-DISTANCE FM AND AM RECEPTION, HIGH-POWER AUDIO OUTPUT, AND AUTOMATIC PHONO



FM IS MUSIC SHOW FEATURE

11 Companies Display A-FM Sets at N. Y. Music Trades Show

FREQUENCY Modulation was certainly the high spot of interest at the New York trade show sponsored by the National Association of Music Merchants.

Generally regarded by the music merchants with disdainful suspicion, radio sets capable of FM reception won the enthusiastic interest of dealers who came to sniff and remained to place orders—if they were permitted to do so.



This year, there were 41 companies displaying radios, phonographs, and sound equipment, far more than ever before. Of these, 11 showed radios and phono combinations designed for FM reception.

If the A-FM set manufacturers could have accepted all the orders that the dealers were ready to place, this show might have broken all records for business booked. As it was, the shadow of Priorities was cast upon those who wanted to buy as many sets as they were sure they could sell.

FM set manufacturers were generally confident that they could take care of deliveries to their regular customers up to the end of this year, but they were reluctant to take on new accounts other than important ones they had solicited unsuccessfully in the past.

So far as FM equipment was concerned, it was distinctly a sellers market, and each of the exhibitors booked all the business he dared to accept for fall delivery.

The Hotel New Yorker, where the Show was held, was an excellent spot for demonstrating the ability of FM circuits to eliminate interference from man-made static that frequently blanketed AM signals with clicks and background noise.

Located in the DC district, and immediately adjacent to the terminal of the electrified Pennsylvania railroad, there was all the interference needed for ideal demonstrations of the difference in FM and AM reception quality.

Many dealers had their minds made up that,



LEFT: ONE OF THE NEW ANSLEY A-FM PHONOGRAPH COMBINATIONS, DESIGNED PARTICULARLY FOR THEIR MUSIC-TRADE DEALERS. PRACTICALLY ALL MODELS CAN BE SUPPLIED WITH FM CIRCUITS

BELOW: TWO VIEWS OF A VERY POPULAR MODEL IN ZENITH'S VERY COMPLETE LINE OF A-FM SETS. THIS, AND SEVERAL OTHERS, ARE EQUIPPED WITH AUTOMATIC PHONOGRAPHS

while FM might be better out in the country, there would be no need for FM's static elimination in New York, where listeners have the advantage of being within the primary service areas of powerful stations. Thus, they were surprised to hear how noisy AM reception sounded in comparison to FM.

A-FM models were displayed by Ansley, Brunswick, Capehart, Espey, Farnsworth, Freed, General Electric, Magnavox, Philco, Pilot, and Stromberg-Carlson. All these companies, with the exception of one which is not

an Armstrong licensee, had their receivers in operation at the Show.

There was no question in the minds of the music dealers as to the superiority of FM tone. Typical of their comments was the remark: "Now you're making musical instruments out of radio sets." Undoubtedly, one of the reasons for the interest of the music dealers is the fact that A-FM sets are sufficiently high in price to keep them out of borax furniture houses, hardware stores, and credit jewelers.



Analysis of Markets for

FM BROADCASTING AND A-FM SETS

A Unique Method of Evaluating the Average Cultural Level of Counties, Cities, and Metropolitan Areas in the U. S. A.

HOW can markets for FM broadcasting and the sale of A-FM receivers be examined and appraised by counties and metropolitan areas? This is a matter of the greatest importance to those contemplating the erection of FM transmitters, for an estimate of potential income is related directly to a reasonably accurate determination of receiving set sales.

Data on income groups is available, but actual experience in the merchandising of AM sets has shown that buying power is not an index of taste in the purchase of radio receivers. FM reception and FM programming is distinctly different from AM. Figures on the number of homes¹ equipped with sets have little significance, since nearly everyone who could pay \$9.95 for a set at the rate of twenty cents a week has some kind of an AM receiver.

Since all A-FM sets operate on 115 volts, it might appear that this would be a broad basis for estimating A-FM set sales, but that is too broad and general.

What is needed in this case is really a measure of the average cultural level of cities and counties, related to population and retail sales. But how can the average cultural level of a given area be estimated by any authentic data available?

An exhaustive study of sales data available from the Department of Commerce for 1939 and the Bureau of the Census for 1940 has led to the compilation of figures from these sources which are considered an acceptable basis for cultural evaluation. From these figures potential A-FM set sales and, therefore, potential FM broadcasting audiences can be estimated.

Average Cultural Level ★ For this purpose we have used a unique measure which, as far as is known, has not been applied previously in market research. To establish a cultural level at which families would be rated as being appreciative of fine radio reception, we must look into the homes.

The census figures show the number of homes equipped with private baths and which are in good structural condition, as differentiated from those defective to the point where, if repairs are not made, the soundness of the structure would be impaired and a safety hazard created.

Further, to get a picture of a community, we must relate the number of homes with private baths and in good structural condition to those which lack these qualifications. Then, to gain a further understanding of those figures, we must consider the local retail sales and the retail sales in the Furniture-Household-Radio Stores group. There is no breakdown of radio sales by all types of stores, but sales by the home furnishings group of stores is a useful indication of home conditions.

Surprisingly, there are many more homes equipped with electric lights than there are homes in good structural condition and with private baths. To choose a state at random: In Delaware, there are 70,541 occupied dwelling units. Of these, only 9,812 need major repairs, but 28,906 have no private baths. However, the number of homes in good repair, with private baths, is only 39,466 out of the total of 70,541 dwelling units. Practically all urban and rural non-farm homes have electricity, but of the 11,641 occupied rural farm homes, 9,999 need major repairs and/or lack private baths, while only 7,198 do not have electricity.

This shows the degree of selection in relating the number of homes in good condition, with private baths, to the potential market for A-FM receivers.

The percentage of non-white population is given for each state. This factor can be disregarded in considering the number of potential A-FM set homes, however.

Listing of States ★ At this writing, the data required is not yet available for all states. Rather than wait until all figures have been compiled, they will be published from month to month in *F.M.* Magazine as they are furnished by the Bureau of the Census. Furthermore, the complete tables could not be presented in a single issue.

¹ These figures for 1940 will not be available until sometime in 1942.

ARIZONA

State:	1940	1940	1939	1940	1940	
	Dwelling Units in Good Re- pair, with Private Baths				Total Occupied Units	Retail Sales Add 000
Urban.....	32,186	48,924		173,981		
Rural non-farm.....	20,613	55,813		} 325,280 65% rural		
Rural farm.....	1,059	26,396				
Total.....	53,849	131,133	\$162,003	499,261	165	\$5,370
Counties:						
Apache.....	544	5,240	\$2,449	24,095	2	\$.....
Cochise.....	4,400	9,190	10,988	34,627	14	311
Coconino.....	865	4,677	6,750	18,770	4	115
Gila.....	2,673	6,616	6,504	23,867	6	128
Graham.....	663	2,894	3,138	12,113	5	89
Greenlee.....	945	2,185	2,216	8,698	2
Maricopa ¹	26,286	50,455	66,688	186,193	62	2,873
Mohave.....	630	2,654	4,201	8,591	5	34
Navajo.....	413	5,911	5,680	25,309	7	140
Pima ²	11,190	19,050	28,603	72,838	26	1,167
Pinal.....	2,006	6,979	5,443	28,841	11	126
Santa Cruz.....	1,025	2,377	3,519	9,482	5	112
Yavapai.....	2,718	7,822	9,321	26,511	13	249
Yuma.....	1,836	5,083	6,503	19,326	3	26

Cities over 10,000:

Phoenix ¹	13,710	19,278	47,922	65,414	46	2,654
Tucson ²	7,107	9,964	23,646	36,818	24	1,000*

Metropolitan Districts:

Phoenix ¹	23,808	36,466	(* Estimated)			
----------------------------	--------	--------	---------------	--	--	--

Summary

IN 1940, of all occupied dwelling units, 47.9% were occupied by their owners, an increase from 44.8% in 1930. Of the 131,133 occupied units in the state, 41% were in good structural condition and had private baths. To break this down further, 84% of the units were in good repair, but only 46% had private baths.

Retail sales in Arizona totaled \$162,003,000 in 1939, an increase of 36.3% over 1935. This is within 16% of 1929 volume. The number of stores increased since 1929 by 31%, compared to a population gain of 14%. Retail stores payroll was 40% higher than 1935, but 10% lower than 1929. The number of retail employees,

16,577, and active proprietors, 5,726, was higher than in 1935 or 1929.

Average monthly rent of urban dwelling units was \$24, of rural non-farm units, \$15.21. Non-whites occupied 12.5% of the units. These families were mostly Indian.

Cities of Phoenix and Tucson accounted for 44% of the retail sales in Arizona. Population of Phoenix is up 36% over 1930, while 1939 retail sales were 36% above 1935, but 18% below 1929. Population of Tucson was up 13% over 1930, while 1939 retail sales were 40% above 1935, but 2.5% below 1929.

DELAWARE

State:	1940 Dwelling Units in Good Re- pair, with Private Baths	1940 Total Occupied Units	1939 Retail Sales Add 000	1940 Population	1940 Furniture, House- hold, Radio Stores Group. Add 000 to Retail Sales	
					Stores	Sales
Urban	25,633	37,070	139,432		
Rural non-farm	13,066	21,830	}	127,073		
Rural farm	1,874	11,641		47% rural		
Total	40,573	70,541	\$110,052	266,505	152	\$4,865
Counties:						
Kent	3,064	9,672	11,955	34,441	26	382
Newcastle ¹	31,958	45,948	78,115	179,562	90	3,906
Sussex	5,551	14,921	19,982	52,502	36	577
Cities over 10,000:						
Wilmington ¹	20,959	29,293	64,951	112,504	78	3,829
Metropolitan Districts:						
Wilmington	34,392	48,583				

IN 1940, of all occupied dwelling units, 47.1% were occupied by their owners, a decrease from 52.1% in 1930. Of the 70,541 occupied units in the state, 57% were in good structural condition and had private baths. To break this down further, 86% of the units were in good repair, but only 59% had private baths.

Retail sales in Delaware totaled \$110,052,000 in 1939, an increase of 45% over 1935. This was 8% above 1929 volume. The number of stores increased since 1929 by 29%, compared to a population gain of 11%. Retail stores payroll was 23% higher than 1935 and 17% higher than 1929. The number of retail employees,

10,972 and active proprietors, 4,001, was higher than in 1935 or 1929.

Average monthly rental of urban dwelling units was \$36.04, of rural non-farm units, \$30.75. Average for Wilmington was \$37.75. Non-whites occupied 12.5% of the units, but this is not a factor in the units in good repair, with private baths.

The City of Wilmington accounted for 59% of the retail sales in Delaware. Population of Wilmington is up 4.5% over 1930, while 1939 retail sales were up 33.6% over 1935, but 6.2% below 1929.

IDAHO

State:	1940 Dwelling Units in Good Re- pair, with Private Baths	1940 Total Occupied Units	1939 Retail Sales Add 000	1940 Population	1940 Furniture, House- hold, Radio Stores Group. Add 000 to Retail Sales	
					Stores	Sales
Urban	30,271	50,774	176,708		
Rural non-farm	12,435	41,235	}	348,165		
Rural farm	7,372	49,718		66% rural		
Total	50,078	141,727	\$175,873	524,873	232	\$5,947
Counties:						
Ada ¹	7,963	14,423	24,695	50,401	28	\$1,164
Adams	85	971	613	3,407
Bannock ²	4,868	8,892	14,097	34,759	19	833
Bear Lake	750	1,961	2,133	7,911	4	44
Benewah	408	2,103	1,530	7,332	3	26

Bingham	1,239	4,964	\$4,716	21,044	9	\$ 187
Blaine	402	1,473	2,177	5,295	3
Boise	97	753	389	2,333
Bonner	978	4,606	3,495	15,667	2
Bonneville ³	2,502	6,467	11,776	25,697	12	463
Boundary	436	1,657	1,669	5,987	1
Butte	85	504	392	1,877
Camas	41	369	296	1,360	2
Canyon ⁴	4,212	11,225	13,512	40,987	20	509
Caribou	203	630	807	2,284
Cassia	1,110	3,488	4,485	14,430	8	152
Clark	48	276	190	1,005
Clearwater	457	2,254	2,111	8,243	2
Custer	142	1,008	877	3,549
Elmore	479	1,549	1,732	5,518	3	17
Franklin	900	2,357	2,555	10,229	4	98
Fremont	698	2,430	2,375	10,304	5	42
Gem	662	2,601	2,826	9,544	4	66
Gooding	545	2,451	2,668	9,257	6	122
Idaho	702	3,543	3,200	12,691	5	133
Jefferson	506	2,522	1,846	10,762	3	40
Jerome	496	2,546	2,820	9,900	6	100
Kootenai ⁵	2,966	6,723	5,847	22,283	9	131
Latah	2,012	5,355	6,140	18,804	9	135
Lemhi	289	1,890	2,105	6,521	3	69
Lewis	293	1,302	1,300	4,666	1
Lincoln	224	1,137	988	4,230	1
Madison	611	2,098	2,426	9,186	6	104
Minidoka	610	2,563	2,587	9,870	5	89
Nez Perce ⁶	2,435	5,620	9,613	18,873	7	233
Oneida	416	1,285	1,224	5,417	3	29
Owyhee	148	1,526	909	5,652
Payette	932	2,687	2,845	9,511	2
Power	305	1,033	1,120	3,965	2
Shoshone	2,950	6,073	8,686	21,230	8	258
Teton	129	817	539	3,601	2
Twin Falls ⁷	3,684	9,979	14,802	36,403	20	505
Valley	299	1,162	1,531	4,035	2
Washington	761	2,454	3,230	8,853	3	188
Cities over 10,000:						
Boise ¹	5,627	7,866	22,103	26,130	27	1,000*
Coeur d'Alene ⁵	2,040	3,209	4,586	10,049	7	125*
Idaho Falls ³	2,023	4,010	11,086	15,024	12	463
Lewiston ⁶	1,975	3,394	9,157	10,548	7	233
Nampa ⁴	1,898	3,521	6,820	12,149	11	289
Pocatello ²	3,712	4,939	11,733	18,133	18	800*
Twin Falls ⁷	2,070	3,459	11,230	11,851	13	439

(* Estimated)

IN 1940, of all occupied dwelling units, 57.9% were occupied by their owners, an increase from 57% in 1930. Of the 141,727 occupied units in the state, 35% were in good structural condition and had private baths. To break this down further, 75% of the units were in good repair, but only 37% had private baths.

Retail sales in Idaho totaled \$175,873,000

in 1939, an increase of 27.6% over 1935 and 6.4% above 1929 volume. Retail stores payroll was 30.1% higher than in 1935 and 8.7% above 1929. The number of retail employees, 16,549, and active proprietors, 6,223, were higher than in 1935 or 1929.

Average monthly rent of urban dwelling units was \$22.51, of rural non-farm units,

\$13.28. Non-whites occupied 1% of the units. These were mostly Indians.

The seven cities of over 10,000 population accounted for 43.6% of retail sales in Idaho. Retail sales in these cities were above 1935

and 1929 volume except Lewiston, which was ahead of 1935, but slightly behind 1929. Population in all seven cities was up in 1940 over 1930, with Idaho Falls first with 59% increase and Nampa second, at 48% increase.

MAINE

State:	1940 Dwelling Units in Good Re- pair, with Private Baths	1940 Total Occupied Units	1939 Retail Sales Add 000	1940 Population	1940	
					Furniture, House- hold, Radio Stores Group. Add 000 to Retail Sales	Stores Sales
Urban	54,276	88,406		343,057		
Rural non-farm	14,961	90,186		504,169		
Rural farm	2,916	40,376		} 59.5% rural		
Total	72,153	218,968	\$281,356	847,226	419	\$10,131
Counties:						
Androscoggin ¹	10,549	19,562	\$29,144	76,679	38	\$1,054
Aroostook	4,211	19,853	23,065	94,436	31	652
Cumberland ²	20,186	38,636	65,240	146,000	56	3,115
Franklin	968	5,332	5,421	19,896	11	96
Hancock	1,179	9,390	10,339	32,422	24	280
Kennebec ³	7,268	19,250	27,033	77,231	40	855
Knox	1,359	8,176	9,439	27,191	20	319
Lincoln	2,466	4,846	5,445	16,294	15	96
Oxford	2,747	11,011	11,474	42,662	19	194
Penobscot ⁴	9,203	24,307	34,512	97,104	43	1,538
Piscataquis	1,257	5,086	4,286	18,467	3	149
Sagadahoc ⁵	1,024	5,346	5,991	19,123	11	174
Somerset	2,164	10,213	9,375	38,245	21	309
Waldo	224	5,943	4,884	21,159	8	67
Washington	1,734	10,164	9,016	37,767	17	184
York ⁶	8,372	21,853	26,692	82,550	62	1,049
Cities over 10,000:						
Auburn ¹	3,506	5,480	5,801	19,817	4	23
Augusta ³	2,615	4,446	8,939	19,360	8	280
Bangor ⁴	5,296	7,420	20,312	29,822	25	1,181
Bath ⁵	1,257	2,816	4,932	10,235	10	167*
Biddeford ⁶	2,707	4,758	8,662	19,790	16	506
Lewiston ¹	6,072	9,259	19,731	38,598	23	930
Portland ²	13,997	19,643	45,895	73,643	40	2,799
South Portland ²	3,383	4,124	3,575	15,781	2	...
Waterville ³	2,797	4,218	9,670	16,688	13	359
Westbrook ²	1,688	2,927	3,478	11,087	5	123
Metropolitan District:						
Portland	20,064	28,167

(* Estimated)

IN 1940, of all occupied dwelling units, 57.3% were occupied by their owners, as compared to 61.7% in 1930. Of the 218,968 occupied units in the state, 33% were in good structural condition and had private baths. To break this

down further, 80% of the units were in good repair, but only 38% had private baths.

Retail sales in Maine totaled \$281,356,000 in 1939, an increase of 24% over 1935, but 6% below 1929 volume. The number of stores in-

creased 29% since 1929, compared to a population increase of 6% over 1930. Retail stores payroll was 22% higher than 1935, but slightly lower than 1929. The number of retail employees, 28,113, and active proprietors, 11,821, were higher than in 1935 or 1929.

Average monthly rent of urban dwelling units was \$25.51, of rural non-farm units, \$22.78. Non-whites occupied .3% of the units.

The ten cities of over 10,000 population ac-

counted for 47% of the retail sales in Maine. Retail sales in these cities were above 1935. Portland volume was below 1929 by 18%, Lewiston by 5%, Bangor by 12%, Augusta by 2%, and Westbrook by 10%. The others were above 1929, with South Portland showing a gain of 63% over 1929. Population in all ten cities was up in 1940 over 1930, with South Portland first with 14.3% gain, Augusta second with 12.4% and Biddeford third with 12.1% gain.

MISSISSIPPI

State:	1940	1940	1939	1940	1940	
	Dwelling Units in Good Repair, with Private Baths				Total Occupied Units	Retail Sales Add 000
Urban	46,949	120,360		432,882		
Rural non-farm	19,903	95,920		1,750,914		
Rural farm	8,939	318,676			80% rural	
Total	75,791	534,956	\$282,440	2,183,796	405	\$9,601
Counties:						
Adams ¹	1,783	7,556	5,666	27,238	12	301
Alcorn	1,271	6,755	4,461	26,969	7	149
Amite	83	5,035	1,112	21,892		None
Attala	494	6,937	3,306	30,227	7	109
Benton	145	2,373	326	10,429		None
Bolivar	1,674	18,138	8,491	67,574	8	170
Calhoun	346	4,924	1,408	20,893	1	..
Carroll	460	4,746	982	20,651		None
Chickasaw	872	5,085	1,654	21,427	3	15
Choctaw	44	3,007	830	13,548	2	..
Claiborne	198	3,385	1,404	12,810	3	12
Clarke	274	4,803	1,625	20,596	5	23
Clay	674	4,709	2,223	19,030	5	121
Coahoma ²	2,532	13,529	8,079	48,333	8	221
Copiah	644	8,252	3,851	33,974	4	50
Covington	162	3,792	1,418	17,030	3	20
DeSoto	1,495	6,660	1,905	26,663		None
Forrest ³	2,315	9,098	8,970	34,901	12	518
Franklin	97	3,061	877	12,504	1	..
George	155	1,942	1,020	8,704	3	10
Greene	125	2,044	734	9,512	1	..
Grenada	606	4,493	2,564	19,052	3	114
Hancock	671	2,808	1,292	11,328	1	..
Harrison ⁴	5,498	13,020	11,333	50,799	24	535
Hinds ⁵	9,694	26,921	31,978	107,273	37	1,747
Holmes	1,002	9,540	4,139	39,710	1	..
Humphreys	181	6,522	2,467	26,257	3	..
Issaquena	67	1,779	294	6,433		None
Itawamba	168	4,562	739	19,922	1	..
Jackson	1,331	5,191	3,049	20,601	12	195

(TO BE CONTINUED IN THE OCTOBER ISSUE)

WHAT THE FM BROADCASTERS HAVE TO SAY:

**A Statement Concerning K45LA by
Lewis Allen Weiss, Vice Pres-
ident and General Manager,
Don Lee Broadcasting
System, Hollywood,
California**

FREQUENCY Modulation is booming on the West Coast and the outlook for continued success of the new broadcasting art is indeed encouraging.

The Don Lee transmitter, K45LA, went into operation on August 11th with a great deal of fanfare, as it is the first commercial FM station in the entire west.

To assure FM set owners of unexcelled reception, the Don Lee Broadcasting System had a special 15,000-cycle telephone line, about seven-wire miles in length, laid between the KHJ broadcasting studios at 5515 Melrose Avenue in Hollywood and the K45LA transmitter atop 1,700-foot Mt. Lee, overlooking the film capital.

A large transmitter building has been erected on the site, sharing the dominating altitude with our television station W6XAO. The FM tower is 265 feet in height, with a four-bay turnstile antenna extending upward 35 feet more, making the over-all height 300 ft.

The top of the antenna thus is 2,000 ft. above sea level, having nearly half a mile sheer vertical clearance and providing an exceptional signal range to all parts of Southern California.

Well prepared in advance by a strong K45LA promotion campaign, dealers and public alike were ready for FM in this area, and dealers' shelves were well stocked. Indeed, one merchant had the foresight to cram his warehouse with 2,000 sets built after his own design.

At present, the only other FM transmitters operating in California are non-commercial: The Gomper's Trade School in the San Fran-



cisco Bay Area and the San Diego Consolidated Gas and Electric Company. The latter went into service in July for communication between headquarters and service trucks in the field.

Broadcasting of the Don Lee Broadcasting System's K45LA is on a 12-hour-a-day seven-day-a-week schedule from 10:00 A.M. to 10:00 P.M.

Temporarily, a 1-kw. Western Electric transmitter is being used, until our 50-kw. equipment, now under construction by the same company, is delivered.

In programming, Don Lee has a distinct advantage as our program department has wide experience in producing high quality shows which are particularly adaptable to FM. For instance, the current schedule of KHJ and the Don Lee network includes the following, some of which will be aired simultaneously on K45LA in addition to special FM presentations: Standard Oil Symphony, the Ballantine Ale show, Barrel of Fun, California Melodies, starring Maxine Gray, and Adventures in Melody, starring Betty Rhodes, both with Dave Rose's orchestra, Haven of Rest, Rehearsal of the Hollywood Bowl "Symphony under the Stars" orchestra, the Hancock Ensemble, the Adohr Golden Hour, Paradise Isle, and a host of famous dance orchestras from the

(CONTINUED ON PAGE 47)

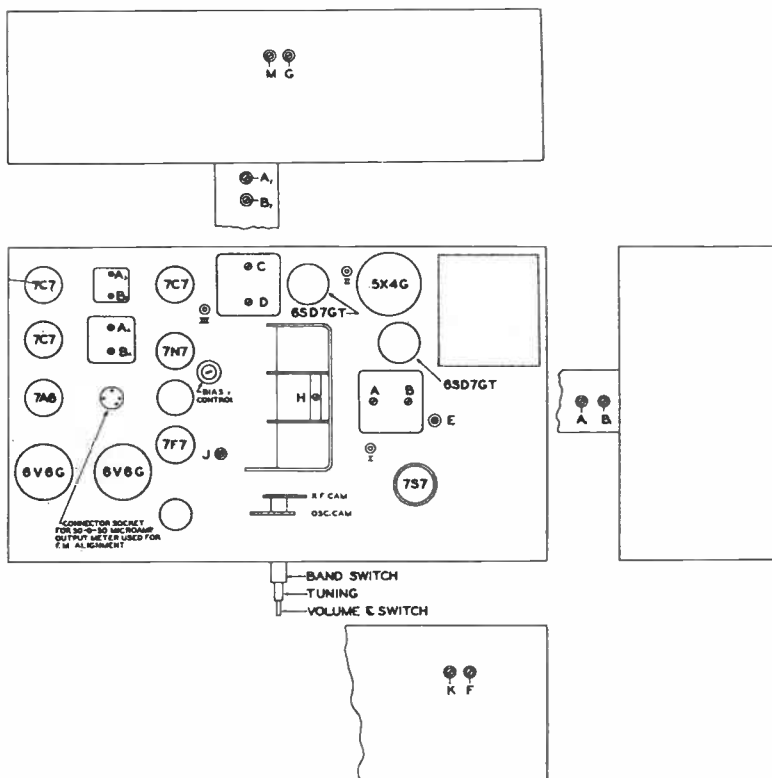

FIG. 3. THIS CHASSIS DRAWING SHOWS THE LOCATIONS OF THE TUBES AND TRIMMERS

ZENITH A-FM PHONO DATA

Circuit and Service Notes on 12B2 Phono Chassis for Zenith Models 12H689-12H695-12H696 *

THE 12B2 chassis described here is used in the Zenith vertical Kenwood cabinet 12H689 and in the two lowboy cabinets known as the walnut Williamsburg model 12H695 and the Georgetown mahogany model 12H696. All three sets are equipped with automatic record-changers to handle ten 12-in. or twelve 10-in. records. The Kenwood carries the record-changer in a pull-out compartment, while the other two have the changer mounted behind doors.

SPECIFICATIONS

Voltage: 117 volts, 60 cycles
 Type of Circuit: Armstrong Frequency Modulation and Superheterodyne
 Tuning Range:
 Broadcast, 540 to 1,620 kc.

Shortwave, 5.6 to 10.5 mc.
 FM, 42 to 50 mc.
 Types of Tubes:
 6SD7GT—RF amplifier
 7S7 —Converter
 6SD7GT—1st IF amplifier
 7C7 —2nd IF amplifier
 7C7 —1st limiter
 7C7 —2nd limiter
 7A6 —Discriminator-detector
 7N7 —Meter-amplifier-detector
 7F7 —Amplifier-inverter
 2-6V6G —Power amplifier
 5X4G —Rectifier
 Output: 15 watts
 Power Consumption: 150 watts, including phono motor
 Intermediate Frequency: AM, 455 kc.
 FM, 8.3 mc.

* From the official Zenith service manual

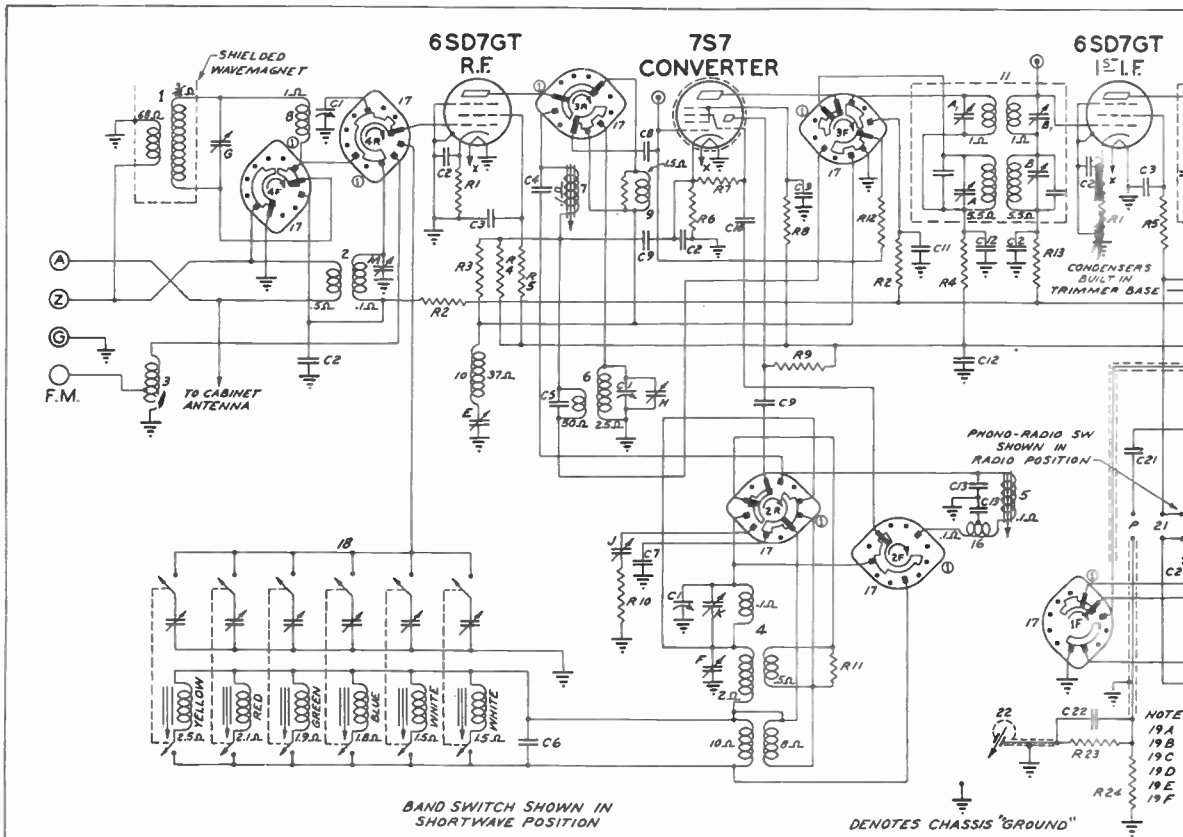

DIAG NO	PART NO	DESCRIPTION	DIAG NO	PART NO	DESCRIPTION	DIAG NO	PART NO	DESCRIPTION	DIAG NO	PART NO	DESCRIPTION
C1	22-1224	THREE GANG VARIABLE	C27	22-1137	.00015 MFD	600V	R18	63-1102 15M OHM	1/2 W	6	59847 DETECTOR COIL ASSEM (A.M)
C2	22-829	.05 MFD	C28	22-1126	.01 MFD	200V	R19	63-957 39M OHM	1 W	7	59849 DETECTOR - (F.M)
C3	22-243	.01 MFD	C29	22-448	.004 MFD	600V	R20	63-879 82M OHM	1 W	8	59559 LOOP LOADING COIL
C4	22-1259	5MMFD COMP	C30	22-1134	.02 MFD	600V	R21	63-597 470M OHM	1/2 W	9	59550 COIL PRES. ASSEMBLY
C5	22-470	.00015 MFD	C31	22-1124	30MFD ELECTROLYTIC	450V	R22	63-250 100M OHM	1/2 W	10	59832 WAVE TRAP
C6	22-868	COMPENSATING COND.	C32	22-1041	.005 MFD	600V	R23	63-657 330M OHM	1/2 W	11	95-849 1E I.F. TRANSFORMER
C7	22-1257	.005 MFD	R1	63-246	150 OHM	1/2 W	R24	63-661 680M OHM	1/2 W	12	95-850 25P I.F.
C8	22-162	.0001 MFD	R2	63-600	2.2 MEGOHM	1 W	R25	63-1204 3300 OHM	1/2 W	13	95-787 3E I.F.
C9	22-492	.002 MFD	R3	63-680	10 M OHM	1 W	R26	63-205 1500 OHM	1/2 W	14	95788 DISCRIMINATOR I.F. TRANS (F.M)
C10	22-289	50 MMFD	R4	63-593	1000 OHM	1 W	R27	63-1251 VARIABLE RESISTOR	1/2 W	15	510015 PLATE CHOKE
C11	22-826	.01 MFD	R5	63-1159	39M OHM	1 W	R28	63-1074 VOLUME CONTROL	1/2 W	16	59882 PEAKING COIL
C12	22-828	.05 MFD	R6	63-742	180 OHM	1 W	R29	63-593 47M OHM	1/2 W	17	85-302 BAND SELECTOR SWITCH
C13	22-1257	COMPENSATING COND.	R7	63-713	47M OHM	1 W	R30	63-711 22M OHM	1/2 W	18	510217 AUTOMATIC TUNING
C14	22-319	.005 MFD	R8	63-773	180M OHM	1 W	R31	63-976 15 MEGOHM	1 W	19	59606 TONE CONTROL SW ASSEM
C15	22-229	.005 MFD	R9	63-1065	15M OHM	1 W	R32	63-585 2200 OHM	1/2 W	20	122-15 TUNING METER
C16	22-127	25 MMFD	R10	63-578	15 OHM	1 W	R33	63-296 220M OHM	1/2 W	21	85-303 PHONO-RADIO SWITCH
C17	22-1178	15MFD	R11	63-587	4700 OHM	1 W	R34	63-311 15M OHM	1/2 W	22	169-89 PHONO PICKUP
C18	22-1138	.0005 MFD	R12	63-271	1 MEGOHM	1 W	R35	63-1189 200 OHM WIREWOUND	2 W	23	95-854 POWER TRANS
C19	22-1203	.001 MFD	R13	63-719	470M OHM	1 W				24	59504 LIME CHOKE
C20	22-1138	.0005 MFD	R14	63-633	680 OHM	1 W				25	100-96 DIAL LIGHT 6.3V .25A
C21	22-1220	.02 MFD	R15	63-606	1000 OHM	1 W					
C22	22-1220	.02 MFD	R16	63-656	470M OHM	1 W					
C23	22-1135	.05 MFD	R17	63-599	1.5 MEGOHM	1 W					
C24	22-1127	.02 MFD									
C25											
C26											

FIG. 1. SCHEMATIC WIRING DIAGRAM AND PARTS LIST FOR THE ZENITH 12B2 A-F PHONOGRAPH CHASSIS

SERVICE NOTES

The complete schematic is given in Fig. 1. Voltages measured from socket contacts to the chassis are indicated in Fig. 2. These measurements must be made in the 20,000-ohms-per-volt meta. All voltages are DC unless marked otherwise.

Fig. 3 shows the locations of the tubes, as

well as the trimmers and other adjustments referred to in the table which lists the succession of steps in the Alignment Procedure.

Broadcast and IF stage gains are as follows:

Antenna RF grid, 8 times at 1,000 kc.

RF grid to converter grid, 7.25 times at 1,000 kc.

Converter grid to IF grid, 41.5 times at 455 kc.

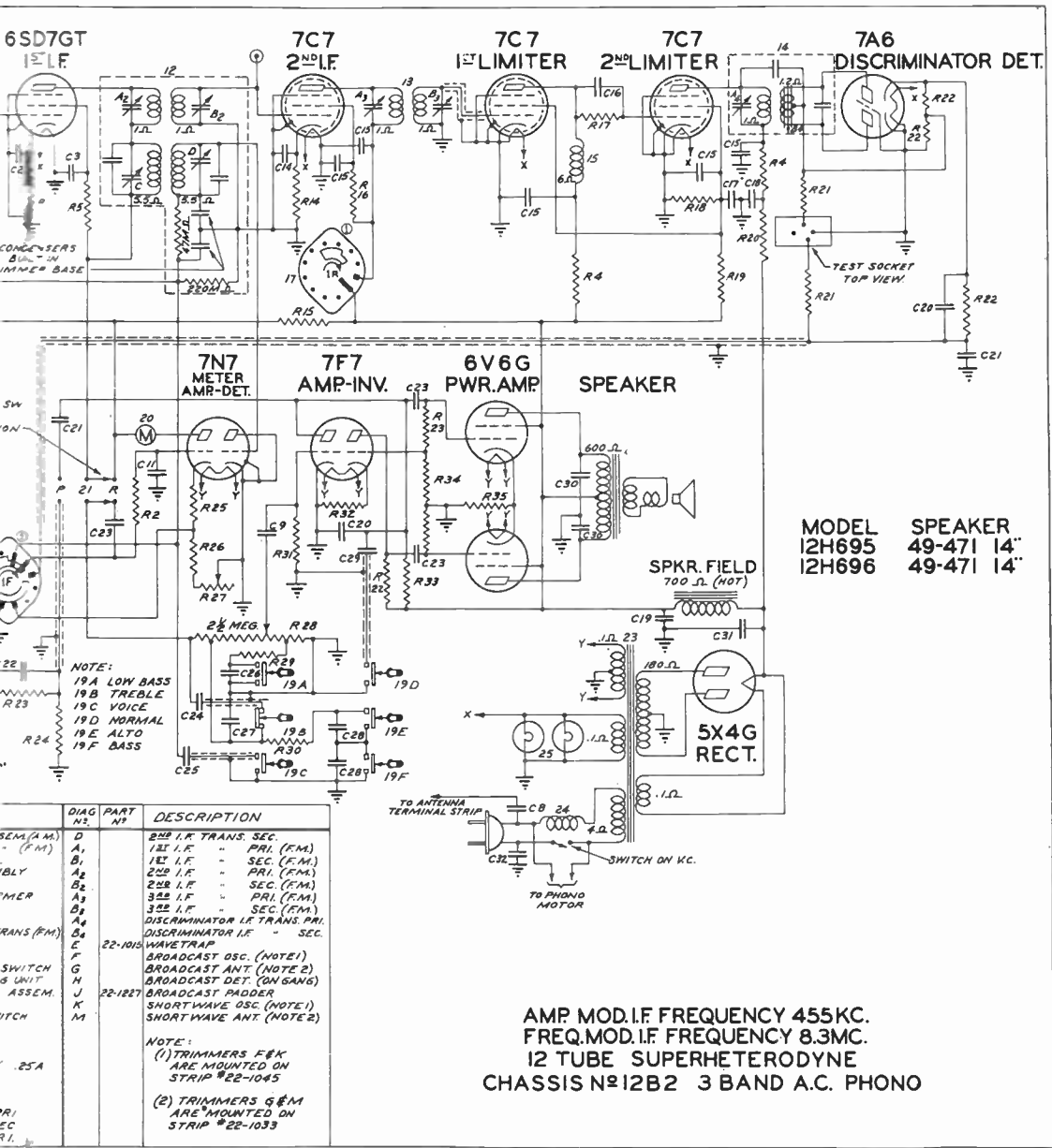

MODEL 12H695
12H696
SPEAKER 49-471 14"
49-471 14"

NOTE:
19A LOW BASS
19B TREBLE
19C VOICE
19D NORMAL
19E ALTO
19F BASS

DIAG. NO.	PART NO.	DESCRIPTION
SEM. (A.M.)	D	2ND I.F. TRANS. SEC.
" (F.M.)	A ₁	1ST I.F. " PRI. (F.M.)
	B ₁	1ST I.F. " SEC. (F.M.)
ASSEMBLY	A ₂	2ND I.F. " PRI. (F.M.)
	B ₂	2ND I.F. " SEC. (F.M.)
TUNER	A ₃	3RD I.F. " PRI. (F.M.)
	B ₃	3RD I.F. " SEC. (F.M.)
	A ₄	DISCRIMINATOR I.F. TRANS. PRI.
	B ₄	DISCRIMINATOR I.F. " SEC.
	E	22-1016 WAVE TRAP
	F	BROADCAST OSC. (NOTE 1)
SWITCH	G	BROADCAST ANT. (NOTE 2)
UNIT	H	BROADCAST DET. (ON GANG)
ASSEM.	J	22-1227 BROADCAST PADDER
	K	SHORT WAVE OSC. (NOTE 1)
	M	SHORT WAVE ANT. (NOTE 2)

NOTE:
(1) TRIMMERS F & K ARE MOUNTED ON STRIP #22-1045
(2) TRIMMERS G & M ARE MOUNTED ON STRIP #22-1033

AMP MOD. I.F. FREQUENCY 455 KC.
FREQ. MOD. I.F. FREQUENCY 8.3 MC.
12 TUBE SUPERHETERODYNE
CHASSIS NO. 12B2 3 BAND A.C. PHONO

GRAPH CHASSIS, USED IN THE KENWOOD 12H689, WILLIAMSBURG 12H695, AND GEORGETOWN 12H696

Overall audio, 1850 times at 1 watt, 400 cycles
The alignment procedure for all three bands is detailed in the following table. The various operations are numbered in their proper sequence, and should be carried out in the order shown.
Servicemen are advised to check the performance of A-FM sets carefully for faults

which may lie outside the actual circuits before attempting realignment. This suggestion is made because servicemen have found that they have made themselves unnecessary trouble, due to their lack of familiarity with FM installations, by blaming the sets for troubles caused by outside sources. If alignment is attempted, there should be no deviation from the sequence given in Alignment Procedure.

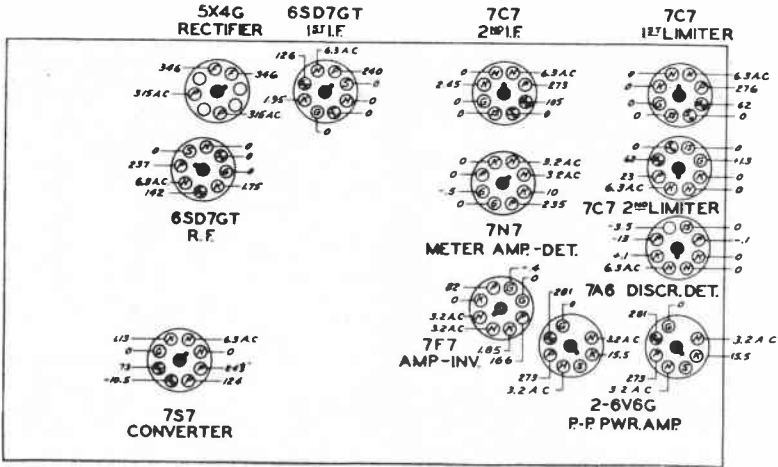

FIG. 2. SOCKET VOLTAGES MEASURED FROM SOCKET CONTACTS TO THE CHASSIS

ALIGNMENT PROCEDURE

Operation	Connect	Oscillator At	Dummy Antenna	Input Frequency	Signal Band	Set Dial at	Trimmers	Purpose
1	Control Grid	RF	0.5 mfd.	455 kc.	BC	600 kc.	A, B, C, D	Align IF
2	RF Grid		0.5 mfd.	455 kc.	"	600 kc.	E	IF Trap. Adjust for Minimum IF Signal
3	Ant. A and G		400 ohms	18 mc.	SW	18 mc.	K	Scale SW Osc. at 18 mc.
4	"		"	15 mc.	"	15 mc.	M	Align SW antenna
5	One turn loop made with generator lead or Radex loop		1600 kc.	BC	1600 kc.	F	Set BC Osc. to scale at 1600 kc.
6	"		1400 kc.	"	1400 kc.	H	Align BC RF Stage
7	"		1400 kc.	"	1400 kc.	G	Align broadcast loop
8	"		600 kc.	"	600 kc.	J	Rock gang to tract BC padder
9	7C7 2nd IF Grid Pin Jack III		0.5 mfd.	8.3 mc.	FM	8.3 mc.	A ₄	Align for max. deflection across 1/2 discriminator load
10	"		"	"	"	"	B ₄	Align for zero deflection across full disc. load.
11	"		"	"	"	"	A ₃ , B ₃	Repeat Operation No. 9. Align for max. deflection across 1/2 discriminator load.
12	6SD7GT 1st IF Grid, Pin Jack II		"	"	"	"	A ₂ , B ₂	Align for max. deflection across 1/2 discriminator load.
13	Con. Grid Pin Jack I		"	"	"	"	A ₁ , B ₁	"
14	FM Ant. Terminal	Ter-	100 ohms	46 mc.	"	46 mc.	Ajust osc. cam gang shaft to scale osc.	Align zero deflection across full discriminator load
15	"		100 ohms	46 mc.	"	46 mc.	Adjust RF cam for BC tracking	Align for max. deflection across 1/2 discriminator load
16	Adjust Tuning Meter				"	Clear of Signals	Bias Control	Adjust bias for tuning meter

Remove 2nd IF tube (7C7) from socket. Adjust bias control until meter reads exactly center. Replace IF tube and check meter behavior on FM and AM signals.



W55M DEMONSTRATED THE DIFFERENCE BETWEEN FM AND AM RECEPTION TO THOUSANDS OF LISTENERS DURING THE MILWAUKEE MUSIC FESTIVAL

B.B.B. ASKS FM QUESTIONS

National Better Business Bureau Charts BCLs' Understanding of FM

BY M. B. SLEEPER

THE specifications for the performance of FM broadcast stations have been established by the engineers of the Federal Communications Commission. These specifications are set forth in detail in the FCC's Standards of Good Engineering Practice, together with information as to how the performance of FM transmitters are to be checked against those Standards. Furthermore, each station must submit its proof of performance to the FCC which, in turn, checks the station's maintenance of the prescribed standards.

Purpose of FM Station Standards ★ The reason the FCC established these standards for FM stations and set them at much higher levels than those already in effect for AM stations was to assure listeners of the full benefits of the FM system of broadcasting.

The advantages afforded by FM over AM were established to the satisfaction of the FCC more than a year ago, at which time the Commission decided that, thenceforth, all

ultra-frequency broadcast stations must operate on FM and that existing ultra-frequency stations should be converted to FM.

Among the reasons on which the FCC based its decision were:

1. All natural and man-made static is eliminated or substantially reduced on FM of established minimum signal strength.
2. FM tone is a complete and perfect reproduction of the original speech, sounds and music, in contrast to the limited audio capabilities of AM.
3. FM provides full dynamic volume range, giving the true, natural relation between loud and soft passages, while AM requires studio monitoring to strengthen soft passages and to cut down the loud ones.
4. FM does not cause squeals and whistles which are so objectionable on AM and if two FM stations come in on the same frequency, the stronger suppresses the weaker.

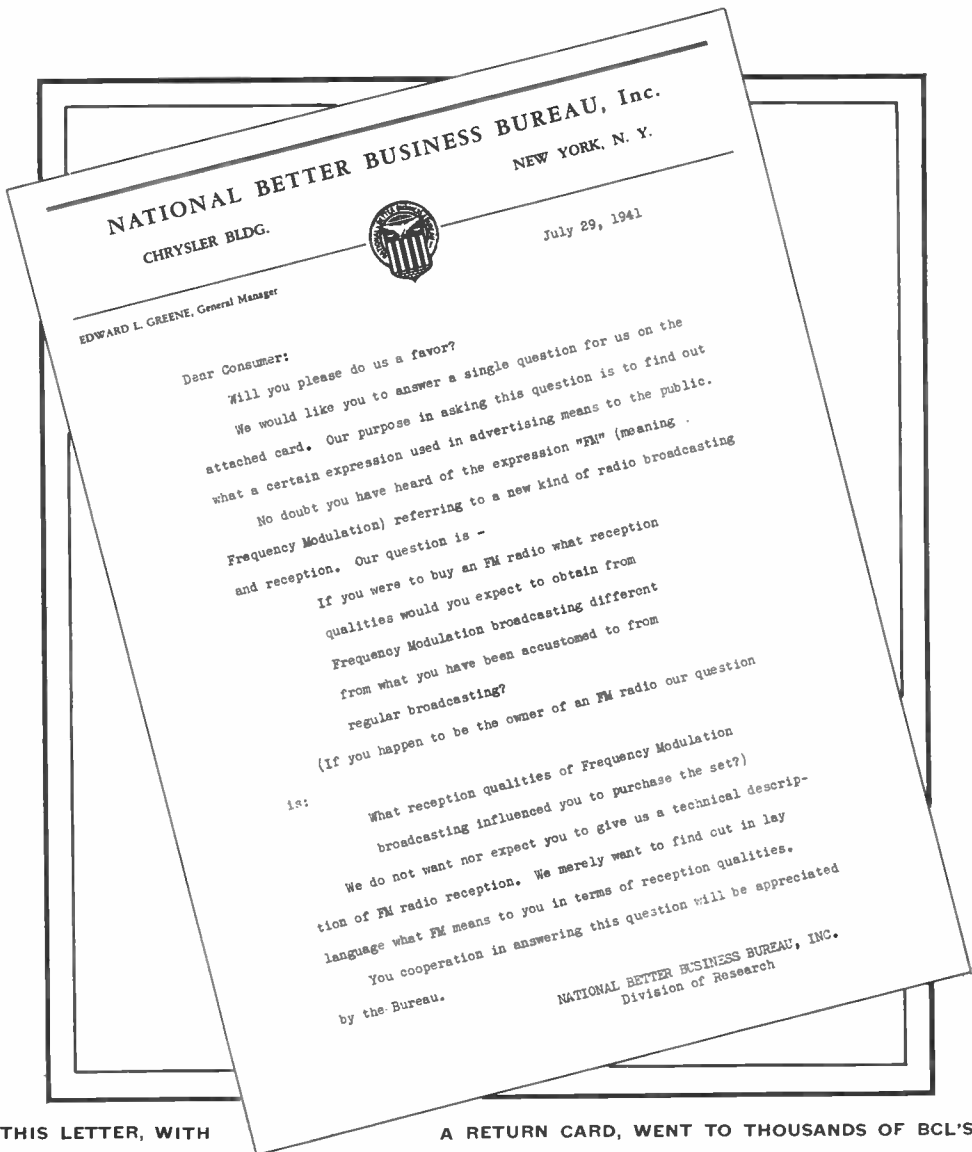

THIS LETTER, WITH

A RETURN CARD, WENT TO THOUSANDS OF BCL'S

5. FM signals are of the same strength during the hours of daylight and darkness, whereas signals from an AM station may be strong at night but inaudible in the daytime.

Now, in order to realize these advantages from FM, the transmitter and its emitted signal must be of certain definite and standard characteristics. But that is not all. The receiving set must be of such design as to make full use of the signals picked up!

What the Public Expects ★ All publicity and public information on FM has featured the five

points of superiority over AM listed above. What is of equal importance, these five points of AM's inferiority have been brought to the attention of radio listeners. Consequently, people expect to hear from FM the distinct improvement in reception that is afforded by sets designed to give the full advantages of the FM signals delivered by the broadcast stations, in conformity with FCC Standards.

The Milwaukee Journal, operating station W35M, is running a series of large-space newspaper advertisements which explain, in compelling and graphic illustrations, the advantages of FM. One of these, originally



FRED M. LINK

HIS SUCCESS AS AN ENGINEER AND MANUFACTURER OF EMERGENCY COMMUNICATIONS EQUIPMENT AND APPARATUS FOR SPECIAL AND UNUSUAL APPLICATIONS IS EXPLAINED IN PART, AT LEAST, BY HIS SLOGAN: "THE DIFFICULT WE DO IMMEDIATELY. THE IMPOSSIBLE TAKES A LITTLE LONGER."

THE MANUFACTURERS SAY:

A Statement by Fred M. Link, President, Link Radio Corporation, New York City

AS A confirmed representative of the currently thinning ranks of the avowed "independent specialized technical organizations," the writer is constantly asked why the Link group seems to make every possible effort not to grow to over-size proportions.

Especially is the question apropos at this time since we, like every other communications group of standing, have enough business on our books and enough potential orders if we want them to justify elaborate expansion. Under such circumstances, it seems that the incentive is to develop into Big Business if such a move is possible. However, in our case we feel that now more than ever the necessity and justification for the small specialized business is being recognized.

It has long been the creed of the Link organization that we have a niche to fill that is non-competitive in a true sense. In the development of our activity, we have tried to select the fields of endeavor where the large communications companies were not flexible enough, or where the return was not substantial enough for them to do a clean-cut job consistent with their prestige in other lines. Experience as an employee in large companies proved to me that in many cases the big name organizations attempted to qualify in certain specialized fields mainly to maintain position, with little or no attempt to contribute in a solid manner to the ultimate advancement of the art in these limited fields.

One of the fields of specialized communications that in past years suffered most severely was police radio. This now, in general, includes fire service, public utility and similar emergency applications. Frankly, there was sufficient reason why some of the big companies should treat police radio as a step-child and so they did by offering apparatus for the service that was misfit and most often did not represent the same degree of design proficiency that was accorded other types of equipment for more lucrative fields. In fact, the situation was so desperate that "home-builders" were put into business throughout the country and police and fire departments looked to local amateurs as readily as to recognized communications companies for advice and equipment. This situation can be traced to high costs for recognized manufactured equipment, but only in

part, since many police groups selected the local "home builders" because they earnestly felt the technical proficiency of the standard manufactured equipment was well below par and in many cases was obsolete when offered and would prove unsatisfactory in performance.

Obviously the situation as described above could not and never would have existed if the large communications companies with their years of experience and cherished prestige had taken the problem seriously or, more to the point, could have justified the economic expense necessitated by this new and rapidly changing specialty field with such a small ultimate market.

With a thorough appreciation of the problem of emergency radio communication as a guide, the Link organization started to take form roughly eight years ago. From the beginning we made our position clear—namely, we were going to specialize in emergency communications equipment and the engineering service that is so closely allied to it. It was not our intent to compete with the major companies, since we were not economically situated at the time to even consider seriously such a move. Furthermore, we felt certain that there was a spot somewhere between the independent home builder and the major radio companies for an established technical organization specializing in the field of emergency communications. We believe the record will justify our contention since, from a one-man attempt to survive the depression, our position has been consistently improved until we now feel that certainly Link Radio is recognized at present as one of the soundest organizations offering service and equipment in the emergency radio field.

Now, we face the present as a group of earnest technicians backed by eight years of consistent study and applied effort in the highly specialized field of emergency communications, ready to serve not so much as a competitor of the larger radio companies, but more in the position of a trained supplementary group, often closely cooperating with the large, internationally known radio companies. We feel that the need for such a service is now more pronounced than ever.

FM SPOT NEWS

Notes and comments, personal and otherwise, that have to do with FM activities

Double: Manufacturers' A-FM sets sales reported to accountants retained by FMBI show June deliveries double those of May. Total has now reached 50,000 mark.

No Flies Allowed: Buzzing intruder in W55M studio practically disrupted a program, so clearly could it be heard on local FM sets.

New York City: W2XWG, Empire State Building, will not get the 10-kw. RCA transmitter in time to put it on the air in August, as NBC officials had hoped.

Chicago: Similar transmitter is expected for the NBC Chicago station in November.

Brunet-Cook: Elected vice-presidents of RCA Manufacturing Company, according to announcement by George K. Throckmorton, president. Meade Brunet will continue in charge of Engineering Products and Jay D. Cook will carry on in charge of the International Division.

Zenith: Authorized by FCC to operate its television transmitter on Channel No. 1-50-56 mc.—with unlimited time, for commercial programs. Station will use facilities of Zenith's experimental transmitter W9XZV.

Pittsburgh: Walker-Downing takes first place among FM stations in Pennsylvania. W47P is scheduled to go on the air with commercial programs at the end of August.

CARL J. MEYERS, RIGHT, CHIEF ENGINEER OF WGY, CHICAGO, AND CLYDE WHITE, AT THE NEW W59C TRANSMITTER INSTALLATION

FMBI: Now lists 51 memberships. Of these, 29 members have already received their C.P.'s. This makes a most influential aggregation for the protection and advancement of FM broadcasting.

San Francisco: Don Lee Network, with first west-coast FM station in Los Angeles, has 50-kw. station under way in San Francisco. Site is in Marlborough Terrace, highest peak in Berkeley Hills, due east of S.F., across the bay. Information comes from William D. Pabst, general manager of KFRC.

Chicago: Reported by Halter Hinchell in Zenith Radio Distributing Corporation's house organ: "Abe Riley, owner of Honest Abe's Radio Service, last week burned all his books and hanged himself from a rafter in his shop after reading a certain article in *Reader's Digest*."—His example might well be followed by some others we know.

Sprague: New Koolohm resistor catalog lists interesting and important new types and shapes. Included are Navy Specifications series, and a series designed to be ganged together for tapped sections. All units are wire-wound, moisture-proof, and able to take 1000°. Address request for catalog to Sprague Specialties Company, North Adams, Mass.

W.E.: Is sub-contracting 40% of its Government orders for radio and telephone equipment, thereby sharing its business with smaller

W59C WILL HAVE ITS G.E. FM TRANSMITTER ON REGULAR SCHEDULE ABOUT SEPTEMBER 20TH. BIG DEALER MEETING WILL BE HELD THEN

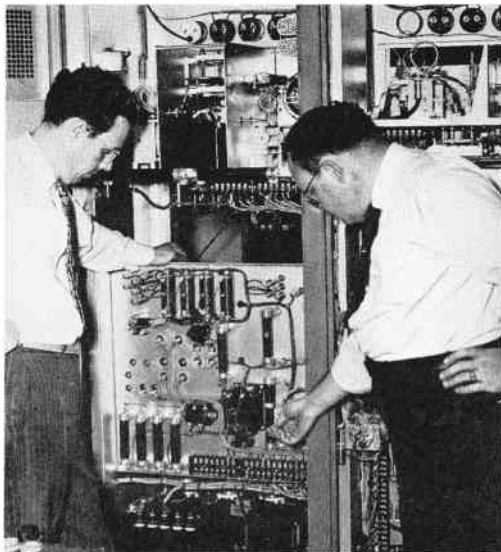

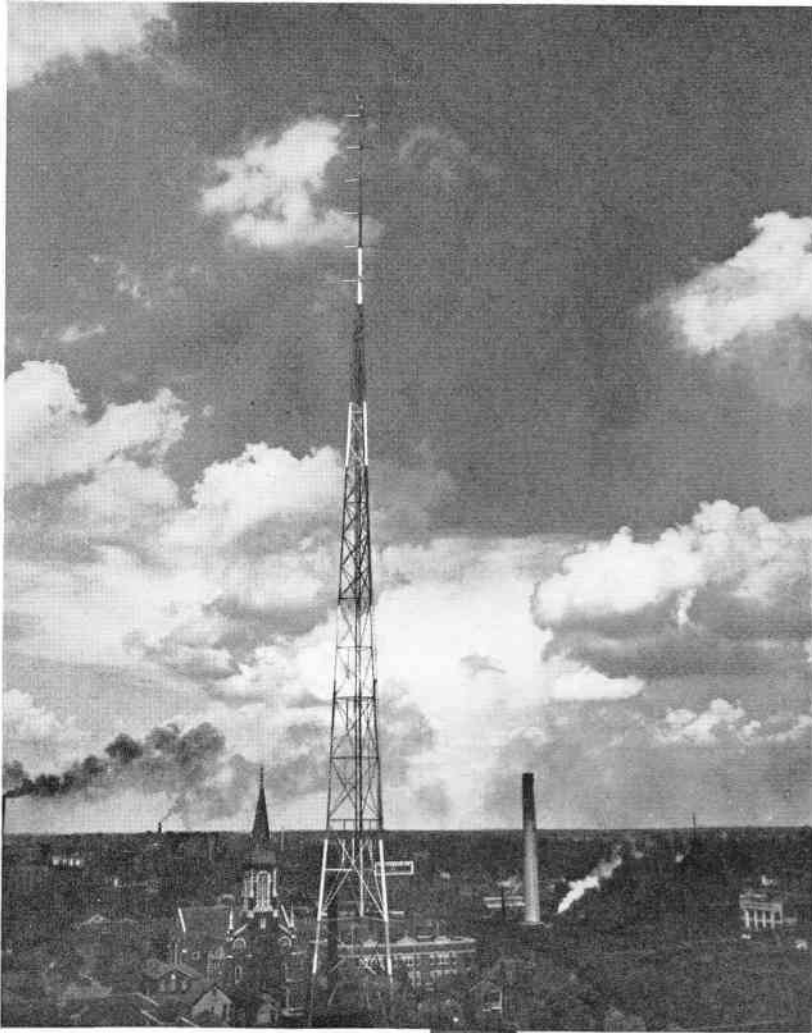

NEWS PICTURE

Evansville on the Air with FM station W45V. Final tests are nearly completed, and full commercial operation is scheduled to start September 7th. The antenna is a 6-bay Lingo turnstile carried by a 64-ft. mast atop the WEOA broadcast antenna tower. The transmitter uses a 250-w. G.E. exciter, with a 10-kw. amplifier built by W45V's engineering staff. This is one of the first fifteen FM stations authorized by the FCC.



G. E. TELEVISION RELAY ANTENNA AT SCHENECTADY, BEFORE IT WAS COVERED BY WOOD HOUSING AS PROTECTION AGAINST WEATHER

companies not in a position to get orders direct. Of a \$17,000,000 order for radio equipment, \$10,000,000 was let out to 250 different suppliers in 14 different states.

FCC Bar: Five attorneys newly approved to practice before the FCC are: Leo J. Bartoline of Chicago, Herman Jervis of New York City, and Camden R. McAtee, Morris Miller, and Frank M. Schap, all of Washington.

Milwaukee: WTMJ has applied for authority to operate its experimental television station W9XMJ on a full-time commercial basis. Application specifies Channel No. 3, which is 66-72 mc.

Link: Under new set-up, Link radio equipment is manufactured by Link Radio Corp., while sales are handled by Fred M. Link.

Tele Sports: Lee Hats is sponsoring a sports-

interview program on WNBT, New York. Stanley Woodward, sports editor of the *Herald Tribune* will conduct the interviews. Contract was placed through Birmingham, Castleman & Pierce agency.

J. Albert Stobbe: Former general manager of Arcturus is now practicing as attorney and consultant for industrial, communications, electronic and management matters at 63 Wall Street, New York City.

W45V: Issues certificates of membership in the FM branch of the Sidewalk Foremen's Club and furnishes telescope for close-up of mast construction. Certificate sets forth privileges and duties of Superintendents, gives diagram of FM antenna construction, and questions and answers relating to W45V.

Tele Prices: Receivers produced by Philco and RCA will be down considerably in price from pre-standardization levels. Indicated range is \$200 to \$300. No information is available yet from G.E., Dumont, and Farnsworth.

Stromberg: Is enlarging facilities and personnel engaged in research on products for production when present war emergency is over, according to announcement by Dr. Ray H. Manson, vice president and general manager. Added to research staff are T. L. Bowser, formerly of Leich Electric, A. E. Newlon, from the RCA License Laboratory, E. S. Wilson, from IBM, and Dr. Harold Goldberg, of the University of Wisconsin.

SLS: These initials will no longer appear in the lower left hand corner of the Editor's letters, as his daughter, and secretary, Sara Lee Sleeper, is now Mrs. John I. Shutts, of Schenectady, N. Y.

IRC: Has revised and enlarged their Volume Control Replacement Manual. Completeness of reference data and cross indexing makes this 136-page manual of great value and helpfulness. Copies can be obtained from IRC jobbers, or from International Resistance Company, 401 N. Broad Street, Philadelphia, Pa.

Paul F. Godley: Has applied for a C.P. for a 250-watt AM station at Newark, N. J., to use unlimited time on 1,230 kc. Should be an FM station, Paul!

K45LA: Thomas S. Lee scored a first on the Pacific coast when Mount Lee, overlooking Hollywood, went on the air August 11th with preliminary 1 kw. Later, power will be increased to 50 kw. K45LA is on the air daily from 10 A.M. to 10 P.M.

(CONTINUED ON PAGE 46)

FM EMERGENCY UNITS FROM REL

Manufacturers of First 2-Way AM Find Accelerated Swing to FM

BY COL. GUSTAVUS REINIGER *

THE occasion of the APCO convention is appropriate for reviewing the progress that has been made in police radio equipment, a field now expanded to take in all the various emergency applications of radiophone communications.

It is only eight years ago that the first 2-way police system was installed, yet developments have moved so rapidly that many police communications officers may not realize that the No. 1 system was engineered, designed, and installed by REL for Bayonne, New Jersey.

That was coincident with the adoption of technical equipment by organized criminals, bringing about the need for fast-action police communications. Following the demonstrated effectiveness of 2-way radio at Bayonne, similar installations were set up in cities all the way from remote points in Canada, down

*Sales Manager, Radio Engineering Laboratories, Long Island City, N. Y.



FRED SCHNELL, TECHNICIAN OF CHICAGO POLICE, AND REL'S FRANK GUNTHER

through the U. S. A., and into Central and South America.

However, the characteristics of AM ultra-frequency communications are such as to limit these systems to areas where conditions are favorable. This is due particularly to their susceptibility to interference from both man-made and natural static. Not until Major Armstrong's invention of Frequency Modulation were these limitations overcome.



FM TRANSMITTER AND RECEIVER UNITS MANUFACTURED BY REL FOR EMERGENCY USE



2-WAY REL HEADQUARTERS RADIO CONTROL

Now, with the special FM equipment which has been designed for 2-way emergency service, and perfected under conditions of use in action, low-cost installations can be engineered to meet the requirements of any area.

An increasingly high percentage of new systems call for 2-way FM instead of the conventional 1-way AM. The greater speed and effectiveness of 2-way over 1-way would justify its selection even if it were more expensive. Surprisingly enough, FM has proved to be lower in cost. Maintenance records show

REAR VIEW. RECEIVER AND 25-W. EXCITER UNITS ARE ON SECOND SHELF DOWN

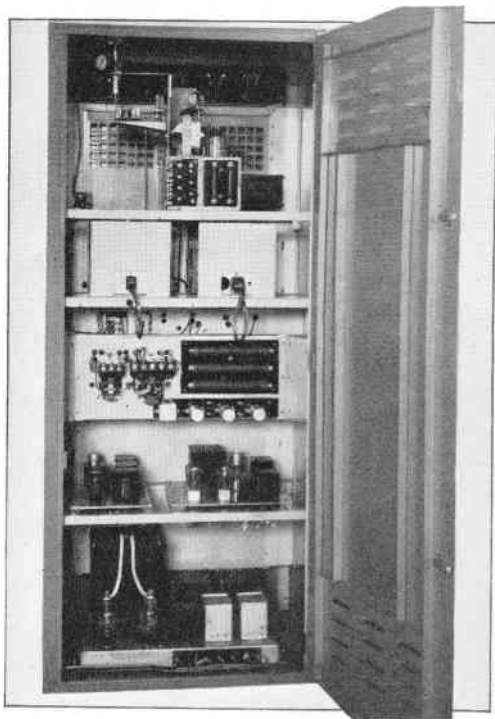

the operating costs of FM headquarters transmitters are less, and that repairs and out-of-service time on car equipment have been lowered greatly over 1-way AM systems.

So thoroughly successful has 2-way FM proved to be that among those who have investigated its performance, there remains only the question as to how AM equipment now in use can be replaced, and the existing

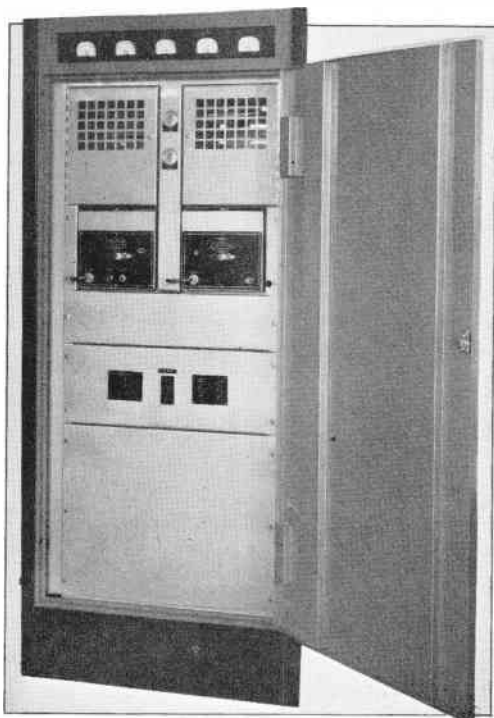

COMPLETE HEADQUARTERS EQUIPMENT WITH RECEIVER AND 250- TO 400-W. TRANSMITTER

system modernized with FM. Chicago was the first large city to arrive at a practical solution, the credit for which belongs to Fred Schnell.

With such an extensive 1-way AM system already in use, a complete shift to FM might have disrupted the service, and would have called for a large investment. Accordingly, it was decided to continue with AM communications from headquarters to the cars, and simply add FM talk-back car transmitters and headquarters receivers. Later, when funds are available, the fixed AM transmitters and car receivers will be changed over to FM.

It should be noted, however, that the use of FM is not limited to large cities. It offers to small communities the same advantages in greater effectiveness and in first-cost and maintenance economy.

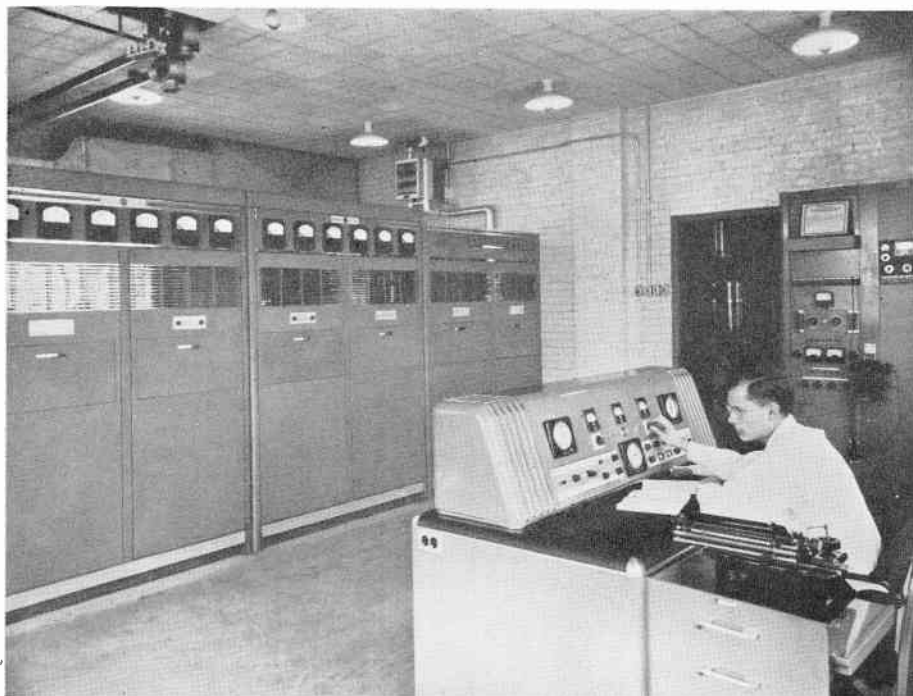

FIG. 1. 50-KW. G.E. FM TRANSMITTER SET UP FOR TESTS UNDER OPERATING CONDITIONS

50,000-WATT FM TRANSMITTER

Technical Data on New G.E. Equipment Installed in the Helderbergs

BY W. R. DAVID *

THE photograph in Fig. 1 shows General Electric's new 50-kw. FM broadcast transmitter, installed at the Helderberg station, twelve miles south of Schenectady. This is General Electric's "Proving Ground" for FM and television transmitters. Lacking factory floor space on account of National Defense radio work, the transmitter has been set up at the Helderberg station for tests which normally would be conducted in the factory.

General Design ★ In the early days of planning General Electric FM broadcast transmitters, it was decided to design a basic unit which could be used as a low-power transmitter or as an exciter for the high power units. Two hundred fifty watts were determined upon as the output rating of the basic unit, this being considered the smallest practical FM transmitter for any service area. Also, because of the cir-

cuits and component parts required for generating high-quality FM with the mean carrier frequency stability as specified by the Federal Communications Commission for broadcast service, there would be no appreciable saving in making a smaller transmitter.

In designing the high power units, three factors were considered, namely, logical steps of power from the standpoint of economy and service area; possible tube complements with tubes then being developed by G. E. especially for high frequency applications such as FM and television; and, third, flexibility of the units in making up complete high power transmitters. Fig. 2 shows the manner in which it is possible to assemble high power transmitters from the basic unit and the intermediate power-amplifiers. As can be seen from the illustrations, modern styling is employed so that the cabinets of the various units, when placed together, present an overall coordinated unit assembly.

* Radio and Television Department, General Electric Company, Schenectady, N. Y.

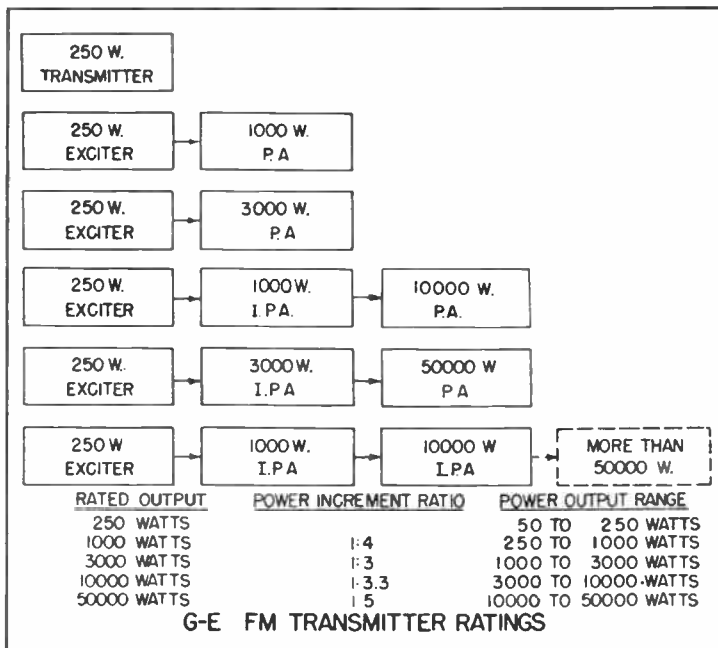

FIG. 2. COMBINATIONS OF FM UNITS REQUIRED TO DELIVER ANY GIVEN OUTPUT

Special Features ★ The following special features of the complete 50-kw. transmitter are listed to indicate the careful attention that has been given to reliability in general and specifically to continuity of service for transmitting commercial programs.

1. Simplified transmitter circuit design. See schematic diagram Fig. 5 and schematic block diagram Fig. 3.
2. Direct frequency modulation is accomplished with only two tubes. Total frequency multiplication in the RF circuits requires nine.
3. Instant-acting electronic center frequency control is accomplished with only four tubes, by comparison of the transmitter output frequency with that of a crystal. The correction factor is approximately 100 to 1. There are no moving parts.
4. Temperature-compensated oscillator and discriminator circuits.
5. Voltage-regulated power supply for the modulator and oscillator.
6. The new G-31 crystal unit is hermetically sealed with built-in thermostat and heater. In addition, the crystal is the low temperature-coefficient type.
7. A spare crystal is furnished with the 50-kw. transmitter, and provision is made in all transmitters for mounting a spare crystal with the

heater connected. It is possible to switch instantly from the active crystal to the spare and back to the active.

8. No temperature-controlled compartments other than the crystal chamber.

9. Tubes with air-cooling fins are used in the 3-kw. amplifier. The 50-kw. power-amplifier tubes are water-cooled and a closed water-cooling system is furnished (except for installation piping).

10. The 3-kw. and 50-kw. RF amplifiers of the transmitter employ tubes developed by General Electric tube engineers especially for high frequency applications such as FM and television — the same engineers who developed many of the present-day broadcast transmitter tubes, notably, the GL-862, GL-858, GL-846, GL-207, GL-857B, and GL-869B. The type numbers of the new high-frequency tubes used in the 50-kw. transmitter are GL-8002, and GL-880. The former is used with an air-cooled radiator.

11. Power cut-back is provided in the 50-kw. transmitter. This is accomplished by a single switch control which cuts the 50-kw. transmitter back to 3 kw. This feature avoids more than a momentary interruption of program in case of power-amplifier tube failure. It is possible to service the 50-kw. power-amplifier and its rectifier while the 3-kw. unit is on the air, with complete safety to the operator.

12. Single push-button starting for the entire transmitter with automatic sequence. This is accomplished at the operating console of the 50-kw. transmitter.

13. Operating console, with executive type desk and chair, is furnished with the 50-kw. transmitter.

14. Automatic off-on reclosing of plate supply with automatic reset 15 seconds after one off-on cycle. This feature is provided on all General Electric FM broadcast transmitters of 1 kw. and higher output rating.

15. All units are self-contained and self-shielded. The plate transformer, water-cooling unit, and operating console are external to the 50-kw. unit assembly.

16. Pyranol-type plate transformer is furnished with the 50-kw. transmitter. This trans-

20. Modern styling of all transmitters, with the overall appearance of the several units presenting a single unit front panel.

The operating console is designed to mount on top an executive-type desk which is included as a part of the console. A chair is furnished and the desk is arranged for accommodating a typewriter in the lefthand lower compartment. Controls and indicator devices are provided for the following functions:

A. Master transmitter control start-stop push-button switches for fully automatic operation.

B. Three sets of plate on-off push-button switches for exciter, driver, and 50-kw. power-amplifier.

C. Step-by-step control transfer switch.

D. Automatic, semi-automatic control transfer switch.

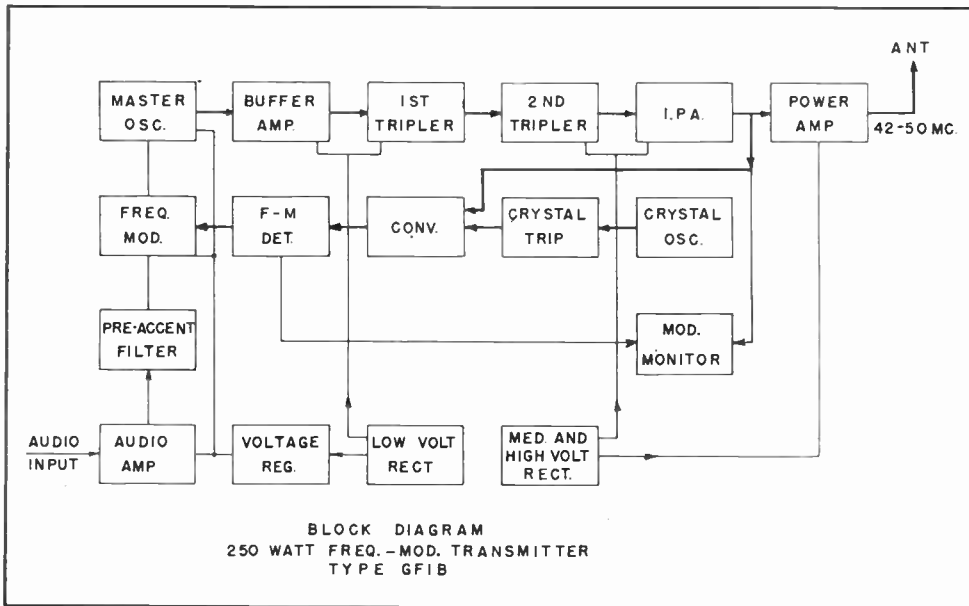

FIG. 3. BLOCK DIAGRAM SHOWING THE CIRCUIT ELEMENTS OF THE G.E. TRANSMITTER

former can be installed indoors or outdoors. No vault is needed for indoor installation.

17. All units are provided with large front and rear doors for maximum accessibility.

18. The large doors are interlocked with the control circuits and equipped with positive acting switches to ground all high-voltage circuits.

19. Vertical chassis construction is employed for all low-power stages for maximum accessibility.

E. A cut-back control switch to shift the RF output transmission lines from the 50-kw. P.A. to the 3-kw. driver unit in case of P.A. outage.

F. Monitor-amplifier audio-level control.

G. A three-position, audio monitor input selector switch.

H. Transmitter starting and stopping status indicator lights.

I. Three Telechron clocks are provided, connected so that one indicates local time, one



where a General Electric FM station monitor is employed. The instruments indicate center frequency deviation and percentage of modulation. Also, an adjustable peak modulation flasher is included.

The indicator light associated with each push-button switch is located inside the push button. The push buttons are appropriately colored and semi-transparent.

These and other convenience features are the result of General Electric's many years of experience in building all types of radio transmitters for broadcast, television, emergency, Government and other services.

Technical Characteristics ★ The heart of the 50-kw. transmitter and, for that matter, all General Electric FM broadcast transmitters, is the basic exciter unit. Its circuit is shown in the schematic diagram, Fig. 5, and the block diagram, Fig. 3. The fine characteristics of the basic exciter unit are unaltered in the amplifier stages. AM ripple, contributed by the amplifier, is made negligibly small in the output by a degenerative feed-back circuit inductively coupled to the final power-amplifier tank circuit.

The guaranteed performance characteristics for the 50,000-watt transmitter are listed below.



FIG. 4. CLOSE-UP OF THE ANTENNA USED AT THE HELDERBERG STATION FOR TESTING THE 50-KW. TRANSMITTER, AND A VIEW FROM THE STATION OF THE VALLEY BELOW

indicates time of carrier failure, and the third indicates total time of carrier-off in case of an outage of the set during operation. A reset push button is provided to re-start the time-of-carrier-failure clock.

J. Extension instruments for installations

Radio-Frequency Range ★ A single mean frequency in the range of 42 to 50 mc., but all tuned circuits can be adjusted to operate at any frequency within this band.

Power Output ★ The rated power output is 50 kw.

Power Supply Requirements ★ The power consumption for the three units is as follows:

- Exciter—1.25 kw., 115 volts, single-phase, 60 cycles
- 3000-Watt Amplifier—8.25 kw., 230 volts, three-phase, 60 cycles
- 50,000-Watt Amplifier*—109.00 kw., 230 volts, three-phase, 60 cycles

Over-all Power factor approximately 95%.

Audio-Frequency Response ★ Plus or minus 1 db from 30 to 16,000 cycles without pre-emphasis; with pre-emphasis, plus or minus 1 db of RMA pre-emphasis standard.

Audio Input Level ★ Normal, 0 vu; balanced "H" pad, incorporated in transmitter, permits levels from -7 vu to +8 vu in thirty 1/2-db steps; input impedance, 600 ohms.

Harmonic Distortion ★ Less than 1 1/2 per cent for

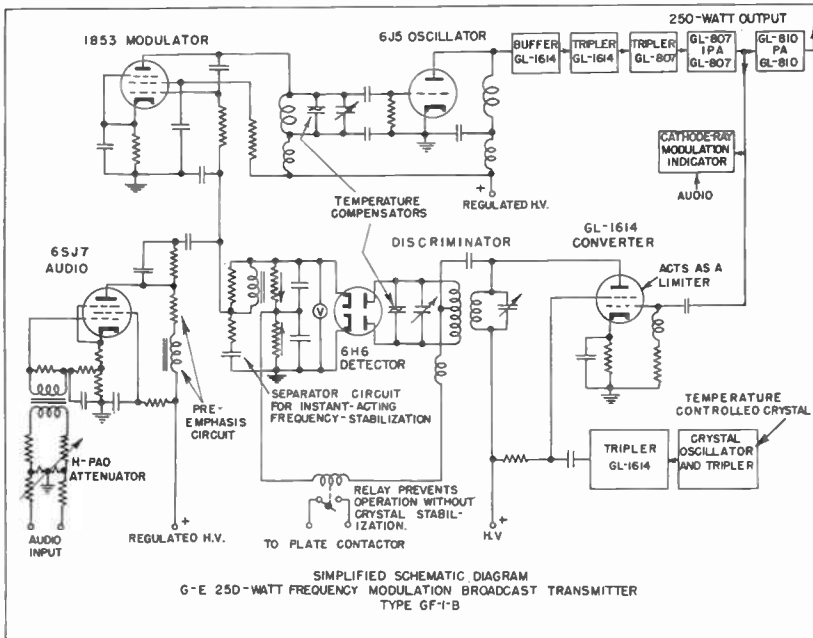

FIG. 5. FURTHER DETAILS OF THE TRANSMITTER CIRCUIT ARE GIVEN IN THIS DIAGRAM

Frequency Stability ★ Plus or minus 1000 cycles over a normal room temperature range.

Frequency Modulation ★ Normal frequency swing plus or minus 75 kilocycles, representing 100 per cent modulation.

)* Power input for the amplifier is an estimate and includes power for the blowers and water cooling unit. Actual measurements are to be taken on the Helderberg transmitter.

modulating frequencies between 30 and 15,000 cycles, for carrier-frequency swing of ±75 kilocycles with pre-emphasis.

Intermodulation ★ Less than 1 per cent rms with audio input combinations of 400 and 700 cycles, and of 4000 and 7000 cycles.

FM Carrier Noise Level ★ Down 70 db at ±75 kilocycle swing.

TUBE COMPLEMENT

Exciter		3-kw. Amplifier		50-kw. Amplifier and Rectifier	
1 Type GL-2A3	4 Type GL-866A 866	2 Type GL-8002R	2 Type GL-880	6 " " 869B	
2 " " 5Z3	5 " " 1614	6 " " 872-A	6 " " 866A/866	2 " " 83V	
1 " " 902	1 " " 1853		1 " " 83V	1 " " 83	
1 " " 6H6	1 " " VR105-30		1 " " 83	1 " " 6AC7	
1 " " 6J5	3 " " 807		2 " " 6L6		
3 " " 6SJ7					
2 " " 810					

AM Carrier Noise Level ★ 60 db below 100 per cent amplitude modulation.

Output Coupling ★ The output circuit is arranged for concentric transmission line feed to the antenna and the coupling is variable from front of panel. Provision is made to tune out the reactance of the output coupling circuit.

Tube Complement ★ The complete complement of

Control unit	1400 lbs.
Plate transformer	4500 "
Water-cooling unit (including water)	3000 "
Operating console	350 "

It should be noted that the values stated represent guarantees rather than actual performance. As a matter of fact, the measured characteristics of the transmitter are expected to be appreciably better.

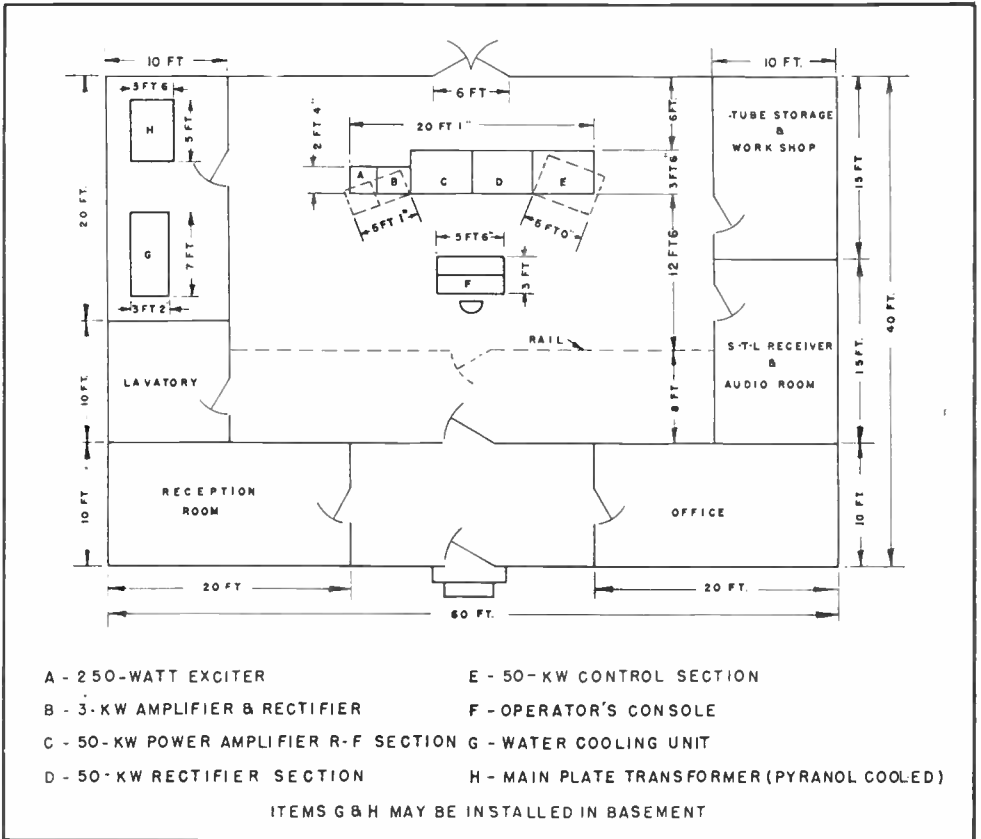

tubes for the transmitter units are given in the accompanying table.

Total cost one set of tubes \$2903.44. Two sets of tubes are furnished with the transmitter. Provision is made for mounting one of the spare 869B tubes in the main rectifier where it is kept in readiness for quick substitution in one of the other positions.

Dimensions ★ For overall dimensions, see Fig. 6. The net weights of the units are:

Exciter	635 lbs.
3-kw. amplifier	1182 "
50 kw. amplifier	1500 "
Main rectifier	2000 "

Physical Layout ★ The 50-kw. transmitter comprises five self-contained and shielded units each 6½ feet high. A suggested arrangement is given, with dimensions, in Fig. 6. The units are identified as follows, from left to right facing the front panel.

- 250-watt basic exciter unit
- 3-kw. intermediate power-amplifier
- 50-kw. power-amplifier
- Main rectifier for power-amplifier
- Relay and contactor control unit

In addition, there are three external units:
 Plate transformer
 Water-cooling assembly
 Operating console



ZENITH
RADIO

Chooses the Zenith in
Vacuum Tubes for FM

Eimac 1500T Tubes tried
and proven for the job



ZENITH
RADIO

1KW FM STATION
W9XZR

A pair of Eimac 1500T's in the
final driven by a pair of Eimac
152TL's and a pair of 35T's

Zenith Radio Corporation in selecting Eimac tubes for their FM station took no chances with untried tubes. Eimac tubes have been in FM almost from the time experiments were begun. Major Edwin E. Armstrong's revolutionary Frequency Modulation scheme has put them to the tests for a matter of years. Now you can save time and money by simply following the leader in selecting the tubes for your new FM Station.

Eimac tubes have been consistently out in front in the outstanding NEW developments in radio. It will pay you to investigate their many advantages. See advertisement in September Electronics for list of representatives or write direct for further information.

Eimac
TUBES

In Use by
Practically
every Major
Airline

Eitel-McCullough, Inc. • San Bruno, California

World Radio History

All units are designed for maximum accessibility of components to facilitate inspection and maintenance. All tubes in the equipment are replaceable without removal of shielding. Access to any component is possible without removal of wiring. This is accomplished through the use of large front and rear doors. The front doors are the concealed type.

Control Circuits ★ All units of the amplifier equipment are interconnected and operated by a control system which permits either manual step-by-step control, semi-automatic control, or completely automatic control. In the second case, one Start and one Stop button control all circuits up to the main rectifier plate. A second Start and Stop button control the application of the plate voltage to the main rectifier. The various circuits are interlocked so that each successive operation takes place in proper sequence. Complete protection to apparatus and operating personnel is provided by the control system.

Protective devices guard against rectifier filament undervoltage, overheated cooling water, stoppage of cooling water, failure of blower, main rectifier and RF exciter overloads, and improper circuit adjustments. Indicating lights and instruments in the various circuits afford means for detecting unusual conditions.

The main rectifier plate starting control circuit is provided with an automatic reclosing relay. This relay will provide one immediate reclosure if the plate contactor is opened due to AC or DC overload, provided that plate volt-

FIG. 7. CONTROL EQUIPMENT AND PROTECTIVE DEVICES FOR THE 50-KW. STATION



age has been applied at least 15 seconds. If the overload relays again open the plate contactor, plate voltage may be reapplied manually by pushing the Plate On switch. However, if no overload occurs within 15 seconds of the reclosure, the reclosing relay is automatically ready for another reclosure in case of overload. A DC over-current relay is provided for each RF tube and two AC over-current relays are provided in the main rectifier 3-phase supply line.

A pickup circuit loosely coupled to the 50-kw. amplifier tank, using a type 83-V rectifier tube, furnishes rectified power for operation of a carrier-off alarm signal. Contacts are provided for the connection of external carrier-off-time electric clocks which are located in the control console.

Operating Economy ★ The economies resulting from the use of frequency modulation, as compared to any conventional system, are nowhere better demonstrated than in the use of transmitting equipment operating at comparatively high power level. Among these economies are the following:

A. Lower power consumption from power line (109 kw. for amplifier) and smaller transformer capacity in the substation.

1. No high-level modulator is required.
2. RF amplifier tubes operate at Class C telegraph rating, resulting in higher plate efficiency.

B. Initial and replacement tube costs are lower because:

1. No high-level modulator is required.
2. Smaller RF tubes can be used for a given power output since high plate efficiency and high power output per tube are possible when operating at Class C telegraph rating.

C. A smaller cooling system is required due to low plate dissipation when operating tubes at Class C telegraph rating.

D. The transmitter as a whole is smaller, simpler and hence more reliable due to the design features noted above.

Continuity of Service ★ Precautions have been taken in the design of this equipment to provide conservative operation of all components, reliability, simplicity of operation and control, flexibility, and means of quickly locating and correcting troubles.

Protective devices throughout the equipment guard the apparatus from severe overload and transient phenomena which may be caused by power line surges. Visual indicators and instruments make it possible to observe conditions in the radio, control and power circuits.

The automatic recloser for the main-rectifier plate circuit provides for a minimum of lost

(CONTINUED ON PAGE 46)

Meets
FCC REQUIREMENTS
for both

**FM and AM Police,
Fire, Public Utility,
and other Emergency
Transmitters**

1. Scale can be read with precision because of wide spread of the dial calibrations.
2. Designed for use by operators of police, fire and emergency radio transmitters.
3. Checks frequencies within any two or three bands specified at time of purchase. Each band is 50 to 1000 kc. wide, depending upon position in the 1.5 to 60 mc. spectrum.
4. Complete stability of standard crystal oscillator and electron-coupled oscillator
5. Cathode ray indicator for accurate visual check against crystal standard as well as against transmitter.
6. 100-kc. crystal oscillator provides at least two check-points within each band.
7. Fast operation. Less than one minute required to check transmitter frequency exactly.
8. Light in weight — easy to carry — plugs into any 115-volt AC or DC supply.
9. Each instrument precision-built on order, hand-calibrated to better than .01% for each band.

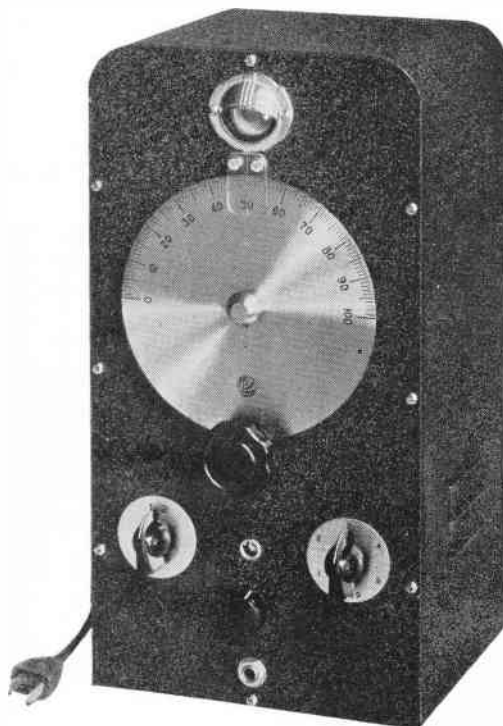

PRICE, complete, any two bands, **\$107.65** — Any three bands, **\$134.70**

BROWNING FREQUENCY METER

Now Widely Specified as Standard Equipment

Fast Operation: the simplified and improved design of the Browning Frequency Meter saves time in checking emergency transmitters. **Easy Reading:** no need to use a magnifying glass and flashlight to read the clearly calibrated scale. **Accurate:** exceeds the FCC requirements of .01% on each band. **Rugged:** not a delicate instrument, but a sturdy piece of emergency service equipment. **Universal:** the same instrument can be used for checking both FM and AM transmitters. — For additional details, write

BROWNING LABORATORIES, Inc.

755 MAIN STREET

WINCHESTER, MASSACHUSETTS

Frequency Modulation

First in Michigan

Michigan's pioneer F.M. station is now on the air. Independent programing 10 hours daily. Owned and operated by The Detroit News, associate station WWJ.

Rate Card on Request

W 4 5 D

4500 Penobscot Bldg.
DETROIT, MICHIGAN

FM SPOT NEWS

(CONTINUED FROM PAGE 32)

Cannon: Plugs and receptacles manufactured by Cannon Electric Development Company, Los Angeles, are now distributed from stock by Terminal Radio at 68 W. 45th Street and 80 Cortlandt Street, New York City. Broadcast stations, recording studios, and sound specialists will no longer have to order from west coast factory.



Stanley H. Manson: Son of Dr. Ray H. Manson has been named Stromberg-Carlson sales promotion manager, moving up from post as southwestern sales manager at Kansas City. Previously, he was radio manager at

Rochester Gas & Electric, and at Philpitt Music Stores, Miami.

Ansley: Another broadcast receiver manufacturer has gone into Government radio contract work. Said Arthur Ansley: "There isn't any profit in it yet, but we hope there will be on future orders."

REL: Montreal Tramways have purchased through Canadian Marconi a 400-watt Transmitter and 10 2-way FM mobile outfits from Radio Engineering Laboratories.

Allied Radio: Issues a 1942 radio catalog of 212 pages, listing AM and A-FM sets and communications models, over 15,000 parts items, amateur supplies, and tools and equipment. There are also kits and projects planned for radio training courses for National Defense. Copies sent on request to Allied Radio Corp., 833 W. Jackson Blvd., Chicago, Ill.

Columbus: WBNS will have their 10-kw. FM station W45CM on the air by September 28th. According to chief engineer Lester Nafzger, delivery on original transmitter did not materialize, so order was cancelled and new one placed with REL. Charles Srebroff, REL president has promised to have W45CM going before the end of September, when their C.P. would expire.

Aluminum Short-Circuit: More manufacturers are eliminating the use of aluminum shields by employing high frequency iron-core coils and, when needed, iron sleeves to form a complete electromagnetic circuit. Also, permeability tuning is being used in place of aluminum-plate condensers. Henry L. Crowley & Company, West Orange, N. J., producers of high-frequency iron, have added a wing to their extensive plant to meet increased volume of orders.

Frank B. Koessler: Sales engineer for Norman B. Neely Enterprises, covered 3,500 miles during a vacation trip by automobile through northern California, Oregon and Washington.

50-KW FM TRANSMITTER

(CONTINUED FROM PAGE 44)

time in case of AC or DC rectifier overloads.

Two solenoid-operated DPDT switches make it possible to use the output of the driver unit, should it become necessary to service any of the PA equipment during normal operation. The solenoids are operated by a switch located on the control console.

Mounting for a spare heater tube is provided in the main rectifier so as to minimize the lost time in case a rectifier tube must be changed during operation.

Safety to Operating Personnel ★ The grounded metal front panels and complete grounded enclosure of the units effectively prevent the operating personnel from coming in contact with dangerous voltages. As a further safety precaution, lead-covered cable, rather than copper tubing, is used for the high-voltage connections from the plate transformer to the main rectifier.

Each access door on the RF amplifier and rectifier units is equipped with a safety switch. When a door is opened, the switch operates to ground or short-circuit all potentials within the unit greater than 230 volts. In addition, each of these doors is provided with an interlock which serves to remove the source of power from all high voltage equipment in case the door is inadvertently opened with power on.

FCC Requirements ★ The equipment covered by these specifications fully complies with the Federal Communications Commission Standards of Good Engineering Practice Concerning High-Frequency Broadcast Stations issued June 29, 1940.

WHAT THE FM BROADCASTERS SAY:

(CONTINUED FROM PAGE 22)

Cocoanut Grove, Ciro's, the Trianon, Casa Manana and the Seven Seas.

In pioneering Frequency Modulation here, the Don Lee organization is carrying out the far-sighted policies of its alert young president, Thomas S. Lee, and his determination to set the pace of broadcasting progress on the West Coast.

B.B.B. ASKS FM QUESTIONS

(CONTINUED FROM PAGE 35)

reception with transmission, and unless the amplifier system, both as to power and audio response, is designed correctly, faults A, B, C, D and E, as listed above, will not be overcome.

Thus, a model capable of bringing in signals from FM broadcast stations might still fail entirely to deliver what the public understands to be "FM reception." FM sets, capable of overcoming faults A, B, C, D and E cannot be produced in the price range of cheap AM sets.

If FM circuits are simplified beyond a certain point, in order to cut production costs, the receiver loses the "reception qualities you would expect to obtain from Frequency Modulation broadcasting different from . . . regular broadcasting."

The findings of the B.B.B. will be most interesting and perhaps very useful to all concerned. In any event, however, the responsibility for being well informed as to the performance characteristics of each A-FM set lies with the individual dealers, upon whose judgment and frankness their customers rely.

The recent article in *Reader's Digest* about radio service shows how dangerous it is to tell the customer what he may seem to want to hear—if it isn't technically accurate and strictly honest.

W39B STRIKES WATER AT 1,100 FT.

RADIO engineers at Yankee Network's Mt. Washington FM station will have a special luxury in the new transmitter building under construction for the high-power equipment. It's running water, and a luxury indeed for the men who, up to the present, have had to transport every drop from the 4,000-ft. elevation to the 6,300-ft. summit.

The well drilling started early last June. A total of 720 drilling-hours were required to bore down 1,100 ft., at which depth water came in and rose within 200 ft. of the top.

Now, the engineers who will operate the 10-kw. REL FM transmitter which will replace the present 1-kw. installation are assured of an ample supply of water, available by merely turning a faucet!

It's Meissner again

WITH A BRAND NEW

F-M ★ A-M

3-BAND COMBINATION



TABLE MODEL RECEIVER

that has everything!

- ★ Two-tone, hand-rubbed walnut cabinet
- ★ 12¼" high — 22¾" wide — 11" deep
- ★ FM and AM in two separate channels
- ★ Covers Broadcast & Short Wa. on AM
- ★ Full coverage of 42–50 mc FM band
- ★ Calibrated glass scale, edge-lighted
- ★ Tuning indicator, accurate adjustment
- ★ Includes seventeen latest type tubes
- ★ High-gain RF stage on all three bands
- ★ Wide-band I-F chan. on both AM bands
- ★ 3-stage I-F channel on FM at 4.3 mc
- ★ Audio system common to both channels
- ★ Response flat from 30 to 15,000 cycles
- ★ Push-pull output, 6½ watts undistorted
- ★ Heavy-duty 8" PM Hi-Fidelity Speaker
- ★ Operates on 105–125 volts, 50–60 cyc.

Complete Receiver as shown, with tubes,
Model 9-1053 List Price **\$108.00**

Chassis Only, with tubes
Model 9-1054 List Price **\$95.00**

**WRITE TODAY FOR FREE 48-PAGE
COMPLETE CATALOG**

ADDRESS DEPT. F-9





FM MAGAZINE ranks No. 1 among radio engineering papers as an advertising medium because it is: More carefully read —

More widely discussed —

Referred to more frequently—by Men Who Make Decisions among the broadcasters, manufacturers, government and police departments, public utilities, and leading retailers—Circulation 6,000



THE RADIO ENGINEERING NEWS JOURNAL OF BROADCASTING, COMMUNICATIONS AND TELEVISION

ARMSTRONG'S LATEST CONTRIBUTION to FM A NEW PHASE-SHIFT MODULATOR

Used Exclusively in the New **REL** DL Line of FM Broadcast Transmitters

SIMPLER—MORE EFFICIENT

MAJOR E. H. ARMSTRONG—the inventor of FM—has recently developed a new phase-shift modulator circuit which REL has now incorporated in all of the new DL line of FM broadcast transmitters—now available for early delivery in five power ratings from 250 W. to 50 KW.

Remember—when you deal with REL—you deal with FM's Pioneer Manufacturer—with experience and knowledge gained from having built and put in operation—more FM broadcast transmitters than all other manufacturers combined.

The general overall characteristics of DL FM transmitters are:

- ★ **OPERATING FREQUENCY:** Available to operate on any predetermined frequency from 40 to 50 mc. The exact frequency must be specified when the order is placed.
- ★ **FREQUENCY STABILITY:** These transmitters are guaranteed to maintain their frequency within less than 200 cycles of the assigned frequency. The frequency is directly controlled by a single crystal, without the use of complicated mechanical or electronic devices.
- ★ **FIDELITY:** The overall response is within plus or minus 1 db from 30 to 15,000 cycles.
- ★ **DISTORTION:** The measured r.m.s. harmonic distortion is less than 1% for all normal frequencies between 50 and 15,000 cycles at ± 75 kc. swing, (100% modulation) AND IS LESS THAN .2% FOR FREQUENCIES FROM 400 to 15,000 CYCLES.
- ★ **NOISE LEVEL:** The signal-to-noise ratio is better than 70 db, measured at the output of a monitor receiver. This is an unweighted measurement, with 150 kc. maximum swing, and includes hum.
- ★ **INPUT:** The audio input to the transmitters is zero level, 500 ohms, 6 milliwatts.
- ★ **ECONOMY:** New Type 558 Modulator employs only 28 small tubes from program input to operating frequency—affording lowest possible tube cost; for example, a complete set of tubes for the new catalog 518 DL 1000 W. transmitter including modulator is only \$238.

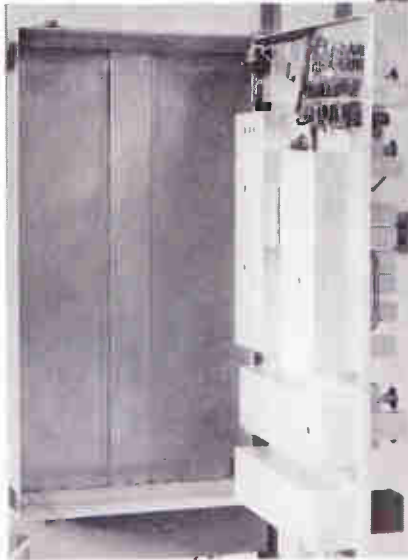

Illustrating a new, exclusive REL feature: Type 558 modulator panel hinged to swing out of its cabinet—making all parts quickly and easily accessible for adjustment and maintenance.

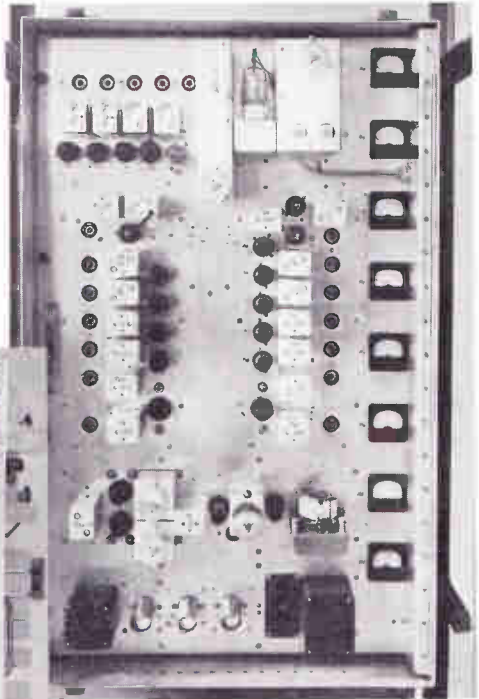

The new Type 558 modulator—built directly into the 250 and 1000 watt basic transmitter units, which are used to drive amplifiers of all higher powers.

Write for booklet describing this new DL line of FM transmitters.



RADIO ENGINEERING LABORATORIES, INC.

35-54 36th Street

Long Island City, New York

Pacific Coast sales offices:

5334 Hollywood Blvd., Hollywood, Calif.
420 Market Street, San Francisco, Calif.

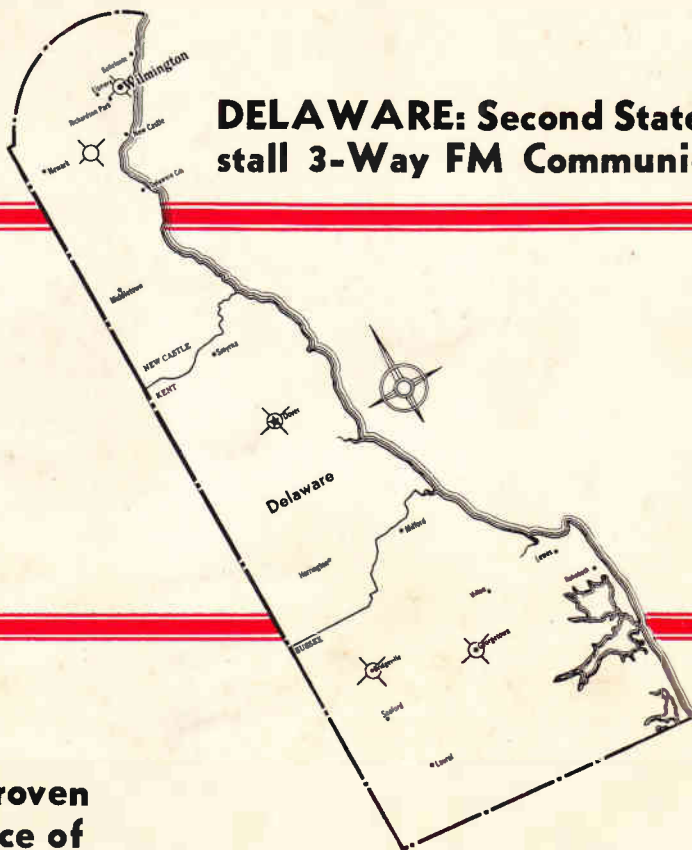

DELAWARE: Second State to Install 3-Way FM Communication*

**Chooses Proven
Performance of**

LINK Emergency FM Equipment

for the five fixed stations and all cars

Like Connecticut, the Delaware State-wide Police Communication System will be LINK FM exclusively.

Confident in the knowledge that into every LINK unit is built dependable, trouble-free service, and negligible maintenance, the authorities of the Delaware State Police selected the LINK organization to work out their communication problem.

Thus they have obtained much more than proven equipment, for "100% LINK" means the experience of the largest independent organization specializing in Emergency Communication Equipment — sound, unbiased technical advice — a background of years of recognized leadership in the field — a record of personalized service second to none — and competent and prompt field service by experienced technicians whenever required.

It means coordinated engineering and production that assure every purchaser that his equipment is that best suited to his requirements.

WHEN YOU USE LINK YOU USE THE BEST

* Both Maryland and Virginia State Police have also selected LINK FM for state-wide service

ENGINEERS and MANUFACTURERS of FM and AM EQUIPMENT for GOVERNMENT, PUBLIC UTILITY, POLICE and FIRE



Fred M. Link

Engineer • Manufacturer

125 WEST 17th ST., NEW YORK, N. Y.

Telephone: CHELSEA 2-3838