

Price 25 Cents

July '50

# FM-TV RADIO

★ ★ Edited by ★ ★  
Milton B. Sleeper

## COMMUNICATION

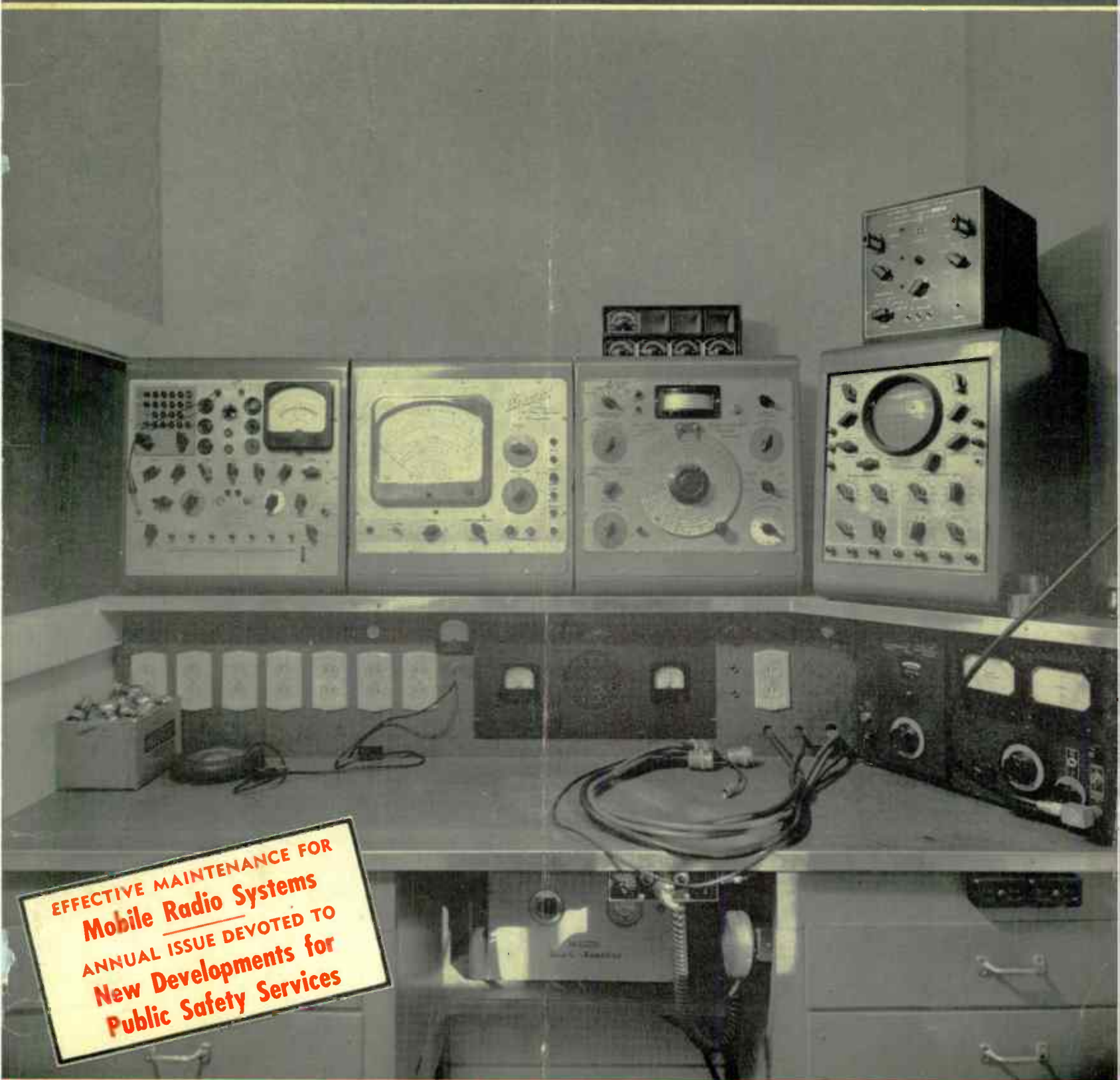

**EFFECTIVE MAINTENANCE FOR  
Mobile Radio Systems**  
**ANNUAL ISSUE DEVOTED TO  
New Developments for  
Public Safety Services**

10th Year of Service to Management and Engineering

# Here's a NEW G-R Catalog of QUALITY PARTS & ACCESSORIES



**G**ENERAL RADIO announces a new Parts Catalog listing all of the parts, components and accessories manufactured by G-R . . . the first catalog of its kind printed in a number of years.

Here you'll find complete specifications of the entire line of G-R high-quality parts and accessories, and a number of simplified unit instruments. Included are knobs, dials, plugs, and jacks, fixed and variable air condensers, attenuators, coaxial elements, decade inductors and resistors and capacitors, filters, simple bridges, amplifiers and oscillators, rheostats and potentiometers, U-H-F Wavemeters, and dozens of other essentials.

For thirty-five years G-R parts have been used by the leading manufacturers, designers and custom-builders as integral parts of all types of communications and electronic equipment.

You'll find many items of interest. We'll be glad to send you a copy immediately if you'll fill in the coupon below.



**GENERAL RADIO COMPANY**

275 Massachusetts Ave., Cambridge 39, Mass.

NEW YORK

CHICAGO

LOS ANGELES

GENERAL RADIO CO., 275 Mass. Ave.,  
Cambridge 39, Mass.

(1)

Please send me a copy of the NEW G-R PARTS CATALOG.

Name .....

Street Address .....

City ..... Zone ..... State .....



# HAMMARLUND

**REMOTE SUPERVISORY  
CONTROLS, EMPLOYING  
THE PERFECTED MULTI-  
GATE\* PRINCIPLE, FOR  
ALL TYPES OF SERVICE**

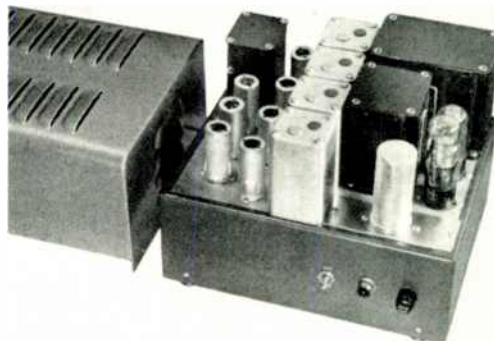

**Hammarlund Multi-Gate\* systems provide all-electronic, remote controls over radio and wire circuits.**

**Multi-Gate\* units can be used for an unlimited number of separate control functions. These include: manual and automatic transmitter switching, selection of pickup or monitoring receivers, supervisory controls, fault alarms, servo mechanisms, and telemetering.**

**Hammarlund Remote Supervisory Controls offer the following basic advantages of both dependability and economy:**

- 1. Unconditionally guaranteed to provide 100% reliability over wire or radio circuits.**
- 2. 50% wire rental reduction per control circuit.**
- 3. No modification of transmitters or receivers required.**
- 4. Trouble-free dependability through wide variations of line level, input balance, impedance, noise and line reflections.**
- 5. The only commercially available equipment featuring absolute immunity to accidental operation by extraneous sources.**
- 6. Multi-Gate\* Remote Supervisory Controls automatically establish their own threshold of optimum operating level.**

**We invite you to submit details of your requirements. Hammarlund engineers will assist in planning Multi-Gate\* equipment for all types of remote-control application. Write for descriptive literature on Hammarlund Selective Calling and Remote Supervisory Control products.**

\* Trade Mark applied for.

## HAMMARLUND MFG. COMPANY, INC.

460 WEST THIRTY-FOURTH STREET, NEW YORK CITY, N. Y.

July 1950—formerly FM, and FM RADIO-ELECTRONICS

1

# FM STATION OPERATORS!

Here's what one  
FM broadcaster  
says about  
Zenith,  
its distributors  
and its dealers...

## Radio WFMW Station

"The Radio Voice of The Messenger"  
OWNED AND OPERATED BY  
MESSENGER BROADCASTING COMPANY  
INCORPORATED  
Madisonville, Ky.  
16 Mar. 50

PHONE  
1865

Zenith Radio Corporation  
Attention: Mr. Ted Leitzell  
Chicago, Illinois

Dear Sir,

This station will broadcast all of the baseball games of the "Madisonville Miners"... a member of the Kitty League... on all of the road games. The baseball corporation will not allow us to broadcast the home games.

The Madisonville Miners is a farm club of the Chicago White Sox.

We had also planned to carry the St. Louis Cardinal games, however due to the fact that we are in a "Dry" territory and the sponsor is a beer company, we have had to drop these.

The games we carry will be sponsored by a local coal mining company, and we as well as the sponsor will welcome your attention.

We also wish to take this opportunity to thank the Zenith Corporation for their untiring efforts in the promotion of FM broadcasts. YOUR PROMOTION HAS HELPED US PUT THIS STATION ON A PAYING BASIS IN LESS THAN ONE YEAR OPERATION.

Radio Station WFMW

*H. W. Wells*  
H. W. Wells, Station Mgr

The Zenith Distributor in your territory is anxious to work with you to get more good FM sets throughout your listening area . . . to build bigger, better audience for you. Get in touch with him now . . . or write direct to Advertising Manager

ZENITH RADIO CORPORATION • 6001 Dickens • Chicago, Illinois

COPYRIGHT 1950, by Milton B. Sleeper

## CONTENTS

### INDUSTRY NEWS

<b>TV-FM-AM Set Production</b> Compiled from figures released by the RMA .....	4
<b>Spot News Notes</b> Items and comments about people and companies .....	6
<b>What's New This Month</b> Registry of Public Systems — Plain talk from FCC Chairman — Americans abroad — WNBF-FM listeners respond .....	24

### FM COMMUNICATIONS

<b>3,000 Watts For State Police</b> William Fingerle, Jr. ....	11
<b>Remote Supervisory Controls</b> J. K. Kulonsky .....	13
<b>Municipal Police Radio System</b> Lieut. Louis Roub .....	14
<b>Mobile Radio News &amp; Forecasts</b> Jeremiah Courtney .....	17
<b>Design Data For Mobile Radio Unit</b> Dale Somuelson .....	18
<b>Short-Range Phone</b> Howard V. Corlson .....	20

### FM & TV BROADCASTING

<b>FM, AM, and TV — The Road Ahead</b> The Hon. Wayne Coy .....	21
--	----

### AUDIO SECTION

<b>Developments In England</b> James Moir .....	26
<b>Design Data For AF Amplifiers, No. 2</b> Roy F. Allison .....	28

### SPECIAL DEPARTMENTS

<i>Professional Directory</i> .....	8
<i>Special Services Directory</i> .....	9
<i>News Pictures</i> .....	25
<i>Advertisers Index</i> .....	39

THE COVER DESIGN AND CONTENTS OF FM AND TELEVISION MAGAZINE ARE FULLY PROTECTED BY U. S. COPYRIGHTS, AND MUST NOT BE REPRODUCED IN ANY MANNER OR IN ANY FORM WITHOUT WRITTEN PERMISSION

**MILTON B. SLEEPER, Editor and Publisher**

ROY F. ALLISON, *Associate Editor*  
CHARLES FOWLER, *Business Manager*  
LILLIAN BENDROSS, *Circulation Manager*  
SOPHIE FORTY, *Production Manager*  
Published by: FM COMPANY

Publication Office: 264 Main St., Gt. Barrington, Mass. Tel. Gt. Barrington 500

Chicago Office: Louis Reinig, 176 W. Adams St. Tel. Andover 3-5585

FM-TV Magazine is issued on the 10th of each month.

Subscriptions: Should be addressed to 264 Main St., Great Barrington, Mass.

Single copies 25c—Subscription rate: \$6.00 for three years, \$3.00 for one year in the U. S. A.—Canada, add 50c per year postage—foreign, add \$1.00 per year postage.

Contributions will be neither acknowledged nor returned unless accompanied by adequate postage, packing, and directions, nor will FM-TV Magazine be responsible for their safe handling in its office or in transit.

Entered as second-class matter August 22, 1946, at the Post Office, Great Barrington, Mass., under the Act of March 3, 1879. Additional entry at the Post Office, Boston, Mass. Printed in the U. S. A.



CIRCULATION AUDITED BY  
HENRY R. SYKES,  
CERTIFIED PUBLIC ACCOUNTANT  
SYKES, GIDDINGS & JOHNSON  
PITTSFIELD, MASSACHUSETTS

**SPECIFICALLY DESIGNED FOR RUGGED SERVICE**

**MORE FOR YOUR MONEY**

**VIBRATORS**  
*The Complete Replacement Line*

Radiart solves all the problems on the vibrator side of the radio communications picture with the complete RUGGED SERVICE line that has been the leader for years. Exclusive design plus quality controlled manufacture deliver vibrators that are completely dependable! No short-lived performances... they work perfectly even under the most adverse conditions BECAUSE THEY ARE BUILT TO "TAKE IT"! Make a comparison and you, too, will agree RADIART VIBRATORS ARE THE STANDARD OF COMPARISON!  
At All Good Radio Parts Jobbers

IT'S RIGHT WHEN IT'S RADIART  
**THE RADIART CORPORATION**  
CLEVELAND 2, OHIO

- VIBRATORS
- POWER SUPPLIES
- TV ANTENNAS
- AUTO AERIALS



# POINT TO POINT COMMUNICATION

LINK single or multi-channel FM Radio Equipment Type 2048 is available now for 960 mc operation. Capable of 15 watts output, this tested and dependable unit will handle up to 32 voice channels impressed upon the R. F. carrier. Standard single-sideband carrier telephone multiplexing equipment may be used for channeling purposes. Relatively inexpensive dual yagi antenna arrays are available for use over propagation paths of up to 15 miles. Parabolic reflectors may be used over greater distances.

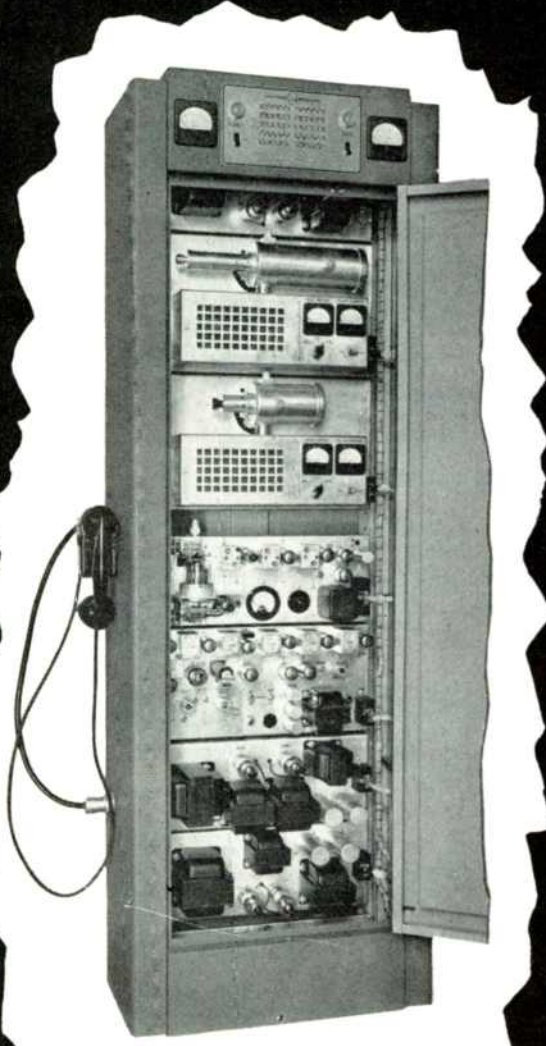

Link Radio Equipment Type 2048

IF you are planning to establish a radio communication circuit between two points, this is the economical and reliable equipment to use. Our Engineering Department will be pleased to give prompt consideration and careful assistance to your plans.

**Link Radio Corporation**

125 W. 17th St., New York 11, N. Y.



**B**REAKDOWN of 1st quarter TV shipments by RMA members shows 1,298,602 sets shipped to 35 states plus the District of Columbia. The distribution has no relation to population, however, for New York received more sets than were shipped to 27 other states, while 80% of the total shown in the breakdown went to the first nine states listed below. Just over 1/4 million sets were not included in the list, presumably because they were produced by non-member companies. Here are the figures:

NY	266,976	Tex	22,686	Okla	4,409
Penn	145,763	Wis	18,900	Wash	3,844
Ill	116,061	Minn	18,044	Neb	3,562
Ohio	110,720	RI	13,756	Ia	3,068
NJ	99,871	Va	12,069	NC	2,969
Cal	90,831	Ind	11,922	Utah	2,463
Mass	89,665	Go	11,061	Ala	2,091
Mich	60,918	Ky	10,453	Ariz	1,217
Md	55,919	La	8,279	WV	1,161
Ma	40,632	Tenn	7,056	Kan	890
DC	26,257	Flo	5,247	NM	496
Cann	24,129	Del	5,047	SC	176

Total Above 1,298,602  
Others 257,398  
Total 1st Quarter 1,556,000

This unevenness of distribution serves to emphasize the potential market for TV sets when the freeze is lifted, and

service can be provided in areas where no stations are operating now. For all the protests about the current continuation of the freeze, TV sales are continuing at such high level that the manufacturers, at least, have not been harmed. In fact, they have probably benefited, for if the national market had been opened up last year, and if more sets had been produced, facilities would have been built up to a point where the eventual leveling off of demand, or even a sudden shift to color, would have had a disastrous effect on the industry. There is even reason to suspect that the present rate of production is dangerously high, and that a condition of instability has been reached. With 12 1/2-in. receivers selling at about \$150, only a few companies have sufficient production to compete in the mass-market field.

April FM and AM production dropped below March, but that was due to the difference between 4-week and 5-week months. The rate of production was about the same. Both FM and AM are continuing to run substantially above the monthly average for 1949. Production of TV sets with FM tuning is increasing also.

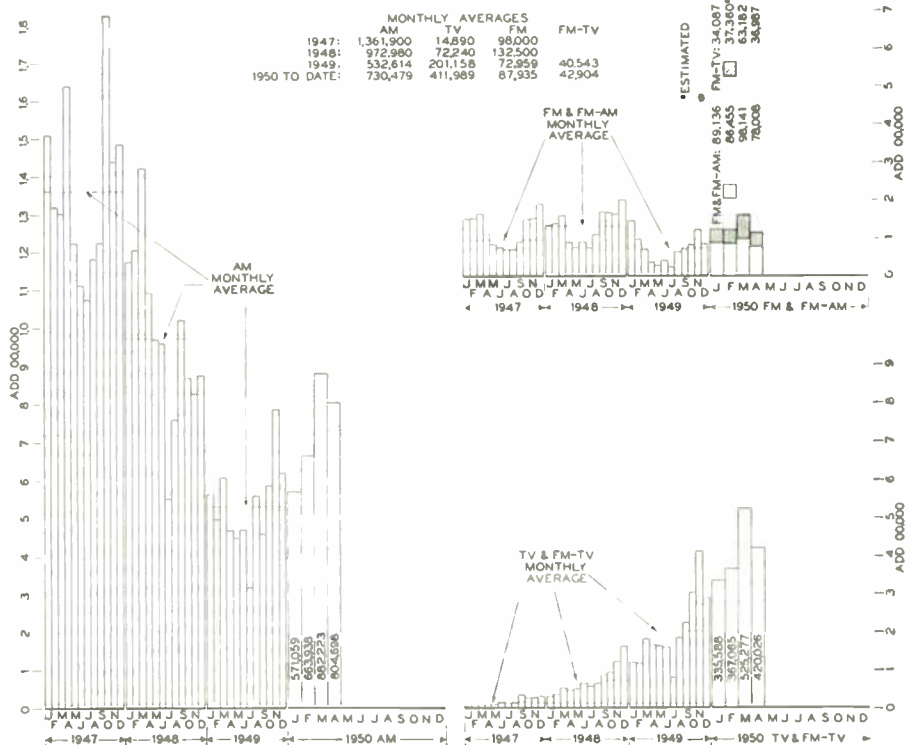

TV, FM, and AM Set Production Barometer, prepared from RMA figures

FM-TV, the JOURNAL of RADIO COMMUNICATION

**ACKNOWLEDGED STANDARD OF FM PERFORMANCE**

## *The Biggest FM Broadcast Network Runs on 646-B Receivers*

**W**HEREVER there's important FM activity, you will find the REL 646-B on the job. For example: programs from *The New York Times* station WQXR-FM are now being carried every night and Sunday over the 10 stations of the Rural Radio Network, plus WFMZ Allentown and WBIB New Haven. It is the largest FM net in operation, with inter-station distances totalling over 600 miles, reaching into six states!

What part do 646-B's play in this operation? Well, to pick up and repeat the programs and still deliver perfect audio quality to the last transmitters in the net, each receiver employed must, first of all, have extreme sensitivity, complete noise-limiting, and absolute freedom from drift.

Then, the audio systems in these receivers must be so flat, and so free from harmonic distortion that each one feeds a perfect signal into its associated transmitter.

When the utmost in sensitivity, noise-limiting, and freedom from distortion is required, 646-B's are always used. There isn't any second choice. So it's not surprising that the stations carrying the WQXR-FM programs

have bought a total of 35 REL receivers, and they are used at each point in the RRN chain.

The 646-B was designed originally for this type of commercial broadcast service. Of course, conventional high-speed production methods can't be employed for this receiver. You can see that just by examining the construction of the cabinet and chassis. But some things you can see only at the REL plant.

For example, these sets are aligned by methods such as are used to calibrate precision measuring instruments. As for the audio end, a special laboratory setup is used to make a complete run on the output characteristics of each set. Sometimes, more transformers are rejected than accepted at this point. *The factory cost of testing*

*one 646-B is much more than the retail price of many home receiver models.*

In the beginning, REL built these FM sets in small numbers, for sale only to broadcasters. But so many people who heard them insisted they would be satisfied with nothing less than 646-B performance that we had to increase our production. Now, by building 646-B's continuously, rather than in short runs, we are able to supply parts jobbers and companies handling custom installations. Usually we can make prompt shipments.

*If you are handling equipment of this sort, we invite you to write for technical data on the 646-B, and information as to the trade discount. You will find it an exciting and profitable experience to demonstrate and sell FM receivers of such distinctive performance.*

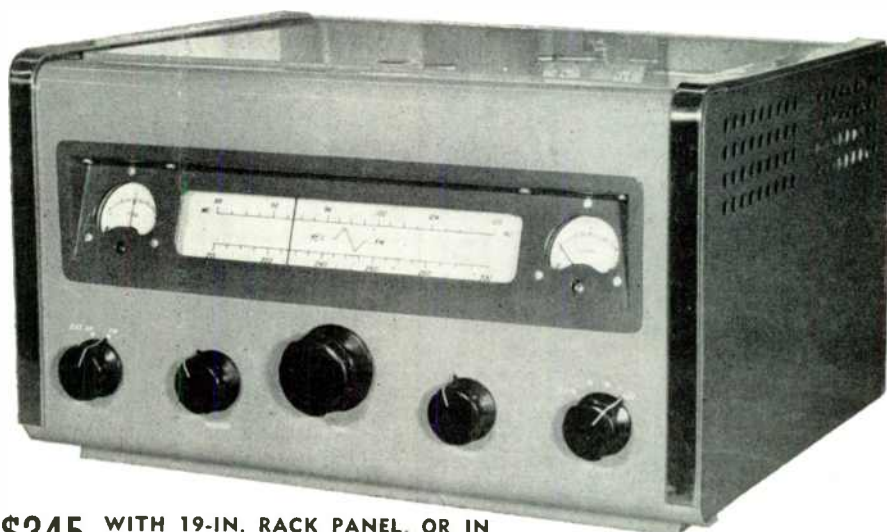

**\$345** WITH 19-IN. RACK PANEL, OR IN METAL CABINET, AS ILLUSTRATED



**RADIO ENGINEERING LABORATORIES, Inc.**

36-40 37th STREET  
LONG ISLAND CITY 1, N. Y.



## NOW—ONE FULL WATT ANTENNA POWER

*littlefone*

### Portable FM Radiotelephone

PJZ-4                      PJZ-14  
25-50 MC                152-174-MC  
\*PJZ-2                    \*PJZ-12

Especially designed for the new low power industrial radio service, the "littlefone" now provides real power output for maximum performance under FCC regulations.

Complete in one lightweight unit, the "littlefone" includes a powerful 10-tube transmitter, an ultra-sensitive 12-tube superheterodyne receiver, self-contained rechargeable storage batteries and power supply . . . ready for immediate 2-way communication.

Available in one-watt and half-watt *Hand Carried* and *Backpack* models.

"SQUELCH" available on all Models

\* Dry Battery Operation Optional  
\* ONE-HALF WATT MODELS

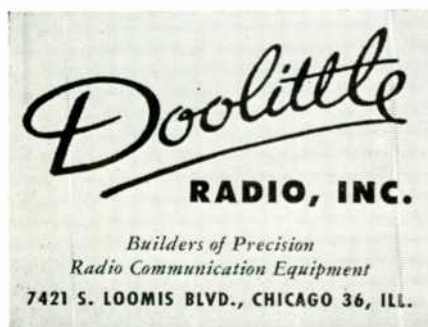

## THIS MONTH'S COVER

Essential to smooth operation of any mobile radio system are adequate servicing and testing facilities. For the larger systems, it is convenient and usually less expensive to have maintenance work done within the organization. This month's cover shows the interior of the shielded test room in the police radio shop at Erie, Pa. Within easy reach are all instruments necessary for any servicing job. The complete story of Erie's mobile system is presented pictorially in this issue, beginning on page 14.



## SPOT NEWS NOTES

ITEMS AND COMMENTS, PERSONAL AND OTHERWISE, ABOUT PEOPLE AND COMPANIES CONCERNED WITH RADIO COMMUNICATIONS

### Antenna Polarization:

Our esteemed contemporary, the *Wireless World* of London reports that American pigeons are bending our horizontally-polarized antennas by disobediently roosting on the ends of the elements. This possibility, says *WW*, was foreseen by the BBC, which wisely adopted vertical polarization. "Not so," reports the London branch of our underground information bureau. The truth is that Winston Churchill conceived the idea of using vertical polarization. In fact, he personally issued secret instructions to English manufacturers to make the vertical antenna elements of tool steel, with hardened points. Purpose is to impale flying saucers, in case of an invasion from Mars.

### Co-Channel AM Interference:

All the co-channel interference on AM doesn't come from Cuba and Mexico. We are hearing complaints that Toronto spoils nighttime reception of the Yankee games from New York station WINS, at distances of less than 50 miles.

### George E. Sterling:

He may refer to himself as a Maine clam-digger, but Commissioner Sterling's confirmation for a 7-year term in the FCC is well-earned recognition of 27 years of Government radio service, antedating even the Federal Radio Commission. In January, 1948 he was advanced from the post of Chief Engineer to that of Commissioner, to fill E. K. Jett's unexpired term.

### Argument for TV Films:

Dr. Millard C. Faught, addressing the Commonwealth Club of Chicago: "Movie producers leave their errors on the cutting-room floor; a live television program may leave them in several thousand living rooms."

### John Shepard, 3rd, 1886-1950:

With the passing of John Shepard at Brookline, Mass., on June 11, broadcasting lost one of its most active and successful pioneers. In 1922 his interest in radio as a hobby led him to install WNAC at the old Shepard department store in Boston, and WGAN at the store in Providence. Later, he had an active part in organizing the Mutual Broadcasting System. Again, in 1939 he backed Paul de Mars in erecting the powerful Paxton FM transmitter, and another on Mt. Washington. In 1944, the Yankee Network was sold to General Tire & Rubber, but John Shepard completed a 5-year contract as board chairman.

### Multiple FM-TV Antenna:

RCA, NBC, and Empire State, Inc. have signed a contract for a new, multiple antenna on the Empire State Building, New York City. It will provide TV antennas for WCBS, WABD, WJZ, WPIX, and WNBT, and FM antennas for WNBC, WJZ, and WCBS. Height to top of the new structure will be 1,500 ft. Antennas will be built by the Engineering Products department of RCA, Camden. Directing the project is a committee comprising O. B. Hanson of NBC, Dr. Frank B. Kear, consultant to Empire State, Inc., and W. W. Watts of RCA. Wayne Masters, of Ohio State University, will be chief consultant.

### New York Audio Fair:

Will be held under the auspices of the Audio Engineering Society at Hotel New Yorker, N. Y. City, on October 26 to 28. Displays will occupy 5th and 6th floors.

### Elliot M. Sanger:

Executive vice president of *The New York Times* station discussing the new  
(Continued on page 7)



## SPOT NEWS NOTES

(Continued from page 6)

setup for carrying WQXR-FM programs on the Rural Radio Network supported by the most intensive promotion campaign ever put behind FM broadcasting: "It is ridiculous to assume that the closing of a relative handful of FM stations across the country symbolizes the failure of FM. FM has not failed. Some broadcasters have failed to realize its possibilities."

### Audio Reproduction:

In our October issue, we shall start a series of articles on what has been described by experts as the greatest contribution to audio reproduction since the development of electrical recording. During the past three years, some 500 engineers, musicians, and audio enthusiasts have attended demonstrations of this new system of reproduction. Without exception, they have described it as delivering music of such quantity as they had never heard before. As one engineer put it: "Theoretically, such performance is impossible to achieve, yet I have heard it with my own ears." The complete details of the equipment will be made public for the first time in the articles which *FM-TV* will carry exclusively.

### Commissioner E. M. Webster:

Addressing the American Taxicab Association at Atlantic City on June 19: "At the end of 1948 there were 1,400 taxicab systems, base stations and mobile units, in operation. Since then, this number has increased by over 800, to a total of 2,235. Before the end of 1950, we estimate that there will be approximately 3,200 taxicab radio systems throughout this country . . . there are currently authorized approximately 60,000 mobile units in the taxicab radio service, and we estimate that this figure will be increased by another 7,000 before the end of 1950."

### Raymond M. Wilmotte:

Testifying at the TV hearing: "The cost of four Polycasting stations [each with 2 kw. of effective radiation] is likely to be about \$72,000, exclusive of studios and control equipment. The area served by four Polycasting stations is given in the record as about the same as that which would be served by a single station with a power of 1,000 kw. No estimates are available for a 1,000-kw. station, but the cost would clearly be far greater than the above estimate for Polycasting."

### AT & T Cross-Country Relay:

FCC has authorized construction of the final link in the FM relay system which  
(Continued on page 8)

# Let's can the bunk!



Nothing could be sweeter than GAUSSING your OERS-TED meter, but with Soundcraft tape you don't have to do it!

We production-test every running inch of recording tape against "magnetic holidays," keep it CONSTANT-OUTPUT within 1/2 db over the audio spectrum.



Sherlocking the signal-to-rasp ratio or silly-scoping dog-whistle frequency-responses may be exhilarating, but with Soundcraft discs you don't have to do it!

Our blank discs have made over three million broadcast-quality transcriptions, every coating-mix is pretested, each disc is individually inspected.

Steam heating a jewel-facet may well be a hot-cutting asset and you may perspire for a good sapphire, but with Soundcraft styli you don't have to do it!

Like other suppliers, Soundcraft has your sapphires made to NAB specifications, sees to it that, be they long, short, standard, or microgroove, they meet the specs.

### Tell-you-what-we're-gonna-do:

So many of our recording friends have been sending in sample-offer coupons in triplicate that we have decided that our stuff may even be good enough to stop giving it away.

Accordingly, for those genuinely interested in maybe using the same Soundcraft recording media the other experts use, we offer absolutely free (use the coupon) a brand new six-page three-color catalog and price list, each one of which set us back about 15 cents.

Secondly, we'll send you a list of convenient distributors one of which is sure to have the item you require out of the 79 regular and special types of discs and tape that Soundcraft manufactures.

Third, we'll put you on the Soundcraft propaganda list so you can read all the tripe that we are currently disgorging.

Dear Soundcraft:

Please send us the stuff you offered in the ad.

Name \_\_\_\_\_

Address \_\_\_\_\_

REEVES — "20 YEARS WITH SOUND RECORDING MEDIA."

## REEVES Soundcraft CORP.

35-54 36th STREET, LONG ISLAND CITY 6, N. Y.

## Professional Directory

### Jansky & Bailey

Consulting Radio Engineers

EXECUTIVE OFFICES:  
970 National Press Bldg.,  
Washington 4, D. C. ME 5411

OFFICES AND LABORATORIES:  
1339 Wisconsin Ave. N.W.,  
Washington 7, D. C. AD 2414

Member AFCE

### GARO W. RAY

CONSULTING RADIO ENGINEERS

Standard, FM and Television Services

HILLTOP DRIVE  
STRATFORD, CONN. Tel. 7-2466

### ANDREW ALFORD

Consulting Engineers

ANTENNAS & RF CIRCUITS

Laboratory and Plant:  
299 Atlantic Ave., Boston 10, Mass.  
Phone: HANcock 6-2339

### DALE POLLACK

FREQUENCY MODULATION

development and research  
transmitters, receivers  
communications systems

352 Pequot Avenue New London, Conn.  
New London, 2-4824

### GEORGE C. DAVIS

Consulting Radio Engineers

501-514 Munsey Bldg.—Sterling 0111

Washington 4, D. C.

### AMY, ACEVES & KING, Inc.

Specialists in the  
Design and Installation of

HIGH-GAIN  
AM, FM, and TELEVISION  
ANTENNA SYSTEMS

LOngacre 5-6622  
11 West 42nd St., New York 18, N. Y.

## SPOT NEWS NOTES

(Continued from page 7)

will connect New York City and San Francisco via Chicago and Omaha. The first leg is nearly ready to carry TV programs between New York and Chicago. It is expected that the Chicago-Omaha section will be finished by April, 1951, and the last part, from Omaha to San Francisco, by January, 1952. There will be four channels, with one in each direction available for TV programs. Total cost of the transcontinental microwave system is estimated at \$37.6 million.

#### Curtis B. Plummer:

FCC's Chief Engineer, addressing the Canadian Manufacturers Association at Toronto on May 25: "The [TV] receiving antennas at the frequencies involved are very efficient radiators. Our engineers have measured as much as .2 volt on the receiver antenna terminals, and 4,000 microvolts per meter at 100 ft. . . . The Commission is of the opinion that 15 microvolts at 100 ft. is not an unreasonable value at which to fix maximum radiation from receivers."

#### Precision Components:

New General Radio parts catalog, reminiscent of the 1920's, lists a wide range of items for the construction of all kinds of special equipment, test instruments, and laboratory apparatus. There are knobs and dials, rheostats, switches, terminals, and many hard-to-find parts in great variety. Every engineer should have a copy of this catalog in his desk.

#### Sam Norris:

Elected president of Amperex Electronic Corporation. He was previously executive vice president.

#### Increased Interest in Audio:

Willie Turntable says that the garbled speech and music from cheap TV sets is what is encouraging so many more people to go in for high-quality audio.

#### Patent Suit Settled:

Litigation between Du Mont Laboratories and RCA, pending since 1948, was settled out of court on June 6, when each company granted a patent license to the other.

#### FM's Superiority Restated:

It has been said that former FCC Chairman Denny sold FM to the broadcasters, and then his successor sold them out of FM into TV. However, Chairman Coy, speaking at the RMA Chicago convention on June 8 said: "I reiterate that, despite the welcome addition of television, we are going to need a strong, healthy,

(Concluded on page 9)

## Professional Directory

### McNARY & WRATHALL

CONSULTING RADIO ENGINEERS

906 National Press Bldg. DI. 1205  
Washington, D. C.

1407 Pacific Ave. Phone 5040  
Santa Cruz, California

### KEAR & KENNEDY

Consulting Radio Engineers

1703 K St., N.W. STerling 7932

Washington, D. C.

### GEORGE P. ADAIR

Consulting Engineers

Radio, Communications, Electronics

1833 M St., N.W., Washington 6, D.C.

EXecutive 1230

### RUSSELL P. MAY

CONSULTING RADIO ENGINEERS

★ ★ ★

1422 F Street, N. W. Wash. 4, D. C.

Kellogg Building Republic 3984

Member AFCE

### RATES FOR PROFESSIONAL CARDS

IN THIS DIRECTORY

\$12 Per Month for This Standard  
Space. Orders Are Accepted  
for 12 Insertions Only.

### LYNNE C. SMEBY

Consulting  
Radio Engineers

820 13th St., N.W. EX 8073

WASHINGTON 5, D. C.



## Professional Directory

### RAYMOND M. WILMOTTE Inc.

*Consulting Engineers  
Radio & Electronics*

1469 Church St. N. W. Decatur 1232  
Washington 5, D. C.

### WELDON & CARR

WASHINGTON, D. C.  
1605 CONNECTICUT AVE.

DALLAS, TEXAS SEATTLE, WASH.  
1728 WOOD ST. 4730 W. RUFFNER

### —McINTOSH— & INGLIS

*Consulting Radio Engineers*  
710 14th St. N.W., Wash. 5, D. C.  
METropolitan 4477

Paul W. Klipsch  
Professional Engineer  
Acoustic development  
and consulting

Klipsch and Associates  
building the authentic  
KLIPSCHORN  
world's finest sound reproducer

Hope, Arkansas

Tel. Hope 995



### FOR YOUR CONVENIENCE

To help you get information quickly, the telephone number of each advertiser in this issue is listed in the Advertisers Index which appears on page 51.

## SPOT NEWS NOTES

(Continued from page 8)

and indeed improved system of aural broadcasting. . . .

"FM's superiority over AM is as unchallenged as ever—freedom from static, noise, and fading, with day and night operation, high fidelity, and many more stations of uniform range. . . .

"FM, despite its many growing pains as an infant service, has in these five postwar years grown to more than 700 stations that give the nation more total nighttime coverage than is given by all the regional and local AM stations after AM's quarter-century of existence. The area covered by these [FM] stations holds 100,000,000 people." (See page 21 for full text.)

### RMA Elections:

Robert C. Sprague succeeds R. C. Cosgrove as RMA president. Although Bond Geddes had announced his intention to retire July 31, he was reelected executive vice president and secretary, to serve until that date. Leslie F. Muter was reelected treasurer, for his 14th term. The following were elected division chairmen: sets, G. W. Thompson of Noblitt Sparks; parts, Ray Zender of Lenz Electric; transmitters, H. J. Hoffman of Machlett; tubes, Max F. Balcom of Sylvania; amplifiers and sound equipment, A. G. Schifino of Stromberg.

### 470- to 500-Mc. Hearing:

Completion of hearing on Bell Laboratories' petition to have 470 to 500 mc. assigned to mobile radio service has been postponed until fall, when FCC will complete its consideration of TV allocations.

### Percy J. Spencer:

The honorary degree of Doctor of Science was conferred on Percy Spencer, vice president in charge of Raytheon's power tube division, by the University of Massachusetts on June 4.

### Radiation from FM & TV Sets:

Radiation from wartime shipboard receivers was limited to a field intensity of about 4 microvolts per meter at 100 ft. The RMA proposal of 25 microvolts at 1,000 ft. for TV sets could cause interference over an area of about 1 square mile, according to FCC engineers. They report that current models tested even exceed this amount of radiation. Interference situation has become so serious that Chairman Coy told RMA Convention at Chicago that the question now "is whether cooperation from the industry will solve the problem, or whether it will have to be solved under the power of the Commission to license transmitters." (See page 21 for full text.)

## Special Services Directory



ANTENNA  
EQUIPMENT  
SPECIALISTS

*Andrew*  
CORPORATION  
363 EAST 75th STREET • CHICAGO 19

### RANGERTONE

TAPE RECORDERS

HIGH-FIDELITY EQUIPMENT FOR  
BROADCAST & RECORDING STUDIOS

RANGERTONE, INC.

73 Winthrop St. Newark 4, N. J.  
Tel. Humboldt 5-2550

### THE WORKSHOP ASSOCIATES INCORPORATED



*Specialists in  
High-Frequency  
Antennas*

135 Crescent Road  
Needham Heights 94, Mass.  
NEedham 3-0005

### MEASUREMENTS CORPORATION



*Research &  
Manufacturing  
Engineers*

Specialists in the Design & Development  
of Electronic Test Instruments

BOONTON, N. J.

### HAROLD M. HEIMARK

Communication Engineers

Specialists in the design of low  
power portable & mobile two-  
way radio equipment.

MANUFACTURING FACILITIES

734 N. Austin Blvd. Chicago phone  
Oak Park, Illinois Estebrook 8-7047



16-MM Professional Motion Picture  
Production Equipment

J. A. MAURER, Inc.

37-07 31st Street, Long Island City 1, N. Y.  
Tel. 5Tillwell 4-4601

# The look that keeps telephone costs

# DOWN

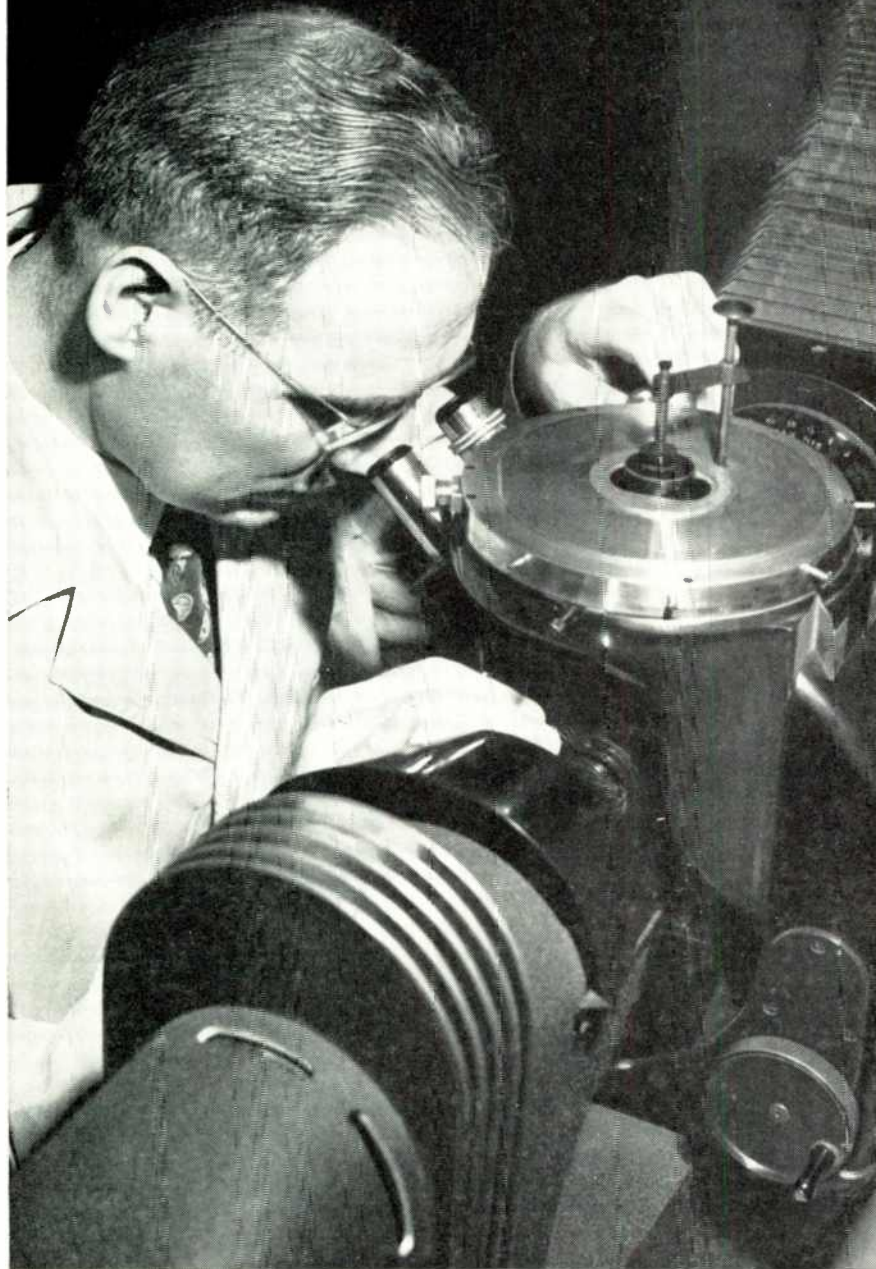

*Examining specimen on metallographic microscope at Bell Telephone Laboratories.*

Through his microscope this Bell metallurgist examines a bit of material which is proposed for telephone use. From what he sees of grain structure, he gains insight into performance not provided by spectrum or chemical analysis. He learns how to make telephone parts stand up longer, so that telephone costs can be kept as low as possible.

The items which come under scrutiny are many and varied, ranging from manhole covers to hair-thin wires for coils, from linemen's safety buckles to the precious metal on relay contacts.

In joints and connections—soldered or welded, brazed or riveted—photomicrographs reveal flaws which would escape ordinary tests. They show if a batch of steel has the right structure to stand up in service; why a guy wire let go in a high wind or a filament snapped in a vacuum tube; how to make switchboard plugs last longer.

In their exploration of micro-structure, Bell Telephone Laboratories scientists have contributed importantly to the metallographic art. You enjoy the benefits of their thoroughgoing testing and checking in the value and reliability of your telephone system, and the low cost of its service.

*Photomicrograph of white cast iron which is hard and brittle.*

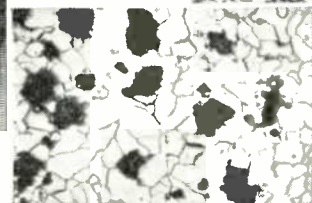

*Same iron rendered malleable by heat treatment. Shows spots of nodular carbon.*

## BELL TELEPHONE LABORATORIES



WORKING CONTINUALLY TO KEEP YOUR TELEPHONE SERVICE BIG IN VALUE AND LOW IN COST



# 3,000 WATTS FOR STATE POLICE

HOW STATEWIDE COVERAGE CAN BE ACHIEVED WITH 40-MC. FM, USING HIGH-POWER TRANSMITTERS AS PROPOSED BY FCC — *By* WILLIAM FINGERLE, JR.\*

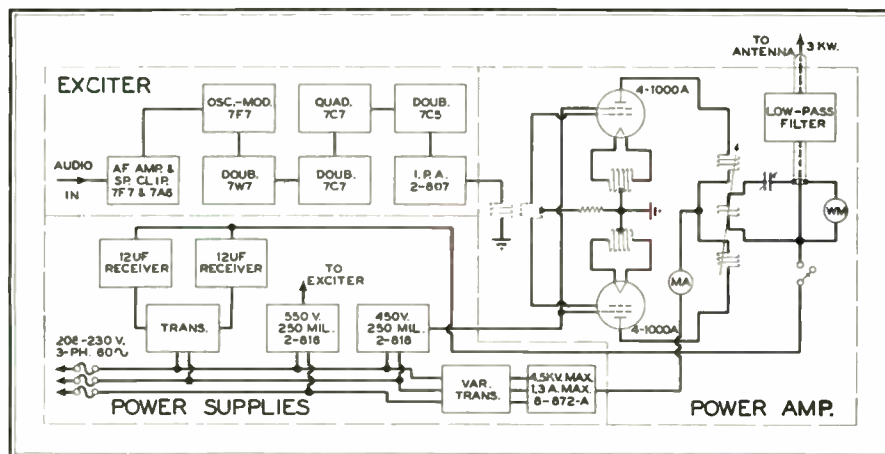

Fig. 2. Three-kw. FM communications transmitter provides long-range coverage

THE experimental operation of state police transmitters with 3-kw. output on 40 to 50 mc. has been so successful in solving coverage problems that it has opened the way to FCC authorization of power up to 10 kw., in areas where interference will not be caused with other systems, and where the use of such power is justified by operating requirements.

FCC Rules concerning state police systems, which became effective in July, 1949,<sup>1</sup> specified 500 watts maximum plate input power to the final RF stage for operation on 25 to 100 mc., and 600 watts on 100 to 220 mc. The 40-mc. band has been used for 2-way statewide communications networks since 1940, and nearly the ultimate in operating range at this comparatively low power was reached at an early date. Those techniques which provide service ranges of 50 miles or more, such as main-station antenna placement in high-altitude, low-noise locations, and the use of receivers with 0.5-microvolt sensitivity, makes possible the satisfactory coverage of small states.

However, larger states found that in order to replace obsolete low-frequency high-power AM equipment with 2-way FM units, an inconveniently large number of main stations was necessary for adequate coverage. Such systems are not only expensive to install and service, but they are not compatible with the organization of law-enforcement agencies and, therefore, create operational problems. Many expedients have been tried, such as the use of repeaters and unat-

tended satellite stations, but they are not adequate in many cases.

Several states installed 3-kw. FM transmitters on an experimental basis, in order to demonstrate that higher power was the answer to coverage problems. Missouri, in particular, equipped its entire system with high-power units. Tests of coverage and interference were run for several years. Results indicated conclusively that range was increased  $2\frac{1}{2}$  times, and that this increase was accompanied by no discernible increase in co-channel interference. Similar tests were made in 1940 by the Detroit Edison Company, and had given the same results.

Because of the higher power radiated during the tests, several cases of harmonic interference occurred, however. Some improvement was obtained by the use of traps on the specific frequency involved. Better and more complete elimination of harmonics was obtained subsequently with low-pass output filters at the transmitters, and this problem was reduced to a minor consideration.

These tests demonstrated that there is a real need for higher power in order to provide adequate coverage of large states, and that this power can be used with no appreciable increase in interference to other services. Thus, the proposed amendments to sections 10.255 (g) and 10.255 (h). Rules concerning final amplifier power inputs on frequencies assigned for state police operation, will be a solution to the problems of conversion from AM to FM.

### 3-kw. Equipment:

Link 3000-UFS 3-kw. FM transmitters, shown in the accompanying illustrations,

were used for the tests in all cases. The transmitter, Fig. 1, was designed specifically for communications service, and embodies features which provide excellent performance at reasonable cost.

Fig. 2 is the block diagram of the 3000-UFS. A standard Link 50-UFS unit is used as an exciter, followed by a 3-kw. push-pull amplifier. The audio section, consisting of a 7F7 AF amplifier and a 7A6 speech clipper, passes a frequency band of 3 to 4,000 cycles. The output feeds a 7F7 crystal-oscillator phase-modulator stage. A peak modulation control limits instantaneous deviation to  $\pm 15$  kc., as required by the new FCC Rules. Frequency stability is  $\pm 0.005\%$  from center-carrier frequency, anywhere in the band from 30 to 50 mc.

The oscillator frequency is multiplied 32 times before reaching the intermediate power amplifier, which consists of two 807's, operated at 550 volts with a power output of 50 watts. The modulator-exciter unit can be seen at the center of the cabinet, Figs. 3 and 4, and at the bottom, Fig. 5.

A maximum of 4 kw. is available from two 4-1000A air-cooled tetrodes operated push-pull, shown at top center in Figs. 1, 3, and 4. A detailed view is given in

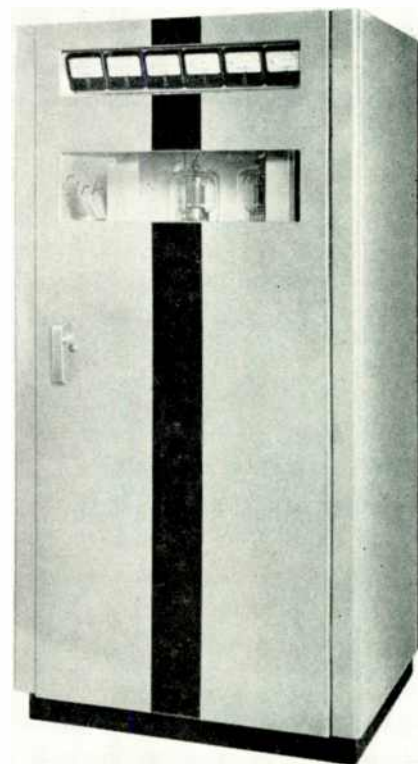

Fig. 1. Single cabinet holds the 3,000-UFS

\*Chief Engineer, Link Radio Corporation, 125 W. 17th Street, New York 11, New York.  
<sup>1</sup>For details of FCC police radio rules and allocations, see pages 13 and 14 of the MOBILE RADIO HANDBOOK, published by FM-TI MAGAZINE.

Fig. 5, showing the plate tanks and the coupling coil. The three control knobs visible just under the row of meters, Fig. 3, are for plate and output tuning and coupling control. Maximum input to the final amplifier is 5 kw., giving an efficiency of 80%. Plate voltage is continuously variable to 4.5 kv. Minimum power output is 1 kw.

#### Power Supplies:

Three power supplies are provided. The exciter power supply delivers 550 volts, .25 ampere, using two 816 rectifiers. Two more 816's are employed in a separate power supply for the 4-1000A screen grids, and provide 450 volts, .25 ampere. These power supplies can be recognized as the two chassis just below and to the right of the exciter unit in Fig. 3, and below and to the left in Fig. 4.

Plate voltage for the power amplifier is obtained from a 3-phase power supply, utilizing six 872-A high voltage rectifiers. High-voltage leads are made as short as possible by placing the rectifier tubes on either side of the final amplifier compartment, Fig. 4. Transformers are at the bottom of the cabinet. Power output is controlled by adjusting the final amplifier plate voltage. This is done with a variable line transformer, seen at the lower right in Fig. 3.

For protection of maintenance and operating personnel, power control circuit

interlocks are installed on front and rear doors. All high-voltage circuits are well shielded, and shorting switches are on the rear doors and the PA compartment door. The equipment is provided with a plate time-delay relay, primary filament- and plate-circuit breakers, and a DC overload relay which can be reset from a remote location. All controls are located behind locked doors at the transmitter.

Forced-air cooling is employed. Air enters at the bottom through a perforated 4-in. base, and is ejected at the top of the console. Both inlet and outlet openings have glass-wool filters.

Space is provided for two receivers, installed just to the left of the two low-voltage power supplies, as shown in Fig. 3. A transformer reduces line voltage

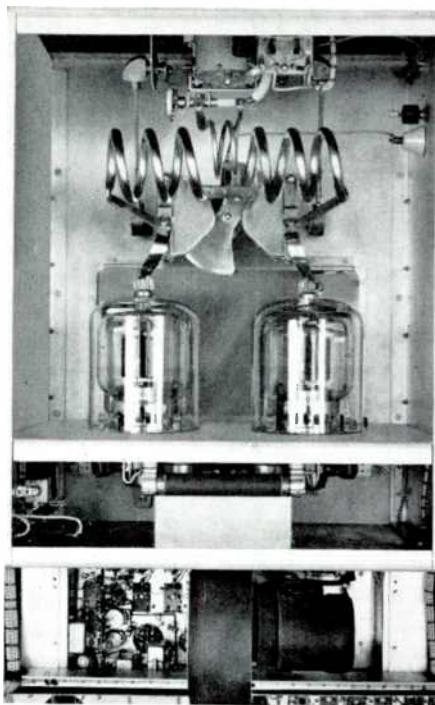

Fig. 5. PA is two 4-1,000A's in push-pull

for the receiver power supplies. Communication from the transmitter location to the operating headquarters is provided by a control unit included with the transmitter. Interphone operation is provided also. Therefore, no accessory equipment is needed except for remote control units, transmission line, and the antenna.

#### Transmission Line:

The transmitter was designed for use with 1 5/8-in. air-dielectric line, with an impedance of 51.5 ohms. For fairly long runs of line, or where maximum power must be brought to the antenna, it is recommended that this be used.

In cases where more loss can be tolerated, or where conditions make this type of transmission line impracticable, either 7/8-in. air-dielectric or RG-19/U solid-dielectric line can be employed.

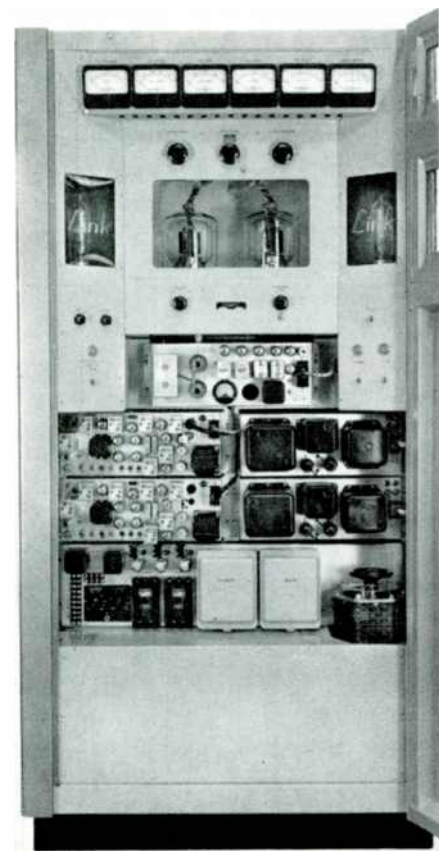
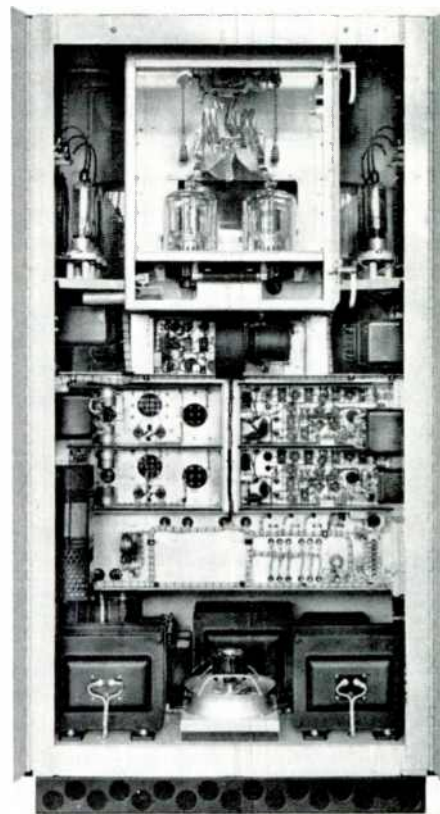

Fig. 3. High voltage is shielded at front

Fig. 4. Rear doors open to expose wiring

When using either of the latter types, care must be taken to avoid high standing-wave ratios, which cause hot spots and increased power losses. The losses for 300-ft. lengths of various types of line, assuming 3 kw. output on a frequency of 50 mc. with no standing waves, are as follows:

LINE	APPROX. LOSS
1 5/8 in. air-dielectric	240 watts
7/8 in. air-dielectric	420 watts
RG-19/U	810 watts

An integral low-loss transmission-line filter at the transmitter output attenuates all harmonics at least 60 db.

#### Metering Facilities:

Figs. 1 and 3 show the metering facilities. Six directly-illuminated meters, mounted on a sloping panel at the top, give a fast check on the operation of the equipment.

At the extreme left is a filament voltmeter for the voltage-regulated PA filament supply. Next is a plate-current milliammeter for the IPA. At left center is a PA grid-current meter, and at right center the PA plate current meter. A switch is provided to permit measurement of the plate current of either 4-1000A tube, or both.

Next on the right is a PA plate kilovoltmeter. At the extreme right is a wattmeter for indicating power output directly. This meter can be converted,

(Concluded on page 33)



# Dependable Wire-Line and Radio Operation of REMOTE SUPERVISORY CONTROLS

## PART 1: APPLICATIONS OF REMOTE CONTROLS — FACTORS OF INSTABILITY — BASIC CONTROL METHODS—THE MULTI-GATE PRINCIPLE—By J. K. KULANSKY\*

AS engineers have conceived new uses for radio communications, and improved methods of operation, an increasing demand has developed for remote supervisory controls to perform many and varied functions. In some cases, this need arises from the operation of unattended relay repeaters, or transmitters and receivers to accomplish mechanical functions at remote points. In other instances, such controls are needed to reduce operating costs or for frequency conservation.

### Remote Control Applications:

Space does not permit a review of the various applications of remote controls. The number is great, and is increasing as new radio systems are devised. Some are very simple, such as turning a remote FM broadcast transmitter on and off. The circuit may be over a wire line or a radio link between the studio and the transmitter.

In a mobile radio system, the operator's press-to-talk microphone switch must turn the main transmitter on and off. An alarm may be needed to indicate that the power line to the transmitter has failed, and that the emergency generator is running. Or the control of additional point-to-point circuits, monitoring and pickup receivers, or highway relay systems may be involved.

Most elaborate of all are the multiplex relay systems for communications and sub-station controls which are being installed by oil and gas pipe-line companies. These systems generally handle voice and teletype or facsimile, and provide for the remote operation of valves and booster pumps. They may be required to signal back the information that they have actually been operated or to show by telemetering instruments the actual amount of pressure or flow. In addition, the failure of any function must be made known at the terminal stations.

### Wire-Line Conditions:

The operation of remote controls is simplified when a 2-wire DC line can be used. Such lines are seldom available over any considerable distance, and when they are, the monthly rental generally rules them out. Moreover, controls are

usually worked over voice circuits which, even if they are set up for DC-operated devices, introduce factors of uncertainty.

The characteristics of wire lines which most frequently cause unreliable operation or failure of tone-operated remote controls are:

1. Transient currents or shock-excitation: These are caused by unsuppressed magnetic surges, cross talk, electrostatic discharges, or intermittent leakage.

2. Line level changes due to weather conditions which affect leakage or cause electrostatic interference: The threshold of satisfactory operation is considered to be approximately -30 db, since the level of inherent hash noise is approached at that point. Thus, if the line level drops below -30 db, noise interference may be set up. Or, if it rises to +10 db, overloading may result.

3. Variations of impedance: Although the standard impedance of a line is rated at 600 ohms, the actual value may be changed substantially by the addition of other equipment, particularly if improper bridging practices are employed.

4. High-frequency attenuation, particularly on long lines.

5. Frequency and phase distortion due to the characteristics of a particular line.

6. False operation of controls by voice frequencies carried on the same line.

These are not all the factors of instability which affect the operation of remote controls over wire lines, but they are the principal ones, plus the possibility that the lines may fail entirely as a result of extraordinary weather conditions.

### Radio Circuit Conditions:

In many cases, remote controls can be operated over radiophone circuits, thereby eliminating the use of wire lines. Such a system removes the possibility of line failure, and the considerable item of rental charges. FCC allocations provide frequencies for point-to-point control systems. Also, under many conditions it is cheaper to install radio equipment than to run wires and maintain them, particularly over rough terrain.

However, radio communication circuits present conditions of instability comparable to those listed for wire lines in the preceding section, except for item No. 3. The problems of static interference and signal-level variations must be considered, as well as high-frequency attenua-

tion and distortion, and false operation by voice frequencies. These factors multiply the possibilities of failure inherent in the equipment used for control purposes.

### DC Relay Controls:

Over short distances, it may be possible to achieve reliable operation of very simple controls by the use of DC relays on a 2-wire, balanced telephone circuit. As the distance is increased, however, the line charge may become prohibitive.

A single line and ground return can be used for DC controls, but that involves the use of sensitive relays. This is a poor grade of circuit, and is unreliable, due to the fact that the resistance may vary greatly.

### Single-Tone Controls:

Single audio frequencies can be employed for the selective operation of relays over a radio or wire voice circuit. A long signal interval is required due to the need for delayed operation of the relay, in order to avoid voice interference. However, the introduction of delayed operation sets up a condition under which charges may accumulate from voice frequencies, causing the relay to close, even though no operating signal has been transmitted. If the line level is not maintained at close tolerances, the relays will fail to operate, or they may be operated by random noise or voice frequencies. Also, under overload conditions, operation may be caused by sub-multiples of the tone frequencies present in voice signals.

Even with extremely sharp filters, such a system is not suited to operation by tones below 2,600 cycles. Voice-frequency energy is relatively high between 400 and 2,000 cycles. Thus, to get approximately 14 db below the maximum level of voice-frequency energy, it is necessary to operate controls on frequencies above 2,600 cycles. Also, filters operating below 2,000 cycles are expensive, and the components are inconveniently large in size.

### Simultaneous-Tone Controls:

A seemingly obvious way to prevent accidental operation of control relays by voice frequencies is to use two or more tones transmitted simultaneously, or successive combinations of simultaneous tones to actuate each relay. It is pos-

*(Concluded on page 30)*

\*Mobile Systems Engineer, Hammarlund Manufacturing Company, Inc., 460 W. 34 Street, New York City.

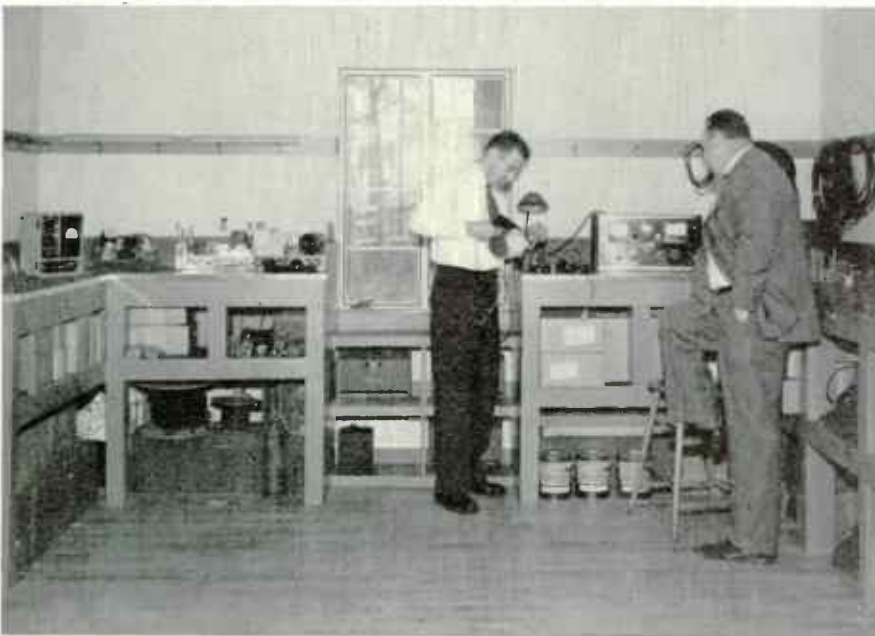

Views of the main station. Fig. 1, left top: Cinder-block building houses the transmitter and complete facilities for installing mobile units, maintenance, and shielded laboratory. Fig. 2, center: Rear of drive-in shop. Fig. 3, left bottom: part of service shop. Shielded room is at left. Fig. 4, above: self-supporting Blaw-Knox antenna for main station. Fig. 5, below: controls for the tower lights





# HOW ERIE USES MOBILE RADIO

POLICE AND FIRE DEPARTMENTS, SHERIFF'S OFFICE, AND CITY HOSPITAL ARE TIED INTO ONE COORDINATED RADIO SYSTEM — *By* LIEUT. LOUIS A. RAUB\*

THERE are two approaches to planning a municipal radio communications system. One way is to set up an appropriation and, within that limitation, to get as much service as can be provided by a system that will fit into the budget figure. The other way is to start with a comprehensive survey of the extent to which radio can serve in the protection of lives and property, and the apprehension of criminals. Then, from that data, a thoroughly adequate, modern system can be laid out, and the cost determined not only for the initial installation and possible needs for future expansion, but of maintaining the equipment at top efficiency from year to year.

## Cost of Complete Service:

Fortunately, the latter course was followed by city officials at Erie, Pa. As a result, we have one of the finest communications systems in the Public Safety category. The City of Erie covers 22

square miles, with a population of 136,000. Basically, our radio installation was planned to coordinate the activities of the Police and Fire Departments, and two City hospitals. It was decided to include the County Sheriff's office, also. Since all local police officers have deputy sheriff's papers, in case of emergency they can carry out orders from the County Sheriff. Finally, it was planned that our system should work with the police cruisers of the New York Central Railroad.

The cost of the complete installation worked out this way: Building for the main transmitter, and complete service and maintenance facilities, \$15,000; self-supporting Blaw-Knox transmitter tower, \$7,500; Motorola radio and associated equipment, \$50,000. On a shared-cost basis, this amounted to approximately \$1.50 for each family in the City.

## Plan of the System:

The 250-watt main transmitter, shown in the accompanying illustrations, is the

focal point of our system. Police Headquarters are connected to the station by one pair and a spare, plus a 60-watt transmitter for use in case both wire lines fail. Fire headquarters and the Sheriff's Office each have two pairs running to Police Headquarters.

Each of those three points has a control console for handling message traffic. Although a 24-hour watch is kept at the main station, message traffic is not ordinarily cleared there. Each control console has a receiver tuned to the main transmitter. One speaker monitors the transmission and operates a squelch-controlled relay and signal light to show when the carrier is on the air. Talk-back signals from the cars are received at the main station and carried over wires to the other monitor speaker in each console. Twelve fire houses have monitor speakers only.

## Mobile Units:

We have a total of 40 radio-equipped vehicles, divided as follows: 15 on police

\*Engineer in Charge of Radio Communications, Police Department, Erie, Pa.

Fig. 6. The author at the main-station control console. Window opens into the transmitter room, which is shown in Fig. 7



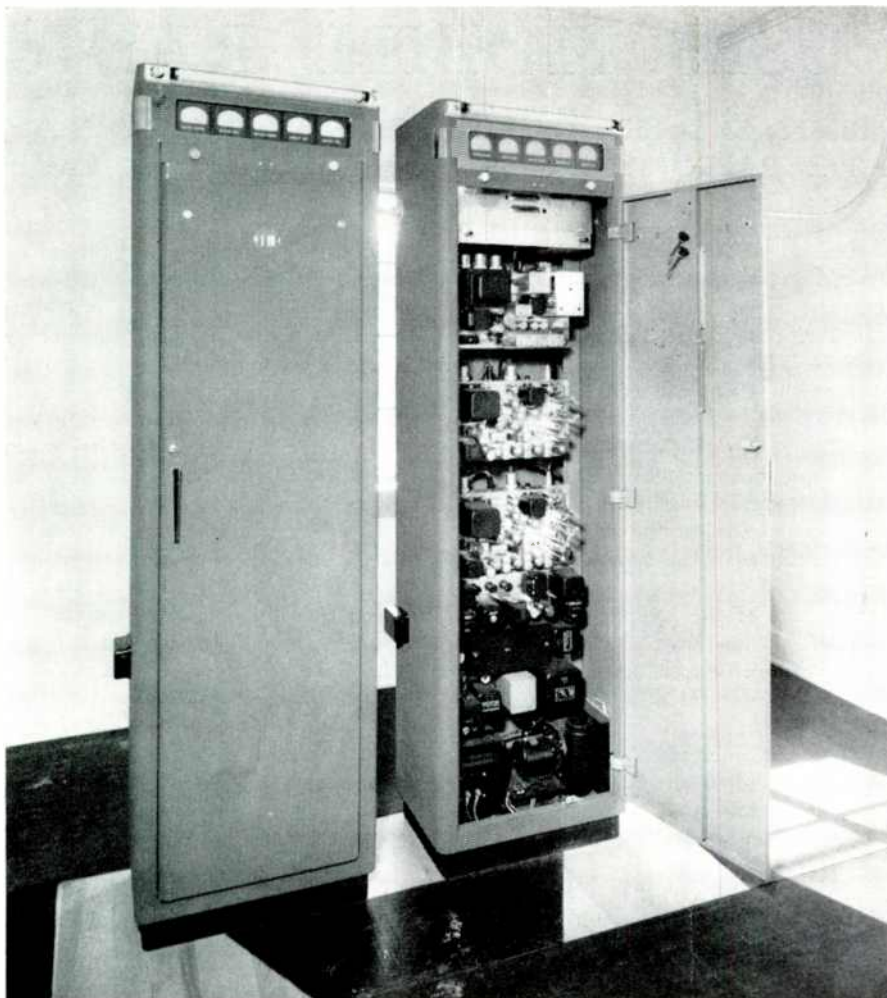
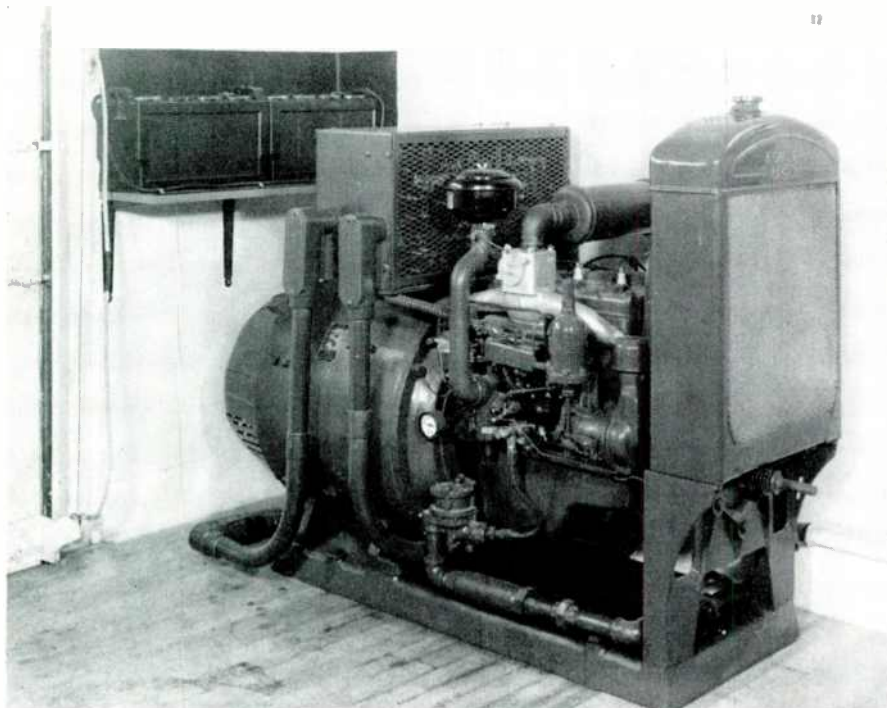

Fig. 7. Two Motorola transmitters are arranged for instant switching, in case of failure

cars, 3 on Sheriff's cars, 15 on fire apparatus including the Fire Chief's car, 4 on Vincent Hospital's ambulances, and 1 on the Manot Hospital ambulance. These municipal maintenance vehicles, 2 on St. units all operate on 155.01 mc.

Fig. 8. In case of power line failure, this 10-kw. Kochler unit starts automatically



We also provide service to West Lake and Lawrence Park townships, and we work the New York Central Railroad cruisers up to 75 miles to the east and west. Finally, we monitor the State Police transmitters at Lawrence Park, 14 miles distant, and at West Springfield, 35 miles, and they monitor us.

#### Main Station Facilities:

All our service and maintenance facilities are located at the main station, Fig. 1. The drive in workshop runs the full depth of the building. Fig. 2 shows the rear of this room. This is an ideal arrangement, for cars can be serviced at all times, regardless of the weather, and mobile transmitters can be checked for frequency and modulation swing under ideal conditions.

The control console, Fig. 6, is located just inside the front entrance. A window above the console opens into the transmitter room, Fig. 7, which is at the right of the entrance. Duplicate 250-watt transmitters are provided, with automatic switches so that operation can be shifted from one to the other instantly.

A large service shop and shielded laboratory, Fig. 3, occupy the rear of the building at the left. Complete facilities are available for testing and repairing equipment, and for building special apparatus for which need arises from time to time. Replacement units are also stored here. If trouble develops in a transmitter or receiver, it is quickly replaced. Thus, no vehicle is held up for radio repairs.

The front cover photograph of this issue shows the setup in the shielded room. These instruments enable us to locate any fault in mobile units accurately and quickly. Our ability to keep the entire system at peak efficiency has been an important factor in building confidence in the use of radio communications. Also, it has eliminated any tendency to blame the equipment as an excuse for not carrying out instructions transmitted by radio.

At the center rear of the building, space is provided for toilets, an oil heater, and the power line switches. The tower-light line comes in at this point, too, with a photo-cell relay control, and meters to check the light circuit.

Protection against power-line failure is provided by a 10-kw. engine-driven generator, Fig. 8. This is installed just inside the door of the drive-in shop. If the outside power fails, this generator is cut in automatically.

When a power failure occurs, a relay connects the batteries on the shelf at the left to the starting motor. The engine fumes are carried through the wall and exhausted outside the building, as can be seen above the engine.





# JEREMIAH COURTNEY'S\* MOBILE RADIO NEWS and FORECASTS

THE FCC has selected the common carrier mobile radio field to show that its high hard one carries a lot of steam. Using a short wind-up, with scarcely a pause between pitches, the FCC recently rifled three fast ones past the still blinking eyes of the miscellaneous common carriers.

### Service to Vessels Restricted:

Strike one was called, before the miscellaneous common carriers had settled down in the batter's box, when the Commission granted a number of telephone company applications to serve marine units in the domestic public land mobile radio service on condition that:

"The station authorized herein may be used for the rendition of service to vessels, provided that the rendition of such service to vessels will be so restricted as not to degrade, by kind or extent of usage, the service which would be available, in the absence of service to vessels, to land vehicles now receiving or hereafter requesting such service in the area, and provided that this authorization to render service to vessels shall automatically terminate at the expiration of 60 days after inauguration of public coastal VHF service in the area involved."

The final condition, calling for the termination of service to vessels upon the establishment of a mobile radio system utilizing the marine channel, was the crippling condition. The land mobile radio common carrier now develops service to vessels at its peril. Since there is only one marine channel available in any locality, the miscellaneous common carrier who develops marine service may now be developing it for a competitor. The only way this risk may be forestalled is for the miscellaneous common carrier to apply for the marine channel, even though the number of units to be served may not warrant the expense of separate facilities for that traffic.

It would seem that the Commission could well permit both the telephone and miscellaneous common carriers to service marine vessels upon the single condition that the marine service did not result in

a degradation of service to the land mobile units for whose purposes these frequencies have been primarily assigned. Otherwise, many carriers will be forced to choose between neglecting the marine field entirely or adding to their red-ink entries in developing it upon separate frequencies.

### Dispatching Service:

Strike two came in a denial of the National Mobile Radio System protest against the entry of the Diamond State Telephone Company into the special direct dispatching service. The Diamond State Telephone Company was the first Bell System company to experiment with the provision of special direct dispatching service between customers' offices and its transmitter, without inter-connection with the public telephone system.

The national association of miscellaneous common carriers had protested the grant of the Diamond State Telephone Company's application for this purpose, on the ground that the miscellaneous common carriers had developed these techniques and were therefore in the best position to render this kind of service, just as the telephone companies were in the best position to render the telephone extension type of radio service which connects the mobile radio subscriber with the entire telephone system.

The Commission, in denying the National Mobile Radio System protest, reiterated its previous position to the effect that each type of licensee should be free "to make whatever utilization of frequencies as will best serve its needs and the needs of the public." The National Mobile Radio System held that the needs of the public would be best served by having the telephone companies concentrate on the telephone extension type of radio service and the miscellaneous common carriers on the dispatch types of radio service. This position was rejected by the Commission as a matter of theory. In practice, however, it is likely that the field will develop much along the lines suggested in the NMRS protest.

### Adjacent-Channel Operation:

Strike three was the Commission's notice of proposed rule-making calling for the

use and assignment of all four miscellaneous common carrier channels in the same area. The present plan of assignments in this service calls for the use of alternate channels only. This permits a 120-kc. separation and, more important, limits the number of authorized carriers in any city to a total of two.

The Commission's proposal would not only require the use of adjacent channels 60 kc. apart, but apparently envisioned the authorization of as many as four carriers in a single city. It was this latter aspect of the Commission's proposal that most vitally affected the existing carriers, who are all having a difficult job of covering expenses under present conditions of competition. If as many as four carriers are to be authorized in a single city, however, it is difficult to see how any of the carriers will ever recover their initial capital expenditures, to say nothing of showing a profit.

The proposal for operation on 60-kc. channel separation would also inflict a serious economic loss to those taking service from the miscellaneous common carriers with equipment that they have purchased themselves. The Commission's proposal stated, in this connection:

"A recent survey of representative radio equipment manufacturers indicates that equipment capable of satisfactory interference-free operation on adjacent channels (60-kc. separation) in the 152- to 162-mc. band is now available. From such survey, it also appears that transmitters presently in use could be modified, where necessary, to operate on a 60-kc. separation basis, at reasonable cost. Existing receivers, however, would probably have to be replaced in some cases in order to eliminate undesirable interference from new systems operating 60-kc. removed in the same area."

The Commission's proposal for the use of all four common carrier channels would seem to be a move in the right direction if the additional channels thereby created were reserved for assignment to the existing carriers as the need for expanded miscellaneous common carrier service in each city was evidenced to the Commission. This sort of assurance would permit the existing carriers to lay concrete plans for expansion and for the depreciation of their old 120-kc. equipment at an early date. The economic burden entailed in the Commission's order would then be compensated for, in large part, by the assignment of the additional channel. This extra channel will be indispensable in all large cities if the existing carriers are going to come out on their investment and fixed overhead charges. Protests have been filed by a large number of the miscellaneous common carriers against the Commission's

*(Concluded on page 34)*

\*1707 H Street, N.W., Washington, D. C.

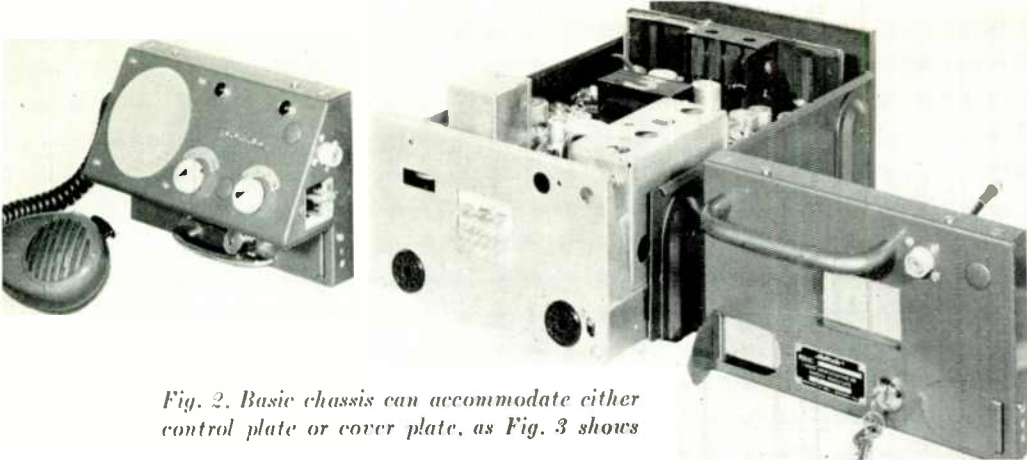

Fig. 2. Basic chassis can accommodate either control plate or cover plate, as Fig. 3 shows

## Advance Design Details of Single-Channel MOBILE RADIO UNIT

SMALL, LOW-COST TRANSMITTER-RECEIVER FOR ADJACENT-CHANNEL SERVICE — By DALE SAMUELSON\*

THE number of mobile radio systems licensed by the FCC has grown from 560 in 1935 to more than 17,000 in 1949. Approximately 12,000, or better than 72 per cent, have been added since 1945. This tremendous growth is shown graphically in Fig. 1. The supply of available alternate-channel assignments has been practically exhausted in some of the bands designated for mobile communications. Hence the urgent need for equipment capable of operating on a single channel without picking up signals on adjacent channel, or causing interference to other systems.

The first Motorola equipment which provided the necessary selectivity, transmitter deviation control, and stability for this type of service was the DeLuxe Sensicon.<sup>1</sup> Now, these features are pro-

vided in the Uni-Channel Sensicon Dispatcher, the low-cost transmitter-receiver pictured on these pages. This model was developed for services which require light weight, high-performance equipment, but do not need high transmitter power.

### Housing Construction:

One of the most remarkable features of the new equipment is its unique housing assembly, which greatly simplifies installation in the front or rear of any motor vehicle. The basic housing is shown at the center in Fig. 2. To this can be attached a front plate which carries the controls and speaker, Fig. 2 left, or the dust-tight cover shown at the right. The latter is used with a separate control head and speaker when the unit is not installed in the driver's compartment. Four screws are used to attach either the cover or the control head.

Both versions can be seen in Fig. 3. The dash-mounted assembly is only 6 ins. high, 9<sup>7</sup>/<sub>8</sub> in. wide, and 18 15/32 ins.

long, weighing 37 lbs. For the trunk-mounted unit, the height and width are the same, while the length is 18<sup>1</sup>/<sub>4</sub> ins., and the weight 35 lbs. Dimensions and weights are the same for both 25- to 50-mc. and 152- to 174-mc. bands.

Installations are shown in Figs. 4 and 6. For mounting under a dashboard, Fig. 4, adjustable brackets are provided. Four holes in the automobile floor or wall and dashboard are necessary to accommodate Parker-Kalon sheet-metal screws. The rear-mount unit is designed to lie flat on the floor or to fit a standard mounting-rack, as in Fig. 6.

The chassis can be removed from the housing in either of two ways. In dash-mounted units, Fig. 5, the control head and chassis assembly slide out lengthwise. Chassis and housing are electrically independent, so that there is no need to disconnect cables when the chassis is removed for checking or serv-

\*Communications and Electronics Division, Motorola, Inc., 4545 Augusta Blvd., Chicago 51, Illinois.

<sup>1</sup>For a complete description of the first adjacent-channel equipment design, see "Adjacent-Channel Equipment" by Harold A. Jones, *F.M.T.V. MAGAZINE*, November and December, 1949.

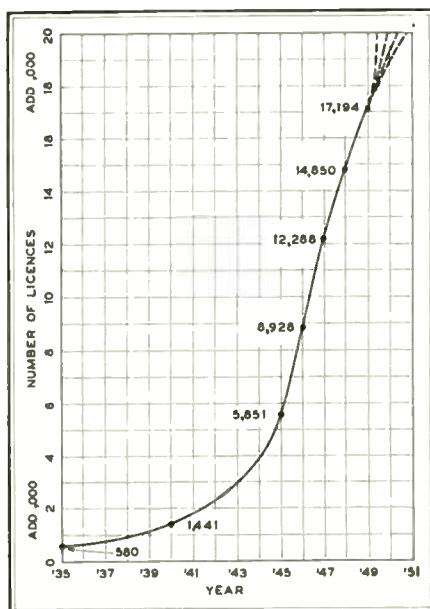
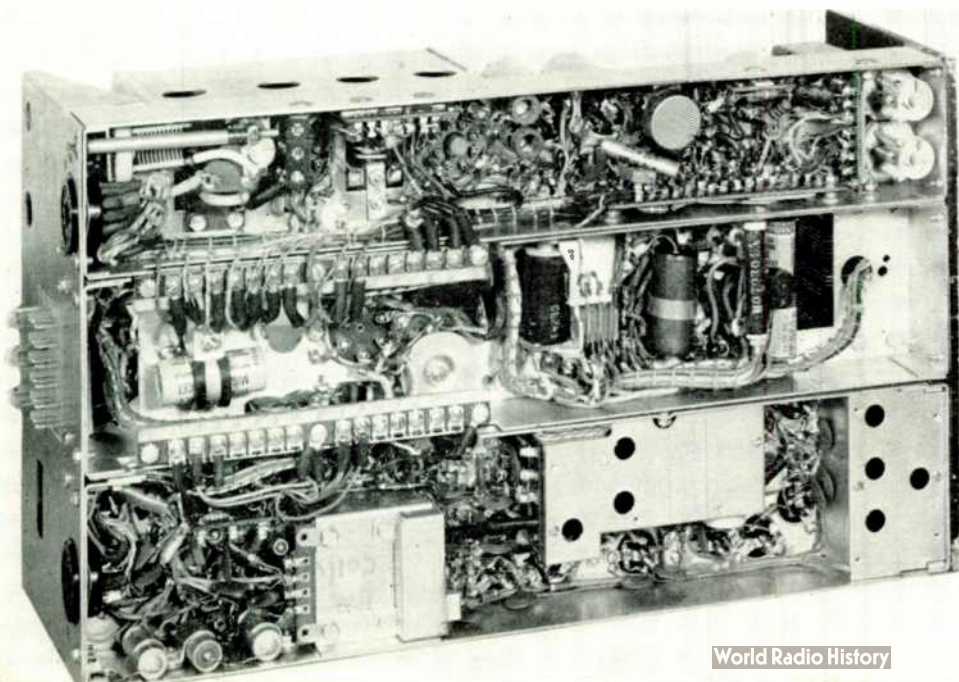

Fig. 1. Growth of mobile radio systems

Fig. 7. Under view of chassis assembly, showing the three individual sub-chassis



icing. The top cover is also removable. Thus, the chassis can be lifted vertically out of the housing in rear installations.

Power- and control-cable connections are handled in an interesting way. As can be seen in Fig. 2, the front of the chassis contains a multiple-contact plug at the center for power and control connections. When the front plate for dashboard installation is attached, connections are made directly to the controls, and the power plug is brought out at the right side, as shown in Fig. 3. In cases where the unit is mounted in the trunk, as in Fig. 6, both power and control contacts on the chassis extend through an opening in the front cover to the connector on the cable which runs to the control head, speaker, and battery terminals. Coaxial antenna connections are also brought through the cover.



### Electrical Design:

The main chassis contains three sub-chassis, mounted lengthwise side-by-side. In Fig. 7 the transmitter sub-chassis is at the top, the power supply is in the center, and the receiver sub-chassis is below. The front of the unit is facing left in this view.

The receiver has a total of 30 tuned circuits. Seven are permeability-tuned in the RF and oscillator sections, with ribbon-wound coils in the high band. The IF and discriminator sections contain 23 tuned circuits, 10 of these being fixed and cast in plastic. This plastic block is an IF bandpass filter, consisting of M-derived and constant-k sections, and determines the broad-nose and steep-skirt selectivity characteristics of the receiver. Attenuation at  $\pm 35\text{kc.}$  is 100 db, and at  $\pm 15\text{kc.}$  6 db. Spurious responses are attenuated at least 85 db. The filter

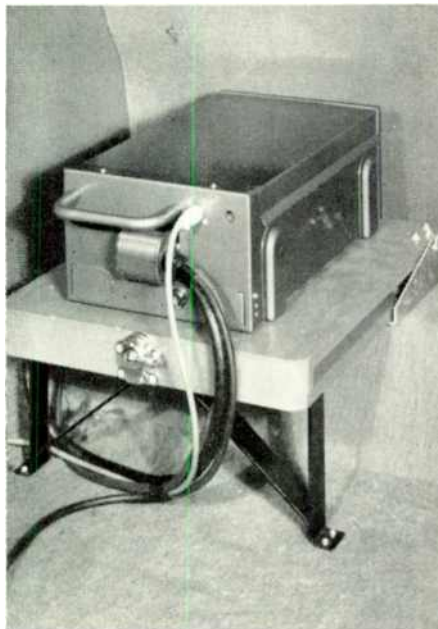

Fig. 6. Luggage-compartment installation

block is so designed that it can be replaced if necessary.

All tunable circuits are provided with locking devices. In normal service they should not require adjustment. The local

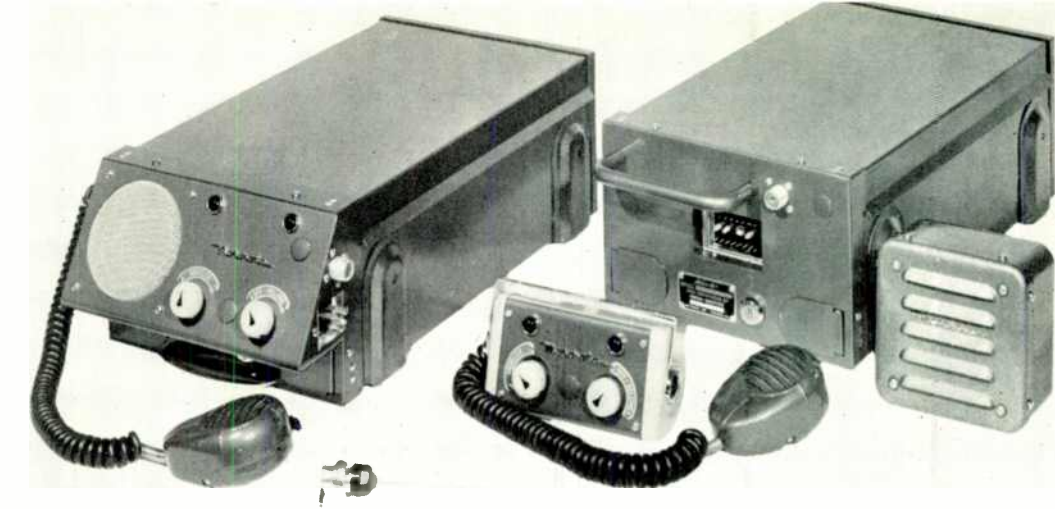

Fig. 3. Units assembled for dash board installations, left, and rear mounting, right

oscillator of the receiver is crystal-controlled but tunable, and receiver tuning is accomplished by adjustment of the oscillator rather than IF alignment.

Local oscillator stability is maintained by a crystal oven. Overall stability is held within  $\pm 1\text{kc.}$ , or  $\pm .0006$  per cent of the assigned frequency, from 152 to 174 mc.; and within  $\pm 750$  cycles, or  $\pm .0015$  to  $.003$  per cent of the operating frequency, from 25 to 50 mc. Either one- or two-frequency operation is available in both frequency bands.

The limiter-discriminator detector circuit, in conjunction with inverse feedback in the audio system, provides high detector sensitivity and linearity, and assures good audio quality.

Squelch sensitivity is continuously variable, with a maximum threshold sensitivity of 2 db receiver noise-quieting. Automatic gain control is provided to prevent overloading the IF stages when the receiver is used in high-signal areas. Maximum sensitivity of the receiver is 0.6 microvolts or less for 20 db quieting on 152 to 174 mc., and 0.4 microvolts or less for 20 db quieting on 25 to 50 mc.

Following is a table of tube complements and functions:

FUNCTION	25-50 Mc.	152-174 Mc.
1st RF amp.....	6BC5	6AK5
2nd RF amp.....	None	6AK5
Oscillator & Mult.....	6C4	6J6
1st mixer.....	6CB6	6AK5
1st IF.....	6BH6	6BH6

2nd mixer & osc.....	6BE6	6BE6
2nd IF stages 1, 2, 3, 4.....	6BH6	6BH6
1st limiter.....	6BH6	6BH6
2nd limiter.....	6BJ6	6BJ6
Discriminator.....	CK5829	CK5829
Noise amp.....	6BH6	6BH6
Noise rect.....	CK5829	CK5829
1st AF & sq.....	12AX7	12AX7
AF power amp.....	6AK6	6AK6

### Power Supply:

The power supply is of the vibrator type, for 6 volts DC operation, and employs selenium rectifiers in a double bridge circuit. Following is a table of output power values supplied to the transmitter and receiver circuits:

	25-50 Mc.		152-174 Mc.	
	VOLTS	MA.	VOLTS	MA.
TRANSMITTER	350	120	350	150
	300	30	250	14
	250	14	150	30
	150	30	-20	Bias
	-20	Bias		
RECEIVER	200	60	200	55

Power input on 25 to 50 mc. is 10 amps. standby, and 23 amps. transmit. Input on 152 to 174 mc. is 10 amps. standby, and 25 amps. transmit.

### Transmitter:

In our new transmitter design, suppression of spurious and harmonic emissions

(Concluded on page 33)

Fig. 4. Chassis slides from housing in drawer fashion. Fig. 5. Access ports permits metering of important circuits

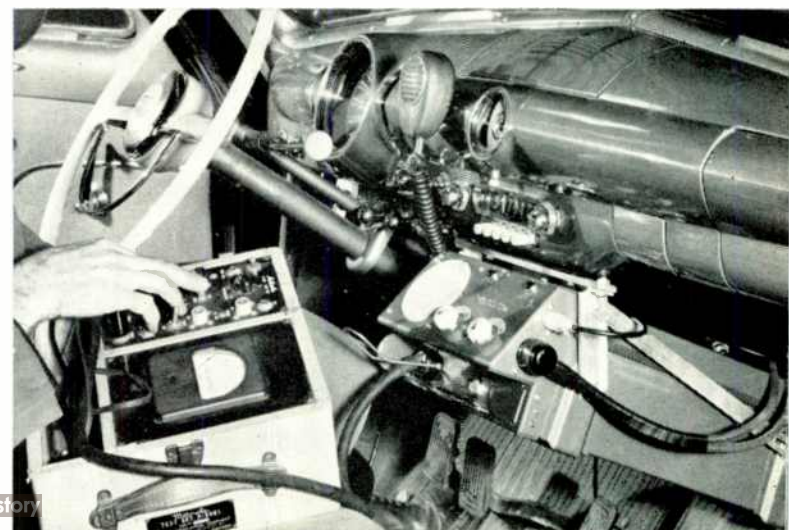
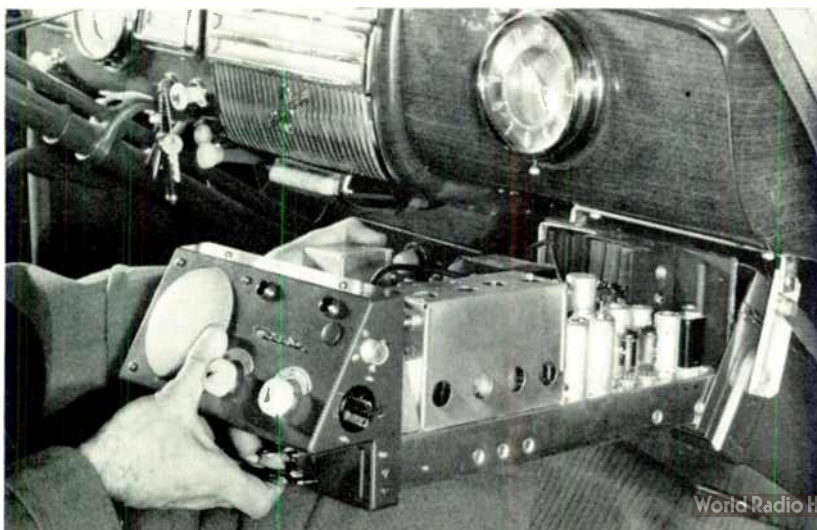



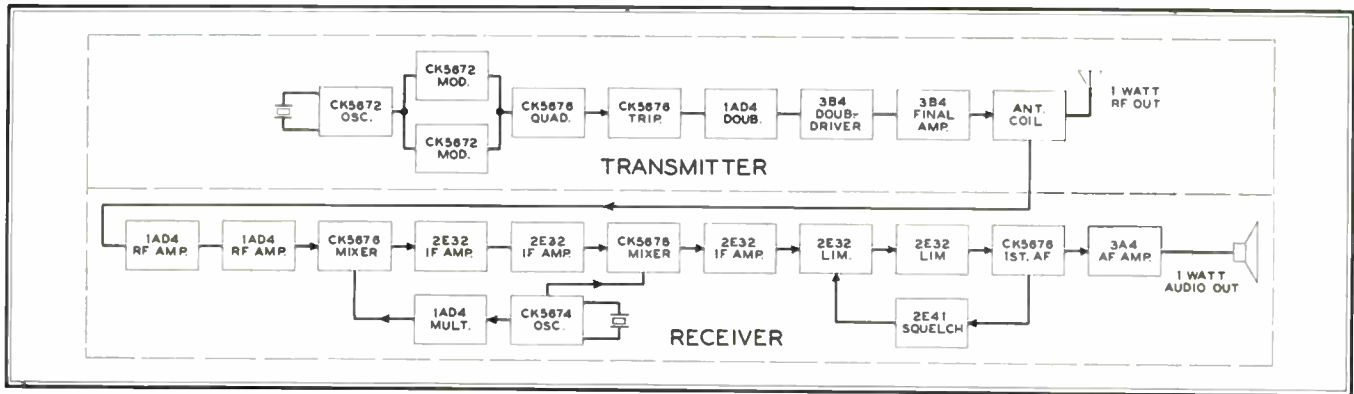

Fig. 1. Tube lineup in CeeCo series 51 equipment. All tubes are subminiature except RF driver, PA, and AF output stage

# SHORT-RANGE PHONE

HAND-CARRIED TRANSMITTER-RECEIVER UNITS USE SUB-MINIATURE TUBES — *By* HOWARD V. CARLSON\*

**L**OW-POWER transmitter-receiver units employing sub-miniature tubes are now available. In the equipment shown here, developed by Communications Equipment and Engineering Company, these tubes are used almost exclusively. They are rugged, dependable, and last upwards of 5,000 hours. And because of their small size, performance comparable to conventional mobile radio units can be obtained from surprisingly compact, battery-operated equipment which can be carried easily.

Short-range transmitter-receiver units have many important applications in day-to-day use, as well as in emergencies. The primary advantage of low-power equipment is that it can be made portable, needing no external power source. Since the units are self-contained, there is no installation problem. They can be used anywhere that a man can reach by conveyance or on foot. Last but not

least, interference to other transmitters on the same frequency is held at a minimum.

One of the many uses to which this equipment is particularly adapted is communication from caboose to locomotive on railroad trains. It is not necessary to provide a special power supply, since the radio units are self-powered. The same equipment used for this purpose also provides portable communication facilities in case of emergencies.

This type of equipment is finding wide use by police in situations where it is necessary to get about on foot, by fire departments at the scenes of large fires, and by industrial plants to coordinate

Fig. 2. Unit above has 1-watt RF and AF outputs. Below, 1/4-watt handset model

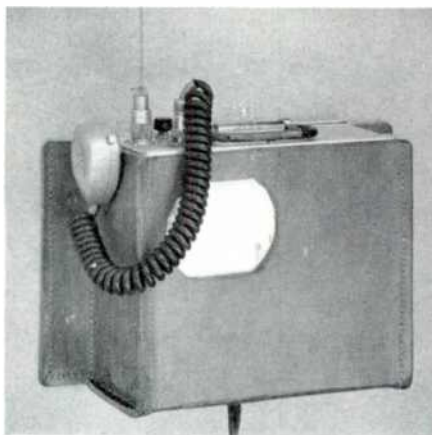

yard or supply activities. In the last application, the use of portable units on material-handling trucks can increase efficiency and reduce operating costs.

There is a wide variety of models for different applications. Units are available as 2-volt DC self-powered types, 6-volt DC and 110-volt AC externally-powered types, and 6-volt DC models which can be used either way. RF output is 1 watt or 1/4 watt, with either 1 watt audio to drive a built-in speaker or 10 milliwatts output for a handset or earpiece. Units can be provided for 25 to 50 mc. or 152 to 174 mc. Rechargeable storage batteries, for 8 or 15 hours of use, are provided for portable models.

Fig. 1 shows the tube lineup in the model 51 series, delivering 1 watt RF and 1 watt audio on 152 to 174 mc. All tubes are of the sub-miniature type, excepting the transmitter driver, PA stages, and the audio output stage. Both transmitter and receiver are crystal-controlled.

Stability of the transmitter is held within  $\pm .01$  per cent, and spurious radiation is attenuated at least 40 db. The receiver is a double-conversion superheterodyne, employing 2 limiter stages. Sensitivity is 1 microvolt for 20 db quieting. Squelch is supplied on all receivers, but

(Concluded on page 32)

Fig. 4. 1/4-watt packset weighs only 9 lbs.



\*Communications Equipment and Engineering Company, 5646 W. Race Avenue, Chicago 44, Illinois.

Fig. 3. Battery case clamps on 1-w. units





# FM, AM, AND TV: THE ROAD AHEAD

MORE PROGRESSIVE MANAGEMENT THINKING AND AGGRESSIVE ENGINEERING EFFORT ARE NEEDED NOW TO MEET NEW CONDITIONS—By THE HON. WAYNE COY\*

PERHAPS the key problem of all of us concerned with radio at this particular time is the maximum utilization of the radio spectrum in the public interest. For the public, maximum utilization of the spectrum means maximum service. For the broadcaster it means maximum coverage. For the radio manufacturer it means maximum production. And for the Federal Communications Commission it means the fulfillment of the mandate of Congress to encourage the larger and more effective use of radio in the public interest.

## New Industry Problems:

You gentlemen construct the vehicles that haul our loads of communication up and down the electronic highways of the radio spectrum. That spectrum space is so precious that we should strive for the most efficient operation, the maximum utilization of these highways of the ether.

That is why, at this particular stage of radio's development, the radio manufacturer finds himself more and more confronted with problems that the manufacturer of yesterday might not have considered so immediate to his planning. But now it is becoming increasingly obvious that the extent of our efficiency, ingenuity, and economy in employing these highways determines the extent of the manufacturers' production opportunities.

I think television affords a splendid example of the mounting importance of the inter-relationship of the manufacturer, the broadcaster, the public, and the government.

In the television area of the radio spectrum, we have seen what happens when, in response to enthusiastic demands for a new and exciting broadcast service, we authorized more traffic on the electronic highways than the development of the art would permit. The result was a traffic jam that could only be straightened out by halting all new construction. In this particular instance the solution of the over-crowding was complicated by the necessity of providing for color, along with black and white, in the spectrum space allocated to television, if we are to have color in the foreseeable future.

## Ending the TV Freeze:

In general, we seek the same objectives: We want to lift the freeze as soon as

practical so that construction of stations can resume. The freeze has already lasted more than a year and a half. We want to employ channels in the ultra-high-frequency band so that we can have many more stations and give the public, by means of a proper distribution of station assignments, a truly national and competitive television broadcasting system. We want to have color if it is feasible. To use only black and white pictures when color is feasible would not be maximum utilization of the spectrum.

The color phase of the Commission's hearing was concluded on Friday afternoon, May 26. Proposed findings, arguments and rebuttal briefs will be in the hands of the Commission on July 10th and then the decision-making process can get under way. The most critical questions which the Commission must decide as a result of this phase of the hearing and in the light of the continued halt on construction of television stations are:

1. Can we get good color television in a 6-me. channel?

2. Are the interference conditions, which affect the station assignment plan, the same, substantially the same, or more or less critical than for black and white television?

The Commission could answer the first question in the negative and, therefore, express no concern as to question number two. Such an answer would have these consequences: A) color no longer would be an issue prolonging the freeze; B) color would not be available to the people of this country until some unknown date in a presently unknown and probably presently unexplored part of the radio spectrum, perhaps as far away as two or three decades, if at all. I add "if at all" because television is now allocated such a large amount of the known radio spectrum that it is very doubtful if additional space will be granted this service in our lifetime in view of the many, many other demands for use of the spectrum.

## Color Now or Later:

Some of you have made it clear that you would answer the color question in the negative. Others in your organization have strongly inferred such an answer would be yours. But most of you, in my

opinion, see the merits of the proposition that adequate provision for both color and black and white television must be made now in the public interest and in your own interest, if such action is possible at this time.

The Commission can answer the question affirmatively by any one of the following decisions: the writing of engineering standards for color television transmission; provision for multiple standards, permanently or temporarily; or provision for further experimentation and development. Involved in the making of such an affirmative decision is the consideration, among other things, of whether apparatus for the showing of color from any of the proposed color systems has been developed or seems certain of such development as would permit the sale of receivers at a sufficiently low price so as to be economically available to practically all homes in America.

As to the question of color in 6 mc., we have had help, great and important help, from segments of the radio industry. At times it has seemed that some segments of the industry wanted to hold back color for another day, even at the risk of not having color in the future. But on the whole color has progressed in its development at a rather rapid pace. It seems to me that the inventive genius of the electronic scientists has been stimulated and put to working overtime. I see no stopping the advance and I see no one willing today to lie down in its path as an impediment.

## Interference on Color TV:

I must, however, express my concern about the help the Commission has had on the interference problems of color television, a key to our station allocation list if we are to have color or, to put it another way, a key to the lifting of the freeze. I cannot and I do not ignore your interest in the lifting of the freeze. I recognize the necessity of such action not only in your interest but in the broader public interest.

But I do not understand why the Commission has had such difficulties in getting necessary information from the industry on these interference problems. We have had to prod you continuously for it in the face of the assumptions which you were giving us to the effect that the interferences would be the same as in black and white.

You say it isn't your problem—that

\*Chairman, Federal Communications Commission, Washington, D. C. An address before the Radio Manufacturers Association Convention, Hotel Stevens, Chicago, June 8, 1950.

it is the problem of the proponents of color systems and the Commission.

And I say to you it is your problem and it is to your selfish interest that you regard such problems as your own. Anything that determines the size of the service areas, including the people living in the marginal service areas, determines the size of your market. Complete and accurate knowledge of both the co-channel ratios between stations and the magnitude of undesired interfering signals are large factors in determining the size of your markets. Having usable television signals reach all the people of this Country is in the public interest, and likewise serves your economic well-being.

#### **The Interests of All Concerned:**

And I do not think it will be difficult for me to establish with you the view that it is in the public interest—and in your own interest—that television quickly achieve its full potential of usefulness to the American people. Television must have something to say to the people of this Country. It is not to your interest that it become third rate, or even second rate, in the field of entertainment, culture, education and as a “window on the world.”

Television must be an affirmative force in our national life. It is to your interest as manufacturers that every possible program resource is available to the telecasters and thus to the homes of America. We must be as vigilant in guarding against monopolies in the creative fields—the greatest source of programming materials—as we are in the marketing of electric light bulbs or groceries.

On Monday, the Commission began a hearing on the petition of the American Telephone and Telegraph Company for an allocation of a portion of the UHF for common carrier services. This hearing is a harbinger of further conflict over the use of the radio spectrum.

Following this phase of the hearing and the decision on the color issue, our next step will be to begin taking testimony on the general allocation part of this hearing. In this general allocation phase we will take up the feasibility of employing UHF, antenna heights, power, spacing between stations in VHF and UHF, classification of stations (metropolitan, rural, community and perhaps some intermediate class), directional antennas, offset carrier, carrier synchronization, service areas, oscillator radiation (about which I will have more to say), stratovision, polycasting, the reservation of channels for non-commercial educational stations and metered television.

This portion of the hearing will be followed by the hearing on allocation of channels, in both VHF and UHF, to

specific communities throughout the Country.

When all this is completed, the Commission will proceed with the processing of applications as speedily as possible. In some communities there will of course be delays because of hearings on competitive applications.

Considering the large number of station assignments available, and considering the tremendous enthusiasm already evidenced by the public, and considering the improved and relatively interference-free allocations we will have, it is easy to understand why some of your industry leaders are predicting that there will be 28,000,000 sets in use within the next four years.

#### **Trouble From Radiation:**

And now I wish to refer to another area in which the radio manufacturer is confronted with new opportunities to improve the effectiveness of his operations in the light of the realities of today's radio transmission conditions, and thereby further serve the public interest.

The problem I refer to is interference caused in some areas and under certain circumstances by TV and FM receivers having excessive oscillator radiation. The TV or FM set in the living room, if proper safeguards have not been built into it, is in effect a schizophrenic—a split personality—a Dr. Jekyll and Mr. Hyde.

In the living room, as Dr. Jekyll, it shows a smiling, benign face to its owner, amusing, informing, spellbinding, even educating or uplifting. But simultaneously, as Mr. Hyde, it may be up to nefarious activities elsewhere. It may be radiating interference which is causing havoc far and wide. It may be spoiling television reception for many blocks away—producing shimmying and Venetian blind and herringbone effects on other screens.

It and its companion miscreants may be causing hundreds, even thousands of TV set owners to gnash their teeth, tear their hair, complain to TV broadcasting stations and the FCC, or perhaps to wind up by demanding that the TV retailer come and take their sets back and refund their money.

It may be up to something far more sinister than spoiling somebody's television enjoyment. It may be acting as a deadly weapon, interfering with aviation radio and endangering the lives of passengers on airliners.

What is happening? As a split personality, the TV or FM set is acting as both a receiver and a transmitter.

The TV and FM receiving sets, by thus transmitting radio waves far and wide, are also interfering with each other. Interference-wise, they are their own

worst enemies. It is a kind of an electronic cannibalism in which they are all trying to destroy each other.

This problem is grave enough today when we have only 104 television stations on the air and more than six million receivers in the hands of the public. But after the freeze is lifted and hundreds of new stations go on the air and the number of receivers climb to 10, 20, and 30 million, this problem could become extremely magnified unless something is done about it now. Three possible solutions have been advanced:

1. Reallocate channels.
2. Change the intermediate frequencies of receivers.
3. Limit the amount of receiver radiation.

To reallocate channels would mean a reduction of the number of television stations and would require a change in the frequency of many stations now on the air. This seems quite impractical.

Both the Commission and the RMA have given considerable study to the possibility of changing the intermediate frequencies of receivers. If the industry changed from the present almost universally-employed 21.6- to 26.1-mc. intermediate frequency to 41.2 to 45.7 mc., it could completely eliminate oscillator radiation in the VHF TV channels, but the signal generated would cause interference to vital safety services, primarily aviation.

#### **Receiver Radiation Limits:**

As to the third solution—limiting receiver radiation—both the Commission and industry have taken some steps looking thereto. In its Notice of Proposed Rule Making on April 13, 1949, relating to the revision of Part 15 of its Rules, the Commission proposed to bring receiver oscillator radiation under its rules. In the discussion of ways of specifying a limitation, a value of 15 microvolts per meter at a distance of 100 ft. was used by way of example.

No such value has been proposed formally, but tests of different types of receivers and a careful study of receiver requirements indicate that such a value may be achieved by television receivers if adequate consideration is given to the problem in the design stages.

During the war, the Commission required that the radiation of shipboard receivers should be less than 400 microwatts, which corresponds to a field intensity of about 4 micromicrovolts per meter at a distance of 100 ft.

In contrast, in September of 1948, the RMA committee on television receivers suggested a limitation of 25 microvolts per meter at 1,000 ft. Under conditions of rural reception, each receiver would cause interference to about 1/100th



square mile under the suggested value of 15 microvolts per meter, whereas the RMA proposal could result in interference over an area of about 1 square mile.

However, tests on recent receivers indicate that even the more lenient RMA proposal has not been met in practice.

Of course, cost is a factor in the determination of a reasonable and tolerable level of suppression. At the present time, exact information on such costs is not available, as methods of suppression are still under study. However, informed opinion is that it is a matter of a few dollars on the price of each receiver. In any event, the results of our failure to take the necessary corrective action will be so far-reaching that we cannot allow the relatively insignificant increase in receiver cost to stand in our way.

Three committees are now working on this problem. There is a Central Coordinating Committee composed of representatives from the FCC, the RMA and the American Standards Association. As a contribution to this work, the American Standards Association Committee C-63 is studying receiver susceptibility for various services which may receive interference, radio noise, and methods of its measurement. Also, the RMA Committee R-15 is obtaining data from RMA members and cooperating organizations as to the amounts of radiation from present TV receivers and methods of measuring and reducing such radiation.

The Commission has asked the parties in the color television hearing to file, as a part of their proposed findings of fact, a statement of the precise data available concerning the susceptibility of the system and various types of apparatus to interference and similar effects, and a statement of how such interference may be minimized with respect to oscillator radiation as well as other types of interference.

In the meantime, the Commission solicits the wholehearted cooperation of the radio manufacturing industry — those outside the RMA as well as the RMA members — in this important problem. The Commission also solicits the cooperation of servicemen, retailers, and broadcasters in alleviating local conditions pending a general solution of the problem.

#### **Industry or FCC Must Act:**

Some manufacturers are already making plans to reduce radiation in their upcoming models. Other manufacturers, however, are making no plans. Meanwhile, receivers continue to cascade off the assembly lines at the rate of 400,000 per month. The need for action is urgent.

The question before us now — today

— is whether the cooperation from the industry will solve the problem or whether it will have to be solved under the power of the Commission to license transmitters — and that is what we are dealing with in the cases of those receivers radiating excessive amounts of power.

As many of you know, the Commission maintains 19 monitoring stations over the nation to act as watchdogs of the air waves, to police all illegal radio transmission, and to track down interference. However, in view of the skyrocketing growth of radio, we cannot hope to keep the situation in hand without stringent regulations.

The Commission may have to establish interim standards. But in certain areas where safety of life and property is jeopardized, immediate action is mandatory.

All of us here recall how industry after industry in the past has had to set up safeguards when an aroused public decided that the public interest was being injured. The railroads have had to eliminate grade crossings. The building industry has had to meet zoning and safety regulations. The drug industry has had to establish the safety of new drugs before they are permitted to market them. The maritime industry, after tragic shipwrecks, has been required to adopt various life-saving measures.

The public looks to us — both the industry and the government — for a solution. We cannot evade it. The amount of good will, broad-gauge thinking, concern for the welfare of the radio manufacturing industry as a whole, and the regard for the public interest that you exhibit here will be a test of the leadership and sense of responsibility of this giant industry.

And the Commission's ability and zeal to carry out the mandate of the Communications Act to foster communications for the benefit of all the people are also on trial.

I hope, and I have a good deal of reason to believe, that both the Commission and the industry have been sufficiently schooled by the lessons of the past, by examples in other industries, to approach this problem as an opportunity to demonstrate that we can join forces and seek a speedy and satisfactory solution that will serve the public interest.

#### **Better Audio Service Needed:**

Now, because I have talked so much about the problems of television, I would not want anyone here to get the impression that I think that your upcoming opportunities for expansion do not include aural radio.

I reiterate that despite the welcome addition of television, we are going to need a strong, healthy and indeed im-

proved system of aural broadcasting.

You have a tremendous stake in the improvement of that system. And the public has a tremendous stake in the improvement of that system.

Despite the undoubted rosy future of television it will be many years before many small communities can support their own television stations. In the meantime, they are going to need a local radio station to give them their local news, to serve as a forum for the discussion of local issues, to serve as an outlet for their local talent. And even in the larger cities we are seeing today that there is a growing demand for the services of aural stations that can cater to specialized tastes.

#### **Increased Interference on AM:**

The great postwar demand for AM radio stations resulted in hundreds of American communities getting their first station for serving local community needs. On the other hand, because of the limitations of the AM band, these stations could only be installed at the cost of creating interference to the existing stations and cutting down the range of most of the existing regional and local-channel stations. The local station in many areas can give interference-free service at night to an area within a radius of only a few miles. The daytime station of course leaves the community without its own local radio service when the sun goes down.

Some observers predict that this interference problem will be aggravated in the near future by interference to secondary AM service areas from Cuba and Mexico — regardless of whether or not there is a North American Regional Broadcasting Agreement.

Can we continue to justify our tolerance of these defects in AM when we have at hand another system of sound broadcasting — FM — that has none of these defects and has, moreover, some other highly desirable advantages?

#### **Better Service on FM:**

FM's superiority over AM is as unchallenged as ever — freedom from static, noise and fading; with day and night operation, and high fidelity, and with many more high power stations of uniform range so that competition must be on the basis not of power but of programming.

With FM, we can give American communities more local stations to serve their local needs; and stations that will reach far, far beyond their present AM stations with a clear, loud signal and with stations that aren't blacked out at sunset.

It is a startling but true fact that a  
(Continued on page 34)

# WHAT'S NEW THIS MONTH

## REGISTRY OF PUBLIC SAFETY COMMUNICATIONS SYSTEMS — PLAIN TALK FROM FCC CHAIRMAN — AMERICANS ABROAD — WNBC-FM DISCOVERS ADDED COVERAGE

FOR many years, our July issue has carried the Registry of Public Safety Communications Systems. The fact that it is missing from this issue doesn't mean that we have abandoned this very important service. Far from it. But it has been crowded out of the editorial pages by virtue of the enormously increased number of systems, and it is now available in a separate book of 72 pages!

This Registry covers municipal, county, state, zone, and interzone police, fire, forestry, special emergency, and highway maintenance systems. Each listing shows the name and address of the licensee, location of each base station, number of mobile units operated, frequencies, call letters, and make of equipment used.

By authority of the Federal Communications Commission, this Registry is revised annually from FCC file records at Washington. It is the only Registry thus compiled, and its accuracy is assured since the information is taken directly from copies of the station licenses.

Now, publishing it separately, the space formerly required in *FM-TV* is released for articles, of which a considerable number this month relates to communications systems and equipment.

Not even the annual FCC report shows the number of fixed transmitters and mobile units in each communications service. However, this data can be compiled from our Registry of Public Safety Systems. Here are the figures as of June 1, 1950:

		MOBILE TRANS. UNITS
<b>MUNICIPAL &amp; COUNTY</b>		
POLICE .....	3,656	37,162
STATE POLICE .....	901	12,463
ZONE & INTERZONE POLICE .....	80	
FIRE DEPARTMENTS .....	325	4,461
SPECIAL EMERGENCY .....	77	452
HIGHWAY MAINTENANCE....	28	803
FORESTRY-CONSERVATION....	1,180	8,449
	<hr/>	<hr/>
	6,547	63,790

These figures do not include control and repeater stations.

A reasonably accurate estimate of fixed transmitters and mobile units in all the communications services would be 16,000 and 200,000 respectively, with the rate of increase still going up. Total investment in the equipment, exclusive of land and buildings, is now over \$100 million. With enormous sums being spent now for

multiplex relays, in addition to mobile systems, that figure may be up 50 per cent by the end of this year.

STARTING on page 21 is the complete text of FCC Chairman Coy's address before the RMA Convention at Chicago. It is important reading for everyone in the industry. The text covers specific points that require serious attention and immediate action. They add up to the fact that the separate segments of the industry can no longer go their separate ways, planning independently of one another as they have always done in the past. As Chairman Coy said, we are confronted with "the mounting importance of the inter-relationship of the manufacturer, the broadcaster, the public, and the Government."

His statement that "FM's superiority over AM is as unchallenged as ever" has set the industry buzzing. It came just at a time when G. E. was making last-minute preparations to bring out a high-sensitivity FM receiver of moderate price. And with both Zenith and G. E. promoting such models, the other manufacturers will be forced to join them.

Chairman Coy's remarks on FM versus AM coverage are echoing around the offices of broadcast stations and advertising agencies. He said: "A class B FM station can cover from 300 to 500 times the area now served by many local stations at night," and that commercial FM stations, now totaling 740 by FCC count "give the nation more total night-time coverage than is given by all the regional and local AM stations."

The FCC count as of June 9 shows 2245 AM stations in continental U.S.A. As accurately as we can determine, 171 of these are day-and-night clear-channel stations. There are also 339 clear-channel stations that go off the air at sundown. This leaves 1,735 local and regional AM stations which, according to Mr. Coy, do not equal the coverage of the 740 FM transmitters. (In addition, 82 educational FM stations are now operating.)

WE are glad to see some frank and honest statements on the FM-AM situation from such an authoritative source. By way of contrast, *Wireless World* of London for April 1950 carried a piece by its American correspondent from which we quote: "The interference-free feature of FM carried little weight.

There is little interference in the primary service area of an AM station. So public interest in FM (in the U.S.) died overnight." The American correspondent was not identified by name. Maybe he didn't know that the primary service area of a station is that in which there is *no* interference, no matter how interference reduces the size of the primary service area!

AT the NAB convention last April, we had quite a discussion about public interest in FM with Lou Stantz, chief engineer of WNBC, the CBS affiliate in Binghamton, N. Y., that has added FM and TV. He said that there was serious doubt about keeping the FM transmitter on the air. Plans were being made then to determine the extent of listener interest.

Opinion was polled by broadcasting the announcement: "WNBC will decide next week whether or not to continue with the FM system. Write Post Office Box 48, Binghamton, telling us of your use or dependence upon our FM system."

In one week, 637 letters were received from people urging the continuance of FM transmission, and a substantial number came in subsequently. Only 9 advised the discontinuance of FM, according to general manager Cecil Masten, while 431 said they use FM exclusively, day and night and 65 at night. There were 179 specific complaints of interference on AM.

But here is the most interesting fact disclosed by the letters: Most of the people who wrote lived 25 to 50 miles from the station, and they wanted WNBC-FM continued because they had no satisfactory AM service from any AM station at any time of the day!

We can't understand it, but broadcasters generally ignore their FM audiences out beyond the limits of their primary AM area. Elliott Sanger, vice president of WQXR, in a letter published by *The New York Times*, expressed considerable satisfaction over the growth of WQXR-FM's audience in the metropolitan area. However, he made no reference to the fact that his FM station is giving noise-free service to a distance of 100 miles, and that is probably 4 times the radius at which clean signals can be heard from their AM station. As we have reported previously in these pages, WQXR-FM puts a consistent, year-

(Concluded on page 34)





1



2

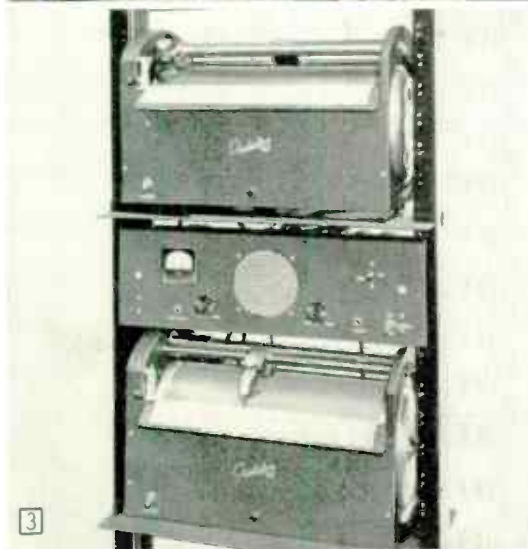

3

vision was sponsored last month by the San Francisco Chapter of the Academy of Television Arts and Sciences, with station KRON-TV as host. Present were 65 West Coast producers, engineers, and technicians. Four of the panel of experts in this photo are, left to right: Herbert L. Santer, RCA Service Company; Dr. Norman L. Simmons, Eastman Kodak; Arthur Blaney, RCA; and Dr. J. G. Frayne of Westrex.

3. Audiolog Corporation, 440 Peralta Avenue, San Leandro, Cal., has recently announced this recording unit for monitoring radio and phone communications. One hour of speech or code is recorded magnetically on a flexible, reusable tube. Tubes can be telescoped to file a 24-hour log as a compact unit.

4. This television antenna, under test by RCA engineers at Camden, N. J., is one of five designed for the new multiple FM and TV installation on the Empire State Building.

5. Bell Laboratories engineers photograph sound waves from horn at left, after passing through an acoustic lens. A small mike and neon lamp are used to scan the sound wave area. The mike output is amplified and applied to the lamp, thus changing its brightness according to the variations of sound intensity within the area.

6. A new FM relay receiver has been designed by Radio Engineering Laboratories. Model 722, shown here, succeeds the well-known REL 670. It is intended for use in the broadcast band, but can be obtained on special order for any frequency from 40 to 216 mc.

7. Inverse feedback and a voltage-regulated power supply are incorporated in this audio power amplifier by RCA. 70-watt output is suitable for high-power industrial and commercial sound systems.

8. Indoor and outdoor acoustics, machinery noise, and hearing requirements can be determined quickly with this flashlight-size sound-level meter by H. H. Scott, Incorporated, 385 Putnam Avenue, Cambridge 39, Mass. Range is 34 to 140 db above ASA weighting.

9. Flat frequency-response to 500 kc., down 6.8 db at 1 mc., makes this RCA portable, low-priced oscilloscope ideal for TV service work. A direct-coupled vertical amplifier is included.

10. Capacities from 0.1 to 5,000 mmfd.,

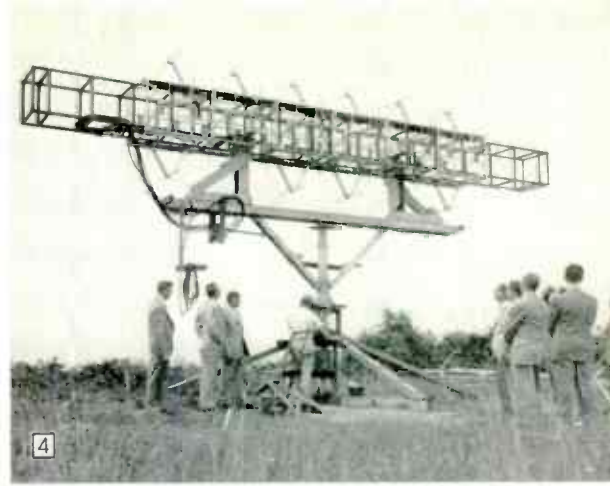

4

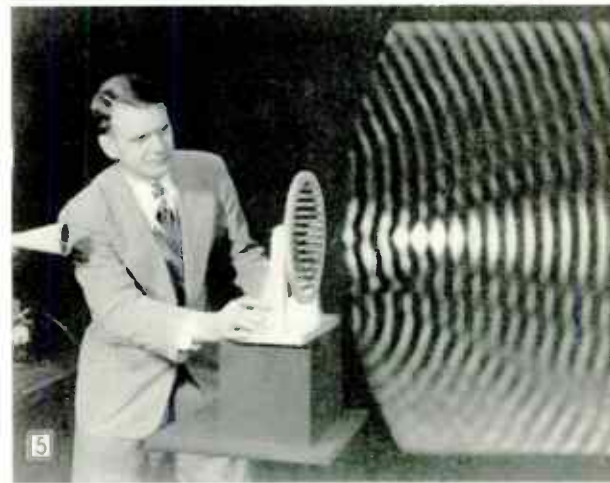

5

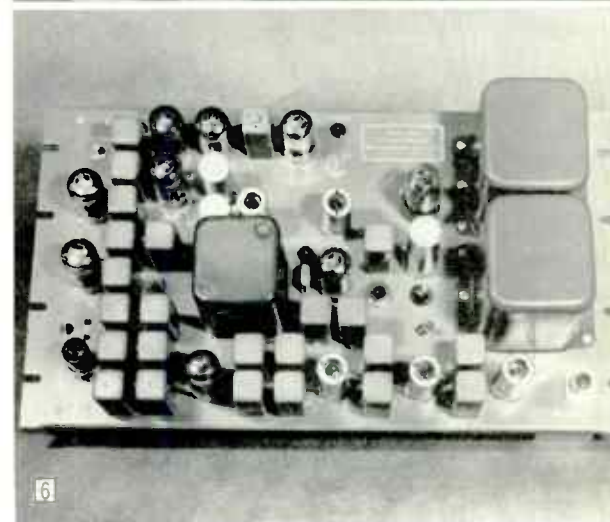

6

and inductances from 1 to 250 microhenries can be measured with the Micro-Miker, a product of Kalbfell Laboratories, 1076 Morena Blvd., San Diego 10, Calif. Used to determine interelectrode and wiring capacities and peaking-coil inductance under dynamic conditions, the instrument is invaluable for wide-band amplifier design.

## NEWS PICTURES

1. Group of television antennas serving the Los Angeles area. Site is the top of Mt. Wilson.
2. A symposium on the problems and techniques of film production for tele-



7



8



9



10



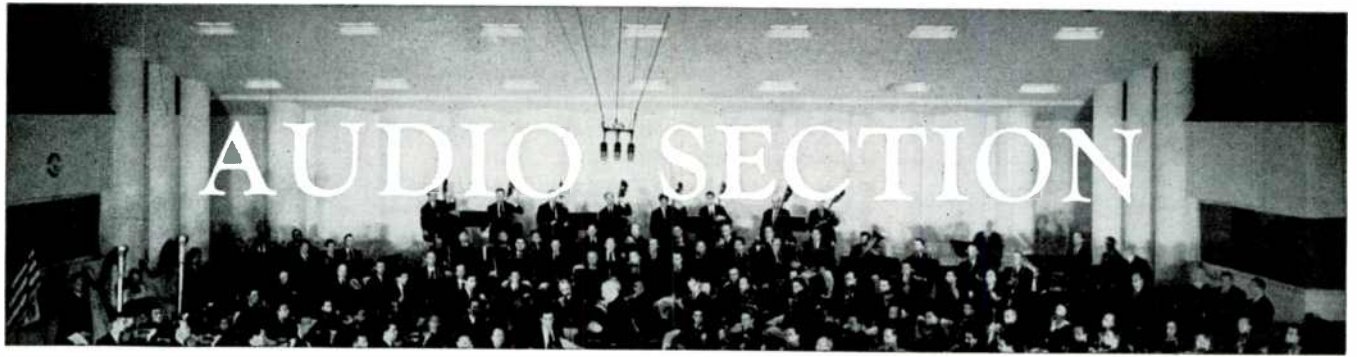

## DEVELOPMENTS IN ENGLAND

A DISCUSSION OF THE LATEST TRENDS IN THE DESIGN OF ENGLISH LOUDSPEAKERS INTENDED FOR HIGH-FIDELITY APPLICATIONS—By JAMES MOIR\*

A TREMENDOUS amount of work has been directed toward improving the loudspeaker, but it still remains a tantalisingly inefficient device. The major effort has probably been expended in lowering the prices, but this paper is intended to deal mainly with efforts to improve performance.

Good loudspeakers are expensive, but there is a very large market for high-quality units for broadcast monitoring, sound recording, high-quality speech re-enforcement systems, and among high-fidelity enthusiasts. There is a remarkable number of high-fidelity enthusiasts in England. As a percentage of total population it is probably higher over here than it is in the States.

A fairly wide choice of high-fidelity units is available in England, certain types being comparatively little known in the States. So it is intended first of all to review what we want, secondly to see what we have got, and then to study some of the efforts that have been made to find out why a unit that "measures good" does not always sound good. This disparity provides wide latitude for friendly argument, and sometimes makes it possible for the small man, with little or no measuring equipment, to pull a winner out of the bag for which his well-equipped competitor has been searching for a considerable time without success.

Well, first of all what is wanted? Wide frequency-range is accepted as a desirable quality, 50 cycles to 10,000 cycles at least, with a strong contingent claiming that a range of 30 to 15,000 cycles is essential. Wide frequency-range like this is of little value if it consists of a series of peaks and dips, an aspect that has received increased attention lately. Any loudspeaker that is better than  $\pm 4$  db over this range is a claimant for first-class honours.

\*87 Catesby Road, Rugby, England.

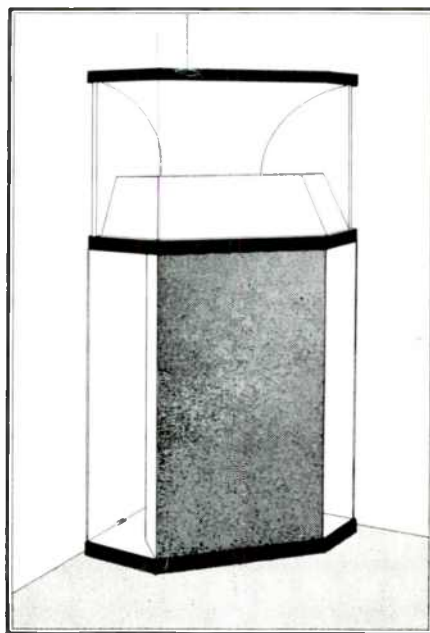

Fig. 1. Mordaunt twin-speaker corner horn

Low harmonic and intermodulation distortion is essential. Harmonic distortion of 2%, and the related value of intermodulation have been considered good, but more recently it has been claimed that  $\frac{1}{2}$ % harmonic distortion, or less, is necessary for any unit in the top class.

The advantage of uniform directivity is becoming appreciated, and attempts are now being made to obtain some control over the polar diagram.

This short list practically exhausts the ordinary criteria, but before going on to deal with some of the other factors that may be of importance in assessing the performance, some typical English units will be reviewed with particular emphasis on those types that appear to be relatively unknown in the States.

A straightforward loudspeaker without any special frills will reproduce 5,000 to

6,000 cycles before the output begins to fall away. The standard sort of trick practised both in the States and over here is to add a second unit of the horn type (Altec Lansing), or of the cone type (Olson RCA). Sometimes the separate HF unit is mounted near the LF unit (Klipschorn), sometimes inside the LF unit. Both methods have their adherents in England, and recently the BBC purchased a number of the HF horn-through-the-centre-pole type for special monitoring duties. Of the alternative types, the most popular solution over here is to add a second cone, not in the Olson manner, but attached directly to the voice coil and having its outer edge free and unsupported. The centre cone is generally much smaller than the outer cone and is constructed of a hard, glazed paper, sometimes with a rolled or stiffened outer edge. Typical examples of this type are marketed by H. J. Leak,<sup>1</sup>

<sup>1</sup>H. J. Leak & Co., Ltd., Westway Factory Estate, Acton W. 3, England.

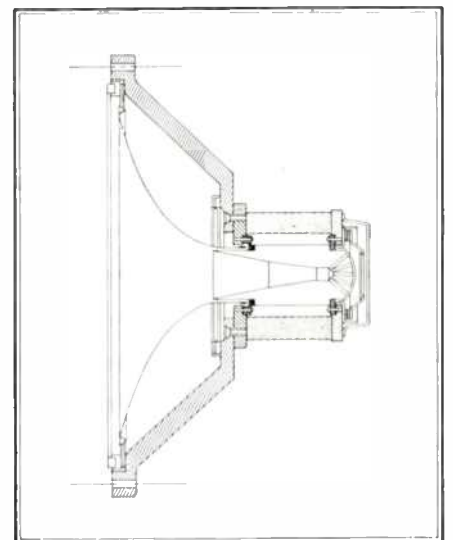

Fig. 2. Tannoy dual-concentric speaker



Voigt Patents,<sup>2</sup> Goodmans Industries,<sup>3</sup> and others. The Goodmans Axion 22 is a high-quality unit of this type, 12 ins. in diameter. The improvement in top response can be remarkable, and careful design is required if the upper register is not to be overpowering.

Given careful design, the aural result can be very impressive. I have a vivid recollection of hearing a live orchestra reproduced by two of these units (the H. J. Leak model). Corner horns are sometimes employed to extend the base and smooth out the top response of this type of unit, a very good example being marketed by Voigt. Mordaunt markets a twin-speaker corner horn, Fig. 1, employing a large single-cone unit in a folded horn to cover the range to 500 cycles and a small twin cone unit in a reflector to extend the range to 14,000 cycles. This combination is impressively clean and free from intermodulation, particularly in the middle register.

Yet another solution not employing horns is the Tannoy Dual Concentric, a horn-through-the-centre-pole type, having the horn portion confined to the centre-pole section, the large paper cone forming an extension of the centre-pole horn. This is shown in Fig. 2. Air loading of the HF unit diaphragm is not so satisfactory as in the longer horn model, but one type of interference between the HF horn and LF cone in the middle range is avoided, and there is no doubt that the aural result is very satisfactory.

Whiteley Boneham<sup>4</sup> uses two entirely separate HF and LF cones with concentric driving coils, Fig. 3, in a manner somewhat similar to Olson but employing a free outer edge cone for the HF range. A response flat to 16 kc. is

<sup>2</sup>Voigt Patents, Ltd., London W. C. 1, England.  
<sup>3</sup>Goodmans Industries, Ltd., Lancelot Rd., Wembley, Middlesex, England.  
<sup>4</sup>Whiteley Electrical Radio Co., Ltd., Mansfield, Notts, England.

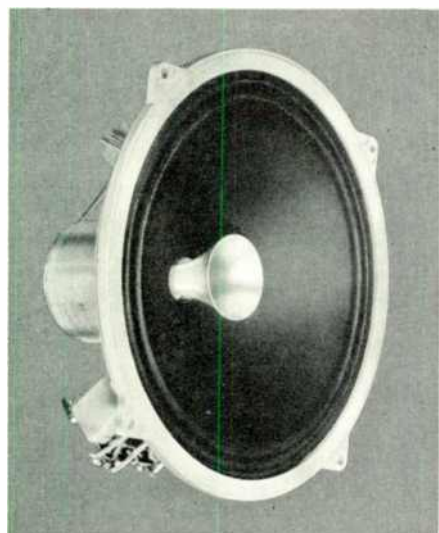

Fig. 3. Whiteley Boneham 2-coil coaxial

claimed when the appropriate crossover network is employed.

There is no doubt that in a small room, where the listeners must be close to the speaker, the use of separate HF and LF units requires careful design if the separate sound sources for the two frequency ranges are not to be irritatingly apparent. The straightforward solution is to place the HF source inside the LF source, but this also requires careful design if interference and intermodulation between units is to be avoided. Single-cone, wide-range units offer a solution but present real difficulties in achieving wide range with this construction.

Single-cone, wide-range units are marketed by Hartley Turner<sup>5</sup> and by Barker,<sup>6</sup> the former employing a specially-treated cone, while the Barker unit employs a special cone and voice coil. On the assumption that the upper register is restricted by the voice-coil mass, a double voice-coil construction, Fig. 4, is employed to reduce the effective mass at high frequencies. The coil form is an

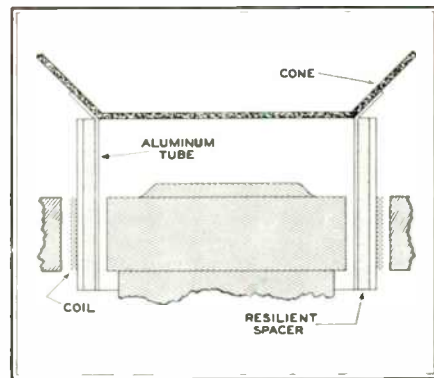

Fig. 4. Double voice-coil form by Barker

aluminium tube, with a layer of resilient material on which is wound the copper voice coil. At low frequencies, the voice-coil resilient material and centre tube move as a whole, but at high frequencies the driving coil is practically stationary while the aluminium tube form moves, due to current induced into it by transformer action from the voice coil. Thus the effective mass is greatly reduced in the high-frequency range. The overall result is a smoothly-extended upper register, which is very pleasant.

Two firms, E. M. I.<sup>7</sup> and Aconstical Manufacturing Company,<sup>8</sup> employ ribbon-driven short horns to extend the upper register to somewhere in the 14,000-cycle region in a particularly smooth manner. Both firms are able to extend the range to 20 kc. when considered desirable. Ribbons seem to produce smooth

<sup>5</sup>H. A. Hartley Co., Ltd., 152 Hammersmith Rd., London W. 6, England.  
<sup>6</sup>A. C. Barker, London W. C. 1, England.  
<sup>7</sup>E. M. I. Sales & Service, Ltd, Hayes, Middlesex, England.  
<sup>8</sup>Aconstical Manufacturing Co., Ltd., Huntingdon, Hunts, England.

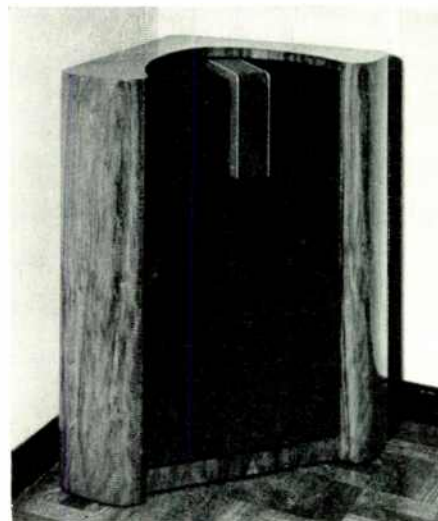

Fig. 5. Aconstical employs ribbon for HF

response but have a restricted, though probably ample, power-handling capacity. E. M. I. uses two elliptical cones to cover the bass end, whereas Aconstical employs a single unit in an interesting design of ported cabinet, Fig. 5.

At the bass end large baffles, vented cabinets, folded horns, and labyrinths all have their exponents, but the problem of obtaining good bass response in a small space remains unsolved. Two unusual types are the Voigt horn with the rear of the unit coupled to a bass chamber, resonant in the 40- to 100-cycle region, and the BBC monitor cabinet using an exponential absorber to couple the rear of the cone to the air.

To an engineer who has spent only two months in the States, this variety of speakers seems to be somewhat more extensive than is available in U. S. designs, but it may appear this way because of the vastness of your Country and the impossibility of seeing more than a fraction of its products in a limited time. I will be delighted to hear from you even if it is only to show me that I have overlooked some of your best models. Some of the British units should be available to you in the States shortly, but there is no doubt that all the firms would be pleased to provide you with any further data. If you have any special requirements let me know, and I will put you in touch with some of the firms that appear most likely to meet your needs.

In the next note, I intend to review some of the research that has been going on over here in an effort to get agreement between "what is measured" and "what is heard." There can be a whale of a difference between these two methods of estimating performance, and while what sounds good is the final choice, the development department must have something they can measure if development is to proceed satisfactorily.

## AUDIO NOTES

Before we acquired a Klipsch speaker, we were told by various audio experts that we would be disappointed in its performance, because of the breakup of the high and low frequencies between the tweeter above and the woofer below. However, each expert who expressed this opinion admitted that he had neither seen nor heard this type of speaker.

Now, we can report from personal experience, and from the comments of experts who have heard our Klipsch in action:

The first impression is that of remarkable diffusion. There is no sense of going into or out of a high-frequency beam. And, sitting 20 ft. in front of the speaker, it is difficult to tell from what direction the sound is coming.

As for any breakup of high and low frequencies, the only way to find out which comes from where is to put one's ear directly against the grill at the top, or one of the ports on the side. The two sections seem to function as a single unit. Moreover, the theory of making the walls of the room a part of the acoustic system certainly works out in practice, making the speaker seem to be as big as the room itself.

So far, we have only used the Klipsch

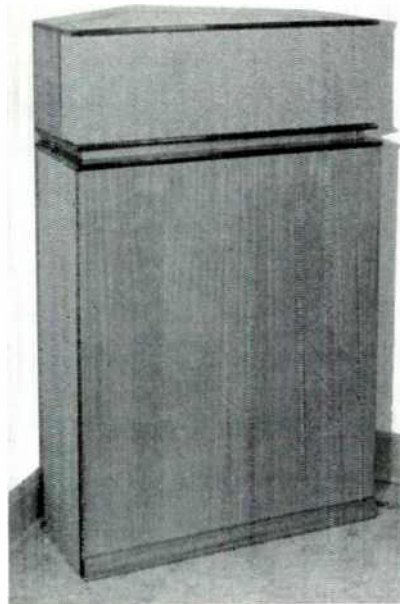

*The Klipsch corner-horn reproducer* on FM reception. Live talent programs from WNBC-FM New York, and CBS originations picked up on FM and rebroadcast by WDRC-FM Hartford have given us ample opportunity for critical listening. We have a Presto 3-speed turntable, however, and at this moment we are awaiting the arrival of a Pickering pickup and preamp, and a Gray viscous-

damped tone arm. At least to start, we shall use the 10-watt amplifier in our REL 646-B receiver.

Then we can compare notes on record reproduction with Charles Fowler, *FM-TV's* business manager. An enthusiastic record man, he has an installation made up of a Browning FM-AM tuner, Williamson amplifier, Jensen speaker, G. E. reluctance pickup, and a Webster changer. His record reproduction is really beautiful, but he can't get WDRC-FM and WNBC-FM because his antenna blew down in the spring, and he hasn't put it up yet. Meanwhile, we can't make any significant checks between his setup and ours because it doesn't mean anything to compare radio with record reproduction.

Comparisons don't mean much, anyway, between different combinations of equipment used under totally different acoustical conditions. But we are having a lot of fun from our private competition. That's what makes high-fidelity such an absorbing hobby, apart from the pleasure of listening to good music.

One final note on the Klipsch speaker: there is a very beautiful four-color advertisement of the English version in the *Wireless World* for June. Manufacturer is Vitavox Ltd., Westmoreland Road, London N. W. 9.

## DESIGN DATA for AF AMPLIFIERS — No 2 Biasing Methods

WHY BIAS IS NEEDED — CIRCUITS USED FOR OBTAINING BIAS IN AF AMPLIFIERS — ADVANTAGES AND DISADVANTAGES OF THREE BASIC METHODS

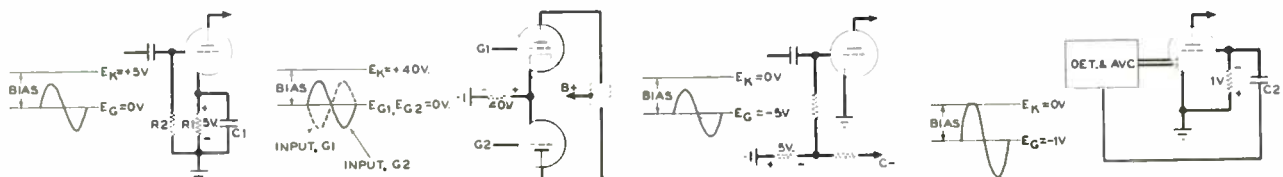

Figs. 1 and 2. Cathode-bias circuits in single-ended and push-pull stages. Fig. 3. Typical fixed-bias circuit. Fig. 4. Grid-leak bias sacrifices fidelity

VACUUM TUBES are constructed so that approximately half the maximum value of plate current flows when the control grid is at a nominal negative potential with respect to the cathode, assuming rated DC potentials on the other tube element or elements. The usual practice in audio amplifier design is to fix the DC grid potential at the point where changes in grid voltage produce the most directly proportional changes in plate current. Since this point occurs at or very close to the grid voltage for one-half maximum plate current, it follows that the most desirable operating conditions are obtained when the control grid is at some DC potential negative with respect to the cathode. This DC potential between grid and cathode is called the tube bias, and the fact that it is usually negative means that no appreciable current flows from cathode to grid with normal input signals.

There are three general methods for obtaining grid bias. Figs. 1 and 2 show typical methods of generating CATHODE BIAS. Fig. 3 is a circuit for obtaining FIXED BIAS, and Fig. 4 shows a typical GRID-LEAK BIAS circuit.

The basic cathode-bias circuit in Fig. 1 is the one most often used for single-tube audio amplifier stages. Under no-signal conditions, plate current flowing through the cathode resistor causes a steady voltage drop across cathode resistor R1, making the cathode positive with respect to ground. Since no current flows in

the grid resistor R2, which is connected to ground, the grid is at ground potential. Therefore, the grid is negative with respect to the cathode.

When a signal is applied to the grid, the plate current changes in accordance with the changing value of the grid potential. Capacitor C1 is made large enough to bypass the AC current which would otherwise flow through R1, and the DC potential across R1 remains constant. With a normal input signal, the grid does not become positive with respect to the cathode. Therefore, the grid draws no current and only AC current flows in the grid resistor. The grid remains at DC ground potential, and the bias is not changed by the input signal.

Fig. 2 shows a push-pull amplifier stage, also employing cathode bias. Operation is identical with Fig. 1. No bypass capacitor is required, however. The grid signals are 180° out of phase, and as the current increases in one tube it decreases in the other. The sum of these currents is constant. Therefore, the current in the cathode resistor is constant, and a fixed DC cathode potential is maintained.

Fixed bias is commonly obtained from a voltage-divider circuit as in Fig. 3. In this case the grid resistor is connected to some negative voltage source instead of to ground, and the cathode is grounded.

In Fig. 4 is a circuit commonly used when the cathode must be grounded. Grid conduction

occurs during the peak positive swings of the input signals. Capacitor C2 charges quickly to the peak signal voltage. The time constant of C2 and the grid resistor is extremely long, so that C2 discharges only slightly during one cycle of the signal. However, some grid current must be drawn at each positive swing to recharge C2. This causes appreciable distortion. Also, bias varies with input signal amplitude.

### APPLICATION NOTES

Cathode bias has a disadvantage in that it reduces the effective value of the B voltage by the amount of bias required. However, it is convenient and dependable, introduces no distortion, and does not require a separate voltage source negative with respect to ground. Bypass capacitors can be removed, if desired, to provide negative feedback. For these reasons, it is the most commonly used method for obtaining bias.

Fixed bias is used, in most cases, only when a negative voltage source is already available. Its primary advantage is that the full B supply voltage can be utilized for amplification.

Grid-leak bias is not used in high-fidelity applications. A common application is the second-detector first-audio stage in an AM receiver, as shown in Fig. 4, where the cathode must be grounded because of its use with the diode plates in the detector and AVC circuits. It is employed also for class AB2 and B operation in PA systems.



# HOW Salisbury, Maryland USES

## 2-WAY RADIO



The G-E 25-50 megacycle equipment in vehicles of the Salisbury Police Department continues to deliver superior service after more than 5 years of operation. Chief W. J. Chatham is particularly pleased with low maintenance cost of General Electric units.

● This community solved all of its mobile communication problems with one answer—General Electric! Vehicles and fixed stations of the police department, fire department, public service company, rural electric cooperative, and the city's leading cab company are equipped with G-E 2-way radio systems performance-engineered for each job.

Adjacent channel operation, sharp and clear and free from annoying interference . . . day and night all-weather dependability . . . well-constructed, easy to service units . . . complete systems reasonably priced—these are the things to look for when your community needs radio communication. General Electric engineers are at your service. Let them study your communication needs now. No obligation, of course. Call the G-E office nearest you, or write: *General Electric Company, Section 4370, Electronics Park, Syracuse, New York.*

*You can put your confidence in—*

**GENERAL  ELECTRIC**

General Electric Company—Section 4370  
Electronics Park  
Syracuse, New York

Send me complete information on G-E Radio Communication Systems.

NAME .....

TITLE .....

ADDRESS .....

CITY ..... STATE .....

New  
**HICKOK**

# UNIVERSAL Micro Volt SIGNAL GENERATOR



MODEL 292-X

## RANGE

120 kc to 220 mc  
in  
One Instrument

## CRYSTAL ACCURACY

Available to .0025%

### TECHNICAL CHARACTERISTICS

**Frequency Range:** 120 kilocycles to 120 megacycles; 150 to 220 megacycles in 8 ranges—all on fundamentals.

**Frequency Calibration:** Each range is individually calibrated and is guaranteed to an accuracy of within  $\pm 1\%$ .

**Crystal Accuracies:** Special oscillators available with accuracy to .0025%.

**Crystal Controlled:** 1000 kc crystal provided with each generator with an accuracy of .05%.

**Attenuator:** Heavy cast aluminum.

**Output Voltage and Impedance:** 1 to 100,000 microvolts into 52 ohms.

**Modulation:** 400 cycles.

**A.F. Output:** 0-2 volts.

**Decibel Meter:** -10 to  $\pm 38$  db in 3 ranges.

**Specifications:** 14" x 16½" x 8"; 29 lbs., 115V, 50-60 cycles, 35 watts.

In strong portable case shown, or in attractive steel display case \$231.95. See the HICKOK Model 292-X at your jobber's, or write for additional information today!

**THE HICKOK ELECTRICAL INSTRUMENT CO.**

10530 DUPONT AVENUE • CLEVELAND 8, OHIO

1910 \* *40th Anniversary* \* 1950

## REMOTE CONTROLS

(Continued from page 13)

sible to obtain some improvement by this method, but the gain in that respect may be offset by the elaborate equipment necessary. Further, as compared to single-tone operation, the use of two simultaneous tones requires an increase of input sensitivity in the order of 10 to 12 db to compensate for amplitude distortion. If more than two tones are used simultaneously, this requirement becomes much more severe. And, as the sensitivity is increased, frequency discrimination is degraded sharply.

Faulty operation may, therefore, re-

sult from intermodulation distortion, and the need of higher input sensitivity. Also, R-C time constants must be high to provide proper integration of signal energy, introducing the possibility of operation by voice frequencies, as explained in the section on single-tone operating controls.

### Vibrating Reeds:

Selective response to audio-frequency signals can be obtained by the use of tuned reeds. They have certain electrical and mechanical limitations, however, and are relatively expensive to produce within the close tolerances required.

Reeds for this purpose must have an appreciable swing, making it necessary to

employ low frequencies. The upper limit is about 400 cycles, where the peak level of voice-frequency energy occurs. They are susceptible to operation by sub-multiple frequencies. The need for comparatively long build-up time increases the calling time, without giving positive rejection of cumulative noise voltage and sub-multiple operation by vibrator hash.

Another problem is introduced below 400 cycles, because it is difficult to obtain sufficient audio actuating voltage, due to the attenuation of low frequencies by communications receivers.

The usual method of using reeds is to charge a condenser. This action occupies about 18° of the 360° sinusoidal actuating signal frequency, or less than 36° for double-contact reeds. Thus, they are relatively inefficient, and require long actuating signals.

### Tuned Electrical Circuits:

Vacuum-tube filters have certain advantages over mechanical types. They permit the full utilization of the tone cycle, thereby operating on shorter signals with lower time constants. The stability of performance is high, for adequate protection can be provided against the severe external conditions encountered in mobile service. Better operation can be obtained at frequencies of 2,000 cycles and up, with the added advantages of cheaper, smaller circuit components. Further improvement is possible by the use of volume limiters and clippers.

### The Multi-Gate Principle:

From the foregoing, it can be seen that there are many unstable conditions external to the selective remote control equipment itself which may multiply the factor of failure in the controls. On the other hand, an external condition may cause false operation in one type of control, but not in another. The attainment of dependable operation thus becomes a matter of setting one factor against another to cancel out the faults.

That, briefly, was the plan followed in the development of the Hammarlund Multi-Gate principle of remote control.

*Part 2 of this paper will explain in detail the characteristics of Multi-Gate remote controls, and the circuit functions.*

(Continued from page 20)

the control is located inside the chassis where it is not available to the operator. The only external control is a combination on-off switch and volume control.

The upper illustration in Fig. 2 shows the same unit modified for use where an external power source is available, such as on a loading truck. A full watt of audio output overrides most surrounding noises. This model is especially useful in

(Concluded on page 32)



# For Mobile Radio System Maintenance



Model MD-25 Universal FM Modulation Monitor covers all frequencies from 30-50, 72-76, 152-162 mc.

## Universal FM Modulation Monitor

With this moderately-priced, precision monitor, you can keep your fixed and mobile transmitters within the 15-ke. limit required by FCC rules now in effect.

Operation is very simple: The multi-range band selector is set at the proper band, and the unmodulated transmitter carrier is tuned in precisely. Then the carrier is modulated by voice or an audio oscillator, and the frequency swing read directly from the 4-in. panel meter calibrated to 20 kc. A flasher indicates modulation peaks in excess of 15 kc. The instrument can be set up at headquarters, and the cars checked without bringing them into the shop. **NOTE:** No crystals are used in the BROWNING Modulation Monitor.

The new BROWNING Universal FM Modulation Monitor is an outstanding addition to the complete line of BROWNING Frequency Meters which have been recognized as standard equipment for all communications services for over ten years.

## Browning Frequency Meters for Mobile Services

### MODEL S-4

Calibrated at any 1 to 5 points within the band of 1.5 to 70 mc. Hand-calibrated crystal control accurate to .0025 per cent as required by the FCC. So easy to use that any fixed or mobile transmitter can be checked in 60 seconds. Rugged construction, as illustrated, will withstand years of use. Built-in, regulated power supply for 110-115 volts AC or DC.

### MODEL S-7

Calibrated at 1 or 2 points within the bands of 72 to 76 and/or 152 to 162 mc. For systems operating on either or both of the two bands indicated. Hand-calibrated crystal control accurate to .0025 per cent as required by the FCC. Similar in design and ease of operation to the model S-4 illustrated here. Built-in, regulated power supply operates on 110-115 volts AC or DC.

### MODEL S-5

Calibrated at any 1 to 3 points within the band of 30 to 500 mc. This semi-portable meter, not illustrated, is maintained at an accuracy of .0025 per cent by the use of a temperature-controlled crystal and a temperature-compensated electron-coupled oscillator. Furnished in a steel case or for rack mounting. Front panel 8¾ by 19 ins. For use on 105-115 volts AC.

### IMPORTANT INFORMATION

The accuracy of any BROWNING frequency meter can be checked in the field with WWV standard frequency signals, because the crystal frequencies employed are submultiples of WWV. *This essential feature is not found in other communications-type meters.* The BROWNING RH-10 WWV calibrator is designed specifically for this purpose.

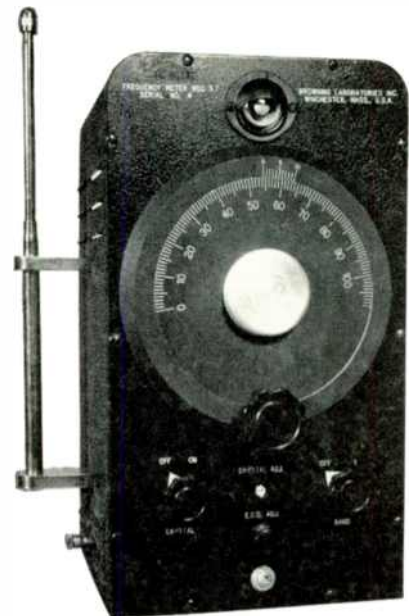

IN CANADA, ADDRESS:  
Measurement Engineering, Ltd., Arnprior, Ont.

EXPORT SALES  
9 ROCKEFELLER PLAZA, Room 1422  
NEW YORK 20, U. S. A.

BROWNING LABORATORIES, Inc.  
750 Main St., Winchester, Mass.

Please send me technical details and prices on the following Browning precision products:

- Model MD-25 Universal Modulation Monitor
- Frequency Meters, calibrated at the following frequencies  
.....mc.....mc.....mc.....mc

Name .....

Address .....

Company Connection .....

*Requested by*  
**MAINTENANCE  
 ENGINEERS...  
 OPERATORS...**

*Recommended by*  
**COMMUNICATIONS  
 MANUFACTURERS...**

**SHURE  
 MICROPHONES**  
 are the "FIELD PROVED"  
**STANDARD in MOBILE  
 COMMUNICATIONS**



## *At the Transmitter...*

Here's the famous "55" Unidyne Dynamic—the favorite microphone of police forces . . . taxis and trucking lines . . . government agencies . . . radio stations throughout the world. There must be a reason for its amazing popularity. Year in—year out dependable performance of the highest standards.



Shure "55"  
 Unidyne Dynamic  
 List Price \$67.50



"100" Series  
 Carbon Microphone  
 List Price \$30.00

## *.....In the Car.....*

This is the "old faithful" Shure "100" Series Carbon—a microphone that can take it under the most severe handling and "knocking around" a microphone could get. Under any and all circumstances the mighty "100" Series Carbon will "get the message through."

## **SHURE BROTHERS, Inc.**

*Microphones and Acoustic Devices*

225 West Huron Street

Chicago 10, Illinois

Cable Address: SHUREMICRO

### SHORT-RANGE PHONE

*(Continued from page 30)*

industrial plants or in a railroad locomotive or caboose. When used as a portable unit, Fig. 3, a battery compartment is added, held by snap clamps.

The lower picture in Fig. 2 shows the 1/4-watt model 61 series, in this case supplied with a handset. The handset cradle makes a convenient handle for carrying

the unit, which weighs only 9½ lbs. Since only 10 milliwatts are required to drive the handset, smaller batteries can be used, carried in the space made available by elimination of the speaker. This type of equipment can be supplied with a harness for carrying on the back, as in Fig. 4. A hand microphone and earpiece are then provided instead of the handset.

Fig. 5 shows the battery compartment in the 61 series. Storage batteries are

accessible through the hinged cover for replacement. Dry batteries can be used if desired. At the bottom, left, is the power switch and volume control. Just to the right is the lead to the earpiece and microphone, and at the bottom, center, the coaxial antenna connector.

Fig. 6 shows the compact construction of the basic chassis in the 51 series. This 22-tube unit, with loudspeaker and power supply at the top, weighs just 9 lbs.

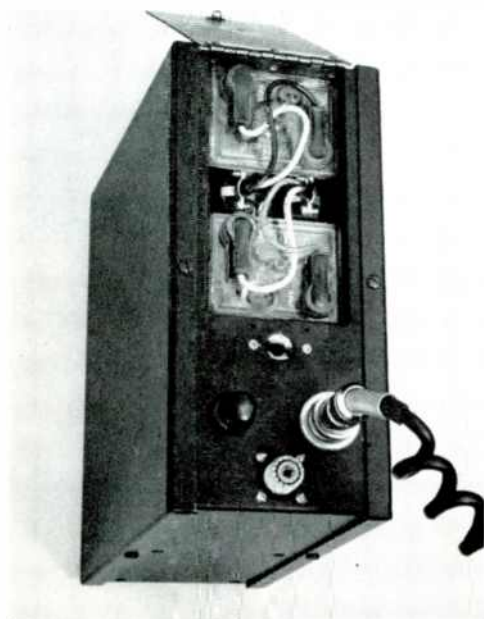

Fig. 5. Battery and control layout for 1/4-watt models. Fig. 6. Same size chassis is used for 1-watt models on AC or batteries



## SINGLE-CHANNEL UNIT

(Continued from page 19)

has been increased to at least 60 db in both bands. Either one- or two-frequency operation is available. Crystal control is employed, and frequency stability is equal to that of the receiver.

Tube complement and functions for 25 to 50 mc. are as follows: 6AK6 oscillator; 6AU6 modulator; 6AU6 buffer and first doubler; 6AU6 second doubler; 6AK6 third doubler; 2E26 doubler-driver; 2E26 power amplifier; two 12AX7 IDC amplifiers; CK5829 clipper. The tube lineup for 152 to 174 mc. is identical except for the substitution of a tripler in place of the second doubler.

Power output is 12 watts on 25 to 50 mc., and 10 watts on 151 to 174 mc.

### Controls and Metering:

Front-panel controls provided on both types of control heads, Fig. 3, consist of a squelch adjustment and a combination power switch and step-type volume control. A toggle-switch can be installed in the plugged hole between the control knobs to change operating frequencies if two-frequency operation is desired. Transmitter or receiver frequencies can be switched, or both. The two receiver frequencies can be separated by a maximum of 240 kc. without degradation of the single-frequency characteristics.

A similar plugged hole can be seen at the top, right, on both the blank front cover and the control plate. This plug can be removed for access to the transmitter power amplifier plate-tuning.

In the lower indented section of the control plate, and at the bottom of the dust cover can be seen two hinged access-ports, Fig. 3. Behind the port-covers are metering plugs for use with a Motorola test meter, as shown in Fig. 4.

Transmitter-receiver units for both frequency bands are available for operation on 117 volts AC as fixed-installation equipment.

## 3,000 WATTS FOR POLICE

(Continued from page 12)

by simply turning a switch, to read the transmission line standing-wave ratio.

At the bottom center of the exciter unit, Fig. 3, there is a test meter for checking circuits in that unit. Finally, a coupling coil is built in for use of a frequency or modulation monitor.

Power requirements are 6.5 kw. at 3 kw. output, supplied from a 208- to 230-v. 3-phase 60-cycle line. Power factor is 0.9. Standby power, including receivers, is approximately 1.4 kw.

The cabinet measures 42 in. by 26 in. by 82 in. high, including mounting base. Weight of the complete equipment is about 1,800 lbs.

# NEW!

# THE HIGHEST GAIN COMMUNICATIONS ANTENNA EVER BUILT!

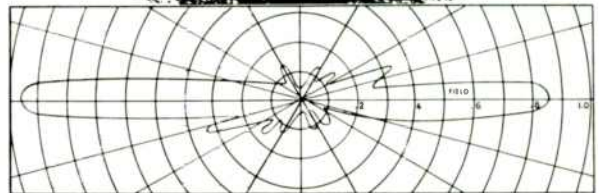
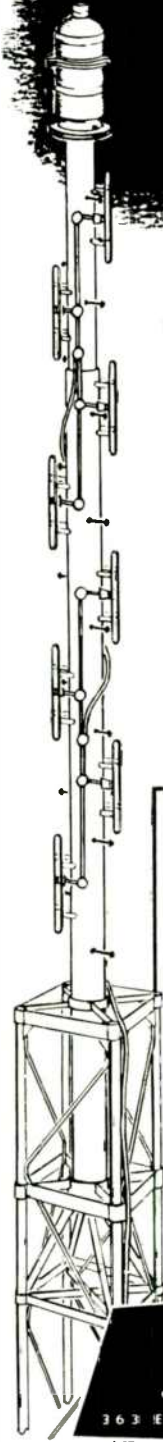

VERTICAL RADIATION PATTERN OF TYPE 3000 ANTENNA

## Actually delivers 6 db . . . . . increases your power 4 times!

Now, for the first time, you can operate in areas previously far out of your reach. This vast extra service area is yours at no additional operating cost because the 6 db actually delivered by this new ANDREW antenna is equivalent to increasing your power 4 TIMES! Think of the economy! This tremendous extra power also fills in any dead spots.

It's another pace-setting ANDREW "first".

Uniformity of performance is assured regardless of supporting structure height through a NEW EXCLUSIVE ANDREW METHOD of electrically isolating the radiating elements from the support structure.

Lightning protection and quieter reception during electrical storms are achieved by a DC path which conducts static charges from the elements to ground.

### SPECIFICATIONS 148-174 MC

TYPE NO.	3000	3001	3002
Gain	6 db	6 db	3 db
Height above top of tower	27½ ft.	27½ ft.	13½ ft.
Length of support mast extending into tower	5 ft.	5 ft.	5 ft.
Weight	625 lbs.	375 lbs.	175 lbs.
Moment at tower top*	9300 ft. lb.	6150 ft. lb.	1600 ft. lb.

\*Based on 100 mph wind loading and ½" radial ice. Moments include loading added by 300 mm beacon for Type 3000 and double obstruction light for Type 3001.

Type 3000 is designed to support a 300 mm code beacon, and includes a suitable mounting plate. Type 3001 is designed to support a double obstruction light.

All models are designed for connection to ANDREW Type 737 transmission line, and are provided with climbing steps.

All orders filled chronologically. Deliveries begin September 1. Write, wire or phone (ask for Mr. Bickel) today.

**Andrew**  
CORPORATION  
363 EAST 75th STREET · CHICAGO 19

**ANDREW**

WORLD'S LARGEST ANTENNA EQUIPMENT SPECIALISTS

TRANSMISSION LINES FOR AM-FM-TV · ANTENNAS · DIRECTIONAL ANTENNA EQUIPMENT  
ANTENNA TUNING UNITS · TOWER LIGHTING EQUIPMENT · CONSULTING ENGINEERING SERVICES



# RADIO ENGINEERING LABS., Inc.

PIONEERS IN THE CORRECT USE OF ARMSTRONG FREQUENCY MODULATION

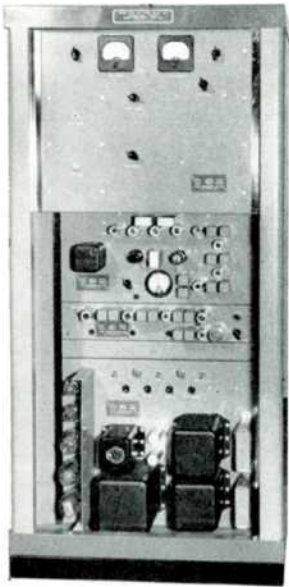

**NEW REL  
900 Mc.  
MODEL 707-B  
STUDIO-TO-  
TRANSMITTER  
LINK FOR  
AM, FM & TV  
BROADCAST  
STATIONS**

## CUT YOUR OPERATING COSTS

Higher Speech Quality, Lower Monthly Rate

More and more AM, FM, and TV broadcasters are using REL 707-B S-T links to eliminate line charges, increase reliability, and improve program quality. Installation of the Serrasoid transmitter, shown above, and the receiver is very straightforward. All tubes are standard, low-cost types. Antennas are parabolic type. Any 3rd class radiophone permittee may operate the transmitter.

FM signal-to-noise ratio for the complete system is 70 db below 100% modulation; audio response is flat within .5 db from 50 to 15,000 cycles; maximum harmonic distortion less than .5% at 100% modulation. These specifications exceed FCC requirements. Write for complete information and prices.

Engineers and Manufacturers of Broadcast, Communication, and Associated Equipment since 1920

# RADIO ENGINEERING LABORATORIES, Inc.

TEL.: STILLWELL 6-2101 TELETYPE: N. Y. 42816  
36-40 37th Street, Long Island City 1, N. Y.

## MOBILE RADIO NEWS

(Continued from page 17)

proposed 4-channel operation, and the authorization of more than two carriers in the same city. Oral argument will undoubtedly be heard by the Commission before any final action on the proposal is taken.

### Industrial Applications:

The dual processing lines that have been set up in the Commission's industrial radio service engineering department have been found most satisfactory in operation. Under this system, the applications which are improperly prepared or present serious question for upper staff-level or Commission consideration are segregated from the properly prepared applications not presenting special questions. These later applications have been moving at an accelerated rate recently.

However, it appears that three processing lines could be used to advantage, since those applications which are of a complicated nature are being placed in the same processing line with improperly prepared applications requiring several staff reviews.

## WHAT'S NEW THIS MONTH

(Continued from page 24)

round signal into Great Barrington, at a distance of 95 miles. In fact, it is our most powerful New York station. WNBC-FM is a close second. But such AM signals from New York City as reach us at all are far down in daytime noise or nighttime interference and fading.

With all the furor about reducing AM rates, we've never been able to figure out why duplicating stations don't use the added coverage of their FM transmitters as a reason for maintaining or even increasing their rates.

## FM, AM, AND TV

(Continued from page 23)

Class B FM station can cover from 300 to 500 times the area now served by many local-channel AM stations at night.

FM has had a rough time. Only a handful of broadcasters are showing a profit or are near a profit status. They complain that networks treat FM as a stepchild; that they refuse to affiliate with FM stations even though FM stations provide additional coverage, particularly at night; that networks have never provided proper, high fidelity inter-city network lines. And they complain that manufacturers have not produced easy-to-tune, stable, and cheap FM receivers; that manufacturers are so preoccupied with television that there is

(Continued on page 36)

## THE NEW Improved MODEL 3HW-A Workshop Antenna will . . .

More than triple the effective power of the transmitter.

Increase the effective power of the mobile transmitter.

Increase the operating area.

Permit the use of low power, low cost equipment.

Workshop High-Gain Beacon Antennas are designed specifically for the 152-162 megacycle band—taxicab, fire, police, and private fleet communications.

### Design Features

- Low angle of radiation concentrates energy on the horizon.
- Symmetrical design makes azimuth pattern circular.
- Can be fed with various types of transmission lines. Special fittings are available for special applications.
- Enclosed in non-metallic housing for maximum weather protection.

Available for immediate delivery through authorized distributors or your equipment manufacturer.

## —THE— WORKSHOP ASSOCIATES

INCORPORATED

PAT. APP. FOR

Specialists in High-Frequency Antennas

135 CRESCENT ROAD  
Needham Heights 94, Mass.



FM-TV, the JOURNAL of RADIO COMMUNICATION



# PROVED *in every service*



## RAYTHEON FM MOBILE RADIOPHONE

In fire and police service; in the rough and rugged going of forestry, and construction work; along oil, and gas pipe lines; on the highways and in jangling city traffic... Raytheon Radiophone has proved its remarkable dependability and adaptability. For ease of installation, for simplicity

and economy of operation, for clarity of reception and freedom from adjacent channel interference, Raytheon Radiophone provides the finest in mobile and fixed station equipment. Write today for complete information. Use the coupon below.



### NEW MODEL UM 30 MOBILE UNIT

- Available in both single and dual channel models covering the entire 152-174 mc. frequency range.
- Requires less space — easier to install.
- Lowest battery drain — no special batteries or generators required.
- Meets all new F. C. C. requirements including adjacent channel operation and modulation limiting (deviation control).
- Furnished complete with all accessories.

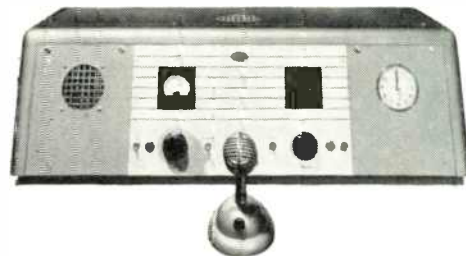

### COMPLETE BASE STATION EQUIPMENT

- Complete transmitting-receiving equipment for 30 or 60 watt base station systems.
  - Designed throughout for maximum convenience, efficiency, ease of operation and simplified maintenance.
- Model US 60-1-LC control console (shown above) contains every desirable feature of a fixed station control unit. Equipment for wall or rack mounting also available.

**RAYTHEON**

*Excellence in Electronics*

**RAYTHEON**  
MANUFACTURING COMPANY  
WALTHAM, MASSACHUSETTS

Sold Exclusively in Canada by Canadian Marconi Co., Marconi Bldg., St. Sacrament St., Montreal  
Export Sales and Service: Raytheon International, 50 Broadway, New York 4, N. Y.

### MAIL THIS COUPON TODAY!

Dept. 6460 FM  
**Raytheon Manufacturing Co.**  
Waltham 54, Massachusetts

Please send complete information on Raytheon Mobile Radiophone:  
Model UM 30 (30 watt) Mobile Unit  
Model US 30 (30 watt) Base Station Equipment  
Model US 60 (60 watt) Base Station Equipment

NAME .....

ORGANIZATION.....

ADDRESS.....

CITY.....ZONE.....STATE.....

**ALWAYS** Surplus **BATTERY**  
**Power**  
 WITH LEECE-NEVILLE AC-DC GENERATING SYSTEMS



Power to Spare

- **KEEPS YOUR 2-WAY RADIO Ready FOR ANY EMERGENCY**
- **25 TO 35 AMPERES WHILE IDLING...**

Type 5058-GA3 — 80 Amperes . . .  
 Type 5172-GA3 — 50 Amperes from  
 18 M. P. H. to Top Engine Speed

FOR HIGH POWER MOBILE RADIO TRANSMITTERS LEECE-NEVILLE IS YOUR BEST BUY, BECAUSE THE AC-DC SYSTEM HAS AMPLE CAPACITY TO TAKE CARE OF YOUR FUTURE NEEDS AS WELL AS YOUR PRESENT REQUIREMENTS

- **PAYS FOR ITSELF WHILE SERVING PUBLIC SAFETY**  
 Every cruiser in operation at *all times* . . . No breakdowns due to battery failures!

**NO OTHER ELECTRICAL SYSTEM CAN MATCH THE PERFORMANCE OF LEECE-NEVILLE AC-DC SYSTEMS**

**The Answer to Your Battery Problems**  
**LEECE-NEVILLE**  
 CLEVELAND 14, OHIO

**FM, AM, AND TV**  
*(Continued from page 34)*

a substantial unmet demand for FM receivers in many communities.

**FM Tuning in TV Sets:**

The FM members of the National Association of Broadcasters have asked manufacturers to install FM tuners in all television sets. The circuitry of FM is such, I am told, that it can be added to the TV set at comparatively small cost. In TV sets which have continuous tuning, the cost would be negligible.

This would mean that FM set production could ride TV piggy-back up the ladder of success. Every television market would, therefore, automatically become an FM market. At this stage of television's development, when daytime service is limited, such an arrangement would make it convenient for the set owner to snap on the FM when television is not on the air. Whenever a manufacturer sells a TV-only set as the principal receiver in the home, he is slamming a door on aural radio.

Such an innovation by the manufacturers would be a tremendous spur to FM while being an extra sales argument. Rendering this service would be a splendid example of manufacturing in the public interest.

But even today we have 5,500,000 sets with FM, which does not compare unfavorably with the 6,700,000 TV sets produced up to date.

**FM Has Greater Coverage:**

And here is another significant fact: FM, despite its many growing pains as an infant service, has in these five post-war years grown to more than 700 stations that give the nation more total nighttime coverage than is given by all the regional and local AM stations after AM's quarter of a century existence. The area covered by these stations holds 100,000,000 people.

A survey just completed in New York City shows that there are now three times as many sets with FM as there were two years ago and, furthermore, that the number of families actually using their FM sets has also tripled. It also found that more than 10 per cent of all the homes are using their FM sets in preference to AM.

The future of our aural broadcasting system is a matter of concern to the broadcasters of this Country and to the Federal Communications Commission. And when it is viewed in the light of future marketing opportunities for your products, I am sure you will agree that it is a matter of urgent importance to the radio manufacturer.

*(Concluded on page 38)*





**NOW! A 6-VOLT MOBILE FM  
RECEIVER COVERS ALL 2-WAY FM  
RADIOTELEPHONE COMMUNICATIONS**

The New MONITORADIO Model M-101 is a complete receiver . . . Not a converter! Designed for use in areas where transmitters operate on a frequency of 152 to 162 megacycles—this Mobile FM Radio is well engineered and built of quality parts to give long, trouble-free service. For full technical information, see your parts jobber or write us today!

**\$7250**  
NET



RADIO APPARATUS CORPORATION • INDIANAPOLIS 3, INDIANA

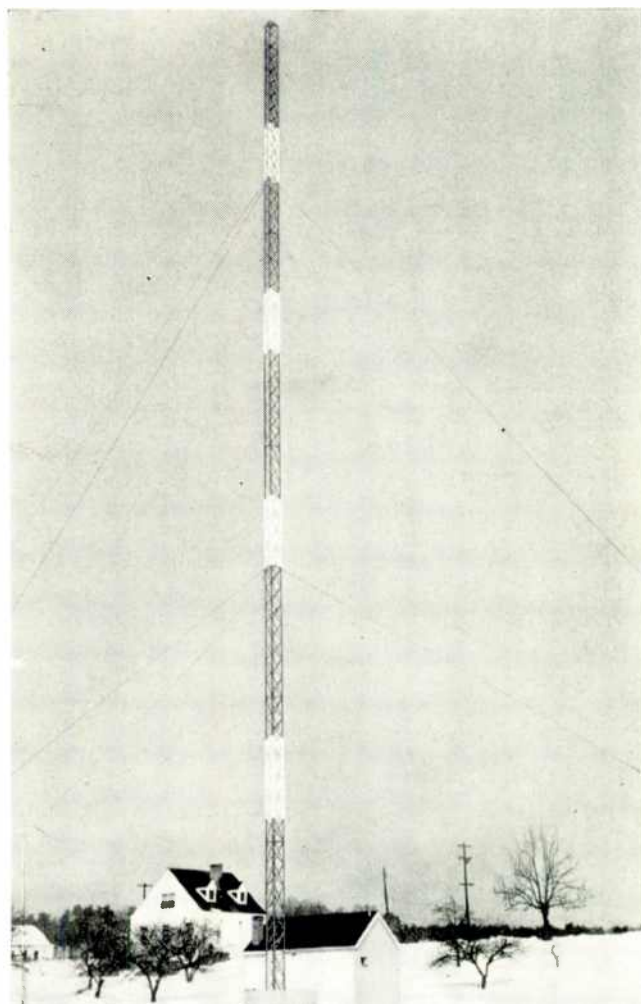

**DESIGNED FOR  
THE JOB . . .**

Why compromise on the antenna towers for your Mobile Communication System when you can be sure with a Blaw-Knox Tower *designed* especially for this important radio field? Scores of Blaw-Knox guyed and self-supporting towers are now providing safe support for antennas in both congested areas and the "wide open spaces." The cost? No more than "make-shift" structures. For complete technical data just drop a note to . . .

**BLAW-KNOX DIVISION**

OF BLAW-KNOX COMPANY

2138 Farmers Bank Building  
Pittsburgh, Pa.

**BLAW-KNOX  
ANTENNA TOWERS  
FOR MOBILE SYSTEMS**

NOW READY TO MAIL:

**1950 REGISTRY OF  
PUBLIC SAFETY**

**Communications Systems**

Municipal Police	Fire Departments
County Police	Forestry
State Police	Highway Maintenance
Special Emergency	Medical Services
Relief Agencies	Com. Carrier Emergency

THIS REGISTRY OF SYSTEMS SHOWS:

1. Name of Licensee.
2. Address of Control Point.
3. Number of Mobile Units.
4. Station Call Letters.
5. Operating Frequencies.
6. Make of Equipment.

Completely revised from FCC records by permission of the Federal Communications Commission.

**\$1.00** PER COPY, POSTPAID IN THE U.S.A.  
READY FOR MAILING JULY 1ST

NOTICE: Contents of this Registry is copyrighted, and must not be used as a mailing list without permission of the Publisher.

**FM-TV MAGAZINE**

SAVINGS BANK BLDG., GREAT BARRINGTON, MASS.



## HOW LEADING NETWORKS USE Carter CONVERTERS

Photo above shows NBC's Tommy Bartlett and Universal Recording Company engineers making transcriptions from STORAGE BATTERY POWER by means of Carter Frequency Controlled Converter. Wherever 115v. line voltage is not available, or hard to get, Carter Converters supply dependable AC power to make on location recordings. Operates from storage batteries. . . . Used by leading networks, broadcast stations, and program producers.

*Recommended by Brush  
and Magnecord*

One model operates both Brush and Magnecord equipment. Delivers clean 60 cycle AC power. Requires no filtering. Frequency control feature compensates for 10% input voltage variation. Available for 6, 12, 24, 28, 32, 64, and 115v. DC input voltage. Size 8 1/4" x 5 3/4" x 7 1/2" high. Weight only 15 3/4 lbs. Performance Guaranteed!



**MAIL COUPON FOR  
FREE CATALOG**

New Converter catalog illustrates entire line of Carter Rotary Converters for recording, TV, sound projection and transcription players. SELECTION CHART included tells model to suit your purpose. Mail Coupon now for your copy and name of nearest Carter distributor.

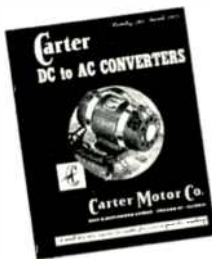

**Carter  
MOTOR CO.**

Carter Products will be on Display at  
APCO Convention,  
Hollander Hotel,  
Cleveland, Aug. 28-31

2641 N. Maplewood Ave., Chicago 47

Carter Motor Co.  
2641 N. Maplewood Ave.,  
Chicago 47, Ill.

Please send catalog #349 with information on Frequency Control Converters, and name of nearest distributor.

Name .....  
Station or  
Company .....  
Address .....

## FM, AM, AND TV

(Continued from page 36)

### Urgent Need for More Research:

I believe that the points I have discussed here tonight point to this inevitable conclusion: that radio—all types of radio—is living in a shrinking spectrum, and that the radio manufacturer, if he is to build soundly for the future, must take the implications of that into account.

He must project his planning beyond circuits, cabinets, inventories. He must plan beyond vacation shut-downs and next season's new models. The broad base of radio itself must be of prime concern to him. Why are we in a freeze today which has already halted all new television construction for more than a year and a half? Principally because of lack of basic information. That information must come in large part from radio manufacturers. It should be produced as the result of a consistent year-round program of research by the members of your industry.

For example: We are now proposing to quintuple the number of television channels by moving into the UHF. Here is a problem involving the expenditure of hundreds of millions of dollars by the public and by the radio industry. This part of the spectrum is relatively unexplored for television purposes. And yet in all America there were only a half dozen experimental UHF TV stations broadcasting programs last year, and they were on the air for limited periods. Another half dozen licensees have carried on propagation studies and other limited research in the UHF. A billion dollar industry is no place for operation by guess.

We cannot afford, and the public will not long permit us to plan our radio system on a crisis basis. By allocating a reasonable amount of your energy and your money to such research programs you will be helping to assure the stability of your industry, and you will be serving the public interest.

Your responsibility for instituting research programs to help chart a sound course for radio's future cannot be negated by the claim of the stresses of business competition. In fact the interest of the radio art, the interest of your industry and the interest of the public would be best served by a healthy competition that would extend not only to products and prices but to fundamental research that will pave the way for consistent expansion.

Armed with this modern weapon of scientific research, and operating in the public interest concept, the radio and television manufacturers of America will be prepared to push on to greater heights of achievement in the great days that lie ahead.

## ZOPHAR WAXES COMPOUNDS and EMULSIONS

FOR  
INSULATING and WATERPROOFING  
of ELECTRICAL and  
RADIO COMPONENTS

Also for  
CONTAINERS and PAPER  
IMPREGNATION

FUNGUS RESISTANT WAXES

ZOPHAR WAXES and COMPOUNDS

Meet all army and navy  
specifications if required

Inquiries Invited

**ZOPHAR MILLS, INC.**  
FOUNDED 1846  
122-26th ST., BROOKLYN, N. Y.

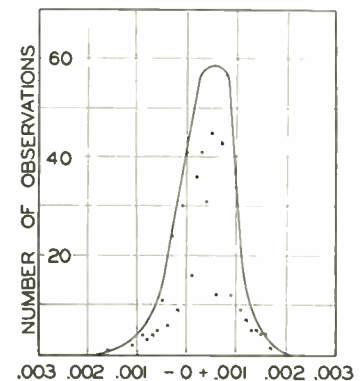

PROBABILITY of error, when monitoring radio transmitters above 70 MC with the Type 105-A MICROMETER FREQUENCY METER, is graphically shown above.

RECENT improvements put guaranteed accuracy at 0.0025%. Write for the story—it's useful alike to old and to prospective customers.

**LAMPKIN LABORATORIES  
INCORPORATED**  
— Bradenton, Fla. —



### FM STATION

General Electric Kilowatt Amplifier  
 Model 4BT2A1 Type BT2A Serial RC25  
 General Electric 250 Watt Exciter  
 Model 4BT1A1 Type 3T1A Serial CC833  
 General Electric Station Monitor  
 Model 4BM1A1 Type BM1A Serial WC268  
 General Electric Power Supply  
 Model BP241 Type BF2A Serial WC547  
 General Electric Transmitter Console  
 Model 4BC3A1 Typs BC3A Serial WC5  
 Type BX-2A Two Bay Circular Antenna with  
 Mast, Transmission Line, Elevators and  
 Matchers.

100 Feet of 1 1/2 coax. transmission line includ-  
 ing 90° elbows.

Dehydrator for Transmission line  
 Desk and Chair Transmitter console  
 Phone or write for Data & Prices

### POWER EQUIPMENT

STEP DOWN TRANSFORMER: Pri. 440 220/110  
 volts a.c. 60 cycles. 3KVA. Sec. 115 v. 2500  
 volt insulation. Size 12" x 12" x 7" \$40.00

PLATE TRANSFORMER: Pri.: 117 v. 60 cy. Sec.  
 17,600 @ 144 ma. with choke. Oil im-  
 mersed. Size: 26" x 29" x 13" American  
 \$120.00

FIL. TRANS. UX6899. Pri.: 115 v. 60 cy. Sec.  
 Two 5 v. 5.5 amp wdgs. 29 KV test \$24.50

VOLTAGE REG. Transstat. Amertran type  
 RH 2 KVA load, input: 90/130 v. 50-60 cy.  
 output 115 v. \$40.00

ITE CIRCUIT BREAKER, 115 A, 600 v. Mod.  
 KJ \$15.00

UX 6801 (Raytheon): Pri.: 110 v. 60 cy. 1 ph.  
 Sec.: 22,000 v. 234 ma., 5.35 KVA., Dim.:  
 23" x 24" x 10 3/4".

PLATE XFMR: Pri.: 198, 220, 240 v., 60 cy.,  
 1 ph. 16.7 KVA. Sec.: 3650 v., 30 KV test.

FIL XFMR: Kenyon: Pri.: 210/215/220/225/  
 230/235/240 vac. 60 cy. Sec.: 11 v., 35  
 amp; 10 v., 35 amp ct; 7.5 v., 35 amp ct;  
 5 v., 35 amp ct #S-10768 \$37.50

FIL TRANS: KS8767: Pri.: 115 v., 60 cy. Sec.:  
 2 wdgs.: 5 v. @ 5 amps each 15 KV  
 test \$15.00

Also available catalog of Surplus Army &  
 Navy Electronics Equipment.

### COMMUNICATIONS EQUIPMENT COMPANY

350 PEARL STREET, DEPT. FT  
 BROOKLYN 1, NEW YORK MAIN 4-8373

## INDEX OF ADVERTISERS

FOR YOUR CONVENIENCE, TELEPHONE  
 NUMBER OF EACH COMPANY IS SHOWN HERE

Adair, George P. Washington, D. C.: Executive 1230	8
Alford, Andrew Boston: Hancock 6-2339	8
Amy, Aceves & King Co., Inc. New York City: Longacre 5-6622	8
Andrew Corp. Chicago: Triangle 6461	9, 33
Bell Telephone Labs. New York City: Chelsea 3-1000	10
Blaw-Knox Division Pittsburgh, Pa.: Sterling 1-2700	37
Browning Laboratories, Inc. Winchester, Mass.: Winchester 6-2121	31
Carter Motor Co. Chicago, Ill.: Humboldt 6-1289	38
Communications Equip. Co. Brooklyn, N. Y.: Digby 9-4124	39
Davis, George C. Washington, D. C.: Sterling 0111	8
Doolittle Radio, Inc. Chicago, Radcliffe 3-4100	6
Eitel-McCullough, Inc. San Bruno, Cal.: San Bruno 4000	40
FM-TV Gt. Barrington, Mass.: Great Barrington 500	37, Inside Back Cover
General Electric Co. Syracuse, N. Y.: Syracuse 6-4411	29
General Radio Co. Cambridge, Mass.: TRowbridge 6-4400	Inside Front Cover
Hammarlund Mfg. Co., Inc. New York, N. Y.: Longacre 5-1300	1
Heimark, Harold M. Chicago: Estebrook 8-7047	9
Hickok Elec. Instr. Co. Cleveland, Ohio: Liberty 1-8060	30
Jansky & Bailey Washington, D. C.: ME 5411	8
Jones, Howard B., Division Chicago: Nevada 2-2000	39
Kear & Kennedy Washington, D. C.: Sterling 7932	8
Klipsch & Associates Hope, Ark.: Hope 995	9
Lampkin Labs., Inc. Bradenton, Fla.	38
Leece-Neville Co. Cleveland, Ohio: Henderson 1-0740	36
Link Radio Corp. New York City: Chelsea 2-1100	4
Maurer, Inc., J. A. Long Island City, N. Y.: Stillwell 4-4601	9
May, Russell P. Washington, D. C.: Republic 3984	8
McIntosh & Inglis Washington, D. C.: Metropolitan 4477	9
McNary & Wrathall Washington, D. C.: District 1205 Santa Cruz, Cal.: 5040	8
Measurements Corp. Boonton, N. J.: Boonton 8-2131	9
Motorola, Inc. Chicago: Spaulding 2-6500	Back Cover
Pollack, Dale New London, Conn.: New London 2-4824	8
Radiart Corp. Cleveland, Ohio: Melrose 1-6660	3
Radio Apparatus Corp. Indianapolis, Ind.: Franklin 1052	37
Radio Engineering Labs. Long Island City, N. Y.: Stillwell 6-2101	5, 34
Rangertone, Inc. Newark, N. J.: Humbolt 5-2550	9
Ray, Garo W. Stratford, Conn.: Stratford 7-2465	8
Raytheon Mfg. Co. Waltham, Mass.: Waltham 5-5860	35
Reeves Soundcraft Corp. Long Island City, N. Y.: Astoria 8-6082	7
Shure Bros., Inc. Chicago, Ill.: Delaware 7-4550	32
Smeby, Lynne C. Washington, D. C.: Executive 8073	8
Weldon & Carr Washington, D. C.: Michigan 4151	9
Willette, Raymond M. Washington, D. C.: Decatur 1232	9
Wincharger Corp. Sioux City, Iowa: Sioux City 8-6513	39
Workshop Associates, Inc. Newton Highlands, Mass.: Needham 3-0005	9, 34
Zenith Radio Corp. Chicago: Berkshire 7-7500	2
Zophar Mills, Inc. Brooklyn, N. Y.: South 8-0907	38



## FOR PUBLIC ADDRESS, RADIO, and kindred fields, **JONES** 400 SERIES **PLUGS & SOCKETS**

of proven quality!



p.406-CCT



S.406-AB

Socket contacts  
 phosphor bronze  
 cadmium plated.  
 Plug contacts hard  
 brass cadmium  
 plated. Insulation  
 molded bakelite.  
 Plugs and sockets  
 polarized. 2, 4, 6,  
 8, 10, 12 contacts.  
 Steel caps with  
 baked black  
 crackle enamel.  
 Catalog No. 17  
 gives full informa-  
 tion on complete  
 line of Jones Elec-  
 trical Connecting  
 Devices — Plugs,  
 Sockets and Ter-  
 minal Strips. Write

**Jones** HOWARD B. JONES DIVISION  
 CINCH MANUFACTURING CORPORATION  
 CHICAGO 24, ILLINOIS  
 SUBSIDIARY OF UNITED-CARR FASTENER CORP.

# WINCHARGER

REG. U. S. PAT. OFF.

## ANTENNA TOWERS

# st CHOICE\*

\* 1st CHOICE of  
 new station  
 applicants.  
 \*\* 1st CHOICE of  
 station operators.  
 \*\*\* 1st CHOICE of  
 Police, Airlines,  
 Government,  
 and private  
 communications  
 systems.

There is a reason. VHF, FM, and standard  
 AM broadcasters acclaim the structural ex-  
 cellence and all around low cost of Win-  
 charger's performance proven towers. The  
 precision of Wincharger vertical radiator's  
 patterns is testified by the fact that over one  
 hundred and twenty stations are now using  
 Wincharger towers in directional arrays  
 even six element arrays! Higher quality,  
 wider versatility, lower cost have made  
 Wincharger antenna towers America's first  
 choice.

**WINCHARGER**  
 Corporation

Sioux City 6, Iowa, U.S.A.

# The new Eimac 4X150G will . . .



**DELIVER 20 KW AS A PULSED AMPLIFIER OR OSCILLATOR TO OVER 1200 Mc.**

**GIVE A POWER-GAIN OF 10 AT 1200 Mc.**

**PROVIDE 100 WATTS CW POWER AT 750 Mc. WITH A POWER GAIN OF 8.**

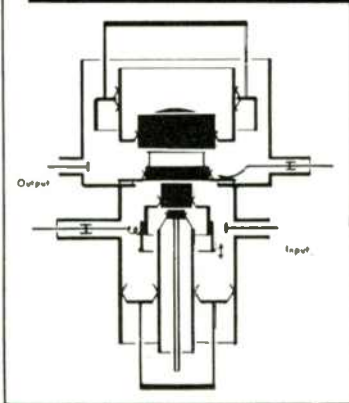
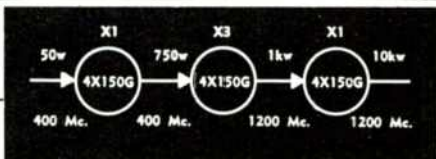

These illustrations show an example of the simplicity made possible by the 4X150G. The cavity is for a broad-band 1200 Mc. power amplifier for a pulse application. The block diagram indicates the tube line-up of the IPA, tripler, and final PA stages. More detailed data on the 4X150G are available. Please make requests on your company letter-head.

The 4X150G has been specifically designed to make feasible relatively high power at UHF. It is excellent as an amplifier, oscillator or frequency multiplier in either pulse or cw service. Good efficiency is obtained over a wide range of plate voltages to over 1500 Mc.

Power-gains of 10 are easily obtainable at 1200 Mc. when pulsed, and peak pulsed outputs of 20 kw per tube are possible without extending the tube beyond its maximum ratings.

At lower frequencies, for instance around 750 Mc., the 4X150G operating as a cw amplifier will provide 100 watts output with but 12½ watts of grid-drive . . . a power-gain of 8, with complete stability.

These examples are only indicative of the tube's potentialities. More comprehensive data are contained in a new data sheet, available upon request.

**E I T E L - M c C U L L O U G H , I N C .**  
**S a n B r u n o , C a l i f o r n i a**

Export Agents: Frazar & Hansen,  
301 Clay St., San Francisco, California

Follow the Leaders to

**Eimac**  
TUBES  
The Power for R-F

**The 4X150G is another Eimac-developed contribution to electronic progress.**



258



# MOTOROLA ANNOUNCES UNI-CHANNEL SENSICON DISPATCHER

FM 2-WAY RADIO

FRONT MOUNT \$ 375

TRUNK MOUNT \$ 395

2-WAY RADIO'S **Greatest VALUE!!** TODAY and TOMORROW

with exclusive **SENSICON RECEIVER** - NOW AVAILABLE in the Dispatcher.

## PERMANENT VALUE of **ADVANCED DESIGN**

The Sensicon Circuit with the Permakay Wave Filter, Statomic Oscillator, Differential Squelch, Capacitance Discriminator, and Thermally Balanced Crystal Oven, all exclusive Motorola developments, has advanced the art to permit practicable adjacent channel operation. Further, it provides the only uncompromised design capable of accepting full modulation on the desired channel, and adaptable to "split-channel" frequency assignments. With "Instantaneous Deviation Control" of the transmitter carrier plus the broad nose, steep skirt characteristic of the Sensicon Receiver, you have an advanced design combination which will give superior performance *now and tomorrow!*

## RELIABILITY

Put it in and forget about it! It breezes along with peak performance always. With fixed-tuned, sealed circuits, precision compensated elements, quality components and workmanship—the day of radio tinkering is over! Remember! the Sensicon System is *coasting* while ordinary systems using fewer tubes are taxed to the false-economy limit!

## UNIVERSAL PACKAGING

Built for quick and easy installation—with full accessibility, *here is the solution* to any mounting problem in any type of vehicle. Choice of new all-in-one front model, or trunk mount unit—both are drawer-type with quick lift cover. Both units provide for complete metering and antenna alignment through the covered ports on front—yet the complete housing is closed against dust or other foreign particles.

## ENDURING ECONOMY

A quality communications unit designed to deliver longer sustained service at the lowest operating cost. New single vibrator power supply provides for minimum tube and vibrator replacement.

## FREEDOM FROM OBSOLESCENCE

The growth of land mobile services licensees from 5,000 in 1945 to over 17,000 (over 160,000 transmitters) today indicates that channel-splitting is imminent. With adjustable modulation control, I.D.C., and exclusive exchangeable Permakay filter you have every factor in hand for your future protection.



BROADEST NOSE AND STEEPEST SKIRT

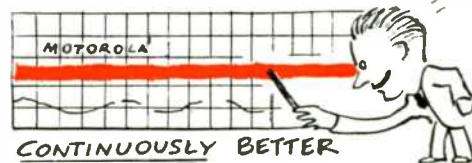

# Motorola

4545 Augusta Blvd., Chicago 51 - in Canada: Rogers Majestic, Ltd., Toronto

MADE BY THE WORLD LEADERS IN 2-WAY MOBILE RADIO BACKED BY 20 YEARS RESEARCH, EXPERIENCE, AND SPECIALIZATION IN MOBILE RADIO

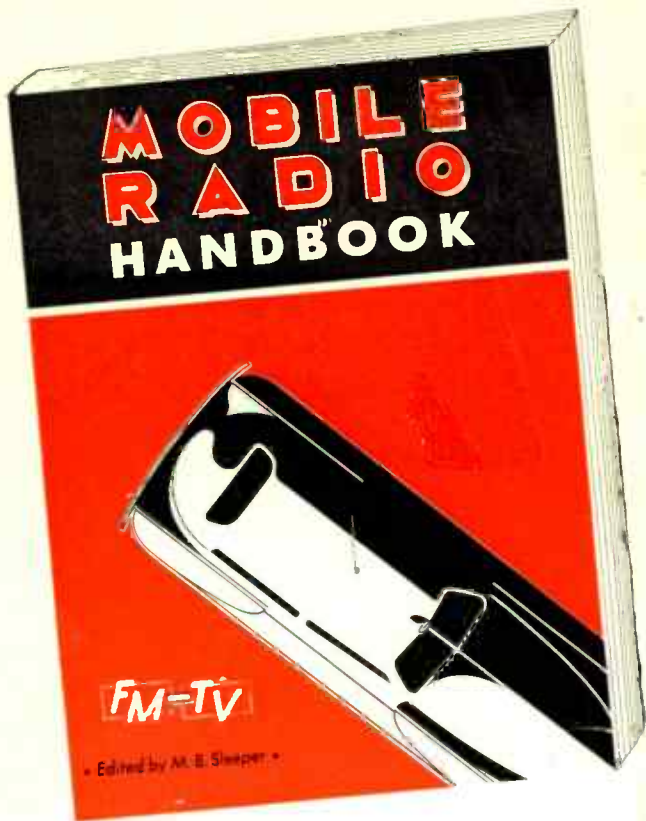

# THE ONLY BOOK OF ITS KIND!

**A COMPLETE  
AUTHORITATIVE  
UP-TO-DATE  
HANDBOOK ON  
MOBILE RADIO &  
POINT-TO-POINT  
COMMUNICATIONS**

## COVERS ALL THE NEW SERVICES

**B**ASED on the new FCC Rules now in effect, the Mobile Radio Handbook covers this field from cost figures, system planning, and license applications, to installation, operation, maintenance, and theory.

Complete information is given for all common carrier, industrial, public safety, and transportation services. It is a big book, 8¾ by 11½ ins., 184 pages, profusely illustrated with photographs and diagrams covering the very latest developments in communications. Following is a list of chapters:

**PLANNING:** How to plan a mobile or point-to-point system. This chapter covers the overall problems of power and topography, interference, city ordinances, public liability, operation, maintenance, expansion, and interconnection.

**FREQUENCIES:** Complete details of the new FCC Rules and Allocations cover all the different communications services.

**LICENSES:** How to apply for a construction permit, license, and renewal. All FCC forms, filled out in the correct manner, are shown.

**EQUIPMENT:** Three chapters are devoted to the problems of selecting the right equipment for a particular system; specifications on transmitters and receivers of all makes; selective calling and fleet control, and adjacent-channel operation.

**ANTENNAS, TOWERS:** The problems of planning antenna installations are covered in two chapters which explain the various special purpose radiators, and the correct method of erecting a standard guyed, steel tower.

**MAINTENANCE:** How to keep a system at peak performance. Methods and record forms, perfected by years of experience are explained, and proper balance between essential and superfluous maintenance.

**OPERATORS:** The FCC is becoming increasingly strict about rules relating to operators. Official information is given, with a detailed explanation by FCC Secretary T. J. Slowie.

**HOW FM WORKS:** Advantages of FM over AM, coverage, interference, static elimination, and circuit functions are explained pictorially in 83 illustrations. The use of mathematics has thus been avoided in this clear, practical presentation.

While the Mobile Radio Handbook is a complete reference volume on the technical phases of radio communications, its arrangement is planned to meet the

needs of non-technical company executives and government officials, as well as communications engineers, system supervisors, maintenance experts, and operators.

Milton B. Sleeper, whose experience in the mobile radio field goes back over a period of 16 years, is the Editor of the Handbook. The Assistant Editors are Jeremiah Courtney, former FCC Assistant General Counsel, and Roy Allison, Associate Editor of *FM-TV Magazine*.

Use the coupon below to order your copy of the Handbook TODAY.

### FM-TV MAGAZINE

Box 600, Great Barrington, Mass.

Please enter my order for a copy of the MOBILE RADIO HANDBOOK, for which my remittance is enclosed:

\$2.00 Paper Bound Volume

\$4.00 Cloth Bound Volume

(Add 25c postage outside U. S.)

Name .....

Street .....

City ..... State .....