

Everyday Engineering

"It Tells You How to Make and How to Do Things"

VOL. 3

AUGUST, 1917

No. 5

STEAM vs. ELECTRIC DRIVE FOR FAST-WORKING MODELS

THE ADVANTAGES PECULIAR TO EACH, WITH A FEW NOTES ON THE USE OF COMPRESSED AIR

By the Editor.

CERTAIN it is that there is no all-around, ideal means of propulsion for a fast-working model. In each system we find disadvantages which partially offset the many points of recognized merit. Therefore, in making an intelligent selection it behooves the designer to weigh well each and every feature of each system, applying the evidence for and against to the case in hand.

The experience of our English cousins would seem to indicate that steam offers a satisfactory solution of the problem in the case of a speed boat or, in fact, any mobile model wherein the power plant must be self-contained and where a relatively large amount of power must be delivered by a plant of comparatively light weight. There are many cases on record where forty-inch model speed boats have been driven at the astonishing speed of twenty miles per hour by steam plants weighing but a few pounds.

Actual brake tests in the laboratory indicate that for a given weight a greater amount of useful power can be obtained from a well constructed steam plant than from any other source of prime mover, not even excepting the gasoline engine. While this is a broad statement to make, it will be borne out by the experience of nearly every model maker.

Steam would have a mighty rival in the present-day electric motor if it were not for the relatively large weight of the storage battery. This appears to be an unsurmountable obstacle, however, in the case of models wherein the power plant must be entirely self-contained. With model railways, there can be no question about the superiority of electric drive to that of any other system. Here the storage battery may be permanently located and its weight is of no particular consequence. Indeed, there is no good

reason why such models should not be operated directly from the lighting circuit if proper fusing precautions are taken. Small and powerful motors are now manufactured for operation on 110-volt circuits as well as for battery current, and this offers the cleanest, most economical and the best all-around motive power for models which can be supplied with current from an external source.

The principal objection to the gasoline engine for model propulsion is found in the terrific vibration inherent in this form



Model of a steam speed boat engine with reversing gear.

of prime mover. Another objection is the weight and bulk of the ignition coil and battery; the latter are practically as heavy as the engine itself in the case of a very small plant.

Thus far the evidence appears to be in favor of steam. But even this form of motive power has its objections. For one thing, it is messy and a nuisance. The engine, boiler and blow-lamp require constant attention and supervision. The time of operation is limited in the case of a steam plant. While a truly phenomenal

amount of power is available, the duration of the run is limited to perhaps half an hour at one filling.

The speed boat enthusiast will, however, put up with these disadvantages in order to avail himself of the tremendous speed offered his model through the medium of the steam engine. He will wipe carefully his engine, clean the lamp and boiler, and nurse the whole plant just in order to gain a few miles per hour.

COMPRESSED AIR AND CARBONIC ACID GAS

It is not beyond the range of possibilities that either compressed air or carbonic acid gas may be made to supplant the

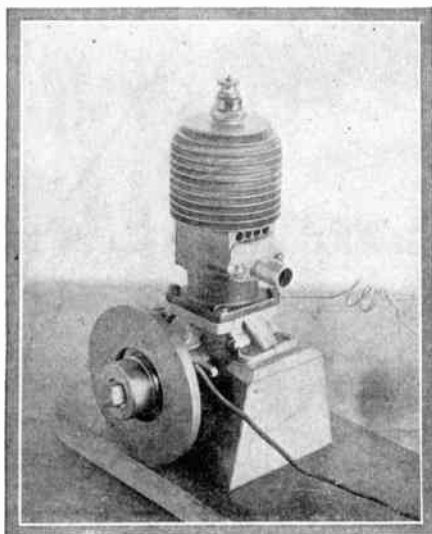

This tiny gasoline engine is rated at one-half horse power.

troublesome steam plant in model ships. Either of these gases will drive a steam engine with entire satisfaction. It only remains to provide a suitable container and means of storing the necessary gas under pressure.

Air may be compressed into metal bottles or tanks tucked away into the innermost recesses of the hull and a relatively large capacity secured in this manner. Light but strong tanks may be

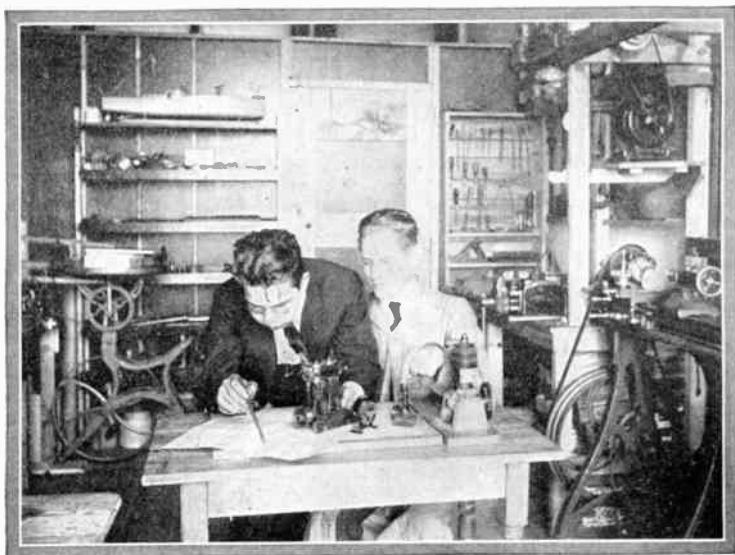

Plotting comparative results obtained with gasoline, steam, electric, and compressed air drive in the laboratory.

constructed of drawn tubing with riveted or hard-soldered heads, and if the utmost strength per pound of weight is desired, the finished tank may well be wound with fine steel wire after the manner of certain pieces of ordnance.

Carbonic acid gas is now a commercial product that may be purchased in steel bottles of many different sizes in practically every city of the country. It is used at every soda fountain to put the "pep" into soda. It is used by artists to operate their air brushes. It is used in countless ways by workers who require a harmless, odorless gas under high pressure in convenient and easily obtainable form.

When carbonic acid gas is liberated from one of the bottles wherein it is stored at a pressure approximating 2,200 pounds into the open air, it forms a dry and very cold "snow." This characteristic of producing a troublesome low temperature as the gas expands is the one objection from the standpoint of the steam engine. The steam chest, cylinder, and exhaust port become coated

with frost, and if the engine is speeded up beyond a certain point the ports become clogged with snow. The lowering of the temperature also shows a tendency to solidify the oil, thus retarding the speed of the engine.

Notwithstanding this seemingly formidable disadvantage, carbonic acid gas offers a practical and powerful substitute for steam in a model engine. If the speed is kept within reasonable limits,

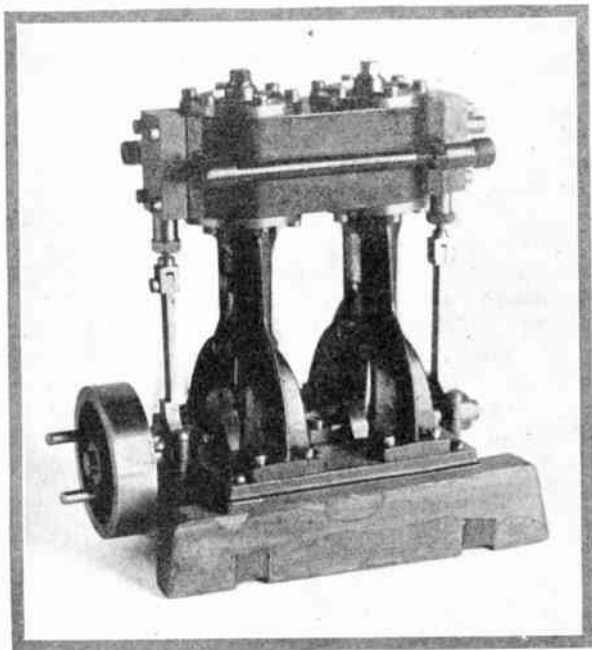

A beautifully-executed model of a twin-cylinder fast boat engine adapted for either steam or compressed air drive.

and if a small "expansion chamber" is introduced between the tank and the inlet port, the gas may be used for fast and comparatively long runs. The gas may be stored in very small tanks, as it is readily liquefied under compression.

The remaining possibility is liquid air. This wonderful product offers all of the advantages of carbonic acid gas, with a number of additional ones. It is comparatively scarce, however, and is

available as a rule only from college laboratories which will supply it for experimental purposes at small cost.

Liquid air is, however, a very unstable proposition under varying degrees of temperature. When it is confined, it has the power and characteristics of an explosive unless due precautions are taken to provide the necessary safety valves to ease off the pressure in the event that the engine cannot absorb the gas as fast as it is liberated.

SUMMARY OF VARIOUS SYSTEMS.

We may take a summary of the several systems of model propulsion somewhat as follows: For railways and other models where electric power can be supplied from outside the model, electric drive is the best. For slow-moving ship models, armored motor cars, etc., where considerable weight can be carried, the electric motor and storage battery offer the solution for a clean, safe drive with great endurance of run. For fast submarine chasers, torpedo boat destroyers, speed boats, etc., where very light weight and great power are necessary, steam or one of its substitutes applied to a steam engine is indicated.

Subsequent articles will give the results of laboratory tests, designs for small engines, boilers, compressed air tanks, etc. Following this, the design for very small gasoline engines suitable for the operation of large and comparatively heavy models will be given. Many readers have requested such articles, but the inevitable policy of this magazine first to test for comparative results has prevented an earlier discussion.

TRANSPARENT LIBRARY PASTE

A transparent library paste is essential for mending sheet music and other printed matter. Grind rice until as fine as flour; mix with cold water, rubbing until smooth and free from lumps. Add hot water and boil, stirring carefully, until thick. Brush over the parts to be mended, cover with transparent paper and press. Printing may easily be read through the paper.—Contributed by H. G. FRANK.

LABELS ON TIN

Mix one-half ounce of pulverized gum-arabic, ten grains sulphate of aluminum and five ounces water. Free tin of grease and apply warm.—H. G. FRANK.

PRACTICAL ELECTRO-PLATING FOR AMATEUR MECHANICS.

BY RAYMOND FRANCIS YATES

Part I.

THE average amateur mechanic seems inclined to regard electro-plating as a very complicated and difficult process involving the use of costly materials and apparatus. This is not the case, however, as the successful electro-deposition of copper, nickel

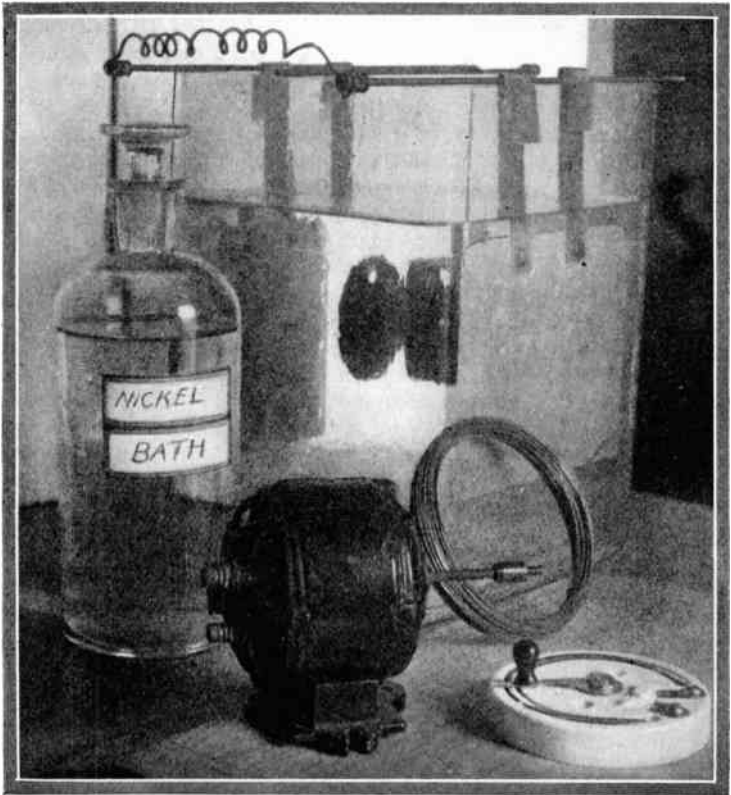

Simple plating outfit.

and silver is a comparatively simple process, the practice of which easily comes within the resources and ability of the amateur. An electro-plating outfit should be included in the equipment of every workshop, and it is the purpose of the author to describe in the following lines the construction and manipulation of a small but practical outfit, which will enable the mechanic to properly plate and finish his machine or instrument parts.

THEORY OF ELECTRO-PLATING

While it is not the purpose of the author to give a lengthy treatise on the theory of electro-deposition, a brief outline of the fundamental principles involved will be given as an elementary understanding of the theory of any process or operation about to be performed invariably proves helpful and advantageous in actual practice.

Pure water is a very poor conductor of the electric current, but if a small quantity of table salt (sodium chloride) is dissolved in it, it at once becomes a comparatively good conductor of electricity and in this state is technically known as an electrolyte. If we immerse two electrodes in such a solution and pass a current between them, it will tend to decompose the table salt into its constituent elements, i.e., sodium and chlorine. The atoms of sodium will accumulate at the negative electrode or cathode and the chlorine will be attracted by the positive electrode or anode.

This is exactly what happens in the process of electro-plating. For an illustration, we will assume that we are plating with nickel. In place of the sodium chloride, nickel-ammonium sulphate would be dissolved in the water, and upon passing an electric current through such a solution we would find that the negative electrode would soon become covered with a thin deposit of metallic nickel owing to the decomposing action of the current. If we take the negative electrode out and substitute it with articles to be plated, we will find that the articles will undergo the same process and a deposit of nickel will form on them. If we wish to plate with copper, copper sulphate should be substituted for the nickel-ammonium sulphate, etc.

CONSTRUCTION OF A SMALL PLATING VAT WITH ACCESSORIES

In many cases, where there are but a few small articles to be electro-plated, a small vat may be used with entire success and the results will be found to be just as good as those attainable by means of larger vats and more costly apparatus. For general

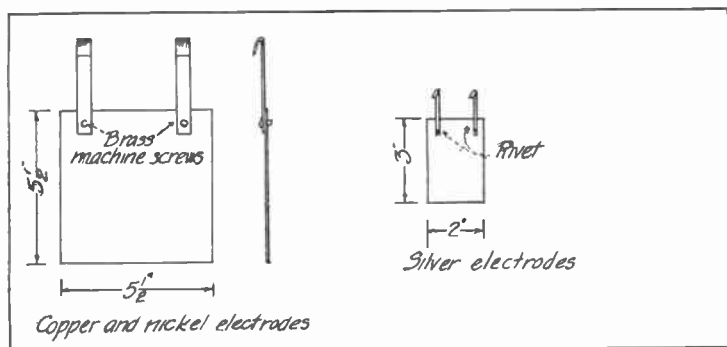

Dimensions of electrodes.

workshop use, the outfit described in the following lines will be found to be both practical and serviceable.

The vat proper should be a square earthenware or glass jar with dimensions not smaller than 8 in. square and 10 in. deep. A glass storage battery jar of the proper size is very suitable. The top of the vat should be equipped with three $5/32$ in. brass rods as shown in the photograph. One end of each rod should be threaded to receive $8/32$ machine nuts. Two of the rods are to be used to hold the electrodes, and the articles to be plated are suspended from the third one. On account of the necessity of varying the distance between the electrodes for different classes of work, it will not be found desirable to construct a permanent arrangement to hold the rods in place, as they are heavy enough, when equipped with the electrodes, to remain in any position they are placed in.

The electrodes of a plating vat should be of the same metal that is to be deposited. Thus, if we desire to copper plate, copper electrodes should be used; if we wish to nickel plate, nickel electrodes should be used, etc. For this reason, it will be found necessary to construct three sets of electrodes for use with the vat; one set of copper, one of nickel, and one of silver. Owing to the greater expense of silver, the electrodes of this metal are made much smaller than those of nickel and copper, and on this account it will be found necessary to plate one article at a time when depositing silver. As the silver plating solution is equally expensive, the amount prepared should only equal one-third that of the copper or nickel solutions, and the silver electrodes should

be suspended into the solution by means of longer strips than those used on the other electrodes so they will be completely immersed. The dimensions of the various electrodes and the method of suspending them from the brass rods are plainly shown in the sketch.

While three Bunsen cells connected in series will be found to produce sufficient current to operate successfully the vat described above, the use of a small 8 ampere, 10 volt dynamo of the shunt-wound variety is to be recommended on account of the steady and unvarying current it is capable of generating. It is utterly impossible to use dry cells as they polarize too rapidly for work of this nature. A small rheostat should be included in the outfit as it is often necessary that the current be properly proportioned for the work required from it.

Part II

PREPARATION OF PLATING SOLUTIONS

SUCCESSFUL electro-plating depends, to a great extent, upon the chemical purity of the solutions used, and only the purest substances should be used in their preparation. If it is impossible to obtain pure distilled water, the next best substitute is rain water.

SOLUTION FOR COPPER PLATING

First make a saturated solution of copper sulphate (blue vitriol) by dissolving the crystals in a gallon of pure water until it is found that the crystals will no longer dissolve. The solution is then said to be "saturated." To this preparation add about a half tea cup of chemically pure sulphuric acid, care being taken that the acid is poured in a small, gentle stream. After filtering through blotting paper, the solution is ready to be used or stored away in flasks until it is desired to use it.

SOLUTION FOR NICKEL PLATING

Dissolve one pound of nickel-ammonium sulphate in one gallon of water. To this add about 2 tablespoonfuls of pure sulphuric acid. The preparation is then filtered, after which it is ready for use. After this solution is used for some time as a bath, it is advisable to test it with litmus paper to ascertain whether it is acid or alkaline, as there is a tendency for ammonium (NH_4) to form, which renders the bath alkaline. In this case, sulphuric acid should again be added until the bath is just acid.

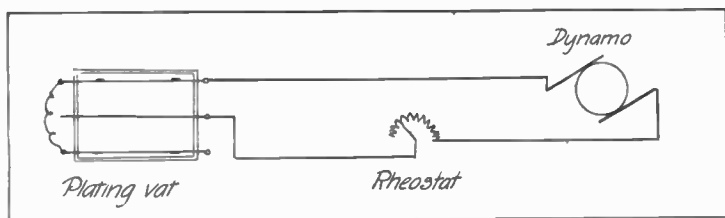

Wiring diagram for operation of plating outfit.

SOLUTION FOR SILVER PLATING

Obtain two ounces of silver nitrate from a chemical supply house and dissolve it in two quarts of pure warm water. To this add a solution of cyanide of potassium (a deadly poison) which will cause the silver to precipitate as crystals of silver cyanide. Immediately discontinue adding the potassium cyanide after it is found that all the silver has precipitated. The whole solution is then filtered through blotting paper to recover the crystals of silver cyanide formed. The filtrate may then be disposed of as it is of no further use. Now place the silver cyanide crystals in a vessel containing about one and one-half quarts of pure water and to this add potassium cyanide, stirring the solution at the same time until all the silver cyanide crystals have dissolved. We then have a standard solution of the double cyanide of silver which is used in silver plating. The solution may be kept in a clean, stoppered bottle until it is used.

CLEANSING SOLUTIONS AND THE PREPARATION OF ARTICLES FOR ELECTRO-PLATING

One of the most important operations in the process of electroplating is that of properly preparing the surface of the articles to receive the deposit. The smallest speck of foreign matter upon the surface of the article to be plated is sufficient to cause the deposit to peel off. Many times the mere touching of the surface with the fingers so contaminates the object that it becomes impossible to electroplate it successfully without again putting it through the cleansing process.

It is, of course, understood that the surfaces of the article to be plated should first be rendered sufficiently smooth by a mechanical process, if it is not already so. In the case of the amateur, this can usually be accomplished by polishing the surface with fine emery cloth.

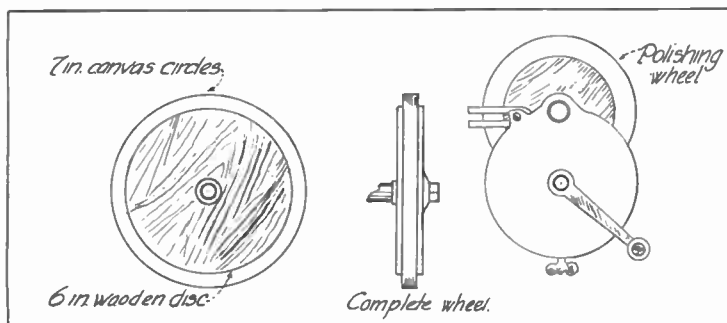

Details of polishing wheel.

After the surface is mechanically prepared, it then becomes necessary to render it chemically clean before it is immersed in the plating bath. As it is impossible to prepare one cleansing or pickling bath that will be suited for all metals, it will be found necessary to mix several different pickles; one for each different metal.

Before the articles are immersed in the pickle, they should be dipped in clean water, and after they are brought out of the pickle they should again be thoroughly rinsed in clean, running water before they are finally placed in the plating bath. The articles should be dipped in the pickle by means of a copper wire.

PICKLE FOR COPPER, BRASS AND GERMAN SILVER:

100 parts of sulphuric acid, 50 parts of nitric acid and 1 part of table salt. Permit the preparation to stand one day before using.

PICKLE FOR ZINC:

100 parts of water and 10 parts of sulphuric acid.

PICKLE FOR IRON AND STEEL:

1 part sulphuric acid, 15 parts water, $\frac{1}{2}$ part nitric acid. It is advisable to add a few pieces of zinc to such a solution.

When using the acid dips, especially in the case of copper and brass, care should be taken that the metal is not left too long in the pickle as the acids act quickly and will pit the surface if permitted to act long enough. The proper method is to alternately dip the articles in water and then in the pickle until the surface appears bright and clean.

If it is desired to plate a brass article that has already a fine

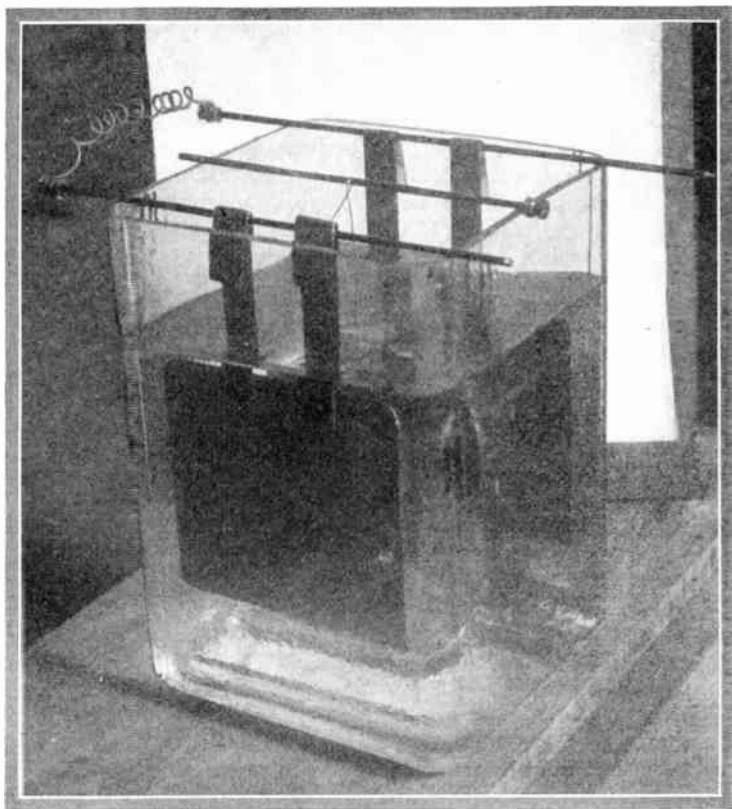

The plating vat.

polish upon its surface, the acid cleansing bath should not be used, owing to its tendency to destroy the polish. A dip composed of 1 part of potassium cyanide to 10 parts of water may be substituted for the acid dip in this case. It will be found necessary to leave the brass much longer in this than in the acid pickle.

HINTS FOR THE AMATEUR ELECTRO-PLATER

When plating objects that have large projections, the electrodes of the vat should be placed as far apart as possible, otherwise an

unequal deposit will result owing to the great current density at the projections where the resistance of the bath is least.

In electro-plating, care should be taken that the deposit does not form too rapidly, as plating of this nature invariably proves to have poor adhesive qualities and soon peels off. Equally wrong is the practice of permitting the deposit to form too slowly. The current should be regulated by means of the rheostat, until the deposit formed is flesh-pink in the case of copper, and milky white in the case of silver and nickel. If the current is not of the proper proportion, the deposit has a noticeable tendency to become dark in color.

If the plating solutions are not in use they should be kept in stoppered vessels, otherwise they will become contaminated with foreign matter from the atmosphere.

The articles should be dipped in the pickle on a copper wire, bent in the form of a hook, and immediately after cleaning the articles should be placed in the plating vat by hanging the copper wire or hook on the central brass rod.

The fact that the amount of current passing through the bath is dependent upon the proximity and size of the electrodes should be kept in mind. If a single small article is being plated, it is necessary to move the electrodes closer together in order to reduce resistance and permit sufficient current to pass owing to the small surface of the negative electrode which is formed by the article to receive the plating.

POLISHING AND FINISHING PLATED ARTICLES

After the articles are taken from the plating vat, they should be washed in hot water and dried in a box of sawdust. They are then ready to receive the final polishing, which may be done on a small grinding head equipped with a buffing wheel. If the mechanic is not fortunate enough to have one of these in his workshop equipment, a good substitute will be found in a bench grinder, which may be fitted with a polishing wheel as shown in the illustration. The polishing wheel is made by cutting out about twenty 7-in. circles from thin canvas and clamping them between two wooden discs as shown. The purpose of the wooden discs is to hold the canvas circles in place under the pressure of polishing. With a helper to turn the grinder and a little rouge on the buffing wheel, very good polishing can be done.

HOW TO MAKE STEREOSCOPIC PICTURES

BY P. K. MCGALL

CONSIDERING the pleasure and interest derived by the average amateur in making his own photographs, there are few who realize how simple and easy it is to make stereoscopic pictures with an ordinary camera.

It may not be out of place to state the differences between ordinary pictures and stereoscopic pictures for the benefit of those not acquainted. The objects in the ordinary picture appear flat, as objects appear when viewed with one eye, whereas in the stereoscopic picture the objects appear to stand out in relief, or as we view them when using both eyes.

To take these pictures, make two photographs of the same object, but from slightly different positions. They are best taken

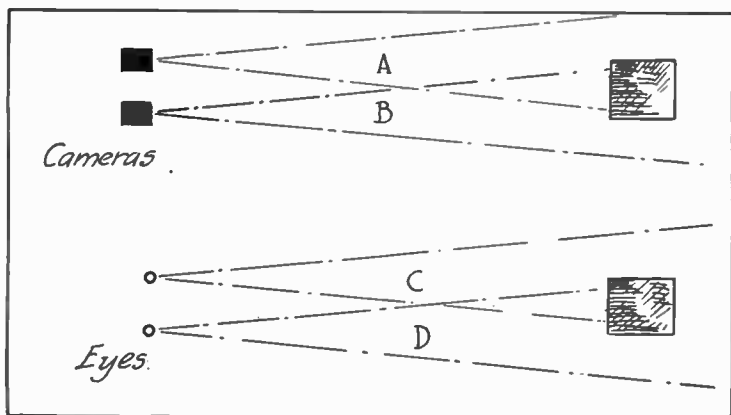

Showing the principle of the stereoscopic view.

with a camera which uses roll film. The camera is first placed in such a position that the film rolls from right to left viewed from the back. The first picture is taken in the usual manner. The camera is then moved to the right about six inches, the next picture number of the film rolled for exposure and the second picture is taken. After developing, the pictures are cut from the film in pairs and printed in pairs on the same sheet of paper. After the pictures are dry they are mounted on cardboard mounts of a size to fit in the stereoscope through which they are to be

viewed. These pictures take on a most life-like aspect. This is explained by the illustration.

It may be said that taking pictures in this manner applies to time exposures or snapshots of objects not in motion. To take stereoscopic picture of objects in motion, it would be necessary to employ two cameras and make the exposures exactly at the same time.

JIG FOR DRILLING HOLES IN RODS

IT is almost impossible to drill holes through small rods, even though the rod is spotted and set in a V-block. This is quite an important operation, however, in turning up binding posts, switch points, and other small parts for electrical and mechanical apparatus.

A jig, such as that illustrated in the drawing, solves this problem. It is made from a block of cold rolled steel, drilled at one end to take the rod. The upper face has a hole the size of the hole to

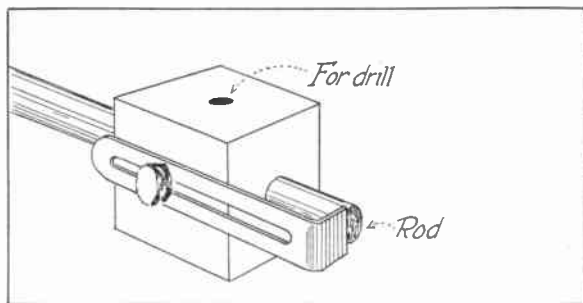

The jig for drilling holes through rods.

be made in the rod. Now, if the rod is inserted in the block, and the drill put through the hole made for it, it will pass directly through the center of the rod.

When any quantity of parts is to be drilled, a gauge may be added to the block, to gauge the distance of the hole from the end of the piece. This is a slotted brass strip, held to the block by a thumb screw threaded into the block. The threaded part of the thumb screw must not be too long, however, or it will reach to the hole which takes the rod.

MORE WORKSHOP TIPS FOR HOME MECHANICS

MAKING SMALL WEDGES

MORE than once I have seen handy men, who ought to have known better, making small wooden wedges in a very laborious sort of way, says a writer in *Junior Mechanics*. Of course, it is quite possible to take a thin strip of wood, and sharpen one end with a chisel, and then cut off the wedge so made; but when a fair number of wedges are required, that process is, as I said, a laborious one. Besides this, however, a wedge produced in this way does not give such good results in practice as one formed by means of a saw, because the surfaces produced by a sharp chisel cut are

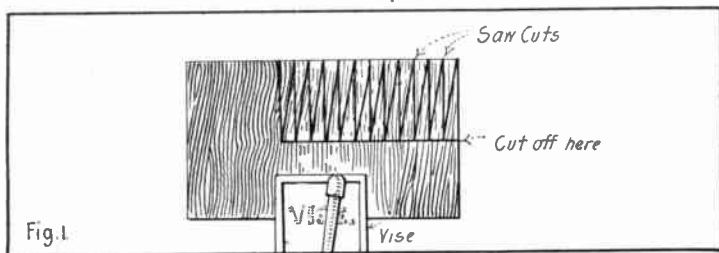

How wedges may be made in quantities.

smooth, whereas those left by a saw are more or less rough, though they should be even and uniform, and therefore absorb the glue better when the latter is applied.

The sketch, Fig. 1, shows how these may be produced by the dozen in a very quick and easy fashion. Take a piece of wood of the thickness the wedges are required to be, and then cut it up as shown in Fig. 1, which is quite self-explanatory.

Small wedges are little things, and it may appear to some readers who have not done much in the woodwork line that a wedge is a wedge, and there's no need to talk about them. But many a nice job has been spoiled, or, at any rate, might have been completed with a more workmanlike finish, had the worker given a thought or two to this insignificant item. As an instance: There are only two really good ways of fixing footstool legs—(1) by dowelling, and (2) by fox-wedging. Dowelling is a process—even an art, some folk declare—which will be dealt with later on, however.

Fox-wedging is an equally useful method to adopt for such a job as instanced above; particularly for the worker who has a limited

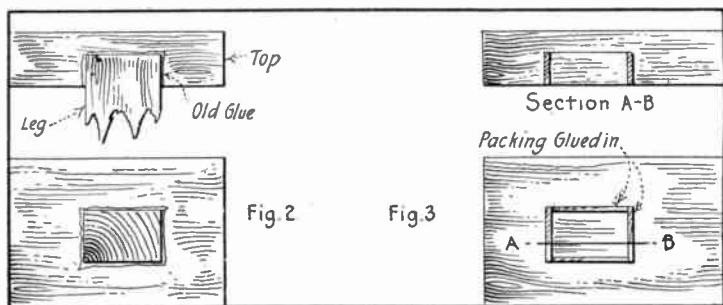

Method of fastening table legs.

number of tools—in this case all that is required is a $\frac{1}{2}$ -in. or $\frac{3}{4}$ -in. chisel and a tenon or back-saw—a useful size being 10 or 12 in. long. Assuming we have to re-fasten the legs in a footstool or other small article, in which the material used is of about the dimensions shown in Fig. 2, most likely the hole in which the leg ought to fit tightly will be found to be too large, and possibly thickly covered with old glue. If the wood of the stool top and the legs is quite sound, there will be no need to make new legs. First scrape all the old glue off both legs and out of the hole. It may be difficult to get the hole well cleaned without enlarging it still further. This does not matter, for by cutting away, say a good $\frac{1}{8}$ in. on each side, a piece of picture-backing may be neatly fitted and glued in as a sort of lining, as shown in Fig. 3. This must be allowed to dry well before the next proceeding is carried out. Now take the leg and reduce its one end to such a size that it just drives into the hole an easy-driving fit. Needless to say, the four sides must be quite square with each other, and not “drunk” as Fig. 4. Now our wedges come into use. Having prepared these to the necessary dimensions, place the leg in the vise and make a neat saw cut, into which the point of the wedge can just be inserted, as Fig. 5. Next take the chisel (well sharpened) and under-cut the hole to the extent of about $\frac{1}{8}$ in. at each end (see Fig. 6), then quickly apply the hot glue to leg, wedge and hole, and holding the leg in position (Fig. 7), drive home with the mallet. Fig. 8 is a section of the finished joint. One point must be carefully watched, however—the under-cutting must be done only at each end of hole which presents the cross-grain to the chisel, otherwise when the wedge spreads the leg end out so as to form a dovetail, the stool top would most probably split, and the whole job be spoiled.

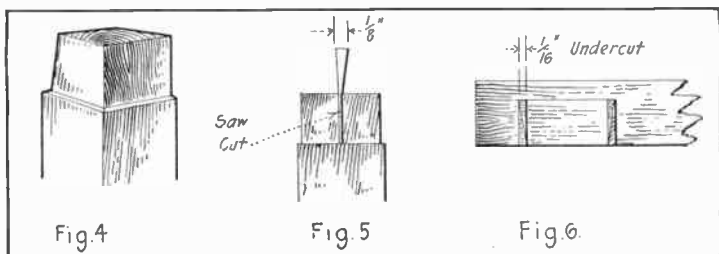
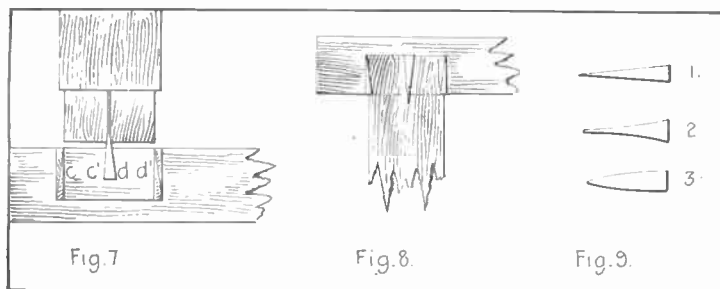

Table legs must not be "drunk" to insure their straightness.

Then there is *another* point to watch carefully—there always are a lot of troublesome points in these simple jobs, and that is why it is possible to judge the ability of any craftsman from a simple specimen of his work as well as from a work of greater pretensions. This second point is the size and shape (*i. e.*, the taper) of the wedge in relation to the amount of under-cut. The sketches given herewith are to a scale of half an inch to the inch, *i. e.*, half full size, and it will be seen that the wedge used is $\frac{1}{4}$ in. thick, tapering to nothing. Therefore, when driven right home, as in Fig. 8, the end of the leg will be spread $\frac{1}{4}$ in., and the amount of under-cut must be just sufficient to allow for this spread, no more and no less. Then, again, the sides of the hole *c* and *d'* must be parallel with the sides *c'* and *d* of the wedge (see Figs. 7 and 8), for if they are not parallel to each other the joint will never be a good solid one—and, remember, a glued joint, to be a good joint, must be a *well-fitting one before any glue is applied to it*. Glue should never be used to fill up the holes and corners produced by bad workmanship, although one must admit it often *is*. Fig. 9 shows a correct form of wedge, and two other forms which, if used, are fatal to good work. When fox-wedging is employed, the joint is, of course, completely hidden, and no one will discover that it is a bad one until it "gives out"—and then he will probably hear all about it; but when used for any one of the dozen other jobs, of which the little wedge forms a part, faulty shape and size are at once, and always, apparent. Try to drive No. 2 type when wedging up a mortised and tenoned door (for your tool cupboard, say) and you will probably find the tips at the wide or outside end—chip off and leave an ugly gap. Try to drive No. 3 type, and, unless the wood it is being driven into is much softer than the material the wedge is made of, you will find it enters so far, but rebounds in-



How the leg is fastened and three types of wedges. Only the first type is practical. In fact, it is ten to one you will never get it to "bite"—and, by the time a more suitable wedge is made, the glued joint is quite cold and perhaps so badly mutilated that it has to be "faked" before it will present a decent appearance to the inquisitive eye of the lay critic! But "faking" is a poor game. It will always be discovered sooner or later, and the young craftsman will be well advised to spend plenty of time on the early stages and in the preparation of his job, rather than hurry until it is too late, and then *have* to spend more time in covering up or obliterating the effects of scamped work.

EXPERIMENTS WITH ELECTRICITY IN PLANT CULTURE

BY P. M. EAMES

MY first experiments were conducted indoors with a static machine capable of giving a two-inch spark. I attached a motor to this machine and thus was able to operate it hours at a time. I removed the Leyden jars and adjusted my voltage by the spark gap. Radishes and beets were sown in two boxes; the dirt being thoroughly mixed. The net which was made of number eighteen copper wire was placed seven and a half inches over the box to be treated and ten thousand volts of static were applied to the net for about one hour a day. This experiment lasted for eleven days and at the end of that time the stems on the treated box of radishes were larger than in the check box. The beets were simply a failure in the treated box. Another experiment which lasted for twenty days with beets and radishes with the net twenty inches over the treated box and the voltage the same as in the previous experiment, proved the reverse. My theory is, if the

vibrations of the applied current are in excess to a small degree to those of the plant cells, the plants will be benefited by the current. I have not been able to work my theory out due to the fact of the common complaint that the majority of amateurs have.

DRAFTSMAN'S PENCIL SHARPENER AND PAPER CUTTER

BY HENRY HOLTZER

THIS is a very convenient tool to hang from the drawing board. It consists of a strip of wood, $\frac{3}{8}$ in. in width on which an ordinary razor blade is fastened with two screws. At the end of the handle is a screw-eye to which a string is tied. This keeps it

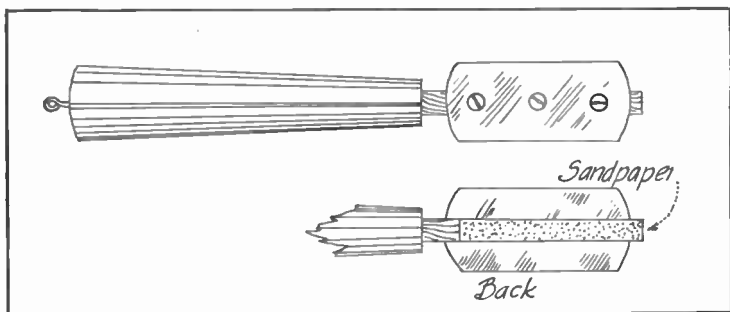

The draftsman's pencil sharpener.

out of the way when not in use. On the side opposite the blade is a strip of sandpaper used to grind down the point. When the razor blade is dull, it is easily replaced by another.

TO PURIFY HYDROGEN GAS

To produce hydrogen in quantities, common zinc and sulphuric acid are ordinarily used. These chemicals, however, always contain some arsenic, phosphorus, sulphur, etc., which, combined with hydrogen, produce arsine, phosphine, hydrogen sulphide, etc. To eliminate all these impurities make and use the simple apparatus shown, using two glass jars with cork or rubber stoppers, some lengths of glass and rubber tubing. Jar No. 1 is half filled with a solution of permanganate of potash or bichloride of mercury to size the arsine or phosphine. Jar No. 2 is half filled with a solution of potassium or sodium hydroxide to size the hydrogen sulphide.

APPLICATION FOR MEMBERSHIP

The American Society of Experimental Engineers,
 Aeolian Building, New York, N. Y.

Gentlemen:

I hereby make application for the degree of Associate Membership in the American Society of Experimental Engineers in which, upon acceptance of my application, I am to share all of its rights and privileges.

I enclose (check, money order, draft) for Two Dollars (\$2.00), one-half of which sum is to enter or extend my subscription to EVERYDAY ENGINEERING MAGAZINE, for a period of one year, and the remaining half to pay my annual dues in the Society, for one year from date.

It is understood that, upon acceptance of my application, I am to be supplied with the regulation certificates of membership and the Official Publications of the Society during the tenure of my membership.

In making application for membership, I do hereby solemnly pledge myself to abide by the By-laws of the Society and to do my best in the advancement of practical scientific knowledge and the development of the characteristic of resourcefulness in my fellow men; furthermore, I do pledge myself never wilfully to be guilty of an act unbecoming an American citizen. Failing in these pledges, by word or deed, I shall be deemed unworthy of membership in the American Society of Experimental Engineers, and shall thereby forfeit said Membership with all of its rights and privileges.

Signed

City or Town

Street Address

State

My age is Nationality
 If naturalized, say so.

My Education
 Grammar or High School, College, Correspondence, etc.

Am employed as
 If still at school, say so.

Am particularly interested in
 Branch of Science or Craftsmanship.

Why I want to join the A. S. E. E.

.....

.....

.....

I suggest the name of Address

..... as a worthy member of the A. S. E. E.

WILL YOU JOIN THE American Society of Experimental Engineers

AND—Gain recognition for the Experimenter as a class?

Encourage resourcefulness and the ability to do things as American citizens?

Promote the study of Experimental Science with a definite object in view?

Assist in the Industrial and Scientific Preparedness of your Country?

Encourage practical Model Making?

Receive definite, authoritative, understandable information about the fascinating hobby, Experimental Engineering, in all its branches, including Electricity, Radio-Telegraphy, Chemistry and Electro-Chemistry, Mechanics, etc.?

Receive specific reports monthly giving data not found in available text-books, such as the winding to use on a magnet or solenoid to give a certain pull at a certain distance, and the hundred and one questions of this kind that beset every practical worker in this field?



PUT your name to the blank opposite if you know of the A. S. E. E. and its objects. If you do not, send for a copy of the March issue of this magazine in which the organization of the Society was given its first public announcement.

THE EVERYDAY MOTORIST

by VICTOR W. PAGE, M.E.



POWER PLANT FAULTS

CAUSES OF NOISY OPERATION

PART 2

WHEN a gasoline engine becomes noisy this is a sure indication that some portion of the mechanism is deranged. The point to be looked at is indicated by the character of the noise. For example, a sharp hiss denotes the escape of gas under pressure, whereas a dull pounding or knocking noise indicates mechanical depreciation of the bearing points. A leak in the petcock, through the cylinder head packing or around an inlet valve cage, will cause hissing. Carbon deposits in the combustion chamber or on the piston head which cause preignition will result in the engine knocking. Any faulty action of the inlet valve will result in back-firing through the vaporizer. Looseness of the valve stem in its guide bushing will cause a clicking noise which will become a pronounced rattle in a multiple-cylinder engine when it is speeded up.

Defective lubrication produces squeaking or grinding noises. If the camshaft driving gear is loose on the shaft, or if it has worn or broken teeth, a distinct metallic knock will be heard. The bolts holding the cylinder in place on the engine bed or those holding the engine base down on the foundation should be inspected to insure that they are tight and that the components they retain are held firmly. If the piston has worn to any extent or if the cylinder bore has become enlarged, the piston will "side slap" in the cylinder, which produces a dull pounding noise. Looseness of the crank in connecting rod big end bearings, wrist pin bushings or main journals will cause a distinct metallic knock, whereas if the parts are insufficiently lubricated the bearings will overheat and will indicate their distress by squeaking. If the bearing adjusting bolts, such as used at the crank pin end of the connecting rod or under the main bearings, are loose there will be play in the bearings and knocking will result. If the brasses in the lower portion of the connecting rod become worn so that the crank pin has some degree of play between them, the engine will knock in a pronounced manner.

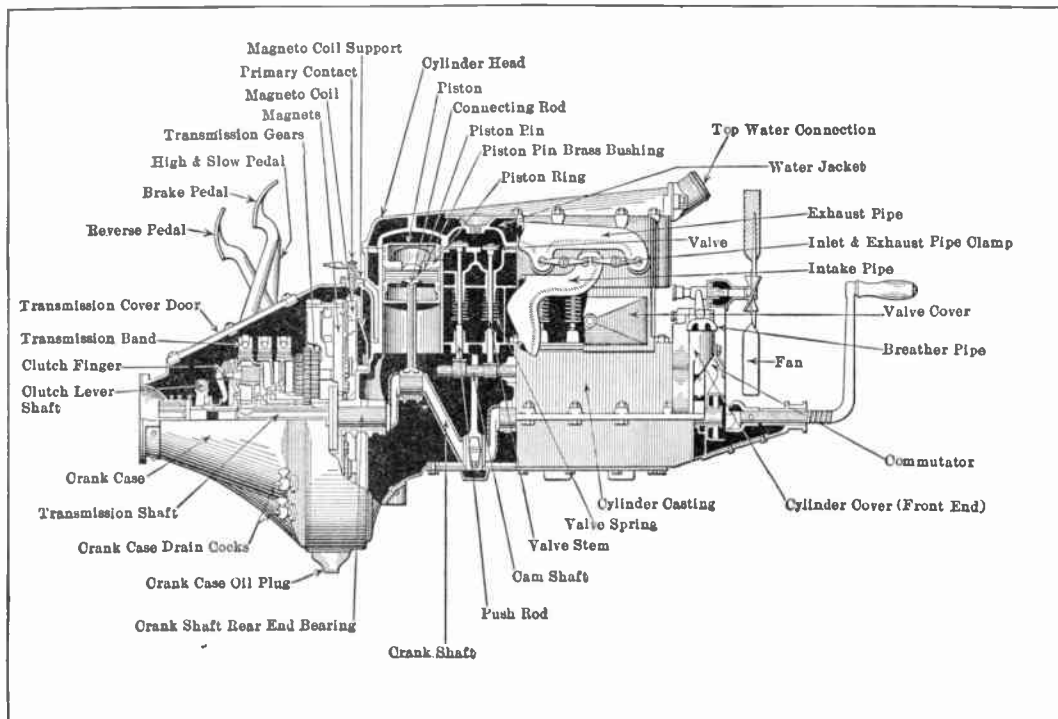

Part sectional view of the Ford four-cylinder unit power plant.

The crank pin bearing adjusting nuts sometimes become loose, which permits the connecting rod brasses to fit the crank pin too freely. The flywheel is generally held on the crankshaft by means of a key or bolts and the retaining means are apt to loosen and the loose flywheel will produce a very pronounced knock. It is not difficult to take up bearing depreciation in the engine shown in illustration, as main bearing cap bolts and shims make it possible to keep the main bearings and connecting rod big ends always adjusted to the proper point. If the bearing is loose the lock nuts on the bolts are released and the nut is turned in, bringing the box carried by the cap into more intimate contact with the crankshaft. The crank pin bearings, however, are brought more closely together by removing the shims of thin metal that separate the bearing cap from the upper part attached to the lower end of the connecting rod and then screwing up the adjusting nut until the proper degree of bearing is obtained.

A frequent cause of grinding noises is wear in the timing gears or the movement of reciprocating or sliding parts relative to each other when not supplied by proper quantities of lubricant. A low blowing sound usually denotes a leaky packing in the crank case or the loosening of some of the bolts holding the various inspection plates in position. Whenever a loud or sharp knocking sound is heard the engine should be stopped immediately and careful inspection made to locate the cause of the trouble. Irreparable harm may be done in a very few minutes if an engine is operated with a loose connecting rod or bearings that would be prevented by taking up the wear between the parts promptly by the adjustment means provided. Another cause of lost power is reduction of valve lift, due to wearing a flat spot on either the exhaust cam roller or the roller carried by the inlet cam rider, should these members bind on their supporting pins and not turn freely. Weak valve springs also result in diminished power output because the valve action is sluggish. Sometimes the valve stems become gummed with a coating of solidified oil and do not work freely in the guides.

PRACTICAL METHOD OF TURNING ROUGH BRAKE DRUM

IN relining the external constricting brake bands of a popular make of car recently, it was noticed that the brake drums were very badly scored their entire width. This not only reduced the effective braking surface materially, but would cause premature

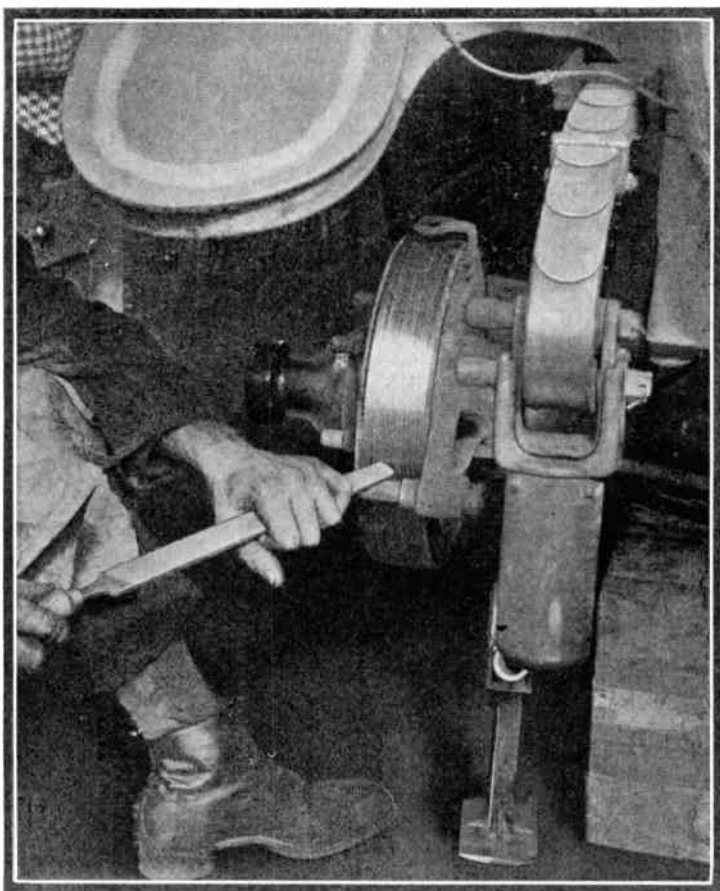

The rear axle was used as a lathe.

depreciation of the new brake bands if they were assembled on the worn drums. The first thought was to remove the drums and place them in a lathe so they could be trued up by taking a light cut across the face. This meant taking the axle shaft and wheel hub out of the axle in order to support the parts in a lathe. The car was equipped with removable wire wheels so this would not

have been as bad as removing the brake drum from a wooden wheel hub. The thought then came, why not use the rear axle as a lathe and turn the brake drum by engine power? The brake band supporting and anchorage pin member would make a very satisfactory tool rest, and a large, flat file could easily be touched up on an emery wheel to make a very practical hand turning tool of the round nose type. The car was jacked up on one side and the wire wheel removed to gain access to the drum. The engine was run slowly with the change speed gearing in reverse, and the drum was soon rendered smooth enough for all practical purposes by the cutting action of the hand tool which soon leveled down all the ridges. The same scheme could have been worked with the conventional wooden wheel, though not as handily as the illustration shows.

LACING FLAT FAN BELTS

LACING a fan belt is not a difficult operation, but unless care is taken in performing the work it is not easy to obtain a joint that will be neat and enduring. Certain preliminary precautions are necessary, an important point to observe being to make sure that the approximate edges of the belt be cut straight and at right angles to the longitudinal edges. The holes should be punched through with a belt punch, should be no larger than absolutely necessary, and should be distributed so as to weaken the belt the least. Belts used for driving cooling fans are seldom wide enough for more than three holes. It is not always possible to obtain rawhide belt lacing narrow enough to be used with these narrow belts, but it is possible to cut strips from the wider lacings such as can be obtained from any machine shop.

The cutting may be done as indicated at *A* in accompanying illustration, it being important that the knife have a very keen edge. The knife should be held between the fingers and the palm of the hand so the thumb can be employed as a guide to maintain the strip to be cut off of regular width. The lacing to be split should be given a preliminary cut of about two inches, then the knife should be placed with the point resting on a bench, the blade being inclined slightly to secure a good cutting angle. Take hold of the strip to be cut off with the free hand, and by pressing the thumb firmly against the edge of the lacing and the bench draw the strip carefully upward. When the laces are cut, trim the ends to a long, narrow point, so these may be inserted in the holes punched in the belt.

In lacing a belt, first stick one lacing end through one of the center holes in the belt from the under side, which is the portion that will run next to the pulleys. Repeat with the other end of the belt lace and draw the ends of the belt together, as shown at *B*. Next place one end down through the side hole at the opposite end of the belt and bring it up through the hole on the same side of the end of the belt, as shown at *C*. Repeat this operation with the other end on the other side, as shown at *D*. The last step is to tie

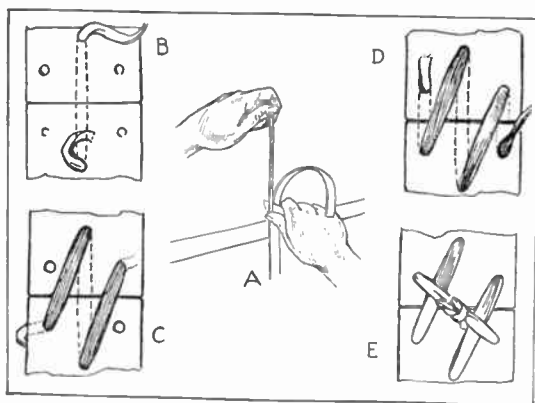

Steps in lacing the fan belt.

the ends of the lacing together at the top of the belt and cut off the surplus material. The three strips on the under side of the belt will run parallel to each other and there will be no bunching to interfere with smooth running over the pulley. Metal belt lacings are sometimes used for this purpose, but these are not so satisfactory as the more pliable material, owing to the small diameter of the fan pulley. While the flat belt is the type most generally used, as it is the most serviceable, the round section belts are sometimes employed, these running over grooved pulleys, or V belts running in 28 degrees straight side grooved driving members.

TRUCK CHASSIS PARTS THAT NEED PERIODICAL ATTENTION

THE means of adjusting brakes may easily be ascertained by inspection. If brakes do not hold properly and the friction facing is in good condition and free from oil, the failure to grip

the drum is probably due to wear in the operating leverage. On some forms of internal brakes, notably those which are expanded by a toggle, wear in the toggle links and pins may prevent proper spreading of the shoes or bands. The only way to counteract this lost motion is to shorten the operating rods, though if there is much depreciation new parts must be fitted. If the brake lining is charred or worn badly, new friction facings are absolutely necessary. The proper functioning of the steering mechanism and brakes is extremely important, as failure of these important members may result in loss of lives and considerable damage to the truck, if not in its complete demolition. Spring shackles wear out quickly, compared to other truck parts, even if well lubricated. Spring leaves may break in service, and the clips holding springs to axles must be periodically tightened. The torque members, radius rods, etc., may develop loose joints and cause annoying rattles while the truck is in operation, this noise being intensified by the solid rubber tires and being particularly prominent when the truck is operated under light loads. The tires must not be allowed to wear down too far before renewal. A little false economy in getting the last possible mile out of the rubber may result in a large expenditure for repairs at some future date because of the stresses produced in the mechanism by vibration. Never run a truck with a flat spot worn on the tire so it "bumps" along or with blocks out of a sectional block tire. A flat spot on a rear wheel will be very injurious to the entire driving mechanism.

SANDWHEEL TABLE FOR THE LATHE

A LATHE can be put to many uses beside the turning of round pieces. The drawing with this article shows a table for sawing wood and metal, or finishing flat surfaces. The ends of wooden bases, for example, are difficult to sandpaper perfectly smooth and true. There are also castings with flat surfaces which can be polished by means of this device without any great manual exertion.

The table is about 6 inches square, of cold rolled steel. This material is sold in all kinds of shapes and is easy to secure. A short bar, also cold rolled steel, of a diameter to fit in the tool rest holder, supports the plate. An adjustable guide is provided to keep the work true against the faceplate.

The polishing head is simply a round piece of wood on which is glued a sheet of emery cloth or sandpaper. Several of these heads may be turned out, carrying different grades of sandpaper

The wooden head is fastened to a faceplate with wood screws, which, in turn, is held in the tapered hole of the spindle or screwed on to the nose.

With the table and guide it is an easy matter to hold wooden or metal parts against the revolving head and give the piece a smooth finish in a moment.

Saws for cutting either wood or metal are not at all expensive.

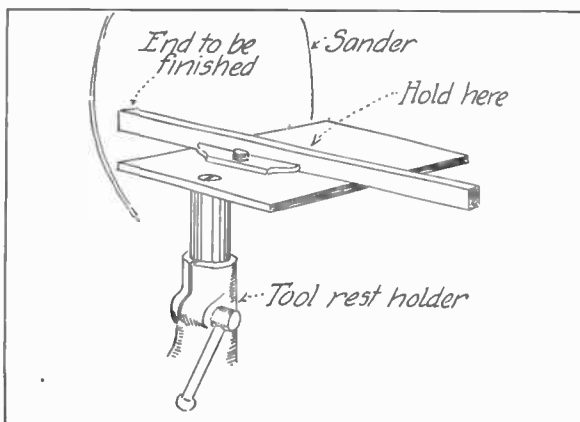

The table is held in the tool rest holder.

The Brown and Sharpe Company list a slitting saw $2\frac{1}{2}$ inches in diameter and $\frac{3}{64}$ inch thick at ninety-five cents for carbon steel and two dollars and forty cents for a high speed steel saw of the same size. A mandrel is necessary, of course, to hold the saw in the lathe. This is a straight bar of cold rolled steel, turned down at one end to take the saw, and threaded for a nut to hold the saw tightly against the shoulder of the mandrel.

Parts to be sawed are moved along the guide of the table, just as is done with a real circular saw. The table should be set at such a height that the top of the saw will be just above the upper surface of the work. In other words, the saw must cut forward and not downward.

To ease drawers which have stuck, either because of undue weight, or from the wood swelling, rub ordinary yellow soap where the tightness appears, and the drawers will then run easily.

Everyday Chemistry

THE QUALITATIVE ANALYSIS OF BAKING POWDER

BY GUSTAVE REINBERG, JR.

BAKING powders all contain sodium bicarbonate, starch (to keep the mixture dry), and either potassium bitartrate (cream of tartar) with or without free tartaric acid, calcium acid phosphate, ammonium alum, or potassium bisulfate, the function of these latter substances being to liberate carbon dioxide (CO_2) from the bicarbonate, all of them being of acid reaction. Calcium sulfate and ammonium salts are also found in some baking powders.

Shake a teaspoonful of the powder with about 30 ccs. of water in a small flask or beaker, then filter the solution and divide it into five parts of about 5 ccs. each. To one add a few drops of sulfuric acid and evaporate to dryness in a porcelain dish—a charring of the mass with a burnt-sugar odor indicates tartrates. To another part add 5 ccs. barium chloride (BaCl_2) solution (1:10), and 5 ccs. hydrochloric acid—a white precipitate indicates sulfates. A solution of 0.35 gram ammonium molybdate, 1 cc. nitric acid, and 5 ccs. water is added to a third part and the mixture warmed—a yellow precipitate upon standing indicates phosphates. Boil another portion with 5 ccs. of a 10 per cent. sodium hydroxide solution—a gas having the odor of ammonia and turning moistened red litmus paper blue, indicates ammonium salts. Aluminum is tested for by adding ammonium hydroxide (NH_4OH), little at a time, to a fifth portion of the baking powder solutions—a white, gelatinous precipitate insoluble in excess of the NH_4OH indicates its presence; to confirm, heat a little of the baking powder moistened with a drop of cobalt nitrate solution in the bunsen flame—a blue color confirms aluminum. To a pinch of the baking powder add 5 ccs. dilute (1:4) hydrochloric acid, filter, add ammonium hydroxide to the filtrate until the latter is alkaline to litmus paper, then add acetic acid until just acid. Now add 5 ccs. of a 1:10 ammonium oxalate solution—a white precipitate indicates calcium.

A LABORATORY FILTER PUMP

A vacuum pump for hastening filtration may be constructed by making the simple alterations described below to a Liebig con-

denser, which provides the experimenter with a very useful piece of apparatus at practically no extra cost.

The inner tube, *A*, of the condenser is moved until it occupies the position shown in the figure. A glass tube of approximately the same diameter as *A* is heated and drawn out, as shown at *C*, and cut off at the point where its diameter is a trifle larger than

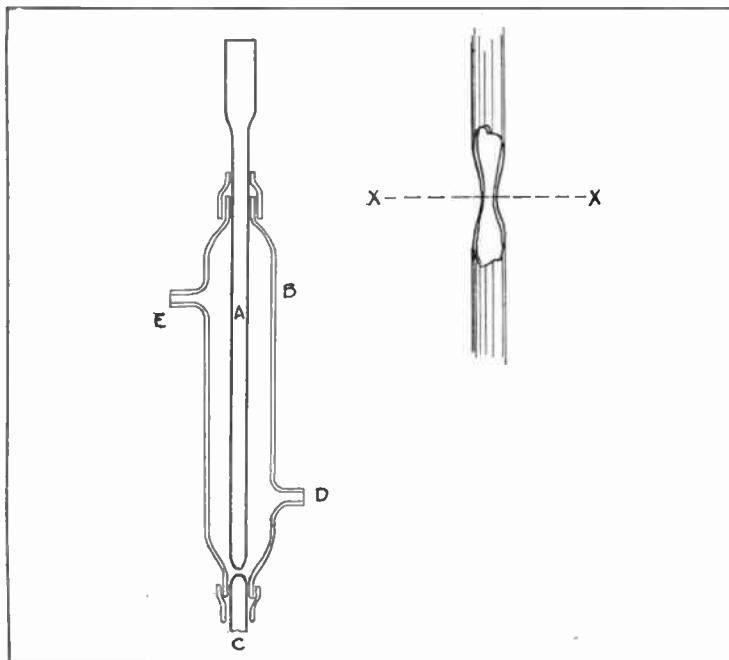

Sectional view of a laboratory filter pump.

that of the end of *A*, indicated by the line *xx*. This piece is placed in the lower connection as shown. The water is supplied to the upper end of *A*, and connection with the filtration apparatus made at either *D* or *E*, preferably the latter. Some adjustment of the positions, relative to each other and to the shell *B*, of the pieces *A* and *C* will be necessary, to conform to the water pressure used.

A STUDY IN DRILLS AND DRILLING FOR THE EXPERIMENTAL ENGINEER

BY RAYMOND FRANCIS YATES

DRILLING generally forms an essential operation in the construction of anything an experimental engineer makes, and knowing how to drill accurately and properly is a distinct asset that every amateur mechanic should avail himself of.

In the following paragraphs will be found a short but practical treatise on the subject of drilling which has been prepared for that class of readers who have never had the opportunity of becoming learned in general machine shop practice.

MEASURING AND MARKING

Unless the holes are to be drilled promiscuously, measuring and marking constitute the first operation in drilling any object. As a means of illustrating, we will assume that we have a brass plate 3 in. square and $\frac{1}{4}$ in. thick to be drilled with holes of various

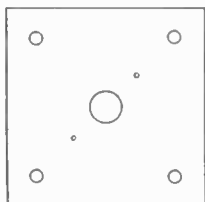

Fig. 1. How plate is to be drilled.

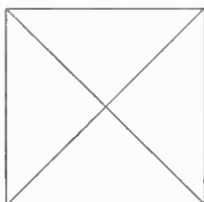

Fig. 2. Finding exact center.

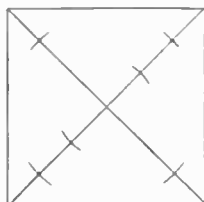
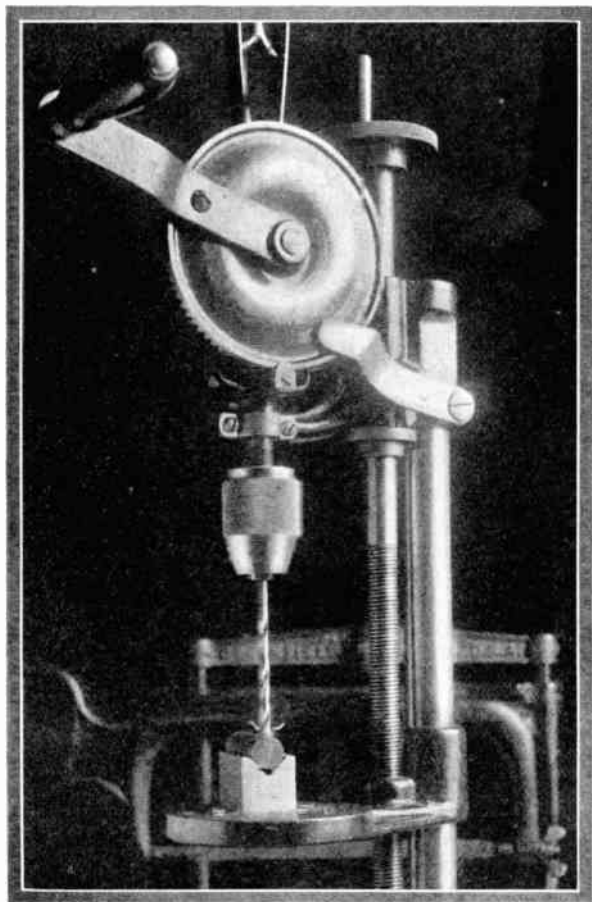

Fig. 3. Locating holes.

sizes. With the exception of the method of sharpening the drills, the drilling of a piece of brass is no different than the drilling of any other metal.

The tools necessary for marking are a rule, a pair of dividers, a center punch and a scribe. The scribe, which is merely a sharp-pointed piece of steel used to scratch marks on metallic surfaces, can be made from an old round file ground down on a wheel. A center punch can also be made in the same way. The rule is a steel one of the machinists' type and the dividers need not be larger than four inch.

The brass plate is to be drilled as shown in Fig. 1.. The first operation will be that of finding the exact center and this can easily be done by scratching two lines as shown in Fig. 2. (Do not scratch the lines too deeply as they will have to be papered off



The "V-block" can be used to advantage in many cases.

when the drilling is done.) At the point where the lines intersect, make a small indentation with the center punch, as this is the exact center and all future measurements will be made from this. We will now measure for the holes in the corners. As they are $1\frac{1}{2}$ in. from the center, we will open our dividers to $1\frac{1}{2}$ in., and with one point in the center, scratch a small arc in each corner of the plate so it crosses the line we first drew. This is shown in Fig. 3. With the dividers open to $\frac{3}{4}$ in. and the point in the center, mark two arcs as shown for the two small holes which are to be $\frac{3}{4}$ in. from the center. At each point where the arcs intersect the two original, make a small indentation with the center punch.

With the dividers open $\frac{3}{8}$ in., scratch a circle in the center of the plate and within this circle draw another one, about half the size of the first one. Also scratch a small circle at each corner and for the two small holes just off the center. These circles are to aid us in drilling and their use will be described later.

TWIST DRILLS AND HOW TO USE THEM

Before describing the actual drilling of the brass plate, a few lines will be devoted to the twist drill and how to use and sharpen it for different classes of work.

First, let it be known to every amateur mechanic that it is absolutely impossible to drill accurately unless the drill has been sharpened properly—with mechanical exactness. In order to sharpen a drill in the proper way, an elementary understanding of its working principles is essential.

Fig. 4 shows an ordinary twist drill together with the names of its various parts. It will be noted that there is a pronounced clearance between the cutting edge *A* and the back edge *B*. Both cutting edges of a drill should be at exactly the same angle and the clearances on each side should also be as nearly equal as it is possible to make them. In sharpening a drill, the angle of the lip clearance must be left to the judgment of the mechanic, and care should be taken that it is not too great as this will cause the drill to bite too greedily. Equally defective is a drill without enough clearance between the cutting edge and the back edge as it will heat up excessively and also cause the flute edges to wear rapidly, thereby throwing the drill out of caliber. To those who are not experienced in grinding drills, the writer would suggest studying the clearance on new drills of various sizes. This will be found to be very helpful. In grinding the small drills (Nos. 60 to 80),

care need not be taken in rounding off the clearance as a flat clearance will suffice. Small drills should be ground on wheels of fine grit.

If the clearance on each side of a drill is not equal, it is impossible to drill accurately with it as it will have a tendency to revolve eccentrically, owing to unequal pressure, and thereby produce a hole considerably larger than the gauge of the drill.

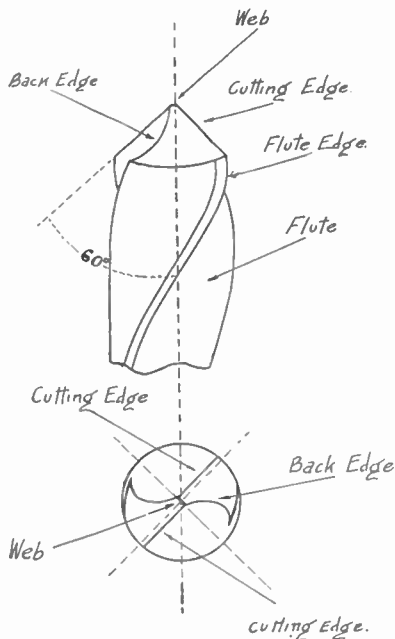

Fig. 4. Ordinary twist drill with names of various parts.

When a drill is to be used for drilling brass or cast iron, it should not be sharpened in the ordinary manner. The lip of the drill should be ground off as shown in Fig. 5. Aside from the advantage of cutting faster, this prevents the drill from worming its way just as it breaks through at the end of the bore.

DRILLING THE PLATE

Assuming that the drills are accurately and properly sharpened for the drilling of brass, we will now describe the procedure

in boring the holes in the brass plate. The large center hole shall be the first one drilled. It would be very bad practice to start drilling this hole with a $\frac{1}{2}$ -in. drill as the web of such a drill is so broad that it is a very difficult matter to accurately "center" it. The only way to overcome this disadvantage is to start the hole with a drill of smaller gauge—in this case a $\frac{1}{8}$ -in. drill will do nicely. It is at this point that the circles scratched on the plate come into use. Place the $\frac{1}{8}$ -in. drill in the chuck, start the press and bring the spindle down until the drill touches the center dot. Permit the drill to go just far enough to drill the dot off, then raise the spindle, and, by means of the small circle scratched on the plate, see if the tiny indentation made is exactly in the center, using the circle as a guide. If it is properly centered, drill just a little further (do not permit the point of the drill to go very far below the surface) and follow out the same operation on each corner. When the $\frac{1}{2}$ -in. hole in the center is drilled, go cautiously until the drill is centered accurately and do not bore right through the plate without raising the spindle several times to see that the drill is in the exact center.

MISCELLANEOUS NOTES

Those amateur mechanics who have tried to drill a transverse hole in a piece of round stock know what a difficult matter it is to do it accurately. This can easily be accomplished, however, by the use of a V-block, and, as these can be purchased for a few cents, the mechanic is urged to procure one. Their use is shown in the photograph. In the event the mechanic desires to make one for himself, it can easily be done on a shaper and the sides of the groove are cut at exactly 45 degrees.

The rate of feed and speed for small bench drills should vary with the diameter of the drill and the hardness of the metal being drilled. As a general rule, small drills should be run at high speed and larger ones at lower speed. An easy method of obtaining the approximate speed is that of dividing 80, 110 and 180 by the diameter of the drill which gives the number of revolutions per minute for steel, cast iron and brass, respectively. In drilling wrought iron or steel, the drill should be flooded with oil or cutting compound (soap and water make a good substitute). Brass, copper and cast iron should be drilled dry.

If about to drill brass, don't fail to sharpen the drill for this particular metal by grinding off the cutting lips so they will have no angle of rake. On a power driven press, and by means of a

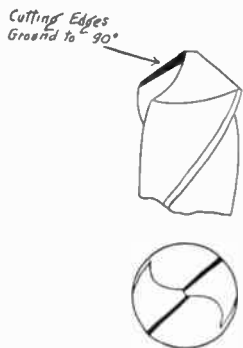

Fig. 5. How to grind drill for drilling brass or cast iron.

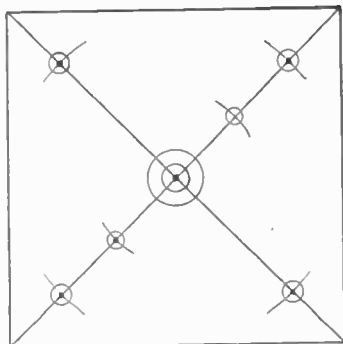

Fig. 6. Plate showing holes started after circles were made.

jig, the writer has drilled as many as twenty $\frac{3}{8}$ -in. holes in one minute through a brass strip with a thickness of $\frac{5}{16}$ in. This high rate of production can only be obtained when the drill is sharpened properly.

When grinding a drill be careful not to "burn" it by holding it on the wheel too long without dipping it in a convenient receptacle of cold water. "Burning" a drill means excessively heating it until it loses its temper.

TESTING CYLINDER PRESSURES OF GASOLINE ENGINES

By K. M. COGGESHALL

A GOOD bit of the engine trouble experienced by automobilists is caused by poor cylinder compression. This condition may often be recognized by a lack of reserve power and the inability to start the engine quickly after it has stood idle for a few hours.

A simple little device may be quickly made by the automobile owner which will indicate the exact pressure of each cylinder under operating conditions.

A rubber stopper, large enough to fit very tightly into the priming cups, should be secured and a hole drilled through the center. Fit into this hole the inlet tube of a tire air gauge, taking extreme care to see that an air-tight connection is made.

To test the compression of a cylinder, detach the spark connection so the charge will not fire and press the stopper into one of the priming cups. It may be found necessary, where large engines are

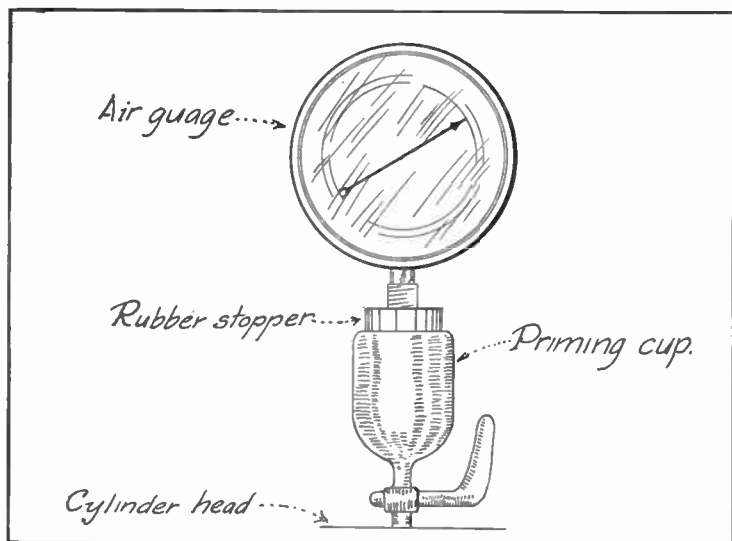

The rubber stopper is pushed into the priming cup.

under test, to wire the stopper tightly to the priming cup. Start the engine and while it is running idle, turn the cock so the cylinder gas will enter the gauge under full pressure at each up-stroke of the piston. Naturally, the gauge will register this pressure, which should be noted and recorded.

Each cylinder should be tested in the same manner. Those cylinders showing a pressure below normal should receive special attention by a mechanic and every effort made to locate and remedy the cause of the trouble. If the cylinder pressure of an engine is checked every few weeks, a great saving in gasoline, as well as keeping the power output at the maximum point, will be accomplished.

Scratches on furniture may be removed by placing a wet piece of blotting paper over the dent, and held there by the pressure of a warm (not hot) iron. This will draw the dented tissues of the wood into place, provided the scar is not too deep. The polish will be dulled if it is a bright finish, but that may be remedied by an application of furniture polish.—C. V. MOWAT.

EVERYDAY AERONAUTICS



LIGHTER-THAN-AIR CRAFT *

SPHERICAL AND KITE BALLOONS, DIRIGIBLE AIRSHIPS

THE reason why air craft of the lighter-than-air type leave the ground is a simple one. It is known that there are a number of gases which are lighter than air, *e.g.*, coal gas and hydrogen. The amount of lift possible depends upon the "buoyancy" of the gas, which is the difference between its weight and the weight of an equal volume of air. If one has an understanding of the approximate buoyancy of the gas used as a lifting medium, it is very easy to compute the lifting power of a given quantity of this gas. A balloon with a capacity of 16,000 cu. ft. of hydrogen, if it is filled at the sea level and at a temperature of 60 degrees Fahrenheit, will lift about 1,000 lbs. This, of course, including the weight of the gas and the container; and a balloon capable of lifting 1,000 lbs. would of itself weigh about 550 lbs.; this means that the envelope or container, the net-work, the observation car and the equipment it carries, as well as the weight of the gas, are all considered. The lifting power of a balloon of the same size filled with coal gas would be no more than 600 lbs. It will be evident that to lift a given weight with coal gas that it will be necessary to use a container holding nearly twice the quantity that is needed to handle the same load with hydrogen gas.

SPHERICAL BALLOON PARTS

The parts of a spherical balloon are clearly shown at Fig. 1, and may be readily understood. At the top of the main container, which is made of some fabric chemically treated to prevent leakage of gas, is placed an escape valve which is kept seated by pressure of the gas from the inside, and which can be opened only by pulling a cord convenient to the aeronaut who is in the basket. The function of this valve is to permit of a certain degree of gas escape-ment, which can be controlled by the operator when it is desired to

* This article is fully protected by copyright. Use of part or whole thereof will be considered an infringement and will be prosecuted to the fullest extent of the law.

descend. As soon as the operator ceases to exert pressure on the valve cord, the valve closes and prevents further escape of gas. It will be evident that when it is desired to descend from any altitude, that a decrease in the lifting power of the gas bag would permit it to settle to the ground. There is an open neck at the bottom of the gas bag to permit the gas to escape when it expands, as it would do when coming into warm sunshine. The heat produces an expansion and increases the volume of the gas. It will be apparent that unless some means were taken for relieving this excessive pressure, that it might disrupt the gas bag; therefore, as the gas expands it rushes out of the gas bag through the open neck at the bottom. If for any reason the sun should be obscured by clouds or there should be considerable moisture in the air, the cooling of the gas will result in its contraction, and there should be a corresponding reduction in volume; the lifting power of the balloon is therefore impaired, inasmuch as the lifting ability is the ratio between the weight of the gas carried and the amount of air that it displaces. In order to keep the balloon from falling too rapidly, and to offset this condensation of the supporting gas, it is necessary for the aeronaut to throw off ballast usually carried in the form of sand, until a state of equilibrium is reached and under which conditions the balloon will stay up as the decreased weight carried is proportionate to the lifting power.

When it is desired to make a rapid descent in order to avoid an approaching storm, or for any other reason, the escape valve is kept open until the balloon begins to settle, and when it has reached a point near the ground the operator will pull the ripping cord and tear away the ripping panel, which is normally sewed to the bag, in order to provide a large outlet for the sudden escape of gas. A grappling hook is carried to permit of securing an anchorage to any convenient tree or fence, and in addition a drag rope, which may be dropped for 100 feet or so below the car, is provided so that it may be grasped by people on the ground who would assist in bringing the balloon to a stop.

Owing to the high cost of hydrogen gas, balloons that have been used for ordinary observation purposes are filled with coal gas, but in all military ballooning the gas bags are filled from compressed hydrogen tubes. It will take about 5 hours to fill a large balloon with coal gas, whereas when the hydrogen is carried in tubes in which it is held under high pressure, less than one hour suffices to fill the bag. Owing to the ease with which hydrogen

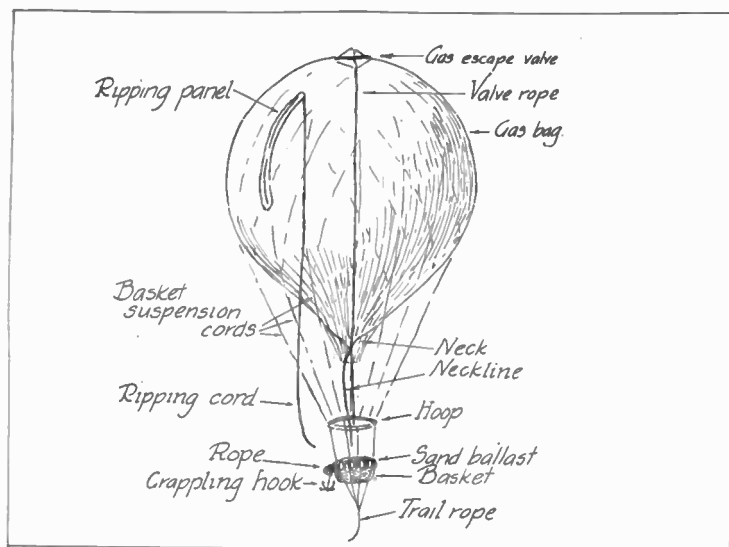

Fig. 1. Simple free balloon of the spherical type with parts designated.

may be carried when it is contained in tubes under pressure, it is always considered best for military purposes. Relatively simple hydrogen making plants have been devised which may be carried in the field in the event of the supply of compressed hydrogen tubes giving out.

It will be noted with a free balloon that there is no movement of the balloon relative to the air, as is true of an airplane or dirigible airship. A balloon must move with the air currents in which it is supported. The only control the aeronaut has over the movements of the balloon is to vary its altitude and attempt to seek air currents or winds flowing in the direction in which he wishes to go.

The material ordinarily used for making gas bags is silk, though cotton has been employed. The balloon is surrounded by a netting of cord from which cords used to suspend the basket radiate down to a hoop or spacing member of steel, which keeps them separated by the proper distance and prevents them from getting tangled. The baskets are usually of wicker work. Another use for the drag or controlling rope besides that of providing a convenient means of having people on the ground assist in bringing the balloon to a

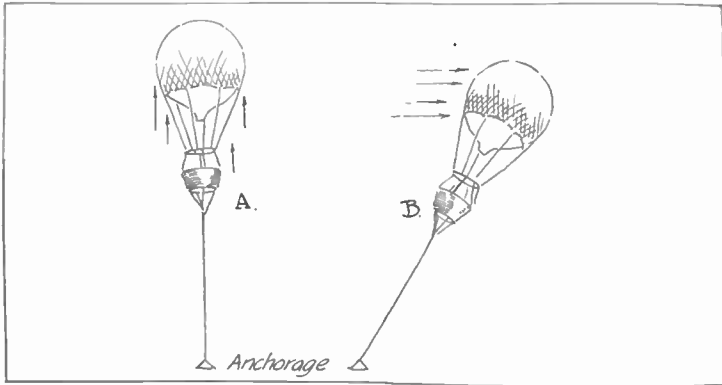

Fig. 2. Why spherical captive balloons are not suited for observation work.

stop is to preserve equilibrium at low altitudes; when the rope is trailing, a certain portion of its weight is supported by the ground, but as the balloon tends to settle more of the rope will be supported by the ground, in which case we have exactly the same effect as though an amount of ballast equal to the weight of rope dragging on the ground had been thrown out of the basket. This relieves the balloon from some of its burden. Then again, if the balloon should tend to rise, some of the rope will be lifted from the ground and the extra weight will tend to check the ascent of the gas bag.

Free balloons have no definite value for military purposes because of the uncertainty attending their use; there is no guarantee that a balloon of this nature would reach any desired point when released, inasmuch as its voyage would depend entirely upon atmospheric conditions. A cold, wet day would produce rapid condensation of the gas, shortening the duration of the flight, whereas the operation on a warm day would be much more satisfactory inasmuch as the time of flight would be greatly extended—then again unfavorable winds might blow the balloon out of its course.

The ordinary form of spherical balloon is of little value as a captive balloon for military observation because of its action when restrained from movement. Reference to the illustration of Fig. 2 will demonstrate clearly why the spherical type is not the type for military observation purposes under ordinary conditions. If one refers to *A* in this illustration it will be observed that in an ascending air current the balloon will ride in a position that will readily

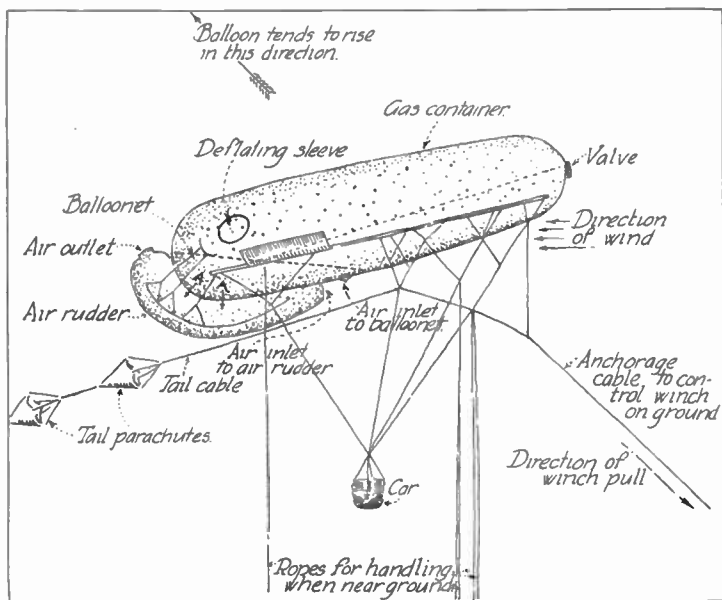

Fig. 3. Parts of typical kite balloon.

permit of observations being made; however, should the wind change, and instead of being moderate in velocity assume any speed, it will tend to move the balloon along with it, and the restraining rope, which is anchored to the ground will, of course, keep the balloon from moving. The result is that the balloon becomes inclined to a degree that makes it very dangerous for the observer, and as it would be swaying violently it would not permit of any observations of value being taken. The condition under which the balloon would work in a wind is shown at *B*.

The kite balloon, such as shown at Fig. 3, is the type that is best adapted for captive balloon work. In this balloon, by changing the shape of the gas bag and by the addition of supplementary tail members, it is possible to have the balloon act just as a kite does, and remain reasonably stable in winds of some magnitude. The construction of a typical kite balloon used for military observation purposes is shown at Fig. 3. This consists of a main bag of gas retaining material in which a smaller bag called a "balloonet" is placed. The function of the balloonet is to be filled with air

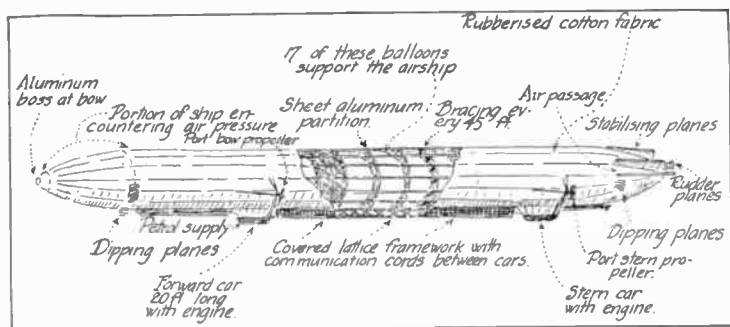

Fig. 4. Part sectional view of Zeppelin airship.

which rushes into the opening and takes care of any expansion or contraction of the gas in the main bag. When the gas in the main bag expands under the influence of the sun's heat, the air in the balloonet can flow out through outlets, as indicated by the small arrows AA that communicate from the interior of the balloonet to the supplementary air bag or air rudder attached to the bottom of the main gas container. As the air rushes into the opening of this air rudder and passes out of the way it will be apparent that as the velocity of the wind increases its speed through the air rudder bag will increase, and that it will tend to keep the assembly steady, as a tail assists in keeping a kite stable; by the use of a tail cable carrying a number of parachutes or inverted cones, which can fill with air, a further steadying influence is obtained that will keep the balloon from swaying unduly. The pull on the anchorage cable is such as always to keep the balloon in a certain position relative to the air, and as the shape of the container is that of a sausage the air actually assists in keeping the balloon up. Many hundreds of these observation balloons are in use on the battle fronts and form an invaluable method of enabling military observers to gauge the accuracy of fire of the batteries under their control.

For offensive purposes the *Zeppelin* type of airship has received considerable use by the Germans. The *Zeppelin* airship depends upon numerous independent gas bags ranging in number from 18 to 23, which are held in a lattice work of aluminum metal, so as to form a cylinder with conical ends having from 16 to 20 sides when viewed as a cross section; each of the gas bags has the usual form of deflating valve and also is provided with an automatic safety

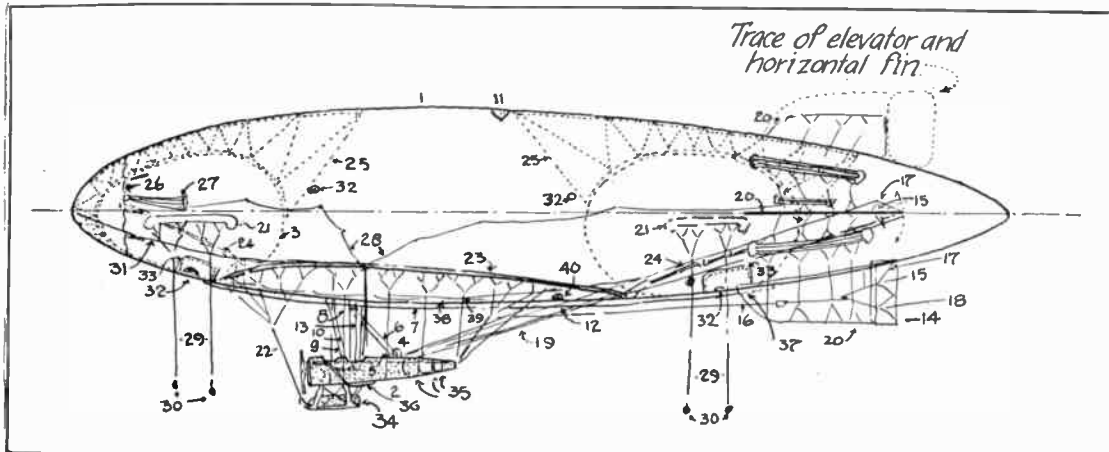

FIG. E. GENERAL ARRANGEMENT PLAN FOR NEW NAVY "BLIMPS"

- | | | |
|--|--------------------------|-------------------------------------|
| 1. Gas Envelope | 14. Rudder—Twin | 28. Rip Cord |
| 2. Car | 15. King Post | 29. Grab Ropes |
| 3. Balloonet | 16. Leads, Steering Gear | 30. Weights |
| 4. Blower Intake Pipe | 17. Bracing Wire | 31. Mooring Rope |
| 5. Engine for Blower | 18. Elevator | 32. Sight Holes |
| 6. Main Air Discharge Pipe | 19. Leads for Elevator | 33. Patch for Removing Balloonet |
| 7. Air Pipe to Balloonet | 20. Fin, Stabilizing | 34. Kapok Floats |
| 8. Air Manifold | 21. Doubling Patch | 35. Fuel Tanks |
| 9. Operation Cord, Balloonet Exhaust Valve | 22. Car Suspension | 36. Muffler |
| 10. Operating Cord, Butterfly Valve | 23. Belly Band | 37. Trimming Tanks |
| 11. Valve, Pressure Relief | 24. Webbing | 38. Operating Cords, Trimming Tanks |
| 12. Valve, Maneuver Gas | 25. Balloonet Suspension | 39. Guides for Operating Cords |
| 13. Operating Cord, Maneuver Valve | 26. Nose Reinforcement | 40. Filling Hole and Doubling Patch |
| | 27. Rip Panel | |

valve to permit the escape of gas from the bag if the pressure becomes too high. The capacity of some of the latest *Zeppelin* types varies from 800,000 to 1,200,000 cu. ft., and the dimensions range from 450 to 550 ft. in length. The diameter varies from 40 to 50 ft. A number of gondolas or cars are attached very close to the frame work carrying the gas bags, and have double bottoms and are provided with shock absorbers so that the *Zeppelin* may descend on both land and water. The rigid type of construction permits of much greater speed than can be secured with the "Blimp" design, because their shape varies to a degree as the pressure inside of the bags varies. The external form of the *Zeppelin*, which is regulated by the interior frame work construction, does not alter its shape. Another thing is that the *Zeppelin* does not only depend upon the lift of the gas it contains for ascent and descent, but it is provided with horizontal rudders or elevators which can be tilted upwards to give a certain lift when the ship is propelled in a forward direction. The long under-surface of the airship itself also acts as an elevator as it is driven at high speed through the air. Owing to the small size individual gas bags the *Zeppelin* airship does not need "balloonets," as the gas expansion is taken care of by the automatic valve. Between the gas chambers and the frame work is a space which is filled with non-combustible gas in the war craft in order to serve as some protection from fire. Another thing—this inert gas tends to shield the hydrogen gas to some extent from changes of temperature.

These airships are usually provided with water ballast and use several high-powered engines for propulsion. Four propellers are used, these being attached to the frame work of the airship and driven from the engines carried in the cars by means of gearing.

The *Zeppelin* is capable of attaining speeds as high as 50 or 60 miles per hour against mild winds, and as it is provided with stabilizing planes and other surfaces that act as elevators to raise or depress the airship, it can be readily controlled. The gas bags are in place inside of the frame work; the entire frame assembly is covered with a special fabric which is coated with an aluminum powder compound to increase heat radiation and to reduce the risk of fire. The *Zeppelin* balloon, however, owing to its large size, is very vulnerable and is much easier to hit with anti-aircraft guns than faster and smaller airplanes are.

The "Blimp" type of balloon is a non-rigid form in which the shape of the gas bag is maintained by means of an interior bal-

loonet which may be filled with air either from the slip stream of the propellor or by means of a separate blower outfit driven by an auxiliary power plant of the small air-cooled engine form as used for motorcycle propulsion. The amount of air entering the balloonet can be controlled by the operator and, of course, depends entirely upon the condensation or expansion of the gas used inside of the bag as a lifting medium.

A typical "Blimp" is shown at Fig. 5, and this type of air craft is receiving considerable application for patrolling purposes. It is capable of reasonable speed in the latest types which are provided with engines of 100 or more horse power, and is of especial value in hovering over the sea to locate the presence of submarine boats. The usual construction is to use a special cigar-shaped bag, or one with a proper stream-line form as will provide for minimum air resistance and ordinary airplane type fusilage, with places for two operators, suspended from the bag by means of the usual suspension wires. These are capable of speeds from 35 to 45 miles per hour and are provided with lifting planes and rudders to facilitate control. Where the lifting planes are used it is not always necessary to change the amount of gas in the container or to throw out ballast to obtain different altitudes. These changes may be obtained by manipulation of the rudders, and as the gas is retained for longer periods it is possible to make longer trips without excessive wastage of gas.

ED. NOTE.—The next instalment will consider the various airplane types, and how they fly.

A BURGLAR PROOF WINDOW LOCK

The frail window catches or locks used in most houses are of little protection against the determined burglar; at the most they are only screwed to the framework of the window. Positive protection can be obtained by drilling a $\frac{3}{8}$ -in. hole through the frames where they overlap at the center of the window as shown. If a short, $\frac{3}{8}$ -in.



The rod locks the window securely.

rod is inserted in the hole it will be impossible to open either the upper or lower sash without completely shattering the frames, which the average burglar will hesitate to do on account of the noise. Contributed by K. M. COGGESHALL.

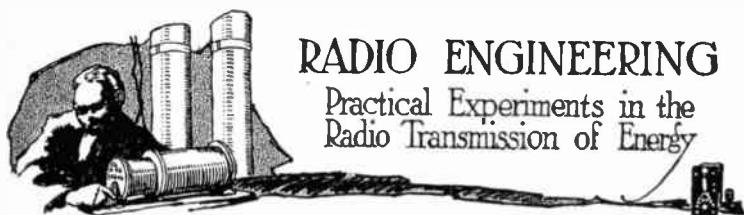

RADIO ENGINEERING

Practical Experiments in the
Radio Transmission of Energy

USING THE AUDIBILITY METER

By M. B. SLEEPER

With Drawings by the Author

THE audibility meter has become an essential instrument in the experimental laboratory. There are a number of uses to which it may be put, both for experimenting and testing apparatus.

An audibility meter, built by the General Radio Company, is illustrated in Fig. 1. It consists of a set of resistances mounted

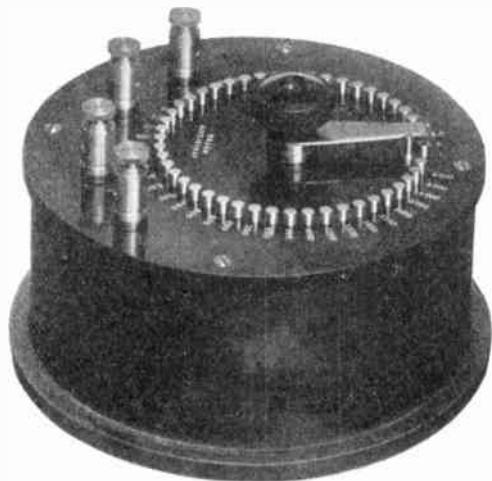

Fig. 1. An instrument used to determine the strength of signals.

in the case, and adjusted by the switch on the top. There is also a tiny, closed core impedance within the case.

A diagram of connections is given in Fig. 2. It will be seen that the telephones, when connected to the posts marked *T*, are in

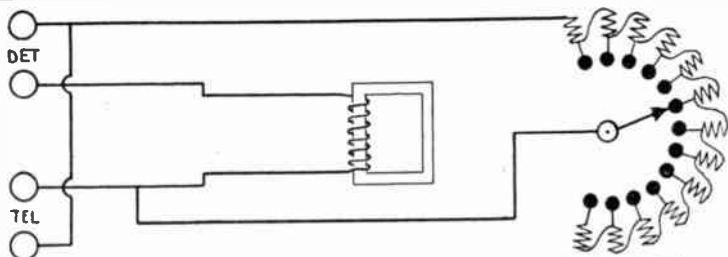

Fig. 2. Connection of meter. The impedance is to prevent local oscillations or changing of the constants.

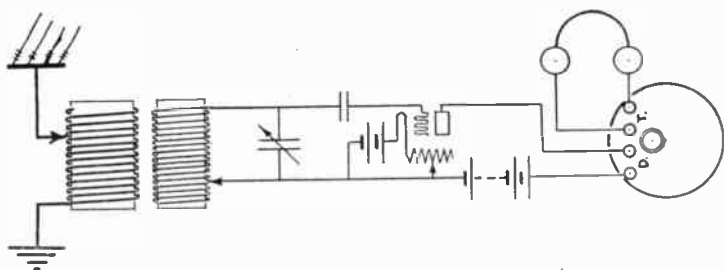

Fig. 3. Measuring the strength of signals with an Audion

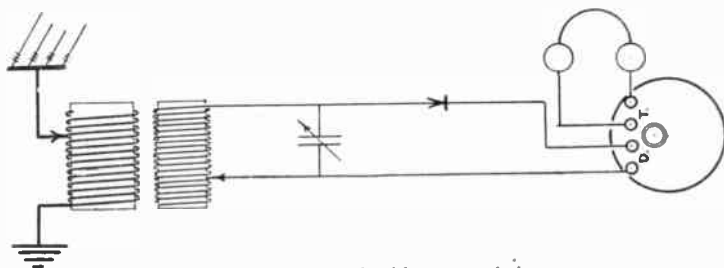

Fig. 4. The meter used with a crystal detector.

series with the detector and are shunted by the resistances of the meter. Therefore the current is divided, part flowing through the meter, and part through the phones. As the resistance of the meter is decreased, less current will pass in the telephones and the signal will be weakened. If, for example, 2,000 ohm phones are used, and the resistance of the meter is 100 ohms when the signals have been cut down so that they are just audible,

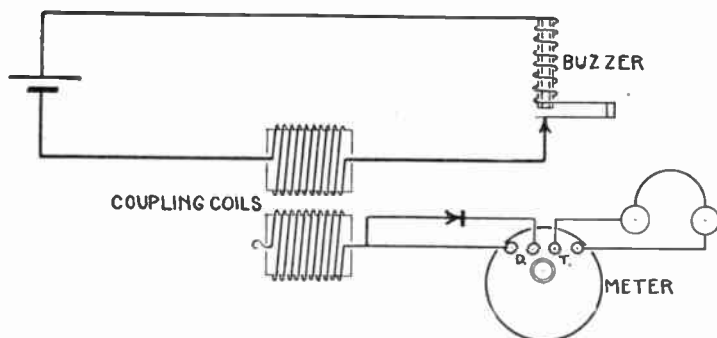

Fig. 5. Determining the sensitivity of detectors.

$$A = \frac{R_T}{R_M}$$

where

A = audibility,

R_M = resistance of meter,

and R_T = resistance of telephones,
2000

or, in this case

$$A = \frac{\quad}{100}$$

A = 20 times audibility.

The one trouble with this type of meter is that any outside noises or the adjustment of the phones on the head vary the point at which signals are loud enough to distinguish between dots and dashes.

One of the most common uses of this meter is in measuring the audibility of incoming signals. With an Audion detector, it is connected as in Fig. 3. The contact arm of meter is first placed on the point marked 1, at which no resistance is across the phones, and the apparatus adjusted in the usual manner. When signals are heard, the resistance is slowly reduced until the dots and dashes are just distinguishable. On the General Radio meter the audibilities are marked at each point, as the meter is designed for a given phone resistance, usually 2,000 ohms. The effect of slight variations in the adjustment of the Audion or tuning apparatus can be noted with very faint signals, while on the strong signals they are not noticeable. A crystal detector is wired as in Fig. 4. Comparative tests can be made on the signal strength of a distant station at different times during the day to show the effect of the light on transmission, or on the signals of different stations, to bring out

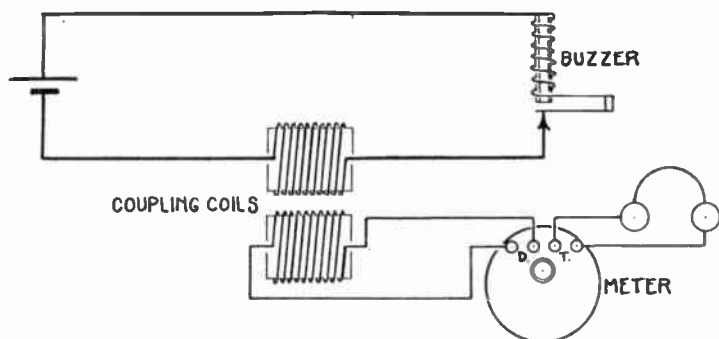

Fig. 6. Connections for testing telephone receivers.

the relation between tone and audibility or other factors. There are many tests which can be made along this line.

Another use of the audibility meter is in testing the sensitivity of detectors. A circuit is given in Fig. 5 for this work. The exciting circuit is made up of a small, constant pitch buzzer in series with a battery and a coil of about 50 turns of wire. The dimensions are not important, as it is only used to transfer a slight amount of energy to the detector. The second coil is identical to the first. Only one end of the winding is connected to the detector, as in the unilateral connection of a wavemeter. It is necessary to place the buzzer at some distance from the apparatus, that it will not be heard.

To determine the sensitivity of the detector, it is first adjusted, and the sound in the phones reduced by varying the contact of the meter. The greater the sensitivity of the detector the higher the audibility indicated. If an Audion is to be tested, the grid should be connected to the coupling coil and the meter as in Fig. 3.

The audibility meter is also useful in comparing the sensitivity of telephones, either of different makes or to determine if all of a quantity are up to standard. A diagram is shown in Fig. 6. The exciting coils are the same as those just described. In this case both ends of the second coil are joined to the meter posts marked *D*, and the phones to the *T* posts. The readings of the meter indicate the relative sensitivity of the telephones.

The diagrams in this article can also be applied to comparative tests of other apparatus in selecting the most efficient combinations of instruments for receiving.

NOTES ON BANK-WOUND INDUCTANCES

BY GORDON CROTHERS

ALTHOUGH many experiments have been made with pancake inductance coils for wireless receivers, very little has been done with bank-wound coils. This refers to coils with two to four layers, in which the turns are wound back and forth on each other.

Fig. 1 shows three types of bank-wound coils. Type *B* has two layers, with the turns wound in the order indicated by the numbers. The first turn acts as a retainer for the rest. Then come the second, third, and fourth, which is bent back, opposite the start of the

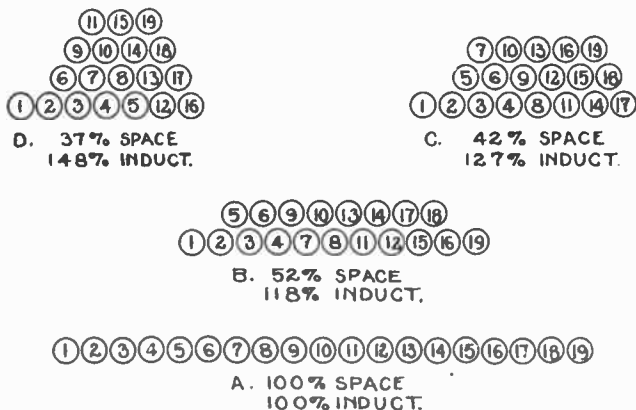

Fig. 1. Showing the relation in space and inductance of different types of bank windings.

winding, and placed between the second and third turns. The sixth turn is brought down to the tube, and two more turns wound. This may seem difficult at the beginning, but is easy to do after a few trials. The whole secret of bank windings is in getting the right tension, that the turns will stay in place. Cardboard tubes are the most satisfactory cores, as they are just rough enough to keep the bottom layer from slipping. Hard rubber or composition tubes should not be threaded, but rubbed down with coarse sandpaper. One company building apparatus for the Government uses Bakelite tubes wrapped with a sheet of sandpaper, although this method is not recommended.

Types *C* and *D*, Fig. 1, are more difficult to wind, as the wires are apt to slip off the upper layers. They have their advantages,

however, in saving space, and increasing the inductance for a given number of turns.

A simple series of experiments was made, using 19 turns of braided litzendraht, wound on a tube $2\frac{3}{4}$ in. in diameter. This wire gives 17 turns per inch. The first test was made with 19 turns wound in a single layer. The inductance was 28,180 cms., and the

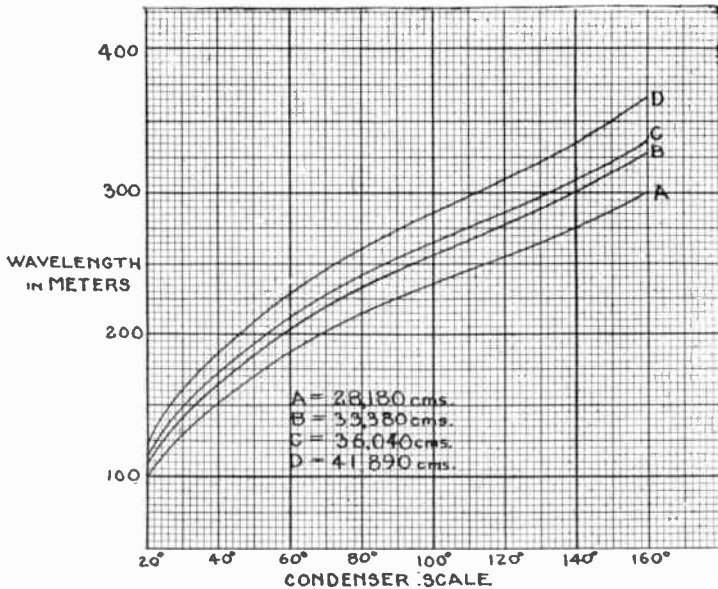

Fig. 2. Wavelength of bank coils of the same number of turns shunted by a Murdock 366 condenser.

wavelength, with a No. 366 Murdock condenser in shunt, as indicated by curve A in Fig. 2.

Another coil of 19 turns, wound as at B, Fig. 1, showed an inductance of 33,380 cms., or 118 per cent. of the inductance of A. Coil C had an inductance of 36,040 cms., and coil D 41,890 cms. The increase in inductance over the single-layer coil of an equal number of turns is shown in Fig. 1. There was practically no difference in the length of wire on the different inductances.

Where the saving of space is important, bank-wound coils offer a considerable advantage. Calling the length of a single-layer coil 100 per cent., the fraction of space occupied by bank coils is given

in Fig. 1. Since the inductance is also increased, with the same number of turns, there is quite a saving.

To show graphically the difference between the types of windings the wavelengths of the coils, shunted by a No. 366 Murdock condenser, were measured. The results are given in the four curves, Fig. 2.

In the matter of efficiency, bank-wound coils compare very favorably with single-layer coils, and have less distributed capacity than pancake windings. Practically no difference in efficiency can be detected between a four-bank coil and a single-layer coil. The capacity is only slightly higher, since the difference in potential between turns is low. Wavemeter inductances, coils for receiving sets, and inductance standards are made with bank windings.

OIL PIPE REPAIR

WHILE touring, a motorist had the misfortune to crack an important oil feed pipe so that a large part of the lubricant pumped was lost and very little was supplied to the engine. The trouble was discovered while a tire was being changed because a large amount of oil dripped to the ground from the pan under the engine.

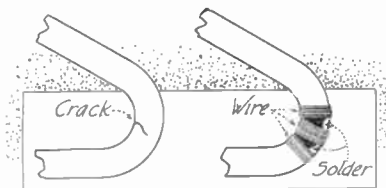

Wire was wound around the tube and then solder was applied.

As the tube was cracked only part way through it was taken off and brought to a near-by garage. The tubing was a special size that the garage man did not carry in stock, and, as the bend was peculiar, it was decided to try and save the pipe. Because of the vibration, soldering without a reinforcement was not practical.

The garage man soon had the pipe repaired in the manner shown. Some copper magnet wire, about 18 gauge, was stripped of its insulation and cleaned as was the injured portion of the tube. The wire was wound around the pipe to reinforce the weak portion and then soldered.

DIRECT CURRENT MOTOR ARMATURES

DIRECTION OF ROTATION, COMMUTATION AND ARMATURE REACTION

BY TERRELL CROFT

(All Rights Reserved by the Author)

THE relation between the direction of rotation of a motor, the direction of flux and the direction of e. m. f. is the same as for a generator, except that in the case of a motor it is the impressed e. m. f. which is usually considered. The impressed voltage is that which causes the motor to operate. This impressed e. m. f. is opposite in direction to the e. m. f. induced if the machine were operated as a generator. Hence, the left hand, as shown in Fig. 1-II, is used in determining the relations of the directions for a motor. The direction of the armature current in a motor is always in the direction of the impressed e. m. f. It follows that the direction of current in a motor is opposite to that of the current in a generator.

The direction of rotation of a motor and the method of reversing the direction of rotation can, for instance, be ascertained by applying the left-hand rule of Fig. 1-II. If a machine operating as a generator is being rotated in a certain direction, clockwise, for example, the same identical machine will, if a current is forced through it making it operate as a motor, rotate in the same clockwise direction. A consideration of the hand rule will indicate that the direction of rotation is determined by the relative directions of armature current and flux. It follows that to change the direction of rotation the direction of either the flux or of the armature current should be reversed. Hence, to reverse the rotational direction of a motor reverse EITHER the field-coil connections or the armature connections. Do not reverse both. Obviously, if both flux and armature current are reversed, their directions as related to one another remain the same, and the change will have no effect on the rotational direction of the armature. Verify this statement by applying the left hand rule (Fig. 1-II).

Commutation in motors involves the same principles as does commutation in generators. In this respect motor commutation is similar to motor armature reaction. But with motor armature reaction the field distortion is *back* (Fig. 2) instead of ahead as in generators. Hence, in a motor, the neutral plane is *back of* or *behind* the normal neutral plane. The brushes of a motor then are given a *backward lead*. The commutating plane of a motor is a

trifle back of the neutral plane (Fig. 3) when the brushes are set in the plane of sparkless commutation. The motor brushes are thus located so that when any armature coil rotates into the location where commutation occurs there will be then no current flowing in the coil (Fig. 3) before it rotates into the neutral location where it will cease to cut flux.

In a motor, the cutting of flux by an armature conductor induces a counter e. m. f. opposite in direction to the current which is flowing in the armature and which is causing the motor to rotate. Hence, if the brushes are shifted back of the neutral plane just the right distance, *the counter e. m. f. induced by the armature conductors cutting flux* will be just equal to the *e. m. f. of self-induction* developed when the short-circuited-coil circuit (Fig. 3) is opened by the commutation bar *B* rotating from under the brush. The direction of an e. m. f. of self-induction is always such that it opposes any change. Therefore, in an armature coil, the e. m. f. of self-induction at the instant of commutation tends to maintain the current in the coil in the same direction as that in which it was flowing prior to the instant of commutation. For sparkless commutation, the motor counter e. m. f. should neutralize the e. m. f. of self-induction in the coil at the instant of commutation.

Commutating poles insure sparkless commutation in motors because their effect in a motor is essentially the same as in a generator. Where motors are subject to extreme changes in load or to sudden reversal in rotational direction they are, if of ordinary construction, prone to spark. Furthermore, with motors of ordinary construction, it is usually necessary to shift the brushes as the load changes to insure minimum sparking. With well-designed commutating-pole motors, sparking does not occur even when the motors are operating under heavy overloads or when they are suddenly reversed under load. It is not necessary nor desirable to change the brush setting—the brush position—of a motor of this type after the best brush location has once been determined. Fig. 4 shows the appearance of a commutating-pole motor frame—the construction of the motors and generators of this type is practically identical.

Armature reaction in motors is, as might be inferred from the fact that any generator will operate as a motor, similar to armature reaction in generators. However, the current in a motor armature, which is rotating, say, clockwise, is in the opposite direction from the current in the armature of the same machine when it is

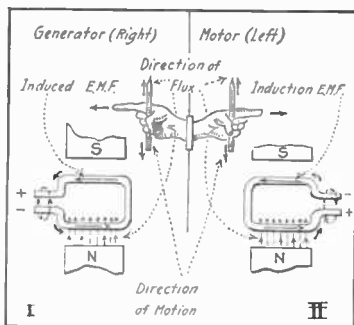

Fig. 1. Application of hand rules to rotating coils.

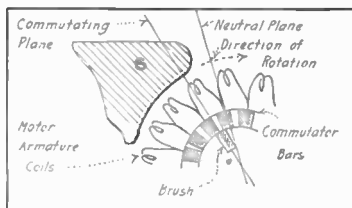

Fig. 3. Showing how the brushes of a motor should be shifted behind the neutral.

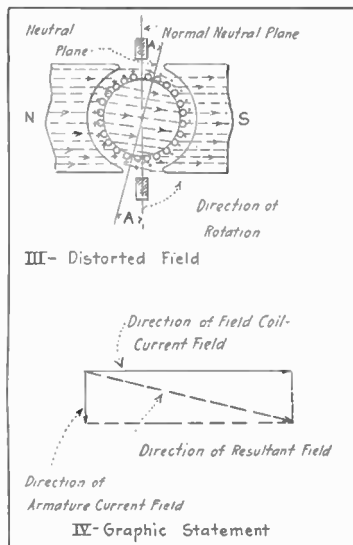

Fig. 2. Field distortion caused by armature reaction.

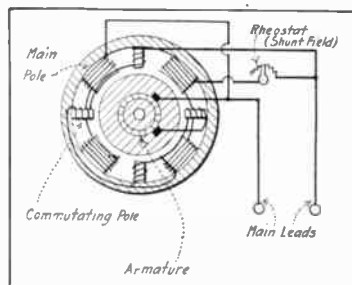

Fig. 4. Arrangement of main-pole and "Interpole" windings in a commutating pole generator.

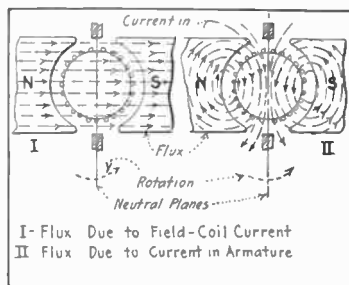

Fig. 5. Showing two fields which cause armature reaction and field distortion (generator).

operating as a generator and rotating clockwise. This renders motor armature reaction different in detail from generator armature reaction. However, the essential principles involved are the same.

EXPLANATION. Consider the generator armature which is shown diagrammatically in Fig. 5, and which is rotating counter-clockwise: The current direction in the inductors on the right of the neutral plane is *in*, while that in the inductors on the left of the plane is *out*. Now, if this same generator be operated as a motor by forcing a current through it, obviously the direction of current in the motor armature will be reversed. But, the direction of rotation of the armature will remain the same.

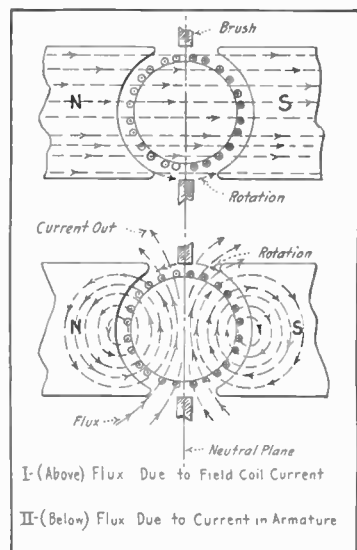

Fig. 6. Same as Fig. 5, for motor.

shown in Fig. 6-II. Since the direction of the field-current field remains the same (Fig. 6-I) in a motor as in a generator, the field of the motor will be distorted as shown in Fig. 2-III. Note that the field distortion in a motor is in the opposite direction to that in a generator. Then the neutral plane will be shifted *back* (against the direction of rotation) as shown in III.

The reader should compare carefully the illustrations showing *generator* armature reaction with those showing *motor* armature reaction. Note particularly that, in the diagrams illustrating these conditions which are given in this article, that the directions of rotation of generator armature and of the motor armature is the

Then, the current in those inductors on the right of the neutral plane will be *out* while that in the inductors on the left of the neutral plane will be *in*, as shown in Fig. 6-II and in Fig. 2.

The reversal of direction of the armature current will magnetize the armature core in a direction opposite to the direction of magnetization of the generator armature core, as

same. With the generator the field is distorted *ahead*; in the motor the field is distorted *back*. Hence, the neutral plane is *ahead* of the normal neutral plane in a generator and *back* of the normal neutral plane in a motor.

STRAIGHT WATER LINES ON BOATS

By J. E. CARRINGTON, JR.

APPLY the paint to the upper part of the sides down to a few inches below where the water line is intended to be. Then cut long strips of paper one or two inches in width and paste these on the sides so that their lower edges will mark the water line.

Apply the color desired for the lower part of the hull up to and

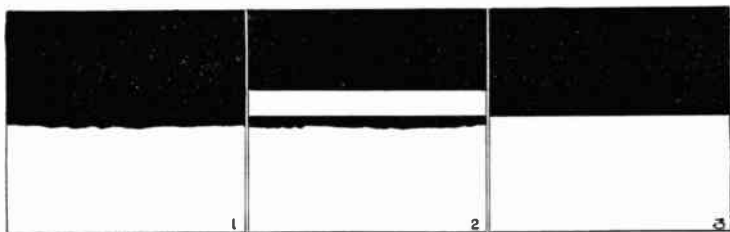

The three steps in painting by the method described.

on the paper strip. If flour and water are used in pasting the strips, they will soak off a few minutes after the boat is launched, leaving a remarkably straight water line.

By making a groove with a screw driver or scribe along the lower edge of the paper before it is removed, the boat may be repainted without the use of the paper strips.

Far superior to any furniture polish on the market is this treatment for the finest woods: Take a small piece of muslin, wet it thoroughly, then wring out as tight as possible. On this pour a few drops of olive oil, and rub the polished surface well. Then wipe off with a clean, dry, soft cloth. This leaves absolutely no murky, cloudy effect, which even the highest priced furniture polishes do. It costs a great deal less, and the piano finish which it gives is a delight to the eye. "Try it on your piano."—C. V. MOWAT.

HOUSEHOLD ENGINEERING

Practical Mechanics
for Everyday Men

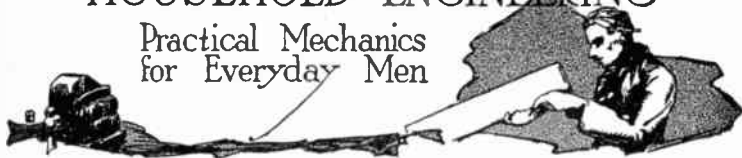

WIRE SCREEN PREVENTS PILFERING OF STOCK SUPPLIES

The stock supplies are often subject to petty pilfering and it is therefore necessary that they be protected. One shop has solved the problem by the use of large steel wire screens. They are fastened to the shelf supports at the side so they will swing open out of the way of the clerk who is obtaining

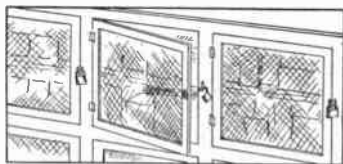

The stock can be seen, yet is safe from pilferers.

stock. When closed they may be locked securely. The wire screen has several advantages over wooden doors, chief of which is that the stock can be seen at a glance without the necessity of opening the doors of each section. This means a material saving of time in taking the periodic inventory.—Contributed by K. M. COGGE-SHALL.

DRILLING GLASS

To drill holes in plate glass break an old 3-corner file in two and grind one end of larger piece to concentric point and then cut off obliquely as in the illustration.

Grind the smaller piece to a

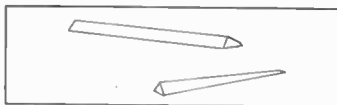

Files cut to be used as drills.

full taper and cut off obliquely as shown, to use as a reamer. Insert the drill in a bit brace and mark the hole by pressure. Then start boring and keep the drill moist with turpentine. Drill half way on one side of the glass over and then turn from the other side until the holes meet. Now take the reamer and enlarge to the size wanted. Be sure to keep both tools well moist with turpentine.—Contributed by E. E. WILSON.

IMPROVING THE PASTE BOTTLE

The ordinary paste bottle can be easily improved by inserting a pill vial or test tube and par-

tially filling it with water to keep the brush moist and in good condition.

The greatest difficulty, usually, is to keep the brush in usable shape. This kink solves the trouble and costs nothing, as

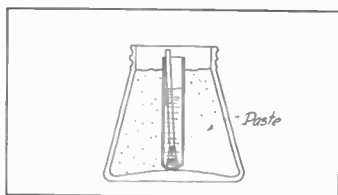

The vial is filled with water.

a discarded vial will do the trick.—Contributed by N. G. NEAR.

SILVER POLISH

The following makes a very good silver polish:

Cream of tartar 2 ounces, prepared chalk 2 ounces, pulverized alum 1 ounce.

Add enough water to make a paste. Apply with soft cloth. When dry polish with flannel.

Contributed by L. E. FETTER.

GRIMY CEILINGS

Make a simple mat or cover of coarsely woven burlap and place it on the radiator, and you will not be bothered with dirty ceilings in the future. The open-woven hemmed cloth allows air to rise through it, but sifts or filters out the dust, which is removed by occasional washing.

Contributed by MARY F. SCOTT.

A MOTORCYCLE KINK

Most of the nuts and bolts on a motorcycle are in places inaccessible to the ordinary wrench. The one pictured here is one of a set made especially for a motorcyclist.

Obtain a length of pipe of a suitable length with an inside diameter that will just go over the nut or bolt head. Heat the end of the pipe and place it

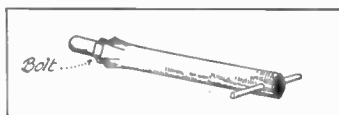

The head of the bolt fits into the end.

over the nut, then hammer until the walls conform with the nut.

Drill two holes near the other end so that a length of rod may be inserted to act as a handle.

Different sized sockets may be made to suit the varying needs of the motorcyclist. The same rod can be used as the handle for all.—Contributed by J. A. WEVER.

SOAP IN THE TOOL BOX

Soap is insoluble in gasoline and a piece of it in the tool box will prove a friend in need to the motorist who finds a leak in his gas tank.

A bit of soap rubbed on the threads of the union holding the carburetor to the manifold will guarantee a gasoline-tight joint.—Contributed by J. A. WEVER.

KEEPING DIRT OUT OF OIL CAN

Because one of the farm machines shook dust and chaff so thickly that the oil can spout was always clogged, one man devised a cap made of an empty 32-calibre shell. A plug of wood was driven into the shell and a small hole bored, so that it would just fit over the spout.



The cap prevents dust from settling.

This avoided the necessity of cleaning it with a piece of wire before using.—Contributed by D. R. VAN HORN.

CLOTHESLINE HOOK

By fastening a halter-snap to the end of the clothesline it can be removed without the usual fuss which attended the function heretofore. This is espe-

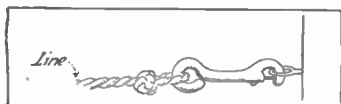

The halter snap was fastened to the end of the rope.

cially convenient when the line has to be taken in on a rainy day.—Contributed by Mrs. C. E. NOYES.

Practical mechanics should be interested in the announcement on pages 278 and 279.

A RECIPE BOOK KINK

Here is a handy kink for keeping the cook book open. Just lay a plate or other glass over the book as shown.

This kink is especially valuable in the kitchen because the housewife usually has sticky fingers while using the book and it is therefore handled with difficulty.

The method will be found handy not only in the kitchen,



The glass keeps the book open.

but wherever recipes must be followed and where the user has wet, sticky, or greasy fingers while doing the work.—Contributed by N. G. NEAR.

LENGTHENING THE LIFE OF SHOES

First buy two or three packages of brass clinch nails (which come in all sizes from $\frac{3}{8}$ in. up), and use them according to the thickness of the soles. Wear your new shoes one or two days, which enables you to see just where the most wear comes. Now, using an iron stand and last, drive in the nails quite thick where the sole shows wear. The brass nails will wear down, and do not scratch or mar the floor.—Contributed by Mrs. C. E. NOYES.