

# Everyday Engineering

"It Tells You How to Make and How to Do Things"

VOL. 3

JUNE, 1917

No. 3

## CULTIVATING VEGETABLES BY ELECTRICITY

BY THOMAS STANLEY CURTIS

*"Let me suggest also that every one who creates or cultivates a garden helps, and helps greatly, to solve the problem of the feeding of the Nations."*—WOODROW WILSON.

EVERY radio telegraphic transmitter, large or small, amateur or professional, is a potential cultivator of plant life. Through a simple conversion of the oscillation transformer, the apparatus to be found in the possession of every licensed radio amateur can be made to perform this practical service in connection with the so-called "kitchen gardens" springing up all over the country.

Following this line of reasoning, Mr. F. F. Pickslay, an ardent experimentalist of Mamaroneck, N. Y., called at the offices of this magazine a few weeks ago and made known his plans, which were formulated largely as a natural result of the order to dismantle all radio stations. The net result of the conference is that Mr. Pickslay will collaborate with the Laboratory Staff of EVERYDAY ENGINEERING in the conduct of a line of serious experiments made on the plot adjoining his residence at 24 Tenney Avenue in Mamaroneck, which is situated a short train ride from New York City.

The entire stretch of ground being planted measures 38 ft. front by 110 ft. deep. This plot is divided into two parts, one of which will be electrified, and the other without current, for purposes of checking results obtained.

### THE DISTRIBUTING SYSTEM

The system for distribution of the high-tension, high-frequency current is simple. It comprises essentially a net-work of copper wire suspended above the garden at a distance of some 8 ft. from

the ground, and a series of copper wires placed in shallow trenches beneath the ground.

In the case of our garden, the placing of the ground wires was a simple matter. The plot was first plowed, then raked, and finally the ground wires were placed in furrows produced by means of a hand plow or cultivator of the kind sold in nearly every country hardware store. The ground wires, nine in number, were bridged at either end with a piece of heavy stranded copper wire. All

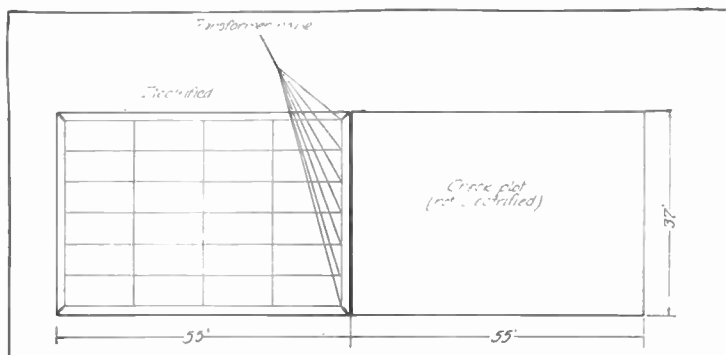

How the aerial network is stretched over the cultivated plot.

joints were soldered before the wires were buried. The ground lead is a piece of No. 4 stranded copper wire leading down a side of the house from the transformer apparatus and making connection with the nearer bridging wire beneath the ground.

The aerial net-work was formed by stretching four stranded copper wires between insulators secured to the supporting posts in the four corners of the electrified plot. Guy wires and turnbuckles stiffen the structure and enable us to make the net-work taut. Smaller copper wires are stretched between the stranded conductors, forming the closed loop as shown in the drawing. All joints in this net-work were carefully soldered with the aid of a blow torch. A rat-tail, composed of wires leading from each of the longitudinal strands, leads directly to the switch outside the house which formerly served the purpose of a lightning switch when the wireless outfit was in commission. Indeed, the scheme of connection is exactly the same as that employed for wireless, the switch being so arranged that when current is not being sent through the

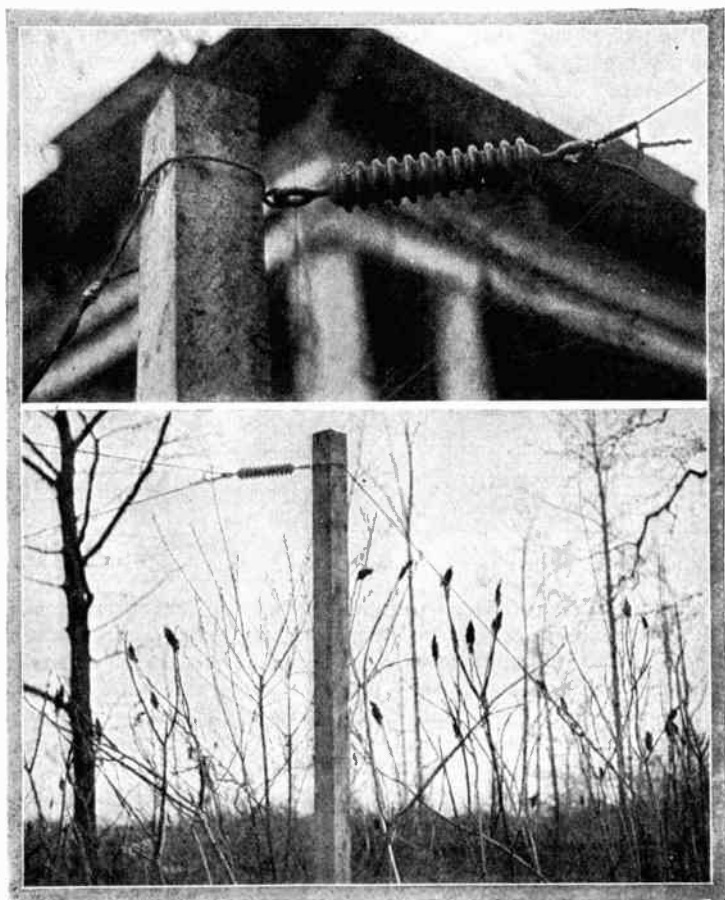

Above: A ten-inch composition insulator used to support the network. Below: How the poles are guyed. The insulation is an important consideration. In spite of the special pains taken in this case, we expect to find it necessary to add additional insulators. These will probably be placed above the turnbuckle in the guys.

net-work the switch connects the aerial net-work with the ground wires.

### CONSTRUCTION DIFFICULTIES

A shelf of rock runs beneath the entire plot under cultivation. The depth of the soil varies from less than a foot to over four feet at different points. While this forms an ideal condition from the

To right: Method of overcoming the weight of our aerial network.

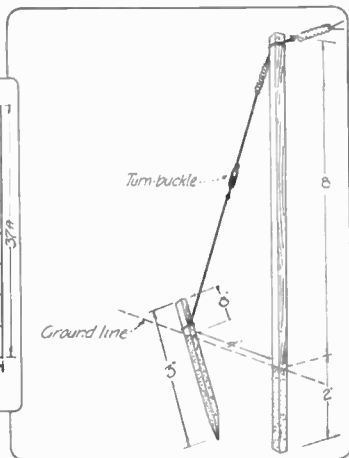
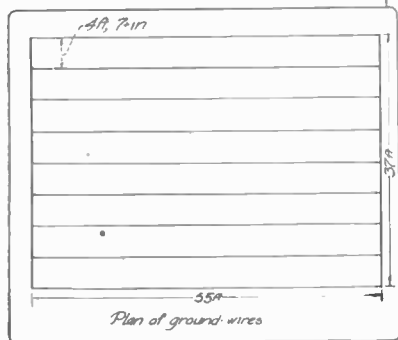

Above: The ground wires are buried in the plot to be cultivated

standpoint of vegetable raising, in view of the fact that it maintains practically a constant state of moisture in the earth, the rock caused no little difficulty when we undertook to erect the supporting poles for the aerial net-work. As the strain on the poles is considerable, we found it necessary thoroughly to guy the poles, and in this connection were forced to resort to various expedients such as the use of convenient trees upon which to fasten the guy wires. Where this was found necessary, we protected the bark by placing strips of wood under the loop of wire where it passed around the tree. In other cases, we were forced to rely upon stakes driven into the ground. We are not certain that the latter will stand the strain, and we may find it necessary to use "dead-men" at the ends of the guy wires. Be it understood a "dead-man" in this case is an anchor-like contrivance buried in the earth.

We used one 10-in. strain insulator of the high-tension variety at each pole. We expect to find it necessary to install additional insulators in the guy wires.

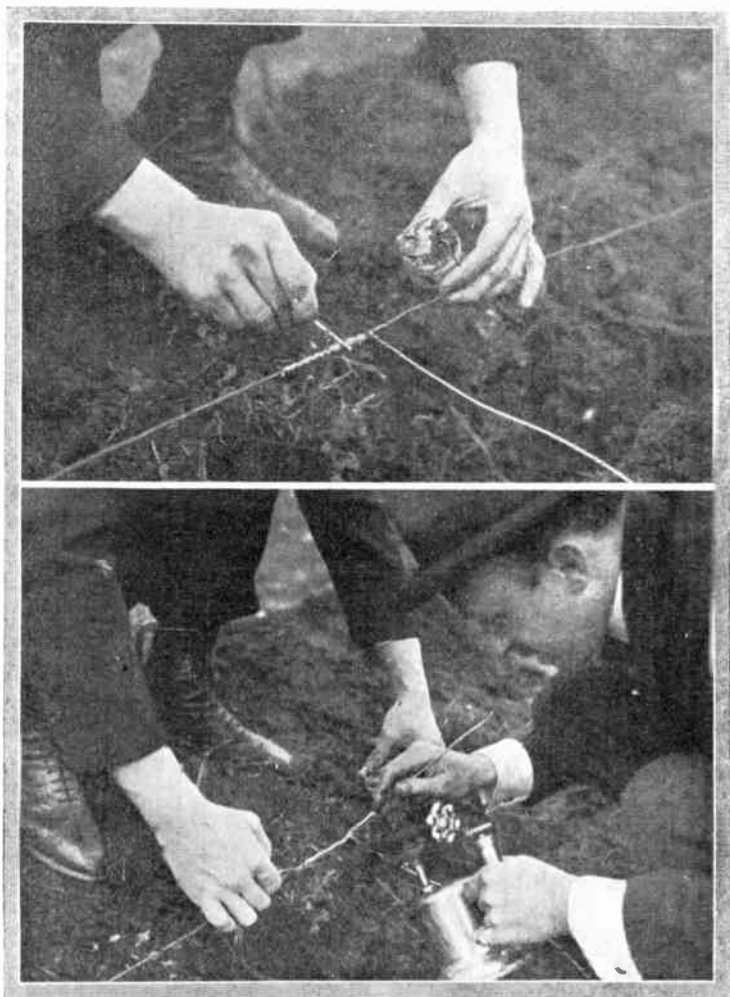

Above: Soldering paste makes the best flux. Below: Soldering the network to be buried in the plot.

In erecting the net-work, the posts were placed about two feet in the ground. In this comparatively small plot only four posts were used. The guy wires were placed next without any attempt being made to tighten them. Finally the stranded wires forming the closed loop were stretched tightly between the insulators on the posts and the joints soldered to insure non-loosening and good conductivity. The turnbuckles were next brought up to stretch the loop tightly. The longitudinal wires, five in number, were next



The ground wire runs from the instruments to the plot, and is soldered to the network in the ground.

stretched tightly between the two end wires of the loop. These joints were soldered. Then the three transverse wires were stretched between the side wires of the loop and the joints soldered. This gave us a perfectly taut net-work of ample height to permit freedom of movement underneath it in cultivating the garden.

#### VEGETABLES PLANTED

At this writing the following vegetables are being planted in both the electrified and check plots: Radishes, lettuce, peas, carrots, beets, onions, potatoes and celery. Corn will be planted as soon as the weather gets sufficiently warm.



A hand cultivator was used to make the furrows in which the wires were stretched.



Two heavy wires were stretched from opposite poles and smaller ones stretched between them. All joints were soldered.

It is proposed to keep accurate record sheets with photographs showing the progress of the vegetables in both plots. The results obtained will be published in this magazine from month to month.

#### APPARATUS REQUIRED

The method of cultivation will be the high-frequency or Tesla current method described at length in Mr. Curtis' book, "High-Frequency Apparatus." Mr. Pickslay is the owner of a Clapp-Eastham Hytone transmitter of  $\frac{1}{2}$  k.w. capacity, and this transmitter will be used to produce the necessary current.

The secondary of the oscillation transformer is composed of 100 turns of No. 18 annunciator wire wound in a single layer upon a cardboard cylinder  $5\frac{1}{2}$  in. in diameter which slips within the edgewise-wound copper strip forming the secondary of the oscillation transformer used for wireless purposes. This coil gives less than a half-inch spark when operated without any capacity

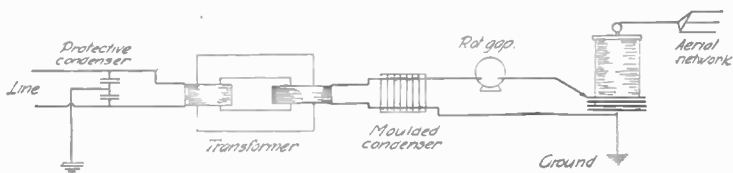

How the apparatus was hooked up.

attached to its terminal; however, when the aerial network is attached, the potential is so increased that a spark several inches long may be drawn from the coil. The diagram of connections is given in the accompanying drawing. A later instalment will cover more specifically the apparatus employed and will give photographs of the installation, with suggestions as to certain protective measures that have been deemed necessary.

#### MUSHROOM GROWING

We have plans under way for the erection of mushroom beds in Mr. Pickslay's basement, where conditions are quite ideal, though not so different from those found in the basement of the average suburban residence.

With the mushrooms it is planned to employ a straight high-tension discharge for the cultivation rather than an oscillatory current. This method is simpler and it requires less expensive



apparatus. Two separate beds will be maintained for checking purposes.

Every reader who has access to the necessary ground, and who is the possessor of suitable apparatus, is urged to take up this work and to report results to the Editor.

## THE SQUARE OF THE HYPOTHENUSE

BY W. H. SARGENT

THE principle of the "Square of the Hypothenuse" is almost equal to the "Rule of Three" in its universal application, and is a useful short cut in many matters of everyday work.

Suppose a tinsmith wishes to make a tin pail to contain twice as much as one 6 in. in diameter, but of the same height. He

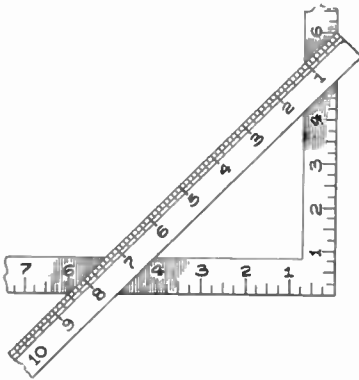

Fig. 1. All that is necessary is a rule and a carpenter's square.

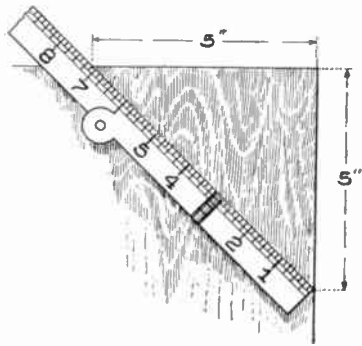

Fig. 2. How the blacksmith applied the rule.

knows in a way that it does not need to be twice as large across, but he does not know how to find the direct diameter easily. All he needs for the solution is a carpenter's square and a foot rule. Let him lay off on his square 6 in. each way, then with his rule measure across the diagonal, as shown in Fig. 1. This dimension will be  $8\frac{1}{2}$  in., which is the size required, since "the square of the hypotenuse is equal to the sum of the squares of the other two sides."

If a blacksmith wishes to know the size of a rod equal in strength to two  $\frac{5}{8}$ -in. rods, it is of little use to tell him that they will be "proportional to the squares of their diameters." How is

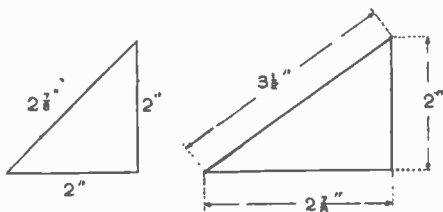

Fig. 3. In some instances more than one operation is necessary.

he to find the answer? Let him pick up a piece of board with one square corner and lay off his dimensions on this. Instead of measuring  $\frac{5}{8}$  of an inch it will be easier and more accurate to mark off 5 inches from each corner, as shown in Fig. 2, each inch representing  $\frac{1}{8}$  in. Then with a pocket rule let him measure from A to B, which will be nearly 7 in., or  $\frac{7}{8}$  in., actual size. Therefore, one  $\frac{7}{8}$ -in. rod will be equal to two  $\frac{5}{8}$ -in. rods welded together. He doesn't need to consult any hand book, nor carry a set of tables, nor does he need an expensive slide rule for his computation.

To solve for three or more factors may require more than one operation. For instance, a plumber wishes to know how large a pipe will be required to supply water to three 2-in. pipes. Let him first find the contents of two of these pipes, as described, and then add the third: by laying off 2 in. on each side of a right angle, as shown in Fig. 3, he finds it requires a pipe nearly 3 in. in diameter to equal two 2-in. pipes. Then measuring 3 in. along one edge of a square and 2 in. along the other edge for the third pipe, the hypotenuse is found to be about  $3\frac{1}{2}$  in. Now the flow of water in pipes is affected by various conditions, such as friction, roughness of fittings, etc., so that some allowance must be made, hence a 4-in. pipe would probably be required.

It will be noted that in solving these problems we used for a starting point something which we knew was square, like a carpenter's square or the corner of a board.

Now "it's a poor rule that won't work both ways." We have used a square corner to find the other elements and by the same method one can quickly and accurately lay out a square corner. If a gardener wishes to cut a path at right angles to a driveway he can do it by the rule of "six, eight and ten." Drive a peg into the ground at the proposed corner of the path and to this attach

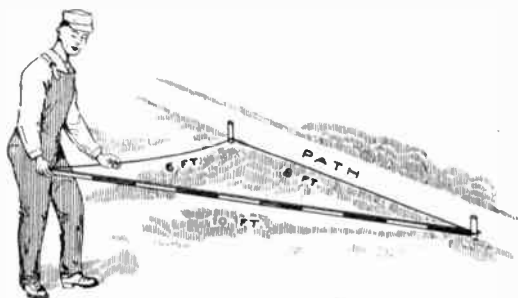

Fig. 4. The rule of six, eight, ten, may be used to lay off right angles.

two cords, one 6 feet and one 8 feet long. Stretch one cord along the driveway and swing the other along the line of the proposed path. When the two cords are so laid that a 10-foot pole will connect the free ends, the cord representing the path will be at right angles with the one in the driveway, Fig. 4. The square of the hypotenuse ( $10 \times 10 = 100$ ) will equal the sum of the squares of the other two sides ( $8 \times 8 = 64$  and  $6 \times 6 = 36$ ,  $64 + 36 = 100$ ).

#### A SIMPLE GREASE GUN

It is at best a dirty job to put grease into the differential and gear cases, but the writer devised a simple device that made this procedure easier and cleaner.

A brass tube 12 in. long and of such a diameter as to fit easily into the plug holes in the cases to be filled is obtained. A round stick of wood 16 in. long and a good sliding fit for the tube is also procured.

To use this device, plunge the tube into the grease, thereby partly filling it with grease. Insert the end of the tube in the plug hole, and by means of the stick force the grease into the case. This can be repeated until the housing is filled. Such a gun never requires cleaning, and is cheaply constructed.

Contributed by T. W. BENSON.

To take rust out of steel cover the steel with sweet oil well rubbed in and in 48 hours rub with unslaked lime (finely powdered) until the rust disappears.—A. E. BRUCE.

## CONSTRUCTION OF AN EXPERIMENTAL STEP-DOWN TRANSFORMER

BY J. H. MILLER

**I**N the course of the writer's experimental work during the past few years, it became increasingly evident that a small transformer, of about 500 watts capacity, with taps for several voltages, would be exceedingly convenient, if not necessary. Alternating current at 110 volts, 60 cycles is available to almost everyone, and with a small transformer at hand, current can be obtained to light small battery lamps, run spark coils and small induction motors, and generally take the place of a group of dry cells for all work where the current does not need to be direct. Using it to operate Christmas tree lights in multiple instead of grouping lamps in series and putting them across the line, is very much better for if one light goes out it does not affect the whole group in the series system.

Starting from the beginning, we have the fundamental transformer equation,

$$E = \frac{4.44 n \phi f}{100,000,000}$$

where  $E$  = the voltage across the coil,  
 $n$  = the turns in the coil,  
 $\phi$  = the flux through the coil,  
 $f$  = the frequency of the circuit.

In the present case, the voltage is 110, and the frequency is 60. so we can reduce to two unknowns, and we have,

$$110 = \frac{4.44 n \phi .60}{100,000,000}$$

or  $n \phi = 41,200,000$

Now since we want a 500 watt capacity, we must have wire that will carry about 4.5 amperes continuously without undue heating. A conservative design will be made on the basis of 1000 circular mils per ampere. This means we should use a wire having a cross sectional area of 4,500 circular mils, which is between number 13 and 14 in the wire gauge. We can use number 14 and still be on the safe side, since the transformer is small and the heat will be dissipated quickly. The diameter of number 14 double cotton covered wire is .075 in.

To solve the above equation, and get our values, we will assume that the cross section of the iron is the same as the cross section of one coil of copper wire. If we use average iron sheets, we can use a value of 60,000 lines per square inch for the value of flux. Let  $A$  equal the cross sectional area of the iron, and also the cross sectional area of the primary winding. Then  $\phi = 60,000 A$ , or the



The completed transformer

total flux. Also,  $n(.075)_2 = A$ . Substituting in the equation above we get the value of  $A$  to equal, 1.965, the area of the iron. Substituting back, we get  $n = 349$ , the number of turns. We will use 352 turns here so that we can subdivide it into sections to give various voltages.

Most small lamps are made to operate on 6 or 7 volts. Christmas tree lights use 14 volts, or they can be obtained in the 7 volt size also. Hence we will make our taps in multiples of 7 volts. Assuming 112 volts on the line instead of 110, we will need 16 coils, each giving seven volts. In this transformer both primary and secondary are of the same size wire, and they can be used together as an autotransformer if so desired.

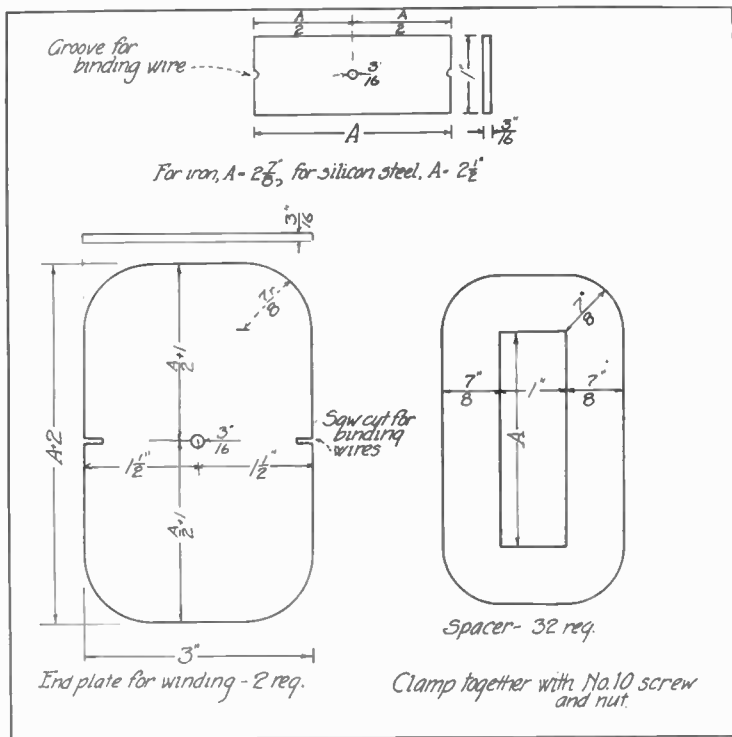

Fig. 1. The winding mandrel

The coils are wound in pancakes, each one giving 7 volts, and connected in series to give coils of various sizes to be brought out to the terminal boards. Each coil has 22 turns, in two layers. The winding mandrel is shown in Fig. 1. The iron used is  $\frac{3}{4}$  in. wide, hence our coil must be a little wider inside to allow for insulation. The iron must be built up to  $2\frac{5}{8}$  in. to allow the required area. If silicon steel can be obtained, less will be needed, and the dimension  $A$  of the mandrel can be reduced to  $2\frac{1}{2}$  in.

Between 8 and 9 pounds of No. 14 double cotton covered wire will be needed. The wire will have to be cut into pieces long enough for one pancake coil each. About 20 ft. will be the length,

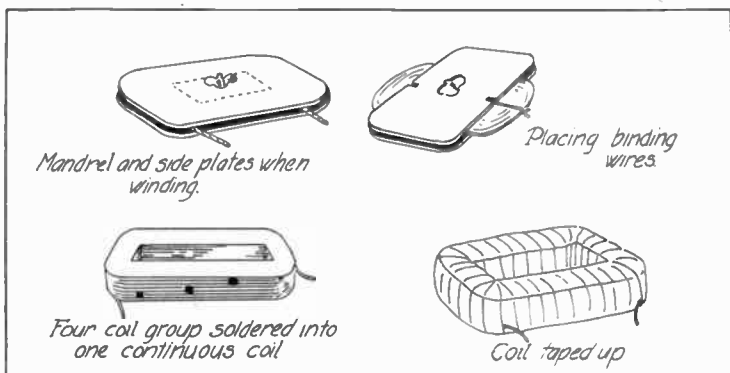

Fig. 2. Assembly of units.

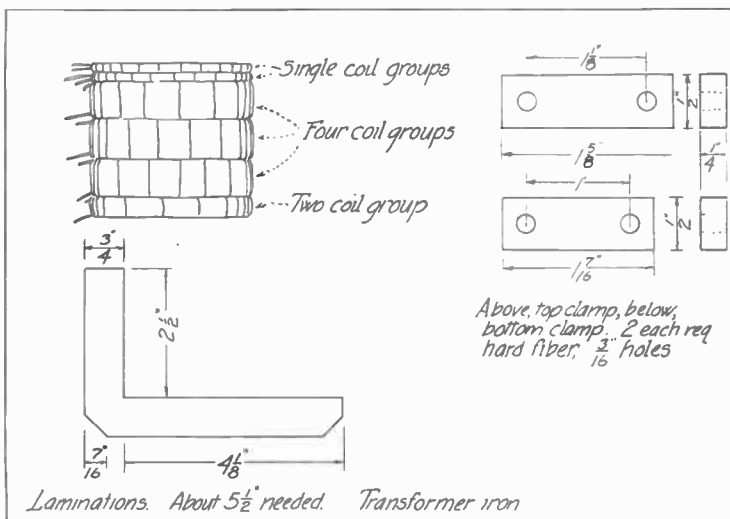

Fig. 3. Assembly of groups, laminations of core and clamps.

but the first piece should be cut extra long, and then the rest of the pieces can be cut to the right length as determined by what was left from this first piece. The mandrel should be made of wood, and the separating piece of cardboard of medium thickness, or, preferably of fishpaper. Find the middle of the piece of wire.

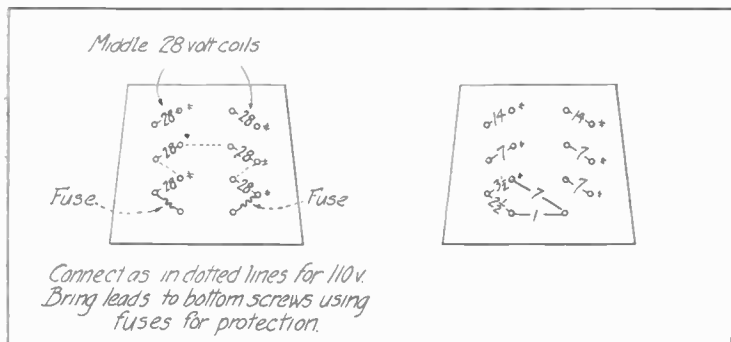

Fig. 4. Connections for various voltages.

thread it through the spacer, and then mount on the mandrel, clamping on the side pieces. Wind the two wires in opposite directions on opposite sides of the spacer and wind them simultaneously, or the spacer will be pushed to one side. When there are eleven full turns on each side, twist the two wires together temporarily and slightly loosen the side plates. Rotate them a quarter turn and pass binding wires around the end of the coil, after which the side plates can be removed, and the coil will hold itself together. About eight inches of wire should be left on the coil as leads. Thirty-one such coils are to be wound this way. The thirty-second or last coil should be wound similarly, but the inside turn should have a tap soldered to it, and also a tap three turns from one end. These give the 1, 2½, and 3½ volt taps.

The coils should next be assembled into groups. Six groups will contain four coils each, two groups two coils each, and four have single coils, including the one with the low voltage taps. Tape the coils together temporarily into groups, and solder their connections so that each group has one continuous path for the current. Then permanently wrap each group with Gibraltar tape. Other tape will do, but the varnished cambric is by far the strongest insulator. The leads may be covered with cotton sleeving, but this is not absolutely necessary. The coils are next assembled into two sections. Start with a two-coil group, then three four-coil groups, then two single coils. Tape these together on the sides with strong linen tape as a protection against the iron, and to bind them into a unit. Keep all the leads on one side, with the fractional tap coil on top of one section.



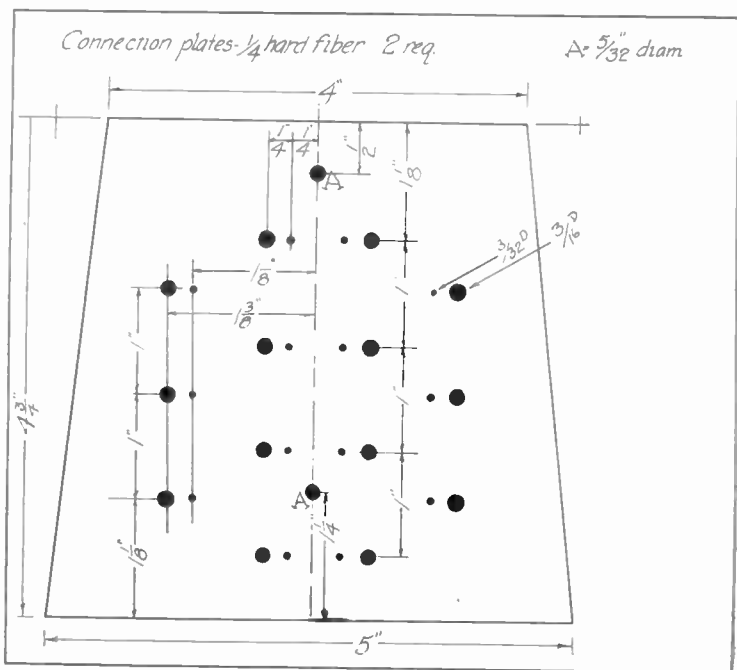

Fig. 5. How to lay out connection plates.

We are now ready to assemble with the iron. The laminations are to be cut as shown. Use the best iron possible about .014 in. thick, which is standard size for transformer iron. Silicon steel is better yet if it can be obtained. Enough must be cut to fill the coils. In assembling, alternate the position of the joint in the iron circuit to make the reluctance as low as possible. When all the iron that will enter with a little urging has been put in, line up the pieces by tapping with a small hammer. A fishpaper lining in the coil sections will aid the insertion of the iron as there will be no cloth for the sharp edges to catch on, but it is hardly needed as regards insulation.

The terminal boards come next. Make them up as in the figure, of fibre board, hardwood, hard rubber or a similar substance. Insert No. 10 screws in all the  $\frac{1}{8}$  in. holes, and put nuts on, jamming them up tight. The screws should be brass, about  $1\frac{1}{4}$  ins. long.

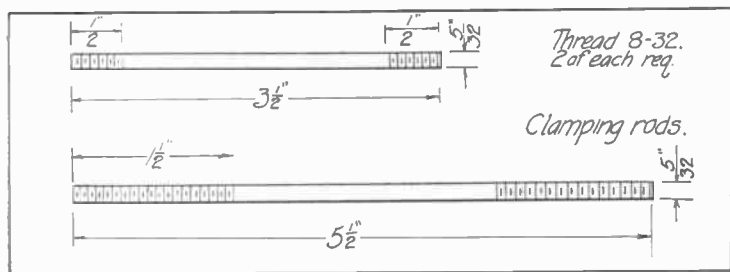

Fig. 6. Clamping rods.

Bring all terminals from the 4-coil groups, or 28-volt coils to one side, and all the other leads to the opposite side. Then insert the clamping rods, which are merely  $\frac{1}{2}$  in. brass rods threaded 8-32, and put on the fibre clamps, holding them with nuts. The cross section view shows this method of clamping in detail. Put on the bottom clamp similarly, using nuts instead of the heavy knobs shown in the top clamp. These knobs are for the purpose of lifting the transformer, and are easy to grasp with the first and fourth fingers.

Call all the leads coming from one side of the coils the  $+$  lead. so that we can cross connect correctly on the terminal boards. Then insert the wires in the small holes as indicated on the diagram, push down the boards till they touch the coils, and screw nuts on the clamping rods to hold them in place. They should set squarely so that the transformer will set straight on a flat surface. Wrap each wire around the screw next to it and cut the excess wire off. A washer should be on each side of the wire loop. Screw down another nut tightly to make good contact. A knurled head nut will complete the terminal, and the transformer is ready for use. In the terminal diagram, the one-coil groups are called 7 volt, the two-coil groups 14 volt, the four-coil groups 28 volt, as this is the voltage they will give.

The open circuit loss as measured on the transformer in the photograph was 8 watts, or 1.6 per cent. on a 500 watt basis. The full load efficiency is about 97 per cent. As to its rating, this transformer will carry 500 watts indefinitely without overheating, and will stand overloads as well as a commercially built machine. Immersing the whole thing in oil will increase its capacity considerably, though a good draft of air on it will help about as much.

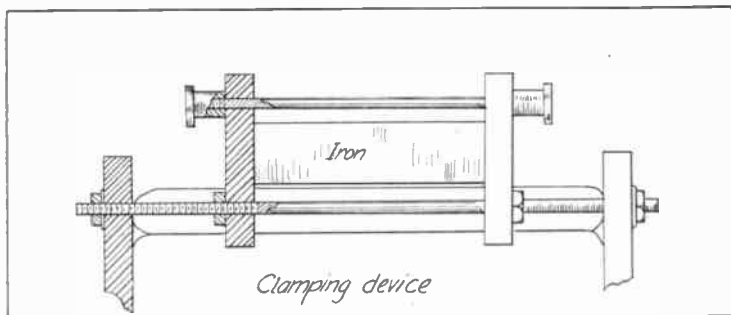

Fig. 7. Clamping device.

In connecting, put 110 volts across the four 28 volt coils that alternate, thus giving a low reactance value. Any voltage may then be tapped off the other coils. In connecting in series, connect a † terminal to a plain terminal, which will give the correct order and will make the voltages add. When paralleling coils, connect † terminals of coils of the same value together, and also their other terminals together. Coils may be connected in series and then in parallel if desired, just so all the combinations paralleled have the same total voltage. Then too, more or less coils may be connected to the exciting circuit, which will also vary the voltage in each coil. However, not less than 3 of the 28 volt coils or their equivalent should be connected to the supply circuit, else the transformer may heat up too much. Various combinations may be thought of and used to fit the experiment at hand, and a 5 or 10-ampere fuse in the primary will protect against wrong connections. There are two extra screws in the lower part of one terminal board, and open fuses may be connected to these, the leads being brought direct to them from the line, the current going through both fuses, thus doubly protecting the machine.

Several coats of shellac over the coils will serve as a mechanical protection to them and will improve their appearance. Shellac on the laminations will also reduce their tendency to hum, and will make a quiet and good looking piece of apparatus.

This transformer has several things to commend itself to experimental work, among them being the pancake coil assembly, the low reactance due to the distributed primary and so forth, but the chief feature is the fact that the transformer is entirely self

contained, and while having many taps, has no wires visible to break off or catch in clothing. It may be carried around and used where convenient, carrying with it in fact its own switchboard with big screws which will stand comparatively hard use. Being dry, and having no oil to spill or compound to ooze out, it may be used anywhere without fear of something happening to destroy the surroundings. It is in fact the most utilitarian article and also the safest the writer has constructed in many years.

The desk  
lamp.

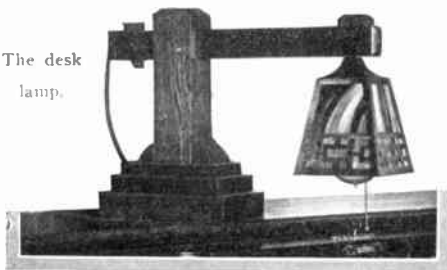

## HOW TO MAKE A DESK LAMP

BY

F. E. TUCK

**T**HE desk lamp shown in the illustration is suited for use on a roll top desk, piano or similar support. It is made in the straight line Mission style, and is a very attractive and useful piece of furniture for the study, office or music room. It is made of hard wood, of which the following finished pieces are required:

One base,  $\frac{3}{4}$  in. x  $3\frac{1}{2}$  in. x 6 in.

One base, 1 in. x  $4\frac{1}{2}$  in. x 7 in.

One base,  $1\frac{1}{2}$  in. x  $5\frac{1}{2}$  in. x 8 in.

One upright,  $2\frac{1}{2}$  in. x  $2\frac{1}{2}$  in. x 9 in.

One arm,  $1\frac{1}{4}$  in. x  $1\frac{3}{4}$  in. x 17 in.

One ornament,  $\frac{3}{8}$  in. x  $1\frac{1}{4}$  in. x  $1\frac{3}{4}$  in.

Also two pieces  $1\frac{1}{4}$  x  $1\frac{1}{4}$  x  $2\frac{1}{2}$  in., and one piece  $\frac{3}{8}$  x 1 x  $2\frac{1}{2}$  in., from which the two small corner braces and key are to be cut out as shown in the working plans.

Cut the  $1\frac{1}{4}$  x  $1\frac{3}{4}$  in. mortise through the upright very carefully, making it a trifle too small for the arm. Plane down the arm until it fits the mortise accurately, yet can be freely moved back and forth in adjusting the position of the lamp over the desk. If the slightest shade too much is removed from the arm, it will not be held at right angles to the upright, and the appearance of the lamp will be ruined.

A passage must be provided through the arm from the rear for the electric wires. This can be done by boring with a  $\frac{3}{8}$ -in. bit from both ends until the holes meet in the middle. The hole in the front end of the arm can be concealed with a wooden plug covered by a pyramid tack or a small wooden ornament secured with glue.

The wire runs from a wall socket through the arm to a socket

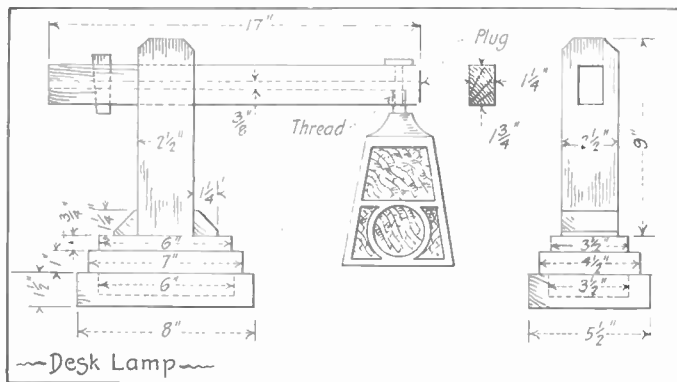

Dimensions and details of lamp.

fitted with a threaded bushing which holds it in the hard wood. On account of the many corners and inaccessible angles in the completed lamp, all the pieces should be scraped and sandpapered to a smooth finish before being put together.

In assembling the parts first fasten the upright to the smallest base block with four  $1\frac{1}{2}$  in. screws, starting all screw holes with the proper-sized drill. Next secure the two small corner pieces at the foot of the upright with a touch of glue and four brads, and screw on the second base block. In order to make the lamp very stable, cut out a mortise  $1 \times 3\frac{1}{2} \times 5$  in. in the upper surface of the lowest base block, and fill it with lead before screwing it on. Be sure that the pieces of the pedestal are well centered and adjusted with margins uniform and edges parallel before they are permanently fastened together.

Stain and finish the lamp to match the desk or furniture of the room. The lamp shown in the illustration was made of oak, and finished as follows: Equal parts of dry burnt umber and raw sienna were mixed with boiled oil until a dough-like mass was formed. Turpentine was added until the mixture was the con-

sistency of cream when well stirred. This was applied with a brush and rubbed off at once with a soft rag or cotton waste. Later it was waxed and polished to match the oak desk on which it stands. The advantage of this stain over those supplied by the trade is that it can easily be made darker or lighter as required by varying the proportions of the two pigments.

A very satisfactory shade for this lamp is a hammered or oxidized cut brass shade set with art glass. Such can be purchased at a very moderate cost. To mount it run the electric drop cord through the wire passage of the arm from the rear, pass it through the bushing, and fasten to it a chain-pull lamp socket. The top of the socket is to be screwed on to the bushing before the lamp cord is passed through. A very serviceable and ornamental desk lamp will be the result.

## A POWERFUL STORAGE BATTERY RECON- STRUCTED FROM OLD GRIDS

BY FRANCIS J. BRENNAN

**I**N reading over descriptions of storage batteries constructed by amateur electricians, I find that there are two main faults: lack of capacity and discharge, and unnecessary dead weight.

The battery which I am about to describe is constructed on different lines from the regular home made affair and is a very powerful battery built for service.

The first thing required is a container. I tried constructing them of wood but it was not a success. Then I went to an automobile battery service station and found that they had hard rubber containers in all sizes and makes. There were a number of jars which were taken from storage batteries and were in excellent condition. four of these were purchased for 15 cents. The jars were U. S. L. make 8 x 4 $\frac{3}{4}$  x 1 $\frac{3}{4}$  ins. The next important thing to consider is the grid. These I secured at the battery station from Willard storage batteries. The active material was played out and the plates were to be sold as junk at four cents a pound. I took 44 plates (Fig. 1). It didn't matter whether positive or negative. I broke them off the pillar to which they were connected, leaving a lug about an inch long on each plate to make connections later. The plates weigh one quarter pound without the old material and they cost one cent each. This type of grid is infinitely better than a plate of lead bored full of holes. The active material which was on the plates is knocked out by gently tapping flat on the plate

with a stick and the paste falls out in chunks. The obstinate crumbs which remain are scraped off with a knife.

The plates are now ready to receive the paste. I will describe the positive plates first.

The materials used are: red lead, sulphate of ammonia, and a strong solution of ammonia. Do not attempt to use dilute sulphuric acid to mix the paste because it is a failure as the material falls out when the plates are being formed. It is important that only enough paste is mixed at one time for two plates as the paste hardens to cement in 45 minutes.

Mix red lead 100 parts by weight with sulphate of ammonia, which is like a white salt, to these two add a little ammonia at a time and stir well. The purpose of the sulphate of ammonia is to make the plate porous in order to allow the electrolyte to penetrate quicker and draw a heavier current than could be accomplished otherwise. It is very important that the mixture is kept about the consistency of putty.

Take some blotting paper and place one grid on it. Then take a putty knife or small trowel and work the paste into the grid with considerable pressure so that there will be no bubbles. When the grid has been completely filled take a smooth stick and smooth off the surface. Then turn the plate over, being careful to place a blotter under the side that has just been smoothed, and smooth the other side. After the plates have been filled they are taken, with the blotting paper still adhering to them, and placed between two smooth boards and placed under considerable pressure for 15 minutes. I jacked up the front wheel of an auto and put them under it; if a letter press can be secured it is just the thing. After the pressing operation the plates are removed. The paper is carefully peeled off taking great care not to draw any of the moist paste along, because it cannot be replaced. The plates are now ready for drying. They are laid flat on a board and put up on the roof of the house or some other exposed place where they can get the full benefit of "Old Sol." It requires 24 hours for the sun to dry them thoroughly. Every few hours they are turned so that they are baked evenly. When dry they will be found to be very hard and of a bright red lustre. The surplus material which may have been pressed around the edges is now scraped off.

The next operation which the positive plates undergo is called sulphating. A solution of distilled water and sulphuric acid is made with a specific gravity of 1,100 degrees. Each positive plate

is dipped for an instant in the solution and quickly withdrawn. It will be noticed a great quantity of bubbles are given up; the plates are dipped again for 5 seconds and withdrawn. Then they are immersed for a third time and left in solution for 20 hours.

After the twenty hours are up, remove the plates and place in running water for two hours and wash with a tooth brush. The positive plates are now ready for forming.

The negative plates are constructed as follows: litharge or yellow lead 100 parts by weight, sulphate of ammonia 8 parts by weight. The mixing matter is made by taking one part pure glycerine and five parts strong ammonia and mixing thoroughly. These are all mixed together the same as the positive. The purpose of the glycerine is to make the material soft so that it can stand hard electrical abuse. It is important that only enough material is mixed to supply about two plates, because it hardens very rapidly. The correct amount can be made by taking the litharge and sulphate of ammonia when dry and spreading it over a plate.

The negative plates are baked in the sun for the same length of time as the positives, but they do not receive the sulphating bath. The negative becomes a dark brown after exposure to the sun. All the plates are now ready for assembling. The usual method of arranging plates is to place a positive between two negatives but it is the positive plate that does the work and gives the capacity, therefore we will use more positives than negatives. Eleven plates are contained in each jar of which six are positive.

It is better to get the separators (40) at the battery station because the wood used in them is chemically treated and they are corrugated on one side. Used separators are all right if not broken. You can get them for nothing. The next thing needed is called a pillar connecting strap as illustrated in Fig. 2. Some have five and some six slots; one of each will be needed for each cell, 6 slots for positives and 5 slots for negatives. On each plate there is a lug about an inch long; the pillar strap fits on these lugs which are soldered fast. The pillar straps can be purchased for 3 cents each. (Those which were used before.) It is better to purchase these straps instead of trying to solder or burn strips of lead to the short lugs on the plates because if it is desired to draw a heavy amperage, large carrying capacity is required and these are just the thing. If, instead, a strap is soldered to each lug on the plate it would make an unnecessarily big bundle to have six straps com-



ing through the top of the case and it would be difficult to keep good contacts. I would also advise purchasing from the same source for same reasons a pillar strap connector. Both of these different connectors can be purchased for a few cents each. The purpose of the pillar strap connector is to join the different cells in series. (Fig. 3.) If you desire to make this connector it can be made by taking a short piece of 000 B. & S. copper wire three inches long and soldering on each end a copper lug of 150-ampere

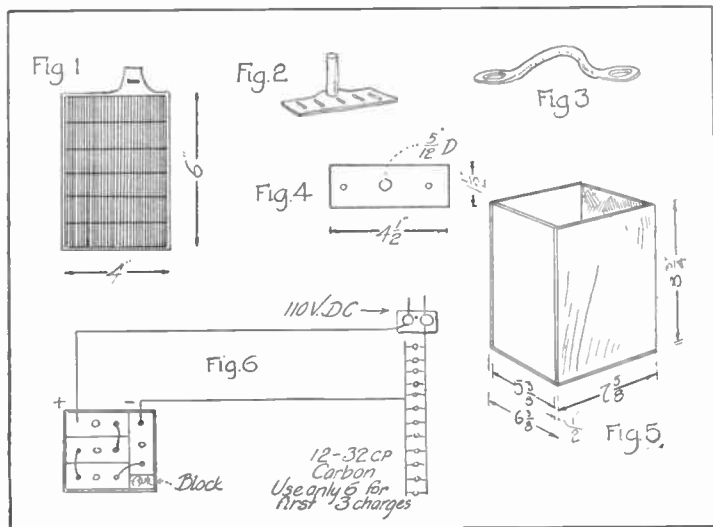

Various parts of the battery, and method of hooking-up for charge.

carrying capacity, the lugs in turn being soldered to the positive and negative posts. It will be necessary to tin the copper wire and also the lugs to prevent corrosion.

The next thing to be considered is a cover for the plates to fit in the jar. Cut four pieces of oak wood  $\frac{3}{8}$  in. thick,  $4\frac{1}{2}$  in. long,  $1\frac{1}{2}$  in. wide, so they will make a very tight fit when pressed into the hard rubber container. A hole  $\frac{5}{12}$  in. in diameter is bored in the center for a vent cap, and threaded to receive the cap. The vent caps can be had for the asking at a battery station as there are hundreds of them lying around. They allow the gases to escape but not the water. The oak wood is boiled in paraffine for two hours to make it acid proof. Two more holes are bored to admit

the positive and negative posts. (Position of holes shown in Fig. 4.)

Having soldered the pillar connecting straps to the positive and negative groups respectively, the cells are ready for assembling. The positive group of one unit is placed on a table with connecting post up. The same is done with the negative plates. They are now interlocked so that there is a positive on each end of a complete group. The positives and negatives are now gently forced apart and the separators placed between them with the smooth side facing the positive and the corrugated against the negative. A rubber band is slipped over the assembly to hold them in position. The complete element is now lifted up by the posts and placed in the container. Then the oak top is forced down over the positive and negative posts until it is  $\frac{1}{4}$  in. below the top of the jar.

Now mix a solution of sulphuric acid and water of 1,180 degrees density. Enough electrolyte is poured into each container so that it will extend  $\frac{1}{4}$  in. above the plates. Now screw the vent caps in the holes and pour a small amount of melted tar or rubber on top of the oak wood. Keep twisting the vent cap back and forth until the tar sets or it will stick fast.

The pillar strap connectors are placed over the posts so that the positive of one cell is connected to the negative of the next, leaving one positive and one negative free. When the strap has been placed over the post, it will be noticed it does not go down all the way; the rest of the space is to be filled in with solder. A box container for the jars is made of half inch oak wood impregnated with asphaltum varnish. The dimensions are given in Fig. 5. Three cells are placed in the box with their greatest widths against one another; this leaves one cell which is placed as shown in Fig. 6. This leaves a little space which is filled with a small block of wood. Then some more rubber is melted and poured over the four cells so that the division marks will be concealed, presenting a smooth surface.

The battery is now ready for charging. The current *must be direct*. A lamp bank of six 32 C.P. lamps is necessary. The positive terminal of the line is connected to the positive battery terminal and negative of the line to the negative battery terminal. The battery is charged for thirty hours at 6 amperes, then discharged through a resistance. Charge again, then discharge and charge and discharge a third time. The plates are formed now. The positive has changed to chocolate brown and the negative to slate gray. The vent caps are removed and the electrolyte re-

moved by turning the battery upside down. Rinse thoroughly with distilled cold water. The old electrolyte is thrown away and a new one made with density of 1.250 degrees and poured in each cell as before. The battery is now charged with 12 amperes for 12 hours, requiring twelve 32 C.P. lamps. The battery is now ready for real service. Four batteries of this type would make an ideal private lighting plant in connection with a small generator. It could also be used for driving small electric launches or carriages. It can't be beat for wireless telegraphy—It puts "Pep" into the spark. Here is something that few home made batteries will do without injury: Crank a Reo or an Overland car for 6 minutes and a Ford for 8 minutes without any apparent effort or injury.

#### A LITTLE ADVICE

Don't let the electrolyte get below the top of the plates. Don't use a naked flame where the battery is being charged. Charge the battery at least every three weeks or when the voltage of each cell while working is 1.8. Spec. Grav. 1,100. Don't lay screw drivers or knives across the terminals to see if there is juice there—it is a dead short circuit. If you wish to take the battery down for the winter or other reason: remove the tar with hot putty knife, lift out oak top and remove elements, separate positives from negatives and take the separators and keep them in water. Wash the plates and put them away. The electrolyte may be stored in glass bottles. *It is understood that the battery is to be fully charged before these operations take place.* When the battery is again set up, charge it again and it is ready for work.

Twelve amperes for twelve hours is the regular charging rate after the battery has been formed. The length of time required to charge the battery depends on how much it is run down. When 1,100 degrees on a hydrometer is reached, the battery should be charged until 1,180 degrees is reached.

---

#### FOR MAKING SHOES WATERPROOF

To three parts of lard, add one part of paraffin wax. Boil these two together and then set out to cool. When cooled off, dip a piece of cloth into the mixture and rub well into the shoes.—

CHARLES JANK.

#### STEAM-HEATED SOIL

It has been found by English investigators that heating soil with steam pipes before planting seeds increases its food value, and that plants raised therein blossom earlier and produce more and better crops.

## A DRILL-PRESS FOR THE HOME SHOP

BY H. H. PARKER

THE amateur who possesses a small screw-cutting lathe soon finds that a drill-press, while not absolutely essential, would be most convenient and would greatly facilitate the drilling of such pieces as are too heavy or hard to hold in the lathe. A regular drill-press is expensive and one suitable for drilling large holes, comparatively speaking, would in all probability come beyond his means. The small hand power drills are only suitable for light and small work. One other type of drill press may be considered, the kind made for blacksmith use and usually sold under the name of "Blacksmith's Drill Press." These machines are built for hard service but are sold very cheaply, a size suitable for drilling holes up to 1 in. in diameter and provided with automatic ratchet feed selling for so low as six or seven dollars. Second hand drill presses of this kind are found almost everywhere and can be purchased at an extremely low figure.

The object of this article is to show how one of these drill presses, with some alterations within the range of the amateur who owns a small lathe and the usual hand tools, taps and dies, may be made into a very presentable and useful machine for the home workshop. Suppose we have obtained a new or second hand blacksmith's drill provided with the usual hand crank and ratchet feed; let us examine it and see what needs to be done to adapt it to the amateur's purpose. A tool of this type, while intended for hard service, is used mainly for rough work such as drilling flat iron stock. The stock used around a blacksmith shop is generally flat, so that no long holes have to be drilled. Therefore the machine is not built with any great degree of accuracy and the range of table adjustment is limited. Usually no provision for driving by power is found on the smaller sizes. The home mechanic as a rule does not work to any extremely close limits, and as these drills are provided with fairly long bearings of liberal diameter he should be able to so reconstruct one and increase the range of adjustment as to make it a most useful part of his shop equipment. Furthermore we will arrange to have the drill press work in partnership with the lathe, so to speak, and make use of the latter's chucks and face plates, thus making unnecessary the buying or making of new ones.

The first thing to do is to decide where the press is to be located

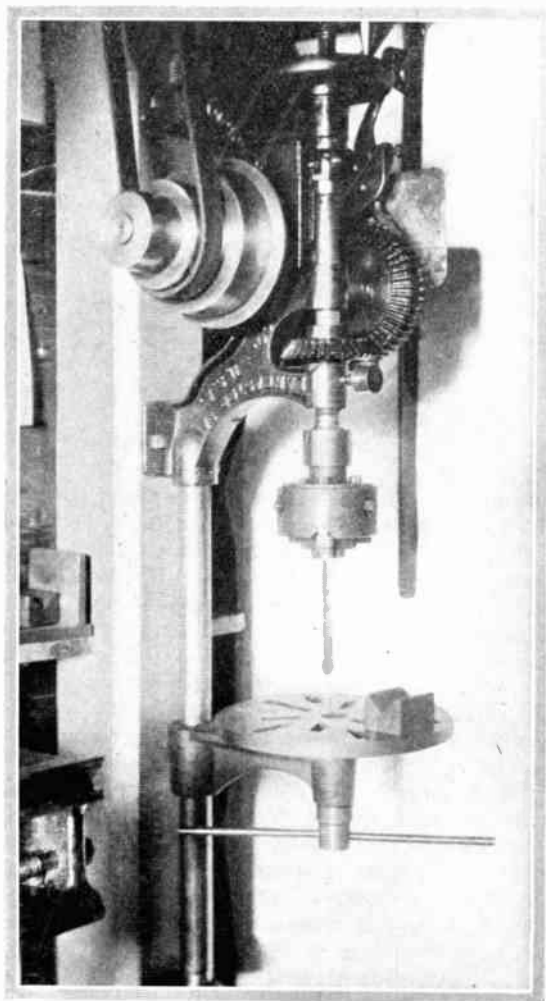

Table and arm are arranged slightly different than the method described, the latter being an improvement.

and then to put up a substantial post to bolt it to. Assuming that the machine is to be power driven, the crank handle being removed but kept nearby for occasional use, a countershaft should be rigged up near the post and driven from the main shaft by a flat belt about  $1\frac{1}{4}$  in. wide. Tight and loose pulleys on the countershaft and a belt shifter with wooden or iron handle afford a quick and easy means for starting and stopping the drill. The post is preferably secured against the wall and should extend to and rest

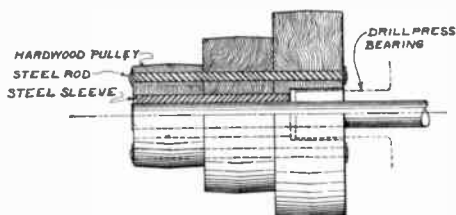

Fig. 1. One method of constructing a step pulley.

upon the floor; since the drill table slides up and down on a steel column which is bolted to the post, this should be heavy enough to stand the strain produced by a large drill without bending, which would destroy the accuracy of the work. Blacksmith's drills are usually sent out secured to a short length of plank; this should be removed and the frame of drill bolted directly to the post. The machine shown in the photograph is fastened to a post about 8 by 8 inches extending down to the floor and secured to the wall by through carriage bolts.

Having set up the post, return to the drill press and remove the short piece of shaft upon which the table arm slides and bolt the framework with gearing and spindle at a height such that the handle on top, which is turned to move the spindle up and down, is within convenient reach. In bolting to the post it is best to use "hanger bolts" instead of ordinary lag screws. A hanger bolt is made like a lag screw except that it has a nut on the end instead of a solid head, so that in case of removal only the nut has to be taken off. Lag screws may be adapted to the purpose by sawing off their heads and cutting threads on the bodies for standard size nuts. In fastening the frame in place use great care to get the spindle as nearly vertical as possible by means of an accurate square and level. Place metal shims under the holding down bolts

where necessary and adjust until the spindle is perfectly plumb when all bolts are set up tight.

The next thing will be to prepare the drive shaft for operation by power. In order to adapt the machine to the drilling of different sized holes more than one spindle speed should be provided for, because the proper speed for large drills would be altogether too slow for the small ones and *vice versa*, if the drill could run at but one speed. This calls for a cone or stepped pulley, both on

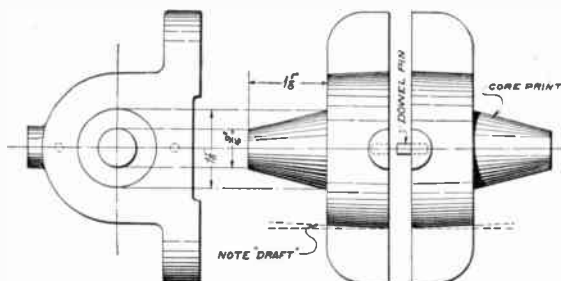

Fig. 2. Wooden pattern for bracket shown in Fig. 3.

machine and on the countershaft, such as the one shown in the photograph. This pulley was turned up from an old casting which happened to be on hand, but ordinarily the easiest way to make one would be to turn it up from hardwood. The iron pulley might, perhaps, look better although as a matter of fact a wooden one would provide a better friction surface for the belt. A longer shaft will in all probability have to be made to hold this pulley, since usually there is only room for a flywheel. A flywheel is unnecessary with a power drive and it should be removed so as to locate the step pulley nearer the bearing. Fig. 1 shows one method of constructing a step pulley: the parts are held together on a steel, brass or cast iron sleeve which is made a close working fit on the shaft. The pulleys are built up of blocks of oak or other hardwood assembled on the bushing, bolted or riveted together, then held between lathe centers and turned to shape. The whole can be held to the shaft by means of a short key and a set screw tapped through bushing or by a set screw alone. It is best to counterbore the large end of the pulley as shown in order to allow this end to overhang the bearing bracket and thus cause less strain on the outer end of shaft. An outboard bearing on an independent bracket could be

installed if thought necessary but this was found unnecessary in the machine in the picture. The diameters and width of the pulleys must be worked out for each individual installation, for the proper sizes depend upon the degree to which the spindle is geared up and upon the speeds at which it is to run. Space will not permit going into an explanation of the method of making calculations for step pulleys; for this the reader should refer to such publications as "*Kent's Mechanical Engineer's Pocket Book.*" In our own case the spindle was found to run about three-quarters of the speed of the drive shaft. The step diameters of the pulley were 6, 4½ and 3 in.; width of face, 1¾ in. The three spindle speeds obtained were as follows: 370, 198 and 85 revolutions per minute. The width of belt, 1½ in., was found a trifle too narrow at the slowest speed; 1¾ or 2 ins. would have been better. It would be well to make out a table of the proper speeds for the different sized drills to be used and for drilling materials such as steel, cast iron and brass. Each drill has a certain speed at which it will work most efficiently in each kind of material, so that as we have but three speeds a compromise must be made. No drill should be allowed to run faster than the allowable speed as there would be danger of overheating it and drawing the temper. A table listing these efficient speeds may be found in almost any tool catalog or engineer's reference book and from it the operator may get up a list for use with his machine. Following is the table for drills from one-quarter of an inch to one inch for use with the drill-press illustrated:

Material	Drill Size	Drill Size	Drill Size
	370 R.P.M.	198 R.P.M.	85 R.P.M.
Steel or wrought iron.	(¼)	⅜, (½)	⅝, ¾, ⅞, (1)
Cast iron .....	¼, (⅜)	½, ⅝	¾, ⅞, 1
Brass .....	⅜, ½, (⅝)	¾, ⅞, (1)	

Parentheses "( )" enclose those sizes driven nearest correct speed.

In the interests of "Safety First" it would be a good idea to house over the gears with sheet iron to such an extent that the operator could not get his fingers caught in them while intent upon the work on the drill table.

The upright column upon which the table arm slides, as regularly supplied with a blacksmith's drill press, is too short for work outside of flat bar stock, so a longer one, at least 2 ft. in length, should be obtained. The usual diameter is about 1¾; the best



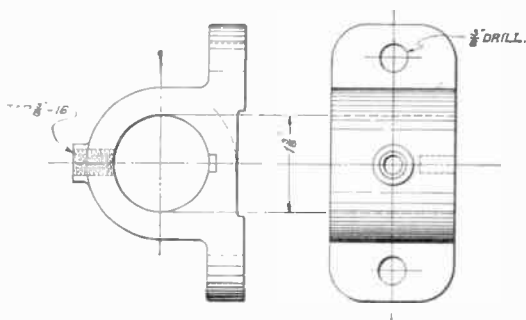
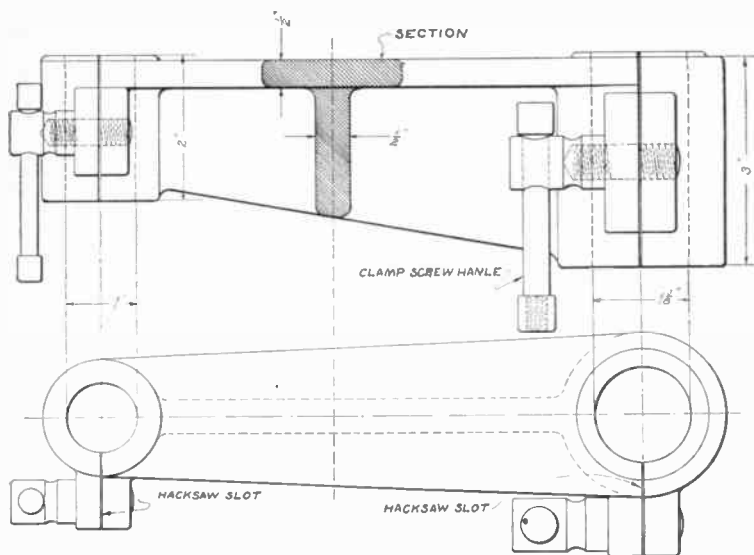

Fig. 3. Bracket used to support lower end of drill column.

thing to use would be a piece of cold rolled steel shafting; a second-hand piece would do if in fairly good condition. If slightly larger in diameter than the old column the piece could be put in the lathe and the ends turned down enough to fit into the supports. The discarded part should be saved and used to make other attachments described later. A cast iron cored out bracket is generally used to support the lower end of this drill column. While the original casting could be used to hold the new part it would be more satisfactory to make a wooden pattern as shown in Fig. 2 and have a heavier and stronger bracket, similar to the one shown in Fig. 3, cast at a foundry. Such a casting has plenty of stock to allow the chipping out of a key-way, say about  $\frac{1}{8}$  by  $\frac{1}{4}$  by  $\frac{1}{2}$  in. long. A key-way corresponding to this may be chipped in the lower end of the new steel shaft and when assembling the parts a steel key driven in will take any torsional thrust from the table arm which otherwise might cause the column to turn. Furthermore the bracket can be bored out in the lathe and thus make a much better fit on the column than if the hole was merely cored out as originally. The pattern should be made in two halves, dowel pinned together as shown in the drawing and the sides should be given "draft," or tapered, so that the parts may be easily drawn from the mould. Tapered core prints are provided in order that a hole may be "cored out" in the casting and thus saved considerable machine work. These core prints are best turned up separately and then glued and screwed in place. All core prints must be painted black so that the moulder will be able to distinguish them. As a rule no core box would have to be made for most foundries have standard ready-made cores on hand which are cut off to length and the ends



Figs. 4 and 5. General proportions of arm, made to hold table as nearly as possible at right angles to spindle.

rasped to the required taper. The large diameter of the prints should be about  $\frac{1}{4}$  in. less than the diameter of the finished hole. A boss is made as shown and later drilled and tapped for a set screw. If given the shape shown in the drawing the casting may be easily held in a three jawed chuck for boring. No special dimensions are given, the bore being made  $1\frac{3}{8}$  to show the relative size of bore and core prints. When fastening column and bracket in place be sure that it is set as nearly vertical as possible, for the accuracy of the drill press will depend to a great extent upon having the column parallel with the drill spindle.

This brings us to the drill table and arm, and here again it will be best to discard the arm which came with the machine which was only intended for rough work. An arm should be made which will hold the table as nearly as possible at right angles to the spindle. Figs 4 and 5 show the general proportions of such an attachment, the special dimensions varying for individual cases. Figs. 6 and 7 show the two part wooden pattern with cylindrical core prints to core out the hole at the big end. The small end is

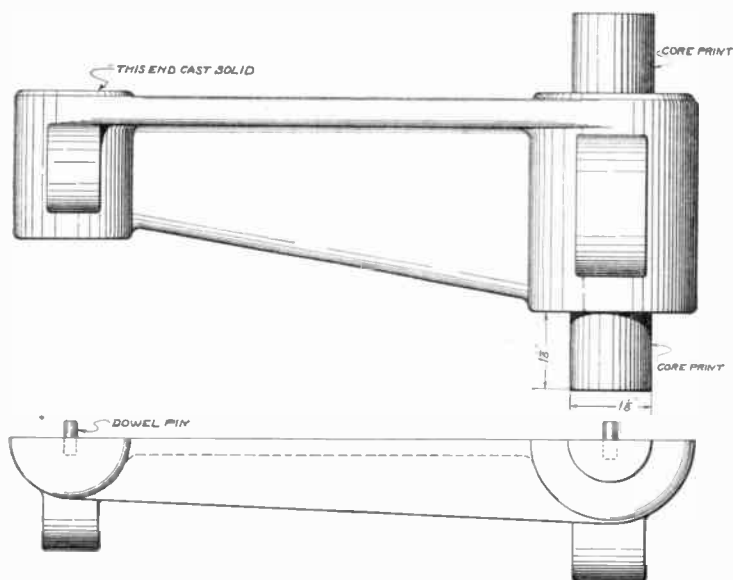

Figs. 6 and 7. Two-part wooden pattern for arm, with cylindrical core prints to core out hole at big end.

left solid and drilled out as described later. Both ends are split and tightened by clamp screws. The boring out of the large end would most likely be beyond the means of the amateur but the work could be done at any machine shop for a small sum. The splitting is done by hand, using a 9 or 10 in. hacksaw blade. In the photograph a different arrangement is shown for the small end but the clamp screw shown in Figs. 4 and 5 is better.

The large end should be bored out so that the arm slides easily up and down on the column, but without shake, when the clamp screw is loosened. Assuming the arm to be bored out and in place on the column we must next see to the finishing of the small end which up to this point is not supposed to have been bored or sawed. Put a small drill or piece of pointed drill rod in the spindle chuck and adjust so that the point will run true, then bring up the arm and clamp it tightly so that the small end comes directly under the spindle. Make a punch mark at the exact point. Then chalk over the face of the small end of the arm and with a pair of dividers scratch a circle the exact diameter of the hole to be drilled

through this end, preferably 1 in. This circle allows us to see if the drill starts true. Then place the 1-in. drill in the chuck and start to drill the hole, but before the point goes all the way in draw out and see if the hole so far is concentric to the scratched circle. If not, take a round point chisel and cut some grooves on that side of the hole which is farthest away from the circle, thus "drawing over" the drill toward that side when it is started again. Be very particular about getting the point of the drill started true, for after the body of drill enters the hole it would be almost impossible to draw it over any more. If the hole had been cored out the drill would have followed the cored opening and gone crooked. Whether this hole is drilled only or drilled and reamed depends upon the equipment at hand; similarly the facing off of the boss on top may either be done by a small counterbore or by hand with a file. When the drilling is finished the arm is removed again and the slot cut and clamp screw and handle fitted, then on replacing it all is ready for fitting the table. If the lathe is provided with a large slotted face plate this will make a fine drill table and the smaller face plates come in handily for drilling small parts. So we will turn up a piece of steel, a portion of the old column will do if of good material, as shown in Fig. 8. The long end is made to fit the hole just bored in the small end of the drill table arm while the upper end is turned and threaded the same as the end of the lathe spindle so that the face plates and chucks may be screwed on. A hole should be bored through this piece about the size of that through the lathe spindle. If the lathe is provided with a universal chuck this will be found most convenient for holding washers and short pieces of shafting, for drilling, when screwed to the arm in place of the drill table. If a regular table came with the drill this could be threaded to fit the attachment of Fig. 8 or a special stud could be turned up to take it. In any event it would be well to face off the table in the lathe to make sure its surface would be at right angles to the drill spindle.

Our drilling machine is now about ready for work, the only thing remaining is the choice of a chuck to hold the drill. A blacksmith drill spindle has a sleeve on the end, bored out to  $\frac{1}{2}$  in. or sometimes 0.648 in. diameter. Special drills, shorter than the ordinary twist drills, and with shanks of the above diameters, are sold to fit these drill presses. But it would be a good plan to have a chuck to hold regular twist drills also, and if the lathe is provided with a chuck of any kind an attachment like the one of Fig. 9 may be

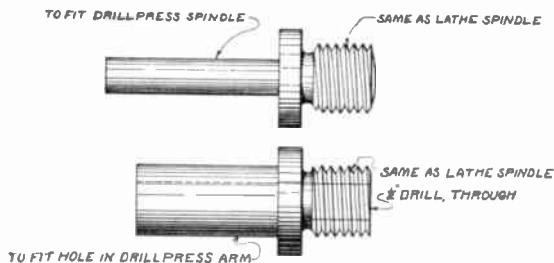

Figs. 8 and 9. Attachments to be turned up for use with drill chuck.

turned up. The shank is made to fit the spindle sleeve and the other end threaded the same as lathe spindle, or if a drill chuck is bought especially for the drill press this end may be fitted to it. In the photograph a small three jawed chuck belonging to the lathe is seen screwed to the spindle, while the slotted drill table is a large face plate also taken from the lathe. On the table may be seen one of a pair of cast iron "V" blocks, which are almost indispensable for resting shafting on while drilling. Such V-blocks may be bought of various sizes but the one shown was cast from a wooden pattern and left rough. While accurately finished blocks are of course necessary for good work, a pair of these cast ones are very handy for rough drilling and cost little to make.

It will be found that a drill press reconstructed along these lines will be sufficiently accurate for most of the amateur's work and will prove to be a most useful adjunct to his lathe.

## ELIMINATING FAN TROUBLE

BY ADOLPH KLEIN

I HAD considerable trouble with the radiator fan of my automobile; it seems that both the drive pulley and also fan hub heated up badly, soon after the engine was started. I determined to repair the trouble one day, and upon taking down the fan, found that a thin graphite wall provided on the inside of the pulley bushing, was the only provision for lubrication that had been made, and further that half of this had already disappeared. I determined to provide some better means for lubrication of the fan, and the sketch illustrates clearly what I did.

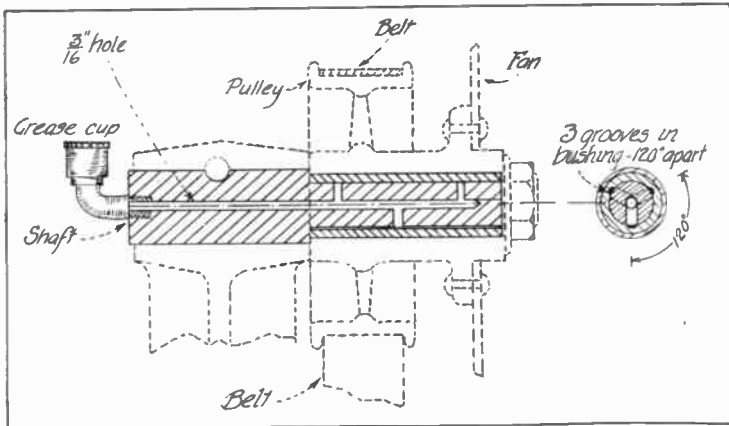

How the trouble was eliminated.

A  $\frac{3}{16}$  in. hole was drilled in the fan shaft up to approximately  $\frac{1}{2}$  in. from the opposite end. The open end of this hole was pipe tapped to receive an elbow fitting and grease cup. Three vertical  $\frac{3}{16}$  in. holes were now drilled; placed 120 degrees apart in a radial direction, and 1 in. apart in the direction of the axis of the shaft. These holes were drilled to a depth until they met the long  $\frac{3}{16}$  in. hole. To facilitate spreading the grease from the grease cup to the bronze bushing, three grooves,  $\frac{1}{8}$  in. x  $\frac{1}{8}$  in., and placed 120 degrees apart radially, were cut in the latter.

Needless to say, the repair eliminated the trouble.

## SILENCING NOISY VALVE ACTION

BY VICTOR W. PAGE

**I**N certain models of the Overland cars, which are in use in large numbers, the valve action becomes very noisy after they have been used for a time. This noise is due to too much clearance between the valve stem and valve stem lift screw in some cases, and to worn push rod ends in others. The sketches herewith show the arrangement of the valve lift parts. The most common trouble and the easiest remedied is flattening of the fiber inserts placed in the heads of the push rod cap screws. This wear is not always noticed because a gauge piece placed between the valve stem and cap screw may indicate the proper clearance as it will rest on the

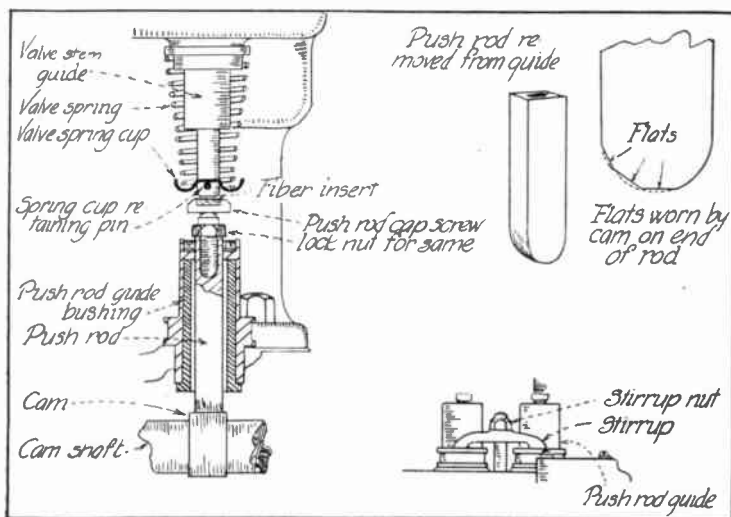

Cause of noisy valve action and its elimination

sides of the depression whereas the valve stem will go to the bottom of the worn fiber. The best method of repairing is to remove the valves from the cylinders, pick out the worn fibers with the point of a pocket knife and put in new ones which can be obtained at a cost of one cent each from any dealer in these cars.

After new fibers are inserted, the valves are replaced and a new adjustment of the valve lifting cap screw made. The lock nut is loosened, and the cap screw raised or lowered until the proper clearance is present between it and the valve stem. Care should be taken when adjusting the lift that the plunger is resting on the lowest point of the cam and that it is not partially lifted.

While the valves are out, the plungers may be lifted from their guides which are attached to the engine base and the end that bears against the cams examined. The plungers are pieces of square rod with rounded ends to rub on the cams. Constant use may wear flats in the rounded surface as indicated. If these are noticed the plungers should be rounded again to insure smooth action. The push rod guides sometimes wear and rods are loosely held.

The guides may be removed for examination by releasing the stirrup retaining nut and lifting the stirrup from the flanges on

the guides on which it bears. When the guides are removed, the cams may be easily examined. If there is much looseness between the push rod and guide, new guides should be fitted if new push rods do not take up the lost motion. Some repairmen swedge out the push rods to enlarge them and file them to fit. This is but a temporary expedient and not to be recommended. In adjusting the clearance between the valve stem and cap screw, an ordinary visiting card makes a good gauge, though some valve rod clearance can be even less than this. The less the clearance, the quieter the valve action. If not enough clearance is allowed, the valve stem will expand from the heat and the valve will not close tightly, this causing the engine to lose power when it becomes hot. It is advised always to be sure to tighten the plunger cap screw lock after correct clearance is obtained and hold the cap screw from turning with one wrench while the nut is tightened with another.

#### TO PREVENT THE LOSS OF SKID CHAINS

The drawing indicates a simple method of securing automobile tire chains, which are continually falling off. Take a

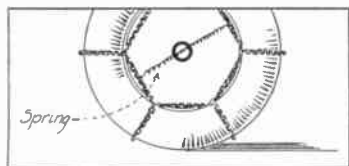

How loss of chains is prevented.

common door spring and fasten it diagonally across the wheel, hooking the ends to the chain.

Contributed by JAMES WHITE.

#### IMPROVED CUT OUT

The main defect of most cut outs is the comparatively small ports for the escape of the dis-

charged gases, having in many cases as much back pressure as the muffler.

A really good cut out may be made by cutting out a section of the exhaust pipe with a hacksaw as shown. A piece of tin is bent to fit over the pipe and cover the hole. A spring is fastened to one end of the tin cover, and a cable reaching to a pedal

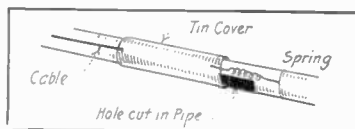

Improving the cut out.

from the other end. By pressing on the pedal, the cover is drawn back so that the gases can escape freely.

Contributed by T. W. BENSON.





## HOW TO SHARPEN EDGE TOOLS

ONE very essential process that must be quickly learned by all beginners in woodwork is the sharpening of the edge tools. Such tools as chisels, plane irons, spoke shave irons, draw knives, and gouges are sharpened in practically the same manner. *Sharpening* is meant to include three processes, i.e., *grinding*, *honing* and *stropping*.

### CLASSIFICATION

*Grinding* is accomplished by holding the tool against a revolving stone, the coarse particles of which cut off bits of the metal. *Honing* consists of rubbing the tool over a stationary stone of finer grit, and *stropping* completes the sharpening process when the tool is dragged over a piece of leather, imparting to it a razor-like edge. When speaking of sharpening in its broader sense, honing on an oil stone is meant.

### GRINDING

There are countless grinding wheels on the market today—bench grinders, power grinders, foot-power grinders, grindstones, emery wheels, dry grinders, oil grinders, water grinders, etc. These names interlap, of course, a grindstone meaning either a power, foot-power, bench, or water machine. But there are two classifications from which the craftsman should choose—a dry grinder, or a wet grinder. Its motive power is a matter of personal choice.

The ordinary grindstone is a wet grinder, while an emery wheel is a dry grinder. Fig. 32 illustrates a foot power grindstone, and Fig. 33 a bench grinder which requires no liquid while in use. For the usual line of home-craft work, the bench grinder is recommended. It costs about \$3.50, while a grindstone of the type illustrated costs \$5.00.

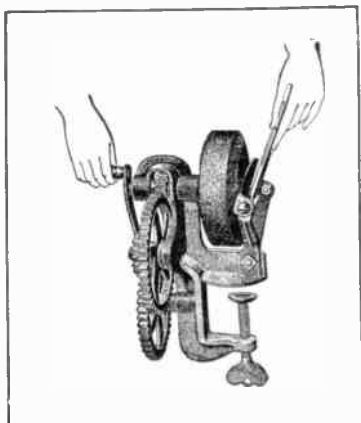
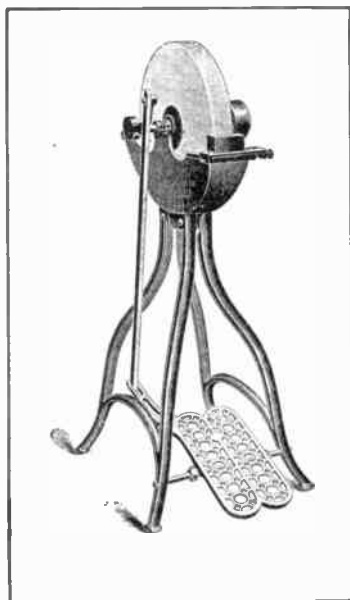

Fig. 32 (left) and Fig. 33 (above). Foot power and bench type grinders.

The grindstone is used in the manner illustrated in Fig. 34. The operator stands in front of the wheel, the latter revolving *toward* him. If the edge of his plane bit or chisel is nicked or very uneven, he should first *joint* it by holding the edge square against the stone—illustrated by Fig. 35. Of course this will thicken the metal on the edge, but it rapidly removes the nicks and permits of better grinding. When jointed, it should be held on its original bevel until the metal has been cut down to an even edge. The angle of the bevel, Fig. 36, should be about 30 degrees. Usually this angle has to be estimated by the workman, but very little difference in the working of the tool will be noticed if this angle varies somewhat. Chisels, as noted in the same drawing, should be ground to a 20-degree angle—giving the tool a *longer* bevel than a plane iron has. Of course the grindstone should be plentifully supplied with water while in use to prevent glazing. Also be very careful to use the full width of the stone, thereby preventing grooves or ridges to form.

To use the bench grinder, there are so many forms that it is

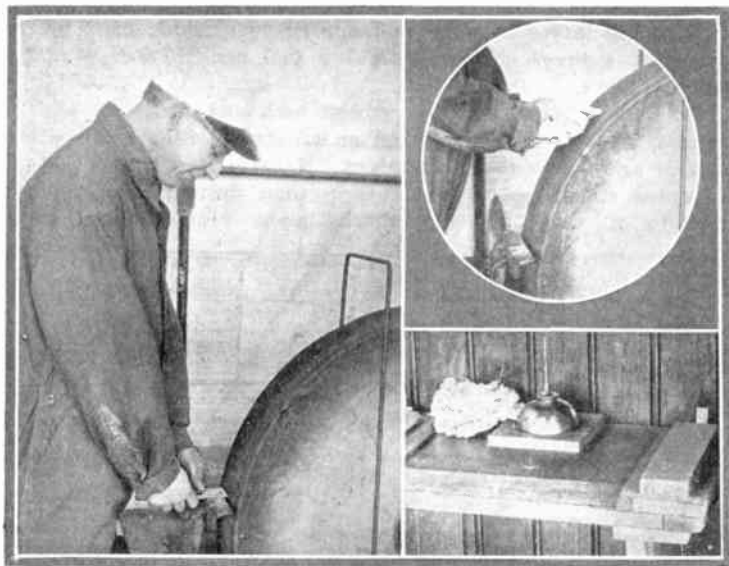

Fig. 35. Jointing the edge of a "nicked" blade.

Fig. 34 (above). Manner of using grindstone. Fig. 37 (below). Oilstone kit.

difficult to prescribe exactly for each. Most of them have some form of patent tool holder that keeps the tool being ground on a constant bevel. Generally speaking, use no water or other liquid—especially with an emery wheel—and hold the tool on the stone *very lightly*. Friction creates heat, and, in case the tool is pressed too heavily on the wheel, the edge will rapidly become blue which draws the temper from the tool. Be extremely careful to avoid this. Having a dish of water handy and occasionally dipping the tool in it will help to keep the temperature down.

Fig. 36 also illustrates what is meant by "hollow grinding." The grinding wheel, being circular in shape, will, of course, leave the edge concave if the tool is held against it in a constant position. Unless a tool holder is handy, hollow grinding is hard to obtain due to the constant tendency of the grinding wheel to force the tool down. A tool that is "hollow ground" will be easier to hone than one which is not, and it will need less grinding to keep it in shape.

## HONING

Grinding leaves a rough and uneven edge which must be removed by *honing*. No woodworking tool can be *sharpened* by grinding alone.

To hone a plane bit it is rubbed back and forth—or with a circular motion—on its bevel on an oil stone. Stones are either natural or manufactured abrasives. Natural stones, such as the Arkansas stones, are slower cutting than the artificial product, but they will hold their shape much longer. Manufactured stones

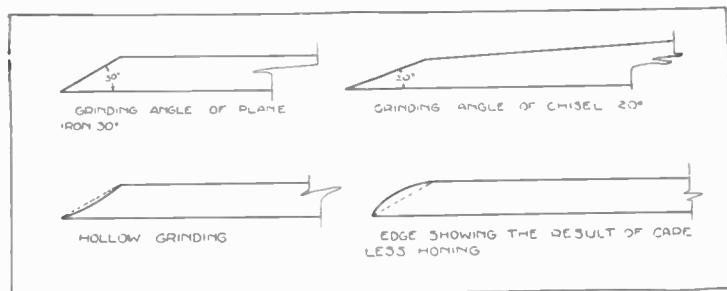

Fig. 36. Grinding angles and bevels.

—Carborundum, Aloxite, Alundum, Crystolon, etc., are very good stones, and, if care is exercised in their use, will give excellent service. The choice of either a natural or an artificial stone is left entirely with the user—they are both good.

If possible, it is recommended that two stones be purchased—a medium grit, and a fine grit. The arrangement in Fig. 37 is good. The stone on the left is a medium grit Alundum stone while the one on the right is a fine grit natural Arkansas stone. Between them a leather strop is fastened. If only one stone is desired, a medium grit stone is recommended.

The oil used on a stone should not be heavy. Any brand of good machine oil will do, and if very thick should be thinned with kerosene. After honing, the stone should be wiped clean and a few drops of the oil left on its surface.

As mentioned above, lay the tool to be honed on its bevel and rub back and forth—using the entire surface of the stone—until a “wire edge” has been turned up evenly on the straight side of the tool. This edge can be felt by passing the fingers down over the end on the straight side. Then lay the bit on its back (straight side) *being positive that it is resting flat on the stone*. If it is

held at any angle, another bevel will be formed on the back, which will cause great trouble when using the tool. *Be very sure that the back is always straight to the extreme edge of the tool.* The wire edge is removed by pushing the tool back and forth on the stone. Sometimes it will be turned up on the bevel in which case it must be reversed and rubbed slightly. Two or three turnings at the most should remove it.

A sharper edge can be given by repeating the process on the fine grit stone.

Some authorities recommend honing the tool at a slightly larger angle than it is ground, but the writer's experience with beginners has been that if the same angle is the objective, the larger angle, in most cases will be the result.

STROPPING

By rubbing the sharpened tool back and forth on the leather strop, a very keen edge can be imparted to it. A little oil on the strop assists the action. It will be noticed that in honing, the cutting away of the metal takes place *against* the edge of the tool, while with stropping the action is *with* the tool, the latter being *dragged* over the strop. (To be continued)

TROUSER HANGER

Make a frame about 12 in. long by 10 in. wide of one inch square stock and hang it on two

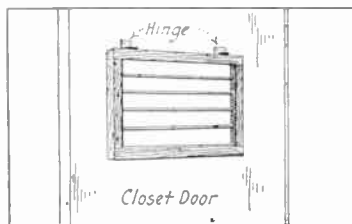

The device is fastened to the door with hinges.

hinges as shown in the cut. Bore holes to insert four or more nicked or brass rods, 1/4 in. in diameter.

Contributed by E. E. WILSON.

A SIMPLE FUSE

A simple fuse may be made for a six-volt storage battery circuit with two binding posts,

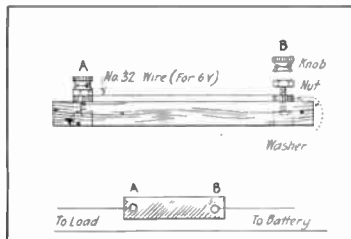

How the fuse is assembled.

a small block of wood and a length of No. 32 wire. Assemble as shown in the cut.

Contributed by EDWARD B. LANFER.

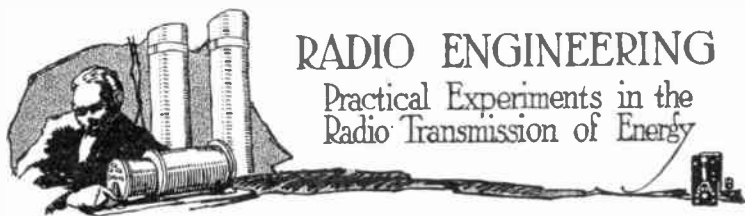

## RADIO ENGINEERING

Practical Experiments in the  
Radio Transmission of Energy

### THE USE OF DUMMY AERIALS

HOW THE SERIOUS EXPERIMENTER CAN CONTINUE HIS RADIO WORK

By M. B. SLEEPER

With Drawings by the Author.

SEVERAL of the manufacturers who have developed radio transmitters for the Government did all the work without transmitting a single signal outside their factories. The experimenters who have had to take down their aerials can continue their radio work by the methods of these manufacturers—by using a *dummy antenna*. While the interests of most radio men have been in trying to get long distance with their transmitters the work of developing sets to give high radiation, on which distance depends, is far more interesting and valuable from the experimental or scientific stand-point. This article takes up the construction of a dummy or phantom antenna, and a subsequent article in a later issue will discuss possibilities for experiments with new types of transmitters and the dummy aerial.

When a transmitter is connected to an antenna and ground, a certain amount of energy is lost by radiation into the ether. Instead of the antenna and ground a circuit may be substituted containing inductance, capacity, and sufficient non-inductive resistance to absorb the same amount of energy radiated by the antenna. This resistance is called *radiation resistance*, and is measured in ohms. This value can be calculated by the formula

$$R = 1578.2 \frac{h^2}{\lambda^2} \quad 1.$$

where

R = radiation resistance in ohms,

h = height of antenna in meters,

$\lambda$  = wavelengths of antennae in meters.

To change feet to meters, multiply feet by 0.304, or to change meters to feet multiply meters by 3.28. A table of antenna resis-

tances of different heights and wavelengths is given here, to save calculating the values.

*Antenna Radiation Resistance in Ohms for T Aerials*

Wavelength.	h=40 ft.	60 ft.	80 ft.	100 ft.
200m	6.0	13.4	24.0	37.0
300	2.7	6.0	10.6	16.5
400	1.5	3.4	6.0	9.3
600	0.66	1.5	2.7	4.1
800	0.37	0.84	1.5	2.3
1000	0.24	0.54	0.95	1.5
1500	0.106	0.24	0.42	0.66
2000		0.134	0.24	0.37
3000			0.106	0.17
4000			0.06	0.093

An antenna used for transmitting has certain values of induc-

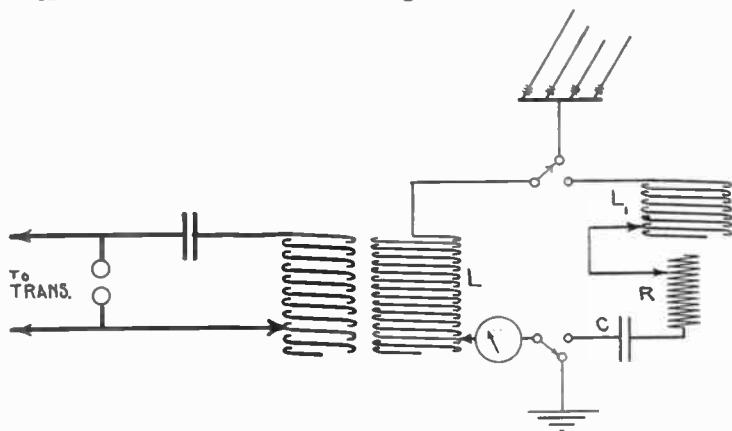

Fig. 1. Method used to determine radiation resistance of an aerial.

tance, capacity, and resistance. The resistance is low compared to the inductance and capacity, for no oscillations will take place if

$$R \text{ is greater than } 2\sqrt{\frac{L}{C}} \quad 2.$$

where

R = resistance of circuit in ohms,

L = inductance in henrys,

and

C = capacity in farads.

If, then, some substitute for an aerial is to be used, it must consist of these three factors.

The method used to determine the radiation resistance of an aerial is shown in Fig. 1. Two point switches are connected to the transmitter to cut in the antenna and ground or the dummy antenna. The radiation is noted at the hot-wire ammeter when the switches are on the antenna and ground. Then, with the switches on the dummy, the inductance and capacity are adjusted by means of a wavemeter to the wavelength of the antenna, and the resistance is varied until the ammeter reads the same with the antenna and ground. Since the resistance is non-inductive, its direct current resistance will be the same as the radiating resistance of the antenna.

Fig. 2 shows the connections for a dummy. The condenser,  $C$ , should be of approximately 0.0002 mfd. for a 200 meter wave, up to 0.001 for a 5,000 meter wave. Inductance  $L$ , is a plain helix of 15 or 20 turns of copper wire on a frame or cylinder 8 ins. in diameter.  $L$  is the secondary of an oscillation transformer. The circuit  $LL_1RC$  is adjusted to the wavelength required, by means of a wavemeter. From the table or formula 1 the required resistance is then calculated. It must be remembered, however, that the resistance of the dummy is not localized in the resistance unit but is partially distributed through the circuit, in the two inductances, the leads, and condenser. An allowance must be made, therefore, on the resistance of the unit. That is

$$R = R_R + R_c \quad 3.$$

where

$R$  = the resistance of the circuit in ohms,

$R_R$  = resistance of resistance unit in ohms,

and

$R_c$  = resistance of the other parts of the circuit in ohms.

According to Ohm's Law,

$$E = I \times R, \quad 4.$$

where

$E$  = volts,

$I$  = amperes,

$R$  = ohms.

multiplying both sides of the equation by  $I$ ,

$$E \times I = I \times I \times R,$$

or since the watts are the product of the current and potential

$$W = I^2 R \quad \text{see p. 17} \quad 5.$$

where

$W$  = watts.

If, then, the ammeter reads 4 amperes when the resistance of the unit is 7 ohms, the output of the transmitting set into the dummy antenna will be



or, in this case, 
$$W = I^2 (R_R + R_c) \tag{6}$$

$$W = 4^2 (7 + R_c)$$

Still, we have not found the resistance of the entire circuit. Now add a certain amount of resistance to the unit, say 7 ohms, making the total 14 ohms in the unit. This will reduce the reading

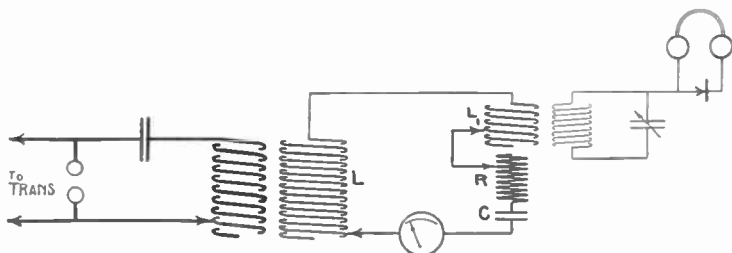

Fig. 2. Hook-up used with phantom aerial.

of the ammeter, but the output in watts will remain the same, as well as the resistance of the rest of the circuit. After the change has been made,

$$W = I_1^2 (R_R + R_c) \tag{7}$$

where

$R_R + R_c$  total resistance of the unit, *see page 217*

and

$I_1^2 R + R_c$  = the new reading of the ammeter.

Or, since the output in watts is the same, we can call the right hand sides of the equations 6 and 7 equal

$$I^2 (R_R + R_c) = I_1^2 (R_R + R_c)$$

Suppose the new reading of the ammeter is 3 amperes. The values of  $I$ ,  $R_R$ , and  $R_R + R_c$  have been found already as 4, 7, and 14, respectively. Substituting in equation 8,

$$4^2 (7 + R_c) = 3^2 (14 + R_c)$$

removing the parenthesis,

$$4^2 \times 7 + 4^2 R_c = 3^2 \times 14 + 3^2 R_c \tag{8}$$

multiplying,  $112 + 16 R_c = 126 + 9 R_c$

then

$$7 R = 14$$

or

$$R_c = 2$$

This shows that the resistance of the inductances, leads, and

condenser is 2 ohms. Now the resistance unit may be varied to give any dummy resistance, for

$$R = R_R + R_c \quad 3.$$

If the dummy is used to replace a 400 meter aerial 60 feet high, the resistance unit,  $R_R$ , must be 1.4 ohms, for, according to the table,  $R$  is 3.4 ohms, and  $R_c$  has been found to be 2 ohms.

There may be some question about the value of the resistance and current. Since the unit is non-inductive, the resistance will be the same in both high frequency and direct current circuits. The current, measured by a hot-wire ammeter, is the root-mean-square value, or the equivalent of a direct current which produces the same heating effect as the alternating current.

Five instruments are necessary for work with a dummy antenna—a wavemeter, hot-wire ammeter, an inductance, a condenser, and a non-inductive resistance. A wavemeter has been described already in the May, 1916, of EVERYDAY.

*(To be concluded)*

## A SUBSTITUTE FOR SWITCH POINTS

Where a large number of switch points are required in a small space or when the experimenter finds the cost of switch points too great, there is a very satisfactory substitute for them. The cross-

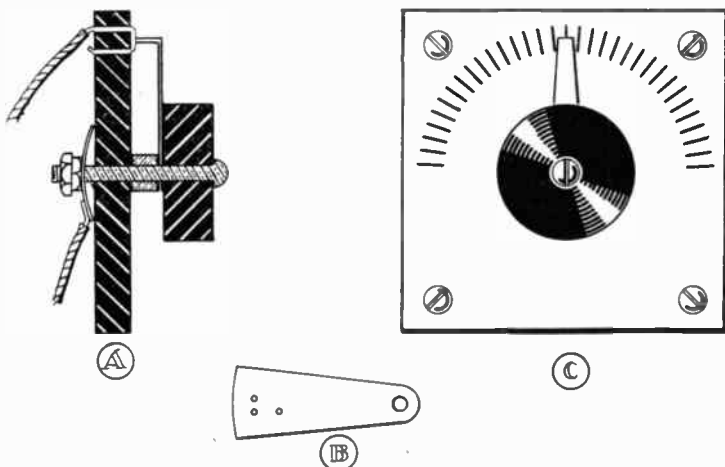

This type of switch points is economical in space and money.

sectional view at A and the front view at C show the method to use in this case. A double circle of holes is drilled by means of the template at B. The large hole of the template is put on a screw through the hole at the center of the hard rubber panel. Then holes are drilled in the panel using the template as a guide. If a small pin is put in the template as it is moved forward the holes will be spaced accurately. These holes should be slightly larger than the size of the wire used for the taps. When the two circles of holes have been drilled, the tap wires are brought through the holes and turned up, as the drawing at A shows. Where the wires are very fine and would wear through quickly, it is more satisfactory to use larger brass wires for the contacts and solder the taps to them. The switch handle and contact are of the usual design.—Contributed by CHARLES E. PEARCE.

### AN EASILY-MADE PAIR OF BOOK-ENDS

By ROBERT N. STANNARD

**T**HE value of the book-ends shown in the accompanying illustration lies in having them leaded to make them heavy. This can be done by boring two or three holes in the bottom and then filling the holes with tin foil, pounding the metal in. Lead would be still better. Then cover the bottoms with felt, glued on.

A piece of beautifully grained wood needs no other embellishment than stain and shellac or wax. If the craftsman is skillful,

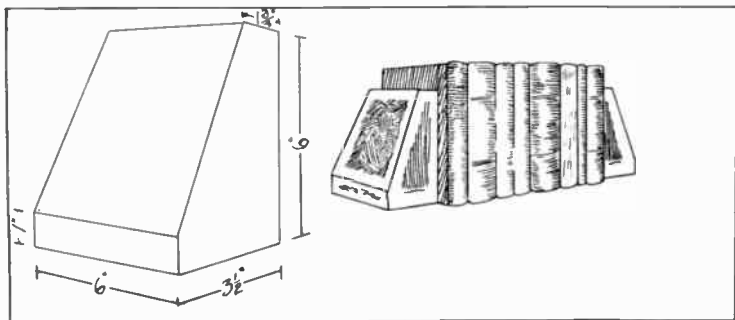

The book-ends are especially attractive.

these ends may be modelled with carving tools or inlaid with other woods. A good rule to follow in design for carving or inlaying is to have the lines of the design follow, for the most part, parallel with the lines of the object.

## SILVERING MIRRORS AND OTHER GLASS SURFACES

BY GUSTAVE REINBERG, JR.

**M**ANY organic compounds have the property of reducing an ammoniacal solution of silver nitrate to the metallic condition, and under the proper conditions glass surfaces may be very satisfactorily silvered by this means. A test tube may be given an indifferant coating of silver by the simple process of adding about 5 ccs. of a 1:10 silver nitrate ( $\text{AgNO}_3$ ) solution to an equal quantity of a boiling concentrated solution of Rochelle salt in the tube. This procedure, lacking the refinements detailed below, is rather uncertain, but is useful to illustrate the process.

The surface to be silvered must first be cleaned by placing it in a dish of some material not affected by nitric acid (aluminum is quite satisfactory), and scrubbing it with a glass rod on the end of which is a wad of cotton dipped in concentrated nitric acid ( $\text{HNO}_3$ ). Then rinse the glass with distilled water and examine the surface. If it is covered with an unbroken film of water it is clean, if it shows dry spots the scrubbing must be repeated. It should then be left covered with distilled water until silvered.

There are several reducing solutions in common use, of which I shall describe two, one employing sugar and the other employing formaldehyde. The former solution consists of:

Sugar .....	20 parts
Nitric acid .....	1 part
Alcohol .....	30 parts
Water .....	200 "

The silver solution used with this reducing agent is made by dissolving 1 part silver nitrate ( $\text{AgNO}_3$ ) in 10 parts of water, adding to this solution ammonium hydroxide (ammonia water,  $\text{NH}_4\text{OH}$ ) until the brown color occasioned when the ammonia is first added has disappeared and the solution again become clear, then adding a solution of 1 part potassium hydroxide (caustic potash,  $\text{KOH}$ ) in 10 parts of water, at which the solution should again become dark, and finally sufficient ammonia water to bring the solution to a straw-colored tint.

The alternative reducing solution is made by adding 3 parts of water to 1 part formaldehyde (commercial). The silver solution for this reducing agent is made by adding ammonium hydroxide to 100 ccs. of a 10 per cent. silver nitrate solution until the brown

precipitate formed just redissolves (avoid excess), and then adding sufficient water to make the total volume 1 liter. In making up these solutions strictly c.p. chemicals (with the exception of the formaldehyde) and distilled water should be used. The sugar solution is best made up some time beforehand, as it improves with age.

There are several ways of performing the actual silvering. One is to place the mirror, face up, in a suitable dish and pour the silvering solution in upon it. Another very satisfactory method is to construct some sort of a dam around the edge of the mirror and pour the silvering solution into the basin thus formed. On large telescopic mirrors this result is achieved by wrapping a wide strip of paraffined paper around the edge, allowing about six inches to project above the surface, and securing the paper by running a soldering iron around the outside.

When silvering with the sugar reducing solution, mix equal parts of the sugar and silver solutions and quickly pour the mixture onto the mirror. The solution is continually agitated during the silvering, which takes from 5 to 20 minutes, and is complete when the bath turns muddy. The solution is then poured off and the glass thoroughly washed with distilled water. The temperature should never be above 21 degrees C. (70 degrees F.) when using this process.

When using formaldehyde a mixture of 2 volumes of the silver solution to 1 volume of the formaldehyde solution is used. At common temperatures the silvering will be complete in from five to ten minutes, after which the glass is removed and washed as described above. When dry the coats obtained by either of the above processes may be polished if desired, but they should never be touched when wet as they are then likely to peel off.

#### INVISIBLE INKS

Of the many formulas for inks which appear only upon special treatment, either with heat or with certain reagents, the following have been selected as the most convenient and efficient, as well as with a view to embrace the various types and colors possible. Other combinations will readily suggest themselves to anyone having at least an elementary knowledge of chemistry.

With a solution of 1 part sulfuric acid ( $H_2SO_4$ ) in 20 parts water the characters turn an indelible black when warmed.

With a dilute cobalt chloride ( $CoCl_2$ ) solution blue characters develop when warmed, again becoming invisible upon cooling.

With a solution of .1 gram phenolphthalein in 30 ccs. of 50 per cent. alcohol the characters turn red when subjected to ammonia fumes or when sprayed with ammonia water ( $\text{NH}_4\text{OH}$ ).

With a 5 per cent. copper sulfate (blue vitriol,  $\text{CuSO}_4$ ) solution the characters turn blue when subjected to ammonia fumes and brown when treated with potassium ferrocyanide (yellow prussiate of potash,  $\text{K}_4\text{Fe}[\text{CN}]_6$ ).

With a 5 per cent. lead acetate ( $\text{Pb}[\text{C}_2\text{H}_3\text{O}_2]_2$ ) solution black characters develop when treated with hydrogen sulfide ( $\text{H}_2\text{S}$ ).

It is understood that characters written with any of the above solutions are invisible when first put on paper.

#### CHEMICAL VEGETATION

Very attractive decorative effects may be secured by the growth of certain minerals, principally silicates. They are best prepared in a goldfish globe or similar vessel, one from 3 to 5 inches in diameter being the most suitable. A layer of sand is spread over the bottom of the globe and some pieces of copper sulfate, iron sulfate, some powdered manganese dioxid and a few crystals of ferric chloride and aluminum chloride are suitably disposed upon it, and the globe is three-quarters filled with a concentrated solution of sodium silicate (water-glass). The iron salt "grows" very rapidly, and a "garden" prepared with only very soluble salts like copper chloride, cobalt chloride, nickel nitrate, and manganese sulfate will complete its growth within a few hours, all the formations being irregular and lumpy columns of various colors rising up through the solution. The first mentioned combination requires several days to complete its growth, but results in a much more elaborate and beautiful crystal formation. Naturally the list of salts used can be varied considerably without causing more than minor changes in the appearance of the "garden".

When the growth is complete the remaining silicate solution must be washed away, which must be accomplished with great care because of the fragility of the growths. A gentle stream of water should be run into the globe through a tube, while the solution overflows over the edge. This is continued until the water looks perfectly clear, after which the growths will last an indefinite time unless broken by a jar.

Other attractive chemical "gardens" can be made by filling a globe with a hot concentrated solution of alum or Glauber's salt and allowing it to crystallize, as it cools, upon a piece of coke or a wire frame suspended in it.

Still a third type of garden is that known as a lead or silver "tree". The former is made by suspending a zinc rod in a solution of about 10 grams of lead nitrate ( $\text{Pb}[\text{NO}_3]_2$ ) in 100 ccs. or more of water, the lead being deposited in irregular tree-like sheets upon the rod. Silver "trees" are made by adding a small quantity of mercury to a silver nitrate solution in a jar, but they are not very permanent.

## TO REMOVE THE EMULSION FROM PHOTO PLATES

BY S. W. HUFF

**M**ANY wireless amateurs have found that large photo plates are just the thing for their condensers, but have hesitated from buying them because of the difficulty involved in removing the emulsion. The method of soaking the plates in hot water is a messy one, and many plates are liable to become broken. They may also be soaked in a concentrated solution of lye, but this method is dangerous to both flesh and clothing.

The following method will solve many difficulties:

Procure, from a drug store or photo supply store, sodium flouride 8 drams and sulphuric acid (C. P.) 8 drams. Commercial sulphuric acid (oil of vitriol) should not be employed, as it will leave a brown stain on the plates which it is impossible to remove.

Procure also a glass tray slightly larger than the plates to be cleaned.

Dissolve the sodium flouride in 16 ozs. of water, and add the sulphuric acid drop by drop while stirring the solution constantly. This solution will cost about 20 cents.

Pour the solution in the tray and immerse a plate, face upward, in it. In about 15 seconds the gelatine will start to "frill" or peel from the edges of the plate. By grasping the emulsion, it may be stripped off the plate in a single piece. The plate should be washed in hot water and stood in a rack to dry. About 75 or 100 plates may be treated in 16 ozs. of solution.

If about 50 plates are to be cleaned, the emulsion can be saved and treated with nitric acid. One hundred 8x10 plates yielded the writer \$2.85 worth of pure silver.

The plates should be rubbed with alcohol before coating. This treatment will "kill" all acid that may not have been removed by washing. As the plates are about 1/20 in. thick, 2 banks of 12 plates each, plates in multiple, banks connected in series, will give a capacity of 0.01 mfd and will stand a 25,000 volt discharge without breaking down.

# HOUSEHOLD ENGINEERING

Practical Mechanics  
for Everyday Men



## A HANDY FLOOD LIGHT

Drop lights are used to a great extent around garage and machine shops, but are at times troublesome to place in the proper position. The device described herewith can be made from parts found in the scrap heap, and will be found indispensable.

A 6 ft. length of 1½ in. pipe is fitted with a flange, and bolted to an old gear wheel. The latter

ing screw so that the pipe may be clamped at any desired point along the upright pipe. The adjusting screw is made by fitting a small valve wheel to a setscrew of the proper size as shown in the detail drawing.

The horizontal pipe has a T-sliding on it, which supports the lamp cluster, and is also fitted with a clamping screw. The cluster should be of the three-light type, as shallow as possible, and covered with a screen to prevent the breakage of the lamps.

A few moments' consideration will show the many advantages of this flood light. By means of the various adjustments it is possible to clamp the light in practically any position, under, over, or alongside the work, and it will stay there under nearly all conditions.

Contributed by T. W. BENSON.

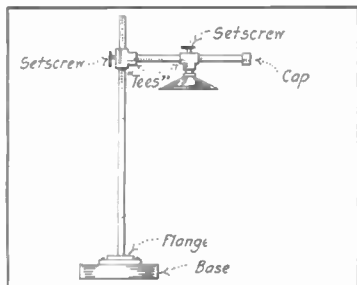

The flood light is made up of odd parts.

is only to hold the pipe upright, and anything may be used that will do this satisfactorily.

Sliding along this upright by means of a T-joint is a 3 ft. length of piping of the 1 in. size. The T is threaded for an adjust-

## TO CURL FEATHERS

Try this way to curl your feathers: Take a round stick and hold the feathers close to it lengthwise and fold the down carefully around the wood.



Next slip over it a closely fitting bag of any material; this bag should be a trifle larger than the curling sticks. Hold this bag in the steam of a kettle until thoroughly dampened, after which place in a warm spot to dry. When the bag is removed it will be found that the feather is nicely curled.

Contributed by MARY F. SCOTT.

### HOME-MADE ICE PICK

Sharpen the end of an old rat-tail file to a point, bend the other end slightly and then in-



An old file is used.

sert it in an old stove knob. Pour lead into the knob and it will hold the file securely, making a good ice pick.

Contributed by E. E. WILSON.

### BLACKENING ZINC

Prepare the following solution: Nitrate of copper 2 grs., chloride of copper 3 grs., distilled water 64 cmc. Hydrochloric acid (Sp. Gr. 1100) 8 cmc. Clean the zinc, dip it in the solution for a few seconds, wash it good and dry it quickly.

Contributed by V. CAROUSO.

### TO KEEP MAGAZINES TOGETHER

Magazines usually begin to tear from the back corners of the cover. Small pieces of ad-

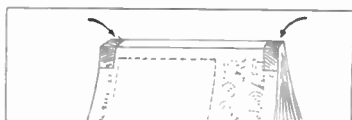

Paste the plaster as shown.

hesive plaster pasted over the back, as shown by the dark marks, make the magazine half as durable as if it were bound.

Contributed by E. P. FERTE.

Do not use patent cleaners on tan shoes, as the acids contained therein cut the leather. Instead, rub the shoes thoroughly with a rag soaked in ammonia. When dry, rub with a dry rag or brush to remove the loose dirt, and polish with a good past in the usual manner.—J. A. DUNN.

### A HANDY SCREW DRIVER

By cutting off an old table fork along the dotted lines in the illustration and sharpening

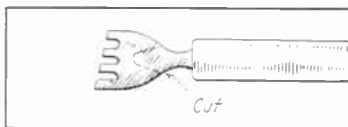

Cut the fork down.

the end down to a wedge, you have a handy short-blade screw driver for close places.

Contributed by E. E. WILSON.

### A HANDY SERVING TRAY

A HANDY serving tray can be made from an old frame, or one made of picture molding for the purpose, by fitting it with glass held in place by a wooden back. Two small handles

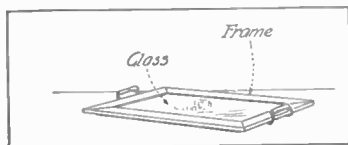

The serving tray.

fastened in the middle of the short sides facilitate its use.

The services of one of the lady members of the family are needed to finish the tray, as she must embroider a doily to act as a background for the glass top.

### SHELLAC BOTTLE KINK

Shellac bottle corks are often broken when being removed, as the cork is held by shellac which has hardened.

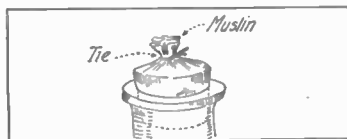

The cork will not stick.

By placing a small piece of muslin over the opening before inserting the cork and then tying the projecting edges as shown, this nuisance can be eliminated.

Contributed by S. KNOECHEL.

### WHEN USING CANVAS

When using canvas for a stiffening of any kind, it should be shrunk before using, otherwise it will shrink the first time the garment gets wet and will cause the garment to lie in wrinkles or give it a puckered effect.

A simple method of shrinking it is to place the canvas on a table and wet it thoroughly with a sponge and water, then press with a hot iron until dry.

Contributed by MARY F. SCOTT.

### TO PREVENT HANDLE FROM SPLITTING

To prevent a mallet handle from splitting cut a square on the end of the handle and make

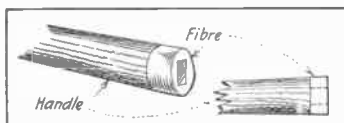

The fibre end prevents splitting.

a piece of fibre to fit over it. Finish with a file to bring the fibre piece down to the level of the handle.—L. H. WAGNER.

### INK ON THE CARPET

To remove ink spots from the carpet after they have become dry rub them with milk, taking fresh as it becomes inky. Afterward wash the spot with ammonia water to remove the grease.

Contributed by MARY F. SCOTT.



---

## MODEL MAKING FOR PLEASURE AND PROFIT.

A Message to Experimental Engineers.

---

**D**OES your hobby pay for itself? Are you hampered by the lack of available funds to carry out experimental work? Would you like to know how to make money with your models, so that the work would be self-sustaining instead of a drain on your purse?

I have asked those questions of a number of experimental engineers recently, and the answers have been so uniform in tone that the suggestions offered in this article are believed to be timely.

In introducing the subject, let us hark back to the early days of photography. Many of us can remember the heavy plate cameras, with their cumbersome tripods. Seemingly innumerable were the obstacles to be overcome in the pursuit of this hobby—for hobby it was, even at that early stage of the art. Expense was a big item, too.

Today we have the modern film camera making a negative the size of a calling card, from which enlargements of any size can be made quickly, cheaply, and of a quality surpassing the original print of years ago.

The modern photographic amateur makes his camera pay for itself; or, better still, makes it pay for his summer vacation in addition. This he does by selling prints to magazines, newspapers and individuals. At the same time, he is a true amateur—a follower of the art for the love of it rather than because of its money-making possibilities.

Can you not sense the beginning of a new era in practical experimental engineering? Has not this fascinating hobby gone through a period of evolution in the past five years? I believe it has.

Well do I remember the days, not so long ago, when the minia-

ture incandescent lamp was an inefficient novelty, selling at a prohibitive price. My first power plant was not a toy; it would be considered today a generating unit of practical worth, for it would produce one hundred and twenty candle-power of useful light with modern, nitrogen-filled miniature lamps. Yet, so low was the efficiency of the best lamp I could buy at that time that I could scarcely produce a reading light.

Magnet wire was precious. We may call it so today; but when we consider the matter sanely, it is cheap compared with the product of ten years ago. Small motors were expensive and inefficient. Today we can buy a drum armature machine with mica-insulated commutator and copper gauze brushes for less than two dollars.

Stock gears, threaded rod, cheap machine screws and nuts, were practically unknown. The raw materials available to nearly every experimental engineer today were secured only at prohibitive expense a few years ago.

Small storage batteries were unknown. Even the dry cell, so common today, was an uncertain novelty yesterday. We were compelled to mess with bichromate cells, or their contemporaries, in order to get a few watts of useful energy.

All of this represents progress. The advance is not confined to the ranks of the experimental engineer, however. It is due largely, if not solely, to the perfectly astounding increase in the technical education of the public at large, and to the demand created by this public for the little luxuries offered by man's greatest servant—Electricity.

There's just the point. The public has been drilled into an appreciation of the importance of practical, everyday science. The man who boasted yesterday that he did not know a screwdriver from a monkey wrench today stops, glued to the curb, when the slightest repair is made to a drawn-up motor car.

That is where our fast-growing hobby fits in. We can take advantage of this new and ever-increasing interest in things electrical and mechanical. We can secure recognition for this, the least important of our really great work, and at the same time make our hobby self-sustaining in order that we may do bigger and greater work as our experience and knowledge increase.

### How to Do It.

As this is being written, New York City is entertaining Marshal Joffre, hero of the Marne, and perhaps the best-loved military

figure of modern times. In his honor the City is draped with bunting from end to end. Nearly every large store has devoted one or more windows to a display military or naval in character.

Just below the wonderful court facing the Library in Fifth Avenue is one of the City's finest department stores. Its windows are a riot of exquisite color. A prominent one is given over to an inspiring naval setting, where the skill of the professional window-dresser is well shown.

As I passed this building last evening I was immediately impressed with the crowd, five rows deep, in front of this one window. My curiosity aroused, I patiently waited in line to see the attrac-



Photo by Levick.

A striking example of the highest type of model work. Scale model of a 110-ft. submarine chaser built by the H. E. Boucher Mfg. Co., through the courtesy of whom we are enabled to reproduce this photograph.

tion. When at last I stood before that window, with its truly marvellous conception of a great subject, I was filled with mingled feelings of satisfaction and disappointment when I saw that every eye in the crowd was fastened upon *three very indifferent toy models* of a patrol boat, a torpedo-boat destroyer, and a submarine chaser. That is to say, the lines of the hulls were sufficiently well drawn to identify the classes of the little ships.

Do you appreciate the significance of this? I did not at first, but after I had spent the morning in browsing around town I formed the conclusion that prompted the writing of this little article. In every case, without a single exception, where a model

of any kind, large or small, from the toy shop or the skilled model maker was shown, there was the same wide-eyed crowd, prodded along by a blue-coated guardian of the peace.

Upon my return to the office, I looked up a certain little pile of correspondence I had purposely laid aside for future reference. Among these letters were requests from widely scattered sections of the country, and apparently from responsible houses in many cases, requesting information as to where models of submarines, battleships, armored cars, submarine chasers, etc., could be obtained on a rental basis for purposes of window display.

Does this not tell the story? Let us summarize the situation. The model-making art has progressed materially in the past five or ten years. The dabbler of yesterday is the experimental engineer of today. Materials and parts can be obtained either partly or wholly finished. Special machine work can be arranged for at nominal cost. Designs for perfect scale models will be published from month to month in this magazine.

Are we not ready for business?

The recently-organized *American Society of Experimental Engineers\** is making arrangements with various manufacturers to supply the parts and materials needed for practical model work. Furthermore its laboratory and shop offer facilities for members to have the more difficult machine work done at cost, so that they will not be hampered by lack of tools.

Lists of stores and concerns which might be interested in models for display purposes are being made up, and will be sent to the various Chapters of the A. S. E. E. as soon as ready.

It remains for the experimental engineers of the country to take advantage of the opportunity now offered. They can rent their models or sell them, and in that manner secure funds for additional work. Furthermore, this magazine will buy photographs and clear working drawings, with descriptions of models made by readers, where such models come up to a certain standard of workmanship and efficiency.

\* For particulars address the Society at Aeolian Hall, New York.

# BOOKS

NEW *and* INTERESTING



**THE THEORY OF MACHINES**, second edition, by R. W. Angus, B.A.Sc. 340 pages, 193 illustrations. Bound in cloth, 6 x 9 inches. Price, \$3.00. Published by the McGraw-Hill Book Co., New York City.

Every man who has attempted to design any kind of machinery, even for the simplest model work, has met mechanical problems which, though they are not difficult, are often very puzzling. "The Theory of Machines" is a book which will come to the rescue at such times. This book is not so technical as to be difficult to understand, yet it gives completely the solution of many usual and unusual mechanical problems. What formulas are given can be solved in almost every case by simple algebra.

The chapters cover motions in machines, difficult kinds of gearing, cams, forces acting in machines, cranks, efficiency, governors, weight of flywheels, and the balancing of machinery. The index is so complete that any special subject can be found immediately.

**HOW TO RUN AN AUTOMOBILE**, by Victor Page. 177 pages, 71

illustrations, cloth bound, 7½ x 5 inches. Price, \$1.00. Norman W. Henley Pub. Co., New York City.

Whether we have automobiles or not, we all like to be able to run them. Many of us who cannot, have been caught in emergencies when even a book-knowledge experience would have saved the day. Mr. Page has written a book which almost equals actual experience in running an automobile. With the instructions in this book understood, it is only a matter of sitting at the wheel and applying the principles given by Mr. Page. Particularly at this time, with the Government listing the men and women who can drive automobiles, it is the duty of every person to have at least some idea of the handling of a car.

A particularly helpful feature of the book is the photographs of working parts in different cars, with each part labeled. The first chapter is on the different parts and their functions. The second chapter takes up starting and driving, from lubrication to rules of the road.

# TYPEWRITERS

All  
makes  
\$10 to  
\$50



We  
save  
you  
money

## MACHINES REBUILT

by the well-known "Young Process." Whether you buy for CASH, on INSTALMENTS, or RENT, we can save you money. If you wish, rent one of our machines. After you are satisfied you have a bargain, buy it and the rental paid will apply on purchase price.

### All Machines Guaranteed

Every machine we sell is GUARANTEED. You do not risk one cent. Send NOW for catalog and details.

YOUNG TYPEWRITER CO., Dept. 139, Chicago

## Mr. Edison's Wonderful Phonograph

Only  
\$1.00

After  
**Free Trial**

Yes, you may keep this new Edison—Thomas A. Edison's great phonograph with the diamond stylus—and your choice of records, too, for only \$1. Pay the balance at rate of only a few cents a day. Try

the new Edison in your own home before you decide to buy. Nothing down. Write today for Our New Edison Book and pictures. No obligation. F. K. BABSON, Edison Phonograph Dist., Dept. A-177, Edison Bk. Chicago



Thos. A. Edison

Chapter three is on the 1917 control systems of thirty different makes. The last chapter gives instructions on caring for automobiles in the garage and on the road.

Whether you have a car or not, you will find this book interesting as well as instructive. THE PRINCIPLES OF ELECTRIC WAVE TELEGRAPHY AND TELEPHONY, third edition, by J. A. Fleming, M.A., D.Sc., F.R.S. 911 pages, 492 illustrations, 7 folding plates. Bound in cloth, 6 x 9 inches. Price, \$10.00. Published by Longmans, Green & Co., New York City.

No introduction is necessary to this work, for it has long been used as a text-book for radio men. As to the contents, it is easier to tell what has been left out than what has been put in, yet even this is difficult, because the book is so complete. The third edition is not the second with an appendix, but a complete revision. Our experiments are particularly favored by this change, since the material is more descriptive, making it possible to build the apparatus described.

The most remarkable feature of this book is the completeness and thoroughness with which every conceivable bit of data on radio work has been collected. All the work of the radio engineers in this country and in Europe is covered in the new edition. Audion, Plotrons, fre-