

Everyday Engineering

"It Tells You How to Make and How to Do Things"

VOL. 2

MARCH, 1917

No. 6

HOW YOUNG AMERICAN SCIENTISTS PLAN TO HELP IN THEIR COUNTRY'S DEFENSE

BY THOMAS STANLEY CURTIS

THERE is, in this land of ours, a vast aggregation of men, young and old, who delve into the mysteries of mechanics, electricity, and science in general, solely because of the wonderful fascination of it. For these men as a class **EVERYDAY ENGINEERING** was started and to these same men will the little magazine under its new and broader name be dedicated.

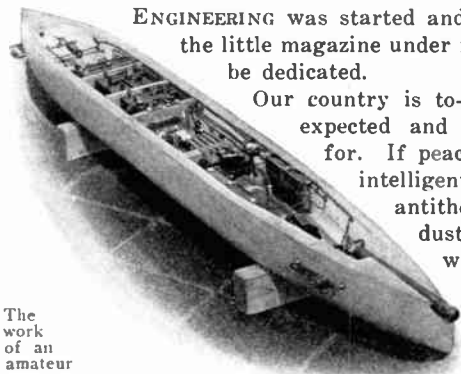

The work of an amateur

Our country is to-day facing a crisis long expected and only partially prepared for. If peace comes—and no sane or intelligent mind can hope for its antithesis—we must have industrial preparedness to cope with the situation created by our positively unique position. If war is the only alternative—then must we be ready to serve our

country with dispatch and efficiency.

No thinking man can say that the European conflict has been other than a battle of Science—a merciless war of Mechanics, Electricity, Chemistry and Engineering. The poor wretches who have given life and limb by the million, have been merely the carrying agent employed by the master mind of Science.

The children of Uncle Sam to-day hold a position of grave responsibility not only to their country but to the world at large. We have power, brains, tremendous resources, and abundant energy and enthusiasm. But we lack organization.

The part this little magazine can play in the great game of military and industrial preparedness is perhaps small compared with the big daily newspapers, but the part its readers can play *as a class* is beyond the power of any single writer to predict.

I have said that the wonderfully great resources of America lack organization. In no sense is the truth of this statement more fittingly demonstrated than in the case of the young scientists, model makers, experimental engineers, amateur mechanics, or whatever you prefer to call them. I refer to that body of young American men, numbering into the hundreds of thousands, who have their little workshops and laboratories, and who devote the greater portion of their waking hours to the pursuit of science and invention.

In a close relationship with this class of workers during the past eight years, I have had unique opportunities to analyze them as a type. They represent, beyond question or doubt, finer specimens of young American manhood, with a higher degree of practical intelligence than any other class of citizens to be found in this country.

These young men have contributed much to the world of science and invention. Many of the greatest achievements of the day are traceable to the young experimental engineer—the erstwhile boy who pattered over his tools at the kitchen table.

As a class, these men are public-spirited, generous, trusting, and resourceful. In their little groups throughout the country, they are quick to exchange ideas and confidences. In their small way they are loyal to the cause and quick to respond to whatever movement may appear conducive to a dissemination of knowledge or an advancement in general of their beloved science. But they lack organization. The group in California receives only meagre details of the work being done in New York or Massachusetts. The published accounts in the magazines and newspapers are ambiguous and not dependable.

In the December issue of this magazine, I called for suggestions relative to a suitable title for the class of men I refer to. Tentative mention was also made of a proposed organization, country-wide in scope, and devoted solely to the advancement of this class of work which, in a nutshell, means the development of resourcefulness and the ability to do things in the rising generation.

The response to this suggestion was tremendous. I have received communications from all over the United States endorsing

the plan and offering hearty co-operation. I have personally visited in the past month the principal centers east of and including Chicago, and have received the personal assurances of leading experimental engineers in each city that they would exert every possible effort to make the movement successful.

In view of the crisis which threatens at present, in which we may be called upon each to do his bit in the particular sphere to which his training has fitted him, it would seem that the time is ripe for the birth of a National Organization to provide a clearing house for the ideas and inventions of Young America. Accordingly, I have the pleasure and honor to announce the formation of the *American Society of Experimental Engineers*, with headquarters at New York City and branch chapters now organizing in many of the larger Eastern cities.

This magazine will be offered as the Organ for the Association and the Research Laboratory of EVERYDAY ENGINEERING will be given over to the use of the Society for the purpose of tests on the work of members, the development of new devices and inventions, etc.

In the future, at least so long as the present crisis exists, the work of the Laboratory Staff will have special reference to the question of military and industrial preparedness. Whatever work has been done in the past which bears upon this important subject will at once be referred to the United States Government to be accepted as a voluntary contribution to the cause of National Defense should there be anything worthy of such application.

While a similar action on the part of members of the A. S. E. E. will be recommended as a mark of patriotism and public duty, this action will not be made compulsory unless the voice of the Society so elects in future.

In the pages which follow, a brief resume of the objects of the American Society of Experimental Engineers, the business conduct of the organization, and the manner in which it is believed the Society will benefit experimental science, has been given. The article is illustrated with photographs of the Laboratory.

Every follower of this magazine who has the interests of practically applied science at heart is urged to read carefully the synopsis which follows, and to give what assistance he can in the work of organization.

THE AMERICAN SOCIETY OF EXPERIMENTAL ENGINEERS

THE American Society of Experimental Engineers will be incorporated at once under the laws of New York State as a Membership Corporation.

The Society is not a money-making or subscription-raising scheme. It is governed by a Board of Directors scattered throughout the country and representing the interests of the members as a class.

The Society will maintain a separate and distinct bank account and set of books, and will have no connection with **EVERYDAY ENGINEERING MAGAZINE** other than a contract by virtue of which that magazine becomes its official organ and is supplied to the members to appraise them of the work done throughout the country.

Object of the Society. The American Society of Experimental Engineers has been organized as a perfectly natural result of the widespread interest in electricity, mechanics, and science on the part of the so-called amateur.

Looking back a comparatively few years, we can recall the time when the amateur mechanics of the country numbered in the hundreds at the outside. To-day we can number them almost by the hundreds of thousands.

In this vast aggregation of experimentally-inclined individuals, there are many who like merely to dabble with tools; the typical handy-man-about-house, for instance. Then there are others who have graduated from that class; for example, the budding engineers and scientists who, one after the other, give to the world some product of their skill and ingenuity to lessen labor, cure human ills, increase efficiency, etc.

This little magazine you are reading has brought together more than fifty thousand of these experimenters of both classes and of all intermediate degrees. A tremendously enthusiastic response to the first public announcement of the proposed organization, signified the eagerness of the **EVERYDAY** following to join in the movement to organize the experimental engineers of the country. The name of the Society was selected by these men.

The net result is this:

The despised "experimenter" is at last to secure recognition for his work. The object of the A. S. E. E. will be to en-

courage and assist the experimental engineer through an interchange of ideas and experiences, the publication of reliable and authoritative reports of the work of those experimental engineers who wish to make known their work to others, the conduct of a campaign of publicity through the magazines and newspapers to force recognition of the class, and the provision of adequate laboratory facilities at minimum cost for the less-fortunate workers.

Official Publications. The Organ of the Society will be **EVERYDAY ENGINEERING MAGAZINE**. Reports of the various chapters and



A glimpse over the roofs of New York from a window of the Laboratory on the nineteenth floor of a modern fireproof building

their work will be published monthly. Every effort will be made to make these reports of practical value to other chapters rather than merely social news items.

The work of the New York City Chapter will be published monthly in a special Bulletin which will be sent gratis to all Members and Associates. This Bulletin will be in a measure a supplement to the magazine. It will contain accurate accounts of the research work conducted by the Laboratory Staff. Each number of the Bulletin will be complete in itself and will cover only one subject. The same article would be too long for publication in the magazine in a single instalment, hence the Bulletin.

The Research Laboratory and Experiment Station. The Laboratory of **EVERYDAY ENGINEERING MAGAZINE** at 104 Fifth Avenue,

New York City, and also the Experiment Station at Van Nest, N. Y., have been donated to the A. S. E. E. for the purpose of assisting members in their research work.

The Laboratory is situated on the nineteenth floor of a modern fireproof building in the heart of New York. It is speedily being equipped with every device and machine needed by the experimental engineer. The tool equipment at the present time is nearly complete. Lathes, a power jig saw, drill press, winding, polishing and grinding rigs, small tools, special attachments, etc., are to be found in plenty, and the only missing link of serious moment is a milling machine which will be added as soon as possible.

The testing facilities are particularly good. The current supply is 110 or 220 volts direct in quantity up to four kilowatts. This current is converted by means of motor-generators into 25, 60, or 125 cycle alternating or 10, 25, or 500 volts direct current. There are in addition the necessary primary and storage batteries for the supply of

The latchstring is out to members of the A. S. E. E.

smaller amounts of current at various voltages. The Staff is at present working on the design for a 500-cycle alternating current machine which will practically complete the generating equipment.

A fairly adequate stock of raw materials is kept on the shelves, and by means of the card-index file, the maker of practically any commodity is instantly available for reference.

Positively no manufacturing will be done in the laboratory. No goods will be sold from there in competition with manufacturers or dealers in standard equipment.

The laboratory is for the sole benefit of the members of the A. S. E. E. and it will be maintained by the income from dues and

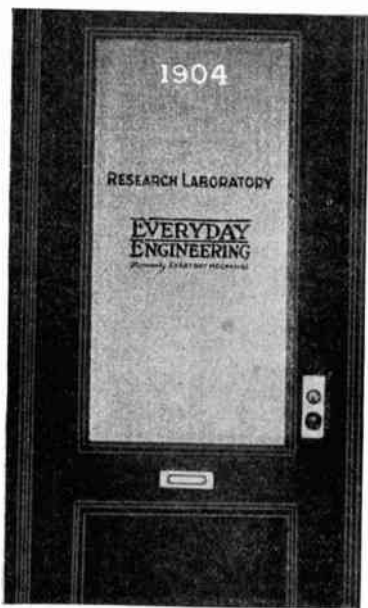

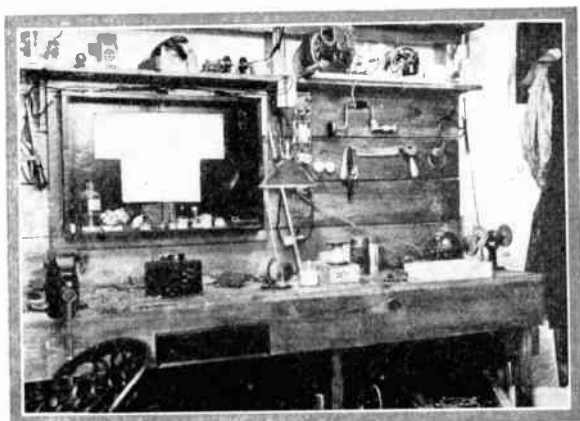

An experimental bench in the shop.

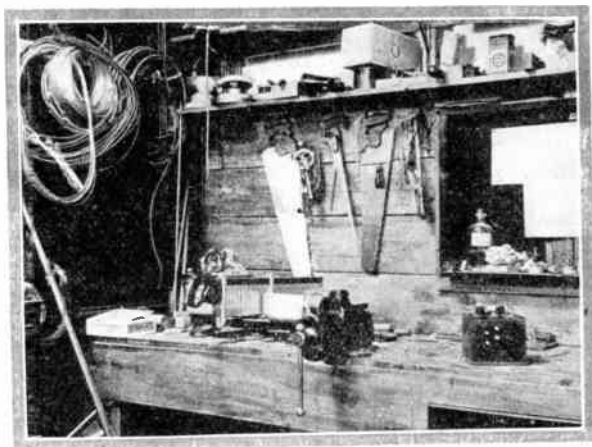

A corner of the shop.

the sale of special publications. The accounts will at all times be open to the inspection of members who are cordially invited to make themselves at home at headquarters.

Special research or construction work, for which a charge must

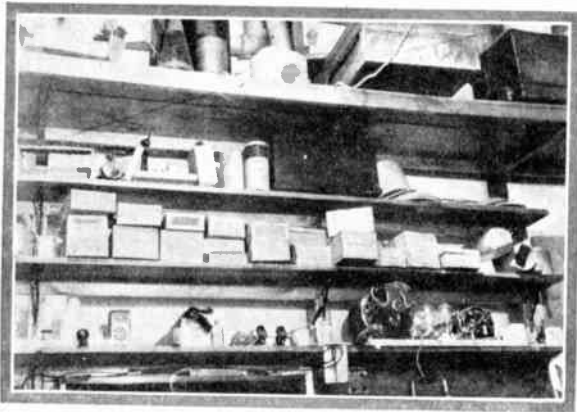

"Junk" that delights the heart of the true experimenter.

be made, will be done at cost, providing the same work cannot be done by a manufacturer of standard products. The income from this work will be payable to the American Society of Experimental Engineers and will show at the end of the fiscal year in the published statement.

Members of the New York Chapter and all outside members who can make the necessary trip will be welcome at the laboratory at all times except when special research work is in progress which would render public inspection inadvisable. Special sessions for experimental or demonstrative work will be arranged each month for the benefit of members without charge.

Meetings of the New York Chapter will be held monthly in the laboratory and at such meetings practical experiments will be made, and reports on the work of the month will be given. In other words, the members-at-large throughout the country will read the report of this work in the bulletin, and the New York members will hear a verbal report in addition to that given in their bulletins.

The discussions will prove enlightening and helpful. Questions may be asked after the paper is read. Likewise, the country-wide members may ask their questions, which will be answered in the following number of the bulletin.

The Experiment Station. The old laboratory of the magazine has been closed up for the winter on account of the difficulty of heating it in its isolated position. The buildings will be opened up again in April and the place fitted up as an electro-horticultural experiment station for the A. S. E. E.

Experiments in the cultivation of plants and vegetables with high tension and high frequency current will be conducted there throughout the entire summer. The location is ideal for these experiments and the facilities adequate.

It is hoped that by spring the new subway station will be opened directly opposite the *Experiment Station*. This will facilitate transportation of members who desire to visit the station for the

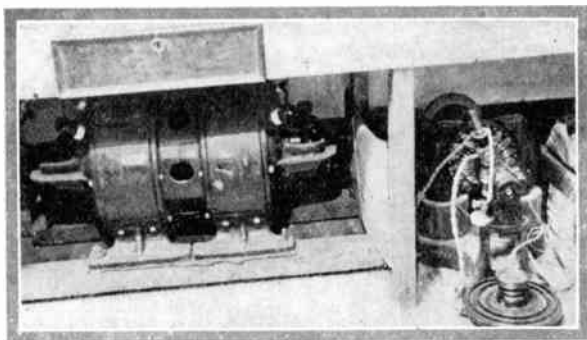

A portion of the generating equipment of the Laboratory.

purpose of observing the tests. The station is located on White Plains Avenue, directly east of Bronx Park.

Special Research and Workshop Projects. The laboratory work for a few months will be confined largely to a study of radiodynamics, or the control of distant mechanism without wires, and to important experiments in radio telegraphy and telephony.

In connection with the former subject many models of boats,

vehicles, mechanisms, etc., have been and will be built. These models are of particular interest to the true model maker or amateur mechanic who builds his models solely for the love of mechanical work without special reference to the purpose for which the model will be used.

The manual training instructor and amateur cabinet maker will find much to interest him in the cabinets for instruments, tables, stands, supports, etc., that are constructed constantly to house or support some special mechanism. Woodworking and machine work are essential features of the laboratory work, even though they do appear to serve merely as a means to an end.

Chemistry and physics will be treated as a matter of course. They are used almost daily in the laboratory and the pertinent features of the work will be picked out for publication whenever they illustrate a principle that may be applied in practical use.

Advantages of the Society. The American Society of Experi-

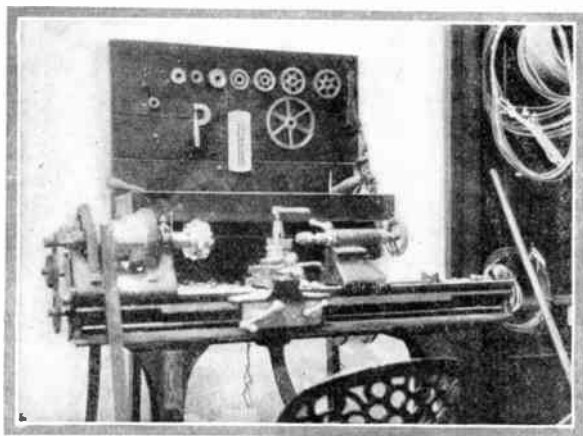

An engine lathe is included in the tool equipment.

mental Engineers will bring together in a composite body the cream of the experimental engineers of this country. It will give them a means whereby they can secure recognition of their labors. It will encourage the development of the young mind in the right channels

—that path which makes a man resourceful and self-reliant—capable of acting in an emergency. It will offer to the young engineers of the country a clearing house for their ideas and ideals, providing sources of information and constructural facilities hitherto beyond their reach. Finally, it will make of the rising generation a group of thinking, analytical, and resourceful citizens of which the country may well be proud.

Given the proper impetus, the society will so organize the ama-

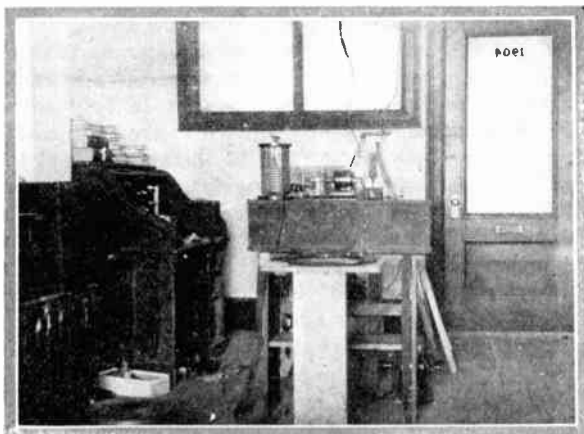

A section of the testing room.

teur workers of the country that they will point to their society emblem and, without fear of ridicule, say in response to the usual query, "I am an American Experimental Engineer." And if the object of the founder of the society is attained, that remark will bring forth the expression of respect and admiration it deserves.

Degrees of Membership. In the early part of this article, reference was made to two more or less distinct classes of workers who would sooner or later become members of the A. S. E. E. The junior element, which does not necessarily mean that its individuals are youngsters in point of age, would not be interested in or capable of understanding the advanced work of the senior worker. For

instance, the junior worker may produce a piece of cabinet work consisting of a library table with a cupboard beneath. This is ordinary woodworking that requires some skill and patience. The senior worker would take that same cabinet or table and install in it or upon it a complete set of high frequency apparatus for a physician's office. Get the point?

Now, both classes of workers are necessary to us. One must at some time or other be a junior before reaching the senior distinction. And as the seniors are developed, new juniors take their places.

The A. S. E. E. will be divided into these two groups for the purpose of creating an incentive to do greater and better work. The junior workers will be admitted as *associates* merely by signifying their interest and their willingness to help advance the cause. These associates may be admitted to the degree of *member* after they have produced some piece of work or evolved some system or effected some improvement which, in the opinion of the Board of Directors, constitutes a practical invention. The degree of member is intended to denote that its holder is sufficiently far advanced in his training and education along experimental engineering lines to be capable of *instructing* an *associate* who may come to him for assistance or advice.

In such manner is it hoped that the life and objects of the society will be perpetual and the movement country-wide.

Certificates and Dues. The dues of the society will be two dollars a year. One dollar of this sum will be paid to EVERYDAY ENGINEERING MAGAZINE for yearly subscription for the applicant and the remaining dollar will be paid into the treasury of the American Society of Experimental Engineers for the publication of the bulletin, for stationery, laboratory support, and society expenses in general. The statement of the society at the end of each fiscal year will show receipts and disbursements and will give a report on the results accomplished in a practical way.

The dues for members and associates will be the same. The associate graduating to membership within the year will not have to pay any extra moneys for his full membership.

A certificate of associate membership and of membership will be given to each applicant in either class upon acceptance. These certificates are suitable for framing. In addition, a card for the wallet will be supplied to identify the member or associate while traveling.

Associates and members have equal privileges in the society. The degree of membership is not intended to mark any superiority in the holder beyond the point of advancement in his work and achievements. An associate will receive just the same consideration as a member at meetings and in discussions. In fact, as we have related previously, the function of the member is to assist and encourage the associate by his superior knowledge and experience.



A corner of the Experiment Station given over to the cultivation of plants by electricity.

Headquarters of the Society. The executive offices of the society are located in the Aeolian Building, 33 West 42nd Street, New York City. The officers are as follows:

President, Thomas Stanley Curtis, Editor of EVERYDAY ENGINEERING MAGAZINE, Author and Counsellor to Experimental Engineers since 1909.

Treasurer, Stephen Roberts, Advertising Manager of EVERYDAY ENGINEERING MAGAZINE, and for nineteen years in charge of the advertising of several mechanical rubber companies, subsidiaries of the United States Rubber Company.

Advisory Directors: Norman W. Henley, President Norman W. Henley Pub. Co., and publisher of practical books for Experimental Engineers for 25 years. Wm. R. Bowen, Business Manager of EVERYDAY ENGINEERING MAGAZINE, formerly Business Executive for *The World's Advance*. C. Vey Holman, Franklin, Me., Mining Engineer, formerly State Geologist of Maine, and one of the country's most enthusiastic advocates of experimental science. J. E. Carrington, Jr., East Orange, N. J., formerly with Thomas A. Edison, Inc., and an experimental engineer of distinction. Ray Francis Yates, author and experimental engineer, now with The Carborundum Company, Niagara Falls, N. Y., and a pioneer in the advancement of experimental science among the younger element.

The full directorate of the society, together with the names of the charter members, will be published in the April issue of this magazine.

Application for Membership. Application for the degree of associate membership may be made by filling out the form following this article and mailing it with remittance to the American Society of Experimental Engineers, Aeolian Building, New York City. If the applicant is already a subscriber to EVERYDAY ENGINEERING MAGAZINE, his subscription will be extended one year from its present date of expiration. Certificates and credentials will be sent to the applicant immediately upon the acceptance of his application. A receipt form is tendered the applicant upon receipt of his application. In the event that for any valid reason, the application must be rejected, the applicant's remittance will immediately be returned to him.

All members must first be associates until they can satisfy the directors of the society that they are eligible to membership. These directors are being chosen from among men of national reputation

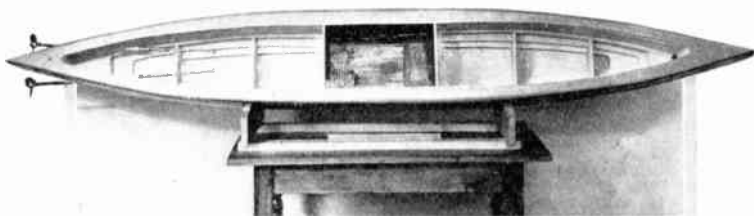

This radio-controlled submersible torpedo boat is being constructed in the Laboratory at the present time.

and acknowledged fairness of vision in the fields of science and education. It is believed that this method will obviate the tendency toward partiality evinced by organizations at times.

The Degree of Counsellor will be conferred upon individuals in various centers of the country. The duty of the counsellor will be to preside at local meetings, take charge of the experimental work, and act as chairman for the discussions of bulletins. As the membership grows in each community, these counsellors will be appointed to assume charge of the work. Responsible men who believe they are fitted for the degree of counsellor will confer a favor upon the association by offering their assistance in the work of organization.

The American Society of Experimental Engineers is now in your hands. If it succeeds, it will mark the awakening of a new era in American institutions. If you are one of its early members, you can look back with pride and perhaps silent amusement to the days when the amateur mechanic was something akin to a half-wit in the eyes of the world in general.

The founders of the American Society of Experimental Engineers have given you the nucleus; they have shown you the path and have given you their all as an evidence of their sincerity in the belief that the idea is sound. Now, it is up to you. Your name on the application blank below means you are one of the fifty-odd thousand reading this who has the courage of his convictions. The name of your friend or workshop companion on *his* blank sent in with *yours* means the start of a local Chapter in your community; where there are two, others will follow quickly. Here's the blank. Will you do your bit?

APPLICATION FOR MEMBERSHIP

The American Society of Experimental Engineers,
 Aeolian Building, New York, N. Y.

Gentlemen:

I hereby make application for the degree of Associate Membership in the American Society of Experimental Engineers in which, upon acceptance of my application, I am to share all of its rights and privileges.

I enclose (check, money order, draft) for Two Dollars (\$2.00), one-half of which sum is to enter or extend my subscription to **EVERYDAY ENGINEERING MAGAZINE**, for a period of one year, and the remaining half to pay my annual dues in the Society, for one year from date.

It is understood that, upon acceptance of my application, I am to be supplied with the regulation certificates of membership and the Official Publications of the Society during the tenure of my membership.

In making application for membership, I do hereby solemnly pledge myself to abide by the By-laws of the Society and to do my best in the advancement of practical scientific knowledge and the development of the characteristic of resourcefulness in my fellow men; furthermore, I do pledge myself never wilfully to be guilty of an act unbecoming an American citizen. Failing in these pledges, by word or deed, I shall be deemed unworthy of membership in the American Society of Experimental Engineers, and shall thereby forfeit said Membership with all of its rights and privileges.

Signed

City or Town.....

Street Address.....

State

My age is Nationality.....
 If naturalized, say so.

My Education
 Grammar or High School, College, Correspondence, etc.

Am employed as.....
 If still at school, say so.

Am particularly interested in.....
 Branch of Science or Craftsmanship.

Why I want to join the A. S. E. E.....

I suggest the name of....., Address.....

....., as a worthy member of the A. S. E. E.

HOW A PHYSICIAN BUILT HIS OWN ELECTRICAL EQUIPMENT

A COMPLETE HIGH FREQUENCY AND X-RAY EQUIPMENT CONSTRUCTED FROM STANDARD AMATEUR WIRELESS TRANSMITTING APPARATUS

A FEW months ago a physician of the younger school came into the Research Laboratory of EVERYDAY ENGINEERING MAGAZINE just to have a look around, as he explained. And thereby hangs this tale:

The eye of our medical friend chanced to fall upon a rotary spark gap of well-known appearance. The gap was doing duty in a set of high frequency apparatus that we were using for the production of long sparks. Said our caller: "That's a new one on me; I bought one of those rotating affairs for my boy last week for use in his wireless set, but I had no idea it could be used in that manner. Why, man, you are getting a bigger and more ferocious-looking spark than Dr. ——— produced with his high frequency apparatus that cost over two hundred dollars."

We assured the doctor that we took his word for it and went on to explain how the various instruments in a modern amateur wireless transmitting set comprised the essentials of a high-grade and exceedingly powerful and efficient electro-therapeutic apparatus. We showed him how the addition of a simple coil of wire upon a cardboard cylinder set on top of his son's oscillation transformer would give him a spark that would make real X-Ray pictures or do very effective work with the vacuum tube electrode when the set was operated at lower than the normal power.

The net result was that this physician went out and purchased seventy dollars' worth of apparatus and a few raw materials and constructed for himself an office equipment that was the equal in every way of his professional friend's at less than half the cost. Furthermore, when he had constructed the apparatus, he understood it. He knew exactly the function of each component part and knew what adjustments to make for each form of current because he knew how that current was produced.

Now, the object of this article and the one that follows it in the April issue of EVERYDAY ENGINEERING MAGAZINE is not to show how the physician may put the manufacturer of therapeutic apparatus out of business by building his own. Some physicians are

engineers and mechanics by avocation, and men of this type will build things for themselves until the ocean freezes over, regardless of whether they could purchase the same thing ready made for more or less money in the open market. Others cannot or will not put up a shelf in their offices. It is to the former class that we appeal.

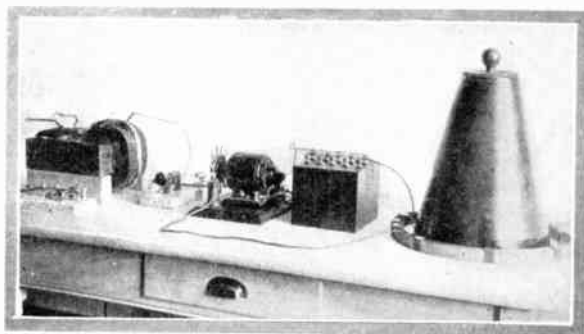

Fig. 1. Complete outfit before assembly in cabinet.

APPARATUS REQUIRED

We shall recommend the purchase outright of certain instruments simply because they can be bought ready made about as cheaply as they can be constructed in the home workshop. In the event that any reader wishes to build every piece of apparatus described, he is advised to refer to Mr. Curtis's book* for detailed description and working drawings of all types of high frequency apparatus. It would take twelve issues of this magazine to give the necessary data, therefore our constructive description will be confined to such pieces of apparatus as may readily be built by the average physician in his home workshop.

The apparatus specified in this article may be obtained from advertisers in this magazine at the prices specified in the estimate.

The complete set of apparatus is shown in Fig. 1. This may be said to represent the essentials of the equipment without the trimmings such as controlling devices, electrodes, treatment chair, etc. The apparatus as shown will produce the high frequency current required for auto condensation, X-Ray or vacuum tube treat-

* High Frequency Apparatus. Its Construction and Practical Application. Curtis. Price, \$2.00. From this magazine.

ment. The containing case or cabinet, controlling switches, etc., will form the subject of the second and concluding part of the description in the next number.

From left to right in Fig. 1 we see the transformer, stationary spark gap, rotary spark gap, condenser, and oscillation transformer. To define the terms just given we may say that the transformer receives the commercial alternating lighting current from the house mains at a voltage of 110 or that commonly used for running motors and lighting lamps in the house. The transformer converts this low potential current into one of several thousand volts pressure at the secondary terminals of the instrument. This high voltage current "charges" the condenser which consists of two groups of metal plates separated by plates of insulating material. The condenser takes the place of the old "Leyden Jar" of your days in the physics class in school. When the charge in the con-

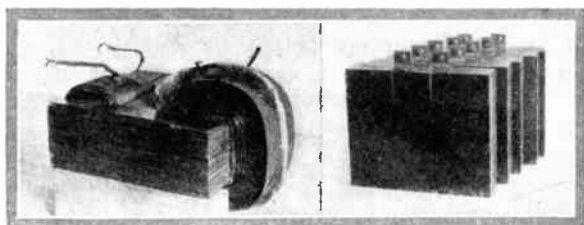

Fig. 2. The transformer, left, and condenser on the right.

denser reaches a certain critical value, the current leaps across the electrodes of the spark gap, thereby setting up electrical oscillations or a high frequency current in the circuit connecting the condenser and spark gap.

Now, the high frequency current generated in this circuit is of comparatively low voltage, so we must utilize the principle of the transformer once more to "step up" the voltage to that required for X-Ray and treatment work. To do this we include in the oscillatory circuit a coil or spiral of brass or copper ribbon, having four or five complete turns, each turn separated from its neighbors by insulating material. This forms the "primary" or low-tension side of an oscillation transformer. To produce a very high voltage, high frequency current, we have merely to place within this primary a cylinder or cone of cardboard wound with a single layer

of insulated copper wire, connecting the lowermost turn of the cylinder or cone winding with the inside turn of the primary. From this secondary coil we may take a current of perhaps hundreds of thousands of volts, depending upon the number of turns in its winding and upon the relation of its winding to the balance of the circuit.

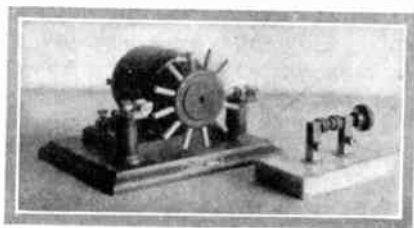

Fig. 3. The rotary and stationary spark gaps.

The transformer and condenser are shown in Fig. 2. The current is applied to the primary at the left and taken from the secondary at the right of the transformer. Primary and secondary are merely coils of very coarse and very fine copper wire, respectively, thoroughly insulated and mounted upon a core or hollow rectangle of silicon steel built up from thin sheets placed one upon the other.

In Fig. 3 is shown the rotary spark gap and beside it the small stationary gap. The rotary gap is used when the apparatus is working at its full power for the production of a long and powerful spark for use with an X-Ray tube. The smaller gap is used for vacuum-tube treatment work where a small and very mild current, under perfect control, is used.

Fig. 4 shows the oscillation transformer which steps up the high frequency current. In Fig. 5 is shown the winding machine, of wood, upon which the cardboard cone is wound.

The oscillation transformer may be purchased, but it is so easily constructed that the builder is advised to attempt it. The first requisite is the cage upon which to do the winding. The construction is obvious. Three discs of wood are cut by means of a scroll saw and mounted upon a length of dowel rod which is in turn carried in the simple wooden uprights which form the bearings. Slats of thin wood are then nailed to the discs to form the conical cage.

In forming the paper cone, red rope insulating paper should be used. This paper is heavy and stiff and it has excellent insulating properties. A disc of paper of the correct size to form the cone should first be cut. The size of the cone may be varied within reasonable limits in the event that the builder may have some substitute for the winding rig shown. However, it is well to adhere as closely as possible to the dimensions given here. This cone is 4 in. across the top, 12 in. at the base, and 15 in. high at the perpendicular.

Some assistance will be required in rolling the disc of paper into a cone or cornucopia before slipping it upon the form. The final trimming may be done when the cage or form is inside. Glue may be used to hold the edges of the paper together, but we recommend the use of shellac or some other insulating compound as the water in the glue is likely to cause trouble. When the adhesive is

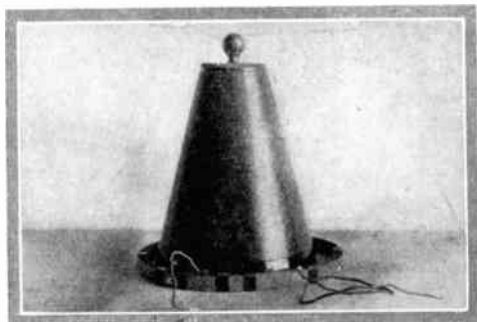

Fig. 4. The oscillation transformer for long sparks.

thoroughly dry, the seam may be sandpapered smooth and the entire surface of the cone coated with shellac preparatory to winding.

The winding for this size of cone is a single layer of No. 22 double cotton covered magnet wire. The winding is started at the smaller end of the cone, small brads being driven part way into the slats at the end of the cone to prevent the succeeding turns of wire from forcing the first ones off as the winding proceeds. The base of the winding rig should be firmly secured to the work table before starting in.

When a single even layer has been placed, the end of the wire is secured by passing it through the cone and plugging the hole

with a toothpick dipped in shellac. Then the entire surface of the winding is thoroughly coated with shellac, care being taken to see that the fluid soaks well into the insulation of the wire. When this coat is *thoroughly* dry, paint a second time and a third. Make sure that each coat is perfectly bone dry, however, before starting the next.

When the winding is finished, attach a wooden disc to the top of the cone and to this a bed-post ball of brass. Solder the top-most end of the winding to this ball. Solder a piece of flexible lamp cord to the lower end of the winding and secure in place so that the fine wire will not unwind in use. The oscillation transformer is not complete with the exception of its primary which is so simple as to need very little description.

The primary is merely four turns of brass or copper ribbon, of about No. 26 gauge, and one inch wide, wound into a spiral 15 in. inside diameter, with turns separated by a strip of corrugated

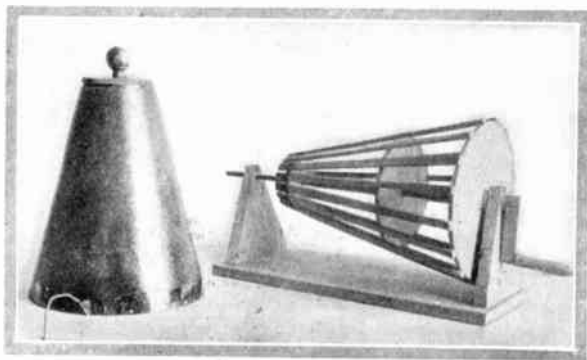

Fig. 5. Winding cage for the cone-shaped coil.

paper packing. Bindings of tape at frequent points hold the turns together. Connection to the turns is made by means of brass clips formed by bending pieces of the brass ribbon in two and soldering a piece of lamp cord to the top of the clip thus formed.

The coil used for D'Arsonval and Thermo-Faradic treatments is shown in Fig. 6. The smaller ribbon spiral is in this case made to displace the conical secondary as a lower potential is required. In the next article, the construction of a more efficient form of D'Arsonval coil will be described.

This completes the description of the essential parts of the apparatus. The intending builder is advised to procure the items listed in anticipation of the actual assembly in the cabinet to be described in the next article.

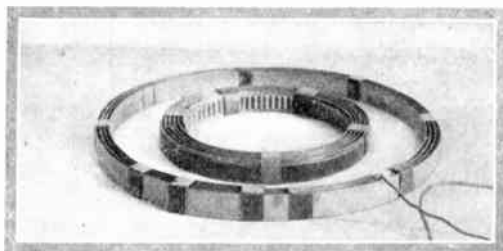

Fig. 6. Coil for D'Arsonval current.

ESTIMATED COST

The cost of the apparatus will depend upon the size of the outfit; that is to say, upon the power of the equipment. For instance, for light tube treatment and auto-condensation work in a patient's home, it would be absurd to build an outfit of the power of that shown in our illustrations. One quarter of that power would be sufficient. For the physician's office, however, where an X-Ray picture may have to be made of any part of the body, the larger power is worth while, particularly as such an outfit is not very expensive.

For convenience, we have divided our estimates into groups of $\frac{1}{4}$, $\frac{1}{2}$, and 1 kilowatt, in size. The oscillation transformer may remain the same for all and as its cost is represented chiefly by the builder's time, this item is not listed. Neither is the cabinet to be described. We have listed only the items it will be necessary for the builder to purchase outright before starting construction:

One-quarter Kilowatt

Transformer, magnetic leakage type.....	\$12.00
Rotary gap	17.50
Condenser, six sections at \$2.00 each.....	12.00
Stationary gap	3.00
Safety condenser	4.50
	<hr/>
	\$49.00

 One-half Kilowatt

Transformer, magnetic leakage type.....	\$18.00
Rotary gap	17.50
Condenser, five sections at \$4.00.....	20.00
Stationary gap and safety condenser.....	7.50
	<hr/>
	\$63.00

One Kilowatt

Transformer	\$30.00
Rotary gap	17.50
Condenser	20.00
Stationary gap and safety condenser.....	7.50
	<hr/>
	\$75.00

In these estimates, the transformer is quoted in the unmounted condition. There is no need for paying several dollars for a mahogany cabinet that cannot be used in the outfit. The condensers are made in two sizes, namely, .0017 mfd. and .002 mfd. The latter are larger and stronger and are therefore used in the large outfits. The rotary gap is the same for all outfits as are also the stationary gap and protective condenser. The latter is necessary to protect the house wiring from danger.

The items specified may be procured from advertisers listed in the Directory at the back of the magazine.

(To be continued)

FOR THE HUMIDOR

A concentrated solution of barium chloride instead of water may be used in tobacco humidors, and will give more satisfactory results than water. The solution keeps a constant vapor pressure irrespective of the amount, and is satisfactory to the majority of smokers.—S. MARCUS.

CLEANING GREASY DISHES

Use newspapers to wipe greasy dishes, pots and pans before washing. Wipe the greasy stove immediately after cooking and frying. Spread them on the kitchen table while preparing meals. The table will not have to be scrubbed so often. Use them to wipe the mud from shoes before it dries.—MARY F. SCOTT.

CONSTRUCTION OF A MODEL SUB-SEA TRANSPORT WITH SELECTIVE RADIO CONTROL

PART III

INSTALLATION OF THE RUDDER AND ITS CONTROL MECHANISM

THE steering rudder is well shown in Fig. 1 as it appears beneath the hull at the stern of the model. Fig. 2 gives us a glimpse into the hull, showing the rudder mechanism in position. Fig. 3 shows the rudder mechanism in parts, giving an idea of the proportions of each piece to the others.

For the structural data, the reader is referred to Figs. 4, 5, and 6, which are working drawings of the several parts of the

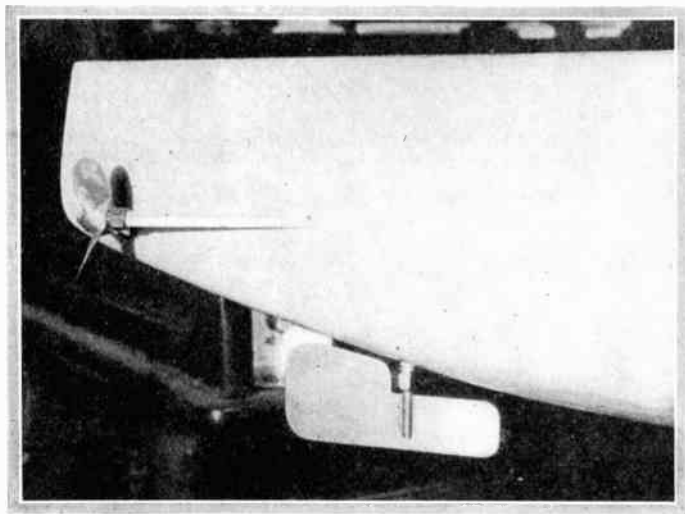

Fig. 1. The stern, showing rudder and one propeller.

control. The remaining illustrations, Figs. 7 and 8, show the complete mechanism installed within the hull.

For an explanation of the working principle, let us refer to Figs. 4, 5, and 6, with an occasional glance at the photographic views. The rudder proper is of sheet brass sweated into a saw-cut

in the end of the rudder post. The latter passes through a brass pipe sleeve or housing fitted with packing glands at either end.

To the top of the rudder post is fitted a brass disc having a shallow groove turned in its periphery to carry the "tiller cord" or its equivalent in this case. The construction and assembly of post

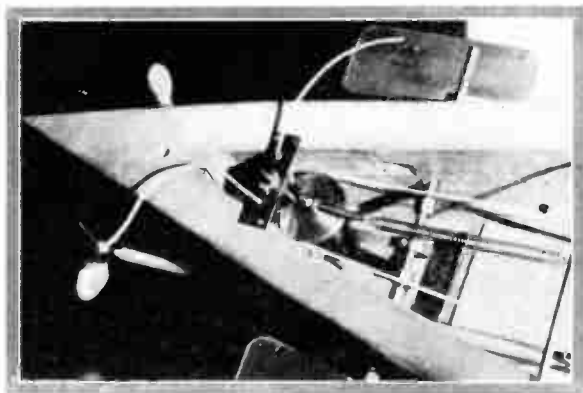

Fig. 2. Showing the rudder control mechanism.

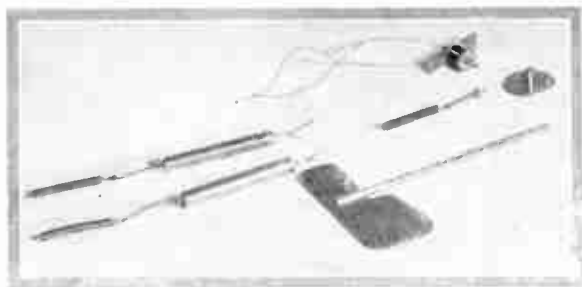

Fig. 3. Parts of the rudder control mechanism.

and disc is clearly shown in the detail drawing, Fig. 4. The hub of the disc is sweated with solder to the disc. The projecting arm of the post is threaded into the latter and tightened by means of the lock nut shown. The function of this projecting arm is to

carry the central spring which helps keep the rudder in a neutral position.

In the disc there are two little countersunk holes. See Detail B in Fig. 5. Each of these holes is 25 degrees to one side of the neutral position of the rudder. Mounted directly above the disc, see Fig. 4, is a small solenoid in which a plunger of iron slides freely. The lower end of this plunger is conical in shape to fit the countersunk holes in the disc.

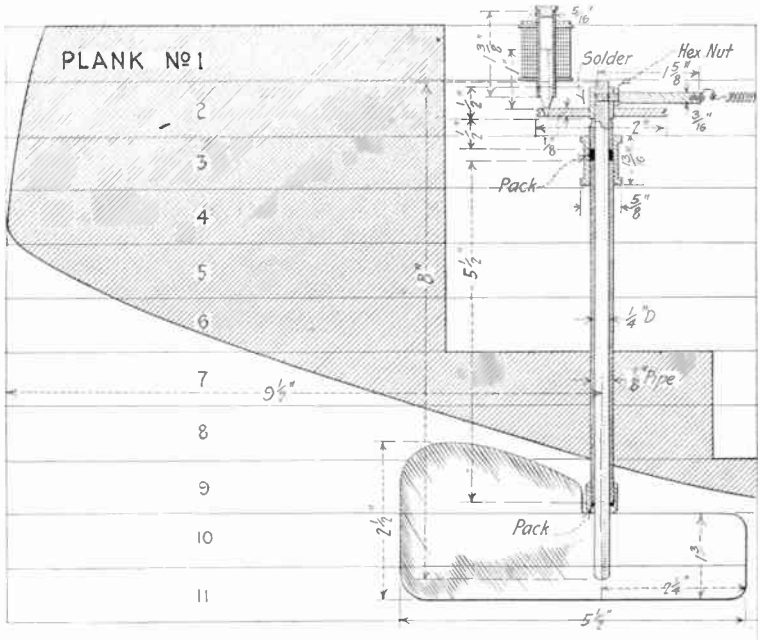

Fig. 4. Cross section through stern showing rudder mechanism in detail.

The action of the mechanism is as follows: When the tiller cord is pulled to the right (by solenoids to be described) against the tension of the neutralizing spring, the disc moves beneath the solenoid plunger until the latter drops into one of the holes. Here the rudder will stay until the next operation, which sends a current through the little solenoid, releases the rudder, sending it back to the neutral position. Likewise the left-hand pull of the rudder serves to engage the solenoid pin with the second hole.

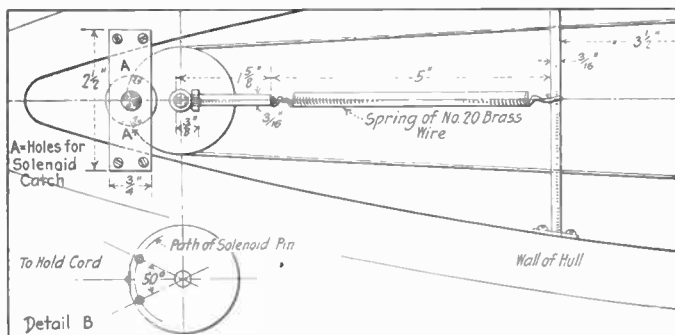

Fig. 5. Plan of stern. See opposite page.

The big feature of this mechanism is the fact that current is used for an instant only—just long enough to pull the rudder to port or starboard. It remains in that position until released, although no current is used in the retaining operation. The net result is that we can use a comparatively large current for the actual pull of the rudder, making the operation positive and trust-

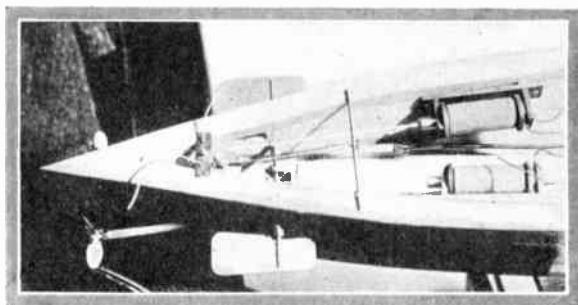

Fig. 7. Photograph of complete rudder mechanism.

worthy, and still maintain the essential economy of current consumption.

The tiller cord has been referred to. This is a length of the round type of shoestring, strong and very flexible, attached to the disc by the retaining screw shown in Detail B, Fig. 5. This cord, running in the groove in the disc, passes on to a large solenoid on

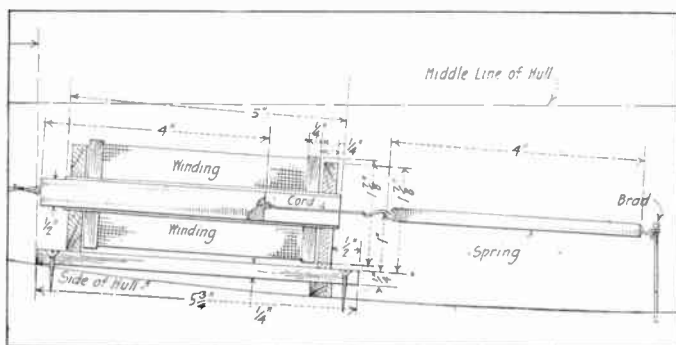

Fig. 6. A continuation of plan on preceding page.

either side of the hull. The photographs and the drawings, Figs. 5, 6, 7, and 8, will make this clear. The plunger of each solenoid passes entirely through the coil in order that tension springs may be attached to the rear end of each plunger to assist in keeping the rudder in a neutral position and to keep the tiller cord tight.

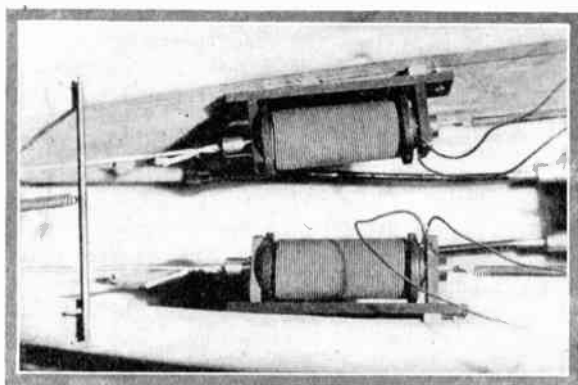

Fig. 8. Enlarged view of rudder solenoids.

SOLENOID WINDINGS

The small solenoid used to retain the rudder in the desired position is wound with No. 24 wire, enameled, in layers one inch long

upon the brass tube of the mechanism. The careful workman can get on 45 turns per layer and the winding should be about 18 layers deep. This winding is designed for use with the 6-volt storage battery.

The large steering solenoids are wound with No. 16 D. C. C. wire, 68 turns per layer, and 8 layers deep to each coil. The brass tube upon which the solenoid is wound should be a sliding fit over a

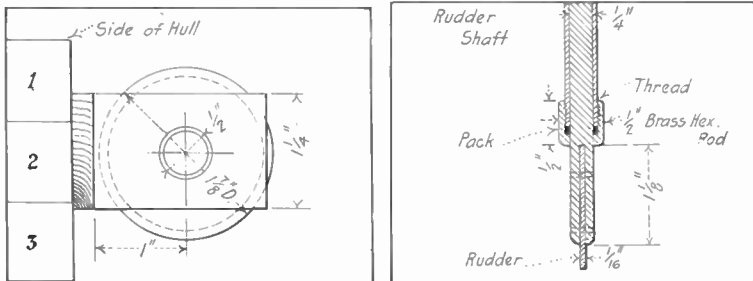

Fig. 9. Dimensions of solenoid supports. Fig. 10. Section through rudder post.

piece of 1/2-in. Norway iron rod made perfectly smooth. There must not be any friction in this sliding fit. If Norway iron cannot be obtained, cold rolled steel may be used, but the pull is lessened appreciably.

The mounting for the solenoids is of hardwood. In mounting the coils within the hull, care should be exercised to see that the plunger of the solenoid has a straight pull on the cord rather than one at a slight angle. It will probably be necessary to block out the rear end of each solenoid base with shims of wood to effect this.

The current density in the solenoids is comparatively high. The small coil pulls about five amperes or enough to heat it disastrously if the current were permitted to remain on. The large coils draw 15 amperes apiece at 6 volts. This amount of current produces a pull that will draw the plunger out of one's fingers nine times out of ten, providing the plunger is inserted three-quarters of its length when the current is applied. This high current density is not objectionable, however, in view of the fact that it is applied for but one or two seconds at a time.

(To be continued)

PATTERN MAKING FOR THE AMATEUR
MECHANIC

BY H. H. PARKER

PART II.—*Conclusion.*

MANY patterns, while varnished or finished "bright," are seen to have cylindrical or other projections painted black, or if the body of the piece is black the projections are left "bright." In every instance these strange looking projections are found to occur at points where holes or openings or recesses are required in the casting, and one is inclined to wonder why holes to correspond were not made directly in the pattern itself. In some cases this could be done, as, for instance, in the patterns shown at *D, H, K* and *L* of Fig. 7, and in the case of the slots of the face plate in Fig. 1-A. It will be noted, however, that all these holes and slots are shallow; if they were longer and of small diameter the draft would have to be excessive to allow the pattern to be drawn at all, and in a great many cases it would be impossible to use a "green sand core" at all, due either to the length of the hole or to the fact of its occurrence below the parting line of pattern or mould, as in Fig. 25. In these instances "dry sand" or moulded and baked cores must be used, and these make necessary the employment of "core prints."

"Core prints" are those parts of a pattern which form depressions in the sand mould, these depressions being used to support a "core" made of sand or sand and glue, moulded in a wooden "core box" and baked hard in a "core oven." When the metal is poured into the mould it flows around this core and a hole is thus formed in the casting. The remains of the core are removed with the casting and dug out of the hole. Core prints do not necessarily have to be of the same size as the hole to be formed in the casting; they may be of any shape that will draw, but the body of the core, allowing a small amount for shrinkage of the metal, *must be the exact size and shape of the hole or other opening required in the casting.* If the hole is to be cylindrical, the core body must be cylindrical; if a square or rectangular core is used, no matter what the shape of the core prints, the casting will be made with a square or rectangular hole, and so on. Then end or ends of the core must fit closely into the core print depressions in the mould, otherwise the molten metal might run between and cause the core to shift in the mould. Now for an example:

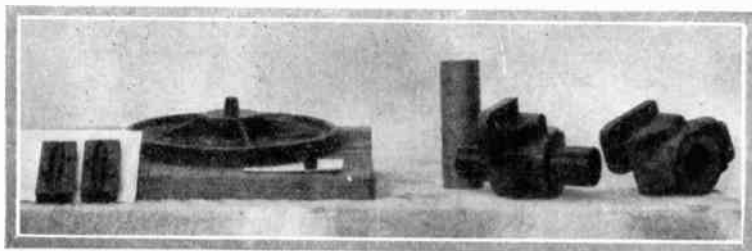

Fig. 5-A. Pattern in place on board.

Fig. 5-B. Typical parted pattern with horizontal core print.

The face plate as shown in Fig. 1 is being cast without a hole in the center. Suppose that in order to make the machine work easier it is decided to have a hole "cored" in the casting, but that the hole is too small in diameter in proportion to its length to make feasible the use of a "green sand" core like that of Fig. 9-A. Since the hole is too small in diameter in proportion to its length to make is known as a "vertical" core will be used. If the core prints were cylindrical, they would be hard to draw, therefore they are tapered or given draft. Fig. 5-A shows the pattern in place on the moulding board with the top core print, which is merely a piece of wood shaped like the frustrum of a cone and painted black, fastened in place. If the bottom one was similarly fastened it would interfere with the use of the moulding board, so it is made removable. This piece is shown standing in front of the pattern. Its bottom has a pin which fits into a hole in the bottom of the main pattern. No set rule is used in tapering these vertical core prints; one often used for small ones is to make the length equal to diameter of core, large end of same diameter and the small end half the diameter.

The core itself is moulded in a "core box," which sometimes is made in halves pinned together like a parted pattern. Such a core box is seen standing at the left of the pattern in the picture. When the core is to be symmetrical, as this one is, it is really only necessary to make half of the box: then at the foundry they will mould two half cores, bake them and "paste" them together, thus forming a whole core and saving the pattern maker considerable work. A half-box must be accurately made in order that the two half cores will fit together. As a matter of fact, it is hardly necessary to make a core box at all, for either a vertical or horizontal *cylindrical* core unless it is of an odd size, for all foundries keep on hand what are

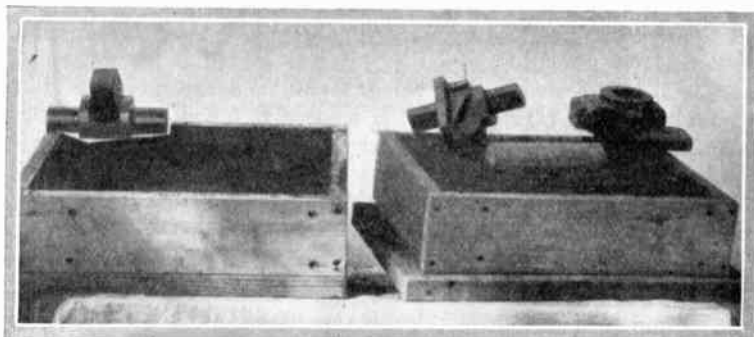

Fig. 6-A. Pattern drawn.

Fig. 6-B. Parted pattern with core print.

known as "standard" cylindrical cores of all diameters, from a quarter-inch up, running by eighths or sixteenths. These are cut to the required length, and if a vertical core with tapered ends is required, they "rasp" off the end to the right taper. There is no extra charge for the use of these standard cores, for the making and baking of special cores is not then necessary, and the pattern maker is thus saved considerable time and labor, especially if he is not provided with a "core box plane," and has to shape his core boxes with gouge and sandpaper.

To return to the face plate: this is moulded in precisely the same way as before, the loose bottom core print being handled the same way as the corresponding part of a parted pattern. Before the mould is closed up for pouring, though, the baked core is set in place in the core print depression formed in the drag by the upper print shown in Fig. 5-A; then when the cope is put on the other core print depression fits down over the top of the core, holding it firmly in place. This procedure is shown graphically in Fig. 16, which represents the successive operations of moulding a flange with a vertical core.

Fig. 17 shows the moulding of a longer flange pattern, which is best made parted and moulded horizontally, thus requiring a horizontal core. In this case the core prints would be made cylindrical, the same diameter as the core, and, of course, parted like the rest of the pattern; in making a pattern of this type the core prints would be turned up as an integral part of the pattern. A good rule for small core prints of this kind is to make the length equal

to the diameter. The core is made similar to the vertical one, either in one piece or moulded in a half core box and the halves pasted together. In Fig. 8-F, is a half box for a cylindrical horizontal core. Although such a core box is easier to make than the kind shown in Fig. 5-A, the amateur is advised to allow the use of the standard cores at the foundry whenever possible.

Photographs 5-B and 6-B illustrate the moulding of a typical parted pattern with horizontal cylindrical core prints. The complete pattern is shown in Fig. 5-B, and to the right of it is a cast-

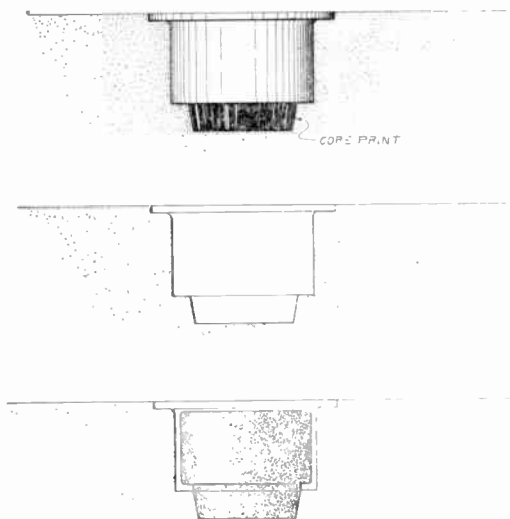

Figs. 18, 19, 20. Moulding of a pattern such as of a steam gauge or meter case with opening on one side only. Rim on open end prohibits use of greensand core.

ing which was made from it. Note the hole through the casting. Standing upright behind the pattern is the core. In Fig. 6-A the cope has been lifted, the half pattern with it, turned over and the pattern drawn. Note that the core prints on this piece have left two semi-cylindrical depressions in the sand. At B the other half of the pattern has been removed also, leaving a half mould in the drag and two semi-cylindrical core print depressions into which the cylindrical baked core has been placed. This done, the cope

will be replaced and the mould will be ready for pouring. The casting shown upon the corner of the drag in Fig. 6-B is not, of course, supposed to have been taken from the mould; it was placed there merely to give another view of the one of Fig. 5-B.

Sometimes a number of holes, vertical, horizontal, or inclined, or recesses and openings of various shapes are cored into the same casting; core boxes are often extremely complicated, and in fact

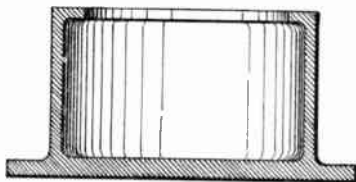
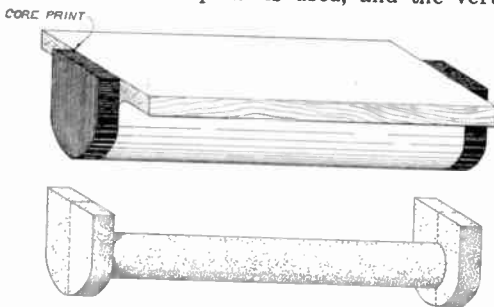

Fig. 21. Cross sectional view of finished casting. Compare interior with core of Fig. 20.

castings are frequently made without a pattern, the mould being made up of cores alone. If the casting is to be open at one side only, as in the case of the box-like steam gauge or meter case shown in Fig. 21, but one core print is used, and the vertical core rests



Figs. 22, 23. Pattern and core prints. Pattern will be moulded with flat (top) surface resting on moulding board. Appearance of core made in core box.

upright in the depression formed by it, the core of course being a "dry sand" one made in a special core box. The core in the picture is short and thick, and is easily supported in this way, but if it had to be placed horizontally or if it had been long and thin, the inner end would have had to have been held in place by one or more short inner cores and the holes formed in the casting plugged

up later. The water jacketed cylinder of a gas engine would be illustrative of such a case. Space will not permit the discussion of such complicated cores and core boxes, which would prove troublesome for the amateur in any event, so only a few of the simpler types are shown in the photographs. Fig. 8-A shows the two halves of a pattern similar to that of Fig. 5-B, except that two sets of core prints, large and small, are used at *P, P*. No core boxes are shown, for standard cores were employed, at the foundry. *B* and *D*, Fig. 8, are instances where both vertical and horizontal core prints occur in the same pattern; *X* denotes the vertical print. At *C* is a more complicated core box which goes with the pattern shown at *B*, Fig. 1, and half of which may also be seen at *H*, Fig. 8. The method of moulding this pattern would be exactly the same as the operations shown in moulding the meter case, Figs. 18, 19, 20; the core box is more complicated because the interior of the casting must contain ribs and bosses. The disc-like core print may be seen on the face of the pattern at *H*. The outside of this core box was made round merely for convenience, and as far as the moulding is concerned could just as well have been square. The inside shape of the box is all that should be considered from the moulding standpoint, for here the core is formed, and when it is placed upright in the mould (in this case) the hot metal surrounds it and leaves an opening in the casting the same shape as the core.

But one other type of core can be considered; one which has to be placed below the parting line of the mould and which may be either horizontal or inclined. Fig. 7-J, and Figs. 22, 23, 24, 25, illustrate such a case. This is a one-piece pattern which will be moulded with its flat side resting upon the board; therefore the parting line of the mould would come even with this side. The part of the casting that is to have the horizontal hole through it will be down in the drag, and it is obvious that if regular horizontal cylindrical core prints were used the pattern could not be drawn, for then the core print projections would tear up the sand. In a case of this kind, therefore, *the core prints must extend up to the top of the mould so that the pattern may be removed therefrom*. They may be given any convenient shape as long as they will draw; for instance, in this pattern they are an extension of the lower part and extend up even with the top and, therefore, even with the parting line of the mould. The body of the core, as previously stated, must be of the same diameter as the required hole through the

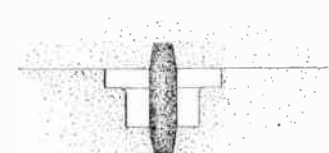
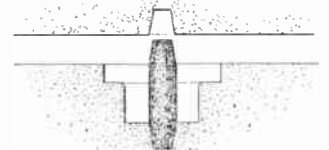
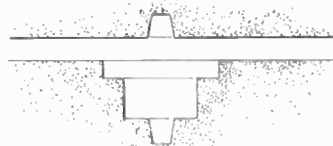
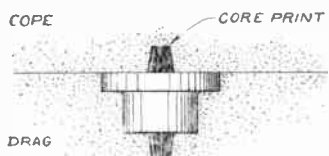

Fig. 16. Moulding pattern with vertical core prints and placing of vertical dry sand core.

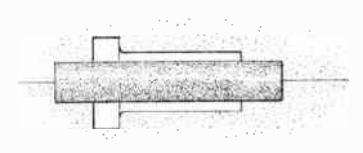
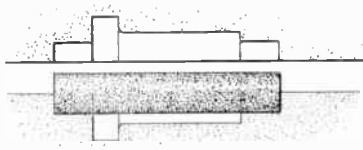
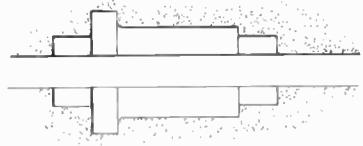
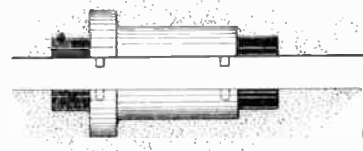
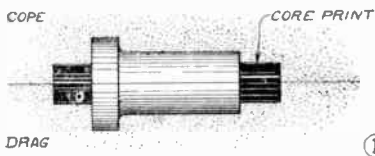

Fig. 17. Moulding of parted pattern with horizontal cylindrical core prints, horizontal core.

casting. A core of this kind always requires the building of a special core box; even though the body of the core were cylindrical a standard core could not be used, for the two end portions which fit into the core print depressions must be moulded and baked with the body. In this case a half core box may be used; such a one is shown at *G*, Fig. 8, and at Fig. 24, and the appearance of the finished core in Fig. 23. If the two ends were not alike, a half box

could not be used, for the two half cores would then not fit together. Fig. 25 shows how the casting would look; *note that the core print projections never appear on the casting; their function is only to form a support for the core in the mould.*

Space will not permit a further discussion of cores and core boxes, for they occur in an endless variety, and every one would require a special description, but the foregoing should give the reader an idea of the principles involved. Therefore we will pro-



Fig. 24. Plan and end view of half core box. Must be made so that half core may fit together.

ceed to explain a few small but important details before closing: "fillets," "loose pieces," and allowance for shrinkage and machine work.

A sharp corner should never be made on a pattern, whether it be curved or straight, but should be rounded off; and internal corner should be filled in by a curved portion called a "fillet." An exception to this rule would occur in the case of such corners as were formed upon that side of the pattern which would rest upon the moulding board, as the top edge of the flange shown in Fig. 1-A. Such a corner could not be rounded to any extent without interfering with the drawing of the pattern. A sharp corner always means a weak place in the casting, for strains are set up in the metal as it cools and are sometimes sufficient to cause a fracture, whereas a rounded corner, or one containing a fillet, causes a more uniform cooling stress in the casting. When cutting a pattern out of a single piece of wood, the fillets can generally be worked out from the solid, but if built up of separate pieces, sharp corners are usually formed and must be filled by a small strip of wood glued in and rounded with gouge and sandpaper after the glue is dry. This is illustrated in Fig. 26, which shows a triangular piece of wood with brads for temporarily holding it in place until the glue dries, after which the brads are drawn and the corner rounded. Strips of

leather may be used for fillets instead of wood, especially in fitting rounded corners where wood fillets would be difficult to fit. They are fastened and shaped the same way as the wooden ones. Beeswax is sometimes used, the wax being softened and worked into the corner, but such work is not very permanent. A fillet should not be too thick in proportion to the thickness of the pattern, as in the dotted line of Fig. 26; this would be as bad as none at all, for the excess of metal in the corner would cause strains to be set up there as the metal cooled.

"Loose pieces" are small parts of a pattern which project in such a way that if permanently fastened in place would not allow the pattern to be drawn from the mould. Instances of this are noted in Fig. 7, one being the lathe slide *M*, which has a boss *X* on one side of the post, and the projection on the lower end of the base of the follow rest *F*. These parts are made separately and held in place by a long pin or brad. In moulding, the sand is rammed down over the pattern until part of the loose piece is covered; then the



Fig. 25. Appearance of casting showing cored hole.

pin is removed leaving the piece in position while the remainder of the sand is filled in. When the pattern is removed the loose piece stays in the mould and may be taken out without breaking up the sand. The piece must, of course, be small enough to be removed through the mould formed by the main part of the pattern. While the best practice calls for sliding dove-tailed joints and other more or less complicated arrangements for loose pieces, the simple method of holding by a pin is perfectly satisfactory for small patterns.

Every metal shrinks to some extent upon cooling from a molten state. The amount of shrinkage depends on the size and shape of the piece as well as the co-efficient of expansion of the metal. For cast iron the shrinkage allowance is generally one-eighth of an inch to the foot; this means that if a casting was required to be one foot long the pattern would have to be made twelve and one-eighth inches long, for the casting would shrink one-eighth of an inch in

its length while cooling. But for most of the small patterns such as the amateur would build, unless very accurate castings were required, the shrinkage could be neglected.

Those parts of a pattern which correspond to the portions of the casting which are to be machine finished must be made thick enough to allow for the material removed from the surface of the casting while turning, boring or planing it. Usually about one-eighth of an inch has to be taken off in order to get down through the surface scale and give a smooth finish to the work. For instance, the top

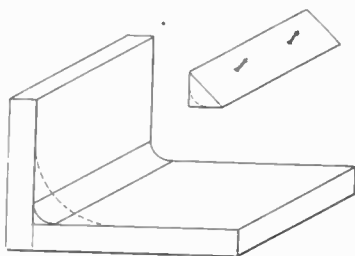

Fig. 26. Making a fillet. Dotted line indicates a fillet with too great a radius in comparison to thickness of pattern.

face, rim and lower face of hub of a casting of the face plate shown in Fig. 1-A, would have to be turned off in the lathe and so the pattern would have to be made one-quarter of an inch greater in diameter than the finished size, the face one-eighth inch thicker and the hub one-eighth longer to allow for the machine work on the casting. If a hole was bored through the center allowance would have to be made for removing at least one-eighth of an inch of metal from the sides of the hole while boring out, and more if there was a chance of the cored hole being crooked.

This article must now be brought to a conclusion, and, while it has touched only briefly upon a few of the more important phases of the art of pattern making, it is hoped that such examples and explanations as have been given will help the reader gain an idea of the general process, and assist him to start in the right direction when taking up the actual work.

(THE END.)

CONSTRUCTION OF A ONE-HALF HORSE-POWER GASOLINE ENGINE

BY WM. C. HOUGHTON, M.E.

PART IV

INLET VALVE.—The valve consists of three parts: the valve proper, the shell and the outer gas ring. The casing is cast solid with a chuck piece on the smaller end. The chuck piece should be trimmed up with a file so that it may be held firmly in the chuck.

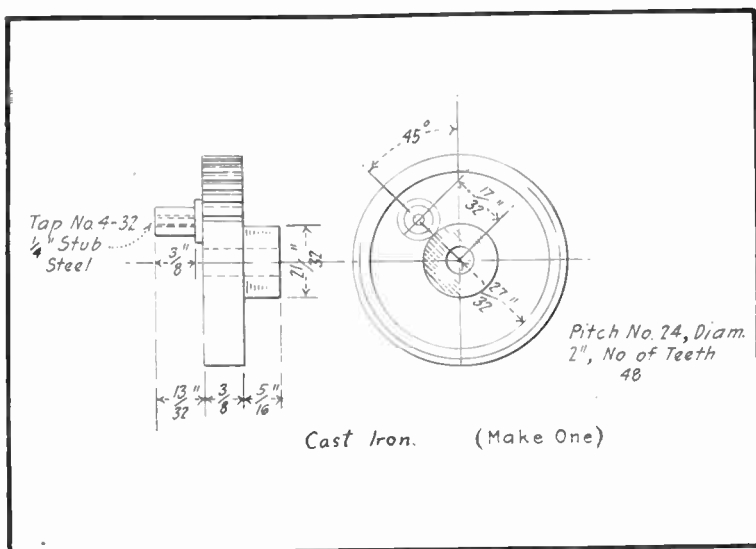

Fig. 18. Half speed gear.

It is then centered, drilled $\frac{1}{2}$ in. to a depth of about $\frac{7}{8}$ in., or a little less than finish size. It is then bored out to $\frac{5}{8}$ in. diameter and $\frac{15}{16}$ in. depth, and the inner end squared. The valve seat is then faced off at an angle of 30 degrees.

The bottom of the hole is next to be recentered very carefully, and a $\frac{3}{16}$ in. hole drilled through the chuck piece. Great care should be used in this operation to see that the drill runs dead true and does not cut oversize.

Remove from the chuck, and put in a piece of soft steel about $\frac{3}{4}$ in. in diameter, and turn down to $\frac{5}{8}$ in. diameter for 1-in. length, making a "soft arbor" on which the shell is mounted. The arbor should be finished smoothly and only tapered very slightly with a dead smooth file. Turn the outside of the shell as per drawing, threading it for $\frac{1}{2}$ in. at the tailstock end—24 threads. The thread may be turned off for $\frac{1}{4}$ in. at the outer end if desired.

Next, lay out 16 holes equally spaced around the shell at the end of the threaded portion, remove shell from chuck and drill with a No. 30 drill. These holes are for air inlets. Nine similar holes are laid out in the valve-seat, equally spaced, and drilled with a No. 45 drill. These are for the admission of gas, and should connect with the space inside the gas ring.

The valve proper may now be taken up. Center the double casting, put in lathe and turn the chuck pieces down true. This is

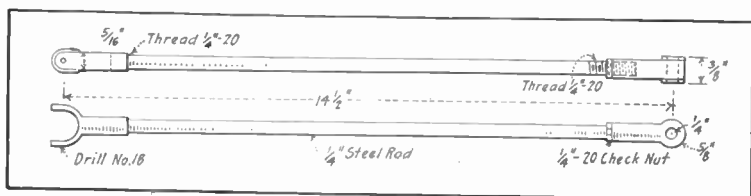

Fig. 19. Valve connecting rod.

worth while to insure true running when put in the chuck. Both valves (the two are cast together) may also be roughed out. The casting is then cut with a parting tool or saw, and one half put in the chuck. Center the hub carefully and drill $\frac{3}{16}$ in. diameter to a depth of $\frac{5}{16}$ in. The drill should first be tried in a piece of scrap to see that it does not cut oversize. Cut a piece of $\frac{3}{16}$ in. drill rod to $2\frac{3}{8}$ in. length, and drive in hole. The tailstock of the lathe may be used to press it in to insure truth.

At this point the shell and valve should be ground to a fit. Valve grinding compound such as is sold for grinding auto valves is best for this purpose, but flour emery and oil will do. Rotate the valve at moderate speed, say 100 R.P.M., pressing lightly and lifting frequently. Do not attempt to polish, but test by removing from chuck and sucking, not blowing at stem end. A small hole is drilled through the end of the valve stem and a steel pin put through it to hold washer and valve spring. The spring should

be of No. 24 piano wire, and made just barely strong enough to close the valve.

The *Gas Ring* should be held in the chuck with the side which goes next to the cylinder head outward. There should be space enough at the back to allow boring through without injuring the chuck. Bore out as per drawing, and thread to fit the shell. Reverse in chuck and face up back side. Next fastened to shelf of

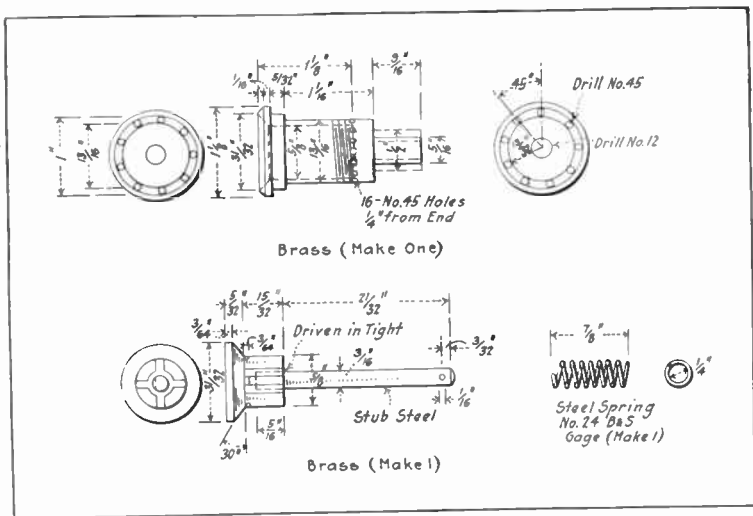

Fig. 20. Detail of inlet valve.

angle plate, center the gas inlet and drill and tap 1/2 in. pipe thread.*

It may be well to state at this point that the gas ring is not necessary if it is intended to use gasoline instead of gas. The short piece of pipe leading from the carburetor may be internally threaded and screwed on in place of the gas ring.

Exhaust Valve. The method of procedure in machining the exhaust valve is very much the same as in finishing the inlet. Hold the shell casting in a chuck and center-drill and bore the inside and finish off valve seat as before. One operation may, however,

* NOTE:—This part was marked *gas outlet* in the assembled drawing p. 143 in December issue. The mistake is obvious.

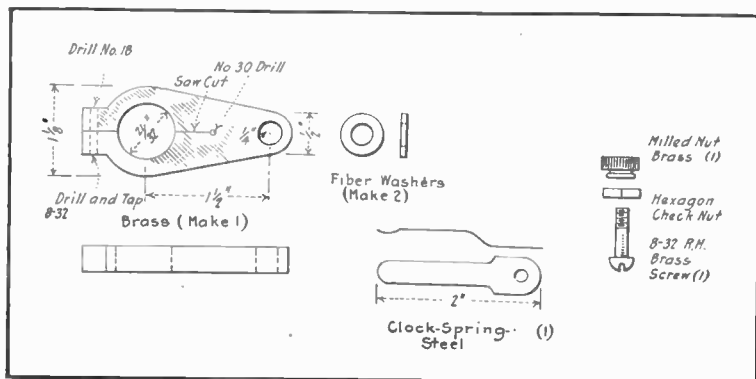

Fig. 21. Ignition contact device.

be saved if the valve seat end is first center-drilled and the lathe center brought up to steady the work. The outside of the shell may then be turned, the shoulder finished, and the thread cut to fit the cylinder head. The internal work may afterward be carried out as indicated and finally the chuck piece cut off. The first method is perhaps a little safer. Two angle-plate operations will follow. The first will be drilling and tapping the exhaust tube boss. It should be noted that the thread is not a standard pipe thread. The part is too small to permit it.

A piece of thin brass or steel tube can be threaded to fit it, and screwed into a piece of standard pipe a few inches from the valve. The second angle-plate operation is to face off the valve lever boss, and drill the pivot hole. The valve proper is made exactly like the inlet valve except in size, and the stem has a notch for the spring instead of pin and washer.

Grinding the valve to its seat may well be done before taking the casing from the chuck. A good way is to smear the valve seat with emery or grinding compound, insert the valve and hold in place with the fingers while rotating at fairly high speed. Remove frequently for inspection and renewing grinding material.

The valve spring is to be made of thin sheet steel. A light clock spring is about right. It may be formed and bent to shape without drawing the temper and rehardening. First lay out and *punch* the holes. Do not try to *drill them*. A suitable punch may be made by drilling holes through a piece of $\frac{1}{2}$ -in. bar steel, near the

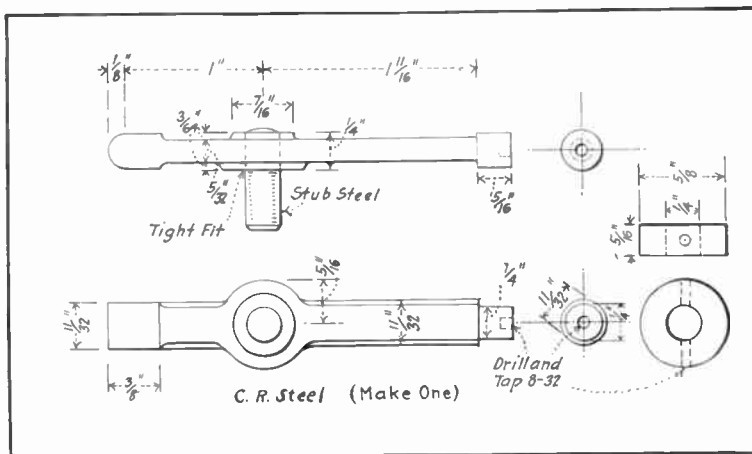

Fig. 22. Exhaust valve lever.

ends. One hole is to be $\frac{3}{16}$ in. and the other $\frac{5}{16}$ in. A hack saw cut is then made in each end of the bar, deep enough to let the hole come at the middle of the spring when slipped in it. The punches themselves may be short pieces of round steel which need not even be hardened. The spring may be cut roughly to shape and finished with file or emery wheel, taking care in the latter case not to draw the temper. Careful use of pliers will easily bend the spring to the proper shape.

The *Exhaust Valve Lever* is made of bar steel, preferably cold drawn stock. Drill hole for steel pivot slightly countersinking one side for riveting it in. File the valve end to shape. Place in a four-jaw chuck and turn down the connecting rod end as per drawing, and at the same time drill and tap for screw to hold the retaining washer. Since this lever moves in a horizontal arc, and the connecting rod vertically, some sort of universal joint is needed here. The ring shown in the drawing serves the purpose. It is pivoted in the forked connecting rod end. This may be cut from heavy brass bar stock, drilling, sawing, and filing to shape, the round portion being turned, drilled and tapped $\frac{1}{4}$ in., 20 threads in the lathe. An alternative method is to make the fork portion of smaller stock bending to shape and sweating to a shoulder turned on the cylindrical portion. The crank pin end of the connecting

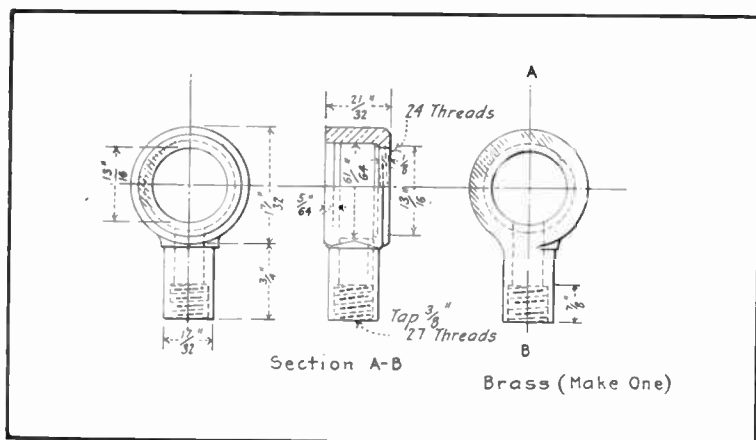

Fig. 23. The gas ring.

rod is cut from bar stock in the same way. The connecting rod itself is merely a length of cold drawn steel threaded at both ends. Check nuts are provided so that the length of the rod may be adjusted in assembling, and the rod held rigidly after the correct length is found. The threaded ends should be made of ample length for this purpose.

The half-speed gear may perhaps be obtained from stock, but if not, it must be cut to order. This should be done at the same time the shaft gear is ordered. A plain flat gear with boss, as per drawing, is required. It should not be spoked or webbed. The only machining required is drilling two holes, one for the valve rod stud, and the other for the igniter contact. The latter is merely a steel bicycle ball driven into a hole drilled to make a tight fit, and sunk a trifle more than half its diameter. Quarter-inch is the right size, though one a trifle larger or smaller will do no harm. The position of the hole, that is, its angular distance from the stud, should be noted, but here again a small variation will not make any particular difference, as the contact spring swings around the boss on which it is mounted, and may be adjusted. The timing of the ignition is regulated in this way.

The ignition contact device consists of two principal parts, the brass supporting arm which is bored out to fit the boss on

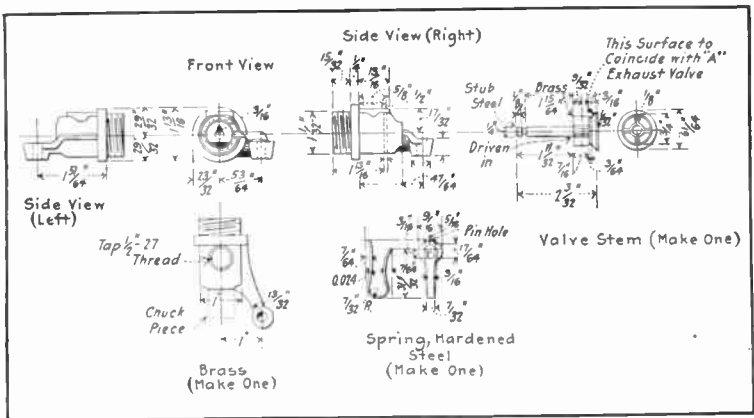

Fig. 24. Detail of exhaust valve.

which the gear stud is mounted, and is split and clamped in place by a screw. An insulated steel spring is fastened at one end by a screw, nut and washer, with a milled thumb-nut for the battery wire. The carbon screw and nuts from a dry battery are just right for this purpose. A fiber bushing and two washers are used to insulate it from the arm. The contact spring is made from clock spring by punching, filing and bending very much in the same way the exhaust valve spring was done. The main spring of a common nickel alarm clock is about right for this purpose. This sort of contact, using as it does hardened steel parts, is sure fire, and may be used a long time without serious wear. The constant rubbing of the steel ball and the spring keeps them bright.

The next instalment will take up the assembling and timing of the engine, the necessary ignition accessories, etc.

(To be continued.)

SWEET POTATOES IN THE NORTH

The common sweet potato sold here is not considered good eating by Southerners. Write now to some Southern friend or nurseryman for small roots by mail of a variety that stands for quality. Start these in a hotbed, take off the sprouts, root them and plant outdoors the end of May.—F. H. SWEET.

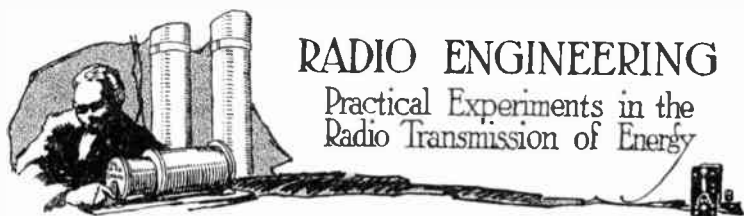

HOW TO UNDERSTAND THE MATHEMATICS OF RADIO TELEGRAPHY

BY M. B. SLEEPER

EDITOR'S NOTE:—This is the first chapter of a most interesting and important book "Radio Apparatus, Its Theory, Design and Operation," written by Mr. Sleeper and to be published early in April by Everyday Mechanics Company, Inc. The author's aim, in this chapter, has been to take the mystery out of "math" as applied to elementary radio and electrical engineering.

THE foundation of radio, as of any of the sciences, is in mathematics. In this book none of the obtuse mathematical explanations are given, for higher mathematics in radio is of use only to the research worker, while this book is for the practical worker and experimenter. At the same time, there are formulas which must be solved in designing radio circuits and apparatus.

To simplify the calculations as much as possible, tables of roots and squares are given. The solution of the equations, however, may puzzle those who have not yet had sufficient experience in mathematics or those who find their memories a little hazy on the subject.

Use of Symbols. The problems in this book which require solution involve only the simplest principles of algebra. Algebra is the science of computation by symbols. The formula for wavelength,

$$\lambda = 59.6 \sqrt{LC}$$

shows the necessity of using symbols in the solution of the problems in radio work.

Equations. We may say that

$$10 + 15 = 25.$$

This is an equation, for the sum of the two numbers at the left of

the equals sign is of the same value as the number at the right. Or if we know that

$$\begin{aligned} a &= 10, \\ b &= 15, \\ \text{and } c &= 25, \end{aligned}$$

we can say that

$$a + b = c.$$

Then $a + b = c$ is an algebraic equation, for the symbols a , b , and

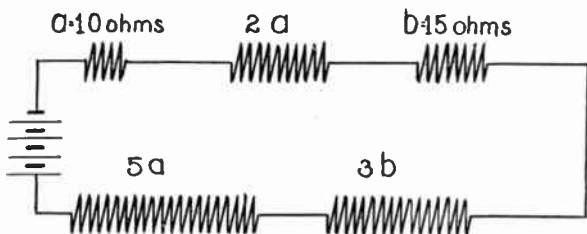

Fig. 1. A number of coils, the resistances of which are designated by letters instead of numbers.

c have been substituted for the numbers. If we did not know the sum of a and b is 25, we could say

$$x = a + b,$$

for x usually stands for an unknown number. Then by substituting the numerical values of a and b , we have

$$\begin{aligned} x &= a + b \\ x &= 10 + 15, \end{aligned}$$

and since the values must be the same on both sides of the equal sign, x must be 25.

Now suppose we had said

$$x = 2a + 3b,$$

keeping the same values for a and b . The $2a$ means simply 2 x a , and the $3b$ means 3 x b . A number directly before a letter or symbol is called the coefficient or multiplier. Substituting the numerical values in the equation, we have

$$\begin{aligned} x &= 2a + 3b \\ x &= 2 \times 10 + 3 \times 15 \end{aligned}$$

or
$$x = 20 + 45,$$

or
$$x = 65.$$

Therefore the value of x is 65. Or suppose it had been written

$$x = ab.$$

Two letters written together, with no sign between them, as ab , signify multiplication, or

$$x = a \times b.$$

Substituting, $x = 10 \times 15$,

then

$$x = 150.$$

No definite value is given to x , as it represents the value to be found.

To take a more concrete example, imagine an electrical circuit with a number of resistances in series, Fig. 1. Resistance a has 10 ohms. If the next has 20 ohms, the resistance will be twice a , or equal to $2a$. The third coil b has 15 ohms resistance, and the fourth coil has 45 ohms, or $3b$. The fifth coil has $5a$ ohms, or 50 ohms. Now the total resistance in a series circuit is the sum of all the resistances, so that the total resistance, represented by x , is

$$x = a + 2a + b + 3b + 5a$$

This makes a rather long equation. Suppose, then, we combine the a 's and the b 's. There are

$$\begin{array}{r} 1 \times a \\ 2 \times a \\ 5 \times a \\ \hline \end{array}$$

which, added, give

$$8 \times a$$

or

$$8a,$$

for we add only the multipliers, or coefficients, of the a 's. Also

$$\begin{array}{r} 1 \times b \\ 3 \times b \\ \hline \end{array}$$

when added, gives

$$4b.$$

Now we have

$$x = 8a + 4b,$$

which amounts to the same thing as

$$x = a + 2a + b + 3b + 5a.$$

Since

$$x = 8a + 4b,$$

$$x = 8 \times 10 + 4 \times 15$$

or

$$x = 80 + 60.$$

This is the same result as that from the solution of the long equation.

In a special case, Fig. 2, there are several resistances, some of which are of German silver, and some of copper wire.

This time we will call the first resistance, which is of copper, a ohms, or 10 ohms. The next one is German silver, of 25 ohms. We can represent the resistance of this coil as b , or, if you wish, by a small number just below the letter, as a_1 , expressed as "a sub one." The total resistance, x , will be

$$x = a + a_1 + 32a + 12a_1$$

or, combining, $x = 33a + 13a_1.$

Substituting, $x = 330 + 325.$

Then $x = 655$ ohms.

The smaller numbers, or sometimes symbols, placed at the right and below a letter, signify different types of the same thing, as a was used to represent a copper wire resistance, and a_1 , a resistance of German silver.

Division. The sign of division is used in algebra as it is in arithmetic. If we write

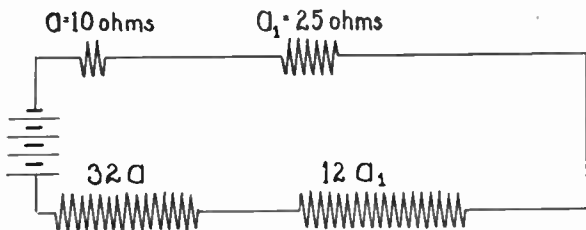

Fig. 2. Here the German silver resistances are designated by numerals below the letters.

$$x = \frac{a}{b},$$

where

$$a = 5$$

$$\text{and } b = \frac{20}{5}$$

it is the same as writing $\frac{a}{20}$, in which the fraction is reduced, as in

arithmetic, by dividing by 5 both above the line and below. Then

$$x = \frac{a}{b},$$

$$x = \frac{5}{20},$$

or

$$x = \frac{1}{4}$$

$$\frac{10}{30}$$

In the equation $\frac{10}{20} = \frac{1}{2}$ it is possible to divide both the numerator, 10, and the denominator, 20, of one fraction by the same number, without changing the value of the fraction, as

$$\frac{1}{2} = \frac{30}{60}$$

Or we can divide both numerators, or both denominators, by the same number, as

$$\frac{2}{20} = \frac{6}{60}$$

without changing the value.

Use of Parentheses. Sometimes there is an equation such as

$$x = 2 (a + b).$$

This means that the numbers within the parentheses, when added together, are to be multiplied by 2. If

$$a = 10$$

$$\text{and } b = 15,$$

the equation can be written

$$x = 2 (10 + 15)$$

or $x = 2 \times 25,$

whence $x = 50.$

Square Root. Another puzzling expression to those who have forgotten their mathematics is one like

$$\lambda = 59.6 \sqrt{LC}$$

The sign $\sqrt{\quad}$ means that the square root of the two values L and C, when they have been multiplied together, is to be multiplied by 59.6. When a number, such as 10 is *squared*, it is multiplied by itself, 10×10 . The square root of a number is a number, which, multiplied by itself, equals the given number. The square root of 100 is 10, for $10 \times 10 = 100$.

Then if

$$L = 20$$

$$\text{and } C = 5,$$

when we substitute, $\lambda = 59.6 \sqrt{20 \times 5}$

$$\lambda = 59.6 \sqrt{100}$$

$$\lambda = 59.6 \times 10$$

The symbol λ stands for wavelength, which, in this case, will be 596 meters.

Suppose we have the expression

$$Z = \sqrt{R^2 + (X_L - X_C)^2}$$

which gives the impedance in an alternating current circuit. This may appear formidable, but is not difficult when simplified. Take the part enclosed in parentheses. X_L stands for reactance due to inductance while X_C represents the reactance from capacity; both are given in ohms.

If

$$X_L = 30 \text{ ohms,}$$

$$\text{and } X_C = 20 \text{ ohms,}$$

the part in the parentheses is $30 - 20 = 10$ ohms.

(To Be Continued.)

THE NEW MORECROFT INDUCTANCES

PROFESSOR J. H. MORECROFT, of Columbia University, has just brought out a new type of inductance which possesses many unique features.

For the benefit of the Radio men, a special interview was arranged with Prof. Morecroft to get the details of his inductances. Photographs were also taken, and some of these coils made in the Everyday Engineering Laboratory.

However, the Radio Club of America objected to the publication of these data until after they had appeared in their *Proceedings*. Rather than arouse any hard feelings from the Radio Club, we are holding the article until the April issue.

A photograph of the Morecroft coils is shown here to give the experimenters an idea of their construction. In the April issue the details and formulas for calculating the inductance and distributed capacity will be given. These coils are of great interest and importance to Radio men, since they have many advantages

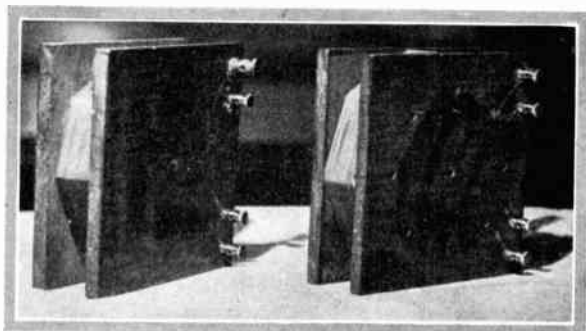

Morecroft coils constructed in the laboratory of this magazine.

over the ordinary pancake and tubular inductances. For instance, it is possible to tune Nauen with a coil five inches square and one inch thick.

It is unfortunate that we must withhold the complete article, but we do not wish to have the Radio Club feel that we have treated them unfairly.

HANDLING HEAVY CYLINDER BLOCK CASTING

BY VICTOR W. PAGE

AS it is general practice to cast automobile engine cylinders in blocks of four or six, the casting of the larger engines is not easily handled when repairs are necessary. The removal from the engine base is a simpler matter than the replacement, because the piston rings on the pistons and the free joints at both ends of the connecting rods make the pistons "wobbly" and difficult to enter in the cylinder bores. Then again, the helpers holding the casting (which may weigh over 150 pounds on large engines), are not always able to hold it steadily, further increasing the difficulty.

This problem is easily met by using rectangular wooden blocks to support the casting. On a four-cylinder engine of the type illustrated, pistons Nos. 2 and 3 work together as do pistons Nos. 1 and 4. Before replacing the cylinder block, the crank should be turned so pistons 1 and 4 are up as high as they will go. The wooden blocks are then cut so the long dimension will be the same as the distance from the crank case top to the bottom of the lowest piston

ring, if all are above the wrist pin. The crankshaft is then turned till all pistons are on the same line and the cylinder block is lowered in place on the wooden supports at each end of the crankcase. The top piston rings on pistons 1 and 4 are compressed by hand or suitable fixture, and while the crank is turned by a helper, the pistons are guided in place in the cylinders. After the top

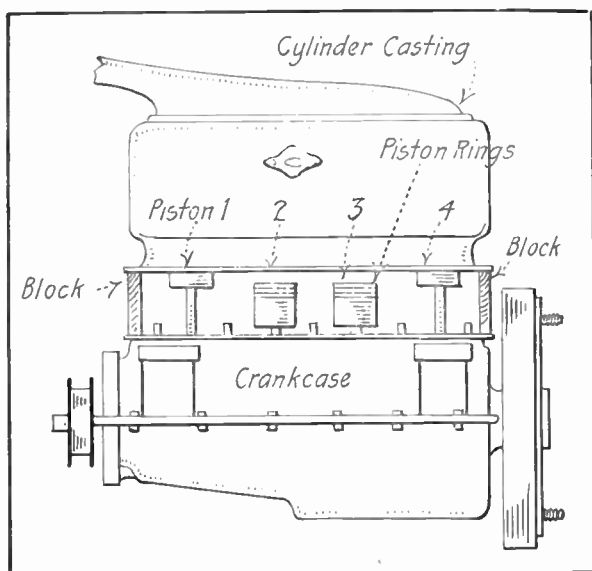

How the cylinder may be handled easily.

rings are entered, the next ones are compressed and pistons worked in further. After the pistons are entered so that the bottom rings are well inside the cylinders, the appearance is as shown in the illustration.

The rectangular blocks have a short dimension that allows lowering of the cylinder block so the tops of pistons Nos. 2 and 3 are just about to enter the cylinder bore. The cylinder casting is lifted slightly, and the blocks turned to allow it to drop in place, completely entering the pistons in the first and last cylinder. Pistons Nos. 2 and 3 are guided in their respective cylinders, and the

wooden blocks removed to permit dropping the cylinders in place on the crankcase. When the cylinder rests on the short dimension of the blocks, it will be necessary to turn the crankshaft to enter pistons Nos. 2 and 3, which will cause pistons Nos. 1 and 4 to work down and out of the cylinders; but if care is taken, pistons Nos. 2 and 3 may be entered without having 1 and 4 come out and expose the rings.

LABORATORY EQUIPMENT FOR THE EVERYDAY CHEMIST

BY GUSTAVE REINBERG, JR.

GENERAL SUGGESTIONS

THE equipment necessary for the different types of chemical work (lists of which are best obtained from textbooks on the subject) varies so greatly that only apparatus of wide applicability can be described here. Simplicity in equipment should be the aim, a few test tubes and a beaker often serving the practical experimenter's purpose more satisfactorily than the quantity of fancy glassware and other paraphernalia usually thought necessary, especially when it is considered that apparatus must be kept perfectly clean and in order, which is more likely to be the case if the equipment is reduced to a minimum.

A word about the bunsen burner may not be out of place here. In its simplest form this consists of a jet at the base of a tube perforated with two holes capable of being closed with a movable ring, as shown in Fig. 1, a partial section. This ring regulates the amount of air atomized with the gas passing through the jet, *B*, and should be adjusted to furnish a clear blue flame having a dark inner cone and a somewhat lighter mantle known as the oxidizing region because it contains an excess of air. This burner will not operate with what is known as gasoline gas, as this gas is already mixed with a certain proportion of air. The remedy is to enlarge the jet, a piece of tubing flattened at the end, which may be exposed by unscrewing the tube, *A*. The jet tube may either be removed, or, if this is not feasible, the flattened end may be cut off. Reducing the quantity of air supplied with either gas causes a luminous tip to appear above the inner cone, which contains free carbon and hydrogen and is consequently known as the reducing region. All objects to be heated should be placed in the exterior

cone of a perfectly non-luminous flame, the luminous flame deposits soot (carbon) on everything it touches, and is only used for special purposes.

An Easily Constructed Kipp Generator. An apparatus which will deliver a stream of gas at any time is a great convenience and time-saver in almost any laboratory. The following easily and

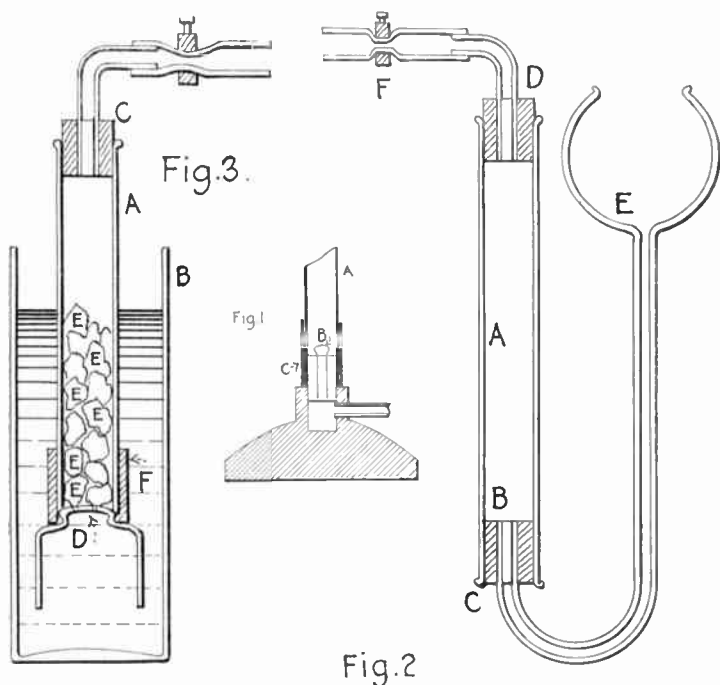

Fig. 1 shows a cross section of a Bunsen burner, Fig. 2 a Kipp generator, and Fig 3 a special generator for oxygen and acetylene.

cheaply constructed generator will be found very satisfactory for this purpose:

First cut off the bottom of a 6 in. x $\frac{3}{4}$ in. test tube by encircling it with a file scratch, winding two strips of wet filter paper around it $\frac{1}{16}$ in. from the mark, and heating the tube between the strips with the tip of the Bunsen flame, when it will crack cleanly. The stem of a thistle tube, *E* Fig. 2, should now be bent into a semi-

circle, beginning about 4 in. from the bottom of the bulb. The radius of the bend should be just sufficient to enable the test tube to clear the bulb, which should be large enough to hold from 150 to 200 c.c. The accompanying figure makes the assembly clear. A rubber stopper, *C*, connects the thistle tube with the tube *A*, the material to be acted upon rests on the button *B*, and the stopper *D*, delivery tube and pinchcock complete the generator.

For generating hydrogen, chlorine, carbon dioxide, or hydrogen sulfide, use dilute (1:3) hydrochloric acid in the bulb *E*, and granulated zinc, potassium permanganate, marble chips, or iron sulfide respectively in *A*. The first opening of the pinchcock allows the acid to flow down and react with the material in *A*, liberating the desired gas. If the cock is now closed, the pressure of the gas continuing to be generated forces the acid back in *E* and stops the action, which may be restarted at any time by opening the pinchcock.

A Special Generator for Oxygen and Acetylene. The great heat liberated when water reacts with oxonium or calcium carbide to produce these gases renders their preparation in the above-described generator inadvisable, while this special generator will effectively cope with these conditions.

A student's lamp chimney, *A* Fig. 3, is fitted with a stopper *C*, delivery tube, pinchcock and a button *D* in the constriction at its base, which supports the oxonium or calcium carbide lumps. The chimney is placed in the glass cylinder, *B*, which may be a hydrometer jar, or even a pickle bottle if this is most available. The water reacts rapidly with the material *E* when the pinchcock is open, but is forced out of contact with it by the gas pressure when the cock is closed. To keep the chimney at all times sufficiently submerged it is weighted with a section of lead pipe *F*, thus being always surrounded with a jacket of water which absorbs the heat evolved.

A Convenient Distilled Water Supply. This may be secured by fitting a bottle of distilled water with a two-hole stopper, and connecting to it an atomizer bulb and a tube reaching to the bottom of the bottle. The latter is connected to a length of rubber tubing fitted with a pinchcock and reaching to the desk, the bottle being kept out of the way on the floor. A few pressures of the bulb will provide a ready flow of water whenever the cock is opened.

The Metric System. This system is used universally by chemists, and will be employed in subsequent articles in this department. It has three fundamental units, that of length, the meter, that of

weight, the gram, and that of capacity, the liter. The prefixes milli, centi and deci are used to indicate .001, .01, and .1 unit respectively, and the prefixes deka, hecto, and kilo to indicate 10, 100, and 1000 units respectively. Small quantities of liquids are expressed in cubic centimeters rather than milliliters. The appended table gives the important metric relations and a comparison of the metric with U. S. measure:

TABLE OF METRIC RELATIONS AND EQUIVALENTS

		Metric Relations	
		10 millimeters (mm.)	= 1 centimeter (cm.)
LINEAR		10 centimeters	= 1 decimeter (dm.)
		10 decimeters	= 1 meter (m.)
CAPACITY		1000 cubic centimeters (cc.)	= 1 liter (l.)
		10 milligrams (mg.)	= 1 centigram (cg.)
WEIGHT		10 centigrams	= 1 decigram (dg.)
		10 decigrams	= 1 gram (g.)
		1000 grams	= 1 Kilogram (or Kilo) (K.)
Metric—U. S. Equivalents			
LINEAR		25.4001 millimeters	= 1 inch.
		1 meter	= 39.37 inches.
CAPACITY		1 liter	= 1.0566 quarts.
		29.574 cubic centimeters	= 1 fluid ounce.
		1 gram	= 15.43235 grains.
WEIGHT		28.3495 grams	= 1 ounce.
		1 kilogram	= 2.20462 pounds.
One cubic centimeter of water at 4° C. weighs one gram.			

THE THERMIT WELDING PROCESS

Due to its greater chemical affinity, aluminum will displace certain other metals from their combination with oxygen, being itself oxidized with the evolution of much heat. Thermit is a mixture of aluminum powder with magnetic iron oxide. When ignited with a special mixture (magnesium powder and an oxidizing agent, or by means of the electric arc) these substances react almost violently, forming aluminum oxide and iron, according to the equation $3\text{Fe}_3\text{O}_4 + 8\text{Al} \rightarrow 4\text{Al}_2\text{O}_3 + 9\text{Fe}$. The temperature of from 3000° to 3500° C. obtained is above the melting point of both the oxide slag and of the iron, which latter being the heaviest collects at the bottom in a molten condition. The usual procedure in mak-

ing a weld is to construct a mould around the fractured part in which the thermit and some steel billets are placed; when ignited the iron settles to the bottom and effects the union, while the slag floats and is subsequently removed.

In recent years another application of the thermit process has been developed, namely, the production of certain metals from their otherwise difficultly reducible ores. Aluminum powder reacts with the oxides of manganese, chromium, cobalt or nickel in a similar manner to its reaction with iron oxide, a remarkably pure specimen of the metal in question being secured. Due to the large amounts of heat liberated, these reactions are termed aluminothermy, and are regularly used to secure pure metals for scientific purposes, or commercially, to secure metals whose oxides are difficult of reduction by other means.

EXTENSION FOR WAGON BED

An expressman had a medium weight delivery wagon, and, as he had to transport many articles too long to carry in the bed of the wagon, he made a

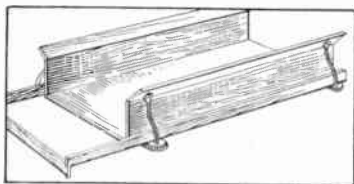

When not in use, the extension may be pushed in.

frame of two by fours which could be pulled out to the rear end of the bed, thus extending the support for the load several feet.

When not in use, the extension pushed up against the end of the bed. The cut shows how the sliding extension was made.

Contributed by C. H. THOMAS.

KINKS FOR THE DRAUGHTSMAN

One day the screw of my bow-pen suddenly snapped. As no substitute was handy, I cut a piece of cardboard, punched a hole in the center and placed it in the position shown. This enabled me to use the part of the screw on which the thread remained.

Very often when the needle of

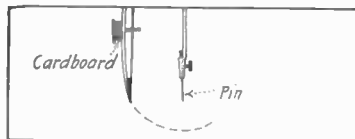

A pin may be used to replace a lost needle-point.

your bow-pen or pencil breaks, you can make a good substitute by cutting a pin and putting the point where the pen center should be.

Contributed by HENRY HOLTZER.

HOUSEHOLD ENGINEERING

Practical Mechanics
for Everyday Men

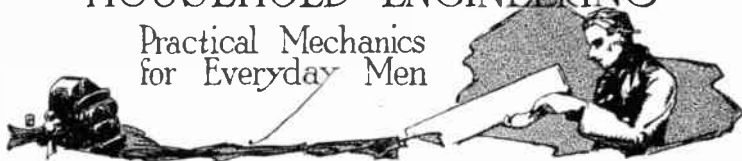

A LEAD PIPE FLANGE

The illustration shows a method of joining two lead pipes. Fig. 1 is an ordinary iron washer, the inside hole of which is slightly greater in diameter than the pipes to be connected. Two of these are slipped over the pipes (one on each) and the ends of the pipe are then turned up (*E*). A rubber washer (*A*) is placed between

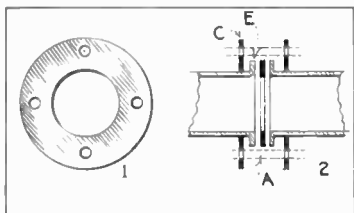

How two lead pipes may be joined.

the two ends and the iron washers are then drawn together by means of small bolts, which pass through the four small holes.

Contributed by JAMES E. NOBLE.

TAP WRENCH

This handy tap wrench or tool holder is made out of 5/16 in. square key steel. The two pieces are five inches long, and the

handles are turned down to 1/4 in. for three inches. The holes marked *a* in the illustration are drilled with a 7/32 in. drill, while the holes marked *b* are drilled and tapped for 10/24 thread machine screw. The wrench is completed by putting

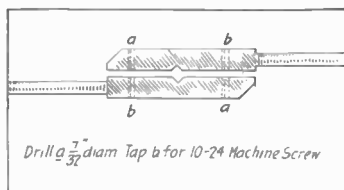

This tap wrench costs almost nothing.

the wrench together with two one-inch 10/24 thread machine screws, after the two notches for the tap have been filed in.

Contributed by F. A. GROHSMEYER.

TO STRAIGHTEN STRAW BROOMS

Take a pail of boiling hot water and completely immerse the straw end of the broom for 10 minutes. After the straws have become completely soaked withdraw the broom and suspend by the handle.

Contributed by MARY F. SCOTT.

EASILY CONSTRUCTED BENCH STOP

The illustration gives the dimensions of a bench stop. Two of these may be used for sawing material, or assembling parts. The lower side sets square with the bench, while the work lies on the upper side. The first operation is to drill two $\frac{1}{4}$ -in. holes, *A*, the center lines of which are to be the faces. When

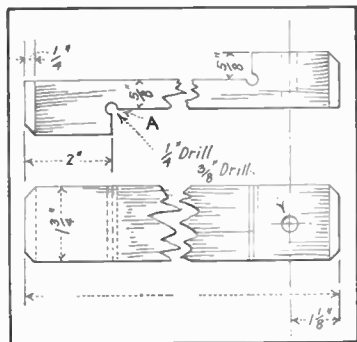

A bench stop is a necessity in the shop.

the faces are squared, the holes will form open corners, permitting the work to set snug against the faces. A $\frac{3}{8}$ -in. hole is drilled through one end for the purpose of hanging it up when not in use. This same hole may be used to bolt the stop onto the bench. The edges of the ends are bevelled to prevent chipping. Hard wood is the best material to be used, but even softer stock would make a val-

uable addition to your tool equipment.

Contributed by C. W. MANLY.

AN EMERGENCY LIME LINER

To fill an emergency, or where no other apparatus is available, the device described herewith serves quite well.

Procure an old water sprinkler and remove the head. Then cut from some reasonably stiff sheet metal a portion as shown in the sketch. The strip is 20 in. long, 2 in. wide at one end, and 3 or 4 at the other. Four or five in. from the wide end cut the notches as shown, and in the corner of the oblique angle punch two holes. Now bend along the dotted lines to within 2 in. of the holes. The strip now resembles a trough with tapering sides. Along the sides at parallel intervals cut down to the bend as shown by *B*.

Now bend the wide end around the end of the sprinkler spout and touch here and there with a drop of solder to hold. Then bend the strip into a crude curve as shown by *C*.

Find the dimensions of the trough at the outlet of the spout and cut a strip of the same metal to fit therein, bending the upper edge around a piece of wire to form a hinge. Curve the lower edge slightly. Now place this regulator, *A*, in the trough as shown by *C*, and run

a small nail or piece of wire through the curved end and the two holes. This, when hung, should rest against the mouth of the neck of the spout. The holes in the sides of the trough are to accommodate a small length of wire to determine the height to which the regulator shall rise, thereby regulating the flow of the lime mixture.

For ordinary purposes, a mixture of the consistency of thick cream does well on a sodded

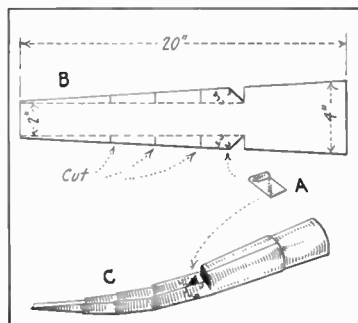

This lime liner is made of sheet iron.

field, while it should be somewhat thinner for bare ground.

Contributed by D. R. VAN HORN.

FINDING THE CENTER OF A CIRCLE

The method shown in the illustration is a simple one for finding the center of a circle. The only tools necessary are a try-square and a pencil. Place the try-square so that the right angle touches the circumference

and mark the points where the sides cross the circumference as at A and B and draw a line connecting these two points. Place the square in any other similar position and draw the line $A'B'$. Where this line intersects the line AB is the exact center of

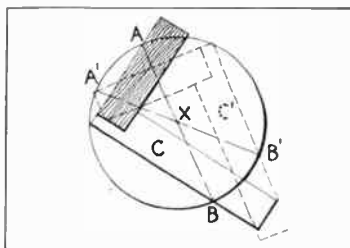

How the center of any circle may be found.

the circle. This method can be used when work jumps out of centers and tears the center out.

Contributed by J. BAUSCH.

WORTH KNOWING

A clean cloth dipped into hot water and then into a saucer of bran will speedily clean white paint without injury.

When gilded frames become tarnished, take the water in which onions have been boiled, dip a soft rag into it, and wipe over the frames lightly.

Wood ashes mixed with kerosene will remove rust from iron.

Turpentine or benzine will remove paint stains.

Contributed by H. G. FRANK.



Snow White FOR YOUR INSTRUMENT SCALES

25c



SNOW WHITE

is a dazzling, smooth-flowing, pure white water color that writes in perfect white on any dark substance.

It has been tested by the Laboratory Staff of Everyday Engineering and pronounced excellent for marking instrument panels, lettering on photos, in albums, etc.

A TRIAL JAR FOR 25c will convince you. Your money back if you are not satisfied.

J. W. JOHNSTON

Dept. E. M., Fine Arts Bldg., Rochester, N. Y.

The TECHNICAL ADVISER



The object of this department is to answer the questions of readers who may experience difficulty in the construction or use of apparatus described in the magazine. The columns are free to all readers whether they are subscribers or not, and questions pertaining to matters electrical or mechanical will be answered in the order in which they are received. If the reader cannot wait for an answer to be published he may secure an immediate answer by mail at a cost of 25 cents for each question.

70. O. S., New York City, whose question was published in the September, 1916, issue, No. 27, inquired as to the value of a device which would feed a rapid stream of round steel balls into a tube, single file, and eliminate the jamming.

The following answer was received from Mr. C. B. Manly, Springfield, Mass.:

In *Machinery*, page 57, September, 1916, there was a full description of a steel ball dropper, which is really a practical tool. The demand for such a device, however, would not justify the expense of a patent, as it would only be used by ball bearing manufacturers, and they have more efficient automatic fixtures to perform the work than a steel ball dropper.

71. W. H. B., Jamestown, Mo., asks if the apparatus described in "A Radio Time Signal Receiver," by Austin Les-carboursa, is sensitive enough to receive Arlington time signals at a distance of 800 miles.

Ans.—With an aerial of one or two wires 200 ft. long and 35

THE WASHINGTON SCHOOL OF ART (THE SCHOOL OF RESULTS)

For the price usually charged by ordinary art schools for one course, we furnish a combined course of the THREE great branches, Illustrating, Cartooning, and Designing, equivalent to three courses and more complete, thorough, and simple than any ever offered.

**BE AN ILLUSTRATOR, A CARTOONIST,
OR A DESIGNER**

according to your natural bent. Our course will teach you, and our system of instruction makes success certain. Put your spare time to good use; an hour or two a day studying this course will prove the greatest investment you ever made.

Get our illustrated book, it tells you all about our methods, and the successes of our students.

Washington School of Art, Inc.

1029 F St., N. W. Washington, D. C.