

FOR
BEGINNERS
**HOW TO USE
OSCILLOSCOPES**
OUR BASIC COURSE

PROJECTS & GADGETS FOR THE HOBBYIST

B/F BRAIN

Basic control module
for Burglar/Fire
alarm systems
customized for your
home.

COOKIE JAR SPEAKER

Play sweet music
in remote rooms

MICRO- COMPUTERS

The KIM-1 is an
excellent beginners
computer for learning theory
and playing exciting games.

MOD-X

Build the simplest
electronic clock
ever designed
for hobbyists

AC BATTERY

Power up those
antique radios
from our
authentic
battery
case
that
plugs
into the
AC line!

PLUS...

Projection TV, Hump mounting
CB Rigs, Heath speaker kit, DXing
Columbia & Venezuela, and lots more!



**NOBODY SHOULD
HAVE TO WORK 2 JOBS
JUST TO MAKE
ENDS MEET.**



What would a second job mean to you? A few grubby dollars and a life that's an endless grind.

You'll hardly ever see your family. You won't have time for friends or fun. Your wife will wonder what happened to the husband she used to have. You'll spend your days off sleeping.

It just isn't worth it. And it doesn't have to be that way. Millions of men make a good living with one job. Millions of men actually like their jobs, because the job pays well, challenges them, and has a good future.

These are men who have had training. And now, so can you. That's where we come in. We're ICS, International Correspondence Schools. We specialize in training men and women for skilled careers.

And while we can't guarantee you a job — no school can do that — ICS can give you the first-rate training you need, especially if you're interested in one of the growing careers where ICS concentrates its training.

AN IDEAL WAY TO LEARN

It's not all fun and games. But you can do it in your own home. Without the hassle of a classroom. Without missing a paycheck. You get the texts and equipment it takes, and all the help you need. If you want to talk to an instructor, you can call ICS from anywhere in the continental United States and Canada, using our toll-free Dial-a-Question® service.

Since 1890, millions of men and women around the world have turned to ICS for career training.

More than 70 of America's largest 100 corporations use ICS training for their own employees.

And the ICS Center for Degree Studies is authorized by the Pennsylvania Department of Education to grant the Associate in Specialized Business degree in Accounting and Business Management, and the Associate in Specialized Technology degree in Civil, Mechanical, Electrical, and Chemical Engineering Technologies.

These degree programs are not mere stepping-stones to higher education nor are they primarily intended for transfer toward more advanced degrees. They are practical, career-oriented programs designed to help you reach your objectives without further academic training.

FREE DEMONSTRATION LESSON

No one can promise success, but if you *want* more — more money, more security, more day-to-day satisfaction and more future — our free Career Booklet and free Demonstration Lesson can help you get started in the right direction. Just check the box next to the field that interests you most and mail the postpaid card today. There's no obligation.

Remember, it's your life. You might as well make the most of it.

ICS

International Correspondence Schools
Scranton, Pa. 18515

(If card is missing, write ICS, Scranton, Pa. 18515)

© 1976 Intext, Inc. J



elementary electronics

March/April 1977
Volume 17, No. 2

Dedicated to America's Electronics Hobbyists—Including Electronics Digest®

SPECIAL FEATURE

39 TV Sets of the Future—*projection TV for your home is here*

YOU BUILD IT

- 49 CB Battery Charger Saves \$\$\$—*recharge Nicad cells for air-time on pennies a day*
- ☆ 59 Mod-X—*simplest digital clock you can build*
- ☆ 68 Foil Your Local Burglar—*build B/F Brain for burglar and fire alarm*

THE WIDE WORLD OF CB RADIO

- 47 Kathi Rides a Mile for a Kamel—*she shows how to install on car hump for CB super-safety*
- ☆ 58 Things You Never Knew About CB Radio—*and that you probably shouldn't*
- 72 CB New Products—*new CB sets and accessories that will keep you 10-4ing*
- 75 CB New Products—*more goodies for Good Buddies*
- 79 Kathi's CB Carousel—*all about powermikes*
- 80 CB Whine—*eliminate that interference for better CB reception*

PATHS TO BETTER SOUND

- ☆ 45 It's a Cookie Jar!—*compact speaker system you build in glass*
- 66 Put Your Cassette on Wheels—*use car speakers for low-cost installation*

THE WORLD OF WIRELESS

- ☆ 43 Power Antique Radios from an AC "Battery"—*build modern B and A batteries with Jim Fred*
- 71 Antique Radio Corner—*news of collectors, meetings and some headphone help*

SHORTWAVE LISTENING

- 32 DX Central Reporting—*Don Jensen's regular column on getting the most out of the ether*
- 77 DXing Colombia and Venezuela—*another Stanbury guide—Latin American DX on 49 and 60 meters*

CONSUMER INFO FROM OUR LAB

- 51 e/e Assembles the Heath AS-1344 2-Way Column Speaker Kit
- 81 e/e Checks Out the—*B&K 2040 CB Servicemaster*

OUR REGULAR DEPARTMENTS

- 6 Hey, Look Me Over—*new electronic products*
- 16 Bookmark—*by Bookworm*
- 20 Newscan—*what's happening in electronics*
- 27 Ask Hank, He Knows—*Hank's usual, with a correction for AC Tester constructors*
- ☆ 55 Computer Readout—*playing games with the KIM-1 microcomputer*
- 73 Reader Service Coupons
- ☆ 83 Basic Course—*how to use oscilloscopes* ☆ Cover Feature
- 89 Literature Library



AUTHORS IN THIS ISSUE

Anthony Caristi, James A. Fred, Herbert Friedman, Don Jensen, Herman Johnson, Kathi Martin, Norman Myers, Hank Scott, C. M. Stanbury, and the ELEMENTARY ELECTRONICS Editorial Staff.



Illustration by Ron Macarthy

THE STAFF

Editor-in-Chief and
Electronics Group Coordinator
Julian S. Martin, WA2CQL

Technical Editor
**Charles Graham, W1HFI,
2W3175**

Communications Editor
**Morgan Godwin, W4WFL,
KCR6444**

Audio Editor
Christine Begole, KFC3553

Citizens Band Editor
Kathi Martin, KGK3916

Workbench Editor
Hank Scott

Editorial Assistant
Sandra Barack

Art Editor
Ralph Rubino

Assistant Art Editor
Augustus Ginnochio

Cover Art Director
Irving Bernstein

Art Assistants
**Robert Modero
Caroline Imperato
John Neely
Joni Erlon**

Advertising Director
David J. Miller, KCX1268

Advertising/Research Associate
Jyll Holzman

Production Director
Carl Bartee

Production Editor
Geri Brakatselos

Newsstand Circulation
Director
Don Gabree

Subscription Circulation &
Marketing Director
Robert V. Enlow

Director of Market
Development
James C. Weakley

President and Publisher
Joel Davis

Vice President and
General Manager
Leonard F. Pinto

Vice President and Treasurer
Victor C. Stabile, KBP0681

ELEMENTARY ELECTRONICS is published bi-monthly by Davis Publications, Inc. Editorial and Executive offices: 229 Park Ave. So., New York, NY 10003; all subscription orders and mail regarding subscriptions should be sent to P.O. Box 2600, Greenwich, CT 06830. One-year subscription (six issues)—\$6.50; two-year subscription (12 issues)—\$13.00; three-year subscription (18 issues)—\$19.00; and four-year subscription (24 issues)—\$25.00. Add 67 cents postage for each year for U.S. possessions and Canada; \$1.34 each year, all other countries. For change of address, please advise 4 to 6 weeks before moving. Send us your current mailing label with new address. Advertising offices: New York, 229 Park Avenue South, 212-673-1300; Chicago, 520 N. Michigan Ave., 312-527-0330; Los Angeles; J. E. Publishers' Rep. Co., 8732 Sunset Blvd., 213-659-3810. Second-class postage paid at New York, NY and at additional mailing office. Copyright 1977, by Davis Publications, Inc.

The 40-channel Cobra 29XLR. From the sleek brushed chrome face to the matte black housing, it's a beauty. But its beauty is more than skin deep. Because inside, this CB has the guts to pack a powerful punch.

The illuminated 3-in-1 meter tells you exactly how much power you're pushing out. And pulling in. It also measures the system's efficiency with an SWR check. In short, this Cobra's meter lets you keep an eye on your ears.

The Digital Channel Selector shows you the channel you're on in large LED numerals that can be read clearly in any light. There's also switchable noise blanking to reject short-pulse noise other systems can't block. The built-in power of DynaMike Plus. Automatic noise limiting

and Delta Tuning for clearer reception.

And the added protection of Cobra's nationwide network of Authorized Service Centers with factory-trained technicians to help you with installation, service and advice.

The Cobra 29XLR. It has 40 channels. And it has what it takes to improve communications by punching through loud and clear on every one of them. That's the beauty of it.



Punches through loud and clear.

Cobra Communications Products
DYNASCAN CORPORATION
6460 W. Cortland St., Chicago, Illinois 60635

Write for color brochure
EXPORTERS: Empire • Plainview, N.Y. • CANADA: Atlas Electronics • Toronto

CIRCLE 24 ON READER SERVICE COUPON

PUNCH AND BEAUTY



Hey, look me over

Showcase of New Products

Dig It Multimeter

Looking at numbers is easier and less apt to cause reading errors than reading a meter's pointer. This becomes obvious

when you see B&K-Precision's Model 283. It's a 3½ digit multimeter priced at \$170.00 that uses high intensity, high reliability LED displays, 0.41-in. high that can be easily read in brightly lit rooms at a distance of at least six feet. The 283 measures DC volts, DC current, AC current and resistance. A special low voltage circuit permits measuring resistance of transistor-shunted resistors. The Model 283 has 100% overrange capability on four ranges, so that one can read to 199.9 on a scale that is normally set for 100.0 maximum. Out-of-range is indicated by a flashing digit and three zeros. All readings have an automatically positioned decimal point. Overload protection is pro-



CIRCLE 32 ON READER SERVICE COUPON

vided, up to 1000V on the ohms, 1500V on the voltage ranges, and 3A on current shunts. An optional battery pack provides 8 hours operation on an overnight charging. Batteries also charge when the Model 283 is used on 110 VAC line. For additional information, write to Myron Bond, B&K-Precision, 6460 W. Cortland, Chicago, IL 60635.

FM Wireless Intercom

Radio Shack's 2-channel, 3-station FM wireless intercom is a convenient home or office communications system. Called the SelectaCom, it works on frequency modulation (FM) to provide interference-free sound. An adjustable squelch control (like on your CB) on the rear of each unit eliminates background noise when they are not in use. Each SelectaCom unit has a volume-on/off thumbwheel control and a red LED pilot lamp which glows while the unit is on. A selector switch lets you operate on either channel A or B. Located just above the talk bar is a call lever which can be used to "beep" the other stations. The talk bar can be locked on for use as a remote babysitter or monitor. Each unit can be moved easily from room to room, upstairs or

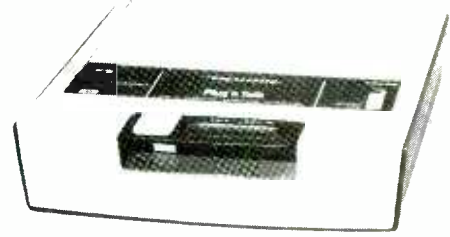

CIRCLE 54 ON READER SERVICE COUPON

downstairs, to the basement, garage or patio. Just plug one into the nearest electrical outlet for instant audible contact with the other stations. The Realistic SelectaCom FM Intercom, priced at \$119.95, is sold and serviced exclusively by Radio Shack. Radio Shack stores and dealers are found in all 50 states and Canada.

Simple Security

The trouble with many anti-theft car devices is that the hookup is a lot of work. The new compact Model 3001 "Quick Connect" (Q.C.) Auto and CB Security System requires only a 3 wire hook-up to intermittently sound any car horn after illegal entry. No horn relay is required. The system is designed to protect CB radios, scanners, speakers, tape deck, stereo radios and your auto from being ripped-off by thieves. It is also for use in RVs, sports cars, and trucks. It can be installed in less than 30 minutes. The simple Q.C. alarm system is trig-

(Continued on page 10)

Checklist of Books for the Libraries of Technicians, Hobbyists & Students

GENERAL BOOKS—JUST PUBLISHED

- Master Transistor IC Substitution Handbook 504 p. \$7.95
- Servicing Medical & Bioelectronic Equipment 336 p. \$8.95
- Model Railroad Electronics 294 p. \$5.95
- Broadcast Engng. Maint. Hdbk. 532 p. 235 il. \$6.95
- Complete Hdbk of Locks Locksmithing 392 p. 348 il. \$6.95
- Practical Solid-State DC Power Supplies 196 p. 151 il. \$6.95
- Optoelectronics Guidebk.—with tested projects 196 p. \$5.95
- Transistor Ignition Systems 252 p. 162 il. \$5.95
- TV Lighting Handbook 228 p. 261 il. \$12.95
- How to Repair Home Kitchen Appliances 294 p. 205 il. \$5.95
- Fun With Electronics 140 p. 88 il. \$3.95
- Talk-Back TV: Two-Way Cable Television 238 p. 64 il. \$5.95
- Understanding Use Modern Signal Generators 294 p. \$5.95
- 106 Easy Electronic Projs. Beyond Transistors 224 p. \$5.95
- Using Modern Electr. Serv. Test Apt. 252 p. 177 il. \$5.95
- Mathematics Unraveled—Commonsense Approach \$6.95
- Master Tube Substitution Handbook 322 p. 548 il. \$4.95
- Modern Guide to Digital Logic 294 p. 222 il. \$6.95
- VHF/UHF Fire, Police, Ham Scanners Man 250 p. 114 il. \$6.95
- OP AMP Circuit Design & Applications 280 p. 239 il. \$6.95
- Master Hdbk of Digital Logic Apt. 392 p. 287 il. \$7.95
- CET License Handbook 2nd ed. 448 p. 381 il. \$8.95
- The Electronic Musical Instr. Manual 210 p. 385 il. \$6.95
- Microprocessor Microprogramming Hdbk 294 p. 176 il. \$6.95
- Sourcebook of Electronic Organ Circuits 168 p. 101 il. \$4.95
- Build Your Own Working Robot 238 p. 83 il. \$5.95
- CBER's Handybook of Simple Hobby Projs. 168 p. 114 il. \$3.95
- Fire & Theft Security Systems 2nd ed. 182 p. 114 il. \$5.95
- How to Rep. Home Laundry Appliances 280 p. 137 il. \$5.95
- Plotting, Navigation & Pocket Calculator 392 p. 233 il. \$8.95

DIY PROJECTS—WITH FULL ILLUSTRATIONS

- How to Make Your Own Built-In Furniture 336 p. 758 il. \$5.95
- Homeowner's Handy "Do-It" Manual 280 p. 84 il. \$7.95
- Building Model Ships From Scratch 378 p. 84 il. \$7.95
- Homeowner's Guide to Saving Energy 196 p. 183 il. \$5.95
- Customizing Your Van 192 p. 150 il. \$3.95
- The Woodworker's Bible 434 p. 1151 il. \$5.95
- Dog Owner's Medical Manual 252 p. 237 il. \$5.95
- How to Train a Watchdog 224 p. 45 il. \$5.95
- Motorcycle Repair Handbook 392 p. 260 il. \$6.95
- Step-By-Step Guide: Carburetor Tuneup Overhaul 224 p. \$4.95
- Complete Hdbk of Model Railroading 350 p. 238 il. \$6.95
- Homeowner's Guide to Solar Heating/Cooling 196 p. \$4.95
- Do-It-Yourself's Guide Home Plan Constr. 238 p. \$4.95
- Step-By-Step Guide to Brake Servicing 238 p. 248 il. \$4.95
- Step-By-Step Guide: Chrysler Eng. Maint. Rpr. 256 p. \$5.95
- Subcontract Your House: Bldg. Remodel. 196 p. 63 il. \$4.95
- Auto Electronics Simplified 256 p. 202 il. \$5.95
- The Complete Auto Electric Handbook 210 p. 139 il. \$5.95
- Concrete & Masonry 392 p. 213 il. \$5.95
- Practical Home Constr. Carpentry Hdbk 448 p. 180 il. \$5.95
- How to Repair Diesel Engines 308 p. 237 il. \$5.95
- Central Heating/Air Cond. Repair Guide 320 p. 265 il. \$6.95
- Small Appliance Repair Guide—Vol. 2 210 p. 119 il. \$4.95
- Elect. Wiring Lighting For Home/Office 2nd ed. 392 p. \$6.95
- How to Repair Engines, Symbolic Engines 224 p. over 100 p. \$4.95
- How to Repair Home Auto Air Cond. 208 p. over 300 p. \$4.95

TELEPHONES, RECORDERS, SCANNERS, CALCULATORS

- Modern Electronics Math 686 p. 424 il. \$9.95
- Master Hdbk of 1001 Pract. Electr. Circ 602 p. 1250 il. \$9.95
- Impedance 196 p. 90 il. \$5.95
- Intro to Medical Electronics—2nd ed 320 p. 126 il. \$7.95
- Computer Programming Handbook 518 p. 114 il. \$8.95
- Computer Technician's Handbook 480 p. over 400 il. \$8.95
- Microelectronics 266 p. 228 il. \$5.95
- Basic Digital Electronics 214 p. 117 il. \$4.95
- Switching Regulators/Power Supplies 252 p. 128 il. \$6.95
- Adv. Appr. For Pocket Calculators 304 p. 275 il. \$5.95
- Tower's Intern. Transistor Selection 140 p. 7 il. 10 il. \$4.95
- Electr. Conversions, Symbols Formulas 224 p. 252 il. \$4.95
- Effective Troubleshooting with EVM/Scope 238 p. 185 il. \$5.95
- Getting the Most Out of Electronic Calculators 204 p. 281 il. \$4.95
- Aviation Electronics Handbook 406 p. 227 il. \$8.95
- How to Test Almost Everything Electr. 160 p. 144 il. \$3.95
- Digital Logic Electronics Handbook 308 p. 226 il. \$6.95
- Modern Applications of Linear IC's 276 p. 301 il. \$9.95
- 10-Minute Test Tech. For PC Svcs. 216 p. 114 il. \$4.95
- Electr. Unraveled—New Commonsense Approach 228 p. \$5.95
- How to Tshoot Repair Electr. Test Exp. 252 p. 143 il. \$6.95
- Understanding Using the Oscilloscope 272 p. 170 il. \$5.95
- Industrial Electr.—Principles & Practice 416 p. 380 il. \$8.95
- Dictionary of Electronics 420 p. 487 il. \$4.95

TELEVISION, VIDEO, STEREO, RECORDERS, SCANNERS

- Color TV Trouble Facts—Probs Sols 3rd ed. 434 p. \$5.95
- Solid-State Color TV Photo Symp. Guide 224 p. 169 il. \$5.95
- Beginner's Guide to TV Repair 176 p. 50 il. \$4.95
- T-shooting With the Dual-Trace Scope 224 p. 252 il. \$5.95
- TV Troubleshooter's Hdbk—3rd ed. 448 p. over 300 il. \$4.95
- Color TV Case Histories Illustrated 238 p. 219 il. \$5.95
- TV Schematics: Read Between the Lines 252 p. 188 il. \$5.95
- Logical Color TV Troubleshooting 240 p. 151 il. \$5.95

- TV Bench Servicing Techniques 228 p. 177 il. \$4.95
- Modern Radio Repair Techniques 260 p. 36 il. \$4.95
- How to Interpret TV Waveforms 256 p. 250 il. \$4.95
- All-In-One TV Alignment Handbook 304 p. 145 il. \$5.95
- TV Tuner Schematic Servicing Manual 224 p. 287 il. \$6.95
- How to Use Color TV Test Instruments 256 p. 230 il. \$5.95
- Home-Call TV Repair Guide 144 p. 20 il. \$3.95
- Pinpoint TV Troubles in 10 Minutes 327 p. 394 il. \$5.95

CB COMMUNICATIONS & MARINE RADIO

- CB Schematic Svcing. Manuals each 200 p. \$5.95. Vol 1 Kris Browning, Hy-gain, Penney's. Vol. 2 Teaberry, Unimetrics.
- Pearce-Simpson, Siltromic. Vol. 3 F. Johnson, SBE-Linear.
- Sonar, Royce. Vol. 4 Pace, Fanon Courier.
- 2nd Class FCC Encyclopedia 602 p. 445 il. \$7.95
- Complete Shortwave Listener's Hdbk 288 p. 101 il. \$6.95
- CB Radio Operator's Guide—2nd ed. 256 p. 139 il. \$5.95
- How to Hear/Speak CB In a Short-Short 172 p. 85 il. \$3.50
- Pictorial Guide to CB Radio Install/Rpr. 256 p. 304 il. \$5.95
- Practical CB Radio T-shooting & Repair 238 p. 108 il. \$5.95
- Complete FM 2-Way Radio Hdbk 294 p. 111 il. \$6.95
- Amal. FM Conversion Constr. Projs. 256 p. 187 il. \$5.95
- Bdcst Ann'c'r 3rd Class FCC Study Guide 168 p. 19 il. \$3.95
- How To Be A Ham—incl. Latest FCC Rules 192 p. 25 il. \$3.95
- Commercial FCC License Handbook 444 p. 150 il. \$5.95
- The 2-Meter FM Repeater Circuits Hdbk 312 p. 194 il. \$6.95
- RTTY Handbook 320 p. 230 il. \$6.95
- CB Radio Service Manual 228 p. 84 il. \$5.95
- AMATEUR RADIO STUDY GUIDES. Novice \$5.95 General \$7.95 Advanced \$5.95 Extra \$5.95 Incentive \$4.95

HOME ELECTRONICS

- How to Read Electronic Circuit Diagrams 192 p. 140 il. \$4.95
- 21 Simple Trans. Radios You Can Build 140 p. 122 il. \$3.95
- Basic Electricity Beginning Electronics 252 p. 191 il. \$5.95
- Radio Control for Models 350 p. 417 il. \$6.95
- MOSFET Circuits Guidebook 196 p. 104 il. \$4.95
- Prac. Circuit Design for the Experimenter 196 p. 119 il. \$4.95
- 111 Digital & Linear IC Projects 210 p. 275 il. \$5.95
- Radio Astronomy for the Amateur 252 p. 96 il. \$5.95
- Build-It Book of Mini Test Meas. Instr. 238 p. 151 il. \$4.95
- RF & Digital Test Eqpt. You Can Build 252 p. 217 il. \$5.95
- Miniature Projects For Electr. Hobbyists 168 p. 77 il. \$3.95
- Practical Triac SCR Projs. For The Exp. 192 p. 146 il. \$4.95
- Integrated Circuits Guidebook 196 p. 119 il. \$5.95
- Solid-State Circuits Guidebook 252 p. 227 il. \$5.95
- Electronics For Shutterbugs 204 p. 109 il. \$5.95
- Prac. Test Instruments You Can Build 204 p. 157 il. \$4.95
- Step-By-Step Guide: Car Stereo Audio Circuits 320 p. 190 il. \$5.95
- Radio-Electronics Hobby Projects 192 p. 214 il. \$4.95
- Handbook of IC Circuit Projects 224 p. 136 il. \$4.95
- Solid-State Projs. for the Experimenter 224 p. 228 il. \$4.95
- Electronic Experimenter's Guidebook 182 p. 86 il. \$4.95
- 125 One-Transistor Projects 192 p. 125 il. \$4.95
- 64 Hobby Projects for Home & Car 192 p. 159 il. \$4.95

AUDIO, Hi-Fi ELECTRONICS MUSIC

- Electronic Music Circuit Guidebook 224 p. 180 il. \$6.95
- Q & A About Tape Recording 264 p. 102 il. \$5.95
- Handbook of Multichannel Recording 322 p. 196 il. \$7.95
- Auto Stereo Service & Installation 252 p. 245 il. \$5.95
- Sync, Cassette & Cartridge Tape Players 294 p. 196 il. \$6.95
- Experimenting With Electronic Music 180 p. 103 il. \$4.95
- Cassette Tape Recorders. How Work Care Repair 204 p. \$4.95
- Acoustic Techniques for Home & Studio 224 p. 168 il. \$5.95
- Pictorial Guide to Tape Recorder Rprs. 256 p. 320 il. \$4.95
- How to Repair Musical Instrument Amps 288 p. 50 il. \$5.95
- Jap. Radio. Record. Tape Player Svcs. Manual 228 p. \$6.95
- Servicing Electronic Organs 196 p. 158 il. \$7.95
- Tape Recording For Fun & Profit 224 p. over 200 il. \$5.95

ALL-IN-ONE COLOR & B&W TV SCHEMATIC/SERVICING MANUALS

Each vol. has complete service data, parts lists, full-size schematics, and all other info needed. Each 8½ x 11", 196 pps. Each only \$5.95 unless marked. COLOR TV: Adm. Vol. 1 Vol. 2 \$6.95 GE Vol. 1 Vol. 2 Jap. Vol. 1 Vol. 2 \$4.95 RCA Vol. 1 Vol. 2 Jap. Vol. 1 \$4.95 Sears Serv. Modular Recr. Vol. 1 \$6.95 Vol. 2 \$4.95 Svl. Vol. 1 Vol. 2 Toshiba Zenith Vol. 1 Vol. 2 Vol. 3 Vol. 4 B&W TV: Adm \$7.95 GE \$7.95 Jap. \$6.95 Mag. \$4.95 Mot \$4.95 Philco \$4.95 RCA \$7.95 Svl. \$4.95 Zenith \$7.95

NO RISK COUPON-MAIL ENTIRE AD

TAB BOOKS Blue Ridge Summit Pa 17214
Please send me books checked above

I enclose \$_____ send postpaid
 Please invoice on 10-day FREE trial

Name _____ Phone _____
Company _____
Address _____
City _____ State _____ Zip _____
SAVE POSTAGE by remitting with order. Foreign add 10%. Pa residents add 6%. EE 37

CIRCLE 14 ON READER SERVICE COUPON

When the world talks, you can listen...

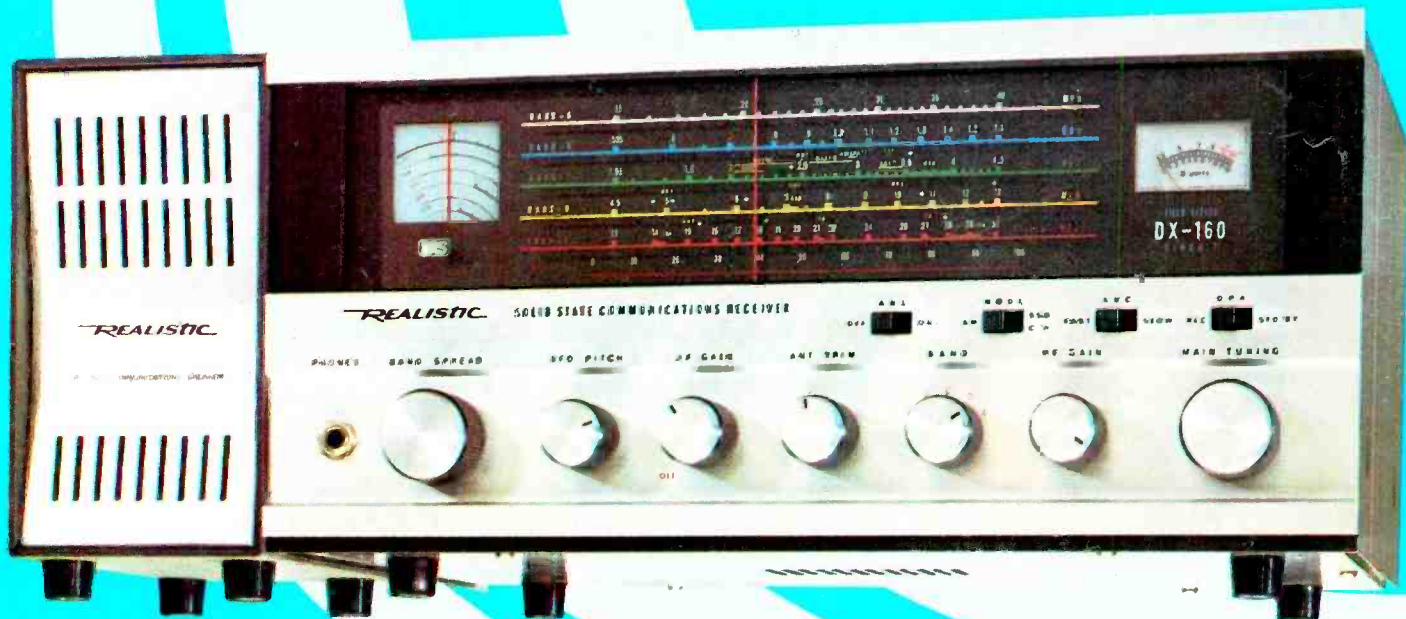

with the Realistic® DX-160 Receiver

Full-feature design for **HAM/SWL CB/SSB/AM** listening **159⁹⁵***

The modern world is a "global village" when you own the versatile DX-160. Five bands covering 130 kHz to 30 MHz let you monitor all types of transmissions from all over the world. Pick up all the CB channels, both AM and SSB. Hear local programs and news from places like Paris, London, Cairo, Rome, Moscow. Tune in longwave aviation/marine weathercasts and special civil defense frequencies. Receive WWV time signals and radio propagation forecasts. And you'll be surprised at the DX-power you get on the standard AM band. Eleven controls and switches let you really "pull out" distant sta-

tions. Main tuning control plus bandspread tuning calibrated for the Amateur bands. A product detector and BFO assure superior SSB and code reception. Controls for audio and RF gain, BFO pitch and antenna trim. Switches for automatic noise limiting, AM-to-CW/SSB, fast or slow AVC, and standby for use with a transmitter. FET's in all critical stages for maximum sensitivity and selectivity and crystal-filter IF stages for reduced noise. Illuminated S-meter. Headphone jack. And the matching speaker is included. U.L. listed. The DX-160—what a way to travel!

SOLD ONLY WHERE YOU SEE THIS SIGN:

*Price may vary at individual stores and dealers.
Prices and products may vary in Canada.

Radio Shack®

A TANDY COMPANY • FORT WORTH, TEXAS 76107
OVER 5000 LOCATIONS IN NINE COUNTRIES

You get your own Experimental Electronics Laboratory... work with components comparable to those used by industry!

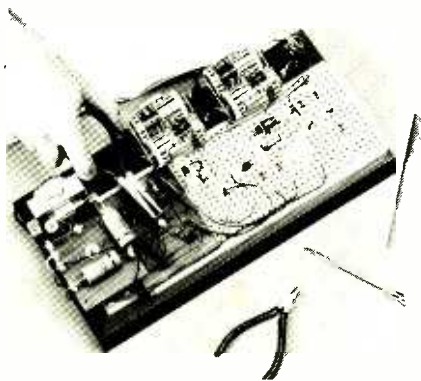

With CIE's Experimental Electronics Laboratory, you'll perform actual experiments and become adept at handling components. This valuable "hands on" experience helps you learn the "how" as well as the "why."

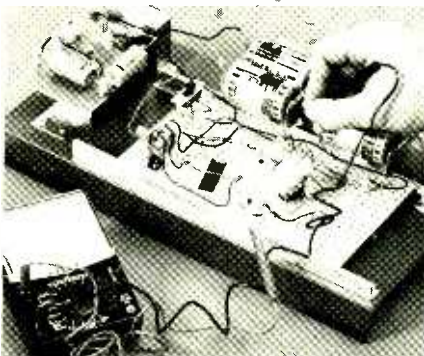

Testing and troubleshooting are an important part of your learning experience. Included in your laboratory is a precision "multimeter" to diagnose electrical and electronic troubles quickly and accurately.

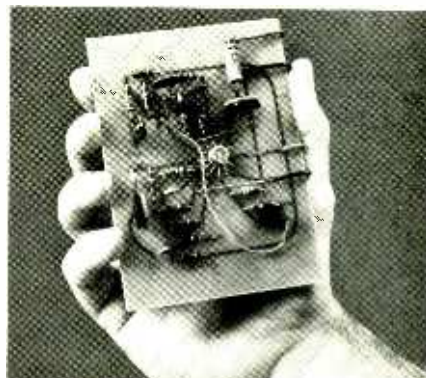

Modern space-age components like this IC (integrated circuit) are professional quality and can be used again and again in many of your projects. Lesson by lesson, piece by piece your knowledge grows!

Prepare now for a rewarding career in Electronics . . . the Science of the Seventies.

Electronics miracles are changing today's world with breathtaking speed.

This growth in electronics technology has generated a need for electronics technicians trained in theory and practice to build the products, maintain them, and troubleshoot them during the Seventies and beyond.

Don't just wait for something to "happen" in your present job. Get ready now for a career you'll really enjoy . . . with the opportunity for a good income and the chance for advancement.

Practical experience with experiments

"Hands on" experience helps to reinforce basic theory. When you learn by doing, you discover the "how" as well as the "why." You'll find out for yourself the right way as well as the wrong way to use electronic components. How to construct your own circuits, to discover trouble spots and learn how to fix them.

CIE offers a number of laboratory courses where you learn Electronics by "doing it yourself." You work with your own hands on electronics components and lab equipment. This combination of "head and hands" learning *locks in* your understanding of the crucial principles you'll use on the job in your new career.

And you do it all at home, in your spare time, at your best study pace. CIE's outstanding lessons allow you to progress step by step. An instructional technique time-tested for over 40 years of specialized electronics independent home-study training.

Importance of an FCC License and our Warranty

If you want to work in commercial broadcasting . . . television or AM or FM broadcasting . . . as a broadcast engineer, federal law requires you to have a First Class Radiotelephone License. Or if you plan to operate or to maintain mobile two-way communications systems, microwave relay stations or radar and signaling devices, a Second Class FCC License is required.

Even if you aren't planning a career which involves radio transmission of any kind, an FCC License is valuable to have as Government certification of certain technical skills. It's a job credential recognized by some employers as *evidence* that you really know your stuff.

To get an FCC License, you must pass a licensing exam administered by the government. And we are confident you can successfully earn your license, if you're willing to put forth an effort, because the vast majority of CIE students have. In fact, based on continuing surveys, close to 4 out of 5 CIE graduates passed their FCC exams!

That's why we can offer this Warranty: when you successfully complete any CIE career course which includes FCC License preparation, you will be able to pass the Government FCC Examination for the License for which the course prepared you or you will be entitled to a full refund of an amount equal to the cash price of tuition for CIE's Course No. 3, "First Class FCC License," in effect at the time you enrolled. This warranty is good from the date you enroll until the last date allowed for completion of your course.

That's it! We *warrant* that you will get the License you trained for.

You'll have attractive job opportunities

There have already been many exciting developments and breakthroughs in Electronics and some people might assume there will be no new frontiers . . . no new worlds to conquer. Not so.

Electronics is still growing. In nearly every one of the new and exciting fields of the Seventies you find electronics

skills and knowledge in demand. Computers and data processing. Air traffic control. Medical technology. Pollution control. Broadcasting and communications. Once you have the solid technical background you need, you can go after the career field you want . . . work for a big corporation, a small company, or even go into business for yourself.

Yes, Electronics can be the door to a whole new world of career opportunities for you. And CIE training can be your key.

Send for FREE school catalog

Discover the opportunities open to people with electronics training. *Learn* how CIE career courses can help you build new skills and knowledge and prepare you for a meaningful, rewarding career. We have courses for the beginner, for the hobbyist, for the electronics technician, and for the electronics engineer. Whether you are just starting out in Electronics or are a college-trained engineer in need of updating (or anywhere in between), CIE has a course designed to fit your background, experience, and future goals.

Send today for our FREE school catalog and complete career information. For your convenience, we will try to have a representative call to assist in course selection. Mail reply card or coupon to CIE . . . or write to CIE (include name and date of this publication), 1776 East 17th St., Cleveland OH 44114. Do it TODAY.



Approved
Under
G.I. Bill

All CIE *career* courses are approved for educational benefits under the G.I. Bill. If you are a veteran or in service now, check box for G.I. Bill information.

CIE Cleveland Institute of Electronics, Inc.
1776 East 17th Street, Cleveland, Ohio 44114
Accredited Member National Home Study Council

Yes, I want your FREE school catalog and career information package today.

I am especially interested in:

EL-80

- | | |
|--|--|
| <input type="checkbox"/> Electronics Technology | <input type="checkbox"/> Industrial Electronics |
| <input type="checkbox"/> FCC License Preparation | <input type="checkbox"/> Electronics Engineering |
| <input type="checkbox"/> Color TV Maintenance | <input type="checkbox"/> Other _____ |
| <input type="checkbox"/> Mobile Communications | |

Print Name _____

Address _____

Apt. _____

City _____

State _____

Zip _____

Phone _____

Age _____

Check box for G.I. Bill information. Veteran On Active Duty

BUILD 20 RADIO

and Electronics Circuits

PROGRESSIVE HOME RADIO-TV COURSE

Reg. U. S. Pat. Off.



Training Electronics Technicians Since 1946

Now Includes

- ★ 12 RECEIVERS
- ★ 3 TRANSMITTERS
- ★ SQ. WAVE GENERATOR
- ★ SIGNAL TRACER
- ★ AMPLIFIER
- ★ SIGNAL INJECTOR
- ★ CODE OSCILLATOR

- ★ No Knowledge of Radio Necessary
- ★ No Additional Parts or Tools Needed
- ★ EXCELLENT BACKGROUND FOR TV
- ★ SCHOOL INQUIRIES INVITED
- ★ Sold In 79 Countries

YOU DON'T HAVE TO SPEND HUNDREDS OF DOLLARS FOR A RADIO COURSE

The "Edu-Kit" offers you an outstanding PRACTICAL HOME RADIO COURSE at a rock-bottom price. Our Kit is designed to train Radio & Electronics Technicians, making use of the most modern methods of home training. You will learn radio theory, construction practice and servicing. THIS IS A COMPLETE RADIO COURSE IN EVERY DETAIL.

You will learn how to build radios, using regular schematic wiring and solder in a professional manner; how to service radios. You will work with the standard type of punched metal chassis as well as the latest development of Printed Circuit chassis.

You will learn the basic principles of radio. You will construct, study and work with RF and AF amplifiers and oscillators, detectors, rectifiers, test equipment. You will learn and practice code, using the Progressive Code Oscillator. You will learn and practice trouble-shooting, using the Progressive Signal Tracer, Progressive Signal Injector, Progressive Dynamic Radio & Electronics Tester, Square Wave Generator and the accompanying instructional material.

You will receive training for the Novice, Technician and General Classes of F.C.C. Radio Amateur Licenses. You will build Receiver, Transmitter, Square Wave Generator, Code Oscillator, Signal Tracer and Signal Injector circuits, and learn how to operate them. You will receive an excellent background for television, Hi-Fi and Electronics.

Absolutely no previous knowledge of radio or science is required. The "Edu-Kit" is the product of many years of teaching and engineering experience. The "Edu-Kit" will provide you with a basic education in Electronics and Radio, worth many times the low price you pay. The Signal Tracer alone is worth more than the price of the kit.

THE KIT FOR EVERYONE

You do not need the slightest background in radio or science. Whether you are interested in Radio & Electronics because you want an interesting hobby, a well paying business or a job with a future, you will find the "Edu-Kit" a worth-while investment. Many thousands of individuals of all

ages and backgrounds have successfully used the "Edu-Kit" in more than 79 countries of the world. The "Edu-Kit" has been carefully designed, step by step, so that you cannot make a mistake. The "Edu-Kit" allows you to teach yourself at your own rate. No instructor is necessary.

PROGRESSIVE TEACHING METHOD

The Progressive Radio "Edu-Kit" is the foremost educational radio kit in the world, and is universally accepted as the standard in the field of electronics training. The "Edu-Kit" uses the modern educational principle of "Learn by Doing." Therefore you construct, learn schematics, study theory, practice trouble shooting—all in a closely integrated program designed to provide an easily-learned, thorough and interesting background in radio.

You begin by examining the various radio parts of the "Edu-Kit." You then learn the function, theory and wiring of these parts. Then you build a simple radio. With this first set you will enjoy listening to regular broadcast stations, learn theory, practice testing and trouble-shooting. Then you build a more advanced radio, learn more advanced theory and techniques. Gradually, in a progressive manner, and at your own rate, you will find yourself constructing more advanced multi-tube radio circuits, and doing work like a Professional Radio Technician.

Included in the "Edu-Kit" course are Receiver, Transmitter, Code Oscillator, Signal Tracer, Square Wave Generator and Signal Injector Circuits. These are not unprofessional "breadboard" experiments, but genuine radio circuits, constructed by means of professional wiring and soldering on metal chassis, plus the new method of radio construction known as "Printed Circuitry." These circuits operate on your regular AC or DC house current.

THE "EDU-KIT" IS COMPLETE

You will receive all parts and instructions necessary to build twenty different radio and electronics circuits, each guaranteed to operate. Our Kits contain tubes, tube sockets, variable, electrolytic, mica, ceramic and paper dielectric condensers, resistors, tie strips, hardware, solder, punched metal chassis, instruction Manuals, hook-up wire, solder, selenium rectifiers, coils, volume controls and switches, etc.

In addition, you receive Printed Circuit materials, including Printed Circuit chassis, special tube sockets, hardware and instructions. You also receive a useful set of tools, a professional electric soldering iron, and a self-powered Dynamic Radio and Electronics Tester. The "Edu-Kit" also includes Code Instructions and the Progressive Code Oscillator, in addition to F.C.C. Radio Amateur License training. You will also receive lessons for servicing with the Progressive Signal Tracer and the Progressive Signal Injector, a High Fidelity Guide and a Quiz Book. You receive Membership in Radio-TV Club, Free Consultation Service, Certificate of Merit and Discount Privileges. You receive all parts, tools, instructions, etc. Everything is yours to keep.

FREE EXTRAS

• SET OF TOOLS

- SOLDERING IRON
- ELECTRONICS TESTER
- PLIERS-CUTTERS
- VALUABLE DISCOUNT CARD
- CERTIFICATE OF MERIT
- TESTER INSTRUCTION MANUAL
- HIGH FIDELITY GUIDE • QUIZZES
- TELEVISION BOOK • RADIO TROUBLE-SHOOTING BOOK
- MEMBERSHIP IN RADIO-TV CLUB:
- CONSULTATION SERVICE • FCC AMATEUR LICENSE TRAINING
- PRINTED CIRCUITRY

SERVICING LESSONS

You will learn trouble-shooting and servicing in a progressive manner. You will practice repairs on the sets that you construct. You will learn symptoms and causes of trouble in home, portable and car radios. You will learn how to use the professional Signal Tracer, the unique Signal Injector and the dynamic Radio & Electronics Tester. While you are learning in this practical way, you will be able to do many a repair job for your friends and neighbors, and charge fees which will far exceed the price of the "Edu-Kit." Our Consultation Service will help you with any technical problems you may have.

FROM OUR MAIL BAG

J. Stataitis, of 25 Poplar Pl., Waterbury, Conn., writes: "I have repaired several sets for my friends, and made money. The "Edu-Kit" paid for itself. I was ready to spend \$240 for a Course, but I found your ad and sent for your Kit."

Ben Valerio, P. O. Box 21, Magna, Utah: "The Edu-Kits are wonderful. Here I am sending you the questions and also the answers for them. I have been in Radio for the last seven years, but like to work with Radio Kits, and like to build Radio Testing Equipment. I enjoyed every minute I worked with the different kits; the Signal Tracer works fine. Also like to let you know that I feel proud of becoming a member of your Radio-TV Club."

Robert L. Shuff, 1534 Monroe Ave., Huntington, W. Va.: "Thought I would drop you a few lines to say that I received my Edu-Kit, and was really amazed that such a bargain can be had at such a low price. I have already started repairing radios and phonographs. My friends were really surprised to see me get into the swing of it so quickly. The Trouble-shooting Tester that comes with the Kit is really swell, and finds the trouble, if there is any to be found."

PRINTED CIRCUITRY

At no increase in price, the "Edu-Kit" now includes Printed Circuitry. You build a Printed Circuit Signal Injector, a unique servicing instrument that can detect many Radio and TV troubles. This revolutionary new technique of radio construction is now becoming popular in commercial radio and TV sets.

A Printed Circuit is a special insulated chassis on which has been deposited a conducting material which takes the place of wiring. The various parts are merely plugged in and soldered to terminals.

Printed Circuitry is the basis of modern Automation Electronics. A knowledge of this subject is a necessity today for anyone interested in Electronics.

Progressive "Edu-Kits" Inc., 1189 Broadway, Dept. 583DJ Hewlett, N.Y. 11557

Please rush me free literature describing the Progressive Radio-TV Course with Edu-Kits. No Salesman will call.

NAME

ADDRESS

CITY & STATE ZIP

PROGRESSIVE "EDU-KITS" INC.

1189 Broadway, Dept. 583DJ Hewlett, N.Y. 11557

Hey, Look Me Over

(Continued from page 10)

all-channel converter and a control unit, inter-connected by a slim 25-foot, plug-in, control cord. The converter is usually located behind or under the TV set. The only wiring necessary is to connect the downlead from the TV antenna into the converter, and then connect the converter output to the antenna terminals of the TV set. The back of the TV set is not removed to make the installation. All necessary jumper cables and accessories are supplied with the TRC-82. The remote control may be placed anywhere in the room. Extension lengths of control cord are available, in case the user wants to operate the TV set from a distance greater than 25 feet. The control cord is slim enough to be hidden under a rug or to run along a baseboard. Direct-access remote-control channel changes are accomplished by a unique feature of a varactor-diode oscillator, its frequency can be changed simply by changing the bias voltage of the varactor. This makes it possible to change channels without physically rotating a TV tuner. Another advantage is that when changing channels, you go directly to the desired channel without clicking through intermediate channels, saving wear and tear on the tuner. The Jerrold TRC-82 converts all incoming VHF and UHF channels to either Channel 3 or Channel 4 (whichever is not broadcast locally). After simple

installation of the TRC-82, the user leaves the TV set tuned to Channel 3 or 4. The power cord of the TV set is plugged into the convenience outlet on the TRC-82 converter. From then on, the set can be turned on and off remotely from the comfort of an easy chair. Jerrold's TRC-82 sells for \$124.50. The extension control cord (Model TRC-82-25CD) is priced at \$8.95.

Car Stereo Hump-Mount

Acoustic Fiber Sound Systems has a new Kar Cricket hump-mount console, Model KK-1080, you will want installed in your wagon. The KK-1080 combines a sculpted appearance with a design that

permits mounting of any stereo radio, 8-track or cassette system with storage space for four 8-track or seven cassette tapes. The unit requires no fastening devices, but simply rests on the drive-shaft hump common to most cars, vans and trucks. Specially designed "teeth" in the base prevent movement while driving. Yet, by simply unplugging power, antenna and remote speaker leads, the entire unit may be lifted and placed in the trunk for maximum security. And, by placing the stereo units at a 45-degree angle to the driver, better dial



CIRCLE 51
ON READER
SERVICE COUPON



BE FOREMOST with the **HUSTLER** "DOUBLE-TALK" antenna system

Join the thousands of CB'ers who communicate longer, louder, while traveling over the miles with the Hustler "Double-Talk" mobile antenna system. Guaranteed superior performance over a single antenna installation — more uniform signal pattern because of uniquely detailed phasing design, more consistent communications with virtually no fading or blind spots when changing direction in travel.

Get Outstanding 40 Channel Performance

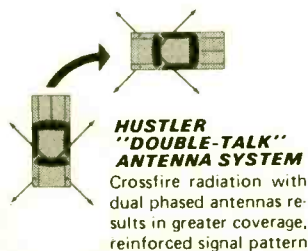
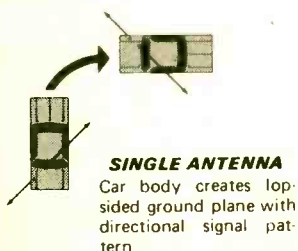

51" HTM-1

42" DFG

48" SDTs

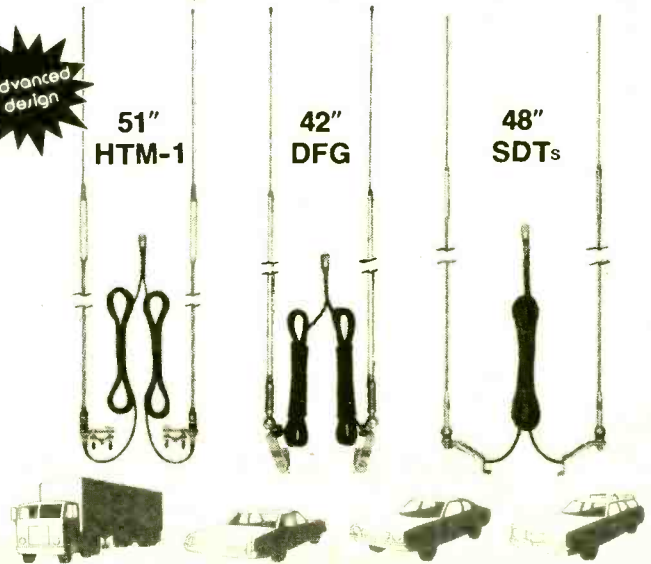

**new-
tronics
corporation**

15800 commerce park drive,
brook park, ohio 44142

HUSTLER

Available from all distributors
who recognize the best!

visibility and safer operation can be expected. No bending down to squint at a dial under the dash is required. The KK-1080 sells for \$9.95. With the attachment to the KK-1080 console of any of the Kar Kriket remote stereo speakers, Models KK-3030, 3040, 3050, enthusiasts can bring the big home stereo sound with them on the road. For more info on Kar Kriket products, write to AFS, 7999 Knue Road, Suite 116, Indianapolis, IN 46250.

CB Music Album

"All Ears," the latest release on Radio Shack's own Realistic label, celebrates America's fascination with Citizens Band two-way radio, otherwise known as "ears," with ten new and original songs. To produce the album Radio Shack commissioned a select group of professional writers, singers and musicians. The result is an exclusive CB concert in special tribute to CB fans and easy-listening music lovers. "All Ears" includes contemporary music for every taste—pop, rock, soul and country—sung and told in the vernacular around which CB "good



CIRCLE 32 ON READER SERVICE COUPON

buddies" have built a cult of togetherness. Featured on the album are "Hey Shirley (This is Squirrely)", which has already become popular as a single, "The Night I talked to the Lord," "The Handles Hall of Fame," and "Hey Good Buddy (Where's My Baby)," which are also expected to be released as singles. Other songs on the album are: "Honey Bee (Please Answer Me)," "Come On, Come On, CB Baby," "Everybody's Somebody (In Our CB World)," "Listenin' CB Blues," "Ain't Ever Gonna Be Lonely Again," and "L. J.'s CB Radio." "All Ears," priced at \$3.49, is available on stereo LP or 8-track tape exclusively from Radio Shack stores and dealers, nationwide.

Intelligent Terminal

A sophisticated, all-on-one-board kit for use as either a computer or intelligent terminal is now available from Processor Technology. Known as the Sol Terminal Computer, the new kit with all memory and interface electronics including video display, keyboard inter-

face, audio cassette interface, all necessary software plus the ability to accept the Processor Technology line of memory and interface modules sells for \$475 in kit form. The Sol can be used as a microcomputer, low cost CRT terminal, and editing terminal. Built around the 8080 microprocessor, the Sol terminal consists of a PC assembly with the microprocessor, 512 eight-bit bytes of PROM on a plug-in personality module, 2048 eight-bit words of RAM, a 1024 character video display generator, keyboard interface, serial and parallel interfaces for connection to external devices and an edge connector for memory expansion. Optional extras include a power supply, video monitor, ASCII keyboard and case. Other options are a floppy disk system, high speed papertape reader, PROM programmer and color graphics interface. Because the Sol uses the 8080, memory can be expanded to 65,000 bytes. The Sol is completely compatible with Imsai, Altair and other S-100 bus computers. Delivery is stock to 45 days after receipt of order. For more information, please write to Processor Technology, 6200 Hollis Street, Emeryville, CA 94608.

Stylus Cleaner

For clean sound you need a clean stylus on the phono. So Audio-Technica has come up with a stylus cleaner that combines a brush and fluid that are especially designed to keep the diamond tip free from dirt or waxy buildup. The new Audio-Technica stylus cleaner dis-



CIRCLE 50 ON READER SERVICE COUPON

solves foreign materials and junk without harming stylus adhesives or record surfaces. Used regularly, the new AT607 cleaner prolongs disc life. It is ideal for tone arms operating at low tracking force. For application info, write to Audio-Technica, 33 Shiawassee Avenue, Fairlawn, OH 44313.

Solderless Breadboards

Continental Specialties (CSC) has two new solderless breadboarding sockets. Designated Experimentor 300 and Experimentor 600, the new one-piece sockets both provide 94 five-point terminals, plus two 40-point bus strips, for a total of 550 solderless tie-points. Experimentor 600, priced at \$10.95, has a 6/10-inch center channel, making it the only socket currently on the market with full 4-terminal fan-out for microprocessors, clock chips, RAMs, ROMs and other larger DIP packages. Experimentor 300, priced at \$9.95, has a 3/10-inch center channel that is perfect for smaller DIPs.

(Continued on page 18)

TEST SEMICONDUCTORS ANYWHERE

Portable, in-circuit tester for all bipolar transistors, Darlingtons, FETs, SCRs



B&K-PRECISION MODEL 510 \$90

- Combines Dynapeak™ testing method with HI/LO power drive
- Tests semiconductors and identifies all leads; base, emitter, collector in LO drive
- Provides GOOD/BAD indicator in circuits with shunt resistance as low as 10Ω; shunt capacitance up to 25 μF, in HI drive
- Test performed as quickly as one can turn the switch
- Measures 6 5/8" x 3 3/4" x 1 3/4"
- Weighs 1/2 pound, less four "AA" batteries
- Price includes test clips and carrying case
- Available from local B&K-PRECISION distributors

B&K PRECISION
PRODUCTS OF DYNASCAN

6460 West Cortland Avenue
Chicago, Illinois 60635 • 312/889-9087
In Canada: Atlas Electronics, Toronto

CIRCLE 36 ON READER SERVICE COUPON



**"FROM TWIN MAMAS
TO LUNCH BOXES, WE HAVE
HARDWARE
FOR EVERY APPLE!"**



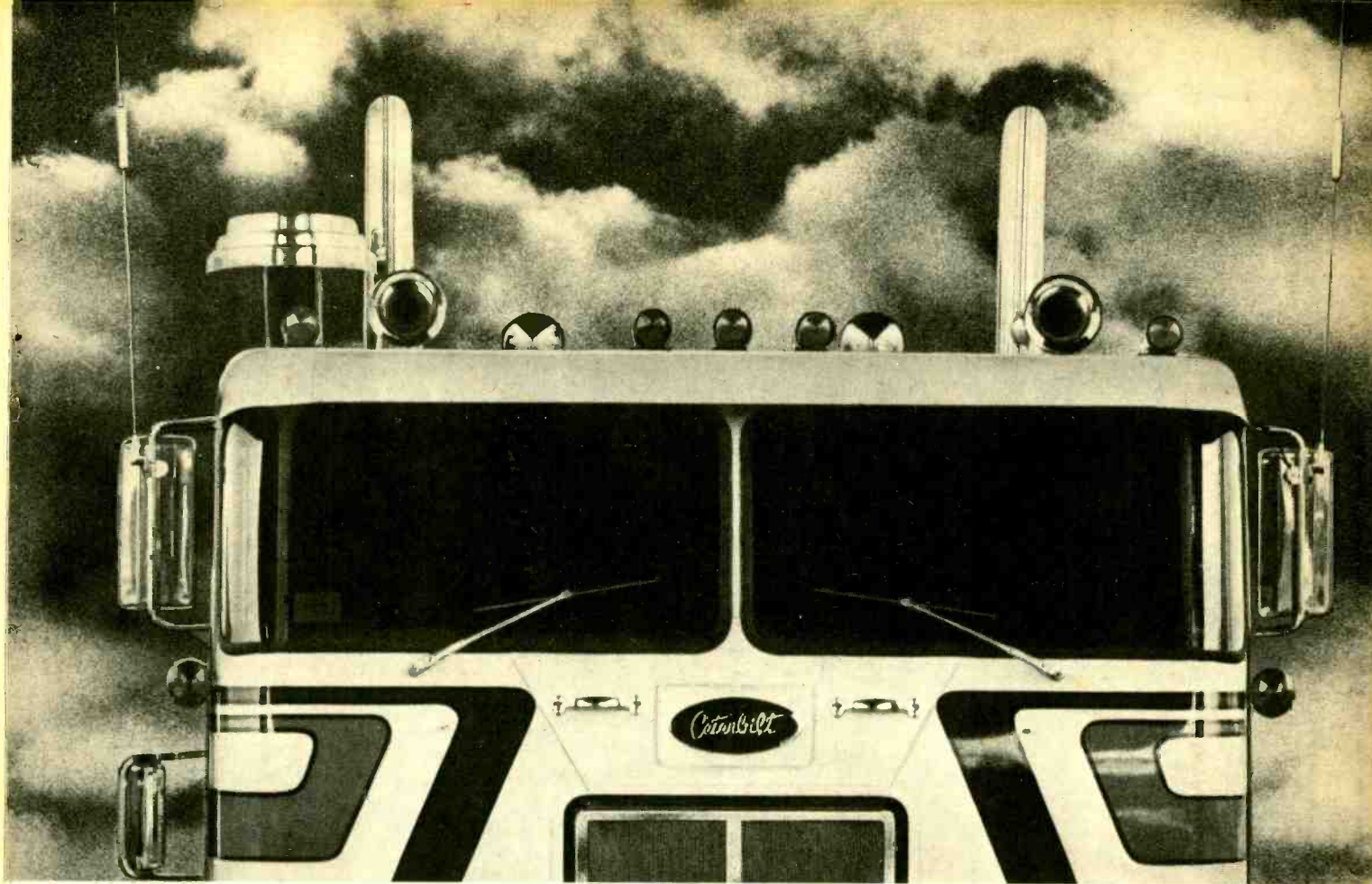

Loosely translated, that's CB talk for: "Sparkomatic has CB twin trucker antennas, CB base station antennas, CB instant mount antennas like magnet mount and clip ons, CB motorized and manually operated disappearing antennas, CB indoor and outdoor public address speakers, CB external speakers with tone purifiers, CB external speakers without tone purifiers and CB converters.

Not to mention, a complete line of 40 channel in-dash and under-dash mobile transceivers and base station units. Including 40 channel transceivers with memory control buttons, digital readouts and other up-to-the-minute innovations."

In other words, Sparkomatic has the very best CB equipment. And enough CB equipment to meet the needs of every CB'er.

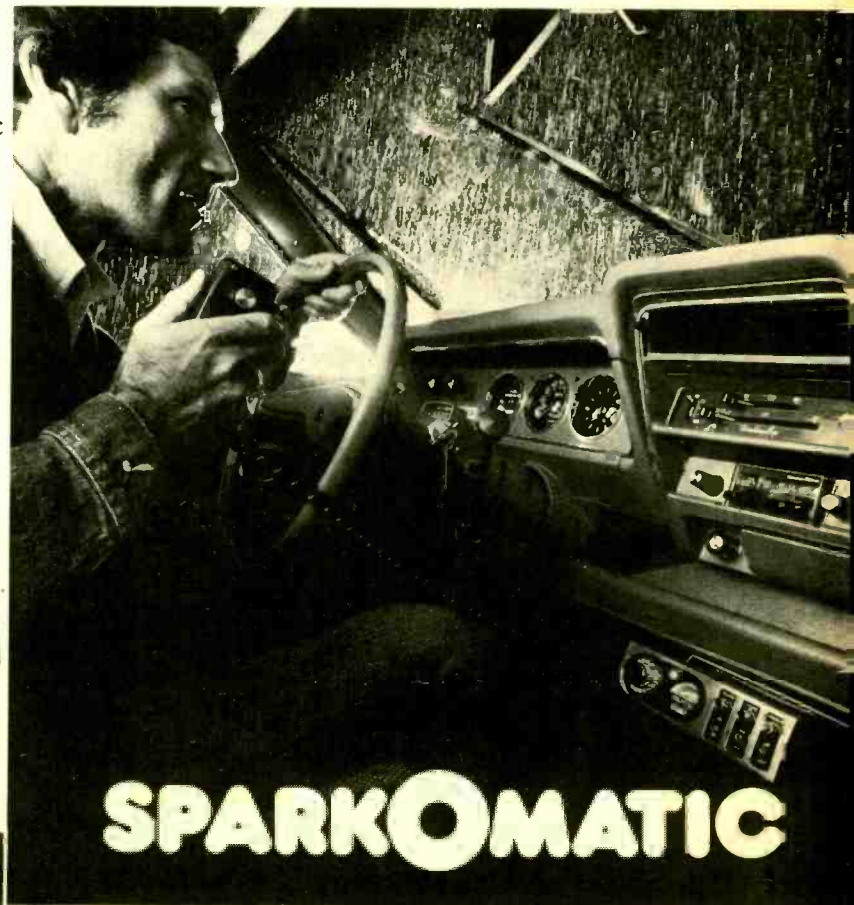

SPARKOMATIC

CIRCLE 17 ON READER SERVICE COUPON



BOOKMARK BY BOOKWORM

Solid Basics. Solid-State Electronics, by Frank P. Tedeschi and Margaret R. Taber, provides an introduction to fundamental semiconductor and electronic principles. Its use requires only a familiarity with algebra and basic electricity. The book is conveniently divided into eleven self-contained sections, each concentrating on specific semiconductor components. Numerous example problems and laboratory experiments bridge the gap between theory and practice, and provide a more comprehensive working knowledge of actual electronic components in practical circuits. Reinforcing the theoretical ideas are a wide variety of illustrative aids, such as graphs, curves, tables, diagrams, formulas and ac-

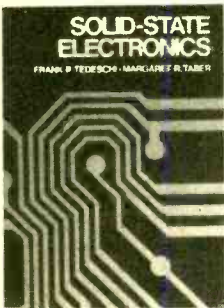

Hard cover
202 pages
\$8.95

tual wiring circuits. In brief, this volume aids in mastery of basics that enable progression to sophisticated semiconductor principles such as feedback amplifiers, field-effect transistors, integrated circuits, and SCR's. Published by Van Nostrand

Reinhold Company, 450 West 33rd Street, New York, NY 10001.

Down With Trouble. Here's a book on how to troubleshoot basic electronic equipment with a minimum of service literature and without any service data. This occurs often in troubleshooting situations. *Handbook of Basic Electronic Troubleshooting*, by John D. Lenk, assumes that the reader is familiar with basic electronics but has no special knowledge of test equipment and no practical experience in troubleshooting. As such, it is ideal for the beginner in the field. However, the basic techniques described apply to all types of electronics; therefore the handbook is helpful to advanced technicians and engineers as well. The use of test equipment during

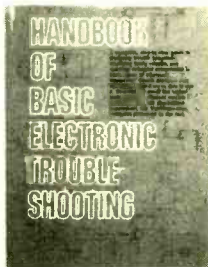

Hard cover
239 pages
\$15.95

troubleshooting is described in detail, including how to connect test equipment to circuits and how to make point-to-point voltage/resistance/continuity checks of basic circuits. Alignment and adjustment procedures are described, assuring that the equipment is restored to normal operation in peak condition. Published by Prentice-Hall, Inc., Englewood Cliffs, NJ 07632.

CB Projects. You can't build a CB transmitter or transceiver because the "law" says you can't. But CB projects that are extremely useful plus inexpensive to

assemble are illustrated and described in Lafayette Radio's *CB Radio Construction Projects*, by Len Buckwalter. Len is no stranger to the pages of **ELEMENTARY ELECTRONICS**—he has authored numerous articles since 1963. His book is packed with projects such as: S-Meter, Modulation Monitor, Headset Amplifier, TVI Trap, Line Filters, On-the-Air Sign and many others. You can purchase your copy



Soft cover
126 pages
\$3.95

at national Lafayette Radio Stores or through the home store's mail order catalog. Write to Lafayette Radio, PR/EE Dept., 111 Jericho Turnpike, Syosset, NY 11791.

Solid State Data Book. A Databook on high reliability integrated circuits and discrete power devices, *High Reliability Devices*, (SSD-230) is now available from RCA Solid State Division as a supplement to the SSD-2-OD two-volume Solid State Databooks. The volume covers MIL-STD-883 slash-series, MIL-M-38510, and Gold Chip types for integrated circuits, and -AN, JANTX, JANTXV and non-JAN types for power devices. The book supple-



Soft cover
429 pages
\$6.00

ments the data and application note abstracts on RCA standard type integrated circuits and power devices contained in the 1,232 pages of the two volumes in the SSD-200D series. High Reliability Devices may be ordered from RCA Solid State distributors or by sending check or purchase orders to RCA Solid State Division, Box 3200, Somerville, NJ 08876.

In the Air. A new 406-page volume, *Aviation Electronics Handbook*, by Edward L. Safford, is a complete, simplified guide to aviation electronics—for radio mechanics, avionics technicians and pilots. From the smallest puddle-jumper to the biggest jumbo jet, all planes depend on transistors, tubes and integrated circuits to do their jobs safely and efficiently. This

(Continued on page 18)

Hey CB'er!! No roof to call your own?



You don't need one!! The AntennaMent is here!! A 4dB gain base station antenna only 64" tall. Lightweight, portable, tunable for minimum SWR, transmits across 23 or 40 channels. Free standing for use on desk top, patio, house, camper, beach - anywhere your radio can go! Assembles and disassembles in seconds.



Pacer did it all for you.

Mail House P.O. Box 804, West Caldwell, NJ 07006

Check or Money Order only Please \$29.95

Shipping and insurance 2.95

10' RG-58/U Cable with 2 PL-259 Connectors 4.95
for quick connection of antenna and radio.

TOTAL

Name _____

Address _____

City _____ State _____ Zip _____

3-4 weeks for delivery Florida residents add 4% sales tax



CIRCLE 41 ON READER SERVICE COUPON

SAVE UP TO 50% ON PARTS.

Hobbyist or professional, there are probably a lot of circuits you build just for the fun of it. And a lot you'd like to build, but never get around to.

One reason is the cost of parts. Parts you buy for one project, but can't re-use... because you haven't time to take them carefully apart. Or because of heat and mechanical damage that occur when you do.

Now, there's an easier way that can save you big money on parts *and hours on every project*, as well: *Proto-Board® Solderless Breadboards*.

Now, assembling, testing and modifying circuits is as easy as pushing in—or pulling out—a lead. IC's, LED's, transistors, resistors, capacitors... virtually every kind of component... connect and interconnect instantly via long-life, nickel-silver contacts. No special patch

MODEL	NO. OF TIE-POINTS	14-PIN DIP CAPACITY	SUGG LIST *	OTHER FEATURES
PB-6	630	6	\$15.95	Kit — 10 minute assembly
PB-100	760	10	19.95	Kit — with larger capacity
PB-101	940	10	29.95	8 distribution buses, higher capacity
PB-102	1240	12	39.95	Large capacity, moderate price
PB-103	2250	24	59.95	Even larger capacity, only 2.7¢ per tie-point
PB-104	3060	32	79.95	Largest capacity, lowest price per tie-point
PB-203	2250	24	75.00	Built-in 1% regulated 5V, 1A low-ripple power supply
PB-203A	2250	24	120.00	As above plus separate 2-amp +15V and -15V internally adjustable regulated outputs

*Manufacturer's suggested list
Prices and specifications subject to change without notice

cords or jumpers needed—just lengths of ordinary #22-30 AWG solid hookup wire.

Circuits go together as quickly as you can think them up. And parts are re-usable, so as your "junk box" builds, you build more and more projects for less and less money.

Before you invest in your next project, invest in a CSC breadboard. See your dealer or order by phone: 203-624-3103 (East Coast) or 415-421-8872 (West Coast)—major charge cards accepted. You've got nothing to lose... and a lot to gain.

CONTINENTAL SPECIALTIES CORPORATION



44 Kendall Street
Box 1942 New Haven CT 06509
203-624-3103 TWX 710-465-1227
West Coast office Box 7809 San Francisco, CA
94119 • 415-421-8872 TWX 910-372-7992
Canada Len Finkler Ltd. Ontario

© 1976 Continental Specialties Corporation
CIRCLE 16 ON READER SERVICE COUPON

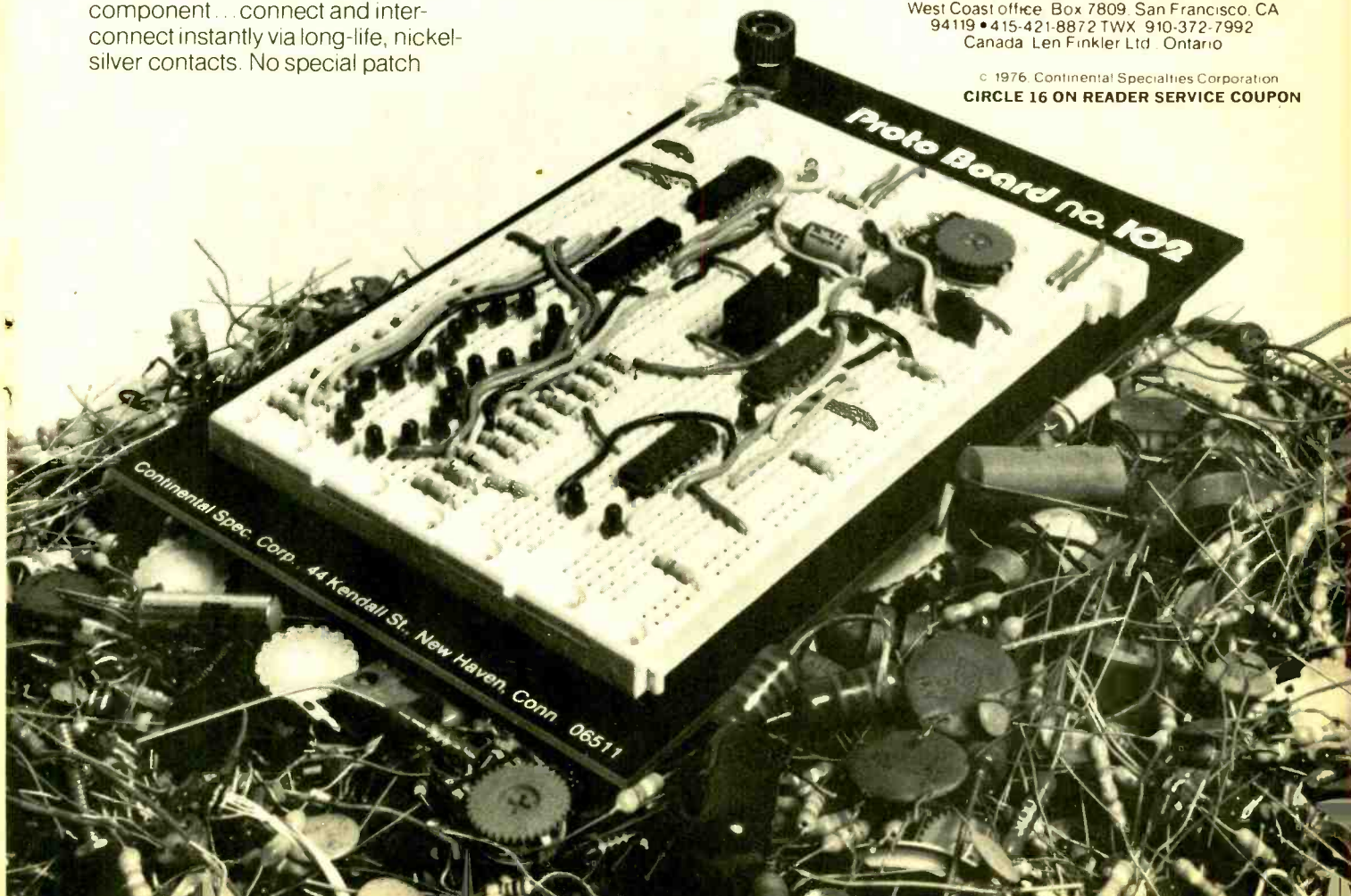

book shows how these parts are assembled into all types of complex avionics systems for military, private and commercial planes. The unique features of aviation

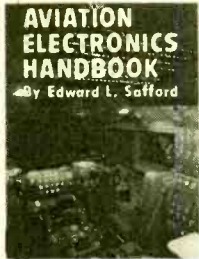

Soft cover
406 pages
\$8.95

communications—the crowded frequency spectrum, the special aerodynamic antennas, the multipath signals, the requirements for reliability—all are explained thoroughly. Another section, a guide through the intricacies of autopilots—tells all about gyros, servos, servoamplifiers, sensors, and actuators—and shows how these and other systems and components are interrelated. Airborne radar—its types, limitations, uses and circuits—are fully detailed. Accuracy search radar, height finding and navigation are covered in depth, along with radar receivers, displays and transmitters. Published by Tab Books, Blue Ridge Summit, PA 17214. ■

Both Experimentor sockets also accept transistors, LEDs, resistors, capacitors, pots—virtually all types of discrete components, as well as lengths of #22-30 solid hookup wire for interconnection—with plug-in ease. Both Experimentor sockets also feature a unique interlocking system that permits sockets to be snapped together, mixed or matched, vertically or horizontally, to provide opti-

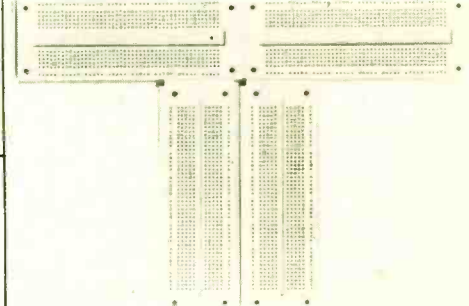

CIRCLE 48 ON READER SERVICE COUPON

mum configurations for almost any type of circuit, and instantly disconnected or reconnected, without tools, to meet requirements. CSC Experimentor sockets are available now from CSC distributors and dealers, or directly from CSC's East- or West-Coast offices. For more information, contact CSC at 44 Kendall St., Box 1942, New Haven, CT 06509.

Hobby-Wrap Tool

The new BW-630 Hobby Wrap is a revolutionary battery-powered tool for wire-wrapping 30 AWG wire onto standard DIP socket terminals (.25 inch square). The tool comes complete with a built-in bit and sleeve for producing the standard "modified" style wrap.



CIRCLE 46 ON READER SERVICE COUPON

A built-in mechanical device prevents overwrapping. Carefully designed and developed for the serious amateur, the tool weighs only 11 ounces and runs on all standard or rechargeable C size batteries. Pistol-grip design of rugged ABS plastic, positive-indexing mechanism and quality construction assure reliable performance. Price is \$34.95. (Batteries not included). Available from local electronics suppliers, or direct from O.K. Machine and Tool Corporation, 3455 Conner Street, Bronx, N.Y. 10475. ■

tenna-loc®

THE ANTI-THEFT CB ANTENNA LOCK

PROTECT YOUR ANTENNA

tenna-loc it!

tenna-loc is the first, really positive protection designed to keep your antenna intact and in place — year round! Yes, you may remove it for car wash or long term storage... but there's no need to every time you park! It works like a charm in all kinds of weather and keeps on working for years. **tenna-loc** features a turn-proof locking stud integrated into a specially notched U-bolt with a 5-tumbler, corrosion proof key lock. We also give you a heavy-duty mounting bracket

and an electro-polished, stainless steel replacement cup, where needed, for easy, quick installation. At \$11.95 (approx), it's a steal! Get one today.

- Choice of models, to fit most trunk mount antennas.
- Installs quickly, easily: keeps your antenna secure.
- Chrome plated, 5-tumbler, corrosion proof key lock.
- Exclusive, turn-proof, U-bolt with lock-in stud.
- Made in U.S.A.; patent pending.

See Your Dealer!



A product of:
VERNITON CORPORATION
CONSUMER PRODUCTS DIVISION
Lake Success Park, Community Drive, Great Neck, N.Y. 11021 (516) 487-0140

CIRCLE 15 ON READER SERVICE COUPON

**AMAZING & HARD-TO-FIND
SCIENCE BUYS!
ALTERNATE ENERGY
SPACE AGE • HOBBIES**

SUPER POWER FOR ANY AM RADIO



Antenna assist has pulled in stations up to 1000 miles* off! No wires, clips, grounding. Solid state—no elec., batts., tubes.
No. 72,095 EK \$19.95 Ppd.
ULTRA SELECT-A-TENNA (OVER 1000* MILES)
No. 72,147 EK\$24.95
*SUBJ. TO LOCAL COND.

SAVE 50%! 8 x 20 MONOCULAR



Top quality Spy Scope, a \$30 value, now \$14.95! Special purchase saves you 50%. 100% coated optics; 393 ft. field of view. Only 2 oz.—stores in pocket, purse, glove box.
No. 1568 EK...\$14.95 Ppd.

SEE MUSIC IN PULSATING COLOR



3-Channel Color Organ lets you modulate 3 independ. strings of colored lamps w/ intensity of your music. "Audio light show" flashes, responds to rhythm, pitch!

No. 42,309 EK (ASSEMBLED).....\$18.50 Ppd.
No. 42,336 EK (UNASSEMBLED).....\$15.95 Ppd.

NASA-CHOSEN FOR APOLLO/SOYUZ



The Astronauts used this super 20X60 binocular (modified) to view Earth! Big 60 mm objective lenses; 173-ft. field of view at 1000 yds. Relative brightness, 9.0. Fully coated optics, more!

No. 1556 EK(9 1/4 x 8 1/2); 47.5 oz) \$99.95 Ppd.

PRO ELECTRONIC SOUND CATCHER



Parabolic mike w/ 18 3/4" transparent reflecting shield & 2 I.C.'s in amplifier magnifies signals 100X over omnidirection mikes. Catch sounds never bef. heard; highest signal to noise ratio poss. 5 1/2 db.

No. 1649EK (REQ. 2 9V BATT.).....\$299.00 Ppd.

KNOW YOUR ALPHA FROM THETA!



For greater relaxation & concentration, monitor your Alpha/Theta brainwaves w/aud. or vis. sig. on Biosone II. Feats. of \$200-up units incl 3 feedback modes! 4-ib.

No. 1668 EK (9 1/2 x 5 1/2 x 4 1/4).....\$149.95 Ppd.
No. 71,809EK (FOR BEGINNERS).....\$59.95 Ppd.

AN ULTRA-MINIATURE AM RADIO!



About the size of a small matchbox. Amazing volume & clarity (depends on locale). Insert earplug (incl) & directional AM mini ravel plays! Runs ab. 100 hrs. on 2 hear. aid batts (incl). (LESS THAN 1 1/4 OZ.)

No. 1976EK...\$14.95 Ppd.

110V FUEL MISER RECLAIMS HEAT



Save your 40% wasted heat to warm a basement, garage, rec rm. at no extra cost! Direct it your way instead of up the chimney. Fan-forced clean hot air via easy ducting!

No. 19,194EK (5 DIA.) Shpg. 17 lb. ...\$121.50 FOB

CAN'T SLEEP, RELAX? TRY THIS!



Electronic sound conditioner simulates 4 kinds of soothing sounds of ocean surf & rain; "white" sound helps mask unwanted noise. Medical tests proved analgesic effects!

No. 71,997EK \$89.95 Ppd.

QUALITY DETECTOR UNDER \$40



Our fully transistorized BFO unit can locate a quarter at 18". Powerful 6 trans.-oscillator-amplifier circuit. Comp. to others priced 50% more! Aluminum, just 2 lb.

No. 80,222 EK \$39.95 Ppd.



Patent Pending

**THERE IS NO OTHER TELESCOPE LIKE IT!
THE NEW EDMUND 4 1/4", f/4
NEWTONIAN WIDE FIELD
REFLECTOR TELESCOPE**

Clear, bright, spectacular wide angle views of stars, moon, comets... easy to use... portable!

IN SECONDS YOU'RE SCANNING THE ASTOUNDING UNIVERSE, able to see and study the breath-taking Cosmos as perhaps you never have before... awesome vastness, unbelievable orderliness, stark silent beauty. All the fascinating heavenly mysteries are yours to enter and explore. This new reflector telescope makes it easy for everyone to span a thousand light-years to space-age enjoyment of the heavens and outdoors. No complicated set up! Just insert the eyepiece, focus, and its big 3 1/2" field of view gives you more stars in a single view than any other type of telescope. Bright, crisp, finely resolved images to capture your interest and imagination. It's probably the easiest to use telescope ever... over your shoulder, in your lap, on a tripod. Or just rotate the spherical base on its own mount for use on a table, car hood. Take it anywhere (only 17" x 10 lb.). Top quality optical system: 4 1/4" f/4 parabolic primary mirror (1/4 wave, 17" F.L.); prealigned 1/4 wave diagonal on a coated optical window seals optics from moisture and dust; 28mm Kellner eyepiece (gives 15X, higher without other eyepiece or Barlow) Fast focusing (25 to infinity) Bright Scharfianian red (doesn't impair night vision); adj. carrying strap. A first scope must... an ideal second scope!

There is no other telescope like it. NO. 2001EK \$149.95 Ppd.

**FOR GREATER RELAXATION, CONCENTRATION,
listen to your Alpha and Theta brainwaves!**



No. 1689EK

Do-It-Yourself Kit #61069EK \$37.50 ppd.
Low Cost 'Starter' Unit #71809EK \$59.95 ppd.

Do it with an amazing biofeedback monitor. This ultra-sensitive sensor detects brain signals, lets you monitor (hear and see!) your Alpha and Theta brainwaves. Great aid to relaxation, concentration. This portable (8 x 3 x 4") lightweight (24 oz.) metal unit has a unique electrode headband to slip on or off in seconds without messy creams or solutions. Hooked to amplifier, it filters brainwaves, and signals an audible beep for each Alpha or Theta wave passed. You get both audio and visual (L.E.D.) feedback with this reliable, completely safe unit. It operates on two 9v transistor batteries, offers features comparable to many costlier models. A comprehensive instruction booklet is included.

No. 1689EK JUST \$99.95 Ppd.



**LOW COST, HIGH QUALITY
INFRA-RED EYE**

Binocular Style, \$329.95; Standard, Only \$299.95

A must for Infra-red crime detection surveillance, security system alignment, I.R. detection, laser checking, night-time wildlife study—any work requiring I.R. detection and conversion to the visible spectrum. Self-contained scope (11 x 14 1/4 x 3") includes I.R. light source (for up to 90' sight at night!), 6032 I.R. converter tube, f/3.5 telephoto lens, adjustable triplet eyepiece, an adapter for use with your car's cigarette lighter—more! Bright 1.6X image (Binocular style gives super-bright 2.5X). Focuses from 10' to infinity, runs on 6 or 12v DC.

Not for sale to Cal. residents other than authorized by U.S. Armed Forces, law enforcement agencies or solely for scientific research and education purposes.

STANDARD STYLE, STOCK NO. 1683EK ONLY \$299.95 Ppd.
BINOCULAR STYLE, STOCK NO. 1685EK JUST \$329.95 Ppd.

COMPLETE AND MAIL COUPON NOW

EDMUND SCIENTIFIC CO. 300 Edscorp Bldg., Barrington, N. J. 08007

Send me the following:

Stock No. _____ Quantity _____ Price Ea. _____

SEND FREE 164 PG CATALOG "EK"

Charge my _____ American Exp

BankAmericard Master Chg

Interbank No. _____

Card No. _____

Expiration Date _____

30-DAY MONEY-BACK GUARANTEE. You must be satisfied or return any purchase in 30 days for full refund.

Add handling charge \$ _____ 1.00

Enclosed is _____ check,

M.O. in amount of \$ _____

Signature _____

Address _____

City, State, Zip _____

**GIANT FREE
164 PG. CATALOG**



4500 UNUSUAL BARGAINS
FOR HOBBYISTS,
SCHOOLS, INDUSTRY

EDMUND SCIENTIFIC CO.

300 Edscorp Bldg., Barrington, N.J. 08007 • (609) 547-3488
America's Greatest Science • Optics • Hobby Center

cb mobile cb base

COVER 40 CHANNELS NOW!

CX-1000 3.75 dB GAIN CITIZEN'S BAND BASE ANTENNA

Designed to withstand nature's abuse... CX-1000 is an 18' high "package of dynamite performance" for AM or sideband. This omnidirectional base antenna has a precision tuned coaxial stub system for perfect match and low ohmic losses. Made of heavy wall, bright finish seamless aluminum tubing and stainless steel fasteners.

TRUNK BUSTER FIBERGLASS MOBILE

Our 48" Top loaded or tunable tip antenna with solid one piece no hole trunk lip mount. The mount has foam protective pad and spring loaded cable contact. Complete high performance systems preassembled with 18' cable and connector.

CM-403 Trunk mt. with 48" whip
CM-404 Trunk mt. with 48" tunable whip

Cushcraft products are stocked by
dealers throughout the world.



Cushcraft
CORPORATION

P.O. BOX 4680, MANCHESTER, N.H. 03108

CIRCLE 22 ON READER SERVICE COUPON

newscan

Electronics in the News!

SUPERVACUUM CHAMBER

IBM scientists have designed and built a chamber large enough to hold several experiments in a vacuum so nearly perfect that it is beyond the capability of present-day instruments to measure. By extrapolation from what



Dr. William A. Thompson (right) and Mr. Stephen F. Hanrahan of IBM have designed and built a super-vacuum chamber to study possible materials for future computer components. Dr. Thompson is holding a replica of an evaporator being used to deposit extremely thin film layers inside the supervacuum chamber.

can be measured, however, the one-cubic foot (.03 cubic meters) chamber appears to approach the "emptiness" of interstellar space. This supervacuum is achieved by cooling the chamber to only a few degrees above absolute zero. "This method is not unique, in that it has been used for many years in small chambers," said Dr. William A. Thompson, one of the chamber's developers. "Our main contribution is that we have tried to make a general-purpose vacuum system of a size such that a variety of instruments can be incorporated within the chamber to study surfaces over extended time periods."

Dr. Thompson sees the vacuum chamber as an important means of forming and studying super-thin layers of material—layers perhaps only one atomic layer thick. Such layers may be useful in the development of future computer components, and have become increasingly important as the size of electronic circuitry for computers has become smaller. It is important to preserve thin layers over extended periods to observe any changes that may

for the Experimenter!

INTERNATIONAL CRYSTALS and KITS



OF-1 OSCILLATOR

\$325
ea.

The OF-1 oscillator is a resistor/capacitor circuit providing oscillation over a range of frequencies by inserting the desired crystal. 2 to 22 MHz, OF-1 LO, Cat. No. 035108. 18 to 60 MHz, OF-1 HI, Cat. No. 035109. Specify when ordering.

.02% Calibration Tolerance

EXPERIMENTER CRYSTALS (HC 6/U Holder)

\$425
ea.

Cat. No.	Specifications
031300	3 to 20 MHz — For use in OF-1L OSC Specify when ordering.
031310	20 to 60 MHz — For use in OF-1H OSC Specify when ordering.



Enclose payment with order (no C.O.D.). Shipping and postage (inside U.S., Canada and Mexico only) will be prepaid by International. Prices quoted for U.S., Canada and Mexico orders only. Orders for shipment to other countries will be quoted on request. Price subject to change. Address orders to:

M/S Dept., PO Box 32497
Oklahoma City, Oklahoma 73132

WRITE FOR BROCHURE



International Crystal Mfg. Co., Inc.
10 North Lee Oklahoma City, Oklahoma 73102

CIRCLE 9 ON READER SERVICE COUPON

occur in a layer's electronic properties. "In a normal vacuum system," Dr. Thompson said, "this surface layer doesn't stay the same long enough for us to get a good analysis of it. We needed something in which we could do experiments over a period of time like two or three days, then preserve the surface and analyze it again a month later."

Although the chamber runs at very low temperatures, it contains within it an evaporator hot enough to melt and evaporate various materials, such as lead, onto test surfaces. These temperature extremes make for unique testing conditions.

CALCULATOR HELPS WITH FLIGHT PLAN

A programmable calculator that fits in the hand is the latest flight planning and navigation aid from Texas Instruments for general and business aviation pilots. TI has produced a library of 21 aviation programs for use with SR-52 card programmable calculators. The pre-recorded programs offer pilots answers in seconds to flight planning and navigation questions, including course, position, time, speed, temperature, altitude, winds, fuel consumption, and weight and balance.

With these aviation programs, the SR-52 can be a tremendous computational resource for the pilot who takes pride in his ability to navigate with precision. The electronic calculator joins the mechanical flight computer and



A 21-program library for SR-52 card programmable calculators has been introduced by Texas Instruments to help general and business pilots with flight planning and navigation.

plotter as a basic navigation aid. To develop a flight plan for a trip with several legs, for example, a pilot inserts a pre-recorded program on a small magnetic card into the calculator memory. He then keys in the flight planning in-

Put Professional Knowledge and a COLLEGE DEGREE in your Electronics Career through HOME STUDY

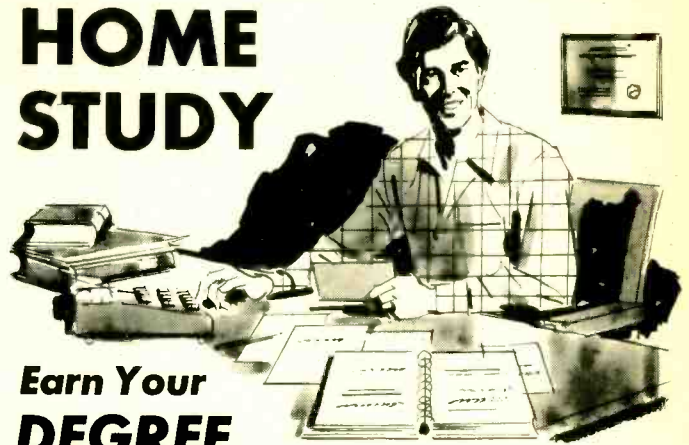

Earn Your DEGREE

by correspondence, while continuing your present job. No commuting to class. Study at your own pace. Learn from complete and explicit lesson materials, with additional assistance from our home study instructors. Advance as fast as you wish, but take all the time you need to master each topic. Profit from, and enjoy, the advantages of independent study.

The Grantham correspondence degree program in electronics is comprehensive. It begins with basics, written in very simple language, and continues through the B.S.E.E. degree level. Throughout the entire program, heavy emphasis is placed on clear explanations written in great detail, progressing from the simple to the complex, in easy steps.

Our free bulletin gives complete details on the curriculum, the degrees awarded, the requirements for each degree, and how to enroll.

GRANTHAM SCHOOL OF ENGINEERING

2000 Stoner Ave., Los Angeles CA 90025

● Telephone (213) 477-1901 ●

Worldwide Career Training thru Home Study

Mail the coupon below for free bulletin.

Grantham School of Engineering EE-3-77
2000 Stoner Ave., Los Angeles, CA 90025

I have been in electronics for _____ years. Please mail me your free bulletin which gives details concerning your electronics degree programs.

Name _____ Age _____

Address _____

City _____ State _____ Zip _____

CIRCLE 8 ON READER SERVICE COUPON

formation for his trip.

For the first leg, the meteorological and aircraft performance information he enters may be as follows: 12° E magnetic compass variation; 200° wind direction; 28 knots wind velocity; 115 knots true air speed; 14 gallons/hour fuel consumption; 245° true course; and 80 nautical miles distance. Takeoff will be at 12:50 p.m.

After performing calculations based on that information and the data in the program, the calculator in a few seconds will show a true heading of

235.0863 in its display or print it out on paper if an optional PC-100 printer is attached. Further program runs will show: 223.0863 magnetic heading; 93.4838 ground speed; 0.5121 estimated time enroute; 11.9807 fuel consumption; 13.4121 estimated time of arrival.

The sequence of computations is repeated for each flight leg. After the second leg is calculated, the program also provides the pilot with running totals of certain information, like total time in flight and overall fuel consumption. Several flight plan programs are

included in the library, including one for use when there are winds aloft, one with a verification routine and another for long range flights. Other programs are included for rhumb line navigation, dead reckoning and great circle flying.

The key element in this system is that the pilot can store information ahead of time on one of his magnetic cards. During the flight, he only needs to key in a reference number for a waypoint rather than its detailed coordinates. This prevents entry errors during the flight. Some of the other programs in the library include those for predicting freezing and lowest usable flight levels, atmospheric conditions, mach number, true air speed, true air temperatures, density and line of sight altitude, and DME speed correction. And the price is right. The SR-52 calculator has a suggested retail price of \$299.95. The aviation program package retail price is \$44.95 and the PC100 printer unit is \$295.00. The 14 V DC adapter/charger is \$12.95. If you'd like more information, write to Texas Instrument Incorporated, P.O. Box 5012, M/S 308EE, Dallas, TX 75222 (Attn: SR-52AV). Good flying!

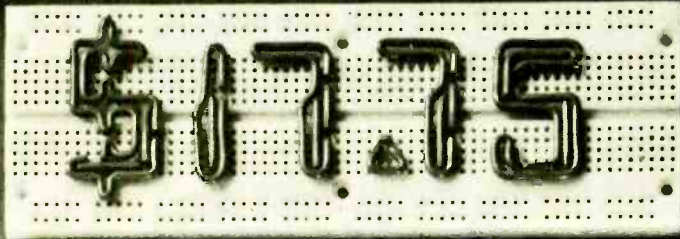

Here's your chance to get started in solderless breadboarding and save in the process. Buy our SK-10 socket above for \$17.75 and we'll also give you our SK-20 socket as a bonus. Not only that, but if the SK-10 doesn't live up to your expectations, return it for a full refund and keep the SK-20 for your trouble.

E&L sockets are the finest made in the industry and have a life of over 10,000 insertions. Integrated circuits and discrete components insert directly without adapters. And all interconnections are made with 20 to 26 gage solid conductor wire. Get started now. E&L solderless breadboarding sockets are available through local participating computer stores. These stores also carry E&L's full line of breadboarding and micro-computer equipment as well as our line of BUGBOOKS®. Stop in today and start going solderless.

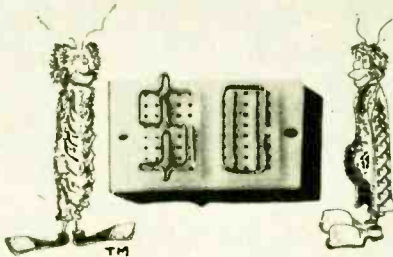

crete components insert directly without adapters. And all interconnections are made with 20 to 26 gage solid conductor wire. Get started now. E&L solderless breadboarding sockets are available through local participating computer stores. These stores also carry E&L's full line of breadboarding and micro-computer equipment as well as our line of BUGBOOKS®. Stop in today and start going solderless.

crete components insert directly without adapters. And all interconnections are made with 20 to 26 gage solid conductor wire. Get started now. E&L solderless breadboarding sockets are available through local participating computer stores. These stores also carry E&L's full line of breadboarding and micro-computer equipment as well as our line of BUGBOOKS®. Stop in today and start going solderless.

stores also carry E&L's full line of breadboarding and micro-computer equipment as well as our line of BUGBOOKS®. Stop in today and start going solderless.



E&L INSTRUMENTS, INC.

61 First Street, Derby, Conn. 06418
(203) 735-8774 Telex No. 96 3536

Dealer inquiries invited.



CIRCLE 21 ON READER SERVICE COUPON

WATER TOWER

Technology developed by industry for offshore oil drilling was used to significantly reduce the costs of our Air Force fighter pilot training program. Known as Air Combat Maneuvering Instrumentation, the system includes five ocean towers where electronic equipment is mounted to track planes as they fly over the Gulf of Mexico near Tyndall Air Force Base in Florida.

The 200-foot high towers will be built by Bethlehem Steel for Cubic Corporation, which is a prime contractor for the system. Use of the oil drilling towers for an electronic application was

(Continued on page 24)

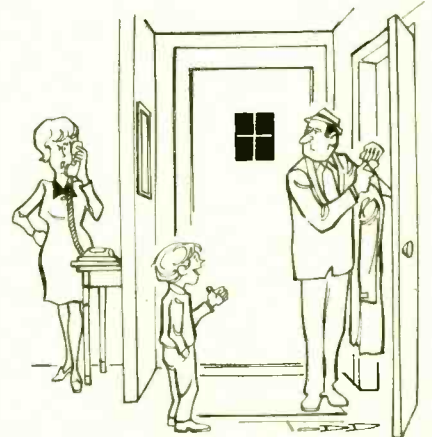

"Hi, Pop . . . Mom's still talking to you down at the office."

DISAPPEARING ACT

MOTORIZED CB ANTENNA by FAMOUS ARCHER[®]

Flip its switch, and the Archer electric antenna extends to its full 33" length *and turns your CB radio on*. Flip again, and it retracts into the fender *and turns your radio off*. Nobody will know you've got ears — it's Archer's automatic answer to CB rip-offs. A top performer that ends the bother of removing your antenna. Adjustable SWR. Center loading coil, excellent for mobile use.

Quality materials and workmanship. Installation hardware and instructions included. Our "disappearing act" is another reason why a million CB'ers will choose Radio Shack's Archer brand this year. Get 21-970 and you'll have something to hide and nothing to lose. Only 59.95*.

**now you see it.
now you don't.**

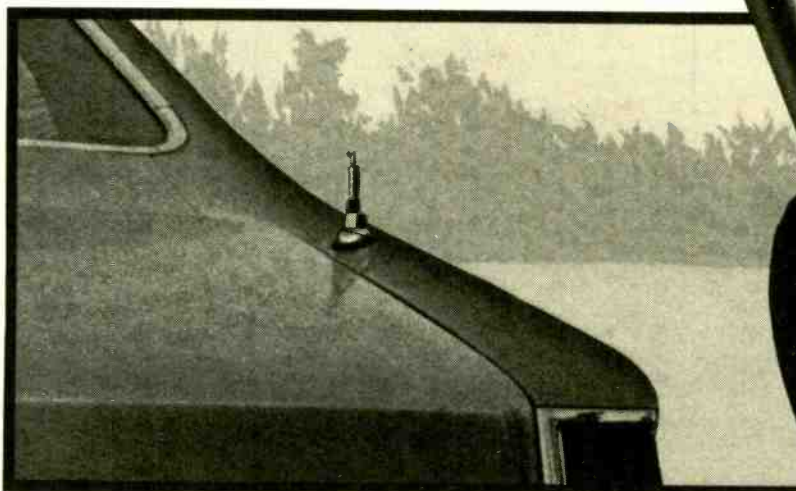
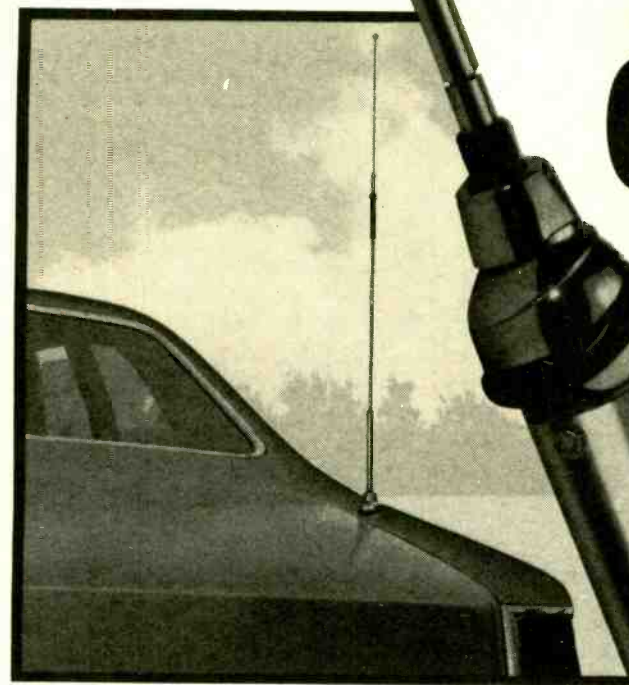

Just Say "Charge It"
at most stores

*Price may vary at individual stores and dealers.
prices and products may vary in Canada.

LEADING THE WAY IN QUALITY CB SINCE 1960

Radio Shack[®]

A TANDY COMPANY • FORT WORTH, TEXAS 76107
5000 LOCATIONS IN NINE COUNTRIES

Nothing is Faster and Easier than ACE for circuit breadboarding.

Used to be you'd get a circuit idea, lay out a pc board, print it, solder everything together, troubleshoot, change your layout, try a new board, and spend absolutely too much time breadboarding. Now A P ACE All Circuit Evaluators let you breadboard in a fraction of the time. Make your changes immediately. Keep full leads on your components. Avoid the heat damage possible with repeated soldering and desoldering. And have a pattern for your board—if you need a board—sitting in front of you. In about as long as it takes to sketch a schematic. Get cooking with ACE. ACE. The All Circuit Evaluator from A P Products.

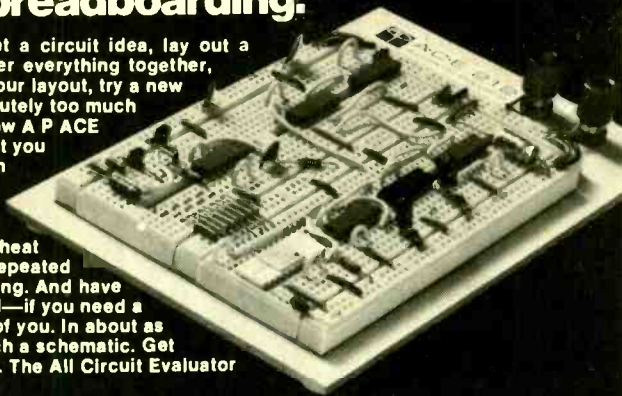

Part No.	ACE Model No.	Tie Points	DIP Capacity	No. Buses.	No. Posts	Board Size (inches)	Price Each
923333	200-K (kit)	728	8 (16's)	2	2	4-9/16x5-9/16	\$18.95
923332	208 (assem.)	872	8 (16's)	8	2	4-9/16x5-9/16	28.95
923334	201-K (kit)	1032	12 (14's)	2	2	4-9/16x7	24.95
923331	212 (assem.)	1224	12 (14's)	8	2	4-9/16x7	34.95
923326	218 (assem.)	1760	18 (14's)	10	2	6-1/2x7-1/8	46.95
923325	227 (assem.)	2712	27 (14's)	28	4	8x9-1/4	59.95
923324	236 (assem.)	3648	36 (14's)	36	4	10-1/4x9-1/4	79.95

Order from your A P distributor today.
Our distributor list is growing daily.
For the name of the distributor nearest you
call Toll-Free 800-321-9668.



Send for our complete A P catalog,
The Faster and Easier Book.

A P PRODUCTS INCORPORATED

Box 110-EE Painesville, OH 44077 (216) 354-2101 TWX: 810-425-2250

CIRCLE 5 ON READER SERVICE COUPON

This is easy- anyone can solder- WITH KESTER SOLDER

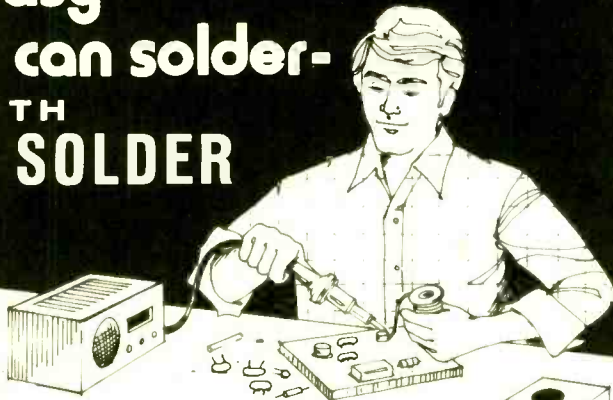

Handymen! Hobbyists! DO-IT-YOURSELFERS!

Let Kester Solder aid you in your home repairs or hobbies. For that household item that needs repairing — a radio, TV, model train, jewelry, appliances, minor electrical repairs, plumbing, etc. — Save money — repair it yourself. Soldering with Kester is a simple, inexpensive way to permanently join two metals.

When you Solder go "First Class" — use Kester Solder.

For valuable soldering information send self-addressed stamped envelope to Kester for a FREE Copy of "Soldering Simplified".



KESTER SOLDER

Litton 4201 WRIGHTWOOD AVENUE/CHICAGO, ILLINOIS 60639

CIRCLE 11 ON READER SERVICE COUPON

NEWSCAN

a joint development of the two companies. The range itself is being built by the U.S. Navy for the U.S. Air Force under a Joint Service Program.

The key to the savings was to design a prefabricated tower with a large mat-type foundation. After it is built, the tower is floated to its location in deep water and then sunk. The tower is stabilized on the ocean floor by weight and friction.

The Air Force quickly saw the advantages of these "soil supported" towers over conventional pile-type, which would have cost more than two or three times the amount to build and erect.

In contrast to the conventional pile-type designs, which were used for radar

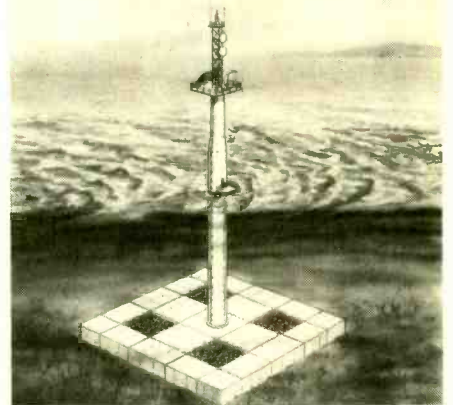

The above 200-foot tower is being built for the U.S. Air Force using technology borrowed from the oil industry. It is part of an offshore pilot training range at Tyndall Air Force Base, Florida. The towers are floated into position and then submerged. Weight and friction hold the tower in place.

stations in the Atlantic Ocean some years ago, the soil-supported design has no need for extensive offshore construction equipment during installation, or removal of the towers years later. For
(Continued on page 26)



"Calling Car 54, Car 54...
Clean your windows... someone
is stealing your hubcaps!"



wire wrapping center...

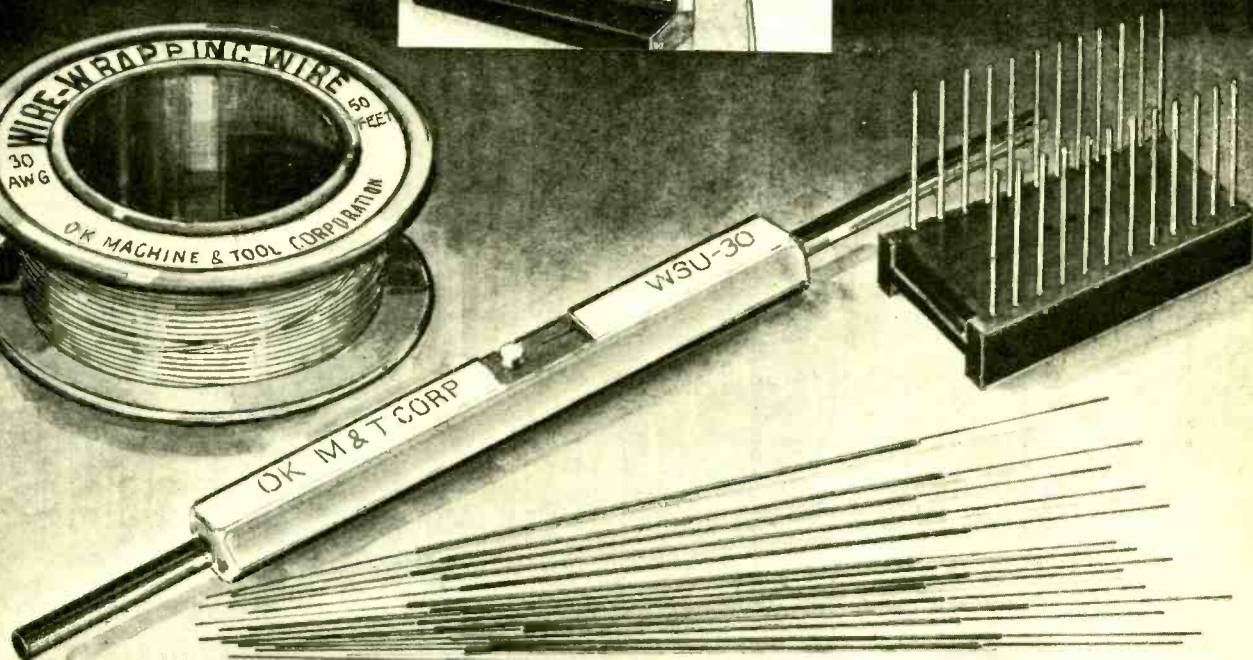
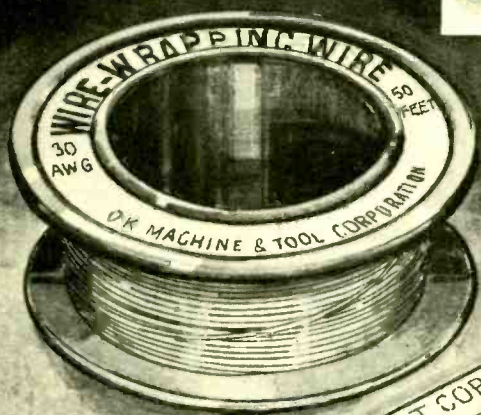

for quality electronic parts and tools.

OK MACHINE & TOOL CORPORATION

3455 Conner St., Bronx, N.Y. 10475 / (212) 994-6600 / Telex 125091

CIRCLE 20 ON READER SERVICE COUPON

VALUE & PERFORMANCE

EICO's 30 Years Experience
Assures More Electronics Value
For Your Money!

TEST INSTRUMENTS



EICO 388 COLOR BAR GENERATOR

Pocket-size, battery operated with LED Indicator. MOS LSI IC provides 9 digitally controlled, stable patterns. Crystal controlled chroma and timing oscillators. Simply connects to TV's VHF antenna terminals.

Wired \$89.95

EICO 390 FUNCTION/SWEEP GENERATOR

Outstanding features include: Sine, Square, Triangle Waveforms; .2 Hz to 200 KHz frequency range; Linear and Log Sweep; Calibrated attenuator, VCO for External Frequency Control; BNC Front Panel Output.

Wired \$169.95

CB ACCESSORIES



EICO 700 CB FREQUENCY COUNTER

Compact in-line mobile frequency counter for the serious CB'er/Hobbyist. Operates automatically on transmit. 10 Hz to 30 MHz. \$99.95

EICO LR-3 "LONG RANGER" INLINE PREAMP

Bring in those distant/weak signals. Boosts receiver sensitivity up to 20 db. Automatic transmit/receive switching. \$29.95

EICO CM-2 "CHANNEL MONITOR" AUTO-SWITCH

Automatically silences car radio when CB call is received/transmitted. \$29.95

EICOCRAFT® IC KITS

EC-5000 SCA ADAPTOR KIT ONLY \$12.95



Convert your FM radio or receiver to pick up the official FCC-licensed background music service (SCA). IC decoder/adaptor permits hearing uninterrupted, commercial-free music broadcast by many FM stations (For personal, non-commercial use only).

IC PROJECT KITS NOW AVAILABLE

EC-5100 ESP Tester \$10.95
EC-5200 "Decision Maker" \$9.95
EC-5400 Stereo Power Amplifier \$10.95
EC-5500 Stereo Pre-Amp \$9.95
EC-5600 Electronic Lock \$11.95
EC-5700 Universal Power Amp \$8.95

HOBBY/AUTOMOTIVE



BW-300 ALPHA BRAINWAVE MONITOR

Lowest cost, battery operated, professional Biofeedback System. IC Circuit design features an active filter and 5-microvolt sensitivity. Complete with stethoscopic earphone, electrode headband and instructions.

Kit \$34.95 Wired \$59.95

885 "TUNEMASTER" ENGINE ANALYZER

Automatic all-in-one test bench for all 6 or 12 volt ignitions—conventional or transistorized. Giant 6" meter with 6 color coded scales. Complete with tune-up and trouble-shooting manual.

Wired \$59.95

BURGLAR/FIRE ALARMS



SS-500 BURGLAR/FIRE ALARM SYSTEM

Professional Security System designed for easy do-it-yourself installation. Features EICO FC-100 Control Center with AC/DC automatic transfer to battery operation. Complete system includes Installation Handbook. Add additional sensors, bells, to suit your own needs. \$159.95

SD-75 BATTERY OPERATED FIRE/SMOKE ALARM

Ionization-type detector gives earliest possible fire warning. Mounts directly to ceiling with 2 screws. "Beeps" when battery needs replacement. U.L. listed. \$39.95

FREE EICO CATALOG

The more you know about electronics, the more you'll appreciate EICO. Every EICO product is designed to provide you with the most pleasure and quality performance for your money. The fact that more than 3 million EICO products are in use attests to their quality and performance.

"BUILD-IT-YOURSELF" and save up to 50% with our famous electronic kits.

For the latest EICO Catalog and name of nearest EICO Distributor, check reader service card or send 50¢ for fast first class mail service.

EICO-283 MaMa Street, Brooklyn, N.Y. 11207

Leadership in creative electronics since 1945.



NEWSCAN

removal, the towers are simply re-floated and towed away.

Future ranges will also be built offshore using the same type of tower and resulting in even greater savings. These new training ranges are solar powered.

The system allows Navy and Air Force pilots to train in air-to-air combat while dueling in mock dogfights with other pilots who are also flying high performance jet planes. The ground instructors monitor the pilots' every move while in action and teach advanced tactics. The entire mission is recorded and may be replayed to the pilots or instructors at later times for study.

SELF SUFFICIENCY

A higher level of self-sufficiency has been opened up for paraplegics, quadriplegics and other persons with impaired limbs through the introduction of a new dictation equipment system. The system, designated the Sony VR-35 (the "VR" stands for Vocational Rehabilitation), utilizes a voice-activated recording mechanism and is operated



By using a magnetic mouth wand, a quadriplegic can gain a high level of self-sufficiency with a new dictation system from Sony. Here, Jack Achtenberg, a quadriplegic, demonstrates his ability to operate the Sony VR-35 to Masaru Ibuka, honorary chairman of Sony Corporation.

by a mouth wand with a magnet at its tip, so even if a person has no functioning limbs, he can control virtually all dictation procedures.

Paraplegics and quadriplegics are already accustomed to using similar mouth wands, with rubber tips instead of a magnet, for turning pages of books. Now, with no more training than that required by a secretary or executive who has received a new dictating machine, the paraplegic has at his disposal the

(Continued on page 90)

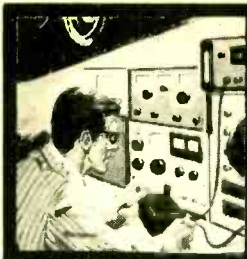

**Ask Hank,
He Knows!**

Got a question or a problem with a project—ask Hank! Please remember that Hank's column is limited to answering specific electronic project questions that you send to him. Personal replies cannot be made. Sorry, he isn't offering a circuit design service. Write to:

**Hank Scott, Workshop Editor
ELEMENTARY ELECTRONICS
229 Park Avenue South
New York, NY 10003**

the material for your viewing or hearing and include your immediate family, in your home. However, do not attempt to sell the material or use it to entertain others. For example, a restaurant owner recorded some musical programs and played it back for his patrons to enjoy while they ate. You guessed it, he was sued and lost in court. Just keep it to yourself and no one will (or can) complain.

AC Tester Problems

Hank, I built your AC outlet tester from the article "Your AC Outlet Will Get You If You Don't Watch Out," in the September/October 1976 issue, and had two technicians check it but the neon lamps don't light up right. Sometimes they're dim, sometimes give wrong or no indication. What have I done wrong? Help!

—J. G., Chapel Hill, NC

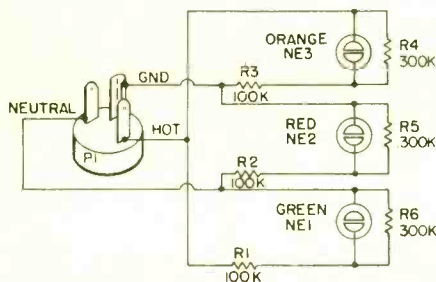

Relax, you haven't done anything wrong. It seems some of those little neon lamps

have wider variations in their firing voltages than the ones in the author's prototype which we tested in our lab. To be sure the neon fires correctly add three 300,000-ohm resistors (any wattage) to the circuit—one across each neon bulb. That'll straighten it out. Good testing!

Wants More Juice

Is it possible to increase the charging capacity (power) of one six-twelve volts battery charger?

—P. C., Trujillo Alto, PR

I'd say no! The transformer is designed for a certain maximum current. To replace it would require a large expense. Also, the meter, rectifiers, and possibly the internal wiring must be replaced. It's easier to buy a new unit.

The Law Has Ears

Is it illegal to tape program material off TV and radio programs?

—D. D., Little Chute, WI

If you record for your own personal use, the answer is no! You may play back

MHz to kHz

Could you tell me how to convert kHz frequency numbers into MHz numbers, because all the radios I come across are in MHz instead of kHz.

—J. J., Gloversville, NY

It's easy, really! Just divide kHz by 1000 to get MHz, or multiply MHz by 1000 to get kHz. For example: 1 MHz = 1000 kHz; 10 MHz = 10,000 kHz; 30 MHz = 30,000 kHz; 21.75 MHz = 21,750 kHz. Just examine the examples given and you'll have no trouble doing it yourself.

Slinky Boinger

I noticed that in your May-June, 1976 issue of ELEMENTARY ELECTRONICS, you published an article on the use of a "Slinky" toy as an antenna.

You may not have known that we manufacture the Slinky Dipole Antenna, for use as either a transmitting or receiving antenna. We use special oversize coils made especially for us, but they resemble the toy coils. Our coils, however, have over 335
(Continued on page 29)

**IN WIRE-WRAPPING  HAS THE LINE...
HOBBY-WRAP-30 FOR AWG 30 WIRE ON (.025 SQUARE POST)**

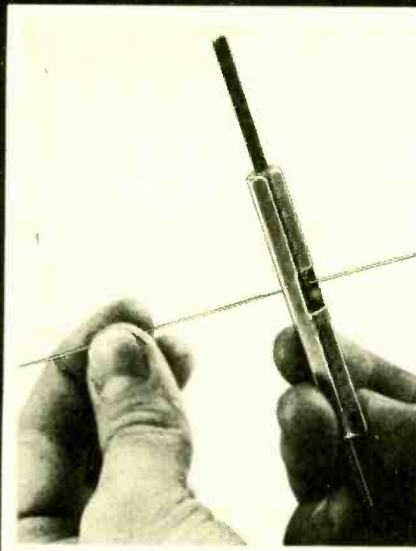

STRIP



WRAP



UNWRAP

OK MACHINE & TOOL CORPORATION

3455 CONNER STREET, BRONX, NEW YORK, N.Y. 10475 U.S.A. • PHONE (212) 994-6600

TELEX: 125091 TELEX: 232395

Learn about
the energy of
the future:

SOLAR POWER!

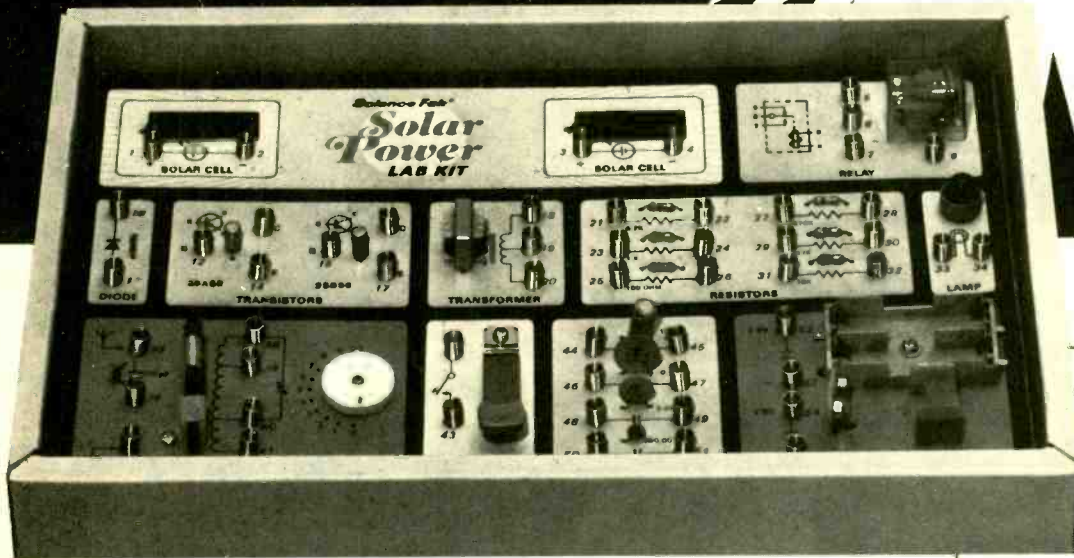
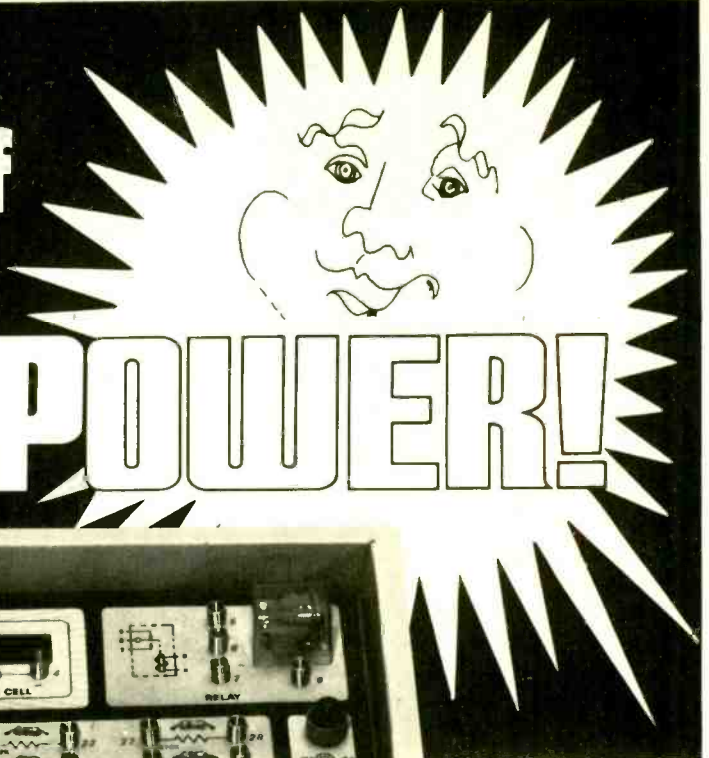

MANUAL GIVES
HISTORY OF
SOLAR POWER
AND ITS USES,
PLUS EASY
INSTRUCTIONS
FOR 25 PROJECTS

Science Fair® Electronic Lab Kit



Includes 2
SOLAR POWER
Panels

12⁹⁵*

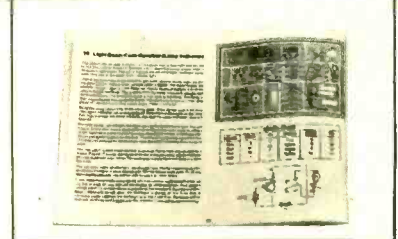

Another Exciting Kit —
Build a Shortwave Radio



1.5 to 30 MHz
Shortwave Bands
Plus Standard AM

29⁹⁵*
28-205

Tune in the world! Five controls, 3" speaker, AC adapter jack. Includes earphone and listening guide. Requires 4 "C" cells for battery operation.

Harness the power of light! Learn the "hows" and "whys" of solar energy as you build sun-powered radios, transmitters, relays, light-beam communicator, even a sound synthesizer — 25 fascinating projects in all. Includes solar cells, transistors, transformer, code key — 22 separate components — all in a 15x10x2" work case. Pre-mounted parts and solderless "breadboard" chassis for safe, simple, neat assembly. Easy-to-follow instruction manual explains each project in non-technical language and includes simple pictorial hookup diagrams to help teach electronic theory as you work with each circuit. The educational kit that's a step into the future for students, beginners, hobbyists of all ages. Ask for 28-246. (Some circuits require batteries, not included.)

SOLD ONLY WHERE YOU SEE THIS SIGN:

Radio Shack®

A TANDY CORPORATION COMPANY
OVER 5000 LOCATIONS • 50 STATES • 9 COUNTRIES

*Retail prices may vary at individual stores and dealers.
Prices and products may vary in Canada.

ASK HANK, HE KNOWS

(Continued from page 27)

feet of radiating (or receiving) conductor. Incidentally, our unit forms a helical resonator which is impedance-matched to a 50 ohm coaxial transmission line. This results in much greater efficiency and a greater received signal. The antenna may be tuned to any frequency from about 3.4 MHz to over 60 MHz.

—Ellen J. Arnow, Chief Engineer
Telethon Data Corp.
P.O. Box 84
Kings Park, NY 11754

The world is getting smaller! Our antenna project, called *Boinger*, used a toy Slinky coil to form a retractable, vertical antenna. The *Slinky Dipole* antenna is another cat—it's horizontally polarized for the 80-, 40- and 20-meter shortwave bands. Why not get all the facts by writing to E. J. Arnow at the address given above.

From a Poet

In late 1978

when CB has met its fate,
We will remember the spree
that started in '73
And our radios we will
give to the state.

But in late 1985

when microPs buz like bees in a hive
We will remember from *e/e*
the Computer Readout compli
And those articles will
still be alive.

So get some microPs on the covers
let's satisfy our microP lovers
In the Masthead put "Norm Myers"
play up to reader desires
And *e/e* will be
the magazine to discover.

—B. M., Red Bank, NJ

You really put it on the data bar. 10-4.

CB Straight Up

I claim that a CB vertical base antenna can be close to a TV antenna without causing interference with the TV reception. After all, the TV antenna is horizontally polarized and the CB is vertically polarized. What do you say, Hank?

—R. D., Waco, TX

Well, first, the TV mast, usually made of metal, will cause some signal loss on CB. Also, it will wreck your omnidirectional antenna pattern. The TV lead-in wire will pick up some signal since it is vertical. If

the TV set is not aligned properly, or the front end is easily overloaded, the CB signal can cause problems. But it's the CB harmonics that'll cause the most problems. Distance between the CB and TV antenna will decrease possible interference.

Ra-ta-ta-tatski

What is this machine gun signal I hear on the amateur frequencies? I monitor the ham bands and would like to know.

—K. M., Skokie, IL

It appears to be a Soviet over-the-horizon radar in the Baltic area beamed at Canada and the U.S. The FCC has complained to the International Telecommunication Union in Geneva, Switzerland.

DOT vs. FCC

I live in Canada and want to get my CB license. While I am waiting for it, am I allowed to use the CB operators temporary



"Well, mercy sakes, back door,
looks like we have a convoy!"

NEW

FROM



THE

HOBBY~WRAP

COMPLETE WITH BIT AND SLEEVE

ONLY \$34⁹⁵

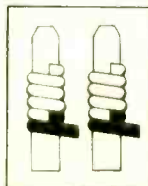

Now you, the hobbyist, can do wire-wrapping professionally with our easy to use Hobby-Wrap gun.

OK MACHINE & TOOL CORPORATION

3455 Conner St., Bronx, N.Y. 10475 / (212) 994-6600 / Telex 125091

CIRCLE 19 ON READER SERVICE COUPON

.025 sq. post.
AWG 30 wire
(batteries not included)

Model
BW-630

FREE burglar — fire alarm catalog



over 900
systems,
detectors,
controls,
sounders,
tools, locks,
supplies

TO PROTECT HOMES, BUSINESSES, INDUSTRY

Huge selection of hard-to-find security equipment from stock. 64 fact-filled pages loaded with 100's of highest quality professional alarm products, technical notes, diagrams.

ONE-STOP SUPERMARKET SELECTION INCLUDES:

ultrasonics, radar, infrared, undercarpet mats, magnetic contacts, smoke & heat detectors; Controls; Alarms: bells, sirens, phone dialers, lights, guard panels. Large selection of tools, relays, wire, holdup alarms, books. Fills need for industry, alarm cos., businesses, homes, institutions. Order your copy today. (Outside U.S., send \$1.00.)



mountain west alarm
4215 n. 16th st.
phoenix, az. 85016
(602) 263-8831

CIRCLE 28 ON READER SERVICE COUPON

QUIET, NEW 40-CHANNEL CB FROM JOHNSON.



MESSENGER 4175

- Exclusive Dual Crystal Filtering cuts adjacent channel interference
- Exclusive Tapered Automatic Noise Limiter — TANL
- Switchable noise blanker
- LED bar-graph meter
- PA capability
- Crisp, clean Johnson sound



JOHNSON

E. F. JOHNSON COMPANY, WASECA, MINN. 56093
In Canada: A. C. Simmonds & Sons, Ltd.

CIRCLE 33 ON READER SERVICE COUPON

ASK HANK, HE KNOWS

permit that appeared in the July-August/76 issue of ELEMENTARY ELECTRONICS?

—L. R., Clementsport, Nova Scotia

Heck, no!

Shopping Guide

Hank, where can I get a 40468 and 2N3394 transistor?

—J. A., Peoria, IL

Here are two parts supply houses you should contact and obtain their parts catalogs: International Unlimited, P.O. Box 3036, Monterey, CA 93940, and New Tone Electronics, P.O. Box 1738, Bloomfield, NJ 07003.

Just 15 More

I have a portable CB rig that runs on D-cells. Can I add one extra D-cell to pep up the signal output?

—D. M., Birmingham, AL

No! First of all, this addition of a D-cell would be tantamount to modifying your CB transmitter, which would invalidate your rig's FCC type acceptance. Further, the extra voltage may upset the circuits resulting in damage, off-frequency operation, or poor reception. Need more power—go ham!

Lend a Hand, Boys

Several of our readers need help that you may be able to give. If you don't want to part with the original copy of a diagram, or manual, write to the person in need and tell him the cost for Xeroxing.

Δ F. M. Engle of 1001 Victory Dr., Minden, LA 71055 needs a manual, schematic diagram and dial cord diagram for the Hallcrafters SX-28.

Δ "I'd like to restore a Globe Sidebander D.S.B. 100 that's missing all the tubes and transformer." If you can help, write to Donald Walker, D & M CB Sales, P.O. Box 394, Marrero, LA 70073.

Δ If you have the schematic diagram for the Atwater-Kent Model 20 receiver, send a copy to James P. Dillman, 721 Nichols St., Clearfield, PA 16830.

Δ Gary Nelson would like a schematic diagram and other info on the Ameco AC-1 transmitter. Write to Gary at P.O. Box 3812, Portland, ME 04104.

Δ Anyone have the diagram and parts list for the RCA Home-Study Course Volt-Ohmmeter? If yes, write to M. J. Lavandor, 4057 Alper, Lincoln Park, MI 48146.

Δ Ed P. Harmon of 12700 2nd St., Apt. 46, Yucaipa, CA 92399 needs the circuit diagram for the Grundig Transistor 1000A 5-channel rig.

Δ Got the instruction book for the Trio Model 9R-59 receiver? Then write to Ed Perreux, 235 Forsyth Cris, Regina, Sask., Canada.

Δ Walter Baker of 162 No. Queens Ave., No. Massapequa, NY 11758 needs the schematic diagram and info on the Mirinda (Nocturne) tape recorder.

Δ James Cummins of 249 Hampden St., Chicopee, MA 01013 needs the schematic diagram for the Engineered Electronics

PR-101 power supply.

Δ Charles Howard of 608 Aetna St., Salem, OH 44460 has an Ozarka radio and would like to know about it and its value.

Δ Sorry, we cannot handle requests for equipment sales. Why not try our Classified Ads Section.

Δ A Murdock Neutrodyne radio (3-gang tuning and 5 tubes) needs fixing and UV-201A tubes. Send help to Michael Perry, 611B Ellen Drive, Goodlettsville, TN 37072.

Δ Vern Kleinendorst wants the Lake Superior ore ship frequencies. Send info to 1815 River Rd., Grand Rapids, MN 55744.

Δ A Symphonic TPS-30 solid-state TV needs a new transformer, and Jay Surdyka needs help. Write to him at 41 Goodrich St., Hartford, CT 06114.

Δ Jerry Bolin of 16576 Sarah St., Mojave, CA 93501 can use an FM multiplex adapter for his Heathkit AJ-30 tuner.

Δ Victor King needs a schematic diagram for a Magnavox Clock/Radio C003, Run 3. He's at 832 E. Garfield, Glendale, CA 91205.

Δ Merle Hobbs of Rt. #1, Box 160B, Pittsburg, KS 66762 needs schematic diagram and service data for a Knight CB, Model Safari I.

Δ Wayne West, 106 E. El Camino, Phoenix, AZ 85020 needs schematic diagrams for the following: RT-70/GRC transceiver, APN-9 Loran navigation set, and ARC-3 receiver.

Δ Hallicrafter S-38 receiver in need of repair. Send schematic diagram and other data to John E. Hinant, 2712 Stacie Rd., Richmond, VA 23224.

Δ Carroll M. Brown of 1233 Crestview Dr., Hurst, TX 76053 wants the schematic diagram for a Hammarlund HQ-110 receiver.

Δ Eric Hagglund of 7220 Mt. Vernon, Riverside, CA 92504 needs diagrams and info on the SC-759A receiver and RA-94 power supply. Also, he can use a VT-145.

Δ Help a Watterson shortwave receiver, model 67, restored by supplying a schematic diagram to Cedric Silverthorn, 4110 Leeshire, Houston, TX 77025.

All our readers who write for help always extend their thanks in advance. And your "good buddy" Hank thanks you. 73s.

Receiver Feature

What is an RF gain control on a CB transceiver? Is it a real advantage?

—S. N., Wrightwood, CA

You can put an RF gain control to good use in CB operation. Most sets don't have them. They operate as if the missing control was set to maximum RF gain. That's good when the band is not crowded and all signals are weak. However, if you are working a local with plenty of signal, turn down the RF gain control (if your set has one) and it will reduce the background noise and weak signals. I know of two remote chain stores that stay in touch with beam antennas and reduced gain. Only their signals get through except for the moments when some mobile rides be-

tween the antennas. This is rare and the store's communications are as reliable as the telephone.

FM vs AM on Two-Way

Hank, what is the advantage of FM 2-way communications over AM like we have on CB?

—J. W., Scottsdale, AZ

FM can be said to have superior signal-noise ratio, lower usable signal level, received signal does not deteriorate gradually with distance between receiver and transmitter, carrier power does not depend on audio power, and interference with weaker signals on the same frequency does not exist. FM is the way to go if you need 100 percent reliability without interference.

Gets the Lead Out

What would happen if a lead acid battery was shorted out by a heavy bus bar that could not melt? My buddy says nothing, but I don't think so. What do you think?

—R. K., New Hyde Park, NY

The lead acid cell, like any other battery, will tend to overheat and maybe self-destruct. Excessive heating in a lead-acid battery causes sulfation, plate buckling and electrolyte boil off. The net result will be an interior short in one of the cells. If the battery survives, its overall capacity to deliver its rated ampere-hours will be greatly reduced.

Please Ease Off, Fellows

Hank, you didn't answer my last two letters. Everything okay with you?

—D. N., Waverly, TN

Yes, except no one listens to me! I cannot answer letters. I can only read them and answer only those which are typical of many received in my column. So please, don't send stamped, self-addressed envelopes or postcards. There are not enough hours in the day to answer all my readers' letters personally.

Pumps RF Also

My 1974 Vega has an electric fuel pump that makes about an S9 racket in my CB set. The pump is located inside the fuel tank so I assume it uses an oscillator in place of an interrupted contact to drive it. I have tried all the usual types of filters and bypass cures, but to no avail. I also contacted General Motors Service and got nothing there except a large telephone bill. Can you help?

—R. L., Lowell, IN

The trouble may be your antenna coax line. Check it very carefully. The fuel pump lines pass through the trunk. As a quick check, turn on your direction lights. If you hear the clicking, your antenna line is defective. Otherwise, you may have to take the CB power line directly to the battery instead of the accessory power line. Can anyone else suggest a remedy?

Dial Troubles

How do I know the frequency calibrations on my SWL receiver dial are accurate?

—H. N., Macon, GA

I can tell you for sure—it's not accurate. I checked my receiver with an RF signal generator and an electronic frequency counter. Pumping a known signal into my rig proved the dial was a little off. I did some fine tuning adjustments in the RF circuit, but some error still remained. So, I made up a calibration chart for each band. At each half-inch across the eight-inch dial I knew how many cycles to add or subtract to each dial reading. In general, the error possibility increases as the band frequency increases.

Call For Help

Hank, can you tell me if it's natural for a transmitter within 1000 ft. of my base to splatter 2 to 3 channels each side of his transmit frequency on AM, and wipe out my incoming signals on all AM channels with a loud hiss when he's on SSB? This is my first radio experience, and I have a tendency to feel I have done something wrong.

—J. T., Michigan City, IN

Can't see how it can be your fault unless you damaged your rig somehow. I suggest you call a few good buddies to monitor the station in question and see what they report. If they agree with your reception report, approach the station involved and offer friendly advice.

Maybe, Tovarish, Maybe

Do I have to be a citizen to get a CB license?

—F. S., Los Angeles, CA

Heck, no! There is, however, a requirement that you are not an agent for a foreign government—and that goes for citizens and aliens alike. Should you be barred from getting a license for this reason, the FCC may waver this rule should you state that your station would be used for personal reasons and not for business.

Sunk

I have a Lafayette Micro-66 CB rig and I live in a canyon and can't get my signal out. What do you suggest?

—B. H., Goleta, CA

Start a landfill project. Or maybe a 60-foot tower would help.

Thought in Harness

Is co-phasing two antennas that important, or is one antenna really enough?

—K. D., So. Fallsburgh, NY

If you are using two antennas on one vehicle, yes. If you are using one antenna, and would like to know if two are better, yes. But, let me say that two antennas do not give you twice the signal one would offer. Two antennas give an improved omnidirectional radiation pattern over a single antenna. Of course, we are talking about mobile antennas mounted on one of the worst ground planes in the world—your car. The harness of cables interconnecting the antennas and the CB set do two things of importance. One, the harness provides the correct cable lengths so that the antennas will be in step with each other, and two, the harness provides impedance matching for minimum SWR and maximum power transfer. This is co-phasing and it may be important to you. ■

avanti ASTROPLANE CB base antennas give you patented performance

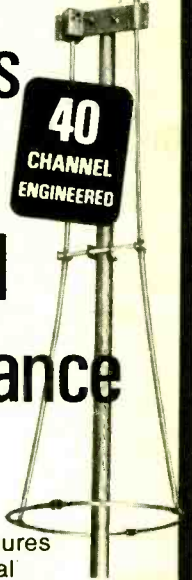

The unique construction features are so exceptional they are covered by U.S. Patent #3587109. 4.46 db gain over isotropic provides a stronger signal in and out.

To make use of the better signal, the Astroplane radiates the signal from higher up than other CB antennas and at a better angle. According to Dr. Alva Todd of the Midwest College of Engineering, "it possesses an unusually low angle of maximum radiation." This low angle of radiation means that your power is radiated at the horizon and not up into the clouds for greater efficiency.

You'll also get long lasting, trouble-free performance because it is compact in design—without long drooping radials, without coils to burn or short out, and high power capacity for lightning and static dissipation.

\$36.95 Suggested Retail
Length 12 Ft. • Dia. 30 in.

Free 24 page color catalog

Avanti makes a complete line of high performance base and mobile CB antennas from \$11.95 to \$373.95.

avanti

RESEARCH AND DEVELOPMENT, INC.
340 Stewart Avenue, Addison, IL 60101

Creators of the famous

MOONRAKER

CIRCLE 6 ON READER SERVICE COUPON

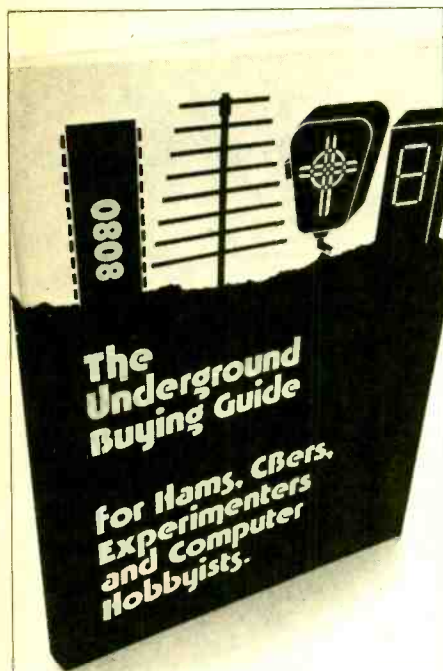

Where to get it.

Equipment, parts, supplies and services. Hard to find and standard items at bargain prices.

Over 600 places to find transceivers, antennas, surplus, new and used equipment, μ Ps/computers, ICs, components, assortments, assemblies, discounted items, test equipment, peripherals, etc. Hundreds of large and small mail order sources.

A complete directory divided by sources, items and locations. Saves countless hours of shopping. Easily pays for itself through comparative buying. Contains no advertising.

Rush my order. I enclose \$5.95 plus 55¢ postage and handling. Californians add 39¢ sales tax. Full refund if not completely satisfied within 10 days.

Name _____

Address _____

City/State/Zip _____

Primary interest: Amateur Radio CB
 Experimenting μ Ps/Computers

Send to: Peninsula Marketing
 Dept. H
 12625 Lido Way
 Saratoga, CA 95070

DX central reporting

A world of SWL info!

BY DON JENSEN

□ How does a major international broadcaster select its program schedule when it will broadcast to certain areas of the world? And how about frequency selection? How are the shortwave frequencies picked and why do they change at least several times a year?

First, the schedule selection is a relatively easy matter. To a great degree, the "when" is determined by the intended audience's listening patterns. It would be senseless to schedule an English language, North American shortwave service at 10 a.m. Eastern Standard Time. Relatively few listeners will be around to tune in. Most U.S. and Canadian listeners do their tuning during our evening hours. Thus you will find many international broadcasters beaming programs our way, in English, during our prime evening time, say 0100 to 0600 GMT.

By the same token, the English language programs from the larger African and Middle Eastern stations which Stateside listeners are able to hear during our afternoon hours are probably intended, primarily, for an audience in Great Britain. Our afternoon is evening there, and the time when the largest British audience is available.

For propagational reasons, reception during our prime evening hours is generally better for stations to the east of us, Europe and Africa, because a path of darkness exists between transmitting and receiving points.

Asian stations are at somewhat of a disadvantage. They are further away from us, but in addition their most favorable reception paths to North America occur in the early morning, not the ideal listening time for listeners here.

Strange things result. For years *Radio Thailand* has scheduled a so-called North American Service in English from 0415 to 0530 GMT. This is a terrific time in terms of having a listening audience available in North America. But it is a wretched time, propagationally-speaking. This service probably never has been heard in North America, though *Radio Thailand* can be heard Stateside mornings when it ostensibly is aimed at other audiences. Inscrutable!

Frequency selection is a more complicated business for the shortwave broadcaster. While some international broadcasting stations change channels more frequently, most of the "big boys" alter their frequencies four times a year. They divide their broadcasting year into four "seasons."

These are the two long seasons, the "J schedule" (May, June, July and August) and the "D schedule" (November, De-

ember, January and February), and the two short, or transition seasons, the "M schedule" (March and April) and the "S schedule" (September and October).

The frequency choices are based on propagational considerations, which change season by season, based on natural phenomena such as the angle of the sun, the number of hours of solar radiation, and so forth.

SWLs, of course, are familiar with the vexing problem of having two, sometimes more, major stations plopped down on the same or adjoining frequencies, causing a headache of mutual interference. With all the stations vying for channels during the optimum evening hours in North America, what is surprising is that there isn't more co-channel interference than there is.

Attempting to co-ordinate this complex business of selecting frequencies is the *International Frequency Registration Board* (IFRB) of the International Telecommunications Union in Geneva, Switzerland.

Since 1960, the IFRB has attempted, with some limited success, to reduce the chaos of seasonal frequency changes, by broadcasters. The SWC stations are supposedly required to submit to the IFRB, five months in advance of their actual use the shortwave frequencies the stations intend to use. IFRB then compiles these intended channel usages into a tentative schedule, and recommends alterations in the plans when obvious problems appear to be pending. Alternative frequencies are recommended in these cases.

The IFRB tries, but it has no real muscle to act as a frequency traffic cop. Thus, while some countries scrupulously try to cooperate with the agency in providing frequency usage information, real and planned, others go their own merry way when it suits them. And so it is not uncommon to find some of the major broadcasters indicating intentions to use far more frequencies than they actually will use. Other stations will jump from frequency to frequency, looking for a competitive advantage, with little consideration for the overall pattern of frequency use within a given band.

So, when all is said and done, the actual

GLOSSARY

AM—Amplitude modulation, a transmission mode, but sometimes used in a shorthand way to refer to the everyday-540 to 1600 kilohertz-Top 40 and Golden Oldie-radio band.

DX—Listening to distant radio signals.

DXer—Person who listens for DX.

GMT—Greenwich Mean Time, the universal time standard also known, in the military as "Z" or "Zulu" time. It is equivalent to EST+5 hours, CST+6, MST+7, and PST+8.

Hz—Hertz, a unit of measure meaning one cycle per second.

kHz—kiloHertz, a frequency measuring unit; 1,000 cycles per second.

MW—Medium wave, also called by listeners, BCB for broadcast band; the range of frequencies below shortwave, between, roughly 540 and 1600 kHz.

SW—Shortwave

SWL—Shortwave listener

choice of frequencies by a shortwave station is a combination of technical planning and seat-of-the-pants guesswork that can drive an SWL to distraction.

Often the "fun" times for DXers occur right after the "seasonal" frequency change dates when the international broadcasters begin their juggling for position in the shortwave bands.

If you want to keep tabs on these frequency changes, remember that the change-over dates are the first Sundays in March, May, September and November.

News Briefs. World Radio TV Handbook, the so-called SWL's "Bible," is expected to be available from about February 1, in its 1977 edition. If there is one single reference and source book that listeners should have, it is WRTH. It contains frequency, schedule and address listings for most stations in the world. It is available for about \$11 from many DX hobby clubs or from dealers such as Gilfer Associates Inc., P.O. Box 239, Park Ridge NJ 07656, or Glen Mueller, Billboard Publications Inc., 2160 Patterson St., Cincinnati OH 45124.

X-Rated DX? Perhaps, according to several listeners quoted in *Freudx*, the

seas Services, CH-3000, Berne 15, Switzerland.

Warming Up. Heading South is WFYR, *Family Radio*, the California-based U.S. shortwave operation. Though this station, with religious orientation, is headquartered on the west coast its shortwave transmitters have been located at Scituate, MA, across the continent. Not long ago, WFYR announced it had been granted permission by the Federal Communications Commission to move its transmitters from Massachusetts to Okeechobee, FL. It is hoped that the southern move will improve shortwave reception of the station in South America.

For now, here are some times and frequencies to check for WFYR's programs: 0000 GMT-6.155 KHz; 0400 GMT-6.155 kHz; 1800 GMT-17.845 kHz; 1900 GMT-11.805 kHz; and 2000 GMT-11.805 kHz.

Backtalk. This is the spot in each DX Central Reporting where you have your say. Comments, questions, observations about the world of DXing and your participation in it are always welcome. Send your letters to me, Don Jensen, DX Central, ELEMENTARY ELECTRONICS, 229 Park Avenue South, New York NY 10003. I'll be looking forward to hearing from you. And, if you've got a spare photograph of you and your shack—that's DX talk for your listening setup—send it along. Include identification of any equipment shown in the photo. If you like the idea, I'll try to feature some of your photographs in DX Central Reporting from time to time.

To start things off, a pair of questions from 18-year-old Wayne Davis of Kansas City, Kansas.

"Last year I was hearing some shortwave stations regularly. When winter came I couldn't hear them even if I "sat" on the frequency. When spring came again, there they were on the same frequencies again. Do the changing seasons have some effect on the shortwaves?"

Yes, there is a seasonal change in shortwave reception patterns. And because of this, shortwave stations alter their frequency usage. I've tried to explain this earlier in this column. Wayne, I've published your question to show how reader comments and queries can provide me with information about the sort of material you'd like to see in this column.

Wayne's second question is: "With Radio Canada International cutting back on some of its services to SWLs, and other stations giving up on shortwave altogether, do you think SW will be popular in the future? Will it live or die?"

All I can do, Wayne, is give you my opinion. No one can predict the long range future so I'm not going to attempt to guess what the SW scene will be like in the year 2000. But it is my feeling that SWling will continue and, perhaps, grow significantly in the next ten years. The SW scene will change, surely. Commercial and military communications use—I'm talking about fixed service point-to-pointers, maritime and aeronautical transmissions—will probably decrease. This should effectively leave more shortwave "space" for the broadcasting stations.

(Continued on page 94)

Old Radio Treasures

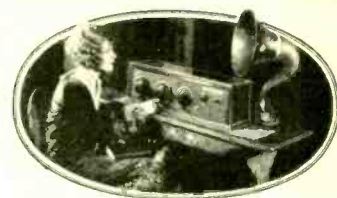

DON'T LOSE OUT
Our books are your key!

VINTAGE RADIO, 1887-1929: Pictorial story of pioneer days, 1,000 photos, 263 pages. \$10.95 hard-cover, \$8.95 soft.

A FLICK OF THE SWITCH, 1930-50: Fun picture reference of home, military, Ham, professional radio-TV-electronics, 312 pages. \$10.95 hard-cover, \$8.95 soft.

RADIO ENCYCLOPEDIA, Gernsback's 1927 classic beautifully recreated, 175 pages. \$14.95 hard-cover, \$10.95 soft.

RADIO COLLECTOR'S GUIDE, 1921-32: Data book with 50,000 facts on 9,000 models by 1,100 makers, 264 pages, \$6.95.

1926-38 RADIO DIAGRAMS: Beitman's classic of 600 models, 240 pages, \$7.00.

IMMEDIATE DELIVERY!

SEND TODAY to Vintage Radio, Dep't E, Box 2045, Palos Verdes, Ca. 90274. We pay postage. Calif. residents add 6%.

Year-round Fun!

Use Quick-Wedge to install a bus, connect a motor, mount a p.c. board, cinch up a connector

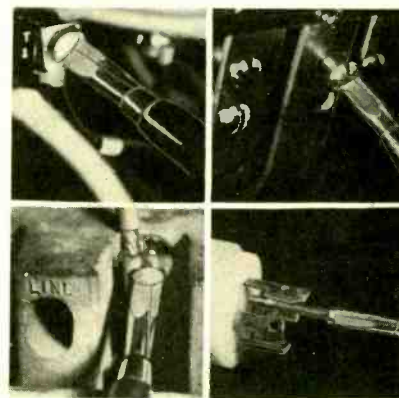

They do all that ordinary screwdrivers do, PLUS they hold and start the screw



QUICK-WEDGE 17 sizes
Screw-holding screwdrivers

Unconditionally guaranteed. BUY A SET TODAY

See your dealer or write to:
Kedman Company, P.O. Box 25667,
Salt Lake City, Utah 84125

© Copyright 1977

CIRCLE 38 ON READER SERVICE COUPON

33



Here's a free sticker from the Swiss Broadcasting Corporation you can have for nothing. It's free! See text for details.

bulletin of the North American SW Association. Richard Wood and Kim A. Elliott told about hearing "four-letter words in profusion on *Radio Sweden's* incredible Saturday Show." The program featured a satirical skit on the subject of fermenting manure to produce methane gas for fuel. Even the title of the humorous sketch was such that I can't reprint it here. According to Wood, himself a linguist, "the feature was spoken in authentic pseudo-peasant accents." Elliott observes that *Radio Sweden's* Saturday Show "is certainly not for everyone," but adds the skit was "very well done."

Elliott also noted that *Radio Finland* "It's Saturday" show is similar to the Swedish effort, with a heavy larding of well-done satire.

For *Radio Finland* you might try 15,110 kHz at 1330 GMT; for *Radio Sweden* 9,695 at 0230 GMT, but there are other times and frequencies as well.

Anyone For a Freebee? How about this attractive sticker? SBC, the Swiss Broadcasting Corporation is offering this colorful sticker to anyone who writes to ask for it. Write to the SBC, European and Over-

Learn to service Communications /CB equipment at home...with NRI'S COMPLETE COMMUNICATIONS COURSE

Learn design, installation and maintenance of commercial, amateur, or CB communications equipment.

The field of communications is bursting out all over. In Citizens Band alone, class D licenses grew from 1 to over 2.6 million in 1975, and the FCC projects about 15 million CB'ers in the U.S. by 1979. That means a lot of service and maintenance jobs . . . and NRI can train you at home to fill one of those openings. NRI's Complete Communications Course covers all types of two-way radio equipment (including CB), AM and FM



Transmission and Reception, Television Broadcasting, Microwave Systems, Radar Principles, Marine Electronics, Mobile Communications, and Aircraft Electronics. The course will also qualify you for a First Class Radio Telephone Commercial FCC License or you get your tuition back.

Learn on your own 400-channel digitally-synthesized VHF transceiver.

You will learn to service all types of communication equipment, with the one unit that is designed mechanically and electronically to train you for CB, Commercial and Amateur communications: a digitally-synthesized 400-channel VHF transceiver and AC power supply. This 2-meter unit gives you "Power-On" training. Then we help you get your FCC Amateur License with



special instruction so you can go on the air. The complete course includes 48 lessons, 9 special reference texts, and 10 training kits. Included are: your own electronics Discovery Lab, Antenna Applications Lab, CMOS Frequency Counter, and an Optical Transmission System. You'll learn at home, progressing at your own speed, to your FCC license and into the communications field of your choice.

NEW CB SPECIALIST COURSE NOW OFFERED



NRI now offers a special course in CB Servicing. You get 37 lessons, 8 reference texts, your own CB Transceiver, AC power supply and multi-meter . . . for hands-on training. Also included are 14 coaching units to make it easy to get your commercial radio telephone FCC license—enabling you to test, install, and service communications equipment.

NRI offers you five TV/Audio Servicing Courses

NRI can train you at home to service TV equipment and audio systems. You can



choose from 5 courses, starting with a 48-lesson basic course, up to a Master Color TV/Audio Course, complete with designed-for-learning 25" diagonal

solid state color TV and a 4-speaker SQ™ Quadraphonic Audio System. NRI gives you both TV and Audio servicing for hundreds of dollars less than the two courses as offered by another home study school.

All courses are available with low down payment and convenient monthly payments. All courses provide professional tools and "Power-On" equipment along with NRI kits engineered for training. With the Master Course, for instance, you build your own 5" wide-band triggered sweep solid state oscilloscope, digital color TV pattern generator, CMOS digital frequency counter, and NRI electronics Discovery Lab.



™ Trademark of CBS Inc.

NRI's complete computer electronics course gives you real digital training.

Digital electronics is the career area of the future . . . and the best way to learn is with NRI's Complete Computer Electronics Course. NRI's programmable digital computer goes far beyond any "logic trainer" in preparing you to become a computer or digital technician. With the IC's in its new Memory Kit, you get the only home training in machine language programming . . . experience essential to trouble shooting digital computers. And the NRI programmable computer is just one of ten kits you receive, including a TVOM and NRI's exclusive electronics lab. It's the quickest and best way to learn digital logic and computer operation.

You pay less for NRI training and you get more for your money.

NRI employs no salesmen, pays no commissions. We pass the savings on to you in reduced tuitions and extras in the way of professional equipment, testing instruments, etc. You can pay more, but you can't get better training.

More than one million students have enrolled with NRI in 62 years.

Mail the insert card and discover for yourself why NRI is the recognized leader in home training. No



salesman will call. Do it today and get started on that new career.

APPROVED UNDER GI BILL
if taken for career purposes Check box on card for details.



NRI SCHOOLS
McGraw-Hill Continuing Education Center
3939 Wisconsin Avenue
Washington, D.C. 20016 6-037

Realistic adds excitement to economy hi-fi!

Three fine receivers under \$200!

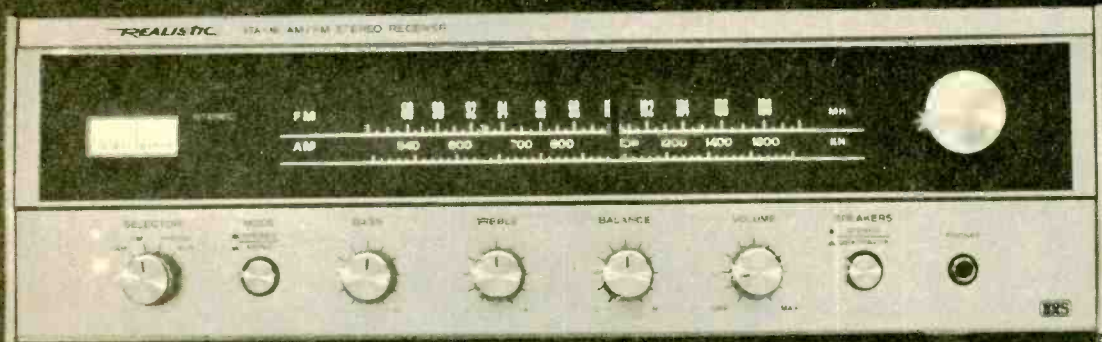

STA-16

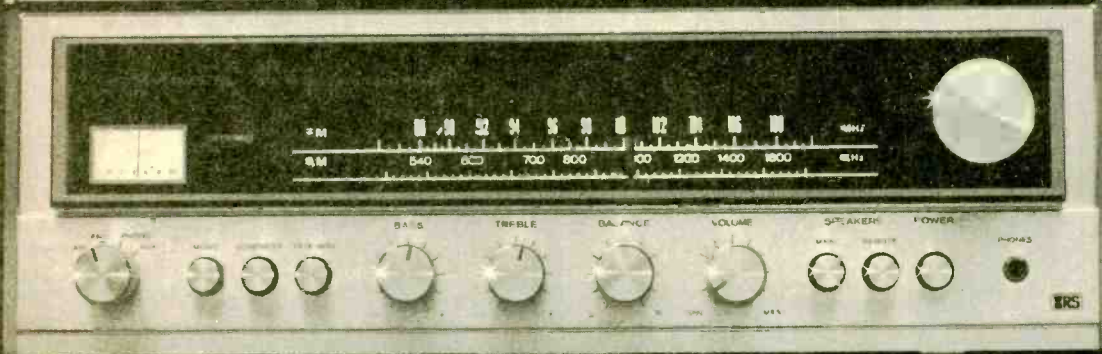

STA-21

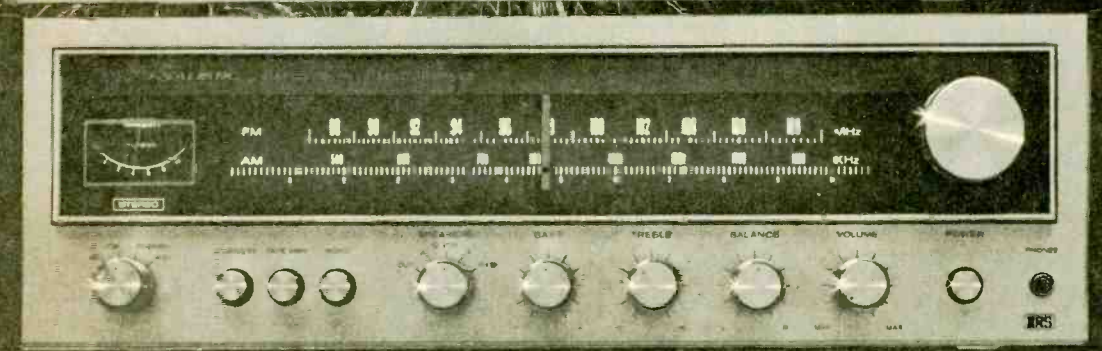

STA-52

The STA-16 offers versatile hi-fi at low cost. FET/IC front end and PLL multiplex for superb FM stereo. 3.5 watts per channel, minimum RMS at 8 ohms from 30-20,000 Hz, with no more than 0.9% total harmonic distortion. Ceramic and magnetic phono inputs. Tape outputs. Exclusive Quatravox® synthesizer. And more. Only 119.95.* Includes custom vinyl veneer case

The STA-21 introduces audiophile controls and circuitry to the economy price range. PLL demodulator. 7 watts per channel, minimum RMS at 8 ohms from 20-20,000 Hz, with no more than 0.9% total harmonic distortion. Loudness, tape monitor, main/remote speaker switching, mono/stereo button, more. Only 159.95.* Includes custom vinyl veneer case

The STA-52 combines clean sound and luxurious design. PLL demodulator. Direct-coupled amplifier. 12 watts per channel, minimum RMS at 8 ohms from 20-20,000 Hz with no more than 0.9% total harmonic distortion. Pushbutton loudness, tape monitor, stereo/mono. Quatravox synthesizer. Much more. Only 199.95.* Includes handsome walnut veneer case

SOLD ONLY WHERE YOU SEE THIS SIGN:

Radio Shack®

A TANDY COMPANY • FORT WORTH, TEXAS 76107
OVER 5000 LOCATIONS IN NINE COUNTRIES

*Prices may vary at individual stores and dealers
Prices and products may vary in Canada.



Use your credit card at most stores

CIRCLE 32 ON READER SERVICE COUPON

TV SETS OF THE FUTURE.....

THEY'RE HERE!

□ Imagine settling back in the comfort of your own living room, preparing to savor a symphony played by the New York Philharmonic, a concert of Arthur Fiedler conducting the Boston Pops, or a jazz set, an opera, a Broadway musical. By the flick of two switches—one on your home hi-fi system, and one on your video projection system—you'll be ready to "be at the concert" without getting wet, cold, or cramped. Tonight? No. Tomorrow? Perhaps.

As of this writing, at least 30

companies are developing, test-marketing, or actively producing/marketing video projection (ex projection TV) systems for the home audio/entertainment center. You may have to scout around a bit to find them on display and for sale in your area. Since they are an "esoteric," limited-sale product, only a small number of stores are handling them. Some larger manufacturers advertise them in major big-city newspapers, but more often via their dealers' ads in local newspapers. Some manufacturers, selling on a

regional basis, advertise video projection systems in the classified sections of newspapers, as for example Altvision in the New York City area.

The video projection systems you're most likely to see in stores carry the Advent, Sony, Worldwide, Tele-Theatre, Tandom and Muntz brand names, since the firms have national distribution. However, you may also find one or two brands in your area from companies in the process of starting regionally, then expanding to national distribution.

You can have a movie-like television projection set in your home today!

by Fred Petras



TV Sets of The Future

In addition to stores, you'll find video projection systems in public places—bars, restaurants, airports, hotel lobbies, museums, etc. Some of the publicly-displayed sets may not, however, be readily available to you as a consumer. To buy, you might have to work through an area sales representative, or contact the manufacturer for purchase arrangements.

The units carry intriguing space-age designations such as Video-Beam, Magna-Vision, Megavision, Stereovision, Eye-Beam, Tele-D Theatre, Video Master, Cine-Vision, and Theatervision, however this current crop of video projection systems is not the first time this idea has emerged. It was preceded by projection TV systems that were developed in the 1940's.

The main difference between the current crop and that of the forties is that today's systems project color pictures in addition to black-and-white and they have brighter picture sources, and improved screens with better reflective capabilities. The brighter picture source/better screen combination makes it possible to view them without totally darkening the room in which they are used. However, for optimum picture brightness and quality most sets should be operated in totally darkened rooms. Even so, projected pictures simply do not have the "punch" that direct-view TV pictures have; that punch is related to the latter's brightness. (We'll ex-

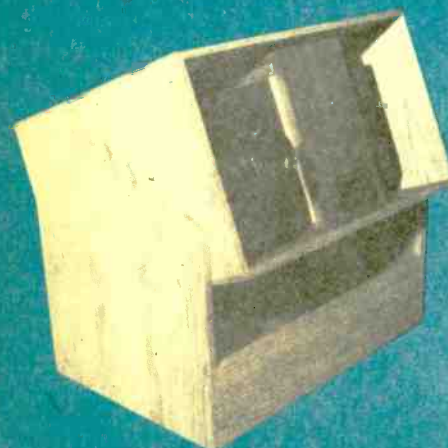

Theatervision setup is similar to Tele-Pro-Systems' Cinema IV. Picture is 32-in. x 40-in.



Tele-Pro-Systems' Cinema IV model CR costs \$2000 and projects on a 30- by 40-inch screen which retracts into the console when not in use. Lens directs light to mirror which then directs image to the screen (not shown here).

plan the matter later.)

Another big difference is the prices of today's systems are generally high. Complete systems consisting of TV source, projector assembly and screen, run from \$995 on up to \$4,995. These are for home use. (Models for professional/industrial use start at \$5,000 and range to \$44,000.) However, you can experience big-screen projection TV for a lot less if you're a handy do-it-yourselfer. Kits that utilize your existing portable or table model TV as the program source can be had for as little as \$325.

How big a picture do you get from a video projection system? A perusal of specs of the 30 companies shows screen sizes ranging from 24 by 32 inches for the self-contained one-unit Sony Model KP-4000 at \$2,495, to 75 by 100 inches for Projection Systems Inc.'s Cinevision, consisting of TV projector and screen, priced at \$4,995. Fifteen companies show units with 32 by 40-inch screens.

By and large, video projection systems are ungainly, "klutzy," and oversized compared with regular TV sets. They require a lot of room for optimum enjoyment. In watching the popular Advent VideoBeam system, for example, you'd want to be at least 10 feet from the screen; try that in your conventionally fur-

nished 12 by 15-foot living room and you'll see it could be a problem. However, some systems can be used in smaller spaces. Television Projection Systems' Tele-Pro-Sys, for example, can be used in a room as small as 7 feet wide by 11 feet deep, the company claims. We suggest that in evaluating your purchase that you bring along a drawing of the room in which you'll use a

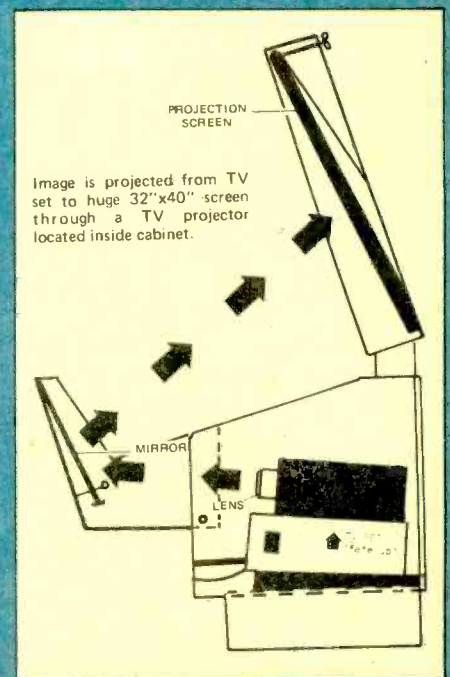

Many projection setups, including large-screen system by Television Projection Systems, use TV set and home-movie screen.

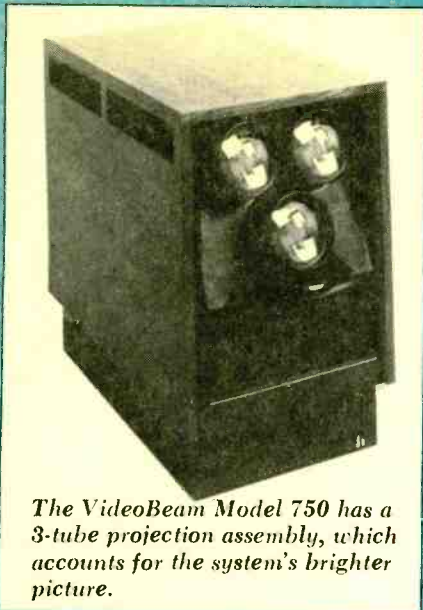

The VideoBeam Model 750 has a 3-tube projection assembly, which accounts for the system's brighter picture.



The Advent Model 750 has a price of \$2495. It uses a curved screen which measures 6 feet diagonally.

four) years in terms of what we as a family save by not going to the movies." Some comments on the order of the above also include the saving of transportation costs to movies.

Here are some of the appeals of projection TV, as heard over a period of several months: The impact of it does not wear off. You get more involved with what's happening on the screen. You can "get away from it all" more effectively than you can via regular TV viewing. The reality of what's on the screen is greater—because people, animals and objects are often shown life-size. The unreality is greater, because some things are portrayed larger than life-size; this unreality is a boon to those viewing TV as an "escape." The emotional impact of giant-screen TV is far greater, more powerful than regular TV, or, put another way, soap operas come across soapier.

video projection system, complete with notations on furniture placements and measurements of room borders and available space.

The Appeals of Projection TV. Video projection systems in their present form can really "hook" you to TV. They are, in essence, a TV addict's dream come true. And for many movie buffs they are also a dream come true. (And that's why they're often called a "dream machine.") Typical of user's comments is one to the effect that "My projection system saves me a lot of money; I go to the movies at home." Another runs like this: "My set will pay itself off within two (three,

an appeal-in-the-making is that of using a video projection system for playing video games. It's an altogether different experience than playing such games through a standard TV set; the excitement factor is far greater, generated in part by the greater distances the playing or moving objects (tennis ball, hockey puck, etc.) travel, and a heightened sense of competition.

If you are into videotape recording a video projection system holds

additional strong appeal. Connect your videoplayer into virtually any video projection system and you're off—to new heights of pleasure. Your favorite recording stars can be taped for audio and video playback. Buffs who videotape family and friends via videocameras say that seeing their tapes on a giant screen is "frightening" in terms of their life-size reality. Some, whose camera work is less than professional say that seeing their videotapes on a video projection system with all their deficiencies magnified has inspired them to greater care in their photographic efforts.

Picture Brightness—Or the Lack of It. While projection TV is enjoying a revival and improvements have taken place, the concept, as noted, is not perfected. Even manufacturers concede that. Although most systems work well, they don't generally offer the level of TV picture quality we're used to in terms of sharpness, for example, that regular direct-view TV offers. In some video projection systems, scanning lines are quite noticeable. But more importantly, all of the systems suffer from a lack of brightness, albeit Advent comes fairly close to offering what might be called a bright picture via its triple-tube/lens Video-Beam projection method.

The basic problem is that lens assemblies used in most video projections rigs are inefficient in "collecting" the light available from the face of the picture tube and project-

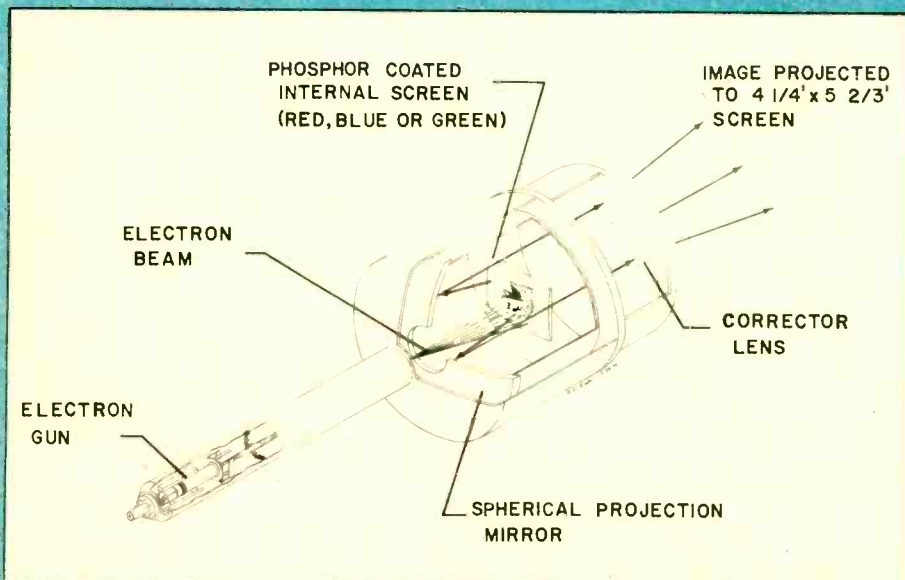

Simplified drawing of single-color TV projection tube developed by Advent founder Henry Kloss. Three tubes, one for each primary color, merge images on screen almost four by six feet, permit viewing in light almost strong enough to read a book.

e/e TV Sets of Future

ing it onto the viewing screen. According to one knowledgeable industry source, the "immutable laws of optics" prevail in the matter. Said he, "Light, in passing through lenses, loses its brightness. There's a formula—the size of the lens, nature of the lens, focal length, etc.—and the results are calculable. You will never get more than 25 or 30 per cent of the brightness of the TV set you're using. Some lens assemblies collect less than five percent of the light on the tube face.

Some companies are looking to fresnel optical systems as the answer. It is claimed that plastic fresnel lens are able to collect a far greater amount of light—perhaps as much as four times that of glass lens assemblies now used in video projection systems. A major problem—at least at the moment—is that fresnel lenses are hard to fabricate in large sizes at prices the average consumer can afford.

The lack of picture brightness is somewhat of a nuisance. In order to get the most out of a video projection outfit you must operate it in a darkened—preferably totally dark—room. Otherwise the picture brightness may be less than acceptable. Under such conditions the picture is faint, with colors pale, or with some element of the colors missing, or otherwise untrue in color. One company advises, "Fluorescent lighting is projection TV's worst enemy.

Projection TV points up the vast variations in basic picture quality of TV commercials. If a commercial is poorly made, its defects will be magnified—literally, and exaggerated. Poor color rendition in the original commercial may turn out to be horrendous on a giant screen such as that of the Advent VideoBeam. Poorly delineated details in a TV commercial—shadows, for example—may wash out totally in a projected picture. Clothing patterns may vanish; faces of old people will be wrinkle-free, etc.

What's Available. Home video projection systems come in a variety of models. You can buy them in one-

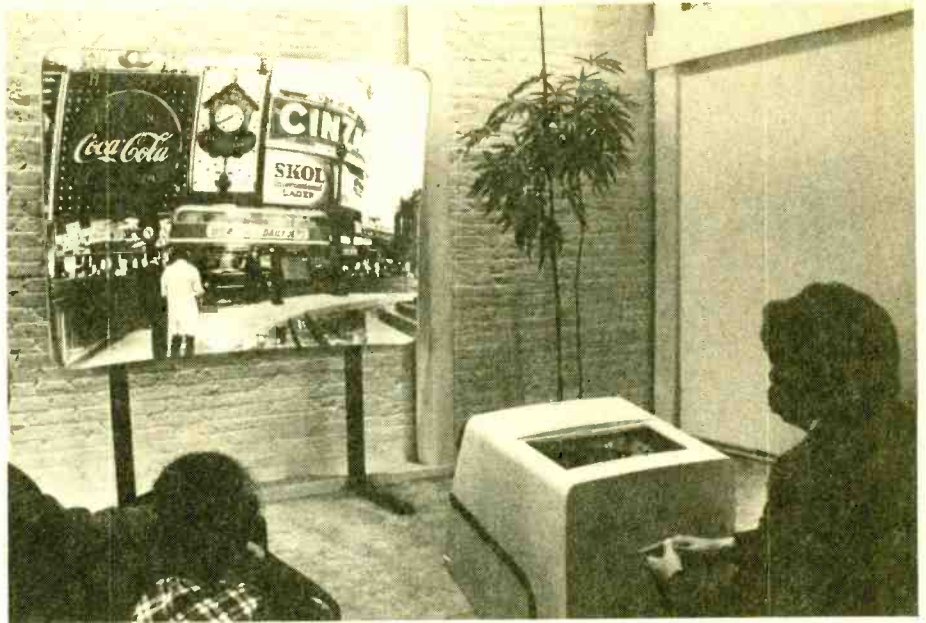

Advent's Videobeam system comes in two versions; major difference is in size of projected picture. Model 750, priced at \$2,495 has six foot diagonal screen. Model 1000 costs \$4,000.

piece, two-piece or three-piece form. The one-piece models contain everything in one large housing, sometimes with the screen a fold-down or fold-away proposition. The two-piece outfits house the TV and projection equipment in one housing, the screen in another. The three-piece ensembles consist of TV, attachable projection lens or lens/mirror assembly, and separate screen. Most commonly used are Kodak Ektalite screens because of their high reflective qualities.

Following are brief descriptions of some of the video projection systems now in the marketplace:

Advent Corp.—The new VideoBeam Model 750, priced at \$2,495, is the offspring of the history-making "granddaddy" Model 1000, priced at \$3,995. The 750 consists of a three-tube projection assembly that is said to project "at least 10 times more light than typical single-tube sets," and a curved screen measuring six feet diagonally. Inside the roll-away, floor-model projector console are three single-color tubes—red, green, blue—measuring five inches diagonally. Each tube is used with a precision lens with an optical speed of f1.4 (versus 2.8 or darker lens on many other sets). Each lens projects a single-color image from each tube to the screen, where the three images combine to create a color picture. The proprietary

VideoBeam screen is easily cleaned, as opposed to some other types which are dirt-smudge prone and require considerable care to clean. The Advent system can operate in a room whose light level is just below the brightness level required for comfortable reading.

Sony Corp.—Model KP-4000, priced at \$2,495, is an adaptation for home use of the firm's earlier professional/industrial Model VPP-2000, priced over \$3,000. The system is self-contained in a single cabinet measuring approximately 63 inches high by 23 inches wide by 38 inches deep when in operating position. The unit's Trinitron receiver (Model VTU-400) projects color images onto a 40-inch (diagonal) curved screen via a lens/mirror arrangement. The projector section of the KP-4000 folds down for operation and conveniently folds up and out of sight when not in use, shutting off all power in the receiver automatically. A roll-top cover slides down to conceal and protect the projection screen from dust and damage.

Worldwide Entertainment Systems—Theatervision is the overall name for this firm's all-in-one projection outfits priced at \$1,995 in a choice of rosewood, walnut or off-white paint finish, less optional speaker systems at \$200 each for

(Continued on page 93)

POWER ANTIQUES FROM AN AC-BATTERY

by James A. Fred

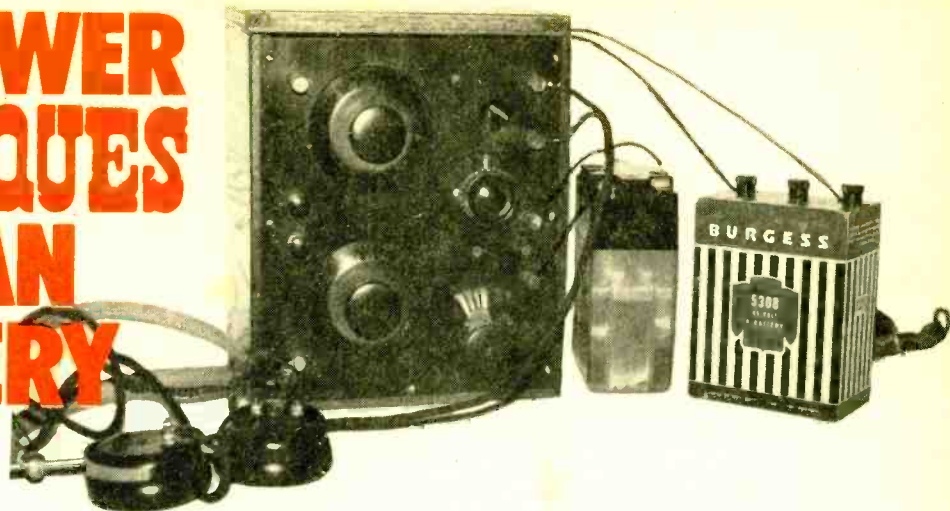

Authentic-looking B battery for tube plates and filaments from the AC line.

□ It always "bugs" me to see an antique radio receiver with an old pair of headphones or a horn speaker being powered by a power supply in a gray hammertone box. Some collectors have built power supplies into a wooden cabinet which is a copy of an old radio cabinet. Why not go one step further and use an actual B battery wrapper to enclose a power supply?

With this idea in mind I built two power supplies, one a combined A & B supply (A batteries power tube filaments, and B batteries power the plate circuits.) and two, just a 22½ and 45 volt DC supply. In order to keep the supplies as small as possible I used the wrappers from a Burgess 5308 (45 volts tapped at 22½ volts) 5 inches high by 4 inches wide by 2½ inches deep. I had found three dead batteries in an industrial plant where they had been used in a high resistance bridge. You may have to modify your supply if you can't find batteries of this size or larger.

The combined power supply delivers 3.3 volts regulated, for the filament of a 199 tube, and 45 volts, Zener-diode regulated, for the B voltage. This supply powers a one-tube regenerative receiver, an Ace model V manufactured by Powel Crosley. The other supply delivers 22½ volts and 45 volts. It is used with a Clapp-Eastham regenerative receiver, which has one 201A tube. A 6-volt storage battery supplies the filament power.

Because you may not be able to find exactly the same batteries that I did I will tell you how to build an electrical equivalent that you can put into a box of your choice.

They're Designed This Way. Both supplies start out alike with a line cord and a 5PST slide switch. Next comes a transformer supplying 125 volts and 6.3 volts AC at 0.6 amperes. If you are building the combination supply use both windings, otherwise you will only need the 125-volt secondary winding.

From here on we will describe the supplies separately.

For the combination supply full-wave bridge rectifiers, encased in plastic, are used. They are small, easily mounted, and have ratings in excess of what we need. The Zener diodes are rated at one watt. This supply uses a phenolic board with terminals staked into place, with the components wired point-to-point. You can use any construction you are familiar with, because parts placement is certainly uncritical.

About the Zener. The other supply uses parts similar to the one described above—full-wave bridge rectifier, large filter capacitors, and Zener diodes to regulate the output voltages.

One word of caution, if you have never used Zener diodes before. Zener diodes come with tolerances of ±5%, ±10%, and ±20%. This means that if you buy a 22½ volt Zener the regulated voltage can vary by 10%, 20%, or 40%. The prices vary inversely as

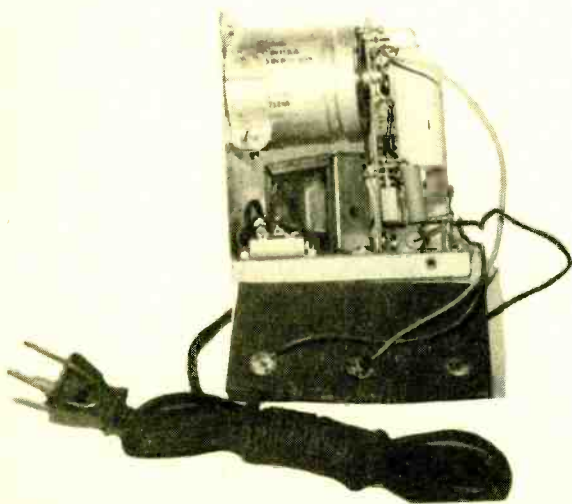

Author packed the components for A and B eliminators into old B case this way. Photo at top of page shows one tube Clapp-Eastham regenerative set with 6V motorcycle-A, and all electric-B batteries.

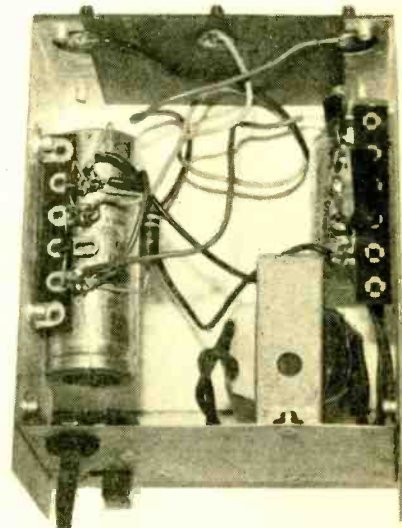

If you build only the B "battery" you'll have plenty of room inside.

Power Antique Radios

the tolerance, i.e., $\pm 5\%$ Zeners are the most expensive while $\pm 20\%$ are the cheapest. If you want the closest regulation buy $\pm 5\%$ otherwise the output voltages may vary considerably.

Take the usual precautions when soldering—use only rosin core solder, and use a heat sink when soldering semiconductors. As you can see from the photographs, galvanized steel was used because it is easily obtainable and it doesn't show in the finished unit. Pop rivets were used to hold the sheet metal together because the heads do not project like machine screws.

When the power supply is completed use your voltmeter to measure the output voltages before connecting to your radio. A carefully-built power supply will give you many hours of listening pleasure and will be well worth the time and money invested.

Figuring Component Values. Here's how to figure the size of current-limiting

The secret of the Zener diode voltage-regulating circuit is the current-limiting resistor. To figure the size of this resistor you must know the voltage output of the bridge rectifier, the load current drawn from the power supply, and the voltage needed at the output of the supply. Connect the power supply to the line and measure the voltage at point X, with the balance of the circuit disconnected. You choose the output voltage yourself. Derive your chosen voltage from the voltage measured at X.

From a tube manual determine the load current your supply must deliver. This is determined by the tubes in your receiver. Remember, with a Zener diode



Whether you build the A "battery" only, or the A-and-B "battery," they'll look like this if you can locate an old case.

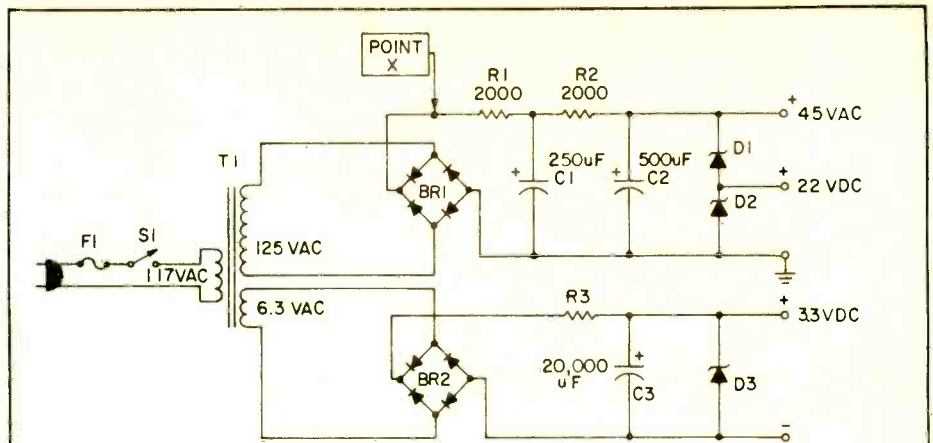

PARTS LIST FOR THE ALL-ELECTRIC B BATTERY

BR1—Bridge rectifier, 50 PIV (Radio Shack 276-1146 or equiv.)

BR2—Bridge rectifier, 200 PIV (Radio Shack 276-1172 or equiv.)

C1—250-uF, 75-VDC electrolytic capacitor (obtainable from local radio-TV parts distributor)

C2—500-uF, 50-VDC electrolytic capacitor (from parts distributor)

C3—20,000-uF, 20-VDC electrolytic capacitor (Allied Radio number 852-0871)

Note: All capacitors in this circuit are approximate values. Any higher voltages and/or higher capacitances are acceptable, but may take up somewhat more space.

R1, 2—2000-ohm, 3-watt resistors (Allied Radio number 880-5334 or equiv.) Different value may be required according to tubes you power. Consult text on this page.

R3—value depends on filament drain of tube(s) you power. Consult text to figure value.

T-1—120 VAC primary, 120 VAC, 15 mA and 6.3 VAC, 0.6 A secondaries, power transformer (Stancor PS8415 or Allied Radio number 705-0034)

D1, 2—25 VDC zener diodes (1N756 from James Electronics, or equiv.)

D3—3.3 VDC zener diode (1N746 from James Electronics, or equiv.)

S1—SPST, 120 VAC switch (Radio Shack 275-011 or equiv.)

Misc.—AC line cord, old B battery or other case, wire, solder, brackets, etc.

Allied Electronics' address is 401 East 8th St., Ft. Worth, TX 76102

James Electronics' address is 1021 Howard St., San Carlos, CA 94070

either the load draws the current or the Zener does. The Zener must always have a current flow through it so we allow 10% of the load current for the Zener. To determine the resistance of R use Ohm's law, and divide the difference between the load voltage and the voltage at X by 110% of the load current. If you use two filter capacitors, as I did, divide R in half and you have R1 and R2.

$$R = \frac{E}{I}, \text{ or,}$$

R1 + R2 equals E (volts) divided by I (amperes). To determine the power rating of R1, 2, 3, use power equation. $P = I^2R$, Power (watts) equals current (amperes) squared, times the resistance (ohms). To determine the power rating of the Zener divide the voltage rating by 110% of the load current. Then add
(Continued on page 91)

Author tries to tune in a station, apparently unaware that the batteries aren't hooked up to his receiver!

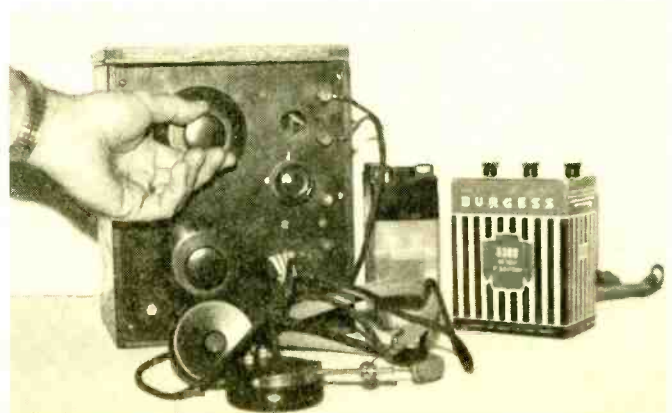

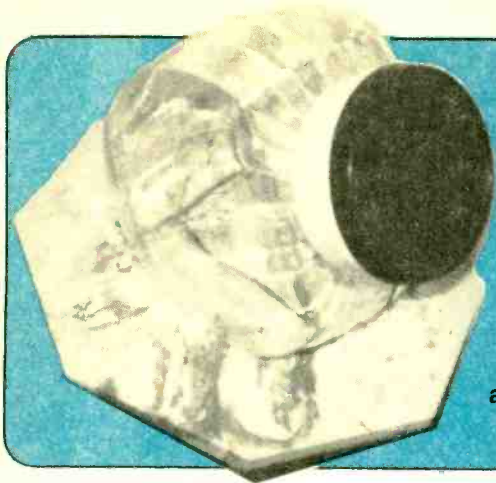

It's A Sound Cookie

Compact speaker system uses glass food jar enclosure and automotive speaker grille for high quality sound you can use anywhere.

by Herman Johnson

□ Here is an unusual loudspeaker system that employs a two-gallon food jar, the kind usually called a cookie jar, as the enclosure for a small loudspeaker system. Depending on the particular driver speaker unit you use, you can get high fidelity sound from this very compact speaker system, or you can use a less expensive speaker and still get very pleasant sound for background music, or mostly listening to talk programs at high sound levels.

Since the enclosure is made of clear glass, it can be used as a terrarium for display of an artificial floral arrangement or a miniature garden. Or, favorite pictures and photographs can be mounted to the inside surfaces with glass insulation filling between, similar to the display made by a photo cube. Another idea—the enclosure can be decorated by filling the inside with small cut cubes of fiberglass. Fiberglass insulation is available in shades of yellow and pink. White cotton balls can also be used for additional color variety.

Construction. You will note in the illustrations that the speaker driver is positioned in the neck of the enclosure at an angle of 45 degrees from horizontal. Thus the speaker can be placed on

a low table or on the floor to provide good dispersion of the treble sound in the listening area. An airtight seal between the driver and the enclosure is assured because we use the top section of a cylinder-shaped plastic food container and its cover.

The photographs and drawings show how the parts that make up the adaptor fit into each other. The inside diameter

of the food container, at the cut-off section, is slightly less than the outside diameter of the glass around the opening. When installed, it is stretched over the glass opening and pressed down, all around, to the body of the jar enclosure. Note that the plastic screw-on cover is placed between the back flange of the speaker unit and a masonite stiffening flange and serves as a gasket. These parts are clamped together by four screws and nuts.

The glass jar and the plastic food container are available in supermarkets and variety drug stores. The two-gallon container has a 5-inch inside diameter opening. The outside diameter is 6-inches.

Making the Parts. Stick a length of masking tape around the food container an inch and one-half from the open end to serve as a guide for sawing the plastic body as indicated in the drawing. Screw the cover on tightly before sawing, to add rigidity. Hold the round body over an open vise or other double-edged support. Now rotate the body as you make the cut, and scrap away the ragged edges with a file.

Scribe the straight and the circular lines on the smooth face of a piece of

MATERIALS LIST FOR COOKIE JAR SPEAKER SYSTEM (quantities shown for stereo pair)

- 2—Food storage container, glass, two-gallon size, used as enclosure (Anchor Hocking or equiv.)
- 2—Freezette food containers, no. 117 soft plastic, 6-in. diameter, 7-in. high, with cover.
- 2—Hardboard 6-in. square or larger, ¼-in. thick (Masonite or equiv.)
- 2—Speaker grille, automotive type, 6½-in. diameter, including metal retaining ring.
- 2—Loudspeaker driver unit, 5-in. diameter (Radio Shack 40-1292, 40-1284, 40-1909, 40-1240 or equiv.)
- 8—Machine screws 1-in long, round head, no. 8-32, with nuts and washers.
- 8—No. 6 sheet metal (self-tapping) screws, ¾-inch long (similar wood screws are acceptable).
- Speaker hookup wire, two-conductor, 24 gauge.

This exploded view shows the speaker driver and five associated parts, all ready to go together just before being set around the neck of the cookie jar enclosure. Metal ring next to the top grille comes with it. A four-inch driver could also be used, with the Masonite piece and the cover using a smaller center cutout in that case.

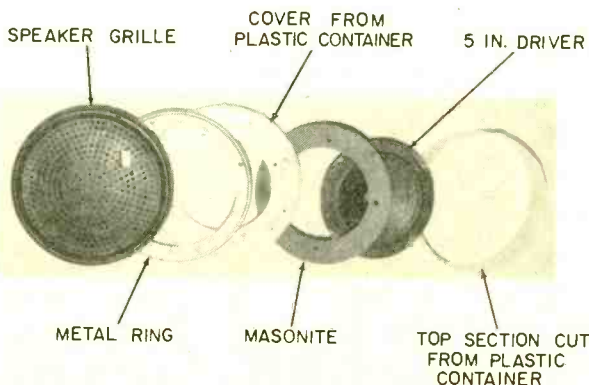

Plastic food container gets cut off near top to secure cover which seals speaker.

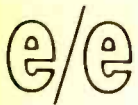

It's Sound Cookie

1/4-inch hardboard to make the stiffening flange. If you make the circular cut with a saber saw, cut slightly inside the line for the 3 7/8-inch diameter cutout first, then cut outside the 5 7/8-inch diameter line. You can obtain an almost-perfect round opening by use of a drum sander chucked into a drill, to remove excess material or by hand with sandpaper. The outside cut is best smoothed by turning the flange against a disc sander or by hand filing to the line.

When you have completed these cuts, place the speaker driver face down on a clean flat surface. Place the masonite piece, smooth side down, over the speaker to determine that it fits the

speaker frame all around. When you are satisfied with the fit, turn them over and rotate the speaker to locate the mounting holes, to the straight lines you have scribed on the masonite. Since the speaker unit extends below the flange, in this position, it is a good idea to support them on two blocks of wood so that the speaker unit will hang between the blocks. Accurate center marks can then be punched for drilling the holes for the four mounting screws. The large opening and screw holes to be made in the plastic cover are shown in the drawing. To make a visible line on the soft plastic of the cover, use a sharp pencil lead with a school compass adjusted to 1 & 15/16-inch radius. A groove can be made in the plastic surface to scribe the outline of the cutout. Then, trace the groove with a felt marking pen to make it more visible. The

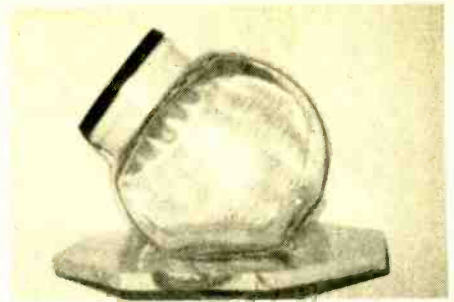

Completed speaker system looks like ordinary cookie jar when viewed from side.

opening can now readily be cut with a sharp knife. Template the mounting holes in the cover from the speaker frame or the Masonite piece.

Putting It Together. Bolt the assembly together with the machine screws and nuts, using washers on the
(Continued on page 93)

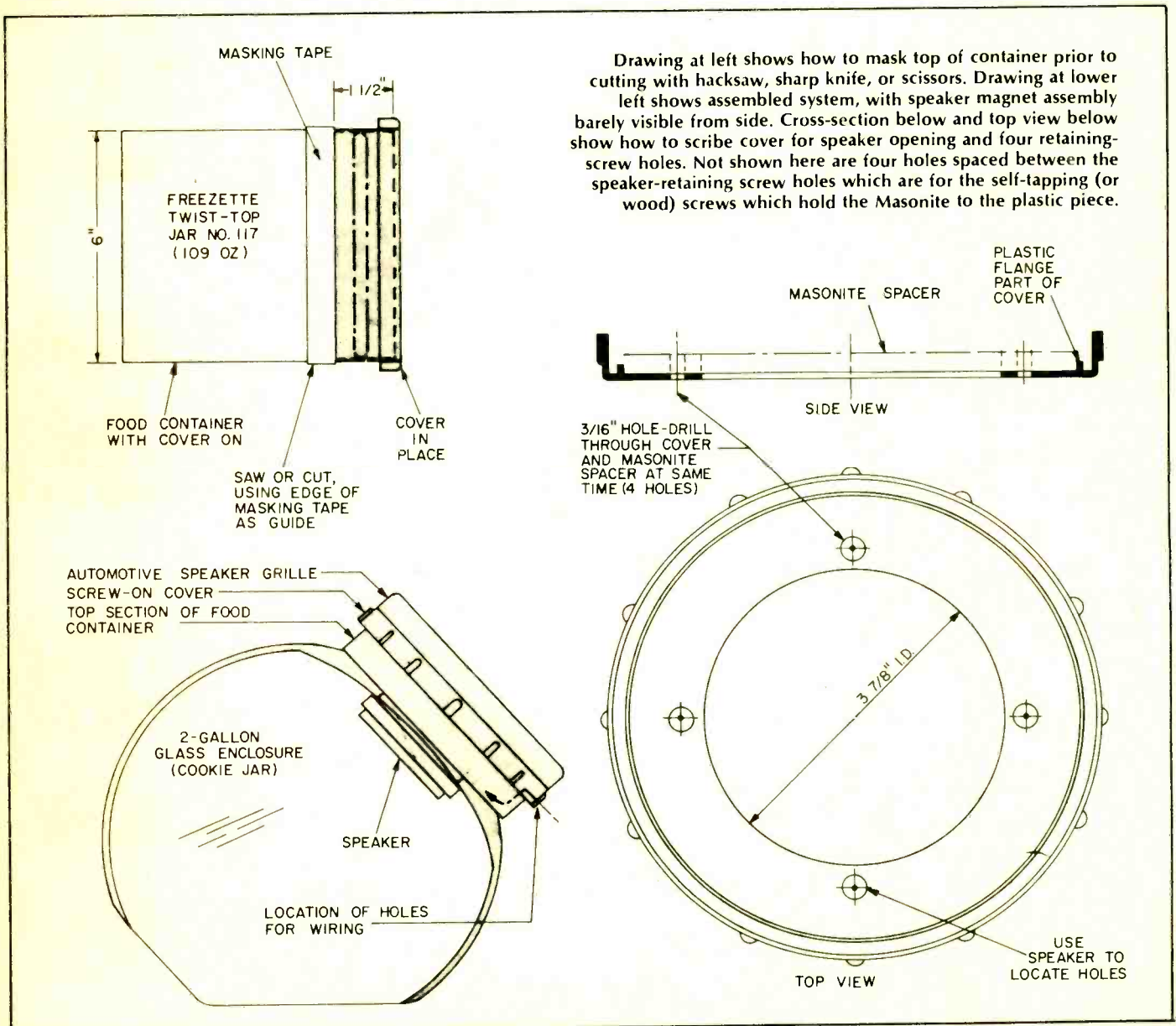

Our CB editor installs her CB rig on a Kriket Kamel

Kathi Rides A Mile For A Kamel

by Kathi Martin
KGK3916

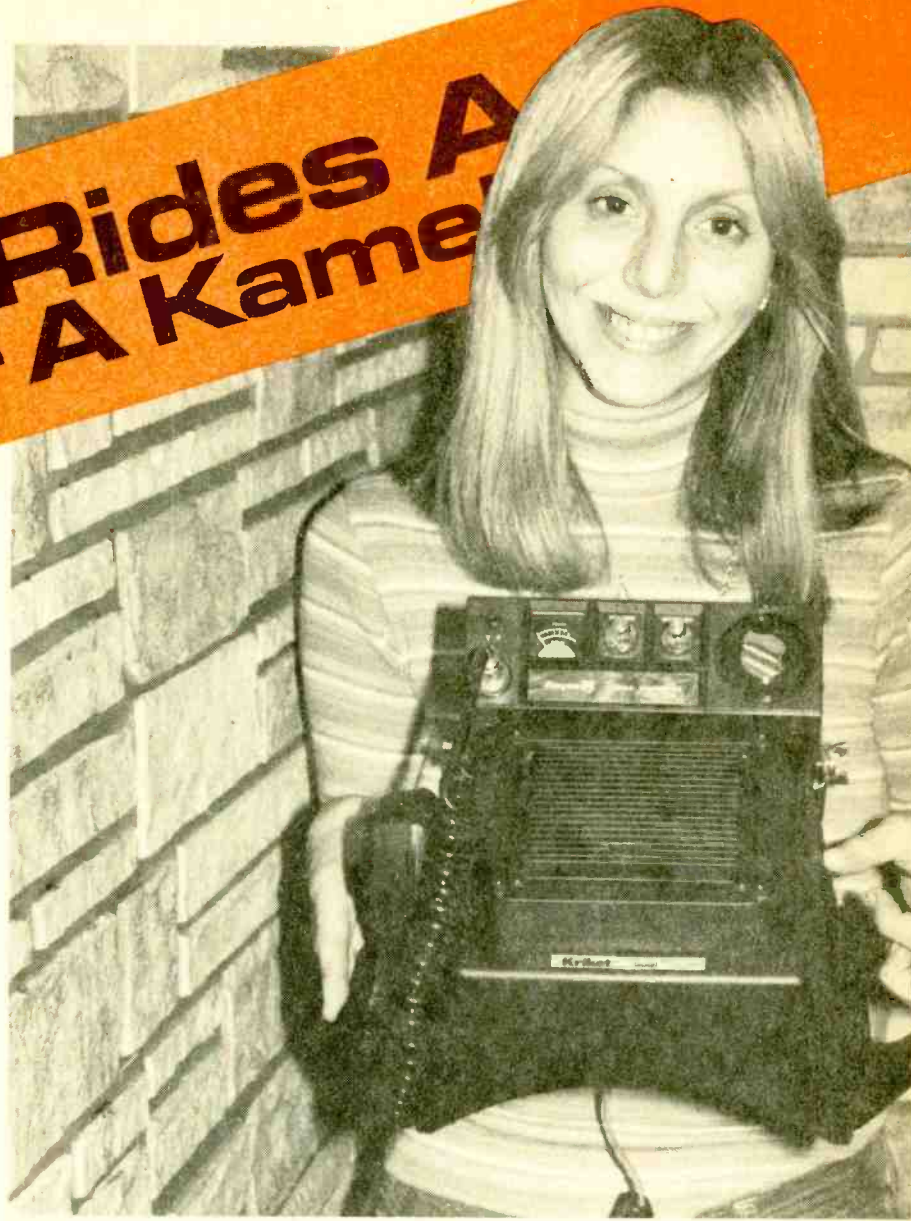

□ I'm beginning to think there's some truth in the notion that, given enough time, even the most useless thing in the world will ultimately serve some good purpose. Take that confounded transmission hump on the floor of your car, for example. It's always been a nuisance. But now it's just what you need to improve the audio performance of your mobile CB unit, and at the same time protect the rig from being ripped off.

First, let's consider the rip-off problem. Maybe you already use a key-locking mount which at least thwarts the more timid, sneak-type thieves who plunder unlocked vehicles from which CB units can be quickly removed by unfastening a couple of wing nuts. But the more determined and experienced Lightfingered Louie isn't fazed by a key lock; he just inserts a small pry bar in the right place and, in moments, literally tears the mounting bracket off your dash. He's not in the least concerned about the damage he also does to the car.

The only truly reliable anti-theft system is one that permits removal of the CB rig *quickly and easily* so that it can be put out of sight in the car trunk or be removed from the car entirely. But you and I know that if even two wing nuts have to be removed to disengage

the unit, we won't bother half the time.

The Kriket Kamel (Model KC-3085 by Acoustic Fiber Sound Systems) is a combination CB mount and extension speaker that offers an ideal solution to the problem. The system rides neatly on that formerly useless transmission hump so that it can't skitter around on the floor when you make a fast turn with the car. Also, specially designed "teeth" hold the unit firmly in place to keep it from jouncing off the hump when traveling on rough roads. And yet, when you want to remove the system, you just lift it off the hump after unplugging the antenna and power leads. There's no fussing with any screws, bolts or nuts.

The really neat part is that your CB transceiver and the speaker/mount come off as a single unit. I'll tell you, after mounting my cherished Royce 1-650 rig on a newly acquired Kriket Kamel, and trying it out a few times, I

became a true believer in the seemingly paradoxical idea that the *easier* a CB rig is to remove, the more *secure* it is!

Now, don't write in to tell me about those "slip-in" mounting brackets that also make antenna and power connections automatically. I know that removal and replacement of the transceiver is easy with such a mount. But there's just one drawback. The thief can see the empty mount and he may risk tearing your car trunk open on the chance that your CB set is in there; he'd get special kicks out of letting you know he hadn't been fooled.

With the Kriket Kamel there's no such telltale evidence because the entire mounting unit disappears from sight along with the transceiver. The antenna and power leads tuck up under the dash, out of sight. Of course, that still leaves the CB antenna to consider because it's the first thing a would-be thief looks for in a crowded parking

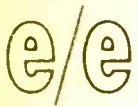

Kathi's Kamel

lot. But that's no problem either, if it's of the removable type or one that folds out of sight into the car trunk.

Another alternative is to use a combination antenna that serves your CB as well as regular car radio; this way you can leave the antenna in place, and the thief never sees that second antenna that advertises the presence of CB equipment. With all evidence removed, there's no reason for even the most persistent crook to go hunting in your locked trunk.

Improved Sound. I'd root for this kind of hump mount even if there were no other advantages. Actually, you also get greatly improved audio with your CB rig because the mount is also an extension speaker. If you have not yet tested your CB with an extension speaker that is larger than that miniscule thing jammed into your transceiver, you have a pleasant surprise coming. The 3½ inch waterproof speaker in the Kriket Kamel provides greatly improved clarity and intelligibility across the entire voice range.

The speaker features a 3-ounce ceramic magnet and ¾-inch voice coil.

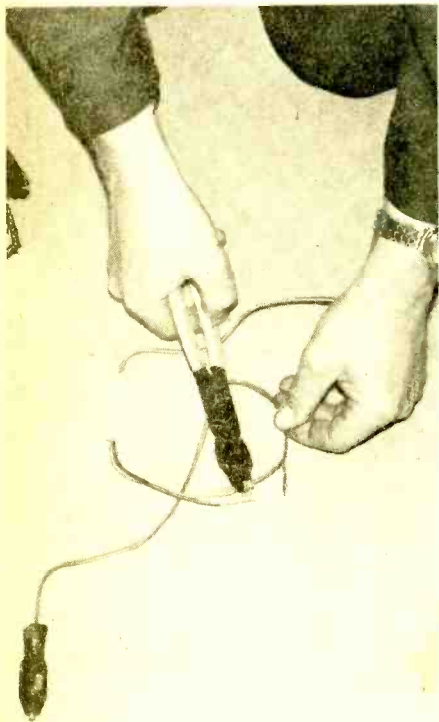

The power cable is assembled with crimp-on connectors with the length selected to provide easy connection to the cigarette lighter with minimum slack cable.

It's air sealed inside an acoustic fiberboard enclosure, AFS's patented "Working Wall" enclosure, that has cross-laminated tubular fiberboard construction.

The power handling capability of the speaker system is rated at 5 watts RMS, 9 watts program, and 13 watts peak. It has a frequency response of 150 to 10,000 Hz, and an 8-ohm impedance.

The entire unit is finished with a newly developed plastic, trademarked *Copolymer*, that is resistant to impact and extreme weather conditions. It comes in one color: black Duralux. The unit is 6¾-in. high, 8-in. wide and 12-in. deep. It weighs only 3¼ pounds, not counting the CB trans-

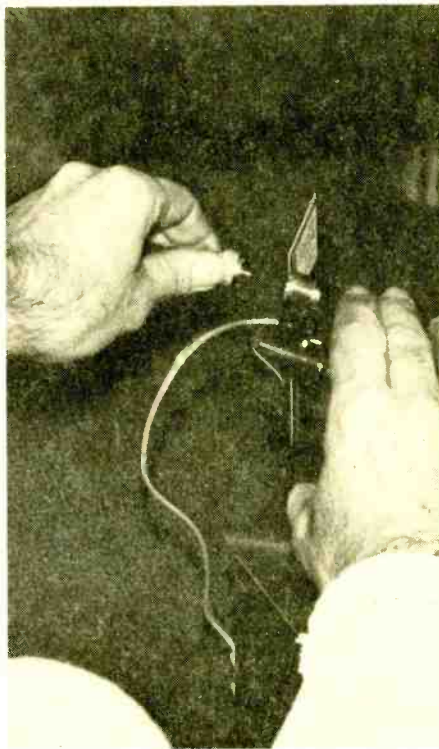

Be sure to connect antenna cable to CB rig when installing the Kriket on hump.

ceiver you will mount onto it. It comes complete with a connector cord with a mini-plug. The KC-3085 has a suggested retail price of \$29.95.

Easy Installation. Connecting my CB transceiver to the Kriket Kamel was no effort at all, especially since I let an eager male who was hanging around do the job for me. It's not that I'm one of those helpless type females, but I figure it does no harm to let the boys demonstrate how clever they can be too—at least once in a while!

There's a slot on top of the Kriket that fits just about any CB mounting bracket, and it takes only moments to attach the two bolts. The single short connector cord coming from the Kriket



The completed installation, with a Royce 1-650 CB rig on top of the Kriket. For more information circle No. 74 on the Reader Service coupon.

plugs into the external speaker jack at the rear of the transceiver.

The easiest and quickest way to provide power is to use a plug that goes into the car cigarette lighter socket. Just cut the cord so that it's long enough to reach to the rear of the transceiver, but so that there's no extra slack to tangle with your accelerator foot. And forget about messing around with a soldering iron; connect the power lead to the section coming from the CB unit with no-solder crimp-on connectors.

That's all there is to it! But do remember to attach the antenna cable to the CB rig before placing the unit on the hump because you could blow some transistors in your transceiver if you attempt to transmit with the antenna disconnected.

To remove the CB rig and speaker/mount, pull the power plug from the lighter socket and disconnect the antenna lead. What could be easier or faster? You can now lift the entire unit off the hump and put it in a safe place. If you must park your car outside every night, you'll sleep better knowing that your CB is safe inside your home. And you will enjoy your next movie—or whatever—a great deal more if you know that your Kriket/CB unit is out of sight in the car trunk.

For additional information circle No. 74 on the Reader Service coupon. ■

CB BATTERY CHARGER SAVES \$\$\$

Low-cost project charges inexpensive nickel-cadmium cells to keep you on the air for pennies an hour.

by Herb Friedman W2ZLF



□ If you're a typical user of one of those high-power hand-held CB walkie talkies rated between 3- and 5-watts input, you know that batteries don't come cheap. And if the cost of the batteries doesn't get you, their leakage will. Leave the power switch on overnight by accident and it's a good bet by next morning the hand-held set will be dripping battery *gook*.

But there is a way to beat the problems of high battery upkeep and leakage, and also to insure maximum RF output at the same time. The answer? Switch to nickel-cadmium (NiCad) penlight batteries (AA size). Are they expensive? Not any more. A NiCad should cost about the price of two alkaline batteries, or even less, and the NiCad can be recharged hundreds, possibly a thousand times. If you use a hand-held transceiver you'll break even

on the second or third recharge.

Hold on, don't go running to the parts catalog to look up the price of NiCads, you probably can't afford them at catalog prices. What you need is a surplus dealer. You see, today everyone is in a hurry and most people can't wait the usual overnight period to recharge NiCads—they demand a *fast-charge* battery. So hundreds of thousands of the overnight (or *trickle charge*) NiCads were dumped on the surplus market, and you can buy them for as little as a buck a piece, no higher than \$1.50. And you get a tremendous advantage with the trickle-charge NiCads: they hold their charge much longer than the fast-charge type. Charge 'em up, stash the transceiver in the closet, or the trunk of your car, and a week or two later they will deliver almost full power. Fast charge NiCads

can't hold a charge that long.

You Can Refrigerate 'Em. Speaking of car trunks, if you leave a hand-held CB set in the trunk and the temperature plunges down near freezing ordinary penlight batteries aren't going to deliver much operating time. But NiCads will still be going like gangbusters in cold weather long after standard batteries are too pooped to pop.

Can your hand-held use NiCads? Simply look inside to tell. If your hand-held uses penlight (AA) size batteries there is probably room for twelve cells though only ten are used; a filler takes up the space of two cells. Since the standard battery delivers voltage of 1.5,

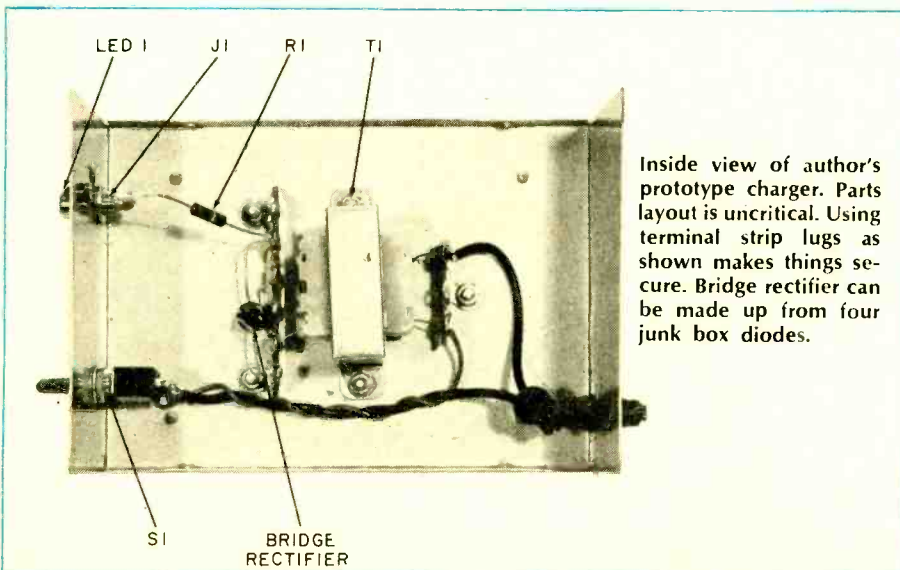

Inside view of author's prototype charger. Parts layout is uncritical. Using terminal strip lugs as shown makes things secure. Bridge rectifier can be made up from four junk box diodes.

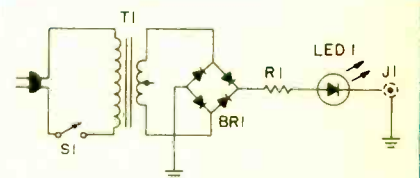

PARTS LIST FOR CB-BATTERY CHARGER

- R1—220-ohm, 1/2-watt resistor (Radio Shack 272-000 or equiv.)
- T1—24-28 volt power transformer rated 100 mA.
- BR1—Bridge rectifier, 50 PIV, 100 mA.
- LED1—50 mA, (Radio Shack 276-026 or equiv.)
- J1—Phono jack (Radio Shack 274-1575 or equiv. Includes PL1, below.)
- PL1—Phono plug (see J1, above)
- PL2—Plug to match transceiver power input receptacle
- S1—Switch, SPST (Radio Shack 275-602 or equiv.)
- Misc.—Cabinet, terminal strips, wire, solder, etc.

e/e CB Battery Charger

ten batteries equals a fresh power pack of 15 VDC. But NiCads only deliver 1.2 volts, so twelve batteries are required to produce 15 VDC. The two "extra" NiCads fit in place of the filler. So in order to use NiCads your set must provide room for twelve, rather than ten cells. There must also be a jack on the side of the transceiver to which a charger can be connected. If you have both these conditions (space for twelve cells, and a charger jack) you can use NiCads. The only exception to this rule is a few models which cannot accept NiCads because some NiCads are very slightly longer than a standard penlight AA battery, or the CB set manufacturer did not allow for the extra size even though he provided a charger connection. Make certain your hand-held set will accept NiCads before you buy them.

Really Low-Cost. Finally, you need a NiCad charger, and that's where you can spend real money, but really! One of the top instrument companies charges \$30 for a NiCad charger you can build for less than \$8. They get this exorbitant price because they manufacture one of the very few chargers that can handle all twelve batteries at the same time. Most chargers handle only four to eight cells at a time, taking two to three days to recharge a complete set of NiCads. If you can recharge all twelve cells at once you plug it in in the evening, and you're ready to go the following morning.

The diagram shows a simple but effective charger circuit that will handle up to twelve cells simultaneously. It needs no regulation or control because it trickle-charges *any* type of NiCad. You can even leave it plugged in continuously without fear of damage to the cells, thereby insuring the NiCads are always in a state of full charge. The

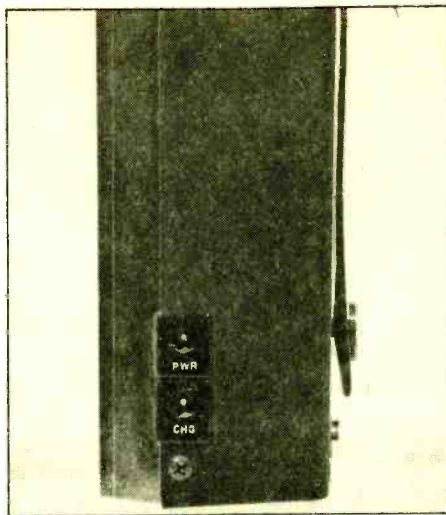

Side view of author's CB transceiver shows two inputs, one for charging internally-contained Nicad batteries.

charging current is 40 to 50mA regardless of the number of cells (in case some become defective), or their state of discharge. From full-discharged to fully-charged the charging current is always a safe 40 to 50mA.

Use These Parts. Excepting the cabinet, if you select surplus components the whole thing will cost less than \$8. If you buy all new, you'll run up unnecessary expense, which have no effect bearing on the performance.

Transformer T1 is 24-to-28 VDC at no less than 100 mA. It doesn't have to be more than 100 mA. Don't waste your money on a high current filament transformer. If you use a 28-volt transformer increase R1's value to 270 ohms. BR1 is a 50 PIV bridge rectifier rated 100 mA or better. Use the least expensive type you can get. If you have four discrete silicon diodes lying about simply connect them as the bridge circuit.

LED 1 serves as both a pilot light and Charge indicator. If the LED doesn't light the batteries aren't being charged. The LED also serves as a fuse. If the rectifier and R1 short

out the NiCads will attempt to discharge through the diodes and the high discharge current could cause considerable damage. But the LED will burn up almost instantly, thereby opening the circuit to the batteries.

The LED is the only critical component, in the sense you must be certain it is rated for a *maximum* of at least 50 mA. We suggest a diffused LED be used as its light can be seen from the sides. If possible, use a Radio Shack 276-026 for LED 1.

To mount the LED simply push it through a hole in the front panel of whatever you use for the cabinet. If you connect R1 between the LED and a terminal strip as shown in the photographs the LED will be held in position without need for glue or a lamp mounting kit. The cabinet can be plastic or metal; the one shown in the photographs is Radio Shack 270-252.

How To Connect It. The charger's output is through phono jack J1 rather than a direct cable. In this way different



Charger can connect to wide variety of NiCad battery packs using the universal cable described in text.

patch cords can be connected to accommodate the several styles of plugs required for transceivers charging jacks. Just make certain you get the charger plug polarity correct. Before PL2 is wired, insert it in the transceiver's charging jack and measure the voltage across the jack noting the plug's polarity. Normally the shield is ground (-) and the tip (center conductor) is positive, but it can sometimes be the other way round. Make certain the charger's positive output connects to PL2's positive terminal. You can damage the NiCads badly if you get it reversed.

Note that most transceivers are disconnected when the charger plug is inserted, so don't expect to operate the transceiver while charging the batteries.

Using The Charger. Resistor R1 limits the charger's output to 40-50 mA even if the output jack is shorted, so the charger can be used with hand-held

(Continued on page 93)

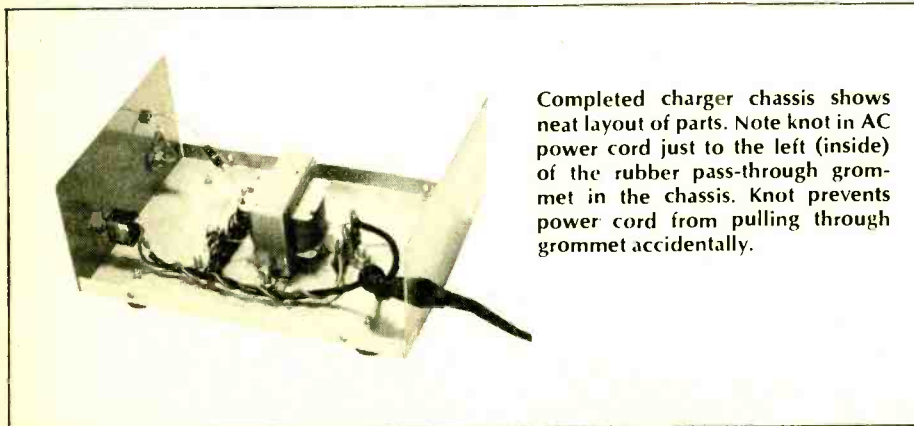

Completed charger chassis shows neat layout of parts. Note knot in AC power cord just to the left (inside) of the rubber pass-through grommet in the chassis. Knot prevents power cord from pulling through grommet accidentally.

e/e assembles the...

HEATH AS-1344 2-WAY COLUMN SPEAKER

One evening project yields high fidelity speaker system at real savings.

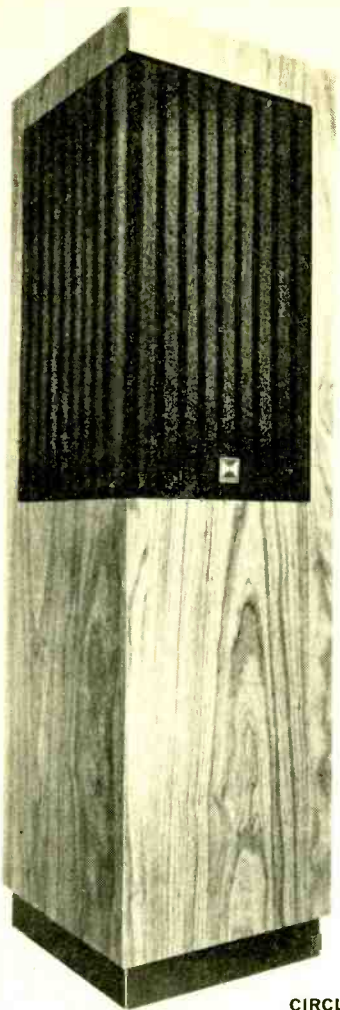

CIRCLE 31

□ Most speaker systems radiate sound forward, and have no way to resolve unusual acoustic problems such as extra-long rooms or walls, unusually *hard* (reverberant), or unusually *soft* (dead) listening areas.

Here's how many unusual sound reproducing problems can be handled. Just use a pair of Heath's AS-1344 Two-Way Column Speaker systems. Unlike most hi-fi speaker systems, which have all the drivers facing in one direction, the Heathkit column has matching speaker systems on two sides for a total of four driver units per column. Each side system consists of a 6½-inch woofer and a 1-in. dome tweeter. Both systems are driven in parallel, with a crossover and a moderate (3 dB) high frequency roll-off switch which may be used to compensate for "hard" rooms. The impedance rating of each column speaker is 4 ohms. Two fuses protect the woofers and tweeters against excessive power input.

Parts for the crossover network and the tweeter level switch are mounted on plate which goes on the bottom of the cabinet. Step-by-step instructions make this kit easy to put together even if you've never assembled a kit before.

Heath provides several illustrations in the instruction manual showing speaker placement for various acoustic conditions. Because each speaker radiates sound energy equally from two sides the user can orient the columns so most sound is radiated forward, or by aiming one side towards a side wall, or a corner, part of the sound can be reflected or diffused to provide a broader or narrower sound field.

This system is designed for flat energy response—a widely overlooked factor in speaker design. The reason is simple: once you're six feet away from a speaker, up to 80% of the sound you hear is reflected off the walls, ceiling and floor of your listening room. So even if the "on-axis" response is excellent, poor response off-axis can make a speaker's treble sound dull. Combining excellent on- and off-axis response produces flat energy and a bright, completely realistic sound.

There are other design features which contribute to the AS-1344's excellent

sound, too. The woofers are located well above the floor, so bass response is very solid and well-defined. There is no mid-bass boom or resonance either, so middle frequencies come through remarkably clean and clear. The tweeters deliver 10 to 20 dB more off-axis output than conventional tweeters for bright, realistic highs—and their 270° dispersion pattern maintains a well-balanced stereo image through a wide area.

What You Get. Each column speaker is supplied as a semi-kit. The cabinet itself is factory assembled and finished. All you do is put the drivers and crossover into the cabinet. Overall dimensions are 40-in. high x 11-in. wide x 11-in. deep. The foam grilles which protect the speaker drivers on adjacent sides of the column snap off to provide access to the speaker openings pre-cut in the cabinet. Similarly, the bottom of the cabinet has a pre-cut opening for the combination crossover and high frequency control switch. The cabinet is

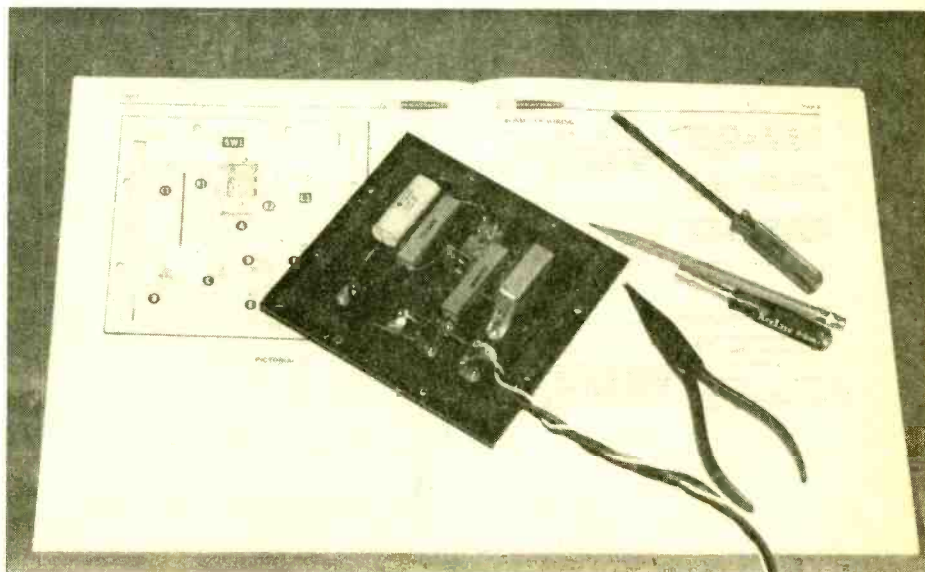

e/e Speaker System

This Heath speaker kit is a confidence builder. Page-size diagrams guide the assembler every step of the way eliminating goofs that would be made usually by novices. Also, checking is simple to do. White area seen in holes for speaker is acoustic batting.

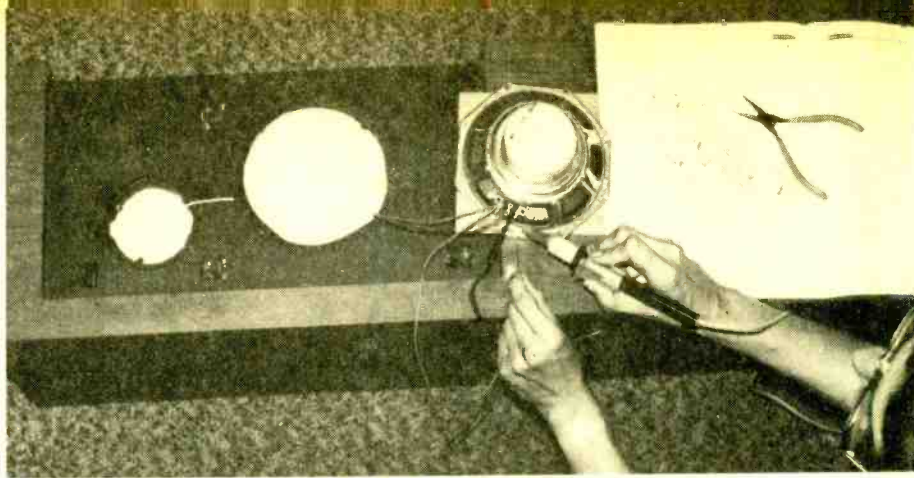

supplied with the sound insulation in place. Some of it must be temporarily removed when assembling the speakers and crossover.

First step in assembly after identifying all the components is to wire the crossover on the plate supplied. This plate also contains the high frequency control switch. After the crossover is wired the speaker-connecting leads are installed in the cabinet and the crossover is connected and then installed on the underside of the cabinet. Finally, the speakers are connected and installed. Foam-tape strips for each speaker opening and the crossover cutout seal the cabinet for acoustic-suspension operation. All that's left is to apply the foam grilles and the column is ready for use. If you want to blend the color of the grilles into your decorating scheme they can be painted with an

enamel or lacquer spray paint.

Speaker Placement. There's no specific recommendation for speaker placement because every listening environment is different, just as every listener's desired tonal response differs from that of other stereophiles.

The best way to get the most pleasing sound quality is to try all the different placement systems suggested in the Heathkit manual, also using the 3-dB control switch for each placement. Use whatever final placement sounds the best to you, regardless of the theoretically optimum placement suggested in the manual. After all, it's *your ears* that do the listening.

Power In—Sound Out. These Heathkit column speakers are rated for a minimum input of 5 watts and a maxi-

imum of 100 watts. A 1½-ampere protective fuse is provided in each woofer circuit and a 1-ampere fuse is provided for tweeter protection.

Normally, an amplifier or receiver of 5 watts rated output is all that's needed for a comfortable sound level, while 15 to 25 watts is required for a robust (loud) sound. In a typical living room of 15 x 20 feet about 20 watts per channel will produce a sound level more or less equal to that of a large orchestra in a concert hall.

The Heathkit AS-1344 Two-Way Column Speaker System is available by mail order for \$129.95 each. Prices in local Heathkit stores are slightly higher. For additional information circle No. 31 on the Reader Service coupon.

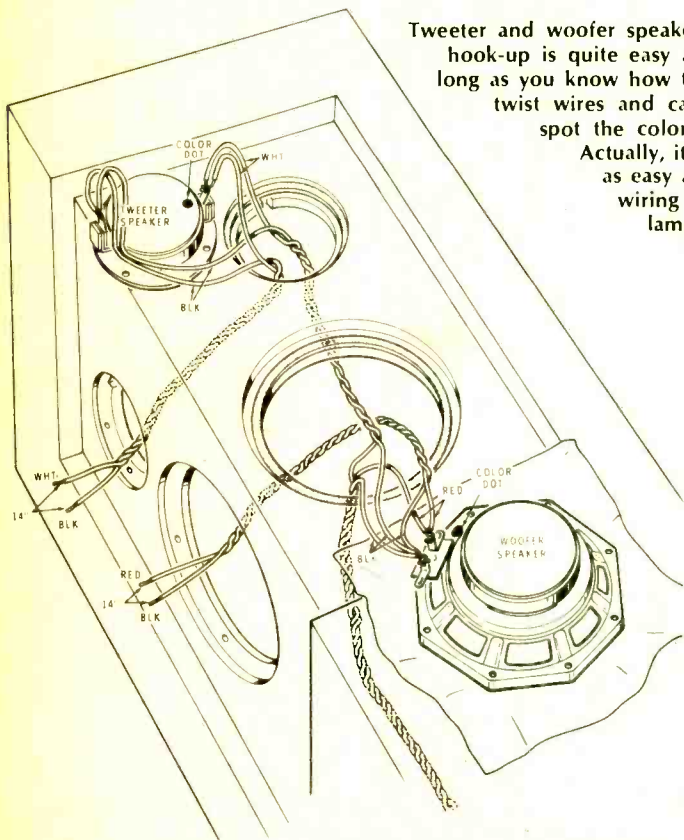

Tweeter and woofer speaker hook-up is quite easy as long as you know how to twist wires and can spot the colors. Actually, it's as easy as wiring a lamp.

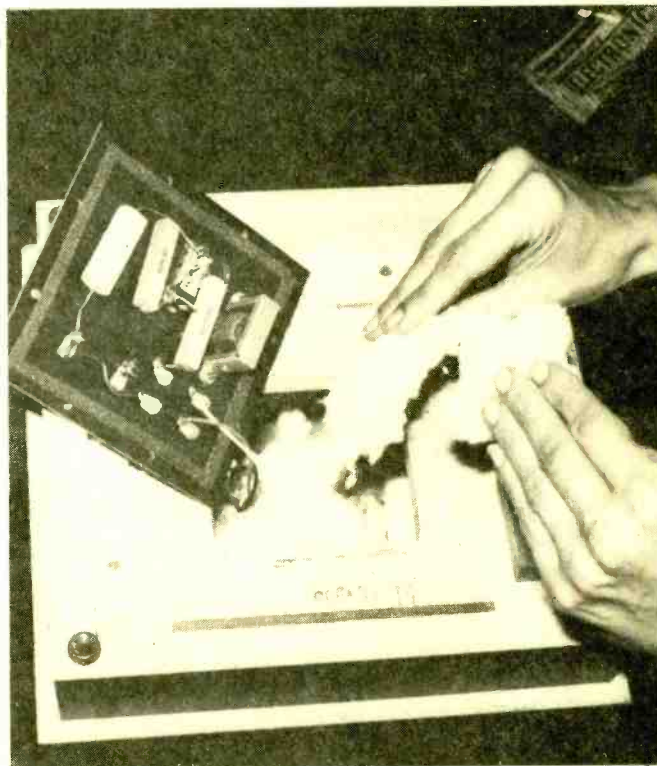

The bottom plate is almost ready to go in place—just as soon as the sound absorbing material is dropped into the cabinet. Note sponge-like strips along bottom of the plate. They keep an air-tight seal as needed.

For more information on the Heath AS-1344 Column Speaker kit circle No. 31 on the Reader Service coupon.

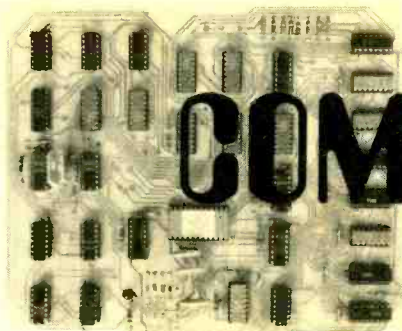

COMPUTER READOUT

by Norman Myers, Computers Editor

KIM-1: Microcomputer of many uses plays games

□ Welcome back to Computer Readout. Last time we visited a micro-computer fair, and then we looked at the popular KIM-1 computer-on-a-board from MOS Technology. In this column we delve deeper into KIM-1's micro-magic and have a guaranteed good time. Cass and Dan Lewart, avid KIM-1 users, have given us lots of ideas on how to use this microcomputer that I'm sure you will find interesting.

First let's quickly review the basic KIM-1. It comes already assembled on a 9 x 10-inch printed circuit board that contains the MCS 6502 microprocessor chip, over one thousand words (or bytes) of random-access-memory (RAM), a small keyboard for entering data or programs, a six-digit LED display and much more. The first four digits of the display show the address of a selected memory location in hexadecimal code (means 16 in Greek, as explained last time) where 0000 is the first location and 03FF is the last location. Remember that in hex, sixteen numbers are represented with a *single* digit by using the notation 0, 1, through 9, and A, B, through F. Count 'em and you will find sixteen characters in this string. So, since 03FF is the last memory location, we must have $4 \times 16 \times 16$, or 1024, memory cells available—and indeed we do. Going back to the six-digit display, the other two hex digits show the data contained in, or being



KIM-1 microcomputer can use a recorder as well as other input and/or outputs.

put into, the memory cells indicated by the four left-most digits. A data byte is 8 bits (0s and 1s) long allowing 256 possible values per byte. In hex notation, 00 through FF covers these 256 values. The data can be written, or any address can be selected, via the keyboard, which has the hex characters 0 through 9 and A through F right on it.

Control of the data flow between the microprocessor and the outside world is via two MCS 6530 chips which have 1024 locations of read-only-memory (ROM). These ROMs have been pre-

programmed by MOS Technology. They contain *Monitor-and-Executive* programs that control display of the digits on the LED, receipt of digits from the keyboard, and even allow a teletype (TTY) or an ordinary cassette tape recorder to be used with KIM-1. The cassette unit is very easy to connect and lets you write programs from the KIM-1 memory onto your tapes and vice-versa. Fantastic! This ability to write, save, and recall programs, and even data, opens up hundreds of possibilities. You can save programs forever, and reload them into your KIM-1 in seconds. The next question, of course, is what can be done with this micro-magic device?

What To Do With It? You may first think that the main function of a computer should be to crunch numbers, that is, add, subtract, multiply, and divide millions of them at a terrific speed. Some people think that because the speed of the KIM-1 is about 500,000 operations per second, it can help in balancing the checking account faster. Well that view is not quite correct because if the calculations are of the ordinary kind and there is not much data to crunch, you can just buy a pocket calculator. On the other hand if you have a large amount of data you might need a teletypewriter, a card reader, a high-speed printer, and a keypunching machine. These are all expensive items far beyond the scope of a simple hobbyist installation. Well, then, what good is your KIM-1? The answer is that it is super as a *controller*, a universal *game machine*, and as an *educational tool*. In these applications your KIM-1 will really shine. These three application areas are discussed in more detail in the following paragraphs. First, I must give you a little advice: Join a microcomputer User's Club. You will be able to exchange your ideas with those of other KIM-1 owners and you will learn a lot in the process. Further, you do not have to be a computer owner to join a club. An excellent way to become familiar with KIM-1 is by subscribing to

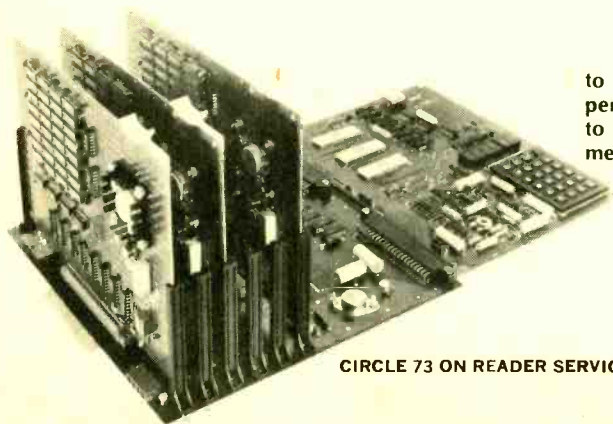

KIM-1 connects to KIM-4 "motherboard" permitting plug in of up to six more boards for memory expansion.

CIRCLE 73 ON READER SERVICE COUPON

e/e Computer Readout

the *KIM-1 User's Notes*, which are published roughly every two months. The notes contain articles sent in by hobbyists on what they have been doing, programs they have written, latest hardware and software available for the KIM-1, etc. You can get on the mailing list by sending a \$5 check to KIM-1 User's Notes, care of Eric Rehnke, Apt. 207, 7656 Broadview Road, Parma, Ohio 44134.

KIM-1 As a Controller. One of the advantages of a microprocessor as compared to a calculator is the ease with which a microprocessor can be connected (*interfaced*, using computer lingo) to the outside world. KIM-1 is particularly simple in this respect because its input and output are permanently associated with a few specific memory locations. These special input/output locations are treated by the microprocessor as if they were regular memory locations. The data in these locations can be read and manipulated by the program in the microprocessor. KIM-1 is an 8-bit machine, therefore 8 pieces (bits) of information can be extracted from each input/output location. One of these special locations appears on 8 pins of the KIM-1 connector. If for example decimal number 5 is stored (00000101 in binary) in one of these special locations a positive voltage would appear on pins #2 and #0 and ground would appear on the remaining 6 pins associated with this location. Similarly one can use the same connector for inputting 1s and 0s to memory by applying appropriate voltages to the pins. A code word in another special location in memory determines which connector pin is the *input*, and which is the *output* of the computer. Voltages on the KIM-1 connector pins can be used to control lights, turn relays on and off and thus do anything which can be operated by an electric sequencing motor. A reading or writing instruction takes only a few microseconds, so KIM-1 can alternately process input signals arriving via input leads and quickly issue commands via output leads. A built-in crystal-controlled timer further increases the microprocessor's usefulness.

A typical application would be an elaborate model-train control where inputs consist of position sensors and manual switches while outputs are relay closings directing the trains and their speed, while also controlling crossing lights and audio signals. Other applications for KIM-1 could be its use as a

light-color organ, or as a robot, finding its way through a maze as it responds to audible signals. As you can readily see, possible applications of the microprocessor as a controller are nearly endless. A simple program can frequently replace dozens of interacting relays. And a small change in the program will make your gadget behave in a completely new and different way. Just try to duplicate such changes with a soldering iron and you will really start appreciating the microprocessor.

KIM-1 As Universal Game Machine. In spite of all the serious-sounding papers given at computer conferences around the world the main microprocessor application at present for the hobbyist is to play games. The simple input/output mentioned in the previous paragraph makes game playing with KIM-1 real child's play! Both the keyboard and the LED displays are connected to the microcomputer via certain memory locations in the same way as the previously-described input/output terminals. Therefore by judicious

programming, and without need for external devices, one can use the built-in keyboard as a "live" game input, while the 6-digit LED display is the game readout. It is amazing how one can, with a little imagination, design a complete alphabet with only a seven-segment LED display. KIM-1 can then be programmed so that messages flash or scroll across the display (right-to-left or left-to-right, whichever you prefer). Only a few of the many games written for KIM-1 are listed here. This is just a small selection, to give you a feel for the possibilities. Many more games, such as Star-Trek have been written but they require additional memory beyond the standard 1024 bytes provided with KIM-1. Here is a partial list.

Lunar Lander You steer a landing craft by varying the amount of fuel. If you run out of fuel (burn too much) or do not slow the craft sufficiently (burn too little), it will crash. You can continuously display the altitude and speed of the craft, or by pressing the F key you can monitor the remaining

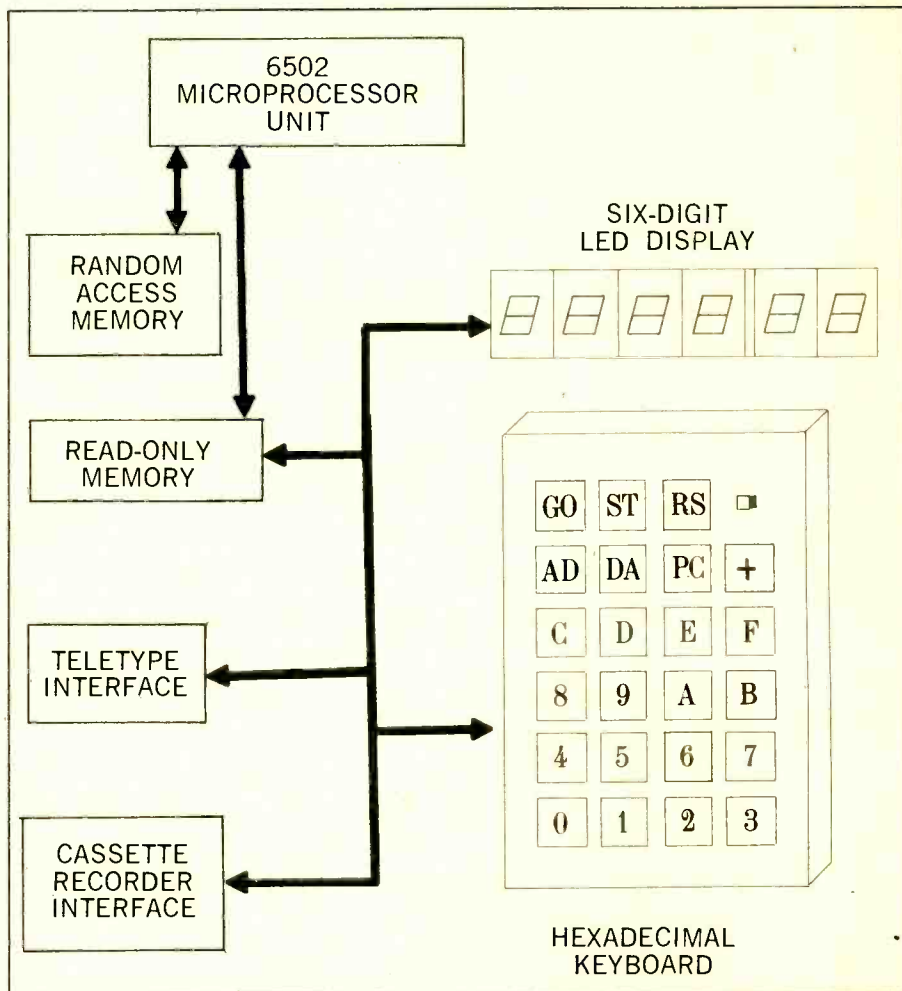

This block diagram shows how the main elements of the KIM-1 microcomputer work together, as well as with additional input and/or output devices. With basic unit only all input is manual keyboard and the only readout is the six LED numerals.

fuel supply.

Music Machine You can write your own song in the form of codes stored in successive memory locations. You specify the pitch and length of each note; you can also repeat certain passages at will. Connect one of the KIM-1 application connector pins to an amplifier to hear the song play.

Electronic Organ Each key on the built-in keyboard corresponds now to a specific note. You play the keyboard like an organ. Program changes make it sound like different instruments. This is a modification of the previous program.

Reaction Time Tester A random 4-digit number appears for two seconds on the display, then it disappears. You then reenter the same number as quickly as possible. The 2 right-most digits indicate how many tenths of a second it took you to reenter the number. If you make a mistake or take more than 10 seconds, FF will appear. A variation of this program indicates (in 1/100 of a second) how long it took you to press a key after a number flashed randomly on the display.

Hunt the Wumpus. Hunt the mythical "Wumpus" through a maze of caves connected via tunnels. The danger consists of bottomless pits, bats which can carry you off (to a random location), and the Wumpus which can eat you. Messages appear on the display giving you hints about your situation. To catch and to domesticate the Wumpus you throw a sleeping gas canister at his suspected habitat by pressing the PC key. The game ends when a message "You got a hug from Wumpus", or "You Lose" scrolls through the LED display.

A nice feature of all these games is that a slight reprogramming will completely change from one to the other.

KIM-1 As an Educational Tool. Finally, with all the fun you can have with KIM-1, do not forget its educational value. A few days of operating your own microprocessor will give you more understanding of its capabilities and possible applications than will reading dozens of books. If you are an engineer or technician, or are planning to study in those areas, you will know that a good knowledge of microprocessors is indispensable. Writing a few KIM-1 programs will teach you concepts of basic computer operation. You will learn the computer instruction set and observe programs working by displaying appropriate memory locations. Your final conclusion about owning a microprocessor may well be: How did I ever get along without one before?

Memory Expansion. It is not easy for

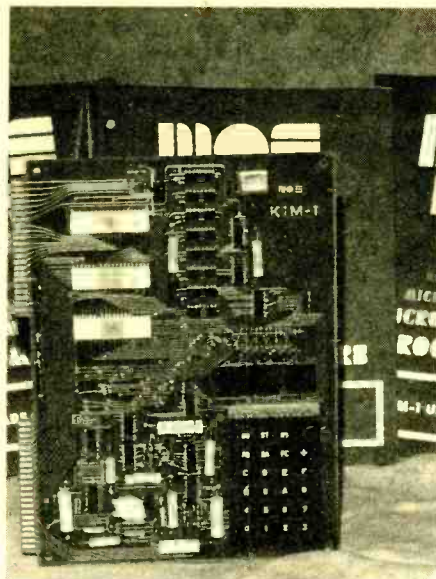

MOS Technology's KIM-1 microcomputer is complete on one board except for the power supply. Readout display is six 7-segment digits above the keyboard. KIM-1 assembled sells for \$245.

people to expand their memories, but with KIM-1 it is easy; you just plug in the extra boards. Suppose you have a super program (like a big Star Trek game) that requires more than the 1024 bytes that the basic KIM-1 can hold. You can simply purchase a KIM-2 memory board which has 4096 locations, or a KIM-3 which has 8192 locations, or both, and connect them to the basic computer. Either of the boards can be wired directly to the computer with cables or you can use the new KIM-4 Motherboard. The Motherboard is actually a kind of frame with plug-in jacks that allows up to 58,000 memory locations to be added to your KIM-1. Both the KIM-2 and KIM-3 have all the built-in control circuitry needed to let them converse with the main computer without losing any bits. Further, each board has four little switches that you set to specify the beginning and end of the memory on that board. For example, setting the switches to 0001 causes the memory address of KIM-2 to run from 2000 to 2FFF, which covers 4096 memory locations. So if you want to talk to that KIM-2 board through your KIM-1, you use any memory location between 2000 and 2FFF. The user's manual for these memory-expansion boards has a test program that can be run to check out their operation. The memory will first fill all the memory locations with 0s, then read back the memory contents to see if 0s are really there. It then uses 1s, and so forth, until all digits and all memory slots are checked. If any memory location fails to properly store a

digit, the address of the defective memory cell is written out to the display, or to your teletype terminal.

Memory Make-up. The make-up (structure) of the memory expansion boards is simple but interesting. The boards are composed of small integrated circuit modules called 2102 static RAMs. Each RAM holds 1024 locations of one bit each so to store 1024 bytes with 8-bits-per-byte you must have 8 of these RAMs in parallel: one RAM for each of the 8 data lines. The data from KIM-1 first enters a buffer on the KIM-2 or KIM-3 board where it sits waiting to be clocked into the RAMs. To tell the RAMs which cell should hold each 8-bit data word, there is a 16-bit address word. The first three bits of this address word tell which board is being called (you can have several boards). Another three bits are used to specify the RAMs on the board. The last ten bits are used to specify one of the 1024 locations in the RAMs.

KIMath. Now let's look at another feature available for use with KIM-1. This is a permanent program in read-only-memory (ROM) that does several mathematical routines. Known as KIMath, the ROM allows nine automatic calculations ranging from square roots and logarithms to trigonometric functions like sines and cosines. This ROM is available on a board that plugs into your Motherboard or which can be cabled directly to the KIM-1. With this math package, all sorts of mathematical routines can be easily written into programs. KIMath is like connecting a calculator to your KIM-1, with data entered from the keyboard or from memory, and results displayed on the LEDs or on the TTY.

The only way to find out what it really is like to create programs, to store them on a cassette, to change them, and to have this microbrain be the center of a lot of interest is to buy it and try it. The KIM-1 with manuals costs \$245, the KIM-2 is \$179, the KIM-3 is \$289, and KIMath with documentation is about \$50. These are not, however, the only add-on modules available. MOS Technology also has a text editor, a program assembler to aid in writing programs, and other things are in the works all the time. For detailed specifications on the products, write to MOS Technology, 950E Rittenhouse Road, Norristown, Penna., 19401, or circle number 73 on the Reader Service coupon.

In the next issue we will continue to keep abreast of the microcomputer world. Stay tuned and remember to write to me with your interests, questions, and ideas. ■

THINGS YOU PROBABLY DON'T KNOW ABOUT CB RADIO AND SHOULDN'T!

by Wally, Unit 944

□ DON'T LOOK NOW, but there are almost as many CB stations operating above, below and in-between authorized CB channels as there are *on* the channels. The FCC hasn't been happy about this, but has been able to do little about it for lack of funds and manpower. As a result, these "channels" buzz away with CBers! These are among the little known facts about CB!

The Low Frequencies. The CB channels start at 26.965 MHz (Channel 1)—or do they? Fact is that if you have a communications receiver you can tune in frequency as low as 26.630 and hear CB communications—and they seem to pop up every 5 or 10 kHz right on up the band to Channel 1.

This is accomplished several illegal ways, by means of sliders, VFO's (Variable Frequency Oscillators), crystals, and PLL modifications. Each method is strictly in violation of Part 95.

A slider is a modification to a CB rig—usually it costs about \$35. It is, essentially, what ham operators used to call a "rubber crystal." With a slider you can move right off any CB channel to any frequency you want as far away as 5, 10, 20 or more kHz from the authorized CB channel.

A VFO is an external device which plugs into the oscillator circuitry of a CB rig, giving the operator the chance to tune a CB rig to any desired frequency within the range of the VFO. The operator then simply dials the frequency wanted the way an AM or FM broadcast receiver would be tuned in on a station.

CBers long ago learned the trick of taking *discrete* receiver crystals (those crystals designed for older CB rigs which didn't have synthesized oscillator circuits) and switching them into their discrete transmitter circuits. Few modern-day CB rigs are designed for such crystals, but all older sets used them—and older CB rigs are still available at give-away prices. The crystals for receiving are 455 kHz lower than the frequency of the CB channels. So if a discrete receiver crystal for CB Channel 23 (27.255 MHz) was plugged into

the transmitter, the CB'er ends up with a transmitting frequency 455 kHz below the channel, or 26.800 MHz. As it turns out, 26.800 MHz is a very busy frequency, and every time there is a *skip* opening it buzzes away with wall-to-wall stations from one end of the country to another, all using old CB rigs tied to communications receivers!

CB'ers have also found that many of the new Phase-Lock-Loop (PLL) rigs are inexpensively modified by underground technicians to open up a whole new world of unauthorized channels. Months before the 17 new CB channels were authorized, CB'ers with PLL type rigs were having these modifications done. One 23 channel PLL rig we saw was quickly fixed up to operate on 44 channels, with the lowest frequency being 26.865 MHz and the highest 27.425 MHz—far past the band edges authorized. There were a few channels "missing" in between, due to the nature of the PLL circuit in that particular unit.

Of course, ham radio transceivers are eagerly sought after by many CB'ers, who have found that ham transceivers such as the Yaesu FT-101-E, the Tempo I, and various Kenwoods, Swans, Drakes, and the new mini rig, the Kachina, all function remarkably

well on CB frequencies—and other frequencies in their general area too! Not only that, some of them will put out a 250-watt (PEP) sideband signal which is quite illegal.

Another World. So what we have is a wide assortment of available equipment, combined with hundreds of thousands of operators who have such gear and the will to use it, and the FCC who seems little more than totally befuddled by the whole situation!

High Frequency. The so-called *high frequencies* are the stomping grounds for many more illegal stations that use the lower frequencies below Channel 1. Up until the advent of the expanded CB channels, the high frequency band started on 27.265 (now Channel 26) MHz and went on upwards to about 27.755 MHz, almost the low frequency edge of the 10 Meter ham band. Operations between 27.265 and 27.315 MHz were used primarily by AM operators, while 27.325 MHz and above were occupied by Sidebanders. Some CW (code) operation has also been noted.

The CB channels now end at Channel 40 (27.405 MHz), so those who have elected to operate on unauthorized channels have had to move their opera-

(Continued on page 91)

SIDEBANDERS' SERVICE BUREAU

CERTIFICATE OF AWARD

This Certificate has been awarded to:

upon proof of qualification for the following Communications Award:

Date: _____ 19____

For: Sidebanders' Service Bureau
P.O. Box 381
Smithtown, NY 11787

Here is the Sidebanders multi-purpose achievement award. Text gives details. You decide value!

MOD-X, THE SIMPLEST CLOCK YET

by Norman Myers



Take just 8 parts, and a couple of switches, connect this module to make an alarm clock in less than two hours.

□ Dozens of clock projects have been published in the past three or four years, and they all have two things in common: an integrated circuit which contains most of the counting and timing circuits for making a digital clock, and *lots* of wiring, especially between the integrated circuit chip and the read-out devices. These range from Numitron or other multisegment display tubes for each number to the more-recent, and easier, all-in-one, 7-segment LEDs which have four or six digits in one compact assembly.

Even with their maze of interconnecting wires many of these clocks offer only time, and (usually) an alarm. Some, but not all, permit you also to read the seconds as they elapse, and more and more have the Cat-nap (snooze) feature.

Now, thanks to today's improved methods of IC manufacture and mass-

production, which continue to bring prices down, down, National Semiconductor Corp. has brought out a *complete* clock-on-a-chip, including the readout display—the numbers which show the time. You no longer have to connect the outputs of the circuit chip which does the computations to the display digits, because the display and the clock chip are all on one small assembly, ready to build into a case and connect to a simple power supply, a couple of switches, and if you like, to an alarm.

If you want to add a couple more switches you can have a clock which displays the seconds, on command, or which includes the cat-nap (snooze) feature. Finally, if you want to add one more switch you can include the *hold* feature, which makes setting the clock a bit faster. The wiring for these extra features is shown in the spec sheet

which comes with the clock module. This module is made in several versions by National, depending on whether the clock is intended for use in 50 Hz or 60 Hz countries, and on whether or not it's intended to display 24-hour or 12-hour time.

In addition to these features, this clock can tell you if there's been a power failure. To tell you that the time it shows is incorrect it flashes on and off once every second until you stop it. When it's telling time the colon between the hours and the minutes numbers flashes once every second. Chip-X also tells you whether it's AM or PM. It does this by showing a dot in the upper left hand corner in the PM. Finally, when the alarm is set to go off, a period at the lower right is lit. Press the alarm button to be sure the alarm is enabled (ready), put S4 on *Alarm*, and go to

(Continued on next page)

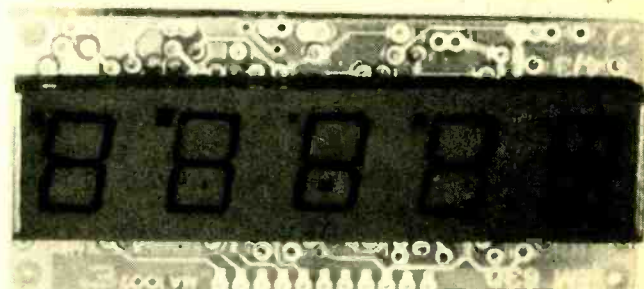
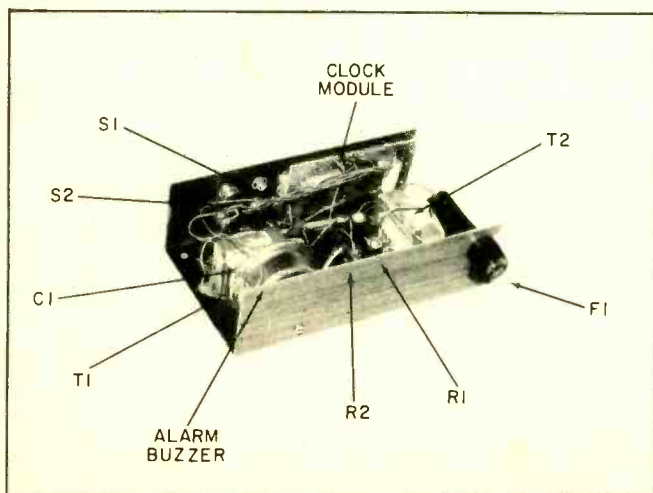
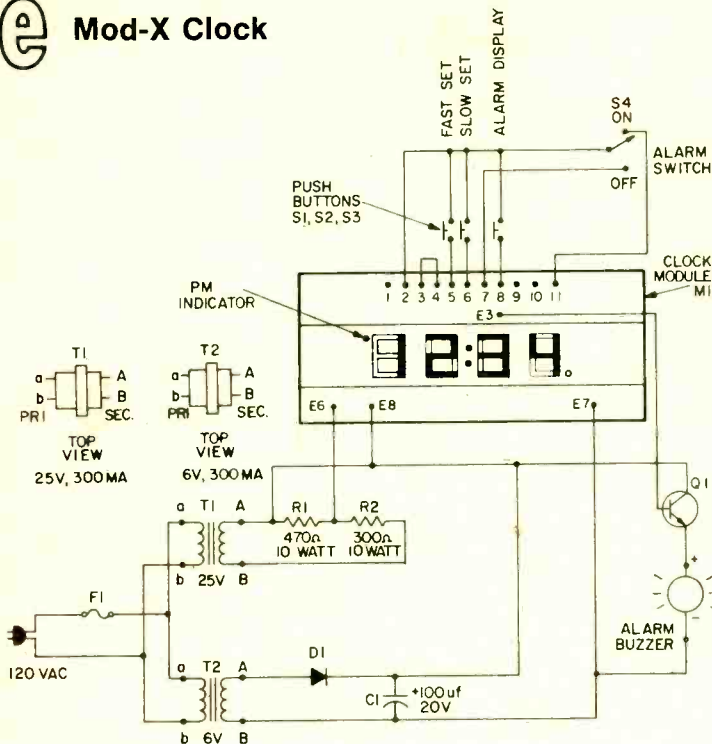

Photo at left shows placement of parts in author's clock. Placement is entirely uncritical and you can use any convenient arrangement, depending on the space you have in the case you select. Picture above shows the actual module. Mod-X has six 7-segment LED numerals (they all look like eights here since no segments are lit up. Connections to the module are made via the 11 terminals (holes) in the bottom edge of the board, plus a few others at the top.

e/e Mod-X Clock



PARTS LIST FOR MOD-X

- C1—100- μ F, 20-VDC or better electrolytic capacitor (Radio Shack 272-1016 or equiv.)
- D1—1-A, 200-V diode (Radio Shack 276-1102 or equiv.)
- F1— $\frac{1}{2}$ -A, 125-VAC fuse (Radio Shack 270 1270 or equiv.)
- M1—Clock module, National Semiconductor MA-1002A. (Digi-Key Corp. See below for address)
- R1—470-ohm, 10-watt resistor (part number 962-9302, Allied Electronics see below for address)
- R2—300-ohm, 10-watt resistor (part number 962-9270, Allied Electronics)
- S1, 2, 3—Single-pole, momentary-On switch, normally open (Radio Shack 275-1547 or equiv.)
- S4—SPDT toggle switch (Radio Shack 275-326 or equiv.)
- T1—120-VAC primary, 24-26 VAC, 300 mA secondary, power transformer, (Radio Shack 273-1386 or equiv.)
- T2—120-VAC primary, 6 VAC, 300 mA secondary, power transformer (Radio Shack 273-1384 or equiv.)

- Q1—NPN general purpose transistor (Radio Shack RS-2009 or equiv.)

Misc. Fuse holder, panel type for F1 (Radio Shack 270-364 or equiv.); Buzzer for alarm, 3-volt type (Radio Shack 273-004 or equiv.); Aluminum "wood" look cabinet $2\frac{3}{4}$ x 6 x 4 inches or larger (Radio Shack 270-260 or equiv.); AC line cord, available at hardware stores; wire, hardware, solder, etc.

ADDITIONAL PARTS FOR CLOCK OPTIONS

- S5, 6, 7—Switches same as S1, 2, 3, above, for **Hold**, **Cat-nap** (snooze), or **Seconds Display** options.

To obtain the clock module and specification sheet, write to Digi-Key, Dept. E, Box 677, Thief River Falls, MN 56701. Ask for Mod-X-MA1002A. Price is \$11.55, plus 75 cents for postage and handling. Minn. resident add 46 cents state tax. Order module before other parts to be sure of module availability at this price.

Allied Electronic's address is 401 E. 8th St. Ft. Worth, TX 76102.

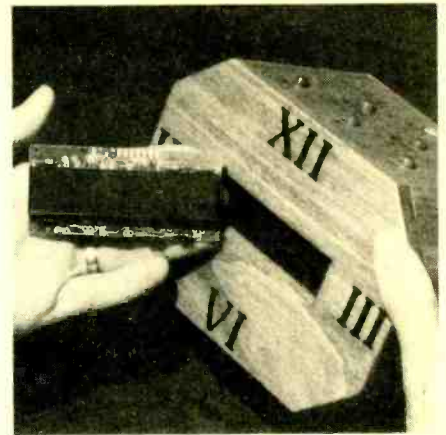

Author also built this handsome wooden case to house another Mod-X clock. He included optional additional functions which can be seen in the schematic diagram in the middle of the next page.

they will not get too hot. Be sure, also, that the unit is built in a safe container. For example, if the clock is to be in a wooden box, be sure that the resistors have plenty of ventilation room around them and that the box has ventilation holes in the top and the bottom. And after building the clock, let it run for a while then unplug it and feel around to see how warm the box is inside. Keep wires from resting on R1 and R2, which tend to get warm, and remember that good ventilation is important. Finally, all connections going to the fuse and to the primary side of T1 and T2 must be wrapped with tape because there will be 120 volts on those points.

All the components can be mounted on a perf board about 2-in. by 4-in. First place all the components on the board by sticking the leads through the holes and bending the leads back to hold the components in place. Transformers T1 and T2 are small but are too heavy to put on the perf board so it is best to mount them on the bottom of the cabinet. Likewise, it is most convenient to mount the fuse on the cabinet so that the 120 V wire coming into the cabinet can go directly to the fuse and then to the transformers. Of course switch S4 has to stick outside of the cabinet, as do the pushbuttons.

With the components mounted on the board, all you have to do is run connecting wires between the components. 18- or 20-gauge wire works well. When soldering wires to the clock module, be very careful. You must use a low-heat iron (25-30 watts as recommended for all integrated circuit projects). The pin connections on the module are actually holes that the wires are placed into and then soldered. You can get to these holes from either the front or the back of the module, but you will probably

sleep. After the alarm goes off, touch the *Alarm* button and you will be able to snooze for nine more minutes

Construction. Now comes the easy part—building the clock. Remember two things here. First, the clock module fits in the palm of your hand and is therefore a nice compact unit that can be mounted in almost anything from a cabinet or workbench to a wall. Second, if you choose not to use the alarm feature your project will have eight components and three switches, so your

construction time will be very short. But the pleasure that comes from those few short construction hours is fantastic, especially when you first turn on the power and see those big, bright numbers staring back at you.

Play It Safe. Now for safety's sake we have to get a few things straight. Remember that this unit is going to be plugged in all day long, day after day, so be sure all your solder connections are good and be sure to use resistors with the correct wattage rating so

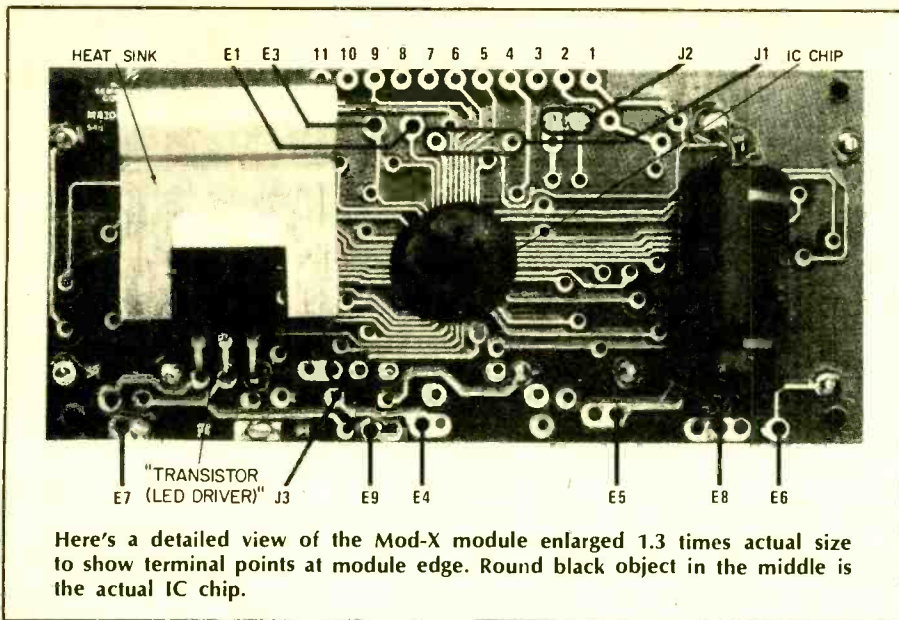

Here's a detailed view of the Mod-X module enlarged 1.3 times actual size to show terminal points at module edge. Round black object in the middle is the actual IC chip.

find that the back is best because it makes mounting of the module very simple. Be sure to check the soldered connections. The solder balls should only be on their own connection points and not short-circuited to any printed circuit wires.

More on Construction. Note on the schematic that transformers T1 and T2

have their primary leads marked a and b, and the secondary leads marked A and B. The leads are not actually marked this way on the transformer itself, but I have designated them this way for the project. As shown on the schematic, if you look down on the top of the transformers, with primary to the left and secondary to the right, the

"a" and "A" leads will be towards your hair and the "b" and "B" leads will be toward your chin. Follow the schematic when connecting these leads. Also, do not forget to use a heat sink when soldering to transistor Q1. Finally (important!) watch out for tricky S4. Most DPDT switches, including the ones on the parts list, are "backwards." When the toggle is up, the *bottom* contacts are engaged. So watch how you do the wiring and labeling of the switch, or you will be confused later on.

Testing. Your clock should work well the first time you try it—so before you plug it in go through the thing everybody hates: Check and double check your wiring. If the display fails to light, you have probably forgotten to connect pin 3 on the clock module to pin 4. The voltage (AC) between E6 and E8 on the module should be about 15 volts. The DC voltage reading between E8 (positive) and E7 (negative) should be about 5 volts. If these voltages are not correct, check out T1 and T2 to see if they have AC output voltage coming from their secondaries when disconnected from the circuit. If the clock portion works but the buzzer will not sound, check E3 to see if the voltage at

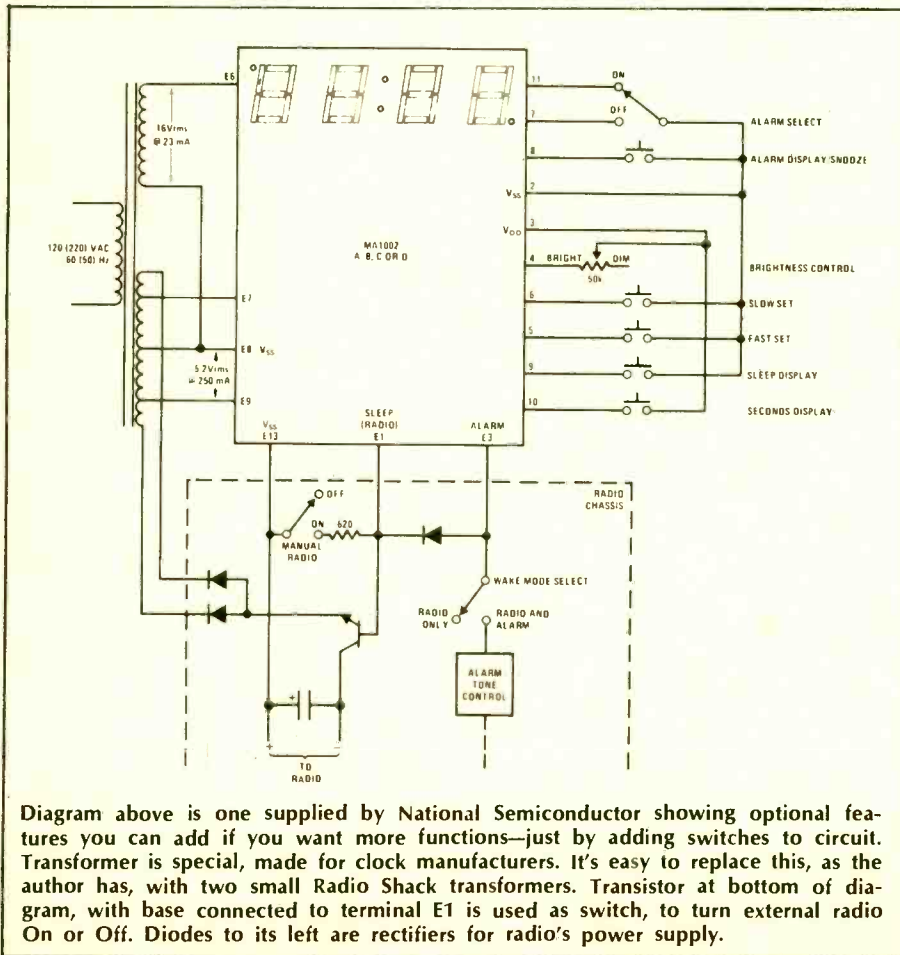
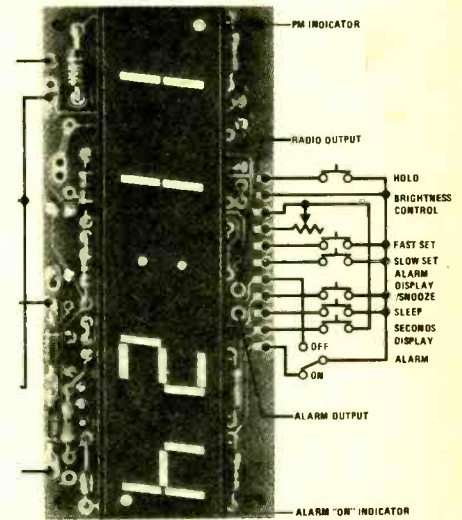

Diagram above is one supplied by National Semiconductor showing optional features you can add if you want more functions—just by adding switches to circuit. Transformer is special, made for clock manufacturers. It's easy to replace this, as the author has, with two small Radio Shack transformers. Transistor at bottom of diagram, with base connected to terminal E1 is used as switch, to turn external radio On or Off. Diodes to its left are rectifiers for radio's power supply.



Additional optional functions diagrammed at left in schematic are shown above connected to the module.

that point goes high relative to E7 when the alarm is supposed to go off. Do not be tricked by the AM/PM capability of this clock when checking the alarm. If your clock is set to go off at 6:00 AM, do not expect it to go off at 6:00 PM when testing it. Pay attention to the little AM/PM dot in the upper left corner.

National makes eight different modules in the MA 1002A through E series. Be sure you use only the one with "A" when you're building *this* project. ■

The better the training the better you'll

Send for
FREE
illustrated
career
guide

NTS guide
to careers in
Electronics

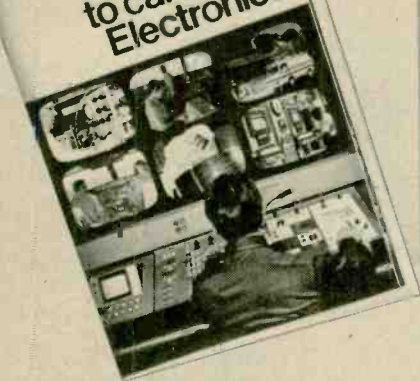

IN-CIRCUIT TRANSISTOR TESTER

COMPU-TRAINER

TROUBLESHOOTER
VOM

SOLID-STATE
OSCILLOSCOPE

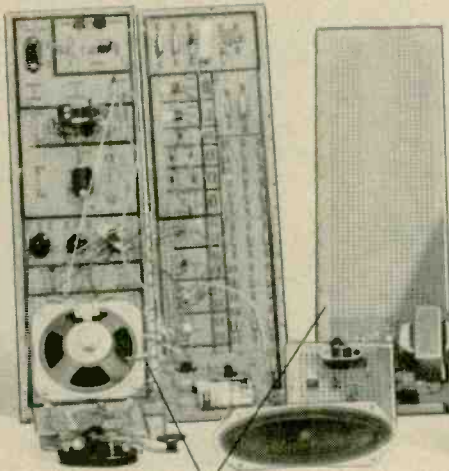

ELECTRO-LAB



(Simulated TV Reception)

As an NTS student you'll acquire the know-how that comes with first-hand training on NTS professional equipment. **Equipment you'll build and keep.** Our courses include equipment like the NTS/Heath GR-2001 computerized color TV (25" diagonal) with varactor diode tuning and digital read-out channel selection; (optional programming capability and digital clock avail.)

Also pictured above are other units — 5" solid state oscilloscope, vector monitor scope, solid-state stereo AM-FM receiver with twin speakers, digital multimeter, and more. It's the kind of better equipment that gets you better equipped for the electronics industry.

This electronic gear is not only designed for training; it's field-type — like you'll meet on the job, or when you're making service calls. And with NTS easy-to-read, profusely illustrated lessons you learn the theory behind these tools of the trade.

Choose from 12 NTS courses covering a wide range of fields in electronics, each complete with equipment, lessons, and manuals to make your training more practical and interesting.

Compare our training; compare our lower tuition. We employ no salesmen, pay no commissions. You receive all home-study information by mail only. All Kits, lessons, and experiments are described in full color. Most liberal refund policy and cancella-

and the equipment be equipped.

COMPARE OUR
KITS AND LESSONS.
COMPARE OUR
TUITION.

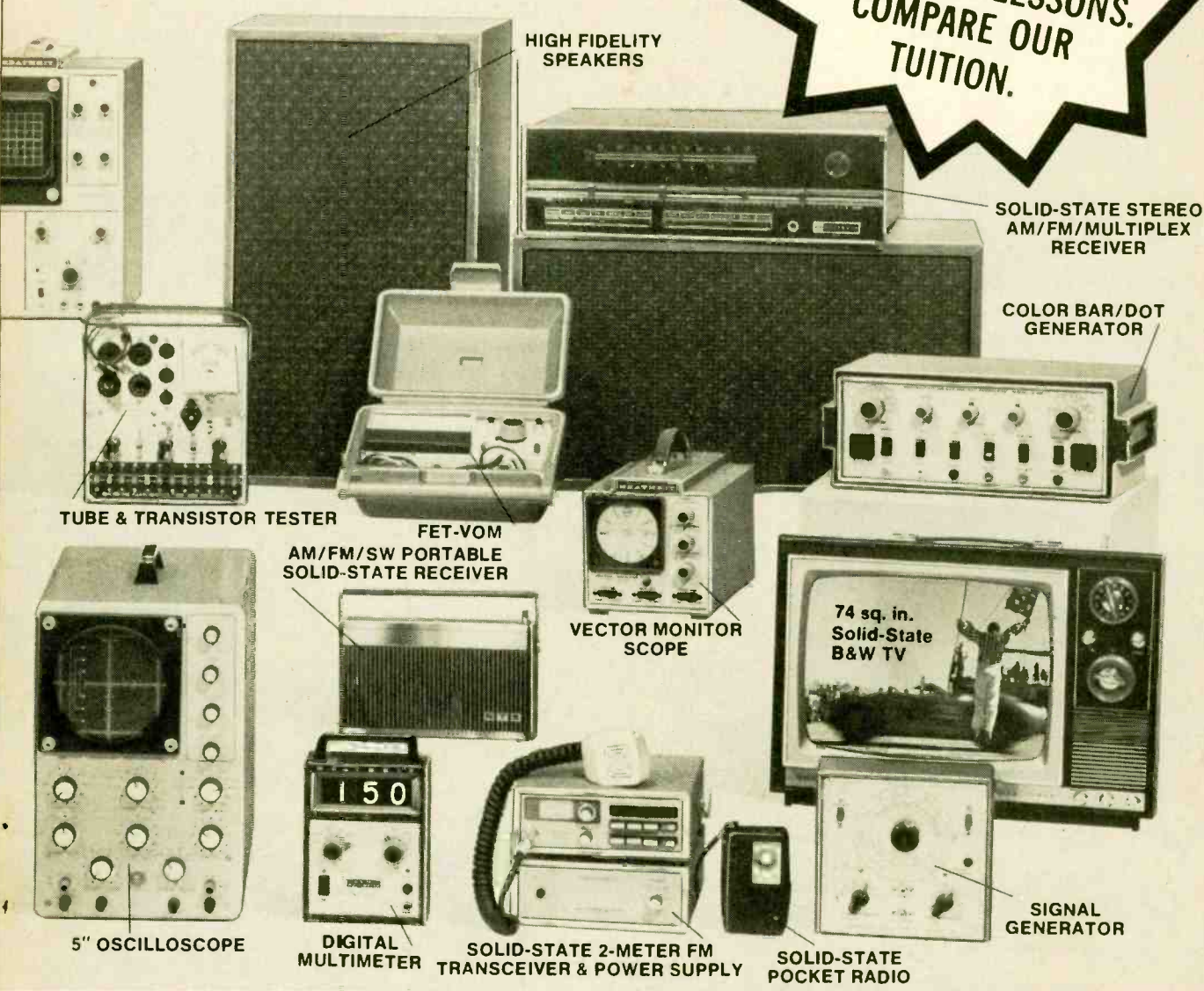

HIGH FIDELITY
SPEAKERS

SOLID-STATE STEREO
AM/FM/MULTIPLEX
RECEIVER

COLOR BAR/DOT
GENERATOR

TUBE & TRANSISTOR TESTER

FET-VOM
AM/FM/SW PORTABLE
SOLID-STATE RECEIVER

VECTOR MONITOR
SCOPE

5" OSCILLOSCOPE

DIGITAL
MULTIMETER

SOLID-STATE 2-METER FM
TRANSCEIVER & POWER SUPPLY

SOLID-STATE
POCKET RADIO

SIGNAL
GENERATOR

tion privileges spelled out. Make your own comparisons, your own decision. Mail card today, or clip coupon if card is missing.

NO OBLIGATION. NO SALESMAN WILL CALL

APPROVED FOR VETERAN TRAINING

Get facts on new 2-year extension

NATIONAL TECHNICAL SCHOOLS

TECHNICAL-TRADE TRAINING SINCE 1905
Resident and Home-Study Schools
4000 So. Figueroa St., Los Angeles, Calif. 90037

NATIONAL TECHNICAL SCHOOLS Dept. 222-116
4000 South Figueroa St., Los Angeles, Calif. 90037

Please send FREE Color Catalog and Sample Lesson.
NO OBLIGATION. NO SALESMAN WILL CALL.

- Color TV Servicing
- B & W TV and Radio Servicing
- Electronic Communications
- FCC License Course
- Electronics Technology
- Computer Electronics
- Basic Electronics
- Audio Electronics Servicing

NAME _____ AGE _____

ADDRESS _____ APT # _____

CITY _____ STATE _____

Please fill in Zip Code for fast service

- Check if interested in G.I. Bill information.
- Check if interested ONLY in classroom training in Los Angeles.

□ Chances are that if you make cassette recordings at home you've given some thought to putting a cassette player in your car or RV. And if you're like most stereophiles there's a good chance you've been turned off of the idea either by the total cost of a mobile cassette system, or the possible theft of the equipment next time you take your car into town.

With a little common sense, however, you can not only enjoy a really good mobile cassette system at a budget price, but you can also reduce the possibility of theft to zero. Here's how it's done.

Generally a stereo cassette player needs at least two speakers, and add-on stereo speakers don't come cheap. Also, the speakers supplied in small "almost cardboard" enclosures don't offer much

in the way of really good sound. But if you have a radio already in the car there's a good chance you already have stereo speakers, perhaps speakers front and rear with a front-to-rear fader. If you don't have rear speakers in your car, and if it's a late sedan American model it most likely has rear-shelf speaker cut-outs with wiring already going to the dash. It's a simple matter to install a pair of rear speakers—and the sound with the trunk as an enclosure is usually a heck of a lot better than an itty-bitty plastic or cardboard box.

Just use these car radio speakers for the cassette player and you save not only the cost of the speakers, but usually the installation time and effort.

The diagrams show how to make the speakers do double-duty. The dia-

gram shows the typical car radio speaker hookup. Note that even though each speaker has two connecting wires there is a common ground system. The radio actually has only two wires for the left and right speaker outputs with the ground (the car's body) serving as the common speaker connection. So all you need is a *double pole/double throw* switch for the speakers to be used for both the radio and tape player. The speaker switch can be mounted on the bottom lip of the dash next to the tape player mounting bracket. To make life easier, solder leads on the switch before it is installed on the dash, then splice the switch leads into the radio's speaker wires later.

You can either pocket the savings on the speakers or put it into a better

PUT YOUR CASSETTES ON WHEELS

Use car speakers for fast inexpensive installation/by Herb Friedman

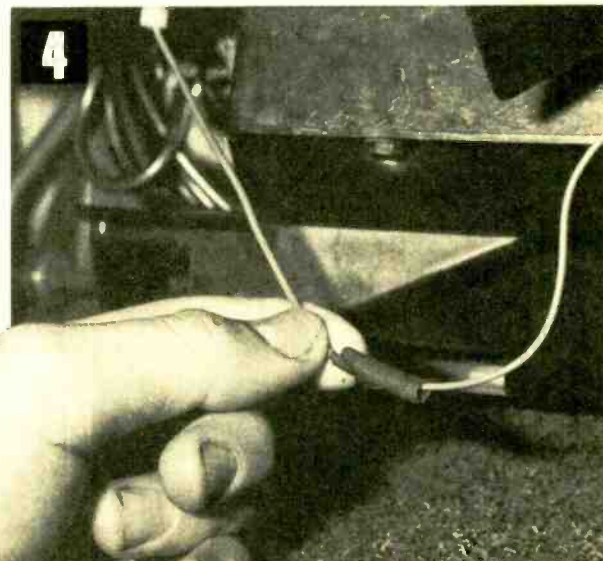
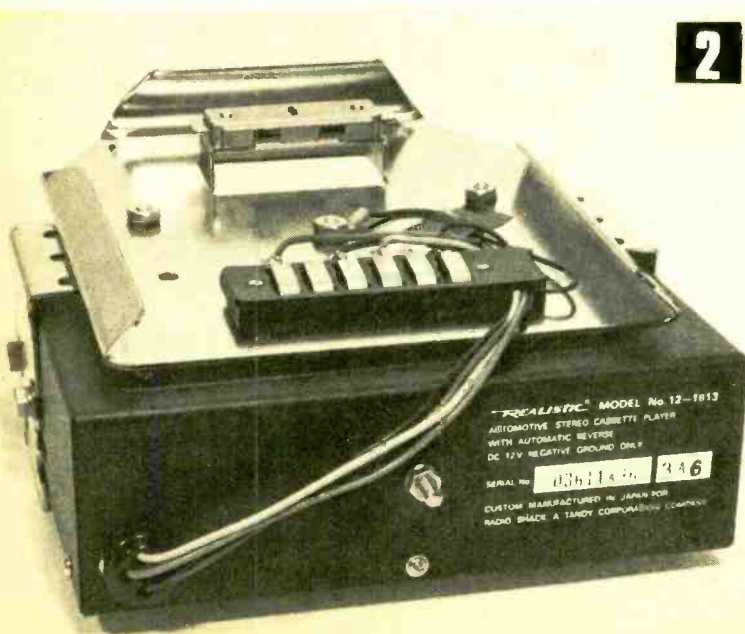
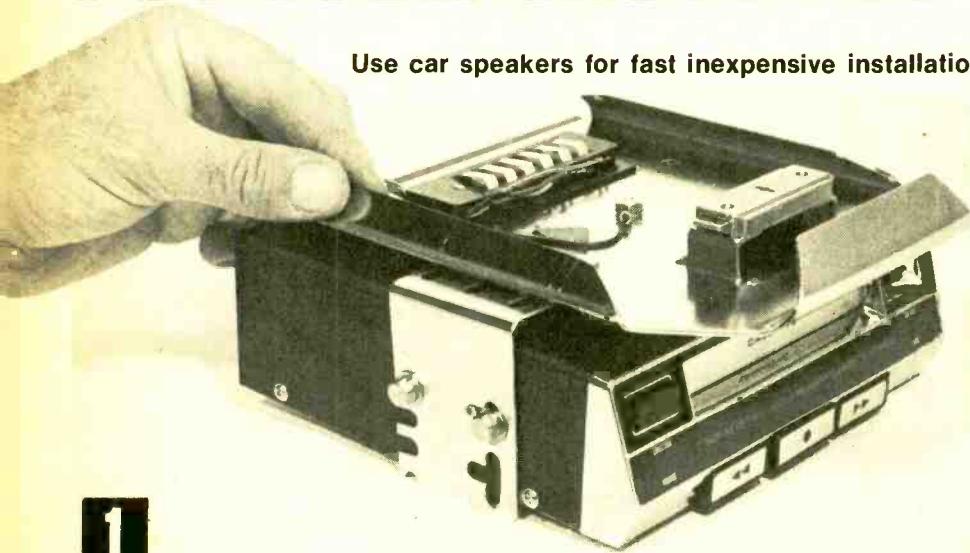

quality cassette player. A better cassette player is always wise because the extra power output and operating features will be enjoyed for thousands of miles.

One good buy is the unit shown in the pictures here. It's Radio Shack's Realistic Model 12-1813. It features automatic end-of-tape reverse giving continuous play (like an 8-track deck), fast reverse and fast forward, user reversing select, and auto-start from the end of the reverse (tape automatically starts from the beginning). All these features in addition to the usual "insert cassette to start," and volume, tone and balance controls.

Another excellent value is Radio Shack's model 12-1815, which has an extremely sensitive FM stereo radio section. It's priced the same as the tape-only model, but omits the reversing action of the tape-only job. The FM section of this unit is extremely sensitive, and is the best FM car radio tuner we've checked.

Safety First. Now all you have to do is make certain it isn't ripped off before

you get a chance to enjoy it. Firstly, a standard auto theft alarm is not protection for a tape player. According to police estimates the average tape player (or CB) can be removed in less than 20-seconds. The rip-off artist can have your player out and be gone before the neighbors realize "that sound" is your car's burglar alarm. And if you use a locking bracket and don't have an alarm you give the hoods enough time to chop the player free, usually causing severe damage to your car's dash in the process.

But no one can steal what isn't there. Simply install the cassette deck with a *slide mount* and you can easily slip the player under the seat or stow it in the trunk. It's simple.

Slide mounts are available in several different models, some with locks, some without. Forget the locks, they only cause grief if some hood chops the lock out. Even if the slide mount you get has a lock don't use it—just hide the player when you park. The slide mount has two pieces. One attaches to the

dash, the other attaches to the player, as shown in the photographs. Each section has sliding-contact terminals which feed the power, ground and speaker connections to the player.

You will find the part of the mount that gets assembled to the player has terminals with attached wires that are supposed to be spliced into the player's output wires. You get a neater installation, and eliminate the chance of the wires getting snagged if you unsolder the terminal wires, and then solder the player's wires directly to the mount's terminals. Make certain the mount's ground wire is secured under one of the screws (or nuts) that fastens the mount to the tape player or the tape player bracket, for this wire supplies both the power supply ground and common speaker connection. If necessary, tape the wires to the mount to prevent them from snagging when the mount is inserted under the dash.

The part of the mount secured to the dash needs only two screws, and #8 or
(Continued on page 94)

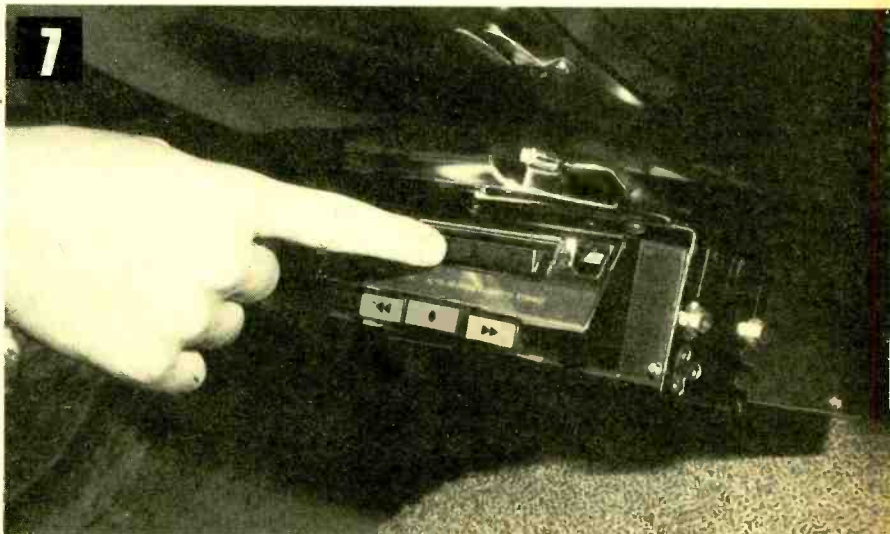
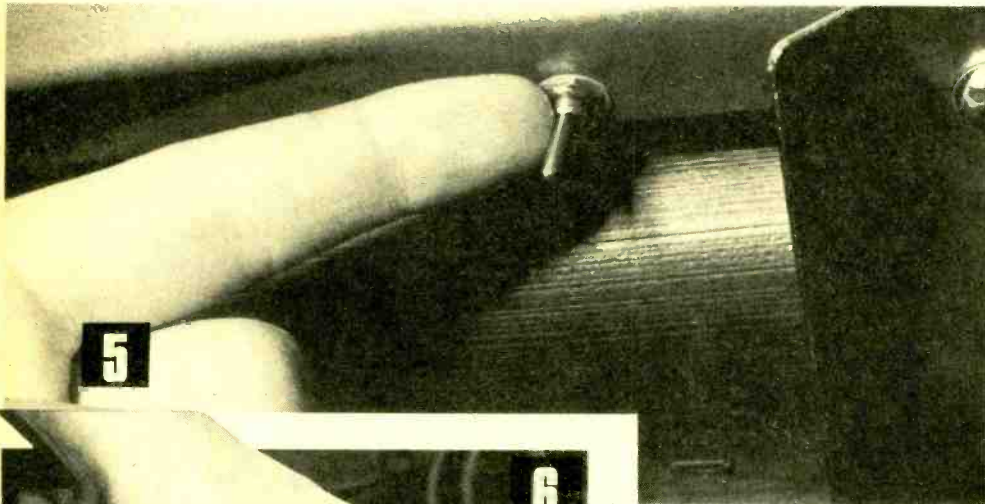

Photo One shows the cassette player with the lower half of the slide mount on top of it. Slide mount attaches to player's bracket. Two is rear view of player showing sliding terminals for connection to speakers and car battery. Three shows the top half of slide mount, screwed under dash. Four is the spliced (red) battery power lead. Make it short! Five shows the small double-pole/double-throw speaker switch, also under the dash. Six is a hash-suppressor which you may not need. Some cars have 'em built in, and other cars have alternators or generators whose output is clean enough not to leak into tape playback. Photo below shows the player in place under the dash. Be sure it's close enough that you can slide the cassettes in and remove them without leaning too far to the right, and without taking your eyes off the road.

□ It's an unfortunate sign of our times, but the burglar alarm is becoming a necessary part of home electronics. Robberies of homes is one of the fastest increasing crimes. In many cases homes are left vacant during the day when both husband and wife work, leaving an unprotected home to the mercy of thieves. If you haven't been victim of such a crime yet, consider yourself lucky. Better yet, consider electronic protection of your home.

There are many burglar alarms available for the home. However, a good alarm system may cost as much as \$500 when installed by professionals. Even the do-it-yourself units available from electronic supply houses or discount stores cost \$100.00 and more.

There's no need for you to spend this kind of money to achieve home security if you are handy at building electronic circuits. B/F Brain can do the job at a fraction of the cost of a do-it-yourself kit, and will be just as effective and reliable as any on the market. By using modern electronic technology an extremely simple circuit has been designed which produces excellent performance at very low cost. The circuit uses two integrated circuits which cost less than \$2.00.

Works Open or Closed. B/F Brain has several desirable features. It may be used as a closed circuit in which all points of entry into the house are protected by a loop of conductive foil and normally-closed switches. There is no limit to the length of the loop or number of switches which may be employed, since they are connected in series. This allows protection of any number of doors and windows, and additional points for protection can be added at any time without any changes in the alarm itself. This type of installation has a distinct advantage over ultrasonic systems which protects only

the room in which they are installed.

Provision has also been made to use normally-open switches as desired, in addition to the series circuit of conductive foil. Thus it is possible to add foot-operated switches in hallways and doorways and as additional protection. This also permits the burglar alarm to be used in an automobile, where the opening of a door, which normally activates the dome light switch now also operates the alarm. Once the alarm is activated by opening or closing a circuit, it cannot be turned off by just restoring

the disturbed circuit to its original condition (i.e. closing the door or window). A reset switch must be pressed, otherwise the alarm will continue to sound.

Works For Fires, Too. B/F Brain becomes a fire sentry as well, simply by buying easily-available fire sensors and installing them wherever you feel they are necessary. Again, there is no limit to the number of sensors which can be added to the circuit. Both open- and closed-circuit sensors may be used.

Inexpensive Alarm. There is no need to purchase an alarm bell. Any inexpensive eight-inch or larger, 3.2- or 4-ohm speaker will do the job nicely. The alarm circuit produces a 12-volt peak-to-peak square wave which will deliver 9 watts of power into a 4-ohm load. This will produce sufficient sound for most applications. If desired, more power may be obtained simply by increasing the supply voltage to the speaker. For example, if a 24-volt supply is used, the power delivered to the speaker will increase by a factor of 4, to 36 watts. B/F Brain produces an up-and-down wailing sound which will command lots of attention, even at the 9-watt level.

Window Protection. Conductive foil for windows and doors is relatively inexpensive. A 150-foot roll of 3/8-in.

**DON'T
SUPPORT
YOUR LOCAL
BURGLAR—
BUILD
B/F
BRAIN!**

Two ICs and a few parts make a simple computer to monitor as many doors, windows, and pressure switches as your home will ever need.

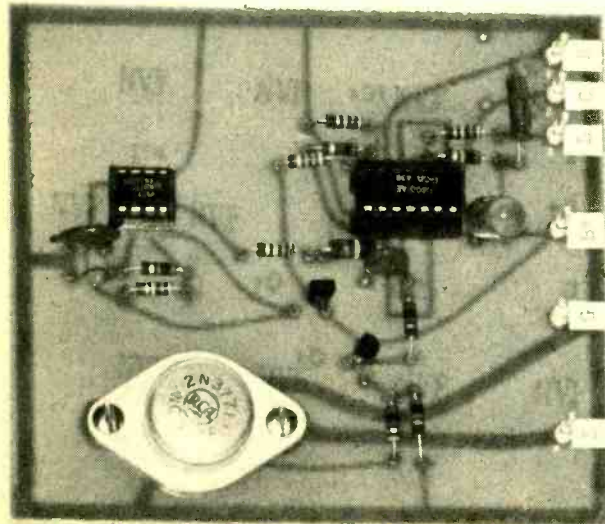

Photograph at left shows completed board with the two ICs. Large power transistor at lower left is Q2 which drives alarm speaker. Six terminals at right edge of board connect to speaker, foil loop, switches, Reset switch, and power source.

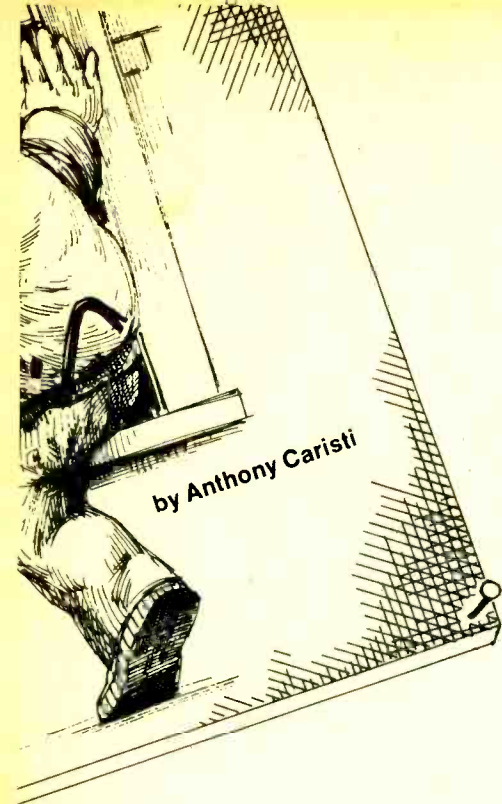

wide tape costs only \$3.29 from Radio Shack. This tape has an adhesive backing and it is not necessary to use the full width of tape. By cutting the tape in half you provide greater sensitivity to glass breakage and a more pleasing appearance. One roll of tape will easily do any average size home.

Timer Delay. An optional feature of the circuit is provision to add a capacitor to produce a delay of several seconds. This feature will allow you to arm the alarm circuit before going out, and then leave the house by a protected door. It also permits you to enter the house through a protected door without sounding the alarm, since you can shut the circuit off before the alarm sounds.

The basic circuit is shown first. This is the complete alarm circuit, constructed on a small printed circuit board.

Also shown is a layout of the foil pattern of the board, viewed from the copper side. We also show the component layout as viewed from the top of the board. Note that Q2, the power output transistor, does not have any heat sink. None is required since Q2 operates as a switch and not a class-A amplifier. When Q2 is conducting it is in a saturated state. This means that the collector-to-emitter voltage is about 0.3 volts. Thus, the total dissipation in Q2 is 0.3 volts times 3 amperes or 0.9 watts. The average dissipation of Q2 is half of this, since it is cut off for half of each cycle when the alarm circuit is delivering power to the speaker.

Note the series of six connections located at one side of the board. These are the required connections to the

Power Supply, Speaker, Open-circuit, or Closed-circuit loop, and Reset control. It is recommended that sockets be used for the integrated circuits. This makes it easy to solder to the board without endangering the integrated circuits with the iron's heat. It also will permit you to remove each IC in the event the circuit ever needs servicing. Once an IC is soldered into a printed circuit board it is extremely difficult to remove. Be sure to insert the ICs into the sockets (or board) in the correct direction. Pin 1 of each IC is marked on the IC itself, as well as on the copper foil side of the printed circuit layout.

About the Circuit. B/F Brain uses two integrated circuits. IC1 is a four-section, 2-input NOR gate constructed in COS/MOS (Complimentary-Symmetry/Metal-Oxide Semiconductor) form. The advantage in using COS/MOS integrated circuits is the extremely low current drain of the chip. The CD4001 chip IC used in this circuit draws only 5 microwatts of power from the 12-volt supply.

A NOR gate is a digital building block which obeys the following rule: If the voltage at either input terminal (or both input terminals) exceeds 70 percent of the supply voltage, the output voltage falls to zero. If the input voltage to both input terminals is less than 30 percent of the supply voltage, the output voltage rises to the supply voltage. Input voltages between 30 and 70 percent of the supply voltage have no logic definition and are not considered legitimate voltages when they're applied to the input terminals.

IC1A and IC1B are connected in a configuration called a *Bistable Latch*,

or *Flip-flop*. This circuit can rest in either of two states: Pin 3 at 12 volts and pin 4 at zero volts, or pin 3 at zero volts and pin 4 at 12 volts. The voltages fed to the input terminals, pins 2 and 5, determine which state the circuit rests in. The normal input condition for the bistable latch is approximately zero volts at both input terminals. Pin 2 is held to about 0.5 volts by means of R2, R1, and the closed loop circuit of conductive foil between terminal L and ground. Pin 5 is held to zero volts by means of resistor R3. Under this condition the output voltage at pin 3 is 12 volts. In order to flip the voltage at pin 3 to zero volts, the voltage at input terminal pin 2 must approach 70% of the supply voltage, or 8.4 volts. This would be caused by the closed loop at terminals L to G being opened, or a connection between terminals C and B+. When either of these conditions exists, even for a few microseconds, the output voltage at pin 3 is flipped to zero. Removing the voltage at pin 2 will have no further effect on the circuit. It can be restored only by applying a voltage to pin 5 through the reset switch.

More on Circuit Operation. Capacitor C1, between pin 2 of IC1A and ground, controls the amount of time delay between the opening of the loop circuit and the activation of the alarm. When the loop circuit is closed, the voltage across C1 is held to about 0.5 volts through the voltage divider action of R2 and R1. When the loop is opened, C1 begins to charge through R2. The latch circuit will change state when the voltage at pin 2 approaches 8.4 volts. Thus, the amount of time delay is

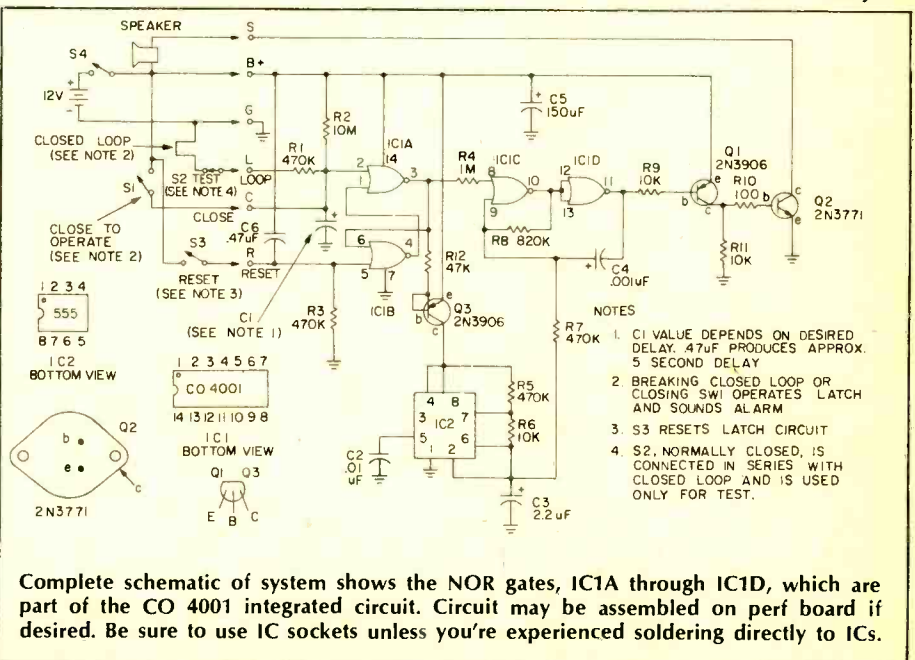

e/e Build B/F Brain

determined by the value of C1, and will be about five seconds for a .47 uF capacitor. If no delay is desired, C1 may be deleted from the circuit.

IC3C and IC3D are considered in a configuration which operates as an astable (free running) multivibrator. DC feedback through R8 and AC feedback through C4 allows the circuit to oscillate at a frequency (about 1500 Hertz) determined by the RC time constant. However, the oscillator circuit will operate only if there is no input voltage at pin 8, IC1C. Thus, the latch circuit of IC1A and IC1B controls the operation of the oscillator.

The Timing Circuit. IC2 is a timing circuit which is connected to operate as an oscillator. The frequency of oscillation for this circuit is about two Hertz, and is determined by the RC time constant of R5, R6, and C3. The voltage across C3 is a sawtooth varying between 5 and 9 volts. This voltage is fed to IC1C, causing the basic frequency of the alarm oscillator to vary up and down to produce the familiar siren effect.

To keep the standby current drain of B/F Brain low, the supply voltage to IC2 is normally cut off by Q3. Since, in the quiescent state, the voltage at pin 3, IC1A, is +12 volts, Q3 has no forward bias and is cut off. When the latch circuit changes state Q3 receives forward bias through R12, turning on IC2.

Output Circuit. A two-transistor circuit is used to drive the speaker. When the alarm circuit is in its resting state, the voltage at pin 11 of IC 1D is +12 volts. Thus, Q1 has no forward bias and is cut off. Q2 base current is zero, and it too is cut off. The circuit of Q1 and Q2 therefore does not draw any current from the supply. Once the circuit of IC1C and IC1D is activated, the output voltage at pin 11 IC1D becomes a 12-volt (peak-to-peak) square wave. This causes Q1 and Q2 to switch on and off at the 1500 Hertz rate. Q2 drives the speaker with the 12-volt square wave, producing 9 watts of audio power. A square wave output is actually more desirable than a sine wave, since it is rich in harmonics. This produces a more natural-sounding siren.

If higher output power is desired, the speaker can be returned to a voltage higher than 12 volts. This will produce a peak-to-peak voltage across the speaker an amount equal to the higher voltage. Such a connection is shown

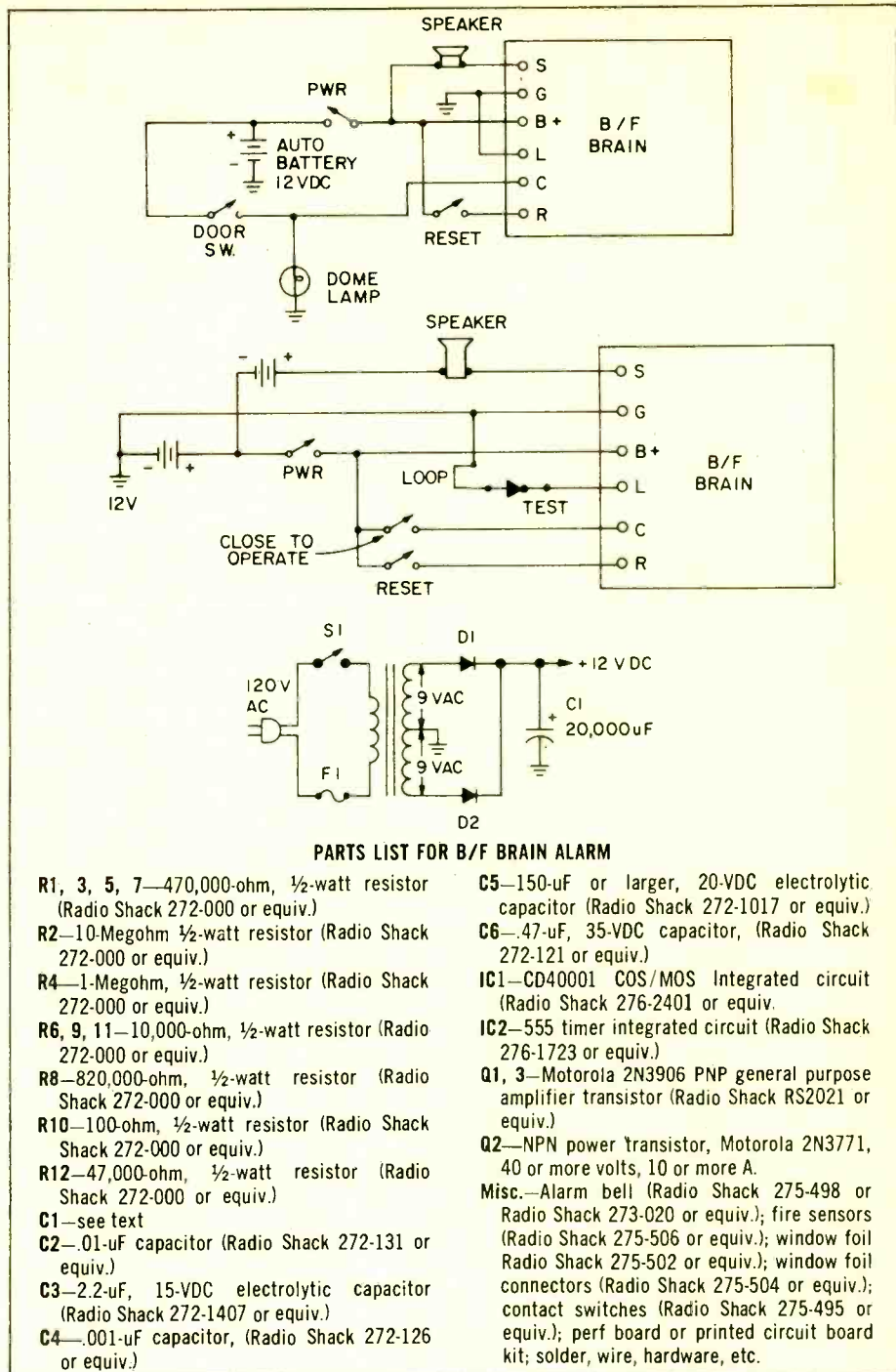

in the schematic. If you use this circuit be sure to feed the higher voltage only to the speaker, and not the alarm circuit. The maximum allowable supply voltage to the CD4001 chip is 15 volts.

Power Supply. The full-load current of the alarm is about ¾ amperes, but this is only when the circuit has been tripped. Under normal operating conditions the standby current is less than 10 microamperes since only the COS/MOS integrated circuit, R2, and R1 are drawing current. The extremely low current drain makes it practical to use eight D cells connected in series to

provide 12 volts. Such a power supply will last more than a year (providing the alarm does not go off). Battery operation provides several advantages including, freedom to locate the alarm anywhere, prevention of a burglar from defeating your alarm by shutting off electrical power, and prevention of false alarms due to line voltage interruptions or surges, and low cost.

DC or AC Power. It is recommended that alkaline cells, Eveready type E95 or equivalent, be used. These cells can deliver more current than ordinary cells and they last much longer. They cost

(Continued on page 88)



ANTIQUE RADIO CORNER

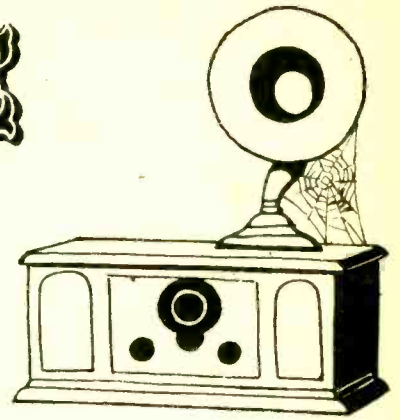

by James A. Fred

□ Hello out there in Radioland! The AWA (Antique Wireless Assn.) conference took place the first weekend in October, 1976 but this is my first opportunity to tell you about it. There was a continuous Flea Market both days, an old radio equipment auction, seminars on vacuum tubes, talks on restoring old radios, historical presentations on Crosley, and the end of RCA's tube production. But most of all I enjoyed meeting collectors who read my column in *ELEMENTARY ELECTRONICS*. Many collectors and their wives came up to tell me that I was responsible for them being there. Many said they had read "Antique Radio Corner" and immediately subscribed to this magazine so as to not miss an issue. Some had been collecting radios for years without being aware that there were other collectors living nearby, or that there were clubs for collectors, or even knew that the AWA existed. It certainly made me feel good to know that I had introduced such an interesting and rewarding hobby to so many persons.

AWA Conference High. Attendance at the AWA Conference reached a new high with over 400 collectors registered for the activities. One of the highlights of the Saturday night banquet was the introduction of Mrs. Alfred Grebe, the widow of the brilliant designer of the

Grebe radios. You are indeed fortunate if you have a Grebe receiver in your collection.

Of interest to all collectors was the announcement of the publication of "The Saga of the Vacuum Tube" by Gerald F. J. Tyne. Mr. Tyne has spent many years revising, expanding, and correcting a series of articles bearing the same name which was printed in *Radio News* magazine between 1943 and 1946. It is a detailed record, extending to 1930, of scientific research, pioneer inventions, development by industrial teams, and the applications and production of vacuum tubes. It includes the story of science and industry combining forces improve the early vacuum tubes to meet the needs of the military in World War I.

The book will contain nearly 500 photos and drawings of tubes. 275 brand names of independently produced tubes are listed to aid collectors in finding and identifying tubes. The book will cost about \$25.00. As soon as definite price and ordering information is available I will have it in this column. I am sure that it will be a book every collector will want for his own library.

Seattle Collectors. If you live in or near Seattle, Washington you will be happy to know that an antique radio collecting club has been formed there.

The first meeting was held at the home of Lee Williams with five persons present. If you are interested in joining you can write Woodrow F. Wells, 8307 NW 22nd Avenue, Seattle, WA 98117, or call him at 789-2370.

If you live near Opelika, Alabama or plan to vacation there next summer you will want to visit the world's largest privately-owned collection of battery-operated radios and phonographs. It's owned by J. Herbert Orr, a pioneer in magnetic tape recording. Mr. Orr's collection includes both cylinder and disc phonographs and they all work. The radios have all been restored to like new condition and there are so many that they are housed in several buildings. One of his major developments, just patented, is a player piano that uses computer technology and magnetic tape to create the player-piano effect. A mini-computer attached to the piano records the movement of the keys, pedals, and hammers on cassette tape. After recording a selection played by a live person the playback switch is flipped and the piano keys hit the proper strings and the original playing is heard. The entire collection consists of many thousand pieces and is the world's largest collection of this type. The collection is available for viewing by the public.

(Continued on page 76)



Antique Wireless Association (AWA) meeting had 400 collectors in attendance. Here are a few of the goodies at the flea market.



Alan Douglas, left, talking about his collection of old medical machines with AWA president Charles Brelford.



Early transmitter (arc type), one of several on view in the Antique Wireless Association's Museum.



CB NEW PRODUCTS



e/e puts together in one neat package some of the newest CB rigs, antennas and accessories for you to use in CB contacts this year!

Covers All 40

A trunk mount antenna spanning all 40 CB channels comes from Antler Antennas. Called the "Super Broad," the antenna delivers flat readings over the entire 40 channels. The shallow SWR curve of the new Antler "Super Broad" provides a high level of performance



CIRCLE 49 ON READER SERVICE COUPON

for both 23-channel units and the new 40-channel models. The Antler "Super Broad" is a trunk mounted, center loaded design. The coil is tuned and sealed against moisture. Fittings are chrome plated brass. Whips are made of 17-7 PH heat-treated stainless steel for added flexing strength and resiliency. Antler antennas are sold nationwide. For more information, write Antler Antennas, MCM Mfg. Co., 6200 South Freeway, Fort Worth, TX 76134.

RF Filters for CB

If you've ever had a neighbor give you a big 10-90, you'll be glad to know about these three TV interference filters from Avanti. The problem could be at the transceiver, the TV set or in the AC power line. Where, determines the type filter required. If the transceiver is radiating harmonics of the same frequency assigned to one or more of the local TV channels, installation of the Avanti Model AV-800 Low Pass Filter (\$24.95) on the transceiver should clear up the problem. If the problem is at the TV receiver due to so-called "front end" overloading,

installation of Avanti's Model AV-811 Filter (\$14.95) on the TV lead-in should solve it. The filter lets the TV signals come through the line unhindered, while choking off the incoming CB signal. The third type problem is caused by transmission of the CB signal through AC power lines. This calls for the



CIRCLE 44 ON READER SERVICE COUPON

Avanti Model AV-820 AC Line Filter (\$19.95). When used at the TV set this filter prevents CB signals from entering the TV through the AC line. Get the facts direct from Avanti Research & Development, Inc., 340 Stewart Avenue, Addison, IL 60101.

Magnetic CB

Here's a new idea for mounting a CB rig and avoiding theft. The Easy Mount uses three powerful permanent magnets to make positive contact, assuring maximum signal trans-

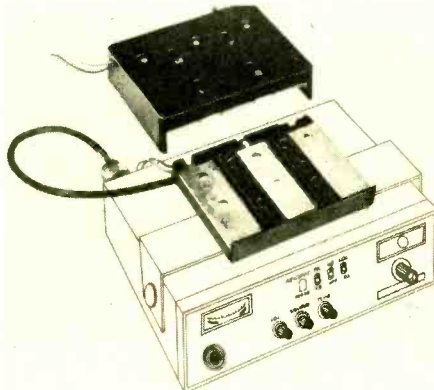

CIRCLE 57 ON READER SERVICE COUPON

fer. Ordinary slide brackets use flexible metal strips which can bend and wear. Installation is extremely simple and gives a neat, flush mount appearance. You have a choice of installing Easy Mount under the dash or on the transmission hump. All necessary hardware and detailed instructions are included. Additional optional top sections are available to allow instant transfer of the transceiver from vehicle to vehicle or to a boat, trailer, office, or home. Easy Mount weighs 1.25 lbs., has a low 1 1/8-in. profile, and occupies a mounting area of 4 3/8-in. wide by 3 1/4-in. deep. It comes with a full year warranty. For additional information, write to Cornell-Dubilier Electronics, 150 Avenue L, Newark, NJ 07101.

"Swivel Whip" CB Antenna

A new swivel-adjustable CB antenna, model M-275, has been introduced by Antenna Specialists. The M-275 is a combined product of the famous M-175 CB antenna and a new swivel whip adaptor, model M-279/12. The

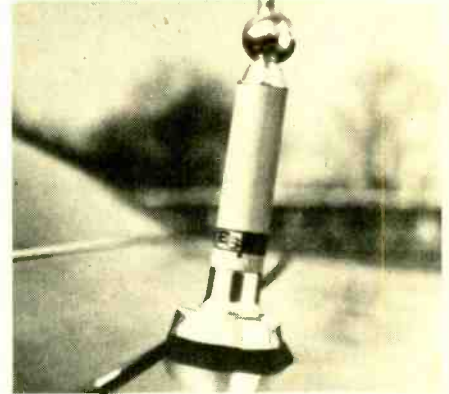

CIRCLE 45 ON READER SERVICE COUPON

swivel whip adaptor provides for quick, easy adjustment of the whip to compensate for sloping trunk mounts. To adjust the antenna, you simply loosen the set screw, swivel to the vertical position, and retighten. The M-275 also incorporates a new low profile version of the original "Quick Grip" universal trunk mount that makes a permanent installation with no holes. Manufacturer's suggested list price for the M-275 is \$25.95; the M-279/12 is \$4.25. For further information contact: The Antenna Specialists Co., 12435 Euclid Avenue, Cleveland, OH 44106.

Visor Speaker

New from Superex, the VS-19 visor speaker is designed specially for mobile CB application. The VS-19 is a twin element design incorporating two high-quality speakers. The unit is engineered for high voice definition. Self-contained clips that enable quick mount-

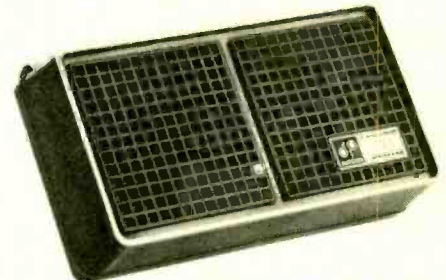

CIRCLE 42 ON READER SERVICE COUPON

ing on the visor are supplied with the VS-19. The VS-19, complete with cable and mini-plug, retails for about \$15. For further information on the VS-19 and other Superex products, write to Marketing Director, Superex Electronics Corp., 151 Ludlow St., Yonkers, NY 10705.



CB NEW PRODUCTS



e/e puts together in one neat package some of the newest CB rigs, antennas and accessories for you to use in CB contacts this year!

Base Beam

Shakespeare it seems has the first and only fiberglass base station directional beam antenna. A totally new design that's been thoroughly tested mechanically and electrically to give top CB communications. The gleaming white fiberglass construction re-

and features a turn-proof locking stud that is integrated into a specially notched, U-shaped locking bolt. It features an extra heavy-duty, chrome-plated holding bracket designed to conform to individual antenna styles as well as a five tumbler, corrosion-resistant, key lock which mates with the special, notched U-bolt. An additional con-

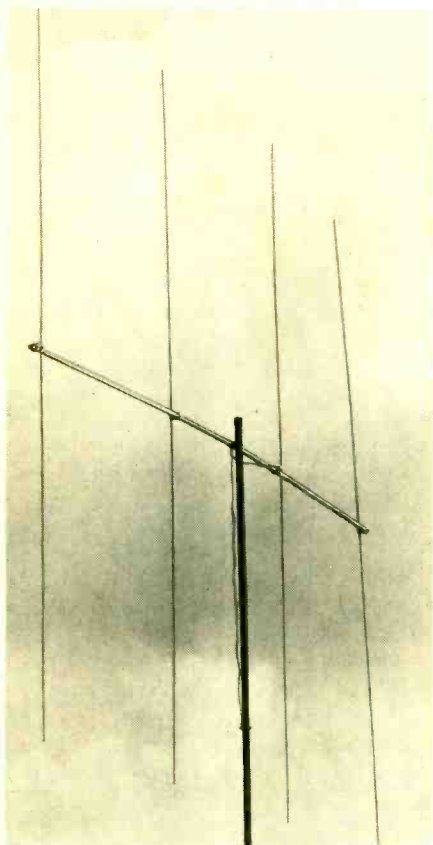

CIRCLE 43 ON READER SERVICE COUPON

sists even the harshest environmental conditions. And fiberglass elements far exceed metal in reducing precipitation static. Shakespeare's MegaBeam (Style 4104) base station directional antenna provides low VSWR over the entire 40 channels. For complete technical facts, write to Shakespeare Company, Antenna Group, P.O. Box 246, Columbia, SC 29202. In Canada: Len Finkler Ltd., 25 Toro Road, Downsview, Ontario, Canada M3J-2A6.

Mobile Antenna Lock

Tenna-loc provides anti-theft protection for CB mobile antennas. Tenna-loc is available in a choice of models to fit most antenna styles, domestic and imported, and it allows CB mobile antennas to remain intact and in place, year round, and in all kinds of weather. Tenna-loc retails for less than \$12



CIRCLE 47 ON READER SERVICE COUPON

venience offered with Tenna-loc is its electro-polished stainless steel replacement cup which is used, where needed, to facilitate quick, easy installations. For all the facts, write to Consumer Products Division, Vernitron Corp., Community Drive, Great Neck, NY 11021.

Pre-Assembled Mobile Antenna

Antenna, Inc.'s new Persuader Model 17610 Citizens Band trunk lip mount antenna in pre-assembled form, will save at least 10 minutes installation time. In addition, the Persuader Model 17610 now includes the company's in-line coaxial cable connector, designed to fit through a 3/8-in. hole. The improvements are offered with no increase in price over the previous unassembled version of the Model 17610. Suggested resale price of the Persuader is still \$25.95. The Persuader comes complete with a base loaded antenna, 34-in. 17-7 PH stainless steel whip to resist bending and stainless steel impact spring to prevent damage in low clearance areas, as well as 17-feet of coaxial cable with both PL-259 type connector and in-line connector and a mount. It is designed to achieve a voltage standing wave ratio of 1.5:1 or less and is fully weatherproof. For

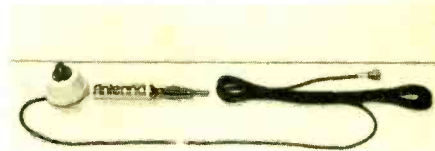

CIRCLE 53 ON READER SERVICE COUPON further information on the Model 17610 pre-assembled trunk lip mount antenna and the complete line of Antenna, Incorporated Products, write to Antenna, Incorporated, 23850 Commerce Park Road, Cleveland, OH 44122.

Three Power Mikes

Mura has a series of three CB microphones incorporating a unique patented circuit that conditions voice signals for greater transmission clarity and power. The new microphones offer a potential increase of 16 dB fully modulated voltage gain, and an average increase of 4 dB in effective RF transceiver output power. These microphones incorporate Peak-Redistribution Modulation (PRM) circuitry, which electronically prevents clipping of voice-signal, allowing maximum modulated power output from limited-level amplifiers. The Mura Model PRX-100 is a power microphone offering a variable gain setting controlled by a slide switch on the microphone and sells for \$39.95 including battery. The Mura Model PRX-200 power microphone



CIRCLE 37 ON READER SERVICE COUPON

offers the advantages of the peak-redistribution modulation circuitry for maximum audio clarity and power, and the flexibility provided by three separate gain settings: 12 dB, 14 dB, or 16 dB. It sells for \$34.95. The Mura Model PRX-300 is a distinctively styled base-station microphone featuring PRM circuitry and variable-gain control for matching microphone gain to the sensitivity level of the transceiver. The manufacturer's suggested retail price is \$69.95. Get all the facts by writing to Mura Corporation, 50 South Service Road, Jericho, NY 11753.

Antique Radio Corner (Continued from page 71)

East Bloomfield Museum. We've visited the AWA communications museum at East Bloomfield, NY again. We visited there two years ago when they were just beginning to work on the building. Now there are hundreds of historical radios, wireless equipment, horn phonographs, and early TV receivers. Outstanding is the vacuum tube display. Some of the earliest, most rare tubes are on display. Another interesting item is one of the water cooled, final amplifier tubes from the 500,000 watt WLW radio transmitter. I highly recommend the museum to any one who finds himself near East Bloomfield, New York.

There are many related items to attract the attention of antique radio collectors. In the past I've mentioned



This beautiful 1912 Murdock crystal receiver won second place in AWA old equipment contest.

tubes, literature, spark transmitters and horn phonographs. Mechanical scanning-disc TV receivers are few and hard to find. In this country C. Francis Jenkins was the foremost experimenter and had over 300 patents in his name when he died. His patent that is most useful to most of us is the intermittent motion of the film in a movie camera and projector. As you know, the film stops while it is exposed through the lens system. It is then rapidly moved to the next frame that is to be exposed. A shutter drops in front of the film while it is moving. Every movie camera and projector used by amateurs as well as commercial photographers is based on this work and patents of C. Francis Jenkins. His mechanical TV receiver systems were soon superseded by the cathode-ray tube and electronic scanning. The invention he least regarded was the spiral-wound cardboard tube. His data, books, models, and memorabilia have been collected and presented to the Wayne County Historical Museum. If you are near there during

your travels drop in and see them.

Shocking Machines. Medical machines using high voltage, heat, or radio frequencies are becoming quite popular with radio collectors. Alan Douglas of Pocasset, MA, displayed quite a number of the machines that he has collected at the AWA Conference. These machines date back to the middle 1800's. Many of the original machines are housed in small wooden suitcases and were designed to give the patient a mild electrical shock. Back in the early days of electricity shocks were thought to be beneficial in treating many illnesses. There was either a hand-cranked generator in the suitcase to develop the shocking voltage, or a battery, vibrator, and induction coil were used. These machines were of doubtful value in treating patients, and eventually the Federal Government passed strict laws concerning the claims advertised by the makers of these small electrical machines. In your travels around the country visiting antique shops and junk stores you will find many of these small suitcase sized machines priced at \$5.00 to \$25.00. If your interest leads to collectibles of this sort you should be able to build up a nice collection in a short time.

Juke Boxes Jumping. Another collectible with definite connections to the radio-wireless hobby is the "Juke" box. It wasn't until the tube-type audio amplifier was perfected that the juke boxes really became popular. In the late



These are just a few of the ancient vacuum tubes to be seen at the AWA's Museum.

1920's the Mills Novelty Company introduced a model that had the record holders arranged like a paddle wheel or as it is sometimes called the Ferris Wheel model. The first one that I recall offered eight selections of 78-RPM records, and used a telephone dial as a selector. The cabinet was massive and usually made of oak. Some models had leaded glass windows in front so you

could watch the mechanism operate. It wasn't long before 12-selection model appeared. The Mills Novelty Co., based in Chicago, Illinois didn't stay in the music machine business too long and soon began making slot machines, vending machines, pinball machines, etc. There is a very active market for these old amusement machines and juke boxes. If you run across any of these machines that are reasonably priced pick them up. If you don't want to collect them yourself you can trade them for tubes, radios, speakers, etc. for your radio collection.

As the radio-electronic scene shifts from the experimenter building his own equipment to the hobbyist who buys only ready-to-play equipment the old established companies keep dropping product lines that they had manufactured for many years. The Yaxley Manufacturing Company was founded in 1916 and became a division of the P. R. Mallory & Company, Inc. in the early 1930s. One of the lines of radio parts made in the 30s were telephone jacks and plugs. These continued virtually unchanged until the fall of 1976. Declining sale of these parts led the Mallory management to discontinue making jacks and plugs and certain types of switches. After the present stock in the hands of radio distributors is exhausted there will be no more Mallory telephone jacks and plugs. If you want to complete a collection of jacks or plugs you had better rush out and buy some while there is a stock available. Thus another old familiar name first Yaxley, then Mallory-Yaxley, and finally Mallory will disappear from the world of radio.

Stuck Headphone Caps? I just discovered a helpful tip that I want to share with you. I recently purchased two pairs of old headphones. The black composition caps were stuck so tight to the aluminum cups I could not unscrew them. I even gripped the cups in a large vise, but this did not help. A friend suggested that I put the phones in a home freezer overnight, then remove them and immediately immerse the black caps only into nearly boiling water for a minute or two. I did this and was quite pleased when the caps unscrewed with hardly any effort. The reason this tip works is because the cold box caused the aluminum cup to shrink, and the hot water caused the caps to expand. This uneven coefficient of expansion caused them to come apart quite easily.

Next time I'll get back to the technical aspects of antique radio collecting. We will have technical tips, radio collector club news, and other items of interest. So long for now. ■



DXing COLOMBIA AND VENEZUELA

Tips for the beginner DXer as well as special notes for old hands looking for new catches on medium wave, 60 and 49-meter bands.

by C. M. Stanbury, II

□ Columbia and Venezuela, two Spanish speaking nations that cover all of South America's Caribbean coast, dominate the popular 60-meter shortwave band. 60M is popular with DXers because it is seldom used by the super-powered international broadcasters found on higher frequencies. Thus Colombia and Venezuela, on 60 and other channels, are ideal for the novice breaking into Spanish language reception, and also offer a number of rare catches for experienced DXers. In addition, there are at least a couple of stations with intriguing histories which make especially good loggings.

60 Meters. Two stations with which every novice should start are R. Rumbos at Caracas, Venezuela and R. Sutatenza at Bogota, Colombia. R. Rumbos operates on 4970 kHz and is the key station for Venezuela's major network. News from Cadena Rumbos often is heard on several Venezuelan 60M outlets. R. Sutatenza operates on two 60M frequencies, 5075 and 5095 kHz, both of which are just above the edge of the band and do not always carry the same programs. This station, operated by the Catholic church, has a network, but all outlying R. Sutatenza's relays are on MW. Both R. Rumbos and R. Sutatenza regularly issue QSL cards for correct reports.

Other inviting targets include R. Continente (another Caracas broadcaster which has a network at times) on 5030 kHz; Ecos del Atrato (Quibo, Colombia) on 5020; R. Barquisimeto, a R. Rumbos affiliate on 4990 (just below WWV's 5 MHz time signal); R. Sante Fe (Bogota) on 4965; R. Colosal (Neiva, Colombia) on 4945, which

sometimes announces as R. Todelar (TODELAR is another Colombian network); and so, on right down to the low edge of the band (4770 kHz). There are many strong Colombian and Venezuelan 60M signals most evenings and one merely has to tune from fre-

Many stations in Latin America have QSL cards printed which they'll send you verifying your reception of their broadcasts. Stations without QSL cards usually will write a special letter to you like these two received by the author.

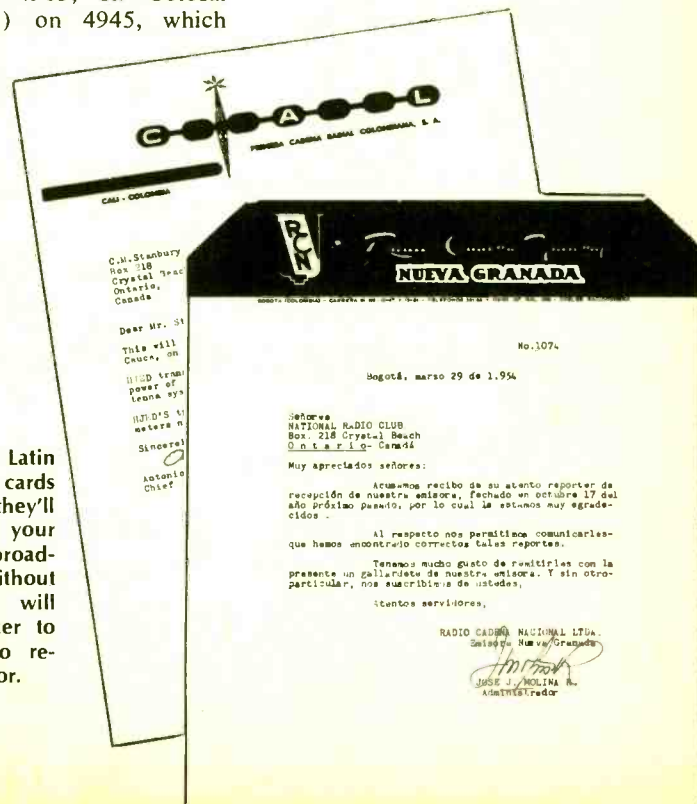

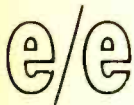

DXing Colombia

quency to frequency and listen for the ID. As a general rule, Colombian frequencies on this band end in 5 and Venezuelans with a 0. Unfortunately, this arrangement does not hold above 5 MHz.

Government Stations. In addition to the privately owned broadcasters mentioned above, both governments operate stations called "Radio Nacional." When its 4955 kHz channel is active, this is by far the easiest frequency upon which to log R. Nacional de Colombia. RNC is most notable for the number of other international broadcast stations it relays, including KGEL, a privately owned missionary station near San Francisco. This is unusual because no international missionary stations are allowed to operate from Colombia itself. (R. Sutatenza's transmissions are intended only for domestic reception).

RNC's operations on 4955 are erratic, but R. Nacional de Venezuela's 60M channel, 5020 kHz, has been silent much longer. RNV (notorious in DX circles for issuing ambiguous information on its frequencies and locations) claims to operate only two transmitters (on 6170 & 15400 kHz). However, it is known that they have access to shortwave facilities of the Venezuelan national telephone company, CANTV, which means RNV can activate additional channels whenever necessary. When RNV/CANTV does reappear on 5020, it will probably be much stronger than the Colombian Ecos del Atrato.

49 Meters. When those ionospheric conditions which make possible propagation around 6 MHz between North America and Europe collapse, sometime before 0300 EST, DXers have an excellent chance to log Colombia's networks. All-night stations include Emisora Nueva Grenada (at Bogota) on

6160 kHz—the key station for Radio Cadena Nacional, Colombia's most important network but not to be confused with the official government station. Two more TODELAR affiliates are on this band, R. Continental (Bogota) on 6125 La Voz de Huila (Neiva) on 6150. There are also the "Radio Super's"—at Medellin which recently moved to 6000; Bogota on 6065; and at Cali on 6120 kHz.

There is at least one all-night Venezuelan 49M broadcaster. It is a time station along the lines of WWV, Observatorio Cagigal on 6100 kHz. Most 49M Venezuelan reception occurs when these stations sign on approximately between 0500 and 0600 EST. Possibly the two most widely reported loggings during this period are R. Turismo at Valera on 6180 and R. Los Andes at Merida on 6010 kHz. Unfortunately, R. Nacional does not sign on until 0700 but reception has been reported occasionally in North America on 6170.

Medium Wave. BCB Dxrs have numerous Colombian and Venezuelan targets to shoot for. The most often reported Venezuelan MW station is Radiotempo (1200 kHz) at Caracas, which may be the most widely heard 10 KW BCB transmitter in the world. It has been logged as far north as Canada, sometimes a few minutes before sunset at Caracas. The chief source of interference in most parts of North America is not 50 kW WOAI at San Antonio, Texas, but A. Almirante at Riohacha, Colombia.

If you live too close to San Antonio to log DX on 1200 kHz, there are other promising frequencies to monitor. Anytime an ionospheric disturbance knocks out signals from KMOX (St. Louis) on 1120, watch for Ondas del Mar from Maracaibo. There is R. Caracas, which has a relatively new 50 KW transmitter on 750 kHz, and seems to be especially well heard in western North America.

The first Colombian station men-

tioned, R. Sutatenza, has a mighty 250 KW outlet on 810 kHz and is the second most powerful BCB transmitter in South America. Another good prospect in the east is R. Aeropuerto (Barranquilla) on 1160 kHz. Under normal conditions, it often is heard after WJJD (Chicago) signs off at Salt Lake City sunset (to protect KSL). After that the major interference will come from a station in the Dominican Republic, Radiolandia. If you don't live too close to Dallas/Fort Worth, La Voz del Rio Cauca (Cali) with 50 KW on 820 kHz is a good bet. This one belongs to yet another Colombian network, CARACOL. Out west, R. Colosal's BCB transmitter often is heard around Midnight PST (0300 EST) on its "split frequency" of 1005 kHz. Another good frequency to watch around 0300 EST is 1040, but only on Monday mornings when WHO (Des Moines) is off. At those times, R. Tropical at Barranquilla is usually on top but if you listen carefully, R. Super de Bogota also can be logged.

Secret Stations. Over the past 15 years Venezuela and/or the area around it has been home for two widely heard shortwave clandestine broadcast stations; R. Libertad ("La Voz Anti-Comunista de America," now defunct) and R. Euzkadi (the Basque name for the northern part of Spain), which is the official voice of the French-based Basque government-in-exile and can be monitored daily by North American SWLs. Although at opposite ends of the political spectrum—R. Libertad is tied to the far right and R. Euzkadi is a liberal Catholic organization not to be confused with the far left "ETA" Basque guerillas)—the two stations have striking similarities. Both at one time had ties to the CIA, both had even stronger ties to wholly European operation (something one would not expect to find in Latin America), and both stations maintained regular schedules clearly indicating they operated with government (Venezuelan) consent.

Before it closed down in 1968, R. Libertad had been completely taken over by a right wing Soviet organization known as "NTS" which maintained headquarters at Paris, operated its own "Radio Free Russia" transmitters in West Germany, and solicited reports and letters to a Rotterdam, Netherlands, post office box.

The Basque government-in-exile was organized during World War II with the help of the OSS (the CIA's predecessor) and other western intelligence agencies including the Free French Army. At that time, according to recent

(Continued on page 90)

POR AVIADA RADIO RUMBOS

LA EMISORA DE VENEZUELA
Y SU CIRCUITO NACIONAL RUMBOS

YVIX 160 KC Onda Limp. 100 KW	YVLL 1020 KC Onda Limp. 10 KW	YVLL FM 99 MC Onda Limp. 1 KW
YVJK 480 KC Onda Limp. 10 KW	YVLR 1180 KC Onda Limp. 1 KW	

CARACAS - VENEZUELA
ESTUDIOS: EMB. JUNWA S. 27 P. 505 EL SILENCIO
TELÉFONOS 421467 - 412861 427215
APARTADO POSTAL 2618
PLANTA CALLES URUGUAY
AVENIDA LA PIZ - EL PARAISO
TELÉFONO 2403

EMISORAS DEL CIRCUITO: RADIO BARCELONA
RADIO SUCRE
RADIO CARUPANO
RADIO PUNTO Fijo

Senior M. STANBURY II
Box 218 Crystal Beach
Antarctic - Canada

For beginning DXers the QSL card shown here is one of the easiest to get.



Kathi's CB Carousel

by Kathi Martin, KGK3916

Powermikes—What They Can Do For You

□ Just about any good idea can be ruined by overapplication. Take *powermikes* as an example. It all started back in the days when CB transmitters didn't have 100 percent modulation limiting—or sufficient microphone preamplification. Someone, the exact name slips my mind, built an accessory preamplifier with about 6 dB compression, thereby providing a boost to both the average voice power and the lower level speech sounds. Someone else added peak limiting to prevent modulating more than 100 percent modulation with its resultant distortion and sideband splatter, and then the whole thing was wrapped up with a little extra gain and a level control so the user could adjust her or his modulation as close as possible to 85-100 percent. Some early "compressors" even had built-in meters to insure optimum adjustment.

These compressors did wonders for

Two high quality CB "powermikes" from Shure Bros. One on right is noise-cancelling mobile mike, responds only to sounds within an inch or two. Base unit mike (left) has built-in amp which works best set at minimum gain. Whole base is PTT switch.



Fig. 3

CB. After all, they simply provided the compression that already existed in just about every other type of communications transmitter.

Then so-called "power mikes" came along. These were actually nothing more than an inexpensive (sometimes high quality) microphone driving a high gain preamplifier. By the time the signal gets into the transceiver it either overdrives the transceiver's input transistor causing signal distortion or de-

struction of the transistor, produces distortion through greater than 100 percent modulation if the transmitter isn't limited to 100 percent modulation—and most transceiver built until 1976 are not limited to 100 percent (regardless of their manufacturer's claims), or distorts if the transmitter is limited to 100 percent modulation.

In case you tend to doubt that many transceivers are not limited to 100 percent modulation, of 25 models recently tested by the FCC, 23 did not provide 100 percent modulation limiting even though the manufacturers had claimed 100 percent limiting.

Figs. 1 and 2 shows what often happens when a CBER uses a powermike. Fig. 1 is the RF output of a transceiver, specified by the manufacturer to have 100 percent limiting, when a 1000 Hz sine waveform at reference voice level is fed into the microphone. Note that the negative (baseline) modulation is just short of 100 percent (at 100 percent it touches the baseline). Fig. 2 is the same transmitter using a popular powermike with the powermike's level control turned fully *down*. This mess of distortion is what's transmitted, and there is negative overmodulation producing sideband splatter 30 kHz either side of the operating channel. Imagine how much worse it is when the level control is turned up.

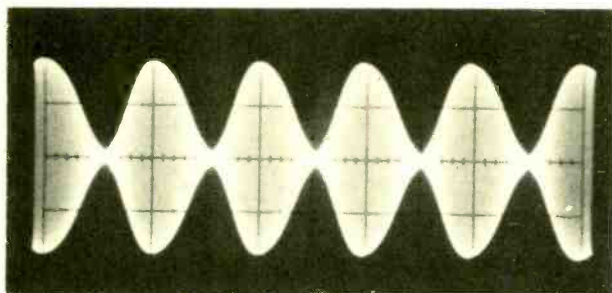
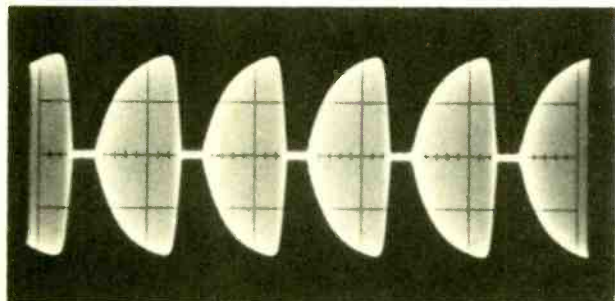

Fig. 1

A sine-waveform at moderate voice level produces almost 100 percent modulation on this transmitter.



But adding a powermike overdrives the preamp and modulator, exceeding 100 percent modulation with resultant distortion and sideband splatter.

Fig. 2

e/e Kathi's CB Carousel

Now I'm certain that every one of you readers know at least one CBer using a power mike that puts out a really solid "easy listening" signal with no distortion or splatter, so before you start writing about these exceptions that prove the rule let me explain how you get not just good, but *great* results with a power mike.

Punch With Quality. First, not every power mike has a built-in amplifier; they are simply superb microphones specifically tailored for mobile communications. Regardless of how impressive the case looks, most mikes supplied with low to moderate quality transceivers are simply miserable—their sound is muddy and distorted. Just replace the typical CB mike with a quality job such as used for police, fire and government transmitters and in one stroke you clean up your signal and pack in solid modulation at the intelligence-carrying midband frequencies. Where do you find such a mike? You find it masquerading as the Shure CB45 Noise Cancelling Controlled-Magnetic Microphone (dual impedance), shown on the right in Fig. 3. This mike is really one of Shure's "pro" models with a CB identification number. It is designed to

respond only to close-in sounds and is used actually touching the lips. It is insensitive to extraneous sounds such as road noise so it puts out a really clean mobile signal—and without need for an amplifier. To give you some idea of the quality built into the Shure CB45: it weighs two to three times more than a typical mike supplied with a CB transceiver (and most of the weight is the microphone element). And you know that little clip supplied with mikes that you screw to the dash to hold the mike? Well the one supplied with the CB45 is literally a work of art, costing more than many so-called CB replacement mikes.

As for amplified mikes, I just don't dig them unless you want to sit back in a nice quiet office and speak low, or mumble. But if you want to relax then one of my favorites is the Shure 526T shown on the left in Fig. 3. The mike element in conjunction with the amplifier—which is powered by a standard 9-volt battery—provides a boost to the midband frequencies, resulting in modulation that literally cuts through QRM. But, and this is a big *but*, the mike works great if the level control is turned all the way down. If the level control is turned up the sensitivity is so sharply increased the mike will pick up every sound in the home, office, and possibly the street, and your on-mike sounds will most likely overload the

transceiver's mike input. Use this mike properly and it's easy-operating, and easy-listening on the receiving end. Oh yes, I shouldn't forget to mention that the 526T has a locking PTT switch. You can either hold it down as long as you want to transmit, or slide it slightly forward so it locks in the transmit position.

Summing Up. But while sitting back and working "no hands" with a voice no louder than a whisper sounds like the way to go, if I had but one choice it would be for a barefoot (unamplified) high performance noise-cancelling microphone, for when the QRM and QRN gets rough and the signal is coming in slightly below the noise level it's the extra clean signal—the one without distortion and extraneous noise pickup—that gets the message through. In short, it's not how *loud* the signal sounds that's important, but rather how *clean* it sounds; wall-to-wall distortion doesn't get your message through.

Keep in mind that while I've shown the Shure versions of quality communications microphones, other manufacturers make mikes of similar quality. Just be certain you stick to the quality brands and you won't go wrong; after all, they have a reputation to protect. Just remember, there's nothing special about CB; a mike that's quality material for any land-mobile radio service is quality for CB. ■

Kill That CB Whine

□ The next time your CB rig whines as you gun the motor, blame it on yourself and not on Detroit. Auto wiring systems are not designed to include communications systems. Therefore, you can expect interference from the alternator—the source of the whine. It's up to you to eliminate the whine. Nope, not every model, or car in a model group, will produce a whine, but when it does, communications can be either a bust or reduced in reliability and usefulness.

To rid yourself of the alternator whine, you could spring for a new alternator, rewire the harness or tune up the engine. However, there is an easier, cheaper way—install a mobile alternator/generator feed-thru filter. It will help suppress unwelcome whine interference and completely or partially reduce other noises, such as clicks and static caused by turn signals, fan motors and other accessories.

A Sprague QX1-18 feed-thru filter

rated at 40 amperes is shown in the photographed installation. It is hermetically sealed for protection against mechanical damage, moisture, grease and grime. The ideal method of installation is to mount the feed-thru filter right onto the alternator but in many cases, this is impractical. The photograph shows the Sprague QX1-18 mounted next to the starter solenoid, where the hot lead from the alternator meets the hot lead from the battery. Before beginning the installation, disconnect the lead from the battery's positive terminal for safety's sake. Then, disconnect the lead that goes from the alternator to the starter solenoid and connect it to one terminal of the feed-thru filter. Attach a cable to handle the hook-up from the feed-thru filter's remaining terminal to the terminal on the solenoid, at the alternator hot cable's original connection. The best kind of cable to use is the approved auto cable. It should handle up to 40

amps or more, and it is available from automotive supply stores. Connections should be kept short and without cable flop or unnecessary loops.

The Sprague QX1 series of feed-thru filters comes in 20, 40, 60, 100 and 200 ampere ratings. 40 amps is more than adequate for the average car.

The feed-thru filter should knock out the whine and most of the *snap, crackle and pops* you'll hear on your mobile CB, tape player and in-dash radio. If your car doesn't need a feed-thru filter today, it may need one tomorrow when you switch to a new CB model. That's right, sometimes the CB rig installation causes whine problems. The filter is always the best remedy. ■



CB whine can usually be eliminated by installing a simple filter such as this one.

e/e checks out the...

B&K 2040 CB SERVICEMASTER

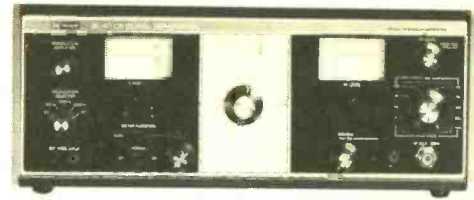

One instrument replaces a benchful of test gear for fast transceiver testing and alignment

□ If you've ever paid hard cash for a CB transceiver checkout, or even accepted a freebie at a so-called CB Clinic, you know that what you generally get is a check of the transmitter's power output, the transmitter's output frequency on one or more channels, and possibly some sort of check of the transmitter's maximum percentage of modulation.

What you rarely, if ever, get in a transceiver checkout is a test of the re-

ceiver section—but you can't work signals you don't receive, can you? The reason few CB checkouts include receiver tests is simple: the required signal generator(s) often cost upwards of \$1200, a steep price for the average service shop.

But now there's a signal generator available specifically designed for lab-grade CB test and repair, and its \$475 price is low enough to permit its use in most shops and service stations.

Within months you're certain to find that even free CB checkouts include a receiver test with B&K's Model 2040 CB Signal Generator. Smart REACT teams and CB clubs might well get their own Model 2040s to insure their members have transceivers working at optimum.

The B&K Model 2040 is so well thought out that even an inexperienced, non-technical CBER can test a transceiver for receiver *sensitivity*, adjacent channel *rejection*, single-sideband (and opposite-sideband) *suppression*, *delta*, *clarifier* (fine tuning) *AGC* action, and even *ANL* (automatic noise limiting) and *noise blanker* effectiveness. Though all these are highly technical tests that generally require a skilled service technician, the Model 2040 lets any high school student get trained in less than an hour to run a complete, accurate receiver checkout. What makes it so easy is that all the 2040's operating features are conveniently grouped in three sections on the front panel, as shown in the photographs.

In the center is the channel selector that covers all 40 channels, showing both the channel number and the exact frequency. The selector covers more than 40 channels because it provides output on the unassigned frequencies between some of the CB channels, as well as a few frequencies below and above the CB band. The extra frequency coverage is provided to permit any type of test on any channel. For example, the frequency between channels 11 and 12 are not assigned to CB. We can call this frequency channel 11A. If you were testing a receiver section set for channel 11, for adjacent channel rejection on the high side (+10 kHz), you'd find the frequency 10 kHz above channel 11 is not channel 12 but channel 11A. With the Model 2040 you can get precise output on channel 11A. The same thing applies with the "hole" in the band between channels 22 and 23. The hole was previously two channels wide. Now, with the 40-channel band the hole becomes channels 24 and 25. You

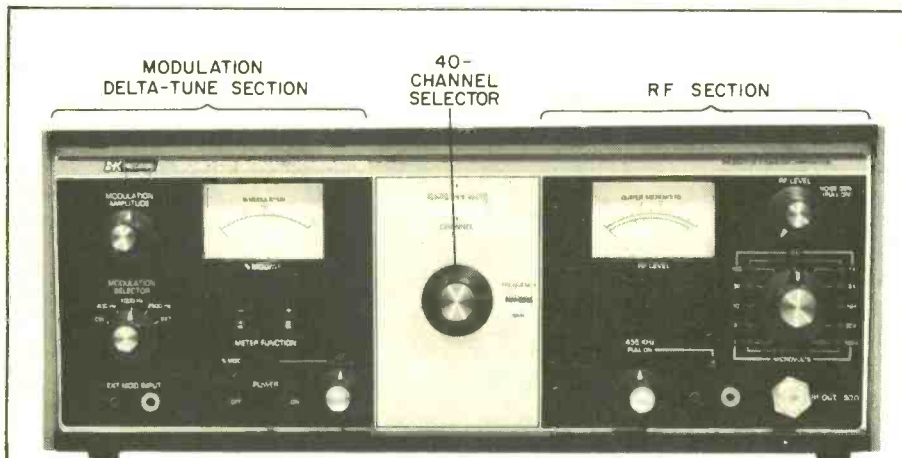

B&K 2040 CB Signal Generator front panel is divided into three sections. 40-channel selector is one knob in center section. RF controls and meter are all in right section. For further information circle no. 75 on Reader Service Coupon.

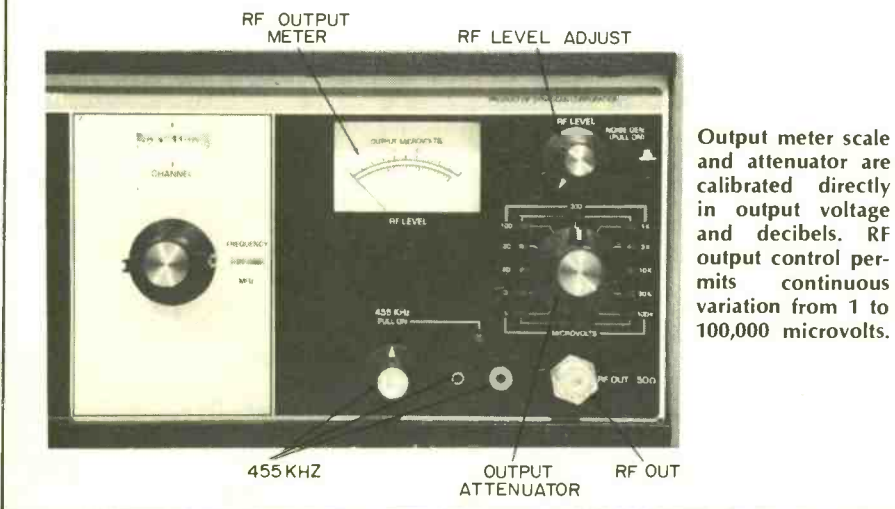

Output meter scale and attenuator are calibrated directly in output voltage and decibels. RF output control permits continuous variation from 1 to 100,000 microvolts.

e/e Servicemaster

will find the signal generator's channel selector calibrated "22, 24, 25, 23, 26, 27," etc.

In short, every needed CB test frequency is available at a flip of the switch. In the event the FCC expands the Citizens Band beyond 40 channels at a later date a simple modification can expand the 2040's output to 100 channels!

The right side of the generator provides a fully-metered RF output calibrated directly in microvolts and dB. The RF output appears at a standard coaxial jack. The attenuator provides full-scale output from 1 to 100,000 μV in 10 dB steps. And an RF-level control permits the output to be adjusted to any value from 1 to 100,000 μV .

A standard EIA noise pulse generator for testing noise limiters is activated when you simply pull outward the RF-level control knob. The noise pulse can be added to a modulated or unmodulated signal. Since the pulse closely approximates the waveshape of typical electrical noises picked up by the CB receiver it is a convenient and accurate way to judge the effectiveness of the ANL and noise blanker circuits. Of course, if the transceiver doesn't have ANL and noise blanker on-off switches it's next-to-impossible to judge if the noise limiter circuits are having any effect on the test signal.

The final feature of the RF section is a 455-kHz oscillator with its separate output level control and banana jacks. This oscillator is intended for service work, and checkout of PLL transceiver circuits. It can be used separately or in conjunction with the 27 MHz output.

On the left side of the cabinet you'll find the signal generator's modulator control and metering. A rotary switch selects modulating frequencies of 400, 1000 or 2500 Hz, or external modulation for the RF output. Banana jacks are provided for connecting the external modulation signal. A *Modulation Amplitude* control sets the percent modulation from zero to 100%. The exact degree of modulation is indicated by the *percentage-of-modulation* meter. The meter has, in addition to the percent-modulation scale, an 0 to 5 calibration, which represents 0 to 5 kHz. Two LED lamps associated with the 0 to 5 kHz scale indicate + (above), and - (below) the channel frequency. Finally, a *Delta* control determines the meter reading, which indicates how far off frequency the RF output has been

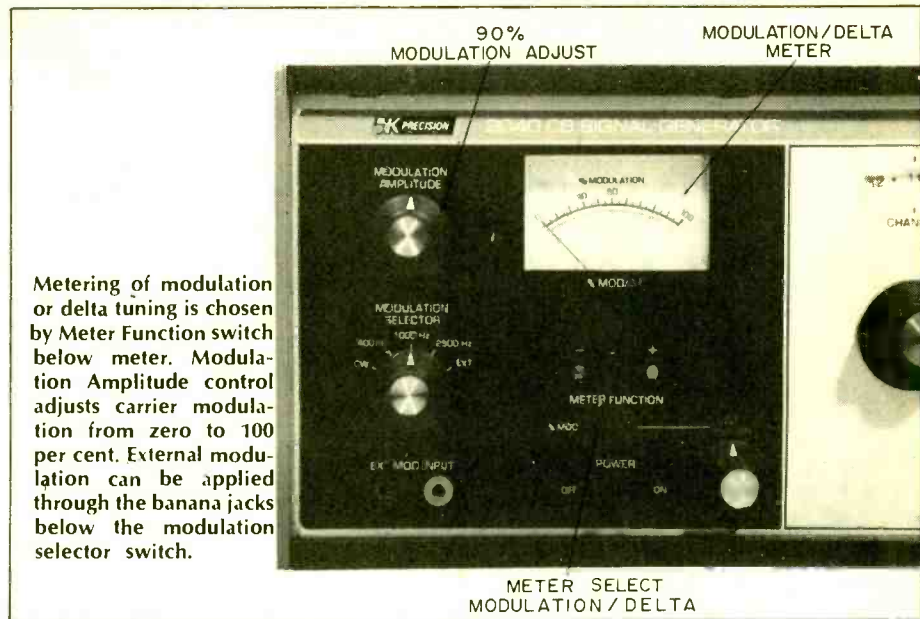

Metering of modulation or delta tuning is chosen by Meter Function switch below meter. Modulation Amplitude control adjusts carrier modulation from zero to 100 per cent. External modulation can be applied through the banana jacks below the modulation selector switch.

adjusted. Here's how it works. Pulling on the *Delta* control activates electronic correction of the RF oscillator's output frequency. If the control is adjusted so the meter indicates say, 1 kHz with the + LED illuminated, the RF output frequency is 1 kHz higher than indicated by the channel selector. For example, if the channel selector is set to 27.065 MHz the actual output frequency will be 27.066 MHz. If the delta control is adjusted so the meter reads 1 kHz with the - LED indicator lit the generator's output frequency is 27.064 MHz. The delta electronic frequency correction

can be used with or without modulation of the RF carrier, so it allows measurements of a receiver's delta, clarifier or fine tuning, SSB receiver sensitivity, and SSB opposite-sideband suppression.

The important thing to bear in mind is that while the B&K 2040 replaces a bench full of test equipment, it is easier to operate than just one standard signal generator when it comes to making CB tests and measurements. We have replaced much of the test gear in our own CB lab with the B&K 2040 CB Signal Generator—it's that good.

The 2040 measures 17.9-in. wide x 7.25-in. high x 10.6-in. deep. Weight is 17.25 lbs. It is strictly 105-130 VAC-powered; there's no option for 13.8 VDC. Priced at \$475, the generator is supplied with an extensive instruction manual covering CB receiver tests. (For a complete transceiver test the 2040 is used with a B&K model 1040 CB ServiceMaster and 'scope.) All connection cables are optional—you provide your own.

For additional information circle number 75 on Reader Service coupon.

What We Said Before. In our review of the B&K model 1040 Servicemaster in our January/February 1977 issue we wrote, "We expect B&K to be coming out soon with companion units for the 1040 Servicemaster." They came out a lot sooner than we thought anybody could—so we were wrong! So to correct a wrong, we reviewed the R&K 2040 above. Also, the start of the fourth paragraph from the end of the 1040 review we started off with, "With two minor exceptions. . . ." This should be stricken from the text and the sentence begins with the word "The." Sorry about the hasty editing. ■

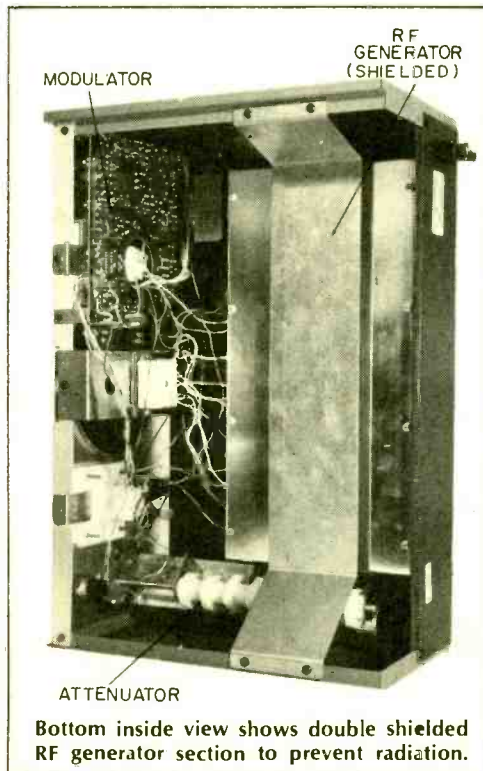

Bottom inside view shows double shielded RF generator section to prevent radiation.

e/e

BASIC COURSE IN ELECTRICITY & ELECTRONICS

RECOMMENDED THEORY FOR ALL CB OPERATORS

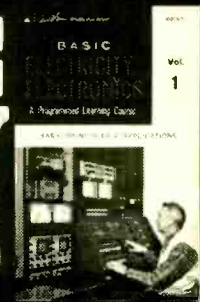

This series is based on BASIC ELECTRICITY/ELECTRONICS, Vol. 4, published by HOWARD W. SAMS & CO., INC.

USING THE OSCILLOSCOPE

WHAT YOU WILL LEARN. You will learn how to turn on and operate an oscilloscope. You will see how the scope can be used to check test points in electronic circuits in order to find possible failures or malfunctions of circuits, stages, or components.

You will see how displaying on the scope the waveforms of signals in working circuits can reveal whether a circuit is working properly or not. In addition the scope can measure (approximately) the amplitude of signals.

The scope can also be used to measure the phase of two related signals. This involves the use of Lissajous figures. You will also learn how a scope creates Lissajous figures to determine the frequency of a signal—by displaying it in combination with a signal of known frequency.

The Scope Graticule

Most scopes are supplied with a circular piece of transparent plastic the same diameter as the face of the CRT screen. This graticule has vertical and horizontal lines drawn on it to form a grid. When the graticule is snapped into place in front of the CRT screen it can be used to measure (approximately) the amplitude of signals. This is done by first pressing (or turning) the **Calibrate** control, which displays a signal of known amplitude on the screen (usually 5 volts or one volt). By adjusting the size of the calibrating signal with the vertical amplitude controls you can make the signal fill five (or 10, or any other convenient) number of gradations on the graticule.

Then, switching off the **Calibrate** signal, and displaying the unknown-amplitude signal will permit you to count the number of gradations on the graticule for ready comparison with the **Calibrate** signal.

Similarity Among Oscilloscopes

The oscilloscope you use may differ in some respects from the one described here. Controls and circuits may be identified by different titles, and many of the circuits may be designed differently. However, all of the functions will be fundamentally the same. Before using an oscilloscope, it is wise to carefully study

the manual that comes with it. Develop the habit of taking all readings with the greatest accuracy possible.

An oscilloscope can be used for several different types of measurements. You know it is most often used to study the shape of a waveform when checking the performance of equipment. The pattern on the scope is compared with the signal that should appear at each test point, and a judgment is then made as to whether the operation of the equipment is good or bad.

Turning the Scope On

First, make sure the scope is plugged into an electrical outlet. Many people have turned all knobs on the front panel out of adjustment before they noticed that the power cord was not plugged in. On most scopes the power switch is part of the **Intensity** control. Turn the knob until a click is heard. Let the scope warm up for a few minutes so that voltages in all of the circuits become stabilized.

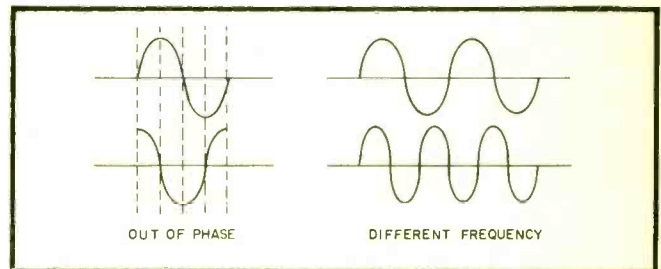

Getting a Pattern on the Screen

When putting a pattern on the screen, adjust the **Intensity** and **Focus** controls for a bright, sharp line. If other control settings are such that a dot instead of a line appears, turn down the **Intensity** at once to prevent burning a hole in the screen coating. Brightness and sharpness will vary at various frequency settings, because of the different speeds at which the beam travels across the screen. For this reason, it may be necessary to adjust the **Intensity** and **Focus** controls occasionally while taking readings.

QUESTION

Q1. What should you do before you turn on the oscilloscope?

ANSWER

A1. You should carefully study the manual that comes with the scope before turning the scope on.



Number of Cycles on the Screen

Because distortion often exists at the beginning and end of a sweep, it is best to put two or three cycles of the waveform on the screen instead of only one.

The center cycle of three cycles provides an undistorted waveform, in its correct phase. The center of a two-cycle presentation will appear inverted, even though it may be undistorted.

The relationship between the frequencies of the waveform on the vertical plates and the sawtooth on the horizontal plates determines the number of cycles on the screen.

The sweep frequency should always be kept equal to, or lower than the waveform frequency; it should never be higher. If the sweep frequency were higher, only a part of the waveform would be presented on the scope.

Proper Display of Waveforms

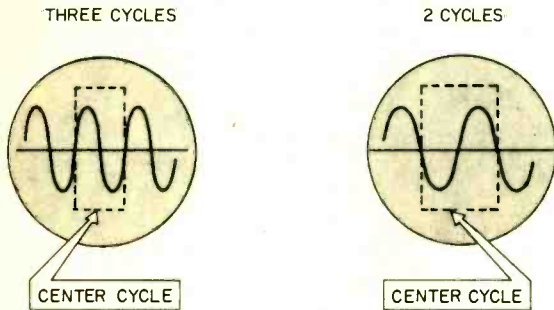

As the preceding drawing shows, three cycles of the waveform will be on the screen when the sweep frequency is set to $\frac{1}{3}$ the frequency of the input signal. If the input frequency is 12,000 cps, the sweep frequency must be 4,000 cps for a three-cycle scope presentation. For two cycles, the sweep frequency must be set at 6,000 cps. If a single cycle is desired, the setting is the same as the input frequency, i.e., 12,000 cps.

The sawtooth frequency is selected by settings on the **Coarse Freq** and **Vernier** controls on the front

Sawtooth Sweep for Display

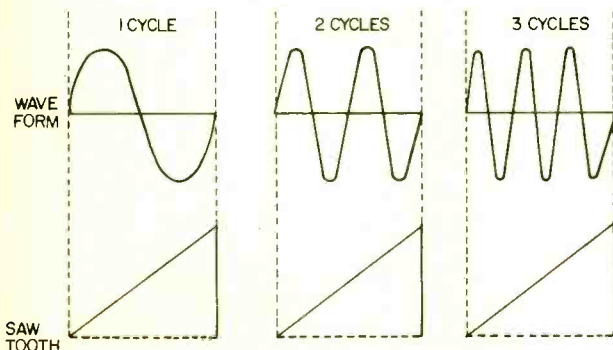

panel. If the exact frequency number is not found on the coarse-frequency markings, set the coarse control

to the closest number and adjust the vernier control for a stationary pattern on the screen.

The ratio of waveform to sawtooth frequencies should be such that it is one the order of $1/1$, $2/1$, $3/1$, $4/1$, etc. When the ratio leaves a quotient that is not a whole number ($3/2$ for example), the display will be a pattern continuously moving across the screen. If the pattern appears to be incorrect, adjust the proper control (**Coarse** or **Vernier**).

Sawtooth Sweep Too Small

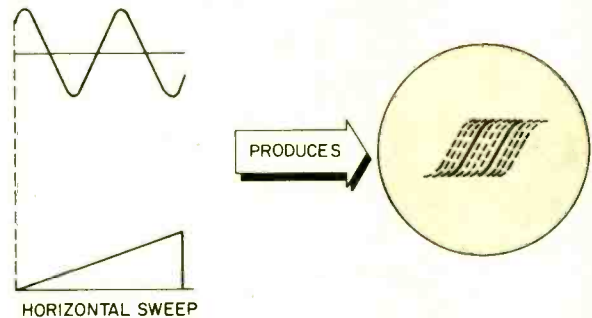

QUESTION

Q2. Why is there only one sawtooth cycle in each example in the drawing preceding the last one?

ANSWER

A. There can be only one sawtooth wave per sweep of the scope, regardless of the number of waveform cycles. The sawtooth will move the electron beam horizontally across the scope during its rise time. When the sawtooth decays, the beam immediately returns to the starting point on the left.

Other Preparatory Settings

So far you have learned how to set the **Intensity** and **Focus** controls for proper brightness and sharpness of the waveform on the screen. A steady pattern has been obtained by setting the **Coarse Freq** and **Vernier** controls of the sweep-oscillator stage for a steady, uniform pattern. If the pattern looks like either of the following, you are ready to proceed with an analysis of the waveform.

Proper Waveform Displays

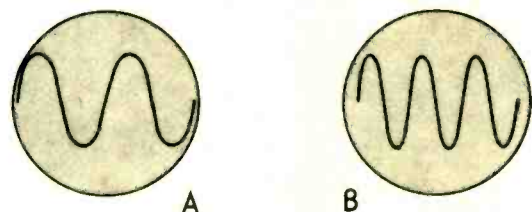

However, you may obtain patterns that appear similar to these:

Which control would you adjust to correct the picture labeled A? Which would you adjust to correct the

picture labeled B? The waveform in A can be adjusted by turning the Vert Pos control to bring the waveform to the center of the screen. The waveform in B can be adjusted by turning the Hor Pos control to bring the waveform to the center of the screen.

The two positioning controls above and to either side of the screen are used to center the waveform. Suppose the display for two cycles appeared like either one of the pictures below. Which controls would you adjust?

It is evident that some parts of the waveform are being deflected off the screen in both cases. The figure on the left has too much horizontal expansion, so you would need to reduce the **Hor Gain** (horizontal gain) setting. Reduction in **Vert Gain** (vertical gain) would bring the waveform on the right back on the screen. For normal viewing purposes the height and width of a waveform pattern should be about equal and

Wrong Waveform Displays

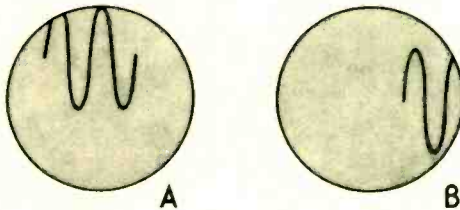

should cover about 60 to 70% of the screen. On a 5-inch scope this would be a little over 3 inches. The pattern should be about 2 inches for a 3-inch CRT. Adjustments of the vertical-gain control not only change the amplitude of the signal fed to the vertical-deflection plates, but they also increase or decrease the amplitude of the signal fed to the sync circuit. Quite frequently the change will affect the ionizing potential of the thyratron sufficiently to cause distortion in the presentation. To remedy this, adjust the **Lock** control in the sync circuit.

Occasionally a waveform frequency will be encountered that is so high that the frequency of the sweep oscillator cannot be made high enough to give a screen presentation of 2 or 3 cycles. If the upper limit of the **Coarse Freq** control were 50 kHz and the

Improper Displays



frequency of the waveform were 1 MHz, the vertical-to-horizontal ratio would be $1,000,000/50,000$ or $20/1$. Twenty cycles of the waveform would appear on the screen at this setting. The **Vernier** adjustment might eliminate a few cycles, but the remaining cycles would be too close together to permit observation.

Multicycle Displays



QUESTION

Q3. To observe three cycles of a 45,000-Hz signal, to what setting(s) would you adjust which controls?

ANSWER

A3. Set the Coarse Freq control to 15 kHz and adjust the Vernier control for a steady display.

When there are too many cycles for easy viewing, expanding the presentation with the horizontal-gain control will separate the cycles for better viewing.

Reading Waveforms

Signals (waveforms) are modified, or changed, as they pass from stage to stage in a piece of electronic equipment until the signal from the final stage contains the desired characteristics. With an oscilloscope you can test the signals at each stage in a piece of equipment to determine whether the circuits are operating properly and/or which one might be the cause of a trouble.

Block Diagram With Waveforms

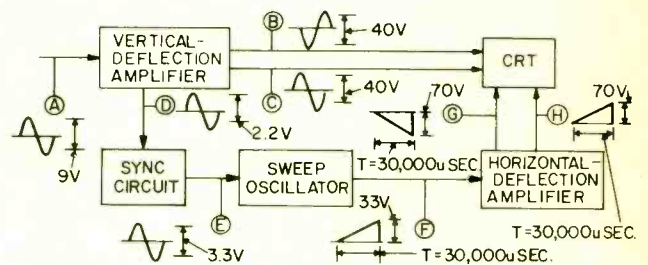

The above block diagram is representative of a **servicing block diagram** for an oscilloscope. The letters in circles identify important test points. The waveforms beside them show the shape, voltage, and time duration (where applicable) that should be observed at these points. Arrows on block-connecting lines show the direction of signal flow. This diagram would be used when matching the characteristics of the waveforms to those shown on an oscilloscope. By using a graticule whose lines have been given voltage values in accordance with the amplitude of a known voltage, the voltage at each of the test points could be checked.

Lissajous Figures

The phase relationship between two waveforms and the frequency of a signal can be measured on an oscilloscope. Patterns placed on the screen to accomplish this are called **Lissajous figures**. A Lissajous



figure is the pattern obtained when AC signals are applied simultaneously to both sets of deflection plates. The following procedures are typical of most oscilloscopes.

Phase Measurement—When you are measuring the phase difference between two signals, one signal is applied to the vertical and the other to the horizontal

Lissajous Figure—Waveform In Phase

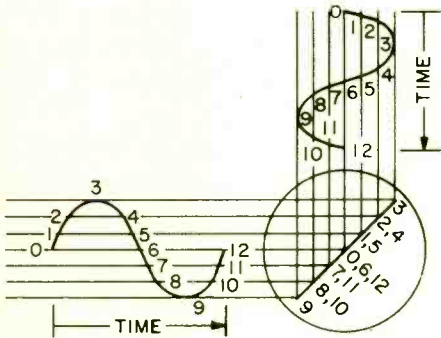

input. Turn the sweep off so that there will be no sawtooth voltage to interfere with the signal in the horizontal channel. For greatest accuracy, the amplitudes of the two signals should be equal. Adjust the gain controls to obtain a pattern that is as high as it is wide. When measuring for phase difference, the two signals must, of course, be the same frequency.

QUESTIONS

- Q4. If test points H, G, and F in the block diagram provide improper waveforms, and test point E shows the correct waveform in which circuit is the trouble located?
- Q5. Patterns placed on the screen to show phase relationship are called
- Q6. Why would you want to enlarge a waveform presentation on an oscilloscope?
- Q7. What is meant by the output stage in electronic equipment?
- Q8. How can the phase relationship between two waveforms be measured using the oscilloscope?
- Q9. When measuring the phase difference of two signals, their frequencies must be

ANSWERS

- A4. The trouble is in the **sweep-oscillator circuit**. This circuit has a good input, but it has a faulty output.
- A5. Patterns placed on the screen to show phase relationship are called **Lissajous figures**.

Two Waveforms Out-of-Phase

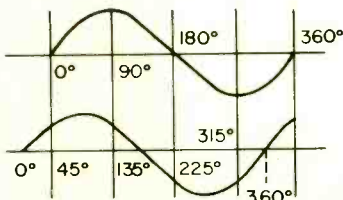

- A6. The presentation is expanded for **better accuracy** when viewing a waveform.
- A7. The output stage feeds the desired signal **to the load** of the equipment.
- A8. **AC signals are simultaneously applied to each set of deflection plates** when comparing their phase.
- A9. When measuring the phase difference of two signals, their frequencies must be **equal**.

Analyzing a Lissajous Figure

The drawing below shows what is called a **Lissajous** pattern for two sine waves. Numbers have been assigned to corresponding voltage points on the two signals. Extensions of these points are brought to the

Lissajous Figures

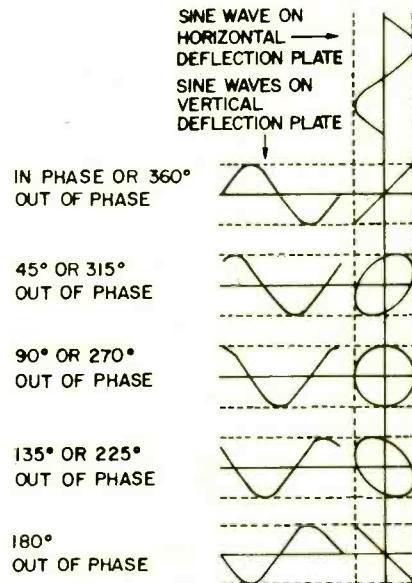

screen. The intersection of corresponding numbered lines is the position of the electron beam at that instant of time. In this case the two sine waves are in phase.

In the figure below, voltage/time relationships are different; corresponding voltage points are 45° apart. Therefore the waveforms are 45° out of phase.

Two Frequencies Equal

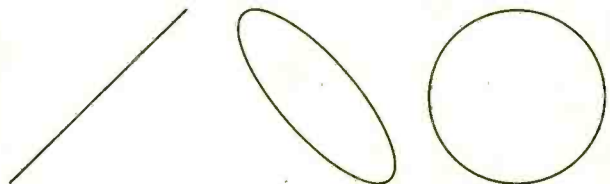

Frequency Measurement—The frequency of an unknown sine wave is determined in a manner similar to phase measurement. A known frequency is applied to the horizontal plates while an unknown waveform appears on the vertical plates. The resulting Lissajous figure will reveal the difference in frequency between

Tangent Points

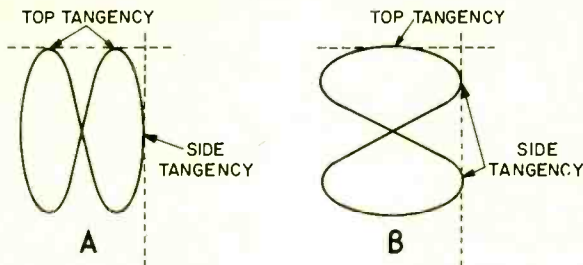

the two. The reference frequency could be taken from a calibrated signal generator or from the 60-cycle AC supply which is available on the front panel of most oscilloscopes.

The electron beam will follow the voltage amplitudes placed on the deflection plates. If the waveforms are of the same frequency, the Lissajous figure will resemble those obtained in measuring phase relationships.

Frequency relationships can be determined by the number of loops or points that touch the top (or bottom) and one of the sides of the pattern. In the figures you have seen so far, there is one point of tangency at the top and one at the side. The frequency ratio is 1/1; the unknown has the same frequency as the standard.

In figure A one cycle of standard frequency appears on the horizontal plates at the same time that two cycles of the unknown are on the vertical plates. There are two points (loops) of top tangency and one point of side tangency. Frequency ratios should be expressed in terms of vertical (unknown) to horizontal (standard). The frequency ratio of figure A is 2/1.

QUESTION

Q10. What circuits must be bypassed in the horizontal channel to obtain a Lissajous figure on the screen?

ANSWER

A10. The sync and sweep-oscillator circuits must be by-passed. If a sawtooth wave and an external signal were fed to the horizontal-deflection amplifier at the same time, a Lissajous figure could not be developed. The sweep oscillator would also be highly erratic.

Additional Samples of Lissajous Figures

Both drawings provide a vertical/horizontal (unknown/standard) ratio of 3/1. But they do not look alike. The drawing labeled A is known as a **closed** pattern. If you will start at any point in the figure and follow the line, you will return to the starting point. The figure is continuous; it has no beginning or end. The drawing labeled B, however, is not continuous; it has a beginning and an end. Its pattern is **open**.

The three points of tangency at the top and one point of tangency at the side are easy to count in A. But the three tangent points do not appear in B. The problem can be resolved by counting tangency points

Three-to-One Lissajous Ratio

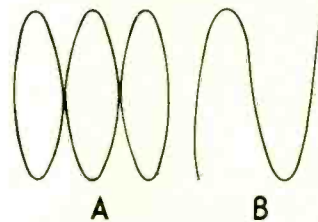

in halves instead of units in an open pattern. Each line that terminates at the top or side is a one-half point of tangency. Each loop is considered to be two ends or two one-half points. Counting at the top, there is one loop (two halves) plus one end (one half) for a total of three halves. At the side there is a single end for one half. The vertical/horizontal ratio is three halves divided by one half, or 3/1.

A continually shifting Lissajous pattern results when the phase relationship between the two input signals is constantly changing. The more complex the pattern

Lissajous Figures Sample Phase Measurements

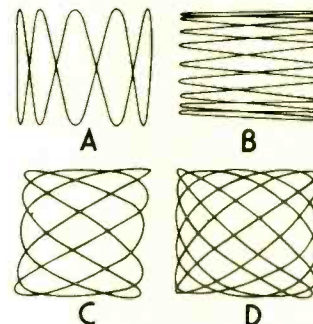

(resulting from a frequency ratio having large numbers, such as 17/13) the harder it is to interpret. It is better, then, to simplify the ratio, if possible, by changing the known frequency.

Other samples of frequency measurements in Lissajous figures are shown below.

QUESTION

Q11. If the standard frequency is 180 cps, what is the frequency of the unknown in each of the above Lissajous patterns?

ANSWERS

- A11. Values of unknown frequencies are:**
 (A) **900 Hz;** vertical/horizontal ratio is 5/1.
 (B) **20 Hz;** 1/9 ratio.
 (C) **108 Hz;** 3/5 ratio.
 (D) **150 Hz;** 5/6 ratio.

WHAT YOU HAVE LEARNED

1. An oscilloscope is a test instrument which displays waveforms. It reproduces the amplitude and time characteristics of a waveform. This permits check-



ing the condition of waveforms at selected test points in many kinds of electronic equipment. The information obtained can tell you the operating status of a circuit or help isolate the trouble to a single circuit.

2. You have practiced analyzing the way circuits operate.
3. You also have practiced reading block diagrams by tracing signals (waveforms) from stage to stage. Waveform information contained in such diagrams was seen to be useful in checking circuit operation.
4. A scope can be used for other tests in addition to checking the shape of a waveform. Voltage measuring is one test. Since an oscilloscope has uniform deflection sensitivity (inches-per-volt) across its screen, it may be used to estimate the peak-to-peak voltage of a waveform placed on the screen. A graticule (plastic sheet containing horizontal and vertical lines) and a voltage standard are required. The graticule is placed on the face of the scope,

and the standard voltage is applied to the vertical plates.

5. Phase measurement is another test. A known signal is applied to the horizontal amplifier, and the unknown signal is applied to the vertical amplifier. The resulting Lissajous pattern determines the phase relationship of the two signals.
6. Lissajous patterns can also be used to measure frequency. A known frequency is applied to the horizontal amplifier; the unknown is applied to the vertical amplifier. By counting the number of tangency points at the top and at one side, a ratio of unknown-to-known frequency can be obtained. By multiplying the ratio times the known frequency, you can determine the frequency of the unknown.
7. You have also learned to study the manual that accompanies an oscilloscope before using it. Different scopes are designed differently. The manual provides the information necessary to operate and use the scope properly.

This series is based on material appearing in Vol. 4 of the 5-volume set, BASIC ELECTRICITY/ELECTRONICS, published by Howard W. Sams & Co., Inc. @ \$25.50. For information on the complete set, write the publisher at 4300 West 62nd St., Indianapolis, Ind. 46268.

Build B/F Brain

(Continued from page 70)

more, but the protection they provide for your house is a small price to pay. If you prefer to construct your B/F

Brain with an AC power supply you may use the power supply circuit we show. The transformer should be rated at 18 volts RMS center-tapped, 2-amperes or more.

Use a filter capacitor at least as large as that shown. Smaller values will result in excessive AC ripple on the 12-

volt DC line. If an AC-operated supply is used, be certain the no-load output voltage of the supply does not exceed 15 volts because the CD4001 integrated circuit may be damaged if fed from a source of power greater than 15 volts.

Use It In Your Auto. Also shown are the proper connections for using B/F Brain in your automobile. Terminal L (loop) is shorted to terminal G (ground) and a wire from the dome light is connected to terminal C (close). When installing the alarm in an auto-

(Continued on page 90)

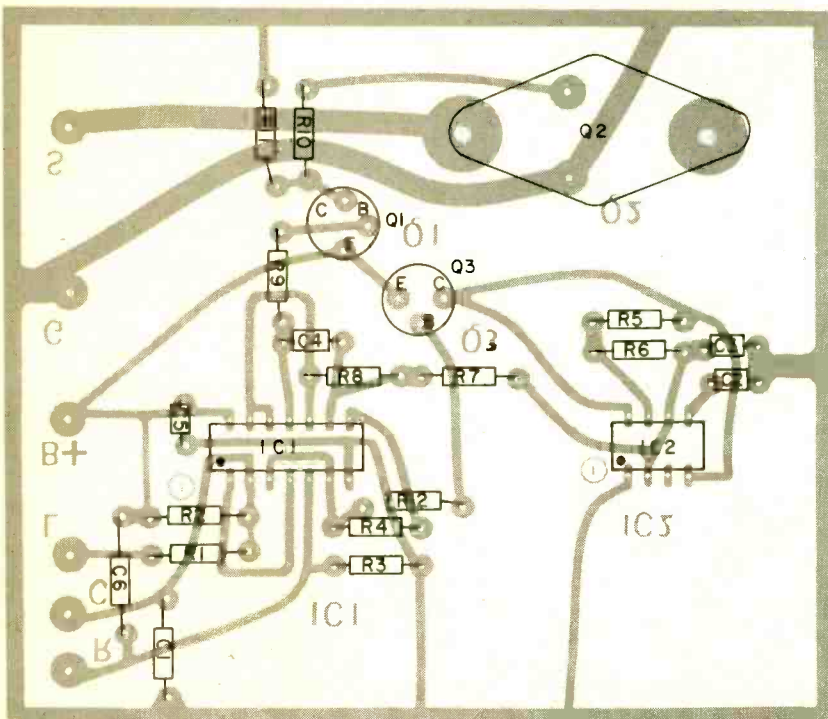

Here's the way the parts are located on the printed circuit board. No heat sink is needed for the big transistor. Use an IC socket for IC2.

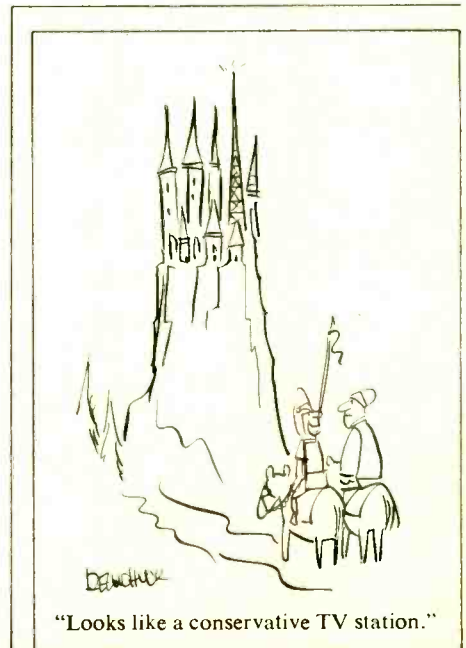

LITERATURE LIBRARY

301. Get acquainted with the new *EICO* products, designed for the professional technician and electronics hobbyist. Included in brochure are 7 IC project kits, *EICO*'s "Foneaids," security products and many varied kits.

302. *International crystal* has illustrated folders containing product information on radio communications kits for experimenters (PC boards; crystals; transistor RF mixers & amplifiers; etc.).

303. *Regency* has a new low cost/high performance UHF/FM repeater. Also in the low price is their 10-channel monitorradio scanner that offers 5-band performance.

304. *Dynascan's* new *B & K* catalog features test equipment for industrial labs, schools, and TV servicing.

305. Before you build from scratch, check the *Fair Radio Sales* latest catalog for surplus gear.

306. Get *Antenna Specialists'* catalog of latest mobile antennas, test equipment, wattmeters, accessories.

307. Want a deluxe CB base station? Then get the specs on *Tram's* super CB rigs.

308. Compact is the word for *Xcelite's* 9 different sets of midget screwdrivers and nutdrivers with "piggyback" handle to increase length and torque. A handy show case serves as a bench stand also.

310. *Turner* has two booklets on their Signal Kicker antennas. They give specifications and prices on their variety of CB base and mobile line. Construction details help in your choice.

311. *Midland Communications'* line of base, mobile and hand-held CB equipment, marine transceivers, scanning monitors, plus a sampling of accessories are covered in a colorful 18-page brochure.

312. *The EDI (Electronic Distributors, Inc.)* catalog is updated 5 times a year. It has an index of manufacturers literally from A to X (ADC to Xcelite). Whether you want to spend 29 cents for a pilot-light socket or \$699.95 for a stereo AM/FM receiver, you'll find it here.

313. Get all the facts on *Progressive Edu-Kits Home Radio Course*. Build 20 radios and electronic circuits; parts, tools, and instructions included.

315. *Trigger Electronics* has a complete catalog of equipment for those in electronics. Included are kits, parts, ham gear, CB, hi fi and recording equipment.

316. Get the *Hustler* brochure illustrating their complete line of CB and monitor radio antennas.

317. *Teaberry's* new brochure presents their complete lines of CB and marine transceivers and scanners for monitoring police, fire and other public service frequencies.

318. *CBers, GC Electronics'* 16-page catalog offers the latest in CB accessories. There are base and mobile mikes and antennas; phone plugs; adaptors and connectors; antenna switchers and matchers; TVI filters; automotive noise suppressor kits; SWR power and FS meters; etc.

319. *Browning's* mobiles and its famous Golden Eagle base station, are illustrated in detail in the new 1977 catalog. It has full-color photos and specification data on Golden Eagle, LTD and SST models, and on "Brownie," a dramatic new mini-mobile.

320. *Edmund Scientific's* new catalog contains over 4500 products that embrace many sciences and fields.

321. *Cornell Electronics'* "Imperial Thrift Tag Sale" Catalog features TV and radio tubes. You can also find almost anything in electronics.

322. *Radio Shack's* 1977 catalog colorfully illustrates their complete range of kit and wired products for electronics enthusiasts—CB, ham, SWL, hi-fi, experimenter kits, batteries, tools, tubes, wire, cable, etc.

323. Get *Lafayette Radio's* "new look" 1977 catalog with 260 pages of complete electronics equipment. It has larger pictures and easy-to-read type. Over 18,000 items cover hi-fi, CB, ham rigs, accessories, test equipment and tools.

327. *Avanti's* new brochure compares the quality difference between an Avanti Racer 27 base loaded mobile antenna and a typical imported base loaded antenna.

328. A new free catalog is available from *McGee Radio*. It contains electronic product bargains.

329. Semiconductor Supermart is a new 1977 catalog listing project builders' parts, popular CB gear, and test equipment. It features semiconductors—all from *Circuit Specialists*.

330. There are over 450 electronic kits described in *Heath's* new catalog. Virtually every do-it-yourself interest is included—TV, radios, stereo & 4-channel, hi-fi, etc.

331. *E. F. Johnson* offers their CB 2-way radio catalog to help you when you make the American vacation scene. A selection guide to the features of the various messenger models will aid you as you go through the book.

332. If you want courses in assembling your own TV kits, *National Schools* has 10 from which to choose. There is a plan for GIs.

333. Get the new free catalog from *Howard W. Sams*. It describes 100's of books for hobbyists and technicians—books on projects, basic electronics and related subjects.

334. *Sprague Products* has L.E.D. readouts for those who want to build electronic clocks, calculators, etc. Parts lists and helpful schematics are included.

335. The latest edition of the *TAB BOOKS* catalog describes over 450 books on CB, electronics, broadcasting, do-it-yourself, hobby, radio, TV, hi-fi, and CB and TV servicing.

337. *Pace* communications equipment covers 2-way radios for business, industrial and CB operations. Marine radiotelephones and scanning receivers are also in this 18-p. book.

338. "Break Break," a booklet which came into existence at the request of hundreds of CBers, contains real life stories of incidents taking place on America's highways and byways. Compiled by the *Shakespeare Company*, it is available on a first come, first serve basis.

342. *Royce Electronics'* new full-color catalog updates information on their CB transceivers (base, mobile, handheld). It also describes new product lines—CB antennas and a VHF marine radiotelephone.

344. For a packetful of material, send for *SBE's* material on UHF and VHF scanners, CB mobile transceivers, walkie-talkies, slow-scan TV systems, marine-radios, two-way radios, and accessories.

345. For CBers from *Hy-Gain Electronics Corp.* there is a 50-page, 4-color catalog (base, mobile and marine transceivers, antennas, and accessories). Colorful literature illustrating two models of monitor-scanners is also available.

350. Send for the free *NRI/McGraw Hill* 100-page color catalog detailing over 15 electronics courses. Courses cover TV-audio servicing, industrial and digital computer electronics, CB communications servicing, among others. G.I. Bill approved, courses are sold by mail.

352. Send for the free descriptive bulletin from *Finney Co.* It tells all about their new auto FM radio signal booster (eliminates signal fading).

353. *MFJ* offers a free catalog of amateur radio equipment—CW and SSB audio filters, electronic components, etc. Other lit. is free.

354. A government FCC License can help you qualify for a career in electronics. Send for Information from *Cleveland Institute of Electronics*.

355. New for CBers from *Anixter-Mark* is a colorful 4-page brochure detailing their line of base station and mobile antennas, including 6 models of the famous Mark Heliwhip.

356. Send for *Continental Specialties* new breadboarding prototest devices. They vary in prices from a mini-budget kit at \$19.95. Featured is the new logic monitor, giving information on what it does, how it works, and how to use it.

357. *Dage Scientific Instruments* offers a 16-page booklet on how to build an electronic thermometer with control. Included is an introductory course on thermocouples, schematics and many applications.

358. *PixTronics* announces its new Model 200 Super Sensitive Electronic Darkroom Exposure Meter, used to determine the correct exposures of all black-and-white and color negatives. Useable with any enlarger.

359. *Electronics Book Club* has literature on how to get up to 3 electronics books (retailing at \$58.70) for only 99 cents each . . . plus a sample Club News package.

ELECTRONICS HOBBYIST March/April 1977
Box 1849, G.P.O. Void After August 15, 1977
New York, NY 10001

Please arrange to have the literature whose numbers I have circled below sent to me as soon as possible. I am enclosing 50¢ for each group of 5 to cover handling. (No stamps, please.) Allow 4-6 weeks for delivery. H6B243

300 Enter my subscription for 9 issues at \$4.97. Check enclosed.
 Add \$1 for U.S. possessions and Canada; \$2 all other countries.

301	302	303	304	305	306	307	308	310	311	312	313
315	316	317	318	319	320	321	322	323	327	328	329
330	331	332	333	334	335	337	338	342	344	345	350
352	353	354	355	356	357	358	359				

NAME (print clearly) _____

ADDRESS _____

CITY _____ STATE _____ ZIP _____

AMATEUR RADIO HAM LICENSE

NEW METHOD OF LEARNING CODE USED BY PEOPLE FROM 10 THRU 65 YEARS. PLENTY OF PRACTICE MATERIAL. NOVICE LICENSE TRAINING SCHEDULE. ALL REFERENCE MATERIALS, CHECKING SHEETS FOR ACCURACY, COMPLETE.

STANDARD 2 TRACK MONAURAL CASSETTES PROVIDE 60 MINUTES EACH OF SCIENTIFICALLY PREPARED CODE PRACTICE (LETTERS, NUMBERS, PUNCTUATION, CODE GROUPS, WORDS). CASSETTES ARE DESIGNED TO MINIMIZE LEARNING PLATEAUS.

0-6 WPM (Novice License) 6 CASSETTES \$19.95

0-8 WPM (Novice License) 7 CASSETTES 22.95

7-14 WPM (General Class License) 3 CASSETTES 9.95

First class postage required per CASSETTE 0.40

THE HERRMAN CO Dept D

BOX 1101, LARGO, FLA. 33540

WRITE
NOW FOR

McGEE'S BIG SPEAKER CATALOG

1001 BARGAINS IN

SPEAKERS — PARTS — TUBES — HIGH FIDELITY
COMPONENTS — RECORD CHANGERS

Tape Recorders — Kits — Everything in Electronics

1901 McGee Street, Kansas City, Missouri 64108

TV JAMMER

Amaze your friends! Makes TVs go into distortion.
Max. range 20'. IN EASY KIT FORM...\$2.65

* SEND FOR FREE CATALOG *

PPG ELECTRONICS COMPANY
6827 Tobias Av. Van Nuys Ca. 91405

348C UHF POLICE CONVERTER

Permits the reception of police calls in the 450-470 MHz range with any car radio at the flip of a switch. Sensitive, easily installed will not interfere with regular BC reception. Complete nothing else to buy \$39.95 postpaid.



KUHN ELECTRONIC PRODUCTS CO.

1801 Mills Ave., Norwood, Ohio 45212

Shortwave Listening

1976 World Radio TV Handbook - \$10.95

Gated 1000/100/50/25/10 kHz Calibrator - \$54.00

Barlow Wadley & R.L. Drake Receivers

1976 "Confidential" Frequency List - \$5.45

GILFER, Box 239, Park Ridge, NJ 07656

HIGHLY
PROFITABLE

ONE-MAN ELECTRONIC FACTORY

Investment unnecessary, knowledge not required, sales handled by professionals. Postcard brings facts about this unusual opportunity. Write today! Barta, BQ, Box 249, Walnut Creek, CA 94597.



MICRO MINI MIKE™ WIRELESS MICROPHONE

World's smallest, solid state, self-contained. Picks up and transmits most sounds without wires up to 300 ft. through FM Radio. Use as mike, ampf., alarm & alert sys., hot line, baby sitter, etc. Money back guar. B/A, M/C cds. COD ok. \$18.95 plus \$1.00 post. & hdlg. Calif. res. add tax. Mail orders only Qty Disc. Avail. AMC SALES, INC. Dept M24 Box 928 • Downey, Calif. 90241

SIZE
2 1/4" x 3/4" x 1/2"

mobile you must add a key-operated power switch which is accessible from the outside of the car, or place the

power switch in the trunk. Otherwise the circuit would be tripped as you open the door to leave the vehicle. ■

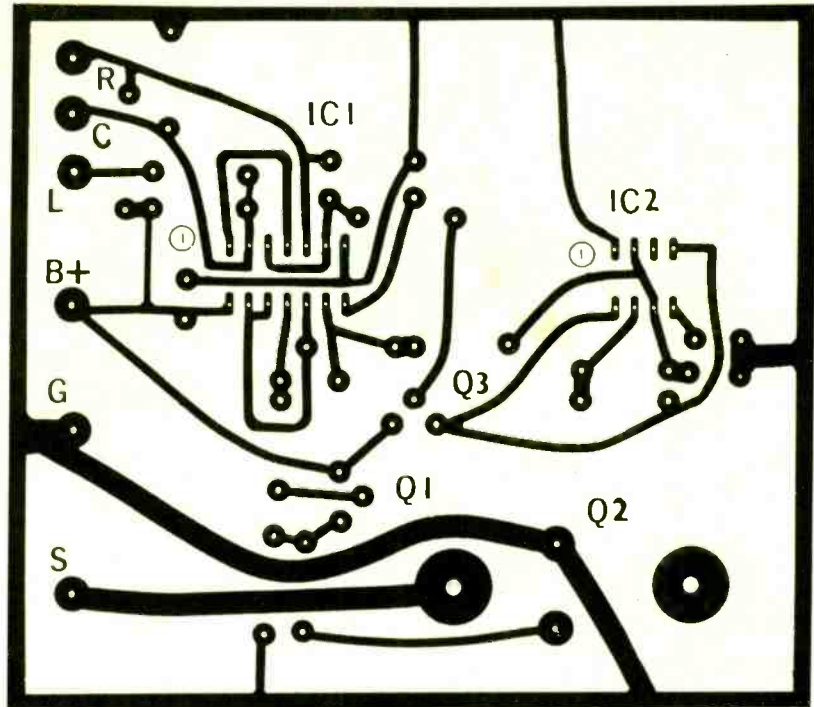

Shown above is exact-size template for making the printed circuit board for B/F Brain. Use Radio Shack 276-1576 or 276-1560 kits

NewsScan

(Continued from page 26)

work capacity of dictation equipment.

He can record, stop, rewind, replay and erase. When finished, his words have been captured on a standard cassette that can either be used directly or turned over to a typist for hard copy.

At the heart of the VR-35 system is a modified Sony BM-35 dictating machine. A small control box sits next to this machine or can even be mounted on a moveable boom for use when a person is in bed.

The equipment is plugged into a standard wall socket through an AC adapter and the system is turned on. Once "on", but not in use, the equipment can stay on for years with extremely little power drain and no damage to the system. This mode is similar to solid state television sets and radios, which, once they are plugged in, are always "on"—ready to start up instantly.

When the paraplegic wishes to dictate, he picks up the wand with his mouth and touches its magnetic end to a circle marked "Record" on the control unit. Actually, even coming close to this circle is sufficient. A red light comes on to tell the users that the machine is now on the record mode.

The recording itself is voice-activated (VOX). That is, the person starts to

speak and automatically, the tape cassette starts turning, with a second light, this one green, indicating the motion.

When the person stops speaking, there is a five-second delay and the cassette stops automatically, waiting for the next voice signal.

If the user wishes to rewind and listen to a particular section or to erase a portion of the tape, he picks up the mouth wand and moves it to the different circles on the control unit responsible for these functions. Standard cassettes can record for up to one hour per side, so with one in the machine, a paraplegic can record for that real time with no assistance whatsoever.

If you know someone who can use the Sony VR-35 system, you can get more information by writing to Sony Business Products, 9 West 57th Street, New York, NY 10019. ■

DXing Colombia

(Continued from page 78)

statements to the press, the Basques set up intelligence networks in Latin America. CIA financial support, according to the gov't-in-exile, continued throughout most of the 1950s. During that period, R. Euzkadi operated from a French site.

Today R. Euzkadi has three daily half-hour transmissions beginning at 1430, 1530 and 1630 EST. They use

two frequencies, 12080 and another varying between 13200 and 13300 kHz. There is no doubt that the studio is at Caracas and one reasonably can assume that the transmitter site is within radio link or landline distance of the Venezuelan capitol. But that could mean anything from a nearby suburb to some remote spot a couple hundred miles away.

On one occasion this author heard R. Euzkadi cross-modulating with another broadcast station. It has been suggested by members of the North American SW Association that the station uses "utility" (eg. telephone) transmitters. If the latter assumption is correct, R. Euzkadi's transmitter site is certainly an interesting mixture.

25 & 31 Meters. Before concluding this roundup of Colombian and Venezuelan DX, it should be noted that R. Nacional de Colombia operates transmitters, somewhat erratically, on 11795 and 9628 kHz. On that same 31 Meter international band, a few Venezuelan

stations operate home service relays to reach the more remote areas of their country. The most widely reported is R. Barquisimeto's on 9510 kHz. ■

Power Antique Radios

(Continued from page 44)

about 50 per cent for safety margin.

Caution. Be careful not to turn the power supply on except when there is a load across *each* output. Should the supply be operated unloaded there is a chance the output voltage at either or both outputs might rise sufficiently to overload one or all of the zeners with too much current and destroy one or more of them.

Trouble Finding Parts? You may have trouble finding a few of the parts shown in the parts list. If you do, you can substitute electrolytic capacitors by using any capacitance larger than that specified, and any working voltage higher than the ones indicated. Happy listening! ■

Things You Should Know

(Continued from page 58)

tions to 27.415 MHz and above.

In Between Channels. The amount of unauthorized operation on non-existent CB channels is not limited to those frequencies outside of the band edges, for there is a rich harvest of frequencies which lie between the regular CB channels. For instance, the Class C radio control channels (26.995, 27.045, 27.095, 27.145 and 27.155 MHz) are in relatively heavy use by CBers who are skirting Part 95! Many a R/C model crashed because of this illegal hobbying.

The Advantages? You may ask, "Why are people going to so much trouble to operate on these channels?" Good question!

Primarily for two reasons—they are not nearly as crowded as the authorized channels, and the folks who operate them are primarily interested in communicating in a manner which existed on the authorized CB channels many years ago but which seems impossible today because of the fact that most CB'ers are only interested in asking for radio checks and time checks. On these other frequencies, it is not uncommon to hear cross-country round table discussions involving numerous stations who discuss any number of topics from radio to sports. It's a rather unhurried and casual form of CB radio although plainly against *this* are many CB rules and regulations as set forth by the FCC.

Yes, every now and then the FCC does impale some of these *channel jumpers*, as the FCC calls them—and when they do, they make an example

of the caught stations by coming down rather hard on them. But this has failed to stem the tide of the many stations which seem to crowd onto these channels in daily increasing numbers.

Achievement? Many serious operators would like to work toward various operators' awards—this is also a little known aspect of CBing. Actually, it's not illegal if you stay on frequency and DX only to 150 miles. It is possible to earn about 100 different awards these days—and you *don't* have to violate a single FCC Part 95 rule to do it! Some awards are easy to walk away with, others are a bit rough, some take an enormous amount of skill and effort. Those who qualify are rewarded with a beautiful blue and black 8½ x 11 certificate to adorn their wall.

These awards are presented by The Sidebanders' Service Bureau, P.O. Box 381-N, Smithtown, N.Y. 11787. The Sidebanders' Service Bureau is the largest and oldest Sideband Network (*The SSB Network*) around, but anybody can qualify for their awards—even AM operators. To obtain a free copy of the rules of their many awards, send a stamped, self-addressed envelope to these people.

More Than Meets The Eye. As you can see, there's more than meets the eye in CB radio as it evolves and grows—many developments are only known to the *in* crowd! We would caution you to be familiar with Part 95 and to follow it closely—the fact that we are reporting certain violations to you does not mean that we endorse them, however you as an active CBER should be as well versed as possible on what's taking place! ■

IT'S HERE!

The Most Advanced Design CB Base Antenna!

Anixter-Mark introduces the new Mark AMB-2 . . . the *space age* version of the famous Mark II Super Beacon, with more advanced features than ever before in a base station antenna.

- Full half-wave design
- Tuneable to reduce the effects of nearby objects & the detuning as height varies
- Four piece construction for easy handling & shipping by UPS
- Eliminates noisy precipitation static
- Improves signal-to-noise ratio
- Affords up to 20 db operating gain
- Increases receiver sensitivity
- Extends intelligible coverage
- Easiest to install design
- No unsightly ground radials

The Mark AMB-2 will step up the efficiency of *any* CB base station. The reactive tuner eliminates matching problems, reduces the effects of nearby objects and gives the *lowest* possible VSWR—all with one simple adjustment! That's truly tuneable . . . and that's just *one* reason why this is the most advanced base station antenna ever. For more information and a free copy of "The CB, Amateur, Two-Way Antennas & Accessories Catalog," send the coupon today.

You bet I'd like a free catalog!

Name _____

Title _____

Company _____

Address _____

City _____

State _____ Zip _____

Anixter-Mark, 5439 W. Fargo
Skokie, Ill. 60076

EE/3-4

ANIXTER-MARK

Manufacturers of a

Full line of Point-to-Point Antennas
Microwave • Two-Way • Amateur • CB

5439 W. Fargo, Skokie, IL 60076 (312) 675-1500

Made in U.S.A.

Visit us at booth 394 & 395 during the
PC-77 Show!

CIRCLE 39 ON READER SERVICE COUPON

It's new! And it's from Isaac Asimov!
The Science Fiction magazine you've been waiting for
—by the most respected and prolific writer in the field.
Published quarterly. The most and best in SF in every issue
you could expect. And you'd expect that from Asimov.

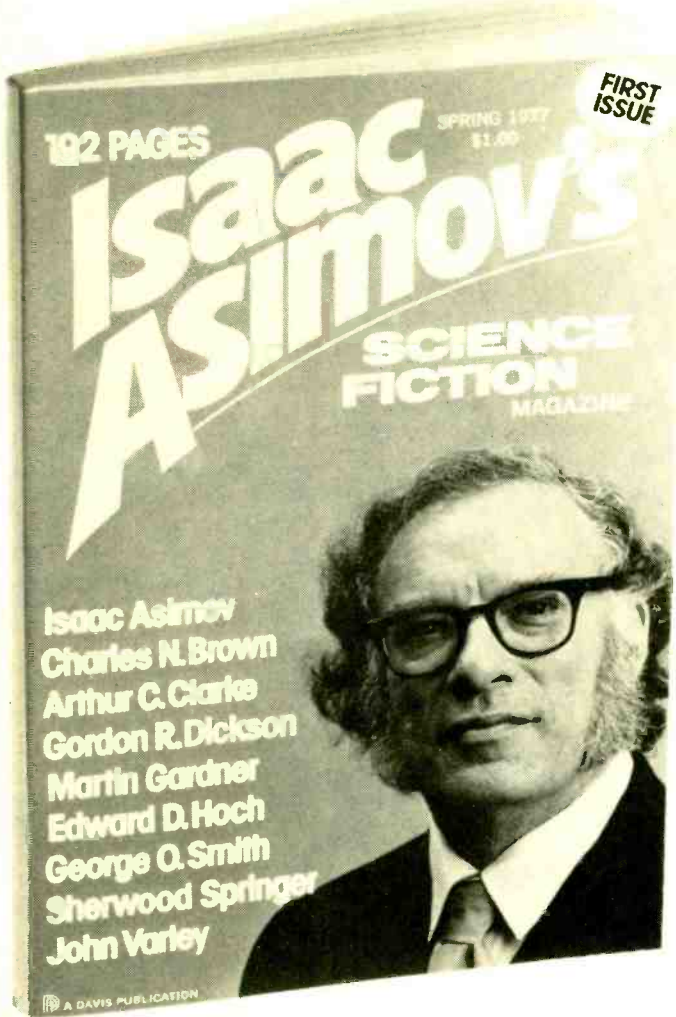

TO: ISAAC ASIMOV'S SCIENCE FICTION MAGAZINE EE M-A 7
Box 1855 GPO, New York, NY 10001

I enclose \$5.40 (includes shipping and postage) for 4 issues of ISAAC ASIMOV'S SCIENCE FICTION MAGAZINE.

 Name (please print)

 Address

 City State Zip

TV Sets of The Future

(Continued from page 42)

stereo sound. Standing over 60 inches high and 43 inches deep when in use, Theatervision is comprised of an enclosed upfacing TV set (Sony Model RM-204, for example) covered by a projection lens assembly, a mirror and a tilted screen measuring 32 by 40 inches. The lens fires TV program material at the mirror which in turn directs it onto the screen. The mirror is in a drawer, which is pushed back into the main cabinet when the set is not in operation.

PM Systems Corp.—Cinema IV (roman numeral) Model CR, priced at \$1,995, is a large (35 by 25 by 49-inch) self-contained system featuring a retractable 30 by 40-inch curved screen that raises to a height of 64 inches when in use. The TV set/lens/mirror/drawer arrangement is very much like that of Theatervision described above.

Brown's Music Store—Video-Master is a completely self-contained "portable" model weighing 100 pounds. It uses a TV/lens/mirror/drawer arrangement similar to Theatervision and Cinema IV, but in a smaller housing measuring 25 inches wide and 22 inches deep when not in use. The parabolic screen measures 32 by 40 inches. In operation, the set stands 78 inches high. It is priced at \$1,395.

Tandom—Model VPS 2 is a two-piece ensemble comprised of a receiver/projector and 36 by 48-inch curved screen, at \$1,595. The receiver/projector measures about 36 by 15 by 21 inches and uses a three-element, 14-inch focal length lens. Approximate weight is 45 pounds, making the rig portable as compared with some others. Interesting is the following company claim: "To our knowledge, Tandom has the only low priced color video projector with variable picture size capability. The VPS 2 has a flat field corrected lens system that permits the user to watch on the attractive screen included, or project the picture on a flat surface with the same clarity."

Projection TV Kits. While the price tags of complete, assembled video projection outfits range from \$995 (in the Sega/Muntz line) on

up, the buff or experimenter on a budget can get by for less. He can buy a video projection system kit. Four companies make them. Here are their products . . .

Miami Projection Television—Kit consisting of f2.8, 12-inch focal length lens in five-inch barrel that fits into 6¼-inch square lens mount, and 30 by 40-inch curved screen in 40 by 40-inch black matte frame. Price, \$325. Units may be bought separately, the lens at \$225, the screen at \$100. Also available is a matching screen stand at \$50. Accommodates sets up to 15-inch size.

Altelevision—Kit comprised of projection lens assembly and 35 by 40-inch Ektalite screen, for use with sets of 12 to 19-inch tube size. Price \$395. To be available soon is a deluxe lens assembly/screen combination to sell for about \$600.

Television Projection Systems—Lens system priced at \$399.95 for use with portable TV sets to 15-inch size. Includes instructions for building cabinet to house TV and lens. Also available at \$499.95 with pre-cut cabinet components for at-home assembly. Optional 40 by 40-inch Ektalite movie screen available at \$114.95.

Melody Music Co.—Kit consisting of projection lens system and 32 by 40-inch screen combined in a single cabinet. For use with portable TV sets to 15-inch size. Price, \$795.

A consideration in buying kits is that the quality of the TV set you use with them determines the ultimate quality of what you see on the giant screen. State-of-the-art TVs with bright picture tubes will project a correspondingly brighter picture than a system using an old TV representing an earlier state of the art. Among favorite sets used by major video projection system suppliers are models from Sony and Toshiba, using the Trinitron and Blackstripe picture tube concepts, respectively. These are noted for their brightness and sharpness.

Another consideration is convenience. If your TV has a remote control, that control will be a boon when operated as part of a video projection system.

In Conclusion. No home entertainment source can be regarded as totally divorced from the other entertainment sources available in to-

day's homes. The hypnotic TV tube shares available family time with the high fidelity system, and very often they share space in the same room. It is possible that with time, projection TV will become wedded to both home video recording systems and high fidelity systems. The result will be one all-encompassing multi-media home entertainment center which will hold possibilities for audio and video reproduction in the home which are now beyond the grasp of the human imagination.

Speculation about the future is, in the end, just that: speculation. Only one thing's certain; projection TV is a step toward the future and chances are good that its ramifications will be felt throughout the home entertainment field, including that of high fidelity. ■

CB Battery Charger

(Continued from page 50)

transceivers that use ten, rather than the usual twelve NiCad batteries. Regardless of the number of batteries the charging current remains a safe 40 to 50 mA. Normally 14 to 16 hours will be required for a full charge, so this can be done overnight. If you want the batteries maintained fully charged and ready for use at any time you can keep them on continuous-trickle charge.

The only caution is not to try and charge two or more hand-helds at the same time. Don't make up a "Y" adaptor that connects two or more hand-held battery packs in parallel because one pack will discharge into the other, and if there is a weak cell in one pack the other pack will discharge with excessive output current. Charge only one set at a time. ■

It's Sound Cookie

(Continued from page 46)

plastic end of the screws. Now place the metal retaining ring from the grille assembly on top of the plastic cover and mark the four holes for securing the ring to the speaker assembly (cover). Remove the ring and make holes in the plastic, right through into the Masonite, with a sharp nail, a scribe, or a small drill. Make the holes only about half the depth of the Masonite. Now take the four self-tapping metal screws, and, after replacing the retaining ring right side up on the assembly, with the holes lined up, screw the whole thing together. The self-

tapping screws will bite into the masonite nicely. Don't screw them tight enough to strip the holes. If you do, by mistake, you can always rotate the top assembly (metal ring) a few degrees and start over on the holes for the self-tappers.

Now drill a hole for the speaker wire through the side of the plastic cover, right at the very top, just under the retaining ring. Angle this hole so it comes out inside the diameter of the plastic cover near the speaker, but outside the speaker frame. It may be easier to drill two holes, one from the inside of the Masonite (side near the speaker) and one from the outside of the plastic. Be sure to use a drill no larger than absolutely necessary to pass the speaker wire through.

Install the top section of the food container over the neck of the enclosure and screw the cover on tight.

Run about 6-inch length of no. 24 speaker wire through the hole and solder to the speaker terminals. Reinstall the speaker unit and dope the hook-up wire around the hole at the under side of the stiffening flange with plastic cement, to insure air tightness. Before you install the grille over the speaker unit you can if necessary, file a 1/8-inch wide slot in the edge of the grille and the retaining ring to clear the hook-up wire where it passes.

Driver Units. For best results I suggest you use the Radio Shack number 40-1292 acoustic suspension speaker driver, which costs just under \$17. You can also get good sound if you use the slightly-less expensive Radio Shack driver number 40-1284, which costs under \$10. If you really must save money and get the best sound (for the money) use number 40-1909, which is under \$6.00. Finally, you can shave some money off this (not much) by using number 40-1240, which goes for

\$5.79 apiece. You'll get as much sound, probably more, with this unit, but the bass won't be as good.

These speakers can be used in pairs for stereo music listening, or as remote speakers in the bedroom, kitchen, etc., when larger, more elaborate speakers are used in the living room or music room for serious listening. You can also use one such speaker to make a table radio or TV set sound better. And of course you can use four of these speakers for quadrasonic sound. ■

Put Your Cassettes On Wheels

(Continued from page 67)

#10 sheet metal screws are satisfactory if air conditioning ducts prevent you from reaching behind the dash to install nuts on machine screws. The wire from the terminals on this part of the mount are spliced directly into the speaker wires from the switch you installed, and into the power wire going to the car radio. Or you can connect the power wire to the accessory terminal on the fuse block. If you haven't used a fuse between the player and the terminals on the slide mount you must install a fuse between the power source and the wires coming from the dash-mount terminals. You can usually remove the

fuseholder normally supplied with the player and splice it into any part of the power wire.

The wiring should give you no trouble because all the wires are color-coded: *red* is the positive battery connection, *black* is ground, and what's left (usually green and brown, blue grey or white) are the speaker connections.

To play a cassette simply slide the player into the dash mount, set the speaker switch to *tape*, and pop the cassette into the player.

When you reach your destination and park, to protect the player just slide it out of the mount and place it out of sight under the front seat or better still, put it in the trunk. And remember not to leave a collection of tapes on the seat as a message you have a tape player in your car. ■

ELEMENTARY ELECTRONICS INDEX TO ADVERTISERS

READERS SERVICE NO.	ADVERTISER	PAGE NUMBER
—	AMC Sales	90
5	AP Products	24
39	Anixter Mark	91
6	Avanti Research	31
36	B & K—Precision	13
—	Barta	90
—	Cleveland Institute of Elect.	98-CV 111
24	Cobra Div., Dynascan	5
16	Continental Specialties	17
22	Cush Craft	20
21	E. L. Instruments	22
7	Edmund Scientific	19
2	Eico Electronics	26
—	Gilfer	90
8	Grantham Schools	21
—	Heath	53, 54
—	Herman Co.	90
—	Int'l Correspondence School	CV 11-3
9	Int'l Crystal	20
33	E. F. Johnson	30
38	Kedman Tools	33
11	Kester Solder	24
—	Kuhn Electronics	90
—	McGee Radio	90
35	Midland Electronics	8, 9
28	Mtn. West Alarm	30
—	Nat'l Radio Institute	34-37
—	Nat'l Technical Schools	62-65
23	New-Tronics	12
18, 19	—	—
20	OK Machine & Tools Co.	25, 27, 29
—	PPG Electronics	90
41	Pacer Antenna (Div. Progress Inc.)	16
—	Peninsula Mktg.	32
26	Polypaks	95
13	Progressive Edu-Kits	11
32	Radio Shack	23, 28, 38, CV IV
25	Shakespeare Antennas	7
17	Sparkomatic	14, 15
14	Tab Books	6
29	Turner, Div. Conrac Corp.	10
15	Vernitron	18
—	Vintage Radio	33

DX Central Reporting

(Continued from page 33)

There is much that has been written about satellite transmission of radio and television signals. I don't think that the use of satellites for rebroadcasting will replace shortwave transmissions, not for a long time yet.

So, Wayne, I think SWLing will, in the next several years, grow in popularity. SW will probably change. But I'm not ready to write its obituary!

Of course, there are quite a number of ELEMENTARY ELECTRONICS readers who enjoy BCB DXing, listening to distant stations on the regular 540-1600 kHz AM radio band.

"The CBC network on medium wave has provided me with many hours of DXing pleasure," writes Eric Steiner, Park Forest, IL. "Canada is a favorite MW listening target with CBW, Winnipeg on 990 kHz, and CBK, Regina, on 540 kHz."

Ronald L. Gibson is serving with the U.S. Army at Ft. Hood, TX. Ron says he is "in radioteletype in the Army."

"Do you have any press service RTTY frequencies? We run at 60 wpm at 85 and 850 Hz shift. We found a few like 14,693 KHz, in Spanish. We use this RTTY stations to test our equipment."

Not many private SWL set-ups contain radio teletype gear so your Army hitch is giving you an excellent opportunity for some off-beat DXing with RTTY.

A couple of newswire RTTY channels I'd suggest, which should be compatible

with your 60 wpm, 850 Hz shift equipment, are 15,607 kHz, 18,145 kHz at 1400 GMT, and 19,580 kHz. Good luck!

Bandsweep. (Times in GMT, frequencies in kHz): 1548—There's a new MW voice from the Caribbean on this frequency lately. The station, reported by BCB listeners in the eastern part of the U.S., is *VSI Radio* on Grand Turk Island. It rides just a bit lower than the nominal and announced frequency of 1550. It has been heard, in English, around 2300. . . . 4832—A DX Central "best bet" for the SWL who has never really listened to and identified a Spanish-speaking Latin American SW station is the Costa Rican powerhouse, *TIHB. Radio Reloj* (pronounced, roughly, ray-LOW). Try any evening, any time between 0000 and 0600. . . . 6,090—*Radio Luxembourg International* was the original pop music station in Europe many years ago. There are other European outlets with pop music featured these days, but RL goes on undaunted. Listen for English on this frequency around 2300. . . . 9,655—*Radio Thailand* is heard on the west coast of North America with programming in Thai, but with an English identification at signoff, just prior to 1430 GMT. . . . 15,084—A nice exotic sounding catch is *Teheran's Voice of Iran* on this semi-off-beat frequency below the 19 meter band. Listen about 1600.

(Credits: Alan Merriman, VA; Robert A. Yajko, PA; Gerald Arrington, CA; Sam Rowell, WA; Naitonal Radio Club, Box 127, Boonton NJ 07005; American Short Wave Listening Club, 16182 Ballard Lane, Huntington Beach, CA 92649.) ■

Poly Pak's EXCLUSIVE \$1.98

Avg. Ship. Wt. 6 ozs.

Every kit carries a money back guarantee!

CITIZENS BAND POWER SUPPLY

REGULATED, CONTINUOUS DUTY • 12 VDC
 CONVERTS CB, HAM RIGS TO HOME • 3 AMPS



115V to 12VDC converter! Built-in automatic RESET circuit breaker. Powerful 3 amps (8 amp peak) makes it ideal for SSB rigs. Tool Attractive walnut like metal modern-design cabinet. (5 1/2" x 2 1/2" x 1 1/2") Big 1.5 amp 12VDC built-in circuit breaker. Front panel has OFF-ON switch and LED light. For 115V AC 60 cycle. Wt. 5 lbs. Cat. No. 2L352

\$19.95

WIRED

BARREL KITS

YOUR CHOICE OF ANY KIT

INCLUDES "100%" MATERIAL TOO!!!!

100'S OF BARRELS PURCHASED!

For the first time anywhere, Poly Pak merchandisers introduce a new way in buying the economical way. Raw stock from the "barrel". Remember the "good ole days"? They're back again. The same way merchandisers

throughout the United States buy from various factories... their overruns in barrels. Poly Pak has done the same. Therefore you are getting the same type of material as the RE-TESTERS DO!

TEST 'EM YOURSELF 'N SAVE!

Buy 10 BARREL KITS AND CHOOSE THE 11TH Free

<p>BARREL KIT #201 6V INDICATORS w/leads 15 for \$1.98</p> <p>Test lamp manufacturer dumps inventory! Worth 69¢ ea. Like train-o-wheat. Cat. No. 2L3526</p>	<p>BARREL KIT #200 9 DIGIT READOUT MODULES 5 for \$1.98</p> <p>Unbelievable! Worth \$50. High precision submini chips for all applications. Wt. 3 ozs. Cat. No. 2L3528</p>	<p>BARREL KIT #195 CARBO-FILM RESISTORS 75 for \$1.98</p> <p>Hard to find; but we got millions. Lo & Hi values, 1/4 and 1/2 watt, 5% 10% tol. All marked. 100% good. Cat. No. 2L3534</p>	<p>BARREL KIT #188 400 Parts \$1.98</p> <p>Includes resistors, caps, transformers, rectifiers, diodes, etc. for p.c. work. Preformed, dumped into barrels by factories. 100% good. Cat. No. 2L3401</p>	<p>BARREL KIT #186 KEYBOARD CHIPS 10 for \$1.98</p> <p>Truthfully we can't test 'em, MM5740's keyboard encoder chips. How good they are we don't know. Cat. No. 2L3414</p>	<p>BARREL KIT #184 1/4-WATT METAL FILM 150 for \$1.98</p> <p>100% metal film resistors. Long leads. 2L3413</p>	<p>BARREL KIT #203 CALCULATOR KEYBOARDS 10 for \$1.98</p> <p>It's true! 20-key, 4 function keyboards at ridiculous give-away. Wt. 12 ozs. Cat. No. 2L3524</p>
<p>BARREL KIT #163 MINI TRIM POTS 30 for \$1.98</p> <p>Asst. values 100 to 1 meg. What a buy. Single turn. 1/4 W. Wt. 6 oz. 2L3345</p>	<p>BARREL KIT #161 'POP' PLASTIC TRANSISTORS 25 for \$1.98</p> <p>2N3904's with some 2N3906's of 100% material. TO-92. Preformed. Cat. No. 2L3343 1 oz.</p>	<p>BARREL KIT #160 V. REGULATORS 15 for \$1.98</p> <p>LM309KC TO-3 V.R.'s barreled. Bot by the pound. No. 2L3330</p>	<p>BARREL KIT #159 MODULAR SWITCHES 25 for \$1.98</p> <p>Centralab switches. TV-makers excess. Dye-d. 6pdt. etc. Brand new. Cat. No. 2L3150</p>	<p>BARREL KIT #158 MAGNIFIED MAN-3's 12 for \$1.98</p> <p>MAN-3. 7-seg readout, with built-on magnifier. Factory discontinued line. 100% material. Cat. No. 2L3225 1 oz.</p>	<p>BARREL KIT #157 MOLEX CONNECTORS 75 for \$1.98</p> <p>Nylon, white cable connector, ass't. factory over-run. NO PICKLE! Mixed in barrels. Cat. No. 2L3324</p>	<p>BARREL KIT #182 JUMBO RED LEDS 15 for \$1.98</p> <p>100% material, user cancellation from factory dumps. 3V. 10 mils. For 100's of projects, red lens. Cat. No. 2L3369</p>
<p>BARREL KIT #145 MINI TRANSFORMER 15 for \$1.98</p> <p>Miniature transformer back again. Ass't. outputs, interstage and audio. Only 1 1/2" sq. Wt. 2 lbs. 2L3294</p>	<p>BARREL KIT #144 RCA PHONO PLUGS 40 for \$1.98</p> <p>1,000,000 RCA phono plugs for this one. You hi-fi-ers know what they are. 100% material. 2L3293</p>	<p>BARREL KIT #143 75-PC TRANSISTORS \$1.98</p> <p>100% material. TO-92, factory discontinued lines, pnp's mixed with npn's. 2N4100-1-2-3-4. 2L3290</p>	<p>BARREL KIT #138 PANEL SWITCHES 30 for \$1.98</p> <p>Did you hear of OAK? Another equi maker barreled all types of rotary, electrical, slides, etc. 2L3268</p>	<p>BARREL KIT #133 CALCULATOR CHIPS 15 for \$1.98</p> <p>National type. Can be used in calculator. Un-terminated. Cat. No. 2L3258</p>	<p>BARREL KIT #135 C-MOS IC'S 60 for \$1.98</p> <p>Deliberately thrown in barrels, so we can't test 'em! The famous CD4000 series. How good? Who knows? Cat. No. 2L3257</p>	<p>BARREL KIT #181 TANTALUM ELECTROS 30 for \$1.98</p> <p>Mixed, marked prime, top grade ass't. values, voltages. Cat. No. 2L3255</p>
<p>BARREL KIT #128 MINI DIP IC'S 75 for \$1.98</p> <p>Large mfg. dumped 100's of lbs into barrels. Includes 741s, LM-380-8, 703, 567, 555, 558—but who knows? Wt. 1 lb. 2L3245</p>	<p>BARREL KIT #127 AXIAL ELECTROS 40 for \$1.98</p> <p>Ass't. capacities and voltages. Cat. No. 2L3227</p>	<p>BARREL KIT #126 UPRIGHT ELECTROS 40 for \$1.98</p> <p>1mf to 300mf in mixture of voltages. 100% marked 'n good. 2L3226</p>	<p>BARREL KIT #119 PRECISION RESISTORS 100 for \$1.98</p> <p>PREFORMED! Designed for printed circuit work. 1/4, 1/2, 1 watt. Marked values, 1 and 2% values. 2 ozs. 2L3205</p>	<p>BARREL KIT #118 MINI SCRS 50 for \$1.98</p> <p>UNBELIEVABLE! TO-92 plastic SCRS in barrels... Factory over-run. Includes all voltages up thru 200 Div. 2L3135</p>	<p>BARREL KIT #115 MOLEX SOCKETS 200 for \$1.98</p> <p>Calculator maker dumped! We get a million of 'em. Used for IC sockets, etc.</p>	<p>BARREL KIT #112 MICRO MINI LEDS 40 for \$1.98</p> <p>All the tiny leds, axial, upright of Monsanto, Litronic. You test. Colorfully mixed. Yield 50% or better. 2L3139</p>
<p>BARREL KIT #109 TERMINAL STRIPS 100 for \$1.98</p> <p>Wide ass't. of terminal strip connectors, from 1 contact up. Strip manufacturers barrel dump is your gain. Wt. 1 lb. Cat. No. 2L3136</p>	<p>BARREL KIT #104 SLIDE VOLUME CONTROLS 10 for \$1.98</p> <p>Cat. No. 2L1057</p>	<p>BARREL KIT #101 RESISTOR SPECIAL 200 for \$1.98</p> <p>Includes: 1/4, 1/2, 1, 2-watt, carbon, 5%, 10% good. 2L3054</p>	<p>BARREL KIT #99 PHOTO ELECTRIC CELLS 10 for \$1.98</p> <p>Ass't. GE types, CDS types. Mixed by factory. Big job for you to separate. 100% good. Cat. No. 2L3052</p>	<p>BARREL KIT #93 HALF WATERS 200 for \$1.98</p> <p>Resistor factory tried to fool us by mixing 100% color-coded resistors in barrel. But value is there. 4 oz. 2L3025</p>	<p>BARREL KIT #92 3 AMP EPOXY RECTIFIERS 100 for \$1.98</p> <p>Cosmetic rejects, electrically fine business! You check 'em, it's not for us. Ass't. voltages. 2L3204</p>	<p>BARREL #91 SILVER MICAS 100 for \$1.98</p> <p>Axial, real case, variety of physical sizes & values. Cat. No. 2L3018</p>
<p>BARREL KIT #88 LITRONICS LED READOUTS 10 for \$1.98</p> <p>17's, 28's, singles, multiples, etc. .33 to 0.6. Bot from factory, all mixed; have fun! No. 2L2861</p>	<p>BARREL KIT #87 NATIONAL IC BONANZA HOBBY LEDS 40 for \$1.98</p> <p>Types 8000, 7300 series, DTLs, ROMs, registers, clock & calc. chips, linear, etc. Cat. No. 2L2860</p>	<p>BARREL KIT #86 HOBBY LEDS 40 for \$1.98</p> <p>747's, 727's, singles, multiples, etc. .33 to 0.6. Bot from factory, all mixed; have fun! 2L2859</p>	<p>BARREL KIT #83 VOLT REG 15 for \$1.98</p> <p>LM-340T. Ass't. types. Factory rejected them for length of leads. May include 5, 6, 8, 12, 15, 18, 24 volts. Power tab. Cat. No. 2L2835</p>	<p>BARREL KIT #82 SUBMINI RESISTORS 200 for \$1.98</p> <p>PC, upright type, color coded. 1/4, 1/2 watt. Ass't. values. Came to us in a barrel. Cat. No. 2L2746 100% good.</p>	<p>BARREL KIT #76 1-WATT ZENERS 100 for \$1.98</p> <p>Factory same as 400-mw's. Never-to-see-again offer. 6, 8, 10, 12, 15V. Under glass. Double plug. Cat. No. 2L2741</p>	<p>BARREL KIT #75 400MW ZENERS 100 for \$1.98</p> <p>Factory out of biz! Amazing offer: 6, 8, 10, 12 to 15V. You test. Hermetically sealed glass pak. Double plug. Cat. No. 2L2740</p>
<p>BARREL KIT #73 TRANSISTOR ELECTROS 50 for \$1.98</p> <p>We don't wish to separate wide ass't. voltages & values up to 300 mf. Cat. No. 2L2747</p>	<p>BARREL KIT #71 CAPACITOR SPECIAL 100 pcs. \$1.98</p> <p>meas, motleds, plastics, ceramics, discs, etc. Nifty 100% good. Cat. No. 2L2738</p>	<p>BARREL KIT #68 2 WATERS 100 for \$1.98</p> <p>Suppliers throw 'em in the barrel. It's a lil' gold mine. All marked. Cat. No. 2L2735</p>	<p>BARREL KIT #65 MIXED READOUTS 10 for \$1.98</p> <p>Factory returns—such numbers as MAN-4's, MAN-7's, MAN-3's, 11 barrels & no time to separate. 100% good. Cat. No. 2L2733</p>	<p>BARREL KIT #61 MIXED IC'S 100 for \$1.98</p> <p>All shapes: 7400 Series, 8000, 9000, ROMS, RTLs, DTL's, linear's of all kinds. Cat. No. 2L2730</p>	<p>BARREL KIT #60 PNP HIGH-POWER TRANSISTORS 20 for \$1.98</p> <p>Popular germanium TO-3 case 2L2618 100% good</p>	<p>BARREL KIT #58 SLIDE SWITCHES 30 for \$1.98</p> <p>All shapes, sizes, spst, apdt, momentaries, etc. Tremendous shop pak for 100's of switching projects. Cat. No. 2L2726 100% good</p>
<p>BARREL KIT #56 POWERS! POWERS! \$1.98 100 for \$1.98</p> <p>Large distributor cleaned house. Barrels of power resistors 3 to 7 watts. Cat. No. 2L2724</p>	<p>BARREL KIT #54 8 DIGIT READOUTS 10 for \$1.98</p> <p>Bargain of a lifetime! All we got was 1 barrel—the finest readout types. Multipleplexed. Cat. No. 2L2722</p>	<p>BARREL KIT #48 741 MINI DIP "BONANZA" 50 for \$1.98</p> <p>Barrels 'n barrels of 'em! This is a buyer's market. How many can we get tested. Cat. No. 2L2626</p>	<p>BARREL KIT #46 G.E. 3.5 WATT AMPLIFIERS 25 for \$1.98</p> <p>Hobby type, factory failures. 2L2624 Un-terminated</p>	<p>BARREL KIT #40 PNP HIGH-POWER TRANSISTORS 20 for \$1.98</p> <p>Popular germanium TO-3 case 2L2618 100% good</p>	<p>BARREL KIT #39 2N3055 HOBBY TRANSISTORS 15 for \$1.98</p> <p>Fallouts of the famous 2N3055. 2L2617 100% good</p>	<p>BARREL KIT #37 1 AMP "BUT TIT" RECTIFIERS 100 for \$1.98</p> <p>Famous style, 1 amp, voltages, silicon, axial include all types of voltages to 1kV. Cat. No. 2L2615</p>
<p>BARREL KIT #35 NEON LAMPS 30 for \$1.98</p> <p>100% good. Famous NE-2's. All prime, but factory made millions and barreled 'em. Your advantage. Cat. No. 2L2613</p>	<p>BARREL KIT #31 METALLIC RESISTORS 100 for \$1.98</p> <p>Made mostly by Corning, the finest resistor made. Mostly 1/2 watt, 1% to 5% tol, & a barrel of values. Cat. No. 2L2609</p>	<p>BARREL KIT #30 PREFORMED RESISTORS 200 for \$1.98</p> <p>We got barrels of 1/2 and 1/4" watters for p.c. use. 100: 1/2, 100: 1/4 watters. No. 2L2608 100% good</p>	<p>BARREL KIT #25 PREFORMED DISCS 100 for \$1.98</p> <p>Hi-mix shelf inventory but he dumped 'em in barrels. Preformed, for PC use. Mixed values too! 2L2605</p>	<p>BARREL KIT #26 PLASTIC TRANSISTORS 100 for \$1.98</p> <p>TO-92 (TO-18) all manufacturers, variety of 2N #'s. Cat. No. 2L2604</p>	<p>BARREL KIT #23 2N3055 HOBBY TRANSISTORS 15 for \$1.98</p> <p>Fallouts of the famous 2N3055. 2L2617 100% good</p>	<p>BARREL KIT #20 LONG LEAD DISCS 100 for \$1.98</p> <p>"auction sale" Prime marked only. Long leads. Cat. No. 2L2598 100% good</p>

KRONOS 'Beepin' Time MACHINES

1095 KIT

• Jumbo .5" readouts! 7-minute snooze!
 • Blinking colors indicate seconds!
 • Beeper alarm with volume control!



6-DIGIT OR 4-DIGIT ALARM CLOCK

Cat. No. 2L3505 — 4 Digits .5" READOUTS; Kit.
 Cat. No. 2L3507 — 6 Digits .3" READOUTS; Kit.

New from Kronos at an alarmin' low price. Compact, it fits in palm of your hand (only 1 1/2" x 4" x 1 3/4"). Beautifully designed! In any room or office—EASY & FUN TO BUILD! Attractive gray plastic case with chrome trimmed transparent red panel. Pushbutton switches control: alarm time/real time display, minutes set, hour set, snooze. Uses famous National MM5375 set clock chip and minimum of parts. Complete kit with step-by-step instructions. Wt. 10 ozs. No. 2L3505

BARREL KIT #17 LINEAR & 7400 DIPS
100 for \$1.98

Marked and unmarked; internal numbers of raw factory stock. No. 2L2431

BARREL KIT #11 POWER TAB TRANSISTORS
40 for \$1.98

NPN, plastic TO220 type. Assorted 2N numbers. No. 2L2425 Un-terminated

BARREL KIT #4 RECTIFIERS
100 for \$1.98

1N4000 series. May include 25, 50, 100, 200, 400, 600, 800 and 1000 voltages. 2L2417

BARREL KIT #5 SCRS, TRIACS, QUADRACS
30 for \$1.98

Raw factory stock! All the 10 amp types. Cat. No. 2L2419 Un-terminated

BARREL KIT #15 MOSFET TRANSISTORS
60 for \$1.98

All 4 leaders TO-18 case, includes UJT transistors too! Cat. No. 2L2429

BARREL KIT #10 ROMS-REGISTERS
75 for \$1.98

28 to 40 pin devices, marked, internal factory numbers, etc. 2L2424

BARREL KIT #3 PLASTIC SWITCHING DIODES
100 for \$1.98

Includes famous switching diodes at these prices! Cat. No. 2L2418 Un-terminated

BARREL KIT #2 SUBMINIATURE IF TRANSFORMERS
100 for \$1.98

Amazing, includes 455kcs, osc. antenna, who knows? From transistor radio manufacturers. 100% 2L2422

BARREL KIT #12 LINEAR OR AMPS, DIPS
75 for \$1.98

May include 709's, 741's, 703's, 560 series, 665 includes. 2L2416

BARREL KIT #12 POWER TAB TRANS
40 for \$1.98

PNP, plastic TO220 type Assorted 2N numbers. Cat. No. 2L2422 Un-terminated.

BARREL KIT #7 VOLUME CONTROL BONANZA!
30 for \$1.98

Singles, duals, variety of values, styles, big ones—small ones. Cat. No. 2L2421

BARREL KIT #1 SN7400 DIP IC'S
75 for \$1.98

Marked 14 and/or with 16 pin dips, may include gates, registers, flip flops, counters. 2L2415 Un-terminated

Terms: Add postage. Rated: net 30
 Phone: Wakefield, Mass. (617) 245-3829
 Retail: 16-18 Del Carmine St., Wakefield, MA

POLY PAKS
 P.O. BOX 942D LYNNFIELD, MASS. 01940

Send for FREE SPRING CATALOG

C.O.D.'s MAY BE PHONED

Classified

MARKET

ELEMENTARY ELECTRONICS—is published Bi-monthly. The rate per word for CLASSIFIED ADVERTISEMENTS is \$1.25 payable in advance—minimum ad \$15.00. Capitalized words 40¢ per word additional.

ADDITIONAL INCOME

ANNOUNCING! Fantastic new homework \$\$\$\$. Write Regal, 10835 SE Powell #35, Portland, OR 97266.

\$3 HOURLY stuffing envelopes. Easy work. Details free. Mitchell, Box 140398, Dallas, TX 75214.

\$250 WEEKLY possible mailing letters. Free details. Brown, E. Star Rt. 205, Nowata, OK 74048.

UNLIMITED EARNINGS (not a scheme). Product sample and details \$2.00. Refundable. Narwid Electronics, 61 Bellot Rd., Ringwood, NJ 07456.

HOMEWORKERS! Stuff envelopes. Make big money. Free details. Cypress, 439 Cypress Dr., Lake Park, FL 33403.

\$850. MONTHLY sparetime homework. Details free. Guizar, 690 Neckel, Imperial, CA 92251.

PLAN reveals \$\$\$ secrets homeworkers. Rohrer, Box 2594 Hyattsville, MD 20784.

YOU can make \$\$\$ stuffing envelopes. Free details. Mahoney, 317 E. Navilla, Covina, CA 91723.

\$200 WEEK working evenings at home. Write: Flesta, Box 2882, Springfield, IL 62708.

NEW, easy homework plan. Free details. Endevo, 129 S. Columbo, Tustin, CA 92680.

AGENTS WANTED

GET cash commission with each order from friends, neighbors, for America's finest shoes. Easy. Profitable. No experience needed. Selling outfit free! Mason Shoes, K-256, Chippewa Falls, WI 54729.

AUTO PARTS & ACCESSORIES

NEW UNIQUE THEFT PROOF CAR KIT \$4.00. BEECO, 280 South Main St., Centerville, OH 45459.

BATTERIES, GENERATORS

REPAIR electric motors! Automobile generators! Alternators! Batteries! Modelco, Box 7266, Kansas City, MO 64113.

BIG MAIL

RECEIVE mail galore! National listing \$1.00. Sullins, Box 1313-EE, Brunswick, GA 31520.

BLUEPRINTS, PATTERNS & PLANS

NEW CRAFT PRINT CATALOG—Choose from over 100 great easy-to-build plans. Send \$1.25 (company refunded with your first order). BOAT BUILDER, (CP Div.)—229 Park Avenue South, New York, NY 10003.

BOOKS & PERIODICALS

WHAT'S going on in housing? Get advice on how to economize in modernizing or improving or adding space from idea to completion. Working blueprints available. Send \$1.35 for 110 Better Building Ideas to: Davis Publications, Inc., 229 Park Avenue So., NY 10003.

INCOME, Educational, Professional, Sports, Music, List 25¢. Wright's, C-222-S.M., Clintonville, WI 54929.

40 BOOKS for only \$5.00! Clearance. Many categories. Free details. Shorefire, 1 Scofield, Norwalk, CT 06855.

FREE Magazine featuring 450 books—natural health, gardening, occult, other interesting subjects. Provoker Press, Lakeshore Rd., St. Catharines 579, Ontario L2R 7C9.

INFORMATIVE HANDBOOK—For people with an interest in electronics and desire to know more. Covers basic electricity, resistors, capacitors, micro-waves, facts on frequency, about fuses, circuit breakers, crystals and much more. Send \$1.50 for your copy (includes postage) to: Electronics Theory Handbook, 229 Park Avenue South, N.Y., N.Y. 10003.

BUSINESS OPPORTUNITIES

MAKE Magnetic Signs. Big Profits. Details. Universal, Lenora, KS 67645.

HOMEWORK! BIG MONEY addressing, mailing envelopes. Exciting offer 10¢. Linc Services, 3636 Peterson, Chicago, 60659.

BUSINESS OPPORTUNITIES—Cont'd

FREE Secret Book "2042 Unique, Proven Enterprises." Fabulous "Little Knowns" Work Home! HAYLINGS-E14, Carlsbad, CA 92008.

BECOME our Mail Order Distributor with \$150 investment. Free brochure. Audit Controls, 35 Brookside Ave., Fair Lawn, NJ 07410.

BORROW ANY AMOUNT Enjoy A-1 credit. Keep money in bank. get 80% more. Send Stamp. Vernon, Box 75010-HH, Oklahoma City 73107.

\$30.00 HUNDRED Stuffing Our Circulars Into Stamped Addressed Envelopes. Immediate Earnings. Beginners Kit \$2.00 COLOSSI, 1433-61 Street, DC-2, Brooklyn, NY 11219.

NEW!! Valuable Informative Manual on Mail-order. Learn "How to Setup... Run" your business. Facts free. Frontierco, 154 (D1) Sprenger, Buffalo, NY 14211.

1000% PROFIT Bronzing Baby Shoes. Free Literature. NBC-DG, Gower, MO 64454.

IMPATIENT? Produce Oil Portraits Instantly! Details 25¢, refundable. Jiffyportraits, 2830-BP-Gaffey, San Pedro, CA 90731.

MAKE \$1,000 A WEEK CAMPING, No Capital, Land, Selling or Experience needed. Details 25¢. Write: "Camping," Dept. 602, Box 1616, Torrance, CA 90505.

\$250 WEEKLY! Stuff our sales letter into stamped, addressed envelope. Immediate Income! Details 25¢. Sunshine, Box 115-S71, NYC 10003.

\$25 DAILY POSSIBLE stuffing envelopes! Free details. Service, Box 715D, Lynbrook, New York 11563.

OWN Your Own Business! Correspondence Club Magazine Information. Details 25¢. Destiny, Box 5637-BC, Reno, Nevada 89503.

\$10,000 GUARANTEED OR OWE ME NOTHING. No competition. \$1000 per hour possible. Details Free. American, Dept. G, P.O. Box 11065, Orlando, FL 32803.

\$800 MONTHLY Possible—stuffing envelopes. Start immediately!! Details \$1.00 (refundable). Elamco, B1337-C12, Waldo, AR 71770.

SELL Books by mail. SASE for complete details. J & J, Box 11766 (IO-14), Winston, Salem, N.C. 27106.

HOW TO RECRUIT Commission Salespeople! Free details! Success Publications, 35 Interlachen Place, Excelsior, MN 55331.

MAKE \$200 weekly with unique mailing program. keep all of it. Guaranteed details free. Sales Exchange Dept. 90, 2418 Belkraid Ct., Augusta, GA 30906.

MAKE \$1000 per month mailing letters. Free details. Tate, Box 443-DP, Morehead City, NC 28557.

EARN IMMEDIATELY. Stuffing envelopes. \$300.00 thousand possible. FREE SUPPLIES. Send stamped envelope. Bill Harasymchuk, General Delivery, Nelson, B.C., Canada V1L-5P3.

BIG PROFITS in becoming a supplier to major industry through electro-plating small parts and metalizing non-metals. Write for free particulars: Mason, Room MC-107-GD, 1512 Jarvis, Chicago, IL 60626.

\$70,000 YEARLY doing nothing. \$15,000 guaranteed. Free details. PH/RR1, Inc. Box 6061-OH, Knoxville, TN 37917.

\$2,600.00 PROFIT monthly stuffing envelopes at home. Send self-addressed stamped envelope to: Chamico Industries, P.O. Box 11762 Dept. 201, Pittsburgh, PA 15228.

DIFFERENT! Moneymaking opportunity. Work home. Details free. Noon, 779 M. St., Davis, CA 95616.

MAILORDER Millionaire helps beginners make \$500 weekly. Free Report reveals secret plan! Executive 101, 333 North Michigan, Chicago 60601.

GUARANTEED secrets of stuffing envelopes. Free. Wayne, Box 581, Ottawa, KS 66067.

AMAZING! \$\$\$ Possible mailing letters. Details free. Glothlin, 508 W. Mulberry, Porterville, CA 93257.

GUARANTEED secrets of stuffing envelopes. Free. Wayne, Box 581, Ottawa, KS 66067.

BUSINESS OPPORTUNITIES—Cont'd

CARPETS-RUGS-WHOLESALE. MAKE big money spare or full time selling carpet to friends, builders, apartments. Work from your home-low. Dalton, GA Mill prices start at \$2.39 yd. Many styles available. Get started now in your own business. Send \$15.00 (Refundable) for professional sample kits of three fast sellers. Owen Carpet, 248-EE Resaca, GA 30735 or call 404-277-1321.

GET RICH with Secret Law that smashes debts and brings you \$500 to \$2 million cash. Free report! Credit 4G1, 333 North Michigan, Chicago 60601.

\$300 WEEKLY Stuff envelopes. Addressed stamped envelope. Aquarius, Box 18438, Milwaukee, WI 53218.

STUFF envelopes, secrets. Free details. Excell, 517 Ave. Y, Birmingham, AL 35214.

FREE details on stuffing envelopes for \$\$\$\$. Write: Ackerman, Pike, NY 14130.

\$1,000 MONTH easy plan. Details free. Goodale, 13052 Giass Cir., Irvine, CA 92714.

NATIONAL BUSINESS COUNCIL Needs Distributors. Amazingly profitable. Details. NSBAC Box 1127, Topeka, KS 66601.

\$30.00 PER HUNDRED stuffing envelopes. Immediate earnings. Beginners kit \$1.00 (Refundable). DTFG, 7714 Canterfield Drive, San Antonio, TX 78240.

STUFF ENVELOPES. \$250/THOUSAND SUPPLIES. Enclose STAMPED Envelope. Enterprises, Route 1, Box 263A3, Pauls Valley, OK 73075.

EASY, sparetime, work home Big \$\$\$\$. Write: Jones, Rt. 2, Box 133-A, Arkadelphia, AR 71923.

NEW! Stuff our circulars for profit. Details free. Cooper, 2108 Yale, St. Louis, MO 63143.

\$1,000 MONTHLY possible stuffing envelopes. Free details. Productive, Box 26, Ericsburg, MN 56640.

BUY IT WHOLESALE

CB Radios—Sell from your home, large profits. Send \$1.00 for catalog (refundable on first order) to B. D. Discounts, P.O. Box 602-E, Glendale, AZ 85311. 602-249-0547.

SAVE MONEY! 2 Giant Wholesale Catalogs \$3.00 Refundable 1st order. Winchester Enterprises, 2807SS Hargrave Street, Phila. Pa. 19136.

STRATUS HOVERCRAFT. Flies over land or water. Completely portable. Details \$1.00. Unique Sales, P.O. Box 534, Nitro, WV 25143.

CB RADIO

CB Slang, Bear Country, Those Crazy Handles, more, in Jason's CB Dictionary. Must reading. Good Buddy! \$3.00. Triour Products, Box 369E, Kokomo, IN 46901.

DETECTIVES

POLICE SECURITY INVESTIGATIVE schematics and equipment listings. Quimtronix, Box 548-DV, Seattle, WA 98111.

DO IT YOURSELF

REPAIR YOUR COLOR or B&W TV. Anyone can. New. Easy. method. Information free. Research Publications, Box 517 B, BREA, CA 92621.

STOP PAYING EXPENSIVE TV REPAIRS "Do It Yourself." Anyone can, new, easy, method. Details free. Publications, Box 517 D, Brea, CA 92621.

TAPE-SLIDE SYNCHRONIZER, lap-dissolve, multi-projector plans, \$5.50. Audiovisual catalog free. Millers/Sountage, 1896 Maywood, S. Euclid, OH 44121.

EDUCATION & INSTRUCTION

USED Courses! Books! List 15¢. Smith's 124 Marlborough, Salem, MA 01970.

UNIVERSITY DEGREES BY MAIL! Bachelors. Masters. Ph.D.s. Free revealing details. Counseling, Box 1425-EE-37, Tustin, CA 92689.

LEARN Recreational Vehicle Repair! Free Information! RV Training, Dept. DP3, 5015 N. Darfield, Covina, CA 91724.

LINEAR AMPLIFIER: 2 - 30 MHz, 140 watt mobile. Construction plans, \$3.00. IGOR, Box 5516-GC, Walnut Creek, CA 94596.

THERE IS NO CHARGE FOR THE ZIP CODE—PLEASE USE IT IN YOUR CLASSIFIED AD

PLACE

To be included in the next issue, please send order and remittance to R. S. Wayner,
ELEMENTARY ELECTRONICS, 229 Park Avenue South, New York, N.Y. 10003

ELECTRONIC EQUIPMENT & SUPPLIES

FREE CATALOG: Electronic supplies—kits for the hobbyist. Low prices. Anklam Electronics, 4709 nth. 6th St., Wausau, WI 54401.

BUILD YOUR OWN TV CAMERA. Great for home and business. Free illustrated catalog. Phone or write: 402-987-3771. ATV Research, 13 E. Broadway Dakota City, NB 68731.

FREE 36-page catalog, updated 5 times a year. Everything for the electronics hobbyist—from TV antenna wire to the latest stereo music equipment. **ELECTRONIC DISTRIBUTORS, INC.** 4900 N. Elston Ave., Chicago, IL 60630 EE-15.

DO-IT-YOURSELFERS: Let our buying experts get those hard to find radio, tv, auto, or alarm parts for you. Complete details 25¢. Paris Procurement Co., Box 1304-EE, Canoga Park, CA 91304.

REPAIR motors! Generators! Alternators! Supplies! Equipment plans! Electroquip, Box 7266, Kansas City, MO 64113.

OSCILLOSCOPE KIT. Assemble your own 5" scope. Combined simple instructions and operating manual included. Special price \$69.95. Send check or M/O. Electronic Technical Institute, Little Falls, NJ 07424 Dept. 2772.

EMPLOYMENT INFORMATION

OVERSEAS Jobs—now hiring! All occupations. High pay. Transportation. Computerized reports, \$2.00. Transworld, International Airport, Box 90802-EEH, Los Angeles, CA 90009.

FOR THE HOME

FOR anyone who wants the satisfaction and economy of repairing, furnishing and maintaining the furniture in his home. Send \$1.50 to **FURNITURE.** 229 Park Avenue South, New York, NY 10003.

FORMULAS & TRADE SECRETS

HAVE YOU EVER WONDERED how some people seem to have all the luck and succeed in business? Let us tell you: It's not luck. Details free with S.A.S.E. Motivation, 461 Alter Ave., Staten Island, NY 10305.

HI-FI EQUIPMENT

CANADIANS—Free Hi-Fi discount catalog. Name brands, immediate delivery from our huge stock. Etco, Dept. AA, Box 741, Montreal "A".

HYPNOTISM

FREE Fascinating Hypnosis Information! Startling! DLMH, Box 487, Anaheim, California 92805.

MAGIC TRICKS, ETC.

FREE Trick and Magic Catalog 25¢ Magic & Fun, Box 1936-AV, New York, NY 10017.

MAGNETS

MAGNETS. All types. Specials—20 disc, or 10 bar, or 2 stick, or 8 assorted magnets, \$1.00. Magnets, Box 192-E, Randallstown, MD 21133.

MISCELLANEOUS

SELF CORRECTING TYPEWRITER RIBBON! Most exciting, needed advance since the typewriter was invented! As of this moment, every messy, smudge, smeary typewriter eraser in the world hits the scrap heap for good. No more erasing—ever! Bottom half of miracle ribbon is like magic wand that makes errors disappear before your eyes. To make corrections, just back space, shift ribbon selector and retype error. Presto! White ink makes error completely invisible. Order extra ribbons for friends. This is one gift they will love you for! 1 ribbon \$3.50, 2 ribbons \$6.00. When ordering name the maker and model of typewriter. Order today!! Cordova Enterprises, 156 Shepard Ave., Kenmore, N.Y. 14217.

ROACHES Killed Fast! Safe. Guaranteed. \$7.95. Powhatan Enterprises, Box 1896, Tampa, FL 33601.

MONEYMAKING OPPORTUNITIES

STUFF MAIL ENVELOPES!! \$250.00 profit per thousand possible. Offer details: Stamped self-addressed envelope. Kings, B-21487K-EE37, Ft. Lauderdale, FL 33316.

HOW to Make Money Writing Short Paragraphs. Information Free. Barrett, Dept. C-21-Y, 6216 N. Clark, Chicago 60660.

\$500.00 PROFIT Stuffing 1000 envelopes. 25 Cents Details: Canapro Enterprises, Box 215C, Station "H", Montreal, Que., Canada.

CASH FOR BOXTOPS. Labels, details 15¢. Re-fund Bulletin, Box 503, Cape Girardeau, MO 63701.

MONEYMAKING OPPORTUNITIES—Con't

\$3 HOURLY stuffing envelopes. Easy work. Details free. Feldco, Box 228 Ryder, Brooklyn, 11234.

FREE "1001 ODDS"! It's about \$10,000-\$100,000 actually made at home by certain oddballs! You'll never get over it! Publico-E, Carlsbad, CA 92008.

BOOKLET—"How to have Money Mailed to you Daily." \$2.00 postpaid. J & J (10-15). Box 11766, Winston-Salem, N.C. 27106.

RECEIVE 10, unique moneymaking plans. \$1.00. FLICKINGER, Box 44, Antioch, IL 60002.

\$1,000 MONTHLY possible stuffing envelopes. Free details. DB, 928 Asbury, Evanston, IL 60202.

\$200 WEEKLY. Mailing Circulars. Samples, 25¢. GRAHAMCO, DPBX 99371, Tacoma, WA 98499.

MONEY! Lots of it mailing letters. Details free. Postal, 215 Hazel, Mill Valley, CA 94941.

ADDRESS ENVELOPES FOR PROFIT. \$100.00 per thousand possible. Send 25¢ plus stamped addressed envelope. McDade, 3031 Nottingham, Markham, IL 60426.

\$500.00 WEEKLY! IMMEDIATE. Guaranteed home income stuffing envelopes. FREE Supplies! Send 25¢. Stamp. Profits. B725-DP3. Belen. NM 87002.

CASH-in on mailorder at start! New, sensible method reveals how! Free details. Crescent-D, 1404 Roller Ocean, New Jersey 07712.

\$1,000 MONTHLY working home sparetime. Write: Gordon's, Box 1432, Oxnard, CA 93030.

NEW, Lifetime Trophies: Family, Wedding, Birth, Graduation Walnut-metal made. Don's Place 2M, 2938 North 90th Street, Milwaukee, WI 53222.

\$400. WEEKLY POSSIBLE. Clip newspapers/stuff envelopes. Proven program. Send stamped addressed envelope, E. MASON, Box 9473-P3B, Fresno, CA 93792.

AMAZING Profits stuffing envelopes. Details Free. Star's 160 Harmon, Somerset, MA 02726.

GET INTO BROADCASTING! Become DJ, engineer. Start own CABLE/FM station, get free tapes-records. Free booklet: "Broadcasting." Box 5516-GC6, Walnut Creek, CA 94596.

\$1,000.00 MONTHLY possible stuffing envelopes. National, Box 4314, Baltimore, MD 21223.

BORROW MONEY. No credit check—7 little known secret ways \$2.00. Lee Enterprises, 6501 North 8th, Fresno, CA 93710.

NEW Plan reveals secret of envelope stuffing. \$\$\$ write: International, 1256 N. Kingsley, #3, LA, CA 90029.

CIRCULAR Mailers make \$\$\$\$. So can you. Write: Gaylord, 1738 SE First, Rochester, MN 55901.

EXCLUSIVE money making info. Free details. Evans, 1165 S. 86th, KC, KS 66111.

MAKE \$1,000 MONTH MAILING LETTERS. 2 Stampis, details Diamond Rt. 1, Box 137, Diamond, MO 64840.

EASY! Money stuffing envelopes. Details free. Brightman, 401 S. Rampart, LA, CA 90057.

DIFFERENT stuffing envelopes secrets. Details free. Holder, 940 Nason, Rossville, GA 30741.

STRIKE it rich. Let \$10.00 cash orders fill your mailbox. Send sase or rush \$10 and get rich quicker! Tina Heckaman, Rt. 2, Box 796 Hampshire, TX 77622.

GUARANTEED \$\$\$ stuffing letters. Free details. Stanvil, 1830 Yates, Bronx, NY 10461.

MUSIC & MUSICAL INSTRUMENTS

INTERNATIONAL Catalog valuable to makers, repairers, string instruments. Biggest variety parts, accessories, all imported woods, bows, kits. Send 25¢ and this ad for catalog, price list. We'll include certificate worth \$1.25 credit on your first order of at least \$10. International Violin Company, Dept. YS, 4026 W. Belvedere Ave., Baltimore, MD 21215.

OF INTEREST TO WOMEN

\$3000.00 MONTHLY! Immediate income. Stuff envelopes at home. Information, send self-addressed, stamped envelope. Cottage, Box 730AFB, Baldwin Park, CA 91706.

AMAZING Find. Collection 100-Year-Old Pioneer Recipes. Write: Mormans, 3975 Rawhide, SLC. UT 84106.

PERSONAL

JAPANESE introductions! Girls' photographs, descriptions, brochure, details, \$1.00. INTER-PACIFIC Box 304-SC, Birmingham, MI 48012.

SINGLE? Widowed? Divorced? Nationwide introductions! Identity, Box 315-DC, Royal Oak, MI 48068.

"DATE WITH DIGNITY" Professional Matching. Drawer 6765, Fort Worth, 76115 (817) 921-0281 Anytime.

JAPANESE Girls Make Wonderful Wives. We have large number of listings. Many interested in marriage. Only \$1.00 brings application, photos, names, descriptions, questionnaire. Etc. Japan International, Box 1181-AA, Newport Beach, CA 92663.

BEAUTIFUL MEXICAN GIRLS Wanting American Boy-Friends. Details. Photos "Free." World, Box 3876-DC, San Diego, CA 92103.

DATES GALORE! Meet singles-anywhere. Call DATELINE, toll-free (800) 451-3245.

OVER 1000 beautiful ladies photos, world's largest matrimonial catalog \$5.00. Interpress: Box 12, Toronto M4A 2M6 or Box 737, Ft. Lauderdale, FL 33302.

ADULT pleasure products—over 600 items! Giant catalog \$1.00. Clifton's, D-1068, Saugus, CA 91351.

LATIN AMERICAN GIRLS appreciate thier men. Let us introduce you to a dark-eyed, unspoiled beauty. Complete application package and photo selection only \$2.00: Maria Garcia, Box 80801D, San Diego, CA 92138.

BEAUTIFUL MEXICAN GIRLS! Correspondence! Photos, information \$1.00. "Latinas," Box 1716-DB, Chula Vista, CA 92012.

RADIO & TELEVISION

TV TUBES 36¢ each. Send for Free 48 page color catalog. Cornell, 4217-W University, San Diego, California 92105.

TUBES. Oldies, latest. Supplies, components, schematics. Catalog free. (Stamp appreciated). Steinmetz, 7519-EE Maplewood, Hammond, IN 46324.

"DISTANCE Crystal Set Construction" Handbook—50¢ "Coil Winding"—50¢. Catalog—25¢, refundable. Laboratories, 1477-G, Garden Grove, CA 92642.

REMAILING SERVICE

CONFIDENTIAL! Remail, forwarding-receiving service rates by month or letter. For information, 7522, Loma Verde Wy, Sacramento, CA 95822.

RUBBER STAMPS

RUBBER stamps made. Three lines, \$3.75. Rubber stamps, B1337 Waldo, Arkansas 71770.

SALESMEN—DISTRIBUTORS

AUTOMATIC Fishhooks, Profitable samples. \$2.00 (refundable), Arons, 61 Mastic Beach, NY 11951.

SCIENCE & CHEMISTRY

FIREWORKS. Spectacular novelties, simplified manufacturers textbook, \$5.00. Guaranteed. Tropic, Box 95M4, Palm Bay, FL 32905.

SONGWRITERS

SONGWRITERS: Poems, Songs Wanted. Creative Music Productions, Box 1943-A3, Houston, TX 77001.

EXCITING Offer! Send poems, songs. Crown Music, 1270-RX, Broadway, New York 10001.

STAMP COLLECTING

TERRIFIC! Giant Illuminated Magnifier. Battery operated. \$5.95. Satisfaction Guaranteed. Kel-Rico, A/0510, Box 400, Anacoco, LA 71403.

SURPLUS EQUIPMENT

GIANT Bargain Packed Canadian Surplus Catalogs \$1.00 Etco Electronics-DG, Box 741, Montreal "A".

WATCHES, WATCHMAKING & REPAIRING

WATCH and clock repairing books, tools, materials. Free catalog. No. 1 American, Box 77, EE27, Fox Grove, IL 60021.

From CIE — Cleveland Institute of Electronics

learn by doing!

Perform more than 200 exciting experiments
with CIE's fascinating **ELECTRONICS**
LABORATORY PROGRAM!

Put theory... into practice

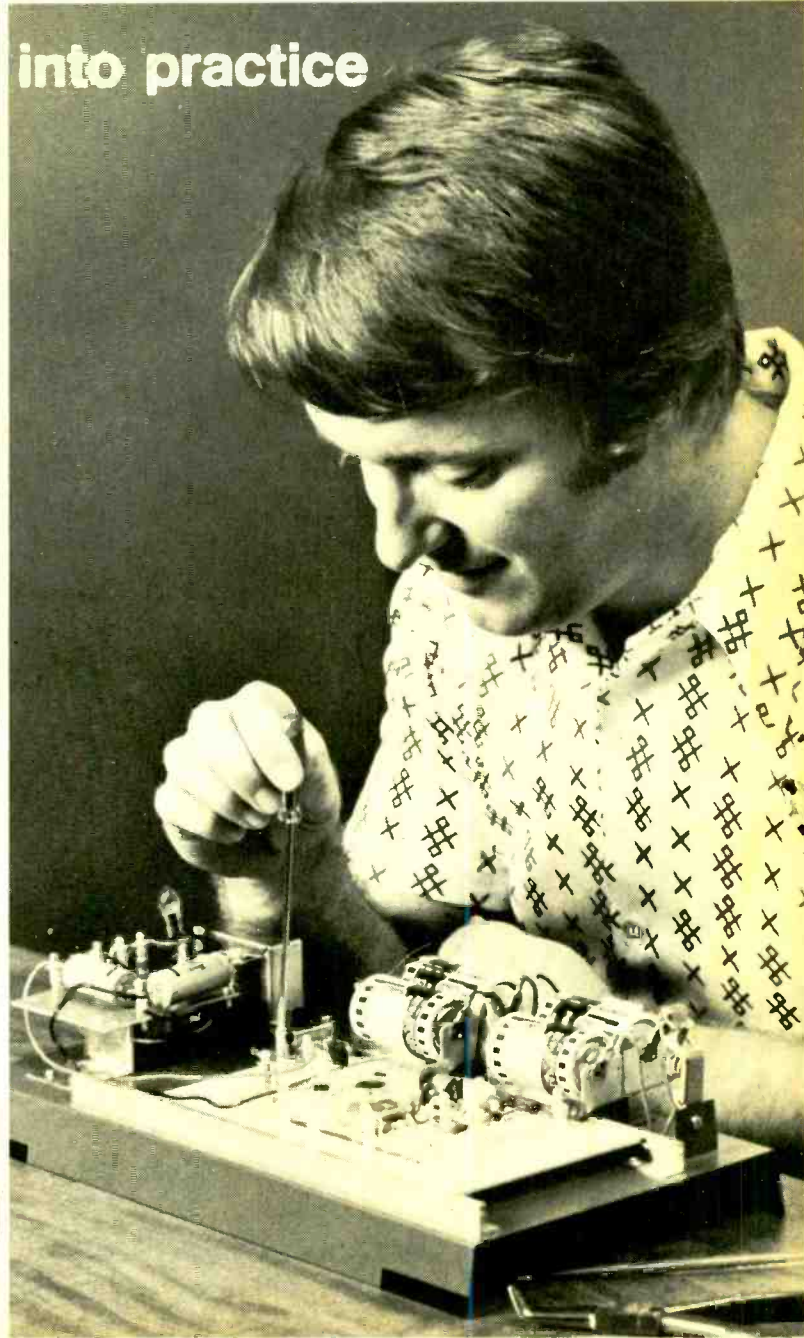

MIDLAND 838

IT'S WHAT YOU GET WHEN YOU

And once you get it, it's going to be all you'll ever need. Because Midland gives you what CB is supposed to give you. The power to communicate. The power to reach out and pull in your own personal horizon. And the clarity to be understood wherever you reach.

For 1977, the power comes to you in an entirely new generation of 40 channel CB radios. Spearheaded by the remarkable Midland 838.

With it comes switchable automatic noise limiter, noise blanker and audio filter—three noise elimination systems that let you receive with greater

clarity. The 838 is also power in your hand with an automatic channel advance and volume control right on the mike. And it's the power to know exactly where you're heading with our large, bright L.E.D. digital channel indicator.



MIDLAND POWER

RUN WITH NUMBER 1. MIDLAND CB.™

The 838, though, is only one aspect of Midland Power.

We offer a complete line of CB's, from base stations to portables, to every kind of mobile transceiver that will put our power in your hands at a very reasonable price. Compare. We don't think anybody, anywhere will give you such quality at such an affordable price.

And we back up that quality with our Midland warranty and convenient service centers from Carolina to California.

And finally, Midland Power is the way we put our 15 years of CB experience into every set we build.

Good experience, obviously. Or we couldn't have done what we did last year. Sell over 2 million Midland CB radios, to

make us the number one selling CB in the world.

Midland Power. It's what you want from a CB.

It's what you get when you run with number 1.

MIDLAND® CB

A member of the Beneficial Corporation Family.

CIRCLE 35 ON READER SERVICE COUPON



Two-way improvement



Avoid CB radio theft with magnetic mount antenna. Just lift off and lock inside vehicle. Extra-strong magnet has 90-lb. pull.



Has your CB ever let you down? Right when you needed it the most?

It could be that "good deal" antenna. Or the lightweight mike that came with the set. To get the most out of your CB, switch to Turner at both ends.

Try a Turner amplified mike. You'll find out how much talk power your set can really deliver. For full range when you need it.

Make sure your antenna is dependable. Step up to a Turner. Turner builds them tougher. There are 43 models for all kinds of base and mobile installations.

Ask anybody who has been around CB for awhile. They know us. Wherever CB is sold, Turner.

The talk of the road

TURNER

MICROPHONES
ANTENNAS

CONRAC
CORPORATION

716 Oakland Road N.E., Cedar Rapids, Iowa 52402

CIRCLE 29 ON READER SERVICE COUPON

Hey, Look Me Over

(Continued from page 6)

gered by current flow caused when any light in the automobile is turned on by opening any door. If equipped with a light, the vehicle trunk or hood is also protected by the system. The System's circuitry beeps the car horn for 2½ minutes to scare-off would-be thieves. The system then shuts down and automatically rearms itself. Excessive battery drain or horn damage associated with



CIRCLE 52 ON READER SERVICE COUPON

continuous horn operation is avoided, and the system shutdown feature also eliminates the nuisance problem of accidentally tripped alarms. For further information on this mobile CB security system, available nationwide at CB and automotive distributors and selling for only \$17.95, contact Harcor International, Inc., 744 Algonquin Road, Dept. PR., Arlington Heights, IL 60005.

TV Remote Control

A remote control capable of selecting all TV channels, UHF as well as VHF, has been developed by Jerrold Electronics Corporation, a subsidiary of the worldwide General Instrument Corporation. Designated the Model TRC-82, it provides instant push-button selection of VHF and UHF channels (2 through 83). Electronically, without motors, the solid-state TRC-82 provides direct-access channel changes, fine tuning and remote on-off control of a TV set from anywhere in the room. The TRC-82 all-channel remote control is attached to any TV set in minutes. It consists of two units, an

(Continued on page 12)



CIRCLE 55 ON READER SERVICE COUPON

Shakespeare's White Knight. The best antenna going. And coming.

Shakespeare comes on strong for the new 40 channel era. With high performance CB antennas that turn on the power on all 23 or 40 channel CB transceivers.

Shakespeare's new White Knight Antenna combines the rugged, mechanical strength of gleaming white fiberglass with precision engineered electronic components. Components like the high quality loading coil permanently fused in a solid polycarbonate thermoplastic base. Totally impervious to the environment. And pre-tuned to an SWR of 1.9 to 1 or less over the 40 channel band (1.3 to 1 or less at the center). To assure maximum range and peak performance everytime you key the mike. That's what sets the White Knight antenna apart from all the others.

Ride full tilt into the 40 channel era with the new White Knight CB Antenna. And take the Shakespeare performance route home.

The White Knight Antenna, Style 430/available in a variety of pre-assembled mounting styles. Complete with cables and connectors. Under \$25.

Shakespeare

Coming on strong for the Knights of the Road.

Shakespeare Company/Antenna Group, P.O. Box 246, Columbia, S.C. 29202
In Canada: Len Finkler Ltd., Ontario.
CIRCLE 25 ON READER SERVICE CARD