

CB, MONITOR RADIO, SWL—Here's Where It's All At!

Elementary
Electronics

©

02342

MAY-JUNE
1976
\$1.00

Elementary Electronics

FOR
BEGINNERS
**UNDERSTANDING
DIODES**
OUR BASIC COURSE

CB Lingo—You can talk like the truck drivers—10/4!

Boinger—A gadget that puts spring in SW DXing

Transtab—You build it and test/rate semiconductors

Design Mates—Three ways to pep up IC projects

Digital Egg Voltmeter

Don't be Chicken! Build this eggs-perlmenter IC project and eggs-pect eggs-act 0 to 99.9 VDC readings. It's really in-eggs-pensive and eggs-citing to make!

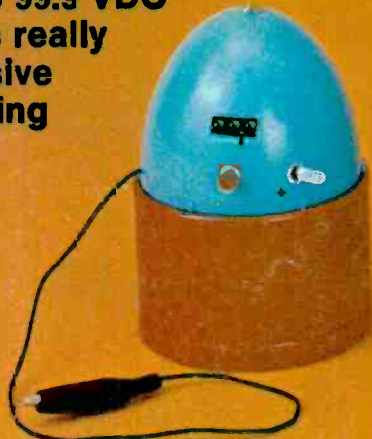

**SPECIAL
CB Lab TEST**
Panasonic's New
Mobile Rig



The United States of America

FEDERAL COMMUNICATIONS COMMISSION

RADIO/TELEPHONE OPERATOR LICENSE

FIRST CLASS
(General Radiotelephone Certificate)

This certifies that JOHN R. DOE

SEX	HEIGHT	WEIGHT	COLOR EYES	COLOR HAIR	DATE OF BIRTH
M	6-1	185	BLUE	BROWN	MONTH 02 DAY 22 YEAR 1946

IS A LICENSED RADIO OPERATOR AUTHORIZED SUBJECT TO ANY SPECIAL ENDORSEMENT PLACED HEREON TO OPERATE THE CLASSES OF LICENSED RADIO STATIONS FOR WHICH THIS CLASS OF LICENSE IS VALID UNDER THE ORDERS, RULES AND REGULATIONS OF THE FEDERAL COMMUNICATIONS COMMISSION, ANY STATUTE OF THE UNITED STATES AND ANY TREATY TO WHICH THE UNITED STATES IS A PARTY.

THIS LICENSE IS GRANTED UNDER THE AUTHORITY OF THE COMMUNICATIONS ACT OF 1934 AS AMENDED AND THE TERMS AND CONDITIONS THEREOF AND OF ALL LEGISLATIVE ACTS, EXECUTIVE ORDERS AND TREATIES TO WHICH THE UNITED STATES IS SIGNATORY AND ALL ORDERS, RULES AND REGULATIONS OF THE FEDERAL COMMUNICATIONS COMMISSION WHICH ARE BINDING UPON RADIO OPERATORS ARE MADE A PART HEREOF AS THOUGH SPECIFICALLY SET OUT IN FULL HEREIN.

NEITHER THIS LICENSE NOR THE RIGHTS CERTIFIED HEREIN SHALL BE ASSIGNED OR OTHERWISE TRANSFERRED TO ANY OTHER PERSON.

PLACE AND DATE OF ISSUANCE WASHINGTON, D.C. MARCH 31, 1973

DATE AND TIME OF EXPIRATION MARCH 31, 1976 AT THREE O'CLOCK P.M. EASTERN STANDARD TIME

SPECIAL ENDORSEMENT

SHP KADAK INDONSENIST WASH, D.C. MARCH 31, *Paul J. Harris*

Paul J. Harris
John R. Doe

SPECIMEN

NOT VALID UNTIL SIGNED

CIE's Warranty says a lot to you!

A lot about CIE's FCC License training programs...and a lot more about our school.

Our FCC License Warranty means just what it says. If you enroll in any CIE career course that includes FCC License preparation and successfully complete your training . . . you'll pass the Government FCC exam. We warrant that you'll succeed.

CIE can make this no-nonsense warranty because we're confident of our in-depth career training programs. You see, we have *specialized exclusively* in Electronics education-by-mail for more than 40 years. Just Electronics. And, the courses we offer today are the result of these years of teaching experience and proven methods of training.

Our courses of study are written in easy-to-understand language, so you can progress at your own learning pace, at home, in your spare time. And, there are never any classrooms to attend.

CIE courses challenge your thinking . . . help you develop your understanding of important electronics theories and applications . . . enable you to learn new skills and knowledge. Our courses are thorough. They have to be.

You see, we're training you for a career in Electronics. And, if an FCC "ticket" is part of your goal, you'll have to pass a tough licensing exam administered by the Federal Communications Commission (an agency of the U.S. Government). And you'll be prepared.

CIE is willing to warrant that you will pass! The reason is . . . we have every reason to expect that *you will* do exactly that. Based on a series of continuing surveys, *close to 9 out of 10 CIE grads pass their FCC exams!*

What's a license worth?

An FCC License can be worth a lot if you're interested in any area of Electronics involving communications. In some fields, federal law requires that you must have one. And, even in careers where a license is not required, it is

Government certification of certain electronics knowledge and skills.

What about other CIE courses?

In every CIE career course, you'll find the same time-tested instructional techniques that have made CIE's FCC License preparation programs so successful.

Each CIE career course is built on the principle that the best way for you to *learn* and *retain* what you've learned is to *explain*; then to *check* your understanding; then to *reinforce* your comprehension with practical applications. In some courses, you will perform experiments and tests with your CIE Experimental Electronics Laboratory using authentic electronic components and gear. And, if you select a course that includes Color TV technology, you will not only build and keep a 25" diagonal Color TV which features digital circuitry . . . you'll also learn how to troubleshoot your TV.

The CIE course you select (beginner, intermediate, or advanced college-level), will be a complete educational program, designed by *experts* to give you the best in Electronics home-study education.

Send for FREE school catalog

Discover more about the career opportunities open to people with electronics training. Learn how CIE career courses can help you build new skills and knowledge and prepare you for a meaningful, rewarding career. Whether you are just starting out in Electronics or are a college-trained engineer in need of updating, (or anywhere in between), CIE has a course designed for *you*. And, more than half of CIE's career courses include FCC License preparation.

Send today for our FREE school catalog and booklet on FCC License information. For your convenience, we will try to have a representative call to assist in course selection. Mail reply card or coupon to CIE . . . or write: Cleveland Institute of Electronics, Inc., 1776 East 17th Street, Cleveland, Ohio 44114. Do it TODAY.

G.I. Bill benefits

All CIE *career* courses are approved for educational benefits under the G.I. Bill. If you are a Veteran or in service now, check box for G.I. Bill information.

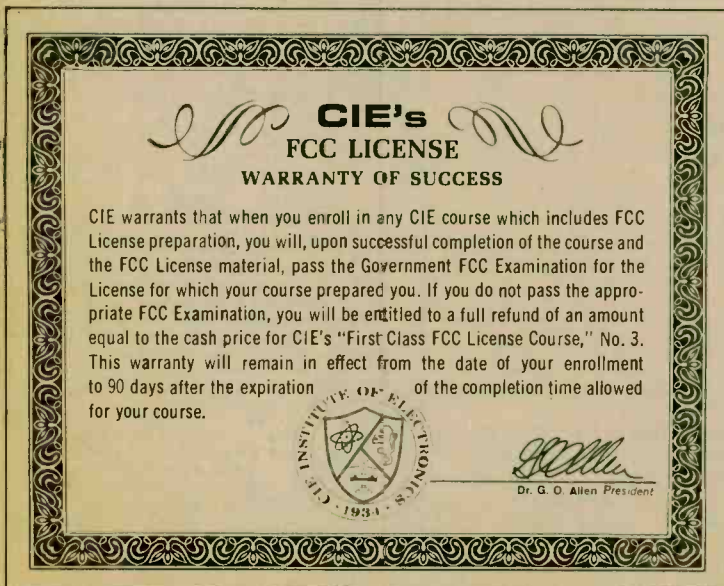

CIE Cleveland Institute of Electronics, Inc.
1776 East 17th Street, Cleveland, Ohio 44114
Accredited Member National Home Study Council

Yes, I want your FREE school catalog and career information package today.

I am especially interested in: EL-65

<input type="checkbox"/> Electronics Technology	<input type="checkbox"/> Industrial Electronics
<input type="checkbox"/> FCC License Preparation	<input type="checkbox"/> Electronics Engineering
<input type="checkbox"/> Color TV Maintenance	<input type="checkbox"/> Other _____
<input type="checkbox"/> Mobile Communications	_____

Print Name _____

Address _____ Apt. _____

City _____

State _____ Zip _____ Age _____

Check box for G.I. Bill information. Veteran On Active Duty

elementary electronics

Dedicated to
America's
Electronics
Hobbyists

Including Electronics Digest®

EGGS-ACTLY WHAT YOUR TEST BENCH NEEDS

- ☆ 43 It's Digital Egg—a digital voltmeter that measures from -100 to +100 volts

CB—THE DICK TRACY WORLD

- ☆ 61 Panasonic's CB/FM-AM combo—in auto or home, this unit is a first-time winner
- ☆ 69 CB Lingo—how to talk like a truck driver
- 69 73's to Messenger III—famous CB set ends its career gloriously
- 70 Kathi's CB Carousel—gadgets from Gold Line

BUILD-IT BONANZA

- 51 Build Heat Controller for Your Soldering Iron—it's inexpensive and easy
- ☆ 54 TransTab—this transistor checker says good or bad, identifies all leads and types
- 72 Waah't's That Sound!—easy project for Wah-Wah pedal control
- 77 Attention Grabber—dual-duration flash handles up to 300 watts of light
- 78 Build an Acu volt Calibrator—it's a precision reference for all measurements

SO YOU CAN COMMUNICATE

- 32 DX Central Reporting
- ☆ 52 DX With Boinger—a compact SWL antenna, out-the-window
- 67 Unveiling Radio Swan—Was it licensed? Did it trigger the Bay of Pigs? Who owns it now?
- 71 e/e Checks Out Regency Whamo-10—VHF-UHF scanner and accessory frequency synthesizer

THE OLDER, THE BETTER

- 57 Antique Radio Corner—Jim Fred revives more olden memories and tuning indicators
- 63 Mystery Radio—One-tube mystifier works with unlit filament on broadcast band

HOW TO FIND OUT HOW

- ☆ 59 e/e Checks Out Design Mates—Continental Specialties' three instruments speed breadboard and design
- 65 You Can Build Your Own Transformers—save money on hard-to-find units
- 80 Our Cartoon Page—it's really very basic theory!
- ☆ 81 Basic Course—all about diodes and rectifiers

WE'RE LONG ON SHORTIES

- 60 20 Big Brothers—custom TV for Customs
- 74 Quickdraw Rickshaw—this electric car really gets around!
- 79 Rats! Caught With His Charge Up—student tests mouse power
- 80 Walking Streets Paved With Gold—he uses electronics to find paydirt

THE REGULARS

- 4 Hey, Look Me Over—new in electronics
- 12 Ask Hank, He Knows!
- 22 Bookmark—by Bookworm
- 30 Newscan—electronic news
- 75 Reader Service Coupons
- 95 Literature Library

☆ Cover Features

• Editor-in-Chief and Electronics Group Coordinator—Julian S. Martin, WA2CQL
• Technical Editor—Charles Graham, W1HF1 • Audio Editor—Stephen B. Gray
• Communications Editor—Morgan Godwin, W4WFL • Editorial Assistant—Christine Begole
• Citizens Band Editor—Kathi Martin, KGK3916 • Workbench Editor—Hank Scott • Production Manager—Hui Wang • Production Editor—Philip Clark • Art Director—Ralph Rubino
• Assistant Art Director—Milena Sokol • Cover Art Director—Irving Bernstein • Art Assistants—John Harper, Robert Modero, David Pindar • Advertising Director—David J. Miller, KCX1268
• Newstand Circulation Director—Don Gabree • Subscription Circulation and Marketing Director—Robert V. Enlow • Instruments Division Manager—Wilfred M. Brown • Director of Market Development—James C. Weakley

• President and Publisher—Joel Davis • Vice President and General Manager—Leonard F. Pinto • Vice President and Treasurer—Victor C. Stabile, KBP0681

May-June 1976
Volume 16, No. 3



Cover photo by Leonard Studios



AUTHORS IN THIS ISSUE

Anthony Caristi, F. Chapman, Frank Cicchiello, Steve Daniels, Jim Fred, Myrtle Gronk, Don Jensen, John Keidel, C. R. Lewart, Kathi Martin, Norm Myers, Ralph Perry, Polish Ham—KGK3915, John Portune, Hank Scott, and the ELEMENTARY ELECTRONICS Editorial Staff.

ELEMENTARY ELECTRONICS is published bi-monthly by Davis Publications, Inc. Editorial and Executive offices: 229 Park Ave. So., New York, NY 10003; all subscription orders and mail regarding subscriptions should be sent to P.O. Box 2600, Greenwich, CT 06830. One-year subscription (six issues)—\$6.50; two-year subscription (12 issues)—\$13.00; three-year subscription (18 issues)—\$19.00; and four-year subscription (24 issues)—\$25.00. Add 50 cents postage for each year for U.S. possessions and Canada; \$1.00 each year, all other countries. For change of address, please advise 4 to 6 weeks before moving. Send us your current mailing label with new address. Advertising offices: New York, 229 Park Avenue South, 212-673-1300; Chicago, 520 N. Michigan Ave., 312-527-0330; Los Angeles; J. E. Publishers' Rep. Co., 8732 Sunset Blvd., 213-659-3810. Second-class postage paid at New York, NY and at additional mailing office.

Copyright 1976 by
Davis Publications, Inc.

ELEMENTARY ELECTRONICS/May-June 1976

BUILD 20 RADIO

and Electronics Circuits

PROGRESSIVE HOME RADIO-T.V. COURSE

Now Includes

- ★ 12 RECEIVERS
- ★ 3 TRANSMITTERS
- ★ SQ. WAVE GENERATOR
- ★ SIGNAL TRACER
- ★ AMPLIFIER
- ★ SIGNAL INJECTOR
- ★ CODE OSCILLATOR

- ★ No Knowledge of Radio Necessary
- ★ No Additional Parts or Tools Needed
- ★ EXCELLENT BACKGROUND FOR TV
- ★ SCHOOL INQUIRIES INVITED
- ★ Sold In 79 Countries

YOU DON'T HAVE TO SPEND HUNDREDS OF DOLLARS FOR A RADIO COURSE

The "Edu-Kit" offers you an outstanding PRACTICAL HOME RADIO COURSE at a rock-bottom price. Our Kit is designed to train Radio & Electronics Technicians, making use of the most modern methods of home training. You will learn radio theory, construction practice and servicing. THIS IS A COMPLETE RADIO COURSE IN EVERY DETAIL.

You will learn how to build radios, using regular schematics; how to wire and solder in a professional manner; how to service radios. You will work with the standard type of Punched metal chassis as well as the latest development of Printed Circuit chassis.

You will learn the basic principles of radio. You will construct, study and work with RF and AF amplifiers and oscillators, detectors, rectifiers, test equipment. You will learn and practice code, using the Progressive Code Oscillator. You will learn and practice trouble-shooting, using the Progressive Signal Tracer, Progressive Signal Injector, Progressive Dynamic Radio & Electronics Tester, Square Wave Generator and the accompanying instructional material.

You will receive training for the Novice, Technician and General Classes of F.C.C. Radio Amateur Licenses. You will build Receiver, Transmitter, Square Wave Generator, Code Oscillator, Signal Tracer and Signal Injector circuits, and learn how to operate them. You will receive an excellent background for television, Hi-Fi and Electronics.

Absolutely no previous knowledge of radio or science is required. The "Edu-Kit" is the product of many years of teaching and engineering experience. The "Edu-Kit" will provide you with a basic education in Electronics and Radio, worth many times the low price you pay. The Signal Tracer alone is worth more than the price of the kit.

THE KIT FOR EVERYONE

You do not need the slightest background in radio or science. Whether you are interested in Radio & Electronics because you want an interesting hobby, a well paying business or a job with a future, you will find the "Edu-Kit" a worth-while investment. Many thousands of individuals of all

ages and backgrounds have successfully used the "Edu-Kit". In more than 79 countries of the world, the "Edu-Kit" has been carefully designed, step by step, so that you cannot make a mistake. The "Edu-Kit" allows you to teach yourself at your own rate. No instructor is necessary.

PROGRESSIVE TEACHING METHOD

The Progressive Radio "Edu-Kit" is the foremost educational radio kit in the world, and is universally accepted as the standard in the field of electronics training. The "Edu-Kit" uses the modern educational principle of "Learn by Doing." Therefore you construct, learn schematics, study theory, practice trouble shooting—all in a closely integrated program designed to provide an easily-learned, thorough and interesting background in radio. You begin by examining the various radio parts of the "Edu-Kit". You then learn the function, theory and wiring of these parts. Then you build a simple radio. With this first set you will enjoy listening to regular broadcast stations, learn theory, practice testing and trouble-shooting. Then you build a more advanced radio, learn more advanced theory and techniques. Gradually, in a progressive manner, and at your own rate, you will find yourself constructing more advanced multi-tube radio circuits, and doing work like a professional Radio Technician.

Included in the "Edu-Kit" course are Receiver, Transmitter, Code Oscillator, Signal Tracer, Square Wave Generator and Signal Injector Circuits. These are not unprofessional "breadboard" experiments, but genuine radio circuits, constructed by means of professional wiring and soldering on metal chassis, plus the new method of radio construction known as "Printed Circuitry." These circuits operate on your regular AC or DC house current.

THE "EDU-KIT" IS COMPLETE

You will receive all parts and instructions necessary to build twenty different radio and electronics circuits, each guaranteed to operate. Our Kits contain tubes, tube sockets, variable, electrolytic, mica, ceramic and paper dielectric condensers, resistors, tie strips, hardware, tubing, punched metal chassis, Instruction Manuals, hook-up wire, solder, selenium rectifiers, coils, volume controls and switches, etc.

In addition, you receive Printed Circuit materials, including Printed Circuit chassis, special tube sockets, hardware and instructions. You also receive a useful set of tools, a professional electric soldering iron, and a self-powered Dynamic Radio and Electronics Tester. The "Edu-Kit" also includes Code Instructions and the Progressive Code Oscillator, in addition to F.C.C. Radio Amateur License training. You will also receive lessons for servicing with the Progressive Signal Tracer and the Progressive Signal Injector, a High Fidelity Guide and a Quiz Book. You receive Membership in Radio-TV Club, Free Consultation Service, Certificate of Merit and Discount Privileges. You receive all parts, tools, instructions, etc. Everything is yours to keep.

PRINTED CIRCUITRY

At no increase in price, the "Edu-Kit" now includes Printed Circuitry. You build a Printed Circuit Signal Injector, a unique servicing instrument that can detect many Radio and TV troubles. This revolutionary new technique of radio construction is now becoming popular in commercial radio and TV sets.

A Printed Circuit is a special insulated chassis on which has been deposited a conducting material which takes the place of wiring. The various parts are merely plugged in and soldered to terminals.

Printed Circuitry is the basis of modern Automation Electronics. A knowledge of this subject is a necessity today for anyone interested in Electronics.



Reg. U. S. Pat. Off.

Training Electronics Technicians Since 1946

FREE EXTRAS

• SET OF TOOLS

- SOLDERING IRON
- ELECTRONICS TESTER
- PLIERS-CUTTERS
- VALUABLE DISCOUNT CARD
- CERTIFICATE OF MERIT
- TESTER INSTRUCTION MANUAL
- HIGH FIDELITY GUIDE • QUIZZES
- TELEVISION BOOK • RADIO TROUBLE-SHOOTING BOOK
- MEMBERSHIP IN RADIO-TV CLUB: CONSULTATION SERVICE • FCC AMATEUR LICENSE TRAINING
- PRINTED CIRCUITRY

SERVICING LESSONS

You will learn trouble-shooting and servicing in a progressive manner. You will practice repairs on the sets that you construct. You will learn symptoms and causes of trouble in home, portable and car radios. You will learn how to use the professional Signal Tracer, the unique Signal Injector and the Dynamic Radio & Electronics Tester. While you are learning in this practical way, you will be able to do many a repair job for your friends and neighbors, and charge fees which will far exceed the price of the "Edu-Kit." Our Consultation Service will help you with any technical problems you may have.

FROM OUR MAIL BAG

J. Statitis, of 25 Poplar Pl., Waterbury, Conn., writes: "I have repaired several sets for my friends, and made money. The "Edu-Kit" paid for itself. I was ready to spend \$240 for a Course, but I found your ad and sent for your Kit."

Ben Valerio, P. D. Box 21, Magna, Utah: "The Edu-Kits are wonderful. Here I am sending you the questions and also the answers for them. I have been in Radio for the last seven years, but like to work with Radio Kits, and like to build Radio Testing Equipment. I enjoyed every minute I worked with the different kits: the Signal Tracer works fine. Also like to let you know that I feel proud of becoming a member of your Radio-TV Club."

Robert L. Shuff, 1534 Monroe Ave., Huntington, W. Va.: "Thought I would drop you a few lines to say that I received my Edu-Kit, and was really amazed that such a bargain can be had at such a low price. I have already started repairing radios and phonographs. My friends were really surprised to see me get into the swing of it so quickly. The Trouble-shooting Tester that comes with the Kit is really swell, and finds the trouble, if there is any to be found."

Progressive "Edu-Kits" Inc., 1189 Broadway, Dept. 578DJ Hewlett, N.Y. 11557

Please rush me free literature describing the Progressive Radio-TV Course with Edu-Kits. No Salesman will call.

NAME

ADDRESS

CITY & STATE ZIP

PROGRESSIVE "EDU-KITS" INC.

1189 Broadway, Dept. 578DJ Hewlett, N.Y. 11557

CIRCLE 14 ON READER SERVICE COUPON

Hey, look me over

Showcase of New Products

SSB CB with PA

A new, solid-state Citizens Band radio transceiver called the SSB-23A Albattross, has a public address capability built in as well as a noise blanker circuit. Fine tuning and a minimum of interference is another feature of the SSB-23A, which is made by Siltronix. Weighing only 5.5 pounds, it has a frequency range of 26.965 to 27.225 MHz. With overall dimensions of 2.5 inches



CIRCLE 56 ON READER SERVICE COUPON

high by 8 inches wide by 11 inches deep, the SSB-23A has conventional AM and suppressed-carrier SSB modulation. The transceiver requires 1.2 amps of power to transmit and 250 milliamps to receive, while operating on 13.8 volts of DC current. Priced at \$359.95, the SSB-23A is available from Siltronix, 269 Airport Road, Oceanside, CA 92054. Write for full details.

DC Regulated Power Supply Kit

All parts and materials necessary to construct a well regulated, stable, ripple-free power supply are included in the DC Regulated Power Supply Kit offered by GC Electronics' Calectro Division. The Power Supply Kit (Cat. No.



CIRCLE 58 ON READER SERVICE COUPON

G2-100) can be used in place of batteries in radios, tape recorders, and other electronic devices using from 2 to 25 volts, up to a current drain of 500 mA. Voltage output remains constant, even when output load varies from none

to a full load. The Kit also includes an illustrated, step-by-step instruction booklet that contains helpful hints and construction techniques. Sells for \$32.50. GC Electronics offers other ready-to-assemble Calectro Kits that are fun, educational, and practical to build, including a Digital Clock, Motor Speed Control, Burglar Alarm, and TTL-5 Power Supply. Get all the facts by writing to GC Electronics, Division of Hydrometals, Inc., 400 South Wyman Street, Rockford, IL 61101.

Pocket-Sized Transceiver

Dick Tracy's famous miniaturized two-way radio is no longer a dream, thanks to *PocketCom*, the world's first complete solid-state two-channel transceiver that operates on the CB channels. *PocketCom* can be used as a paging system, as an intercom, or as a pocket-sized communications link for business or pleasure. The five-ounce *PocketCom* measures only ¾-inch by 1½ inches by 5¼ inches and sells for \$39.95 per unit, plus \$2.50 for postage, insurance, and handling. *PocketCom* has a line-of-sight, clear-channel range of up to five miles between units, and can receive signals from stronger base stations as far as 25 miles away. No FCC license is required to operate *PocketCom* since it generates a 100-milliwatt signal. A unique beep-tone paging system keeps *PocketCom* silent until it is beeped by a

(Continued on page 6)

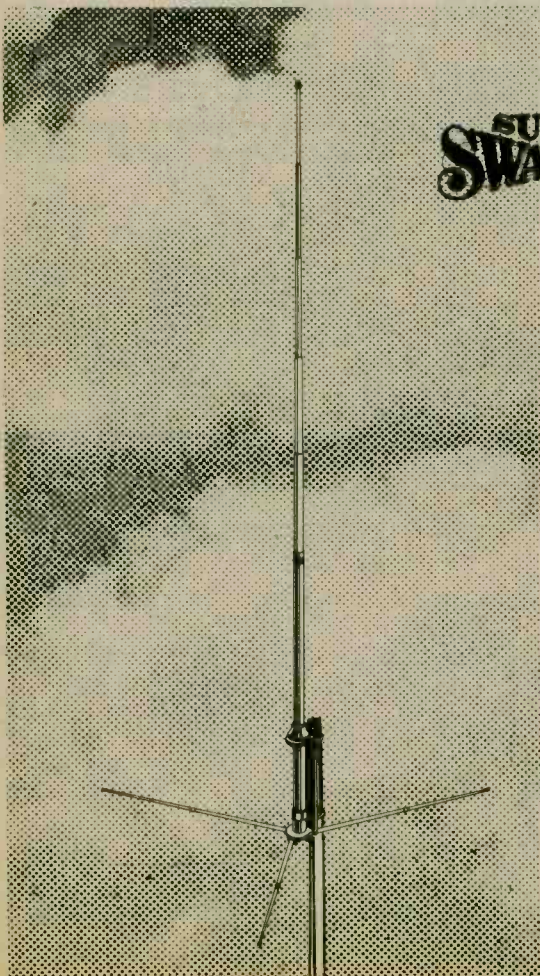

**SUPER
SWAMPER**

Why you need a Hustler CB base station antenna.

Your antenna is your link with other CB'ers. The more effective that link, the better you hear, and the better you're heard. Hustler CB base station antennas are electrically longer for greater range—up to 20%—to extend your signal over the miles. And they're easy to install, stay tuned for peak performance no matter what Mother Nature does. Each Hustler is manufactured to the highest standards of the industry with the very best materials. Get outstanding all directional coverage with a Hustler "Super Swamper"—Model 27TD or "Jam Ram" Model 27JR.

HUSTLER

new-tronics
corporation

15800 Commerce Park Drive
Brookpark, Ohio 44142
(216) 267-3150

"the home of originals"

**Available from all distributors
who recognize the best.**

Hustler designs are patented under one or more of the following assigned to New-Tronics Corporation 3287732, 3513472, 3419869, 3873985, 3327311, 3599214, 3582951

Hey, Look Me Over



CIRCLE 53 ON READER SERVICE COUPON

companion unit. PocketCom comes equipped for switch-selected two-channel crystal-controlled operation. Conventional "N" cell batteries are included with the PocketCom, along with Channel 14 crystals. Extra crystals for any second channel are \$3.95 each. Two are required, and they can be easily inserted by the consumer. Further information is available from JS&A National Sales Group, 4200 Dundee Rd., Northbrook,

IL 60062. Be sure to mention you saw it in ELEMENTARY ELECTRONICS.

Hi-Fi Turntable

The Swiss-made line of fine Lenco transcription turntables is now being distributed by Uher of America. At the top of the Lenco line is the L-851C belt-drive transcription turntable. Among the features of the L-851C are a 16-pole



CIRCLE 50 ON READER SERVICE COUPON

synchronous motor, illuminated stroboscope, viscously damped spring suspension and anti-skating device. The unit is equipped with IC electronics to ensure a trouble-free switch-off and lifting of the tonearm from the record as well as fine speed adjustment. Wow and flutter are ± 0.08 percent, weighted rumble is -63 dB. The two-speed ($33\frac{1}{3}$,

45 rpm) unit comes with base and dust cover and retails for \$299.50. As with all Lenco products, the L-851C features quality, handcrafted Swiss workmanship. For more information, write to Lenco/Uher of America, Inc., 621 S. Hindry Ave., Inglewood, CA 90301.

Full Mobile 23

The new Royce feature-packed Model 1-601 23-Channel Mobile CB Transceiver has an extra-large S-RF meter for easy reading. It also has an amplified AGC circuit that expands the range of an ordinary AGC circuit by several times, and pulls weak stations out of the noise, yet still lets the CBer hear the unit parked next to him. Other features include: positive and negative ground operation; continuous receiver fine tuning control; pushbutton high-low tone
(Continued on page 8)



CIRCLE 54 ON READER SERVICE COUPON

Shakespeare Powers the Citizens Band

No other factor makes such a dramatic difference in CB performance as the antenna that puts out and takes in the signal. A Shakespeare pre-tuned fiberglass antenna can increase your talkpower and improve clarity over ordinary antennas.

So don't let a "do nothing" antenna put a muzzle on your Citizens Band communications.

Power up with a gleaming white Shakespeare antenna, and get top performance everytime you're on the air.

Shakespeare

...the Royal Line of Fiberglass Antenna...

© 1976 The Shakespeare Company



Shakespeare Company
Antenna Group
Box 246
Columbia, South Carolina

In Canada:
L. S. Fisher Ltd.
1000 Road
Scarborough, Ontario
M1B 2A6

CIRCLE 21 ON READER SERVICE COUPON

An Extraordinary Offer to introduce you to the benefits of Membership in

ELECTRONICS BOOK CLUB

take any

3 of these unique electronics books— value to \$58.70 ...for only 99¢ each

with a Trial Membership in the Book Club that guarantees to save you 25% to 75% on a wide selection of electronics books



667 (\$6.95)

671 (\$7.95)

812 (\$9.95)

582 (\$9.95)

821 (\$8.95)

101 (\$17.95)

715 (\$15.90)

672 (\$7.95)

510 (\$17.90)

COUNTS AS ONE

COUNTS AS ONE

586 (\$14.90)

COUNTS AS ONE

COUNTS AS ONE

SPECIAL BONUS

Save us invoicing costs (and yourself postage) by remitting with application and we'll send you this \$4.95 paperback FREE!

676 (\$8.95)

722 (\$8.95)

COUNTS AS ONE

640 (\$15.90)

701 (\$8.95)

732 (\$8.95)

487 (\$22.85)

681 (\$8.95)

563 (\$15.90)

583 (\$8.95)

101-ELECTRONIC CIRCUIT DESIGN HANDBOOK. GIANT 416-p. circuit-designer's cookbook with 639 designs. 8 1/2 x 11" 416p. \$56i List \$17.95
 487-544-p. TRIPLE SELECTION: 64 Hobby Projects for Home & Car. A host of unique "fun-to-build" gadgets bound to please everybody! 192p. 159i List \$7.95—New IC FET Principles & Projects. Learn about today's FETs by building useful projects from simple devices to sophisticated 400 circuits. 160p. 70i List \$6.95—Practical Triac/SCR Projects. Balanced blend of thyristor theory and practical circuits. 192p. 146i List \$7.95
 510-512-p. DOUBLE SELECTION: How to Read Electronic Circuit Diagrams. Anyone can quickly learn his way around circuits and trace signals. 256p. 148i List \$8.95—Basic Electricity & Beginning Electronics. Enjoyable text that combines electron theory with high reader interest. 256p. 391i List \$8.95
 563-328-p. DOUBLE SELECTION: Beginner's Guide to TV Repair. Ideal handbook for anyone who wants to learn the basics of TV repair. 160p. 80i List \$7.95—Installing TV & FM Antennas. How to get clean, interference-free signals to your receiver in all locations. 168p. 158i List \$7.95
 582-COMMERCIAL FCC LICENSE HANDBOOK. Everything you need to know to pass the 1st, 2nd, 3rd class exams is included. 444p. 150i List \$8.95
 586-368-p. DOUBLE SELECTION: Fascinating World of Radio. Communications. Covers the romance of listening to all the bands. 176p. 56i List \$6.95—Understanding & Using Radio Communications Receivers. Semitechnical approach to help upgrade performance. 192p. 75i List \$7.95
 640-476-p. DOUBLE SELECTION: Selecting & Improving Your Hi-Fi System. Tells you what to look for, to expect, and to avoid. 224p. 122i List \$7.95—4-Channel Stereo. From Source to Sound. All the simplified theory and "how it's done" info Shows how you can get started with a couple of speakers and a matrix that costs less than a dollar! 252p. 102i List \$7.95
 667-MINIATURE PROJECTS FOR ELECTRONIC HOBBYISTS. 20 practical, useful projects using miniature solid-state components. 168p. 77i List \$8.95
 671-ELECTRICAL WIRING & LIGHTING FOR HOME & OFFICE. Do complete home or office wiring jobs, incl. illumination systems. 204p. 155i List \$7.95
 672-UNDERSTANDING & USING THE VOM & EVM. Modern guide to every possible application of the VOM. 192p. 187i List \$7.95
 676-SIMPLIFIED COMPUTER PROGRAMMING. Really makes programming Simple Stressors RPG System. 240p. 177i List \$8.95
 681-QUESTIONS & ANSWERS ABOUT TAPE RECORDING. Has ALL the answers, plus ALL the circuits, sketches, and wiring diagrams you'll ever need! Covers just about any problem you might encounter. 264p. 102i List \$8.95
 683-PICTORIAL GUIDE TO CB RADIO INSTALLATION & REPAIR. Step-by-step approach to installing CB and ham gear in home or car... how to reduce interference, tune the antenna, maintain equipment, etc. 256p. 300i List \$8.95
 701-FET LICENSE HANDBOOK. Covers all you need to pass the exam, including new audio & industrial exams. Includes replica test. 276p. 298i List \$8.95
 722-AMATEUR FM CONVERSION & CONSTRUCTION PROJECTS. Covers it all, from the simple to the complex. 276p. 187i List \$8.95
 715-406-p. DOUBLE SELECTION: Small Appliance Repair Guide. Shows how easy appliances are to repair if you know how they work... come apart... go back. 210p. 119i List \$7.95—Home Appliance Clinic. Meaty treasure-trove of hard-to-come-by info on wiring & appliance repair. 356p. 51i List \$7.95
 732-JAP CONSUMER ELECTRONICS SCHEMATIC/SELECTING MANUAL. Gold mine of 83 hard-to-find schematics, plus all the service data needed for radios, tape players, phonos, etc. 8 1/2 x 11". 196p. 240i List \$8.95
 812-RADIO CONTROL FOR MODELS. Most complete R/C handbook ever covers literally everything—planes, boats, cars, helicopters, tanks, etc. 350p. 417i List \$9.95
 821-TV TROUBLESHOOTER'S HANDBOOK. Quick-reference fingertip sourcebook for 100's of tried-and-tested solutions to "tough-dog" TV troubles. Thumb-indexed. Covers Admiral to Zenith. 448p. 300i List \$8.95
 300-BONUS BOOK IF YOU REMIT NOW! Dictionary of Electronics. Handy reference for all in electronics. Defines 1000's of terms. 420p. 487i List \$4.95
 TYPICAL CLUB SELECTIONS and List/Club prices: Master Handbook of 1001 Practical Electronic Circuits \$12.95/7.95—Microprocessor/Micro-programming Handbook \$9.95/5.95—OP AMP Circuit Design & Applications \$9.95/5.95—Electronic Music Circuit Guidebook \$9.95/5.95—Build Your Own Working Robot \$8.95/5.95—Introduction to Medical Electronics \$9.95/5.95—CB Radio Operators' Guide \$8.95/5.95—Microelectronics \$8.95/5.95—21 Simple Transistor Radios You Can Build \$6.95/3.95—Ham Radio Advanced Class License Study Guide \$8.95/4.95—Small-Screen TV Sizing Manual \$9.95/5.95—Aviation Electronics Handbook \$11.95/7.95—Practical CB Radio Troubleshooting/Repair \$8.95/5.95—Advanced Applications for Pocket Calculators \$8.95/5.95—Handbook of Multichannel Recording \$10.95/7.95—Radio Astronomy for the Amateur \$8.95/5.95

May we send you your choice of three of the practical, time-and-money-saving books on these pages as part of an unusual offer of a Trial Membership in Electronics Book Club?

Here are quality hardbound volumes, each especially designed to help you increase your know-how earning power, and enjoyment of electronics. These handsome, hardbound books are indicative of the many other fine offerings made to Members...important books to read and keep...volumes with your specialized interest in mind. Whatever your interest in electronics—radio and TV servicing, audio and hi-fi, industrial electronics, communications, broadcasting, electronics as a hobby—you will find Electronics Book Club will help you get the job you want, keep it, improve it or make your leisure hours more enjoyable. With the Club providing you with top quality books, you may broaden your knowledge and skills to build your income and increase your enjoyment of electronics too.

This Special Offer is just a sample of the help and generous savings the Club offers you. For here is a

Club devoted exclusively to seeking out only those titles of direct interest to you. Members are annually offered over 50 authoritative books on all phases of electronics.

This extraordinary offer is intended to prove to you, through your own experience, that these very real advantages can be yours...that it is possible to keep up with the literature published in your areas of interest...and to save substantially while so doing. As part of your Trial Membership, you need purchase as few as four books during the coming 12 months. You would probably buy at least this many anyway...without the savings offered through Club Membership.

To start your Membership on these attractive terms, simply fill out and mail the coupon today. You will receive the books of your choice for 10-day inspection. YOU NEED SEND NO MONEY! If you are not delighted, return them within 10 days and your Trial Membership will be cancelled without cost or obligation.

ELECTRONICS BOOK CLUB P.O. Box 10, Blue Ridge Summit, Pa. 17214

Facts About Club Membership

- The 3 introductory books of your choice carry publishers' retail prices of up to \$58.70. They are yours for only 99¢ each (plus postage and handling) with your Trial Membership.
- EXTRA BONUS! If you act now and send remittance with Membership Application, we will pay all shipping and handling on your introductory books, and you will also receive the \$4.95 paperback book "Dictionary of Electronics," giving you a total value of up to \$63.65.
- You will receive the Club News describing the current Selection, Alternates and other offerings, every 4 weeks (13 times a year).
- If you want the Selection, do nothing; it will be sent to you automatically. If you do not wish to receive the Selection, or if you want to order one of the many Alternates offered, you simply give instructions on the reply form (and in the envelope) provided, and return it to us by the date specified. This date allows you at least 10 days in which to return the form. If, because of late mail delivery, you do not have 10 days to make a decision and so receive an unwanted Selection, you may return it at Club expense.
- Personal service for your account—no computers used!
- To complete your Trial Membership, you need buy only four additional monthly selections or alternates during the next 12 months. You may cancel your Membership any time after you purchase these four books.
- All books—including the introductory Offer—are fully returnable after 10 days if you're not completely satisfied.
- All books are offered at low Member prices plus a small postage and handling charge. Prepaid orders shipped postpaid.
- Continuing Bonus: If you continue after this Trial Membership, you will earn a Dividend Certificate for every book you purchase. These Certificates, plus payment of the nominal sum of \$1.99, will entitle you to a valuable Book Dividend of your choice which you may choose from a list provided Members.

ELECTRONICS BOOK CLUB

P.O. Box 10
Blue Ridge Summit, Pa., 17214

- Please send the 3 books circled below and invoice me.
- My remittance is enclosed. Send me the 3 books circled plus "Dictionary of Electronics."

Please open my Trial Membership in ELECTRONICS BOOK CLUB as I have indicated above. I understand the cost of the books I have selected is only 99¢ each, plus a small shipping charge. If not delighted, I may return the books within 10 days and owe nothing, and have my Trial Membership cancelled. I agree to purchase at least four additional books during the next 12 months, after which I may cancel my membership at any time.

101	487	510	563	582	586
640	667	671	672	676	681
701	715	722	732	812	821

Name _____ Phone _____

Address _____

City _____

State _____ Zip _____

(Foreign and Canada add 10%) EE-56

HEY, LOOK ME OVER



punch it out with *heliwhip*

Complete Antenna Assemblies by **ANIXTER-MARK**

The exclusive Heliwhip antenna concentrates your signal close to the ground, punches your signal stronger, truer, expands your transmitting and receiving range. Tough molded fiberglass construction is wrapped in a strong dielectric plastic to knock out static precipitation. Anixter-Mark Heliwhip Antenna Assemblies at CB dealers and truckstops nationwide.

Mark IV Heliwhip Co-Phase
Two heavy duty 4' Heliwhips, two mirror mounts and phasing harness. Complete pre-tuned assemblies.

Mark III Heliwhip Co-Phase
Heliwhip light duty antenna, cable harness & mounts for mirror, gutter, trunk groove or lid.
Marine CB Heliwhip Assembly
6' Heliwhip, impedance launcher-matcher coax and mount for fiberglass, wood, metal plate or mast.

FIXED STATION ANTENNAS

Mark V Advanced Design
Antenna for heavy-duty commercial use. Lowest VSWR over the greatest bandwidth.

Mark II "Super Beacon"
Antenna stops precipitation static; improves signal to noise ratio.

Mark CBB-1 "Beacon"
Antenna two section aluminum radiator insulated and supported by strong molded fiberglass section. Mounts easily.

Complete Antenna Accessories
A wide choice of mounts, cable assemblies, harnesses and other accessories.

ANIXTER-MARK

Originators of the Heliwhip Antenna
5439 W. Fargo, Skokie, IL 60076 / (312) 675-1500

CIRCLE 5 ON READER SERVICE COUPON

switch; pushbutton automatic noise limiter; pushbutton CB-PA switch; sensitive dual conversion superheterodyne receiver; tuned RF stage; ANL (automatic noise limiting); three ceramic IF filters; fully-variable squelch control; external speaker jack; full-sized, plug-in microphone; relay switching system; and high RF output power. Sells for \$159.95. For further information on the 1-601 and other Royce CB products, write to Royce Electronics Corporation, 1746 Levee Road, North Kansas City, MO 64116.

Electronic Digital Rain Gauge

Here's a boon for gardening hobbyists, farmers, homeowners, and weather buffs—a remote-reading electronic digital rain gauge that empties itself. To know whether your plants, shrubs, lawn, and garden are getting an adequate water supply, just read the digital counter that you've mounted indoors. It accurately records rainfall up to 100 feet away, by tenths of an inch, to 999.9 inches. The Rain Gauge measures the accumulated total number of inches of



CIRCLE 55 ON READER SERVICE COUPON

rainfall for any period you choose: an hour, a day, a week, etc. You can reset the counter instantly with the push of a button, to start a new counting period. You never need to empty or check the hermetically-sealed outdoor collector. The collector is easily mounted on a fence, roof, deck, patio—anywhere up to 100 feet away—with two ordinary screws. Waterproof wire (30 feet) is included. Unit runs on a 9-VDC transistor battery (not included) which has a minimum of one year's life. Priced at \$44.95 post-paid. The Electronic Digital Rain Gauge (No. 72,165) is available by mail from Edmund Scientific Co., 380 Edscorp Bldg., Barrington, NJ 08007. As with everything Edmund sells, it carries a 30-day money-back guarantee.

Modular Security System

The new Heathkit GD-1158 modular security system protects your home or office from intruders and/or from fire for a fraction of what a professionally installed system would cost. The modular design lets you customize the security system to meet your needs and budget. Installation is as easy as plug-

ging the modules into an AC wall outlet, since they are interconnected through your regular house wiring system. Electrical signals between the units are frequency modulated (FM) to prevent line noise from accidentally triggering the alarm. This modular wireless design makes it extremely easy to move or expand the system. The "brain" of the system, the Central Processor (GDA-1158-1, \$159.95), is divided into two sections. The emergency section responds instantly to signals from heat or fire detectors or from the Emergency Transmitter Module. For convenience,



CIRCLE 31 ON READER SERVICE COUPON

the separate intrusion section has a time delay which allows you to enter or leave the protected area without triggering the alarm. Whenever the Central Processor receives a signal from one of the transmitter modules, the alarm sounds through the Central Processor's built-in speaker or optional high-output, indoor/outdoor speaker (GDA-1158-2, \$19.95). Like many professional systems, the alarm automatically resets itself within two minutes after the cause of the alarm has been removed. Finally, to prevent tampering and to warn you if the system becomes inoperative, the alarm automatically sounds whenever the Central Processor loses AC power. Other available units are: On/Off Transmitter Module (GDA-1158-3, \$29.95), Ultrasonic Detector Module (GDA-1158-2, \$74.95), Auxiliary Transmitter Module (GDA-1158-6, \$39.95), and Emergency Transmitter Module (GDA-1158-4, \$29.95). All GD-1158 modules are sold separately and are available from The Heath Company, Benton Harbor, MI 49022.

Direct-Drive Turntable

Sansui Electronics Corporation has added a new direct-drive electronic transcription turntable, Model SR 525, to their line. This manual, single-record-playing transcription turntable is driven by a 20-pole, 30-slot, DC brushless motor. The motor has direct spindle drive, and is servo-controlled electronically. The platter has a diameter of 12¼ inches, is aluminum die-cast, and weighs

(Continued on page 10)



state-of-the-art in receiver design ...

**engineer's
triumph...
operator's
dream.**

Improving what is already the best is the ultimate challenge for the engineer. And the ultimate reward for the discerning CB operator. In the new Messenger 323A you can experience the incredible interference rejection of the only *dual cascaded crystal filtering system available in any CB radio*. Plus the exceptional noise rejection of both an efficient RF-type noise blanker and a new fully-automatic noise limiter system that adjusts itself for the cleanest, clearest reception possible. Equally important are the features we *didn't change* — the large, easy-to-read meter, easy-to-handle control knobs, built-in electronic speech compression, P.A. function, and rugged steel cabinetry. It's the dream rig you can own for \$249.95.



JOHNSON

E. F. Johnson Company, Waseca, Minn. 56093

In Canada: A.C. Simmonds & Sons, Ltd.

CIRCLE 33 ON READER SERVICE COUPON

avanti's CB mobile antennas

offer:

- Quality construction
- Long range
- Mounting versatility

This is the Avanti Racer 27 mobile antenna. A first quality instrument, it is one of the most popular antennas in the entire CB field. That's because experienced CBers appreciate the benefits of a good, dependable long-range antenna that offers quiet performance.

The Racer 27 is readily adaptable to a wide variety of mounting assemblies:

- a fold-over mount for campers and vans
- a no-hole trunk mount (no drilling into your car)
- a mirror bracket mount for trucks
- a dual assembly for increased performance on all vehicles
- Avanti makes the famous MOONRAKER CB BASE ANTENNA

The Racer 27 is Avanti Model AV-327. Suggested retail \$23.95

This is only one of many Avanti antennas for car, boat or home. Send today for FREE full-color catalog.

avanti
RESEARCH AND DEVELOPMENT, INC.
340 Stewart Ave., Addison, Illinois 60101
CIRCLE 23 ON READER SERVICE COUPON



HEY, LOOK ME OVER



CIRCLE 52 ON READER SERVICE COUPON

3.1 pounds. The flywheel effect of this mass, in conjunction with a control servomotor with a saturable core, has resulted in one of the quietest, and the most accurately speed-maintained direct-drive systems ever introduced to the industry. Wow and flutter are down to a negligible 0.03 percent. This two-speed transcription turntable, working at either 33 $\frac{1}{3}$ or 45 rpm, has an electronic speed-change with a fine adjustment for both speeds. Speed control is aided with the help of an illuminated stroboscope with markings on the platter periphery. The SR 525 sells for \$279.95. For further information, write to Sansui Electronics Corporation, 55-11 Queens Blvd., Woodside, NY 11377.

Quickie Audio Generator

Pushbutton operation for easy switching of frequency ranges along with built-in solid state circuitry to hold distortion down to 0.1% are among the features of the Leader LAG-120 sine/square audio generator. The LAG-120, which is said to be an aid for quick, accurate testing of sensitive high fidelity equipment and products, generates a wide range of sine and square waves from 10Hz to 1MHz. It offers external triggering through the use of the built-in trigger terminals and has a switchable output generator which ranges from 0 to 20 dB continuously variable with frequency accuracy at $\pm 3\%$ ($\pm 1\text{Hz}$). Input impedance is $K\Omega$ while the synchronization range is $\pm 1\%$ per Volt. Compact, portable, and lightweight, the LAG-120 offers 115/230V power supply, 50/60Hz, and approximately 12VA. Size is 5 $\frac{1}{2}$ -in. H x 5-3/16-in. W x 9-13/16-in. D and it



CIRCLE 51 ON READER SERVICE COUPON

weighs approximately 6.5 pounds. It is priced at \$219.95. Available from Leader Instrument Corp., 151 Dupont Street, Plainview, NY 11803.

Cordless Soldering Iron Kit

Weller introduces the "go-anywhere" 11-piece soldering iron kit. Why a go-anywhere soldering iron? Either for those repair situations when house current isn't handy—a leaky seam on a roadside mailbox, the wiring of an outboard motor, a patio light fixture—or for whenever it's just plain easier to take the self-contained kit to the scene of repair, at home or



CIRCLE 57 ON READER SERVICE COUPON

away from home. The portable kit includes the cordless iron and standard AC power outlet charger, three different tips, screwdriver, solder, soldering aid tool, sponge, instruction booklet, and a plastic carrying case with tool tray. The 5 $\frac{3}{4}$ ounce iron, with fingertip control and a safety lock to prevent accidental discharge of the batteries, heats in six seconds and develops a constant tip temperature of 700-degrees F. It features long-life, rechargeable nicad batteries and a built-in work light. Available at hardware and home centers. Suggested retail price is \$29.95. For literature, write to Weller-Xcelite Electronics Div., The Cooper Group, P.O. Box 728, Apex, NC 27502.

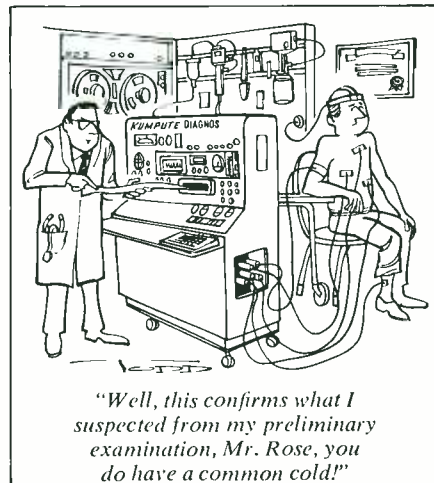

"Well, this confirms what I suspected from my preliminary examination, Mr. Rose, you do have a common cold!"

Move up to Teaberry the Quality CB People



TEABERRY ELECTRONICS CORPORATION Indianapolis, Indiana 46218
CIRCLE 24 ON READER SERVICE COUPON

Electronics Enthusiasts Enlist!

There's an army of people, young and old, who get a kick out of old-time radio. You too can re-live those exciting days. Our books give you many fascinating time-trips, and we introduce you to the rewards of collecting classic radio sets.



VINTAGE RADIO, 1887-1929. Pioneer days. 1,000 photos, 263 pages, \$7.95 hard-cover, \$5.95 soft.

RADIO COLLECTOR'S GUIDE, 1921-32: Data book, 50,000 facts, 9,000 models, 264 pages. Only \$4.95.



A FLICK OF THE SWITCH, 1930-50: Ham, home, military, professional radio-TV, 312 pages, 1,000 photos, \$9.95 hard-cover, \$6.95 soft.

1926-38 RADIO DIAGRAMS book covers 600 most-often-needed sets in 240 pages. Beitman's classic, \$7.00.



RADIO ENCYCLOPEDIA: Beautiful re-creation of Gernsback's 1927 classic, 175 pages. \$12.95 hard-cover, \$9.95 soft.

SPECIAL! ALL five books \$39.50 deluxe, \$32.50 standard.
NEW! Set of four "Progress in Electronics" STAMP PRINTS for framing, \$7.50; plaques \$18.50.
SCHEMATIC: Any pre-1951 radio \$3.50.

SEND TODAY to Vintage Radio, Dep't. E, Box 2045, Palos Verdes, CA, 90274. We pay postage. Calif. residents add 6%.

_____ \$
 _____ \$
 _____ \$
 _____ \$
 Total \$ _____

Name _____
 Street _____
 City _____ St. _____ Zip _____

Beat Our July Price Increase!

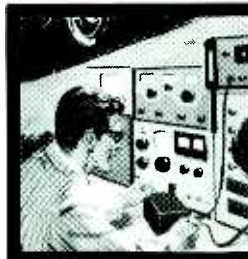

Ask Hank, He Knows!

Got a question or a problem with a project—ask Hank! Please remember that Hank's column is limited to answering specific electronic project questions that you send to him. Personal replies cannot be made. Sorry, he isn't offering a circuit design service. Write to:

**Hank Scott, Workshop Editor
 ELEMENTARY ELECTRONICS
 229 Park Avenue South
 New York, NY 10003**

Donald Duck Strikes Again

My Realistic DX-150 shortwave receiver pulls in the international stations, but when it comes to the amateur stations it's another story. The fine tuner does a good job separating them and I get good volume. The problem is the conversation sounds "mushy" and unintelligible. What causes this?

—C. S., Decatur, IL

The Donald Duck talk you hear is SSB. Read up on SSB!

To Kill a Mistruth

My buddy tells me I can vary the length of coax to my antenna to reduce VSWR. Is this true?

—D. M., Niantic, CT

Heck no! Most VSWR meters sample the RF voltage with a simple bridge circuit and because voltage peaks vary along the line, a point can be selected that will be less than maximum. The variation indication serves its purpose. A true peak power reading instrument such as a Bird Model 94 or Sierra RF watt-meters will give the same reading anywhere on the line. Varying the antenna coax line will not vary the readings of these more expensive meters.

Way Out Crystal

I am fixing a device that requires a 4561.920 kHz series resonant crystal. Where can I get one?

—K. M., Libertyville, IL

Write to International Crystal Manufacturing Co., Inc., 10 N. Lee, Oklahoma City, OK 73102 and tell them as much about the equipment and crystal as you can get from the nameplates. They haven't failed me yet!

Best Seller in Florida

I moved to Florida from Pennsylvania and can't find COMMUNICATIONS WORLD on the newsstand down here. Why?

—R. R., St. Augustine, FL

Because a fellow Floridian is faster than you are. When you can't get a copy of COMMUNICATIONS WORLD locally, send a check or money order for \$1.35 plus 25¢ for handling to 229 Park Avenue South, New York, NY 10003 and tell us what you want.

From the Horse's Mouth

Hank, how can I get information on books published by the U.S. Government?

—J. W., Dickinson, ND

Write a letter to the Superintendent of Documents, U.S. Government Printing Office, Washington, DC 20402. Ask them

to send to you information on new U.S. Government publications. You'll find that the few publications that may interest you will be inexpensive and worthwhile reading.

Square Noise

While working on a simple alternate blinker, using 2 transistors, 2 LEDs, and a few resistors and capacitors, I decided to listen to my TV set. I was amazed that this tiny circuit would cause a jamming signal which would blank the TV's video and sound. How come?

—C. V., Bronx, NY

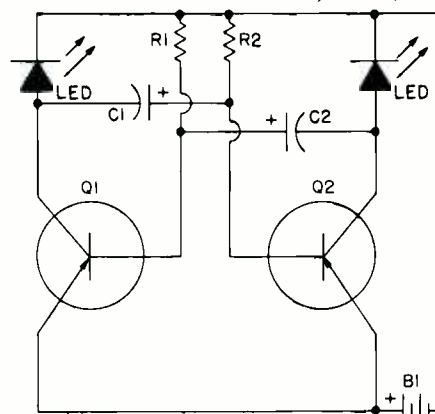

The diagram you sent shows a simple transistorized free-running multivibrator with LEDs in the collector circuits. This circuit is simply a square-wave switching circuit which can generate a lot of RF noise. Place the circuit in a metal box and use coax cable for the antenna lead-in.

MD Hamfest

The Maryland Mobileers Amateur Radio Club would appreciate early publication notice of its Sixth Annual Hamfest to be held on Sunday, June 13, 1976 at Anne Arundel Community College, Arnold, Maryland. Gates open at 9 A.M. Registration: \$2.00. Tailgaters: \$3.00 plus registration fee. Drawings to be held at 3 P.M.: First prize—\$200 Savings Bond, Second prize—\$50 Savings Bond, Third prize—\$25 Savings Bond. Talk-ins on 146.10/70—146.52—146.16/76. Thanks!

—WA3WAN, Millersville, MD

You got it!

Please Ease Off, Fellows

Hank, you didn't answer my last two letters. Everything okay with you?

—D. N., Waverly, TN

Yes, except no one listens to me! I can
 (Continued on page 14)

"Breaker . . . Breaker . . ."

Break-through with BREAKER!

The New Freedom Line of CB Mobile and Base Antennas and Accessories made in the U.S.A. for communications between people.

A wide selection of "revolutionary" new CB High Efficiency communications antennas of superior strength, electronically and physically, for all the talk power your CB rig will deliver—coming and going in the 27 Megahertz frequency band.

Mobile Breaker antennas for cars, trucks, trailers, sports cars, station wagons, motorcycles, boats. Breaker base station antennas to communicate with mobiles and hand helds . . . all designed specifically for the outstanding transmission and reception of CB signals.

The high quality and materials of the Breaker CB antennas and accessories assure you the maximum in performance for many years and at reasonable cost. Performance-tested Breaker CB antennas offer you these advantages plus more:

- ★ Easily adjust for lowest VSWR
- ★ Long-life stainless steel and fiberglass whips
- ★ Highest quality coaxial cable with solderless connections
- ★ Innovative engineering designs
- ★ Packaged for quick, easy installation to get you on the air fast, complete with cables and hardware

All Breaker antennas are American made in Arlington, Texas. In keeping with the tradition of the Bi-Centennial they are proudly named after our revolutionary heroes and places. Red, white and blue are also the colors of Breaker. Chosen because we too are very proud of our heritage and contribution to making exciting products for use by people communicating with people. See and buy the Freedom line of Breaker antennas and accessories at your nearest electronic distributor. Look for the red, white and blue packaging.

WRITE FOR FREE CATALOG.
CIRCLE 41 ON READER SERVICE COUPON

GEORGE WASHINGTON

West Coast Mirror Mount
Dual Truck, RV Antennas
Model 10-200

Weather resistant dual 57" stainless steel whip antennas with static arrestor tips. Secure horizontal or vertical mounting to West Coast side view truck type mirrors. Twin antennas co-phased for more directional power and easily adjustable for fine tuning. Hermetically sealed, white oversized ABS center load. Dual 18' low-loss coaxial phasing harnesses with solderless connectors and quick disconnect PL-259 plugs. Complete with corrosion resistant mounting hardware.

INDEPENDENCE

Gutter Mount Antenna
Model 10-245

Low-profile 21" stainless steel whip antenna with static arrestor and flex-matic shock spring. Fits practically any vehicle rain gutter. No interference with door opening or passenger exit. Heavy-duty molded clamp bracket insulates and supports antenna. Center loaded ABS load coil for excellent transmission and reception. 14' coaxial cable with solderless connector and quick-disconnect PL-259 plug. Complete with corrosion resistant mounting hardware.

PAUL REVERE

Roof Mount Antenna
Model 10-215

Special "power-plus" 42" base-loaded roof mount with long-life stainless steel whip, rugged stainless steel shock spring and high-quality 16-ft. shielded coax cable and solderless connections for fast "on-the-air" installation. Named after the famed communicator and hero of revolutionary era.

THE PATRIOT

Omni-directional
¼-Wave Base Antenna
Model 11-101

High in quality, performance and efficiency, low in cost. Has three 708" quarter wave tubular aluminum radials plus a quarter-wave radiator (vertical element). Heavy-duty U-clamp fits mast up to 1½" diameter. Built-in lightning protector. SO-239 style connector mount. Mates with PL-259 plug. Shunt loaded coil. Heavy duty insulated molded clamp bracket. Easy to assemble and dis-assemble. Fixed construction.

THE MINUTEMAN

Trunk Mount Antenna Model 10-230

Sturdy, durable, no-hole required in trunk of vehicle. Super 44" stainless steel whip, base loaded low-profile antenna with stainless shock absorbing spring, chrome plated brass bell housing, 78-foot shielded coaxial cable and solderless connections.

"Just say it with Breaker!"

BREAKER
CORPORATION

1101 Great Southwest Parkway
Arlington, Texas 76011

ASK HANK, HE KNOWS!

(Continued from page 12)

not answer letters. I can only read them and answer only those which are typical of many received in my column. So please, don't send stamped, self-addressed envelopes or postcards. There are not enough hours in the day to answer all my readers' letters personally.

Pumps RF Also

My 1974 Vega has an electric fuel pump that makes about an S9 racket in my CB

set. The pump is located inside the fuel tank so I assume it uses an oscillator in place of an interrupted contact to drive it. I have tried all the usual types of filters and bypass cures, but to no avail. I also contacted General Motors Service and got nothing there except a large telephone bill. Can you help?

—R. L., Lowell, IN

The trouble may be your antenna coax line. Check it very carefully. The fuel pump lines pass through the trunk. As a quick check, turn on your direction lights. If you hear the clicking, your antenna line is defective. Otherwise, you may have to

take the CB power line directly to the battery instead of the accessory power line. Can anyone else suggest a remedy?

That's What White's Is For

I am a BCB DXer and would like to find out the exact frequency and watts output of my logged BCB stations. Where can I find this information?

—D. C., Parma, OH

Pick up a copy of our semiannual publication COMMUNICATIONS WORLD which contains White's Radio Log. The Log lists all of the U.S. and Canadian BCB stations by frequency, city, and call sign. It's only \$1.35 plus 25¢ for handling if you want us to mail it to you.

The Earth Is Round

The indoor FM antenna which came with my Marantz Model 2015 receiver does not pull in distant stations. What type of antenna do I need in order to pick up FM stations 250 to 300 miles away?

—J. S., Mathis, TX

The same antenna will do the job if you string it from a Goodyear blimp. Or is Goodrich? (Maybe they'll send a set of tires). Joking aside, 300 mile FM reception is out of the question. Maybe a tower will help, but before you send cash, find out if anyone has been successful receiving distant stations and copy their antenna setup.

BBC Boosts CW

While tuned to the BBC, I heard on "Radio Club, World Service," 0815 GMT, 23 November 1975 on the 19-meter band your COMMUNICATIONS WORLD magazine described as "the best they've ever seen."

—R. L., Asaba, Nigeria

Thanks for relaying the BBC compliment. Your letter was one of many that came to this office from around the world. Thanks for writing.

It's a Lot of Noise

I would like to know if you could advise me on a filter for the reverb for my stereo system. As I increase reverberation, both distortion and hiss increase.

—J. P., West Allis, WI

Reverberation is distortion and the transducer that picks up the reverb introduces hiss. If you want reverb, then you'll have to live with the distortion. Reduce hiss by turning down the set's treble control.

CB Hook-Up

My CB is hooked up to the cigar lighter and I get a lot of interference when I start my motor. What kind of filter can I use?

—W. L., Indianapolis, IN

You are probably using the cigar lighter because you want to disconnect and remove the CB rig when you leave the car. I suggest you set up a disconnect plug and jack that come off the car's accessories line. This way, when the car is started, the CB receives no power. It's best this way because the starter motor causes severe voltage transients that cannot be filtered. Also, these voltage transients may damage your CB rig.

(Continued on page 20)

GOLD LINE CB ACCESSORIES

ANTENNA MATCHER



GLC 1044 \$9.99
250 Watts 13-78 MHz

Gives a perfect VSWR match for full power every time. Stops power loss, quick and easy to install.

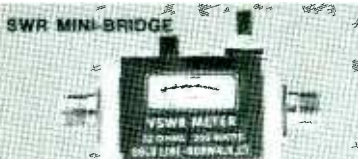

GLC 1048A \$15.99

- Perfect for extra mobile applications
- Very simple meter reading
- No special instructions

WATTMETERS

1000 WATT INLINE WATTMETERS

Gold Line 1000 Watt wattmeters provide all you need to get the most out of your transmitter. Absorbing negligible power, these inline units will continuously monitor adjusted power.

- 1000 Watts continuous
- Hardcase vinyl case
- 3 Scales: 0-10, 0-100, 0-1000 Watts
- VSWR Function
- 50 Ohm Impedance

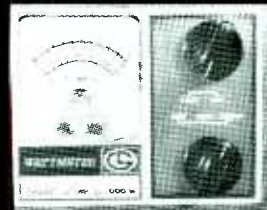

GLC 1091 \$43.91



GLC 1061 \$16.49

Dual range 0-5 Watts, 0-50 Watts, 0-30 MHz

COAXIAL SWITCHES

GLC 1048 \$6.59

2 Position
Rated at 1 KW AM
or 2 KW PEP for SSB

GLC 1070 \$7.95

5 Position
Rated at 1 KW AM
or 2 KW PEP for SSB

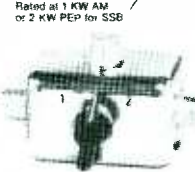

EXTRA LONG — HEAVY DUTY RETRACTABLE CABLES

Rugged cables for microphone or telephone, 18' retracted, full 90' extended — stranded center conductors, tough PVC jackets — 6' tail on each end.

PART NO.	# OF COND.	WIRE GAUGE	O.D.	PRICE
308	3	23	250 1 shielded	\$4.59
309	4	23	240 0 shielded	4.99
310	5	20	180 1 shielded	6.08

FREE! New how to use CB accessories brochure. It includes tips on soldering, Schematics and other valuable information. Available only at your Gold Line dealer or distributor.

Dealers and Distributors - Write for details.

GOLD LINE Your Accessory Power House

25 Van Zant St., E. Norwalk, Conn 06855 Phone 203/838-6551

INTERNATIONAL DIVISION, 2200 SHAMES DRIVE, WESTBURY, N.Y. 11590
CABLE—CHURCHIN WESTBURY, N.Y. TELEX—0961474

CIRCLE 11 ON READER SERVICE COUPON

Experience is the best teacher. You might settle for any CB first time around. Understandably. A lot of people think they're all pretty much alike. But you'll soon discover that, like everything else, there are exceptions.

Ask the pros. America's long distance truckers. These guys talk CB day in and day out. And they demand the best. That's why truckers refer to the Cobra 29 as "The Diesel Mobile."

Listen to Cobra. You'll hear a big difference. Because the Cobra 29 gives you features which assure crystal clear reception. Like switchable noise limiting and blanking, to cut out practically all pulse and ignition interference. Add squelch control and RF gain and you've got exceptional—adjustable—receiver clarity. Even in the heaviest CB traffic. You also get Delta Tuning which makes up for the other guy, because even off-frequency transmitters are pulled in. Perfectly.

Talk to Cobra. And you know you're punching through. One glance at the

29's over-sized illuminated meter tells you just how much power you're punching out and pulling in. For voice modulation the DynaMike delivers at 100%. Same way with power: The 29 transmits at maximum power levels.

Sooner or later you'll get a Cobra. And you'll get engineering and craftsmanship second to none. Performance that will make your first CB seem obsolete. Reliability and durability that have set standards for the industry. Above all, you'll get power. The power to punch through loud and clear like nothing else. Because when it comes to CB radio, nothing punches through loud and clear like a Cobra.



Punches through loud and clear.

Cobra Communications, Products of Dynascan Corp.
1801 W. Belle Plaine, Chicago, Illinois 60613

CIRCLE 26 ON READER SERVICE COUPON

IF YOUR FIRST CB ISN'T A COBRA YOUR SECOND ONE WILL BE.



Four different schools give you this 25" DIAGONAL hobby-kit Color TV...

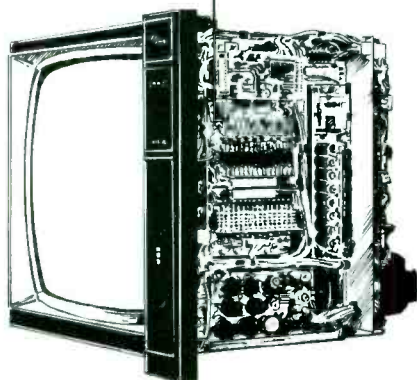

No other home training school gives you both an exclusive solid state color TV and an SQ® Quadraphonic Receiver complete with four speakers . . . all in one course. You get both for less than the tuition cost of TV or Audio alone from the next leading school. And only NRI's Master Course in Color TV/Audio servicing lets you train on equipment designed specifically for training with exclusive "power-on" features.

NRI doesn't give you hobby kits or commercial sub-assemblies. We invested the time and money to design equipment with learning in mind.

It's the only way you can (1) get the feel of typical commercial circuitry, (2) learn bench techniques while building complete units from the "ground" up, (3) perform over 35 "in-set" experiments during construction, and (4) end up with a 25" diagonal solid-state color TV with console cabinet and a 4-channel quadraphonic Audio Center.

NRI passes the savings on to you

NRI can save you money because our engineering eliminates the cost of buying from an outside source. We pay no salesman's commission. Students are enrolled by mail only. The savings are passed on to you in the form of low tuition fees, extras like the TV's console cabinet and the four speaker Quad System; a 5" triggered sweep

Only NRI gives you this 25" DIAGONAL designed-for-learning Color TV...

oscilloscope, CMOS digital frequency counter, and an integrated circuit color TV pattern generator. Where NRI supplies a professional color

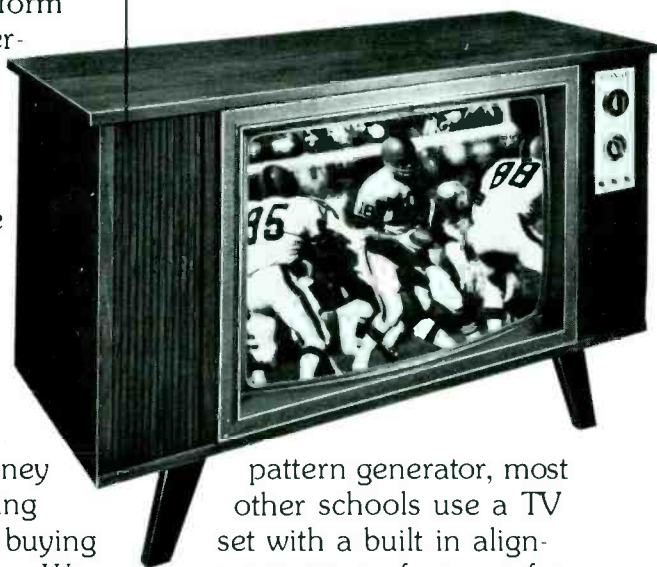

pattern generator, most other schools use a TV set with a built in alignment generator of no use for servicing other sets. Only NRI designs, engineers, and supplies training kits specifically for learning and professional use. You can pay hundreds of dollars more for a similar course and not get a nickel's worth more in training and equipment.

...plus complete Quadraphonic Audio Center!

More know-how per dollar

That's what it all boils down to, the quality of training you get for the money you spend. In our 62-year history, more than a million students have come to NRI and we're fully approved for career study under the G.I. Bill. We must be teaching something right.

Some of those "right" things are bite-size lessons to ease understanding and speed learning . . . personal grading of all tests, with comments or explanations where needed . . . a full-time staff of engineer/instructors to help if you need it . . . plenty of kits and experiments to give you hands-on training . . . and fully professional

programs oriented to full or part-time career needs.

Widest Choice of Courses with CB, Digital Computer, and other career opportunities

NRI offers not one, but five excellent TV/Audio servicing courses so you can tailor your training to your budget.

Or you can study other opportunity fields like Digital Computer Electronics, Citizens Band Radio, Communications, Aircraft or Marine Electronics, Mobile Radio, and more. Send

for our free catalog and see for yourself that no one gives you more training and equipment for your dollar. There's no obligation, and no salesman will call.

If card is missing, write to:



NRI SCHOOLS
McGraw-Hill Continuing
Education Center
3939 Wisconsin Avenue,
Washington, D.C. 20016

6-056



number one cb antennas by a country mile!

One reason why Antenna Specialists' CB antennas are the world's most popular is that it doesn't take a mechanic and three engineers to install 'em.

Our model M-176 Quick Grip®, for instance. Solderless connections. No holes to drill. Clamps to your trunk lid in seconds, yet it's a clean permanent installation with cable completely concealed.

And if you don't have a trunk, there are other A/S models equally simple to install for every vehicle known to man.

... all with the same highest quality components and workmanship that insure maximum range and long life.

**the antenna
specialists co.**



© "Stripes of Quality"

a member of The Allen Group Inc.
12435 Euclid Ave., Cleveland, Ohio 44106
Export: 2200 Shames Drive, Westbury, L.I., N.Y. 11590
Canada: A.C. Simmonds & Sons, Ltd.

**"look for the
stripes of quality"**



ASK HANK, HE KNOWS!

(Continued from page 14)

Sunk

I have a Lafayette Micro-66 CB rig and I live in a canyon and can't get my signal out. What do you suggest?

—B. H., Goleta, CA

Start a landfill project. Or maybe a 60-foot tower would help.

Class A CB Rates an F

What is UHF-CB? A local oil company has a set-up and won't tell me anything.

—G. W., Reidsville, NC

UHF-CB is actually Class A CB. You can read about it in Part 95 of the CB Rules and Regulations. Class A CB is expensive and has difficult licensing conditions. If you want to hobby on UHF, go ham. If you want UHF for business, go business band.

Kids Go CB

Do you have to be 18 or older to operate a CB? I'm 15 years old now, do I have to wait three years?

—G. R., Marietta, OH

You cannot apply for a CB license until you are 18 years old, but your father or other member of your family can apply for a license. Once obtained, anyone in your household can operate CB.

CB PowerMate Corrections

Where can I get the NE550 for the CB Powermate project? Also, are there any corrections or additions I should know about?

—C. B., New York, NY

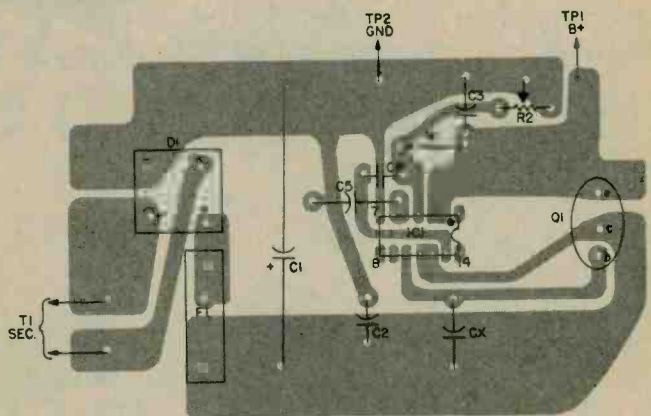

In the January/February issue of ELEMENTARY ELECTRONICS we listed an incorrect source for the integrated circuit voltage regulator. The company which makes IC1, a NE550 (DIP package) is Hamilton Avnet, 364 Brookes Drive, Hazelwood, MO 63042. Connections for the IC shown in the layout on page 52 should be corrected by reversing the positions of pins 7 and 1. The lower of the two C4 designations should be changed to Cx. Also, add a jumper between pin 4 of the IC and the junction of R1 and R2. Add C5, a 0.001 50-V capacitor between GND and pins 5 and 6 of the IC. On the schematic, C2 should be shown as it is in the Parts List, as 0.22 uF.

(Continued on page 40)

Poly Pak's

100'S OF BARRELS PURCHASED!
BUY 'EM FROM THE "BARREL" AND SAVE!

Your choice of any kit

\$1.98

EXCLUSIVE 'BARREL'

THE BIGGEST INFLATION-FIGHTING VALUE EVER!

TEST 'EM YOURSELF 'N SAVE!
Every kit carries money back guarantee.

For the first time anywhere, Poly Pak merchandisers introduce a new way in buying the economical way. Raw stock from the "barrel". Remember

the "good ole days"? They're back again. The same way merchandisers throughout the United States buy from various factories... their overruns in barrels. Poly Pak has done the same. Therefore you are getting the same type of material as the RE-TESTERS DO!

BARREL KIT #1 SN7400 DIP IC'S 75 for \$1.98 Marked 14 and/or with 16 pin dips, may include factory registers, flip flops, counters. Who knows! GUARANTEED SATISFACTION! Cat.No. SL2415 Untested.	BARREL KIT #2 LINEAR OP AMPS DIPS 75 for \$1.98 Un tested May include 709's, 741's, 703's, 680 series. 856 includes diodes marked and unmarked. Cat.No. SL2416	BARREL KIT #3 1N4148/914 SWITCHING DIODES 100 for \$1.98 You never saw this before. Imagine famous switching diodes at these prices! Cat.No. SL2418 Untested.	BARREL KIT #4 "4000" RECTIFIERS 100 for \$1.98 Untested. These are the famous micro miniature rectifiers of the 1N4000 series. May include 25, 60, 100, 200, 400, 600, 800 and 1000 volters. Cat.No. SL2417	BARREL KIT #5 SCRS, TRIACS, QUADRACS 40 for \$1.98 All the famous plastic power-erb type. Raw factory stock! All the 10 amp types. Cat.No. SL2419 Untested.	BARREL KIT #7 VOLUME CONTROL BONANZAI! 40 for \$1.98 100% good Singles, duals, variety of values, styles, big ones — small ones. Cat.No. SL2421	BARREL KIT #8 SUBMINIATURE IF TRANSFORMERS 100 for \$1.98 Amazing, includes 45k5ca, osc, antenna, who knows! From transistor radio manufacturers. Cat.No. SL2422
BARREL KIT #10 ROMS-REGISTERS 50 for \$1.98 Untested 28 to 40 pin devices, marked, internal factory numbers. to Cat.No. SL2424	BARREL KIT #12 POWER TAB TRANSISTORS 40 for \$1.98 PNP, plastic 10220 type, marked 2N numbers. Cat.No. SL2426 Untested.	BARREL KIT #13 RESISTOR NETWORKS 60 for \$1.98 Untested. By Corning Glass, in 14-pin dip paks. Cat.No. SL2427	BARREL KIT #14 PRECISION RESISTORS 200 for \$1.98 Cat.No. SL2428 Marked and unmarked 1/4, 1/2, 2 watts.	BARREL KIT #15 MOSFET TRANSISTORS 60 for \$1.98 All 4 leaders, TO-18 case, includes UIIP transistors too! Cat.No. SL2429	BARREL KIT #17 LINEAR & 7400 DIPS 100 for \$1.98 Untested Marked and unmarked, internal numbers of raw factory stock. Cat.No. SL2431	BARREL KIT #18 ZENER-RECTIFIER MIX 200 for \$1.98 Subminiature, DOT's, includes asst. zeners and rectifiers. It's mixed at the factory, we cannot separate. Cat.No. SL2432 Untested.
BARREL KIT #19 DIPPED MYLARS 60 for \$1.98 Finest capacitors made, shiny finish, imagine factory dumping 'em in barrels. Cat.No. SL2597 100% good.	BARREL KIT #20 LONG LEAD DISCS 150 for \$1.98 Factory distributor stock "auction sale". Prime, marked only. Long leads. Cat.No. SL2598 100% good.	BARREL KIT #25 METAL CAN TRANSISTORS 100 for \$1.98 Untested. Includes TO-8, TO-18, etc., assorted 2N numbers, unmarked etc. Cat.No. SL2603	BARREL KIT #24 HIGH VOLTAGE TRANSISTORS 160 for \$1.98 Untested. Up to 12,000 volts, 4 mila, epoxy, axial leads. Cat.No. SL2602	BARREL KIT #26 TRANSISTORS 100 for \$1.98 Untested. Type TO-92 (TO-18), all manufacturers, variety of 2N's. Cat.No. SL2604	BARREL KIT #28 CERAMIC CAPACITORS 200 for \$1.98 Not only do the barrels contain dogbones, but factory dumped, Erie Central-lab, molded types too! Cat.No. SL2606 100% good.	BARREL KIT #29 VITAMIN Q CAPS 75 for \$1.98 100% good. Every type of oil-impregnated caps, some worth \$2. It's the "ole barrel" sale gives you the bargain-of-a-lifetime. Cat.No. SL2607
BARREL KIT #30 PREFORMED RESISTORS 250 for \$1.98 We got barrels of 1/4 and 1/2" watters for pc use. You'll eat even amount, 100% 1/4, 100% 1/2" watters. Cat.No. SL2608 100% good.	BARREL KIT #31 METALLIC RESISTORS 100 for \$1.98 100% good. Made mostly by Corning, the finest resistor made. Mostly 1/2 watters, 1% to 6% tol., & a barrel of values. Cat.No. SL2609	BARREL KIT #32 TRANSISTORS WITH A HOLE IN IT 50 for \$1.98 Untested. Can't name factory but we bought barrels of 2n watters with mtg. hole in middle. PNP's and NPN's. Cat.No. SL2610 100% good.	BARREL KIT #34 TUBE SOCKETS 100 for \$1.98 Good ole tube sockets, still in demand! Barrels and barrels: 4's, 5's, 7, 8, 9, even computer types. Cat.No. SL2612 100% good.	BARREL KIT #35 NEON LAMPS 40 for \$1.98 100% good. Famous NE-2's. All prime, but factory made millions and barrel'd 'em. Your advantage. Cat.No. SL2613	BARREL KIT #36 GERMANIUM DIODES 200 for \$1.98 Untested Famous maker, popular item. Never grows old. But this is the way the RE-TESTERS buy 'em from the factories. Cat.No. SL2614	BARREL KIT #37 1 AMP "BULLET" RECTIFIERS 100 for \$1.98 Untested. Famous style, asst. voltages, silicon, axial includes all types of voltages to 1KV. Cat.No. SL2615
BARREL KIT #38 2 AMP RECTIFIERS 75 for \$1.98 Untested. "CYLINDER" type, silicon. Mallory, includes all voltages up to 1KV. Axial leads. Cat.No. SL2616	BARREL KIT #39 2N3055 HOBBY TRANSISTORS 15 for \$1.98 100% good. From factory to you, these fallouts of the famous 2N3055. We have 10 barrels. Cat.No. SL2617	BARREL KIT #40 PNP HIGH-POWER TRANSISTORS 20 for \$1.98 Popular germanium TO-3 case units, now available at "good ole barrel" prices. Cat.No. SL2618 100% good.	BARREL KIT #42 ITT "GLASS 4000" RECTIFIERS 150 for \$1.98 Just int 1N4000 silicon rectifiers in epoxy, now in cases encased at barrel prices 50 to 1000v too! Cat.No. SL2620	BARREL KIT #46 G.E. 3.5 WATT AMPLIFIERS 25 for \$1.98 Untested. Hobby type, factory fallouts, we purchased them in barrels. These are unknown. Cat.No. SL2624	BARREL KIT #49 QUADSI QUADSI 50 for \$1.98 Untested. Includes a mirror op amps in one package. Why the factory barrel'd these we don't know. Cat.No. SL2627	BARREL KIT #80 SIGNAL SILICON DIODES 200 for \$1.98 Includes many, many types of switching, signal silicon types, all axial leads. Some may be zeners. Cat.No. SL2628 Untested.
BARREL KIT #53 HOBBY OPTO COUPLERS 40 for \$1.98 We got 1,000's unknown both the sensor or transmitter may be good, or both. WE DON'T KNOW! We don't know the types. 1800V isolation. Cat.No. SL2629	BARREL KIT #52 DISCS! 500 for \$1.98 Cat.No. SL2630 100% good. The bargain of a lifetime! First time ever offered by Poly Pak for the economy-minded bargain busters.	BARREL KIT #55 JUMBO RESISTOR PAK 100-pc. \$1.98 Cat.No. SL2721 Assortment metal films, precision, carbons, metal oxide powers, from 1/2 watt to 7 watts. Color coded & 100% good. Worth \$10.	BARREL KIT #55 3 DIGIT READOUTS 15 for \$1.98 Untested. National cleaned its warehouse — now we have barrels of NSN-33 type. Untested. Cat.No. SL2723	BARREL KIT #57 HI-POWER RECTIFIERS 15 for \$1.98 50-Amp studs; 6, 12, 24, 48V. 100% material. Factory rectifier "line" rejects. Cat.No. SL2725 100% good.	BARREL KIT #58 SLIDE SWITCHES 30 for \$1.98 All shapes, sizes, spat, dpdt, momentaries, etc. Tremendous shop pak for 100's of switching projects. Cat.No. SL2726 100% good.	BARREL KIT #59 POWER TRANSISTORS 40 for \$1.98 15 watt Bendix B-6000 pellet transistors, npn, all good, purchased from a pretester, have millions of 100% good. Cat.No. SL2727
BARREL KIT #60 DTL'S IC'S 75 for \$1.98 Untested. This is prime barrel material. Who wants DTL's? 930, 938, 946's. Your gain is our loss. They're marked too. Cat.No. SL2728	BARREL KIT #61 POLYSTYRENE CAPS 100 for \$1.98 100% good. Finest caps made. As a gamble we bought 10 barrels from factory, mixed values; all good. Cat.No. SL2729	BARREL KIT #65 MIXED READOUTS 30 for \$1.98 Untested. Factory returns — such numbers as MAN-4's, MAN-7's, MAN-3's, 11 barrels & no time to separate. Cat.No. SL2733 Untested.	BARREL KIT #67 2-WATT AMPLIFIERS 50 for \$1.98 Untested. Buy from the barrel 'n save! LM-580 types in dip paks. Are they good? We got millions. Cat.No. SL2734	BARREL KIT #68 2 WATTERS 100 for \$1.98 100% good. Nobody seems to want 'em! So many suppliers don't count, but throw 'em in the barrel, it's a lil' good mix! All marked. Cat.No. SL2738	BARREL KIT #73 CAPACITOR SPECIAL 100 pcs. \$1.98 Emptied stockrooms into barrels of mylars, poly's, mica, muleds, plastics, ceramics, disc, etc. Nifty 100% good. Cat.No. SL2738	BARREL KIT #77 TRANSISTOR ELECTROS 50 for \$1.98 It "bugs" us why the factories dump 'em in barrels. We don't wish to separate wide ass voltages & values up to 300 mf. Cat.No. SL2747
BARREL KIT #75 400MW ZENERS 100 for \$1.98 Untested. Factory out of biz! Amazing offer: 6, 8, 10, 12 to 15V. You test. Hermetically sealed glass pak. Double plug. Cat.No. SL2740 Untested.	BARREL KIT #76 1-WATT ZENERS 100 for \$1.98 Untested. Factory same as 400-mw's. Never-to-see-again offer. 8, 8, 10, 12, 15V, under glass. Double plug. Cat.No. SL2741	BARREL KIT #77 "BROWN" BODY TRANSISTORS 40 for \$1.98 Untested. G-E D-40 series: has hi-voltage, Darlington, hi-current, npn's. Factory line discontinued. Power tabs. Cat.No. SL2742 Untested.	BARREL KIT #79 "RED" BODY TRANSISTORS 40 for \$1.98 Untested. D-42 series. You test — go into your own biz! High current, hi-V. NPN. Untested. Cat.No. SL2743	BARREL KIT #81 SUBMINI RESISTORS 200 for \$1.98 100% good. PC, upright type, color coded 1/4 watt. Asst. values. Came to us in a barrel. Cat.No. SL2748	BARREL KIT #82 8000 SERIES ICs 50 for \$1.98 By National. From factory to you. Assortment of popular series factory fallouts, overruns. Untested. Cat.No. SL2634	BARREL KIT #83 LM-240T Untested VOLTAGE REGULATORS Factory rejected them for length of leads. May include 6, 8, 8, 12, 15, 18, 24 volts. Power tab. Cat.No. SL2635
BARREL KIT #84 25 for \$1.98 Untested MAN-3 "THE CLAW", 5V 15 mila. LED hobby or experimental use, for understanding the working of "mini" or calculator readouts. A segment may be missing. No. SL2679	BARREL KIT #88 HOBBY LEDs 40 for \$1.98 Untested. Wow! A Litronics dump of all kinds of mixed discrete LEDs, shapes, colors, good, poor, etc. Cat.No. SL2689	BARREL KIT #87 NATIONAL IC BONANZA 100 for \$1.98 Untested. Factory dumps into barrels. Includes 800's, 7400 series, DTLs, ROMs, registers, clock & calc. chips, linears, etc. Cat.No. SL2860 Untested.	BARREL KIT #109 SILVER MICAS 100 for \$1.98 Cat.No. SL3018 For the first time silver micas so low in price! Axial, red case, variety of physical sizes & values. Big savings from distributor prices. Wt. 1 lb.	BARREL KIT #94 "BUBBLE" READOUTS 12 for \$1.98 DL-333 bubble magnifiers. Segs missing. Truthfully so many of 'em we don't care. Untested. 3 oz. No. SL3046	BARREL KIT #99 PHOTO ELECTRIC CELLS 10 for \$1.98 Asst. GE types, CDS type. Mixed by factory. Big job for us to separate. 100% good. Cat.No. SL3082	BARREL KIT #100 CLOCK CHIPS 5 for \$1.98 No. SL3085 National is dumping MM-8316 what's wrong with 'em, we don't know, but we got barrels. Hobby special. Wt. 2 oz.
BARREL KIT #104 SLIDE VOLUME CONTROLS 10 for \$1.98 Cat.No. SL3087 Used in hi-fi, volume control maker unloads. Asst. values, what a buy. Worth \$1 ea. We've got barrels of 200% material.	BARREL KIT #107 SQUARE OHMS 60 for \$1.98 Cat.No. SL3096 Factory people are sometimes "squares" when they topple prime square ohms mix 'em up in barrels. Asst. values, wts. Wt. 1 lb.	BARREL KIT #108 TO-5 PLASTIC TRANSISTORS 40 for \$1.98 Untested. Includes PNP, NPN, 2N-3688, 2N3841, 2N5000 series, etc. Untested, but guaranteed to 60% yield.	BARREL KIT #109 TERMINAL STRIPS 150 for \$1.98 Untested. Wide ass. of terminal strip connectors, from 1 contact up. Strip manufacturers barrel dump is your gain. Wt. 1 lb. Cat.No. SL3130	BARREL KIT #110 SUPPRESSOR DIODES 50 for \$1.98 Cat.No. SL3137 Keeps ignition noise out axial. Untested, but the of your eqpt., car, industrial, etc. Double plug.	BARREL KIT #111 MULTI DIGIT READOUTS 8 for \$1.98 barrels of blemished 3, 4 and/or 5 digit readouts to USA for 'dump'. Untested. Cat.No. SL3139	BARREL KIT #112 MICRO MINI LEDs 40 for \$1.98 All the tiny leds, axial, upright of Monsanto, Litronics, variety of colors. Yield 50% or better. Cat.No. SL3139
BARREL KIT #113 STABILIZERS 50 for \$1.98 Cat.No. SL3140 Regulator, sensing and computer circuitry. Axial double plus type. Discontinued factory line. PIV 20 volts. 80% yield. U test 'n save!	BARREL KIT #114 PLASTIC SCRS 25 for \$1.98 Untested. Factory is changing style, top grade yield 80% to 90%. Includes 15, 20, 60, 100, 150, 200 volts. TO-92. A buy! You betchal! Cat.No. SL3143	BARREL KIT #115 MOLEX SOCKETS 300 for \$1.98 100% good. Calculator maker dump! We got silicon of 'em. Used for IC sockets etc. Cat.No. SL3144	BARREL KIT #116 BUTTONS IN FEEDTHRU'S 100 for \$1.98 100% good. Truthfully worth a small fortune. Wide ass. of button-feeder caps. IAMS for IC NOTER RE UHF, etc. Wt. 1 lb. Cat.No. SL3141	Terms: Add postage Rated: net 30 Phone: Wakefield, Mass. (617) 245-3829 Retail: 16-18 Del Carmine St., Wakefield,		C.O.D.'S MAY BE PHONED

POLY PAKS 20¢ CATALOG on 'IC's, Fiber Optics, P.O. BOX 9421-5 LYNNFIELD, MASS. 01940 Semi's, Parts

MINIMUM ORDER — \$6.00

P.O. Box 4430A Santa Clara, CA 95054

TERMS:
\$5.00 min. order U.S. funds.
Calif. residents add 6% tax.

Digital Electronic Watch Kit \$24.95

5 function LED. Large readout unmagnified. Easy to solder and assemble.

M5 Large numeric readout **\$24.95**

M8 Alpha/Numeric readout **\$27.95**

Money back guaranteed if returned within 10 days.

Watch Case & Strap Handsomely styled, stainless, water resistant

C6 All metal **\$15.50** **C7** Leather **\$14.00**



Same Day Shipment. First line parts only. Guaranteed satisfaction. Listed below is just a small sample of the complete lines available. A broad line of IC's at low factory prices. Try us. You'll like the quality and the service!

74LS00 TTL	7403	14	MOS/MEMORY	LINEAR	
74LS00 .29	7405	24	2102P 2.50	301AP 34	
74LS02 .29	7406	24	2102-2P 2.60	301AT 30	
74LS04 .35	7408	25	6331J/ 2.90	709CP 32	
74LS10 .29	7423	35	82S123 2.90	723CP 36	
74LS74 .49	7438	39	8223 3.10	723CT 36	
74LS90 .99	7447	75	1404AT 1.80	741T 42	
74LS93 .99	7473	36		741CP 30	
74LS107 .47	7474	32	CMOS	747CP 40	
74LS151 1.14	7476	30	4000 25	555V 43	
74LS157 1.14	7490	49	4001 25	556A 69	
74LS163 1.89	7493	57	4011 25	550N 73	
	74107	47	4049 69	565A 1.19	
7400 TTL	74154	1.30	4050 69	567V 1.35	
7400 .17	74161	1.39		1458P 56	
7401 .14	74163	1.35			
7402 .17	74192	1.19			

FREE—Send for your copy of our 1976 Quest catalog.

IC Update Master

1976 integrated circuit data manual with free quarterly updates. Complete IC data from all manufacturers devices. **14,000 cross references.** Everything you need to select IC's in one manual **\$30.00 complete with Update service.**

Money Back Guaranteed if not satisfied within first week.

Digital Clock Kit \$12.95

6 digit large LED readout. Add \$1.50 for transformer and \$3.00 for PC board. A tremendous value!

CIRCLE 37 ON READER SERVICE COUPON

GOLDFINGER ENTERPRISES

ATTENTION MONITOR SCANNER OWNERS

ORDER BY MAIL!

Goldfinger has in stock and available for immediate delivery, crystals for both Regency and Bearcat Scanners. **HIGHEST QUALITY PRECISION CRYSTALS**—Order from Goldfinger, one of the nation's largest specialists in scanner crystals. Send us the frequencies you want, the make and model of your scanner, and only \$4.95 per crystal. That's all there is to it! For immediate delivery send postal money order or certified check, **NO COD'S.** Order now and receive **FREE** our special Goldfinger crystal package.

GOLDFINGER ENTERPRISES

9406 N.W. 74th St.

Ft. Lauderdale, Fla. 33319

CIRCLE 7 ON READER SERVICE COUPON



BOOKMARK
BY BOOKWORM

On the Happy Side. Building radios is fun. So what can be more fun than building the projects given in *21 Simple Transistor Radios You Can Build* by R. H. Warring. This is an ideal source-book for those simple radio circuits that interest everyone—the budding young experimenter to the seasoned veteran. It explains exactly how radios work, and shows how to build 21 of

21 SIMPLE TRANSISTOR RADIOS YOU CAN BUILD



Soft Cover
140 pages
\$3.95

them using low-cost parts. The first few projects are presented with both pictorial diagrams and schematics, to make it easy for first-time readers to relate the parts to their symbols. From here on, the material is for anyone who likes to experiment in electronics. The simple and straightforward approach to tuned circuits will serve as a valuable refresher for those who've forgotten some of the important facts about resonance, selectivity, and the art of *winding* rather than buying coils. Published by Tab Books, Blue Ridge Summit, PA 17214.

All in One Volume. *Master Handbook of 1001 Practical Electronic Circuits* edited by Ken Sessions is a reference book every experimenter should have. Here are IC and transistor cir-

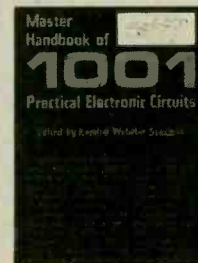

Soft Cover
602 pages
\$9.95

cuits for practically anything and everything—with *all* the data needed to put them to work! It's the ideal schematic sourcebook for all active technicians, engineers, experimenters, amateurs—for
(Continued on page 24)

The Black Watch kit

At \$29.95, it's

★**practical**—easily built by anyone in an evening's straightforward assembly.

★**complete**—right down to strap and batteries.

★**guaranteed.** A correctly-assembled watch is guaranteed for a year. It works as soon as you put the batteries in. On a built watch we guarantee an accuracy within a second a day—but building it yourself you may be able to adjust the trimmer to achieve an accuracy within a second a week.

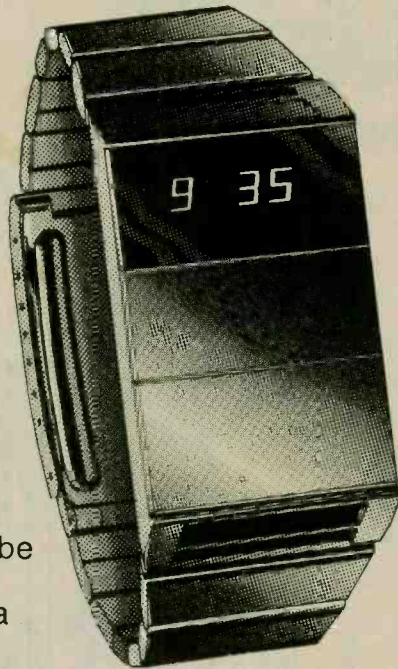

The Black Watch by Sinclair is unique. Controlled by a quartz crystal . . . powered by two hearing aid batteries . . . it's also styled in the cool prestige Sinclair fashion: no knobs, no buttons, no flash . . . just touch the front of the case to show hours and minutes and minutes and seconds in bright red LEDs.

The Black Watch kit is unique, too. It's rational—Sinclair have reduced the separate components to just four.

It's simple—anybody who can use a soldering iron can assemble a Black Watch without difficulty. From opening the kit to wearing the watch is a couple of hours' work.

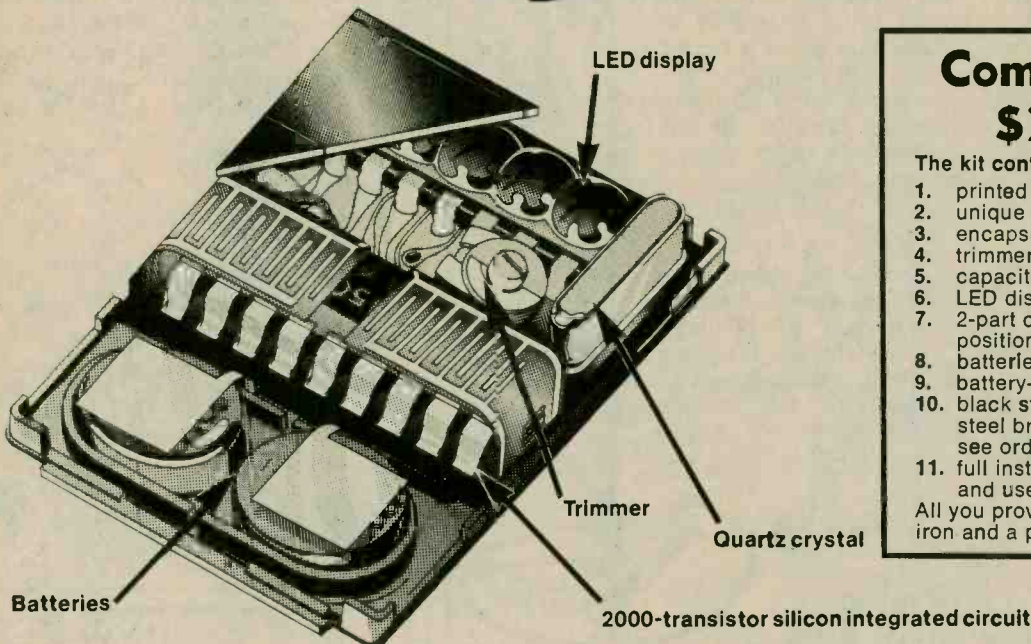

Complete kit \$29.95!

The kit contains

1. printed circuit board
2. unique Sinclair-designed IC
3. encapsulated quartz crystal
4. trimmer
5. capacitor
6. LED display
7. 2-part case with window in position
8. batteries
9. battery-clip
10. black strap (black stainless-steel bracelet optional extra-see order form)
11. full instructions for building and use.

All you provide is a fine soldering iron and a pair of cutters.

Please send me

_____ Black Watch Kits @ \$29.95

_____ plus \$2.50 shpg. & hndlg.

_____ Stainless steel bands
@ \$5.50

NY residents please add sales tax

I enclose my check/MO for \$ _____

Name _____

Address _____

EE-5

IMPORTANT

Print your name and address here →
for use as a shipping label.
Thank you.

Name _____

Address _____

_____ Zip _____

FREE 10 DAY TRIAL

If you decide not to keep your Black Watch Kit, return it undamaged within 10 days for a full refund on the kit.

Mail to:

sinclair
SINCLAIR RADIONICS
Suite 400
888 7th Avenue
New York, NY 10019

GC Electronics

big buster

ANTENNAS

RINGO

the world's most efficient high performance, omni base antenna.

3.75 dB Gain

Only Ringo has exclusive power ring tuning for a true 3.75 dB gain. Power ring gives a perfect match to use all available transmitter power. Ringo amplifies signals through full length capture area and low angle "horizon focus pattern."

Professional quality construction gives Ringo survival ratings for winds in excess of 80 mph. Mount it anywhere from mast to tower. Ringo is designed for instant assembly and installation in the smallest possible space.

CR-1



FOR A MORE POWERFUL SIGNAL MAKE RINGO YOUR PERFORMANCE CHOICE.

SEE YOUR LOCAL DEALER TODAY!



621 HAYWARD ST., MANCHESTER, N.H. 03103

BOOKMARK

(Continued from page 22)

anyone who must occasionally, or regularly, construct or adapt electronic circuits. Each circuit diagram has every component carefully labeled, and every schematic is accompanied by all the information needed to construct the circuit for the reader's own individual application. If there are coils to be wound, there are complete coil-winding details close at hand. If special parts are required, all the necessary information is right there in condensed captions. Anyone who has ever wanted a circuit diagram he couldn't find, or who has spent precious hours breadboarding a circuit from scratch, only to find it's already been perfected by someone else, will really appreciate the ease with which the necessary circuit can be found quickly in the *Master Handbook*. Published by Tab Books, Blue Ridge Summit, PA 17214.

Projects Handbook. Nine projects, each intended to be of interest to the beginner as well as to the experienced hobbyist, are included in the *Semiconductor Projects Handbook* published by GC Electronics, Calectro Division. The Handbook (Cat. No. 98-104) features

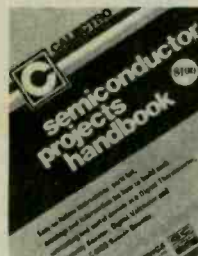

Soft Cover
114 pages
\$1.00

an assortment of general interest projects varying from a simple Decade Counter to a complex Waveform Generator. The collection includes a Crystal Timebase, SCA Decoder, Dual
(Continued on page 86)



HOW TO SAVE HUNDREDS OF DOLLARS ON PARTS. PAINLESSLY.

At CSC, we've developed a family of ingenious Design Mate™ test equipment that gives you professional quality and precision at very *un*professional prices. Each unit can save you money—and time—in a number of interesting ways.

For more information on these, or any other CSC products, see your dealer or write for our catalog and distributor list.



SAVE MONEY AND TIME WITH DESIGN MATE 1

This precision all-in-one unit combines a solderless plug-in breadboarding system with a built-in better-than-1%-regulated variable 5-15V supply and 0-15V voltmeter. Gives you everything you need to design and test circuits faster than you ever could before. Saves money by eliminating lead damage and heat damage to components. Lets you re-use parts over and over again, to save even more. All for just \$49.95*



STRETCH YOUR BUDGET FURTHER WITH DESIGN MATE 2

Precision function generator lets you test all kinds of equipment, with 1Hz-100kHz signals. Low-distortion sine waves, high-linearity triangle waves, fast-rise-time square waves. Five decade ranges, accurate to 5% of dial setting, with variable 100mV-10V P-P output and constant 600-ohm impedance. At \$64.95* it's a lot of signal for very little money.



SAVE MORE MONEY AND TIME WITH DESIGN MATE 3

Accurate R/C bridge helps you use "bargain" components. Quickly and easily measures resistance 10 ohms—10 meg; capacitance 10pF—1μF—both in decade ranges to within 5% of dial setting. Simple, 2-control operation and positive LED indication make measurements in seconds. At \$54.95* it pays for itself in no time.

CONTINENTAL SPECIALTIES CORPORATION



EASY DOES IT

44 Kendall Street, Box 1942
New Haven, CT 06509 • 203-624-3103 TWX: 710-465-1227
West Coast office: Box 7809, San Francisco, CA
94119 • 415-421-8872 TWX: 910-372-7992
Canada: Len Finkler Ltd., Ontario

Who builds the best electronics around?

You Do! when you build these exciting Heathkit products... all in our new spring catalog



Our sensational Modulus™...the music system with total flexibility for your changing listening needs



The GB-1201 programmable digital stopwatch lets you keep track of time...for rallies, races, trips, efficiency studies



ET-3300 Lab Breadboard... makes circuit design and development fast and easy



IO-4550 Dual-Trace DC to 10 MHz scope... featuring brighter trace and faster writing speed



HW-2021 Hand-held 2-meter transceiver... 1 watt out, 5 receive and 10 transmit channels



A complete line of Radio Control devices and systems... and a sleek new glider to go with them!

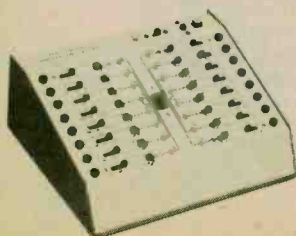

IT-5230 CRT Tester/ Rejuvenator handles the new IN-LINE COLOR tubes without adapters

IT-7400 Digital IC Tester...for RTL, DTL, TTL, CMOS, others...real versatility for your bench

HEATHKIT

The Phoenix Spirit made America Great. Self-reliance, independence, individual participation. You get a taste of that spirit when you build a Heathkit product. Declare your independence now.

SPRING 1976

1. 100W - B-C Stereo
2. 100W - CRT Tester
3. Stereo Plus Speaker
4. 100W - Precision Power Supply
5. 100W - Digital Stopwatch
6. Heathkit In-Line Rejuvenator
7. Programmable Stopwatch

PLUS... over 100 other components and kits for sale and digital storage

© 1976 Heath Company
See index on page 1

Heathkit mail order catalog 1976
"Heath" and "Heathkit" are registered trademarks of Heath Company

Who learns electronics the easy, effective, low-cost way?

You Do! when you study using the exclusive Heathkit Individual Learning Programs.

What better way to learn electronics than from people whose *business depends* on making it as easy to understand and work with as possible?

These Heathkit Individual Learnings Programs will give you a thorough background in basic electronics, while letting you study and learn at your own pace. There are four programs presently available: DC electronics, AC electronics, Semiconductor devices, and for the advanced, Digital Techniques. Each program includes a text written by the same people who write the world-famous Heathkit instruction manuals, audio records to reinforce and "personalize" text materials, and parts for hands-on experiments using low-cost electronic trainers which provide signal sources, power supplies and controls. Find out more about them, send for the FREE catalog below.

**HEATHKIT
CONTINUING
EDUCATION**

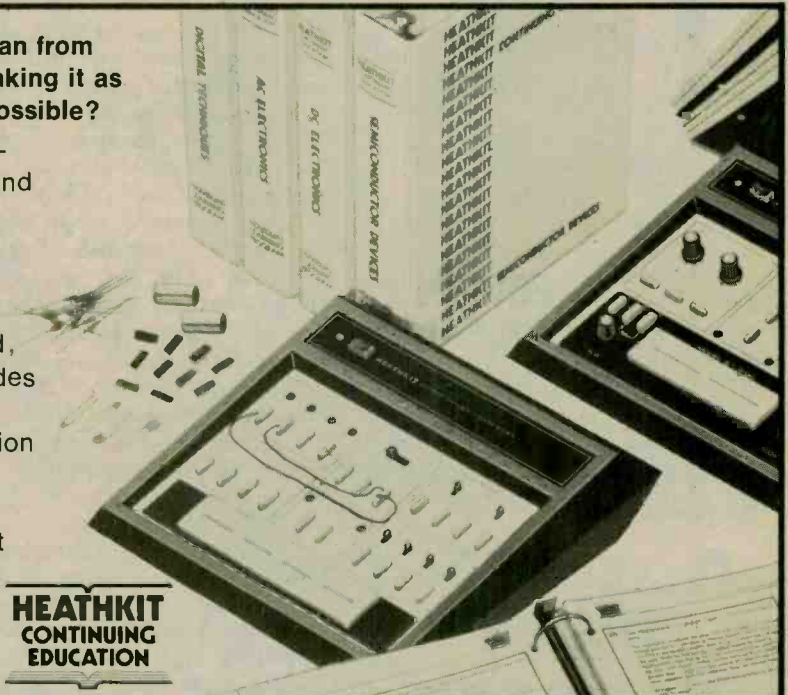

FREE! Read all about them!

The new Spring '76 Heathkit catalog describes those kits above, plus over 400 other money-saving electronic kits that are easy and fun to build! Send coupon or postcard today for your FREE copy. Heath Company, Dept. 139-17, Benton Harbor, Michigan 49022

Complete, accurate, HONEST descriptions of over 400 electronic kits including:

- Automotive, Aircraft and Boating Aids
- Test Instruments
- Stereo Hi-Fi Components
- Amateur and Shortwave Radio
- Color TV • Security Systems
- Educational Self-Study

Use coupon or postcard today!



HEATH Schlumberger	Heath Company, Dept. 139-17, Benton Harbor, Michigan 49022
Please indicate area of interest:	
<input type="checkbox"/> Color TV <input type="checkbox"/> Hi-Fi <input type="checkbox"/> Automotive <input type="checkbox"/> Test Equipment <input type="checkbox"/> Amateur <input type="checkbox"/> Shortwave <input type="checkbox"/> Security <input type="checkbox"/> Self-Study	
Send me my FREE Heathkit Catalog.	
Name _____	
Address _____	
City _____	State _____
CL-593	Zip _____



the original
"wedge-type" screwdriver

QUICK- WEDGE

SCREW-HOLDING
SCREWDRIVER

Does all the Job!

**HOLDS,
STARTS,
DRIVES,
AND SETS**

the screw
normal tightness!

GET A SET TODAY!

At your dealer's
or write

**KEDMAN
COMPANY**

Box 267
Salt Lake City,
Utah 84110

17
SIZES

© 1975 by
Kedman Company

CIRCLE 13 ON READER SERVICE COUPON

STEREO ONE

**Auto FM
Signal
Booster**
to eliminate
signal fading

Compliments Any Dash Board.

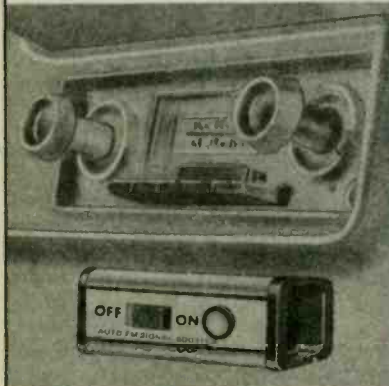

Write for catalog # 20-803

Dept. EE576

THE FINNEY COMPANY
34 West Interstate Street, Bedford, Ohio 44146

CIRCLE 27 ON READER SERVICE COUPON

newscan

Electronics in the News!

Bits on Crime

Computer terminals in the Los Angeles Police Department (LAPD) communication centers permit computer-stored information to be relayed quickly to officers in the field providing them with information on wanted and dangerous persons which could prevent serious injury or death. The system, installed by Sanders Data Systems, can also provide information on stolen vehicles or property, vehicle registrations, and other crime correlated data.

Radio-telephone operators in the LAPD communication center receive about 10,000 calls each day from officers in patrol cars, on foot, in the field investigating and at the desk. The operators enter the requests on the terminal keyboard. The system automatically routes messages to any of several data bases to acquire information for the field officer. These data bases include but are not limited to such files as: the Automated Want and Warrant file, the Department of Motor Vehicles Registration file, the Department of Justice Wanted Persons System, Automated Field Interview System, and Pattern Recognition and Information Correlation System, plus many other files on local, state, and national levels.

In response to the radio-telephone operator's inquiry, the computer-stored data is displayed on the terminal screen of the inquiring terminal and relayed by radio to the field officer, in most instances before the inquiring officer has halted a suspect vehicle.



Sanders terminals located in Los Angeles Police Department communications center enable rapid retrieval of computer-stored information which is relayed quickly by radio to officers in the field. Photo was taken when a patrol car was in hot pursuit of a suspect and requested information.

If criminal history, property, or fire-arm information is needed, the inquiry is computer sent to the Department of Justice file in Sacramento and can be forwarded from there to the National Crime Information Center in Washington, DC.

A computer-stored file enables LAPD officials to compare names and important numbers appearing on stolen or forged checks against existing worthless document data for possible correlation with ongoing investigations. Another file provides information to investigators concerning suspect names, trademarks, physical descriptions, vehicles and weapons used. Both systems used by investigative personnel enable rapid comparison by computers of bad checks, airline tickets, credit cards, and the like. This system is expected to save considerable manpower while also providing leads during investigations.

To date, over 130 terminals including 70 at LAPD locations and 60 in outlying areas have been installed. Let's hope the LAPD has placed a guard at the main circuit breaker panel!

Pole-Hole Mole Burrows by R/C

They mechanized corn planting years ago and now they have mechanized utility pole planting, too, with a new "digger derrick" that drills the holes and sets the poles—all by radio control. Results: more holes dug faster and more safely. Now the operator moves out to where the action is, and commands the auger "mole" to do its pole-hole drilling without a signalman directing the operator with hand signals. His "ace-in-the-hole", is a hand-held FM radio control developed by Moog, Inc. Safety features are built-in so that R/C airplane flyers, automatic garagedoor openers and traffic light controllers cannot accidentally take control.



The mole digs deep as the operator controls actions from an unobstructed vantage point.

BRAND NEW!

WILD BUNCH

**THE GRRREAT MOBILES
FROM PEARCE-SIMPSON**



Receive-O-Slide,
Manual ANL, Automatic
Modulation Control.

Tears You Up

BOBCAT 23C

\$189^{95*}



True RF noise blanker,
built in SWR bridge, S/RF/
Modulation/SWR Meter.
Total of 12 controls.

Sound of Excellence

COUGAR 23B

\$239^{95*}



Big Meter that changes
color, plug in mike and
power leads, P.A.

Sleek

PUMA 23B

\$169^{95*}



Mike gain control, S/RF/
Modulation Meter, Tone
Control.

Wild as it Sounds

TIGER 23C

\$209^{95*}



23 Channels, S/RF meter,
diode switching, crystal filter.

The Untamed

TOMCAT 23

\$139^{95*}

*Suggested list price

Purr-fectness is expected from Pearce-Simpson and these grrreat new mobiles have it. Choose one of the Brand New Wild Bunch and cut through the CB jungle like a pussycat going through a saucer of warm milk.

**PEARCE-SIMPSON
DIVISION OF GLADDING CORP.**

P.O. BOX 520800, BISCAYNE ANNEX, MIAMI, FLORIDA 33152
TELEPHONE: 305-592-5550

CANADIAN DISTRIBUTOR: SCOTTCOM RADIO, INC., 4643 LEVESQUE BLVD., CHOMEDY, LAVAL, QUEBEC, CANADA

FREE burglar — fire alarm catalog



over 500 systems, detectors, controls, sounders, tools, locks, supplies

TO PROTECT HOMES, BUSINESSES, INDUSTRY

Huge selection of hand-to-find security equipment from stock. 96 fact-filled pages loaded with 100's of highest quality professional alarm products, technical notes, diagrams.

ONE-STOP SUPERMARKET SELECTION INCLUDES:

ultrasonics, radar, infrared, undercarpet mats, magnetic contacts, smoke & heat detectors; Controls; Alarms; bells, sirens, phone dialers, lights, guard panels. Large selection of tools, relays, wire, holdup alarms, books. Fills need for industry, alarm cos., businesses, homes, institutions. Order your copy today.



mountain west alarm
4215 n. 16th st.
phoenix, az. 85016
(602) 263-8831

CIRCLE 30 ON READER SERVICE COUPON

NEW!

"Break" into CB for only \$24.95



- Listen to all 23 CB channels on any AM or AM/FM car radio
- Installs in seconds; all mounting accessories included. No modification of car radio required. Uses car antenna
- Black anodized aluminum case
- Eavesdrop on the truckers. Don't feed the bears. Dig where "Smockey" is hiding. Hear emergency calls
- CB-EAR is no plastic toy! It's HOT! Advanced MOS-FET circuitry. Push button with indicator switches unit back and forth between CB and AM
- No license required
- Factory Warranty included, plus 10 day moneyback trial
- Order before June 30, 1976, and receive FREE CB Slang Dictionary (regularly \$3.00)

Send \$24.95 plus \$1.00 for postage and handling (Calif. residents also add \$1.50 State sales tax) Check or Money Order to:

AERO DISTRIBUTORS
P.O. Box 2369
Stanford, California 94305

CIRCLE 31 ON READER SERVICE COUPON

DX central reporting

A world of SWL info!

BY DON JENSEN

□ In this age of détente, little publicity is given to the problem of jamming—the deliberate blocking, in one manner or another—of radio broadcasts.

In the midst of the East-West Cold War two decades ago, most Americans considered jamming to be an activity carried out by countries behind the Iron Curtain. This was never strictly true. Other nations also resorted to jamming, but the bulk of this radio noise did come from the Soviet Union and the East European countries. This is still true today, although to a lesser extent and on a more selective basis. Other countries too, including some you might not expect, such as Chile and Cyprus, have joined the act.

Historically, Imperial Germany was the inventor of radio jamming. This developed during the First World War, not many years after radio was born and before the era of voice broadcasting. The German post office constructed a five-kilowatt jamming transmitter that was used to disrupt the radiotelegraphy between St. Petersburg, which was the capital of Czarist Russia, and Paris.

Nazi Germany continued the jamming in the 1930's, in an attempt to block the international voice of communism, Moscow's *Komintern* broadcasting station. In 1934, Hitler, whose propaganda stations were bombarding neighboring Austria with signals, found the tables turned. Austria began jamming the signals.

World War II resulted in a boom of jammers with both Allies and Axis efforts expanding. A unique form of disrupting

enemy broadcasts, though not exactly jamming, was pioneered by the Russians during the war years. It involved the operation of a powerful transmitter on exactly the same frequency as used by a major Nazi broadcaster. Thus, a mysterious voice, speaking in German, could interrupt and ridicule the German announcers as they read the news. The Western Powers called this Soviet "ghost voice" Ivan the Terrible.

In the post-war years, the USSR constructed a massive chain of jamming stations to prevent its citizens from receiving signals from the non-communist world. By 1959, this network was said to include 2,500 transmitters, built at a cost of \$100 million. The satellite countries of eastern Europe followed suit.

Over the years, those countries that have resorted to jamming have moved in and out of the game with the changing political winds. The targets of the jamming also have varied. Until about 1963, the *Voice of America* was a frequent target of USSR jammers. This was selectively resumed in 1968, but since détente, there has been no Soviet jamming of the VOA programs.

Today the prime targets of Russian jammers—now believed to number more than 3,000—are *Radio Free Europe*, which broadcasts to East Europe; *Radio Liberty*, targeted to audiences in the USSR; and some programs of West Germany's *Deutsche Welle*. By one estimate it costs \$10 to operate a large jamming operation for each \$1 spent by the stations it aims to jam. Another source suggests the Soviet jamming network costs nearly a third of a billion dollars a year to run.

The satellite countries also have had a spotty jamming record. Poland, for example, jammed programs until 1956. After a 15-year silence, jamming was resumed. Today, it is reported, Poland has clean hands. Hungary and Rumania have not jammed outside broadcasters for many years, at least since 1967.

Czechoslovakia has resorted to jamming at various times and recently resumed the practice. East Germany and Bulgaria have never let up. As one RFE source put it,

(Continued on page 34)

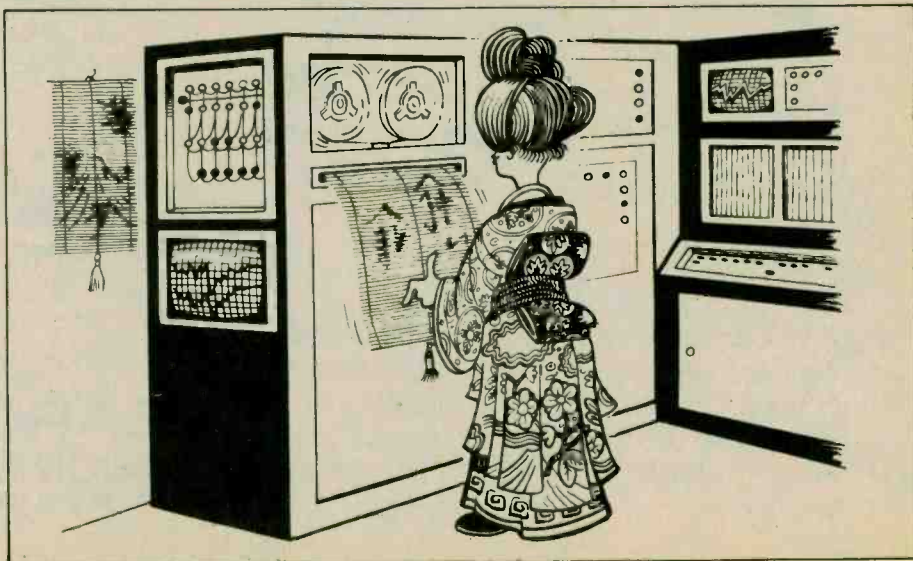

Science Fair P-Box[®] Kits have helped launch 1000's of careers in electronics!



Great for youngsters . . .
Build and learn like an engineer by
"breadboarding" on a unique molded
and coded Perfboard chassis. Fun,
safe, educational!



ONLY
895

Build an Indoor/Outdoor Electronic Thermometer

Monitor indoor or outdoor temperatures, or temperatures at any two locations, on an easy-to-see scale calibrated from -20 to +120° Fahrenheit. A switch selects either of the two sensing probes. You not only build a practical item you'll use every day, but you learn how an electronic thermometer really works. Like all P-Box kits, it includes schematics and pictorials for easy step-by-step assembly. Requires just one 9V battery. 28-135.

Shortwave Radio Kit —a world of excitement



ONLY
795

Continuous Coverage
From 4.5-50 MHz

Tune in foreign stations, Voice of America, Amateurs, CB'ers, and more—on a radio you built yourself. Regenerative high-gain detector, two audio stages. And you can listen privately with the earphone that's included. Requires just one 9V battery. 28-110.

—There's a P-Box for every interest—

- | | |
|------------------------|------------------------|
| Electronic Organ | Shortwave Radio |
| Electronic Metronome | Transistor AM Radio |
| Telephone Amplifier | One-Tube AM Radio |
| IC AM Radio | 2-Transistor FM Radio |
| Voice Controlled Relay | Solar-Powered AM Radio |
| Electronic Thermometer | 3-Way Code Oscillator |
| Metal Locator | OTL Audio Amplifier |
| Rise-Fall Siren | "Goofy-Lite" Flasher |
| Photo Night Light | Light Operated Alarm |
| Wireless AM Mike | 3" Extension Speaker |

SOLD ONLY WHERE YOU SEE THIS SIGN:

Radio Shack[®]

A DIVISION OF TANDY CORPORATION
OVER 4600 STORES • 50 STATES • 9 COUNTRIES

Retail prices may vary at individual stores and dealers. Prices and products may vary in Canada.

CIRCLE 32 ON READER SERVICE COUPON

DX CENTRAL

(Continued from page 32)

"Bulgaria jams everything, all the time!"

There are many types of jamming that have been developed over the years. An early type, and still quite common today, is the buzzsaw, a raucous buzzing noise superimposed on the frequency of the target station. Some countries, such as Spain, which tried to block the signals of several clandestine stations, have used multi-beeper sounds. Also used, especially in the past, is what technicians have termed the bagpipes. This is your basic background buzz overlaid with random musical tones. Yet another jamming method is "white jamming," which blankets a frequency with hissing and crackling sounds.

A popular type of jamming used by the Soviets today, especially against broadcasts

from some Western stations and from China, is the broadcasting of regular program material on the same frequency as that used by the "offending" station. A few years back, the *Voice of America* used this type of jamming on a powerful Moscow channel, drawing protests from the USSR that the VOA signals on 173 kHz longwave interfered with its reception in Russia and eastern Europe.

A number of other countries have played the jamming game too; Rhodesia vs. the British Broadcasting Corporation, the Arab World vs. Israel; Turkey vs. Greece; Chile vs. the USSR; and, well the list of competitors could go on and on.

DXers and casual listeners around the world have protested jamming activities for years. One British club went so far as to ban from its monthly DX newsletter information about any broadcasting stations located in countries that engaged in jamming of others' signals. Anti-jamming efforts by listeners such as these have all failed. Jamming goes on.

Olympic Broadcasts. Canada, our northern neighbor, will host the Olympics in Montreal this summer, July 17 to August 1. You can look for heavy coverage of the games from the host broadcaster, *Radio Canada International*. But numerous other world broadcasters will be on hand to provide broadcast coverage of the Olympiad events.

The *Canadian Broadcasting Corporation*, RCI's parent organization has set up a special division known as the Olympic

Radio and TV Organization to coordinate broadcasting from 27 games sites in and around Montreal. For its own broadcasts, the CBC will use its new broadcasting center, *Maison Radio Canada*. Guest broadcasters from other nations will be located at two other sites in Montreal, the old Radio Canada building and the International Radio and Television Center, which was built for Expo '67.

Jointly the three broadcasting facilities will provide office space, radio and television control rooms, videotaping operations, film processing and editing services, and communications circuits.

Programming Highlights. Speaking of Canada, one of the best spots to find good shortwave entertainment is on the CBC's Northern and Armed Forces Service. Unlike *Radio Canada International*, the foreign service, this program is intended for Canadians living in the northern regions or serving with the military abroad.

Comedy? Well on Friday nights at 0030 GMT, catch a show called "Inside from the Outside." On Sundays at 1800 GMT, on a program called "The Entertainers," you can hear a satirical group called the "Royal Canadian Air Farce."

If you like those little fillers, the quirks in the news that you can find rounding out newspaper columns, try "As It Happens," daily at 2300 GMT. It is basically a news broadcast but has its share of "man-bites-dog" offbeat items sprinkled in.

CBC's Northern and Armed Forces Service uses several frequencies, but 9,625

Glossary of DX Terms

DX—Distant and/or difficult to hear radio stations.

DXing—Listening to such stations as a hobby.

CBC—Canadian Broadcasting Corporation.

GMT—Greenwich Mean Time or Universal Time; an international time standard, equivalent to EST + 5 hours, CST + 6 hours, MST + 7 hours, or PST + 8 hours.

MW—Medium wave, the band of frequencies found on your regular AM radio dial, 540 to 1600 kHz.

kHz—Kilohertz, a unit of frequency measurement, means the same as kilocycles per second (kc/s).

CB or not CB. With RCA, that's not the question.



kHz is as good as any to try.

Bandsweep. Time in GMT, frequencies in kHz: **800**—XEROK is a Mexican MW outlet (in the border town of Ciudad Juarez) that sounds like an American rock station, at least at night when programming is in English. . . . **2,360**—There are few stations that operate way down here in the 120 meter band, or at least few whose signals are loggable in North America. Many listeners have never heard a 120 meter band station with the possible exception of WWV's time signals on 2,500 kHz. But one of your best bets is a missionary outlet, TGBA, *Radio Maya de Barillas*, which programs in Spanish and can be heard sometimes before your local dawn. . . . **3,315**—A western hemisphere station which has been reported more consistently in recent months than in the past is *Fort de France Radio* on the French Caribbean island of Martinique. Give a listen for this one from around 0130 until it signs off just before 0300. . . . **4,870**—The country used to be called Dahomey, a small West African country. Recently, it changed its name to the People's Republic of Benin. Listen for the French language programs of *La Voix de la Revolution* (a station identifier used by several of the newer nations of Africa) around 0600. . . . **7,160**—Malaysia is not one of those nice neat countries whose territory is all neatly packaged. Part of Malaysia is on the Asian mainland, the rest is located on the island of Borneo, the areas known as Sabah and Sarawak. You can hear an English lan-

guage transmission from *Radio Malaysia Sarawak*, broadcasting from Kuching, at 1430. . . . **9,515**—*The Voice of Turkey, Ankara*, is one station many of our readers find fascinating, it seems. Its English language service is normally easy to hear, starting at 2200, and the program "Beat of the Drum" is recommended. . . . **11,945**—For those of you listeners who are looking for a "different" approach to world news and commentary, there's always *Radio Peking*. Widely heard is the English language program on this frequency, beginning at 0000.

(Credits: Chester Johnson, IN; Chris Lobdell, MA; Ken Earhart, PA; Richard Mitchell, CA; Amy Froelich, TX; Woody Seymour, NC; Dave Bies, WA; National Radio Club, Box 127, Boonton NJ 07005; North American SW Association, Box 13, Liberty, IN 47353; American Shortwave Listeners Club, 16182 Ballad Ln, Huntington Beach CA 92649).

Backtalk. All right, let's dig right into the mailbag and see what you readers have to say.

First comes a quickie from John Barth of San Francisco: "I've heard SWLs can get call letters. How?"

I'm a bit too windy to be that brief, John, but I'll try. Yes, you're right. The call letters are not official in the sense that they are not issued by the government as are amateur radio licenses, but they are issued by a private outfit which is Monitor and DX Headquarters, P.O. Box 333, Cherry Hill NJ 08034. It is run by well-

known DX author Hank Bennett. Though the calls—such as your DX Central editor's, WDX9EZ—are not official, they are distinctive and yours alone. There is a nominal charge. A stamped, self-addressed envelope sent to the above address will bring you the details of the registration, John.

"Recently I logged a shortwave station and would like to get its QSL," writes Kyle McKown of Arnoldsburg WV. "All they gave for an address was Haiifi and the station identified as 4VEH. I'm 14 and am very interested in shortwave listening."

(Continued on page 40)



The question becomes which RCA model.

Because when you compare our models with all others in their class, you'll see that RCA's solid state CB transceivers offer you exceptional quality and outstanding performance at a price that's right.

The 23-channel RCA Mobile CB two-way radio Model 14T100 has 4 watts maximum power output, LED transmit light, automatic level control, plus PA and external speaker jacks. Its S/Rf meter does double duty: input signal strength plus relative transmitting power.

RCA's deluxe 23-channel Mobile CB two-way radio Model 14T200 offers the same features as the 14T100 plus a few important extras. A delta-tune switch to improve reception when stations being received are slightly off-frequency; modulation light to show relative modulation level, and an ANL switch to reduce bothersome noise interference.

See the new CB Co-Pilot at your RCA Distributor. Or contact RCA Distributor and Special Products Division, Cherry Hill, Camden, N.J. 08101 (Phone: 609-779-5764).

CIRCLE 15 ON READER SERVICE COUPON

RCA CB Co-Pilot

The better the training the better you'll

Send for
FREE
illustrated
career
guide

NTS guide
to careers in
Electronics

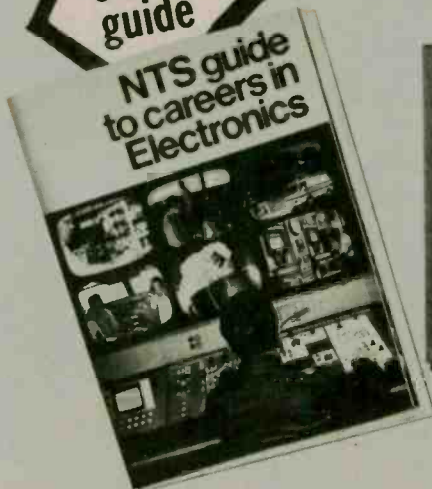

IN-CIRCUIT TRANSISTOR TESTER

TROUBLESHOOTER
VOM

COMPU-TRAINER

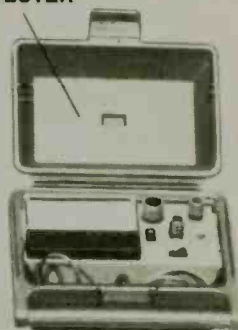
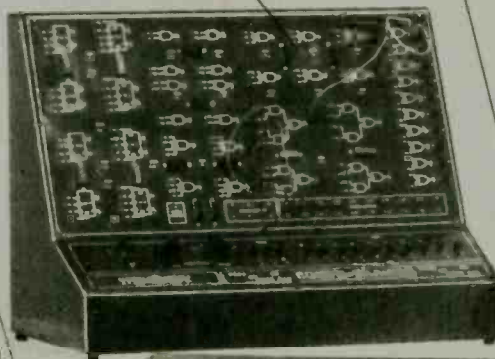

SOLID-STATE
OSCILLOSCOPE

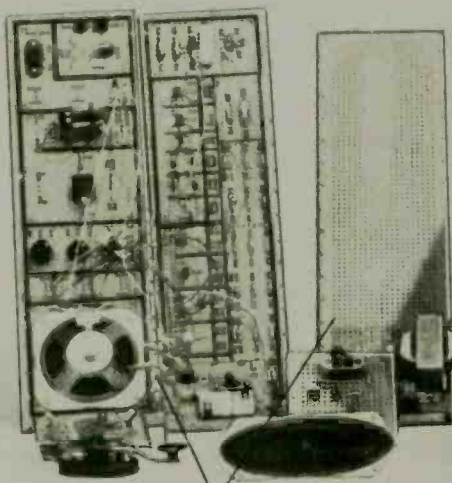

ELECTRO-LAB

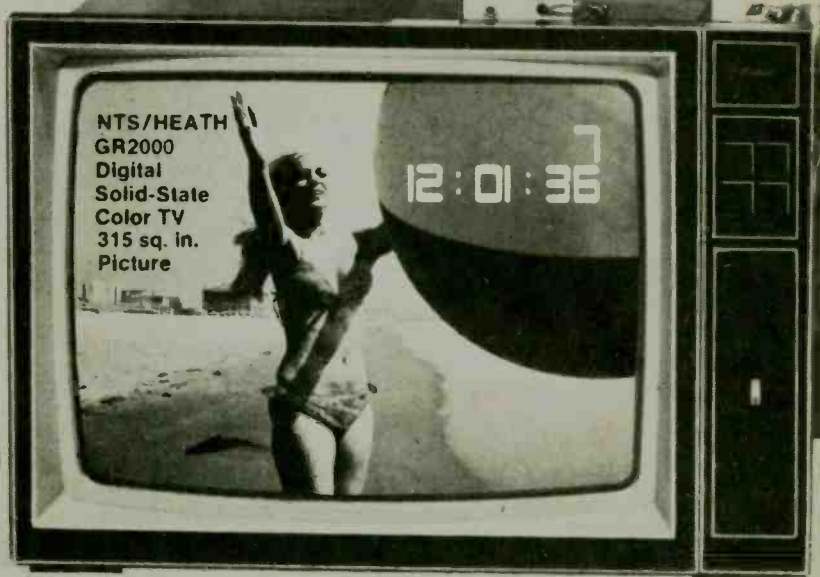

(Simulated TV Reception)

As an NTS student you'll acquire the know-how that comes with first-hand training on NTS professional equipment. **Equipment you'll build and keep.** Our courses include equipment like the **NTS/Heath Digital GR-2000 Solid State color TV** with first-ever features like silent varactor diode tuning; digital channel selection, (with optional digital clock), and big 315 sq. in. ultra-rectangular screen.

Also pictured above are other units — 5" solid state oscilloscope, vector monitor scope, solid-state stereo AM-FM receiver with twin speakers, digital multimeter, and more. It's the kind of better equipment that gets you better equipped for the electronics industry.

This electronic gear is not only designed for training; it's field-type — like you'll meet on the job, or when you're making service calls. And with NTS easy-to-read, profusely illustrated lessons you learn the theory behind these tools of the trade.

Choose from 12 NTS courses covering a wide range of fields in electronics, each complete with equipment, lessons, and manuals to make your training more practical and interesting.

Compare our training; compare our lower tuition. We employ no salesmen, pay no commissions. You receive all home-study information by mail only. All Kits, lessons, and experiments are described in full color. Most liberal refund policy and cancella-

and the equipment be equipped.

**COMPARE OUR
KITS AND LESSONS.
COMPARE OUR
TUITION.**

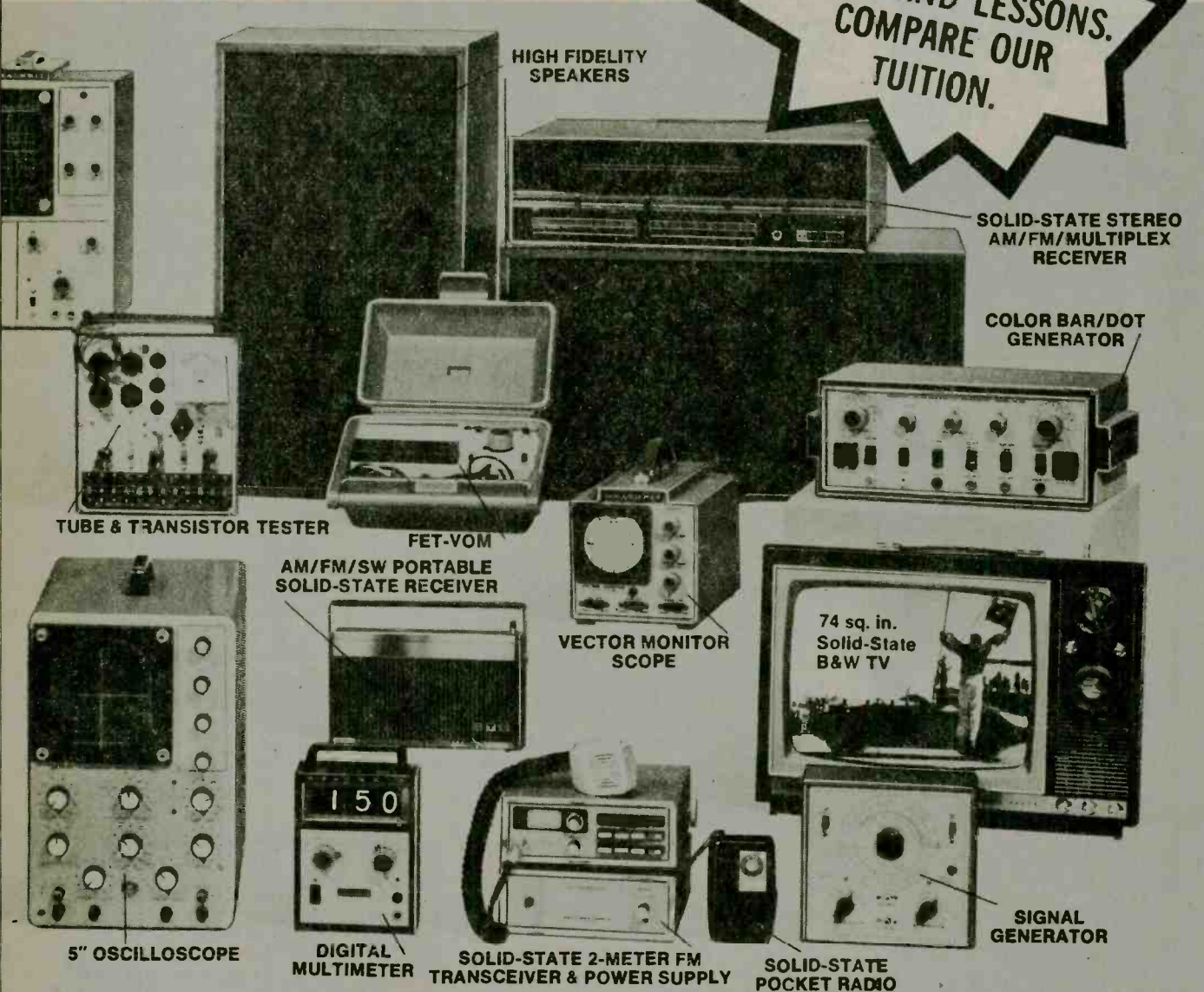

tion privileges spelled out. Make your own comparisons, your own decision. Mail card today, or clip coupon if card is missing.

NO OBLIGATION. NO SALESMAN WILL CALL

APPROVED FOR VETERAN TRAINING

Get facts on new 2-year extension

NATIONAL TECHNICAL SCHOOLS

TECHNICAL-TRADE TRAINING SINCE 1905
Resident and Home-Study Schools
4000 So. Figueroa St., Los Angeles, Calif. 90037

NATIONAL TECHNICAL SCHOOLS

4000 South Figueroa St., Los Angeles, Calif. 90037

Dept. 222-056

Please send FREE Color Catalog and Sample Lesson.
NO OBLIGATION. NO SALESMAN WILL CALL.

- | | |
|---|--|
| <input type="checkbox"/> Color TV Servicing | <input type="checkbox"/> Electronics Technology |
| <input type="checkbox"/> B & W TV and Radio Servicing | <input type="checkbox"/> Computer Electronics |
| <input type="checkbox"/> Electronic Communications | <input type="checkbox"/> Basic Electronics |
| <input type="checkbox"/> FCC License Course | <input type="checkbox"/> Audio Electronics Servicing |

NAME _____ AGE _____

ADDRESS _____ APT # _____

CITY _____ STATE _____

Please fill in Zip Code for fast service _____

- Check If interested in G.I. Bill information.
 Check if interested ONLY in classroom training in Los Angeles.

DO YOU HAVE AN ALLIGATOR RIG?



ALL MOUTH AND NO EARS!

Now you can have
EARS that will
match your mouth...
with a TELCO
Boostwenty®
MODEL: 10-10



FREQ: 2-30 MHz
MOBILE IN-LINE PREAMPLIFIER
WITH RF SNIFFER CIRCUIT

**Boosts
your receive power
100 TIMES**
(a full 20DB gain)

AM or SSB

COMPLETELY AUTOMATIC OPERATION—Exclusive
Telco RF Sniffer Circuit operates instant
MIC is keyed

- CAN BE USED ON NEG. OR POS. GND VEHICLES
- INSERT BETWEEN XCVR & ANTENNA W/ STANDARD CO-AX CONNECTORS
- EASY TRUNK, FIREWALL OR DASHBOARD MFG.

BOOSTS DISTANT WEAK SIGNALS

- 2 MODELS AVAILABLE: BT-20 AM for AM and BT-20 SSB with built-in SSB delay

OPERATES ON 10-15 VDC; 50 MA MAX.
SIZE: 1 1/2" x 1 1/2" x 6" long overall.

Add SIGNAL POWER to your MOBILE RIG without
modification; the easy way with BOOSTWENTY!

MADE IN U.S.A.



INNOVATORS IN COMMUNICATION ELECTRONICS

(515) 759-0300

44 SEACLIFF AVE. GLEN COVE, N.Y. 11542

DX CENTRAL

(Continued from page 35)

Good for you, Kyle! Like you, I began listening at an early age, although my start at age 11 beats you by a bit. That was nearly 30 years ago! How time flies when you're having fun, no?

Your Haitian station, Kyle, can be QSLed by writing to *Radio Station 4VEH*, Box 1, Cap Haitien, Haiti. You didn't mention the time or frequency of your logging, but based on when others are hearing it, I'd guess it was sometime around 1200 to 1400 GMT on 11,835 kHz.

Finally, this month, here's a letter from a Southfield, MI listener, Gedas Vysniauskas, who asks about a couple of lesser-known time/frequency stations.

"The time signals are heard on 7,500 kHz and 6,100 kHz. My listening time is about 0500 to 0800 GMT, the only time I have been able to hear them. Could you help me identify them?"

ASK HANK, HE KNOWS

(Continued from page 20)

Which Tape?

On my home cassette, I have Chrome/Normal equalizer switch. Can I use (play) chromium tapes through my car unit which has no switch?

—M. M., Pittsburgh, PA

Sure you can. Most car units can't tell the difference between the tapes because their maximum performance falls below the tape limitations.

Solid Gold

I know how a gold leaf electroscope works, but why gold leaf?

—D. B., Norman, OK

In an electroscope the gold leaves rest hanging down against each other. When a static charge covers the leaves, this charge is alike on both leaves and the leaves are repelled. If the leaves were heavy, it would take a large charge to displace the leaves, whereas the function of the electroscope is to detect very small charges. Gold is a heavy metal but it can be pounded into very thin leaves that would float on a whisper of air. That is why gold leaves are used and are contained inside a glass jar where air motion cannot disturb the leaves.

SWL Kickoff

I am 15 years old and I want to purchase a Heathkit SW-717 4-band short-wave receiver. Is this a good receiver for a beginner like me?

—D. W., Somerville, NJ

Any receiver is a good receiver to start with. I began with a one-tube triode I built from magazine plans.

Can You Help Out?

Δ Ric Keefe of 8402 John Dowel Rd. #14, Tacoma, WA 98499 needs the schematic diagram and instruction book for the Marka-Sweep Model 1-F made by Kay Electric Co. of Pine Brook, NJ.

Δ Kirk Butler has a 1942 Philco Model 42-360 receiver that he wants to restore.

You bet, Gedas! You made things easy for me because you hit the frequencies right on the head. Too many readers asking for help in IDing stations give only rough frequency approximations which often makes the task well nigh impossible.

Your outlet on 7,500 kHz is VNG, the standard time/frequency station of the Australian Post Office at Lyndhurst. It can be heard on 4,500 and 12,000 kHz as well and the address is 57 Bourke St., Melbourne, Vic. 3000, Australia.

Listen a bit longer next time, Gedas. There is a voice announcement on the quarter hour.

Harder to hear, because it is in the middle of the 49 meter shortwave broadcast band, is your station on 6,100 kHz. This is YVTO, *Observatorio Cagical*, a Venezuelan time-ticker. It also has voice announcements, but they are in Spanish. The address is Apartado 6745, La Planicie, Caracas, Venezuela. ■

He needs help. Write him at 57045 Mayflower Rd., Lot 96, South Bend, IN 46619. Δ Dr. Frank Porth would like a schematic diagram of a Korting Studiotone, Trident T200 made by Schneider Sound Equipment, Ltd. of West Germany. The good doctor receives mail at Box 815, Fort Qu'Appelle, Saskatchewan, Canada SOG-1S0.

Δ If you can, send to Allen Fryou, 3735 Fairmont Dr., New Orleans, LA 70122 schematic and wiring diagrams for Echophase (Echophone Commercial) 3-band radio.

Δ Bruce Ritter has to do some extensive restoration work on a CMX 46159 radio that the previous owner modified. If you can help, write to Bruce at 22208 Ave. San Luis, Woodland Hills, CA 91364.

I wish to thank all those readers who lent a helping hand in the past. Your help made many people happy and made my work enjoyable. I do not have the space to publish thank you letters, but rest assured they come every week. Keep up the good work. (Continued on page 86)

Don't sit back... REACT!

Join the REACT Team...
Monitor Channel 9
... Help provide
emergency communications.

Write for Free pamphlet...
you can join the
REACT Team.



REACT International, Inc.
111 E. Wacker Drive, Chicago, IL 60601
An Independent Non-Profit
Public Service Organization



SILTRONIX

Apache and Mohawk. Big talk power for very little wampum.

Our new AM Citizens Band radios bring you the same kind of straight-arrow performance that made Siltronix a big name in CB.

At prices you can afford.

Apache gives you 23 channels of easy-to-use communications with all the power the law allows and all the features most people need for only \$139.95.

Like an RF power/received signal meter that lights up when you

transmit. Built-in automatic noise limiter. Public address jack and external speaker jack. And microphone and mobile mounting bracket included.

Rugged and dependable when the going gets toughest, the all-solid-state Apache is a real friend in the back country.

For CBers who have to operate on crowded freeways and deep in the wilderness too, for only \$169.95

Mohawk gives you features like automatic noise limiter switch and front-panel RF gain control to help you handle big signals in heavy traffic or sensitize your rig for the very weakest.

Get a war whoop, not a whimper. Put Apache or Mohawk under your dash. Or ask about our Cherokee, the big chief in single sideband. At your dealer's now.



BIG NAME IN CB

A Division of Cubic Corporation • 330 Via El Centro • Oceanside, CA 92054 • (714) 757-8860

CIRCLE 36 ON READER SERVICE COUPON

You're known by the company you keep!

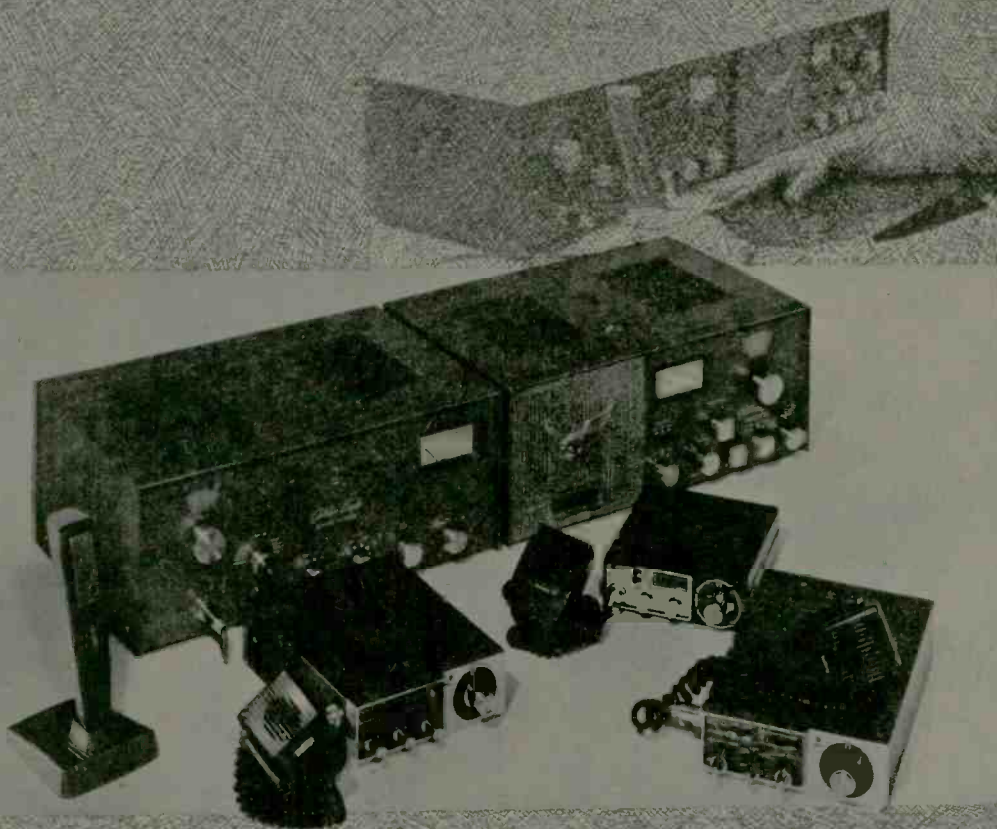

Owners of Citizens Band radios represent a unique consumer group whose word-of-mouth product opinions are voiced using the product itself! These users, who "tell it like it is," have established Browning as the industry's quality leader. In the status-conscious CB fraternity, owning a Browning Golden Eagle means owning the very best—a fact that has been substantiated by actual user resale prices for the past ten years.

As pioneer in the electronics industry for over half a century, Browning has established a heritage of craftsmanship that CBers know and trust. Be it base station or mobile, every Browning unit is backed by an outstanding service policy unequalled in the industry.

For further information about Browning, talk to any of the more than 4,000,000 licensees or write for your free full-color brochure of all Browning products from

browning
laboratories inc.
LACONIA, NEW HAMPSHIRE 03246
TELEPHONE (603) 524-5454

There are so many test instruments with digital read-out available for the experimenter and technician to use today that it seems old-fashioned to use the familiar kind, the ones which have standard meter-scale faces. The old-fashioned needle movement may never completely disappear, but the digital meter has so many good things to offer, that it is fast overtaking the older kind. For the hobbyist and the circuit designer, the digital meter is not only desirable, but also a real asset. Digital meters give precise and quick, easy-to-see readings that the needle-movement can't offer. This has caused a bunch of manufacturers to jump on the bandwagon and offer a variety of assembled digital meters and kits. Most units on the market are the bench-top type, and the hand-held type has hit the market hard in recent months. These units, however, are priced around \$150, although some kits are available for as low as \$80. For the hobbyist needing a digital voltmeter (DVM) at

a low cost there seemed to be no answer—until now. Born from M'Lady's Legs. The Digital Egg is not a toy. The egg shape was conceived from the packaging used to enclose L'eggs brand panty hose. The electronics part of the Digital Egg DVM is easy to build, easy to use, accurate, and inexpensive. Further, it is professionally designed so that it has features you would not expect to find in such a simple unit. In short, our Digital Egg DVM is a hard-boiled competitor that is hard to beat.

Features. Pick Digital Egg up, press the button, touch its antenna-like probe to a voltage point in the circuit and the common lead to ground. Then read the voltage from the three-digit LED display. No need to worry about loading down your breadboard circuit, because the input impedance of Digital Egg is over 1 megohm. If the polarity at the probe is negative, the LED display will read "88.8." This tells you to flip the polarity switch to get the proper negative reading. The Digital Egg goes from 00.0 (zero) to 99.9 DC volts in 0.1 volt steps. And there is no scale switch to fuss with! The 0-to-99.9 DC volt range is all on one scale. The accuracy of your readings will be about 2 percent (typical), which is

better than most needle-movement meters. And this accuracy does not fade away as the supply battery voltage drops; it holds on to the last drop of juice.

How it works. Resistors R2 and R3 provide a voltage divider so that any voltage across the input clip and probe at S2 is divided by approximately 100. When a 50 volt input is read, for example, the voltage applied to the input of the analog-to-digital converter in the Digital Egg is only 0.50 volts. By painting (or inking) the decimal point at

No bunny brought this egg...

It's DIGITAL EGG a digi-voltmeter

This little treasure egg, popular with the fair sex, measures volts from -100 to +100 in one-tenth volt steps—uses CMOS ICs and a mini-LED digital display.

by Norm Myers



e/e DIGITAL EGG METER

the proper place (see schematic) on the LED display, the output will read 50.0, which is *eggs-actly* right.

In the upper half of the schematic diagram is an operational amplifier (1/2 IC1) set up for unity gain, thereby providing high input impedance and the low output impedance required to drive input pins 1 and 2 of the analog-to-digital (A/D) chip, IC2. Resistor R1 and diode D1 simply work with the other operational amplifier in IC1. This op amp is arranged as an inverter so when the input voltage is opposite to the polarity required by IC2, pin 8 of IC4 is driven positive and the display is made to read "88.8." When this reading occurs during use, it tells you to flip switch S2 to reverse the polarity of the input.

Now let's see how the A/D conversion chips work. Chips IC2 and IC3 actually do the conversion while IC4 changes the binary-coded-decimal (BCD) output of IC3 to a seven-segment code to drive the LED display, LD1. These three ICs are state-of-the-art units fabricated in COSMOS form. COSMOS is an acronym for *complementary-symmetry metal-oxide semiconductor*. RCA calls their units COS/MOS, Motorola calls theirs McMOS, and the shorter term generally used by everyone is CMOS. The advantage of CMOS devices is that they consume very little power, typically a microwatt or less. This low power requirement is one reason battery B1 of the Digital

Egg will last so long. CMOS also offers a high level of on-chip complexity that generally exceeds that of DTL or TTL devices. Consider, for example, that whole calculators and clocks are placed on single CMOS chips, and in this project we see an entire A/D converter on two chips. The A/D conversion in IC2 and IC3 is accomplished by what's called *dual slope* conversion. The term *dual slope* comes from the way the ICs first charge up, and then discharge capacitor C1 in order to determine the magnitude of the input voltage.

Here's how it works. It is basically easy to understand. First, there is a clock inside IC3 which puts out pulses to IC2 at a rate determined by C2. The analog input voltage to pins 1 and 2 of IC2 causes integrating capacitor C1 to charge up, but only for a fixed number of clock pulses, which in this circuit is about 1000. This means that higher input voltages will put more current into C1 after 1000 pulses than will lower voltages. In fact, halving the input voltage means halving the charge. Now all that is needed is to determine in some digital way how much charge is on the capacitor, and that charge will tell what the input voltage is.

The amount of charge is determined by chip IC2 which automatically applies reference voltage (Vr) of opposite polarity across C1, at which point IC3 begins counting the number of clock pulses that pass before the capacitor is fully discharged. If, for example, C1 is fully discharged after 1000 pulses, then V1 (the voltage across pins 1 and 2 of IC2) must be equal to the reference voltage, Vr. In other words, if the

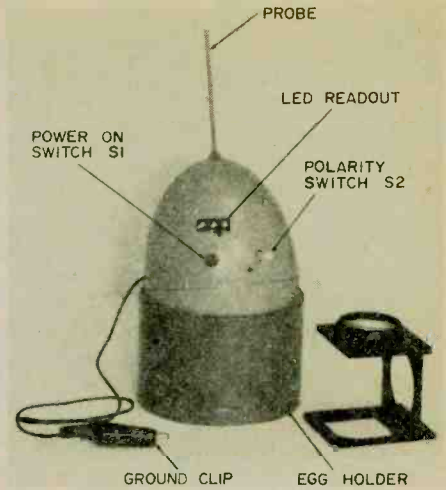

Digital egg sits in its holder (from Leggs package) when not in use. Power switch S1 is momentary-on, with spring to save battery when DVM egg is not in use.

charge put on C1 by V1 after 1000 pulses is completely removed by Vr after 1000 pulses, then V1 and Vr must be equal. If only 500 pulses are needed to discharge C1, then V1 must be 500/1000, or one-half, of Vr. The general equation that applies here is

$$V1 = \frac{K}{1000} \times Vr,$$

where K equals the *number of pulses required to discharge C1*.

Reference voltage. The reference voltage, Vr, is supplied by IC2 and made adjustable by R6, which is the full-scale adjustment for Digital Egg. After adjusting pot R6 for your particular ICs and components, Vr will be

Here's where the four ICs and handful of other small parts go on the printed circuit board—seen from components side.

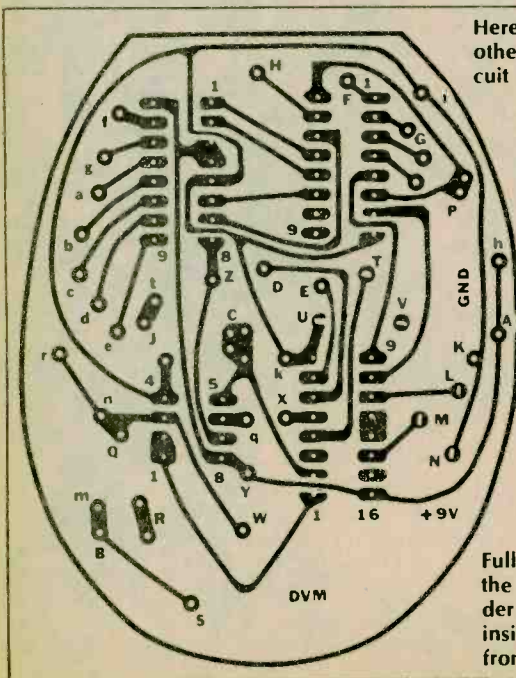

Full-size printed circuit board layout for the Digital Egg voltmeter has outside border shaped so you can trim it to fit neatly inside Leggs case. Etched board is available from supplier at address in Parts List.

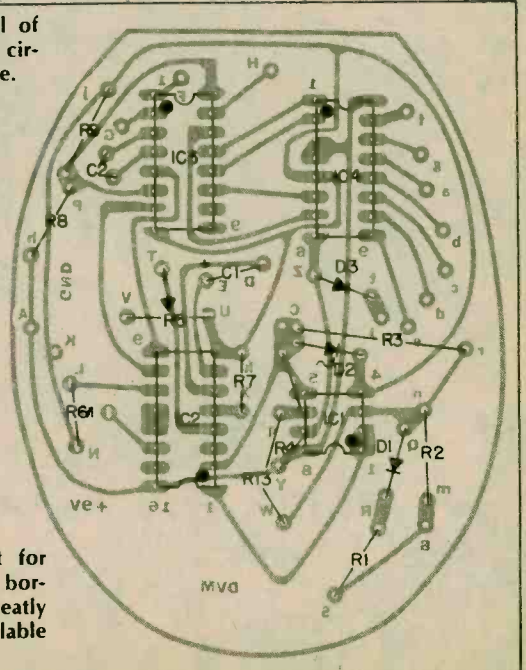

about 1 volt. Therefore, for a 15-volt input between clip and probe there will be a $15/100$, or 0.15, volt input to pins 1 and 2 of IC2 (V_1 , $2^1 = 0.15$). The above equation shows that there will be 150 pulses required to discharge C1 in this example. Chip IC3 will count these 150 pulses and translate that through IC4 to light "150" on the LED display (LD1). By having the decimal point permanently marked between digits 2 and 3 the output will read 15.0, as desired. There is also a zero adjust, R5, which prevents a zero input voltage from generating clock pulses and causing "00.0" to appear on the display.

You may be wondering how IC4 lights all three LED digits at once. Well, it doesn't—it lights them one at a time, but so fast that you "see" all three lit at once. The three leads out of pins 1, 2, and 15 of IC3 tell the LED display which digit to light, while the leads out of IC4 determine just which segments will be lit. This is the same multiplexing scheme used in most pocket calculators. It saves lots of wiring, cost, and battery power.

Construction. While the egg shell is not necessary in this project, it provides a good inexpensive case for a hand probe. The plastic egg can be obtained by buying a pair of nylon stockings in most any grocery store. The printed-circuit board provides the easiest construction because most of the wiring is already done. Also, without this circuit board, it is difficult to get everything inside the egg shell because the wiring

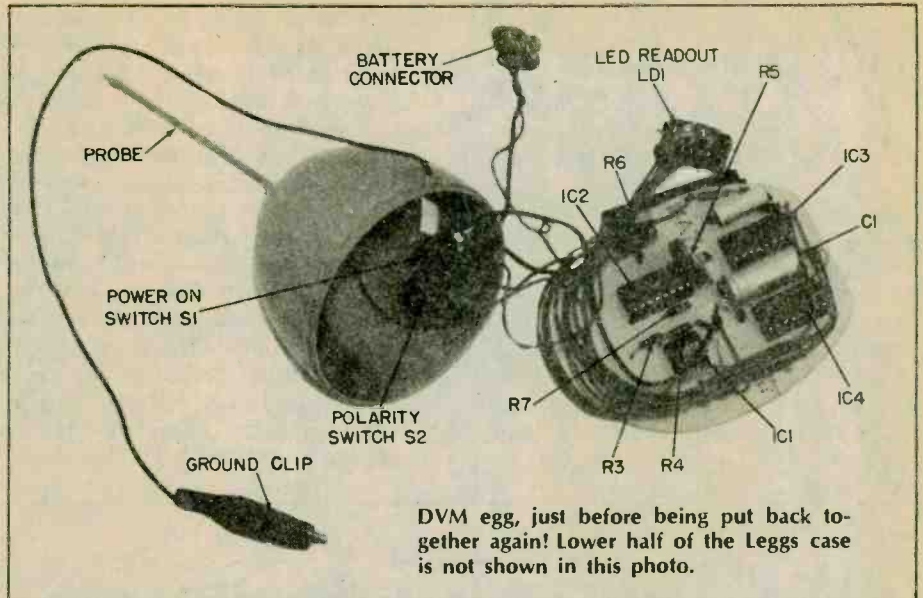

DVM egg, just before being put back together again! Lower half of the Leggs case is not shown in this photo.

might be too bulky. The printed-circuit board can be cut and filed to exactly fit your egg shell (or any other holder).

The author had a lot of fun placing the DVM inside a plastic egg shell. However, you may not find it so easy, or enjoyable. The DVM circuit can be spread out on a larger printed-circuit board and placed in a standard plastic box. How it's done is up to you.

An important point in constructing this (and other CMOS projects) is to take care in handling the ICs. The gate-insulation oxide can be destroyed by static electricity. It helps to be sure you are not carrying static charge before you handle the ICs (reach over and

grab a water pipe) and to be careful not to handle the units by their pins. Also, avoid placing the ICs on plastic material unless it is the conductive (black) plastic in which they are usually packaged. It's also important to be sure the power to any unit which uses CMOS devices is turned off before inserting or removing the ICs. Generally no problems arise in handling these CMOS devices, but it is best to be careful.

With or without the printed circuit board, construction begins by mounting sockets for the ICs. Low-profile sockets, such as Radio Shack 276-1998 (16 pin) and 276-1995 (8 pin for IC1) help save space. A low-profile socket can also be used to hold the LED display. The display has 12 pins, so Radio Shack type 276-1998 can be used to hold it. To plug in the display, first cut the leads just a bit in order to form a point on each. That way the leads will slip easily into the socket. Remember that the ICs must never be placed into the sockets until construction is complete. Again, the battery should be disconnected while the ICs are being inserted in place.

The zero-adjust potentiometer (R5) and the full scale-adjust potentiometer (R6) can be mounted after the sockets are in place. Position them to be accessible for adjustment. In connecting diodes D1, D2, and D3, be certain to place the cathode and anode in accordance with the schematics, and to use heat sinks on the leads (needle-nose pliers will do) to protect the CMOS devices while soldering. Remember, too, it is best in all construction using printed circuit boards or sensitive components like diodes and small resistors,

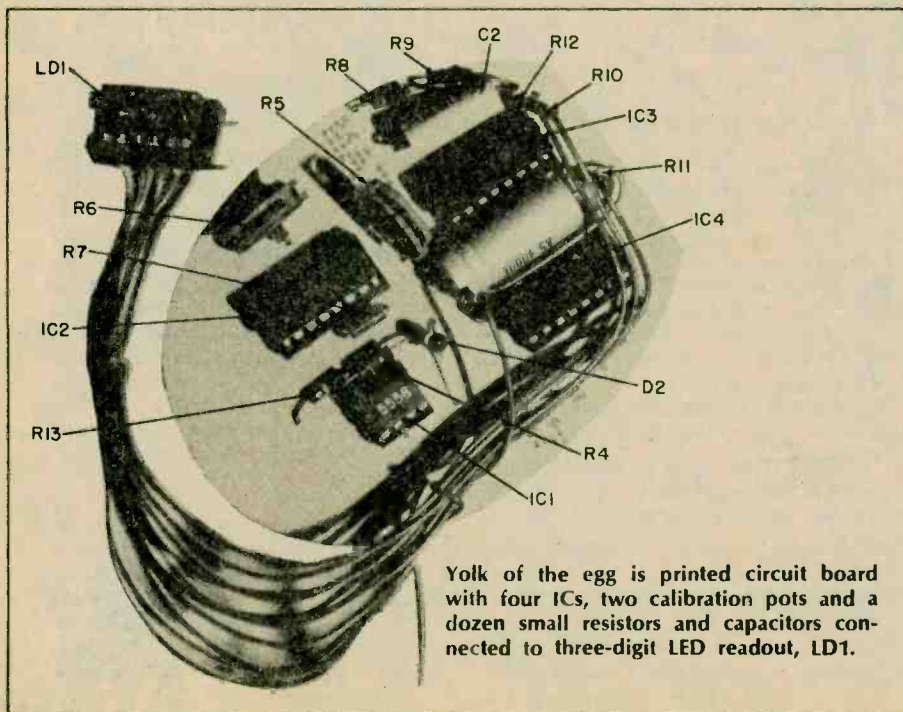

Yolk of the egg is printed circuit board with four ICs, two calibration pots and a dozen small resistors and capacitors connected to three-digit LED readout, LD1.

e/e DIGITAL EGG METER

to use a soldering iron with only a 25- or 30-watt heating element.

The slot in the egg shell for the LED display (LD1) can be cut with a hobby knife. Heating the knife makes the job go faster, but requires lots more care. The edges of the slot can be filed smooth. The switches can be mounted through the egg shell by drilling holes through the plastic. When you are ready to place the battery inside the egg, wrap it with tape first so that the

metal sides of the battery do not accidentally short-circuit some points on your circuit board. Also, by taping a large piece of foam rubber to the battery it can be made to fit snugly in the egg shell. The wire probe coming out the top of the egg is number 14 solid wire covered with insulation.

Printed Circuit Board. If you purchase the printed circuit board from the supplier in the Parts List you will find that the actual board is rectangular. To make the board into the required egg shape you can trim the board, which is a specially-selected glass epoxy, with a pair of scissors. Trim as close as possible to the outside of the oval foil which shows

the outline of the egg shape. After making the cutout with scissors, smooth the edges with medium or fine grade sandpaper to exactly the outside of the foil. When you've shaped the board exactly so it fits neatly into the egg you may leave the oval foil, or remove it, as you wish.

The board is shipped with a 3/64-inch drill which is just right for drilling most of the holes for mounting the components.

Some Changes. The author designed a printed circuit board layout which is illustrated in the photographs. The editors, as they usually do, saw fit to make some changes. For example, the au-
(Continued on page 85)

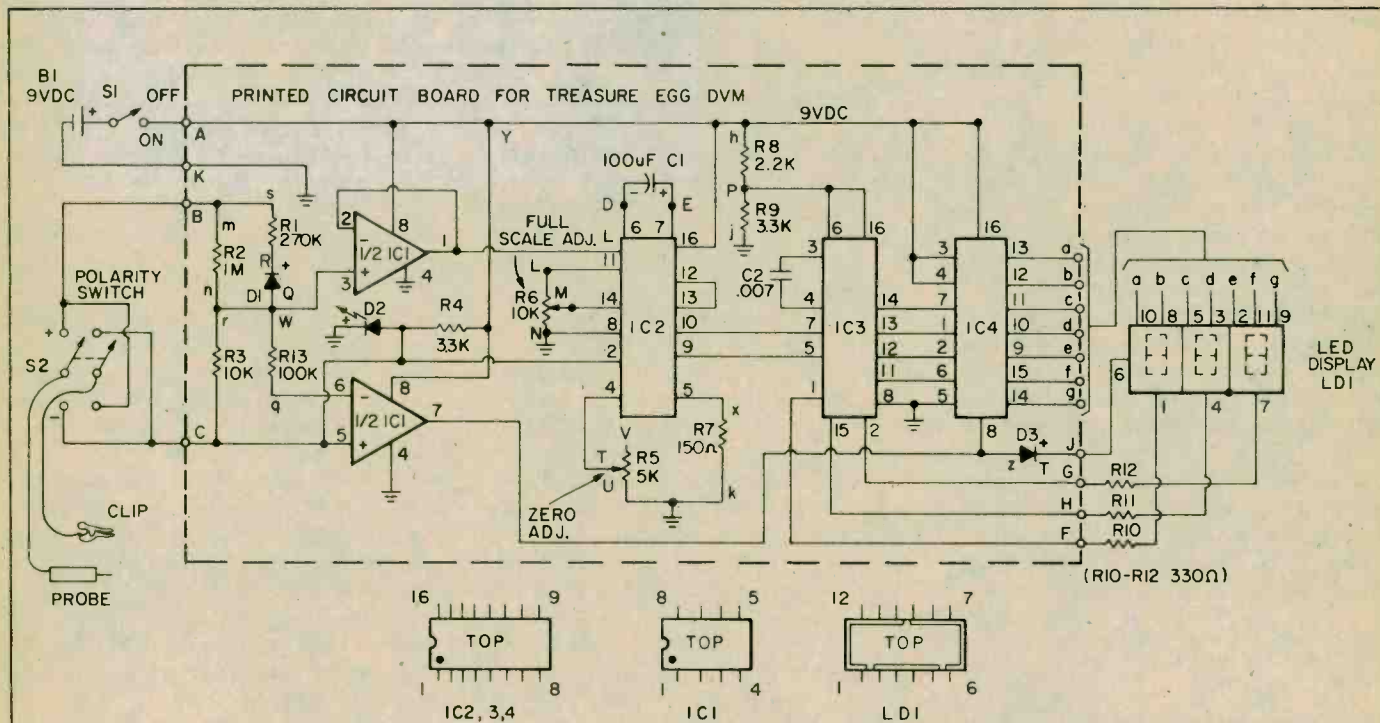

PARTS LIST FOR DIGITAL EGG

- B1—9-VDC transistor battery (Radio Shack 23-151 or equiv.)
- C1—100- μ F, 5-VDC or more electrolytic capacitor (Radio Shack 272-1005 or equiv.)
- C2—0.007 μ F, 50 VDC capacitor (Allied Radio 852-1434 or equiv.)
- D1, D3—1-A, 200-PIV diode rectifier (Radio Shack 276-1137 or equiv.)
- D2—LED, 1.5 to 2.5 forward volts at 20 mA (Radio Shack 276-042 or equiv.)
- IC1—Dual 741 op amp (Radio Shack 276-038 or equiv.)
- IC2—CMOS analog-to-digital converter IC (Motorola MC1405L)
- IC3—CMOS analog-to-digital converter IC (Motorola MC14435VP)
- IC4—CMOS binary-coded decimal driver IC for LEDs (Motorola MC14511CP)
- LD1—3-digit readout display (Radio Shack 276-055)
- R1—270,000-ohm $\frac{1}{4}$ -watt resistor*
- R2—1-megohm, $\frac{1}{4}$ -watt resistor*
- R3—10,000-ohm, $\frac{1}{4}$ -watt resistor*

- R4—3,300-ohm, $\frac{1}{4}$ -watt resistor*
- R5—5,000-ohm printed-circuit-board potentiometer (Radio Shack 271-217 or equiv.)
- R6—10,000-ohm printed-circuit-board potentiometer (Radio Shack 271-218 or equiv.)
- R7—150-ohm, $\frac{1}{4}$ -watt resistor*
- R8—2,200-ohm, $\frac{1}{2}$ -watt resistor (Radio Shack 271-000 or equiv.)
- R9—3,300-ohm, $\frac{1}{2}$ -watt resistor (Radio Shack 271-000 or equiv.)
- R10, R11, R12—330-ohm, $\frac{1}{4}$ -watt resistor*
- R13—100,000-ohm, $\frac{1}{4}$ -watt resistor*

- *NOTE: If space allows, you may substitute $\frac{1}{2}$ -watt resistors (Radio Shack 271-000 or equiv.) for $\frac{1}{4}$ -watt resistors.
- S1—SPST pushbutton switch, normal-off (Radio Shack 275-1547 or equiv.)
 - S2—DPDT toggle switch (Radio Shack 275-614 or equiv.)
 - Misc.—Case made from Leggs hosiery package; printed circuit board kit (Radio Shack 276-1576 or equiv.; IC mounting sockets—three

16-pin (Radio Shack 276-1998 or equiv.), one 8-pin (Radio Shack 276-1995 or equiv.); #22 stranded wire; solder; cement; etc.

A kit of three CMOS Motorola integrated circuits, IC2, IC3, IC4 (MC1405L, MC14435VP, and MC14511CP), for the Digital Egg DVM may be ordered from Corvair Electronics, Inc., 150 Fifth Ave., N.Y., NY 10011. Send postal money order for \$22.95 for Kit 101. It will be sent to you via postpaid, insured mail. N.Y. State residents add applicable local sales tax.

A printed circuit board for the Digital Egg voltmeter may be ordered from Techniques, Inc. 236 Jackson St., Englewood, N.J. 07631. It will be shipped via first class mail anywhere in the United States and Canada for \$2.95. (N.J. residents add 5%). Included with the board is a 3/64-inch drill.



Royce re-invents **THE WIRELESS**

Biggest
breakthrough
in personal
communications
since the
transistor!



Royce brings computer technology to CB!

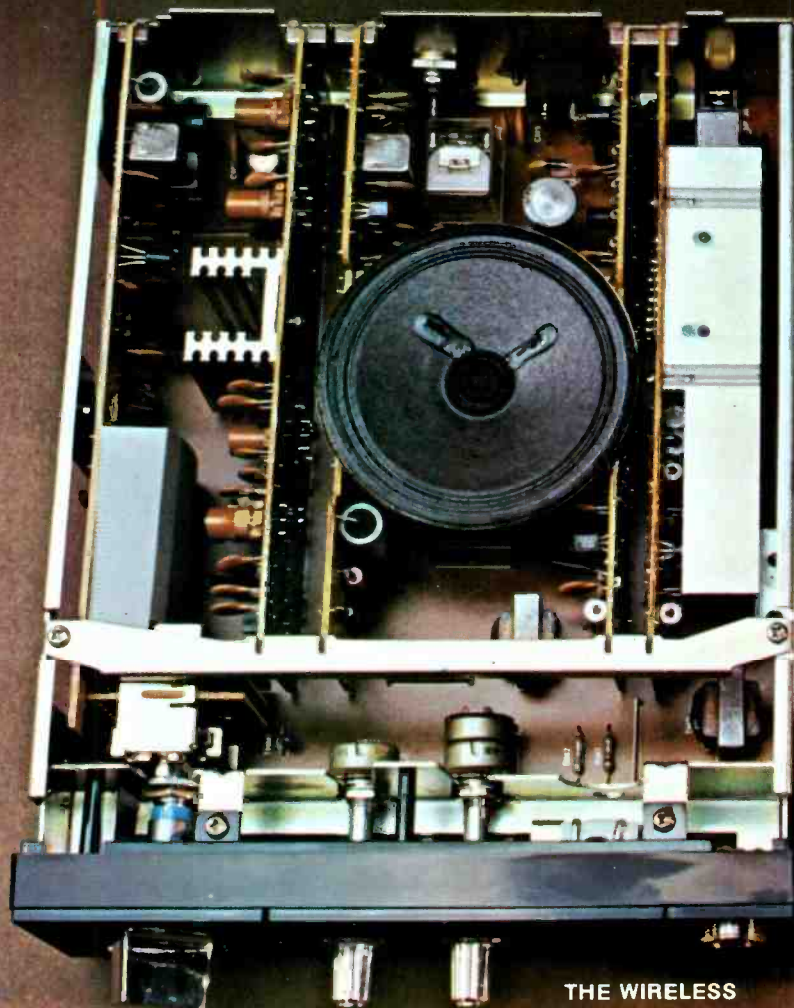

THE WIRELESS

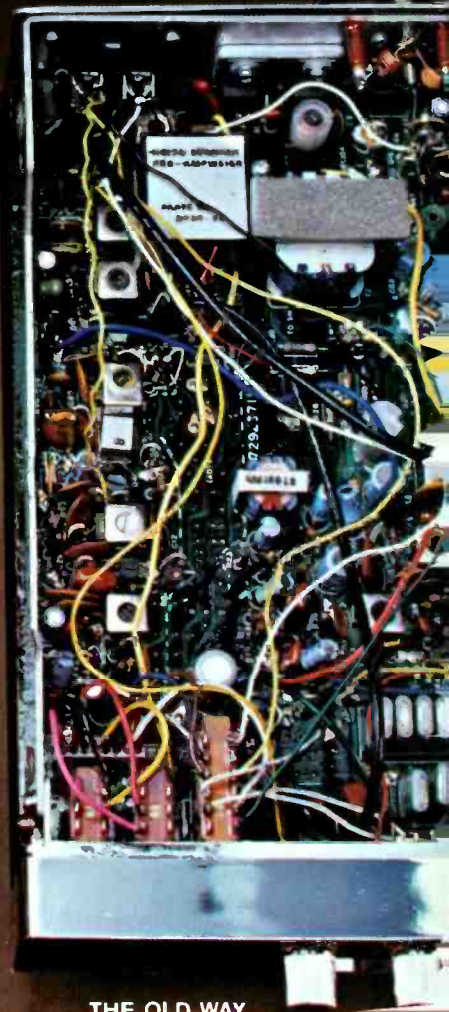

THE OLD WAY

THE WIRELESS in 6 new models



ROYCE MODEL 1-650

THE WIRELESS chassis. Illuminated 1" X 1" S/R/F meter. Synthesized 23 channel circuit—no crystals to buy. External speaker jack—for large, remote speakers. Custom, plug-in mike. Deluxe styling. New black mat camera finish cabinet with custom burl wood inset. Smoked glass black-out dial with soft green channel indicator. Plus Royce quality extras listed above.



ROYCE MODEL 1-653

THE WIRELESS chassis. Full 23 channels from Royce's exclusive Gyro-Lock (PLL) system—No crystals to buy. Advanced integrated circuits replace most of the crystals formerly required. Large, illuminated S/R/F meter. Pushbutton ANL switch which cuts noise, static. Pushbutton PA/CB switch—converts unit to powerful 6 watt P.A. system. Accessory jacks. Full-size plug-in mike. Plus Royce quality extras listed above.



ROYCE MODEL 1-655

THE WIRELESS chassis. Gyro-Lock (PLL)—full 23 channel operation. Large, illuminated 1 1/4" X 3/4" S/R/F meter. Continuous fine tuning control. Pushbutton ANL switch. Pushbutton PA/CB switch. Pushbutton RF Gain Control. Full-size, plug-in mike. Accessory jacks for external speaker, P.A. speaker, antenna, EC power cord. Plus Royce quality extras listed above.

THE WIRELESS has benefits you can read loud and clear!

THE OLD WAY. A tangled mass of wires and hand-soldered connections.

THE WIRELESS. Automated module assembly. Computer tuned and quality controlled.

That is why **THE WIRELESS** chassis promises less chance of failure.

Computer tuning and testing means peak power and performance.

And, automated module assembly assures uniform quality.

Here is greater CB reliability than ever before.

That is why **THE WIRELESS** by Royce is turning the personal communications world upside-down!

Follow the new leader — Royce!

Other quality extras found on all Royce WIRELESS Transceivers:

- **THE WIRELESS CHASSIS**—modular construction.
- Exclusive IC audio stage—6 watts RMS for maximum clarity and power.
- Amplified AGC circuit—a Royce extra which not only helps you pull in weak stations, but prevents overload from nearby stations.
- 3 ceramic filters—twice as effective as most sets in reducing adjacent channel interference.
- Dual conversion receiver plus tuned RF stage—pulls in even weakest signals.
- Metal case RF output transistor—more rugged than conventional plastic types used in most sets.
- Positive or negative ground operation for any vehicle—plug in DC cord.
- Relay switching—permits reception without mike.
- L.E.D. transmit light—indicates set is in transmit mode.
- AMC circuit—for maximum transmitter talk power.
- Fully variable squelch control—reduces background noise.
- Large 3" speaker—for greater clarity.
- Beautiful, yet rugged, vinyl-clad metal cabinet—scuff-resistant.

with these special features!

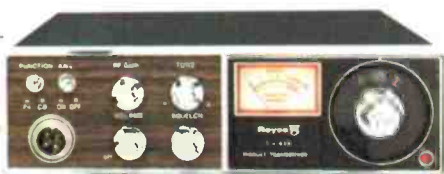

ROYCE MODEL 1-658

THE WIRELESS chassis. Vol-U-Mike lets you adjust receiver volume level from microphone or front panel. Large, illuminated 1 1/4" X 3/4" S/RF meter. Pushbutton ANL switch minimizes noise, static. Pushbutton PA/CB switch. Continuous RF Gain Control and Fine Tuning. Gyro-Lock (PLL)—full 23 channel operation. Accessory jacks for external speaker, P.A. speaker, antenna, DC power cord. Plus Royce quality extras listed above.



ROYCE MODEL 1-660

THE WIRELESS chassis. Digital readout dial system gives channel selection in bright L.E.D. numerals. Gyro-Lock (PLL)—23 channel operation. Large, 1 1/4" X 3/8" S/F/F meter. Pushbutton ANL and PA/CB switches. Full-size, plug-in mike. Accessory jacks for external speaker, P.A. speaker, antenna, DC power cord. Plus Royce quality extras listed above.



ROYCE MODEL 1-662

THE WIRELESS chassis. Vol-U-Mike lets you adjust receiver volume level from microphone or front panel. Digital readout dial system for channel selection in bright L.E.D. numerals with pushbutton bright/dim switch. Gyro-Lock (P_L)—23 channel operation. Large, 1 1/4" X 3/8" S/RF meter. Pushbutton ANL and PA/CB switches. Continuous RF Gain Control and Fine Tuning. Accessory jacks for external speaker, P.A. speaker, antenna, DC power cord. Plus Royce quality extras listed above.

Here's the rest of the line that catapulted Royce into CB industry leadership!

Many of these Royce Models have features that Royce either introduced or produced first. Examples: Chan-L-Matic (Channel selection from set or mike); Vol-U-Mike (Volume control in microphone); Digi-Tron (Digital Readout—large windows, easy-to-read numerals); Warn-Tron (Antenna protection circuit); and Gyro-Lock which is Royce's phase lock loop system.



NEW! Royce Model 1-614
In-Dash CB/AM/FM Stereo



Royce Model 1-580
3-Piece Remote Control Unit



Model 1-640



Model 1-612



Model 1-602



Model 1-636



Model 1-610



Model 1-601



Model 1-635



Model 1-606



Model 1-600



Model 1-624



Model 1-605

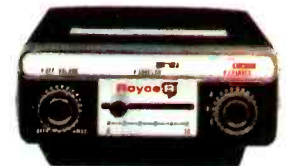

Model 1-590



Model 1-620



Model 1-603

Model 1-408

WRITE FOR CATALOG TODAY! Get more information on THE WIRELESS plus detailed information and specifications on the full Royce CB line, antennas and accessories.

Follow the new leader!



Royce

Royce Electronics Corporation
1746 Levee Road
North Kansas City, Mo. 64116
Call: (816) 842-7505 • Telex: 426-145

Build a Heat Controller for Your Soldering Iron

By John Keidel and Frank Cicchiello

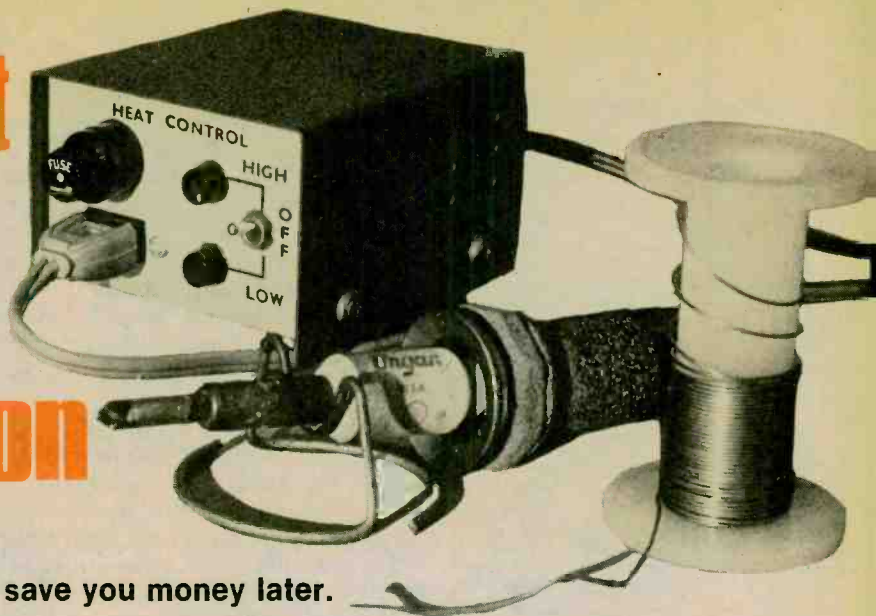

Inexpensive and easy to build, it will save you money later.

One trick that old timers have used for years is to connect a diode in series with a medium-to-heavy duty soldering iron. This halves the value of the iron's wattage rating, making it especially use-

ful for soldering transistors, integrated circuits and low-wattage resistors.

But this arrangement limits the versatility of the iron, since there are times when one may wish to solder to a metal

chassis or make other heavy-duty type connections. The soldering iron Heat Controller described here provides low/high-wattage versatility in a compact case, with a convenience outlet.

How It Works. Diode D1 shown in Fig. 1 provides half wave rectification of the AC line voltage when switch S1 is in the *Low* position. Throwing switch S1 to the *High* position allows full line voltage to be applied to the soldering iron receptacle. The center *OFF* position removes power from the outlet. Fuse F1 prevents any harmful effect if the iron's element should become short-circuited. Indicator lamps I1 and I2 add a professional touch to the equipment, and also act as On-Off pilot lights.

Construction. All components except diode D1 are mounted on the case. Diode D1 is soldered to a terminal strip, which also provides terminal points for the various interconnecting wires. Wiring is point-to-point and not critical. The photo illustrates the location of the components. Transfer letters are used for the individual panel markings.

This is a very easy project, and the hour or so it takes to assemble it (once you've got the parts together) will be quickly repaid by the added convenience of having two different iron heats to work with.

Using the Heat Controller with a 50-watt soldering iron which takes various tips will handle about 95 percent of all your soldering iron work. It's only the very occasional super-heavy job that will require anything else, and that would require a much bigger iron anyhow. ■

Mechanical layout of heat controller. Putting this project together is not only good practice for beginners—it gives you a versatile tool which will make future projects easier.

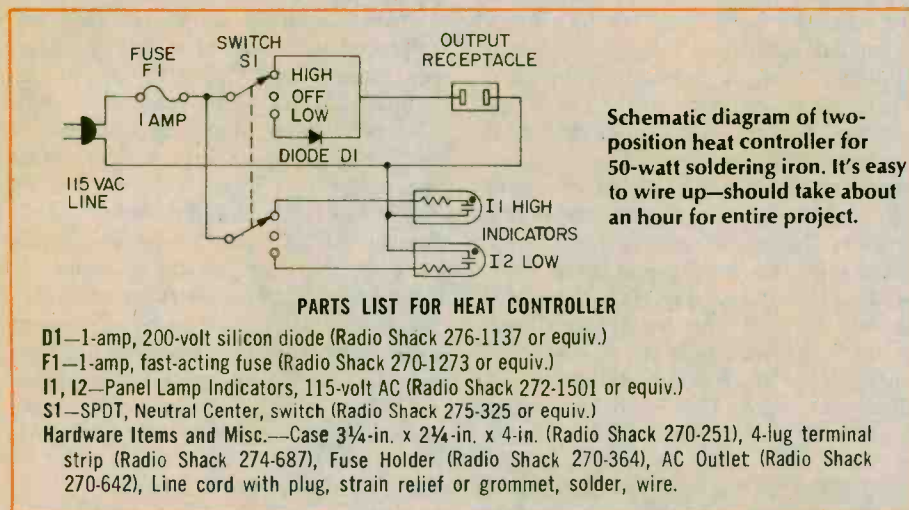

PARTS LIST FOR HEAT CONTROLLER

- D1—1-amp, 200-volt silicon diode (Radio Shack 276-1137 or equiv.)
- F1—1-amp, fast-acting fuse (Radio Shack 270-1273 or equiv.)
- I1, I2—Panel Lamp Indicators, 115-volt AC (Radio Shack 272-1501 or equiv.)
- S1—SPDT, Neutral Center, switch (Radio Shack 275-325 or equiv.)
- Hardware Items and Misc.—Case 3¼-in. x 2¼-in. x 4-in. (Radio Shack 270-251), 4-lug terminal strip (Radio Shack 274-687), Fuse Holder (Radio Shack 270-364), AC Outlet (Radio Shack 270-642), Line cord with plug, strain relief or grommet, solder, wire.

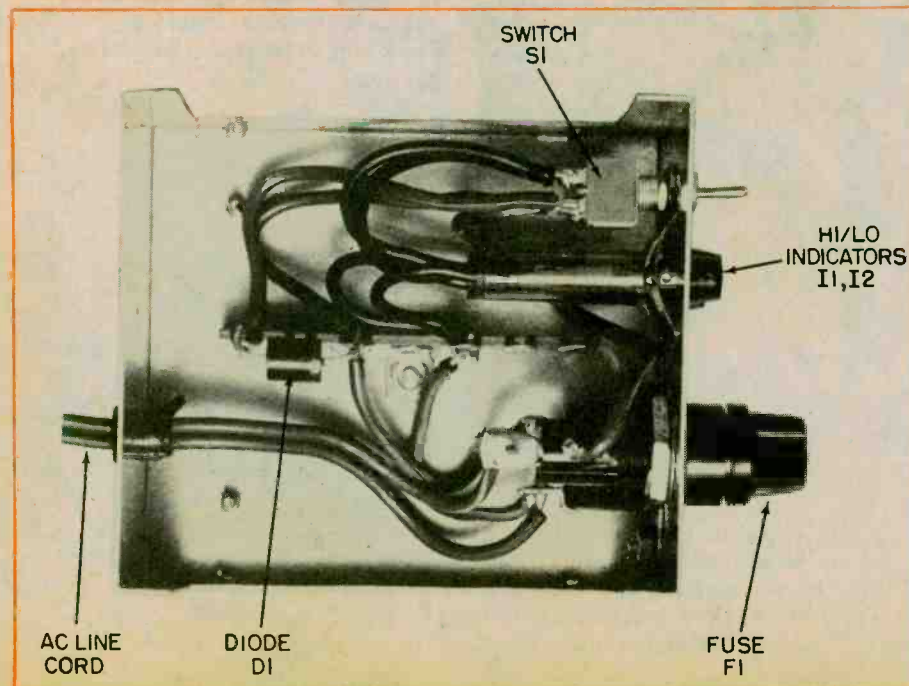

DX with BOINGER

IF YOU'RE an apartment-dwelling DXer, you've no doubt had your share of the age-old antenna hassle. Sad to say, few landlords sympathize with a shortwave listener's need for a good skyhook.

For those of you whose nerves are just about shot from the continual carping about your antenna ("... that confounded wire of yours was crudding-up Kung Fu last night!"), the "Boinger" will bring fast relief.

What's The Boinger. Simply put, it's an inconspicuous *canned* antenna that'll sit on your windowsill, drawing about as much attention as yesterday's newspaper. Fact is, people just don't notice this little marvel. That's the beauty of it! But at the push of a button, this DX-dangler literally springs into action for you, as it accordions out to a fully-expanded shortwave longwire antenna. "Boinger" will be music to your ears. That's the sound made by the key to this antenna, a super-long spring. And as it unravels, it'll also unravel your aerial problems. And when you're ready to call it quits for an evening, just a few turns of the crank retracts the Boinger back into the hardly-noticeable case, ready for another day. It's been suggested we call this unit the "Candestine" (clandestine can antenna), since it does incorporate a bit of the old cloak-and-dagger. Call it what you may, it works in even the most impossible

antenna conditions.

How It Works. Our Boinger is essentially an end-fed helically-wound longwire. The only big difference between it and the longwire most SWLs use is that it is vertically-oriented.

How do you find helically-wound wire? Believe it or not, the first place to check is in Junior's toy-box! Or, head for the local five-and-ten and ask for "the spring that walks down stairs by itself." Right—a "Slinky!"

Since the coil is vertical, gravity will help pull it down for you. Rigging it to a fishing reel will take care of pulling it back up again. You don't have to be 20 stories up to take advantage of this antenna since the helical winding allows you to pack tremendous wire length into a short distance.

How To Build It. You'll need the following items, all of which shouldn't run more than \$6 to \$10:

Slinky. Actually it's a highly stretchable coil which folds down to only a few inches, but can stretch clear across the street.

Tin can to house the spring, about four-inches in diameter by five-inches deep. A salted peanut tin is perfect.

Some odds and ends from your fishing gear—a handful of lead weights, and a fishing reel with heavy-duty line. Now don't panic, the cheapest reel available will do. We've seen, and *used* in our own Boinger, a plastic reel that goes

Canning Slinky after it is fixed to a wood insulating block. Here author is checking clearance of block and Slinky from can's inside.

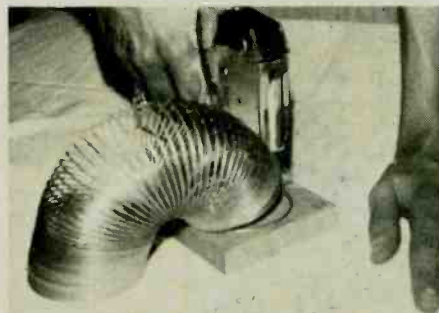

If you decide to solder the lead-in wire to Slinky, use an X-rated iron—something that really gets hot. Slinky can draw away lots of heat before the solder flows.

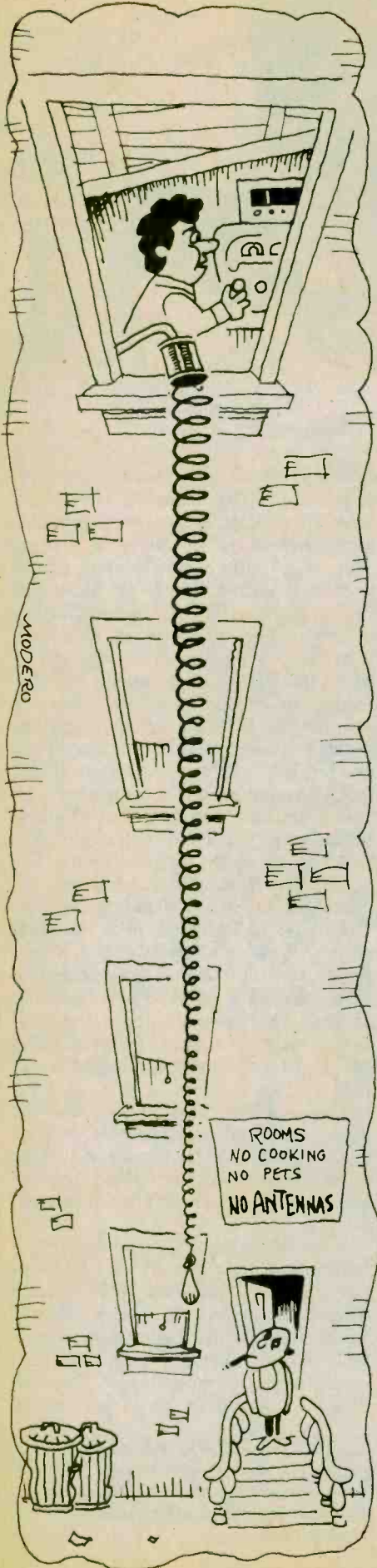

Here's how you can lick the no-antenna-on-the-roof edict landlords use to torture SWLers—by Ralph W. Perry

for about \$3.

1/2-in. conduit pipe cut to the length you need. Aluminum electrical conduit is easy to bend, and you'll need a screw-end adaptor to secure it to the can. If you use iron pipe, it can be threaded at the can end, but it's hard to bend. However, elbow pieces are available. Look at *1/2-in. copper tubing*. It's easy to work with and can be soldered to the tin can.

Miscellaneous hardware: clamps, screws, and a piece of *1/2-inch-thick wood* to fit in the can.

Construction. Solder an insulated leadin wire to the top end of the Slinky coil—or secure it with a machine screw. Any way you do it is okay so long as it's mechanically secure. Be sure not to let the antenna leadin wire contact the can or the conduit.

The conduit pipe serves double-duty in the Boinger. It is both the support for the unit and the feeder channel for the fishing line that controls the antenna's ups-and-downs. Bend the pipe into a flattened-out Z, with the center strut at right angles to the ends. Then, lay the pipe down flat and bend one end so it points straight up.

Put the wood-coil assembly into the can, and drill a hole through both, big enough for the pipe to fit through. Slip the end of the pipe (the end you made the last bend in) through the hole in the top of the can and through the

wood, clamping both below and above with epoxy glue or threaded pipe and nut so it is solidly joined. Slip the wire through a hole in the can top, and tape it along the length of the pipe. It's a good idea to liberally apply putty or silicone sealer to the can top to seal the cracks—the Boinger will withstand some pretty rough weather.

Now, thread the fishing line into the far end of the pipe and pull it through the coil. Make a cross-hatch with two wires across the *bottom* loop of the Slinky (opposite end from the solder), and tie the fishing line, along with a few weights, here.

Mount the fishing reel on your inside window sill, and bolt the pipe to the outside wall. Depending upon the type of window, you may have to cut a small piece of glass out of the corner to feed the pipe through. We found that closing the window on the pipe and then trimming a wooden "stopper" to size for the crack is one good way.

Attach the leadin wire to your receiver and let out some line on the reel. *Boing!* Gravity and the weights will stretch out your mini-antenna as far as you need. When you're finished, the coil will reel up and fit neatly in the can. Paint it a dull black, draw as little attention as possible when you install it and, believe it or not, you'll be surprised when nobody notices all the trouble you've gone to! ■

The finished setup may look a bit weird to the SWL's XYL, but that is the price she must pay to keep the OM at home evenings. Heavy wire running left and down is a shielded coax cable used as the leadin, and thinner wire running left is ground lead.

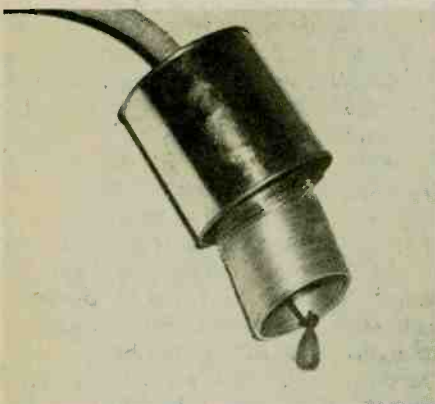

Boinger is finished and ready for installation. Outside world look out! A coat of black paint will keep down reflections and neighbor's questions. Keep in mind the SWLer's code, "Out of sight, out of mind!"

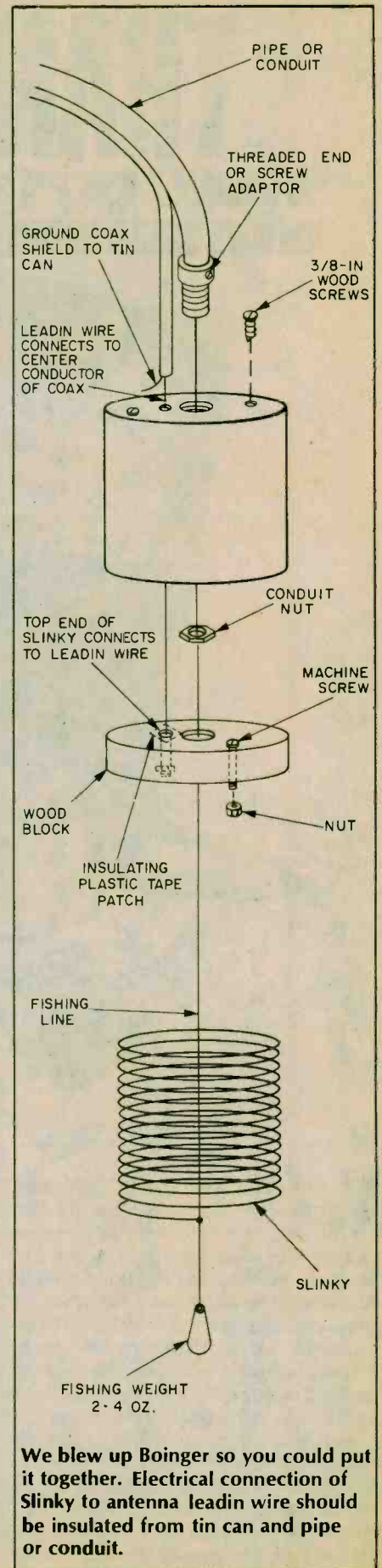
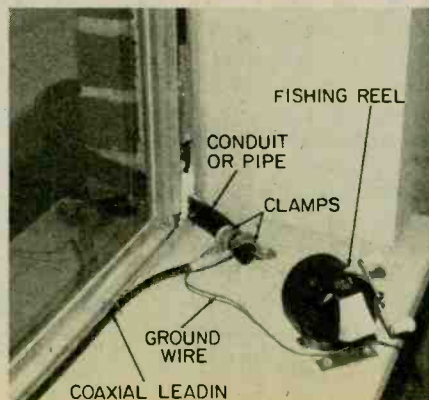

We blew up Boinger so you could put it together. Electrical connection of Slinky to antenna leadin wire should be insulated from tin can and pipe or conduit.

TRANSTAB

We thought it was just another transistor tester until we used it ourselves! / by Anthony Caristi

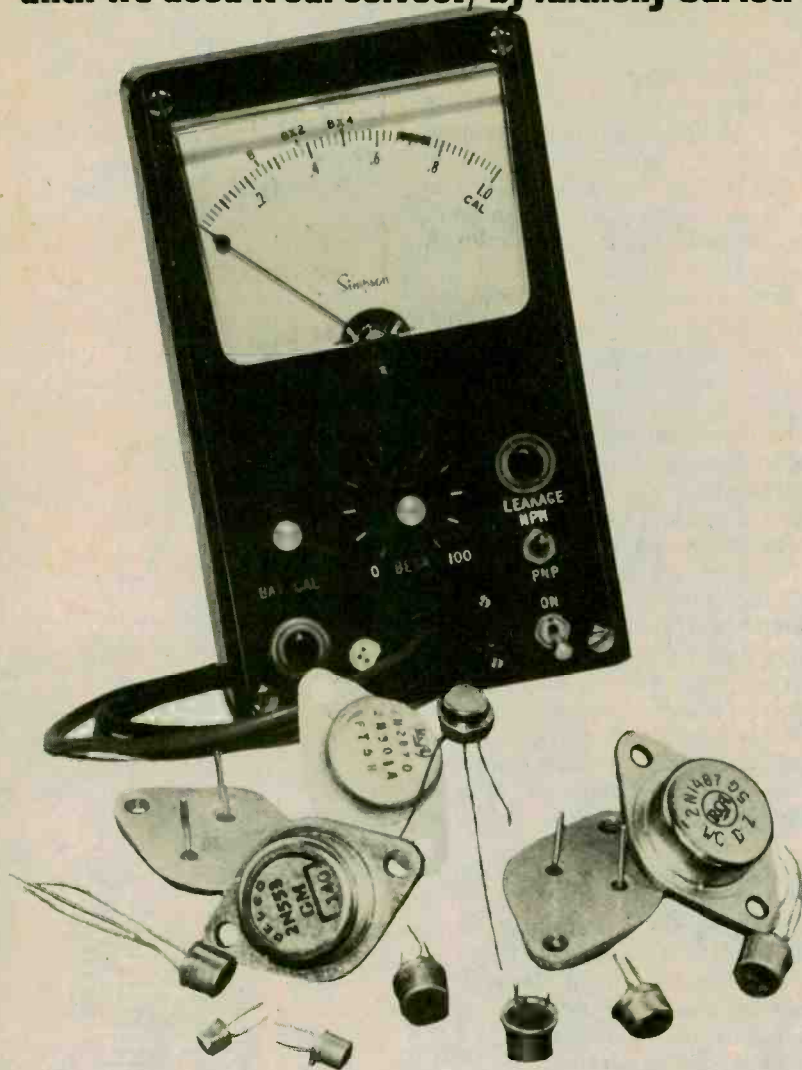

ANYONE who works with solid-state circuits has at one time or another needed an instrument to determine if a transistor is good or bad. Most transistors can be checked by making several ohmmeter measurements, but this is time-consuming and inconvenient. There is also the danger of passing too much current through low-current devices if the *RX1* scale of the ohmmeter is used, resulting in a burned-out transistor.

Here is a simple transistor checker, we call it *TransTab*, which can be built at very low cost to quickly perform several useful tests. If *TransTab* indicates a bad transistor, it will also indicate the type of defect. *TransTab* is also useful in determining the material and

polarity of unknown transistors—a handy feature when checking non-registered transistor types, found in imported radios and TV sets. The gain (beta) of transistors can also be measured with *TransTab*. This feature is handy when using substitute transistors for replacement, or for matching transistors. Finally, leakage tests can be made. Leakage is defined as current flow between emitter and collector of a transistor with no forward bias applied to the base. *TransTab* uses a 1 mA full-scale milliammeter, but any meter with greater sensitivity may be used by changing the values of resistors R5 and R6.

Putting It Together. Most of the

circuitry of *TransTab* is on a printed circuit board which is mounted to the positive and negative meter terminals. Four switches and two potentiometers are mounted on the front panel. This construction allows the entire unit to be assembled on the front panel so no mounting holes need to be drilled in the plastic cabinet. One or two transistor sockets—TO-5, the most common size, and TO-18, the smaller, not-so-common size—are also mounted on the front panel as to testing sockets. If you have trouble obtaining the smaller, TO-18-size socket, it may be left out. Three lead transistors of all sizes can be plugged into the common TO-5 socket.

Larger, power transistors, such as the TO-3 and TO-66 sizes, are connected to *TransTab* for testing by means of three color-coded test leads. The unit is battery-powered with a standard 9-volt battery, and the *power* switch, S2, is spring-loaded so that the instrument cannot be left on by mistake. Under normal operating conditions, the battery in *TransTab* should last as long as the normal battery shelf life, since a transistor can be fully tested in a few seconds.

Using It. To check a transistor, insert it into one of the *TransTab* sockets, or connect the color-coded leads to the proper terminals of the transistor. When using the sockets, be sure the transistor leads are properly positioned to connect to base, emitter, and collector. If an error is made in the connection, the transistor will suffer no damage, but you will not get a correct indication.

Calibrate the meter by pressing the *CAL* button, S4, while adjusting the *CAL* potentiometer, R6, for a full-scale (1.0) reading. Set the polarity switch, S3, to *NPN* or *PNP* as required, and set the *BETA* potentiometer, R3, to the maximum counterclockwise position. Press the *power* switch, S2, *ON*. A good transistor will read about 0.68 if it is silicon, and 0.74 if it is germanium. If the transistor is bad, the meter will read 0, 0.2, 0.9, or 1.0, depending upon the defect. Refer to the **TABLE OF DEFECTS AND METER READINGS**. For convenient reference, this table should be pasted to the outside of *TransTab*. You can also paint a green band on the meter scale between the 0.66 and 0.76 scale markings. If the transistor reads good, press *LEAKAGE* (S1) button. Normal reading for a silicon transistor and low-power germanium transistor will be zero. High-power germanium transistors may show some leakage (about 0.1 to 0.2 meter reading). Such leakage readings on high-power germanium transistors do not necessarily indicate a defective transistor.

CIRCUIT BOARD MOUNTED ON METER TERMINALS

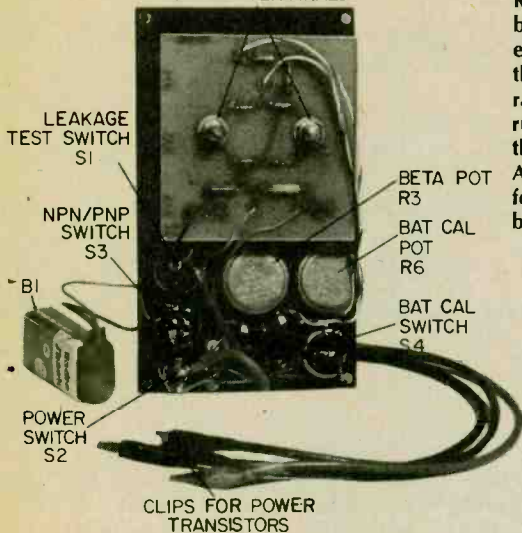

Rear view of TransTab with the back case removed. Everything except the battery is attached to the front panel. To avoid battery rattle, stuff in some foam rubber with the battery when the unit is finally buttoned up. Author suggests using black lead for emitter test lead, green for base, and red for collector.

Printed circuit board layout is shown full size with copper foil side up. Experienced experimenters may wish to use per-board layout with point-to-point wiring. It's up to you!

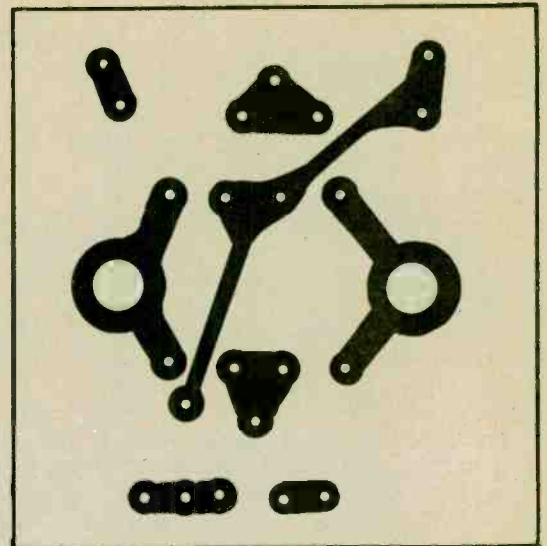

If possible compare the leakage reading with another transistor of the same type known to be good. To measure transistor beta, release the *LEAKAGE* button, S1, and rotate the *BETA* potentiometer, R3, until the meter reading is 0.25. Read the scale around the *BETA* knob, which has a range of 0 to 100. Higher values of beta can be measured by using the *Bx2* and *Bx4* calibrations on the meter scale. Rotate *BETA* potentiometer, R3, so that the meter needle rests at either of these points. Read the 0 to 100 beta scale and multiply the reading by 2 or 4, as required.

When testing a transistor of unknown polarity, try it on the instrument using both *NPN* and *PNP* positions of the polarity switch. The correct polarity will be evident when the meter indicates a good transistor (0.68 to 0.74) and the transistor leakage is zero. There is no danger of harming the transistor when the polarity switch is set to the wrong position.

How the Circuit Works. The basic circuit of TransTab is the emitter follower with the meter and multiplier resistors placed across the emitter resistor to measure the voltage from emitter to ground. The actual voltage at the emitter is not important; the meter is calibrated so that it reads 100 percent (1.0) when full battery voltage is applied to the emitter resistor. The transistor under test is operated as an emitter follower with the base connected to a voltage divider supplying a voltage equal to 80 percent of the battery voltage. *NPN* or *PNP* operation is achieved by reversing battery polarity.

Figure 1 is a simplified diagram showing the circuit with a *NPN* transistor. If the transistor is good, the voltage at the emitter will be equal to the base voltage minus a 0.7- or 0.2-volt base-emitter

voltage drop, depending upon the transistor material. Thus, the meter reading for a properly operating transistor will be 0.68 for silicon and 0.74 for germanium.

Suppose the transistor under test is not good. As can be seen in the simplified schematic of Fig. 1, an emitter-to-

collector short will result in a meter reading of 1.0, since full battery voltage would be applied to the meter through the short. A base-to-collector short will result in a slightly lower reading, 0.9, since there will be the normal base-to-emitter voltage drop through this junction. An open base or an open emitter

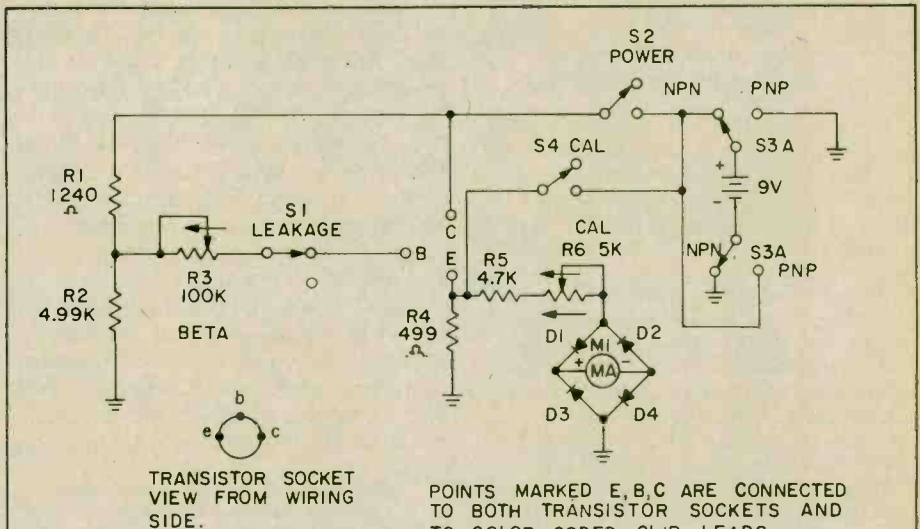

TRANSISTOR SOCKET VIEW FROM WIRING SIDE.

POINTS MARKED E, B, C ARE CONNECTED TO BOTH TRANSISTOR SOCKETS AND TO COLOR CODED CLIP LEADS.

PARTS LIST FOR TRANSISTOR TESTER

- B1—9-VDC transistor radio battery (Radio Shack 23-151 or equiv.)
- D1, D2, D3, D4—Silicon diode, 75-volts PIV (or more), 75-mA (or more) (Radio Shack 276-1102 or equiv.)
- M1—1 mA DC meter (Radio Shack 22-018)
- R1—1240-ohms, 1/2-watt resistor. If not available, use 1200 ohms (Radio Shack 271-000 or equiv.)
- R2—4990-ohms, 1/2-watt resistor. If not available, use 5000 ohms (Radio Shack 271-000 or equiv.)
- R3—100K potentiometer (Radio Shack 271-092 or equiv.)
- R4—499-ohms, 1/2-watt resistor. If not available, use 500 ohms (Radio Shack 271-000 or equiv.)
- R5—4700-ohms, 1/2-watt resistor (Radio Shack 271-000 or equiv.)
- R6—5K ohms potentiometer (Radio Shack 271-1714 or equiv.)
- S1, S2, S3—SPST switch, momentary contact, spring return (Radio Shack 276-1102 or equiv.)
- S4—DPDT switch, toggle or bat handle (Radio Shack 275-1546 or equiv.)
- Misc.—Cabinet w/ front panel removable, 3 3/4 Wx6 1/4 Hx2-in. D (Radio Shack 270-627 or equiv.); transistor socket for TO-5 size (Radio Shack 276-548 or equiv.); transistor socket for TO-18 size, if available (not essential); flexible rubber-covered wire for test leads (three colors—red, green, and black); insulated alligator clips; printed circuit board kit (Radio Shack 276-1576 or equiv.)

will result in no meter reading at all.

Other possible defects are an open collector, or emitter-to-base short. Either of these defects will result in a meter reading of 0.2. This is caused by current through R1 flowing from the base-emitter junction to the meter. Exactly 80 percent of the battery voltage is lost across R1, leaving 20 percent for the meter. When the transistor has an emitter-to-base short, collector current is zero due to lack of forward bias. Thus, the circuit acts as though the collector circuit were open, resulting in a meter reading of 0.2.

A leakage test is made by simply breaking the base connection to R1 and R2. In this condition the transistor has

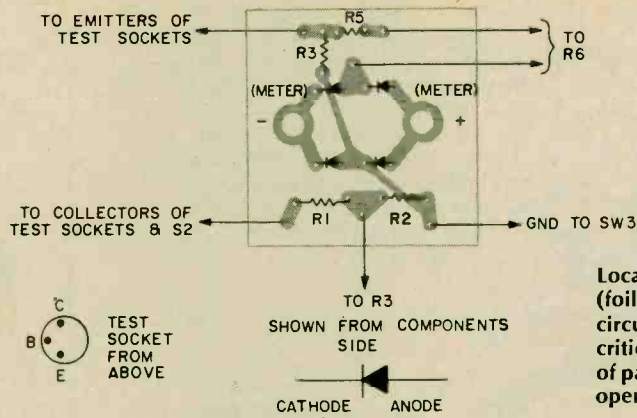

Location of components on flip (foil down) side of printed circuit board. Layout is not critical—any convenient location of parts will do. Circuit is DC-operated, so spread parts out.

no forward bias and the circuit will be open between collector and emitter. The meter reading will go to zero. Some low-power germanium transistors, particularly those found in imported equipment, may exhibit some leakage with this test. Any transistor showing more than a 10 percent full-scale reading should be suspect.

Simplified Circuitry. In the simplified circuit of Fig. 1 potentiometer R3 is omitted. When making Good-Bad transistor checks, this potentiometer must be turned fully counterclockwise so that its resistance in the circuit is zero. After the transistor has been determined to be good, R3 is rotated until the meter reads 0.25. The amount of resistance added to the base circuit, in thousands of ohms, is the beta, or gain of the transistor. This measurement is accomplished by the proper choice of values for emitter resistor R4 and voltage dividers R1 and R2.

Fig. 2 is a simplified equivalent circuit of the emitter follower. By making R4 equal to 500 ohms, and the parallel equivalents of R1 and R2 equal to 1000 ohms, the value of beta is approximately equal to the resistance of R3 in thou-

sands of ohms, when R3 is adjusted to give a meter reading of 0.25. Thus, by using a 100,000-ohm potentiometer for R3, a convenient 0 to 100 beta scale is obtained when R3 is rotated over its entire range. In addition, multiplier ranges for the beta scale are obtained by using scale calibrations of 0.375 for beta times 2, and 0.5 for beta times 4.

Checking Beta. When measuring beta with this instrument, bear in mind that about 4.5 milliamperes current is going through the transistor. The beta of a transistor will vary as the collector current changes. This test for beta is therefore most useful for small transistors which operate in the 0-to-10 milli-ampere range.

OPERATING INSTRUCTIONS

1. Press BAT CAL button (S3) and adjust BAT CAL knob (R6) for full-scale meter reading.
2. Set BETA control (R3) fully counterclockwise to zero position.
3. Set NPN/PNP switch as required.
4. Insert transistor in socket or connect leads to the alligator clips. (Connect green lead to base, red to collector, black to emitter.)
5. Turn power ON (S2). Transistor is good if meter reads between 0.66 and 0.75 (green area). If there's no reading, or improper reading, flip NPN/PNP switch (S3) to other position. If there's still no reading, or improper reading, transistor is defective.
6. Press LEAKAGE button and have power switch (S2) ON. Meter should read zero, except on power transistors, which will show low reading.
7. Adjust BETA control knob (R3) until meter reads 0.25. Read beta directly on the 0-to-100 scale around BETA knob. If the transistor's beta is above 100, set the BETA knob for a meter reading of Bx2 or Bx4, and multiply the BETA knob scale reading by 2 or 4 (see meter indication) for the value of beta.

TABLE OF DEFECTS AND METER READINGS

Condition	Meter Reading
Good silicon transistor*	0.68
Good germanium transistor*	0.74
Open base	0
Open collector	0.25
Emitter-to-base short	0.25
Emitter-to-collector short	1.0
Base-to-collector short	0.9
Emitter open	0

*A green area can be inked in on the meter face between the .68 and .74 indices on the meter scale. This visual indicator will speed up rapid identification of good-bad transistors.

Color-coded TransTab leads connect to power transistor terminals. A more elaborate unit would have transistor sockets for every possible transistor type—but cost is an important factor.

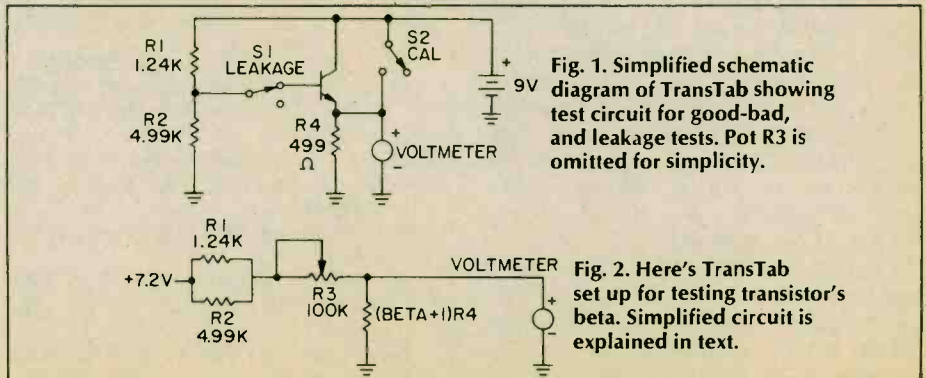
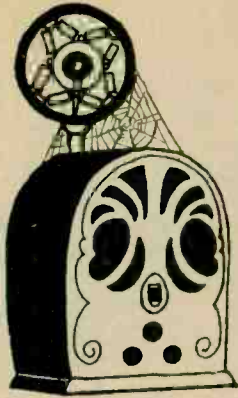

Fig. 1. Simplified schematic diagram of TransTab showing test circuit for good-bad, and leakage tests. Pot R3 is omitted for simplicity.

Fig. 2. Here's TransTab set up for testing transistor's beta. Simplified circuit is explained in text.



ANTIQUE RADIO CORNER



by James A. Fred

□ Hello out there in Radioland! Spring is here and the long winter months of restoring radios are over for a while. Perhaps it would be wise to look at your collection and make a list of what you want to concentrate on this summer. Most collectors seem to drift along without any definite idea of where their collection is headed. Why not make a list of all your collectible radio items, assign values to them, and put a copy of the list in your safe deposit box. Burglaries, fires, tornadoes, and other hazards are destroying collections monthly. Are you going to be the one without a list when it comes time to file an insurance claim? All insurance companies now require a complete inventory before they will pay for your loss. It might also be well at this time to get out your insurance policy and read it carefully. If you do not understand the coverage you have, call your agent and talk it over with him. I remember reading about a collector in California who had most of his collection destroyed in a fire and he had no insurance. This kind of heartbreak you don't need.

Prevention—The Best Medicine. Along these lines I am going to mention several things you can do to safeguard your collection. One is to rent a post office box so that no packages of antique radios or parts are delivered to your home. Another is to arrange to have all packages of this sort insured against loss before they are mailed. I have had packages lost in the mail sev-

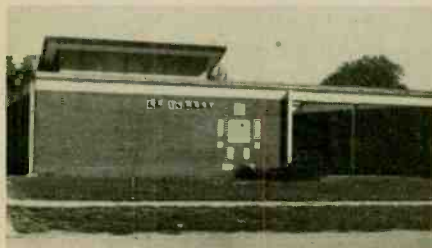

Arthur Trauffer was instrumental in getting elementary school in Council Bluffs, Iowa named after Dr. Lee DeForest, inventor of the triode tube.

eral times in connection with books I have sold. I've sent books to one man in particular on two separate occasions, and he never received either shipment. I sent them by book rate without insurance so there was no way the post office could trace them. I felt obligated to replace them or refund his money. About the only safe thing to do when shipping by Parcel Post is to insure every package. You don't have this problem with UPS because every package must be signed for before the delivery man will leave it.

A New De Forest Museum. As you will recall from reading an old Antique Radio Corner column, Art Trauffer, the well known writer for ELEMENTARY ELECTRONICS, had the de Forest Museum established in his apartment in Council Bluffs, Iowa. I just received a letter from him which says in part:

The Union Pacific Railway donated their big beautiful Union Depot in Omaha, Nebraska, to the city of Omaha, and the new Western Heritage Society is converting the Depot to the Western Heritage Museum.

Most of the de Forest items in the Lee de Forest Memorial Museum in Council Bluffs, Iowa have been donated to the Omaha Western Heritage Museum for display. The de Forest artifacts are displayed in four glass-enclosed display cases in a prominent place in the museum. In fact, the de Forest collection was the first display in the new museum. The museum was opened to the public on November 22, 1975, and nearly 3000 people attended the first two opening days.

Art Trauffer saved a few of the de Forest items from his collection for display in the Lee de Forest Building at the new Iowa Western Community College in Council Bluffs, Iowa.

Each de Forest item on display has a card giving some information about the item, and giving credit to the person who donated the item. Art is the Curator of the two displays, and anyone wishing to donate de Forest memora-

bilia to either of the two displays may contact Arthur Trauffer, at 120 Fourth Street, Council Bluffs, Iowa 51501, or phone 712-322-6278.

Crosley Meeting Held. As you can see from the photographs, a very informative meeting of the Indiana Historical Radio Society was held at Vernon, Indiana.

Vernon is a small town located southeast of Columbus, Indiana just about twenty-five miles north of the Ohio river. Powell Crosley's estate was located just a few miles from Vernon, Indiana. In 1958 the greater portion of the farm land was sold to the Indiana Department of Conservation. The land was to be used for hunting and fishing, and was named the Crosley Fish and Wildlife Area in Powell Crosley's honor.

The meeting was a tribute to Crosley and the radios he manufactured. A large collection of Crosley radio receivers was on display and a half dozen former Crosley employees were on hand. Some of the employees had worked on the Crosley estate and some had been employed by the radio factories. Several former employees gave short speeches about Mr. Crosley and related interesting episodes in their relationships. Meetings of this type are important to collectors because they present an insight into the real lives of the radio pioneers that we can get in no other way.

"Magic Eye" Tuning Indicator. One of the most popular resonance indicators used to be the Magic Eye vacuum

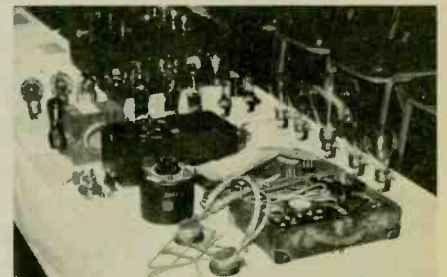

Some very old radio tubes and light bulbs seen at Winston-Salem, N.C. AWA Southern radio meeting.

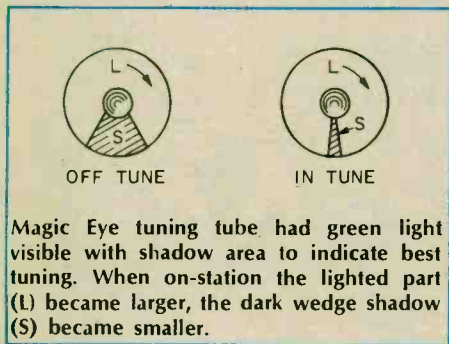

Magic Eye tuning tube had green light visible with shadow area to indicate best tuning. When on-station the lighted part (L) became larger, the dark wedge shadow (S) became smaller.

tube. This is really two tubes in one envelope, one a triode section and the other a cone-shaped target at the upper end of the tube which has a green fluorescent coating.

The tube has a common cathode. The lower part supplies a stream of electrons for the triode section, and the upper part of the cathode supplies electrons that bombard the fluorescent coating on the target. The electron stream illuminates the target area with a greenish glow. A small ray control electrode (connected to the plate inside the tube) placed in this electron stream exercises a control over the area of the target which is struck and illuminated by these electrons. A fan shaped shadow appears where electrons do not strike it.

The detected signal voltage is applied to the triode control grid, and as the radio receiver is tuning in a station, this grid becomes more negative with respect to the cathode. Since this decreases the plate current, there is a smaller voltage drop through the one megohm plate resistor, and the positive voltage applied to both the triode plate and the ray control electrode increases. When the station is tuned exactly to resonance this increased positive voltage on the ray control electrode causes the shadow on the target to narrow down to a thin line. As one tunes away from the station the shadow widens.

This tube was made available in several versions; e.g., 2E5 with a 2.5 volt filament, 6E5, 6U5, 6AB5/6N5, 6AF6G, and the 6AL7GT with two targets, one for tuning AM and one for



Part of collection of Steve Meyerkorth, Omaha, Nebraska. Note directional antenna atop the console.

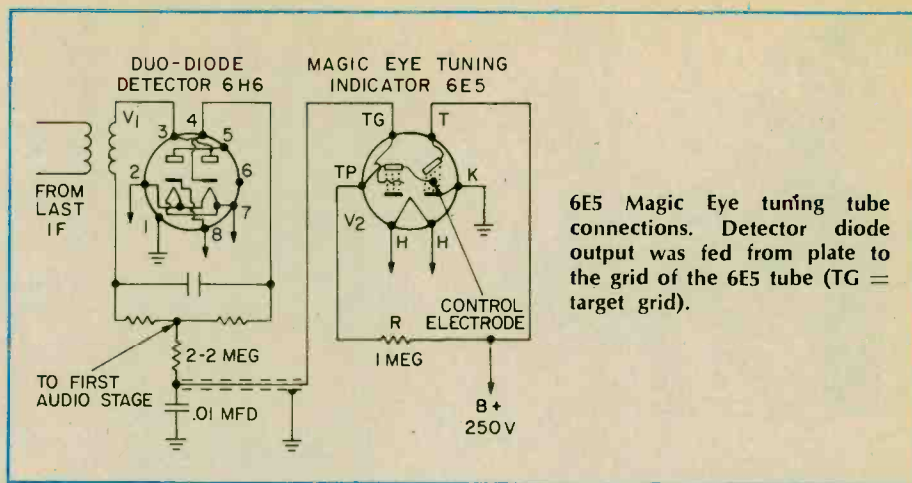

6E5 Magic Eye tuning tube connections. Detector diode output was fed from plate to the grid of the 6E5 tube (TG = target grid).

tuning FM stations. All these tubes whose numbers start with "6" have six volt filaments.

The magic eye tubes seem to lose their brightness quite rapidly. In the socket assembly there is a one megohm resistor. Often this resistor will open up and the green glow will be absent. This resistor is well hidden unless you know where to look.

There were other schemes used to indicate when a receiver was tuned to resonance. Wayne Beever of Palmyra, MO wrote me about one in his General Electric radio. This tuning indicator was called Colorama Tuning by General Electric and was used in models E-126, E-101, E-105, and E-106. This system consisted of 4 red dial lights and 3 green dial lights. The dial would change colors as the stations were tuned in.

In Memory of P. R. Mallory. On December 16, 1975 Philip Rogers Mallory passed away at the age of 90, at his home on Fishers Island, New York. There surely isn't anyone in the radio-electronic industry that hasn't heard of the P. R. Mallory and Company, Inc. There are very few companies founded 60 years ago that have survived with the original founder's name still intact. Mergers, depressions, and death have taken their toll of family owned corporations.

Mr. Mallory incorporated the company bearing his name on April 10, 1916. The first factory was located in Port Chester, New York. Their main product was tungsten wire used as filaments in electric light bulbs. However the General Electric Company owned the basic patents on the light bulb and slowly forced all but a few of the independent light bulb makers out of business. Some of the larger ones were sold licenses by GE with the provision that they must use wire supplied by GE. At this point, The Mallory Company ceased to be a supplier of tungsten wire for light bulbs.

They then entered the toy electric motor business and later bought the Elkton Works from General Electric, in



Collectors looking over goodies at Indiana Historical Radio Society are, left to right, J. Anderson, A. Collins, Ed Taylor, and your columnist, J. Fred. (Photo—Betty Cull)

Weehawken, New Jersey. Elkton material was an alloy of tungsten and molybdenum. It was used to make contact points, X-ray targets, parts for vacuum tubes and welding electrodes when further alloyed with copper. As business improved the Mallory Company outgrew the facilities in the east and a search was made for a plant large enough to house all their activities. An empty, nearly new, building was found in Indianapolis, Indiana and in 1929 the entire manufacturing operation was moved there.

They soon became heavily involved in manufacturing radio parts, such as capacitors, resistors, switches, jacks, plugs, TV tuners, timers, vibrators for auto and home radios, and many other products that Radio-TV repairmen use.

I have been employed in the Engineering and Reliability Departments of a subsidiary company for nearly twenty years. I have seen and heard Mr. Mallory speak several times. His reasoning behind giving his name to the company is quite interesting. He said, "I had made up my mind that this business was to be my life's work, that it had to be a success, that it must stand for the best in its line of endeavor, and that it should be operated under business principles in which all associated could be proud."

So long for now. We will be back with you in two months with more news, helpful hints on restoring radios, history of radio pioneers, and other things of interest to radio and wireless collectors.

e/e checks out ...

Continental Specialties Design Mates

Here are three experimenter devices that let you zip together quickly IC projects that work first time out!



□ Have you ever wondered why experimenter-grade test equipment is so expensive? This may seem especially puzzling, when you consider the fact that the solid state devices, the resistors, and the capacitors that comprise the electronic guts of the equipment cost only pennies. So why the astronomical price? Take a look at the outer shell of this lab equipment for your answer. Those super-colossal cabinets, professional knobs, and fancy front panels cost much more than the basic circuitry that makes the equipment work. Until recently you couldn't buy the test gear without also buying the excess cabinetry, and as a result, many would-be experimenters couldn't afford the good-quality test gear they needed to keep up with the fast-breaking new IC technology.

Regular readers of **ELEMENTARY ELECTRONICS** will remember Continental Specialties' easy-connect QT strips featured in our last issue in the experimenter's breadboard project, *Rig-Kwik*. Continental Specialties specializes in

manufacturing modern, easy-to-use, low-cost design instruments and design aids—of which the QT strips and sockets are the best known and most widely used. Continental Specialties has a few series of three instruments called Design Mates.

The Design Mates are tailor-made for the hobbyist who is willing to pay for good circuits in relatively plain cabinets. The Design Mate line offers rock-bottom-priced test equipment that competes favorably with equipment priced many times higher. In fact, these three units are so good we want to call them to our readers' attention. That's why we tested these units right off the production line before instruction manuals were printed. If we've overlooked any feature of the Design Mates, you'll simply have to allow for the fact we're playing it by ear all the way.

The Design Mate Instrument Series.

The three units consist of a Circuit Designer, a Function Generator, and an R/C Bridge. All share the same inexpensive chassis-cabinet—a sloping plastic cabinet 7.5-in. wide by 3.25-in. high by 6.75-in. deep. Even the feet are molded-in to avoid the expense of rubber feet.

Breadboarder's Dream. The first instrument, the Design Mate 1, is the Circuit Designer, priced at \$49.95. A double row of QT sockets and buss strips across the lower part of the chassis provides a 2 by 6.5-inch electronic breadboard with standard 1/10-inch spacing so ICs can be plugged right into the sockets. The sockets take wire sizes from #22 and smaller, and in a pinch you can force in a #20 lead, the size used on older 1/2-watt resistors. Examine the photographs to see how easy it is to breadboard a project by just plugging the components into the QT sockets.

The Circuit Designer also contains a regulated power supply, adjustable from

1.0 to 5.0 volts at 300 mA. The regulator is short-circuit-proof, so if you make a mistake in wiring your project you won't blow the power supply. A zero-to-fifteen VDC meter, which has its own connection terminals, is also provided. We suggest it be wired to indicate the power supply voltage, because its internal impedance is about 2600 ohms—too low to be used for experimental circuit voltage measurements.

Waveform Delight. Next in the series is Design Mate 2, a Function Generator, priced at \$64.95. A function generator produces the three waveforms needed for linear and digital experimentation. It makes sine waves, square waves, and triangular waves. The shapes are drawn on the panel under the word *Function*, above the knob. The unit has these operating controls: a linear-scale frequency dial calibrated from 1 to 10, a range switch (multiplier) that provides output frequencies from 1 to 100,000 Hz, and a continuously-variable output level control. The output is available at standard instrument-type 5-way binding posts. The output impedance is 600 ohms.

Within the most critical frequency range—the 20 to 20,000 Hz range—the

The Design Mate Series instruments are made by Continental Specialties Corp., Box 1942, New Haven, CT 06509. Design Mates 1, 2, and 3 (the Circuit Designer, Function Generator, and R/C Bridge) are priced at \$49.95, \$64.95, and \$54.95, respectively. Circle No. 70 on the Reader Service Coupon for more information.

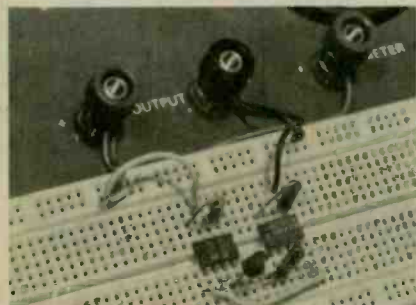

Closeup of Design Mate 1 breadboard area shows how components plug readily into Continental's QT sockets. DC supplies connect via terminals above sockets.



Closeup of Design Mate 3, the R/C bridge shows terminals for unknown capacitor or resistor upper right, large knob and range switch at bottom.

e/e Design Mates



Design Mate 1 is a circuit designer, with quick-connect QT component plug-in sockets and adjustable DC power. \$49.95.

sine wave distortion was found to be under 2.4% THD. Even more impressive, the output level remained absolutely constant from 1 to 100,000 Hz. The maximum output level was 4.2 volts.

Dial calibration was very precise on the low end and was under 8 percent off-frequency at the high end of the dial. For example, the high-end output frequency was 920 Hz when the dial was set for 1000 Hz. If one needed maximum frequency accuracy, one would use an auxiliary counter or set the range switch to get the output from the low end of the dial.

Surprising Value. Design Mate 3, is an R/C Bridge, which makes it easy and quick for the experimenter to find the exact electrical value of almost any unknown resistor or capacitor. It's priced at \$54.95. The bridge uses two LEDs to indicate bridge balance. The bridge measures values from 10 ohms to 10 megohms, and from 10 pF to 1 μ F. As

with Design Mate 2, there is a linear-scale dial calibrated from 1 to 10, and a single control that serves as the resistance and capacitance range selector. The test terminals are 5-way binding posts. Unlike most other bridges, which use an audio tone, a meter, or an electric "eye" to indicate bridge balance, the Design Mate 3 has two LEDs, each labeled HI, NULL, and LO. With the bridge in balance (at NULL) both LEDs glow at reduced brilliance. If the HI LED is at full brilliance and the LO is off, it means that the actual value is higher than indicated by the dial. In this case one adjusts the bridge toward a higher value to attain balance. If the LO LED is on and the HI is off, it means that the actual value of the component is less than indicated by the dial. In this case one adjusts the bridge toward a lower value.

Surprisingly, the accuracy of the Design Mate 3 is better than that of our service-grade R/C bridge priced just under \$200, and almost as good as our laboratory-grade bridge. Obviously it cannot compare with a digital capacity



Design Mate 2 is a three-function generator, producing sine, square, and triangular waves at frequencies from 1.0 to 100,000 Hz with constant output. \$64.95.



Design Mate 3 is the R/C bridge which measures values of unknown resistors and capacitors from 10 ohms to 10 megohms, 10 pF to one μ F. LEDs indicate null \$54.95.

meter, but neither does our adjustable lab bridge, and the Design Mate 3 is about \$700 less expensive than a digital R/C meter. It's a really nice piece of gear—a great value if you buy surplus resistors and capacitors which are unmarked and you have to value-sort them yourself.

Summing Up. If you're hung-up on a status-seeking "professional" appearance, the Design Mate equipment isn't for you. But if you don't mind a plain blue plastic chassis, and are looking for maximum performance at rock-bottom prices, you can't do better than these three Design Mates. With their uncluttered calibrations and simplified controls, all three are top choices for the experimenter. Fact is, we're looking forward to seeing what else Continental Specialties adds to the Design Mate line. Late word is that they will also offer the chassis itself with a metal bottom plate for those who like to home-brew their own test equipment.

For additional information on these Design Mates, circle No. 70 on the Reader Service Coupon. ■

20 BIG BROTHERS

The newest stars on television this year are not on ABC, CBS or NBC—they are the arriving international passengers at the new Detroit Wayne County Airport. The sponsor of the show is the US Custom Service.

Twenty cameras are strategically located inside and outside of the terminal to continuously observe international passengers and flight crews as well as baggage handling operations from the time the aircraft arrives until final Customs inspection in the "sterile" Customs area. Customs inspectors and

patrol officers boarding arriving aircraft, or working on the ramps, keep in constant contact via radio with the console operators at the master control TV monitoring console.

Five of the key camera locations outside of the terminal and in the baggage inspection area are equipped with remote-controlled pan/tilt units and zoom lenses, as well as low-light-level silicon target vidicons that will enable the console operators to "zoom-in" on any out-of-the-ordinary or suspicious situations, even in dimly lighted areas. Three of the outside surveillance units use silicon target (ST) RCA vidicons for low-light-level viewing and zoom lenses for close-up inspection. These cameras are mounted on pan/tilt units in environmental housings with windshield washers and wipers.



21 closed-circuit television monitors in the International Terminal of the Detroit Metropolitan Wayne County Airport protect the nation's revenue against smuggling and fraud attempt. Twenty RCA video surveillance cameras are strategically located inside and outside of the terminal to continuously observe international passengers and flight crews from the time the aircraft arrives until final inspection in the Custom area.

e/e checks out the...

PANASONIC CB/AM-FM CAR RADIO



CB is the hottest thing going in consumer electronics, and just about every highway traveler is loading the old bucket of bolts with CB to keep track of highway conditions. Someone was bound to come out with the all-inclusive *automotive entertainment center*—a combination CB Transceiver/FM-AM radio. Sure you've heard about it for the past year. So have we. But every time we asked to see one the importer "just ran out of stock," or "they were coming in tomorrow by plane," or . . . one hundred other reasons why it wasn't ready yet for the press.

Only Panasonic had a combination CB/FM-AM radio ready for showing to the press when they said it was ready, so here it is—a real winner. This is first-class piece of equipment others will be trying to copy a year from now when in-dash CB/FM-AM radio becomes the most-wanted automobile option.

Full-Feature Set. Before we get into the Panasonic CR-B171EU, a little background so you will understand why we are impressed by this transceiver/radio. Normally, when a new electronic

consumer product is introduced the manufacturer anticipates, and builds into the line, upgrading (step-up) or trade-up. That is, the first design lacks many features and conveniences because the manufacturer wants you to buy again when he introduces the next model, with the features that should have been there to begin with. Sort of like the calculator manufacturer who left the decimal off the first model so you would have to trade up to the next model when you discovered a calculator without a decimal was almost worthless.

Trading-up has been part of CB since way-back-when. To Panasonic's credit, when they decided to enter CB they put full value into their very first equipment, and their CR-B171EU is fully loaded with every important feature. In fact, the unit has exactly the performance and features Kathy, our CB editor, would put in if she had been called on to design a CB/FM-AM radio. Now that you know why we're so impressed, let's take a closer look at what Panasonic has brought forth.

The CR-B171EU CB/FM-AM radio is designed for in-dash mounting. As you can see from the photographs, no cabinet is supplied—just a wood-grained trim plate to cover the cutout.

The radio is just about the same size as any other car radio, the major difference being the control panel, which is about twice the usual height to accommodate a full set of FM-AM radio and CB transceiver controls.

Both the FM-AM radio and the CB transceiver share the same audio output amplifier. Other than that they are separate systems, which as you'll see, make for some interesting and useful conveniences.

The FM-AM radio has stereo front and rear speaker outputs. There are fader controls for front left-to-right, and rear-to-front balance. The front speaker output wires are clearly indicated for those of you who don't have rear speakers. The FM-AM antenna receptacle is exclusively for AM and FM. A separate coaxial antenna jack—type SO-239—is provided for CB. As is usual in car radios, a tone control is provided. Five pushbuttons can be programmed for any five stations.

Switches and Controls. All operating controls and switches are out on the front panel. On the left are the usual concentric volume and tone controls. On the right are the concentric FM-AM tuning and front-rear balance controls. The main control panel has the FM-AM selector, the left-right balance controls and the five FM-AM selector pushbuttons. The remaining controls are for CB. There's a 23-channel selector, concentric squelch and Delta-tune controls, a pushbutton labeled *CB* and a pushbutton labeled *Monitor*. When the *CB* button is depressed the entire unit functions as a CB transceiver. When the *Monitor* button is depressed the unit functions as an AM or FM radio with *CB override*. Any signal on the selected CB channel strong enough to break the user-set squelch level overrides the AM or FM signal in the left speaker (*CB* is always heard from the left speaker). In this way, you can monitor, for example, channel 9, or channel 19, or your personal family channel, while you listen to AM or FM. To switch immediately to total CB operation you simply press the *CB* switch. The micro-

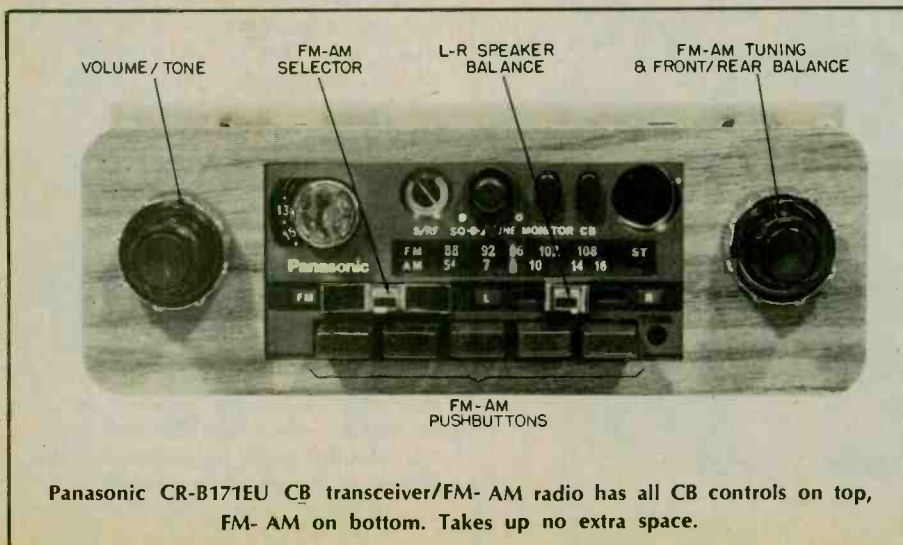

Panasonic CR-B171EU CB transceiver/FM-AM radio has all CB controls on top, FM-AM on bottom. Takes up no extra space.

e/e PANASONIC CB/FM-AM

phone (supplied) plugs into a front panel jack.

As we'll show, the performance is first-class all the way, and the reasons should be obvious, by now. Since the CB can override the AM and FM, the CB section must be completely independent except for the shared audio amplifier. Each circuit therefore, is optimized for its own class or service—either CB or AM/FM.

By not trying to make one circuit do double-duty for FM-AM and CB, Panasonic has combined two high-performance equipments in a single package.

CB Features. The CB transceiver covers all 23 channels, and can be powered from 12 volts DC, negative ground. Overall dimensions are 2³/₄-in.

high by 7¹/₂-in. wide by 5-in. deep. Features include the FM-AM override, double conversion, and an S/RF-output meter. The meter itself is a small dime-sized indicator like those used on walkie-talkies with a red-green dial indicator to show normal operation. When transmitting the pointer rises to the green area to indicate RF output. When receiving, a usable signal level will cause the pointer to indicate the green area. Because of its small size the meter serves as an operating aid, or function tester, instead of as measuring equipment for indicating signal strength received, or RF power output.

Performance Plus. As we have well learned in CB, no idea or feature is valuable if the receiver has low sensitivity or poor selectivity, or if the modulation is so muffled you can only be understood when your signal is 40-over-9.

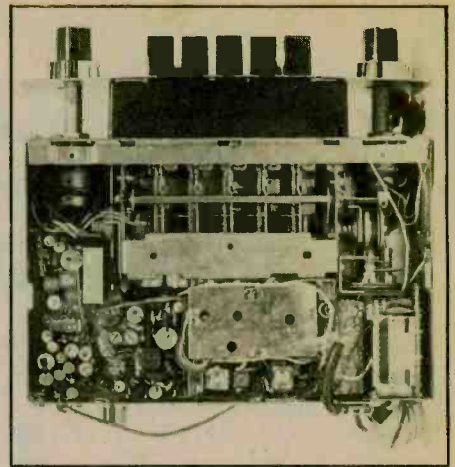

Rear view of CB/FM-AM set shows connectors for speakers, CB & FM-AM aerials.

But in the Panasonic CR-B1717EU we found the overall performance more than reflected the high quality of construction and operating conveniences. The receiver's sensitivity measured 0.3 μ V for 10 dB signal plus noise-to-noise ratio (10 dB S+N/N); one of the most sensitive AM CB transceivers we have seen. Selectivity measured 50 dB adjacent-channel rejection, which is just about the optimum value to receive many of the budget transmitters being sold to motorists, while rejecting interference from adjacent and alternate channels. Since the transmitters of many budget transceivers are almost at the outer tolerance limits any greater selectivity would make receiving these signals difficult, if not impossible under weak-signal or QRM conditions. The Delta-tuning's ± 1 kHz tuning variation allows good reception of signals at the extreme ends of the FCC tolerance limits (and it appears more and more budget transmitters work at the extreme tolerance limits).

The worse-case image and/or spurious interference measured 47 dB. The AGC action for an input range of 2 to 80,000 μ V was 8 dB.

Connected to a 50-ohm dummy load the transmitter delivered exactly 3-watts RF output, and modulation was limited to 100 percent. The relative sensitivity for 85 percent modulation was -29 dB (more sensitive than the "normal" -22 dB). The modulator has a very effective compressor that provides high level *talk power* without unusually high distortion.

As you can see, overall performance is very good, and no tradeoff was made to accommodate the FM-AM radio.

Installation. In most instances there will have to be some modification of the dashboard radio opening in order

(Continued on page 87)

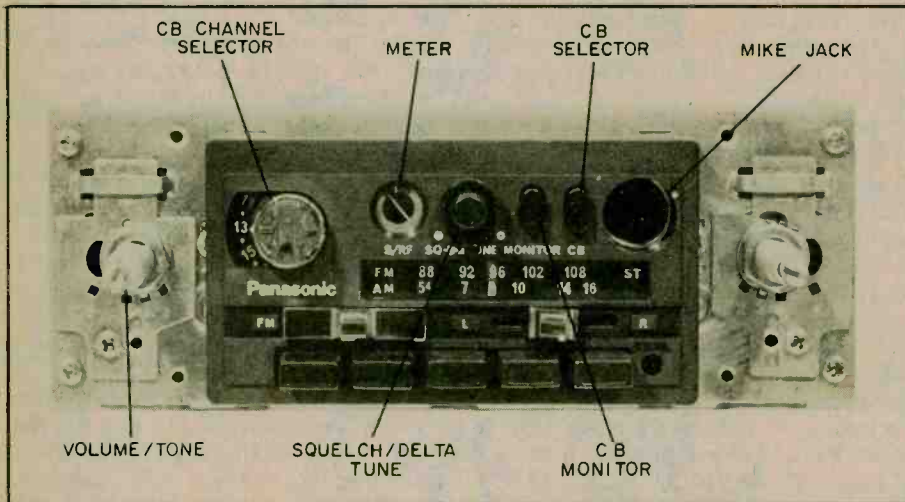

Shown here ready for mounting, with decorative panel removed, the set's CB controls are identified.

Top view of Panasonic CB/FM-AM set shows layout of FM-AM receiver.

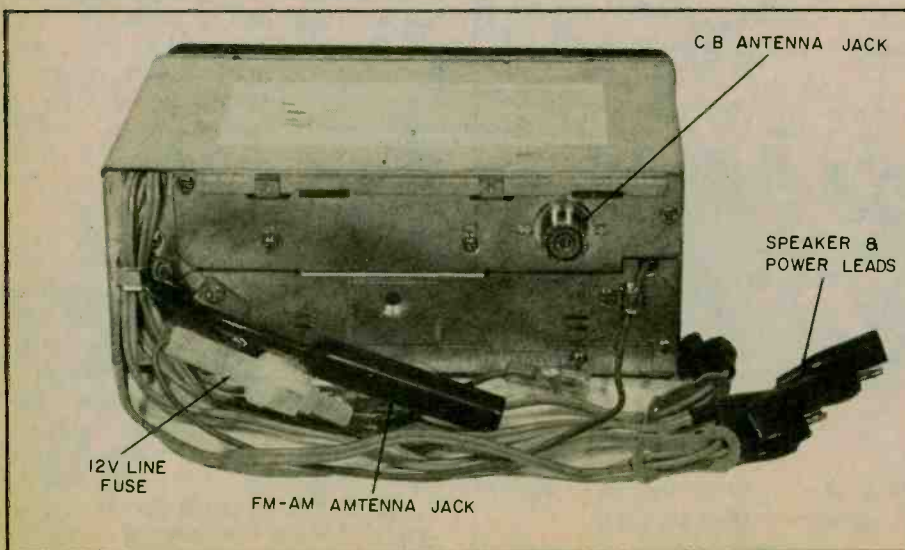

Mystery Radio

by Art Trauffer

Your friends may have to call Casper, the Ghost, to figure this one out!

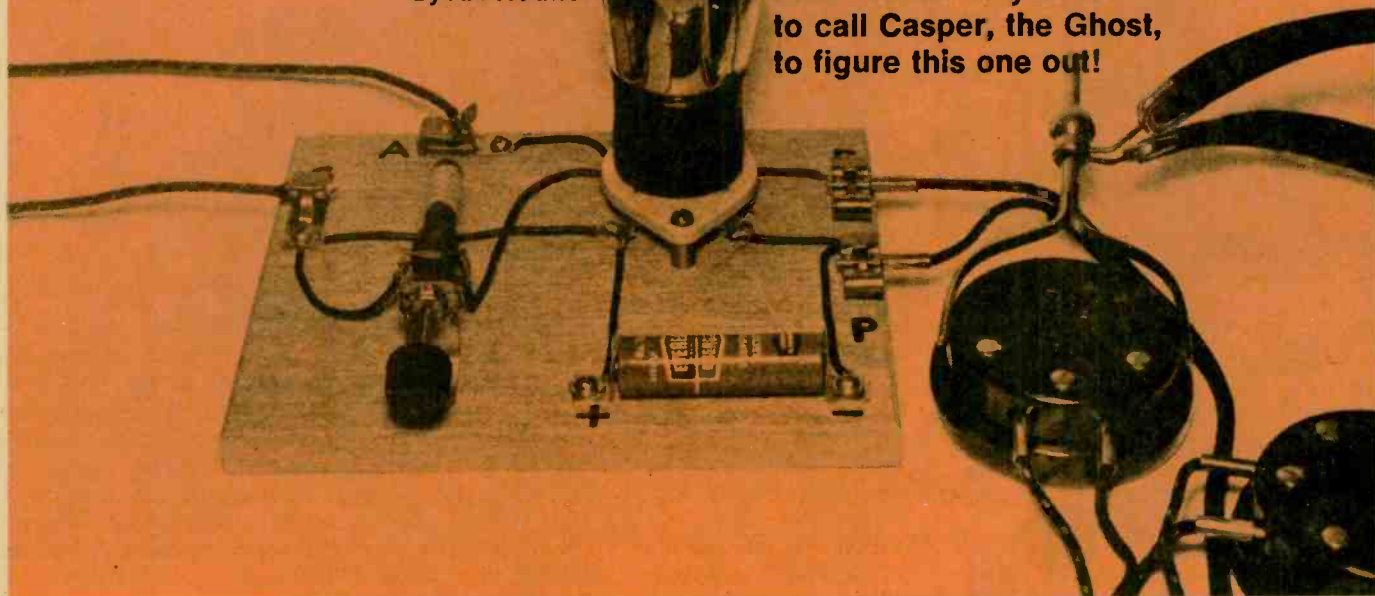

BUILD THIS MYSTERY RADIO. It uses a radio vacuum tube that doesn't glow in the dark. See if your friends can figure out how it works before you reveal the trick. It's a fun project, educational as well as entertaining—a good choice as first receiver for the beginning constructor.

Take a quick look at the photo and you see a one-tube radio tuned by a common ferrite loopstick antenna coil. Nothing too unusual about that. But wait a minute—all there is to power the tube is a small penlight battery of 1½ volts. There is no B battery for the plate of the tube, and there is no grid leak and capacitor going to the grid of the

tube—yet you get a good signal in the phones from local broadcast stations! How can this be?

The secret is revealed when we examine the pictorial drawing. We see a germanium crystal diode detector, with a transistor serving as an audio amplifier. These two units are hidden inside the base of the tube. Looking at the schematic diagram you will see that we have a perfectly conventional crystal detector radio driving a one-transistor amplifier. The tube is a dummy, and can even be one which is burned out. It isn't in the circuit at all. If your friends can't guess the answer, there's the mystery in this "one tube" radio receiver.

Construction. You can use most any 4-prong (or 4-pin) tube you can find which has a loose bulb. The larger the base the better as it gives you more room inside to wire in the diode and transistor. The writer used a dead 201-A having a loose bulb which was easy to remove from the base.

To remove the glass bulb from the base heat the ends of the pins with a soldering iron and shake out the solder, then carefully twist and pull the bulb out of the base. Caution: For safety wear a pair of gloves when removing the glass bulb from the base of the tube. Use a tube that has a loose bulb to start with. Clip off the leads going up into

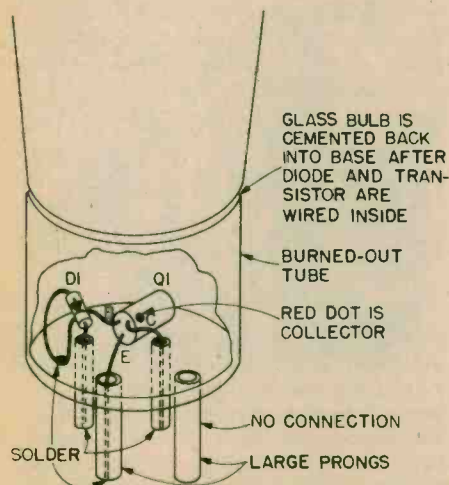

The trick is in the base of the radio vacuum tube. Diode and transistor in its base replace the tube in receiving circuit.

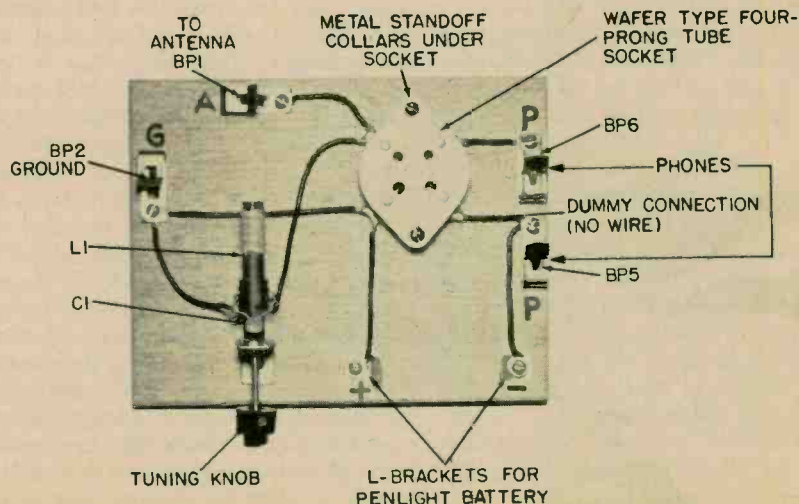

Beginner's one-transistor project uses easy-to-assemble breadboard construction just like the one- and two-tube sets Dad built in the Twenties and early Thirties.

e/e Build Transformers

twice the original output voltage. Basic transformer theory tells us that twice the voltage requires twice the number of turns. But to make the new secondary fit in the same space as the one it replaces, smaller wire must be used. If you own an accurate caliper or micrometer to measure the wire diameter, a standard wire table will tell you which smaller wire size to use. In practice, however, the author has been entirely successful with visual estimates at the wire rack at the local radio store.

In the transformer shown in Fig. 1, the 117 volt primary winding needed to be replaced with a 6.3 volt winding. Since 6.3 volts is exactly half the existing secondary voltage, the new primary was wound with half the number of turns of the secondary, using wire about 50% larger in diameter, or slightly more than twice the cross-sectional area. Following this technique of using the existing wire sizes and number of turns on the unmodified transformer as a guide, it is simple to create new windings of exactly the voltage required for a specific project. Remember, the voltage ratio is equal to the turns ratio.

Audio Transformers. Except for extreme high-fidelity applications, small filament-type transformers work well in audio applications. Normally, however, audio transformers are rated by impedance rather than voltage and current. But Ohm's law tells us that:

impedance = voltage ÷ current
Therefore, the illustrated 12.6 volt, 1.2

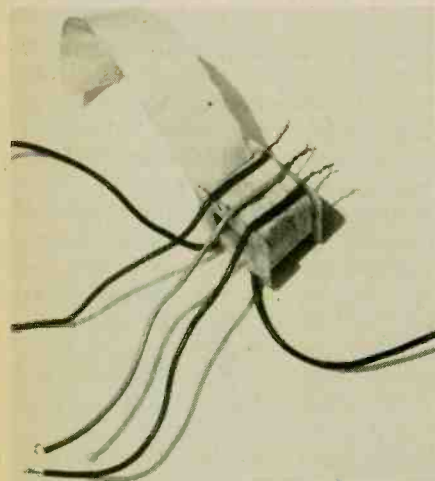

Fig. 4. Coil bobbin with first layers of tape removed shows the connections of the heavy wires which run to other components outside the transformer to the internal transformer windings. Caution: Some of the windings are made of very fine wire. Be very careful in handling this wire not to break it.

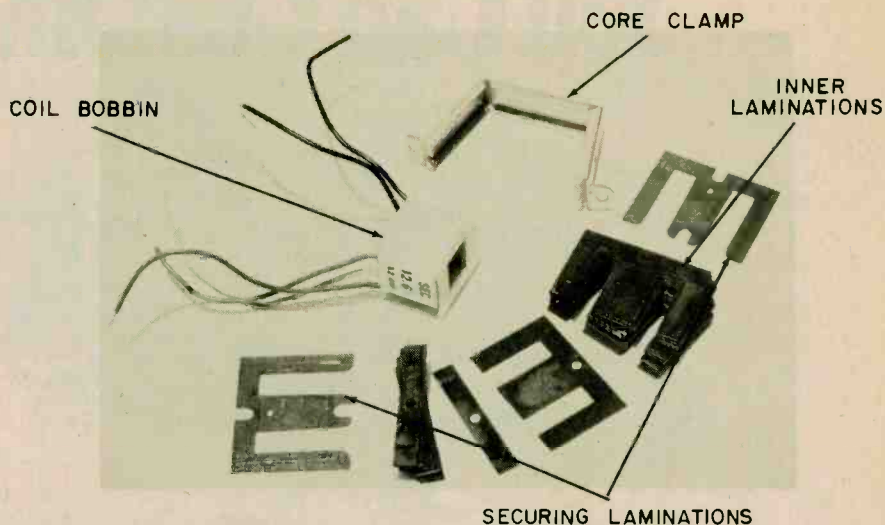

Fig. 3. Transformer is completely disassembled here. The coil assembly has been removed and is ready to be rewound. Be sure to make a diagram of the relative position of the laminations so they can be fitted back together again. Failure to do so will result in having extra pieces left over!

amp transformer has a secondary impedance of 10 ohms (12.6 V ÷ 1.2 A). This would be quite suitable for a loud-speaker output, for example.

To find the primary impedance, we use the formula:

$$Z_p = \frac{V_p}{V_s} \times Z_s$$

where Z_p is the primary impedance, V_p and V_s stand for primary and secondary voltages, and Z_s is the impedance of the secondary winding.

Stated in another way, the impedance ratio of a transformer is equal to the square of the voltage ratio.

$$\frac{Z_p}{Z_s} = \left(\frac{E_p}{E_s}\right)^2$$

Our example transformer has a turns ratio of about 9 to 1 (117V to 12.6V). Therefore, it has an impedance ratio of 81 to 1. Multiplying the 10 ohms secondary impedance by 81, we find that our primary has an impedance of about 810 ohms. Then by rewinding, using these relationships, we could create any desired set of impedances.

Physical Size. The final consideration in selecting a transformer for modification is its physical size. This is determined almost entirely by the power (watts) it must handle. In audio service this is usually known directly from the application. For power supplies, the power can be found by multiplying the supply voltage by the current it supplies.

For maximum efficiency, it is best to

select a transformer only slightly larger than required. A core that is too small will result in damage to the windings or too little voltage. Too large a core will waste power. There are formulas for determining the core size, but it is far easier to multiply the voltage and the current printed on the transformer secondary. The manufacturer has provided a core that will handle this power correctly, so it's a good indicator of the core's wattage capacity. Pick one slightly larger than required, especially for audio applications.

Much more can be said about transformer modification. But to the electronic constructor willing to undertake the simple job of rewinding, the otherwise limited number of easy-to-obtain low voltage transformers becomes a whole range of custom-designed power supply and audio transformers for specialized applications. And the cost savings will be substantial. Wind on! ■

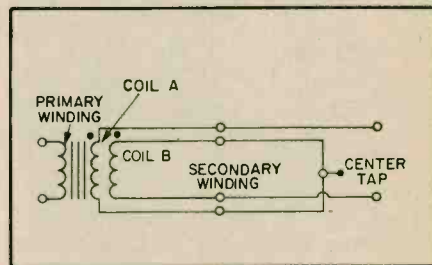
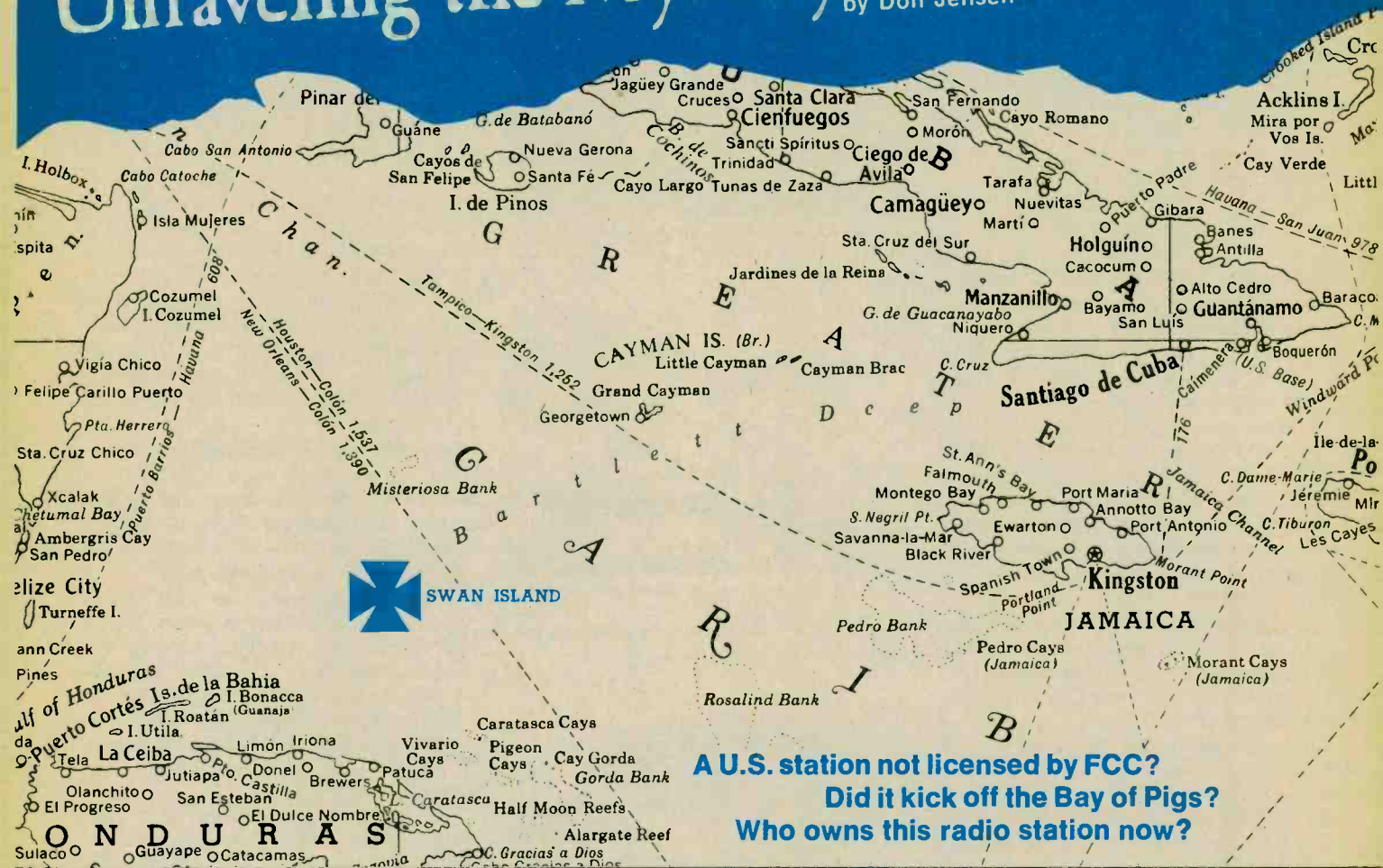

Fig. 5. This diagram shows how a bifilar winding of the secondary coil provides exactly even lengths of wire for the center-tap connection, yielding exact balance of the two secondary halves. Coil A and coil B are wound together starting and stopping at the same place.

Unraveling the Mystery of Radio Swan

by Don Jensen



**A U.S. station not licensed by FCC?
Did it kick off the Bay of Pigs?
Who owns this radio station now?**

APRIL 16, 1961, late at night . . . a mysterious 56-word message crackles out over the airwaves of the Caribbean:

"Alert! Alert! Look well at the rainbow. The first will rise very soon. Chico is in the house. Visit him . . . The letters arrived well. The letters are white. The fish will not take much time to rise. The fish is red!"

On that night in 1961, this cryptic message broadcast by a mysterious CIA radio station, Radio Swan, was supposed to signal an uprising by the Cuban underground movement. And in fact a few hours later, the first wave of an exile invasion force waded ashore at a place known in Cuba as Bahia de Cochinos—the Bay of Pigs.

The rest is history. The Radio Swan broadcast did not spark a revolution in Fidel Castro's Cuba and the invasion force was defeated on the beach. The United States suffered a diplomatic black eye. And the Central Intelligence Agency is still feeling the aftereffects of its setback.

Bury the past. Radio Swan, which had pretended to be merely a private,

commercial station, had blown its "cover." The station, operating from tiny Swan Island in the Gulf of Mexico, quickly tried to change its identity. It was renamed Radio Americas and, as such, continued broadcasting anti-communist programs to Cuba and the rest of Latin America. Though it remained under CIA control, it stayed clear of further covert cloak-and-dagger schemes, as far as is known. And in the late 1960's, the station quietly passed away—or so it seemed.

1975—Last summer, DXers were at first skeptical when a Mississippi listener reported hearing a station identifying as Radio Swan. Radio Swan? Naw! The station's swansong had been played years earlier. A simple case of mistaken identification!

But it was no error. There was a Radio Swan again broadcasting in the 49-meter shortwave band. Listeners throughout North America also heard the station's programs. Those programs, some of them avowedly anti-communist in tone, seemed a throwback to another era.

All sorts of questions were raised by

DXers. Was it the old Radio Swan back doing business at the same old stand? Or was it a completely new venture, attempting to cash in on a well-known old name?

Who was behind the reborn station? The CIA? Cuban exiles? Unreconstructed cold warriors in the U.S.? And where was the station located? On Swan Island, that guano-laden dot in the tropic ocean? Or elsewhere?

Born again? Déjà vu! Longtime listeners had a nagging sense of having been there before. Back in the '60's, the very same questions were asked about the original Radio Swan. It took years of digging to get most of the answers to questions about the first station. Would the reincarnated station prove equally puzzling?

When the U.S. government decided in the late 1950's to back the Miami-based Cuban exile organizations in their efforts to overthrow the Castro regime, it was felt that some means was needed to ideologically prepare the Cuban people for the counter-revolution. Thus a pair of powerful radio transmitters was established on Swan Island to beam

e/e RADIO SWAN

propaganda broadcasts to the Cubans. This station was called Radio Swan.

Why the Swan Island location? Apparently there were several reasons. First the island was small, and thus it was effectively isolated from prying outsiders. Also it was reasonably close to Cuba. But more importantly, Swan Island was disputed territory. The State Department said Swan was "considered by the U.S. government to be an American possession as a result of prior activities by our nationals." However, the Central American country of Honduras argued that it was still owner of the island.

To add to the confusion, a private citizen, Boston industrialist Sumner Smith claimed the island, tracing his ownership through a series of stock sales and mortgage foreclosures to an Alabama ship captain who had lived on Swan in the early 1900's.

The practical result of the territorial dispute was that while the island was occupied and effectively controlled by the U.S., the legal responsibility was conveniently clouded.

This was dandy for the CIA, but embarrassing to the Federal Communications Commission, responsible for licensing all radio stations on U.S. territory. If Swan Island was American soil, why was Radio Swan not licensed by the FCC? The commission could only dodge the question.

"There is a broadcast station . . . which operates on Swan Island, off the coast of Honduras," an FCC spokesman acknowledged. "It is not licensed by the FCC, nor is it operated by the Voice of America. This office is unable to furnish additional information." When pressed, he added, "We don't license government stations."

Was he saying Radio Swan was operated by the U.S. government?

"No, no, no! We don't know what it is!"

What it was, of course, was a clandestine CIA operation, but it was a long time before the facts became known. And Radio Swan continued to claim to be, "an American commercial broadcasting station." Up popped a company in New York City that publicly announced it had leased land on the island from Smith and was operating Radio Swan. That firm was known as the Gibraltar Steamship Corp., although its "officials" admitted it owned nary a steamship. The company, at first headquartered in Manhattan, later was identified as one of the numerous cover



Aerial photo of island shows elaborate support compound with 250-ft. tower (one of pair), upper right, transmitter at base.



One of the transmitter buildings is seen here near the base of a 250-ft. antenna tower. Two 50-kilowatt transmitters supplied the output power for Radio Swan.



Mobile equipment trailer was built in for a long stay. Note concrete path and roof supported over trailer.



Letterhead of the first Radio Swan (top) and QSL response card of 1975 station (below) show intended similarity.



businesses used as fronts by the CIA.

In September 1960, a New York attorney, Richard S. Greenlee, speaking for Gibraltar, announced that the station was interested in receiving listeners' reports and was seeking publicity in various radio magazines.

Swan airs ads. To maintain the image of a commercial station, Radio Swan, through a sales representative, Pan American Broadcasting Co., sought out sponsors. Air-time advertising rates were unrealistically low considering the station's claimed listenership potential of 20 million. Only a few sponsors were attracted to Radio Swan, among them the cigarette manufacturers, R. J. Reynolds and P. J. Lorillard, the Kimberly-Clark Corp. and a handful of evangelist broadcasters.

Radio Swan broadcast in both Spanish and English, political and religious programs, music, newscasts and a few dramas, including one called "Secret Agent K-7," an amusing twist considering the station's real ownership!

Like many a good commercial short-wave broadcaster, Radio Swan began verifying listeners' reception reports. But the incongruities of the station's operations were not lost on the DX world. Listeners were puzzled. And some chose to expand on the already ample mystery, claiming the station wasn't even really on Swan Island.

But on Swan it was! Aerial photos were "leaked" to some DXers which clearly showed the Radio Swan installation on Swan Island. The station operated with a pair of RCA transmitters, a husky 50 kilowatt medium waver, which broadcast first on 1160 kHz, and later on 1165 or 1157 kHz after stations in Chicago and Salt Lake City complained bitterly of nighttime interference, and a 7,500 watt shortwave outlet on 6,000 kHz.

Transmitter installation. Equipment was housed in several big stainless steel trailers, slung with awnings to protect the electronic gear from the tropical sun. On the island's eastern end, in a clearing, stood two 250-foot antenna towers. A mile away down the island was the Radio Swan compound, corrugated steel quonset huts that served as emergency studios, control rooms, work and storage areas and crew quarters.

On-the-air operations were handled by Philco Corp. employees, 15 engineers at a time, part of that company's flying squad of technicians available for hire to private concerns and the government on special assignment.

Programs for the most part were taped in the U.S. and flown to the is-

(Continued on page 88)



CB Lingo

MERCY SAKES ALIVE, Good Buddys, let the hammer up on those doggone Papermates. Polish Ham ten-fours your bodacious requests. Here's a bundle of CB lingo you've been picking up on your ears like bugs on a bumper for sure. Brain bank 'em and you'll turn into a regular CB ratchet jaws. Four? Now, Good Buddys, keep the greasy side down and the shiny side up. Stack them eights. We gone.

—POLISH HAM, KGK 3915

Advertising—A marked police car that has its lights turned on.

Back door—Last vehicle (truck) in a string of three or more—all in contact with each other.

Bear—Policeman.

Bear Cave—Police station or post on highway.

Beat the Bushes—"Front door" (lead vehicle) looks for Smokey by going fast enough to draw him out of hiding. See also "Shake the leaves."

Bodacious—Good signal; clear transmission.

Break One-Oh—Also "Break 10"—I want to talk (on Channel 10).

Bushels—One-half-ton; a 20-ton load would be 40 bushels.

Camera—Police radar unit.

Catch You on the Old Flip/Flop—Catch you on the radio on a return trip.

Check the Seatcovers—Watch for a female driver with her skirt pulled up.

Chicken Coop—Highway truck weigh station.

Clean—No Smokies around.

Comic Books—Truckdrivers' log sheets or log books.

Cotton Picker—Cotton picker (instead of four-letter words on the air).

County Mounity—County sheriff or highway patrol.

Ears—Antennas or radios. (See also "Smokey with Ears.")

Eatum-Up—Roadside restaurant.

Eighteen Wheeler—Any semi-tractor truck with any number of wheels.

Fat Load—Overload, more weight than local state law allows.

Feed the Bears—Collect a ticket from Smokey.

Five-Five—55, the legal limit in most places.

Four—Abbreviation of "10-4," meaning "OK."

Four Ten—10-4, emphatically.

Four Wheeler—Passenger car.

Front Door—First vehicle (truck) in string of three or more trucks in radio contact.

Grass—Side of the road or median strip.

Green Stamps—Dollars.

Green Stamp Road—Tollway.

Hammer—Accelerator.

Hammer Down—Highballing; driving fast.

Handle—Slang names used by CBers.

In the Grass—Parked or pulled over on the median strip.

Keep Your Nose Between the Ditches and Smokey Out of Your Britches—Drive safely and look out for speed traps and speeding fines.

Keep the Greasy Side Down and the Shiny Side Up—Drive safely.

Kenosha Cadillac—Any car made by AMC.

Let the Channel Roll—Let others break in and use the channel.

Mercy—Oh, wow! (Yes, truckdrivers really do say this.)

Negatory—No. Negative reply.

On the Move—Driving, moving.

On the Side—Parked or pulled over on the shoulder.

Other Half—Wife (usually) or husband.

Plain Wrapper—Police car with no markings; unmarked car.

Picture Taker—Same as "Camera"—a police radar unit.

Pickum-Up—Light truck; pickup truck.

Polish Ham—Your Editor, Julian Martin.

Pounds—Number on S-meter (S-3 is three pounds, etc.).

Pregnant Roller Skate—Volkswagen.

Put the Good Numbers on You—Threes and eights—best regards, etc.

Rake the Leaves—Back door or last vehicle in string, bringing up the rear.

Ratchet Jaw—Nonstop talker.

Rest-Um Up—Roadside rest area.

Rig—CB radio; tractor (double meaning).

Rocking Chair—Vehicle that's between
(Continued on page 87)

73'S TO MESSENGER III

by Myrtle Gronk



Mrs. Peg Santo, inspector for E. F. Johnson Company, hands the last Messenger III to Dewey Myers, general foreman for radio assembly and test. Mr. Myers has been involved in the assembly of Messenger III since it was introduced in 1963.

□ The last Messenger III Citizens Band transceiver produced by the E. F. Johnson Company was offered to the Smithsonian Institution for exhibition. Over 113 thousand Messenger III radios were manufactured during the radio's 12 years of production.

In a letter to the Smithsonian Institution, Mr. Richard E. Horner, president of the E. F. Johnson Company, said the Messenger III "pioneered the way for the compact, solid-state citizens band transceiver."

The decision to produce a fully transistorized five-watt citizens band transceiver was made in early 1962 by E. F. Johnson, then President of the Company. There was one major obstacle to producing a reliable five-watt solid-state transceiver: a reliable RF power transistor that could handle the current and frequency of CB radio did not exist.

Then, in 1963, RCA made available an output transistor it had developed for aerospace. RCA supplied the transistor at a cost of \$16 apiece. The cost of this transistor has been reduced to a fraction of its original price and today's cost of \$1.00 is nearly the same as the cost of the vacuum tube it replaced in 1963.

Thus, the Messenger III was born. Its design and reliability required only minor modifications during its 12-year production run. Indeed, the Messenger III's design heavily influenced the 15 succeeding Johnson CB transceiver models from the Messenger 100 to the Messenger 323M.

But don't shed a tear for the Messenger III! A call on most channels for present owners of the unit will bring a flood of responses. The Messenger III may be the Tin Lizzy of CB radio, providing two-way communications for many years to come. ■



by Kathi Martin, KGK3916

Kathi's CB Carousel

□ IT'S GREAT TO BE RIGHT. A few months ago just about every magazine and writer was talking up the FCC's proposals for Class D band expansion and a shift to SSB-only operations—except for channels 9 and 11—and eventual elimination of AM. Go to a convention, or visit a manufacturer or distributor, and one could actually hear these inane ideas promoted as being for the good of the Citizens Band.

I stood alone saying most of these ideas would never take place. More channels? Yes. SSB-only? Never. Phase out of AM? Somebody's insane!

I took a public stand that the goodie-two-shoes 2-meter amateur radio repeater operators were not necessarily better or different than Cbers, and there were 2-meter repeater operators no better than the worst of our CB brothers and sisters.

First, my column on the hams was followed by Wayne Green's blast at these same clods that clutter the amateur radio repeaters; and don't forget that Wayne is publisher of *73*, a top amateur radio magazine and the guy who pushed 2-meter FM while most others believed 2-meters was a dead band. If and when we get Class E CB the equipment will be low cost because the technology will have been paid off through the amateur FM gear made popular by Wayne and his readers.

Next followed the FCC authorization of hobby-type operations for CB, making CB essentially a code-free amateur radio band as originally envisioned for the proposed Communicator's license, which I believe is now a dead issue. At one stroke of the pen we "illegal" Cbers became as pure as fresh-fallen snow, and the amateur radio writers fell over themselves in a rush to join the bandwagon. An issue of anything—magazine, news bulletin, club paper or whatever—didn't come out unless there was some article or letter to the editor (who writes their letters?) recommending a CB rig for every mobile amateur "to keep in touch with road conditions." Were the road conditions different the day before the FCC okayed hobby-CB?

I believe the legalization of CB hobby operations means the end of the proposed Communicator's license—tought by virtually every amateur organization—and is the reason for the sudden love affair between the radio amateurs and CB.

As for the Citizens Band itself, the SSB-only proposal was drowned in the sea of red ink and bankruptcy envisioned for most CB manufacturers if it ever came to pass. CB will remain as it is: AM and/or SSB—take your choice.

In fact, CB is now everyone's choice. It's

become so big it now outclasses calculators as the hottest thing in consumer sales. You'll now find CB gear in the largest department stores, the top photographic supply houses in the U.S. and even at flea market dealers.

Typical of the usual enlightened outlook of many of our CB manufacturers, their first reaction was "But who will pay the extra crystal costs to get all-channel coverage?" (It's amazing how they succeed in spite of themselves. They're still thinking of multiple crystals in this age of the phase-lock loop!) Right now there is available for CB use—and a few *avant garde* manufacturers are trying it—an integrated circuit frequency synthesizer that needs only one crystal to provide in excess of 1000 frequency channels. And this IC *with its crystal*, which can provide all the needed 50 or 54 channels, costs less than just the crystals needed for a frequency-synthesized 23 channel rig (which takes 13 or 14 crystals.) However, based on FCC's previous track record, it might be

quite a while before these new channels become available. The new channels will not make your present rig obsolete and transceivers with 23 or even fewer channels will continue to be sold well after the additional channels come out.

Save a Dollar. Most transmitter test equipment and interference filters are either high power items labeled for CB, or excessively stylized and decorated low-power accessories. Either way you pay a lot of money for power-handling capacity you don't need, or decorator styling that does nothing towards improving your signal.

One place, however, where you will find top CB value for each dollar you spend is the *Gold Line* series of CB accessories. With most accessories sharing a common palm-size cabinet, and power rating strictly for CB, you can pick up a box full of test gear and filters for what a single item would cost in some other branded line. For example, the Gold Line SWR meter

(Continued on page 92)

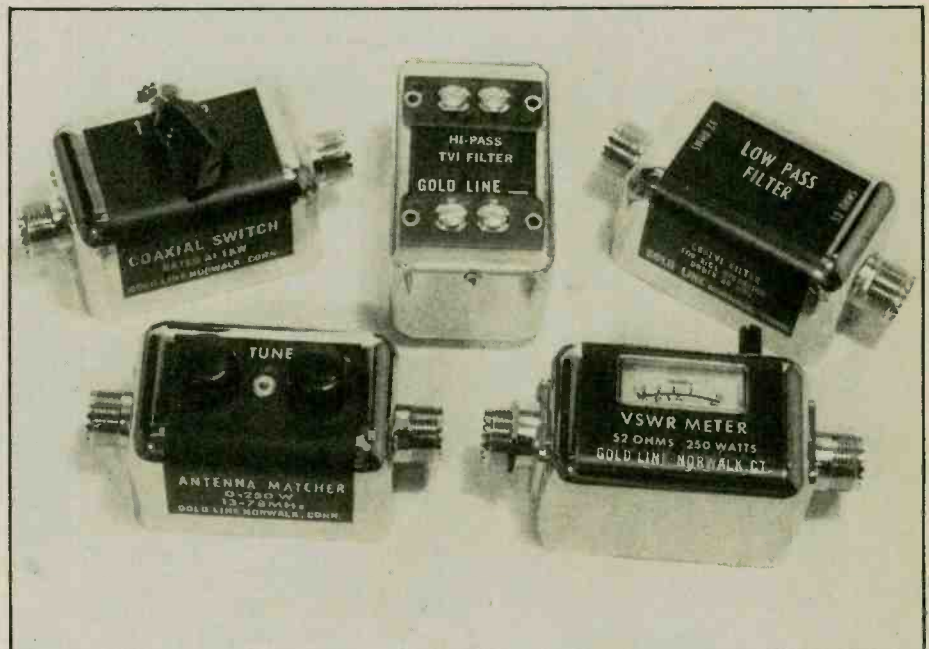

These five items especially designed for CB are a sample of the many miniature Gold Line CB accessories. They share a common housing measuring only 1 1/2 in. x 1 1/8 in. x 2 3/4 in., a size easily tucked away behind the associated equipment or in the glove compartment of a mobile. They are even light enough to be stuck to the equipment, or a dashboard, with a strip of double-sided adhesive. The secret behind the small size of most Gold Line accessories is a power handling capacity suitable for CB rather than high power amateur radio transmitters. For example, the SWR meter can handle 250 watts simply because ordinary standard components are capable of that power, but the meter has a special 0 to 10 watt scale. To get full information on all the Gold Line CB products, circle No. 68 on The Reader Service Card.

e/e checks out the...

REGENCY WHAMO-10 SCANNER

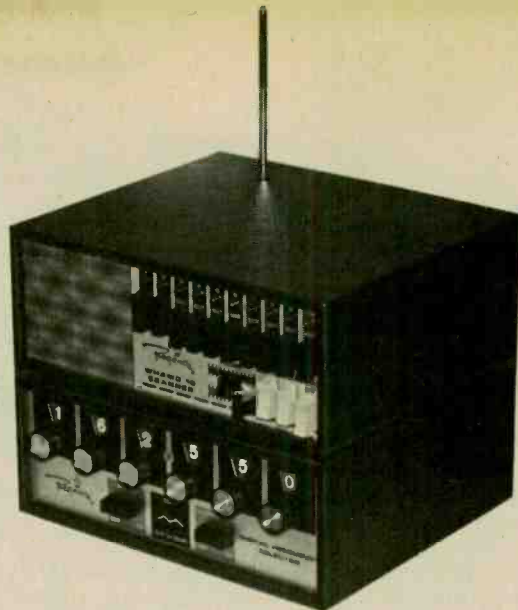

WITH SO MUCH HAPPENING on the public service bands it takes a pocketful of crystals just to keep track of what's going on in your own area. And even if you have that pocketful of crystals there are few monitor-radios or scanners that can accommodate more than a small handful, and you generally must remove the radio's cabinet to plug in a new crystal.

Fact is, now that a second UHF band is in full swing at 470 to 512 MHz it takes something like the Regency *Whamo-10* to cover all bands if you don't want to go broke buying crystals for every new service or police/fire frequency that opens up.

Actually, with a *Whamo-10* you won't even have to buy a single crystal, ever—or take the cabinet apart to change frequency. Anytime, anyplace, you can program the *Whamo-10* to receive any frequency in the 30-50 MHz, 146-148 Mhz (amateur radio), 148-174 MHz, 440-470 Mhz and 470 to 512 MHz bands by simply snapping a few fingers off a metal comb and plugging the comb into one of 10 sock-

ets on the back of the scanner. If you program all ten sockets, or any combination of sockets, the unit will scan all channels stopping at any that have signal, or you can manually preset the tuning to any desired frequency.

Digital Synthesis. How is this magic done? With a digital frequency synthesizer—the very latest technology in frequency control and selection. Since we don't have the space to explain digital frequency synthesis here, suffice to say that a synthesizer, which is generally locked to a crystal-controlled reference oscillator for maximum stability, is capable of inexpensively generating thousands upon thousands of individual frequencies by you simply adjusting one or more switches. In the *Whamo-10* the switch is a combination of the comb's fingers and a diode matrix. The fingers short a diode matrix making the diodes act as switches for a binary code determined by some of the fingers and their location on the comb. Other comb fingers determine which of three front ends is used.

There are three separate front ends: one for the low band (20 to 50 MHz), one for VHF (146 to 174 MHz) and one for the two UHF ranges (440 to 470 and 470 to 512 MHz). All three front ends are connected across the antenna input and electrical isolation keeps each from loading down the other two. The fingers on the comb determine which front end's output is used to drive the IF amplifier.

Rolling Your Own. Twenty combs are supplied with the radio as well as a tool for snapping off the unwanted fingers (you can use long nose pliers, too) and a programming directory for every standard-spaced frequency within the *Whamo-10*'s operating range. You simply lay the comb down on the programming guide for a desired frequency and snap off the fingers indicated with an "X". For those odd-

spaced frequencies not listed (though they are not normally assigned, radio amateurs use them on the 2-meter band) the programming directory details the method for determining the comb's programming; user-program worksheets are also provided.

From the Front. The *Whamo-10* looks like many other scanners. There are ten channel-selector on-off switches with LEDs directly above to indicate when a channel is turned on, a *Power* switch, a *Scan/Manual* mode switch, and a step switch for manually selecting the next channel that's turned on. Linear slide controls are provided for the volume and squelch.

The rear apron has a single antenna jack and a remote speaker jack. The internal speaker is automatically disconnected when the remote speaker is plugged in. Sockets are provided for the AC line cord or a 12 VDC power cable. If used in a vehicle the battery must have its negative terminal grounded.

A (supplied) telescopic antenna can be attached through a small hole in the top of the cabinet.

The Big Difference. Ten long, recessed sockets on the rear apron are
(Continued on page 90)

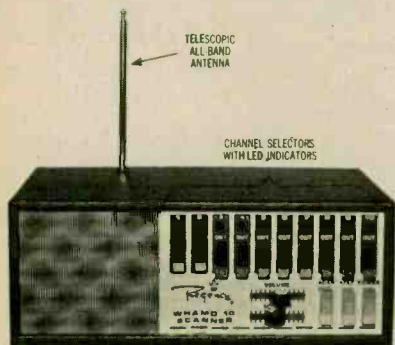

Front view of the Regency *Whamo-10* looks much like many other scanners, except that it has no band switch. Low, High, and UHF front ends are selected automatically.

The Regency *Whamo-10* Scanner and DFS-5K Synthesizer are made by Regency Electronics, Inc., 7707 Records St., Indianapolis, IN 46226. For further information, circle No. 61 on the Reader Service card.

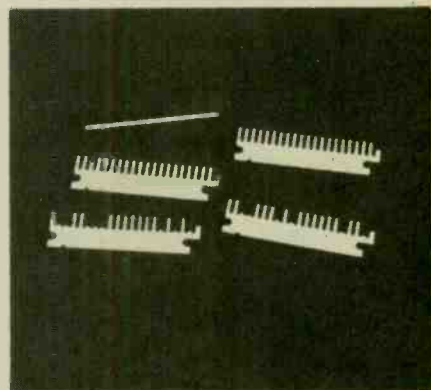

Four combs programmed for various frequencies are shown here. Upper left is programming tool, a stiff metal tube.

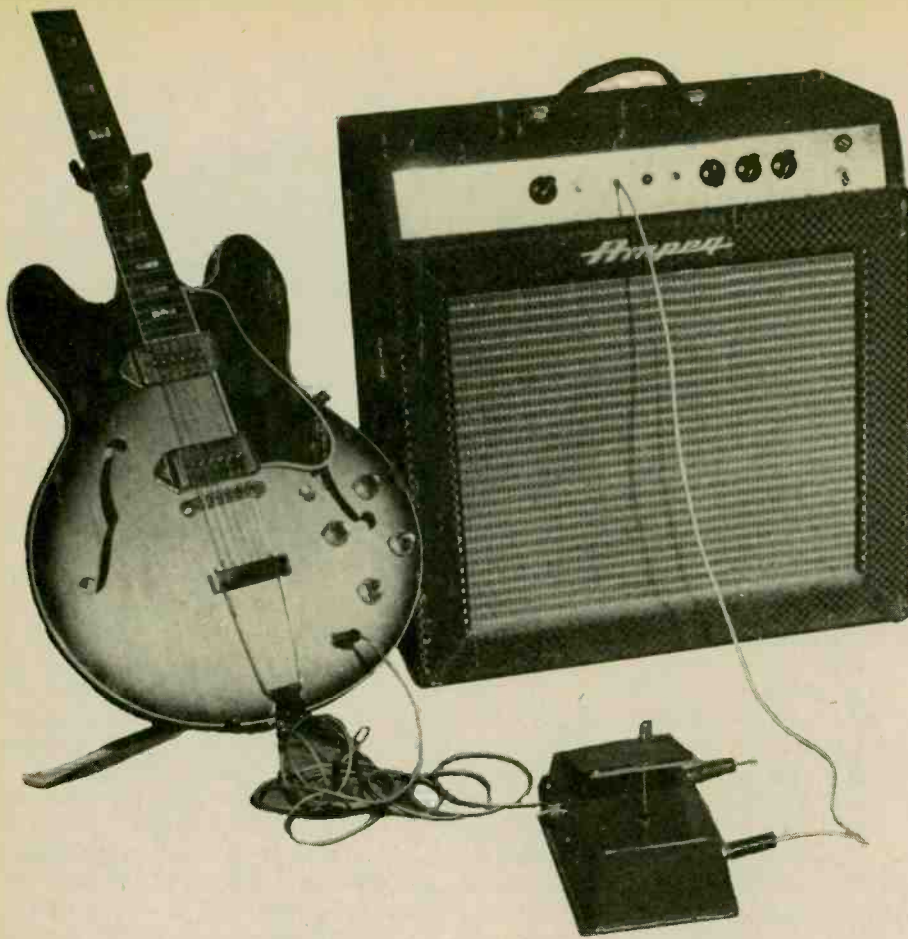

WAAAT'S THAT SOUND!

Simple circuit uses variable tuning slug coil to get foot-pedal wah-wah sound.

by Steve Daniels

A MOST POPULAR gadget in the well-equipped guitarist's sound effects bag is the Wah-Wah pedal, a foot-controlled, one-transistor (FET) amplifier which can produce many different effects, from plaintive wailings to blantly sexy "wow-wow" sounds. If used in conjunction with a fuzzbox, even such off-the-wall sounds as that of a sitar can be closely approximated. Experimentation and imagination are all that are needed.

Commercial Wah-Wah pedals run 35 bucks or more, but you can build our goody for about \$15. If you can find a breadpan and a used AM radio antenna loopstick lying around, you can do it for less than ten—a darn cheap way to beef up the sound of the old axe.

How it works. The Wah-Wah pedal control is an amplifier whose frequency response peak can be varied by an RC (resistance-capacitance) or LC (inductance-capacitance) circuit connected as the load (at the output) of a transistor. The circuit chosen here uses a variable inductance coil which is operated by a foot-pedal. Changing the size of the capacitor in the LC circuit could have been used to alter the output sound, but it would be more complicated mechanically, and would cost much more.

FET (field-effect transistor) Q1 is connected as a common-source amplifier with resistor R2 adjusting for dif-

ferences in individual gain. Switch S2 couples signal to your guitar amp either from the instrument directly or from the drain of transistor Q1. The switch is a push-push type, so be sure to use the one specified in the Parts List.

Loopstick Lowdown. Commercial coils don't have as much "Q" as is required for this application, so we roll our own, starting with an old AM antenna ferrite loopstick, taken from any old broken AM radio. Remove the original windings, clean the terminals, and remove the metal collar from the slug by just screwing it off. Cut two discs about 3/4-in. in diameter from thin cardboard, and nibble out a hole in the center of each so that they fit snugly on the loopstick. Position one disc right up against the collar that holds the terminals of the form and place the other disc about 3/16-in. from the opposite end. Cement the discs in place with just a few drops of household cement or good glue to hold them until the winding is complete. When the cement is dry, punch a pinhole through the cardboard at a point as close as possible to one of the coil terminals. Using a small piece of fine sandpaper strip the enamel from the end of the spool of fine (no. 28) wire. Thread this end through the pinhole to the coil terminal. Tin the bare wire end and solder it in place using as little solder as possible. Now

chuck the longer end of the coil form in an electric drill. Stick a dowel through the center of the spool of wire and hold this between your knees, leaving your hands free to hold the drill with one hand and guide the progress of the winding with the other hand. The exact number of turns isn't critical—just distribute the turns evenly and fill the entire space between the cardboard discs. Finish the winding at the terminal end and bring the ending lead through a second pinhole. Strip the end with sandpaper and attach through the opposite pinhole to the other terminal.

Wire the FET transistor Q1 and the other electronic parts together on a small piece of perf board (the one shown in the picture is 1 1/2-in. x 2 1/2-in.). If this is one of your first projects it might be wise for you to use a transistor socket instead of wiring directly to the transistor itself (because you could overheat the transistor if you don't take the precaution of a socket—or of using a pair of long-nose pliers as a temporary heat sink when soldering to each lead of Q1). Use flea clips to assist in soldering to the various components on the board. The layout isn't critical since there are no radio frequencies involved.

Be sure to use the capacitor specified for C2 because it packs the required amount of capacitance into a very small space. Bring out tie points to the edges

of the board to permit conveniently connecting them to the other parts of the circuit (switches, jacks, variable control inductor coil and battery).

Experiment for best sound. Varying the "Q" of the coil can change the sound, so you may wish at this point to experiment to find the exact LC combination that gives the sound that you want. If so, breadboard the circuit together on your workbench, but keep your leads fairly short. Connect up your guitar and an amplifier and turn S1 on. Set R2 to its midrange, and play a few notes while moving the slug of L1 in and out. If there is no effect, press S2. The Wah-Wah should now be heard. After adjusting R2 for the best effect, you may still want to experiment for a different sound. If so, unsolder the end of L1, unwind about 100 turns and reconnect the end. Replace L1 in the circuit and add capacitors in parallel with C2 in intervals of 0.05 μ F until the Wah sound returns. Repeat this procedure until you get the effect you want, then find a single capacitor to use for C2. What you are actually doing is raising the "Q" of the tuned circuit while keeping the resonant frequency about the same.

Breadpan to Bandstand. The breadpan that we used for our model measures 9½-in. x 5½-in. x 3-in., but anything in this range will serve. The pedal itself is made from a piece of masonite about 3½-in. x 6-in. Cut a piece of thin

sheet metal the same size and screw the two together with the shortest 4-40 hardware that will work. Cut off or file down the ends of the screws as much as possible when this is done. The hinge that allows the pedal to move up and down can be an ordinary butt-hinge from your local hardware store. It is secured in the center of the pedal from the underside, using 4-40 hardware. Here again, file down the screw shanks as short as possible. The rubber matting that we use as a covering also came from a hardware store. Cut a piece exactly the size of pedal and glue it on the metal side with rubber cement.

Using the photographs as a guide, position the pedal assembly on top of the breadpan and mark the position of the mounting holes with a scribe or awl. Drill and deburr these holes. The hinge is supported off the pan by ¼-in. spacers and secured with 4-40 hardware, but only mount it temporarily at this time. Let the pedal lie flat. Take a pencil, and gently draw a line across the pan to indicate where the business end of the pedal rests in the full-down position. Find the center of this line, move in toward the hinge about ⅛-in. and you have located the center of one side of the slot through which the coil slug passes. The one we used measured 7/16-in. x 7/8-in. The slot is best cut with a nibbling tool. Now locate and drill holes for the two switches and two jacks, and the screw holding the circuit

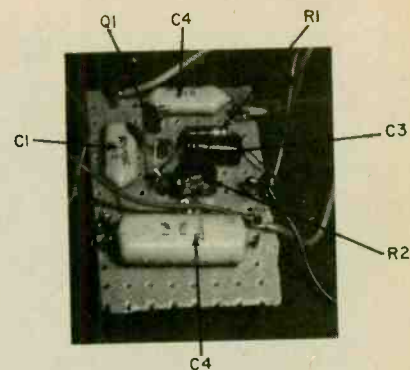

The layout of components on perfboard is not critical. Use any handy arrangement.

board. If it's going to be painted, now's the time to do that.

Build the bracket. The support for the variable inductance control coil, L1, is made from 18-gauge aluminum. The dimensions may be adjusted to your convenience and taste. Find the exact center of the bracket and bore a ¼-in. hole there. Get a large rubber grommet which just fits comfortably onto the tubing of L1. Ream out the hole in the bracket so that the grommet fits in with just a little bit of slack. If you now slip the long end of the coil into the grommet, it should move easily back and forth. The coil form should project about 5/16-in. above the top of the grommet. A small bracket of sheet metal is used as the stop for the coil slug. It's held with two 4-40 screws as the photo indicates. Solder two 6-in. leads to the coil terminals and you are ready to mount the whole assembly in the pan.

Final assembly. Remount the pedal and drill a small hole through the masonite about ⅛ in. from the business end, right on the center line. Don't go

WAAHS SOUND

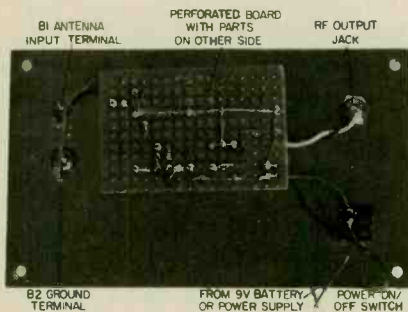

Point-to-point wiring is used to connect the FET, the input and output jacks, bypass switch, battery, and the few components on the small perf-board. Layout on the board is non-critical. Just position parts for convenience.

Inside view of Wah control box, showing the few parts needed. Bypass switch S2 is a push-push type which can be foot-operated to cut the control in, or let your instrument (guitar or other) feed directly to your amplifier-speaker.

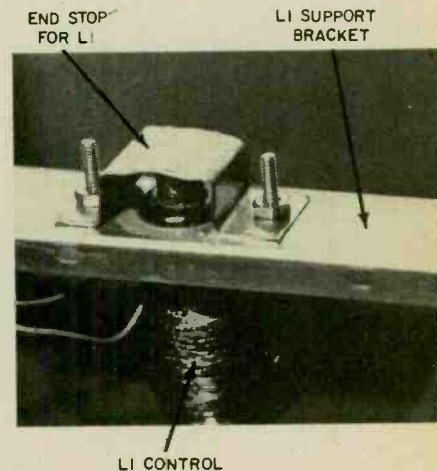
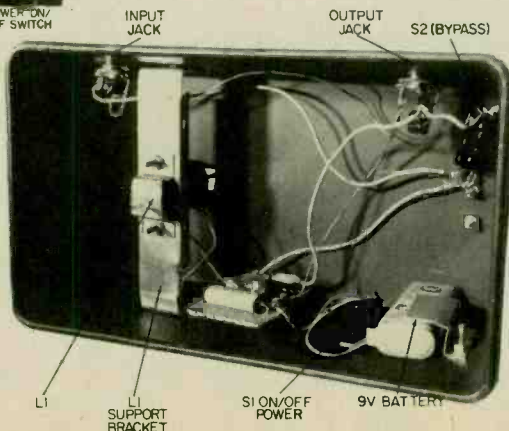

Upside-down view of the support bracket for control coil L1, with small end-stop for the coil. Both are aluminum strip.

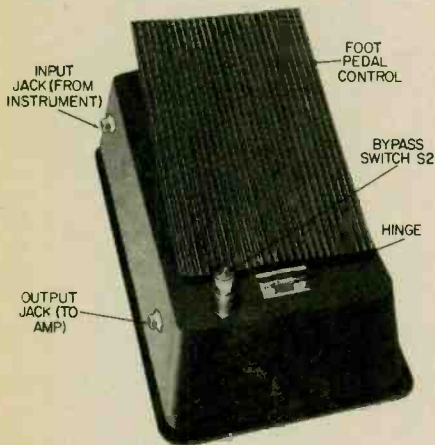

Wah-sound foot pedal control ready to work. Your instrument (guitar or whatever) plugs into the rear-side jack, and connecting cable to your amplifier-speaker plugs into the front side jack. Bypass switch is foot-operated to cut the foot-pedal in.

through the sheet metal because this is where the slug shaft is anchored, using sweat soldering. The slug is properly positioned when it is perpendicular to the top of the pan with the pedal at a 40-degree angle. Bring the bracket with the coil in from the bottom, slip the slug into the form, and find a mounting angle for the bracket that allows the slug to travel freely up and down. Bore mounting holes for the bracket and screw it securely in position. Remove the slug from the coil momentarily and drop a small spring into the form. Find a spring size that allows as much travel

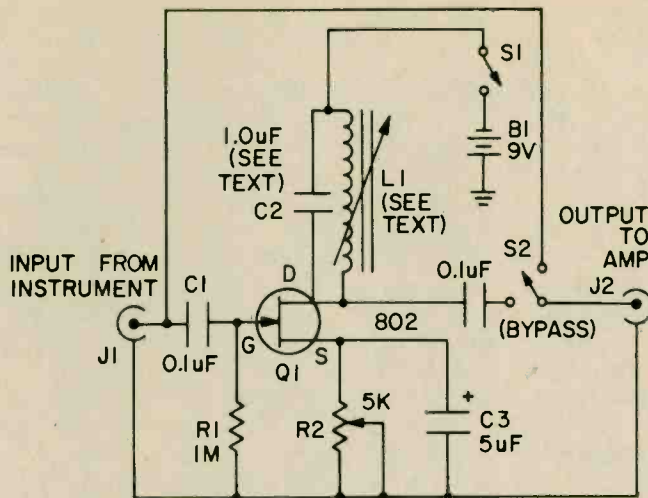

PARTS LIST FOR WAH-WAH PEDAL

- B1—9-volt transistor radio battery (Radio Shack 23-151 or equiv.)
- C1, C4—0.1 μ F tubular capacitor—any voltage over 50. (Radio Shack 272-1058 or equiv.)
- C2—See text. 1.0 μ F (not electrolytic) capacitor any voltage over 50. (Radio Shack 996-69)
- C3—5.0 μ F, 15 VDC miniature electrolytic capacitor (Radio Shack 272-951 or equiv.)
- L1—Inductor, home brewed on old AM antenna ferrite loopstick (or use Radio Shack 270-1430 or equiv.)
- Q1—Field Effect Transistor (FET) Motorola HEP 802 (Radio Shack RS-2036 or equiv.)
- R1—1-megohm $\frac{1}{2}$ -watt carbon resistor (Radio Shack 270-1000 series or equiv.)
- R2—5K miniature potentiometer printed circuit board mtg. (Radio Shack 271-217 or equiv.)
- S1—SPST power On/Off switch (Radio Shack 275-602 or equiv.)
- S2—SPDT push On, push Off switch (Radio Shack 275-1560 or equiv.)
- Misc.—Connecting clip for battery (Radio Shack 270-325 or equiv.); small perfboard (Radio Shack 270-1582 or equiv.); perfboard terminal clips, push-in type (Radio Shack 270-1394 or equiv.); aluminum strip 18 gauge, 1-in. x 6-in. approx.; small piece rubber matting; masonite or thin composition board (see text); small breadpan.

vertically as possible. The rest of the assembly should be clear from the photos. The circuit board is held off the pan with a small spacer, and the battery clamp is bent from sheet aluminum.

It will take some practice to coordinate the use of the Wah sound with your playing, but once you have the trick, you'll have the listeners all asking *Waaah's that Sound?* ■

Quickdraw Rickshaw

□ In the days before the invention of the gasoline engine, instead of going out for a drive on a Sunday afternoon people would take a leisurely ride in a horse-drawn surrey, "a four-wheeled pleasure carriage." In this day and age all we hear about is how fast a car can go, how many miles per gallon we can get on the highway, and how much air pollution is caused by gasoline engines. The days of going out for a ride just for the fun of it seem to be just about gone. But not quite.

Roy Haynes, a British engineer, is in the business of producing four-wheeled, four-seated pleasure carriages which are powered by electric engines. One model of the leisure-mobiles is called the Rickshaw.

You might think that a fun vehicle might be constructed flimsily, like a child's toy.

Not so. In the case of the Rickshaw, the careful planning that has gone into the development of the design is visible in the chassis, the suspension, and in the electrical system.

The Rickshaw has a steel chassis which carries the stylized two-piece, four-door, resin-molded body. The body is made with an integral floor and has separate front and rear folding vinyl hoods. Bench seats are used both in front and in back. The battery packs are assembled below the front and back seats.

The electrical system is powered by

twelve 6-volt 150 ampere-hour lead acid batteries carried in two six-packs. They are under the seats and are thus within easy reach for servicing. The 72-volt system is controlled by a thyristor controller which provides smooth, progressive control of the car's acceleration.

The Rickshaw might have some trouble competing with a gasoline-powered car in a drag race, but what could compare with the looks of amazement you're bound to get when you coolly pull up to the curb and say to your friends, "Hey, how'd ya like a ride in my quickdraw rickshaw?" ■



Electric-powered "Rickshaw" carries four people in stylized resin-molded body. 12 six-volt lead acid batteries provide motive power.

ATTENTION GRABBER



Synchronized dual duration flash rate for up to 300 watts of incandescent light!

by C. R. Lewart

HERE'S A FLASHY project with some interesting and novel features. It can be used to control lamps up to 300 watts. The on-off ratio of the flasher and the relative length of the subsequent "on" times can be adjusted with two controls; thus you create a unique "dot-dash" effect. In addition, the flasher contains only solid-state components for long-term reliability. The flasher can be used for Christmas lights, window displays, Halloween pumpkin illumination, psychedelic lights and many other special effects.

If you watch the blinking lights for a few minutes you will understand the name we gave to this project.

Building it will make you familiar with various solid-state devices such as triacs, timer integrated circuits, optoisolators and photocells.

How Does It Work? The integrated circuit "556" consists of two "555" timing sections described in previous projects. Its two outputs on pins No. 5 and No. 9 (see schematic) are separately controlled with potentiometers R1 and R3. When any of the outputs is in the "low" state, the pilot lamp in the light coupler lights and lowers the resistance of its associated photocell. A low photocell resistance makes the triac conduct and the circuit supplies full AC voltage to the lamp socket. When both of the timer outputs are "high" the light goes out and the triac stops conducting. The process repeats itself thus giving the flasher effect. The low voltage section of the circuit is separated from AC voltages by the light coupler. The transformer T1 with its associated rectifier bridge and capacitor, C5, sup-

plies DC voltage to operate the integrated circuit and the lamp in the light coupler. The two diodes, D1 and D2, isolate the two timer sections of the IC.

Construction. You can build this circuit easily on a 2½ x 3½-in. perf board using point-to-point wiring. No special wiring precautions are necessary except for the section of the circuit which carries AC voltage. Make sure that it is well insulated and kept away from the rest of the circuit and the cabinet. Use a 14 pin socket for the IC. Insert the IC only when you are ready to test the circuit. If you substitute a

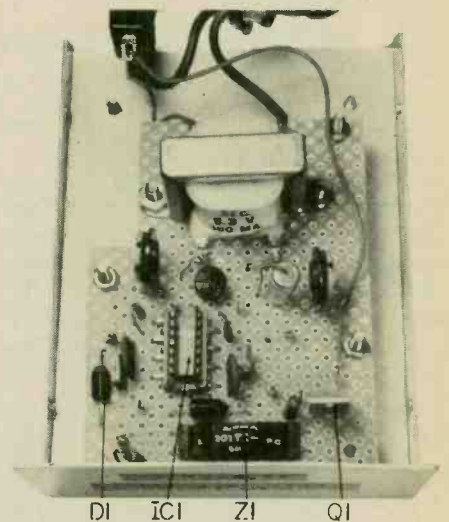
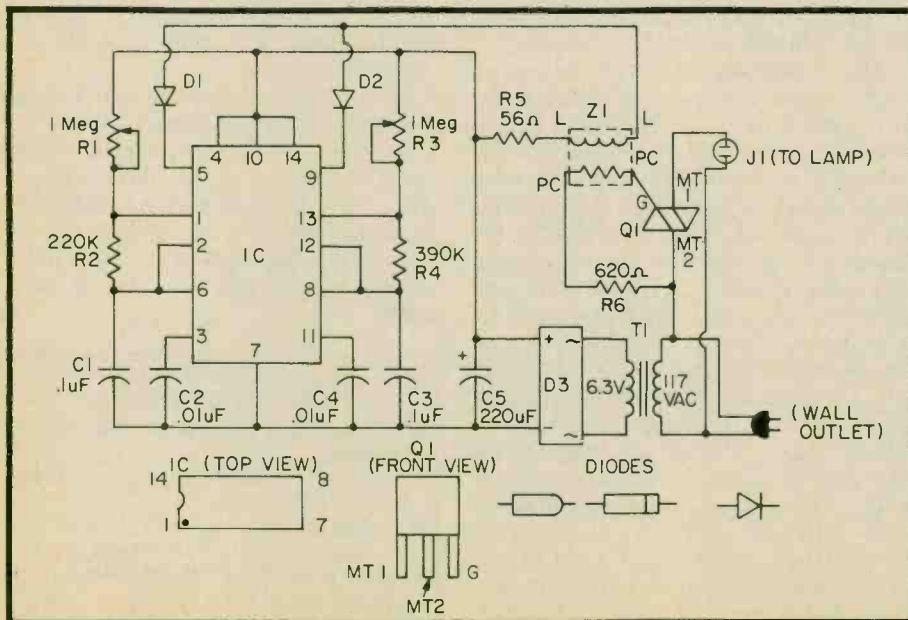

Fig. 1—Inside-chassis view of completed Attention Grabber shows location of parts. Mounting them on perf board is easy because locations are not critical. Larger or smaller board and box can be used, so long as schematic diagram is followed for connections. Any household lamp or bulb up to 300 watts can be turned on-and-off by this unit.

e/e ATTENTION GRABBER

separate pilot light and a photocell for the light coupler, wrap the photocell and the pilot light together with black electric tape. Make sure that the active side of the photocell (the one with the pattern) faces the pilot light and that the photocell pins are insulated and do not touch the pilot light pins. To use this photocell-and-pilot lamp setup in

place of the light coupler see the Parts List.

Operation. The only two adjustments for the flasher are R1 and R3. They let you select the on-off times and also to some degree the two different "on" times. If you wish to do some experimenting try different values for C1 and C3 between .01 and 1 μ F. You may also try different values of R2 and R4 between 50,000-ohms and 1-megohm.

If you would like to be able to change the flasher characteristics while the unit operates, mount R1 and R3 on

the cabinet rather than inside the cabinet on the perf board as shown. ■

PARTS LIST FOR ATTENTION GRABBER

- C1, C3—0.1 μ F capacitor (Radio Shack 272-1069 or equiv.)
- C2, C4—0.01 μ F capacitor (Radio Shack 272-1065 or equiv.)
- C5—220 μ F electrolytic capacitor, 35 VDC (Radio Shack 272-1017 or equiv.)
- D1, D2—1-amp, 50-PIV silicon diode (Radio Shack 276-1135 or equiv.)
- D3—1-amp, 50 PIV bridge rectifier (Radio Shack 276-1151 or equiv.)
- IC—556-type timer integrated circuit (Radio Shack 276-1728 or equiv.)
- Q1—6-amp, 200 volt triac, GE SC141 (Radio Shack 276-1080 or equiv.)
- R1, R3—1-meg potentiometer, PC-type (Radio Shack 271-229 or equiv.)
- R2—220,000-ohm, 1/2-watt resistor (Radio Shack 271-000 or equiv.)

- R4—390,000-ohm, 1/2-watt resistor (Radio Shack 271-000 or equiv.)
 - R5—56-ohm, 1/2-watt resistor (Radio Shack 271-000 or equiv.)
 - R6—620-ohm, 1/2-watt resistor (Radio Shack 271-000 or equiv.)
 - Z1—light coupler, Sigma 301B1-6B1 (Allied Radio 917-1417 or equiv.)
- Note—You can make a light coupler see text with a 6-volt, 25 mA lamp (Radio Shack 272-1140) and a CdS photo cell (Radio Shack 276-116) to use in place of the commercial unit.
- Misc.—case 4 x 2 3/8 x 6-in. (Radio Shack 270-252 or equiv.), AC socket (Radio Shack 270-642 or equiv.), 14-pin IC socket (Radio Shack 276-027 or equiv.), wire, solder, hardware, etc.

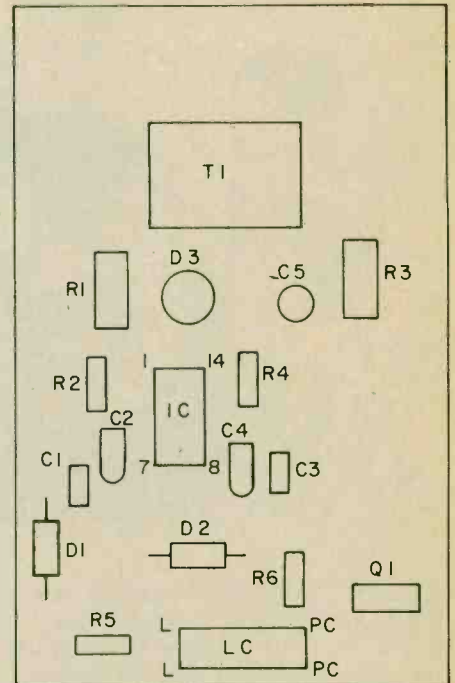

Fig. 2—Parts layout for easy point-to-point wiring is shown above. Inexperienced builders should follow this plan for trouble-free construction. Experienced constructors can use any convenient layout desired.

BUILD AN ACU-VOLT CALIBRATOR

THIS EASY PROJECT GIVES YOU A SUPER-ACCURATE VOLTAGE SOURCE FOR CALIBRATING YOUR VOM OR VTVM.

by F. Chapman

□ You have just finished building that new kit VOM or VTVM and are ready to adjust the calibration. And what do you use—the standard 1.5-volt off-the-shelf dry cell from the local drugstore. Maybe you want to check the accuracy of your meter after a hard bounce in the trunk of the family gas hog. Out comes the slightly used cell from the under-dash flashlight.

Sure, I know, the book says that a fresh dry cell has a terminal voltage of 1.56 volts. But the key word is *fresh*. Just how fresh is that cell you are using? How long has it been sitting on the dealer's shelf, or in the flashlight? It could be three years old!

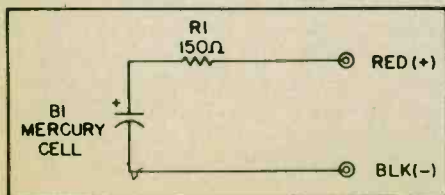

Your VOM probably has an accuracy of 2% of full-scale. Why not use a cell whose *known* accuracy is much better than the meter's?

Use a Mercury Cell. Such an animal is the mercury cell, of which there are two types. One has a cell voltage of 1.4 volts, the other 1.35. The latter has an accuracy of about 1/2% when loaded with one mA or less. Since most VOM's worth calibrating are at least 20,000 ohms per volt, this means they have a full scale deflection current of 50 microamperes. On a 2.5 volt DC scale 1.35 volts will take only 27 microamperes of current from the cell. This allows us to put a resistor in series with the cell and jacks to limit short circuit current to about 10 mA. This insures that the cell will not be damaged by an accidental short. Any of the cells whose voltage is 1.35 volts will do. You will note that they all have an "R" at the end of the type number (Example: An RM12 is a 1.4-volt cell. An RM12R is 1.35 volts.)

Mount the cell, its holder, resistor and red and black pin jacks in a small plastic case and you have a very accurate means of checking your DC meters calibration.

You might feel that it would be good to have several different voltages for calibration. Not so. Most good meters use 1% resistors in the voltage-measuring circuit. Further, they normally only have a single DC adjustment. Set the calibration control on one scale and it should hold within 1% for all other scales. ■

PARTS LIST FOR ACU-VOLT CALIBRATOR

- B1—Mercury cell 1.4 volts (Radio Shack 23-1520 or equiv.)
- R1—150-ohm, 1/2-watt resistor, 10% (Radio Shack 271-000 or equiv.)
- Misc.—Binding posts, one red, one black (Radio Shack 274-662 or equiv.), small box, aluminum (Radio Shack 270-235 or equiv.), or bakelite, (Radio Shack 270-230 or equiv.)

Rats! He was caught with his charge up!

by Myrtle Gronk



Student scientist is a hero one day
and worse than a pussycat the next!

□ "Rats!" might very well have been the first thought that crossed Manfred Gahr's mind when he heard about the charges which were being brought against him. And it all began the day Manfred got interested in learning more about mice.

Sixteen year old junior scientist Manfred Gahr of Haar, Germany, is a promising student who is especially interested in electronics. After a year of studying a number of advanced electronic textbooks, Manfred came up with a way to test the intelligence of mice using electronics.

"A lot is known about the intelligence of rats," Manfred says, "but I have found little information regarding the intelligence of mice. I thought that it should be possible to design and build a device which would help me with my research. Since most, if not all animals react to food, I thought that I would construct something which would show me whether mice possess basic intelligence, or whether they act only by instinct."

Manfred constructed an ingenious electronic contraption which provided answers. He constructed his first test device in 800 hours, and spent about 700 hours designing and building the second one, pictured here. It includes 149 transistors, 170 resistors and potentiometers, 36 diodes, and over 2000 connections. He entered the "Youth Researches" contest and he won first prize.

Manfred got the recognition he deserved, but he also got trouble he hadn't counted on. The German Association for the Prevention of Cruelty to Animals acted on the basis of highly exaggerated, sensationalist reports printed in a Munich paper without checking the facts, and had the First Prize winner charged with cruelty to animals. Manfred was flabbergasted. "Apparently, half truth sells newspapers," he said. "The whole thing is absolutely absurd. Naturally, no cruelty or even discomfort was caused to the few mice I used.

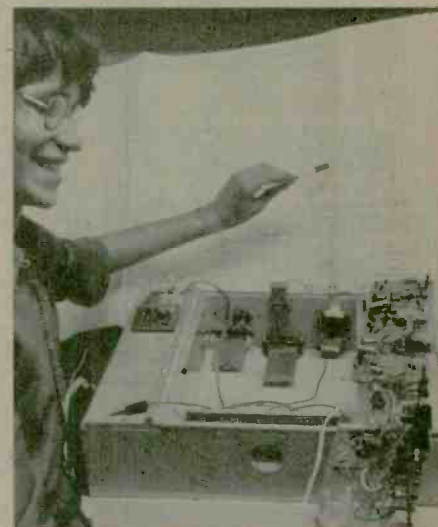

Manfred shows off the wiring system and electronic details of his prize-winning instrument.

The paper ranted about mice-getting-rare-in-Haar and suggested that I had been using many mice. Thus, indirectly the paper suggested that surely a lot of them must have died as a result of my tests. This is utterly untrue and nonsense. Had any mouse died, I would have put a stop to my tests."

It will be months before the animal-cruelty case will actually be tried in court, and it is doubtful that Manfred will get anything but praise for a well-thought out experiment.

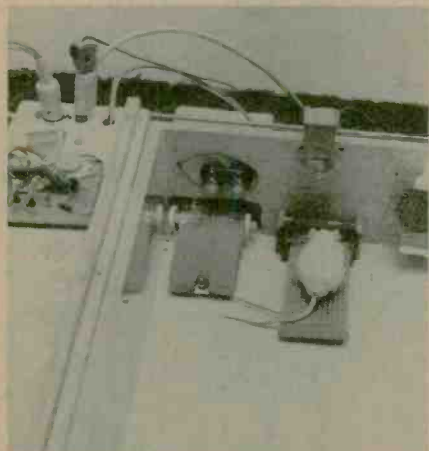

A mouse can prolong his meal by stepping onto a platform (at left) when the lights above it blink. Otherwise a weak electrical pulse will jolt the mouse.

Walking Streets “Paved with Gold”

by Myrtle Gronk



Francis Gardener is collecting coins dropped in the streets of London. He says that the best time to go looking is just after rain, when the dirt has been washed away from the cracks and crannies in the pavement and stones.

□ As long as there have been treasure-seekers there have been stories about cities where the streets are “paved with gold.” None of those stories ever turned out to be true, so far as we know, but a modern treasure-seeker (and finder!) in London is hauling in the cash with his ultra-modern electronic metal detector.

Francis Gardener is often seen walking through the streets of London holding a white stick with a small hoop out in front of him. If asked what he is doing walking through Piccadilly Circus like a blind man, Mr. Gardener might reply, “Looking!” The inquisitive bystander questions again: “Looking for what?” “Looking for gold!” Mr. Gardener responds with a smile as he continues on his way.

You see, the white stick Francis Gardener seems to be following through London’s tourist haunts is a far cry from the simple guiding-stick it seems to be. From the top of the stick runs a cable connected to an earpiece which emits little beeps whenever a bit of

metal comes within range of the detector coil in the hoop. “Tourists flock to London, and in the hustle and bustle they all too often drop money,” Francis explains. “A two-pence here and a five-pence piece there. They hardly notice it is missing.” A few months ago he came across eight coins in the space of a few hundred yards which totaled up to more than five U.S. dollars.

Francis contacted a friend who suggested buying a sensitive metal detector—but one that wouldn’t be too conspicuous. Francis searched around and at last found just the right thing. “The detector costs little, is sensitive, and best of all is pretty inconspicuous.

Whenever possible he goes out during his lunch hour and goes searching for money and other valuables dropped in the streets. In some months he has “earned” as much as \$10 or \$20. He also has come across a number of rings which he hands in to the police. If they are not claimed within a certain amount of time they are his to keep—gold in the streets, indeed!

BASIC THEORY

By Jack Schmidt

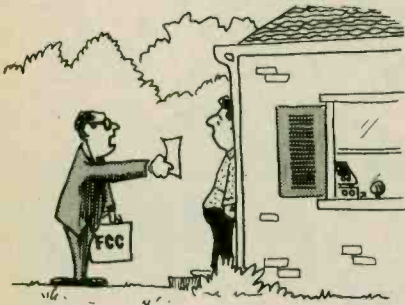

“Radio waves are a lot faster than the U.S. mail . . . and you’re broadcasting before your license was approved!”



“I lost all the small resistors, so I used one big one.”



“You are not putting that stuff in any part of my house!”



“There’s your trouble, Max, . . . your volt meter is reading a little on the low side.”

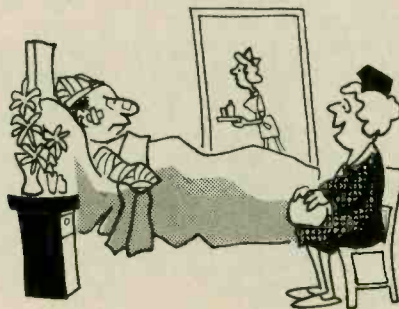

“Would you like to know the difference between microvolts and regular volts?”



“It’s got fantastic power output . . . I just can’t get it to the antenna!”

e/e BASIC COURSE IN ELECTRICITY & ELECTRONICS

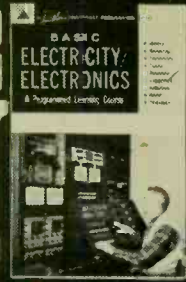

This series is based on BASIC ELECTRICITY/ELECTRONICS, Vol. 1, published by HOWARD W. SAMS & CO., INC.

What you will learn. Diodes are used in virtually all electronic circuits. They are simpler than, but similar to transistors. When you understand simple diode action you are halfway to understanding transistors. The diode is a device through which current passes easily in one direction, but very little or not at all in the other direction. In this article you will learn of the common applications of diodes, and how they work in circuits.

WHAT IS A DIODE?

A **diode** is an electrically operated device which has two elements (or terminals). If a voltage source is applied to these elements in the correct polarity, current flows through the diode. However, if the polarity is reversed, very little (if any) current passes through.

A **solid-state diode** contains two dissimilar metals or two different types of semiconductor materials. Current flows across the junction formed between the differing materials.

Semiconductor Diodes—A semiconductor diode is made of the same materials as those used in transistors, usually **germanium** or **silicon**. The sili-

con diode is more expensive than the germanium diode, but is able to handle a greater amount of current.

During manufacture, a tiny block, identified as **P-type**, is treated in such a way as to have a deficiency of electrons. Another block is identified as **N-type**, and is treated to have an excess of electrons. Such a diode is often called a **PN junction**.

When joined, a voltage barrier forms at the junction, preventing the electrons in the N material from moving over to the P material. However, when a voltage is applied (as shown in the drawing) the barrier is overcome and electrons flow from N to P. The schematic symbol used for all solid-state diodes is also shown.

Voltage polarities necessary for current to flow are labeled on the symbol. Current flows through the diode *toward* the arrowhead.

QUESTIONS

- Q3. N-type germanium has an (excess, deficiency) of electrons.
- Q4. From anode to cathode in a diode is a direction of _____ resistance.
- Q5. The identifying symbol for the anode is a +.

ANSWERS

- A3. N-type germanium has an excess of electrons.
- A4. From plate to cathode in a diode is a direction of high resistance.
- A5. The symbol for the anode is +.

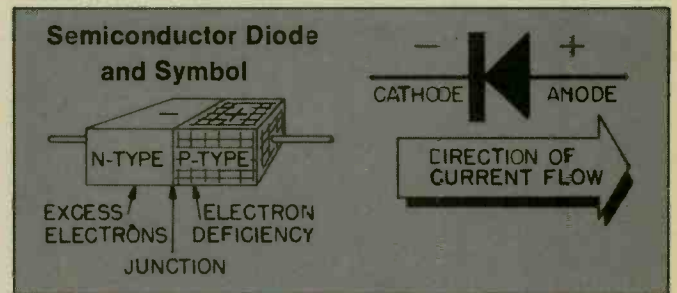
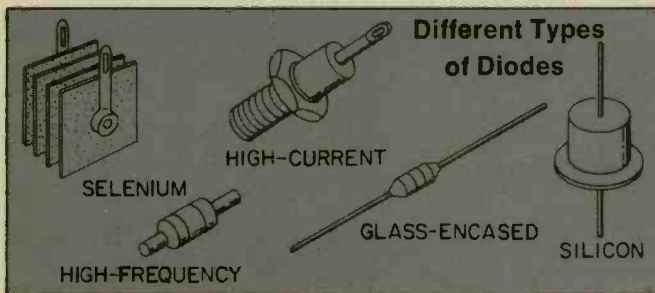

DIODE REACTION TO AC AND DC

It can be easily shown that a diode allows current to flow in one direction and not in the other by constructing the circuit below. A 1.5-volt lamp, an ammeter, and a diode are connected in series across a 1.5-volt cell. (Semiconductor diodes are distinguished from each other by a number-letter designation. The diode recommended for this circuit is a 1N34).

With the connections made as shown,

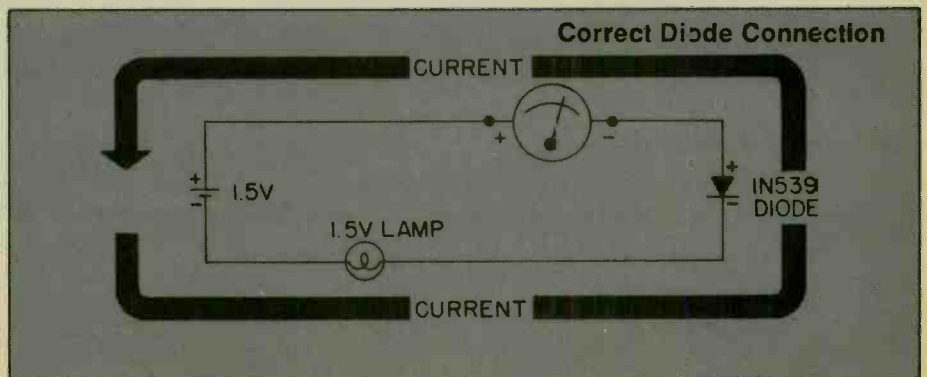

current will flow and the lamp will light. The ammeter will record very close to 200 milliamps. Now reverse the connections of the diode. Will the lamp light? No. And, as indicated in the next drawing, the meter pointer will remain on zero. The anode-to-cathode resistance of the diode is sufficiently high to prevent a flow of current. A small amount may leak through, but it is not enough to record on the meter.

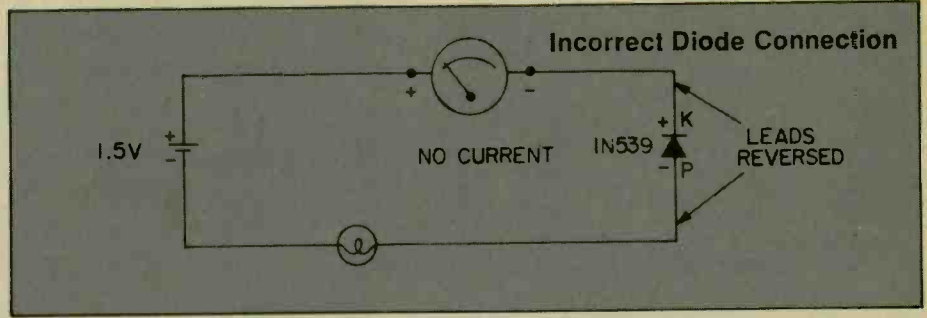

RECTIFYING AC

To **rectify** means to convert AC to DC. A **rectifier** is a device that accomplishes this, and a **rectifying circuit** is one in which it is done. A **diode** is a **rectifier**.

You know that an alternating voltage increases and decreases in positive voltage during a half cycle and in the next half cycle makes the same changes in negative voltage.

As long as the voltage is generated, the positive and negative half cycles repeat themselves alternately.

Diode Reaction to AC

How does current flow in a diode circuit with AC voltage applied? Remember, current flows in one direction through a diode only when the anode is more positive than the cathode.

During a positive half cycle, the upper terminal of the source is positive with respect to the lower terminal. This means the lower terminal may be at zero volts, but it is negative when compared to the positive upper terminal. Therefore, the anode of the diode is positive with respect to the cathode. A changing half cycle of current flows.

If an **oscilloscope** is connected across the load resistor, an exact picture of the changing voltage drop will be shown. This changing voltage will look exactly like the waveform at the voltage source.

During the next half cycle, the upper terminal voltage becomes negative with respect to the lower, and the diode anode is negative with respect to the cathode. As you know, current will not flow under these conditions. Since the diode presents a very high resistance in

the circuit, all of the source voltage will be dropped across it. No voltage will be displayed across the load resistor.

QUESTIONS

- Q6.** As the circuit is connected above, only the _____ half cycles of the AC voltage will appear across the load resistor.
- Q7.** A rectifier converts _____ to _____.
- Q8.** Draw a diagram showing the waveforms that will appear across R in the above circuit.

ANSWERS

- A6.** As the circuit is connected, only the **positive** half cycles of the AC voltage will appear across the load resistor.
- A7.** A rectifier converts AC to DC.
- A8.** See diagram below

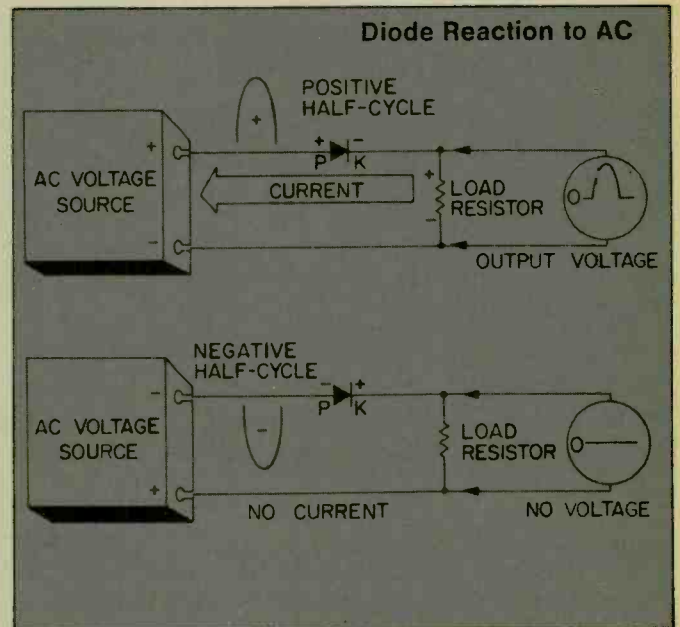
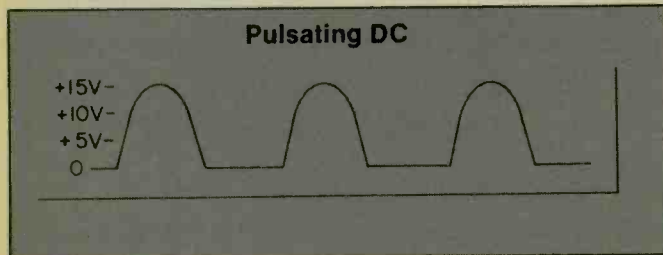
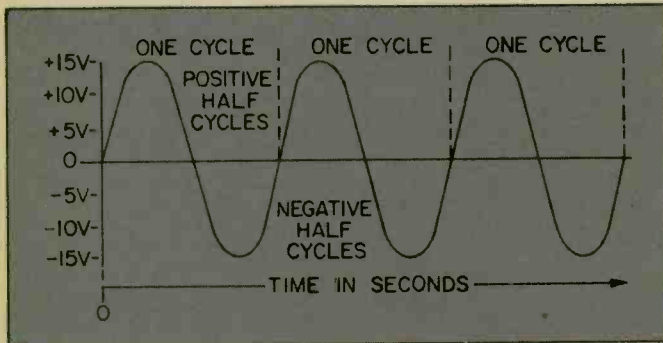

A DC POWER SUPPLY

Most electronic equipment requires DC voltage to operate its circuits. Since alternating current is the normal supply, a **power-supply circuit** is used to

provide the required DC voltage. **Filter Circuit**

The diagram shows the output voltage obtained from the rectifier circuit is DC—current flows in only one direction—but it is not a smooth, nonvarying

DC. In fact, it is called a **pulsating DC**. The waveform is a series of pulses.

Filtering Action—The peaks and valleys of the pulsating waveform can be smoothed out by a **filter circuit**. A capacitor can be used to filter (smooth)

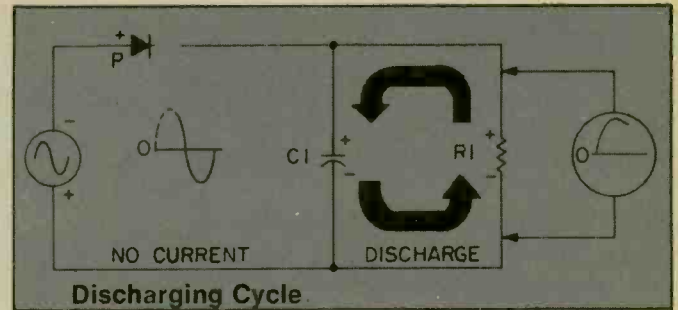
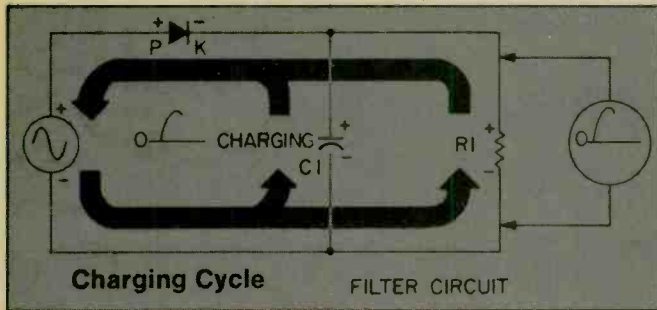

out some of the changes.

As the source voltage rises to maximum positive, current flows through R1 and the rectifier. Some of the current also charges the capacitor to the value of the source voltage.

At the instant the applied voltage begins to decrease, C1 starts discharging, trying to maintain the same voltage level. The discharge path of C1, however, is through R1. The current from C1 cannot flow backward through the rectifier. Since resistance regulates the time of discharge (10 RC time constants to discharge completely), the discharge time is slow. As shown in the diagram below, the output waveform does not follow the descending curve of the input. It decreases at a much slower rate.

During the negative input half cycle, the rectifier does not allow current to flow, but the capacitor continues to discharge. The discharge current decreases as the capacitor charge grows less. On the next positive swing, the rectifier does not conduct current until after the input voltage has increased to

an amount equal to the charge on C1 at that instant. The anode must be more positive than the cathode for the rectifier to conduct. The sequence continues. The resulting output waveshape (in solid lines) is shown below. Such an output is called **DC ripple voltage**.

QUESTIONS

- Q9. The pulse-like waveform developed by a rectifier circuit is called _____.
- Q10. The changing voltage pattern made by these pulses can be smoothed out by a _____ circuit.
- Q11. The filter capacitor begins to _____ as soon as the posi-

_____ tive voltage input begins to decrease.

- Q12. The filtered output is called a _____.

ANSWERS

- A9. The pulse-like waveform developed by a rectifier circuit is called **pulsating DC**.
- A10. The changing voltage pattern made by these pulses can be smoothed out by a **filter** circuit.
- A11. The filter capacitor begins to **discharge** as soon as the positive voltage input begins to decrease.
- A12. The filtered output is called a **DC ripple**.

Half-Wave Ripple Voltage



Full-Wave Power Supply

The preceding circuit is a **half-wave** rectifier. It allows only half the AC wave (positive half cycles) to appear across the load resistor. **Full-wave** (both positive and negative half cycles) rectification can be obtained with the switching action of the diodes in the circuit below.

On the positive half cycle, current leaves the lower terminal of the AC voltage source and enters terminal 3 of the 4-diode network (called a **bridge**). The bridge is positive to negative from top to bottom because of the source polarity. Diode B has a negative cathode and a positive anode, but diode D has reverse polarity across it. Current must therefore flow through diode B to terminal 2. This current charges C1 and flows through R to terminal 4. Because of polarities, this current must flow through diode C. Diodes D and A are of the wrong polarity.

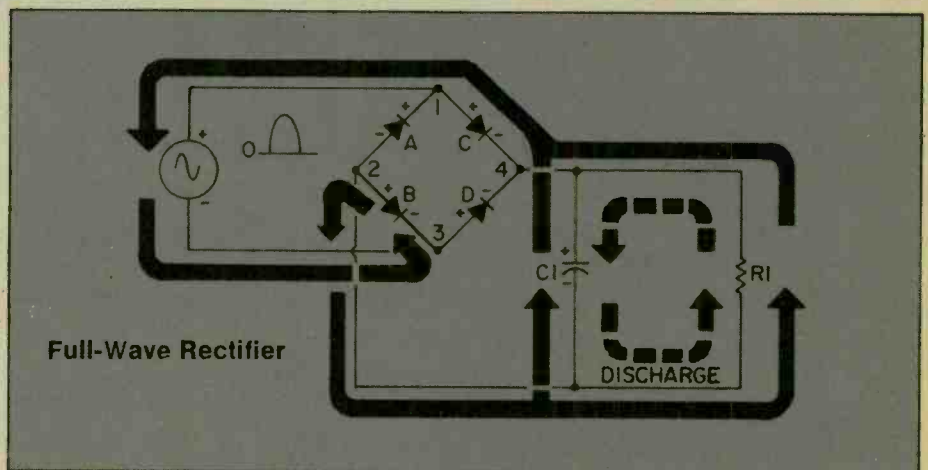

C1 charges as the voltage increases and discharges during the voltage decrease, just as in the half-wave circuit.

During the negative half cycle, the polarities of the voltages on the four diodes are reversed. Current leaving the upper end of the source arrives at ter-

terminal 1. The voltage on diode C is of the wrong polarity, but diode A will conduct. Current leaves terminal 2, and then follows the same path as the positive half-cycle current. C1 has just begun to discharge; the rising current restores the charge to full voltage. The

remainder of the current flows through R1 in the same direction as the positive half-cycle current did. At terminal 4, only diode D has the correct voltage polarity to conduct. Current flows through diode D to terminal 3 and the AC source.

QUESTIONS

- Q13.** A (an) _____ rectifier provides better filtering action than a (full-wave, half-wave).
- Q14.** In the diagram at the top of this page, current at terminal 1 will not flow through diode C because current will not pass from _____ to _____.
- Q15.** Current at terminal 4 will not go through diode C because its cathode is _____ and its plate is _____.

ANSWERS

- A13.** A full-wave rectifier provides better filtering than a half-wave.
- A14.** Current at terminal 1 will not pass through diode C because current will not pass from plate to cathode.
- A15.** Current at terminal 4 will not go through diode C because its cathode is positive and its plate is negative.

Improving the Power Supply

The DC ripple remaining on the full-wave rectifier output may be smooth enough voltage for some equipment but not for others. The output can be made still smoother by improving the filtering action.

By adding another capacitor in parallel with the load resistor and another current-limiting resistor in series with the discharge path, the filter network can reduce more of the ripple.

Both capacitors are charged and recharged by the positive and negative currents switched into the filter by the bridge. Both capacitors discharge together through load resistor R1 as C1 did previously. R2 aids by limiting the flow of current through the filter.

Further improvement to the filtering action can be made by replacing R2 with an iron-core coil called a choke. Such a coil is wound on a bar of iron. The reaction of a coil (inductor) to AC is, as you recall, one of opposing changes in current. Magnetic fields, reinforced by the iron core, smooth out the ripple by preventing the changes from occurring. The iron core inductor is called a choke coil.

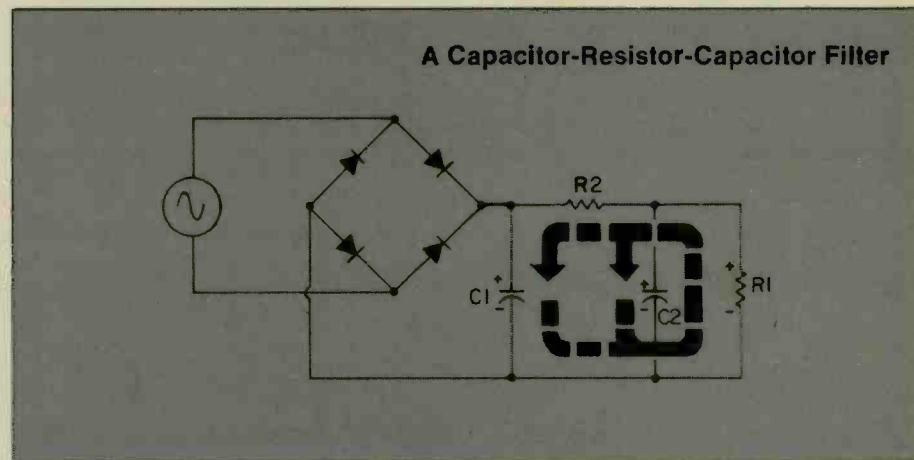
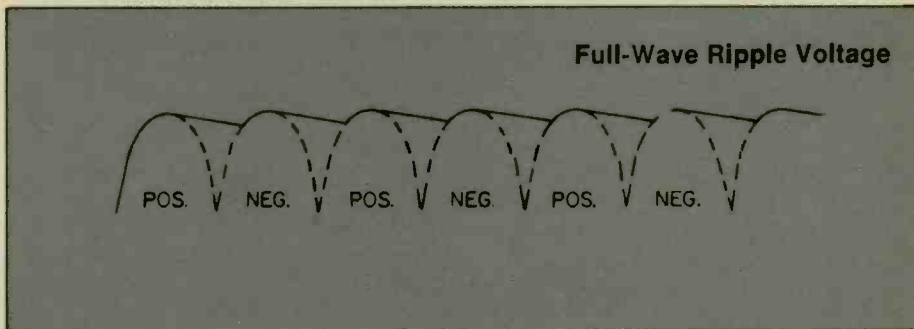
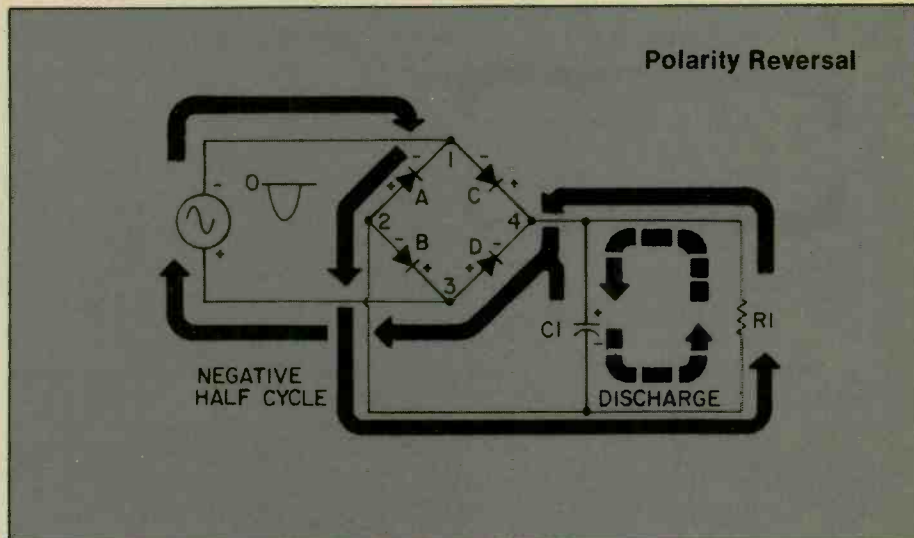

Load Resistors

Some electronic equipment requires two or more values of DC voltage for proper operation. These voltages can be selected from the load resistor.

Suppose that the DC requirements of the rest of the equipment were +200, +100, and +50 volts. A power supply can be selected or designed to produce a current large enough to cause a drop of at least 175 volts across R1.

Either three series resistors of the

correct values, or a bleeder resistor capable of being tapped at the desired values, can be used. The drawing above shows a bleeder resistor symbol.

By making connections to terminals A and Common, 200 volts will be available. To obtain 100 volts, the bleeder is tapped at the halfway point to obtain half the total voltage. For 50 volts, the resistance is tapped halfway between the 100-volt point and the common terminal.

QUESTIONS

- Q16. A capacitor opposes changes in current by storing a _____ on its plates.
- Q17. A coil opposes a change in current by developing a changing _____.
- Q18. Assume in the above figure that the bleeder must be replaced with three separate resistors. If you know that 0.1 amp flows through the bleeder to produce a total of 200 volts, what is the value of R_1 , R_2 , and R_3 ?

ANSWERS

- A16. A capacitor opposes changes in current by storing a charge on its plates.
- A17. A coil opposes a change in cur-

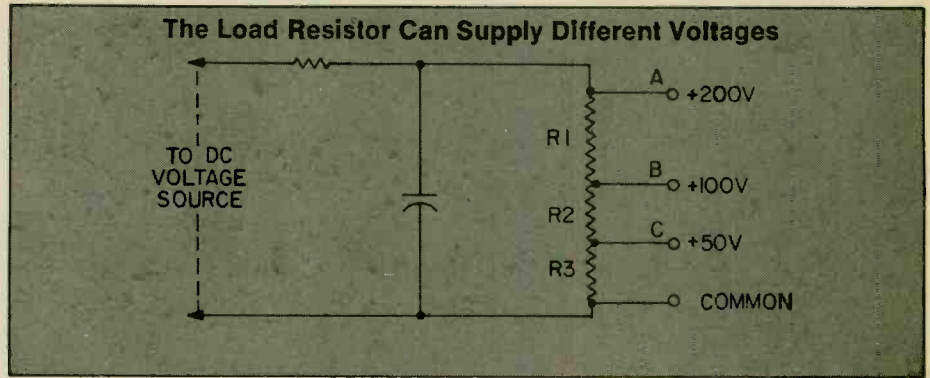

- A18. rent by developing a changing magnetic field.
 $R_1 = 1,000$ ohms; $R_2 = 500$ ohms; $R_3 = 500$ ohms. If 0.1 amp developed 200 volts across the total resistance, the bleeder

would have to be 2,000 ohms. ($R = E/I$). There would have to be 1,000 ohms on either side of the 100-volt tap, B. And the two resistors from B to Common must be 500 ohms each.

WHAT YOU HAVE LEARNED

1. Solid-state diodes allow current to flow in one direction under conditions of proper polarity because of the materials from which they are

2. A diode converts AC to DC because it forms a one-way street for current. A device that does this is called a rectifier.
3. Output from a rectifier is pulsating DC. To smooth out the pulsations, a full-wave rectifier can be used. By

adding a filter circuit—capacitors and resistors, or capacitors and a coil—the ripple can be made relatively smooth.

4. The smooth DC voltage can be taken from the power supply in desired values by tapping a bleeder resistor.

This series is based on material appearing in Vol. 1 of the 5-volume set, BASIC ELECTRICITY/ELECTRONICS, published by Howard W. Sams & Co., Inc. @ \$22.50. For information on the complete set, write the publisher at 4300 West 62nd St., Indianapolis, Ind. 46268.

Digital Egg Meter

(Continued from page 48)

thor's model did not include resistors R_1 , R_2 , R_3 , R_{10} , R_{11} and R_{12} on the circuit board. These parts along with diodes D_1 , D_2 and D_3 were wired to switch S_1 or stuck into the wiring between the board and LED display LD_1 . Now all these parts can be assembled to the board. Resistors R_{10} , R_{11} and R_{12} have only one lead soldered to the board. The other lead is cut short to 1/4-in. and used as a terminal to interconnect LED display LD_1 to the board.

Operation. Now, you're ready to plug in the ICs and give it a try. But before you do, double check all wiring and component placement. One wrong wire can blow an IC and ruin your fun for a while. Now plug in only IC_1 , then connect the battery, and be very sure the battery clip is not wired in backwards which would put the wrong polarity across the ICs. Also, make sure the ICs are not in backwards.

Now put a voltage across the probe and clip (10 volts or so). Press S_1 and see if the voltage across IC_2 , pins

1 and 2, is 1/100 of the input volts voltage (0.10 volts in this example). If this is not the case, you either have some wiring error or a fault in IC_1 . Also note that as S_1 is pressed LED diode D_2 should light. This diode simply provides a voltage drop of about 2.0 volts and can be mounted inside the egg since it is not needed as an indicator. But if it fails to light, you have a wiring or component fault.

Adjustment and Calibration. If IC_1 is working properly, take out the battery and carefully plug in IC_2 , 3, and 4. Replace the battery, and with no input voltage, press S_1 . Display LD_1 should light up and settle down to a constant number within about 3 seconds. This settling time is only needed when S_1 is first pressed because the ICs are "cold." Now adjust R_5 until the reading is "00.0". If the reading will not quite get to zero, either because it only gets to 00.1 or (from the other side of zero) 99.9, replace R_7 with a 200 ohm (or 100 ohm resistor, respectively). If LD_1 does not light at all, check out the display by driving one of its segments with 0.9 ma after LD_1 has been removed from its socket. This

can be done by placing a 9-volt battery and a 10,000-ohm resistor in series with pins 1 and 10 of LD_1 . Be sure the positive terminal of the battery feeds pin 10 of LD_1 .

After adjusting R_5 for a zero reading, R_6 can be adjusted for a proper full scale reading by simply applying a known voltage across the clip and probe and turning potentiometer R_6 until the desired reading appears. A re-adjustment of potentiometers R_5 and R_6 is generally needed only if there is a large change in room ambient temperature (winter to summer, for example).

If the digits flash too quickly, that is, the values bounce around too much, increase C_1 slightly, or try changing C_2 . If the unit is accurate up to some high voltage like 80 volts DC but not accurate above that, C_1 is saturating and should be increased slightly or, at least, replaced. If the unit gives readings that behave strangely, check LED diode D_2 to be sure it is dropping between 1.5 and 2.5 volts (about 2.0 is best). If not, replace it. Also remember that this unit is meant for DC inputs, so don't try reading AC unless you want to design your own op amp-rectifier front-end. ■

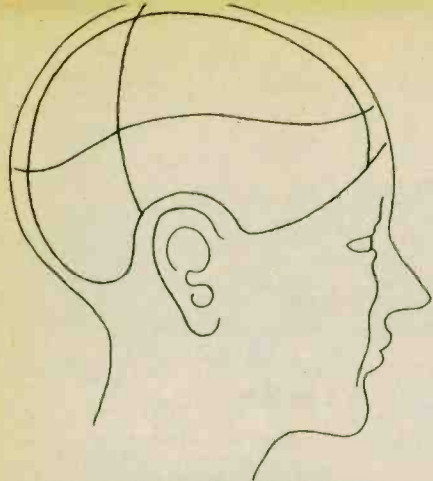

'GET INTO YOURSELF'

Discover your Alpha Brainwaves with this professional Biofeedback System.

Lowest Cost Brainwave Monitor

EICO introduces a price breakthrough in the fantastic new field of brainwave biofeedback... a completely safe, battery operated, biofeedback system that offers features and sensitivity comparable to professional models costing much more.

You Will Be Amazed At What You Hear

The BW-300 will detect your alpha brainwaves (which occur when you are totally relaxed) and produce a tone varying in frequency according to your mental state.

100% Solid State Circuitry

Reliable All Solid State IC Circuit Design features an active filter that isolates alpha brainwaves and a high-gain low-noise amplifier providing 5-microvolt sensitivity for easy alpha recognition. The BW-300 is supplied with stethoscopic earphones, electrodes headband, contact cream and instructions.

KIT 3495
WIRED 59.95

FREE EICO CATALOG

For latest EICO Catalog on Test Instruments, Automotive and Hobby Electronics, Eicocraft Project kits, Burglar-Fire Alarm Systems and name of nearest EICO Distributor, check reader service card or send 50¢ for fast first class mail service.

EICO—283 Malta Street, Brooklyn, N.Y. 11207

Leadership in
creative electronics



CIRCLE 2 ON READER SERVICE COUPON

Ask Hank, He Knows

(Continued from page 40)

△ Walter S. Harley of 2436 Streetsboro Rd., Peninsula, OH 44264 needs circuit and specifications for the Triumph Model 840 oscillograph.

△ Michael Liben would like to build a phase shifter and other audio devices for use with the electronics used by the rock group he manages. If you can help, write to Mike in care of Charles Octet and Fire-dog, 8 Willis Lane, East Falmouth, MA 02536.

△ Our good buddy, Kevin Kendell of 24 Smith St., Glen Head, NY 11545 would like the schematic diagram for his U.S.L. Contact 8 CB transceiver. Help him out, boys.

△ Jeff Lendaro of 25 Fanton Rd., Danbury, CT 06810 would like to buy or trade for a Radiola 28. Write to him.

△ Anyone have a schematic diagram of an old Tecraft, Model Falcon Mk IV CB transceiver? If yes, send it to Ron Eichel, P.O. Box 237, Rockaway, NJ 07866.

△ Jerry D. Pitcock of 607 Chickadee, Apt. 7, Little Rock, AR 72207 would like to obtain a Hammarlund SP400SX or equivalent receiver. Drop Jerry a line if you can help. ■

FCC FIELD ENGINEERING OFFICES

Addresses of the following FCC Field Engineering Offices can be found in local directories under "United States Government." All communications with Field Offices should be addressed to the Engineer in Charge.

Alabama: Mobile, AL 36602

Alaska: P.O. Box 644, Anchorage, AK 99510

California: Los Angeles, CA 90012

California: San Diego, CA 92101

California: San Francisco, CA 94111

Colorado: Denver, CO 80202

District of Columbia: Washington, DC 20554

Florida: Miami, FL 33130

Florida: Tampa, FL 33602

Georgia: Atlanta, GA 30303

Georgia: P.O. Box 8004, Savannah, GA 31402

Hawaii: P.O. Box 1021, Honolulu, HI 96808

Illinois: Chicago, IL 60604

Louisiana: New Orleans, LA 70130

Maryland: Baltimore, MD 21201

Massachusetts: Boston, MA 02109

Michigan: Detroit, MI 48226

Minnesota: St. Paul, MN 55101

Missouri: Kansas City, MO 64106

New York: Buffalo, NY 14202

New York: New York, NY 10014

Oregon: Portland, OR 97204

Pennsylvania: Philadelphia, PA 19106

Puerto Rico: P.O. Box 2987, San Juan, PR 00903

Texas: Beaumont, TX 77701

Texas: Dallas, TX 75202

Texas: Houston, TX 77002

Virginia: Norfolk, VA 23502

Washington: Seattle, WA 98104

Bookmark

(Continued from page 24)

Power Supply, C-MOS Digital Thermometer, and others. Each project describes the theory of operation, and provides printed circuit board layouts, detailed drawings for suggested enclosures, and intended applications. GC Electronics offers a complete line of digital and semiconductor components under its Calectro label, including the most comprehensive assortment of TTL integrated circuits readily available to the hobbyist. For complete catalog, write to GC Electronics, Division of Hydrometals, Inc., 400 South Wyman Street, Rockford, IL 61101.

For Shop and Lab. Here's a practical "working tool" that simplifies and crystallizes the normally complex area of electronic test equipment, and its use in troubleshooting—*Complete Guide to*

Electronic Test Equipment and Troubleshooting Techniques by John Douglas-Young. The book begins by reviewing measurement equipment and principles of measurement that are



basic to all test instruments. The next section sets forth specific ways to test components such as resistors, coils, capacitors, vacuum tubes, and semiconductors in troubleshooting. Subsequent chapters deal with electronic instruments used for performance-testing in every major area of your work. Two of these chapters are devoted specifically to radio, television, and hi-fi testing. There is also a chapter on laboratory calibration standards, and a special section containing a host of

proven troubleshooting shortcuts. Published by Prentice-Hall, Inc., Englewood Cliffs, NJ 07632. ■

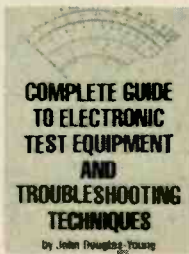

Hard Cover
254 pages
\$12.95

Panasonic CB/FM-AM

(Continued from page 62)

to mount this unit. You can be sort of sloppy with the cut-out because the supplied wood-grain trim panel will hide sloppy cuts. In the event the unit will fit your existing dash opening, or almost fit, you'll find the Panasonic's controls have a small adjustment range to accommodate moderate variation in volume and tuning control dash openings.

The power and speaker connections are pre-wired with auto-type push-on connectors. The speaker output connectors are polarized, and matching cables with attached plugs are provided for connecting the speakers.

The CB antenna connects to the coaxial jack on the rear apron. The regular FM-AM antenna connects to the flexible radio input connector. The AM antenna trimmer is accessible from the front control panel so you won't have to crawl under the dash in order to peak AM reception.

The only thing you must be careful about is the speaker impedance. The radio is rated for 3.5 watts output per channel into 4 ohms. If you plan to use only front speakers they should be 4 ohms each. If you plan to use front and rear speakers, even if you might mute the rear speakers with the front-rear fader control, then the speakers should be 8 ohms each, since the front and rear speakers are parallel connected, providing a nominal 4-ohm load to the amplifier.

Summing Up. As we said at the beginning of this review the Panasonic CR-B1717EU is a well-thought-out, first-class performer. Undoubtedly this type of combined radio and transceiver will eventually become a new-car option. Until then this Panasonic is the only way you can get a combination high-performance CB transceiver and FM-AM radio.

The Panasonic CR-B1717EU complete with mounting hardware, trim panel, microphone and speaker connecting wires is priced under \$300.00. For additional information circle No. 59 on the Reader Service Card. ■

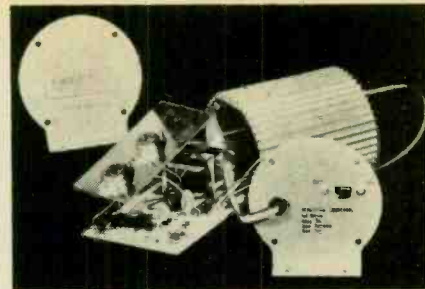

FROM KIT TO CAR IN 80 MINUTES!

Electronic Ignition is "in". Update your car with the TOPS in power, efficiency and reliability — the TIGER SST capacitive discharge ignition (CD).

The TIGER delivers everything other CD's promise — and more: quicker starting, more power, more gas mileage, tune-ups eliminated, lifetime plugs and points, reduced repairs and pollution.

The TIGER can be built and installed in your car in 80 minutes. The TIGER is unique!

The TIGER comes with a switch for TIGER or standard ignition for 12V negative ground only.

SATISFACTION GUARANTEED
or Money Back.

Simpli-Kit \$31.95
POST PAID U.S.A.

WE ACCEPT:

Mastercharge or BankAmericard.

Send check or money order with order to:

Tri-Star Corporation

DEPT. AA, P.O. Box 1727
Grand Junction, Colorado 81501

CIRCLE 38 ON READER SERVICE COUPON

WRITE NOW FOR **McGEE'S**

BIG SPEAKER CATALOG

1001 BARGAINS IN

SPEAKERS — PARTS — TUBES — HIGH FIDELITY
COMPONENTS — RECORD CHANGERS
Tape Recorders — Kits — Everything in Electronics
1901 McGee Street, Kansas City, Missouri 64108

BE A BURGLAR/FIRE ALARM EXPERT



Learn at home how to install burglar/fire alarm systems in cars, homes, businesses. Big money. Growing demand with increased crime, violence, car thefts, arson. Nationally accredited course. Simple, clear, hands-on training. Tools furnished. FREE facts by mail. No salesmen. Write SECURITY SYSTEMS MANAGEMENT SCHOOL, Div. Tech. Home Study Schools, Dept. 7472-056 Little Falls, NJ 07424.

C-MOS PROBE

will convert your voltmeter into a sensitive FET INPUT millivoltmeter. Complete kit \$11.95 plus shipping. Also: Temp Meters • Power Supplies • Design Consoles.

Send for
**FREE
CATALOG**

IDA G E SCIENTIFIC INSTRUMENTS
BOX 1054E LIVERMORE CA 94550



MICRO MINI MIKE WIRELESS MICROPHONE

World's smallest; solid state, completely self-contained. Picks up and transmits most sounds without wires up to 350 ft. through FM Radio. Use as mike, amp., alarm & alert sys., hot line, etc. Money back guar. B/A, M/C cds, COD ok. \$14.95 plus \$1.00 post. & hdlg. Calif. res. add tax. AMC SALES, Dept. 24, Box 928 Downey, Ca. 90241.

SIZE
2 1/4" x 3/4" x 1/2"

CB Lingo

(Continued from page 69)

the front door and back door in a string of vehicles.

Roger Rollerskate—Passenger car going more than 20 mph over the limit.

Roller Skate—Small car.

Seatcovers—Occupants of passenger car, usually attractive females.

Shake the Leaves—Act as lead vehicle to decoy any Smokies out of hiding. See also "Beat the Bushes."

Six Wheeler—Passenger car pulling a trailer.

Smokey—The police.

Smokey on Four Legs—Mounted police (used in New York City and Chicago only).

Smokey the Bear—State Police Patrol (with or without a Smokey the Bear hat). (Continued on page 88)

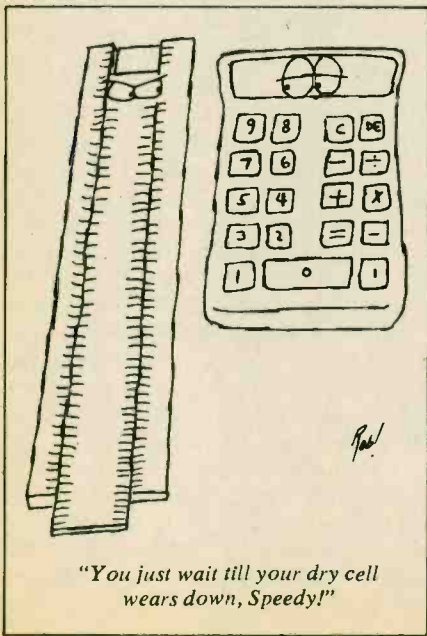

READERS SERVICE NO.	ADVERTISER	PAGE NUMBER
31	Aero Distributors	32
	AMC Sales	87
5	Amixer-Mark	8
6	Antenna Specialists	20
23	Avanti	10
	Barta	92
41	Breaker Corp.	13
3	Browning	43
	Circuit Specialists	92
	Cleveland Institute of Electronics 2nd Cover, p. 1	
26	Cobra Div., Dynascan Corp.	15
25	Continental Specialties Corp.	25
	Cornell Electronics	92
35	Cush Craft	24
	Dage Scientific	87
8	Defender Co.	92
9	Edmund Scientific	5
34	Edsyn	99
2	Eico	86
27	Finney	30
	Gilfer	92
7	Goldfinger (Bomar Crystal)	22
11	Goldline	14
1	Heath Co.	26-29
	Howard Sams	89
	Int'l. Correspondence Schools 3rd Cover, p. 102	
29	International Crystal	99
12	International Electronics	88
33	E. F. Johnson Co.	9
13	Kedman Tools	30
30	Mountain West Alarm	32
37	McDonough Communications, Inc.	22
	McGee Radio	87
	National Radio Institute of Electronics 16-19	
	National Technical Schools 36-39	
39	Newtronics	4
	Pearce-Simpson	31
17	Poly Paks	21
14	Progressive Edu-Kits	3
4,32	Radio Shack Corp. 4th Cover, 33, 91, 93	
15	R.C.A. Distributors	34-35
18	Royce Electronics	47-50
21	Shakespeare Antennas	6
	Sinclair Radionics	23
36	Siltronix Corp.	41
	Security Systems Mgt.	87
	Star-Tronics Corp.	92
19	Tab Books	7
24	Teaberry	11
20	Telco	40
28	Ten-8 CB Sales	98
	Vintage Radio	12
	Western Radio	87, 92

Smokey with Ears—Police listening on CB.

Stack them Eights—Best regards.

Sweeping Leaves—Bringing up the rear. See also "Back Door," and "Raking the Leaves."

Thirty Three—10-33, This is an emergency.

Threes on You—Best regards.

Threes and Eights—Lots of best regards.

Tijuana Taxi—Well marked police car.

Train Station—Traffic court that fines everybody.

Two Wheeler—Motorbike, motorcycle.

Two Way Radar—Radar used from moving police car.

Wall to Wall—Peg full-scale on S-meter.

Wall to Wall Bears—High concentration of police with strict enforcement, traps, etc.

We Gone—Stopping our sending, will listen.

Wrapper—Color; "Blue wrapper" is a blue car, usually an unmarked police car.

XYL—Wife. (ex-young lady.)

Radio Swan
(Continued from page 68)

land's tiny airstrip aboard a CIA plane operating out of Miami. Most of the newscasts were recorded in studios in New York and relayed by point-to-point double-sideband transmitters owned by RCA Communications on Long Island. They were picked up by monitors on Swan Island for rebroadcast.

Cuba not fooled. The pretense of being a commercial, private station did not fool the Castro government. As early as June 1960, Radio Mambi, one of the most vitriolic of the Havana stations in those days, complained that, "a counter-revolutionary radio station, supported by U.S. dollars, is now active on Swan."

And, that fall in an address to the United Nations, Castro charged that the U.S. had taken over a territory that, "belongs to Honduras and has set up a very powerful broadcasting station which it has placed at the disposal of

war criminals and the subversive groups that are being sheltered by this country."

Castro also moved one of his own stations to Radio Swan's medium-wave frequency, jamming that was only moderately effective. Later, for a time, the station on Swan was harassed by the more common buzzing jammer sounds.

There were even reports that Castro had offered a reward to any of his pilots who shot down the chartered CIA aircraft that serviced the island. However the slow-moving, unarmed plane was never molested.

Gradually, by early 1961, commercial advertising spots had disappeared from Radio Swan and the station gave only lip service to its claim of commercialism. Broadcasts designed to undermine the Cuban regime expanded and a more militant role was assumed. This culminated with the invasion eve coded call to arms.

When the Bay of Pigs adventure flopped, Radio Swan changed feathers. With headquarters now in Miami, it became Radio Americas. Its dirty tricks days were over, although it continued to air anti-communist propaganda to Latin America. In the late spring of 1968, it left the air. Later it was reported that the broadcasting equipment had been removed from the island. Swan Island itself was turned over to Honduras, with the U.S. relinquishing all claims.

Where Swan is now. That's where things stood last June when a DXer, doing some post-midnight tuning, picked up a station identifying as "Radio Swan," broadcasting on 6,185 kHz.

After the initial doubts that Radio Swan had really returned, other listeners duplicated the logging. The station was heard, usually in the early morning hours when the frequency was reasonably clear of interference.

Programming was all in Spanish, some romantic Latin music—but, somewhat improbably, with a frequently played theme song, "Zippity Doo Dah"—and some anti-communist commentaries. The station announced a Hon-

(Continued on page 90)

5% OFF ON ORDERS OVER \$50.00
10% OFF ON ORDERS OVER \$100.00
15% OFF ON ORDERS OVER \$250.00

TTL

7400	\$.14	7451	.17	74154	1.25
7401	.16	7454	.17	74155	1.07
7402	.15	7460	.17	74157	.99
7403	.16	7464	.35	74158	1.79
7404	.19	7465	.35	74160	1.39
7405	.19	7470	.30	74161	1.25
7406	.35	7472	.30	74162	1.49
7407	.35	7473	.35	74163	1.39
7408	.18	7474	.35	74164	1.59
7409	.19	7475	.57	74165	1.59
7410	.16	7476	.39	74166	1.49
7411	.25	7483	.79	74170	2.30
7413	.55	7485	1.10	74173	1.49
7416	.35	7486	.40	74174	1.62
7417	.35	7489	2.48	74175	1.39
7420	.16	7490	.59	74176	.89
7422	.26	7491	.97	74177	.84
7423	.29	7492	.71	74180	.90
7425	.27	7493	.60	74181	2.98
7426	.26	7494	.94	74182	.79
7427	.29	7495	.79	74184	2.29
7430	.20	7496	.79	74185	2.29
7432	.23	74100	1.30	74187	5.95
7437	.35	74105	.44	74190	1.35
7438	.35	74107	.40	74191	1.35
7440	.17	74121	.42	74192	1.25
7441	.98	74122	.45	74193	1.19
7442	.77	74123	.85	74194	1.25
7443	.87	74125	.54	74195	.89
7444	.87	74126	.63	74196	1.25
7445	.89	74141	1.04	74197	.89
7446	.93	74145	1.04	74198	1.79
7447	.89	74150	.97	74199	1.79
7448	1.04	74151	.79	74200	5.90
7450	.17	74153	.99		

LINEAR CIRCUITS

300	Pos V Reg (super 723) TO-5	5.71
301	Hi Perf Op Amp mDIP TO-5	.29
304	Neg V Reg TO-5	.80
307	Op AMP (super 741) mDIP TO-5	.26
308	Micro Per Op Amp mDIP TO-5	.89
309K	5V IA regulator TO-3	1.35
311	Hi perf V Comp mDIP TO-5	.95
319	Hi Speed Dual Comp DIP	1.13
320	Neg Reg 5.2, 12, 15 TO-3	1.19
324	Quad Op Amp DIP	1.52
339	Quad Comparator DIP	1.58
340K	Pos V Reg (5V, 6V, 8V, 12V, 15V, 18V, 24V) TO-3	1.69
340T	Pos V Reg (5V, 6V, 8V, 12V, 15V, 18V, 24V) TO-220	1.49
376	Pos V Reg mDIP	2.42
380	2w Audio Amp DIP	1.13
550	Pre V Reg DIP	.89
555	Timer mDIP	.89
556A	Dual 555 Timer DIP	1.49
565	Phase Locked Loop DIP TO-5	2.38
566	Function Gen mDIP TO-5	2.25
567	Tone Decoder mDIP	2.66
709	Operational AMP TO-5 or DIP	.26
710	Hi Speed Volt Comp DIP	.35
711	Dual Difference Compar DIP	.26
723	V Reg DIP	.62
739	Dual Hi Perf Op Amp DIP	1.07
741	Comp Op Amp mDIP TO-5	.32
747	741 Dual Op Amp DIP or TO-5	.71
748	Freq Adj 741 mDIP	.35
1458	Dual Comp Op Amp mDIP	.62
1800	Stereo multiplexer DIP	2.48
3900	Quad Amplifier DIP	.35
8864	9 DIG Led Cath Dvr DIP	2.25
75491	Quad Seq Driver for LED DIP	.71
75492	Hex Digit driver DIP	.80

POCKET CALCULATOR

5 function plus constant — addressable memory with individual recall — 8 digit display plus overflow — battery saver — uses standard or re-chargeable batteries — all necessary parts in ready to assemble form — instructions included.



Kit with AC adaptor included \$14.95
Set of Alkaline batteries (optional) \$2.50

6 DIGIT LED CLOCK KIT

MM5314 clock circuit
6 PHD70 LED displays (.250" red 7 segment)
All necessary transistors, resistors & capacitors
I double sided PC board accommodates LED's & clock circuitry
Schematic & instructions
Does not include 12V-300 ma transformer, switches & case \$12.95

ALARM CLOCK CHIP

MM5375AA 4-6 digit, 12 hour, 60Hz snooze alarm, brightness control capability, alarm tone output 24 pin DIP \$4.95

8038 FUNCTION GENERATOR

Voltage controlled oscillator — sine, square, triangular output. 16 pin DIP with data \$3.95

7001 CLOCK CHIP

4-6 digit, 12-24 hr. alarm, timer and date circuits — with data \$6.95

Satisfaction guaranteed. Shipment will be made via first class mail in U.S., Canada and Mexico within 5 days from receipt of order. Add \$5.50 to cover shipping and handling for orders under \$25.00. Minimum order \$5.00. California residents add sales tax.

INTERNATIONAL ELECTRONICS UNLIMITED
P.O. BOX 1708/ MONTEREY, CA. 93940 USA
PHONE (408) 659-3171

Now-have fun with electronics- **BUILD YOUR OWN BURGLAR ALARM...** **motor oil checker...** **metal locator...** **listening device...** **mini-computer...** **oscillator...** **amplifier...** **and more!**



129R2

Try this library of tested, easy-to-follow guides that tell you the parts you need... where to get them... then lead you step-by-step through building and operating useful electronic devices! Your satisfaction is guaranteed.



ELECTRONIC CIRCUITBOOK Project Construction
 This brand-new book provides all the background you need to begin building electronic devices right away. Explains common circuit components, covers power supplies, even helps you select and use tools. \$2.95



HOW TO BUILD PROXIMITY DETECTORS & METAL LOCATORS. Hunt treasure, find jewelry and coins in the sand. Locate pipes and studs in walls and floors. This is just a sample of what you can do with devices this book helps you build. There are projects for novices and technicians alike. \$4.50



5-MINUTE ELECTRONIC PROJECTS. Learn basics about electronics the easy way—by setting up projects and demonstrations yourself. This picture-packed book features devices that take minutes of building, but hours of using and enjoying. Included are oscillators, generators, transmitters, a crystal radio, and more. \$3.95



PROJECTS IN SIGHT, SOUND, AND SENSATION. Build a digital ESP testing machine yourself? This book makes it possible—along with six other unique projects. Advance from simple novelty devices to a sophisticated bio-feedback machine for muscle relaxation. Theory, diagrams, and parts lists are featured with plenty of illustrations. \$4.95



BUILD-IT BOOK OF FUN AND GAMES
 Put rhythm in your music—"sniff out" energy losses in radio equipment—make an electronic football game. All this and more can be done with a handful of parts—just for the fun of it. \$3.95



INTEGRATED CIRCUIT PROJECTS. Expand your electronics know-how—delve into IC technology. This clearly written, challenging volume helps you sharpen your skills by building a stereo headphone amplifier, tone encoder and decoder, waveform generator, voice scrambler, and more. \$4.95



BUILD-IT BOOK OF CAR ELECTRONICS
 Now you can monitor your car's electrical system from the comfort of your seat. You'll build devices to check oil and battery, analyze circuits, warn about lights and turn signals that shouldn't be on... and much more. \$3.95



SOLID-STATE ELECTRONIC PROJECTS. Three chapters help you understand burglar alarms inside-out. Parts lists help you protect your home by building them. This book also helps you construct metal locators, music circuits, a long-range listening device, and more. \$3.95

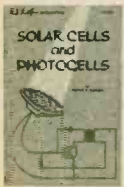

SOLAR CELLS AND PHOTOCELLS
 Here's an easy guide to the electric eye for science fair students and electronics technicians, too. You'll learn how to build photo-cells—and also how to use them in some fascinating experiments and projects. \$3.95



HI-FI PROJECTS FOR THE HOBBYIST. This book takes nothing for granted—not even your budget. Shows you tools, techniques, terms, where to buy, what and how to build. Install a small speaker enclosure with big sound, loudness or balance controls, a four-channel adapter, and more. \$3.95

Build a library of these fascinating fun-to-use books. They're less than \$5.00 each!

Clip out... mail today

MAIL TODAY FOR 15-DAY FREE TRIAL

YES—send me the book(s) checked below to examine for 15 days free. If not completely satisfied, I may return my order and owe absolutely nothing. Otherwise, I will pay the amount on the invoice accompanying my book(s), including shipping and handling.

CHECK HERE AND SAVE 10%! I have checked at least 3 of the books offered. So 10% of the cost is deducted.

- | | |
|--|---|
| <input type="checkbox"/> ELECTRONIC CIRCUIT-BOOK 1 21241 \$2.95 | <input type="checkbox"/> INTEGRATED CIRCUIT PROJECTS 21113 \$4.95 |
| <input type="checkbox"/> BUILD-IT BOOK OF FUN AND GAMES 21219 \$3.95 | <input type="checkbox"/> SOLID-STATE ELECTRONIC PROJECTS 20921 \$3.95 |
| <input type="checkbox"/> BUILD-IT BOOK OF CAR ELECTRONICS 21308 \$3.95 | <input type="checkbox"/> HI-FI PROJECTS FOR THE HOBBYIST 20925 \$3.95 |
| <input type="checkbox"/> SOLAR CELLS AND PHOTOCELLS 21175 \$3.95 | <input type="checkbox"/> 5-MINUTE ELECTRONIC PROJECTS 20968 \$3.95 |
| <input type="checkbox"/> HOW TO BUILD PROXIMITY DETECTORS & METAL LOCATORS 20881 \$4.50 | <input type="checkbox"/> PROJECTS IN SIGHT, SOUND & SENSATION 21125 \$4.95 |

NAME _____ (please print)
 ADDRESS _____
 CITY _____ STATE _____ ZIP _____

Save shipping and handling costs. Full payment enclosed.*
 Mail to: Howard W. Sams & Co., Inc./4300 W. 62nd St.
 Indianapolis, Ind. 46206
 *(Plus sales tax, if any.)

EE17

duran address, Apartado (Box) 882, in San Pedro Sulas.

Before long, listeners' reports sent to that address brought replies from the new Radio Swan.

New Radio Swan. Those letters, from one Ralph H. Nodarse, who identified himself as president of Radio Swan, clearly attempted to forge a link between the original Radio Swan and the new operation.

"As you know, the communists are trying to take over Latin America," Nodarse wrote. "We found it necessary to put Radio Swan on the air again in the defense of democracy and the free world."

Nodarse, somewhat inaccurately, capsulized the history of the original Radio Swan: "(It) was born on a ship in 1960. It was an anti-communist station. It was transferred to the island of Swan. . . . After the Bay of Pigs invasion of Cuba, the Central Intelligence Agency closed down Radio Swan."

(Actually there was a shipboard station, Radio Cuba Independiente that broadcast briefly in 1960. A CIA front organization had leased a 60-foot motor

launch from the International Oceanographic Foundation, according to a story in the Miami Herald. The boat, the "Matusa Time," was used as a floating propaganda station by Cuban exile groups. But it was not the predecessor of Radio Swan for both operated at the same time.)

Late in 1975, the new Radio Swan shifted frequency from 6,185 to 6,000 kHz, probably to escape interference from other stations. But the choice of frequency did nothing to dispel the impression that the new venture was trying to establish a historic link with the past; 6,000 kHz is the same familiar frequency used by the original Radio Swan.

Radio Swan's letterhead also lists a medium wave frequency, 1100 kHz, but this has not been heard by DXers.

Nodarse evaded questions about the station's location. Honduran embassy officials, who otherwise profess to know little about the station, do state flatly that no station now broadcasts programs from Swan Island. This seems to be true and the best evidence indicates that the new Radio Swan does its broadcasts

from San Pedro Sula, Honduras.

Who's in charge? Who runs Radio Swan? Most probably not the CIA, which is busy on Capitol Hill defending its past clandestine activities. The purpose of Radio Swan seems to be keeping the propaganda war against Castro alive. And though it may have cooled a bit lately, the U.S. government's interest appears to be in repairing the rift with Cuba, not prolonging it.

Recently, a radio club bulletin reported that the Honduran ambassador to the United Nations, Sr. Ordonez, told an inquiring DXer that Radio Swan is owned by his brother.

Beyond that, little is known about the personalities behind the revived propaganda voice. Mr. Nodarse, the self-styled president of Radio Swan, does not even have a Spanish name. However, if you spell it "no darse," linguists have noted, it means, in Spanish, "Don't give up!"

So, it seems, many of the mysteries that for so many years surrounded the original station have returned, with Radio Swan, to haunt us again. ■

Regency Scanner

(Continued from page 71)

provided for the plug-in frequency selector combs or the DFS-5K Digital Frequency Synthesizer, a very clever device that can tune the Whamo-10 to any desired frequency as fast as you can program five or six knobs (frequency selectors).

As you can see from the picture the DFS-5K matches the styling of the Whamo-10. The DFS-5K is designed

only for use with the Whamo-10. They are connected together by a 21-conductor cable. Simply plug in both ends of the cable and you can dial in any frequency (no combs needed) to the Whamo-10.

As with the Whamo-10, the digital frequency synthesizer can be powered by AC or an auto battery, and the synthesizer can be used in combination with the combs. For example, you can have the synthesizer connected to the Whamo-10's channel 1 with combs in the remaining nine. As far as the Whamo-10 is concerned the synthesizer is just another comb and it will scan

all the active channels. If the scan stops on the synthesizer channel a *scan lamp* on the synthesizer turns on to let you know the DFS-5K has control. Similarly, if all channels other than the synthesizer are turned off the scan lamp goes on to indicate the synthesizer has control.

The synthesizer has a second lamp to indicate out-of-band frequency selection, which "kills" the receiver. If you attempt to set the synthesizer to a frequency that falls outside the authorized bands the synthesizer's output is muted, making the receiver inoperative, and the *out of band lamp* indicates the condition so you won't think the receiver is defective.

Pre-programmed. The synthesizer is pre-programmed to dial standard frequencies used for the Low, High and UHF bands. Low band frequencies can be changed only in kHz increments. The High band can be changed in 5 kHz increments (last digit can be a 0 or a 5). The UHF band can be changed in increments of 12.5 kHz, and you'll find the last dial has calibrations of 2/5 and 7/5 (as in 493.9625 and 493.9875).

The Whamo-10 can normally accommodate two synthesizers—in channel 1 and 2 positions. If you want to use additional synthesizers there is an optional factory modification of the Whamo-10 that permits up to six synthesizers to be plugged in.

(Continued on page 92)

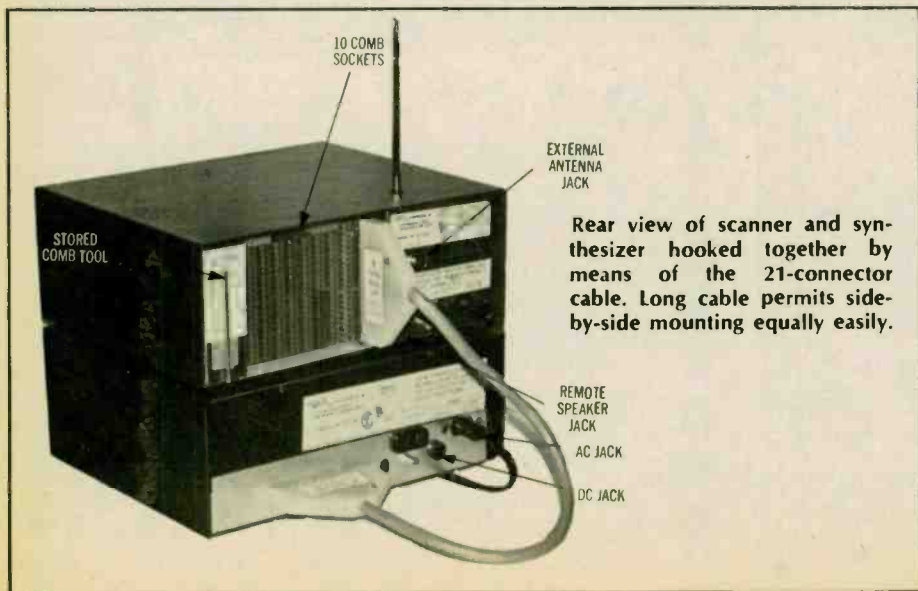

Sleeper!

The Realistic® STA-90 Will Change Your Ideas About Who's #1 in Hi-Fi Features, Value and Style!

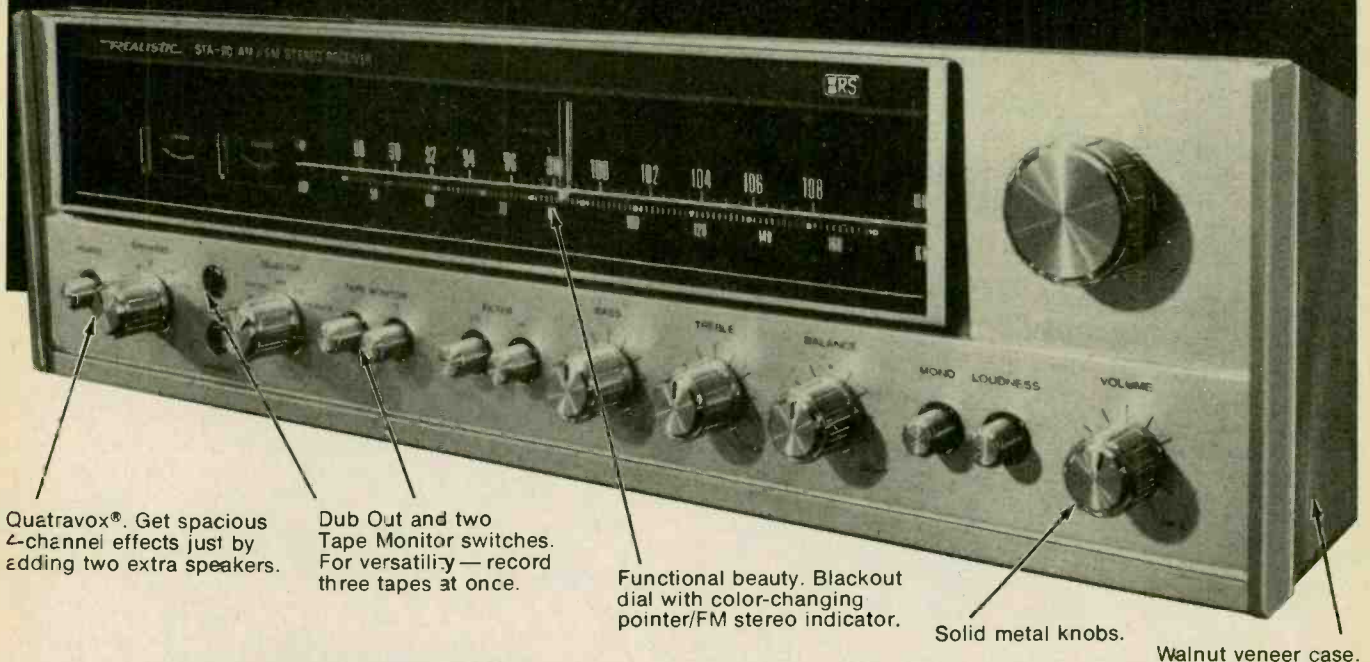

Quatravox®. Get spacious 4-channel effects just by adding two extra speakers.

Dub Out and two Tape Monitor switches. For versatility — record three tapes at once.

Functional beauty. Blackout dial with color-changing pointer/FM stereo indicator.

Solid metal knobs.

Walnut veneer case.

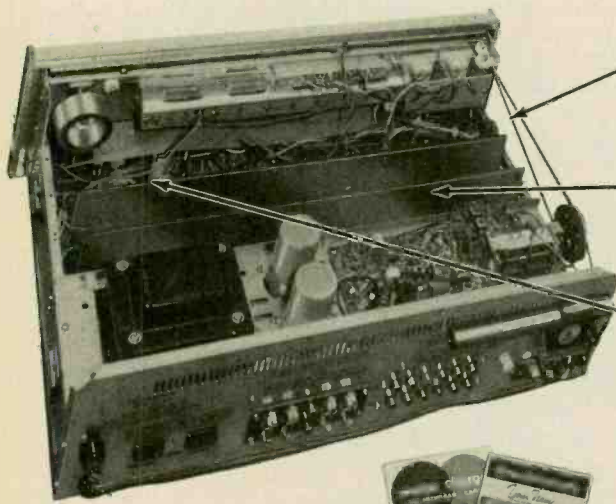

Dual-Gate MOSFET FM. Gets weak stations and still resists overload. Superior to FET designs.

Phase-locked loop FM stereo demodulator. For wider channel separation, almost zero distortion.

Direct-coupled amplifiers for powerful bass even at 20 Hz. 44 watts per channel, minimum RMS at 8 ohms from 20-20,000 Hz, with no more than 0.5% total harmonic distortion.

Amplifier Specs

Power Bandwidth: 17-35,000 Hz
 Response: 20-20,000 Hz ± 2 dB
 IM Distortion: 0.3% at 30W
 Phono Overload: 150 mV
 Hum and Noise (dB):
 Phono 1, -60
 Aux 1, -75

FM Tuner Specs

Sensitivity: 2.0 μ V IHF
 S/N Ratio: 65 dB
 Separation: 35 dB at 1 kHz
 Total Harm. Dist.: 0.8%
 Capture Ratio: 2 dB
 Selectivity: 60 dB

Only 359.95 at participating stores and dealers. Prices may vary at individual stores. U.L. listed. Ask for 31-2063. See what a Sleeper looks like — today!

Prices and products may vary in Canada.

SOLD ONLY WHERE YOU SEE THIS SIGN:

Radio Shack®

A TANDY CORPORATION COMPANY
 OVER 4000 STORES • 50 STATES • 8 COUNTRIES

FREE 164-Page Catalog. Write to Radio Shack, P.O. Box 1052, Dept. 7218, Ft. Worth, TX 76101

SEMICONDUCTOR SUPERMART

FREE CATALOG

NAME BRAND—PRIME QUALITY SEMICONDUCTORS

- MOTOROLA
- NATIONAL
- HEP
- FAIRCHILD
- RCA
- SIGNETICS

Other Parts For Elementary Electronics Projects

CIRCUIT SPECIALISTS CO.

Box 3047, Scottsdale, AZ 85257

PARTS! CORNELL TUBES!

Send For FREE CORNELL'S New Color Catalog 48 Pgs. New Items

33¢ per tube

36¢ per tube

ORDER FREE IF NOT SHIPPED IN 24 HOURS!

4219 E UNIVERSITY AVE. SAN DIEGO, CALIF. 92105

Regency Scanner

(Continued from page 90)

You can, of course, use the synthesizer to locate a desired service if you don't know the precise frequency. If you intend to monitor this service frequently you can then program a comb so you can quickly tune the frequency without tying up the synthesizer.

UHF Peaking. Because the combined coverage of UHF bands 1 and 2 is extra wide the front end can be tuned for maximum sensitivity for either section, but not both. (This split sensitivity is common to scanners that cover both UHF bands.) The Whamo-10 is normally supplied adjusted for maximum UHF sensitivity in the range of 450 to 495 MHz, with approximately 6 dB less sensitivity between 495 and

512 MHz. If you require greater sensitivity in the extended UHF frequencies you can get a factory alignment for optimized sensitivity in the 495 to 512 MHz range, with less than 6 dB reduction in sensitivity in the lower UHF range.

Summing Up. The Regency Whamo-10 priced at \$329.00 and the DFS-5K Digital Frequency Synthesizer, at \$199.00 are an unbeatable combination for the serious VHF/UHF hobbyist or listener for they allow instant *non-volatile* selection of any public service—and some amateur—frequencies. (Other programmable scanners have *volatile* programming that erases itself when the power is turned off, requiring re-entry of each desired frequency when power is again applied.) For additional information on the Regency Whamo-10 and Regency DFS-5K circle No. 61 on Reader Service card. ■

STAR-TRONICS

INDUSTRIAL AND GOVERNMENT ELECTRONIC SURPLUS

PARTS & PIECES FOR SCHOOLS, SHOPS, HAMS & HOBBYISTS

SEND FOR OUR LATEST ALL DIFFERENT MONTHLY PICTURE CATALOG. NOW!

Box 17127, Portland, Ore. 97217

"LISTEN IN" TO POLICE FIRE RADIO CALLS IN YOUR CAR!

Works with Any Car—Portable or Home Radio! Just Plug In—No wiring—3 minute hookup! Switches instantly from regular radio to All Police—Fire—Emergency—Taxi—State—Gov't 2 way radio calls! Works Everywhere—Anytime! Dual Band 36-49 & 150-175 MHz.

SEND ONLY \$2.00 (cash Ck. M.O.) and pay postman \$17.99 COD postage and send \$19.99 for PPD Del in USA. Complete with Special Antenna and Plug In for use with Any Home or Portable Radio! Full Instructions—1 year Service Warranty—10 Day Money Back Trial—Sold Only Direct from Factory.

WESTERN RADIO, Dept. CE-76 KEARNEY, NEB. 68847



Kathi's CB Carousel

(Continued from page 70)

(which could handle up to 250 watts!) costs only \$15.95. A CB antenna matcher that makes the transmitter deliver all its available RF into a "mismatched" antenna system goes for \$10.95, while a very nice coax switch you can tuck away under the seat of a car, or in the glove compartment, can be had for only \$6.95. Gold Line also has a miniature, low cost (\$7.69) low-pass filter for minor TV interference problems, and a brute force low-pass filter (rated 1000 watts) for heavy interference. I still can't figure out what CBER needs a 1000-watt filter, but it's the only way I know to get a lot of harmonic suppression at reasonable cost. And should your mobile be sniffing more alternator noise than signal, Gold Line has a brute force filter for alternators.

These are just a few items in the line that caught my eye. Others include a TVI high-pass filter, a CB phone patch, an in-line wattmeter and a twin-rig coupler.

Though low in cost, the Gold Line products I've had a chance to try out were quite good both in terms of performance and construction. This is another instance that proves you can't judge a book, or CB equipment, by its cover. The Gold Line

range of CB accessories is a plain "pipe rack" operation. Most items are blister packaged on a piece of thin cardboard. That's the whole bit. But keep in mind that a fancy cardboard box and a classy set of printed instructions can represent \$2 or more in cost. When you're spending under \$15 for an accessory a couple of dollars worth of packaging really isn't worth it. In the end it's performance and not packaging that counts, and the Gold Line accessories certainly give you your money's worth. To get full information on Gold Line CB accessories, circle No. 68 on the Reader Service card.

Books on CB? Newcomers to CB, and some old buddies, often ask me to recommend books on CB. Please save your letters and postage. Most books I've seen on CB for beginners are outdated with no insights into CB and its equipment. Many of the CB project books are simply reworks of projects for radio amateurs with coil and capacitor values, or scales, changed for 27 MHz Class D CB. Besides, most CBERs buy, not build their accessories.

The only beginner's book of value—if you can call a paperback sold on newsstands a book—that has real value for the CBER is the 1976 CB YEARBOOK, which has up-to-date info on every aspect of CB as well as test reports on the *latest* CB transceivers. In fact, I use the yearbook when helping friends select CB gear. And if anyone asks me about a rig that isn't in the yearbook I want to know why its test report isn't there before I'll even consider it. About the only excuse I accept is that the rig came out after the latest edition of the CB YEARBOOK.

That's it for now. Maybe by the next issue we'll have worked on channels 29, 35, 43 or even 54. But till the FCC opens those new top-of-the-band channels I'll be reading the mail on channel 19. ■

Gold Line Citizens Band transceiver filters, SWR meters, and other CB accessories are made by Gold Line Connectors, Inc., 25 Van Zant St., East Norwalk, CT 06855. Circle No. 68 on the Reader Service card for more information.

Shortwave Listening

1976 World Radio TV Handbook - \$10.95

Barlow Wadley & R.L. Drake Receivers

1976 "Confidential" Frequency List - \$5.45

GILFER, Box 239, Park Ridge, NJ 07656

"LISTEN IN" TO CITIZENS BAND RADIO IN YOUR CAR!

Works with ANY CAR RADIO and antenna! Just plugs in—1 minute hookup! Gets all 23 CB channels—crystal controlled! Instant switch from CB to regular Radio! Hear location of ALL STATE-COUNTY-LOCAL TRAFFIC RADAR CONTROL and ALL "Smokies"—NEVER GET CAUGHT SPEEDING AGAIN! For Everyone—Everywhere—Emergencies, roads, fuel, lodging day or night!

SEND ONLY \$2.00 and pay postman \$17.99 COD price or send \$19.99 for PPD del in USA. 1 YEAR SERVICE GUARANTEE—10 DAY MONEY BACK TRIAL—COMPLETE READY TO PLUG IN AND LISTEN! Order YOURS—TODAY—NOW!

WESTERN RADIO, Dept. CE-76, Kearney, Neb. 68847



HIGHLY PROFITABLE ONE-MAN ELECTRONIC FACTORY

Investment unnecessary, knowledge not required, sales handled by professionals. Postcard brings facts about this unusual opportunity. Write today! Barta-EF, Box 248, Walnut Creek, CA 94597.

24 HOUR PROTECTION—ANYWHERE!

Protect yourself, your family and your home with this 7-shot automatic .22 caliber non-lethal tear gas pistol. Instantly stop attackers, molesters, rapists and muggers with this high quality precision machined automatic. Fires 7 rounds as quickly as you can squeeze the trigger. Solid metal construction—dependable operation. Convenient trigger safety lock. No Federal Firearms License required. Don't be confused by cheap metal and plastic imitations that might misfire or jam in an emergency.

FITS EASILY IN PURSE OR POCKET

ONLY \$24.99 ADD \$5.00 FOR 25 ROUNDS AND PREPAID, INSURED DELIVERY. NO C.O.D.'S PLEASE.

DEFENDER DEPT. A258 • NEW CASTLE, DEL. 19720



Everything you need to know about CB is in this new book

by Radio Shack

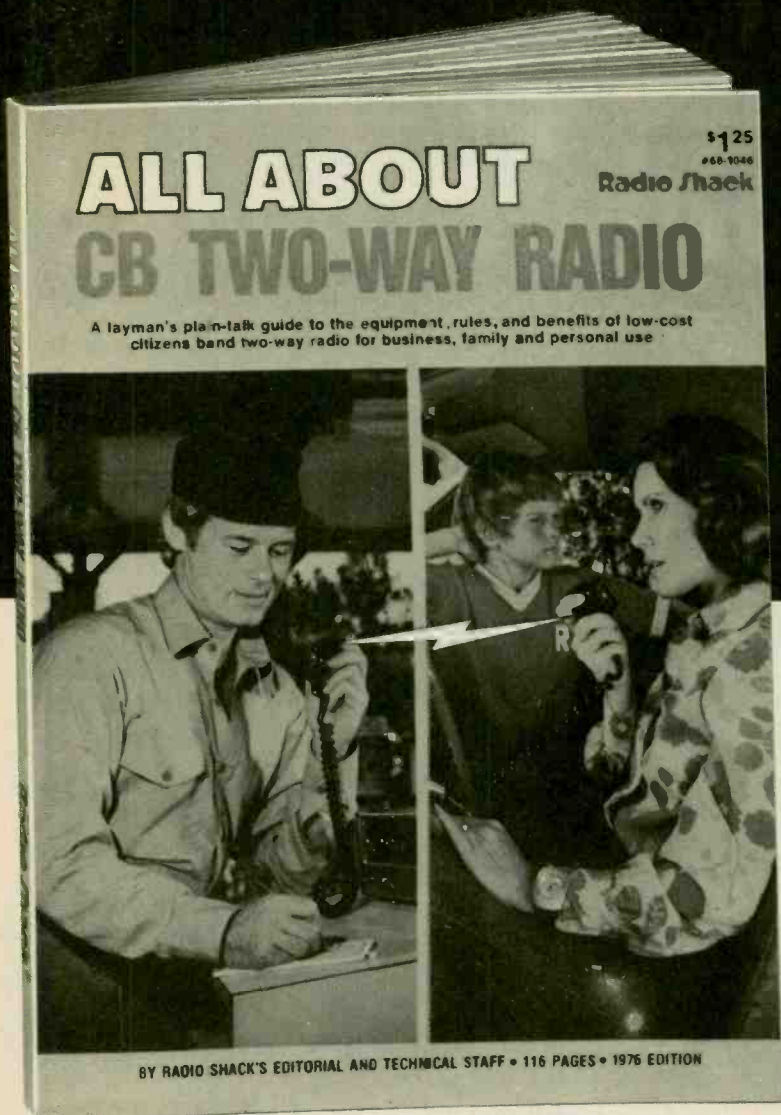

**SPECIAL
INTRODUCTORY
OFFER!**

Reg. \$1.25 CB Book

25¢

* WITH THIS COUPON

Offer Good at Participating Radio Shack Stores and Dealers

NONE SENT BY MAIL

721C

9 Plain-Talk Chapters:

- Personal Two-Way Communications
- Taking the Mystery Out of CB
- Parts of the System
- How Far You Can Expect to Talk
- Equipment Selection
- Installation
- FCC Regulations
- CB Tomorrow
- Detailed Glossary

— Plus —

- 10-Codes ■ CB Slang
- FCC Field Offices
- Over 100 Pictures

Our just-published 116-page CB pocket-size book is available now at Radio Shack stores at a "give-away" price of just 25¢, prior to its listing in our catalog at \$1.25. If you're into CB 2-way radio or getting in (as who isn't!) you'll want this book to avoid costly errors.

Edited by the folks who started our famous Realistic® CB line in 1959, it's authoritative, very easy to read, and tells all about CB for business, family and personal use.

*Get your \$1-off copy—bring this coupon to any nearby participating Radio Shack store or dealer TODAY!

Radio Shack®

LEADING THE WAY IN CB SINCE 1959
A TANDY COMPANY

Prices and products may vary in Canada.

Which of these fascinating electronic gadgets would you like to build?

A photo print-timer that does everything but turn out the lights! Designed by a darkroom craftsman, it features instant reset, backlighted digit-set dials, pushbutton stop and start.

A battery-operated dickey flasher—guaranteed to liven up any party! Suddenly, your shirt buttons start flashing sequentially! Some people laugh. Others just stare. But it's funniest when they try to ignore you!

Elementary Electronics features low-cost, practical projects like these in every issue!

Mail coupon today for your complimentary copy!

Yes, every issue of ELEMENTARY ELECTRONICS brings you step-by-step instructions, with photos and diagrams, for all kinds of devices you'll enjoy building—and be proud to own!

But that's not all. You also get instructive articles on electronics, CB and shortwave. Lively columns. Exciting features that make ELEMENTARY ELECTRONICS America's most absorbing, down-to-earth magazine for the electronics and radio hobbyist.

Invaluable Basic Courses in electronic theory!

For example, you get the fundamental training you need to construct your projects successfully—or lay the groundwork for an electronics career.

Each issue presents a Basic Course that helps you master an important aspect of electricity or electronics. Recent subjects included: *Resistors in Combination*, *Understanding Transformer Action*, *Introduction to Alternating Current*, and *Understanding Semiconductors*.

Our readers tell us these Basic Courses are one of the magazine's most popular and valued features.

A magazine with a personality all its own!

You'll meet a lot of interesting people in the pages of ELEMENTARY ELECTRONICS. Like Hank Scott, our Workshop Editor. He conducts a regular letters-from-readers

A shortwave station finder/ marker. Suppose you pick up an interesting but elusive station in Papeete, Kuwait or Kinshasa. This stable wide-band oscillator lets you relocate it any time you like—without hours of searching.

A nostalgic crystal radio set—just like the one your grandad had. You make it with a Quaker Oats box.

A futuristic pulse-width modulated mini-audio amplifier. It can boost the volume of a pocket radio to dancing level!

column called "Ask Hank, He Knows!" If you have any trouble on a project—or with *anything* electrical—just ask Hank. He knows!

And Kathi Martin, KGK3916, our Citizens Band Editor. She writes "Kathi's CB Carousel"—the most entertaining and informative CB feature you'll find anywhere!

Plus the people who contribute our columns on shortwave, antique radio, new products, electronics news tid-bits—and much, much more!

All our writers, editors and columnists know their stuff backwards and forwards. And they know how to make it interesting! With the same kind of straightforward language you use yourself when discussing electronics or radio.

What's more, they have fun. Which means you'll have fun, too!

SPECIAL INTRODUCTORY OFFER:

Just mail this coupon, and we'll send you a complimentary copy of ELEMENTARY ELECTRONICS.

Send no money now. We'll bill you later for a year's subscription—a total of six bimonthly issues for \$3.49. But if you don't agree the magazine is everything we say it is, simply write "Cancel" across the face of the bill. Send it back to us, keeping the complimentary copy. And you won't owe a cent.

Act today. We're confident that once you see your first copy of ELEMENTARY ELECTRONICS, you'll wonder how you did without it for so long!

A solid-state wind-chill factor meter that can tell you instantaneously just how cold you feel!

A compact, portable gas alarm for home, trailer, car or boat. It detects many kinds of dangerous fumes—and could easily save your life!

CB MEETS SWL IN GOOF-PROOF PROJECT see page 47
Elementary Electronics
 TRANSISTORS FOR BEGINNERS
 THE BASIC COURSE

FUTURISTIC
 Pulse-width modulated mini-audio amplifier boosts pocket radio sound to dancing level.

NOWADAYS
 Buck stretcher clock gives time, date, and alarm, plus two options in simplest design yet!

YESTERYEAR
 It's the real thing! Build your own Quaker Oats box crystal radio just the way granddaddy did, using identical materials for a perfect duplicate.

✓ Fun with the 10-Code ✓ Yamaha CB800 AM/FM-Stereo Receiver Checked Out
 ✓ Practical Antenna Tips for the SWL ✓ Way-Out Play-It-Yourself
 ✓ Midland 13-800 CB ✓ How to Build a...

ELEMENTARY ELECTRONICS

P.O. Box 2600 H6A278
 Greenwich, CT 06830

YES! Please send, without cost or obligation, my get-acquainted copy of ELEMENTARY ELECTRONICS. If I find it is everything you say it is, bill me for a year's subscription (\$5 additional issues, for a total of 6 in all) at just \$3.49. If I don't wish to subscribe, I will write "Cancel" across your bill, return it, and that will end the matter. Either way, the complimentary copy is mine to keep.

Name _____ (please print)
 Address _____
 City _____
 State _____ Zip _____

**NO-RISK GET-ACQUAINTED COUPON
 SEND NO MONEY!**

LITERATURE LIBRARY

101. Get acquainted with the new *EICO* products, designed for the professional technician and electronics hobbyist. Included in brochure are 7 IC project kits, *EICO*'s "Foneaids," security products and many varied kits.

102. *International Crystal* has a free catalog for experimenters (crystals, PC boards, transistor RF mixers & amps, and other comm. products).

103. See brochures on *Regency's* 1976 line-up of CB transceivers & scanner receivers (for police, fire, weather, & other public service emergency broadcasts).

104. *Dynascan's* new *B & K* catalog features test equipment for industrial labs, schools, and TV servicing.

105. Before you build from scratch, check the *Fair Radio Sales* latest catalog for surplus gear.

106. Get *Antenna Specialists'* catalog of latest mobile antennas, test equipment, wattmeters, accessories.

107. Want a deluxe CB base station? Then get the specs on *Tram's* super CB rigs.

108. Compact is the word for *Xcelite's* 9 different sets of midget screwdrivers and nutdrivers with "piggyback" handle to increase length and torque. A handy show case serves as a bench stand also.

110. *Turner* has two booklets on their Signal Kicker antennas. They give specifications and prices on their variety of CB base and mobile line. Construction details help in your choice.

111. *Midland Communications'* line of base, mobile and hand-held CB equipment, marine transceivers, scanning monitors, plus a sampling of accessories are covered in a colorful 18-page brochure.

112. The *EDI (Electronic Distributors, Inc.)* catalog is updated 5 times a year. It has an index of manufacturers literally from A to X (ADC to Xcelite). Whether you want to spend 29 cents for a pilot-light socket or \$699.95 for a stereo AM/FM receiver, you'll find it here.

113. Get all the facts on *Progressive Edu-Kits* Home Radio Course. Build 20 radios and electronic circuits; parts, tools, and instructions included.

115. *Trigger Electronics* has a complete catalog of equipment for those in electronics. Included are kits, parts, ham gear, CB, hi fi and recording equipment.

116. Get the *Hustler* brochure illustrating their complete line of CB and monitor radio antennas.

117. *Teaberry's* new 6-page folder presents their 6 models of CB transceivers (base and mobile): 1 transceiver for marine-use, and 2 scanner models (the innovative "Crime Fighter" receiver and a pocket-size scanner).

118. *CBers, GC Electronic's* 8-page catalog offers the latest in CB accessories. There are base and mobile mikes; phone plugs; adaptors and connectors; antenna switchers and matchers; TVI filters; automotive noise suppressor kits; SWR Power and FS meters, etc.

119. *Browning's* mobiles and its famous Golden Eagle base station, are illustrated in detail in the new 1976 catalog. It has full-color photos and specification data on Golden Eagle, LTD and SST models, and on "Brownie," a dramatic new mini-mobile.

120. *Edmund Scientific's* new catalog contains over 4500 products that embrace many sciences and fields.

121. *Cornell Electronics'* "Imperial Thrift Tag Sale" Catalog features TV and radio tubes. You can also find almost anything in electronics.

122. *Radio Shack's* 1976 catalog colorfully illustrates their complete range of kit and wired products for electronics enthusiasts—CB, ham, SWL, hi-fi, experimenter kits, batteries, tools, tubes, wire, cable, etc.

123. Get *Lafayette Radio's* "new look" 1976 catalog with 260 pages of complete electronics equipment. It has larger pictures and easy-to-read type. Over 18,000 items cover hi-fi, CB, ham rigs, accessories, test equipment and tools.

127. There are *Avanti* antennas (mobile & base) for CB and scanner receivers, fully described and illustrated in a new 16-page full-color catalog.

128. A new free catalog is available from *McGee Radio*. It contains electronic product bargains.

129. Semiconductor Supermart is a new 1976 catalog listing project builders' parts, popular CB gear, and test equipment. It features semiconductors—all from *Circuit Specialists*.

130. There are over 350 kits described in *Heath's* new catalog. Virtually every do-it-yourself interest is included—TV, radios, stereo & 4-channel, hi-fi, etc.

131. *E. F. Johnson* offers their CB 2-way radio catalog to help you when you make the American vacation scene. A selection guide to the features of the various messenger models will aid you as you go through the book.

132. If you want courses in assembling your own TV kits, *National Schools* has 10 from which to choose. There is a plan for GIs.

133. Get the new free catalog from *Howard W. Sams*. It describes 100's of books for hobbyists and technicians—books on projects, basic electronics and related subjects.

134. *Sprague Products* has L.E.D. readouts for those who want to build electronic clocks, calculators, etc. Parts lists and helpful schematics are included.

135. The latest edition of *Tab Books'* catalog has an extensive listing of TV, radio and general servicing manuals.

137. *Pace* communications equipment covers 2-way radios for business, industrial and CB operations. Marine radiotelephones and scanning receivers are also in this 18-p. book.

138. *Shakespeare's* new pocket-size catalog lists and describes their full line of fiberglass CB antennas, mounts and accessories offered in 1976.

142. *Royce Electronics'* new full-color catalog updates information on their CB transceivers (base, mobile, handheld). It also describes new product lines—CB antennas and a VHF marine radiotelephone.

144. For a packetful of material, send for *SBE's* material on UHF and VHF scanners, CB mobile transceivers, walkie-talkies, slow-scan TV systems, marine-radios, two-way radios, and accessories.

145. For *CBers from Hy-Gain Electronics Corp.* there is a 50-page, 4-color catalog (base, mobile and marine transceivers, antennas, and accessories). Colorful literature illustrating two models of monitor-scanners is also available.

150. Send for the free *NRI/McGraw Hill* 100-page color catalog detailing over 15 electronics courses. Courses cover TV-audio servicing, industrial and digital computer electronics, CB communications servicing, among others. G.I. Bill approved, courses are sold by mail.

152. Send for the new, free descriptive bulletin from *Finney Co.* It features the Finco line of VOM multi-testers (and accessories) for electronics hobbyists and service technicians.

153. *MFJ* offers a free catalog of amateur radio equipment—CW and SSB audio filters, electronic components, etc. Other lit. is free.

154. A government FCC License can help you qualify for a career in electronics. Send for information from *Cleveland Institute of Electronics*.

155. New for *CBers from Anixter-Mark* is a colorful 4-page brochure detailing their line of base station and mobile antennas, including 6 models of the famous Mark Helicopter.

156. Send for *Continental Specialties* new breadboarding prototest devices. They vary in prices from a mini-budget kit at \$19.95. Featured is the new logic monitor, giving information on what it does, how it works, and how to use it.

157. *Dage Scientific Instruments* offers a 16-page booklet on how to build an electronic thermometer with control. Included is an introductory course on thermocouples, schematics and many applications.

ELEMENTARY ELECTRONICS
Box 1849, G.P.O.
New York, NY 10001

May/June 1976
Void after October 13, 1976.

Please arrange to have the literature whose numbers I have circled below sent to me as soon as possible. I am enclosing 50¢ for 10 to cover handling. (No stamps, please.) Allow 4-6 weeks for delivery.

Are you a subscriber? Yes No

200 Enter my subscription for 9 issues at \$4.97. Check enclosed.
Add 78¢ for U.S. possessions and Canada; \$1.53 all other countries.

101	102	103	104	105	106	107	108	110	111	112	113
115	116	117	118	119	120	121	122	123	127	128	129
130	131	132	133	134	135	137	138	142	144	145	150
152	153	154	155	156	157						

NAME (print clearly) _____

ADDRESS _____

CITY _____

STATE _____

ZIP _____

ELEMENTARY ELECTRONICS—is published Bi-monthly. The rate per word for CLASSIFIED ADVERTISEMENTS is \$1.25 payable in advance—minimum ad \$15.00. Capitalized words 40¢ per word additional.

ADDITIONAL INCOME

FANTASTIC! Easy money. Details \$3.00. DAHLE, Box 6507, Santa Rosa, CA 95406.

ALARM EQUIPMENT & SUPPLIES

BURGLAR Alarm dialing unit automatically calls police. \$29.95. Free Literature. S&S Systems, 5619-K St. John, Kansas City, MO 64123.

AUTHOR'S SERVICE

PUBLISH your own book! Join our successful authors: publicity advertising promotion, beautiful books. All subjects invited. Send for free manuscript report and detailed booklet. Carlton Press, SME, 84 Fifth Avenue, NY 10011.

BIG MAIL

RECEIVE mail galore! National listing \$1.00. Sullins, Box 1313-EE, Brunswick, GA 31520.

BLUEPRINTS, PATTERNS & PLANS

DETAILED PLANS! \$1.00 brings complete listing of hundreds of electrical, mechanical, and chemical projects. Duane Rysn, P.O. Box 234, Niwot, CO 80544.

NEW CRAFT PRINT CATALOG—Choose from over 100 great easy-to-build plans. Send \$1.25 (completely refunded with your first order). BOAT BUILDER, (CP Div.)—229 Park Avenue South, New York, NY 10003.

BOOKS & PERIODICALS

MAKE Telephone calls for practically nothing! Obtain great wealth with only \$10! Collect more on insurance claims! Never pay traffic/parking tickets again! Beat the bureaucrats at their own game! Cut red tape—Get things done! Details—\$1. (refundable). C. A. B. Publishing, 555 Broadhollow, Dept. EE, Melville, NY 11746.

WHAT'S going on in housing? Get advice on how to economize in modernizing or improving or adding space from idea to completion. Working blueprints available. Send \$1.35 for 110 Better Building Ideas to: Davis Publications, Inc., 229 Park Avenue So., NY 10003.

SPECIAL BICENTENNIAL ISSUE of "Yesterday's Magazine." Send \$1.00 to: "Yesterday's Magazine," P.O. Box 20, Scranton, PA 18504.

INFORMATIVE HANDBOOK—For people with an interest in electronics and desire to know more. Covers basic electricity, resistors, capacitors, micro-waves, facts on frequency, about fuses, circuit breakers, crystals and much more. Send \$1.50 for your copy (includes postage) to: Electronics Theory Handbook, 229 Park Avenue South, N.Y., N.Y. 10003.

BUSINESS OPPORTUNITIES

MAKE Magnetic Signs. Big Profits. Details. Universal, Lenora, KS 67645.

HOMEWORK! BIG MONEY addressing, mailing envelopes. Exciting offer 10¢. Linco Services, 3636 Peterson, Chicago, 60659.

FREE Secret Book "2042 Unique, Proven Enterprises." Fabulous "Little Knowns" Work Home! HAYLINGS-E14, Carlsbad, CA 92008.

BECOME our Mail Order Distributor with \$150 investment. Free brochure. Audit Controls, 35 Brookside Ave., Fair Lawn, NJ 07410.

MAILORDER Millionaire helps beginners make \$500 weekly. Free Report reveals secret plan! Executive IG5, 333 North Michigan, Chicago 60601.

BORROW ANY AMOUNT. Enjoy A-1 credit. Keep money in bank, get 80% more. Send Stamp. Vernon, Box 75010-HH, Oklahoma City 73107.

\$30.00 HUNDRED Stuffing Our Circulars Into Stamped Addressed Envelopes. Immediate Earnings. Beginners Kit \$2.00 COLOSSI, 1433-61 Street, DC-4, Brooklyn, NY 11219.

\$150 WEEKLY stuffing our sales letter into stamped addressed envelopes. Immediate income! Details 25¢. Lily, Box 4967-F65, NYC 10017.

GET RICH with Secret Law that smashes debts and brings you \$500 to \$2 million cash. Free report! Credit 4G5, 333 North Michigan, Chicago 60601.

BUSINESS OPPORTUNITIES—Cont'd

SELL BOOKS by Mail 400% Profit. Free Details. Write: Tate's Enterprises, 9333 S. Merrill, Chicago, IL 60617.

\$800 MONTHLY Possible—stuffing envelopes. Start immediately!! Details \$1.00 (Refundable). Elamco, B1137-C2, Waldo, AR 71770.

NEW!! Valuable Informative Manual on Mail-order! Learn "How to Setup Run" your business. Facts free. Frontierico, 154 (D5) Sprenger, Buffalo, NY 14211.

IMPATIENT? Produce Oil Portraits Instantly! Details 25¢, refundable. Jiffyportraits, 2830BC-Gaffey, San Pedro, CA 90731.

How To Write a Classified Ad That Pulls
What to Say and How to Say It
Only \$1.25
Worth Its Weight In Gold

MAKE YOUR CLASSIFIED AD PAY. Get "How to Write a Classified Ad That Pulls." Includes Certificate worth \$2.00 towards a classified ad in this publication. Send \$1.25 (includes postage) to R. S. Wayne, Davis Publications, Inc., Dept. CL, 229 Park Avenue South, New York, NY 10003.

PLEASE Be sure to include your zip code when ordering merchandise from classified advertisements. You'll receive faster delivery.

HOW much does being your own boss or making \$25,000 per year interest you? The Warner breakthrough in the Engraving field could be your future. Write: Warner, Room EC-107-FF, 1512 Jarvis, Chicago, IL 60628.

100% PROFIT Bronzing Baby Shoes. Free Literature. NBC-DG, Gower, MO 64544.

\$500 WEEKLY at home—New "Guaranteed Daily Income" plans—Free Proof. Box 90133DP, Atlanta, GA 30344.

\$178.00 WEEKLY. Work one hour daily. Guasanteed, FAS, Box 13703-E, San Antonio, TX 78213.

\$500 A WEEK Wholesaleing. Sparetime. Details 25¢. Jure's Gift World, 127 Herriot St., Yonkers, NY 10701.

STUFF Envelopes, Clip newspapers. \$1,000 MONTHLY. Rush 25¢, stamped, addressed envelope. Star Enterprises, Box 2729, Norman, OK 73069.

HOW TO START A CABLE SYSTEM. INSTRUCTIONS \$3.00. Cable Ten, 280 Oak Moss Walk, Manchester, MO 63011.

MAKE 2 TO 3 TIMES YOUR COST on hundreds of products. Gift items, novelties, toys, carded merchandise, 1000 others. \$1.00 brings giant catalog, refundable on first order. ROBERTSON ENTERPRISES, Dept. K-5, 510 West 12th, Plainview, TX 79072.

FREE DETAILS. Unlimited Earnings with Fantastic-Money Making Methods. Capitol, P.O. Box 663, Newark, OH 43055.

HIGH INTEREST CHECKING ACCOUNTS—For Comprehensive analysis of the various types at insured banks, send \$10 to: Brown Investment Associates, Box 79, Ardsley, NY 10502.

\$250-\$500/THOUSAND, Stuffing Envelopes. Complete Assistance. Send stamped, addressed envelope. Howard's, P.O. Box 5207A, Fullerton, CA 92635.

INSERT our ads into pre-stamped envelopes. \$1,000 MONTHLY. Rush 25¢, stamped, addressed envelope. Specialty Products, Box 2064, Norman, OK 73069.

BUSINESS OPPORTUNITIES—Cont'd

\$600.00 PLUS monthly, spare time. Details free. Opportunity, Box 1108, New Milford, CT 06776.

"UNLIMITED HOME EARNING" Stuffing envelopes. Information. Send stamped envelope. Opportunities, Box 721-DP, Lynbrook, NY 11563.

CLIP newspaper articles. Get \$1.00 to \$5.00 each. Details, 25¢ and stamped addressed envelope. Send to B. Jordan, 2230 Fir Street, Wantagh, NY 11793.

FREE moneybook! "Millionaire's Success Secrets." Guide to million-dollar opportunities. Proven, tested plans. Delista Enterprises, Suite 200, P.O. Box 665, Carlisle, AR 72024.

ZERO CASH BUSINESSES! COSIGNERS! 100% FINANCING! BGS International-4, 210 Fifth Avenue, NY, NY 10010.

BUY IT WHOLESALE

WHY PAY RETAIL? Save hundreds of dollars on large selection of personal and gift item products. Free color Catalog! Marketing, 1338 Bennett, Dept. 351-D, North Madison, OH 44057.

SENSATIONAL OFFER! SAVE MONEY!! 5 Wholesale catalogs on low cost unusual items. Send \$2.00. Winchester Enterprises, 2808 SS Hargrave Street, Phila., PA 19136.

DETECTIVES

CRIMEFIGHTERS! Investigators-Detectives-Police, Catalog \$1.00 Refundable. Don-Q, Box 548, Seattle, Washington 98111.

DO IT YOURSELF

BUILD Square Wave Generator, Transistor Tester, Capacitor Tester, Power Supply from spare parts. \$2.00. Bill's, P.O. Box 712-B, Springfield, TN 37172.

WILLS—Make your own. 4 Forms, Instruction Booklet, \$1.98. Prairie Shopper, Box 602, Devilslake, ND 58301.

CONSTRUCTION Plans: Lap-dessolve, multiprojector tape-slide synchronizers, \$5.00. With mixer, compressor, burglar alarms, \$8.00. Millers, 1896 Maywood, South Euclid, OH 44121.

REPAIR YOUR OWN TV. Anyone can, new easy method. Write for information. Research Publications, Box 235T, Brea, CA 92621.

39 Projects using Cassette Recorder. \$2.25. Wheeler Press, 17 Ferguson, Warren, NJ 07060.

YEAR round artificial hill for youngsters. Plans—including cart—\$5.00. John McLoughlin, Route 236, Berwick, ME 03901.

EDUCATION & INSTRUCTION

USED Courses! Books! List 10¢. Smith's 124 Marlborough, Salem, MA 01970.

UNIVERSITY DEGREES BY MAIL! Bachelors, Masters, Ph.D.s. Free revealing details. Counseling, Box 1425-EE-5, Tustin, CA 92680.

UNLOCK Your Future. Become professional Locksmith by spare time homestudy. \$13 in an hour possible. All tools, equipment included. Facts free. Send name. Locksmithing Institute (homestudy), Dept. 1372-116, Little Falls, NJ 07224.

DIGITAL DESIGN NEWSLETTER theory, design, construction kits. Sample \$1.00. ROM ASSOCIATES, Box 296E, Weston, MA 02193.

LEARN ELECTRONICS at home. Industry proven intensive training. Dozens of experiments. Lessons, Tools, instruments, extras. Free booklet. Applied Laboratories, P.O. Box 9473 E, Fort Lauderdale, FL 33310.

GET INTO BROADCASTING! Pass FCC examinations, earn big money, start your own station! Free literature. Broadcaster, Box 5516-GC, Walnut Creek, CA 94596.

BURGLAR/FIRE ALARM EXPERTS NEEDED for cars, homes, industry. Learn high profit systems installation at home spare time. Simple, quick, complete. Free information by mail. No salesmen. Security Systems Management School (homestudy), Dept. 7372-056, Little Falls, NJ 07424.

THERE IS NO CHARGE FOR THE ZIP CODE—PLEASE USE IT IN YOUR CLASSIFIED AD

PLACE

To be included in the next issue, please send order and remittance to R. S. Wayner,
ELEMENTARY ELECTRONICS, 229 Park Avenue South, New York, N.Y. 10003

ELECTRONIC EQUIPMENT & SUPPLIES

FREE 36-page catalog, updated 5 times a year. Everything for the electronics hobbyist—from TV antenna wire to the latest stereo music equipment. ELECTRONIC DISTRIBUTORS, INC. 4900 N. Elston Ave., Chicago, IL 60630 EE-10.

FREE CATALOG: Electronic supplies—kits for the hobbyist. Low prices. Anklam Electronics, 4709 nth. 6th St., Wausau, WI 54401.

BUILD YOUR OWN TV CAMERA. Great for home and business. Free illustrated catalog. Phone or write: 402-987-3771. ATV Research, 13-E Broadway, Dakota City, NB 68731.

ELECTRICAL Projects! Motor! Generator! Battery! Rewinding! Electroplating! Electroqup, Box 7266, Kansas City, MO 64113.

SURPLUS! Fifty Computer Circuit Boards. \$10.00. Good selection, perfect for experimenters! DEV, Box 601, Waterloo, Ontario, Canada.

EMPLOYMENT INFORMATION

AUSTRALIA—WANTS YOU!! 50,000 Jobs!! Paid transportation—Latest Information and Forms \$1.00. H & M, Box 780-K, Ft. Huachuca, AZ 85613.

CALIFORNIA COMPANIES hiring Electronic Engineers and Technicians. Current employment bulletin. \$3.00. Dynamics, Box 1867-B, Covina, CA 91722.

FOR SALE—MISCELLANEOUS

SUPER ELECTRICIAN Decaled 100% Cotton "T" shirt 6-16, Small, Med. Large, X-Large. \$2.99 + 50¢ Postage and Handling. Shirts, Box 308, Alden Manor Branch, Elmont, N.Y. 11003.

FOR THE HOME

FOR anyone who wants the satisfaction and economy of repairing, furnishing and maintaining the furniture in his home. Send \$1.25 to FURNITURE, 229 Park Avenue South, New York, NY 10003.

GIFTS THAT PLEASE

QUALITY gifts at wholesale prices. Novelties, gadgets, etc. Send for free catalogue. L. B. Ltd., 1461 Haynes, Dept. G 2, Birmingham, MI 48008.

WONDERFUL gifts to please those special people. For catalog send 50¢ to Llessurt's of Greensboro, A13, 5107 Amberhill Drive, Greensboro, NC 27405.

SEND \$2.00 for handbag: Reink-Teitelbaum, Box 130, Ryder St. Sta., 1165 E. 54th St., Brooklyn, N.Y. 11234 Free Information.

FREE! Illustrated Catalog of Fine Gifts. Dave's Gifts, Box 673-C, Elmira, N.Y. 14902.

GOVERNMENT SURPLUS

GOVERNMENT SURPLUS Jeeps \$60.00. Boats, guns, cars. These are typical government surplus bargains. How to buy for own use or for resale. Booklet #mo-50's, \$1.50. Hallott's Gifts, P.O. Box 218, Dewitt, New York 13214. New York residents pay sales tax.

HI-FI EQUIPMENT

CANADIANS—Free Hi-Fi discount catalog. Name brands, immediate delivery from our huge stock. Etco, Dept. AA, Box 741, Montreal "A".

HOBBIES & COLLECTIONS

GLASSBLOWING KITS and supplies. Free literature. Willis Glass, Box 3460-D, Anaheim, CA 92803.

HOME WORKSHOP SUPPLIES

25 WEEKEND BUILD-IT PROJECTS—Practical designs for home/shop buffs who enjoy working with wood, tools, materials and techniques. Send \$1.50 for your copy (includes postage) to Davis Publications, Inc., 229 Park Avenue South, New York, NY 10003.

HYPNOTISM

AMAZING self-hypnosis record releases fantastic mental power. Instant results! Free trial! Write: Forum (AF5), 333 No. Michigan, Chicago 60601.

FREE Fascinating Hypnosis Information! Startling! DLMH, Box 487, Anaheim, California 92805.

MAGNETS

MAGNETS. All types. Specials—20 disc, or 10 bar, or 2 stick, or 8 assorted magnets, \$1.00. Magnets, Box 192-E, Randallstown, MD 21133.

MAIL ORDER OPPORTUNITIES

SUCCESS In Mailorder! Ask How: Report, Box 701, Camden, AR 71701.

MISCELLANEOUS

STOP throwing your money away! Make money playing poker. Experts reveal inside secrets. Facts on betting, bluffing, and poker psychology. \$1.50. R. Walker, 34440 So. Gratiot, Dept. 5, Mt. Clemens, MI 48043.

HOW to make delicious German Beer, Champagne, and Wine at home! No special equipment needed. Fantastic Taste! Guaranteed delicious or money back. Send \$3.98—Klyer, 82 Astor Place, Jersey City, NJ 07304.

FIGHT WOMEN'S LiB—Join "Male Supremacy League." Hottest gift idea since Pet Rock. \$5.00 brings T-Shirt, Wall Certificate, and Membership Card. Send cash, check or money order to Gifford/MSL, Box 5522, Redwood, CA 94063. Specify shirt size.

UNDERSTAND POLICE RADIO CONVERSATIONS, 10 CODE and Meanings, \$2.75 per list, Don's Enterprises, Box 4030, Dept. JAA2, Baltimore, MD 21222.

MONEYMAKING OPPORTUNITIES

STUFF MAIL ENVELOPES!! \$250.00 profit per thousand possible. Offer details: Stamped self-addressed envelope. Kings, B-21487K-EE56, Ft. Lauderdale, FL 33316.

HOW to Make Money Writing Short Paragraphs. Information Free. Barrett, Dept. C-308-K, 6216 N. Clark, Chicago 60660.

\$1,000 MONTHLY!! Stuffing Envelopes And Clipping Newspaper: Send Stamped Addressed Envelope. JOY, Box 936-A, Hyattsville, MD 20783.

WILL You actually (really & truly) address, stuff and mail 20 envelopes a day? Then don't let's mess around. Send \$3 and we'll show you how to make up to \$1,000 monthly and even much more. Guaranteed! Contractual Arrangements. Habersham Hall, Box 613-0, San Pedro, CA 90733.

MAKE YOUR CLASSIFIED AD PAY. Get "How to Write A Classified Ad That Pulls." Includes certificate worth \$2.00 towards a classified ad. Send \$1.25 (includes postage) to R. S. Wayner, Davis Publications, Inc., 229 Park Avenue South, New York, NY 10003.

STUFF Envelopes. \$25.00 Hundred. Free Supplies. Send Stamped envelope. Isco, 3835A 42nd, San Diego, CA 92105.

MONEY ADDRESSING AND MAILING CIRCULARS \$250.00 PER 1000. A REAL MONEY MAKER. SEND 50¢ AND SELF-ADDRESSED ENVELOPE TO: POST OFFICE BOX 2532, ZANESVILLE, OH 43701.

MONEYMAKING OPPORTUNITIES—Cont'd

\$300 DAILY in your mailbox—Free report reveals fortune building secrets. Saffar, Box 90133DP, Atlanta, GA 30344.

\$800.00 MONTHLY possible stuffing envelopes. Free supplies. Rush stamped envelope. United, 3838½ Van Dyke, San Diego, CA 92105.

MONEYBROKERS needed! Large earnings guaranteed! Full training! JLS Associates, 391 Gregg, Buffalo Grove, IL 60090.

AMAZING NEW books. Programs will build your FORTUNE. "Details, 25¢." Justamere, 1039 Circle-Green, Worthington, OH 43085.

90 Day Refund. Homeworkers make money, we help. Details \$1.00. Safeco Unlimited, 507 Fifth Ave., New York, NY 10017.

\$150.00 WEEKLY stuffing our circulars into stamped addressed envelopes. Guaranteed earnings. Beginners kit \$2.00. Malone, Box 42-DC4, Brooklyn, NY 11228.

MUSIC & MUSICAL INSTRUMENTS

GUITARISTS! Strings, accessories cheap! Free Catalog. Guitar Clinic, EE-2, 20 Lawnridge Ave., Albany, NY 12208.

OFFICE EQUIPMENT & SUPPLIES

SELF-CORRECTING TYPEWRITER RIBBON. Fastest, easiest, neatest correcting possible. Black/White ribbon. Complete instructions. Give Brand name: Model, standard/portable/electric. \$3.00, two \$7.00. Guaranteed. Ruth's Mail, Box 5285-B25, Jacksonville, FL 32207.

OLD GOLD WANTED

HIGHEST CASH for gold, jewelry, eyeglass frames, gold teeth, any condition. Satisfaction Guaranteed. Postage refunded. Mail today. Stewart Precious Metals, 7902 Kreeger, Hyattsville, MD 20783.

PERSONAL

JAPANESE introductions! Girls' photographs, descriptions, brochure, details, \$1.00. INTER-PACIFIC Box 304-SC, Birmingham, MI 48012.

SINGLE? Widowed? Divorced? Nationwide Introductions! Identity, Box 315-DC, Royal Oak, MI 48068.

REVEALING IRS tax guidebook. Details free. Leighton, 10-G Greystone, Larchmont, NY 10538.

ZERO CASH BUSINESSES! COSIGNERS! 100% FINANCING! BGS International-4, 210 Fifth Avenue, NY, NY 10010.

JAPANESE Girls Make Wonderful Wives. We have large number of listings. Many interested in marriage. Only \$1.00 brings application, photos, names, descriptions, questionnaire. Etc. Japan International, Box 1181-AA, Newport Beach, CA 92663.

"DATE WITH DIGNITY" Professional Matching. Drawer 6765, Fort Worth, 76115 (817) 921-0281 Anytime.

SAVE \$\$\$ On Drugs. Inside Report \$2.00. Pharmacist, Box 98, Willowdale, Canada M2N 5S7.

BEAUTIFUL MEXICAN GIRLS Wanting American Boy Friends. Details. Photos "Free." World, Box 3876-DC, San Diego, CA 92103.

1000 LADIES Photos matrimonial catalog—\$3.00. Intercontact, Box 737, Lauderdale, FL 33302.

COLLEGE DEGREES by mail. Free Details. Write: Rhodes, 8317D S. King Dr., #2C, Chicago, IL 60619.

MORE

For Greater Classified Savings...Results...and Profits...

Place you ad in one of our SPECIAL COMBINATIONS: Business Group, Science & Mechanics, or Davis Combination. Each Combination is designed to give you ad the largest audience available. For further information write to R. S. Wayner, Classified Advertising Manager, Davis Publications, Inc, 229 Park Avenue South, New York, N.Y. 10003.



Wm. D.

Electric

NORRISTOWN

Electric HEATING CONTRACTOR
FLAMELESS
ELECTRIC HEAT
FOR COMPLETE COMFORT AND CONVENIENCE

CALL US FOR
AND AN

“Learn an honest trade,” my old man used to say to me, “and you’ll never have to knuckle under to any man.”

(A TRUE STORY)

Bill De Medio of Conshohocken, Pa., has it made.

At 26, he’s a licensed master electrician. The top of a trade where there aren’t enough good men to go around.

But more important, Bill’s his own boss and calls his own shots. “I just went into my own business. And even before the sign on my truck was dry, I got my first big job.

“The contractor for a new group of houses asked me to do the wiring. And there’s bound to be more work from him and other builders.

“If it wasn’t for my ICS training as an electrician, I’d still be in some dead-end job—hating what I was doing, taking orders from everyone, and never getting any thanks for it.

“As a master electrician, you’re the boss on the job—even when you’re working for someone. You get respect, good money, and like my old man said, you don’t have to take baloney from anyone.”

Bill De Medio is one of our outstanding graduates. He’s hard working. He’s in a growing field. And he has good training.

Of course, we can’t promise you’ll be as successful as Bill—no school can guarantee jobs for its graduates. But ICS can give you the first-rate training you need—especially if you’re interested in one of the growing careers where ICS concentrates its training.

AN IDEAL WAY TO LEARN

As an ICS student, you study at home, on your own schedule. You waste no time traveling to and from class. And you never have to miss a paycheck.

But you’re never alone. If you ever want to talk to an instructor, you can call ICS from anywhere in the continental United States, using our toll-free Dial-a-Question® service.

Since 1890, millions of men and women around the world have turned to ICS for career training.

More than 70 of America’s largest 100 corporations (including Gulf Oil, Bethlehem Steel, 3M, Westinghouse, and International Paper) use ICS training for their own employees.

And the ICS Center for Degree Studies is authorized by the Pennsylvania Department of Education to grant the Associate in Specialized Business degree in Accounting and Business Management, and the Associate in Specialized Technology degree in Civil, Mechanical, Electrical, and Chemical Engineering Technologies.

These degree programs are not mere stepping-stones to higher education nor are they intended for transfer toward advanced degrees. They are practical, career-oriented programs designed to help you reach your objectives without further academic training.

If you already have some college education, you may be able to receive advanced standing toward your degree. With a degree from ICS, you’ll be able to apply with pride for jobs that call for career training.

FREE DEMONSTRATION LESSON

No one can promise you success, but if you want more—more money, more security, more day-to-day satisfaction and more future—our free Career Booklet and free Demonstration Lesson can help you get started in the right direction.

Remember, it’s your life. You might as well make the most of it.

© 1975 Intext, Inc. E

FOR A FREE CAREER BOOKLET & DEMO LESSON, CHECK BELOW.

- | | |
|---|---|
| <input type="checkbox"/> Electrician | <input type="checkbox"/> Automotive Mechanics |
| <input type="checkbox"/> Engineering | <input type="checkbox"/> Business Management |
| <input type="checkbox"/> Accounting | <input type="checkbox"/> Civil Engineering |
| <input type="checkbox"/> Drafting | <input type="checkbox"/> Interior Decorating |
| <input type="checkbox"/> Electronics Technician | <input type="checkbox"/> Construction Electrician |
| <input type="checkbox"/> TV Service & Repair | <input type="checkbox"/> Appliance Service & Repair |
| <input type="checkbox"/> Surveying & Mapping | <input type="checkbox"/> Income Tax |
| <input type="checkbox"/> Diesel Mechanic | <input type="checkbox"/> Motel/Restaurant Mgt. |
| <input type="checkbox"/> Air Conditioning & Refrigeration | <input type="checkbox"/> Mechanical Engineering |
| | <input type="checkbox"/> High School |

EARN A DEGREE WITHOUT GOING TO COLLEGE

The ICS Center for Degree Studies is authorized by the Pennsylvania Department of Education to offer career programs at home leading to Associate in Specialized Business and Associate in Specialized Technology degrees. For information, check the field of your choice below.

- | | |
|--|-------------------------------------|
| Business Programs: | Engineering Technologies: |
| <input type="checkbox"/> Accounting | <input type="checkbox"/> Civil |
| <input type="checkbox"/> Business Management | <input type="checkbox"/> Electrical |
| | <input type="checkbox"/> Mechanical |
| | <input type="checkbox"/> Chemical |

Name _____ Age _____

Address _____

City _____

State _____ Zip _____

Phone _____

ICS

XA907R

INTERNATIONAL CORRESPONDENCE SCHOOLS
SCRANTON, PA. 18515

VETERANS: TAKEN FOR CAREER PURPOSES. ICS PROGRAMS QUALIFY FOR VA BENEFITS. CANADIAN RESIDENTS USE SCRANTON, PA. ADDRESS FOR SERVICE FROM ICS CANADIAN, LTD. IN HAWAII: 931 UNIVERSITY AVE., HONOLULU, HAWAII 96814.

At 26, Bill De Medio has more freedom, more security, and gets more respect than guys twice his age. (Photograph by Frank Cowan.)

The Incredible One-Hander™

New Realistic® Mobile Radio
Puts **EVERYTHING** in
One Hand. Everything?
Yes . . . **EVERYTHING!**

- ★ Pushbutton Mike!
- ★ Built-In Speaker!
- ★ Illuminated Channel Selector!
- ★ On-Off Switch!
- ★ Volume and Squelch!

*Handset shown
actual size*

**Invented by Radio Shack
to give you one-hand
control for driving safety,
amazingly easy operation!**

A CB "first"—either-hand ONE HAND control of all functions. And the rest of the transceiver is so small you can hide it away under the dash or seat, even in the glovebox for theft protection. A high-quality, super-convenient radio in every detail. With all crystals for full 23-channel coverage. Built-in blander and ANL to chop out ignition-type noise. Ceramic filtering to cut station interference. Positive or negative ground. Jack for optional extra remote speaker. FCC Type Accepted, of course. Adjustable mounting bracket, power cable for any 12VDC vehicle included. Better hurry in for yours—everybody is going to want the One-Hander!
Ask for 21-161. **149⁹⁵***

TRC-61 Specifications

Sensitivity for 10 dB S+N/N: 0.5 microvolt
Selectivity at -6 dB: ±3 kilohertz
Adjacent Channel Rejection: 60 dB
RF Output: 4 watts maximum
Audio Output: Push-Pull, 4 watts maximum
Mixer: Dual C-MOS Field Effect Transistor
All Other Transistors: Silicon Type



The 1½x5¼x7" remote section is easily concealed. 3-way switch for its own built-in speaker, handset speaker, external speaker.

We've put the whole works in ONE hand. Even a red "LED" that lights up when the set is "on" and indicates the channel number. Coiled cord extends to 5 feet, gives you freedom of movement and lets you place the handset anywhere.

PATENTS PENDING

SOLD ONLY WHERE YOU SEE THIS SIGN:

Radio Shack®

A DIVISION OF TANDY CORPORATION
OVER 4600 STORES • 50 STATES • 9 COUNTRIES



Use Your Credit Card
at participating stores

Prices and Products May Vary in Canada.

* Retail Price May Vary at Individual Stores and Dealers.