

WHY EARTHQUAKES ARE COMING—AND SOON!

©  
**elementary**  
**Electronics**

SEPTEMBER-OCTOBER 75¢

**Our DX Devil Packs Real DX Dynamite**

- Works Anywhere
- Tunes Anything
- Delivers 40-dB Gain



**NOW—YOUR COMPLETE GUIDE TO TUNING THE CAPITALS OF THE WORLD!**

Build an Electronic Slide Rule  
• Touchomatic for the Touch that Tells

## CUT ANY MATERIAL with Naval Super-HACK Blades

As low as \$1.60 ea.

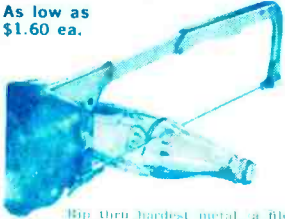

Naval Carbide Drill Bits for glass, steel, etc. in diam. 1/16" and 1/8" for \$9 and 1/4" \$16 ppd.

Chip thru hardest metal in files in less than 2 minutes. Cut even curves or notches in materials formerly considered un-sawable. Like glass, glazed tile, bricks, tool steel, marble. Very little effort. This famous cousin of the diamond, tungsten-tungsten carbide, now joins the old saw blade. Fits any hacksaw. Only \$2.79 for one blade, 3 for \$8.20, 6 at \$2 each (total \$12); 24 at \$4.60 each (total \$38.10). All postpaid.

**MEREDITH,**

Dept. EE-9, 310 West 9th St., KANSAS CITY, MO. 64105

## and now . . . NAVAL ROUND SAW

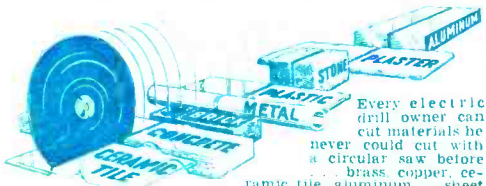

Every electric drill owner can cut materials he never could cut with a circular saw before—brass, copper, ceramic tile, aluminum, sheet metal, slate, stone, fiberglass, brick, cement.

Stainless and other steels, even a hardened file! NAVAL Round Saw has silicon carbide grains imbedded in an open weave nylon mesh. No sharp teeth grab the work and throw it back at user. And it is a sanding disc too! Use it to sand and shape all metals, wood, tile, glass, paint, rust, etc. This 7" disc comes complete with 5" rubber disc for sanding and shaping applications, a 1/2" shank arbor, 2 steel flanges and an excellent instruction sheet. Order NAVAL Round Saw . . . \$5 for one, 3 for \$4.50 ea. (total \$13.50) 6 @ \$4 ea. (total \$24) . . . 24 @ \$3.50 ea. (total \$84)



## COLONIAL SPIKE CANES

Hewn from a single log of jungle-hardened wood. Inside sheath a gleaming round spike. Like canes carried by British colonial gentlemen of Singapore and Mandalay. Collectors' items and soon not available.

- Uncarved \$16.95
- Carved \$17.95

(Carving is a Twining Dragon) we pay postage



## LIQUID PLASTIC

Polyurethane that applies like paint forms a skin so tough it won't crack, chip or peel. Cuts painting costs . . . covers and protects like a shield of unbreakable glass.

## WATERPROOF in 30 MINUTES

Adheres to practically anything, stops leaks. Ideal for concrete, aluminum, wood, masonry, canvas, any metal. Clear—any major color. Just specify. \$5.95 per qt., \$18.50 per gal. We pay all shipping costs. Order NAVAL 5.

MEREDITH SEPARATOR CO., Dept. EE-9, 310 West 9th St., Kansas City, Mo. 64105

- Ship as follows: Satisfaction Guaranteed:  Carbide Drills (specify diameter)  Super-Hack  1  3  6  Bugmasters as checked above  Round Saws as checked above  Air Guns  Air Gun Extras  Naval Jelly as checked above  Naval 5  QC  Gal.  Spike Canes  Carved  Uncarved

Name . . . . . Address . . . . .

City . . . . . State . . . . . Zip . . . . .

## \$50 REWARD



for Any Spider, Bug, Insect that Bugmaster Electric Units fail to kill. Here is your automatic, odorless electrical way to rid apartment, home, office or plant of disease carrying bugs, roaches, fleas, bedbugs, ants, moths, silverfish.



## KILL BUGS INDOORS

### THE INSTITUTIONAL WAY

- Model H—\$9.95 plus 75¢ p&h
- Xtra Crystals for H—75¢ per box
- Model G—\$15.95 plus \$1 p&h
- Xtra Crystals for G—\$1.50 per box
- Model H—6,000 cubic feet
- Model G—12,000 cubic feet

Pkg. Chlorophyll Odor Kill Crystals 75¢

When Ordering retail crystals only please add 40¢ post. & htlg.

**MEREDITH,** Dept. EE-9, 310 West 9th St., KANSAS CITY, MO. 64105

## \$70 AIR-GUN only \$29.95

Complete with chisel this 3 lb. Air-Gun rips into metal, chips concrete, drives nails, etc. It's 4½ lbs. 2½" strokes a minute. Operates on a 4 to 10 lb. compressor. Made especially for navy and manufacturer units too many. At only \$29.95 ppd. while they last, a \$70 value. Three extra attachments for exhaust pipe, extra and other uses. \$9.95 ppd.

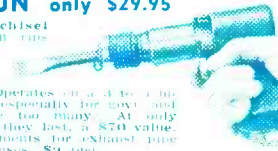

**MEREDITH,** Dept. EE-9, 310 West 9th St., KANSAS CITY, MO. 64105

## WATCH RUST DISAPPEAR

## NAVAL JELLY

is an extremely active new cleaner that removes rust by chemical combination . . . sticks to verticals and overheads. Brush it on, hose it off.

Use on pipes, fences, tools, tanks, all machinery. Eliminates sandblasting, scraping, etc. Easy and quick.

- 40 @ .65/lb. \$26
  - 10 @ 1.50/lb. \$15
  - 4 @ 2.00/lb. \$8.00
- =4 ppd.—other units FOB KC

**MEREDITH,** Dept. EE-9, 310 West 9th St., KANSAS CITY, MO. 64105



Cast your ballot for a successful future!

# 266 ICS COURSES



You get the widest choice from ICS —oldest, largest home study school. Check the list. (Also available, programs tailored to your special needs.) You receive individual instruction, plus success-proved facts

and theory you can apply immediately. Mastery of subject is assured. No skimping. You earn your diploma.

Why mark time when you can make the coupon and get a fast, sure fix on your best course to success.

**ACCOUNTING**  
Accounting (U.S.A.)  
Accounting (Canadian)  
Accounting for Business Programmers  
Accounting for Management Decisions  
Auditing  
Business Law (U.S.A.)  
Cost Accounting  
CPA Review (U.S.A.)  
General Accounting  
Income Tax (U.S.A.)  
Industrial Accounting  
Junior Accounting  
Office Accounting  
Practical Accounting  
Public Accounting  
Small Business Accounting (U.S.A.)  
Starting and Managing a Small Bookkeeping Service (U.S.A.)

**ARCHITECTURE AND BUILDING**  
Architectural Drawing and Designing  
Architecture  
Building Contractor  
Building Estimator  
Building Inspector  
Building Maintenance  
Carpenter-Builder  
Carpentry and Millwork  
Fundamentals of Urban Planning  
House Planning and Interior Design  
Mason  
Painting Contractor  
Reading Arch. Blueprints  
Review in Architecture  
Design and Practice  
Review of Mechanical Systems in Buildings

**ART**  
Amateur Artist  
Commercial Art  
Commercial Cartooning  
Illustrating with Options: —Magazine  
—Advertising Layout and Illustration  
Interior Decorating  
Oil Painting for Pleasure  
Show Card and Sign Production  
Show Card Writing  
Sign Painting and Design's Sketching and Painting

**AUTOMOTIVE**  
Automatic Transmission Specialist  
Automobile Body  
Rebuilding & Refinishing  
Automobile Elec. Tech'n  
Automobile Engine Tune-Up  
Automobile Mechanic  
Automobile Technician  
Diesel-Gas Motor Vehicle Engines  
**BUSINESS**  
Advertising  
Business Administration  
Business Practice (Cond.)  
Canadian Business Course  
Condensed Marketing  
Direct Mail and Mail Order Advertising  
Industrial Psychology  
Inventory Control  
Mag. & News'g'r Adv.  
Managing a Retail Business  
Managing a Small Store  
Marketing Management  
Marketing Research  
Modern Executive Mgmt.  
Office Automation  
Office Management  
Production Management  
Purchasing Agent  
Retail & Local Advertising  
Retail Bus. Management  
Retail Merchandising  
Retail Selling  
Systems and Procedures Analysis

**BUSINESS SALES**  
Creative Salesmanship  
Real Estate Salesmanship  
Salesmanship  
Sales Management  
**BUSINESS SUPERVISION**  
Basic Supervision  
Industrial Foremanship  
Industrial Supervision Management,  
Salesmanship and Sales  
Modern Woman as a Supervisor  
Personality Development  
Personnel-Labor Relations (U.S.A.)  
Supervision

**CHEMICAL**  
Chemical Engineering  
Analytical Chemistry  
Chemical Engineering Unit Operations

Chemical Laboratory Tech'n  
Chemical Process Operator  
Elements of Nuclear Energy  
General Chemistry  
Instrumental Laboratory Analysis  
**CIVIL ENGINEERING**  
Civil Engineering  
Construction Eng'g Tech.  
Highway Engineering Tech.  
Principles of Surveying  
Reading Highway Bl'pts  
Reading Structural Bl'pts  
Sanitary Engineering Tech.  
Sewage Plant Operator  
Structural Eng'g Tech.  
Surveying and Mapping  
Water Works Operator

**COLLEGE COURSES**  
American History  
Calculus  
Economics  
**COMPUTERS**  
COBOL Programming  
Fortran Programming for Engineers  
Programming for Digital Computers  
Programming the IBM 1401 Computer  
Programming the IBM System/360 Computer, Introduction

**DRAFTING**  
Architectural Drafting  
Architectural Drafting  
Design Drafting  
Drafting Technology  
Electrical Drafting  
Electrical Eng'g Drafting  
Electronic Drafting  
Introductory Mech. Drafting  
Mechanical Drafting  
Pressure-Vessel and Tank Print Reading  
Sheet Metal Layout for Air Conditioning  
Structural Drafting

**ELECTRICAL**  
Electrical Engineering —Electronics Option  
—Power Option  
Electrical Appliance Serv'g  
Electrical Appliance Serv'g with Equipment Training  
Electrical Contractor  
Electrical Eng'g Tech.  
Electrical Home Maint.

Electrical Home Maint. with Equipment Training  
Electrical Instrument Tech.  
Electric Motor Repairman  
Industrial Electrical Tech.  
Power-Line Design & Const.  
Power Plant Operator —Hydro Option  
—Steam Option  
Practical Electrician  
Practical Electrician with Equipment Training  
Practical Lineman  
Reading Electrical Bl'pts  
**ENGINEERING (Refresher Courses for Graduate Engineers)**  
Chemical Civil Electrical Industrial Mechanical Sanitary Structural

**ENGLISH AND BETTER WRITING**  
Better Business Writing  
English for Spanish (U.S.A.)  
Free Lance Writing for Fun and Profit  
Introductory Tech. Writing  
Modern Letter Writing  
Practical English  
Short Story Writing

**HIGH SCHOOL**  
High School Business  
High School (Canadian)  
High School General  
High School Mathematics  
High School Secretarial  
High School Vocational  
High School College Preparatory—Arts  
High School College Prep.—Eng'g and Science  
Preparatory Course for High School Equip. Tech

**MACHINE SHOP PRACTICE**  
Drill Operator  
Foundry Practice  
Industrial Metallurgy  
Lathe Operator  
Machine Shop Inspection  
Machine Shop Practice  
Metalurgical Eng'g Tech.  
Milling Machine Operator  
Multicraft Maint. Mech.  
Practical Millwright  
Reading Shop Prints  
Rigging  
Tool Engineering Tech.  
Tool Grinder Tool Making

Turret Lathe Operator  
Welding Engineering Tech.  
Welding Process  
**MATHEMATICS**  
Advanced Mathematics  
Math and Mechanics for Engineering Technicians  
Math and Physics for Engineering Technicians

**MECHANICAL**  
Mechanical Engineering  
Aircraft and Power Plant Mechanic  
Hydraulic & Pneu. Power  
Industrial Engineering  
Industrial Eng'g Tech.  
Industrial Instrumentation  
Machine Design  
Quality Control  
Safety Engineering Tech.  
Tool Design  
Vibration Analysis and Control

**PETROLEUM**  
Natural Gas Production and Transmission  
Oil Field Technology  
Petroleum Production  
Petroleum Production Engineering Technology  
Petroleum Refinery Oper.  
Pipeline Engineering Tech.

**PLASTICS**  
Design of Plastic Products  
Plastics Technican

**PLUMBING, HEATING AND AIR CONDITIONING**  
Air Conditioning  
Air Conditioning Maint.  
Domestic Heating with Gas and Oil  
Domestic Refrigeration Heating  
Heating & Air Conditioning with Drawing  
Industrial Air Conditioning  
Industrial Heating  
Pipe Fitting  
Plumbing  
Plumbing and Heating Est.  
Practical Plumbing with Equipment Training  
Refrigeration and Air Conditioning

**PULP AND PAPER**  
Paper Machine Operator  
Paper Making  
Pulp Mak'g  
Pulp & Paper Eng'g Tech.

**SECRETARIAL**  
Clerk-Typist  
Commercial Secretary, Engineering Secretary, Legal Secretary, Medical Secretary, Professional Secretary, Stenographic Typewriting

**STEAM AND DIESEL POWER**  
Boiler Inspector  
Industrial Building Eng'r  
Power Plant Engineering  
Stationary Diesel Engines  
Stationary Fireman  
Stationary Steam Eng'g

**TEXTILES**  
Carding and Spinning  
Dyeing and Finishing  
Loom Fixing  
Spinning  
Textile Designing  
Textile Mill Supervision  
Textile Technology  
Woolens and Weaving

**TRAFFIC**  
Motor Traffic Management  
Railway Rate Clerk  
Traffic Management

**TV-RADIO-ELECTRONICS**  
Color Television Principles and Servicing  
Electronics Instrumentation and Servo Fundamentals  
Electronics Technician  
First Class Radio-telephone License  
Fundamentals of Electronic Computers

General Electronics with Equipment Training  
HI-FI Stereo and Sound System Servicing  
Industrial Electronics Tech.  
Numerical Control Electronics and Maint.  
Practical Telephony  
Principles of Semiconductor Radio & TV Servicing with Equipment Training  
Second Class Radio-telephone License  
Sound Systems Specialist  
TV Servicing and Repair  
Telephony, Electronics, & Radio Communications

Clip coupon here . . . take your first step to real success! ICS, Scranton, Penna. 18515



INTERNATIONAL CORRESPONDENCE SCHOOLS Dept. N23346, Scranton, Penna. 18515

(In Hawaii: P.O. Box 418, Honolulu. Canadian residents mail to Scranton address—further service handled by ICS Canadian Ltd.)

Approved for veterans under the G.I. Bill.

Accredited member, National Home Study Council.

Convenient payment plan.

Special Canadian courses in French and English.

Special rates to members of the U.S. Armed Forces.

I'm interested in a program of independent study.

Send me, without cost, your booklet on the principles of success, your illustrated brochure on the ICS method, and your catalog for \_\_\_\_\_

(Print name of course. See list.)

Miss \_\_\_\_\_  
Mrs. \_\_\_\_\_  
Mr. \_\_\_\_\_

Age \_\_\_\_\_

Address \_\_\_\_\_

City \_\_\_\_\_

State \_\_\_\_\_

Zip Code \_\_\_\_\_

Occupation \_\_\_\_\_

Employed by \_\_\_\_\_

Working Hours \_\_\_\_\_ A.M. to \_\_\_\_\_ P.M.

ELEMENTARY ELECTRONICS is published bimonthly at \$4.00 per year, by Science & Mechanics Publishing Co., 229 Park Avenue South, New York, N.Y. 10003. Second class postage paid at New York, N.Y. and at additional mailing office. Copyright 1968 by Science and Mechanics Publishing Co.



# elementary Electronics

Dedicated to America's Electronics Hobbyists



### SWL CONSTRUCTION SPECIAL

41 DX Devil—a devilishly hot little preselector that puts pizzazz aplenty in most any shortwave receiver around!

### THREE CHEERS FOR DX:

18 DX Central Reporting



65 DX the Capitals of the World—our hot-off-the-press directory to the world's jumpiest metros and the frequencies you'll find them on

### FEATURES FRAMED FOR FUN



31 Forecast: Earthquakes—if you're planning a move, any planet but earth looks good

45 X Marks the Time—mini-electronics for master clocks

64 Homer Hackleby, Electronics Genius—pride went before his fall

69 The Weakest Link—how to handle your fuse drain

93 A Basic Course in Electricity and Electronics Part IV—Understanding Trans-

formers

### CONSTRUCTION PROJECTS



35 Computer Goes to Pot—e/e's all-electronic slide rule



49 Touchomatic—switch a kilowatt with a light touch

61 Wall Phone Wireless—Ma Bell shoulda thought of this one

81 Cigar Box Spark Coil—zaps an air gap with 25,000 volts!

### HAPPENINGS FAR & NEAR

30 Underground—cartoon page

38 When There Are Grey Skies—you're in for lethal lungfulls

56 Code 99—heartbeat of a hospital!

68 Booze by the Button—a device for the pause that refreshes

89 Computer Cuts Up . . . and howl—want to program a bikini?

91 Jump, Then Run for Your Life—a report on the action trail

### TIMELY TIPS ON TAP

76 We've Got Some Case—small package packs a lot

77 Stringing Out the Sound—CB and mowing lawns do go together!

86 Painting With Light—tricky way to show off your shack

### AS OUR LAB SEES IT

59 Knight KG-666 Inverter/Charger

### THE REGULARS

8 Random Noise—editorial chit-chat

12 Hey Look Me Over—

15 NewScan—electronics in the news

20 En Passant—chess column

22 e/e Etymology

24 Literature Library—info you can use

Cover Photo by Leonard Heick



Cover Highlights

### AUTHORS IN THIS ISSUE:

John W. Collins, Webb Garrison, Charles Getts, C. Hansen, Erik Horneman, Jorma Hyypia, Jim Kyle—K5JKX, Robert Levine, Marshall Lincoln—W7DQS, Clarence Massey, D. T. Monson, Edward A. Morris—WA2VUL, Jack Schmidt, Hartland B. Smith—W8VVD, Gary W. Towner, Art Trauffer, and the ELEMENTARY ELECTRONICS' Editorial Staff.

# F.C.C. COMMERCIAL OPERATOR LICENSE

## Training

is part of the Grantham

## A. S. E. E. DEGREE CURRICULUM

In today's world of electronics employment, an FCC license is important — sometimes essential — but it's not enough! Without further education, you can't make it to the top. Get your FCC license without fail, but don't stop there. To prepare for the best jobs, continue your electronics education and get your Associate Degree in Electronics.

This is good common sense for those who want to make more money in electronics. It also makes sense to prepare for your FCC license with the School that gives degree credit for your license training — and with the School that can then take you from the FCC license level to the Degree level.

The first two semesters of the Grantham degree curriculum prepare you for the first class FCC license and radar endorsement. These two semesters, in addition to other parts of the Grantham

This booklet  
**FREE!**

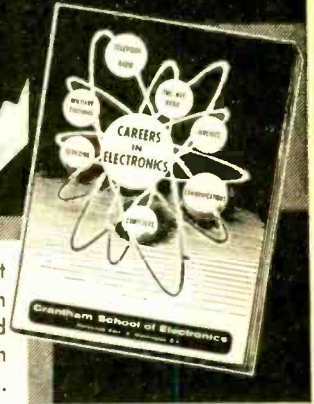

This free booklet explains what an FCC license and ASEE degree can do for your future.

degree curriculum, are available by correspondence\* at very reasonable tuition. *The ASEE Degree can be earned by correspondence with a minimum of one semester in residence.*

### Accreditation, and G.I. Bill Approval

Grantham School of Electronics is *accredited* by the Accrediting Commission of the National Home Study Council, and is *approved* for both correspondence and resident training under the G.I. Bill. Mail the coupon, or simply write or telephone for your free copy of our Associate Degree Bulletin which gives complete details of our educational program.



## GRANTHAM School of Electronics



\*Semesters 1, 2, and 3 of the Grantham electronics curriculum are available *also in resident classes* at our Washington, D.C. school — at the address shown below.

• Established in 1951 •

### Grantham School of Electronics

1505 N. Western Ave.  
Hollywood, Calif. 90027

or

818 18th Street, N.W.  
Washington, D.C. 20006

Telephone:  
(213) 469-7878

Telephone:  
(202) 298-7460

Grantham School of Electronics EE 9-68  
1505 N. Western Ave., Hollywood, Calif. 90027

Please mail me your free catalog, which explains how Grantham training can prepare me for my FCC License and Associate Degree in electronics. I understand no salesman will call.

Name \_\_\_\_\_ Age \_\_\_\_\_

Address \_\_\_\_\_

City \_\_\_\_\_ State \_\_\_\_\_ Zip \_\_\_\_\_

# Can't find the key to electronics?

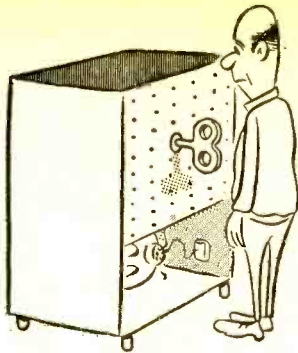

—then get your electronics cool with this introductory offer to the two leading electronics magazines! Use coupon:

DAVIS PUBLICATIONS, INC. EE-968  
 229 Park Ave. S./New York, N.Y. 10003

Yes! I want to find the key to electronics.

Begin my subscription to both RADIO-TV EXPERIMENTER and ELEMENTARY ELECTRONICS at your special low-subscription rate of \$7.00

Bill me later.       Check enclosed.

Name .....

Address .....

City ..... State ..... Zip .....

(Outside U.S.A. & Canada add \$1.50 pstge. & hndlg.)

—Now, both of these fine magazines will be delivered to you at the special subscription rate of just \$7.00 . . . save \$2 from newsstand price.



## ELEMENTARY ELECTRONICS

The magazine that serves up electronics theory in pleasant spoonfuls and reinforces the knowledge you gain with exciting and useful projects.

## RADIO-TV EXPERIMENTER

The magazine dedicated to the hobbyist—the man who wants to obtain a fuller and broader knowledge of electronics through the applications of his hobby.



# elementary Electronics

Sept./Oct. 1968

Vol. 7/No. 1

Dedicated to America's Electronics Experimenters

*Editor-in-Chief*

JULIAN M. SIENKIEWICZ  
 WA2CQL, KMD4313

*Managing Editor*

RICHARD A. FLANAGAN  
 KQD2566

*Technical Editor*

CLIFFORD L. FORBES  
 KBQ8535

*Art Editor*

JIM MEDLER

*News Editor*

HELEN PARKER  
 KQD7967

*Art Director*

ANTHONY MACCARRONE

*Cover Art Director*

IRVING BERNSTEIN

*Associate Art Director*

JOHN YUSKO

*Art Associate*

JACK GOLDEN

*Advertising Manager*

JIM CAPPELLO

*Production Manager*

CARL BARTEE

*Assistant Production Manager*

PAULA S. HELFANT

*Kit Division Manager*

WILFRED M. BROWN

*President and Publisher*

B. G. DAVIS

*Executive Vice-President and Assistant Publisher*

JOEL DAVIS

*Vice-President and Editorial Director*

HERB LEAVY, KMD4529

*Vice-President and Production Director*

LEONARD F. PINTO

*Vice-President and Treasurer*

VICTOR C. STABILE, KBP0681

ELEMENTARY ELECTRONICS (Vol. 7, No. 1) is published bi-monthly by Science & Mechanics Publishing Co., a subsidiary of Davis Publications, Inc. Editorial, business and subscription offices: 229 Park Avenue South, New York, N.Y. 10003. One-year subscription (six issues)—\$4.00; two-year subscription (12 issues)—\$7.00; and three-year subscription (18 issues)—\$10.00. Add \$1.00 per year for postage outside the U.S.A. and Canada. Advertising offices: New York, 229 Park Avenue South, 212-OR 3-1300; Chicago: 520 N. Michigan Ave., 312-527-0330; Los Angeles: J. E. Publishers' Rep. Co., 8380 Melrose Ave., 213-653-5841; Atlanta: Pirnie & Brown, 3108 Piedmont Rd., N.E., 404-233-6729; Long Island: Len Osten, 9 Garden Street, Great Neck, N.Y., 516-487-3305; Southwestern advertising representative: Jim Wright, 4 N. 8th. St., St. Louis, 314-CH-1-1965.

EDITORIAL CONTRIBUTIONS must be accompanied by return postage and will be handled with reasonable care; however, publisher assumes no responsibility for return or safety of manuscripts, art work, or photographs. All contributions should be addressed to the Editor, ELEMENTARY ELECTRONICS, 229 Park Avenue South, New York, N.Y. 10003.

Second-class postage paid at New York, New York and at additional mailing office. Copyright 1968 by Science and Mechanics Publishing Co.

ELEMENTARY ELECTRONICS

# Here's a new, complete ICS course in TV Servicing that costs less than \$100.

## With the first two texts, you can repair 70 percent of all TV troubles.

You need no previous experience to take this complete, practical course in TV Repairing.

You don't even have to know a vacuum tube from a resistor. Yet in a matter of months, you can be doing troubleshooting on color sets!

Course consists of 6 texts to bring you along quickly and easily. 936 pages of concise, easy-to-follow instruction, plus 329 detailed illustrations. You also receive a dictionary of TV terms geared directly to course material so you'll understand even the most technical terms.

Instruction is simple, very easy to grasp. Photos show you what a TV screen looks like when everything is normal, and what it looks like when trouble fouls it up. The texts tell you how to remedy the problem, and why that remedy is best.

Quizzes are spotted throughout the texts so you can check your progress. At the end of the course,

you take a final examination. Then you get the coveted ICS® diploma, plus membership in the ICS TV Repairman Association.

By the time you've finished the course, you should be able to handle tough, multiple TV problems, on color sets as well as black and white.

This new TV Servicing and Repair Course has been approved by National Electronic Associations for use in their Apprenticeship program. Because of its completeness, practicality and price, it is the talk of the industry. The cost is less than \$100—just slightly over ½ the price of any comparable course on the market today.

Remember, the sooner you get started on your course, the sooner you'll be turning your spare time into real money. Fill out the coupon and mail today. We'll rush you complete information at no obligation to you.

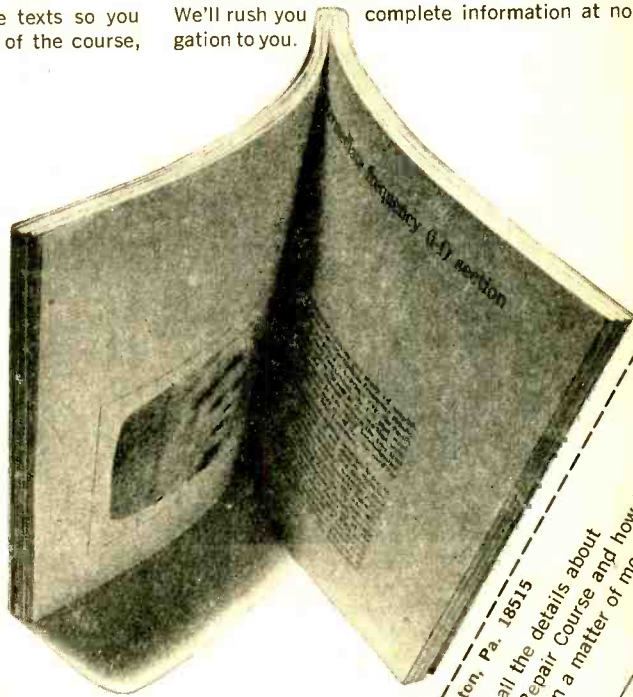

ICS, Dept. J9334G, Scranton, Pa. 18515

Yes, I would like to have all the details about your new TV Servicing/Repair Course and how I can break into TV work in a matter of months.

Name \_\_\_\_\_

Street \_\_\_\_\_

City \_\_\_\_\_

State \_\_\_\_\_

Zip \_\_\_\_\_

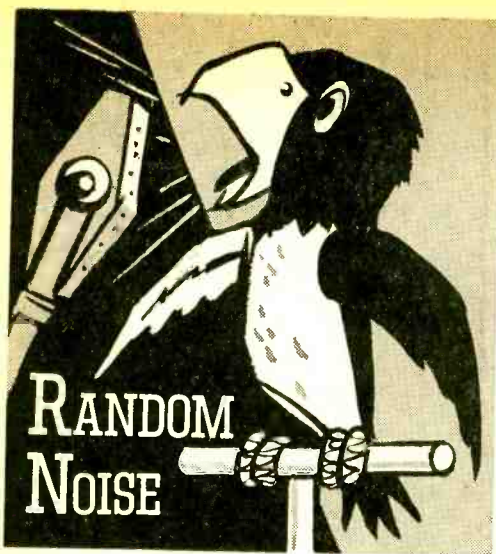

BY JULIAN M. SIENKIEWICZ, Editor

**T**here's nothing that'll take the devil out of a boy and his dog faster than our very own DX Devil—a one field-effect transistor short-wave booster his dad can put together in a weekend. Our cover boy is Gary Bulger, and the beagle is called Gladys; the glove is a Mickey Mantle model, and the ball is a used official American League horsehide fouled into the stands by Yogi Berra years ago. But that's enough chitchat; back to the DX Devil. It's a tunable shortwave preselector that'll add *mucho* poop to any SW rig such as the Heathkit GR-43 (a unit that also pulls in the BCB, FM, and long-wave bands) shown on our cover. Interested? Then discover and build our DX Devil for yourself—see page 41.



Here's Gary twisting the knob of the DX Devil which is connected to the Heathkit GR-43. This photo is very important to us since it's the first photo we've run in years to placate the dog lovers of America.

**4-Meg!** The American Radio Relay League, ARRL to most of the ham fraternity, has published its 4,000,000th copy of the *Radio Amateur's Handbook*. First published in 1926, the *Handbook* is among the top 25 all-time, non-fiction bestsellers on a recent list. It is the standard reference work, not only for hams, but for many electronic professionals as well. This Editor used the *Handbook* as a textbook when he learned his electronics many moons ago and still considers it an important part of his reference library. Why don't you get a copy? See your local ham or parts dealer, or check the pages of your favorite mail-order catalog.



Rosel H. Hyde (left), Chairman of the FCC, receives the four-millionth copy of the *Radio Amateur's Handbook* from Robert W. Denniston, President of the ARRL. Also present were Wayland M. Groves, ARRL First Vice President (left, background) and Everett Henry, Chief, Amateur and Citizens Radio Division, FCC.

**Computers Shoot Sevens!** Scientists "playing dice" with the structure of the earth have won the game at odds of about a million to one. Their results show that our planet's structure is very likely to be much more complex, and of different proportions, than most geophysicists have thought. Five million models of the earth were calculated by a computer; only six survived when tested against what is actually known about the earth.

That the earth has three main divisions—a central core, an intervening mantle, and a very thin crust—has been known for a long time. Fact is, it was some 300 years ago that Isaac Newton noted that the average density of the earth was five to six times that of water. Since the rocks on earth's crust are only about three times as dense as water, the case for heavier material inside was cinched. During the last 60 years, scientists have not only found layers within these divisions but have also learned to estimate the depths of these internal layers with increasing confidence. However, the computer models of the earth's structure indicate the previously assumed dimensions for the core and mantle, and the layers within them, could well be off by many miles.



Previously, all known earth models based on observation were founded on certain assumptions. Among them: a chemically homogeneous mantle below 600 miles, and a relationship between the velocities of earthquake waves and internal chemical composition based on laboratory test of minerals and rocks.

These assumptions are not necessarily true of the real earth, Dr. Frank Press of Massachusetts Institute of Technology believes, on the basis of the five million computer models. His calculations were made using what is known mathematically as the Monte Carlo method; that is, the various figures were fed into the computer on a completely random basis, as when dice are thrown, and the resulting mathematical model then tested to see how closely it resembled the real earth.

Of the six that passed this examination, all had a larger core than is usually assumed for the earth, with the outer, fluid core consistent with an alloy of iron and 15 to 25 percent silicon. The inner, solid core, Dr. Press believes.

(Continued on page 105)



Okay, okay! What's this doing in the middle of an electronics editorial column? This is tough to believe, my dear readers, but our pretty girl, Donna Wright, is modeling an electronic beach hat. The mod chapeau was designed by engineers at Motorola's semiconductor products division in sunny Phoenix. And therein lies the reason why it's decorated with hundreds of integrated circuits and transistors, used widely in computers, space equipment, automotive and consumer products. I don't know how the engineers will explain this to their wives, but company officials claim it was all in the line of duty.

# SHOPPING ART

Selection of products available by mail. Money-back guarantee. Order by Stock No. Send check or M.O.

## "SINGING CRYSTALS"—See May-June Feature Article



Do a crystallography project—illustrate with large beautiful crystals yourself. Study and demonstrate factors affecting growth, refraction, piezoelectric effect, symmetry, etc. Incl. book, "Crystals & Crystal Growing" plus generous supply of chemicals to grow 7 large display crystals (clear, purple, blue-green, green and red).

Stock No. 70.336EK

\$9.50 Ppd.

## TOP-QUALITY LOW-COST STROBE

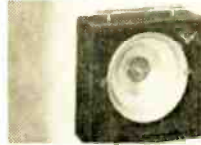

Create spectacular psychedelic lighting effects with this genuine electronic strobe. Terrific for parties, special occasions, experiments... perfect for combos, night clubs, dances, exhibitions. Adjusts from 1 to 10 short-duration flashes per second—not a make-shift mechanical device. Amaze friends with old-time movie effects. Best party ice-breaker ever—"freeze" the action and "freeze" your guests. Practical too—check action of moderate speed machinery. Xenon lamp gives one million flashes. 3 1/2" diam. reflector. Uses rec. 110-120 volt A.C. current. Handsome solid walnut cabinet, 9 1/2" x 9 1/2" by 4". Send for Bulletin #75—describes other startlingly new unique lighting effects.

Stock No. 70.989EK

\$79.95 Ppd.

## "FISH" WITH A MAGNET



Go treasure hunting on the bottom! Fascinating fun & sometimes profitable! Tie a line to our 5-lb. Magnet—drop it overboard in bay, river, lake or ocean. Trawl it along bottom—your "treasure" haul can be outboard motors, anchors, other metal valuables. 5-lb. Magnet is war surplus—Alnico V type—Gov't. cost \$50. Lifts over 120 lbs. on land—much greater weights under water.

Stock No. 70.571EK

\$12.50 Ppd.

## 23 ELECTRONIC PROJECTS in 1 KIT



Now easily build 23 fascinating electronic projects that really work including transistors, radio receivers, phono-amplifier, electronic organ, burglar alarm, flashing beacon etc. Complete, foolproof individual template for each model clearly shows parts to be used. Pencil-and-assembly. Fully illustrated step by step procedures. No soldering or tools required. Put it together—work

It—take it apart quickly and easily. Absolutely safe—uses inexpensive 9-V battery. Great fun—educational too.

Stock No. 70.904EK

\$27.95 Ppd.

STARTER KIT (Parts for 8 Projects)

Stock No. 70.903EK

\$17.95 Ppd.

## ROTATING MULTI-COLORED LIGHT



Dazzling colors stream endlessly from constantly rotating light. Faceted, transparent globe has louvered drum inside with red, green, blue & yellow stars. Bulb heat rotates drum which projects flickering star points on walls, ceilings, etc. while individual globe facets present constantly changing array of brilliant colors. 9 1/2" star—approx. 12" high on bell-shaped base. Surplus.

Inexp. light. Easily placed on table, TV, fireplace, or Xmas tree top.

Stock No. 71.000EK

\$6.00 Ppd.

## FLY 9-FT. HOT AIR BALLOON



9 Ft. tall. Rises to amazing heights on just hot air. Supplied with burner attached, so can be used over and over. Easy to make, launch, fly. Loads of fun. Great for celebrations, science fairs, plain fun. Will lift model gliders, parachutes, instruments, etc.—anything up to 1/2 lb. Approx. 3 ft. diam. when fully inflated. Kit contains 10 pre-cut red & white gores (No. 1 model paper), 6 ft.

Stock No. 60.691EK

\$2.00 Ppd.



## MAIL COUPON FOR FREE CATALOG

148 PAGES! 1000'S OF UNUSUAL BARGAINS! Completely new 1968 edition. New items, categories, illustrations. 148 pages-to-read packed with nearly 4000 unusual bargains. Dozens of electrical and electromagnetic parts, accessories. Enormous selection of Astronomical Telescopes.

SEND FOR FREE CATALOG "EK"

NAME \_\_\_\_\_  
ADDRESS \_\_\_\_\_  
CITY \_\_\_\_\_ STATE \_\_\_\_\_ ZIP \_\_\_\_\_

ORDER BY STOCK NUMBER • SEND CHECK OR MONEY ORDER • MONEY-BACK GUARANTEE  
**EDMUND SCIENTIFIC CO.** 300 EDCORP BUILDING  
BARRINGTON, NEW JERSEY 08007

# Look What's New



**NEW**

Kit  
IT-18  
\$24.95

**NEW**

Kit  
IP-18  
\$19.95



**NEW**

Kit  
IO-17  
\$79.95



**NEW**

Kit  
IM-17  
\$21.95

**NEW**

System Kit  
GD-47  
\$219.95

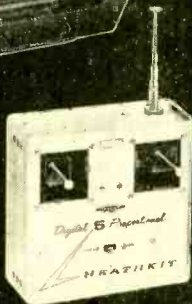

## NEW HEATHKIT In-Circuit Transistor Tester

At last, a realistic price for in-circuit testing of transistors! The new Heathkit IT-18 Tester has the facilities you need and it costs a lot less. It measures DC Beta in-or-out-of-circuit in 2 ranges from 2 to 1000 (the spec. commonly used by mftrs. and schematics to determine transistor gain). It tests diodes in-or-out-of-circuit for forward and reverse current to indicate opens or shorts. Measures transistors out-of-circuit for ICEO and ICBO leakage on leakage current scale of 0 to 5,000 uA. Identifies NPN or PNP devices, anode and cathode of unmarked diodes; matches transistors of the same type or opposite types. Cannot damage device or circuit even if connected incorrectly. Big 4½" 200 uA meter. 10-turn calibrate control. Completely portable, powered by "D" cell (long battery life). Front panel socket for lower power devices. Attached 3' test leads. Rugged polypropylene case with attached cover. Build in 2 hours. 4 lbs.

## NEW HEATHKIT 1-15 VDC Regulated Power Supply

Labs, service shops, hams, home experimenters . . . anybody working with transistor circuitry can use this handy new Heathkit All-Silicon Transistor Power Supply. Voltage regulated (less than 40 mV variation no-load to full-load; less than 0.05% change in output with input change from 105-125 VAC). Current limiting; adjustable from 10-500 mA. Ripple and noise less than 0.1 mV. Transient response 25 uS. Output impedance 0.5 ohm or less to 100 kHz. AC or DC programming (3 mA driving current on DC). Circuit board construction. Operates 105-125 or 210-250 VAC, 50/60 Hz. 6 lbs.

## NEW HEATHKIT Low-Cost 5 MHz 3" Scope

Here is the wideband response, extra sensitivity and utility you need, all at low cost. The Heathkit IO-17 features vertical response of 5 Hz to 5 MHz; 30 mv Peak-to-Peak sensitivity; vertical gain control with pull-out X50 attenuator; front panel 1 volt Peak-to-Peak reference voltage; horizontal sweep from internal generator, 60 Hz line, or external source; wide range automatic sync; plastic graticule with 4 major vertical divisions & 6 major horizontal; front mounted controls; completely nickel-alloy shielded 3" CRT; solid-state high & low voltage power supplies for 115/230 VAC, 50-60 Hz; Zener diode regulators minimize trace bounce from line voltage variations; new professional Heath instrument styling with removable cabinet shells; beige & black color; just 9½" H. x 5½" W. x 14½" L.; circuit board construction, shipping wt. 17 lbs.

## NEW HEATHKIT Solid-State Portable Volt-Ohm Meter

There's never been a better buy in meters. Solid-state circuit has FET input, 4 silicon transistors (2 used as diodes), and 1 silicon diode. 11 megohm input on DC, 1 megohm on AC. 4 DC volt ranges, 0-1000 v, with ±3% accuracy; 4 AC volt ranges, 0-1000 v, with ±5% accuracy. 4 resistance ranges, 10 ohms center scale x1, x100, x10K, x1M, measures from 0.1 ohm to 1000 megohms. 4½", 200 uA meter with multicolored scales. Operates on "C" cell and 8.4 v. mercury cell (not included). Housed in rugged black polypropylene case with molded-in cover and handle and plenty of space for the three built-in test leads. An extra jack is provided for connecting accessory probes to extend basic ranges. Controls include zero-adjust, ohms-adjust, DC polarity reversing switch, continuous rotation 12-position function switch. Easy-to-build circuit board construction completes in 3-4 hours. 4 lbs.

## NEW HEATHKIT/Kraft 5-Channel Digital

### Proportional System with Variable Capacitor Servos

This Heathkit version of the internationally famous Kraft system saves you over \$200. The system includes solid-state transmitter with built-in charger and rechargeable battery, solid-state receiver, receiver rechargeable battery, four variable capacitor servos, and all cables. Servos feature sealed variable capacitor feedback to eliminate failure due to dirty contacts, vibration, etc.; three outputs; two linear shafts travel ¾" in simultaneous opposite directions plus rotary wheel. Specify freq.: 26.995, 27.045, 27.095, 27.145, 27.195 MHz.

# From Heath

## NEW HEATHKIT AJ-15 Deluxe Stereo Tuner

For the man who already owns a fine stereo amplifier, and in response to many requests, Heath now offers the superb FM stereo tuner section of the renowned AR-15 receiver as a separate unit. The new AJ-15 FM Stereo Tuner has the exclusive design FET FM tuner for remarkable sensitivity, the exclusive Crystal Filters in the IF strip for perfect response curve and no alignment; Integrated Circuits in the IF for high gain, best limiting; elaborate Noise-Operated Squelch; Stereo-Threshold Switch; Stereo-Only Switch; Adjustable Multiplex Phase, two Tuning Meters; two variable output Stereo Phone jacks; one pair variable outputs plus two fixed outputs for amps, recorders, etc.; front panel mounted controls; "Black Magic" panel lighting; 120/240 VAC operation. 18 lbs. \*Walnut cabinet AE-18, \$199.95.

## NEW HEATHKIT AA-15 Deluxe Stereo Amplifier

For the man who already owns a fine stereo tuner, Heath now offers the famous amplifier section of the AR-15 receiver as a separate unit. The new AA-15 Stereo Amplifier has the same superb features: 150 watts Music Power; Ultra-Low Harmonic & IM Distortion (less than 0.5% at full output); Ultra-Wide Frequency Response ( $\pm 1$  dB, 8 to 40,000 Hz at 1 watt); Ultra-Wide Dynamic Range Preamp (98 dB); Tone-Flat Switch; Front Panel Input Level Controls; Transformerless Amplifier; Capacitor Coupled Outputs; Massive Power Supply; All-Silicon Transistor Circuit; Positive Circuit Protection; "Black Magic" Panel Lighting; new second system Remote Speaker Switch; 120/240 VAC. 26 lbs. \*Walnut cabinet AE-18, \$199.95.

## NEW HEATHKIT 2-Meter AM Amateur Transceiver

2-Meters at low cost. And the HW-17 Transceiver has 143.2 to 148.2 MHz extended coverage to include MARS, CAP, and Coast Guard Auxiliary operation. Output power of tube-type transmitter is 8 to 10 watts, AM. 4 crystal sockets plus VFO input. Relayless PTT operation. Double conversion solid-state superhet. Receiver has 1  $\mu$ V sensitivity with prebuilt, aligned FET tuner. ANL, Squelch, "Spot" function, and lighted dial. Signal-strength/relative power-output meter. Battery saver switch for low current drain during receiving only. 15 transistor, 18 diode, 3 tube circuit on two boards builds in about 20 hours. Built-in 120/240 VAC, 50-60 Hz power supply and 3" x 5" speaker; low profile aluminum cabinet in Heath gray-green, ceramic mic. and gimbals mount included. 17 lbs. \*Optional DC mobile supply, HWA-17-1, \$24.95.

## NEW HEATHKIT Home Protection System

Customize your own system with these new Heathkit units to guard the safety of your home and family. Warns of smoke, fire, intruders, freezing, cooling, thawing, pressure, water, almost any change you want to be warned about. Your house is already wired for this system, just plug units into AC outlets. Exclusive "loading" design of transmitters generates unusual signal which is detected by the Receiver/Alarm. Solid-state circuitry with fail-safe features warns if components of system have failed. Any number of units may be used in system. Receiver/Alarm has built-in 2800 Hz alarm and rechargeable battery to signal if power line fails (built-in charger keeps battery in peak condition). Receiver accepts external 117 VAC bells or horns. Smoke/Heat Detector-Transmitter senses smoke and 133°F. heat (extra heat sensors may be added to it). Utility Transmitter has several contacts to accept any type switch or thermostat to guard against any hazard except smoke. All units feature circuit board construction and each builds in 3-4 hours. All are small and finished in beige and brown velvet finish. Operating cost similar to that of electric clocks. Invest in safety now with this unique new low-cost Heathkit system.

NOW, THE TUNER AND AMPLIFIER OF THE FAMOUS HEATH AR-15 RECEIVER ARE AVAILABLE AS SEPARATE COMPONENTS

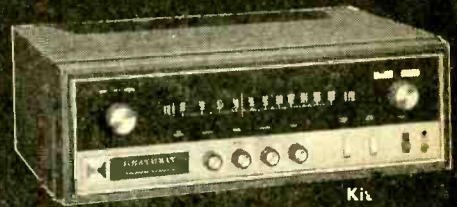

Kit  
AJ-15  
**NEW**  
\$189.95\*



Kit  
AA-15  
**NEW**  
\$169.95\*



Kit  
HW-17  
**NEW**  
\$129.95\*



GD-77  
Receiver /  
Alarm  
**\$39.95\***



GD-87  
Smoke/Heat  
Detector-  
Transmitter  
**\$49.95**



GD-97  
Utility  
Transmitter  
**\$34.95**



**NEW**  
**FREE 1968 CATALOG!**  
Now with more kits, more color. Fully describes these along with over 300 kits for stereo/hi-fi, color TV, electronic organs, electric guitar & amplifier, amateur radio, marine, educational, CB, home & hobby. Mail coupon or write Heath Company, Benton Harbor, Michigan 49022.

HEATH COMPANY, Dept. 139-9  
Benton Harbor, Michigan 49022  
In Canada, Daystrom Ltd.

Enclosed is \$ \_\_\_\_\_ plus shipping.

Please send model (s)  
 Please send FREE Heathkit Catalog.  
 Please send Credit Application.

Name \_\_\_\_\_

Address \_\_\_\_\_

City \_\_\_\_\_

State \_\_\_\_\_

Zip \_\_\_\_\_

Prices & specifications subject to change without notice.

CL-328R



### Versatilize Your Car Radio

With the aid of this lil' converter, model 191 from Mobilefone, you can receive police and fire calls, aircraft, business radio, utilities, taxicabs, etc., all on your car radio. Solid-state design, crystal control, 1 MHz band spread by tuning broadcast receiver. The 191 operates

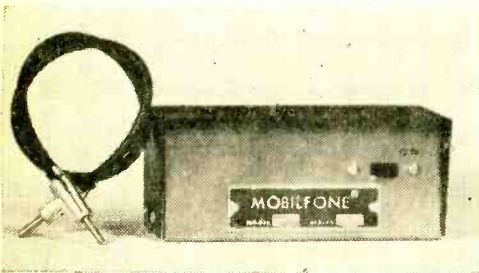

Mobilefone Model 191 RF Converter

directly from a 12-volt car battery, and new improved circuitry reduces noise level. The frequency range is 25-175 MHz. The easy-to-mount case measures only 5 x 2¼ x 2¼ in., the finish is black wrinkle and gold. Weighs 1 lb., price \$39.95. Write for more specs to Mobilefone, Box 1132, Anderson, Ind. 46015.

### Men of Parts, Organize!

Here's a beautiful portable tool and small parts storage/organizer, called the Tool-Mate. Taking only a minute to assemble, its overall dimensions are 11½ x 14 x 7 in. Molded of high-impact styrene, the Tool-Mate provides 39 different tool-holding slots for screwdrivers, wrenches, pliers, etc., as well as two jumbo storage bins (2¼ x 6¾ x 5¾ in.). Also, there are four dust-free drawers, 1¼ x 2¾ x 5¾ in. The carrying handle is guaranteed not to break.

Really a place for everything and all this for only \$4.98. Available at local 5-&-Dimes and hardware stores. For additional information, write Akro-Mils, Inc., Box 989, Akron, Ohio 44309.

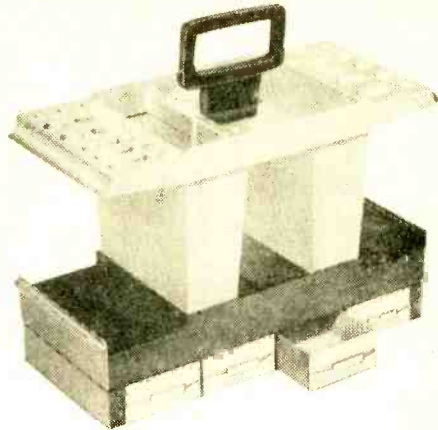

Akro-Mils, Inc. Tool-Mate

### Painless Eavesdropping

With the T-1110 Phone Monitor you can hear both sides of a telephone conversation without the need for getting another extension phone or for interfering with the call. Unit is completely self-contained, with no physical connection to the telephone, and is supplied with an earphone for listening. Powered by long-life 9-volt battery (supplied), the Kalimar-Tronics T-1110 retails at \$7.95 complete. If you want to know more, write to Kalimar-Tronics, Inc., 2644 Michigan Ave., St. Louis, Mo. 63118.

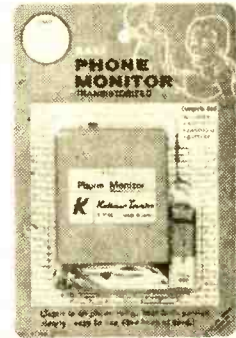

### Bargain Alignment Facility

All you servicemen will be happy to hear that Heath has come out with a post marker generator kit for only \$99.95. The IG-14 is solid-state, crystal-controlled and will give fast, accurate color and FM alignment. The IG-14 has 15 switch-selected crystal-controlled markers; all controls and switches are up front. With trace and marker amplitude controls you can use a regular scope, and stage by stage alignment is easier. With its input and output connections you can use it with any sweep generator and scope, and it also has an external marker input. BNC connectors are used throughout. Markers are injected after the sweep signal passes through the set being tested, thereby eliminating the scope trace distortion usually

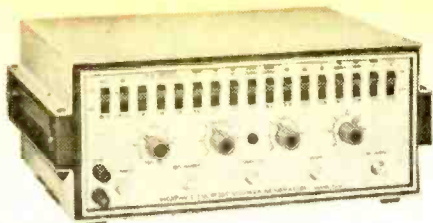

Heathkit IG-14 Post Marker Generator Kit

found when injection or absorption type marker generators are used. The variable bias supply, 0 to 15 VDC @ 10 milliamps, is isolated from the chassis so either positive or negative bias can be used. Four marker frequencies are provided for setting color bandpass, one marker for TV sound, eight at the IF frequencies between 39.75 and 47.25 MHz, and markers for channel 4 and 10 picture and sound carriers for checking tuner RF response. For FM there are visible markers at the 10.7 MHz center frequency plus 100 kHz markers on each side. The stackable cabinet is finished in beige and black, and everything except the front panel switches and controls mount on two circuit boards, even the crystals. More info? Write Heath Co., Benton Harbor, Mich. 49023.

### Paint-Up Time in the Ole Shack

When you do that Fall Cleaning and Painting in your shack that you put off from last spring, here's an ingenious aid. The Princess Rolo-Matic is a self-feeding paint roller that eliminates the roller pan, the drip, the general mess. The Rolo-Matic can also be used for waxing, wall and ceiling cleaning, and washing windows. Its greatest feature is that the liquid saturates the roller from the inside, not the

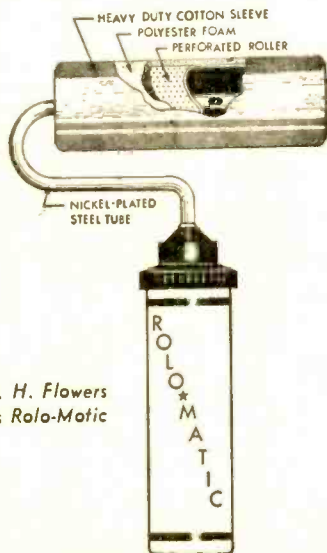

M. H. Flowers  
Princess Rolo-Matic

# compact sets

## SPEED DRIVING OF BRISTOL AND ALLEN HEX TYPE SCREWS



No. 99PS-60  
Bristol Multiple Spline Type  
Screwdriver Set

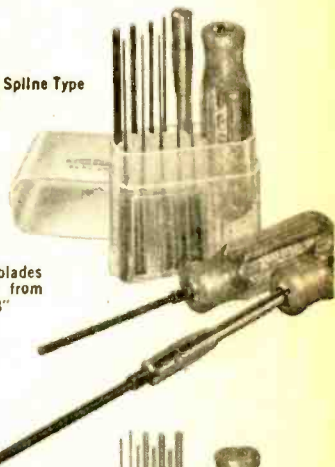

4 and 6-flute blades  
with diameters from  
.048" thru .183"



No. 99PS-40 Allen Hex  
Type Screwdriver Set

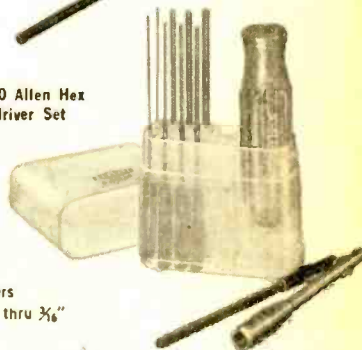

Hex diameters  
from .050" thru  $\frac{3}{16}$ "

Compact, interchangeable blade, Xcelite sets permit quick selection of the right tool for the job. With greater reach than conventional keys, these handy blade and handle combinations make it easier to get at deep set or awkwardly placed socket screws, simplify close quarter work.

Each set contains 9 precision formed, alloy steel, 4" blades; 4" extension; shockproof, breakproof, amber plastic (UL) handle with exclusive, positive locking device.

Sturdy, see-thru plastic cases fit pocket, have flat bases for use as bench stands.

# XCELITE

XCELITE INC. • 80 BANK ST., ORCHARD PARK, N. Y.  
Send Bulletin N365 on 99PS-60 and 99PS-40 sets.

name \_\_\_\_\_  
address \_\_\_\_\_  
city \_\_\_\_\_ state & zone \_\_\_\_\_

## HEY, LOOK ME OVER

outside. For \$2.98 you can own this time and strain saver by writing to M. H. Flowers & Associates, 1573 Mesquite, Wichita Falls, Tex. 76302.

## Be the Flash of the Party

Bend your guests' minds with the Mini-Strobe, a slim unit that plugs into any 110 AC outlet. An adjusting knob can create many psychedelic or slow-motion movie effects. The flash rate can be varied from 1 to 10 cycles per second. In a solid walnut cabinet, the Mini-Strobe weighs only 3½ lbs., with a 6-in. aluminum reflector. The price is \$79.95 and it comes from CosCo Research, Inc., Dept. DP, 3524 N. Tejon St., Colorado Springs, Colo. 80907.



CosCo Research Mini-Strobe

## Fuzz Finder

This good-looking set is the Kaar QJ75, an all solid-state FM monitor receiver operable on up to six crystal-controlled channels within any 1 MHz segment of its 137.5-174 MHz frequency range. You can run it from a 12-VDC or 115/230-VAC source and it may be mounted under the dash for mobile use or on a table top or shelf at fixed locations. The QJ75 can be used for monitoring public safety, industrial,



Kaar Model QJ75 FM Monitor Receiver

land transportation and marine communications as well as for receiving U.S. Weather Bureau broadcasts on 162.55 MHz. With a single channel the QJ75 is \$350.00, with each additional channel approximately \$20.00. For full details write to Kaar Electronics Corp., 1203 St. Georges Ave. W., Linden, N.J. 07036.

## Hobbyists, Get HEP!

Motorola has come to the aid of experimenters with an integrated circuit kit containing five popular integrated circuits. The devices in the kit include two dual 2-input gates and one each J-K flip flop, dual buffer, and 4-input gate. Also, the kit includes a booklet on the theory and use of ICs; eight integrated circuit projects for the experimenter and an IC cross-reference guide.

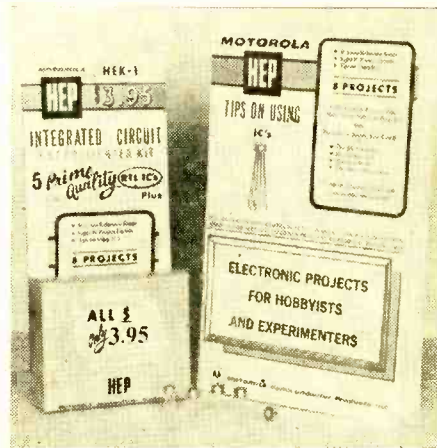

Motorola HEP-1 IC Experimenter Kit

Some of the enticing projects outlined in the booklet are an audio signal generator, ultra-high gain amplifier, 4-input mixer, precision tachometer, sine-square wave converter, miniature RF probe, electronic siren, and frequency standard. The whole kaboodle is only \$3.95—available at Motorola distributors, or write to Motorola's HEP Div., PO Box 955, Phoenix, Ariz. 85001.

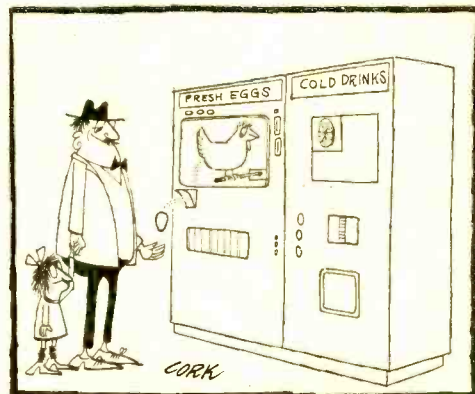



### Mini Color

The engineers at Ampex Corporation have come up with a color broadcast television camera that's approximately one-third the weight and two-thirds the cost of conventional models and designed for both studio and remote. The new Ampex camera weighs less than 50 pounds with viewfinder compared to more than 150 pounds for standard studio color cameras. It costs approximately \$50,000, well below the



*New Ampex color broadcast television camera features easy-to-handle lightweight camera cable that permits greater maneuverability by cameraman than ever before possible with a studio color camera. Camera can be operated on 3,000 feet of lightweight cable weighing just 375 pounds, compared with 1.5 tons for a similar length of conventional color camera cable.*

*These great minds were Rosicrucians . . .*

Francis Bacon Benjamin Franklin Isaac Newton

## WHAT SECRET POWER DID THEY POSSESS?

### *Why were these men great?*

How does anyone—man or woman—achieve greatness? Is it not by mastery of the powers within ourselves?

Know the mysterious world within you! Attune yourself to the wisdom of the ages! Grasp the inner power of your mind! Learn the secrets of a full and peaceful life!

Benjamin Franklin, statesman and inventor . . . Isaac Newton, discoverer of the Law of Gravitation . . . Francis Bacon, philosopher and scientist . . . like many other learned and great men and women . . . were Rosicrucians. The Rosicrucians (NOT a religious organization) have been in existence for centuries. Today, headquarters of the Rosicrucians send over seven million pieces of mail annually to all parts of the world. Address: Scribe N.H.Z.

**THIS BOOK FREE**

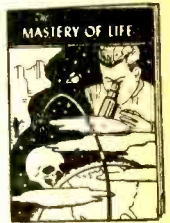

## The ROSICRUCIANS

San Jose (AMORC) California, 95114, U.S.A.

### SEND THIS COUPON

Scribe N.H.Z.  
The ROSICRUCIANS  
(AMORC)

Please Include  
Your Zip Code

San Jose, California, 95114 U.S.A.

Please send me the *free* book, *The Mastery of Life*, which explains how I may learn to use my faculties and powers of mind.

Name \_\_\_\_\_

Address \_\_\_\_\_

City \_\_\_\_\_

State \_\_\_\_\_ Zip Code \_\_\_\_\_

## NEWSCAN

\$75,000 average of studio color cameras now in use. It produces pictures equal to or better than larger studio cameras. It may be set up faster and operated easier because of its small size and two-tube design, and it offers complete picture stability for 12 operating hours without readjustment.

Because of its small size and miniature, light-weight cable, it will add flexibility to multi-camera productions and remote pickups of networks, television stations and commercial production houses. Because of its quality, it will be an ideal first camera for those broadcasters going to color.

The dramatic reduction in camera size is made possible by the use of just two television tubes. Standard cameras use either three or four tubes. In addition, the camera makes maximum use of integrated circuits and contains a minimum of circuit redundancy. The new Ampex design permits the use of approximately one-half the electronics of conventional color cameras.

### Astro Ward

The Apollo program now has a mobile quarantine unit which will be used to house returning lunar flight crews. Consisting primarily of a specially modified aluminum trailer with an interconnecting tunnel, the isolation unit is one of four which has been ordered by the NASA. Need for such specialized equipment results from unknown aspects of the lunar surface materials which astronauts will collect and return to earth for study and inspection.

The special quarantine trailer will house crew members and support personnel while in transit to the Lunar Receiving Laboratory in Houston. Immediately following splashdown, astronauts will exit from the command module (space capsule) and enter the isolation compartment through an air tight plastic tunnel.

*Illustration shows the mobile quarantine facility made by Melpar, Inc., which will be used to biologically isolate the transport returning Apollo astronauts. Lunar crew members will exit from the command module, left, directly into the trailer unit through the air tight connecting tunnel.*

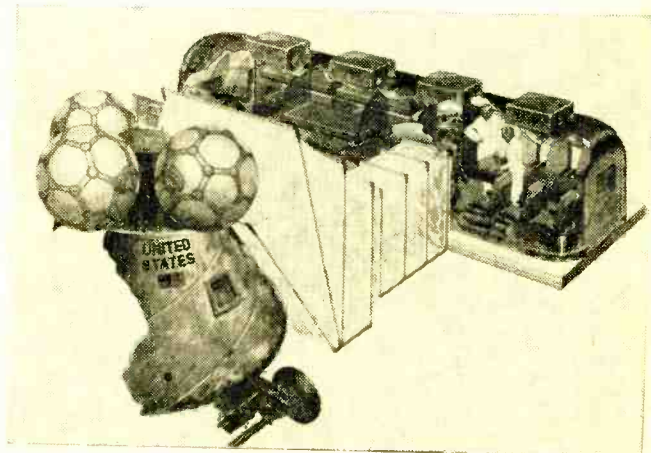

The trailer shell is fabricated of heat-treated aluminum which has been constructed to ensure an air and watertight condition. It is approximately 35 feet long and weighs less than 10,000 lbs. when fully occupied. The entire unit is pallet-mounted for air transportation and comes equipped with a single hoisting sling for placement aboard ship or flat bed truck.

### Booze Hounds, Watch Out!

A portable alcohol detector, only a little larger than a shoe-box and as accurate as present clinical tests, may soon be in the hands of our police. A battery-operated demonstration unit has been built by General Electric for showing to interested law enforcement agencies.

Called the "Infrared Intoxograph," the unit has a number of advantages over conventional blood, breath, and urine analyses. Since the device is small and self-powered, it can be carried in a patrol car so a police officer can test a suspected drunken driver at the point of arrest, rather than at a police station or hospital. The test requires less than five minutes.

The Intoxograph is easy to operate and a police officer can be completely trained in its use in less than an hour. Accuracy of analysis does not depend on the skill of the officer. A permanent recording of the analysis, like those produced by radar speed instruments, is made which can be used later as court evidence.

The Intoxograph is based on the technique of infrared spectroscopy; no chemicals are used in the detection process. Preliminary tests of the Intoxograph at an electronics laboratory have shown that it is as accurate as any of the clinical tests now accepted as court evidence in cases of intoxication.

Most of the alcohol detection techniques currently used by law enforcement agencies cannot distinguish between ethanol, which is the type of alcohol common to all alcoholic beverages, and acetone, which is a chemical produced in the body of a diabetic person prior to a coma. The Intoxograph detects only ethanol and there-





General Electric's Electronics Laboratory new portable device measures precisely the amount of alcohol in a person's system by analysis of his breath. By testing suspected drunken drivers at the point of arrest, the time spent by a police officer with a drunken driver can be cut from three hours to 45 minutes or less.

fore cannot confuse a diabetic with an intoxicated person.

The principal advantage of the new device is the amount of time that can be saved by a police officer in the handling of a suspected drunken driver. On the average, an officer spends three hours or more from the time he apprehends a suspect until the suspect is finally booked or released. Discussions with various law enforcement agencies indicate that this time could be cut to 45 minutes or less by using the Intoxograph.

### Look, Ma, I'm on TV!

A community antenna television system was recently employed in the Alice, Texas, public schools to record special teaching methods for use in a teacher's workshop. As a public service, the CATV system was asked to tape 10 separate classroom activities to emphasize spe-



Fred Dowdy, system manager, is shown operating the television camera while the teacher, Mrs. Margaret Salazar, directs her students at the Saenz Elementary School in a creative writing project.

# Olson



\* **FREE**

\*

Fill in coupon for a **FREE** One Year Subscription to **OLSON ELECTRONICS'** Fantastic Value Packed Catalog—Unheard of **LOW, LOW PRICES** on Brand Name Speakers, Changers, Tubes, Tools, Stereo Amps, Tuners, CB, and other Values. Credit plan available.

NAME \_\_\_\_\_

ADDRESS \_\_\_\_\_

CITY \_\_\_\_\_ STATE \_\_\_\_\_

GIVE ZIP CODE \_\_\_\_\_

If you have a friend interested in electronics send his name and address for a **FREE** subscription also.

## OLSON ELECTRONICS

INCORPORATED

942 S. Forge Street Akron, Ohio 44308

Seen any



## flying saucers lately?

Thousands claim they have and hundreds of eye-witness reports, plus the most complete directory of sightings ever published, appear in the fascinating pages of this Official Guide to UFOs. Pick up a copy at your newsstand or send \$1 to include postage and handling to Official Guide to UFOs, Dept. EE-968, 229 Park Ave. South, N. Y., N. Y. 10003.

**TUBES!**

FREE Send For  
**CORNELL'S**  
New 1968  
**CATALOG**  
Many New Items



30¢

per tube \*

**TUBES!**

33¢ per tube

WE SELL  
PICTURE  
TUBES

42 19 E. UNIVERSITY AVE., SAN DIEGO, CALIF. 92105

## NEWSCAN

sific teaching objectives. The classroom activities were planned, rehearsed and finally taped. The edited tapes were shown later at a teacher's workshop and proved to be invaluable in aiding the teachers to reevaluate their classroom methods.

Alice Cable Television, operator of the CATV system for Jerrold Electronics Corporation, also plans a secondary use of the tapes. The company, with the cooperation of the school board, will run the tapes on its system in a special program for subscribers.

In a continuing program of cooperation with the local schools, Jerrold also has agreed to assist the public schools in McAllen, Texas, by running a cable directly into the classrooms. The schools will be able to originate their own programs for distribution over CATV system.

## They Don't Need Ice Cubes

Polar pack ice, one of the most unforgiving environments on Earth, has dealt harshly with intruders since man first attempted organized polar exploration in the 16th century. To this day, only one party has reached the North Pole by overland travel and lived to report it; and no man has done it since Admiral Robert Peary's dogsled ordeal in 1909. Six adventurers (five Minnesotans and one Canadian) from various walks of life failed last year after 52 rugged days. They learned from their mistakes.

In their second attempt to become the first  
*(Continued on page 105)*



Thermoelectric generator, here at winter training camp of Plaisted Polar Expedition in northern Minnesota, will be lone sentinel for vital fuel cache 200 miles from the North Pole. Beacon on top "beeps" continuously to guide aircraft to fuel needed for planes and snowmobiles. Deputy leader Donald E. Powellek is expedition's radio and electronics expert.

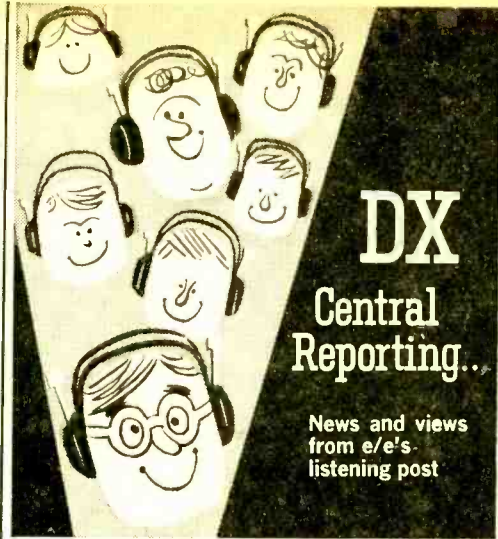

## More Fallen Giants

Last issue we talked about some former powers in international broadcasting. But, through the years another kind of SW giant has held sway in Latin America. In most of these republics, whichever group that happens to be in power operates at least one potent transmitter on the international SW bands. When that group is overthrown, the giant is slain, sometimes a kW at a time and then eventually replaced by another equally powerful voice.

Broadcasting in the Dominican Republic, for example, closely follows this pattern. Throughout the 50s La Voz Dominicana, owned and operated by the Trujillo family, was widely heard by SWLs on 31 meters. In 1960 as the regime became more ambitious and aggressive, a second outlet, R. Caribe, appeared on the scene. When the regime was overthrown, La Voz Dominicana was merged with R. Caribe which later became R. TV Santo Domingo (HISD). Also, with Trujillo's overthrow, the name of the capitol city has been switched back



QSL card from former Latin powerhouse La Voz Dominicana which has now become R. Quisqueya.

from Ciudad Trujillo to the traditional Santo Domingo.

For a time HISD dropped 31-meter operations entirely and transmitted only on 49 meters (6090 kHz) along with the BCB of course. Then, this year, R. TV Santo Domingo created a new international division, R. Quisqueya, who promptly reactivated 31 meters (9505 kHz) and imported numerous English language tapes. At present these are a weird mixture of programs from the Broadcasting Foundations of America, faith healers and United Nations productions. It will be interesting to see, or we should say hear, how their format develops in the next few months.

**Weird Signal Dept.** Occasionally those DXers who roam around between the SWBC bands will encounter strange series of musical notes repeated over and over. SWLs, who sit on one of these stations, are really apt to blow their cool when the transmitter either suddenly disappears or, better still, a voice begins speaking in an unknown tongue. In fact such incidents are probably responsible for most of the "lost in space" legends which originate in shortwave circles. Such tales have emanated from Alaska, Italy, Germany, Sweden and Texas.

But these strange sounds do not come from secret satellites nor from Mars, but are test signals used by certain international telephone organizations. One of the longest of these sequences, and therefore the most spectacular, is a 22-note job used by the Portuguese Marconi Radio Co. (CRPM) with headquarters at Lisbon. The HQ station transmits on many frequencies. Some of those logged recently include 7805 and 10905 kHz.

CRPM also operates shortwave telephone links in all Portuguese colonies like Angola, Mozambique, etc., and the two mentioned may occasionally come on strong with that 22-note jazz. But, what happens if you hear someone with say 30 notes? Call your local UFO club.

**"In" Games.** Want to be famous as an *in* DXer? Well, the way to do it *isn't* to log as many stations, or QSL as many countries as possible. The real knack of becoming famous is to pick some special branch of the hobby and then hammer away at it, as loudly as possible, until a major portion of the DX fraternity is so sick of hearing about it they're ready to stage a necktie party in your honor. And when that happens you'll automatically attract a small, but very loyal, group of followers.

But the category you select must be very very specialized—for example, daytime DX on the medium wave (AM) BCB. What is the most distant BCB station you can hear between 1100 and 1500 local standard time? How many stations over 100-miles distant? How many states? Ironically, stations receive very few reports for this time period and you might

(Continued on page 106)

Live Better Electronically With

# LAFAYETTE RADIO ELECTRONICS

1968 Catalog 680 **FREE!**



Now OFF PRESS  
BETTER THAN EVER  
Over 500 Pages

Stereo Hi-Fi • Citizens Band • Ham Gear • Tape Recorders • Test Equipment • TV and Radio Tubes and Parts • Cameras • Auto Accessories • Musical Instruments • Tools • Books

Featuring Everything in Electronics for  
• HOME • INDUSTRY • LABORATORY  
from the "World's Hi-Fi & Electronics Center"

LAFAYETTE Radio ELECTRONICS  
Dept. DI-8, P.O. Box 10  
Syosset, L.I., N.Y. 11791

Send me the FREE 1968 LAFAYETTE Catalog 680 DI-8

Name \_\_\_\_\_

Address \_\_\_\_\_

City \_\_\_\_\_ State \_\_\_\_\_

Zip \_\_\_\_\_

(Please Give Your Zip Code No.)



## Keep up to date with SCIENCE & MECHANICS

Science & Mechanics—the only magazine that keeps you right up to date on developments in space technology, weapons, automobiles, medicine, boats, planes, tools, new products, and exciting world events.

Keep up to date. Make sure of your home delivered copy by returning the coupon today.

SCIENCE & MECHANICS EE-968

229 Park Ave. S., N. Y., N. Y. 10003

12 issues \$4; 24 issues \$8; 36 issues \$12. (Foreign: Add \$1 a year.)

Please enter my \_\_\_\_\_ year(s) subscription.

I enclose \$ \_\_\_\_\_  Bill me.

Name \_\_\_\_\_ (Please Print)

Address \_\_\_\_\_

City \_\_\_\_\_ State & Zip \_\_\_\_\_

# EN PASSANT



BY JOHN W. COLLINS

 This is my second time around with an introduction to the opening, middle-game, and ending. Seven issues ago I gave examples of four standard debuts: Ruy Lopez, Queen's Gambit Declined, Sicilian Defense, and King's Indian Defense. Here are four more of the big ones.

**English Opening.** This one derives its name from the great English master Howard Staunton (1810-1874). It is really a *Sicilian Defense*, with colors reversed. A positional debut, it is subject to transpositions, and strikes at the Q5 square. It runs:

- |         |       |          |       |
|---------|-------|----------|-------|
| 1 P-Q84 | P-K4  | 8 P-Q3   | O-O   |
| 2 N-QB3 | N-KB3 | 9 B-K3   | P-B4! |
| 3 P-KN3 | P-Q4  | 10 N-QR4 | P-B5  |
| 4 PxP   | NxP   | 11 B-B5  | B-N5  |
| 5 B-N2  | N-N3  | 12 R-B1  | B-Q3  |
| 6 N-B3  | N-B3  | 13 BxB   | PxB   |
| 7 O-O   | B-K2  |          |       |

Black

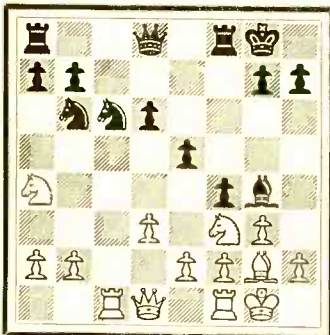

White

Equal chances.

**French Defense.** The *French Defense* was born in a correspondence game between London and Paris in 1834. Its ultra-virtuoso is former World Champion M. M. Botvinnik.

And Black's ideas are to provide against an attack on his KB2, prepare a counter-attack on K5, and to "break" with P-QB4 and P-KB3. An old line in it is the *Classical Variation*:

- |         |       |           |        |
|---------|-------|-----------|--------|
| 1 P-K4  | P-K3  | 8 P-B4    | P-QB4! |
| 2 P-Q4  | P-Q4  | 9 N-B3    | N-QB3  |
| 3 N-QB3 | N-KB3 | 10 PxP!   | NxBP   |
| 4 B-KN5 | B-K2  | 11 O-O-O  | P-QR3  |
| 5 P-K5  | KN-Q2 | 12 B-Q3   | P-QN4  |
| 6 BxB   | QxB   | 13 N-K2!  | B-N2   |
| 7 Q-Q2  | O-O   | 14 N/3-Q4 | ....   |

Black

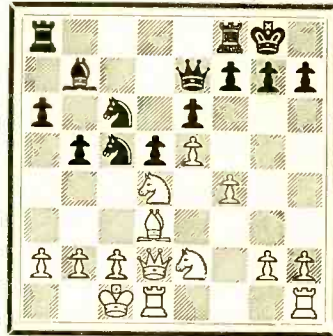

White

White stands slightly better.

**King's Gambit Declined.** The *King's Gambit* is a swashbuckling opening, full of open, attacking, sacrificial play. White stakes a Pawn for a dominating center, better development, and an attack along the King's Bishop file. Many practical players, with safety and the time-clock in mind, refuse the proffered Pawn and adopt the *Declined* version below which ends in the diagram position.

- |          |        |         |      |
|----------|--------|---------|------|
| 1 P-K4   | P-K4   | 7 P-B5  | P-R3 |
| 2 P-KB4! | B-B4   | 8 Q-K2  | B-Q2 |
| 3 N-KB3  | P-Q3   | 9 B-K3  | N-Q5 |
| 4 N-B3   | N-KB3  | 10 BxN  | PxB  |
| 5 B-B4   | N-B3   | 11 N-Q1 | O-O  |
| 6 P-Q3   | P-QR3! | 12 O-O  | R-K1 |

Black

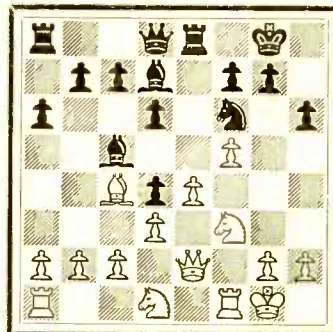

White

The position now offers equal chances.

**Nimzowitsch-Indian Defense.** Known for short as the *Nimzo-Indian*, this opening bears the name of Aron Nimzowitsch, a Latvian-Danish grandmaster. Characterized by the pinning move 3 . . . . B-N5 it exerts pressure on K5, and threatens to double White's Queen's Bishop's Pawns. The Rubenstein Variation of it, which follows, is the most fashionable today.

|         |       |         |       |
|---------|-------|---------|-------|
| 1 P-Q4  | N-KB3 | 8 P-QR3 | B-R4  |
| 2 P-QB4 | P-K3  | 9 Q-B2! | BPxP  |
| 3 N-QB3 | B-N5  | 10 KPxP | PxP   |
| 4 P-K3  | O-O   | 11 BxP  | BxN   |
| 5 B-Q3  | P-Q4  | 12 PxB  | P-QN3 |
| 6 N-B3  | P-B4  | 13 R-K1 | B-N2  |
| 7 O-O   | QN-Q2 | 14 N-K5 | R-B1  |



White

Equal chances.

**Game of the Month.** Dr. Hans Berliner of Bethesda, Maryland, a computer analyzer, is the new World Correspondence Chess Champion. After almost three years of combat against 17 opponents from nine countries, he emerged the winner with a score of 13-2 without the loss of a game! Thus he becomes only the second American to win an Individual World Championship, the other one being Father William Lombardy of New York, who won the 1957 World Junior Championship.

Correspondence chess (moves are exchanged by regular or Air Mail) has a peculiar fascination for those who enjoy the slow pace, those who do not reside in chess centers, those who try to improve on opening theory, and for those who like to prepare a little something special for a particular opponent. In the following game the new champion, playing Black, defeats International Master J. Estrin of the Soviet Union with a carefully prepared variation of the Two Knights Defense. Berliner says it is his 10th move that turns the tables on existing theory. Diagrams on page 107.

|         |       |         |       |
|---------|-------|---------|-------|
| 1 P-K4  | P-K4  | 5 PxP   | P-N4! |
| 2 N-KB3 | N-QB3 | 6 B-B1  | N-Q5! |
| 3 B-B4  | N-B3  | 7 P-QB3 | NxP   |
| 4 N-N5? | P-Q4  | 8 N-K4  | Q-R5! |

(Continued on page 107)



## Don't Miss the all new ELECTRONICS HOBBYIST 1968 Fall-Winter Edition at your Newsstand September 5th

Now you can reserve the newest, most exciting magazine for those whose interest in electronics is on the hobby level. The **ELECTRONICS HOBBYIST** contains easy to build, tested and proven construction projects of every description.

**SPECIAL**—in this issue—the best in communications projects with extra emphasis on low-cost receivers you can build. For Hams, CBers, SWLers, experimenters and just anybody who enjoys listening to radio.

**FOOLPROOF DESIGN! EASY CONSTRUCTION!** Each construction project has been carefully researched and tested by experts. Each article is complete with theory, construction tips, parts lists, diagrams and photos.

**RESERVE YOUR COPY NOW!**

### THE ELECTRONICS HOBBYIST

229 Park Ave. South / N.Y., N.Y. 10003 EE-968

Please reserve my copy of the 1968 Electronics Hobbyist Annual. Enclosed is \$1.25 which includes postage and handling.

Name \_\_\_\_\_  
Address \_\_\_\_\_  
City \_\_\_\_\_ State \_\_\_\_\_ Zip \_\_\_\_\_

WRITE  
NOW FOR  
1969  
SENT FREE

## McGEE'S CATALOG

**1001 BARGAINS IN**

SPEAKERS—PARTS—TUBES—HIGH FIDELITY  
COMPONENTS—RECORD CHANGERS—  
Tape Recorders—Kits—Everything in Electronics  
1901 McGee Street, Kansas City, Missouri 64108

## World Famed BREVETTATA TEAR GAS PISTOL

Appearance of this fine tear gas weapon is similar to real gun. It is ideal for people who work in lonely, dark locations and require protection. Men give this gun to wives and daughters for night security. Many industrial applications. Shooting of gun stuns aggressor without permanently injuring him. Neither permit nor license is needed, but it is not sold to minors. It fires six cartridges without reloading. Each gun comes with six tear gas shells and six blanks for practice and is shipped prepaid. Gun unit prices include, 12 shells and all shipping costs.



- 1 Gun-unit at ..... \$13.07
- 2 Gun-units at \$22.86 ..... (\$11.43 ea.)
- 3 Gun-units at \$29.94 ..... (\$ 9.98 ea.)
- 4 Gun-units at \$35.16 ..... (\$ 8.79 ea.)

Extra boxes of ten tear gas shells at \$1.50 per box (prepaid with gun orders). Extra boxes of blanks at \$1.25 per box.

**UNITED SAFETY SUPPLY CO.**

310 West 9th Street  
Kansas City 7EE, Missouri 84105



# ELEMENTARY ELECTRONICS ETYMOLOGY

By Webb Garrison

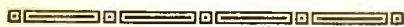

## Tube

▲ Relatively soon after copper entered general use, artisans learned to blend tin with it in order to make bronze. Much harder than copper, this versatile alloy had such impact that almost every culture went through a Bronze Age.

Working chiefly with bronze, Roman metallurgists perfected ways to produce hollow cylinders open at both ends. *Tubus* was the label for such a device. A metal war trumpet bore a closely related name—*tuba*.

Modified only a trifle during centuries of use, the old Latin term was fixed in English as *tube*. This name was applied to a great variety of devices—open at both ends—which served to convey water, air, and light.

Eventually “hollow cylinders” were fashioned with both ends closed, but the old label clung to them. As a result, acorn tubes, picture tubes, thermionic tubes and others are so widely used that a host of special accessories have been developed: tube sockets, tube shields, tube testers, tube voltmeters, and the like. ■

## X Ray

▲ William Conrad Roentgen, a tall and bearded physicist, was enamored with the idea of unlocking the secrets of nature. But at the University of Wurzburg, Germany, he had only a little equipment for experiments.

Several kinds of glass tubes were available, though. One of them, the Crookes tube, had been developed in England by William Crookes. Using direct current, it was possible to produce a strange kind of light by sending a stream of electricity through the partial vacuum of such a tube.

Cathode rays (named because they flowed from the cathode toward the anode) were the subject of many experiments. Philipp Lenard discovered that they could be bent by a magnet.

With no practical goal in mind, the Wurzburg professor set out to experiment with cathode

rays. On Friday afternoon, November 8, 1895, Roentgen covered a pear-shaped Crookes tube with black cardboard. He closed the shutters and turned on the electricity. An instant later he saw a faint green glow on a bench about a yard away from his apparatus. It came from a barium-coated screen that glowed only when current was flowing.

Since the screen was shielded from the stream of cathode rays, Roentgen theorized, correctly, that he had stumbled on a new kind of radiant energy with high penetrating power. He knew nothing of its origin or nature. So he turned to the mathematical symbol for “unknown” and labelled his discovery the X ray. ■

## Copper

▲ Late in the Stone Age, men roaming about the Mediterranean basin made a strange discovery. Chunks of hard reddish stuff, found lying on the ground, could be hammered into any desired shape. Unlike stone, the substance didn't chip or fracture. Instead it actually became harder in the process of being pounded and shaped.

At least as early as 8000 B.C., the metal—for that is what it was—found a variety of uses. Hammers, knives, and other utensils were made of it. Some time after 6000 B.C. there came another break-through. Perhaps as a result of a campfire having been built on ore-bearing ground, it was found that the metal could be melted and cast. From this crude beginning, metallurgy progressed so rapidly that men soon abandoned the use of stone as their primary material for tools.

Vast, easily accessible deposits of the prized reddish metal were found on the island of Cyprus. Its mines were so valuable that the land was seized first by one great power, then another. Egyptian and Assyrian overlords were succeeded by Phoenicians and Greeks; finally the Romans seized the island.

During the long period of Roman dominance, *aes cyprium* (“ore of Cyprus”) was vital to the economic and military life of the empire. Shortened to *cyprium* the name of the metal was corrupted to *cuprum*. That name, current in the third century, is the source of the atomic symbol, Cu.

Spellings used by Englishmen varied widely; in 1386 Chaucer referred to the red stuff as Iuppiter! It was later called coper, couper, and cooper. No written use of the modern form has been found prior to 1590. But translators of the King James Version of the Bible (1611) employed *copper* in their preface. From that source, the word spread throughout the world as the standard label for the metal whose conductivity gave it a stellar role in the rise of the electronic age. ■

# S&M's SUPERSENSITIVE DARKROOM METER

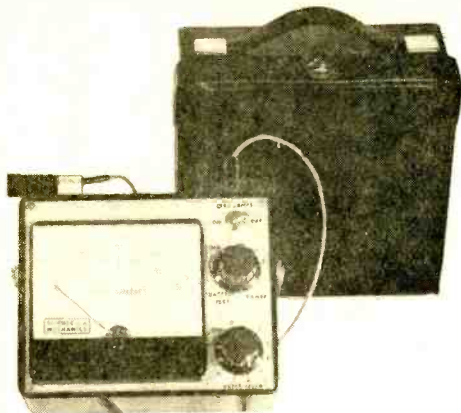

You get your money's worth when you own an S&M A-3 Supersensitive Darkroom Meter.

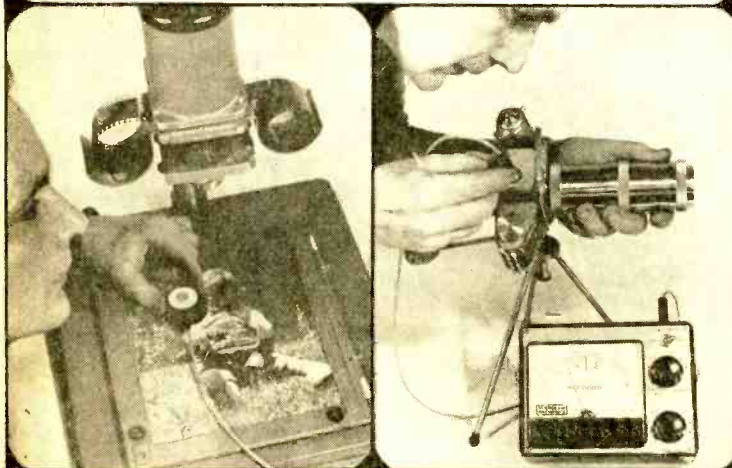

Use the coupon below to order your meter today. Satisfaction guaranteed!

SCIENCE & MECHANICS—KIT DIVISION EE-968  
229 Park Avenue South / New York, N.Y. 10003

Please send the S&M, A-3 Supersensitive Darkroom Meter as I've indicated below. I understand that if I am not satisfied, I may return the meter within 10 days for a complete refund.

Add 10% for Canadian and foreign orders. N.Y.C. residents add 5% for sales tax.

- |                                      |   |
|--------------------------------------|---|
| _____ \$44.50—in kit form            | _____ \$6.50—Easel Probe                          |
| _____ \$49.50—fully assembled        | _____ \$6.50— $\frac{3}{8}$ -inch Miniature Probe |
| _____ \$ 4.95—Carrying Case          | _____ Enclosed \$3.00 deposit,                    |
| _____ Check or money order enclosed, | Ship COD, plus postage & COD                      |
| ship post-paid                       | charges   |

Name (PLEASE PRINT) \_\_\_\_\_  
 Address \_\_\_\_\_  
 City \_\_\_\_\_ State \_\_\_\_\_ Zip \_\_\_\_\_

U.S. Camera says,  
 "The meter is a  
 marvelously sensitive  
 and accurate  
 instrument."

- \$44.50 in Kit form\*
- \$49.50 Fully assembled\*
- \*Carrying case included
- \$4.95 extra Carrying case

This Model A-3 Meter is named the "Darkroom Meter" because it has been so widely accepted for reading enlarger easel exposures. It has earned a reputation as a precision instrument in color studio photography, copy work, portraiture, and available light photography. You can use it with movie cameras and with single lens reflex cameras. The A-3s are also used for ground glass exposure readings with microscopes, telescopes and can even be set up for use as a densitometer.

An exclusive feature of this versatile instrument is its standard plug-in probe assembly with three foot flexible cable. This probe utilizes the newest Clairex Corp. CL-505L cadmium sulfide photocell—the best grade available today—balanced for color, and the complete range of exposures from dim available light to full bright sun light. Its field of view is 43 degrees, equal to normal camera lens angles.

The meter is supplied with a 5-inch, easy-to-read computer with four-range selection and EV-EVS-LV settings to give F stops from .7 to 90 and list exposure time from 1/15,000 second to 8 hours.

The  $\frac{4}{2}$ -inch dial of the meter is self-illuminated with built-in battery lamps. You read on 4 sensitivity ranges, therefore the meter dial and selector switch give you an equivalent of 18 inches of total dial space for reading accuracy. The paper speed control knob is used to set sensitivity, to match the various grades of printing papers. The meter sensitivity is sufficient to detect the light of a match 10 feet away.

This S&M Light Meter is supplied with a probe holding bracket for darkroom work. An accessory easel probe  $\frac{3}{8}$ -inch (see photol) is recommended for use with high speed enlarging papers. The standard  $\frac{3}{8}$ -inch diameter probe can be used to read a  $\frac{1}{2}$ -inch circle on the viewing glass of many SLR's. To read a smaller target through the lens of Exactas, Practicas, etc., order the  $\frac{3}{8}$ -inch diameter probe which has a  $\frac{1}{4}$  wide photocell.

Whether you buy the S&M A-3 Meter as an easy-to-assemble kit, or completely factory-assembled, you can be sure you have the advantage of owning a rugged and dependable instrument. A complete manual tells you step-by-step how to assemble the instrument, how to use it for profitable photography and how to keep it working right for years

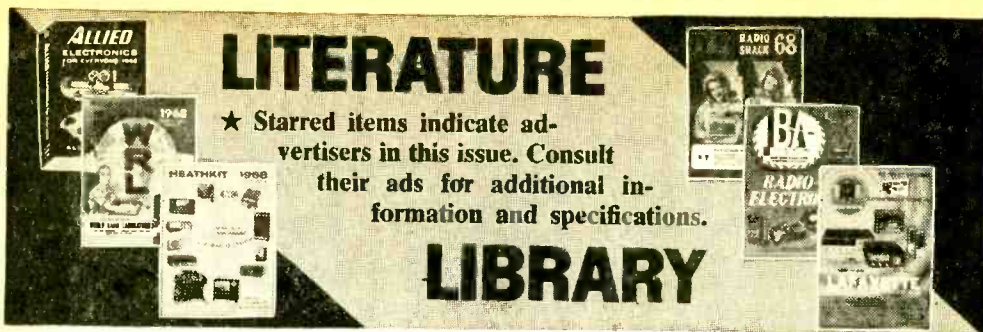

### CB—AMATEUR RADIO— SHORTWAVE RADIO

102. No never mind what brand your CB set is, *Sentry* has the crystal you need. Same goes for ham rigs. Seeing is believing, so get *Sentry's* catalog today. Circle 102.

130. Bone up on the CB with the latest *Sams* books. Titles range from "ABC's of CB Radio" to "99 Ways to Improve your CB Radio." So Circle 130 and get the facts from *Sams*.

107. Want a deluxe CB base station? Then get the specs on *Tram's* all new Titan II—it's the SSB/AM rig you've been waiting for!

101. If it's a CB product, chances are *International Crystal* has it listed in their colorful catalog. Whether kit or wired, accessory or test gear, this CB-oriented company can be relied on to fill the bill.

96. Pick up *E. F. Johnson's* new 12-page booklet "Can Two-Way Radio Help Me?". Interesting facts for the man who works out-of-doors.

★129. Boy, oh boy—if you want to read about a flock of CB winners, get your hands on *Lafayette's* new 1968 catalog. *Lafayette* has CB sets for all pocketbooks.

103. *Squires-Sanders* would like you to know about their CB transceivers, the "23'er" and the new "55S." Also, CB accessories that add versatility to their 5-watters.

46. A long-time builder of ham equipment, *Radiorcrafters* will send you lots of info on ham, CB and commercial radio equipment.

122. Discover the most inexpensive CB mobile, Citi-Fone II by *Multi-Elmac Company*. Get the facts plus other CB product data before you buy.

116. Pep-up your CB rig's performance with *Turner's* M+2 mobile microphone. Get complete spec sheets and data on other *Turner* mikes.

48. *Hy-Gain's* new CB antenna catalog is packed full of useful information and product data that every CBer should know. Get a copy.

111. Get the scoop on *Versa-Tronics' Versa-Tenna* with instant magnetic mounting. Antenna models available for CBers, hams and mobile units from 27 MHz to 1000 MHz.

45. Hams, CBers, experimenters! *World Radio Labs* 1968 catalog is a bargain hunter's delight. Get your copy—it's free.

50. Get your copy of *Amphenol's* "User's Guide to CB Radio"—118 pages packed with CB know-how and chit-chat. Also, *Amphenol* will let you know what's new on their product line.

115. Get the full story on *Poly-Tronics Laboratories' latest CB entry Poly-Pup*. Full 5-watts, great for mobile, base or portable use. Works on 12 VDC or 117 VAC.

100. You can get increased CB range and clarity using the "Cobra-23" transceiver with speech compressor—receiver sensitivity is excellent. Catalog sheet will be mailed by *B&K Division of Dynascan Corporation*.

54. A catalog for CBers, hams and experimenters, with outstanding values. Terrific buys on *Grave Electronics' antennas, mikes and accessories*.

### ELECTRONIC PARTS

★135. Get with ICs! *RCA's* new integrated Circuit Experimenter's Kit KD2112 is the first of its kind and should be a part of your next project. Get all the facts direct from *RCA*. Circle 135.

132. Discover 18 new and different professional-quality amplifiers, tuners, and preamps completely assembled on PC-boards now offered by *Amperex*. Prices will amaze you!

★1. *Allied's* catalog is so widely used as a reference book, that it's regarded as a standard by people in the electronics industry. Don't you have the 1968 *Allied Radio* catalog? The surprising thing is that it's free!

★2. The new 1968 Edition of *Lafayette's* catalog features sections on stereo hi-fi, CB, ham gear, test equipment, cameras, optics, tools and much more. Get your copy today.

8. Get it now! *John Meshna, Jr.'s* new 46-page catalog is jam packed with surplus buys—surplus radios, new parts, computer parts, etc.

23. No electronics bargain hunter should be caught without the 1968 copy of *Radio Shack's* catalog. Some equipment and kit offers are so low, they look like misprints. Buying is believing.

★5. *Edmund Scientific's* new catalog contains over 4000 products that embrace many interests and fields. It's a 148-page buyers' guide for Science Fair fans.

106. With 70 million TV and 240 million radios somebody somewhere will need a vacuum tube replacement at the rate of one a second! Get *Universal Tube Co.'s* Troubleshooting Chart and facts on their \$1 flat rate per tube.

★4. *Olson's* catalog is a multi-colored newspaper that's packed with more bargains than a phone book has names. Don't believe us? Get a copy.

7. Before you build from scratch check the *Fair Radio Sales* latest cat-

alog for electronic gear that can be modified to your needs. *Fair* way to save cash.

6. Bargains galore, that's what's in store! *Poly-Paks Co.* will send you their latest eight-page flyer listing the latest in available merchandise, including a giant \$1 special sale.

10. *Burstein-Applebee* offers a new giant catalog containing 100s of big pages crammed with savings including hundreds of bargains on hi-fi kits, power tools, tubes, and parts.

11. Now available from *EDI (Electronic Distributors, Inc.)*: a catalog containing hundreds of electronic items. *EDI* will be happy to place you under their mailing list.

120. *Tab's* new electronics parts catalog is now off the press and you're welcome to have a copy. Some of *Tab's* bargains and odd-ball items are unbelievable offers.

117. Harried by the high cost of parts for projects? Examine *Bigelow's* 13th Anniversary catalog packed with "Lucky 13" specials.

### ELECTRONIC PRODUCTS

★42. Here's colorful 108-page catalog containing a wide assortment of electronic kits. You'll find something for any interest, any budget. And *Heath Co.* will happily send you a copy.

44. Kit Builder? Like wired products? *EICO's* 1968 catalog takes care of both breeds of buyers. 32 pages full of hi-fi, test, CB, ham, SWL, automotive and hobby kits and products—do you have a copy?

128. If you can hammer a nail and miss your thumb, you can assemble a *Schober* organ. To prove the point, *Schober* will send you their catalog and a 7-in. disc recording.

126. *Delta Products* new capacitive discharge ignition system in kit form will pep up your car. Designed to cut gas costs and reduce point and plug wear. Get *Delta's* details in full-color literature.

66. Try instant lettering to mark control panels and component parts. *Datak's* booklets and sample show this easy dry transfer method.

109. *Seco* offers a line of specialized and standard test equipment that's ideal for the home experimenter and pro. Get specs and prices today.

### TOOLS

★78. Need an extra hand? *Xcelite's* Seizers clamp tightly, hold wires for soldering, act as heat sinks, retrieve small parts from hard to reach places. Get *Xcelite Bulletin N564* for details.



118. Secure coax cables, speaker wires, phone wires, etc., with Arrow staple gun tackers. 3 models for wires and cables from 3/16" to 1/2" dia. Get fact-full Arrow literature.

**SCHOOLS AND EDUCATIONAL**

★74. Get two free books—"How to Get a Commercial FCC License" and "How to Succeed in Electronics"—from Cleveland Institute of Electronics. Begin your future today!

★136. "Power Engineering," a new 32-page, illustrated brochure by ICS (International Correspondence Schools) describes seven ICS Power Engineering courses that may open a new career for you. Get a copy today!

114. Prepare for tomorrow by studying at home with Technical Training International. Get the facts today on how you can step up in your present job.

★137. For success in communications, broadcasting and electronics get your First Class FCC license and Grantham School of Electronics will show you how. Interesting booklets are yours for the asking.

138. For a complete rundown on curriculum, lesson outlines, and full details from a leading electronic school, ask for this brochure from the Indiana Home Study Institute.

105. Get the low-down on the latest in educational electronic kits from Trans-Tek. Build light dimmers, amplifiers, metronomes, and many more. Trans-Tek helps you to learn while building.

★3. Get all the facts on Progressive Edu-Kits Home Radio Course. Build 20 radios and electronic circuits; parts, tools and instructions come with course.

139. Altec Lansing covers both ends of the audio market—microphones and loudspeaker systems. Altec supplies the facts—you do the asking. Circle 139 now!

19. Empire's new 16-page, full-color catalog features speaker systems in odd shapes for beautiful room decor. Also, rediscover Empire's quality turntable line and cartridges.

124. Now, Sonotone offers you young ideas in microphone use in their new catalog. Mikes for talk sessions, swinging combos, home recording, PA systems and many more uses.

26. Always a leader, H. H. Scott introduces a new concept in stereo console catalogs. The information-packed 1968 Stereo Guide and catalog are required reading for audio fans.

85. Write the specs for an ideal preamp and amp, and you've spelled out Dynaco's stereo 120 amp and PAS-3X preamp. So why not get all the facts from Dynaco!

119. Kenwood puts it right on the line. The all-new Kenwood stereo-FM receivers are described in a colorful 16-page booklet complete with easy-to-read-and-compare spec data. Get your copy today!

131. Let Elpa send you "The Record Omnibook." It's a great buy and Elpa wants you to have it free. Your records will thank you when the mailman delivers it.

17. Mikes, speakers, amps, receivers—you name it, Electro-Voice makes it and makes it good. Get the straight poop from E-V today.

27. 12 pages of Sherwood receivers, tuners, amplifiers, speaker systems, and cabinetry make up a colorful booklet every hi-fi bug should see.

99. Get the inside info on why Telex/Acoustech's solid-state amplifiers are the rage of the experts. Colorful brochure answers all your questions.

31. All the facts about Concord Electronics Corp. tape recorders are yours for the asking in a free booklet. Portable, battery operated to four-track, fully transistorized stereos cover every recording need.

32. "Everybody's Tape Recording Handbook" is the title of a booklet that Sarkes-Tarzian will send you. It's 24-pages jam-packed with info for the home recording enthusiast. Includes a valuable table of recording times for various tapes.

34. "All the Best from Sony" is an 8-page booklet describing Sony-Super-scope products—tape recorders, microphones, tape and accessories. Get a copy before you buy!

35. If you are a serious tape audiophile, you will be interested in the all new Viking/Telex line of quality tape recorders.

**HI-FI ACCESSORIES**

112. Telex would like you to know about their improved Serenata Headset—and their entire line of quality stereo headsets.

104. You can't hear FM stereo unless your FM antenna can pull 'em in. Learn more and discover what's available from Finco's 6-pages "Third Dimensional Sound."

**TELEVISION**

★70. Need a new TV set? Then assemble a Heath TV kit. Heath has all sizes. B&W and color, portable and fixed. Why not build the next TV you watch?

127. National Schools will help you learn all about color TV as you assemble their 25-in. color TV kit. Just one of National's many exciting and rewarding courses.

91. Interesting, helpful brochures describing the TV antenna discovery of the decade—the log periodic antenna for VHF and UHF-TV, and FM-stereo. Get it from JFD Electronics Corporation.

**HI-FI/AUDIO**

134. Discover PlayTape—America's newest tape cartridge and tape players. Units priced at under \$17 with cartridges at 45-disc prices. PlayTape has one of America's largest recording libraries.

**TAPE RECORDERS AND TAPE**

123. Yours for the asking—Elpa's new "The Tape Recording Omnibook," 16 jam-packed pages on facts and tips you should know about before you buy a tape recorder.

**ELEMENTARY ELECTRONICS**

Dept. 968  
229 Park Avenue South  
New York, N.Y. 10003

Please arrange to have the literature whose numbers I have circled sent to me as soon as possible. I am enclosing 25¢ for 1 to 10 items; 50¢ for 11 to 20 items to cover handling. No stamps, please.

Indicate total number of booklets requested

|     | 1   | 2   | 3   | 4   | 5   | 6   | 7   | 8   | 10  | 11 |
|-----|-----|-----|-----|-----|-----|-----|-----|-----|-----|----|
| 17  | 19  | 23  | 26  | 27  | 31  | 32  | 34  | 35  | 42  |    |
| 44  | 45  | 46  | 48  | 50  | 54  | 66  | 70  | 74  | 78  |    |
| 85  | 96  | 97  | 99  | 100 | 101 | 102 | 103 | 104 | 105 |    |
| 106 | 107 | 109 | 111 | 112 | 114 | 115 | 116 | 117 | 118 |    |
| 119 | 120 | 122 | 123 | 124 | 126 | 127 | 128 | 129 | 130 |    |
| 131 | 132 | 134 | 135 | 136 | 137 | 138 | 139 |     |     |    |

1-10 items

11-20 items



CHECK ONE

maximum number of items = 20

NAME \_\_\_\_\_

ADDRESS \_\_\_\_\_

CITY \_\_\_\_\_

STATE \_\_\_\_\_ ZIP \_\_\_\_\_

# Discover the ease and excitement of learning Electronics with programmed equipment NRI sends you

When you train at home with NRI, you train with your hands as well as your head. You learn the WHY of Electronics, Communications, TV-Radio the NRI pioneering "3-Dimensional" way. NRI training is the result of more than half a century of simplifying, organizing, dramatizing subject matter, and providing personal services unique for a home study school. You get the kind of technical training that gives you priceless confidence as you gain experience equal to many, many months of training on the job.



*NRI—The 53 Year Leader in Electronics Training*

## APPROVED UNDER NEW GI BILL

If you served since January 31, 1955, or are in service, check GI line in postage-free card.



*Earn \$5 or more an hour  
spare or full time in*

## **TV-RADIO SERVICING**

Color Television has arrived. Sales are soaring, along with the continuing popularity of other home entertainment equipment like portable radios, tape recorders, hi-fi sets, phonographs and auto radios. TV-Radio servicing is one of your best routes to spare-time earnings, a good paying job or a business of your own. NRI not only trains you quickly and expertly, but also shows you how to get started in Servicing soon after you enroll, earning as you learn. NRI trains you in today's methods of installing and repairing all Electronic equipment for the home—including booming Color TV. You even build, experiment with and keep to enjoy your own solid-state radio and your choice of black-and-white or Color TV receiver. Like thousands of others, you can be earning \$5 or more an hour extra in spare time starting soon.

*There's money and  
success awaiting you in*

## **BROADCASTING— COMMUNICATIONS**

The experience you gain from intensely practical NRI training in Complete Communications equals as much as two years of training on the job. With NRI, you can train for a choice of careers ranging from mobile, marine and aviation radio to TV broadcasting and space communications. You learn how to install, maintain and operate today's remarkable transmitting and receiving equipment by actually *doing* it. You build and experiment with test equipment, like a VTVM you keep. You build and operate amplifier circuits, transmission line and antenna systems, even build and use a phone-cw transmitter suitable for transmission on the 80-meter amateur band. Whichever of five NRI Communications courses you choose, you prepare for your FCC License exams, and you must pass your FCC exams or NRI refunds your tuition in full.

*Move ahead in America's  
fast growing industry as*

## **ELECTRONICS TECHNICIAN**

Electronics touches everyone's lives. This vast field of opportunity is open to you with NRI training. Industrial/Military Electronics training—like all NRI courses—prepares you quickly, thoroughly the practical "hands on" way. You build with, and learn to understand the functions of, today's miracle solid-state components like printed circuits, diodes and transistors. You build and experiment with Electronic circuitry used in automation, data processing, ultrasonics, telemetry. Whatever your interest in Electronics, NRI training can fill your needs. Prove to yourself what nearly a million NRI students could tell you . . . that you get more for your money from NRI. Check the postage-free card and mail it today for your FREE NRI Color Catalog. No salesman will call. NATIONAL RADIO INSTITUTE, Electronics Division, Washington, D.C. 20016.

**YOU GET MORE FOR YOUR MONEY FROM NRI** — Build, test, explore, discover. Everything you see here is included in one NRI course—including Color TV. Other courses equally complete. And you'll be surprised at the low tuition costs. Text for text, kit for kit, dollar for dollar—you get more for your money from NRI.



# THE UNDERGROUND

By Jack Schmidt

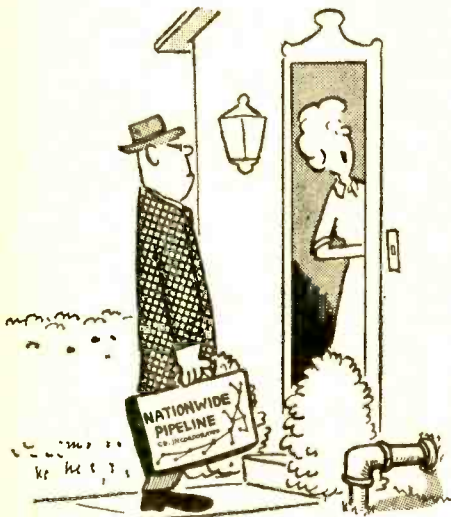

"Oh, Harry, there's a man here about your low-ohmic ground."

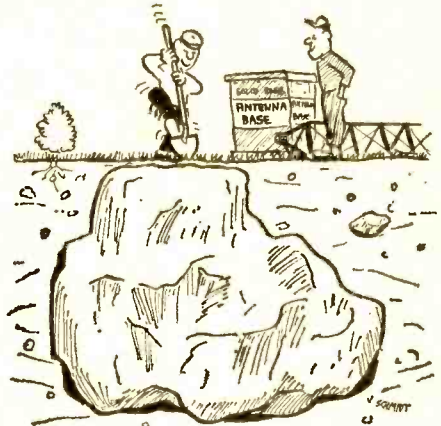
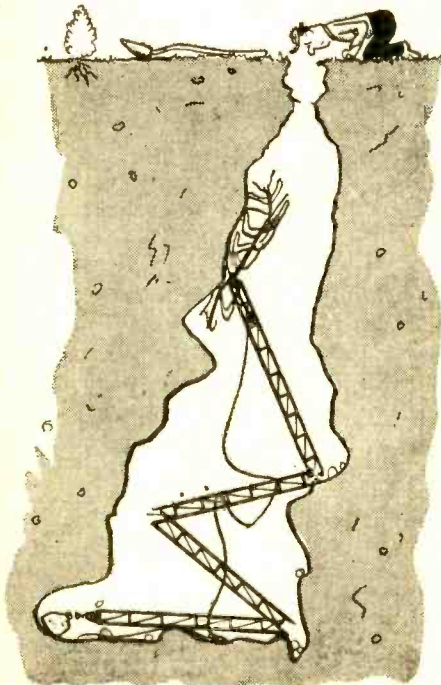

"Oh, David . . . even I thought you were drilling a well all this time!"

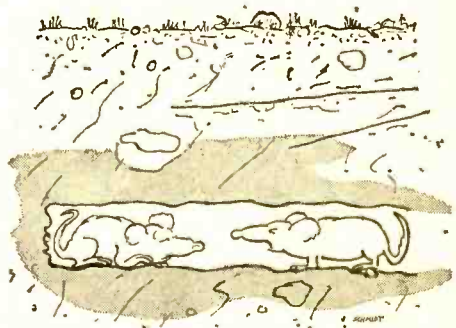

"I felt his car come in. We have about an hour before we get grounded."

FORECAST:

# EARTHQUAKES

Bettman Archive Photo



By Jorma Hyypia

In 1968, Californians will suffer a severe natural earthquake. And residents of Colorado can expect to be jolted by a damaging man-made earthquake any day now.

Grim predictions, you say? True. Yet they are based on sound seismic observations, observations which have convinced leading seismologists that strong earthquakes are likely to occur in these areas this year. But that's as far as prophesy can go. Reason: there's no way to foretell exactly when precautionary actions should be taken to protect life and property. For seismic prediction at present is hardly more accurate than forecasting the weather by sticking a wet finger into the wind.

Still, there is now hope that seismologists in time will devise a monitoring system--some sort of electronic earth stethoscope--

# e/e EARTHQUAKES

capable of predicting imminent earth convulsions. Elaborate earthquake research programs are being established in the U.S. and Japan. The answers won't come overnight, but at least some significant research directed at earthquake prediction is now underway.

A few years ago, U.S. seismologists managed to convince the federal government that science now has the instrumentation available to tackle the earthquake problem effectively. The plea for government financial support could hardly have come at a more opportune time. Fresh in everyone's memory was the catastrophic Alaska earthquake of March 1964 that took 110 lives and caused property damage amounting to hundreds of millions of dollars. It was obvious that even an hour's warning would have been enough to save most of the lives lost.

In 1967, the National Center for Earthquake Research was set up at Menlo Park, California. One of NCER's first discoveries was that earth movements averaging one-half inch per year are now taking place in the San Andreas Lake area south of San Francisco. A Menlo Park geophysicist has been quoted as saying that the San Andreas fault zone is being "very sharply" loaded with stress and that the situation "is getting pretty critical." This view agrees with an earlier prediction, made by a University of Michigan professor, that the strain on the San Andreas fault at the present time is probably greater than it was just prior to the 1906

earthquake that devastated much of San Francisco.

**Man-made Quakes.** It may seem unbelievable that man's puny works can alter the massive subterranean crustal pressure balances enough to cause earthquakes. Yet this can—and does—happen.

Frequent minor earthquakes were recorded when water accumulated in Lake Mead after completion of Hoover Dam. More recently, a quake of 7.5 magnitude on the Richter scale occurred as water was impounded by a new dam at Koyna, India.

Perhaps the most bizarre man-made earthquake is in the making right now at Denver, Colorado. In 1962 the U.S. Army began dumping 160 million gallons of waste water into a two-mile deep well that had been drilled for waste disposal purposes at the Rocky Mountain Arsenal near Denver. The objective was to dispose of dangerous chemical research waste products in a safe manner. But the elimination of one kind of hazard served only to create a new peril—the threat of earthquakes in an area where they seldom occur naturally.

During the past six years hundreds of tremors have been recorded in the Denver area; several quakes have already been strong enough to cause some property damage. Now the frequencies and intensities of the tremors are changing in such way that scientific authorities are forced to the reluctant conclusion that bigger quakes are very likely to occur—quite probably this year. And no one knows for certain what, if anything, should be done about the situation. Removal of the waste water from the well might reduce the likelihood of a major



Streets split open, buildings topple, and fires rage when earthquakes strike. Photos above and on p. 31 show San Francisco during 1906 holocaust.



Because San Francisco lies in a major earthquake belt, 1906 could repeat itself at any time. Above, 1957 fissure on coast road just south of the city.

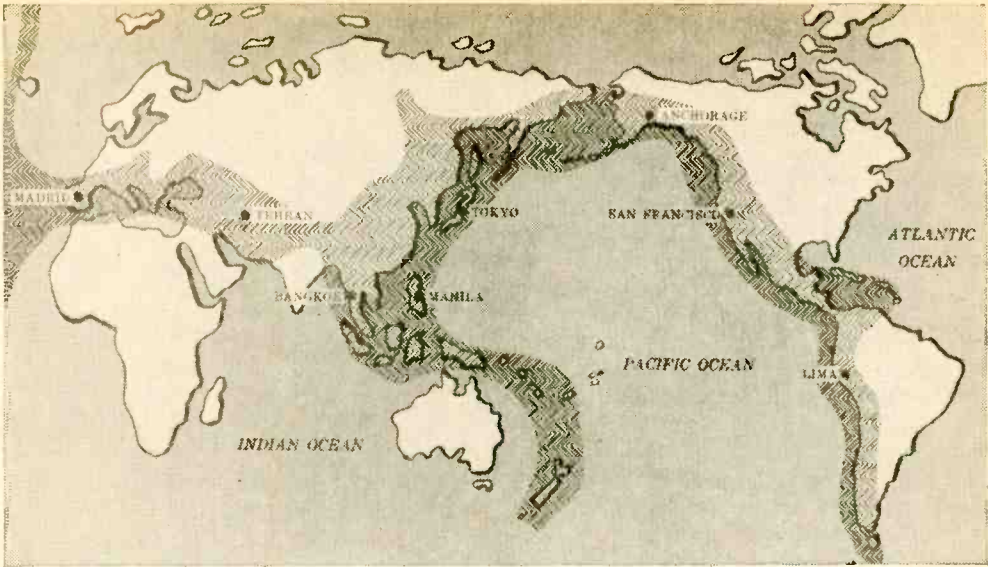

Quakes occur primarily in earth's orogenic (mountain-building) regions (shaded areas), which also happen to contain bulk of world's active volcanoes. Note that quake belt skirts entire Pacific Ocean,

earthquake. Too, it might actually trigger the event.

**Mild Or Mammoth?** There is no way to predict how violent the Colorado and California earthquakes will be when they come. But if the seismologists are correct in their assessment that underground strains in California are now greater than prior to the 1906 quake, the implication is that another quake of equal intensity is possible—though not necessarily inevitable. It all depends on how the built-up strains are eventually released by subterranean adjustments.

The 1906 California earthquake had a magnitude of 8.3 on the Richter scale. The

magnitude of the 1964 Alaska quake was somewhere between 8.3 and 8.75. Thus, both earthquakes can be rated as *Great* earthquakes since their magnitudes were greater than 8; *Major* earthquakes have magnitudes between 7 and 8.

Earthquake classifications are often misunderstood, since the terms magnitude and intensity are not synonymous. Any one earthquake has but one magnitude, but it may have several different intensities.

Earthquake *magnitudes*, as numerical values on the Richter scale, are simply *indexes* to the potential energies of the disturbances at their sources. The Richter value

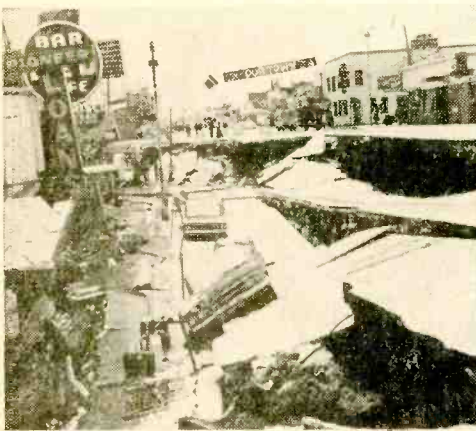

Further north, but still in same quake belt, cars lay 20 ft below surface of Anchorage's main thoroughfare following 1964 quake that left state in ruins.



Falling on same quake belt as San Francisco, Huacho, Peru saw its houses crumble, its residents panic when severe quake rocked area in 1966.

# e/e EARTHQUAKES

cannot be used to express earthquake damage; it is a *logarithmic* expression of the maximum amplitude detected with instruments. Thus, a difference of one unit on the scale represents a ten-fold difference of magnitude. For example, an earthquake having a magnitude of 8 is 10,000 times stronger, in terms of instrument response, than one having a magnitude of 4 (not merely twice as strong, as laymen often assume).

The actual *energies* released at the sources of earthquakes vary even more from one Richter number to the next than do the instrumental responses. An increase of one unit in the Richter scale represents, approximately, a 60-times increase in energy. Thus, an earthquake of magnitude 8 releases 10 million times as much energy as does a quake of magnitude 4. The following table may make these relationships clearer:

| Richter No. | Relative sizes of measured amplitudes (factors of 10) | Relative energy released at the source (factors of about 60) |
|-------------|---|--|
| 1           | 1   | 1  |
| 2           | 10  | 60   |
| 3           | 100   | 3,600  |
| 4           | 1,000   | 216,000  |
| 5           | 10,000  | 12,960,000   |
| 6           | 100,000   | 777,600,000  |
| 7           | 1,000,000   | 46,656,000,000   |
| 8           | 10,000,000  | 2,799,360,000,000  |

Earthquake *intensities* are established, not by instrumental measurements, but by assessing the physical damage wrought and by determining how the quake affects people in the area. The intensity of an earthquake is greatest at the epicenter, and falls off gradually with increasing distance from the center.

A twelve-step Modified Mercalli scale is used to rate earthquake intensities. For example, an MM intensity of I represents a quake so weak that it is detected only by instruments, not by human beings; intensity VI is strong enough to be felt by everyone, whether indoors or out; intensity XII is so strong that it creates general panic and total physical damage.

**Magnetic Monitoring.** Magnetic disturbances that began about one hour before the Alaska earthquake momentarily increased the magnetic field at Kodiak by as much



Rumble seat of California is San Andreas fault, a cleavage created by 1906 quake. Current rumblings in area suggest another major quake is imminent.

as 100 gammas. Some scientists have inferred a possible causal relationship between these magnetic disturbances and the earthquake. For this reason, they feel encouraged to speculate that magnetic monitoring may someday be used to predict earthquakes.

Similar magnetic disturbances associated with seismic events have been observed in other places—notably in Japan and in the  
(Continued on page 108)



Pair of three-component photographic recording units chart short- and long-period seismic data at an Ogdensburg, N.Y. geological observatory.



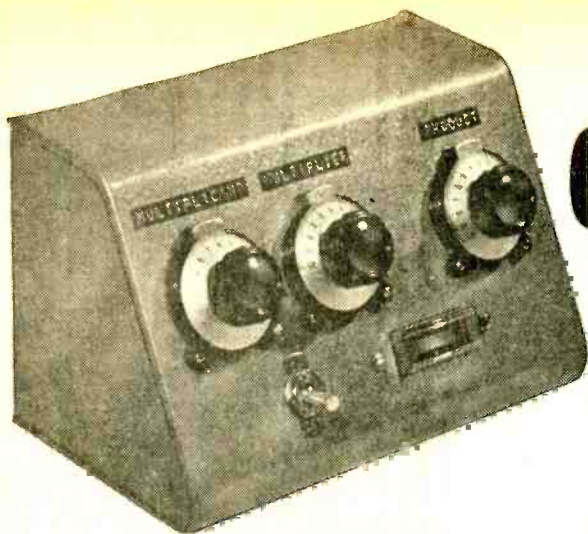

# Computer goes to Pot

**Build our Electronic Slide Rule with ordinary radio parts and then you will discover the vast, interesting world of analog computers**

**A**ccording to at least one humorous dictionary, an engineer "is a man who multiplies two by two and says that the answer is *approximately* four." The reason for the word "approximately" is that our engineer probably used a slide rule—a popular mechanical analog computer—when he made his calculation. And the very nature of all analog computers is that all of the answers they produce are approximate—some more than others.

You can make your own electronic analog computer—our Electronic Slide Rule—that'll knock out simple multiplication and division problems accurate to  $\pm 3$  digits out of every 100. No, it will not replace your slide rule, but it's great for simple rapid estimations and checking. Before we show you how to build our Electronic Slide Rule, let's peek into the electronics of the gadget.

**Voltage Analog.** An ordinary potentiometer will help us see how a number can be converted into a voltage analog. Fig. 1 shows a simple circuit of a potentiometer, R1, connected in series with a battery, B1. Rotating the dial on the shaft of R1 causes the pot wiper to "pick off" a voltage proportional to the dial setting.

In Fig. 1 the dial is calibrated from zero to one, and the voltage supplied by the battery is 1.0 volt. Thus, in this particular instance, the dial setting indicates the voltage

at the wiper of the pot. A voltmeter connected at the output terminals of this circuit will indicate the setting of the dial—0.5 V would mean that the dial is set at 0.5. The voltage is an analog voltage, since it may represent a dial quantity of 0.5 acre, quart, or even light year.

**Multiplying.** In Fig. 1, a voltage analog for the number 0.5 was developed at the wiper of R1. It can also be said that the supply voltage across R1 was multiplied by

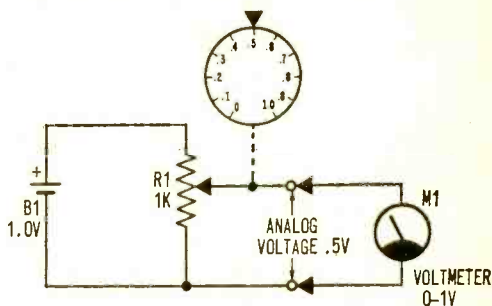

Fig. 1. Hypothetical circuit showing how potentiometer can convert number into voltage analog. Dial calibrations represent any desired quantity.

0.5. Thus, 1 V times 0.5 will be 0.5 V. If a voltage other than 1 V were supplied by B1 in Fig. 1, we would be multiplying the supply voltage by the dial setting.

This apparent ability of potentiometers to multiply can best be seen in Fig. 2. Battery

# e/e ELECTRONIC SLIDE RULE

B1 supplies 1 volt across pot R1. Dial A is set at 0.5 so that analog voltage A developed at the wiper of R1 (0.5 volt) is applied across pot R2. Dial B is set at 0.8 so that the voltage at the wiper of R2 will be only 0.8 times the voltage across R2, or simply  $0.5 \times 0.8$ . The voltage developed at the wiper of R2 is appropriately called analog voltage A · B, and voltmeter M1 will indicate this voltage to be 0.4—the product of 0.5 and 0.8.

**Null Readout.** In Fig. 2 the voltmeter presents a load across the resistive network—this introduces errors. One way to eliminate this loading effect is to replace the voltmeter with a null indicator. It's nothing more than inexpensive center-reading ammeter hooked up as shown in Fig. 3 (more properly called a galvanometer). When the voltage on the wiper of R3 is equal to the voltage on wiper R2, no current will flow through the galvanometer. So, a calibrated dial is added to the shaft of R3 which is read when the galvanometer is zeroed. Now all it takes to get an answer for any multiplication problem is to rotate the dial on R3 until the galvanometer is zero and the dial is read.

Another way to reduce loading error is to isolate the pots from each other by the use of isolation amplifiers. This is important because the pots are interconnected and one will load one another. Sounds like a big task but it's quite simple. Fig. 4 shows you how.

Transistor Q1 draws only a few microamperes from the wiper of R1, which is used to supply an identical voltage from the wiper

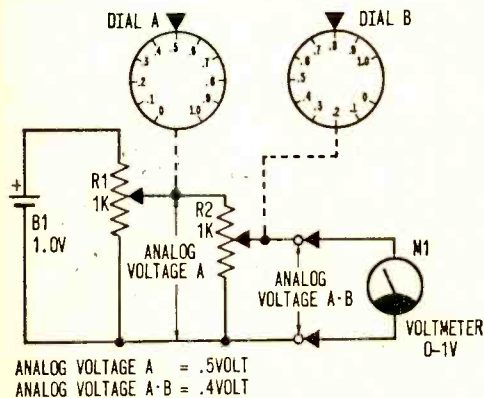

Fig. 2. Addition of second potentiometer to hookup in Fig. 1 results in circuit which can multiply. Voltmeter M1 now indicates analog voltage  $A \times B$  rather than analog voltage A only.

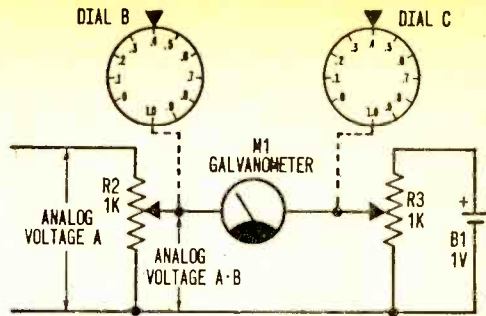

Fig. 3. Adding pot R3 and moving battery B1 reduce loading error inherent in circuit of Fig. 2.

of R1 to the top of R2. This could have been done with a wire, but the isolation effect of Q1 removes any loading effect R2 could have on R1. The story is the same for Q2. The nulling circuit is connected across emitter resistors R2 and R6. The galvanometer functions as previously explained. However, a series damping resistor, R7, is added to prevent slamming the needle at its extremes when the voltage drops across R2 and R6 are significantly different. The original unit used a 10K resistor, but it was later changed to 2200 ohms for snappier indications.

**Building It.** The Electronic Slide Rule is housed in a sloping aluminum box. A piece of perforated phenolic chassis board is used as the sub-chassis with push-in terminals used as wiring points. The circuit is very simple (see Fig. 4), and parts positioning is absolutely non-critical.

The sub-chassis is supported in place by an angle bracket at its bottom, and by the three vernier drive mechanisms that hold the potentiometer shafts at the top. Mount the 6-volt battery inside the rear panel of the case in a battery holder.

You may want to replace the on-off toggle switch (S1) with a pushbutton type. If so, mount the pushbutton on the top of the unit so the case will not move when the button is pressed.

**Calibration.** Turn all three vernier dials to zero (their set screws are still loose, so the pot shafts can turn freely). Then, turn the pot shafts of R1, R2, and R3 fully counterclockwise. Tighten the set screws.

Now, turn switch S1 on and observe M1's pointer. It will move ever so slightly. Possibly, you may be able to eliminate the pointer's movement by resetting R2's shaft position a smidgeon. Maybe not! Now, adjust all dials to read 1.0 (that's the top of the dial). With the unit on, adjust R5 until the galvanometer is zeroed. If the galvanom-



# When there are gray skies...

... the pollution detective  
identifies and measures  
the gaseous morass  
we breathe  
into our lungs!

**S**trange as it sounds, the soot and dust that collect on the window sills of America's cities has little to do with the air crisis now facing one of history's most affluent societies. To be sure, airborne dirt is a nuisance. But it's not nearly as deadly as are some of the less visible air pollutants.

Sulfur dioxide, released in abundance from every factory or home that burns fuel oil, is one of the major offenders, eating into building stone and metal. And when this compound combines with some forms of ash and soot, the re-





Visible smoke, like that from apartment house incinerator (left), is major offender to clean air. Other, more damaging pollutants, are not discernible by human senses and must be detected by instruments, such as those contained in U.S. Public Health Service mobile unit (above).

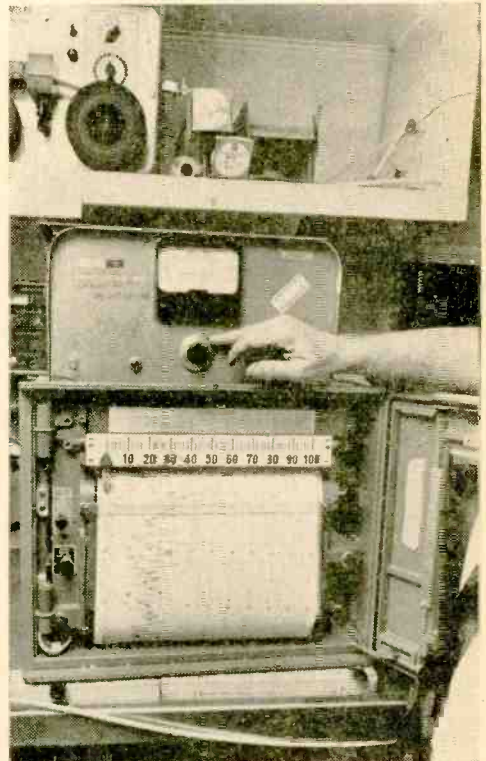
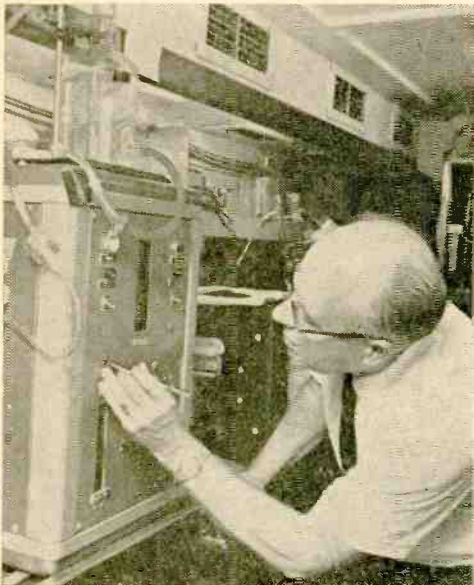

Sophisticated equipment within Health Service truck includes units for measuring and recording air's content of sulfur dioxide (left) and equally toxic carbon monoxide (right).

# e/e POLLUTION DETECTIVE

sult is sulfur trioxide, which, when exposed to moisture normally present in the air, results in sulfuric acid (need we say more?). Carbon monoxide released from automobile, bus, and truck exhausts, is yet another toxic gas in the air. And there are many, many others.

Chemical content of the filthy air we breathe is readily measurable with devices contained in the U.S. Public Health Service's air-pollution mobile units. Much condemning evidence indicates that many deaths routinely attributed to asthma and chronic bronchitis are actually the result of air pollution. Legislators, however, seemingly find their hands tied when it comes to cleaning up the air. Meanwhile, some cynics offer one answer to the solution problem: "Stop breathing!" —C. Hansen



Even test tubes get into the how-bad-is-our-air act during Public Health Service studies. Researcher places air sample and reagent in test tube, then relies on resultant color of tube's contents to determine what foreign gases are present. Below, photo shows part of instrumentation used to measure level of sulfur dioxide in atmosphere. Gas is especially dangerous because of its proclivity to reform into sulfur trioxide and, ultimately, sulfuric acid.

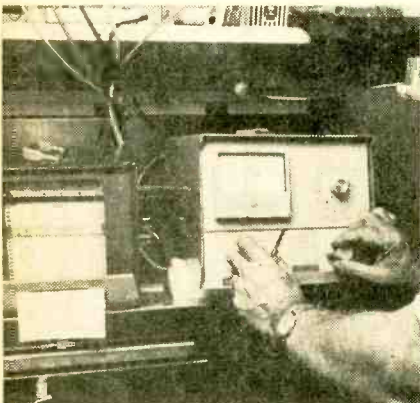

Two other measuring instruments used by Public Health Service cleaner-air team are units for measuring amount of nitrogen dioxide (above) and smoke (below) in air. Strip-chart recorder adjacent to  $\text{NO}_2$  analyzer provides minute-by-minute, hour-by-hour summation of unit's findings.

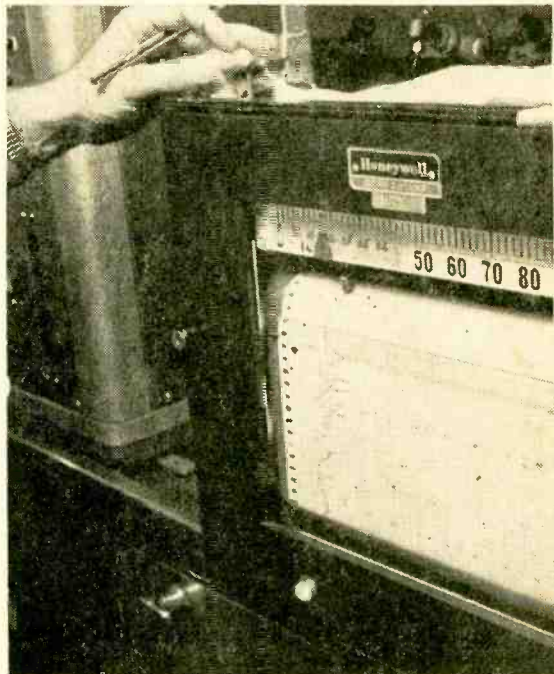
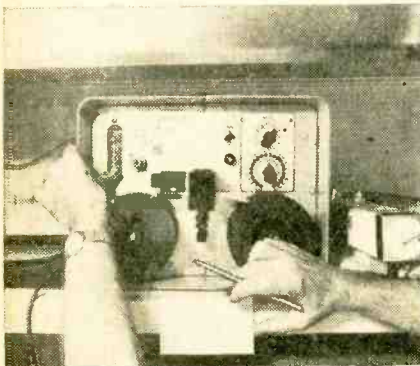

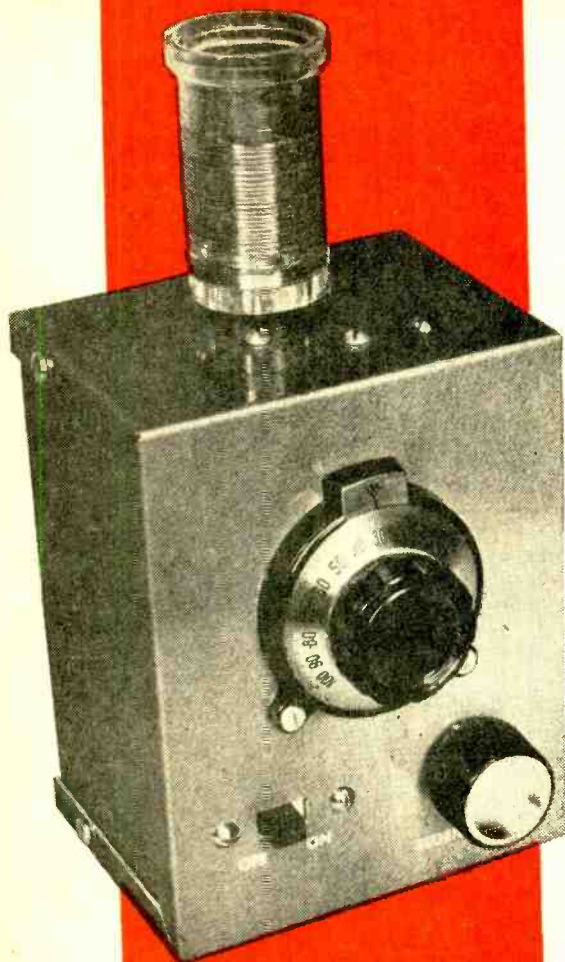

Put the bite on weak  
signals by building  
this devil device  
that'll turn you on  
with real DX sound

# DX DEVIL

By Hartland B. Smith, W8VVD

**I**s your shortwave set plagued with puny signals, excessive fading, or CW birdies that chirp across your favorite stations? Do you find that signals repeat themselves about 900 kHz away from where they're supposed to be on the dial?

If you must reluctantly answer yes to any of these questions, then the sooner you build our DX Devil the sooner you can enjoy improved reception from 4 to 30 MHz. This remarkably simple gadget easily boosts nebulous DX transmissions about 40 dB (that's  $\times 10,000$ )! It'll make a lazy S-meter climb as much as 6 or 7 S-units. Further, it'll force the receiver's AVC (automatic volume control) to work much better, thereby minimizing very deep, quick fades that often cause annoying momentary dropouts.

**No Secret.** The DX Devil is an old-fashioned idea dressed in brand new clothes. It's a battery-powered regenerative preselector built around a high-gain field-effect transistor (FET).

The device acts as a single stage of tuned radio-frequency amplification which may be connected between the antenna feed and the input terminals of your receiver. It not only boosts weak signals before they reach the first stage in the receiver, but it also adds selectivity (*Continued overleaf*)

# e/e DX DEVIL

to reject unwanted signals that might otherwise interfere with a desired transmission.

Many shortwave sets, especially those selling for less than \$75, contain no tuned RF stage ahead of the mixer or first detector. Consequently, these receivers often lack both sensitivity and front-end selectivity.

These deficiencies show themselves in two very obvious ways. First, only the more powerful nearby stations come through with really adequate strength. Peanut whistles and DX from the other side of the globe can usually be heard, if at all, only very weakly. Second, the dearth of selectivity ahead of the mixer is evidenced by numerous unwanted birdies, or images.

**More Rejects.** On the higher frequencies, above 10 MHz, inexpensive superhet receivers often have a habit of picking up the same signal at two points on the dial. This can be a real problem when a 14-MHz ham rides in on top of a 15-MHz shortwave broadcaster, or a fellow on the low end of 28 MHz clobbers another fellow near the high end.

With some sets the situation is reversed. That is, a 15-MHz signal will stomp all over the 14-MHz ham, and the fellow at the top end of 28 MHz will also come in at the low end of the band. In either case, the unwanted

signals you hear in the wrong places are images created by the heterodyning process. A preselector ahead of the receiver will provide additional selectivity that will either reduce or completely eliminate these images.

Because it is regenerative, the DX Devil boasts almost as much gain and selectivity as you would normally expect to obtain from a complicated two-stage preselector without regeneration. Coil L1 includes a feedback winding between pins 3 and 4 which causes the circuit to oscillate when a full 9 volts is applied between the source and drain electrodes of transistor Q1.

Regeneration control R2 makes it possible to reduce the drain voltage until the unit operates just below the point of oscillation. This is the region of maximum amplification and selectivity.

The cost and complexity of band switching are eliminated in the DX Devil through

## PARTS LIST FOR DX DEVIL

- B1—9-volt transistor battery (2U6, 216 or equiv.)
- C1—15-409-pF variable capacitor (Allied 43B3524—see text)
- C2, C4—.05- $\mu$ F, 10-V disc ceramic capacitor
- C3—.001- $\mu$ F, 500-V disc ceramic capacitor
- D1, D2, D3, D4—Silicon or germanium diodes (see text) *OR TRANSISTOR*
- L1—Series of three coils: (1) 14-30 MHz: Pri. 3 turns, closewound, Sec. 4 1/4 turns, 5/8-in. long, tapped 1/4 turn from ground end; (2) 7-14 MHz: Pri. 3 turns, closewound, Sec. 11 turns, 1-in. long, tapped 1/3 turn from ground end; (3) 4-7 MHz: Pri. 3 turns, closewound, Sec. 22 turns, 1 1/8-in. long, tapped 1/4 turn from ground end. All coils wound with #28 Formvar insulated wire on 2 1/4 x 1 1/4-in. polystyrene plug forms (Allied 47B6696 or equiv.)
- Q1—Motorola MPF-107 field-effect transistor (available from Newark Electronics, 500 N. Pulaski Rd., Chicago, Ill. 60624)
- R1—1000-ohm, 1/2-watt resistor
- R2—5000-ohm, linear potentiometer
- RFC1—2.5- $\mu$ H RF choke
- S1—3PDT slide switch
- TS1—4-screw terminal strip
- 1—4-lug terminal strip with grounded lug
- 1—5 x 4 x 3-in. aluminum Minibox
- 1—5-prong tube socket (Amphenol 7855 or equiv.)
- Misc.—Knob, vernier dial, screws, nuts, spacers, battery plug, wire, solder lugs, solder, etc.

*DX Devil preselector boosts signal levels as much as 40 dB at frequencies from 4 to 30 MHz. Three plug-in coils which cover frequency range mount in 5-prong socket at top of unit. When regeneration control (R2) is set just below point of oscillation, tuning of C1 is very sharp. Vernier dial permits careful adjustment by operator so that desired station can be received at maximum strength. Improved performance will be especially noticeable at higher frequencies.*

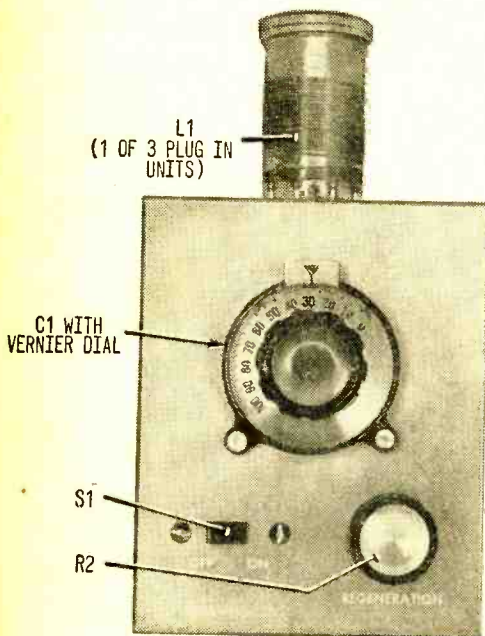



use of plug-in coils. Wiring the preselector is relatively easy because there are so few components inside the uncluttered chassis. All in all, the device is a fine project for the fellow who's looking for an inexpensive, easily built gadget that will markedly improve the performance of his receiver.

**Construction.** The first order of business is to modify C1. Cut  $\frac{3}{8}$  in. off the shaft and remove 11 of the rotor (movable) plates. Start at the rear of the capacitor and slowly bend backward one plate at a time, then carefully pull it out of the brass shaft. When you are finished, there should be six rotor plates remaining in the capacitor.

When operating at maximum gain, the unit tunes very sharply, and you must employ a vernier dial. The actual method of mounting C1 will depend on the type of dial you buy. In the prototype, C1 was supported on two 1-in. spacers through which

were passed two 6-32 screws. Self-tapping screws can be employed if you have no way of threading the holes which are factory drilled in the capacitor frame.

Mount the coil socket after you have installed C1 and the dial. Then drill holes for R2, S1, and the three-terminal mounting strip. Carefully file the slot for S1 so that the knob slides back and forth without binding. Mount TS1 on the rear cover of the Minibox.

Plastic-coated, solid #20 hookup wire is recommended for all leads except those running to TS1 and the battery connector. In these cases, insulated stranded wire is preferable. Solder the gate terminal of Q1's socket directly to pin 2 of L1's socket and cut the leads of the disc capacitors and R1 as short as possible. Wire R2 as shown, so that it is at minimum resistance when the regeneration control knob is turned fully clockwise.

**Three Coils.** Wind the coils on  $2\frac{1}{4}$  x  $1\frac{1}{4}$ -in. polystyrene forms. While it is true that large-diameter wire makes the most efficient coils, #28 Formvar insulated wire is much easier to work with, and you'll find it provides results that are entirely satisfactory.

Closewind the primaries, and space the secondaries so that the winding lengths are approximately as specified in the Parts List. When soldering the coil prongs, don't let them get too hot. Otherwise, the form will melt and the prongs will tilt askew. Use an iron with lots of heat, but apply it to the pins for only a short period of time. After each coil has been completed, coat it thoroughly with Q-dope or polystyrene cement.

The top end from a discarded 9-volt battery can serve as a power plug. Tape the preselector's battery to the bottom of the Minibox.

Diodes D1, D2, D3, and D4 must be used if you have a radio transmitter in the house. The purpose of these diodes is to short out dangerously high voltages which might otherwise reach the

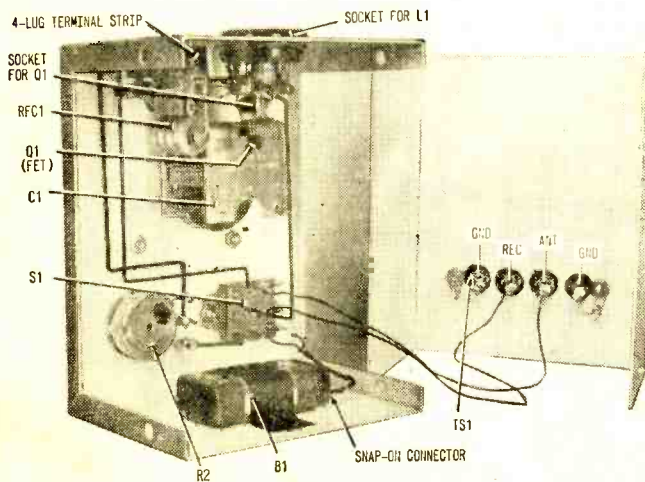
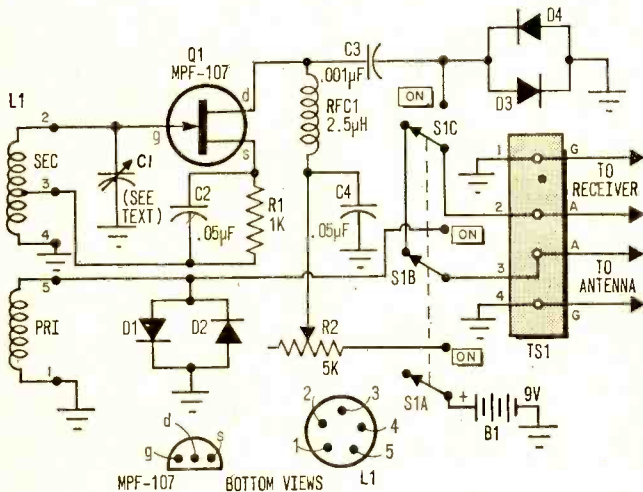

transistor and burn it out. They will also protect Q1 from static discharges resulting from nearby lightning strokes.

The diodes offer a fairly high resistance to the tiny signal voltages present on the antenna feed, but they break down to form a direct short whenever they are subjected to more than a few volts of RF energy. Just about any low-cost silicon rectifier will do the job. The ones in the photo below are inexpensive 750-mA, 400-PIV units. Type 1N34A germanium diodes will also prove satisfactory. The diodes can be omitted if you have no transmitting gear and live in an area with few thunderstorms.

**Adjustment.** After carefully checking for wiring errors, plug in Q1 and the battery. Run twinlead or a coax between the receiver's antenna connector and terminals 1 and 2 of TS1. Attach the feed from a doublet antenna to terminals 3 and 4.

If you use coax at either point, attach the shield braid to the G terminal and the center conductor to the A terminal as marked on the schematic. If you run twinlead to the receiver, be sure to connect the wire on terminal 1 of TS1 to the ground terminal. If you use a single wire rather than a doublet, connect it to terminal 3 and then run a lead from terminal 4 to an earth ground.

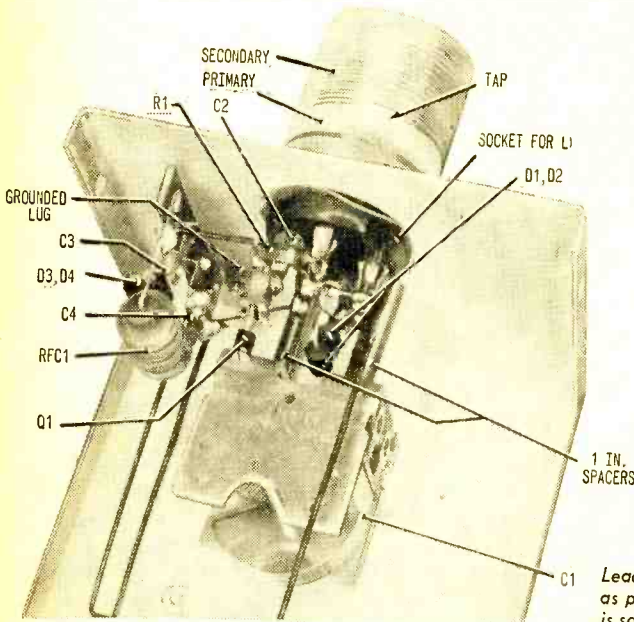

Leads to L1's socket should be as short as possible. Gate terminal of Q1's socket is soldered directly to pin 2 of L1.

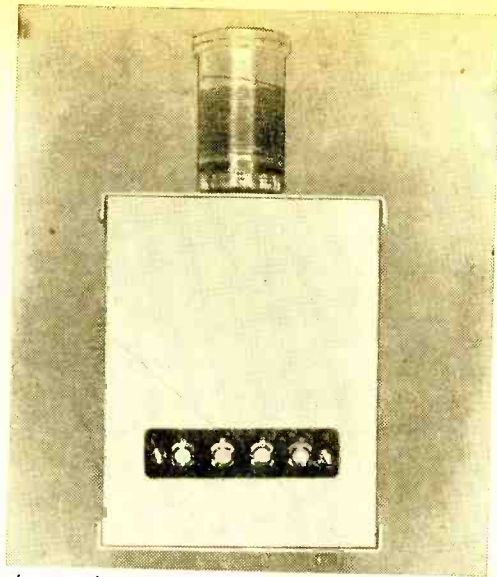

Input and output leads attach to terminal strip as follows: from left to right, Gnd—Ant—Rec—Gnd.

Snap the back on to the Minibox and fasten it in place with sheet metal screws. The unit won't work unless you do this, because there must be a good electrical connection between the two halves of the case.

Tune the receiver to a 4-MHz signal, preferably one from an AM station, and plug in coil 3. Turn on S1 and set R2 in its maximum clockwise position. Tune C1 back and forth. You should hear some birdies (extraneous signals) in the receiver. These indicate oscillation in the preselector.

Rock C1 while turning the regeneration control counterclockwise. You should finally reach a setting of R2 where the birdies disappear, and a point on C1 where the 4-MHz signal is much louder when S1 is on than when it is switched off.

**Feedback.** The small portion of coil which appears between pins 3 and 4 is the feedback winding. It causes the circuit to be regenerative. Because of variations in transistor gain, as well as antenna and receiver input impedances, it may be necessary to modify the coil a bit to provide optimum (Continued on page 106)

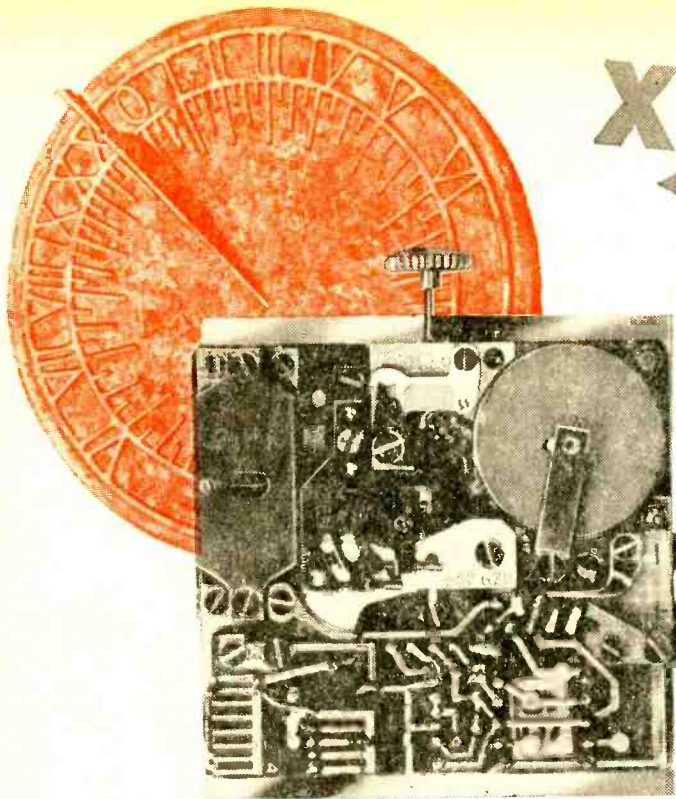

# MARKS THE *time* SPOT

Micro-electronics and micro-mechanics combine thin films and tiny motors in a watch so accurate it chops each second into thousands of equal, miniscule pieces

By Jorma Hyyppia

**T**he watchmakers of Switzerland have done it again! Helvetian horological scientists have now created an ultra-precise wristwatch by splitting a second of time into ten thousand equal parts! To turn the trick, they've crammed a vibrating crystal and the equivalent of several transistor radios into a pea-size package, then used this remarkable micro-electronic system to operate a miniscule synchronous motor in a normal-sized wristwatch.

The feat has won for the Swiss renewed recognition as master craftsmen in the art of designing precision timepieces. At a recent International Chronometric Competition held at the Neuchatel Observatory in Switzerland, a Swiss-engineered electronic quartz wristwatch garnered top honors in competition against 227 other competing watches.

This revolutionary watch might have taken longer to develop except for one significant factor: rough competition. When the Bulova

Watch Company introduced its Accutron watch in 1960, the Swiss watch industry was badly shaken by the expected competitive impact. Hurriedly, the Swiss collected the best available horological brains and put them to work in a new, ultra-modern research laboratory called *Centre Electronique Horlogère (CEH)*. The crash objective: create electronic timepieces that would ensure the economic security of Swiss watchmakers. Here's how researchers at the Horological Electronic Center reclaimed Swiss fame.

**Old Idea, New Twist.** Though the CEH quartz watch is a wholly new kind of wristwatch, it incorporates no new design features other than ultra-miniaturization. Basically, the watch is a quartz clock that has been squeezed small enough to fit into an average-size watch case. But that squeezing took some doing!

Quartz clocks—actually chronometers—

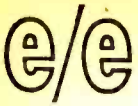

## X MARKS THE TIME

have been widely used for a long time, and much has been done in recent years to reduce their sizes. In 1966, the Swiss watch industry created the first pocket quartz watch. Few would have guessed that within a year the final step of miniaturization would be accomplished.

CEH researchers are understandably loathe to reveal all the design secrets embodied in the new watch. For example, they refuse to reveal the exact electronic circuits used in the watch. But a pretty good idea of the probable nature of these circuits can be obtained by examining the workings of a typical quartz clock and making the assumption that the watch circuits are quite similar except for size (see Fig. 1).

**Piezoelectric Time Standard.** A quartz crystal is the heart of any electronic quartz timepiece; it is capable of beating out a fractional-second time pulse with incredible accuracy and reliability. In fact, a vibrating quartz crystal is recognized to be the most precise time standard known, with the exception of atomic standards.

The vibrational regularity of quartz is a manifestation of the mineral's piezoelectric properties. When a properly prepared crystal is electrically energized, it physically vibrates at some steady, high frequency. In a typical quartz clock, the crystal may have a vibrational frequency as high as a million cycles per second (Hz). In the new CEH watch, the crystal is made to vibrate at a frequency of about 10,000 Hz.

High-frequency vibration—or oscillation—is the key to very accurate timekeeping. The higher the frequency, the more effectively it can maintain timing accuracy.

Conventional watch mechanisms that utilize a hairspring-balance wheel timing system oscillate at frequencies ranging from 2.5 to 5 Hz. The Bulova Accutron watch uses a tiny, vibrating tuning fork to obtain a much higher frequency of 360 Hz. This substantial frequency step-up accounted for the much improved timing accuracy of the Accutron. Now, by utilizing the unique properties of the quartz crystal, CEH researchers have increased the oscillatory standard to a phenomenal 10,000 Hz!

How much of an improvement does this frequency increase represent in actual time-keeping accuracy? Mass-produced Accutron watches are guaranteed to keep correct time within two seconds per 24 hours under normal use conditions. CEH reports that the new quartz watch loses or gains only a few tenths of a second in the same period of time. This degree of accuracy has been obtained with prototype watches carefully handcrafted for research purposes; mass-produced versions are quite likely to have a guaranteed accuracy in the order of at least one second per day.

**Frequency Step-Down.** To improve timing accuracy, the second must be sliced into ever smaller fractional increments. But the high-frequency oscillations that represent these minute time intervals cannot be used to directly drive a watch indicator mechanism. The high frequency must be stepped down to a level that can be used to control a synchronous electric motor coupled to the gear system that operates the hands of the timepiece.

Incidentally, this frequency step-down may not be required when the ultimate electronic watch has been perfected. The reason: such a watch will have *no* moving parts—not even the traditional hands.

**Frequency Divider Circuit.** The frequency step-down is accomplished electroni-

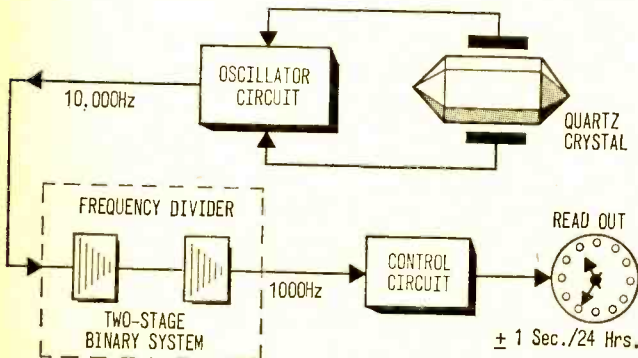

Fig. 1. Ultra-precise quartz watch uses crystal-controlled oscillator as a frequency reference. The high-frequency signal is reduced to a lower multiple by frequency divider network and fed to a control circuit which adjusts the rpm of a tiny synchronous motor. Design is same as quartz clock, but oscillator frequency is lower and two-stage frequency divider is simpler.

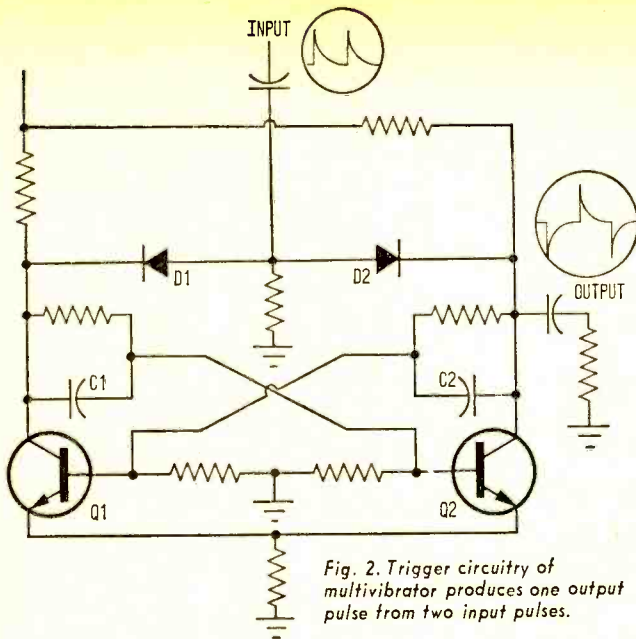

Fig. 2. Trigger circuitry of multivibrator produces one output pulse from two input pulses.

cally by means of a complex frequency divider system made up of a chain of binary divider circuits. Just what is a binary divider? How does it work?

Figure 2 shows a basic binary (flip-flop) circuit. In any such flip-flop system, the symmetrical circuit provides two possible stable conditions: 1) transistor Q1 is on and Q2 is off. 2) Q2 is on and Q1 is off.

Assume that Q1 is on when a positive pulse is applied at the input. The pulse passes through the steering diode D1 and then through capacitor C1 to the base of the npn transistor Q2 which thus becomes slightly conducting. The collector voltage of Q2 is decreased, and this decrease is passed on through C2 to the base of Q1, which becomes less conducting than it was before the

pulse was applied to the input. The resulting voltage increase on the Q1 collector is passed on to the base of transistor Q2 to further increase its conductivity. This regenerative process continues until a reverse equilibrium is reached.

The significant result is that only one output pulse is derived from every two input pulses. This scale-of-two or binary system forms the basis of the more complex divider circuits used in the quartz timepieces. In large quartz clocks, these basic binary flip-flops are often integrated to form scale-of-ten systems in which ten input pulses are needed to produce one (see Fig. 3).

The CEH watch presumably uses a similar chain of integrated binary frequency divider circuits to bring the oscillator frequency down to the required 1000 Hz, the frequency needed to control the tiny synchronous motor in the watch.

These integrated circuits operate in the microwatt power range. The truly amazing fact is that in the CEH watch two stages of divider circuits are contained in a single, plastic-covered capsule measuring only 6 x 4.3 x 1.5 millimeters! Most of this tiny volume is occupied by the protective plastic; the actual circuits—the equivalent of several transistor radios—represent only about one one-hundredth of the total capsule volume!

**Thin Film Circuitry?** The CEH researchers aren't saying just how they manage to cram so much complex circuitry into such microscopic space. A good guess: they use "thin-film" microcircuit techniques devel-

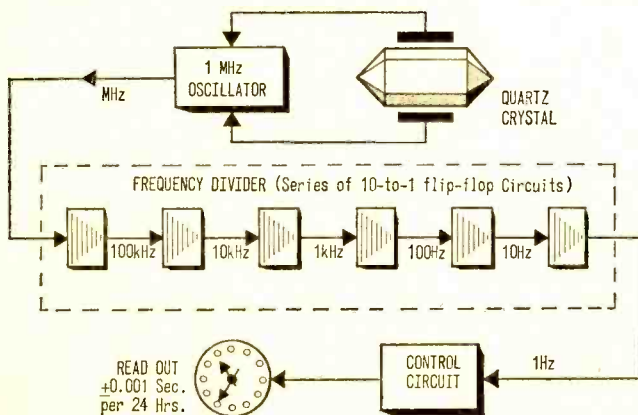

Fig. 3. Since scale-of-two (binary) circuits can be integrated in a frequency divider network, multiples of basic two-to-one input-output ratio are obtained. Ten-to-one scales are common in quartz clocks. Precision quartz chronometers use a high-frequency oscillator and multi-stage frequency divider with series of binary flip-flop circuits for ultra precise timekeeping.



## X MARKS THE TIME

oped by members of the computer industry.

It is quite possible to vaporize various substances onto extremely thin supporting films to create complex circuits containing all types of components including transistors, diodes, resistors, capacitors, as well as interconnecting leads. These films may be as thin, or thinner, than the skin of a soap bubble. A few square millimeters of such a film may contain several dozen transistors and resistors, all properly connected as they would be in a conventional micro circuit.

**Micro-mechanics.** Ordinary electronic circuits require at least a few milliwatts of electrical power to make them operational. To make the delicate circuitry of the quartz watch function properly, the designers had to scale these usual wattages down a thousand-fold. Power consumed by the electronic watch is in the order of 10 microwatts—10 millionths of a watt! This is roughly a millionth the power consumed by a ten-watt light bulb.

The wizardry of the CEH researchers wasn't all electronic. They also had to make use of their expertise in micro-mechanics in order to construct an extremely minute, yet rigorously synchronized electric motor to turn the watch hands. This motor is not only small in size, but it operates on only a few microwatts of power and responds to electrical pulses in the order of a thousandth of a second.

This low power consumption makes it possible to operate the quartz watch for a full year using one small mercury cell.

**Atomic Judge.** How is it possible to measure and judge the time-keeping accuracies of such high-precision watches, and the even more accurate quartz clocks? The sole solution is to use even more accurate time-pieces as the standards. And the only time-piece that is more accurate than a quartz chronometer is an atomic clock (see Fig. 4).

Basically, an atomic clock is a glorified

quartz clock, with one very significant difference. In the quartz clock the vibrating quartz crystal is used as the prime frequency standard that cuts time into accurate increments. In an atomic clock the quartz crystal is coupled through a frequency multiplier and control circuit to a new frequency standard of even greater inherent precision—atomic energy.

The element cesium-133 has been selected as the most practical atomic standard for time measurements, though other atoms can be used. Cesium-133 sublimates when heated, and the resulting vapor is used to create a cesium beam. When this beam is energized, the cesium electrons are moved to higher spin energy levels. Subsequent spin transition to lower energy levels releases energy in very precise frequency increments—exactly 9, 192, 631, 770 Hz.

The cesium is not a clock in itself. But it is a primary standard and as such can be used to measure and define a second very accurately. In the atomic clock, the output of the quartz oscillator is multiplied to provide a frequency equal to the cesium resonance frequency. A control circuit then compares the two frequencies—that of the cesium and of the quartz oscillator circuit. If the quartz oscillator frequency starts to drift, the control circuit generates an error signal which automatically adjusts the frequency of the oscillator to again exactly match that of the cesium standard.

This precisely controlled output of the quartz oscillator is then fed through the usual frequency-divider circuits to a synchronous motor used to drive the final read-out system.

An atomic clock is capable of truly incredible accuracy. For example, a portable atomic clock made by the Hewlett-Packard Company was recently transported to several countries for purposes of making precise time checks on a world-wide basis. This clock is so accurate that it would require 1600 years for it to accumulate an error of only one second!

**Cautious Marketing.** When will you be able to buy one of the CEH electronic quartz  
*(Continued on page 110)*

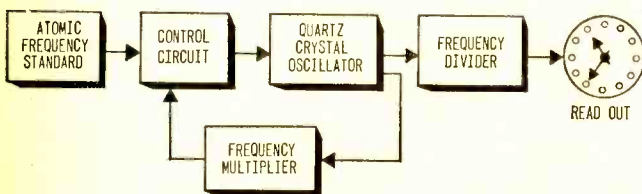
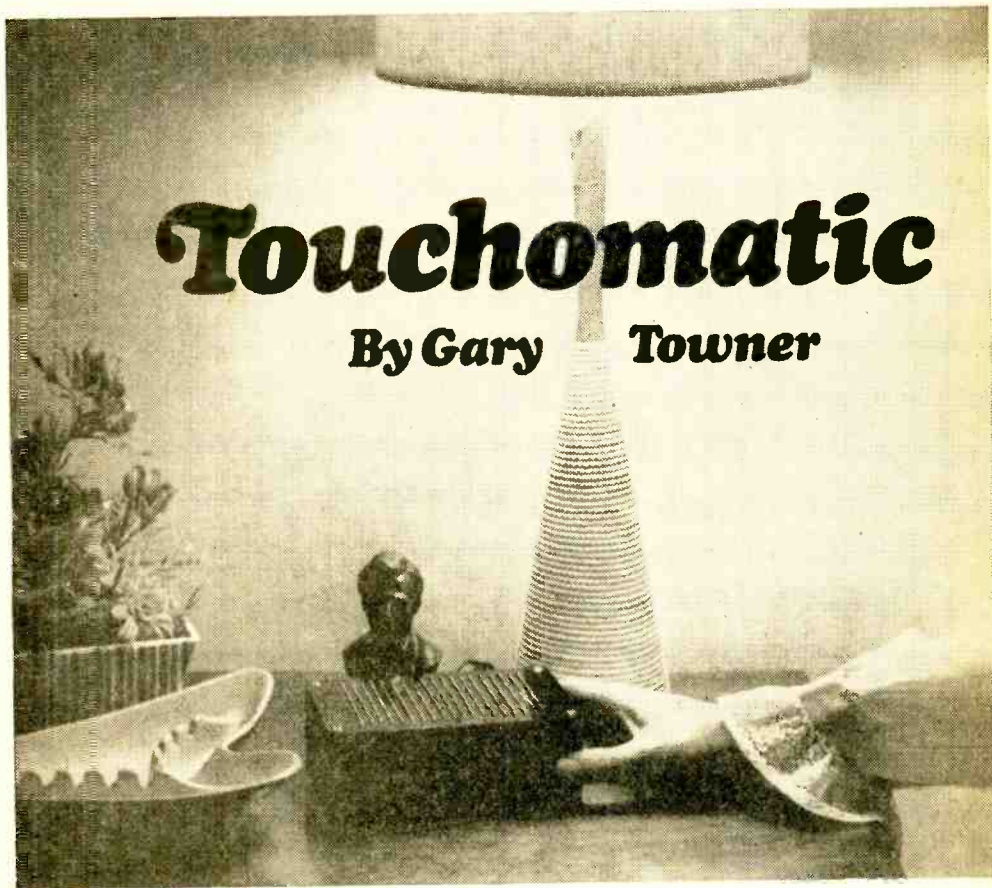

Fig. 4. Atomic clocks can judge performances of other chronometers and watches. While they use quartz-crystal oscillator and frequency divider network, their timing accuracy is based on atomic frequency standard rather than quartz vibrations.

**Your instamatic silent switcher allows you to switch at least a kilowatt of power with almost no pressure at all. In fact, this nifty device wants only the right touch—just a light touch!**



# Touchomatic

By Gary Towner

**E**ver get tired using heavy, bulky switches for equipment that takes a lot of power? Well, snap on the Touchomatic and see that there is, indeed, a better way!

Ever get tired of having to leave the room to turn out the lights or having to get up from your chair to switch on the TV? Then give in and build the Touchomatic for a touch that will really tell. Its applications are limitless. You can even control the power input to your ham or CB shack from one central point with this snappy control box.

Anyone can have magic fingers with this do-all switch. And with the heavy-duty relay that's included, just under a 1000 watts of resistive power can be controlled. No modifications to your present equipment need be made, and operation is safe and

reliable. But if you're the kind of fellow who touches all bases, you can even add an isolation transformer to make sure that the AC line voltage stays in its place.

**A Working Model.** Taking a look at the schematic, you can see that R1, the touchplate (TP), R2, C1, and NE1 would form a basic relaxation oscillator if it were not for 1000-ohm resistor R3. With the addition of R3, a pulse-generating circuit is formed.

When someone touches the touchplate (TP), the resistance of his finger across points A and B is added in series to the combination of R1 and R2, and capacitor C1 begins to charge. When the voltage across C1 is finally sufficient to fire NE1, C1 will begin to discharge.

When NE1 fires, it produces a short be-

# e/e TOUCHOMATIC

tween its terminals. Since R3 is connected across C1, they are effectively in series after NE1 fires. A voltage spike will then be passed by C2 and this will act as a positive triggering pulse. The pulse is fed to both SCR gates; SCR2 conducts, thereby closing relay K1. With a finger no longer on the touchplate, no more pulses are forthcoming because the C1 charge path is open.

The next contact with the touchplate will produce a pulse which triggers SCR1. SCR2 is now turned off by capacitor C3 which was charged by current passing through R6 and

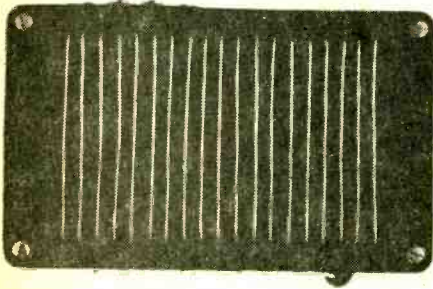

Author's design for touchplate is shown above. Touching any combination of two wires connecting points A and B (see schematic, above right) will trigger relay. Underside of cover (below) shows wiring layout for touchplate. Leads from A and B are connected to solid wires in alternate rows.

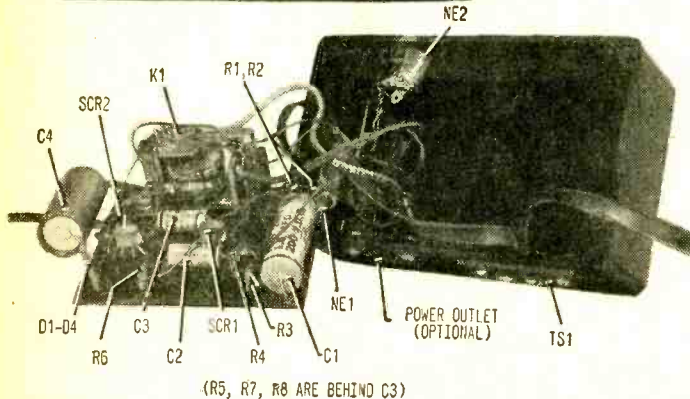
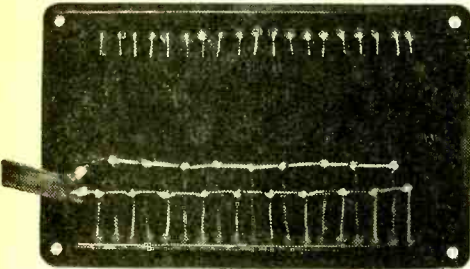

(R5, R7, R8 ARE BEHIND C3)

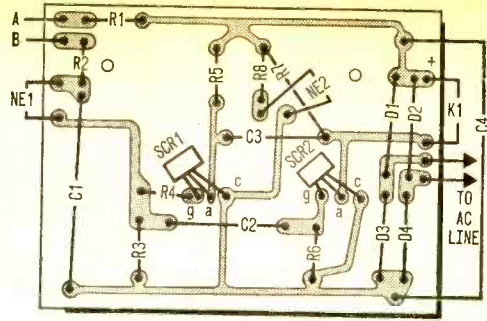

Heavy lines show how components mount on top of PC board. Relay K1 fits between two holes at top of board, covering R5, R7, and R8. A perf board and flea clips or push-in terminals will also work fine.

SCR2. The firing of SCR1 in this way places a negative voltage across SCR2 which momentarily drops the relay current to a point below the holding current value of SCR2. (Holding current is the minimum current an SCR requires to remain in a conducting state once its gate voltage is removed.)

With SCR2 turned off, the relay will open and SCR1 will turn off due to the large resistance in series with its anode. Starved in this way, SCR1 turns off because of a forced lack of holding current.

**Construction.** Due to such high sensitivity, one might expect the parts layout to be critical. This just isn't so. If you follow the photos and pictorial you shouldn't have any trouble.

Together R1 and R2 offer excellent isolation from the AC line. A transformerless power supply is used. But as said before, an isolation (power) transformer might be a good idea, particularly if you want to be certain that you're always on the safe side.

The actual form of the touchplate is pretty much up to you. The model shown was constructed by drilling holes in the box lid and placing solid wire in alternate positions

Circuit board removed from plastic case. Parts layout corresponds to wiring pictorial at top of page. While NE2 mounts on case in a panel light assembly, NE1 is connected to board with heavy wire soldered to terminals of bulb. A #51 neon lamp having wire leads might be more convenient. If perf board is used, parts layout will be basically the same. Optional power transformer should fit into plastic case.



Note that touchplate (TP) is connected to circuit with 300-ohm twinlead at points A and B. These two points are located on terminal strip TS1. With this design, an external input (i.e., from a switch) would connect to screw terminals of TS1. Twin lead is also used to connect points A and B at TS1 to PC board.

Since R1 and R2 offer only minimal isolation from AC line, and diodes D1-D4 could short out, an isolation transformer is recommended for beginners.

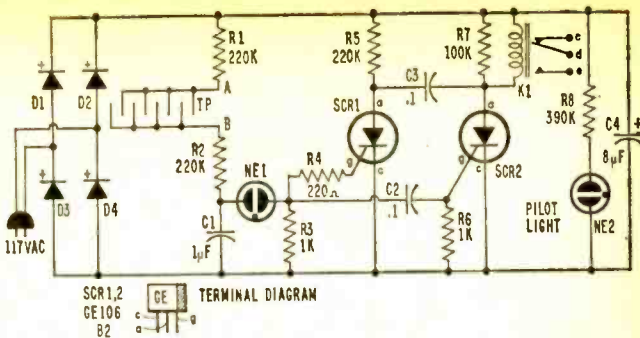

### PARTS LIST FOR TOUCHOMATIC

C1—1- $\mu$ F, 200-VDC capacitor  
 C2, C3—0.1- $\mu$ F, 400-VDC capacitor  
 C4—8- $\mu$ F, 450-VDC electrolytic capacitor  
 D1, D2, D3, D4—10B2 silicon rectifier  
 K1—110-VDC, spdt, 8000-ohm power relay (P&B MR5D, Allied 41 E 6760 or equiv.)  
 NE1, NE2—#51 neon bulb  
 R1, R2, R5—220,000-ohm, 1/2-watt resistor  
 R3, R6—1000-ohm, 1/2-watt resistor  
 R4—220-ohm, 1/2-watt resistor  
 R7—100,000-ohm, 1/2-watt resistor  
 R8—390,000-ohm, 1/2-watt resistor  
 SCR1, SCR2—GE 106B2 silicon controlled rectifier  
 Misc.—Plastic box and cover, touchplate (see text), panel light assembly for #51 neon bulb, 2-screw terminal strip, optional chassis-mounting AC outlet (Allied 47B0830 or equiv.), zip cord, 300-ohm twinlead, PC board or perf board (optional), rubber feet, spaghetti, wire, solder, hardware, etc.

so that touching any combination of two different leads (A and B) will close the relay. The wire should be rugged and spaghetti should be used to insulate one group of wires from the other (A from B).

**Applications.** Your touchplate needn't be the end of the line for the Touchomatic. While the basic Touchomatic hookup is shown (Fig. A), other hookups can be made to points A and B via terminal strip TS1. Figs. B and C show circuits for a burglar alarm and hall light system.

The hall light system—as well as similar circuits—requires only low-current wires and switches, and the whole system is switched on or off at any one control point. These are just starting points for people who want to experiment—just use your imagination.

Last but not least! Touchomatic can be one hell of a devilish device. Just leave a sign next to it saying DO NOT TOUCH. Then hook up points A and B to whatever gimmick you can think of, and watch your panic button go to work on an unsuspecting victim! Yikes!

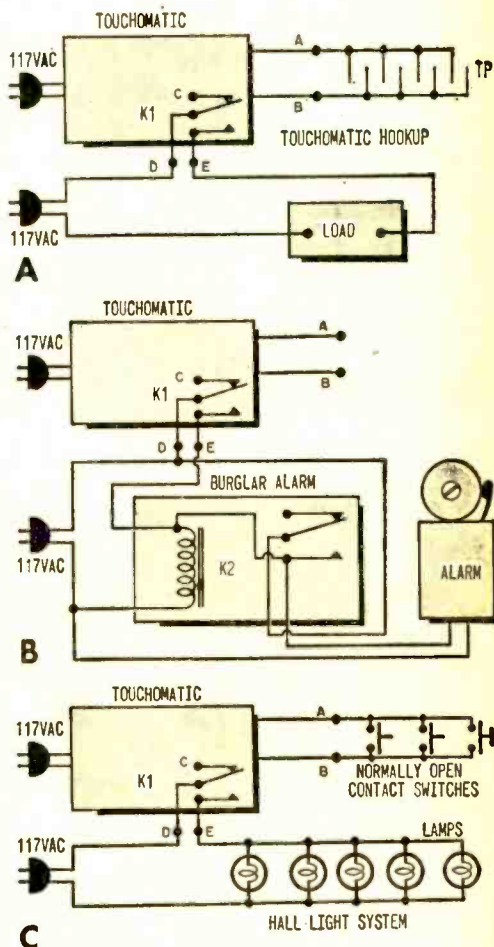

Basic Touchomatic hookup is shown above in Fig. A. While relay K1 is a spdt model, only two contacts (d and e) were used by author. However, experimenters may wish to use contact c for some kind of indicator to show that switch is off, etc. Fig. B is design for a burglar alarm, and contains an external relay K2 to control current to alarm and to provide a latching circuit so that alarm cannot be switched off. Builder might want to add a switch so that relay may be de-energized at his command. Finally, Fig. C illustrates typical lighting circuit where external switches connected in parallel can control lights at any one point.

# SOMEONE SHOULD DEVELOP AN EASY WAY TO LEARN ELECTRONICS AT HOME

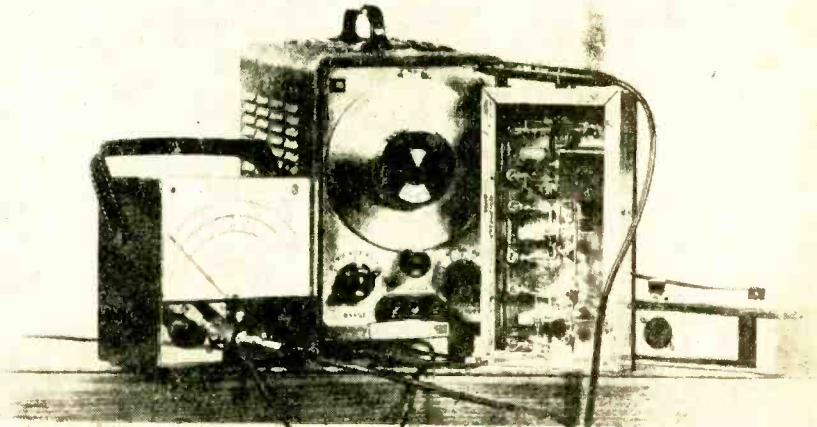

## RCA INSTITUTES DID!

Here is a whole new approach to learning electronics at home! RCA Institutes, one of the nations' largest schools devoted to electronics, has developed a faster, easier way for you to gain the skills and the knowledge you need for the career of your choice. Here for the first time, is a student-proved, scientifically designed way to learn. If you have had any doubts in the past about home training in electronics—if you have hesitated because you thought you might not be able to keep up—or that electronics was too complicated to learn—here is your answer! Read how RCA Institutes has revolutionized its entire home training ideas!

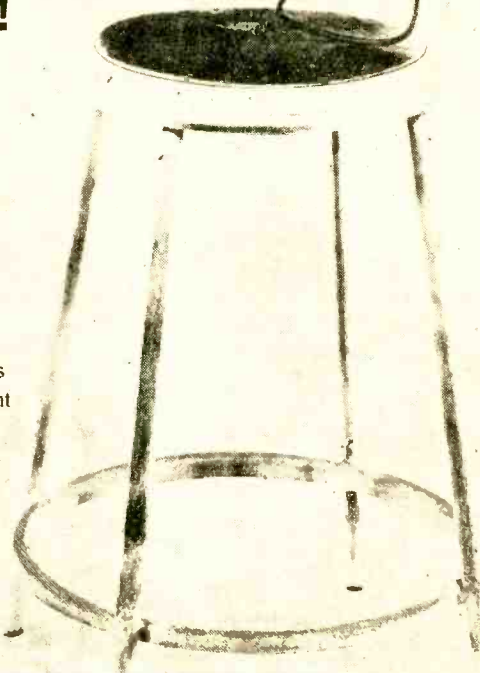

## NEW CAREER PROGRAMS BEGIN WITH "AUTOTEXT" INSTRUCTION METHOD!

Start to learn the field of your choice immediately!

No previous training or experience in electronics needed!

With this new revolutionized method of home training you pick the career of your choice—and RCA Institutes trains you for it. RCA's Career Programs assure you that everything you learn will help you go directly to the field that you have chosen! No wasted time learning things you'll never use on the job! The Career Program you choose is especially designed to get you into that career in the fastest, easiest possible way!

And each Career Program starts with the amazing "AUTOTEXT" Programmed Instruction Method—the new, faster way to learn that's almost automatic! "AUTOTEXT" helps even those who have had trouble with conventional home training methods in the past. This is the "Space Age" way to learn everything you need to know with the least amount of time and effort.

### CHOOSE A CAREER PROGRAM NOW

Your next step may be the job of your choice. Each one of these RCA Institutes Career Programs is a complete unit. It contains the know-how you need to step into a profitable career. Here are the names of the programs and the kinds of jobs they train you for. Which one is for you?

**Television Servicing.** Prepares you for a career as a TV Technician/Service man; Master Antenna Systems Technician; TV Laboratory Technician; Educational TV Technician.

**FCC License Preparation.** For those who want to become TV Station Engineers, Communications Laboratory Technicians, or Field Engineers.

**Automation Electronics.** Gets you ready to be an Automation Electronics Technician; Manufacturer's Representative; Industrial Electronics Technician.

**Automatic Controls.** Prepares you to be an Automatic Controls Electronics Technician; Industrial Laboratory Technician; Maintenance Technician; Field Engineer.

**Digital Techniques.** For a career as a Digital Techniques Electronics Technician; Industrial Electronics Technician; Industrial Laboratory Technician.

**Telecommunications.** For a job as TV Station Engineer, Mobile Communications Technician, Marine Radio Technician.

**Industrial Electronics.** For jobs as Industrial Electronics Technicians; Field Engineers; Maintenance Technicians; Industrial Laboratory Technicians.

**Nuclear Instrumentation.** For those who want careers as Nuclear Instrumentation Electronics Technicians; Industrial Laboratory Technicians; Industrial Electronics Technicians.

**Solid State Electronics.** Become a specialist in the Semiconductor Field.

**Electronics Drafting.** Junior Draftsman, Junior Technical Illustrator; Parts Inspector; Design Draftsman Trainee Chartist.

### SEPARATE COURSES

In addition, in order to meet specific needs, RCA Institutes offers a wide variety of separate courses which may be taken independently of the Career Programs, on all subjects from Electronics Fundamentals to Computer Programming. Complete information will be sent with your other materials.

### LIBERAL TUITION PLAN

RCA offers you a unique Liberal Tuition Plan—your most economical way to learn. You pay for lessons only as you order them. No long term contracts. If you wish to stop your training for any reason, you may do so and not owe one cent until you resume the course.

### VALUABLE EQUIPMENT

You receive valuable equipment to keep and use on the job—and you never have to take apart one piece to build another. **New—Programmed Electronics Breadboard.** You now will receive a scientifically programmed electronic bread-

board with your study material. This breadboard provides limitless experimentation with basic electrical and electronic circuits involving vacuum tubes and transistors and includes the construction of a working signal generator and superheterodyne AM Receiver.

**Bonus From RCA—Multimeter and Oscilloscope Kits.** At no additional cost, you will receive with every RCA Institutes Career Program the instruments and kit material you need to build a multimeter and oscilloscope. The inclusion of both these kits is an RCA extra.

### CLASSROOM TRAINING ALSO AVAILABLE

RCA Institutes maintains one of the largest schools of its kind in New York City where classroom and laboratory training is available in day or evening sessions. You may be admitted without any previous technical training; preparatory courses are available if you haven't completed high school. Coeducational classes start four times a year.

### JOB PLACEMENT SERVICE, TOO!

Companies like IBM, Bell Telephone Labs, GE, RCA, Xerox, Honeywell, Grumman, Westinghouse, and major Radio and TV Networks have regularly employed graduates through RCA Institutes' own placement service.

SEND ATTACHED POSTAGE PAID CARD FOR COMPLETE INFORMATION, NO OBLIGATION. NO SALESMAN WILL CALL.

ALL RCA INSTITUTES COURSES  
AVAILABLE UNDER NEW GI BILL.

Accredited Member  
National Home Study Council

**RCA INSTITUTES, Inc., Dept. EA-98**  
320 West 31st St., New York, N.Y. 10001

# RCA

# CODE 99

An urgent, cryptic message speeds doctors and nurses to a troubled heart in need

“**A**ttention, please! Attention, please! Code 99!”

These words announced over the public-address system of New York's Saint Vincent's Hospital mean someone is dying of a heart attack. Nurses run for a cart loaded with specialized life-saving equipment. (Continued on page 58)



A patient is dying of cardiac arrest—Code 99!



Doctors and nurses hasten to the patient's bedside, some bringing specially prepared carts containing respiration equipment, ECG machine, and vital medical supplies.

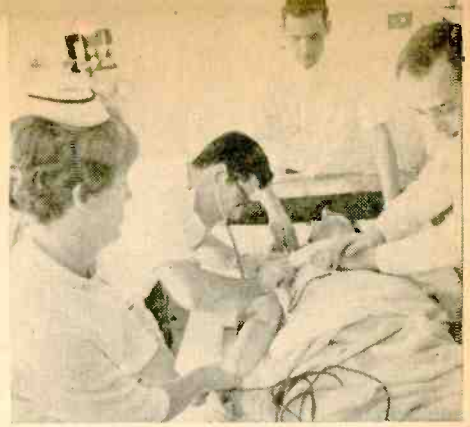

Only seconds have elapsed since Code 99 was sounded. Heart is massaged and oxygen is administered (top left). Patient's breath is returning, and doctor (top right) listens to determine whether it is adequate. Heart massage continues. External cardiac massage apparatus (right), which shocks heart back into action, is applied. Nurse in background prepares injection of sodium bicarbonate to neutralize dangerous acids that build up when circulation is stopped. Doctor (below left) monitors and interprets tape from ECG machine connected to patient for on-the-spot heart data. Important decisions can be made immediately. Later, same doctor (lower right) remotely monitors patient's heart action at central cardiac monitor. (Turn page)

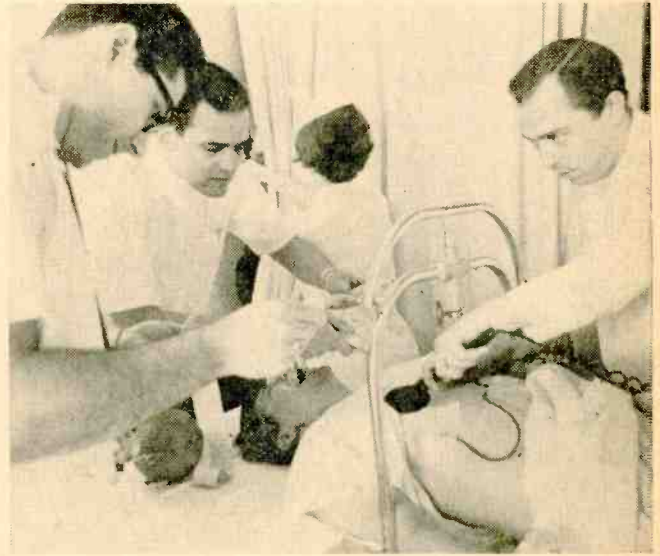

# e/e CODE 99

(Continued from page 56) Doctors come on the double, direct to the patient's bedside. In seconds, a remarkable team is formed and functioning, a team which may literally bring the patient back from the grasp of death.

St. Vincent's Hospital is one of the first in the country to use this unique method of saving the dying. The pioneering Code 99 was prompted by new techniques in artificial respiration and circulation, coupled with electronic devices which permit doctors to revive people who otherwise would be lost. Code 99 makes sure doctors get to the patient during the first four minutes—the vital period before the brain begins to die. ■

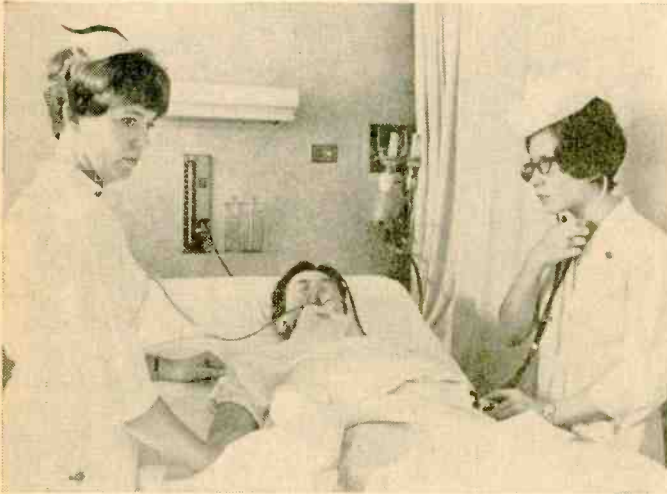
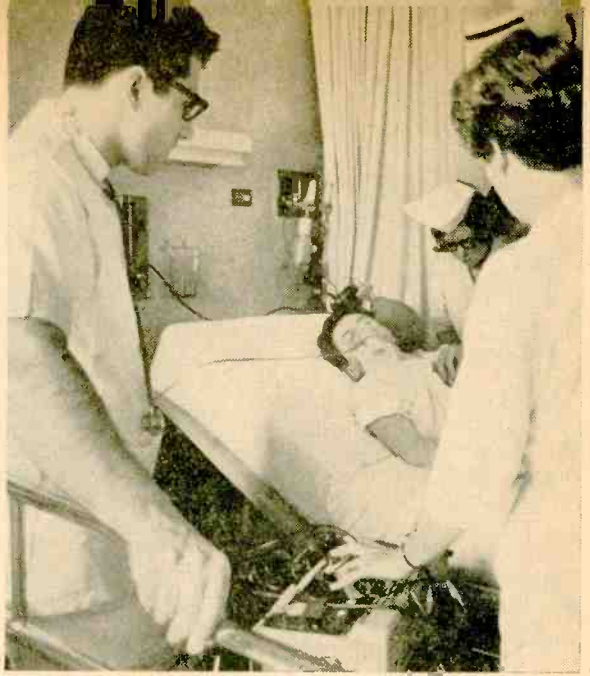

Code has been successful again. Patient's heart activity has been restored and he breathes with help of oxygen (top). Only minutes have passed. Nurses follow patient's progress as he begins to regain consciousness (left). His chest may feel like it has been stepped on by an elephant from the severity of the external massage, but he will be alright. Nurses keep a constant vigil until he is back to normal. Getting ready for the next Code 99, doctor examines automatic respirator (bottom), part of the many pieces of equipment used in treatment. All is kept in complete readiness, since Code 99 alert can be sounded any time.

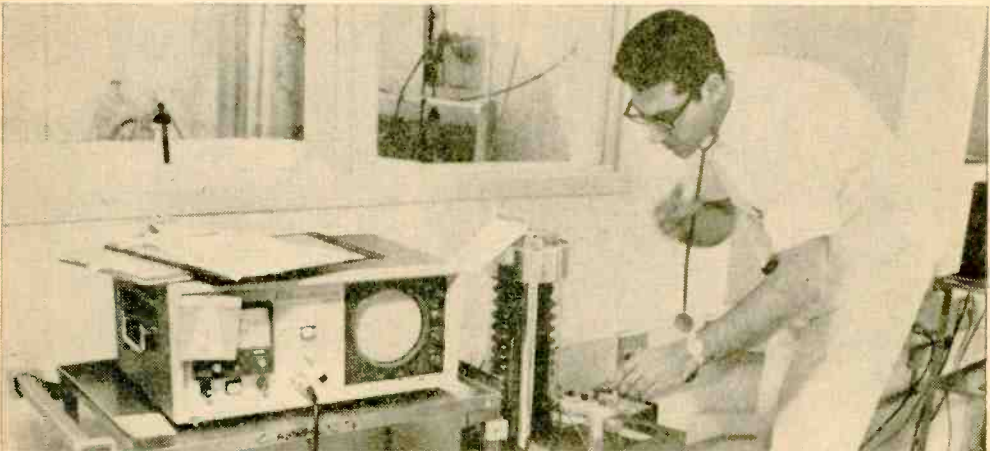

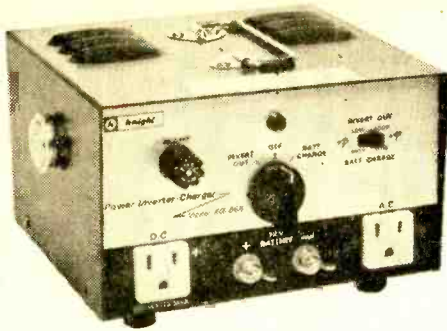

### KNIGHT-KIT Model KG-666 Combination Inverter, DC Supply, & Charger

**A**t some time or other, just about everyone seriously interested in electronics finds that life could be a whole lot easier if he just had 117 VAC in the car. Sometimes it's a need to power a TV receiver to keep the kids occupied in the back of a station wagon. Other times, it's a desire to take along the ham rig as a portable, or the base CB transceiver. Then again, maybe you just want to power an electric drill without a long "snake" trailing back to the house; or a portable electric typewriter; or a tape recorder. Whatever the case, 117 VAC is a mighty handy thing to have in a car, boat, or—you name it!

While budget-priced AC inverters—devices powered off the battery which deliver 117 VAC—have been around a long time, most are sharply limited in power-handling capacity. But now, if you're willing to spend a few hours rolling your own, you can have 200 watts of AC virtually sitting on the seat of the car. Damage is only \$44.95, the price of the Knight-Kit KG-666 Inverter/Charger.

**Three In One.** The KG-666 combines three functions in one instrument. First, the unit is a 12-VDC to 117-VAC inverter capable of delivering up to 200 watts output. Second, the unit provides 117 VDC for more efficient operation of AC/DC equipment or appliances with universal motors. Finally, the KG-666 functions as a battery charger.

The KG-666 is designed as a portable, with an attached handle and rubber mount-

ing feet. Two binding posts on the front panel provide the battery connection. On either side of the binding posts is a standard U-ground socket. One is for 117 VAC, the other for 117 VDC, and the positive (+) DC terminal so marked. For battery charging, a plug-in power cord connects on the rear apron.

A mode switch on the front panel provides instant selection of the *invert*, *off*, or *charge* modes. And a slide switch (also on the front panel) selects high or low *inverter* out voltage or *charging current*. Both the charge and inverter circuits are protected; the charger by a rear-apron circuit breaker and the inverter output by a panel-mounted fuse.

**Square, Almost Sixty.** It is important to keep in mind that the inverter output is approximately 60 Hz and that the voltage waveform is square, not sine. While both waveform and frequency are adequate for most equipment, some problems can arise. For example, the square waveform results in a slightly lower B+ in transformer-operated equipment, such as a portable TV. This produces a slight shrinkage of the picture—not enough to be objectionable, but it is there. Similarly, with tape recorders where tape speed depends on the frequency of the applied power, tapes will tend to be slightly off-speed when inverter-made recordings are played back in the home.

Another problem is buzz, both audible and visual. The leading edge of the inverter's square wave output has a very steep over-

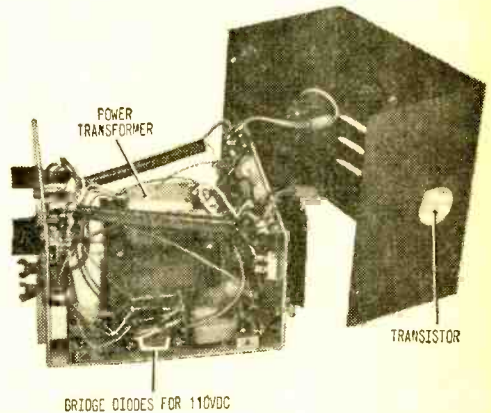

Power transformer is biggest single component in KG-666. Similar to lower-priced KG-662, unit boasts larger transformer and extra set of transistors.

# e/e KNIGHT-KIT KG-666

shoot (a pulse), which produces a waveform rich in harmonic content. These harmonics can show up as a very slight buzz in audio and radio equipment, or as weak interference on the low TV channels.

In our unit, the output voltage measured 116 V with the slide switch in the *low* position and about 10% higher (125 V) with the switch set to *high*. This is about 10 volts higher than Knight claims, but it is typical of the variations to be found in transistor equipment. Note that these voltages were obtained from a fully charged battery with the engine *off*. With the engine *on* and the battery charging, the higher "battery line" voltage increased the inverter's output voltage some 5 to 10%.

As a battery charger, our KG-666 delivered a 6-A taper charge. In other words, the charger started out delivering 6 A into a run-down battery and then gradually reduced the charge current as the battery was charged. Though the charger is rated for 6 A, it is capable of delivering more than this.

In the event a shorted or severely run-down battery begins to draw excessive current, the KG-666's pilot lamp will dim, indicating overload. The user then reduces the current by setting the slide switch to the *low charge* position for whatever time is necessary to bring the battery to the point where it draws 6 A.

Because the charger's output is unfiltered, a DC meter might not indicate the true output voltage. In fact, it's quite possible the KG-666 will be charging a battery even though a meter connected across the charger's terminals indicates *less* than the battery voltage. (Theoretically, at least, a lower voltage cannot deliver current to a circuit of higher potential.)

**Assembling The Kit.** Kit assembly isn't particularly difficult, since there are few components and interconnections. The real trouble spot is the two transistors which are mounted on the rear-apron heat sink. While it's true that doorknob-type transistors have a keying pin, it is possible—as happened to our builder—to install the entire heat sink assembly upside down. The result is reversed base and emitter connections. Therefore, take extra care when installing the heat-sink assembly to ensure that the transistor keying

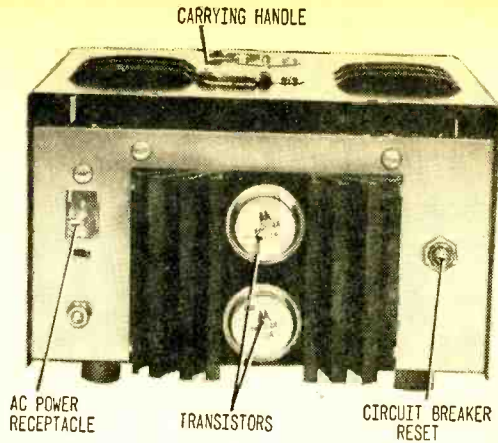

Rear apron contains AC power socket, additional transistors on heat sink, and battery-charger circuit breaker. Screw at lower left is for ground.

pin is oriented exactly as shown in the pictorial (the pins face up, towards the inverter's cover).

**Summing Up.** Bear in mind that the inverter can put a severe drain on the auto battery. Take, for example, a recorder drawing 100 watts. With a 12-volt battery, the 100 watts works out to about 8 A. This, plus the inverter's minimum drain of 3 A, means that the battery is called on to deliver a total of 11 A. A 200-watt appliance would require about 20 A total.

The KG-666's value lies primarily in its function as an inverter, which it does as well as can be expected. As a charger, the 6-A output is typical of low-current battery chargers.

For additional information on the KG-666, write to Allied Radio Corp., 100 N. Western Ave., Chicago, Ill. 60680. ■

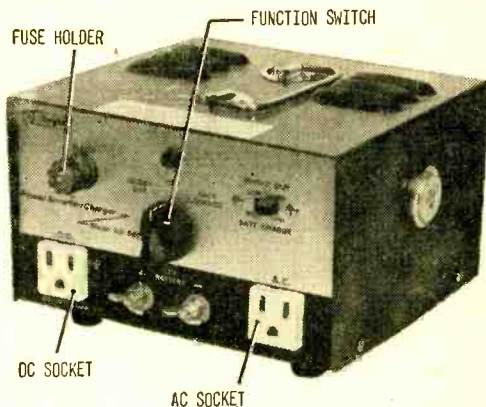

Outlets are at bottom of KG-666's front panel, function switch in center. Lamp above function switch is overload indicator for charge mode.



# WALL PHONE WIRELESS

By Art Trauffer

**M**r. Bell doesn't get to meet Mr. Marconi in this project, but you can try to bring them together in spirit. You can put a modern transistor radio into what looks like ye olde telephone. Besides serving to dress up the decor of your home, it's great as a conversation piece. It's functional, too . . . if you get tired of talking about it, you can sit back and listen. And the listening is good. The larger speaker and the larger enclosure



used here (compared to most small transistor radios) do much to enhance sound quality. And for a change, the left bell is the *on/off* and volume control, while the right bell is the station selector. Other parts are for show.

You can try your hand at finding some practical and some not-so-practical applications for the other telephone parts. For example, if the receiver hook is equipped with a switch, you can use it to turn the radio *on* and *off*, or you can use it to switch the sound from the speaker to the telephone receiver. What can be done with the various parts depends upon imagination and a desire for the unusual.

Old wood wall phones of various styles and sizes are available from

# e/e WALL WIRELESS

several firms. If you prefer, you can construct your own. All of the parts, including the receiver, hook, and bells, can be purchased separately. However, for your convenience, some of the sources for complete units are listed. Construction isn't difficult, and there's more than enough room inside the box to hold all the components.

Most of the old phone boxes were made of solid oak, but you can use clear pine. It is easier to work with, and while pine won't take the same abuse as hardwood, it does serve the purpose. Use glue and small finishing nails to hold the box together.

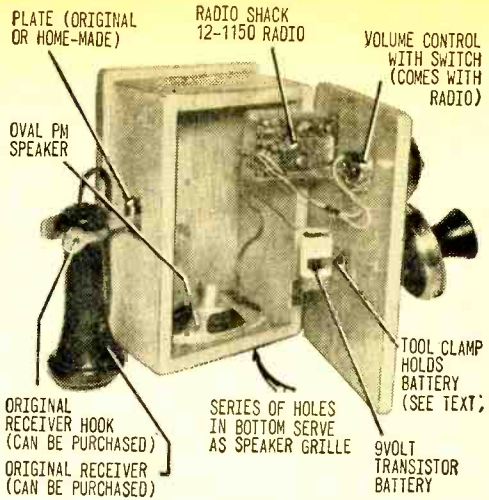

*The 9-V battery is held in place by a small metal clamp. A group of small holes directly under the speaker permits passage of sound. Be sure to check clearance of all parts before securing them in place.*

*At left, front panel overlaps top, bottom, and sides slightly. Center the panel and carefully mark exact hinge positions. You will have to do an accurate job of aligning panel closing screw to its bracket—it may be easier to substitute a magnetic door catch.*

*Completed unit (below) can be hung on a nail or screwed into wall. One or two holes in back panel is all you need. You can mark broadcast band frequencies on tuning bell and mark the off position on other control bell.*

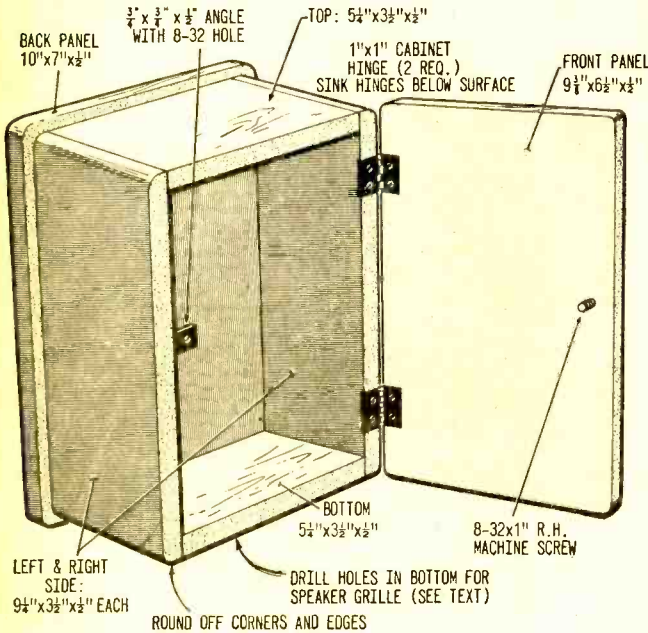

Countersink the nails and fill in with plastic wood. Then round off all the corners and outside edges. Sand the exterior surfaces and finish with a coat of oak stain, rubbed with a cloth or wad of facial tissue. Finally, apply a couple of coats of clear varnish to all the surfaces to seal the wood and to protect the finish.

Mount the transistor radio on the front panel of the box as shown in the photo and illustration. Fasten a bell to the station-tuner shaft. When mounting the radio use screws that are just long enough. If they are too long, you could cut into the circuit board and other wiring.

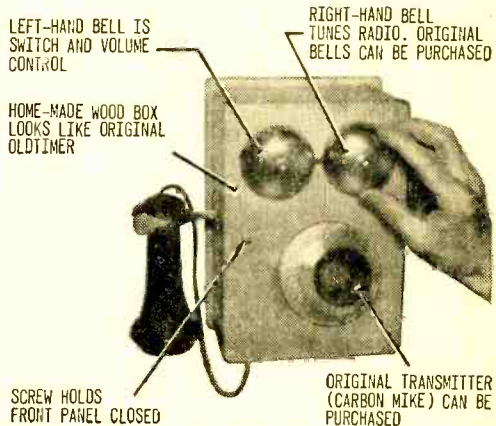

*Important—length of screws should be just long enough to penetrate the thickness of front panel and radio's case. Excessive length can cause short circuits and other damage. Tuning shaft should be centered in panel opening. After mounting bell, check for smooth operation.*

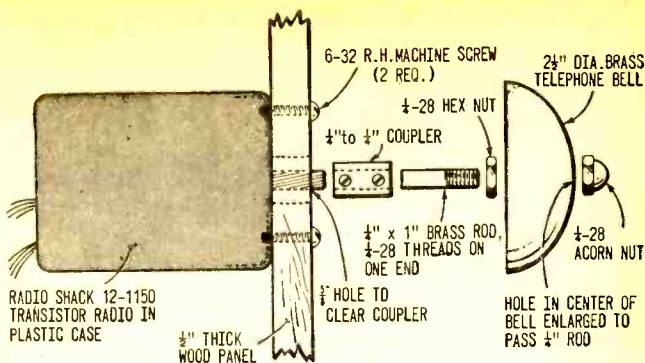

### MATERIALS LIST FOR WALL PHONE WIRELESS

#### ELECTRONICS PARTS

- 1—Transistor radio (Radio Shack 12-1150 or equiv.)
- 1—3 x 5-in. speaker
- 1—9-V transistor radio battery

#### CABINET MATERIALS

- 1—10 x 7-in. back panel (see text)
- 1—9 3/8 x 6 1/2-in. front panel
- 2—9 1/4 x 3 1/2-in. side panels
- 2—5 1/4 x 3 1/2-in. top and bottom
- 2—1 x 1-in. brass cabinet hinges (with 8 brass, flat-head wood screws)
- 1—3/4 x 3/4 x 1/2-in. brass angle (front panel lock)
- 1—8/32 x 1-in. brass round-head machine

screw (front panel lock)  
Misc.—Small finishing nails, glue, etc.

#### TELEPHONE PARTS

- 2—2 1/2-in. dia brass telephone bells
- 1—Transmitter (carbon mike) with mounting bracket and screws
- 1—Receiver, with cord
- 1—Receiver hook with mounting bracket

#### HARDWARE

- 2—1/4 x 1/4-in. couplers with set screws
- 1—1/4 x 3/4-in. brass rod
- 1—1/4 x 1-in. brass rod
- 2—1/4-28 brass hex nuts
- 2—1/4-28 acorn nuts

*Use a coupler and small rod to mount bell on shaft of volume control and switch assembly. Drill an undersized hole in panel to obtain a tight grip on volume control's threaded shank. The shank isn't long enough to go all the way through panel. If you insist on putting a nut on the shank, you will have to do a very careful job of countersinking to avoid punching too large a hole through panel.*

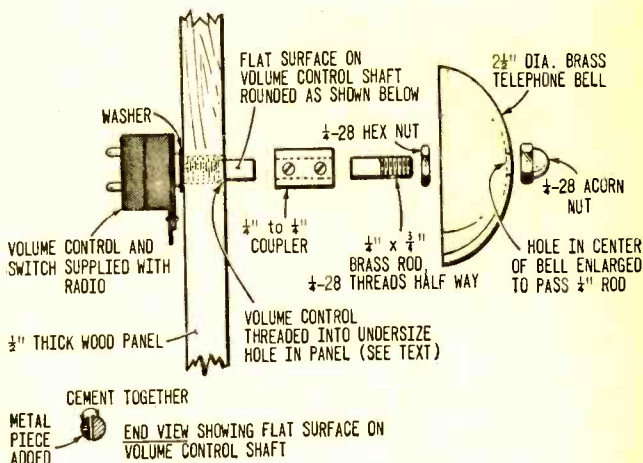

### OLD WOOD WALL TELEPHONES AND PARTS SOURCES

#### A-M TELEPHONE CO.

Turtle Lake, Wis. 54889

#### MR. & MRS. G. BILLARD

21710 Regnart Rd., Cupertino, Calif. 95014

#### BURDEN SALES CO.

814 "O" St., Lincoln, Neb. 68508

#### CONTINENTAL TELEPHONE SUPPLY CO.

49 W. 46th St., New York, N.Y. 10036

#### DELTA ELECTRONICS

Box 2262, Dallas, Tex. 75221

#### ORA HARDACRE

555 S. Harbor Blvd., Anaheim, Calif. 92805

#### R. L. LOVELACE & SONS

Old Nauvoo Antiques, Nauvoo, Ill. 62354

#### SURPLUS SAVINGS CENTER

Waymart, Pa. 18472

#### TELEPHONE ENGINEERING CO.

Lincoln Bldg., Simpson, Pa. 18407

#### TELEPHONE REPAIR & SUPPLY CO.

1760 W. Lunt Ave., Chicago, Ill. 60626

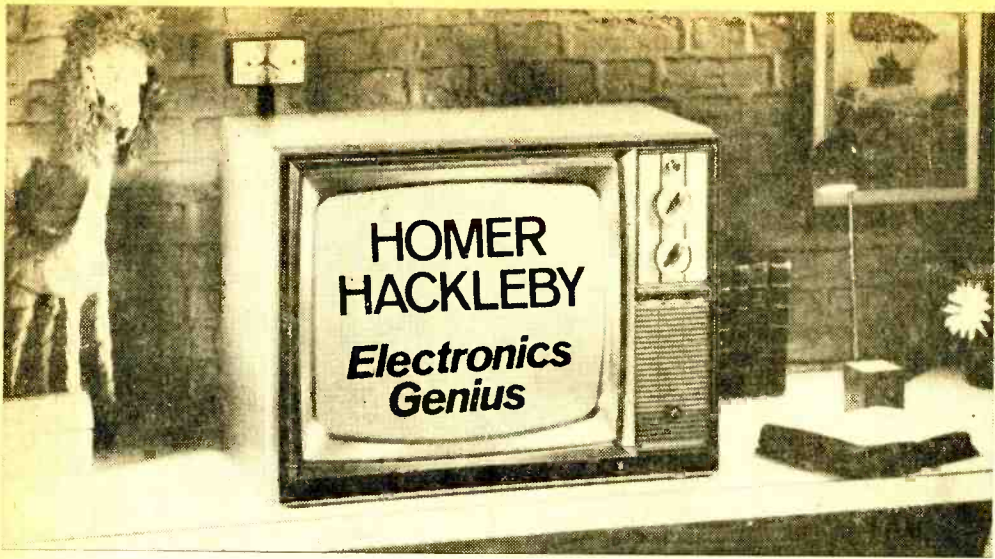

Fortune smiled on a talented TV repairman, name of Homer Hackleby, who then saw fit to prove again that power most definitely corrupts

By Charles Getts

**H**omer Hackleby, through some maladjustment or perhaps a short-circuit of the creative forces of our universe, was born with electronic tubes in his head instead of brain cells (or at least this is what his wife would have us believe). Homer was an active ham radio operator. He was also a radio-television repair man, according to the sign outside of his small shop, located on the fringes of Big City, U.S.A.

Homer, however, considered himself an inventor. And when his wife passed the 200-lb mark, he turned all of his energies into becoming the electronic genius of his day.

It was as he was repairing a TV set one afternoon that his mind was struck by the spark of inspiration. He raised his head to glance at Spencer, his assistant in the shop.

"Say, Spence, I wonder why a person couldn't wire up a transmitter so it would operate over the sound carrier sent out by TV stations? Then, instead of having to listen to all the drivel of the commercials, you could just pick up your own mike and broadcast something interesting to hear. Not only that, but a transmitter like that could cancel out the station's sound."

"If you could succeed in riding the sound wave sent out by the broadcasting stations," said Spencer in surprise, "you'd only jam it with your set. You can't send sound two different ways at the same time! That's for sure!"

"Electric current goes two ways in the same conductor," remarked Homer calmly, "in order to complete the circuit."

"Yes, but there are two wires in order to do it."

"Well then, the problem would simply be to invent a double-band transmitter on one wavelength. Sort of a two-way traffic over the same road. Most of the programs are sent out over several different mikes in the TV studios. Therefore, the sound could come in from a shortwave transmission through one mike and then be picked up and transmitted by one of the others."

Spencer shook his head as he shot a quick glance at his boss. He must be cracking up, he thought to himself. Maybe in a few months he'd break down completely. Then he, Spencer, could take over the shop and be the boss. Of course, if that did happen, he'd let Homer do odd jobs around the place . . .

"That would be impossible, boss," he said with a grin.

"It's the things that people say are impossible that somebody comes along and does," said Homer. "A hundred years ago everyone would say that it was impossible to send a picture through the air and into the homes of the nation, right? If men like Edison had thought anything was impossible we'd never have an electric light today—think that over, Spence."

*(Continued on page 103)*



Washington, D.C.

# DX the Capitals of the World

London



Rome



London! Moscow! Karachi! Pyongyang!  
Jerusalem! Bucharest! Want to QSL these and  
dozens of other exciting capitals? You can, you  
know—and you'll be off on what's bound to be one  
of the most rewarding shortwave marathons ever.

All that most broadcasters require for a QSL  
is the date and time of the  
transmission as well as the  
frequency on which it was

heard. But to be on the

safe side, many DXers also include

a little information about the content

of the program itself; thoughtful ones

offer data on reception conditions. Our

chart on the following pages tells when and

where to listen for those capitals most easily

heard here in North America. All transmis-

sions are in English, and all times are in

GMT. Reports, by the way, should be addressed

to the broadcasting

agency in the par-

ticular capital

involved.



Vatican City

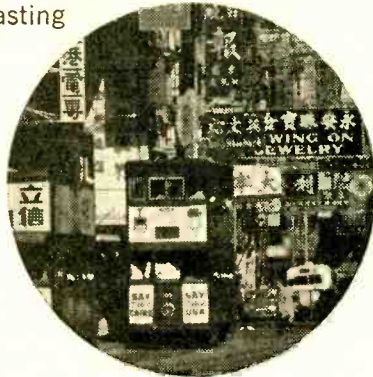

Tokyo

Photos courtesy  
Pan American Airways  
and TWA

By the Editors of  
ELEMENTARY ELECTRONICS

*(Continued overleaf)*

# WHEN AND WHERE TO LISTEN IN

## WESTERN EUROPE

| COUNTRY        | CAPITAL      | TIME      | FREQUENCIES        |
|----------------|--------------|-----------|--------------------|
| Denmark        | Copenhagen   | 0145-0215 | 9520               |
| Finland        | Helsinki     | 2300-2330 | 15185              |
| West Germany   | Bonn         | 0130-0250 | 11945, 9640        |
|                |              | 0445-0545 | 11945, 9545        |
| Italy          | Rome         | 0100-0120 | 11810              |
| Monaco         | Monte Carlo  | 0630-0700 | 7135               |
| Netherlands    | Amsterdam    | 0130-0220 | 9590               |
| Portugal       | Lisbon       | 0200-0245 | 11935, 9680, 6025  |
|                |              | 0345-0430 | 11935, 9680, 6025  |
| Spain          | Madrid       | 0100-0345 | 9760, 6130         |
| Sweden         | Stockholm    | 0330-0400 | 11705              |
|                |              | 1400-1430 | 21585, 17840       |
|                |              | 1600-1630 | 17840, 15240       |
|                |              | 0130-0230 | 15305, 11715, 9535 |
| Switzerland    | Bern         | 0445-0545 | 11715, 9720        |
| United Kingdom | London       | 0000-0300 | 11780, 9580, 6110  |
| Vatican        | Vatican City | 0050-0110 | 9690, 7255         |

## EUROPE—Communist Sphere

|                |           |           |   |
|----------------|-----------|-----------|---|
| Albania        | Tirana    | 0030-0100 | 7300, 6200                                    |
|                |           | 0130-0200 | 7300, 6200                                    |
|                |           | 0300-0330 | 11857, 9510                                   |
| Bulgaria       | Sofia     | 0000-0100 | 9700  |
|                |           | 0400-0430 | 9700  |
| Czechoslovakia | Prague    | 0100-0200 | 11840, 15365, 11990, 9630, 9540, 7345         |
|                |           | 0330-0430 | 11840, 11990, 9630, 9540, 7345                |
| East Germany   | E. Berlin | 0100-0145 | 9730, 9500                                    |
|                |           | 0230-0315 | 9730, 9560                                    |
|                |           | 0330-0415 | 9650, 9560                                    |
| Hungary        | Budapest  | 0030-0130 | 11910, 9833, 7100, 6235                       |
|                |           | 0300-0400 | 11910, 9833, 7100, 6235                       |
|                |           | 0430-0500 | 11910, 9833, 7100, 6235                       |
| Poland         | Warsaw    | 2200-2230 | 11955, 11815, 9675, 9570, 7145, 7125          |
| Rumania        | Bucharest | 0130-0230 | 11940, 11810, 9590, 9510, 6190, 6150          |
| Yugoslavia     | Belgrade  | 2200-2215 | 9620, 7200, 6100                              |
| U.S.S.R.       | Moscow    | 0200-0330 | 11735, 9700, 9685, 9610, 6175, 6045           |
|                |           | 0400-0600 | 11960, 11890, 11860, 11735, 9665, 9640        |
|                |           | 0330-0730 | 17775, 15180, 11980, 11850, 11755, 9735, 9540 |

## ARAB WORLD and MIDDLE EAST

|                      |         |           |              |
|----------------------|---------|-----------|--------------|
| Iran                 | Teheran | 2000-2030 | 15143, 11730 |
| Iraq                 | Baghdad | 1930-2020 | 6095, 6030   |
|                      |         | 2030-2120 | 6095, 6030   |
|                      |         | 2115-2130 | 9725, 9009   |
| Turkey               | Ankara  | 2200-2230 | 17820, 15160 |
| United Arab Republic | Cairo   | 0200-0330 | 9475         |

## AFRICA—Sub Sahara

|                                  |             |           |                                      |
|----------------------------------|-------------|-----------|--------------------------------------|
| Central African Republic         | Bangui      | 0430-0700 | 7220                                 |
| Congo Republic                   | Brazzaville | 0515-0530 | 15445, 11725, 9730, 5970, 4795, 3232 |
| Democratic Republic of the Congo | Lubumbashi  | 1900-1945 | 11866                                |

# ON THE CAPITALS OF THE WORLD

Compiled by the Editors of Elementary Electronics

| COUNTRY                          | CAPITAL                    | TIME  | FREQUENCIES   |
|----------------------------------|----------------------------|---|---|
| Ethiopia                         | Addis Ababa                | 0330-0355<br>0400-0425  | 7245<br>7245  |
| Ghana                            | Accra                      | 2000-2100   | 11850   |
| Ivory Coast                      | Abidjan                    | 1830-1900   | 11920, 6015   |
| Rhodesia                         | Salisbury                  | 0300-0600   | 3396, 3306  |
| Senegal                          | Dakar                      | 1840-1900   | 15115   |
| Somali                           | Mogadiscio                 | 0315-0330   | 6095  |
| South Africa                     | Johannesburg               | 0030-0120   | 11900, 11875, 11785, 9720, 9705,<br>9570, 9525, 7270, 7185, 6075, 5990,<br>5980 |
| Tanzania                         | Dar es Salaam              | 1700-1710<br>1800-1810  | 15435<br>15435  |
| Togo                             | Lome                       | 0530-0800   | 5047  |
| Upper Volta                      | Ouagadougou                | 0600-0800   | 4815  |
| <b>ASIA</b>                      |                            |   |   |
| China (Taiwan)                   | Taipei                     | 0200-0350   | 17890, 17775, 17720, 15345, 15125,<br>7130                                      |
| India                            | New Delhi                  | 1745-2230   | 15080, 11755, 11620, 9912, 7215   |
| Japan                            | Tokyo                      | 2345-0045   | 17825, 15135  |
| Indonesia                        | Djakarta                   | 1100-1200   | 11770, 9685   |
| Malaysia                         | Kuala Lumpur               | 2245-2315   | 11900, 6175, 6100   |
| Pakistan                         | Karachi                    | 1945-2020   | 15345, 11672  |
| South Korea                      | Seoul                      | 0300-0400   | 15430   |
| South Vietnam                    | Saigon                     | 1530-1600   | 7245  |
| Thailand                         | Bangkok                    | 0415-0515   | 11910   |
| <b>FAR EAST—Communist Sphere</b> |                            |   |   |
| China                            | Peking                     | 0000-0500   | 17680, 15095, 15060, 11945, 11820,<br>11630, 10865, 9457, 8240                  |
| North Korea                      | Pyongyang                  | 0400-0500<br>0800-0900<br>1100-1200<br>1400-1600              | 15520, 6540<br>15520, 6540<br>7580, 6480<br>7580, 6480                          |
| North Vietnam                    | Hanoi                      | 0500-0530   | 11760, 9760   |
| <b>NORTH and SOUTH AMERICA</b>   |                            |   |   |
| Argentina                        | Buenos Aires               | 0300-0400   | 11780, 9690, 6090   |
| Canada                           | Quebec<br>(Ottawa)         | 0600-0630   | 5990  |
| Cuba                             | Havana                     | 0100-0450<br>0100-0600<br>0330-0600<br>0630-0800<br>2050-2150 | 9525<br>15285<br>11760<br>9655<br>15285, 15230                                  |
| Ecuador                          | Quito                      | 0200-0430<br>1400-1500  | 11915<br>15115  |
| Netherlands<br>West Indies       | Bonaire                    | 0230-0330   | 9695  |
| Windward Islands<br>U.S.A.       | St. George's<br>Washington | 2300-0230<br>0200-0700  | 15105, 11970<br>15205, 9635, 5995   |
| <b>SOUTH PACIFIC</b>             |                            |   |   |
| Australia                        | Melbourne                  | 0100-0300<br>1115-1215  | 21740, 17890, 15320<br>11710, 15320, 9580                                       |
| New Zealand                      | Wellington                 | 2245-0545   | 15110   |



"Candy is dandy, but liquor is quicker," quoth the poet Ogden Nash, and, like candy, alcoholic beverages can now be dispensed by machine. Soan to grace homes, yachts, and executive suites, the automatic bartender above can pour any one of 24 separate drinks in four seconds. Like its commercial counterpart, the Bar-O-Mat (below), the Bar-Tronic makes extensive use of special, momentary-action switches by Switchcraft, Inc. Both machines are said to be goof-proof and to mix a perfect drink every time.



# BOOZE



## BY THE BUTTON

The day of the clever houseboy and adroit butler is over. Now the gap in gracious living must be filled by transistors and solenoids." The speaker? Stephen R. Krause, president of K & M Electronics Co. The occasion? Unveiling of K & M's "Bar-Tronic" (top photo) and "Bar-O-Mat" (Bottom photo) automatic bartenders.

The Bar-Tronic, Mr. Krause explains, is designed for homes, yachts, and executive and hospitality suites where speed, perfectly mixed drinks, and carefree host and hostess are required. As for the Bar-O-Mat, it's intended for commercial establishments where the bartender would ordinarily have no contact with the drinking public. The Bar-O-Mat can be run by a waiter, waitress, or other attendant, since its operator has only to select the desired drink on a small control box and press a button.

The Bar-O-Mat is also available in coin- or slug-operated models. And if desired, the machine will automatically imprint all bar checks and provide the total daily dollar value of all drinks dispensed.

The Bar-Tronic is expected to find ready acceptance among the well-heeled yacht set. Similarly, the Bar-O-Mat should prove popular with restaurants, catering firms, clubs, and hotels across the nation. Even so, neither is intended to replace the bartender. After all, who ever heard of telling your troubles to a robot?

—Robert Levine ■



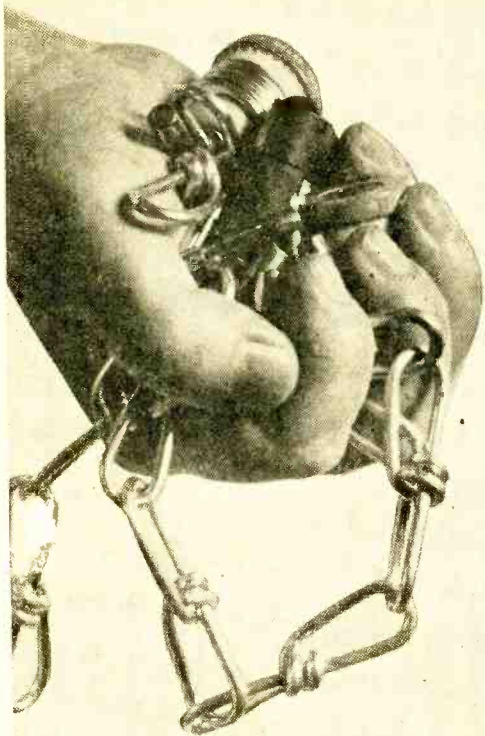

# The Weakest Link

By Jim Kyle, K5JKX

**O**bviously, no one in his right mind would intentionally install a deliberately weakened part in a piece of equipment—or would he?

Well, if the equipment is electrical or electronic, and at least one intentionally weakened part (or its equivalent) is *not* included, then the design is faulty!

For the weak link we're talking about is the item which protects not only the rest of the equipment, but even the building in which it is used. This intentionally-weak link is the *fuse*.

The purpose of the fuse is always to protect something. And the characteristics of any specific fuse depend on those of the item it is designed to protect. For some applications, mechanical or electronic circuitbreakers take the place of the fuse. But no matter what type of protective device is employed, its characteristics are always dependent upon those of the protected item.

Few professional engineers—and almost no home experimenters—are knowledgeable enough about fusing and circuitry protection to choose protective devices wisely. All too often the *design* consists merely of chalking up the current drain, sticking in a fuse of the next higher standard rating, and letting it go at that. Instead of using such hit-or-miss methods, you can join the select ranks of those who truly *design* their circuit protection: the details aren't difficult. And that's what the rest of this article is all about.

**Types of Protective Devices.** While most of us tend to think of the fuse (and fusing) as being symbolic of the entire subject of circuit protection, actually the fuse is only one member of

# e/e THE WEAKEST LINK

one class of protective devices. Let's do a little classification and arranging of classes to get an idea of what kinds of protective devices we can use.

The term *protective devices* divides into two almost equally general sub-classes. These are *expendable devices* which operate only once and must then be replaced, and *reusable devices* which are capable of repeated operation. The fuse typifies the first class; the circuit breaker the second.

Within the class of expendable devices we find conventional fuses. It may come as somewhat of a surprise to find lamp bulbs and resistors also present in this class. However, in many designs resistors serve dual purposes, and for this reason they must be included here.

Reusable devices include not only the familiar thermal circuit breakers (found in many recent TV sets) but also special "crow-bar" circuits, high-speed electronic switches which interrupt a circuit within 100 microseconds, and (believe it or not) even ordinary lamp bulbs.

**Fuses and Resistors.** Fuses and resistors, which make up the most widely used expendable devices, come in dozens of shapes and sizes. The fuses we're most likely to meet in our experimentation generally consist of glass-bodied cartridges with nickel-plated brass end caps, containing a length of wire which melts when excessive current passes through it.

These fuses come in amperage ratings from 5 mA up to 30 amperes (larger physical sizes with higher ratings are available for power circuits) and in three "speed" ratings known as *slow-blow*, *medium lag*, and *high-speed*. Fuses are also voltage rated. The controlling characteristics of these fuses are time and current. In other words, the whole idea is for them to carry their rated current indefinitely, yet burn out and interrupt the associated circuit in case of even a slight overload.

For circuits that would be damaged rapidly at even slight overload *high-speed* fuses are used. Most circuits can withstand very slight overload for considerable periods of time, and occasionally even draw more than normal current for very brief intervals. For these, the *medium-lag* fuse is employed. Finally, some electrical devices draw from 2

to 10 times their normal operating current for extremely brief periods. (An example of such a device is an electric motor, which draws very heavy current when starting but settles back to its rated value after the armature begins to turn.) Fuses for these circuits would employ *slow-blow* types.

The speed ratings of fuses also depend to a large extent upon the current rating. For example, a high-speed 5-mA fuse will blow in  $\frac{1}{10}$  second at 100% overload (10 mA.). However, a high-speed 1-amp fuse requires 10 amps—a 1000% overload—to open in that same  $\frac{1}{10}$  second. This is caused by the physical size of the wire necessary to carry the higher current; the larger the wire, the longer it takes to melt it out.

Maximum delay time for a high-speed fuse at 100% overload (twice its rating) is 5 seconds. For the same overload factor, a medium-lag fuse is allowed up to 30 seconds to open the circuit, and slow-blow units may take as much as two minutes.

Construction of these fuses varies with both current rating and speed rating. The low-current units frequently employ *bead* construction, the medium-current values *filament* construction, and the higher current values employ *shaped elements*. These three types of construction are illustrated in Fig. 1. High-speed fuses use all three types, depending upon current rating. Medium-lag fuses generally employ either filament or element construction, while slow-blow fuses most frequently use a modified element construction.

Frequently, slow-blow fuses actually incorporate several fuses within a single unit. The first is the slow-blow element itself, with characteristics already described. In series with this is a second element with approximately seven times the slow-blow's current rating, which opens rapidly in case of extreme overload. These fuses generally employ one of the three types of construction shown in Fig. 2.

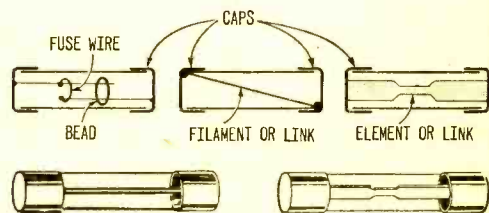

Fig. 1. Three major fuse types. All are used for high-speed and medium-lag fuses. Bead type is found in low current ratings, element type is for heavy jobs.

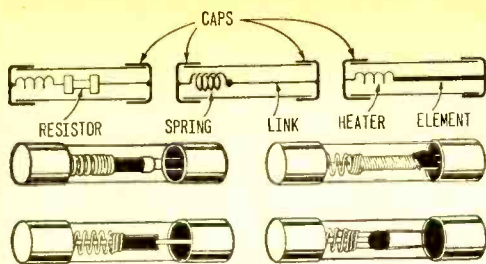

Fig. 2. Three major fuse constructions for slow-blow are seen along top row. Resistor construction is often applied at lower current ratings. Heavier flows can be handled by fuses using a heater-element.

Not all the fuses we encounter are of the cartridge type. TV servicemen often meet a fuse with a superficially similar appearance, but having wire leads similar to those of a resistor, in horizontal output circuits. Power distribution technicians, on the other hand, frequently encounter large high-current fuses which appear to be monster cousins of the cartridge fuse—but which have replaceable fuse elements inside. The principles, however, are similar for all.

**Resistors as Fuses.** Since almost all vacuum-tube amplifier circuits require some series resistance between each stage and the common power supply, as a part of the decoupling circuitry, many modern amplifier designs make these resistors do double duty as fuses. In case of an overload-causing

fault within a stage, the decoupling resistor in that stage burns out and opens the circuit. While this is suicidal to the 10-cent resistor, it protects the much more costly power-supply components from damage as well as pinpointing the stage in which the trouble occurred for the technician.

The resistors are made to double as fuses simply by using the minimum wattage rating capable of standing up in normal operation. If such a resistor is replaced by one having the same resistance but a higher wattage rating, the designed-in fuse action is lost—and the next trouble may be in the power supply. When replacing components in a factory-built item, be sure to match all characteristics rather than just a single characteristic.

Occasionally, resistors other than those in the decoupling network are employed as double-duty fuses. These are almost always found in either the cathode circuit or the screen-grid circuit of vacuum-tube stages. Since transistors make so much better fuses than even fuses themselves, this trick is not used in transistorized circuitry.

**Fuses as Resistors.** The general tendency among experimenters—and engineers as well—is to consider a fuse as being just a special kind of wire that melts before anything else in the circuit. Very few persons consider fuses to be resistors. (Turn page)

## Circuit Breakers Are Replacing Old-Fashioned Fuses

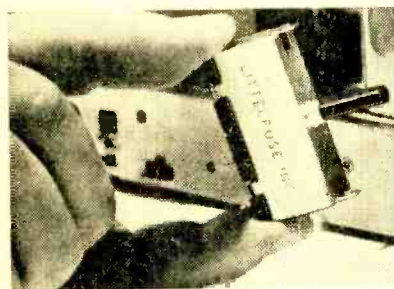

Though it looks like a neon lamp (top left), it's actually a tiny circuit breaker. Excessive current heats and opens contacts to break the circuit. Just below it, hand holds a circuit breaker that replaces the fuse in new TV sets. For lighting circuits in the home, breakers like the one at left are doing away with plug-type fuses. All the breakers shown can eliminate familiar fuse types, like the plug and cartridge models seen along the bottom.



In the days of vacuum-tube circuits this caused no trouble, since the resistance of even a small fuse is usually considerably lower than that of any other part of the circuit. But in these days of low-voltage, high-current transistor circuits, the fuse must always be considered as not only a fuse but a resistor, too.

For instance, a laboratory power supply designed to deliver 4 amperes at 12 volts with better than 1% regulation—less than 1/8-volt change in output between no load and full load—met its specifications when tested. The same supply, when used to power a circuit, drooped by 1/2 volt with less

**TABLE 1. MEDIUM-LAG FUSE RESISTANCE**

| Ampere Rating | Measured Resistance Values |         |      |
|---------------|----------------------------|---------|------|
|               | Min.                       | Average | Max. |
| 1/16          | 7.1                        | 12.7    | 36.0 |
| 1/8           | 4.6                        | 5.3     | 6.0  |
| 1/4           | 3.0                        | 3.2     | 3.5  |
| 1/2           | 1.1                        | 1.2     | 1.4  |
| 3/4           | 0.6                        | 0.7     | 0.8  |
| 1             | 0.4                        | 0.5     | 1.6  |
| 2             | 0.2                        | 0.2     | 0.2  |

than 1/2 ampere being drawn from it. While a half-volt change with tubes would be negligible, with transistors this could change

**TABLE 2. HIGH SPEED FUSE RESISTANCE**

| Ampere Rating | Rated Resistance | Ampere Rating | Rated Resistance |
|---------------|------------------|---------------|------------------|
| 1/100         | 263              | 1/2           | 2.7              |
| 1/32          | 40               | 3/4           | 2.0              |
| 1/16          | 7                | 1             | 0.24             |
| 1/8           | 6                | 1.5           | 0.13             |
| 1/4           | 4.7              | 2             | 0.10             |
| 3/8           | 3.0              | 3             | 0.060            |

all operating conditions and nullify the circuit design.

After much tracing, the bug was located—a 1/2 amp fuse with slightly over 1-ohm resistance had been substituted for the 4-amp fuse. Ohm's law shows that the drop across the fuse was 1/2 volt when the rated 1/2 amp was being drawn. At 4 amps (assuming that the fuse remained unblown) the drop would be 4 volts, a 30-time degradation of performance.

The resistance of a fuse can't be elimi-

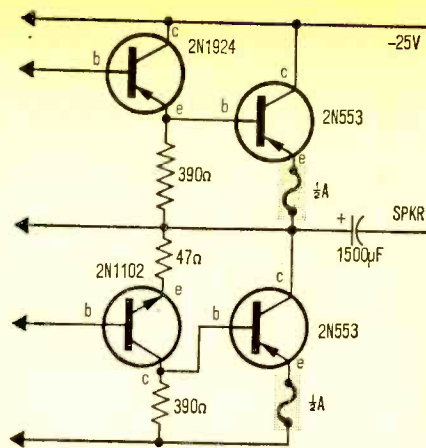

Fig. 3. Two 1/2-amp fuses (in shaded areas) are used in the output stage of this 10-watt transistor amplifier. They act as resistors in the emitter circuits and also protect the stage against some types of overload.

nated, since it is a necessary characteristic which produces the heat to melt the element and thus make the fuse do its duty. All that can be done is to take the resistance values into account, and keep the fuses out of critical regulated-voltage circuits (they can always be placed on the input side of the regulators where they do no harm, and protect the regulating circuits as well).

Tables 1 and 2 list typical resistance ratings for medium-lag and high-speed fuses, respectively. Slow-blow fuses are not usually used in circuits in which their resistance would be critical.

Occasionally this characteristic of the fuse comes in handy, for its own sake. For example, 1/2-ohm resistors are not easily come by except in large industrial-parts supply houses. On the other hand, 1-amp fuses are readily available the nation over. Fig. 3 shows that the typical resistance value for a 1-amp fuse is approximately 1/2 ohm—

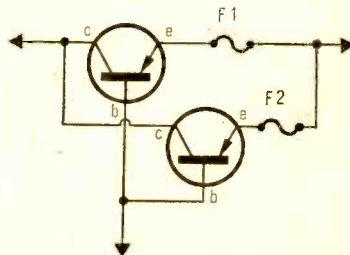

Fig. 4. When two power transistors are connected in parallel, small resistors must be connected to the emitter of each to equalize current between the transistors. Fuses F1 and F2 do the job well.

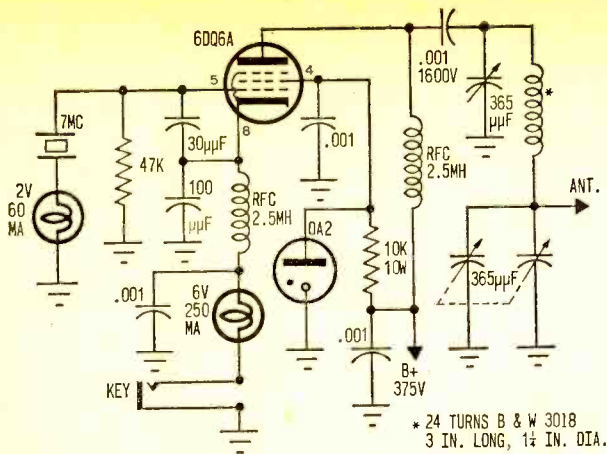

Fig. 5. This one-tube transmitter for the Novice ham uses two pilot lamps in its protective circuitry. One is a 60-mA pilot lamp in series with the transmitting crystal (left). The other is a 250 mA lamp in the tube's cathode lead. Both lamps serve as combination current meters and fuses. Their relative brightness indicates amount of current flow. A circuit overload, however, will burn out the lamp filament. The action is similar to that of a conventional fuse. Lamps for this type of operation must be selected carefully to prevent excessive power consumption when the transmitter is operating under normal loads.

presto, a resistor that also offers circuit protection.

The author has used this trick in construction of hi-fi amplifiers, to provide equalizing emitter resistors, and in making parallel hookups of power transistors, where equalizing resistors are necessary to assure that each transistor carries its share of the load. Circuits used appear as Figs. 3 and 4.

**Lamp Bulbs as Fuses.** The lowly pilot lamp is one of the most versatile components available to the experimenter—but its application as a fuse may be slightly unusual. Fig. 5 shows a 1-tube novice-ham transmitter circuit in which a single 250-mA pilot lamp serves as both plate-current indicator and B-plus fuse, while a second 60-mA bulb indicates crystal current and protects the crystal. In this and similar circuits, the amount of current flowing is judged by the relative brightness of the bulb; if too much current flows, the bulb burns out.

The circuit of Fig. 5 and its relatives depend upon bulb burnout for the protective action. Fig. 6, though, shows another way to use a lamp as a circuit protector, which is more like a circuit breaker than a fuse. This

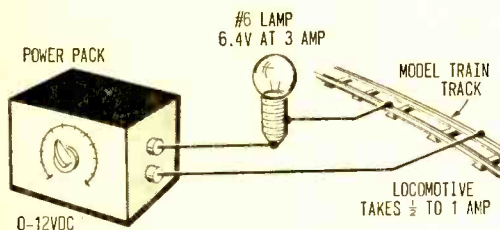

Fig. 6. Automatic reset "circuit breaker" for a model railroad has automotive lamp in series with track wire. Bulb is normally dark, but short circuit applies power to bulb, which protects power pack.

circuit is taken from model-railroad practice, where the most likely overload is a dead short across the rails (which, in turn, shorts out the power supply).

With normal current flowing, the lamp bulb filament stays cool and all the power is delivered to the rails. A heavy overload, however, draws enough current through the filament to cause it to begin to get warm. As the filament warms, its resistance rises—and as the resistance rises, the filament heats more. This action rapidly causes the resistance to rise and the filament to heat to the glowing point. The higher resistance limits current flow in the external circuit, while the glowing bulb indicates the overload.

For this circuit, it's essential that the bulb rating be at least two to three times the normal current flowing in the circuit. Otherwise, the filament will begin to warm under normal conditions, and the bulb will then rob the external circuit of power. The whole idea is that the bulb stays cool until an overload occurs.

**Circuit Breakers.** In the power-distribu-

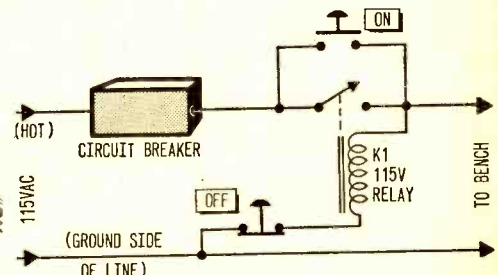

Fig. 7. Power to workbench is controlled by breaker. When "on" button is pressed, relay supplies power. An overload lets relay drop out, halting power. Text gives additional details on a suitable breaker.

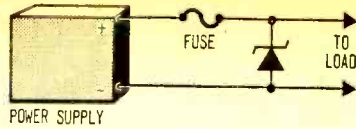

Fig. 8. Simple "crowbar" circuit protects parts from excess voltage with zener diode. If voltage soars, zener conducts heavily and blows the fuse.

tion field, dozens of types of circuit breakers are used. However, only one type need concern the experimenter, since all the others are extremely rare in the general electronics area. The circuit breaker available to experimenters is the thermal variety, based on the same principles as the familiar thermostat.

Specifically, two classes of thermal circuit breaker are presently easily available to experimenters. One is the type used on most new TV sets, consisting of a small case about 1/2 x 1 x 1 1/2 in. with a red plunger extending from one of the sides. This type is distributed nationwide by *P. R. Mallory & Co.* in rating from 1/2 amp to 7 amps at a net cost of approximately \$1 (exact cost depends upon rating). This breaker is rated to trip within 10 seconds at 100% overload, putting it into the same speed class as a medium-lag fuse. Once tripped, it remains open until the red plunger is pressed.

The other class of thermal circuit breaker is *Sylvania's Mite-T-Breaker*, which resembles a NE-2 neon lamp in appearance. The *Mite-T-Breaker* comes in two varieties. One, called "automatic reset," opens the circuit at 100% overload and holds the circuit open only until the breaker element cools. It then closes the circuit, and if the overload is still present re-opens the circuit a few seconds later. This cycling action continues as long as the overload is present. Automatic reset *Mite-T-Breakers* are rated at 1, 2, 3, or 4 amps, are for use on circuits up to 125 VAC, and cost approximately 30 cents each.

The other variety of *Mite-T-Breaker*, known as *remote reset*, is rated for use on

24-volt DC circuits only. This type includes a small filament similar to a pilot lamp, which lights when the breaker opens. The filament keeps the breaker open by heating the element. To reset the breaker, the voltage to the circuit is removed long enough for the filament to cool. Remote reset *Mite-T-Breakers* come in 1-, 1.5-, 2-, and 2.5-amp ratings, and cost 1/3 more than the automatic reset variety.

Either the push-to-reset type or the automatic-reset *Mite-T-Breaker* can be used to good advantage by experimenters to fuse not only their equipment, but the main power supply to their workbenches. A circuit (Fig. 7) is shown which includes pushbutton on-off control of power, as well as positive overload protection with either type of breaker.

If the automatic-reset *Mite-T-Breaker* is used, it interrupts the circuit the first time latching relay K1 drops out; with K1 de-energized, the main power leads are broken and all power is removed from the bench. After the fault is cleared, pressing the "on" pushbutton re-latches K1. Since the breaker will have reset itself automatically by this time, no other action is required. If a push-to-reset breaker is used, both the "on" pushbutton and the reset plunger must be pushed after clearing the fault.

**Crowbar Circuits.** Both fuses and circuit breakers share the quality that a slight over-

Fig. 9. A more complex crowbar circuit from General Electric uses one SCR and two UJTs. The UJT at left (Q1) senses voltage and will trip at value determined by pot R1. The other UJT (Q2) detects an overload in supply current. Pot R2 is adjusted to set up desired value. Either UJT section can be omitted if only one function is desired. An experimenter's stock. A zener diode (D2) serves as the reference point in the sensing circuit.

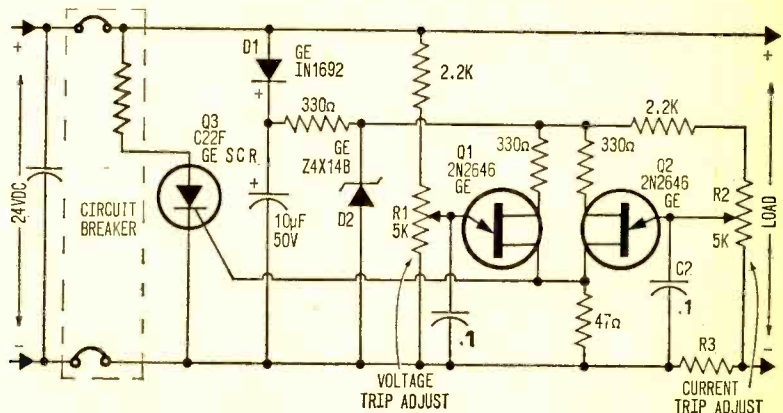

load will be tolerated for a much longer time than will a severe overload. Some circuits, however, can be severely damaged by only a slight overload if it persists for any appreciable length of time. To protect such circuits, the special kind of protective device known as a *crowbar circuit* was devised.

*Crowbar* circuits get their name from their effect; when they detect a slight overload, they perform the electronic equivalent of dropping a crowbar across the supply lines. The simplest of these crowbar circuits—though it protects against too-high voltage, rather than against a current overload—is shown in Fig. 8.

Here, nothing happens as long as the supply voltage remains *below* the voltage rating of the zener diode. When the zener-diode voltage rating is reached, however, the zener becomes a virtual dead short across the power supply. The vastly increased current drawn under such conditions blows the fuse much more rapidly than would the slight increase in current simply caused by excessive voltage, without the diode.

A more elaborate version of such a circuit is shown in Fig. 9. This one, from *General Electric's SCR Manual*, uses two unijunction transistors and an SCR in addition to the zener diode, but offers precise control of both its overvoltage trip point and the current at which it will open the circuit.

The overvoltage and overcurrent parts of the circuit operate separately, each requiring one UJT. The overvoltage circuit applies a fraction of the supply voltage to the emitter of Q1, through potentiometer R1. When the voltage rises above the preset trip point, this Q1 conducts and triggers the SCR (Q3). The SCR then connects the circuit breaker's sensing circuits directly across the supply line, causing immediate circuit-breaker action. The overcurrent circuit operates in the same manner, except that the voltage applied to its UJT's emitter is obtained from a sensing resistor (R3) in series with the load.

Fig. 11. An "electronic fuse" by General Electric relies on a pair of SCRs and three rectifier diodes in series. It can also be viewed as a solid-state circuit breaker which trips when load current drawn from the supply exceeds 16 amperes. Reaction time to an overcurrent condition is only 20 microseconds since the C40B SCR units are special, rapid turn-off types. Circuit begins to operate when Start is depressed, permitting load current to flow through right SCR (Q2).

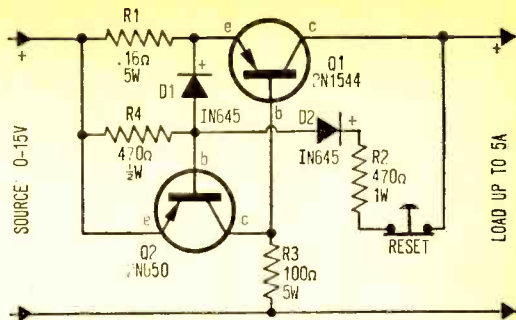

Fig. 10. "Electronic fuse" design by Motorola will interrupt circuit within 90 microseconds of a 10% overload. Reset returns circuit to a standby state.

**Electronic Fuse Circuits.** The crowbar circuits speed up action of conventional fuses or circuit breakers by providing a vast increase in overload current when they sense a small overload. However, for some types of circuits—particularly transistorized circuitry—even the crowbar can't make a conventional fuse or circuit breaker operate rapidly enough to protect the semiconductors. For this kind of circuit protection, fast-acting *electronic* fuses have been developed.

The electronic fuse circuit shown in Fig. 10 was designed by *Motorola's* engineers to operate indefinitely at a load of 5 amps, yet open the circuit within 90 millionths of a second should the current rise by 10 percent to 5.5 amperes. Here's how it works.

When the supply voltage is initially applied, current flows through R3 and turns transistor Q1 *on* (both transistors act as switches in this circuit rather than as amplifiers). Current drawn by the load flows through both R1 and Q1, with very little voltage (IR) drop across either. As long as the voltage drop across R1 is less than 0.8 volts, Q1 remains *on* and the circuit from source to load is closed.

When load current reaches 5.5 amps,

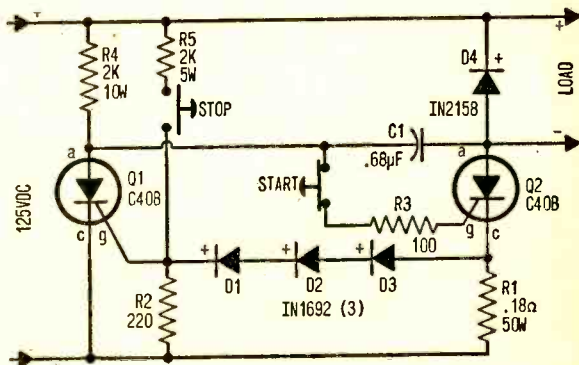

## e/e THE WEAKEST LINK

however, the drop across R1 rises to 0.88 volts; diode D1 then begins to pass current to the base of Q2 and permits Q2 to conduct. As soon as Q2 begins to conduct, the current through R3 (which had been going into the base of Q1 and keeping Q1 *on*) is diverted through Q2 instead. The action is regenerative; the less Q1 can conduct, the greater the drive to Q2.

As soon as the voltage at the base of Q2 rises high enough to permit diode D2 to conduct, the circuit latches into its *off* condition with D1, D2, and Q2 all *on* and Q1 *off*. In this state, only enough current flows through the external circuit to keep Q2 turned on; this is measured in milliamperes rather than amperes. To reset the circuit, the reset switch turns off Q2 and Q1 again conducts.

Another electronic-fuse circuit, using SCR's rather than transistors, is shown in Figure 11. *General Electric* designed this circuit, for use on a 125-VDC power line. With the components specified, it can pass up to 16 amperes; similar circuits have interrupted current at 50 amperes within 20 microseconds. Considering that 50 amps at

125 volts is more than 6000 watts, and the C40B is a typical small SCR, this is anything but poor performance.

With this circuit, the start button is pressed to permit power to reach the load. When the start button is pressed, the SCR in series with the load is turned *on*, and since the power is DC the SCR remains on as long as the load draws normal current. When load current causes the voltage drop across R1 to exceed 3 volts, the three series diodes (D1, D2 and D3) pass current to the gate of Q1 and cause it to turn on (the same result is obtained if the stop button is pressed).

When Q1 turns on, the sudden charging of capacitor C1 diverts current from Q2 and turns off Q2. Resistor R4 provides sufficient current to keep Q1 on. As long as Q1 is *on*, pressing the *start* button cannot provide current to turn on Q2 and the circuit remains broken. Once tripped, the circuit cannot be reset until power is removed from it so that Q1 can turn *off*.

If other types of SCRs are substituted in this circuit, the value of C1 may need to be increased. The value shown is for tripping at 16 amperes, with C-40B SCRs.

Someplace between the lowly fuse and the complex electronic fuse is the protection you need for any circuit. ■

## We've Got Some Case



Kodak M2/M4 Camera Case with home-brew project inside.

**K**odak calls it their M2/M4 camera case. Electronics hobbyists call it their *Find Of The Year*. Who's right? Why both, of course. For the truth of the matter is that this is just the case you've been looking for to package your home-brew gear. Its handy size (7¼ x 4 x 3½ in. overall) makes it highly adaptable to most projects. What's more, its good looks can't help but lend a professional appearance to your work.

The case itself weighs only a few ounces, but it's plenty rugged. (It has to be, since it was originally intended to protect a camera from everyday knocks and falls!) Another plus is that it's rainproof, and, if need be, it can be made water-tight. Simply apply a thin layer of General Electric RTV silicon rubber in the recessed groove of the aluminum extrusion rimming the case.

The M2/M4, which also comes with a shoulder strap (not illustrated), is available from your Kodak dealer for under \$5.00. All in all, here is a case whose ruggedness, pleasing appearance, and low cost rate is a Best Buy!

—Edward A. Morris, WA2VLU ■



# Stringing Out the Sound

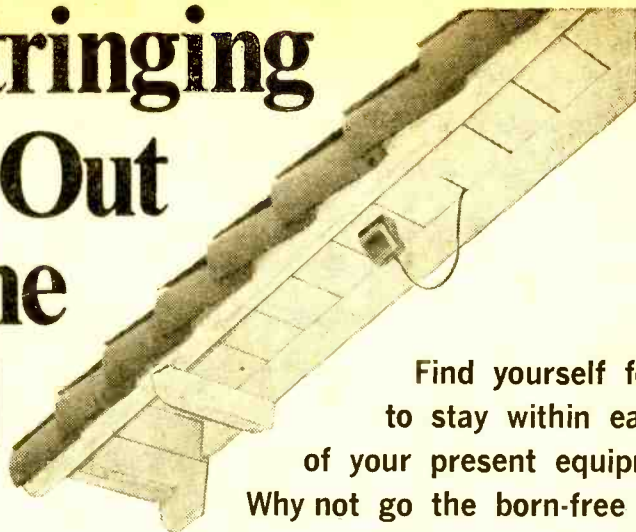

Find yourself forced to stay within earshot of your present equipment? Why not go the born-free route by wiring up extension speakers?

By Marshall Lincoln, W7DQS

**Y**ou don't have to be a stereo fan to enjoy the advantages of having an additional speaker connected to your receiver. Among those who can benefit from the convenience of added ears at remote locations are users of two-way radio equipment. The additional speakers permit you to hear all calls and yet allow you to stray far from the equipment at the base station.

Let's say you're a ham waiting for a call from a buddy, and your wife wants you to paint the back fence this weekend. You can keep her happy and yet not miss your buddy's call by listening for him on an outside speaker while you go ahead with the painting. Or if you're a CBER monitoring a channel for a call from a member of your family who's away, you needn't sit by the rig and let the weeds grow in the garden. Turn on an outside speaker and then grab that hoe.

If you have a commercial radio installation and are waiting for a call from an employee who's out in the truck, you needn't put off washing your car. Just snap on an outside speaker and pick up the hose! Even if you're the one who's out driving on the street, you can keep your ears peeled for radio calls while you're away from the car by installing an outside speaker under the hood. In all these cases, you can go ahead with other activities, yet know when it's necessary to return to the transmitter.

**Strategic Spots.** Some ideal locations for installing additional speakers could be:

the outside wall of your workshop or garage, the back wall of your house, or, as already mentioned, under the hood of your car. For most installations, you'll need weatherproof speakers. This isn't a problem, however, since weatherproof units of acceptable quality are available at economy prices.

When connecting outside speakers, you have several choices of wiring arrangements, each suited to a particular operating situation. Let's look at some typical circuits for connecting speakers to your receiver.

Fig. 1 is the simplest and probably the most common circuit used for adding a remote speaker. Speaker 1 is the receiver's regular speaker, and speaker 2 is the remote unit. Use a simple spst toggle switch to turn the remote unit *on* and *off*.

Since closing the switch puts both speakers in parallel, the effective load presented to the receiver will be less, just as connecting two resistors in parallel produces a total resistance less than either resistor alone. The lower resistance will produce a slightly lower audio level in the speakers, but the loss will be almost unnoticeable.

If you want either speaker to operate without the other one operating, you'll need the circuit in Fig. 2. In this case, an spdt toggle switch is used.

**Three's A Crowd.** Fig. 3 shows how three (or more) speakers may be connected to a receiver. Here, a rotary switch is used to select the desired speaker. If you want

# e/e STRINGING SOUND

two particular speakers *on* at the same time, wire them in parallel and connect them to one of the switch positions.

Fig. 4 shows an alternate way to connect three speakers so one of them is in operation in one switch position and two of them are in operation in the other. In this case, two speakers are connected in series instead of in parallel. You could use this circuit to avoid even the small loss of audio power that results from connecting them in parallel.

In this arrangement, speakers 2 and 3 should have voice-coil impedance of approximately half the output impedance of the receiver's output transformer. Since most receivers have an output impedance of 8 ohms, you would use an 8-ohm speaker for speaker 1, and 3.2-ohm speakers for units 2 and 3. In this way, you will have almost the same amount of audio power in each.

**No Wiring Worries.** Since you are dealing with very low impedances there is no need for shielded cable to feed the speakers, no matter how far they may be from the receiver. Ordinary lamp cord is generally the handiest wire to use.

If the wire is exposed to the weather, you'll be better off using wire that has plastic

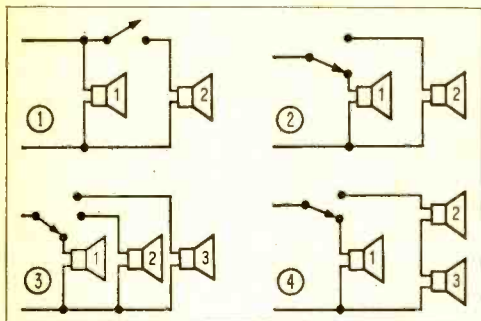

Toggle or rotary switches can be used to hook up remote speakers to receiver's audio. Connecting remote speakers in parallel, however, will affect output.

insulation able to withstand moisture and hot sun, rather than rubber insulation which may crack and cause short circuits. The wire needn't be heavy-duty—ordinary hookup wire is plenty large enough to carry the small amount of power involved—but all connections should be clean and tight to avoid intermittent circuits which will cause crackly audio. Tighten all terminal screws well and solder all other connections.

The speakers shown are among those suitable for outside use in wet weather, yet they're economical in price. Both are available from Allied Radio Corp., 100 N. Western Ave., Chicago, Ill. 60680. The trumpet model (#24B9843) works well when you prefer the sound concentrated in one direction and sells for \$7.95. The other speaker, shown under the eave of a workshop roof (#16B3414), costs \$5.75, or two for \$10.40.

So take it from there. The expense isn't great, but the convenience will obviously be considerable. ■



Trumpet speaker mounts under hood in forward position. But toggle switch under dash will cut it out fast so passersby won't worry about your talking engine!

## Alligator clip won't bite third hand that needs it!

**W**e've all wanted to be jugglers, but when you're soldering wires things sometimes get out of hand. Solution? Take one alligator clip, fasten it in a block of wood, and place errant wires and components in clip. ■

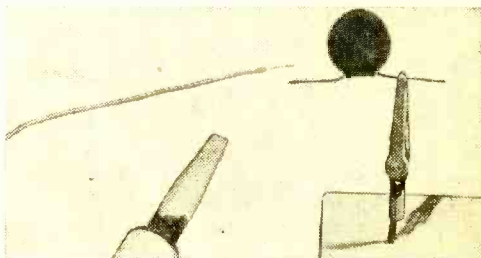

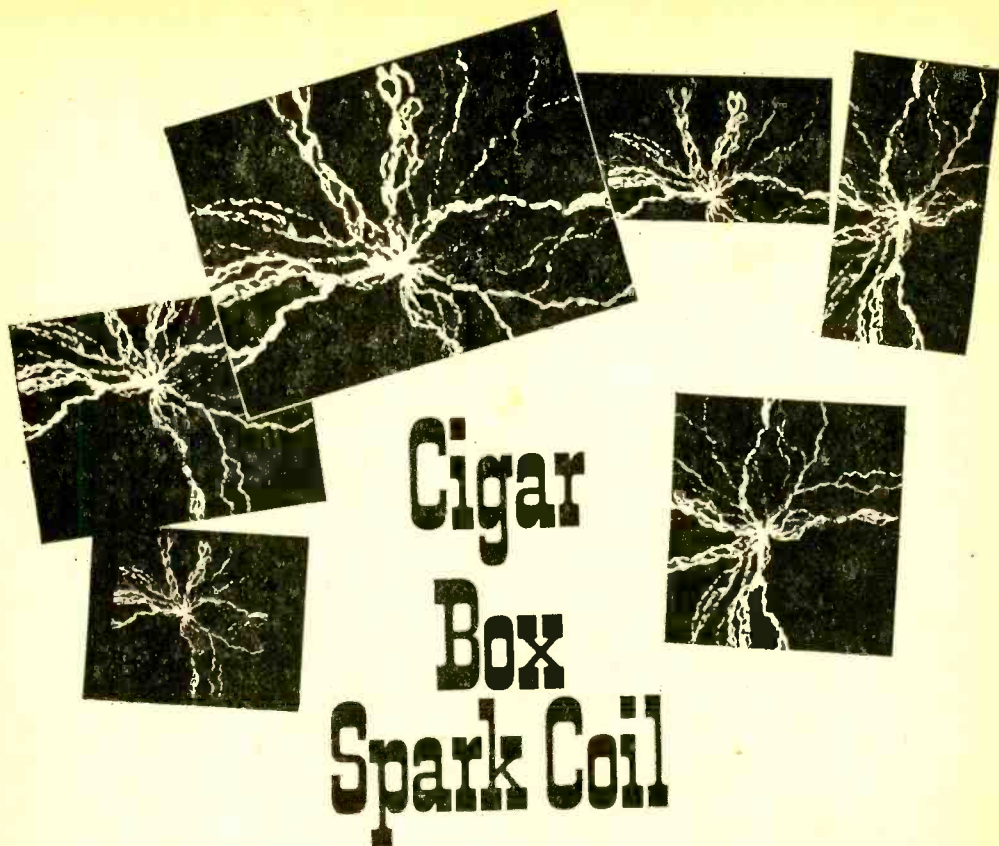

# Cigar Box Spark Coil

The old Model T spark coil lives again in this jiffy spark blaster that'll make your electronics lab boom

By Erik Horneman

**A** few decades ago, a kid felt like a second Edison when he first hooked up a dry cell to a Model T spark coil to find out what would happen. Chances are that these first experiments led to a finger-tingling experience. At least mine did.

The young experimenters of today, however, are far more sophisticated in their electronic know-how. They are more likely to concentrate on such high-voltage generators as the Tesla coil, eschewing the simple spark coil as a poor cousin lacking in sufficient high-potential pizzazz.

Another reason why the spark coil tends to be bypassed is that those little wooden boxes—the Model T coils—just aren't lying around for the taking as they once were. They now must be ordered through auto supply dealers or from science supply houses.

This neglect of the spark coil is unfortunate. The spark coil's scientific applications are virtually endless, and many experi-

ments that can be performed with it are excellent show pieces for electronics demonstrations. For the novice electronics enthusiast, the spark coil provides a most interesting and illuminating first step into high-voltage experimentation.

Though Model T coils aren't as plentiful as they once were, an equally good and inexpensive spark coil is only as far away as your nearest auto junkyard and local radio supply house. The first will provide an ignition coil and condenser, the second, a suitable vibrator.

A few other components, including a large cigar box, will round out the makings of a very efficient induction coil. The unit described here features safety high-voltage terminals having two advantages: they reduce the chances of unpleasant shocks and permit speedy changes from one experimental setup to another.

**Taking Stock.** If you buy a new ignition

## e/e CIGAR BOX SPARK COIL

coil and condenser from an auto supply dealer, the spark coil may run about ten dollars. But an undamaged, used coil will cost less than half this figure. The ignition coil is the highest-priced item, so check your local auto junkyard first. You should be able to obtain a usable coil for a pittance. And if you shop for a new coil, remember a little comparison shopping may pay off handsomely.

Before buying any coil, decide whether you want a 6- or 12-V job. This will depend on the DC power source available to you. If you plan to use dry cells—for very limited experimentation—stick to the 6-V model. Even this pulls about half an ampere, so the dry cells won't last very long. A battery eliminator is probably the best answer.

Another thing worthy of note: older cars may have coils with only one binding post on the top (in addition to the special high-voltage terminal). Here, the coil case serves as a second primary terminal. For a more convenient assembly, look for a coil having two binding posts, as shown.

And if you pull your ignition coil from an old car, remember to also pull the matching condenser and its mounting bracket off the distributor. A new condenser should cost about 75¢.

Radio vibrators differ, so take care to pick the right type. Your electronics supply house can probably suggest the best model for your

needs. The vibrator shown is a Cornell-Dubilier type C-1 rated at 6-V, 115 Hz, with an A-1 type base. The base diagram of this particular vibrator is shown. If you buy a different vibrator, be sure to obtain the applicable base diagram from the dealer so that you can figure out what terminals to use. Note that only two of the four terminals are actually used.

**Tricky Terminals.** Two 1¼-in. long *tip* jacks are used for high-voltage terminals. This jack is just long enough to reach the contact point inside the ignition coil's high-voltage terminal (i.e., the projecting plastic sleeve on top). By bending the lug on the jack sideways, it makes good contact with the inside terminal.

A length of rubber tubing (or electrician's plastic tape) can be placed around its threaded shank to thicken it enough to make a tight fit inside the sleeve. The coil shown is a Holley 33-1 (86D-38750, 6-V model). Other coils may have terminal sleeves of different sizes and may require substitution of different jacks. The second tip jack is mounted on top of the cigar box, about 5 in. from the coil jack.

If about ⅜ in. of insulation is stripped from the end of #12 wire (used in house wiring), the wire can be thrust into the tip jack to make a firm, wobble-free contact, while still allowing instant removal when desired. This plug-in convenience and the stiffness of the wire make it very easy to form all sorts of electrodes and leads.

When shopping for the jacks, take the ignition coil along to check the jack length in

*Model T spark coils are getting scarce, though they were once a lot of fun for experimenters. Photo shows an improved version which has wire-holding terminals like those described in text. Coiled wire on right side of unit is one primary lead, while other primary connects to terminal at left side indicated by the arrow. Looking for one of these sparkers might be an extremely rewarding enterprise.*

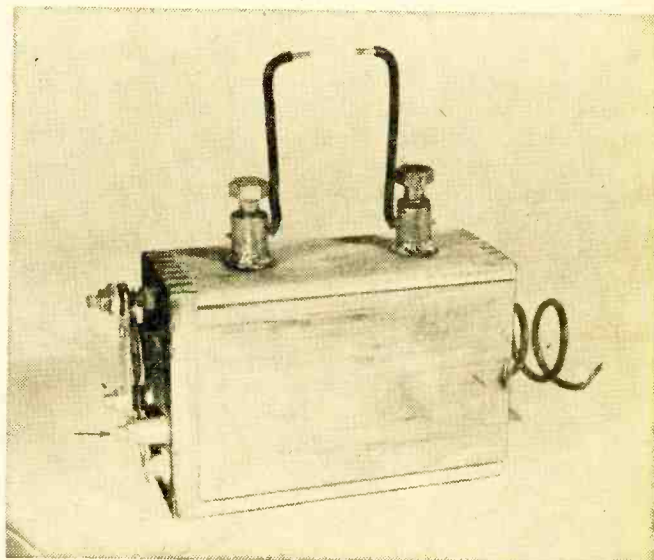

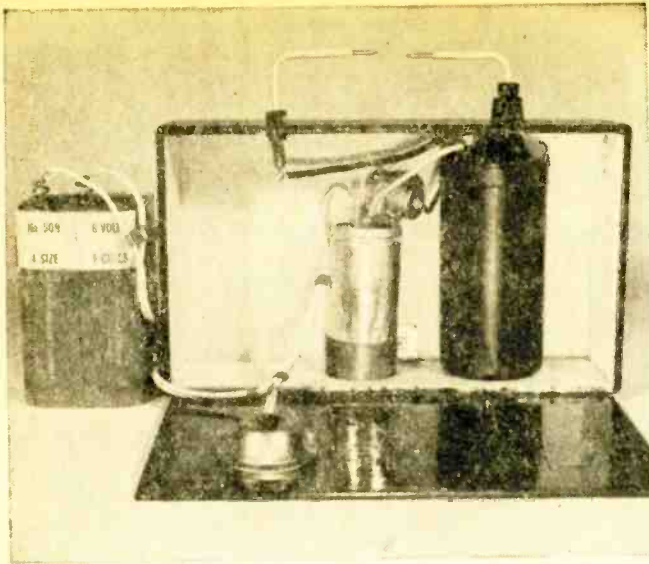

*Cigar box measuring 2½ x 5 x 9-in. houses ignition coil, vibrator, and condenser. By mounting push-button doorbell switch on inside of cover, it can be operated with one hand without any danger of sliding or slippage. Battery cord and switch fit nicely into extra space inside box during storage. Use quick-drying enamel spray paint to decorate finished unit.*

relation to the high-voltage terminal. Also take along a bit of #12 wire to make sure it will fit firmly. Note that this plug-in feature provides relatively safe insulation from the high-voltage terminals as compared to the usual exposed metal terminals on traditional spark coils such as the Model T.

**No-Touch Connections.** Only short lengths of #12 wire are required, so you can probably get the scrap wire from a local electrician. Primary leads should be of ordinary lamp (zip) cord, and solder lugs



*Typical high-voltage terminal of ignition coil is shown above. Tip jack fits into plastic sleeve on top and reaches down to make contact with inside terminal. Jack should be about 1¼ in. long, with its lug bent slightly to form a good contact. It will fit snugly into sleeve if rubber tubing or plastic tape is placed around threaded shank. Take coil and #12 wire along while buying jacks.*

should be used on wires connected to the coil's binding posts to prevent loosening and sparking.

An ordinary doorbell pushbutton is used as the switch. Note that the switch is located on the *inside* of the cigar box cover, and that the cover must be open when the coil is in use. This arrangement allows good one-hand switch operation (the unit won't slide or require bracing). It also permits storage of the switch and line cord inside the box when the coil is not in use. The switch must *not* be placed on the top of the unit near the high-voltage terminals.

Circuit operation is simple. The vibrator chops up low-voltage DC so that pulsating AC current in primary winding of coil is stepped up by the secondary winding to a voltage high enough to jump the air gap. The vibrator's contacts interrupt battery current (like a high-speed switch) at a rate of approximately 250 Hz.

These sharp pulses of current induce about 25,000 volts in coil's secondary. The condenser serves as a buffer capacitor. It helps induce a higher voltage in the secondary and prevents sparking at vibrator contacts.

A cigar box measuring 2½ x 5 x 9 in. should hold all components nicely. Place the switch on the inside of the cover and fasten it with flat-headed bolts or rivets. If solid rather than split rivets are used, slip short lengths of spaghetti on the ends of the rivets to hold the switch in place.

On the top of the box, cut a ¾-in. hole about 2 in. from one end of the box for the

# e/e CIGAR BOX SPARK COIL

coil terminal. Also, drill a 1/4-in. hole the same distance from the other end for the second tip jack.

**Coil and Vibrator.** The binding posts on the ignition coil are marked BAT and DIST. Attach a short length of #12 insulated wire to the coil's battery terminal and connect it to the second tip jack. A long length of zip cord then goes to the positive terminal of the battery.

to fit onto the *reed* contact (pin 1) of the vibrator. Slip a 1/4-in. length of spaghetti on to the pin, add the bracket, and hold it in place with a second piece of spaghetti.

Zip cord soldered to the condenser bracket goes to one side of the switch. A longer lead then goes from the switch to the negative terminal of the battery. To prevent shorts, place spaghetti on the two unused pins of the vibrator. The ignition coil should fit snugly inside the cigar box without the need of special supports. If necessary, however, a metal strap wrapped around the base of the vibrator and bolted to the rear wall

*Electrodes made from #12 insulated wire feature plug-in convenience for easy removal. Modified high-voltage terminals on top of box will accept electrodes of various shapes to accommodate different experiments. For extensive experimentation, battery eliminator is preferable to dry cells due to large current drain. Photo shows an EICO 1064S battery charger/eliminator hooked up to spark coil.*

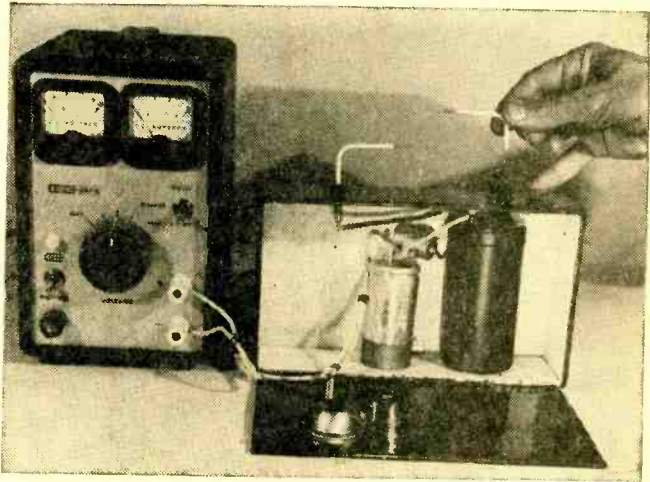

The wire lead on the condenser is attached to the coil's distributor terminal. Before you attach it, solder a short length of zip cord to the condenser wire lug. This lead will go to the vibrator's *pull interrupter pin* (pin 2). The zip cord leading to pin 2 from the DIST terminal can be soldered to the pin. Alternatively, a small solder lug at the end of the wire can be slipped on the pin and held in place with a bit of spaghetti.

The condenser's mounting bracket has a small hole that can be enlarged just enough

of the box will serve to hold this component in place.

**Plenty of Power.** The spark coil can be operated with any available 6-V DC power source. Lantern batteries will work, but they won't last long because of the high current consumption. A rechargeable storage battery is better, and best of all is some sort of battery eliminator. Another source of current is an old auto generator run by means of an electric motor.

*Warning.* Keep away from the high-volt-

## BILL OF MATERIALS

- 1—Auto ignition coil and matching condenser (see text)
- 1—Radio vibrator (see text)
- 1—Pushbutton (normally open) doorbell switch
- 1—6- or 12-V power source (see text)
- 2—1 1/4-in. tip jacks (H. H. Smith #206, Allied 47E3940, or equiv.)

Misc.—#12 insulated wire, spaghetti and rubber tubing, zip cord, 2 1/2 x 5 x 9-in. cigar box, metal strap for vibrator (optional), rivets, solder lugs, hardware, solder, etc.

*Base diagram for Cornell-Dubilier C-1 vibrator. When purchasing vibrator, don't forget to obtain diagram.*

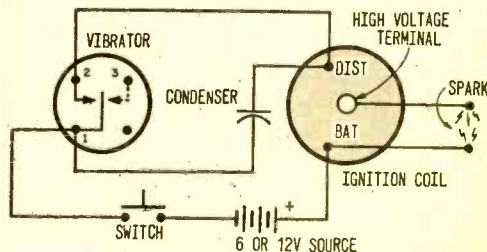

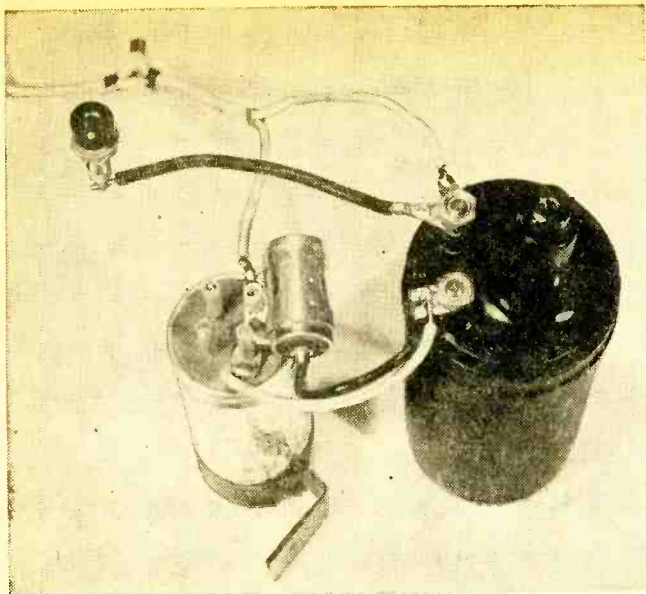

Components are all wired and ready for installation in cigar box. Condenser mounting bracket is held on reed-contact terminal of vibrator with piece of spaghetti. A sheet metal strap can also be used to stabilize vibrator. Note that one large and one small pin of vibrator are not used; spaghetti should be placed on these terminals to keep them from shorting. Starting clockwise with terminal holding condenser bracket, vibrator's pins are called: 1) reed pin, 2) pull-interrupter pin, and 3) inertia interrupted pin. Last is one of two not used.

age terminals and any attached equipment when the coil is in operation. Ignition coils generate about 25,000 V—enough to produce nasty shocks which could be fatal to some people. Much higher voltages can be taken safely from such generators as a Van de Graaff static generator or a high-frequency Tesla coil, since they produce less current.

An excellent reason for using the normally open doorbell switch is that it makes contact only when pressed. You can avoid accidental shocks! Do not substitute an ordinary on/off switch that can be left on unintentionally. The coil can zap you even if it isn't producing a visible spark.

Also remember that the spark generates RF signals that could interfere with radio and TV reception. Use the coil only for brief periods of time, and during hours when you are not likely to annoy your neighbors. Finally, don't allow the high-voltage electrodes to touch each other. If the spark gap

is shorted, the coil's secondary winding may be damaged irreparably.

**Experiments.** A spark coil is highly instructive and entertaining and deserves a place in any amateur electronics lab. Classic experiments—such as Jacob's Ladder—are described in many books covering experimental electronics. These are generally easy to find in school and public libraries. Physics textbooks also provide additional ideas for experimentation.

You will surely discover many fascinating experiments just by playing around with the coil for a few hours. For example, in the course of testing the spark coil, I found a way to make crackling lightning bolts several inches long. Just watch your friends react when you pull off this trick. ■

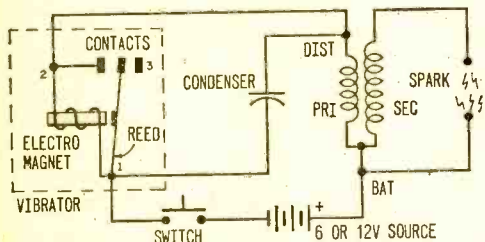

Spark coil operation is simple and should be familiar to all car buffs. Vibrator contacts open and close at high rate, thereby interrupting DC current going to coil's primary. These alternating pulses of current induce about 25,000 volts in secondary winding.

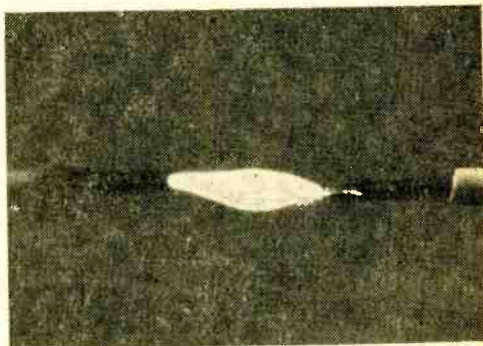

Since coil's primary has 200-300 turns of wire and secondary is made of about 21,000 turns, enough voltage is produced to throw a half-inch spark at atmospheric pressure. Spark can be made longer by increasing voltage or reducing air pressure at gap.

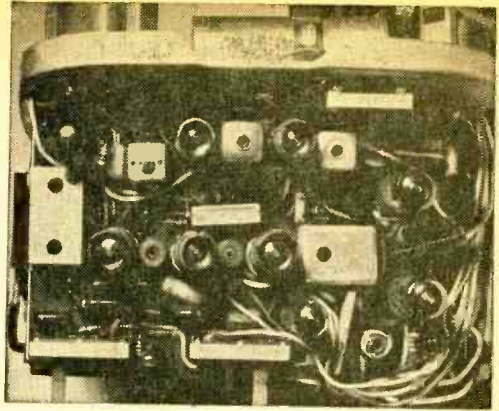

# PAINTING

## PRO TECHNIQUE LETS YOU SNAP PERFECT PIX OF YOUR FAVORITE PROJECTS

**T**he intricate jungle of wires, transistors and tubes contained in a radio or TV chassis creates numerous problems for the amateur photographer. No matter how many lights are used to illuminate deep shadow areas, the result is often a confused jumble of strong highlights and dark shadows that hide important construction details.

Professional photographers have as many methods of lighting a still-life subject as there are ways of laying out a ham's dream shack. Since maximum detail is of paramount importance, it follows that the photographer must choose a method which will result in soft, shadowless lighting and an abundance of fine detail in all areas.

One of the oldest tricks of commercial photographers is their unique way of lighting an inanimate subject with a single light. Rarely do you see an amateur use this technique, yet it is the simplest and most effective way of obtaining a soft, even light. In photographic jargon it's known as *painting with light*.

Briefly, it is the taking of a photograph by using one constantly moving light during a prolonged time exposure. As you know, each light beamed on a subject will cause a shadow. If two lights are used, one on each side of the camera, there will be two opposing shadows. Now it's true that each light will soften the shadow cast by the other, but each light also casts its own shadow. The addition of more lights is apt

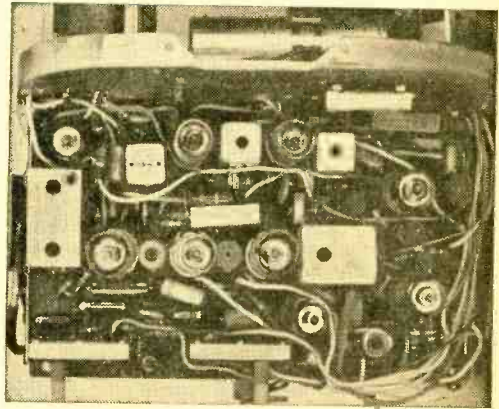

*Closeup of portable TV chassis (at top) shows heavy shadows and loss of detail in dark areas. These are typical problems encountered when artificial light is stationary during exposure. Second closeup (bottom photo) shows difference when Painting With Light technique is used. Light moves constantly.*

to result in more confusing and conflicting shadows. With an intricate subject such as a TV chassis, this can be disastrous.

**A Steady Hand.** The equipment needed to paint with light is simple. In addition to the camera, all that's required is a sturdy tripod and a single light reflector on an ample extension cord. Of course, you must be able to keep your camera shutter open for an indefinite period. Actually, a shutter isn't really necessary for this kind of exposure. (Time exposures can be made simply by removing and replacing a lens cap over a lens.)

Theoretically, if your light is constantly moving during the entire exposure, there will be no sharp shadows visible on the film. In actual practice, however, a few soft shadows will usually remain because it's almost impos-



sible for the photographer to continue moving the light without retracing his path occasionally. If the light is moved over the same pattern again and again, a rough shadow edge will begin to build up, thereby defeating your primary purpose—elimination of shadows.

Because of the required careful manipulation of the light during exposure, the photographer should allow himself ample exposure time. Accordingly, cut down the brightness of your light bulb until you arrive at an exposure that allows you plenty of time to move your light about without having to hurry.

In the photos shown, a single 60-watt

## WITH LIGHT

By Clarence Massey

bulb was used in the reflector in place of a 500-watt photoflood normally used for most amateur photography. By using a small bulb and tiny diaphragm stop, the exposure was long enough (about 60 seconds) to permit moving the light up and down, sideways, and around to the opposite side of the subject while the lens was still open.

**Mindful Meter.** As with all photography, the determination of proper exposure is important. The shutter bug who has decided to paint his subject with a light should place it on a stand in a position which gives the subject normal three-quarter lighting. Then he can take a meter reading of the subject that will give the basic exposure. (A basic exposure is simply a starting point for further calculations.)

In a conventional exposure the light remains stationary and the film takes the full brilliance of the light during the entire exposure time. Not so when you are painting with light! Because the light is moving during the entire exposure, its brilliance is evenly distributed and its effect on a single area is reduced.

Therefore, you must allow additional exposure time beyond what you would normally use if your light remained stationary on a light stand—often, half again as much as the meter indicates. However, this is still based on only one side of the subject! You must move your reflector to the side *opposite* the camera and continue painting with light. Since this doubles your exposure time, it's easy to build up quite a long exposure.

For example, you might start out with a

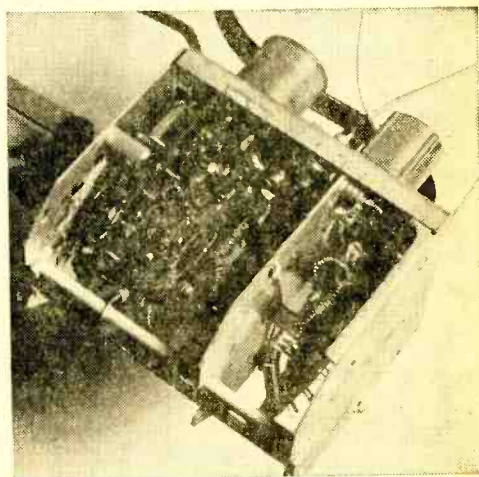

*Closeup of TV tuner shows extremely poor detail in dark areas. Note difference (below) when Painting With Light illuminates unit from four positions.*

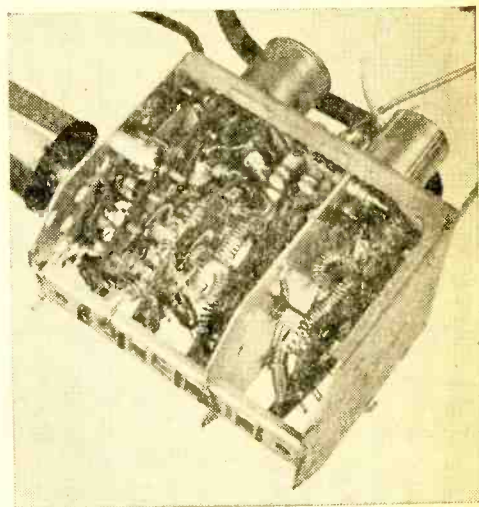

## e/e PAINTING WITH LIGHT

meter reading calling for a one-second exposure at  $f/32$ . This is your basic exposure. But since most detailed photographs require a closeup, you will also have to allow an additional factor to compensate for a long bellows extension. For the purpose of demonstration and to make our calculations simple, let's suppose you are making a *one-to-one* shot. That is, the image on the film will be the same size as the subject. This would require an increased exposure factor of four, so your basic exposure of one second increases to four seconds. (If you were to

light and a long time exposure. He must be aware that any movement of the camera during the exposure will ruin the photograph. He must also be cognizant of a floor that vibrates as you walk over it or of a building that shakes a bit when a large truck rumbles down the street. Either event can cause the camera to vibrate.

Be especially careful to tread softly when you move from one side of the camera to the other while the shutter is open. If you choose to close the shutter while you walk to the other side of the camera do so very carefully, for any movement of the lens between your two exposures will result in a double image.

**Plan your Pan.** Here's another pitfall

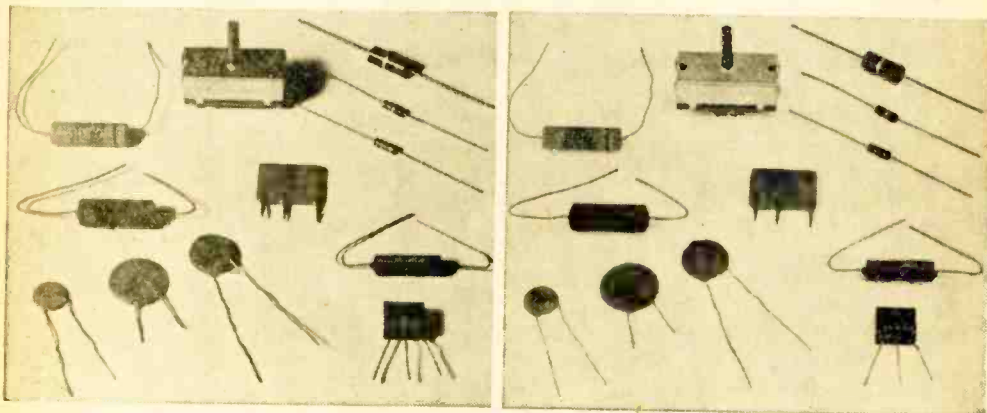

At left, closeup of electronic components was made using stationary light; note shadows under protruding wires. Painting With Light technique, at right, produced soft, clearly delineated image.

make your image only half the original, the bellows extension factor would be two, etc.)

**Getting in Close.** Since you will want extreme depth of field, you'll have to use a lens opening of  $f/45$  or even  $f/64$ . Suppose you decide on  $f/45$ . This requires double the exposure needed at  $f/32$  so you now have an eight-second exposure. Because you are going to be moving the light, you add a factor of 50 percent and your exposure totals 12 seconds for each side of the subject. This means that you'll be exposing for 24 seconds in all—ample time for a careful and continuous movement of your single light.

There may be times when you'll feel that you need additional light overhead, or a little backlight on the subject, or even some additional light on the background. With all these extras, it's not uncommon to have your exposures run up to a minute or more, even with today's high-speed films.

Of course, there are some pitfalls for the unwary photographer when using a moving

for the unwary. Be sure to keep the light of your reflector from shining into the lens while you are moving it around the subject. Plan your movements carefully before you open the shutter. It's a good idea to dim the room lights before you start your long exposure. If you have subdued the general room illumination, you can simply turn off your light when you change positions. This way you avoid touching the camera shutter until the exposure is completed.

Moving the light requires no special skill except that you should avoid making the same movements. Remember that if you pause for just a few seconds, a shadow edge will begin to build up. When changing directions, the light shouldn't stop at any one

One last tip might be helpful. When using the painting with light technique, the entire effect is soft and sometimes it's necessary to develop films a bit longer to gain increased contrast. This will compensate for any loss brought on by the elimination of shadows. ■

# Computer Cuts Up ...and how!



Today, programmed figures . . . tomorrow?

**W**ould you believe the machine pictured above is sharp enough to pattern the teeny-weeny bikini on Peggy Edwards? She's a model for Catalina, Inc. The "engineer" for hers and the suits hanging behind her is CalComp's automated pattern grading system. Catalina utilized the system in their Los Angeles plant to grade their fall line.

Original patterns are automatically traced and digitized for computer processing. A special computer program goes to work on the digitized forms and produces a magnetic tape which is played back on a plotting machine. The plotting system draws a series of similar but different-sized patterns to fit all sizes and shapes (Peggy's being the "mean" shape).

The reason for the automated system is to reduce to a practical minimum the man-hours and to enhance the precision required to make a family of graded patterns resembling the original design. Besides increasing grading quality and garment fit, seam lengths can be accurately computed and controlled to minimize production problems. Also, knowledge of exact seam length increases the accuracy of trim buying and of estimating standard labor costs.

In the apparel industry, creating, correcting, and grading an original pattern to provide production patterns in a complete run of sizes is an expensive and time-consuming process. Poor grading can create production problems, and can cause an adverse effect on brand loyalty. When the work load reaches a peak, usually when styles are changed, the grading process can cause a serious bottleneck in production start-up. This time loss between creation of a style and the availability of production patterns can result in a significant loss of income.

As in any computer system, both "hardware" and "software" are needed. The "hardware" consists of a curve tracer, a plotter, and associated electronics. The "software" includes a computer program, grading sheets, and related procedures. The use of this plotting equipment can be extended to include the preparation of graphical management reports as part of an over-all production management system and to prepare financial analysis charts, as well as displays related to critical-path-method scheduling and many other scientific and management documents.

The operator places the original pattern on the Curve Tracer, inserts an identifying

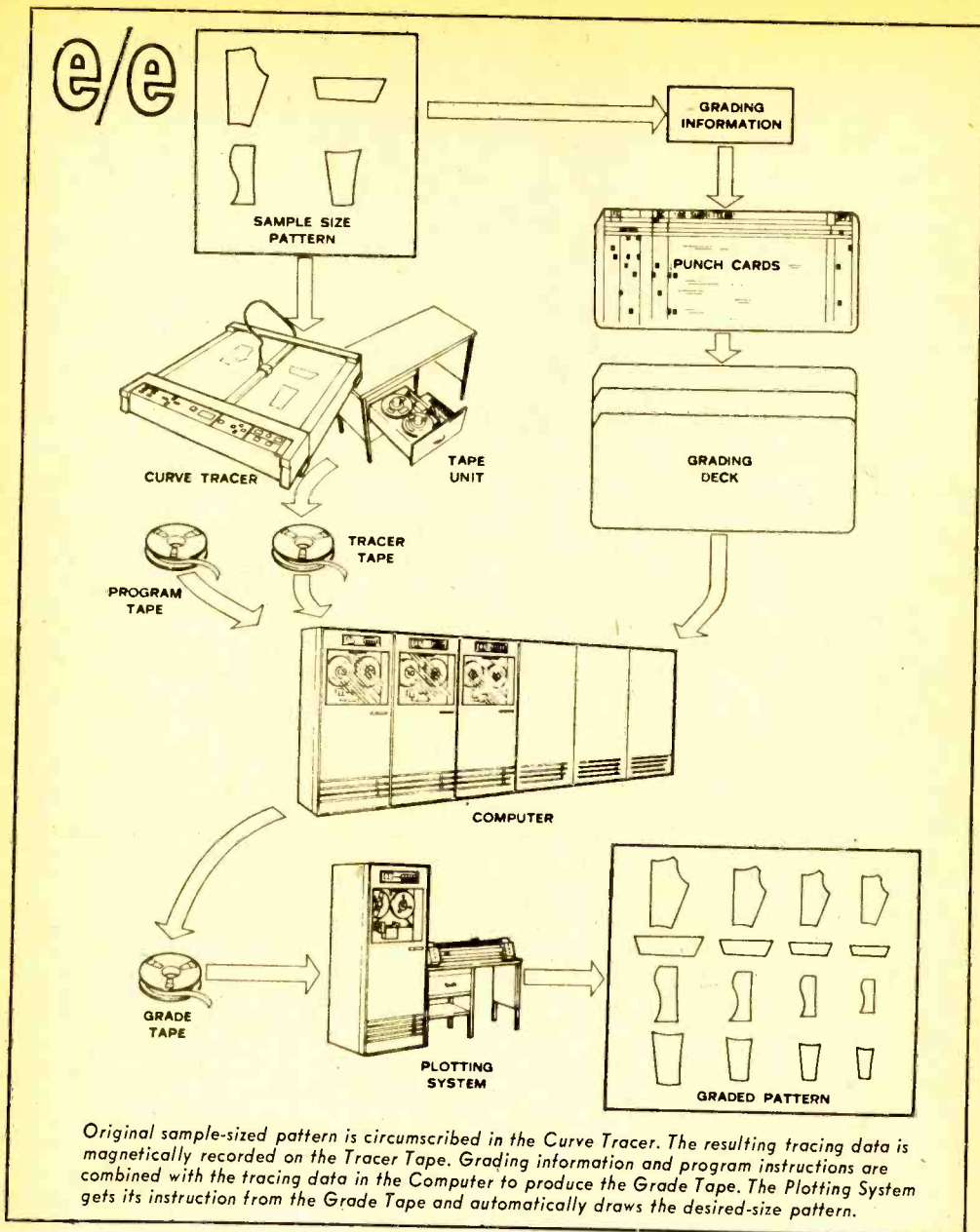

number, and presses a start button (see diagram). Within a few seconds the Curve Tracer automatically locates the edge of the pattern and follows it at an average speed of 30 inches per minute. An entire bathing suit can be traced in about 10 minutes.

The data gathered by the Curve Tracer is magnetically recorded and identified as the Tracer Tape. Grading information is placed on a deck of punch cards. The Grading Deck, Tracer Tape, and a Program Tape are fed into the Computer. The Computer

combines all of this information in proper form and produces a reel of Grade Tape. The Grade Tape is then fed into the Plotting System which turns out a set of graded production patterns.

Logically extending this computer, Cal-Comp and Catalina are working together on computer programs and equipment to automatically mark the cloth.

We're sure you'll appreciate the machine's prowess on whatever beach you do your girl-watching from. ■

# *Jump, then run for your LIFE!*

**Thar she blows!**—Timberrr!—The Russians are coming! Ever since man began warning his buddies of imminent danger, he's been using his trusty but short-range vocal cords. That may have been alright in earlier days ("Don't move, there's a saber-tooth tiger behind you"), but it's hardly adequate for the space age. And that's what troubled officials at Canada's Glacier National Park. Lung power couldn't communicate one ominous threat of the park's rugged mountains: "Avalanche!"

This danger had tragic consequences back in 1965. An avalanche had piled over a section of the Trans-Canada Highway in British Columbia. As road crews attempted to remove the snow, a second avalanche thundered down the mountainside. It buried snow-clearing vehicles, killing two men. There simply wasn't enough time for the men to jump, then run for their lives.

**Enter NRC.** Park officials turned to the National Research Council of Canada for help. Maybe the Council's radio engineering division could offer an electronic answer. Somehow, electronics might provide speedy warning of an impending avalanche. After studying the problem, engineers came up with the answer shown in the photos. It's a novel mix of several elements: the watchful eye of an "avalanche observer," a Citizens Band handie-talkie, and a bell-triggering system. Here's how it works.

It'd been known that three minutes, at most, elapse between the time the avalanche releases and when it strikes the highway be-



Facts and photos courtesy National Research Council of Canada



*Avalanche warning system is in cab of snow removal vehicle. It picks up signal from observer with handie-talkie and sounds alarm bell. Crew scrambles.*

low. That's all the time there is for road crews to scramble out of their "cats" and sprint from under the wall of tumbling snow. But how does the crew know just when the avalanche starts?

This one is solved by the avalanche observer. He stands back to see the bigger picture. Stationed up to a mile away from the crew, the observer scans the mountainside to check for suspicious trigger areas that could turn into an avalanche at any moment.

At first sign of trouble, he presses a button on a hand-held unit.

**Beep Warning.** That unit is a portable CB transceiver of the 5-watt variety. The engineers, though, added a modification of their own to fit it for the alarm function. They constructed two tuning-fork oscillators and added them to the CB transmitter section. The oscillators produce accurate audio tones, used to modulate the transmitter. Thus, it's a pair of tones, not a voice warning, that goes out over the air when the button is pressed.

The signal is picked up in the cab of the snow-clearing vehicle. There, another modified CB unit processes the received tone signal to operate an alarm bell. It's heard by the road crew. Whenever that bell sounds, they immediately abandon the area and run for their lives. The margin of safety, however, is significantly increased, thanks to the early warning triggered by the observer.

After the system was initially installed in the summer of 1967, two vehicles were equipped with the alarm device for full-scale trials throughout the following winter. Six trained avalanche observers served as spotters. (Mike Pittaway, one of the six, is shown in our lead photo on duty in Glacier National Park.)

Why CB? Engineers picked it because CB equipment is economical to maintain and available off-the-shelf. It eliminated lengthy development time in the lab and required only minor modification. ■

—D. T. Monson

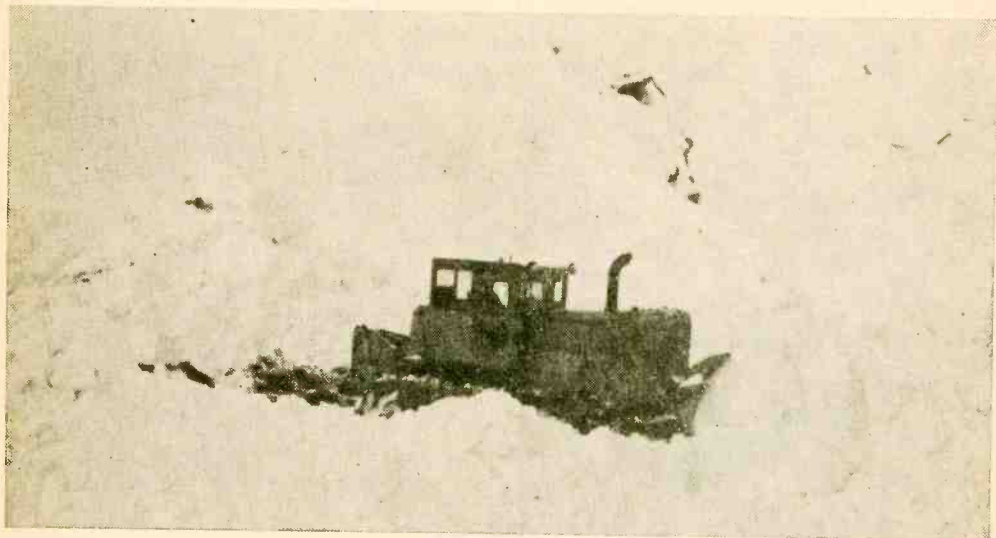

*Vehicle is clearing snow caused by avalanche on Trans-Canada Highway. Snow slides like this have taken the lives of men during snow-removal operation. But thanks to new alarm system, warning time is extended.*

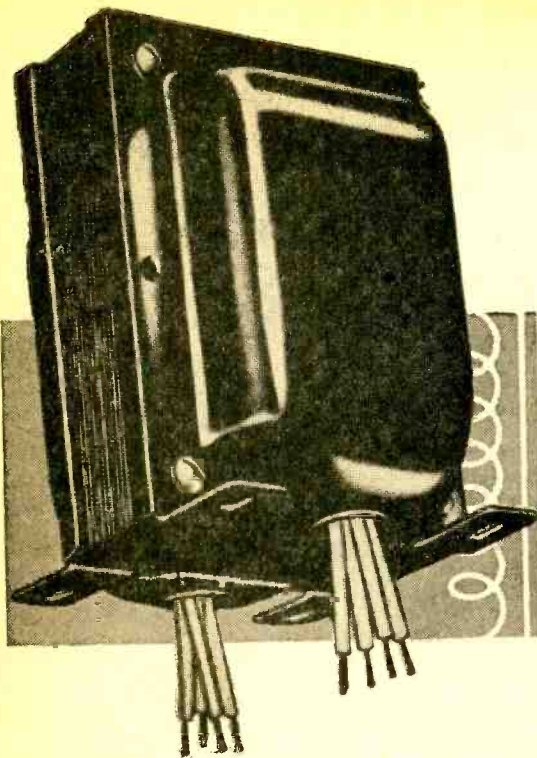

# e/e's

## BASIC COURSE IN ELECTRICITY AND ELECTRONICS

**W**HAT YOU WILL LEARN. Man has learned how to improve the usefulness of AC voltage by converting it to higher and lower values. In this chapter you will learn how a transformer can accomplish this. When you have finished, you will be able to explain what transformers are, how they are used, and how they are connected into circuits.

### WHAT IS A TRANSFORMER?

A transformer is an electrical device which converts AC voltages from one value to another. Transformers are made in a number of varieties and sizes. Large transformers are used to furnish 117 volts AC for homes. The voltage at the generating plant may be several thousand volts, which is reduced to the 117-volt level by a series of transformers along the power line leading to the user. The final step-down in voltage is usually accomplished by a transformer on a utility pole near the user's home.

There are also transformers in most homes. Door bells or chimes usually operate on 12 or 16 volts AC. A transformer changes the house voltage of 117 volts to the bell-ringing voltage. Most radios, television receivers, record players, stereo systems, etc., contain one or more transformers. Some of these convert the 117 volts to lower or higher voltages to operate the sets; other transformers are used as connecting links between circuits.

Transformers contain coils of insulated wire wound on an iron frame. As we are about to learn, AC flowing through a coil develops a magnetic field

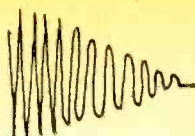
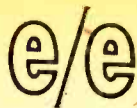
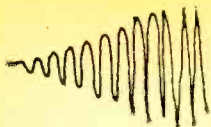

that expands and contracts in step with changes in the current. The magnetic field of one coil *induces* current to flow in the other coil by cutting through the turns of wire.

## HOW DO TRANSFORMERS WORK?

### Transformer Windings

The basic transformer is constructed with two coils wound around a single *core* (iron frame). The coils are called *windings*. The input side is the *primary winding*, and the output side, the *secondary winding*.

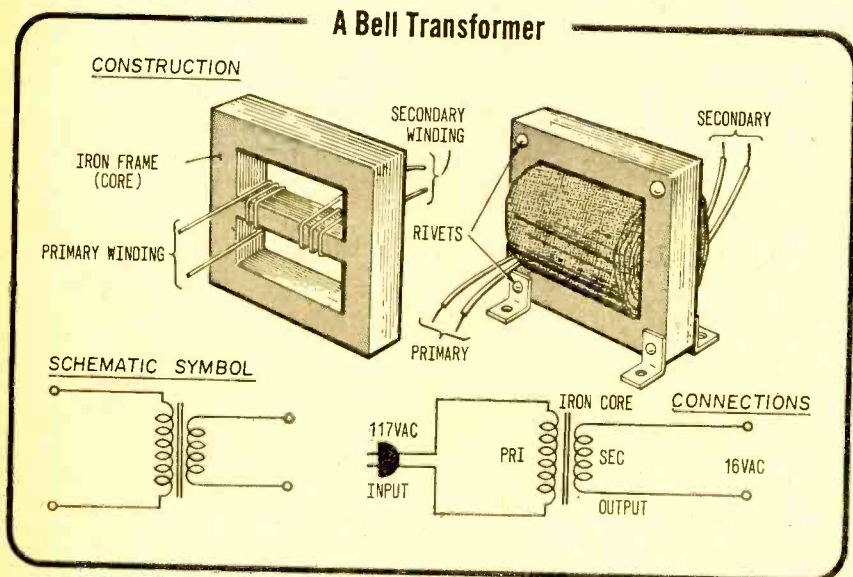

**The Primary Winding.** The primary winding is the input to the transformer. It receives AC voltage and current from a source. The primary of the bell transformer, for example, is connected to a 117-volt line.

**The Secondary Winding.** The secondary winding is the output from the transformer. Its voltage value is normally different from that in the primary. In the bell transformer, the 117 volts applied to the primary is converted to a 16-volt AC output in the secondary.

### Fundamental Principle

The transfer of energy that takes place between the coils of a transformer is called *transformer action*. Transformer action is based on the fundamental electrical principle of a *moving* magnetic field being able to induce current in a conductor.

There are two facts regarding the relationship of current and a magnetic field:

1. A current flowing in a conductor develops a magnetic field about the



- conductor. As shown in our illustration, the direction of the lines of force in the field depends on the direction of the current flow. In part A, the lines of force are counterclockwise—in part B, clockwise.
2. *Magnetic lines of force cutting through a conductor cause current to flow in that conductor. The field must be moving.* In a single

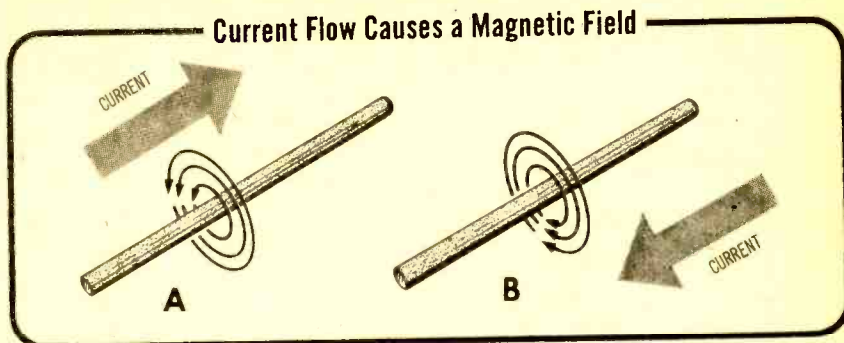

conductor, the current is very small. If the conductor is formed into a coil, many turns will be cut by the moving field, thus developing a larger current. An example is shown below.

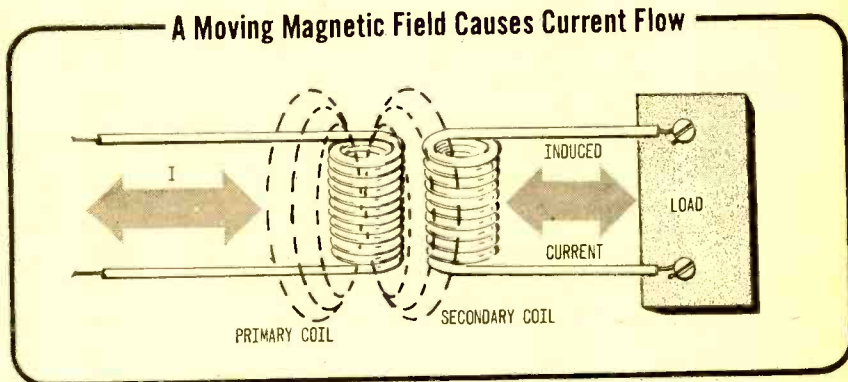

- Q1. Magnetic lines must be (moving, stationary) to induce current in a conductor.**

**Your Answer Should Be:**

**A1. Magnetic lines must be *moving* to induce current in a conductor.**

### Transformer Action

The requirements for induced current are that magnetic lines of force must cut through a conductor and the magnetic field must be moving (expanding outward or contracting inward).

**DC Current.** Direct current, as you know, maintains a steady level and always flows in the same direction. Does DC induce current to flow in another conductor? It produces a magnetic field whose strength (number of force lines) is proportional to the number of amperes flowing. But the magnetic field remains steady, neither expanding nor contracting. Therefore, DC does not induce current in another conductor.

**AC Current.** Does alternating current induce electrons to flow in another

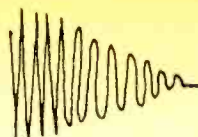
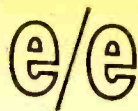
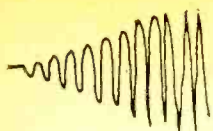

conductor? Yes, because AC is constantly increasing and decreasing in value. The magnetic lines of force generated by the AC increase and decrease correspondingly. The magnetic field expands outward and contracts inward as the value of current changes. This means that the magnetic lines of force change direction as the current changes from the positive half cycle to the negative half cycle.

### An AC Magnetic Field Is Constantly Expanding and Contracting

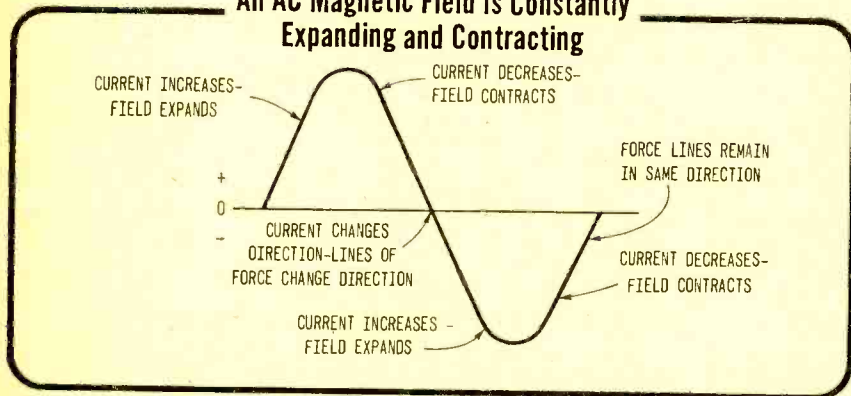

Our diagram demonstrates how the magnetic field expands and contracts with the rise and fall of current. The field is in constant motion. An alternating current, therefore, induces current to flow in another conductor or coil. In this case, the induced current will also be alternating.

**Energy Transfer.** An applied AC voltage causes current to flow in the primary winding of a transformer. This causes a changing magnetic field which induces a current to flow in the secondary. The induced current will

### Transformer Action

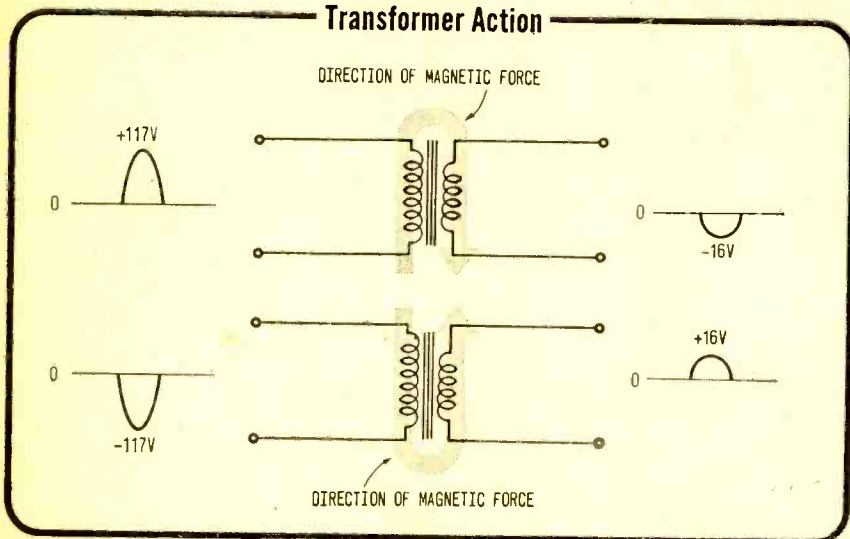

develop an AC voltage across the secondary winding. Therefore, it is the nature of the voltage and current in the primary to transfer energy to the secondary in the form of a voltage and current. Transformer action for one full cycle of AC voltage is shown in the illustration at the bottom of the opposite page. Note that a 180-deg. phase shift occurs.

- Q2. AC current develops a changing ----- .  
 Q3. A changing magnetic field develops a(an) ----- in a conductor.  
 Q4. To induce current, a field must ----- through a conductor.  
 Q5. -- but not -- induces current in a conductor.

**Your Answers Should Be:**

- A2. AC current develops a changing *magnetic field*.  
 A3. A changing magnetic field develops an *alternating current* in a conductor.  
 A4. To induce current, a field must *move* (or cut) through a conductor.  
 A5. *AC* but not *DC* induces current in a conductor.

**TRANSFORMER CHARACTERISTICS**

Now that you understand the fundamental principles of the transfer of energy (voltage and current) from primary to secondary, you are ready to learn how transformers are rated.

**Basic Transformer Circuit**

Below is a schematic diagram of a basic transformer circuit. This circuit

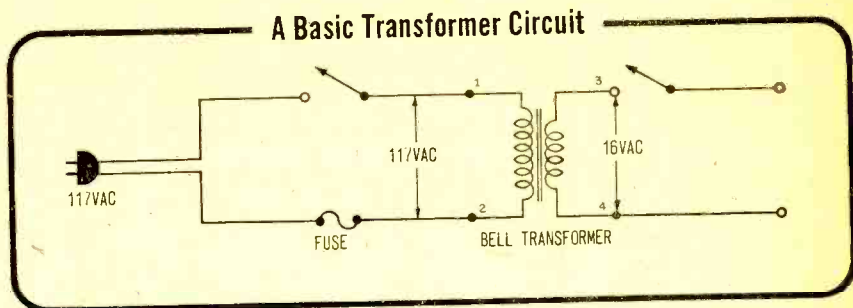

demonstrates the principles and characteristics of nearly all transformers.

If you decide to build the circuit, a bell transformer can be purchased in most hardware stores. The circuit contains a fuse (note the symbol) to protect the transformer. If the secondary of the transformer should accidentally have a short placed across it, the short circuit will be reflected back into the primary, causing the primary current to increase to a large value. If this happens, the fuse will blow instead of the transformer windings burning out.

The lines between the primary and secondary windings indicate an iron core which provides an easier path for the magnetic field through the coils.

**Voltage Ratio**

One of the specifications for rating transformers is stated in terms of a

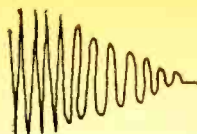
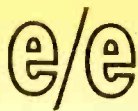
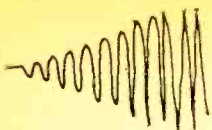

*voltage ratio*. This ratio is a comparison of primary voltage to secondary voltage, and is written as:

$$\text{Voltage ratio} = \frac{\text{primary voltage}}{\text{secondary voltage}}$$

Remember, the primary voltage is on the input side of the transformer and secondary voltage is on the output side.

**Step-Down Transformer.** A *step-down transformer* is one having an input (primary) voltage larger than its output (secondary) voltage. The bell transformer is an example of a step-down transformer. Its voltage ratio is 117 to 16. It can be written as 117/16 or 117:16.

**Step-Up Transformer.** The input voltage of a *step-up transformer* is smaller than its output voltage. The transformer steps up the primary voltage to a higher value in the secondary. The distinction between step-up and step-down transformers is one of use only. As the following diagram shows, the same transformer can be used for either purpose.

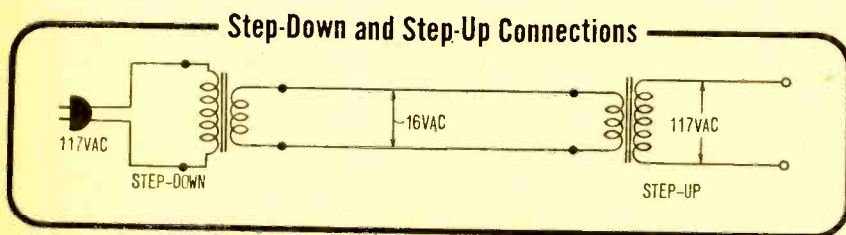

- Q6. What is the voltage ratio of the step-up transformer in the diagram?
- Q7. A(an) ----- in a transformer helps direct the magnetic field through the coils.
- Q8. For a given magnetic field, (more, less) current is induced in a straight wire than if it were wound into a coil.
- Q9. A DC current does not induce current in a coil because its magnetic field is (moving, stationary).
- Q10. Induced current flows in the (primary, secondary).

**Your Answers Should Be:**

- A6. The voltage ratio of the step-up transformer is 16/117 (or 16:117).
- A7. An *iron core* in a transformer helps direct the magnetic field through the coils.
- A8. For a given magnetic field, *less* current is induced in a straight wire than if wound into a coil.
- A9. A DC current does not induce current in a coil because its magnetic field is *stationary*.
- A10. Induced current flows in the *secondary*.

## Turns Ratio

Since transformers must have a variety of different voltage ratios, what is there about transformer action that permits this to occur? Look at Answer 8 just given, then answer the question. If one coil turn (loop) will induce a certain voltage, two turns will develop twice as much, and 100 turns 100 times as much.

Therefore, the voltage ratio between the primary and secondary windings depends on the turns ratio between the two windings. The diagram below shows an example.

Parts A and B both have 1000 primary turns each. (This is an example only—a transformer might have many more.) The secondary winding of the

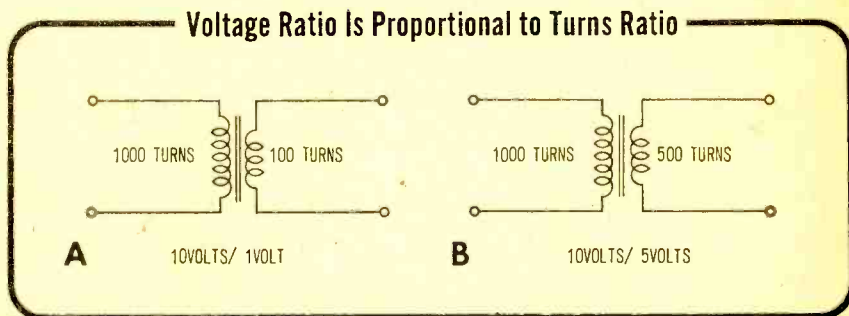

transformer in Part A has 100 turns. The turns ratio is therefore 1000/100, or 10/1. If ten volts were placed across the primary, the turns ratio would produce 1 volt in the secondary. If 20 volts were applied to the primary (providing the wire could handle the increased current), the output would be 2 volts, etc.

In Part B, a turns ratio of 1000/500 (or 2/1) permits a voltage ratio of 10/5. If the primary voltage were reduced to 5 volts, there would be 2.5 volts on the secondary.

If current is doubled in the primary, the magnetic field strength will also double. Twice as many lines of force will cut the secondary and induce twice as much current. Secondary voltage will also be doubled.

But would the proportions of the voltage ratio be changed? No. To double the primary current, the primary voltage must be doubled. The voltage ratio would be increased in number but remain the same in proportion.

The reason voltage ratios are given in voltage figures instead of reduced fractions is to advise the user what the correct input should be. Wire size of the windings is selected for the amount of current that will flow at that voltage. If voltage is increased beyond the rated figure, the increased current may burn the winding.

While the voltage ratio is usually given in voltage figures, the turns ratio is reduced to its lowest terms. For example, a turns ratio of 25,000/10,000 would be expressed as 5/2.

The diagram on the next page shows a power transformer similar to those used in some radio receivers. It has three secondary windings—SEC 1, SEC 2 and SEC 3. Disregard the center tap on SEC 1.

**Q11. The voltage ratio of the primary to SEC 1 is ----- .**

**Q12. The turns ratio of the primary to SEC 3 is ----- .**



- Q13. The transformer (does, does not) have an iron core.
- Q14. The symbol designated by F1 is a(an) - - - -.
- Q15. Would SEC 1 increase to 1400 volts if the primary were connected to a 230-volt source?

**Your Answers Should Be:**

- A11. The voltage ratio of the primary to SEC 1 is 117/700.
- A12. The turns ratio of the primary to SEC 3 is 23/1.
- A13. The transformer *does* have an iron core.
- A14. The symbol designated by F1 is a *fuse*.
- A15. SEC 1 would probably *not* increase to 1400 volts. (Doubling the current in the primary would undoubtedly blow F1, so there would be no voltage on either side of the transformer.)

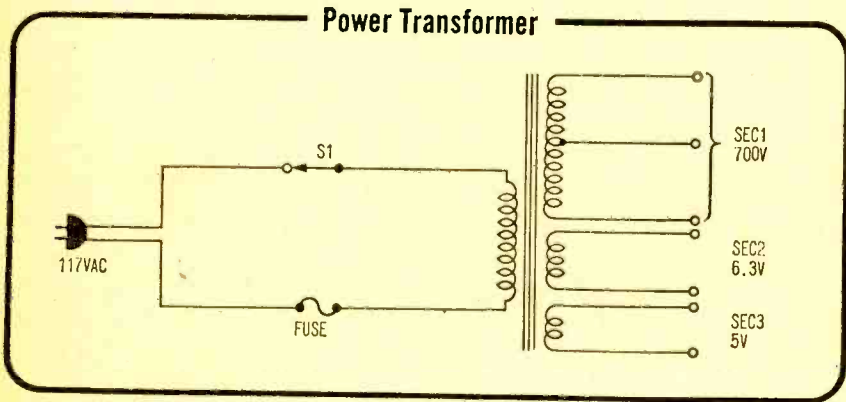

**Frequency Rating**

Another transformer rating is the AC frequency for which the transformer is designed. Frequency, as you recall, is measured in cycles per second (Hz). DC has zero frequency because its voltage does not vary. AC voltage varies because its value rises and falls during its positive half cycle followed by a similar rise and fall in the negative direction. The frequency of the voltage is the number of times a complete cycle repeats in a second.

Power transformers (such as the bell transformer mentioned earlier) are designed to operate at one specific frequency. Wire, insulation, and core material are selected to operate efficiently at the number of times the voltage (current) values rise and fall and change direction.

**Reactance**

You are aware that the atomic structure of a resistor or wire offers a resistance to the flow of electrons (current). Electrons find it twice as difficult to flow through a 2000-ohm resistor as through one of 1000 ohms.

Constantly changing AC current encounters a similar *reaction* when flowing in a coil. Expanding and contracting lines of force cut through the primary

coil (the conductor in which they were developed) as well as the secondary winding.

As our illustration shows, the magnetic field induces a current in its own coil that tends to oppose the coil current. These two currents react against each other. This characteristic is called *inductive reactance*. It opposes or limits the flow of AC just as resistance limits AC or DC in a resistor.

For purposes of simplicity, only one segment of the total force lines is shown in the diagram. Keep in mind that the magnetic field actually surrounds the conductor at every point along its length.

Reactance is directly related to frequency. The amount of reactance in a coil is determined by the frequency of the current and by the number of turns of wire in the coil. The greater the number of times the magnetic field changes direction in a second, the more times adjacent turns will be cut, and the greater will be the opening current.

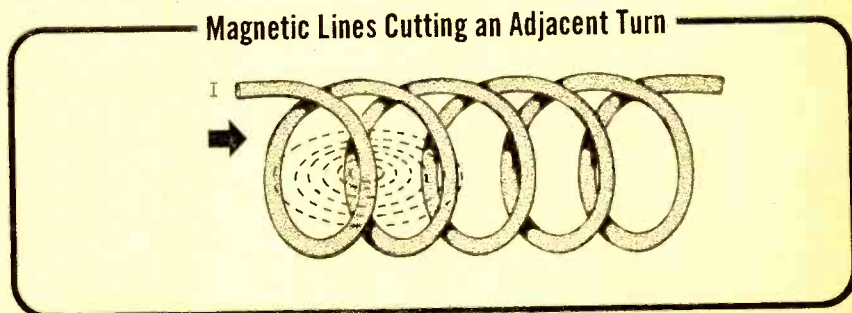

Coils and transformers are designed to operate at the reactance established by the designated frequency. For example, a coil may have a reactance of 30 ohms to a current whose frequency is 60 Hz. If the coil is connected to a 600-cycle source, its reactance will increase to 300 ohms. Since reactance is an opposition to AC, the current through the coil will be less with the 600-cycle source than with the 60-cycle source.

Suppose a 400-cycle transformer is connected to a 60-cycle, 117-volt wall outlet. What will happen to the transformer? The reactance will be reduced to almost one seventh its 400-cycle value and almost seven times as much current will flow. The excess current will probably burn the winding. For this reason you should always check the frequency rating before connecting a transformer to a voltage source.

**Q16. A full AC cycle contains ----- and ----- half cycles.**

**Q17. Transformers are designed to operate at one specific -----.**

**Q18. A transformer is designed to operate at 60 cycles per second. What will happen if it is connected to a DC source?**

**Your Answers Should Be:**

**A16. A full AC cycle contains *positive* and *negative* half cycles.**

**A17. Transformers are designed to operate at one specific *frequency*.**

**A18. A transformer designed for 60 cycles per second and con-**

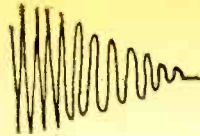
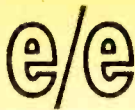

nected to DC will have its winding burned. DC has a frequency of zero cycles per second and therefore a reactance of zero ohms. The only limit to the flow of current would be the resistance of the wire itself.

### WHAT YOU HAVE LEARNED

1. Transformers are electrical devices which convert AC voltage and current from one value to another.
2. Transformers contain at least one primary and one secondary winding. The windings are coils and are sometimes wound on iron cores.
3. Current flowing in a conductor develops a magnetic field about the conductor. Magnetic lines of force cutting through a conductor cause current to flow.
4. Transformers can be designed for AC but not for DC.
5. Transformer action is a transfer of energy. AC in the primary generates a magnetic field which induces current in the secondary.
6. Transformers are rated as follows:
  - a. Voltage ratio. The voltage ratio specifies the number of volts transferred between the two windings. The transformer can be used as either a step-up or a step-down unit, depending on which winding is used as the input.
  - b. Turns ratio. A ratio of primary turns to secondary turns.
  - c. Frequency. Because of AC reactance, many transformers are designed for use at a specific frequency. Use at any other frequency may damage the windings.

### NEXT ISSUE: Part IV—Understanding Vacuum Tubes

This series is based on material appearing in Vol. 1 of the 5-volume set, BASIC ELECTRICITY/ELECTRONICS, published by Howard W. Sams & Co., Inc. @ \$19.95. For information on the complete set, write the publisher at 4300 West 62nd St., Indianapolis, Ind. 46268.



## Homer Hackleby

*Continued from page 64*

That night, after he had closed the shop, Homer went to work on his idea. It took him several weeks to make certain changes in his transmitter and bring it up to the wavelength of one of Big City's TV stations.

Finally, he felt that he was ready to make a test. He sat before a TV set and tuned to the correct channel. A well-known male singer was on the air, giving his all with his latest hit record. Homer picked up his small mike, flipped a switch on his set, and began singing *Home On The Range* in his rather thin and often shrill falsetto voice.

The softly-modulated voice of the famous star suddenly became a gibberish of screeching and whining noise. Homer watched him stare in open-mouthed amazement and horror at the gesticulations coming from the control room.

Homer grinned as he stopped his vocal effort and switched off his set to sit back and listen to the broadcast.

"Ladies and gentlemen, due to mechanical difficulties, our program has been temporarily interrupted. We will resume the broadcast within a few minutes," came the voice of an engineer.

After a short pause, the program resumed with the star's voice rather shaky as he watched the mike with white face.

"Well, I got into the studio OK but I didn't manage to get back out and on the air," said Homer to himself. "I've got to find a way to split the sound wave and insulate it to keep my signal from jamming it in transmitting. I've got to be able to kill the original signal and still keep my signal alive."

Four weeks passed and he was ready for a second test. He had put together a weird-looking thing which might, by some stretch of a feverish imagination, be called a transmitter. Homer called it an electronic sound-separator. It had several most unusual components, one being a filament from an electric toaster which was wired up to several transistors, an electric toothbrush motor, and several parts of a television CRT gun. In fact, it looked more like a southern moon-shiner's still than anything resembling a transmitter.

He locked the door of the shop, sat down before his TV set, tuned to the right channel,

and proceeded to pick up his mike again.

Two comedians were on the air trying frantically to do or say something funny. Then came the break for the commercial for a cigarette. Homer flipped his switch and went into action.

"Folks, let me tell you a few vital facts about this cigarette which make it distinct and inferior to other brands."

His pulse rate suddenly shot up into the red as he heard his voice come out of the TV set. His hand shook a little in his excitement as he went on talking in a wave of elation.

"First, it is made from a blend of . . . ah, material gathered from the best stables in West Virginia and carefully blended with finely shredded rope and molding tree leaves. It has a filter on both ends which is the best part of the cigarette. In fact, many people smoke only the filter and throw away the cigarette. So join the ranks of our disgusted smokers, folks, and if you find you can't smoke our product, use it to fumigate your house. It is guaranteed to kill termites, roaches, and ants."

He put down his mike and shut off the switch to sit back in his chair with a smile of satisfaction. He'd done it. He could now become the invisible power behind the entire television industry. He turned off the light, locked the shop, and drove happily home.

"Homer, you just missed hearing the strangest cigarette commercial that I've ever heard," said his wife as he entered the house. "Really, I don't understand how they expect to sell any cigarettes the way the man talked. He sounded something like you, Homer. In fact, I thought of you when I heard him."

"Is that so?" said Homer with a little smile. "Edison was famous all over the world, wasn't he—when he was alive?"

"Edison? Why, I guess so. He was one of the greatest inventors ever known," said his wife with some surprise. "What made you think of Edison now? Are you feeling all right, dear?"

"Never felt better," replied Homer. "Never felt better."

The following morning he looked in the paper and checked the TV programs scheduled for his station. One of the candidates running for president was to make a speech.

As he drove to work, Homer's fertile mind began forming the speech which would be unknowingly delivered that night by the unsuspecting politician. He didn't care much

## Homer Hackleby

*Continued from previous page*

for the man and he now had the chance to make a few improvements in the ideas he was pretty certain would be included in the speech.

He spent over an hour at his shop writing down these improvements while Spencer took care of the day's work.

That night, after carefully locking the door of the shop, he sat down, mike in hand, to address the nation. He turned the set on and, a few minutes after the hour, watched the smiling political candidate step up before an array of mikes. The presidential palaverer cleared his throat and began his speech.

"Fellow citizens of these great United States of America, ladies and gentlemen of the vast television audience, and, my friends, I come before you tonight with humble heart seeking the greatest office in our country. Like that noble American, Abraham Lincoln, I stand ready to serve my people, not to rule them. The great issue before this country today is the war in Vietnam. In all sincerity, in all honesty, and in all determination, I promise you that if I am elected President, I will end this futile, senseless struggle. There are several possible ways in which this can be done. First, . . ."

Homer flicked his switch and began talking.

"We can simply broadcast twenty-four hours of commercials all over North Vietnam. This will soon drive them crazy and they will beg us for peace."

He turned off his set as he enjoyed the astonished expression on the face of the candidate as he stared at the mikes.

"Ladies and gentlemen, there seems to be some kind of an interference," said the politician, looking around him in a helpless manner. "Where was I? Oh yes, the war and its solution. Well, as I was about to say, my fellow Americans . . ."

Homer cut in again with a placid smile on his face.

"Of course, I only say that fellow American stuff during my campaign. Actually, you all know that once I get into that White House, I couldn't care less if you all dropped dead!"

Homer cut off his set and watched the candidate slump to the platform in a faint

as the voice of an engineer came on.

"We regret, that due to technical difficulties, we will be unable to continue the campaign speech of our distinguished guest. We will now run the Late Movie Show a few hours early. Please stay tuned for John Wayne in that great production *The Gunman of Whiskey Gulch*."

Homer found himself left with quite a lot of brilliant ideas which he now couldn't use. But he was enjoying himself, so he decided to stay on the job and liven up the Late Movie Show.

The film began with a shot of a small group of unshaven and villainous looking characters riding into a small Western town. They tied their horses at a hitching post and strode into the Last Chance Saloon. The next shot showed them lined up at the bar.

Homer flicked his switch on as he became an actor.

"Where's the topless waitresses in this lousy joint?" he drawled in what he considered a Western accent. "Get rid of these ugly bags standing around here and bring out some nice classy dames, get me? Pronto. And send somebody for that yellow-bellied, no-good son of a coyote you call the Sheriff. I want to fill his belly with hot lead and get this stinking picture over with quick!"

He sat back with a smile and let the regular sound continue until, a few minutes later, John Wayne came striding in the swinging doors to walk up to the outlaws at the bar and address the big, burly man who was evidently their leader.

"Hello there," said Homer, returning to action and this time speaking with a slight lisp. "My goodneth, but you look like a real bad man. I like bad men. I like the strong masculine type with an air of the outdoors. You really have a strong air about you. I'm the Theriff, tho you'll have to be a good boy now or I'll take you over to my nice little jail and keep you there. Won't that be fun?"

"Ladies and gentlemen," the voice of the frantic sound engineer broke in, "due to circumstances beyond our control, this station is now going off the air at once. Good night!"

Homer realized that his recreation was over for the night. He turned off the set and closed the shop to return home.

"Homer," cried his wife as she met him at the door, "our TV set is acting up in some strange manner. You must fix it!"

"Everything will work out all right in a

few days, dear," he said. "Something probably went wrong at the station. By the way, I've been thinking we should take a little vacation—maybe to Tahiti or around the world for a few months."

"Homer Hackleby, are you out of your mind? You know very well we haven't enough money to go to Coney Island," replied his wife with more disgust than surprise in her voice.

"Well, you never can tell what might happen," he said.

The following day he sat down at his workbench to write a letter to the president of the broadcasting system. Among other things, he suggested that he would enjoy becoming a member of the Board of Directors.

After he finished that letter, he began a second addressed to the president of a certain large tobacco corporation.

## Random Noise

*Continued from page 9*

has a composition consistent with an alloy of iron and 20 to 50 percent nickel.

The mantle is not the same throughout. And the transition zone between the deep and upper mantle shows large density fluctuations, one of the most surprising results of the computer calculations.

Each of the six successful models required an increase in the radius of the earth's core of between 10.8 to 13.2 miles over the normally assumed value of 800 miles. Each also showed inner core densities significantly higher than the standard model, with central densities vary-

## Newsan

*Continued from page 18*

group to reach the Pole via mechanized overland travel, snowmobiles, the members of the 1968 Plaisted Polar Expedition have augmented raw courage with the finest space-age devices.

This time, for example, they plan to build a fuel cache 200 miles from the Pole. As they near the end of their 460-mile trip to the Pole, supply aircraft will locate this cache on the ice, guided by a search and rescue beacon powered by a 3M thermoelectric generator.

That severe storm, and temperature that warmed dangerously to 10 degrees below zero, broke up the ice prematurely last April and forced the expedition to abandon the effort 370 miles from the pole. ■

"Dear Sir: You no doubt have been informed by now of what happened to one of your commercials recently. If you are interested in remaining in your present occupation, I suggest that you forward a small sum of money to me at once, let us say \$15,000, in the form of a money order and sent care of General Delivery to the above city. Yours truly, Homer Hackleby, former radio-TV repairman and inventor."

He sat back and lit a cigarette as he began thinking. As long as he controlled the television channel there was almost nothing that didn't lay within his reach. Perhaps he should run for president . . . after all, he could have all the free time he wanted. Yes, things were going to change from now on. He threw down his cigarette as he rose to go down to the store and buy a dozen Super Corona-Corona cigars. ■

ing between 4.80 and 4.88 pounds per cubic inch, rather than some 4.30.

The density changes, if due to lateral or vertical variations or both, imply unstable conditions. Evidence to support such instability can be found in the upper mantle and includes such phenomena as spreading sea floors, volcanism, seismic activity, heat flow variations, and pole wandering.

In the past, ELEMENTARY ELECTRONICS has presented many articles on the earth's instabilities just mentioned, and we will continue to do so. Though the electronic interest may be slight, we are members of a large scientific community whose specialty sciences blend into many esoteric fields that make up the scientific community. We must be informed in order to service our community. ■



"I zap 'em with microwaves!"

## DX Central

Continued from page 19

actually interest some who don't ordinarily answer reception reports.

Daytime DX on the BCB offers one obvious advantage—you will have no difficulty locating a receiver. But, that could make it too easy and your choice may not be unique. A more esoteric field might be in order. Like how many stations can you log in the Dominican Republic? Or on Swan Island? (*That's a joke, son!*)

Or you might confine your efforts to 8 MHz marine stations such as WOO Ocean Gate, New Jersey on 8773½ kHz and VIS25 Sydney, Australia on 8805½ kHz. Needless to say, after logging the latter you'll emphasize to your fellow SWLs how much superior this DX is to SWBC's R. Australia who most of them have QSLed. In addition, there are numerous ships at sea so your 8 MHz cult will never run short on new locations to hear. Unfortunately, there are some aeronautical stations using the high end of this band but you'll avoid these in the interests of purity.

In the event one of your DX buddies has already caught VIS25, simply switch things around. If not already committed to 8 MHz, see how many different SWBC frequencies on which you can find R. Australia. Surely 10 of these channels would be worth more than one VIS25.

It's all good clean fun of course, but if the listener really gets desperate he can always go look for a 30-note message from Mars. That's really *esoteric!* ■



"Wait 'til you see the secondary on this Tesla contraption—it goes clean through the attic!"

## DX Devil

Continued from page 44

results with your particular installation.

If you hear no birdies even when R2 is fully clockwise, you need a little more coil between pins 3 and 4 of L1. Add a turn or two. On the other hand, if you still hear birdies with R2 at its full counterclockwise position (maximum resistance), there is too much coil between pins 3 and 4. Shorten this winding a bit. In rare cases, it may even be necessary to operate the preselector with only a short jumper between pins 3 and 4 of the coil form.

DX Devil is most sensitive when R2 is set just below the point of oscillation. When operated in this manner, the tuning of C1 will become extremely sharp. Carefully adjust the capacitor for maximum strength of the desired station.

Coil 3 will cover both the 4-MHz and 7-MHz amateur bands and all the frequencies in between. Once you have this coil working correctly over its entire range, make similar checks with Coil 2 (7 MHz to 14 MHz) and Coil 1 (14 MHz to 30 MHz).

**Performance.** The improvement in reception which can be achieved with the aid of your DX Devil varies inversely with the quality of the companion receiver. The worse your set is, the more startling will be the results. Tests on a pre-World War II receiver showed that 28-MHz amateur signals could be lifted from inaudibility to 100% copy, and weak signals boosted to S-9 plus. Annoying images were almost completely suppressed. Unreadable holes in fluttery 15- and 17-MHz shortwave broadcasts were either eliminated or drastically reduced.

Even when connected to the author's modern, 13-tube double superhet, performance on 28 MHz was improved. Weak signals became much more readable, and the S-meter jumped 20 to 30 dB with the preselector switched on. Because the average receiver is more efficient at lower frequencies, results weren't quite so spectacular from 4 to 7 MHz. However, the S-meter went up and lots more signals were heard with true armchair copy.

Though the SWBC bands are more crowded today than ever before, broadcasts have never been more fascinating. Hook up the Devil to your catch-all receiver, and you'll DX like crazy. ■

## En Passant

*Continued from page 21*

|          |        |           |         |
|----------|--------|-----------|---------|
| 9 N-N3   | B-KN5  | 27 QxP    | QxQ#    |
| 10 P-B3  | P-K5!! | 28 KxQ    | BPxN!!  |
| 11 PxN   | B-Q3!  | 29 R-KB1  | K-K2    |
| 12 BxP#  | K-Q1   | 30 R-K1#  | K-Q3!   |
| 13 O-O!  | PxP    | 31 R-KB1  | R-QB1!! |
| 14 RxP!  | R-QN1  | 32 RxP    | R-B2!   |
| 15 B-K2? | BxR    | 33 R-B2   | K-K4!   |
| 16 BxB   | QxQP#  | 34 P-QR4? | K-Q5    |
| 17 K-R1  | BxN!   | 35 P-R5   | KxP     |
| 18 PxB   | R-N3   | 36 R-B3#  | K-B7!   |
| 19 P-Q3! | N-K6   | 37 P-N4   | P-N4!   |
| 20 BxN   | QxB    | 38 P-R6   | R-B5    |
| 21 B-N4! | P-KR4! | 39 R-B7   | RxP     |
| 22 B-R3  | P-N4   | 40 R-QN7  | R-N5#   |
| 23 N-Q2  | P-N5   | 41 K-B3   | P-N5    |
| 24 N-B4  | QxNP   | 42 RxRP   | P-N6    |
| 25 NxR   | PxB    | Resigns   |         |
| 26 Q-B3  | PxP#   |           |         |

Black

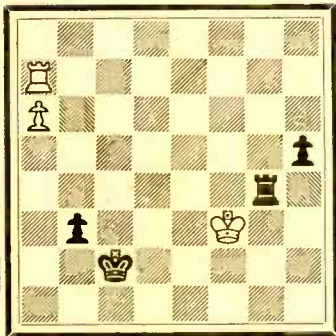

White

Why did White resign? Because he must sacrifice his Rook for the Queen Knight Pawn to prevent it from queening and then forcing mate. Here is the analysis:

A. If 43 R-QN7, R-QR5 44 P-R7, P-N7 (threatening 45 . . . . RxP! 46 RxR, P-N8=Q

and wins) 45 R-B7# K-N8 46 K-K2, K-R8 47 R-QN7, P-N8=Q 48 RxQ#, KxR and Black can pick off the Pawn and then mate with King and Rook or mate with Queen and Rook after promoting his remaining Pawn.

B. If 43 R-B7# K-N8 44 R-B5, R-QR5 45 R-B6, P-N7 and Black wins as in the preceding variation.

C. If 43 R-B7# K-N8 44 R-B5, R-QR5 45 RxP, P-N7 (or 45 . . . . RxP) 46 R-R6, K-R8 47 R-QN6, P-N8=Q and Black wins.

### Problem 14

*By P. Overkamp  
Holland*

Black

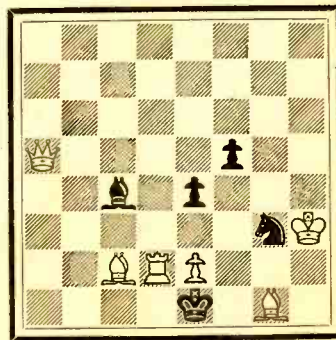

White

*White to move and mate in two.  
Solution in next issue.*

Solution to Problem 13: 1 B-B4

**News and Views.** Carl Wagner of M.I.T. won the U. S. Intercollegiate, held at Stevens Institute of Technology, with a score of 7½-½.

The first international chess match played by electronic computers ended in a victory for the Soviet Union over the United States. Two games were won by the Soviet and two were drawn. The American team of mathematicians was headed by Prof. John McCarthy of Stanford and the Russian one by Georgy Adelson-Belsky.

Boris Spassky of the U.S.S.R. beat his compatriot Ewfm Geller, 5½-2½, in the first Candidates' Elimination Match at Sukhumi.

The U. S. Open Championship will be held at Snowmass-at-Aspen, Colorado, August 11-23, 1968.

Our game was dealt a grievous blow when Jerry Spann of Oklahoma City passed on in his mid-fifties. Jerry, as he was known to all, was a former President of the U. S. Chess Federation (and its most successful one) and was Vice-President of the International Chess Federation. Jerry will never be forgotten in the world of American Chess. ■

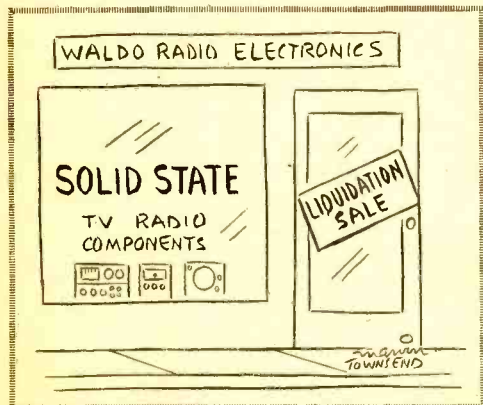

## Forecast: Earthquakes

Continued from page 34

U.S. In 1965, five highly sensitive, optically-pumped rubidium magnetometers (instruments used to measure magnetic field strengths) were set up along the San Andreas fault in California. Distinct local changes in the geomagnetic field occurred on three occasions during the first nine months of study using this equipment. Significantly, the only rupture creep events and/or the largest local earthquakes also occurred within a few days of these geomagnetic events.

No one knows yet just why abrupt magnetic disturbances should precede an earthquake. One possibility is that these phenomena result from piezomagnetic effects of rocks undergoing changes in stress.

A directed stress on magnetite-bearing rocks is known to reduce the magnetic susceptibility (degree of magnetization in relation to the magnetizing force) and the remanent magnetization in the direction of the applied stress; simultaneously, these effects increase in directions at right angles to the direction of stress. This phenomenon has several names: piezomagnetic effect, seismomagnetic effect, inverse magnetostriction, and piezoremanent magnetization.

The measurement of such weak geomagnetic effects is tricky, not because instruments are lacking, but because other confusing variations in the earth's magnetic field are caused by ionospheric phenomena. However, if a series of instruments are used (as in the San Andreas experiment), these ionospheric effects can be largely accounted for and local effects caused by underground piezomagnetic phenomena can be determined.

Preliminary studies indicate that magnetic changes are gradual during the two or three years before an earthquake, and more rapid just before and after the earthquake. However, much still remains to be learned about the exact relationship of magnetic disturbances to tectonic stress changes before earthquake prediction systems can be established.

**Electronic Tools.** Perhaps the outstanding reason for optimism concerning the development of earthquake forecast techniques is that seismologists now have highly sophisticated electronic tools for studying earthquake phenomena.

The classical magnetometer invented in 1832 by K. F. Gauss consisted of a permanent bar magnet suspended in a horizontal position by means of a thin gold fiber. Oscillation of the magnet is a function of the magnet strength and the strength of the earth's magnetic field.

Modern magnetometers are more accurate and provide results faster. The sine galvanometer makes use of a Helmholtz coil wound on a hollow marble cylinder in which is mounted a small magnet. A known current passed through the coil deflects the magnet a certain amount, depending on the strength of the earth's magnetic field at the test site.

Even more accurate are so-called nuclear magnetometers, The *proton-precession mag-*

### THE DEADLY DOZEN

- The twelve most deadly earthquakes on record killed a total of more than 2 million people. Two of these disastrous quakes occurred within the last 40 years.

| Place               | Year | Deaths  |
|---------------------|------|---------|
| China, Shensi       | 1556 | 830,000 |
| India, Calcutta     | 1737 | 300,000 |
| China, Kansu        | 1920 | 180,000 |
| Japan, Tokyo        | 1923 | 143,000 |
| China, Chihli       | 1290 | 100,000 |
| Caucasia, Shemaka   | 1667 | 80,000  |
| Italy, Messina      | 1908 | 75,000  |
| China, Kansu        | 1932 | 70,000  |
| Asia Minor, Silicia | 1268 | 60,000  |
| Italy, Catania      | 1693 | 60,000  |
| Portugal, Lisbon    | 1755 | 60,000  |
| India, Quetta       | 1935 | 60,000  |

*netometer* requires only the accurate measurement of an audio-frequency voltage induced in a coil by precessing protons contained in a small quantity of water. (Precession is the "wobble" characteristic of free-spinning objects; examples are the precession of the earth caused by unequal gravitational pulls of the sun and moon and the precession of a toy top caused by earth gravity.)

The rubidium-vapor magnetometer is another highly sensitive instrument. In addition to such *absolute* magnetometers requiring no direct comparisons with standard instruments, there are also many types of *relative* magnetometers which do require comparisons with standard magnetic instruments.

**Japan's 5-Year Plan.** The Japanese are currently engaged in a 5-year plan for earthquake prediction. One important part of the overall program consists of making accurate measurements of geomagnetic phenomena throughout the country by use of a network

of 21 proton-precession magnetometers. Some of the magnetometers are used in pairs to observe differences in the total magnetic field intensities between two stations a few kilometers apart. These *differential* proton-precession magnetometer systems require the use of two magnetometers and an electronic computer that calculates the differences in data observed at the two locations.

Geomagnetic signals picked up by the sensing heads of the magnetometers are amplified, and the signal frequencies are then multiplied by a frequency multiplier before being fed into a frequency counter. Proper selection of the gate-time permits conversion of the counted frequencies directly to total intensities of the geomagnetic fields in gammas. The counted frequency is printed digitally and is also recorded in analog form and on punched paper tape.

The sensing head of each magnetometer consists of two aluminum wire coils wound on bakelite cylinders; one cylinder is filled with water, the other is empty. The amplifier consists of a two-transistor preamp and a three-transistor main amplifier. The frequency multiplier steps up the detected frequency 10 to 40 times. The frequency counter is a 446.459-kHz quartz oscillator of high accuracy and stability; the intensity of the total geomagnetic field in gammas is obtained by counting the signal frequency and multiplying by 20. A crystal clock used to synchronize the magnetometers at the two locations utilizes a highly stable quartz oscillator of 1.024 MHz.

**Electronic Seismographs.** Seismometers and seismographs have also gone electronic. The classic pendulum seismograph is now made highly sensitive by the use of optical magnifiers or by use of such electronic devices as electromagnetic transducers, galvanometers, photocells, and electronic amplifiers.

An electromagnetic pendulum seismograph having galvanometric registration is perhaps most widely used in seismograph stations. In this instrument, a sensitive galvanometer is connected to a coil attached to the pendulum. The galvanometer movement is activated by an electromotive force induced by motion of the coil through the earth's magnetic field. The galvanometer mirror deflects a light beam to produce a record of the oscillations on photographic paper.

Another version of the pendulum seismograph uses a variable-reluctance transducer

in which the pendulum movement varies the reluctance of a magnetic circuit. The magnetic flux variations thus produced induce an electromotive force in a coil surrounding an armature in the magnetic circuit.

No single type of seismograph can serve all earthquake recording purposes. To study all frequency ranges, a series of narrow-band seismographs is preferable to a single broad-band instrument. Also, some instruments must be designed to record very strong tremors that would disable more sensitive instruments.

The strain seismograph is a very unique and sensitive instrument working on a prin-

### DISASTERS OF THE DECADE

● The twelve most deadly earthquakes that occurred within the past decade killed close to 38,000 people. The death toll in Alaska, in 1964, was remarkably low considering the fact that this quake was one of the strongest on record. The first killer earthquake of 1968 took about 300 lives in Sicily, in mid-January.

| Place              | Year | Deaths |
|--------------------|------|--------|
| Morocco, Agadir    | 1960 | 12,000 |
| Iran, northwestern | 1962 | 10,000 |
| Chile, southern    | 1960 | 5,700  |
| Iran, northern     | 1957 | 2,500  |
| Turkey, eastern    | 1965 | 2,477  |
| Iran, western      | 1957 | 2,000  |
| Mongolia, outer    | 1957 | 1,200  |
| Yugoslavia, Skopje | 1963 | 1,100  |
| Chile, central     | 1965 | 428    |
| El Salvador        | 1965 | 125    |
| Alaska             | 1964 | 115    |
| Taiwan             | 1964 | 110    |

ciple quite different from the pendulum seismograph. The object is to detect small distance changes, caused by earth tremors, between two rigid posts set in bedrock about 100 ft. apart.

Stretched horizontally between the posts is a long fused quartz tube; it is attached by one end to one post only, the free end of the tube being just short of the second post. Strains in the bedrock move the posts to produce small variations in the gap between the end of the quartz tube and the second post. These gap variations are measured by means of electromagnetic and variable discriminator transducers to provide records of the earth tremors.

**Microearthquakes.** The development of reliable earthquake prediction techniques obviously calls for the fullest possible understanding of the total seismic process—all the

(Continued overleaf)

## Forecast: Earthquakes

*Continued from previous page*

way from the smallest detectable tremors and magnetic disturbances to the ultimate cataclysmic upheavals.

Consequently, increasing attention is being given to methods of detecting *micro*-earthquakes, and still weaker tremors called *ultramicro*earthquakes. The study of such weak seismic events imposes three basic research problems 1) the development of increasingly sensitive instruments, 2) the use of mobile equipment, and 3) processing of data using electronic data processing methods.

The Japanese are pioneering *micro*earthquake research—understandably so, considering the high incidence of earthquakes in that country. A Japanese seismologist, reporting at the U.S.-Japanese conference on earthquake research in 1966 said: "In any place in Japan at least 10 to 30 *micro*earthquakes can probably be observed every day on the average. At Matsushiro about 10,000 shocks per day are recorded with highly sensitive short-period seismometers, but this is quite exceptional. At Tsukuba about 200 shocks are recorded per day. . . . Analysis of the data will become a burden for seismologists unless automatic data analysis is developed quickly."

*Micro*earthquakes have relatively short detection ranges, hence it is necessary to use dense networks of observation stations or arrays of stations. Consequently, the Japanese have mobilized much of their *micro*-earthquake detection equipment by installing it in trucks.

The Japanese use fairly simple systems consisting of geophones, amplifiers, and FM tape recorders; the amplifiers have flat responses from 1 to 200 Hz. Another type of apparatus, also developed and used in Japan, consists of a delay system utilizing an endless tape, trigger circuit, tape recorder, and a visible recorder. Fast-running visible records of shocks, as well as reproducible records on FM tape, are obtained with the equipment.

U.S. seismologists are also developing new instrumentation to measure *micro*- and *ultra*-*micro*earthquakes. The basic seismometer used by scientists of the Lamont Geological Observatory (near New York City) has a 500-ohm coil with an output of about 580

microvolts per micron per second of ground motion. The output from this unit is fed into an amplifier having a voltage gain of one million, an input impedance of 2200 ohms, and a noise level, referred to the input of approximately a tenth of a microvolt rms.

**Other Studies.** Earthquake research of course involves many other kinds of studies besides the measurement of earth tremors with seismographs and geomagnetism with magnetometers. Triangulation and leveling networks utilizing tiltmeters and extensometers are used to detect gradual land deformation. Other types of instruments gather data about ocean tide patterns. Large man-made explosions help obtain information about seismic wave velocities. Underground heat flow and electrical conductivity phenomena are naturally also of considerable interest.

The National Aeronautics and Space Administration is sponsoring considerable research in the development and application of remote-sensing techniques using satellites.

Earthquake research still has a long way to go before magnetic or other types of prediction methods can be developed. But the big research push is on. Meanwhile, those who live atop seismic powder kegs can only do what they have done for thousands of years in the past—hang on tight when the big rumbles arrive. ■

## X Marks The Time

*Continued from page 48*

watches? How much will such an exotic time-piece cost? Sorry, but it will be some time before you sport one of these electronic marvels, and there isn't the slightest hint about what it might cost.

The researchers admit that they still have technical production problems to overcome. It is one thing to make these watches in a laboratory where time and expense are of little consequence. It is quite another thing to mass-produce the delicate mechanisms and still maintain high degrees of accuracy and performance reliability.

You can bet that when the watch does become generally available it will command premium prices—even if production costs are comparable to those of other types of watches. This would be the only practical way that the manufacturers would be able to limit sales of the watches. ■



# CLASSIFIED Market Place

FOR BIGGER PROFITS! NEW CAREER OPPORTUNITIES!  
READ AND REPLY TO THESE CLASSIFIED ADS

Classified Ads 65¢ per word, each insertion, minimum 10 words, payable in advance. To be included in the next available issue of ELEMENTARY ELECTRONICS, copy must be in our New York Office by Sept. 10th. Address orders to C. D. Wilson, Manager, Classified Advertising, ELEMENTARY ELECTRONICS, 229 Park Avenue South, New York, N. Y. 10003.

## ADDITIONAL INCOME

**PANELISTS At Home Wanted By New York Researcher.** Leading research firm seeking people to furnish honest opinions by mail from home. Pays cash for all opinions rendered. Clients' products supplied at no cost. For information write: Research, 669, Mineola, N. Y. 11501, Dept. 633-EE.

**MAKE Your Classified Ad Pay. Get "How To Write a Classified Ad That Pulls."** Includes certificate worth \$2.00 towards classified ad in S & M. Send \$1.25 (includes postage) to C. D. Wilson, Science & Mechanics, 229 Park Avenue South, New York, N. Y. 10003.

## BOOKS & PERIODICALS

**TERRIFIC. New Army Written Book.** Basic Theory And Application of Transistors, \$1.40 Postpaid. Devices, Box 136B, Bronx, N. Y. 10463.

**CATALOG of all Science & Mechanics Craftprints.** Send 25¢ to cover postage and handling to Craftprint Div., Science & Mechanics, 229 Park Avenue South, New York 10003.

## BUSINESS OPPORTUNITIES

**I MADE \$40,000.00 Year by Mailorder!** Helped others make money! Start with \$10.00—Free Proof! Torrey, Box 318-T, Ypsilanti, Michigan 48197.

**FREE Book "990 Successful Little-Known Businesses"** Fascinating! Work home! Plymouth 211-H, Brooklyn, New York 11218.

**FOR Business Opportunities—read Science & Mechanics, 12 issues \$4.00.** Write Science & Mechanics, 229 Park Avenue South, New York N.Y. 10003.

## CAMPERS, CAMPING EQUIPMENT & TENTS

**FOR Consistent Fun, Excitement and Expert Advice,** subscribe to "Camping Journal," America's Leading Camping Magazine. Only \$4.98 for 12 Issues. Write Camping Journal, 229 Park Avenue South, New York, N. Y. 10003.

## EARTHWORMS

**BIG Money Raising Fishworms and Crickets.** Free literature. Carter Farm-O, Plains, Georgia 31780.

## EDUCATION & INSTRUCTION

**FCC License and Associate Degree correspondence/residence courses.** School bulletin free. Grantham Institute of Electronics, 1505 N. Western Ave., Hollywood, California 90027.

**EARN Your Degree In Electronics Engineering.** Highly Effective Home Study Courses In Electronics Engineering Technology And Electronics Engineering Mathematics. Free Literature. Cook's Institute Of Electronics Engineering, P. O. Box 36185, Houston, Texas 77036. (Established 1945.)

**PRACTICAL tips for home, garden and workshop** are in "1001 How-To Ideas." A high value reference for all craftsmen. Send \$1.00 for your copy includes Postage, to 1001 How-To Ideas, 229 Park Avenue South, New York, N. Y. 10003.

## ELECTRONIC COMPONENTS

**ELECTROSHOCK MODULE** produces 1200 volt shock from 6 volts. No battery drain until touched. Non lethal. Protects property for months on lantern battery. \$4.95. Catalog 206. Franks Scientific Co., P. O. Box 156, Martelle, Iowa 52305.

## HYPNOTISM

**Self-Hypnosis for self-improvement.** New Concept. Free literature. Smith-McKinley, Box 3038, San Bernardino, California 92404.

## INVENTIONS WANTED

**WE either sell your invention or pay cash bonus.** Write for details. Universal Inventions, 296-3, Marlon, Ohio 43302.

## MAGNETS

**MAGNETS.** All types. Specials—20 disc magnets or 2 stick magnets, or 10 small bar magnets, or 8 assorted magnets, \$1.00. Maryland Magnet Company, 5412-R, Gist, Baltimore, Md. 21215.

## MONEYMAKING OPPORTUNITIES

**\$200.00 MONTHLY Telephoning or re-fund.** 50¢. Charles Redmond, Box 8454-DP, Los Angeles 90008.

**"8 GOLDEN Keys" Mailorder Course-book.** Save sending quarters, dimes, elsewhere. Everything complete, \$2.00. Free, 500 personalized labels with order. Pauls-3, Postbox 3258, Boulder, Colo. 80302.

**START Profitable Business in spare time.** Investigate many money-making opportunities. Send 25¢ for sample copy of Income Opportunities Magazine. 229 Park Avenue South, New York, N. Y. 10003.

## PERSONAL

**HIGHER Income, Security and Power.** 256 page Book "Thinking Big" reveals secrets that make men Rich! Send \$2.00 Forrest Gifts, 103 North Taylor, Jefferson City, Missouri 65101.

**FOR the best in Mystery Reading—Subscribe to Ellery Queen's Mystery Magazine, 229 Park Avenue South, New York, N. Y. 10003.** Send \$3.87 for 12 issues.

## RADIO & TELEVISION

**THOUSANDS and thousands of types of electronic parts, tubes, transistors, instruments, etc.** Send for Free Catalog. Arc-turus Electronics Corp., EME, 502—22nd St., Union City, N. J. 07087.

**10 DISTANCE Crvstal set plans—25¢; 20 different—50¢.** Includes Transistor experiments, catalog. Laboratories, 12041-G Sheridan, Garden Grove, Calif. 92640.

**C.B. BUYERS' Guide—A new magazine for the buyers of Citizen's Band Electronic Equipment.** Send \$1.25—Includes Postage to C. B. Buyers' Guide, 229 Park Avenue South, New York 10003.

## STAMP COLLECTING

**GENEROUS Bargain Lot \$1.00.** High Value Packet \$2.00. Persile, 436 New York Avenue, Brooklyn, N. Y. 11225.

**FREE 121 Different Flag Stamps.** W-E Stamp Company, Wilkes-Barre, Penna. 18703.

## For Greater Classified Profits

WHY NOT TRY THIS NEW

## combined classified ad medium

Your classified ad will appear in SCIENCE & MECHANICS MAGAZINE as well as in a minimum of four other SCIENCE & MECHANICS PUBLICATIONS. Write now for information to C. D. Wilson, Manager, Classified Advertising, SCIENCE & MECHANICS, 229 Park Avenue South, New York, N. Y. 10003.

**Hunting for a better job?**

**Here's the  
license  
you need  
to go after  
the big ones**



**A Government FCC License can help you bring home up to \$10,000, \$12,000, and more a year. Read how you can prepare for the license exam at home in your spare time — with a passing grade assured or your money back.**

**I**F YOU'RE OUT TO BAG A BETTER JOB in Electronics, you'd better have a Government FCC License. For you'll need it to track down the choicest, best-paying jobs that this booming field has to offer.

Right now there are 80,000 new openings every year for electronics specialists—jobs paying up to \$5, \$6, even \$7 an hour...\$200, \$225, \$250 a week...\$10,000, \$12,000, and up a year! You don't need a college education to make this kind of money in Electronics. You don't even need a high school diploma.

But you *do* need knowledge, knowledge of electronics fundamentals. And there is only one nationally accepted method of measuring this knowledge...the licensing program of the FCC (Federal Communications Commission).

**Why a license is important**

An FCC License is a legal requirement if you want to become a Broadcast Engineer, or get into servicing any other kind of transmitting equipment—two-way mobile radios, microwave relay links, radar, etc. And even when it's not legally required, a license proves to the world that you understand the principles involved in *any* electronic device. Thus, an FCC "ticket" can open the doors to thousands of exciting, high-paying jobs in communications, radio and broadcasting, the aerospace program, industrial automation, and many other areas.

So why doesn't everybody who wants a good job in Electronics get an FCC License and start cleaning up?

The answer: it's not that simple. The government's licensing exam is tough. In fact, an average of two out of every three men who take the FCC exam fail.

There is one way, however, of being pretty certain that you will pass the FCC exam. And that is to take one of the FCC home study courses offered by Cleveland Institute of Electronics.

CIE courses are so effective that better than 9 out of 10 CIE graduates who take the exam pass it. That's why we can afford to back our courses with this iron-clad Warranty: Upon completing one of our FCC courses, you

must be able to pass the FCC exam and get your license—or you'll get your money back!

**They got their licenses and went on to better jobs**

The value of CIE training has been demonstrated time and again by the achievements of our thousands of successful students and graduates.

Ed Dulaney, Scottsbluff, Nebraska, for example, passed his 1st Class FCC License exam soon after completing his CIE training...and today is the proud owner of his own mobile radio sales and service business. "Now I manufacture my own two-way equipment," he writes, "with dealers who sell it in seven different states, and have seven full-time employees on my payroll."

Daniel J. Smithwick started his CIE training while in the service, and passed his 2nd Class exam soon after his discharge. Four months later, he reports, "I was promoted to manager of Bell Telephone at La Moure, N. D. This was a very fast promotion and a great deal of the credit goes to CIE."

Eugene Frost, Columbus, Ohio, was stuck in low-paying TV repair work before enrolling with CIE and earning his FCC License. Today, he's an inspector of major electronic systems for North American Aviation,

"I'm working 8 hours a week less than before," says Mr. Frost, "and earning \$228 a month more."

**Send for FREE book**

If you'd like to succeed like these men, send for our FREE 24-page book "How To Get A Commercial FCC License." It tells you all about the FCC License...requirements for getting one...types of licenses available...how the exams are organized and what kinds of questions are asked... where and when the exams are held, and more.

With it you will also receive a second FREE book, "How To Succeed In Electronics." To get both books without cost or obligation, just mail the attached postpaid card. Or, if the card is missing, send your name and address to CIE at the address below.

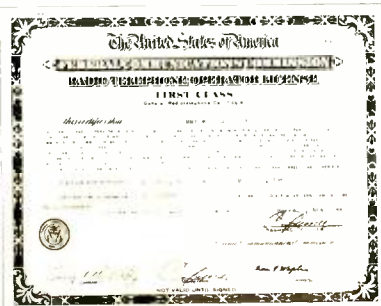

**ENROLL UNDER NEW G.I. BILL.** All CIE courses are available under the new G.I. Bill. If you served on active duty since Jan. 31, 1955, or are in service now, check box on reply card for complete details.

**CIE**

**Cleveland Institute of Electronics**

1776 E. 17th St., Dept. EL-10 Cleveland, Ohio 44114

Accredited Member National Home Study Council  
A Leader in Electronics Training...Since 1934



# BUILD YOUR OWN RADIO

Reg. U. S. Pat. Off.



Training Electronics Technicians Since 1946

**CIRCUITS AT HOME** only \$29.95  
with the New Improved  
**PROGRESSIVE RADIO "EDU-KIT"®**  
A Practical Home Radio Course

**Now Includes**

- \* 12 RECEIVERS
- \* 3 TRANSMITTERS
- \* SQ. WAVE GENERATOR
- \* SIGNAL TRACER
- \* AMPLIFIER
- \* SIGNAL INJECTOR
- \* CODE OSCILLATOR

**EXPANDED "EDU-KIT" NOW INCLUDES**

- \* TRANSISTOR (Solid State) CIRCUITS
- \* VACUUM TUBE CIRCUITS
- \* PRINTED CIRCUITS
- \* HAND WIRED CIRCUITS

**YOU DON'T HAVE TO SPEND HUNDREDS OF DOLLARS FOR A RADIO COURSE**

The "Edu-Kit" offers you an outstanding PRACTICAL HOME RADIO COURSE at a rock-bottom price. Our Kit is designed to train Radio Electronics Technicians, making practice and servicing. THIS IS A COMPLETE RADIO COURSE IN EVERY DETAIL. You will learn how to build radios, using regular schematics; how to wire and solder punched metal chassis as well as the latest development of Printed Circuit chassis. You will learn the basic principles of radio, you will construct, study and work with RF and AF amplifiers and oscillators, detectors, rectifiers, test equipment, and work with and practice code, using the Progressive Code Oscillator. You will learn and practice trouble-shooting, using the Progressive Signal Tracer, Progressive Signal Injector, Progressive Dynamic Radio & Electronics Tester, Square Wave Generator and the accompanying instructional material.

You will receive training for the Novice, Technician and General Classes of F.C.C. Radio Amateur Licenses. You will build Receiver, Transmitter, Square Wave Generator, Code Oscillator, Signal Tracer and Signal Injector circuits, and learn how to operate them. You will receive an excellent background for television, Hi-Fi and Electronics.

Absolutely no previous knowledge of radio or science is required. The "Edu-Kit" is the product of many years of teaching and engineering experience. The "Edu-Kit" will provide you with a basic education in Electronics and Radio work many times the low price you pay. The Signal Tracer alone is worth more than the price of the kit.

**THE KIT FOR EVERYONE**

You do not need the slightest background in radio or science. Whether you are interested in Radio & Electronics because you want an interesting hobby, a well paying business or a job with a future, you will find the "Edu-Kit" a worth-while investment. Many thousands of individuals of all

ages and backgrounds have successfully used the "Edu-Kit" in more than 79 countries of the world. The "Edu-Kit" has been carefully designed, step by step, so that you cannot make a mistake. The "Edu-Kit" allows you to teach yourself at your own rate. No instructor is necessary.

**PROGRESSIVE TEACHING METHOD**

The Progressive Radio "Edu-Kit" is the foremost educational radio kit in the world, and is universally accepted as the standard in the field of electronics training. The "Edu-Kit" uses the modern educational principle of "Learn by Doing." Therefore you construct, learn schematics, study theory, practice trouble shooting—all in a closely integrated program designed to provide an easily-learned, thorough and interesting background in radio. You begin by examining the various radio parts of the "Edu-Kit." You then learn the function, theory and wiring of these parts. Then you build a simple radio. With this first and trouble-shooting. Then you build a more advanced radio, learn more advanced theory and techniques. Gradually, in a progressive manner, and at your own rate, you will find yourself constructing more advanced multi-tube radio circuits, and doing work like a professional Radio Technician.

Included in the "Edu-Kit" course are Receiver, Transmitter, Code Oscillator, Signal Tracer, Square Wave Generator and Signal Injector Circuits. These are not unprofessional "breadboard" experiments, but genuine radio circuits, constructed by means of professional wiring and soldering on metal chassis, plus the new method of radio construction known as "Printed Circuitry." These circuits operate on your regular AC or DC house current.

**THE "EDU-KIT" IS COMPLETE**

You will receive all parts and instructions necessary to build twenty different radio and electronics circuits, each guaranteed to operate. Our Kits contain tubes, tube sockets, variable, electrolytic, mica, ceramic and paper dielectric condensers, resistors, tie strips, hardware, tuning, punched metal chassis, Instruction Manuals, hook-up wire, solder, selenium rectifiers, coils, volume controls and switches, etc.

In addition, you receive Printed Circuit materials, including Printed Circuit chassis, special tube sockets, hardware and instructions. You also receive a useful set of tools, a Tester. The "Edu-Kit" also includes Code Instructions and the Progressive Code Oscillator, servicing with the Progressive Signal Tracer and the Progressive Signal Injector, a High Fidelity Guide and a Quiz Book. You receive Membership in Radio-TV Club, Free Consultation Service, Certificate of Merit and Discount Privileges. You receive all parts, tools, instructions, etc. Everything is yours to use.

Progressive "Edu-Kits" Inc., 1186 Broadway, Dept. 527DJ, Hewlett, N. Y. 11557

**UNCONDITIONAL MONEY-BACK GUARANTEE**

Please rush my Progressive Radio "Edu-Kit" to me, as indicated below:

Check one box to indicate choice of model

- Regular model \$26.95
- Deluxe model \$31.95 (same as regular model, except with superior parts and tools)
- Expanded model \$36.95 (same as Deluxe model, except with 5 additional solid state circuits plus valuable Radio & TV Tube Checker).

Check one box to indicate manner of payment

- I enclose full payment. Ship "Edu-Kit" post paid.
- Ship "Edu-Kit" C.O.D. I will pay postage.
- Send me FREE additional information describing "Edu-Kit."

Name .....  
Address .....

**PROGRESSIVE "EDU-KITS" INC.**

1186 Broadway, Dept. 527DJ, Hewlett, N. Y. 11557

**FREE EXTRAS**

**• SET OF TOOLS**

- SOLDERING IRON
- ELECTRONICS TESTER
- PLIERS-CUTTERS
- VALUABLE DISCOUNT CARD
- CERTIFICATE OF MERIT
- TESTER INSTRUCTION MANUAL
- HIGH FIDELITY GUIDE & QUIZZES
- TELEVISION BOOK RADIO
- TROUBLE-SHOOTING BOOK
- MEMBERSHIP IN RADIO-TV CLUB: CONSULTATION SERVICE & FCC AMATEUR LICENSE TRAINING
- PRINTED CIRCUITRY

**SERVICING LESSONS**

You will learn trouble-shooting and servicing in a progressive manner. You will practice repairs on the sets that you construct. You will learn symptoms and causes of trouble in home, portable and car radios. You will learn how to use the professional Signal Tracer, the unique Signal Injector, and the dynamic Radio & Electronics Tester. While you are learning in this practical way, you will be able to do many a repair job for your friends and neighbors, and charge fees which will far exceed the price of the "Edu-Kit." Our Consultation Service will help you with any technical problems you may have.

**FROM OUR MAIL BAG**

J. Stataitis, of 25 Poplar Pl., Waterbury, Conn., writes: "I have repaired several sets for my friends, and made money. The "Edu-Kit" paid for itself. I was ready to spend \$240 for a course, but I found your ad and sent for your Kit."

Ben Valerio, P. O. Box 21, Magna, Utah, writes: "The Edu-Kit is wonderful. Here I am sending you the questions and also the answers for them. I have been in Radio for the last seven years, but like to work with Radio Kits, and like to build Radio Testing Equipment. I enjoyed every minute I worked with the different kits; the Signal Tracer works fine. Also like to let you know that I feel proud of becoming a member of your Radio-TV Club."

Robert L. Shuff, 1534 Monroe Ave., Huntington, W. Va., writes: "Thought I would drop you a few lines to say that I received my Edu-Kit, and was really amazed that such a bargain can be had at such a low price. I have already started repairing radios and phonographs. My friends were really surprised to see me get into the swing of it so quickly. The trouble-shooting Tester that comes with the Kit is really swell, and finds the trouble, if there is any to be found."

**PRINTED CIRCUITRY**

At no increase in price, the "Edu-Kit" now includes Printed Circuitry. You build a Printed Circuit Signal Injector, a unique servicing instrument that can detect many Radio and TV troubles. This revolutionary new technique of radio construction is now becoming popular in commercial radio and TV sets.

A Printed Circuit is a special insulated chassis on which has been deposited a conducting material which takes the place of wiring. The various parts are merely plugged in and soldered to it.

Printed Circuitry is the basis of modern Automation Electronics. A knowledge of this subject is a necessity today for anyone interested in Electronics.