

elementary Electronics

JULY-AUGUST 75c

HOW TO—

- DX the Arctic
- Swing a Xtal
- Dope Out AVC

\$9 CB CONTROL COMBO

1-FET multi-mike command center
no Dynamic Duo can do without ↴

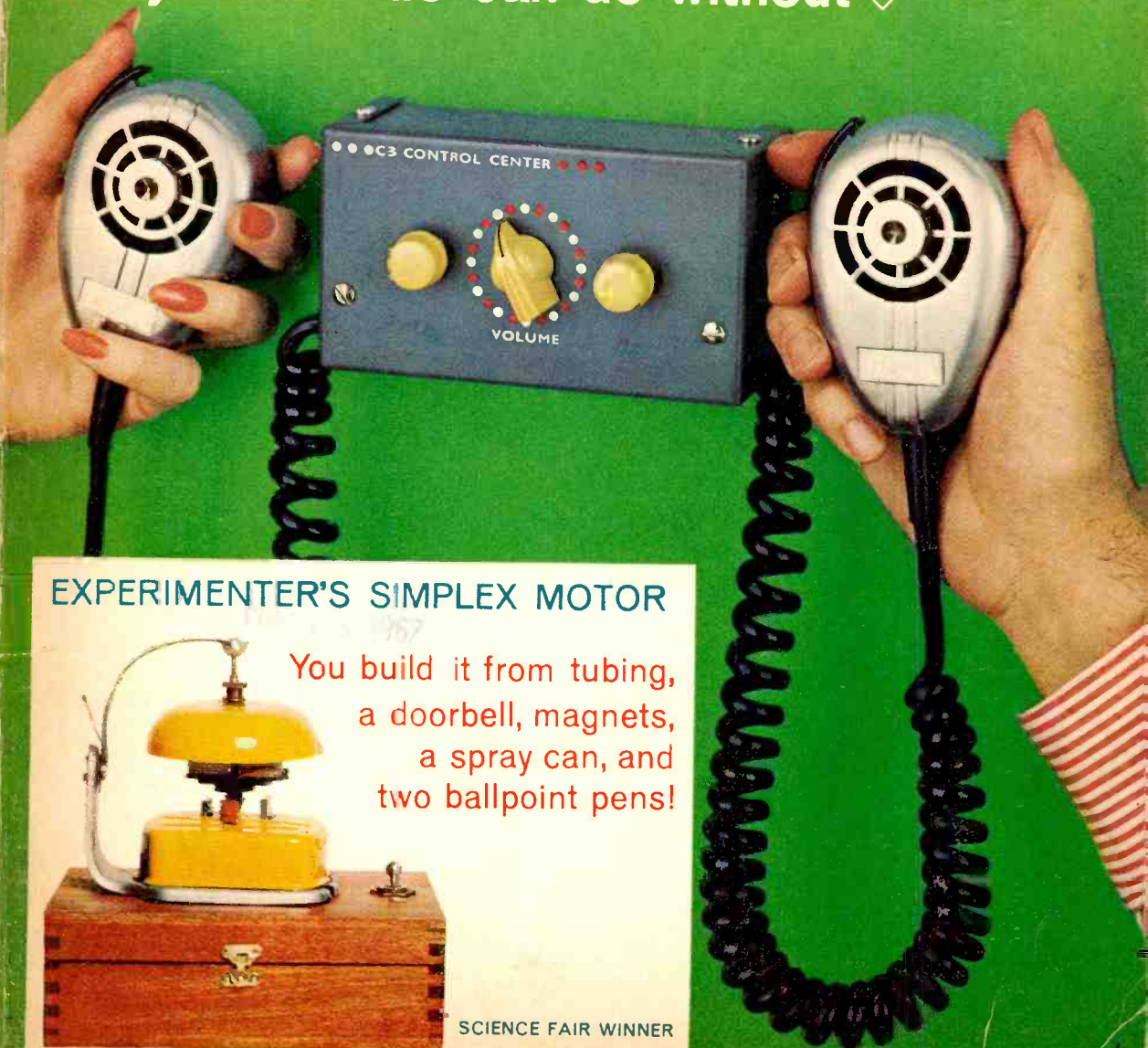

EXPERIMENTER'S SIMPLEX MOTOR

You build it from tubing,
a doorbell, magnets,
a spray can, and
two ballpoint pens!

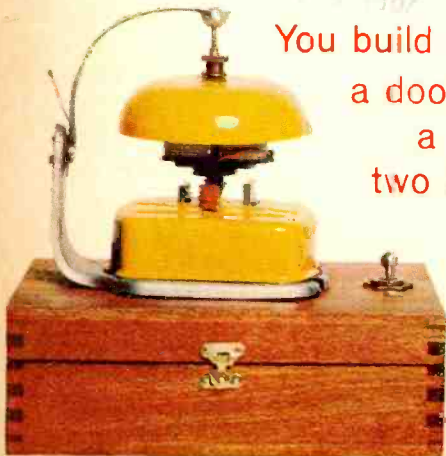

SCIENCE FAIR WINNER



Introducing EICO's New "Cortina Series"!

Today's electro-technology makes possible near-perfect stereo at moderate manufacturing cost: that's the design concept behind the new EICO "Cortina" all solid-state stereo components. All are 100% professional, conveniently compact (3 1/8"H, 12"W, 8"D), in an esthetically striking "low silhouette." Yes, you can pay more for high quality stereo. But now there's no need to. The refinements will be marginal and probably inaudible. Each is \$89.95 kit, \$129.95 wired.

Model 3070 All-Silicon Solid-State 70-Watt Stereo

Amplifier: Distortionless, natural sound with unrestricted bass and perfect transient response (no inter-stage or output transformers); complete input, filter and control facilities; failure-proof rugged all-silicon transistor circuitry.

Model 3200 Solid-State FM/MPX Automatic Stereo Tuner: Driftless, noiseless performance; 2.4 μ V for 30db quieting; RF, IF, MX are pre-wired and pre-tuned on printed circuit boards — you wire only non-critical power supply.

7 New Ways to make Electronics more Fun!

Save up to 50% with EICO Kits and Wired Equipment.



You hear all the action-packed capitals of the world with the NEW EICO 711 "Space Ranger" 4-Band Short Wave Communications Receiver — plus ham operators, ship-to-shore, aircraft, Coast Guard, and the full AM band. 550KC to 30MC in four bands. Selective, sensitive super-het, modern printed circuit board construction. Easy, fast pinpoint tuning. Illuminated slide-rule dials, logging scale; "SI" meter, electrical bandspread tuning, variable BFO for CW and SSB reception, automatic noise limiter, 4" speaker. Headphone jack. Kit \$49.95. Wired \$69.95.



More "ham" for your dollar than ever — with the one and only SSB/AM/CW 3-Band Transceiver Kit, new Model 753 — "the best ham transceiver buy for 1966" — Radio TV Experimenter Magazine. 200 watts PEP on 80, 40 and 20 meters. Receiver offset tuning, built-in VFO, high level dynamic ALC, silicon solid-state VFO. Unequaled performance, features and appearance. Sensationally priced at \$189.95 kit, \$299.95 wired.



NEW EICO 888 Solid-State Engine Analyzer

Now you can tune-up, trouble-shoot and test your own car or boat.

Keep your car or boat engine in tip-top shape with this completely portable, self-contained, self-powered universal engine analyzer. Completely tests your total ignition/electrical system. The first time you use it — just to tune for peak performance — it'll have paid for itself. (No tune-up charges, better gas consumption, longer wear) 7 instruments in one, the EICO 888 does all these for 6V and 12V systems; 4, 6 & 8 cylinder engines.

The EICO 888 comes complete with a comprehensive Tune-up and Trouble-shooting Manual including RPM and Dwell angle for over 40 models of American and Foreign cars. The Model 888 is an outstanding value at \$44.95 kit, \$59.95 wired.

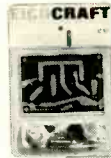

New EICOCRAFT® easy-to-build solid-state electronic kits: great for beginners and sophisticates alike. As professional as the standard EICO line — only the complexity is reduced to make kit-building faster, easier, lower cost. Features: pre-drilled copper-plated etched printed

circuit boards; finest parts; step-by-step instructions; no technical experience needed — just soldering iron and pliers. Choose from: Fire Alarm; Intercom; Burglar Alarm; Light Flasher; "Mystifier"; Siren; Code Oscillator; Metronome; Tremolo; Audio Power Amplifier; AC Power Supply. From \$2.50 per kit.



New EICO "Nova-23" (Model 7923) all solid-state 23-channel 5 watt CB Transceiver featuring a host of CB advances—plus exclusive engineering innovations.

EXCLUSIVE dual-crystal lattice filter for advanced razor-sharp selectivity of reception. **EXCLUSIVE** highly efficient up-converter frequency synthesizer provides advanced stability and freedom from trouble in all 23 crystal-controlled transmit-receive channels. All crystals supplied. **EXCLUSIVE** use of precision series-mode fundamental crystals for superior transmit and receive stability. **Wired only, \$189.95**



Model 460 Wideband Direct-Coupled 5" Oscilloscope. DC-4.5mc for color and B&W TV service and lab use. Push-pull DC vertical amp., bal. or unbal. input. Automatic sync limiter and amp. \$99.95 kit, \$139.95 wired.

FREE 1967 CATALOG

EE-7

EICO Electronic Instrument Co., Inc.
131-01 39th Ave., Flushing, N. Y. 11352

Send me **FREE** catalog describing the full EICO line of 200 best buys, and name of nearest dealer. I'm interested in:

- test equipment ham radio
 stereo/hi-fi Citizens Band radio
 automotive electronics

Name _____

Address _____

City _____

State _____

Zip _____



Model 232 Peak-to-Peak VTVM. A must for color or B&W TV and industrial use. 7 non-skip ranges on all 4 functions. With exclusive Uni-Probe. \$29.95 kit, \$49.95 wired.

Cast your ballot for a successful future!

253 I.C.S. COURSES



I.C.S. is the oldest, largest correspondence school. Over 200 courses. Business, industrial, engineering, academic, high school. One for you. Direct, job-related. Bedrock facts and theory plus

practical application. Complete lesson and answer service. No skimping. Diploma to graduates. Send for the 3 free booklets offered here and find out how I.C.S. can be your road to success.

ACCOUNTING
Accounting for Business
Programmers
Accountant (Canadian)
Auditing Business Law
Cost Accounting
C.P.A. Review
Estate & Trust Accounting
Executive Accounting
Federal Tax
General Accounting
Industrial Accounting
Junior Accounting
Legal Accounting
Office Accounting
Personal Income Tax
Procedure
Practical Accounting
Public Accounting
Small Business Accounting
Starting & Managing a
Small Bookkeeping Ser.

**ARCHITECTURE
AND BUILDING**
Arch. Drawing & Designing
Architecture
Building Contractor
Building Estimator
Building Inspector
Building Maintenance
Carpenter-Building
Carpentry & Millwork
House Planning & Interior
Design
Mason Painting Contr.
Reading Arch. Blueprints
Review in Arch. Design &
Practice
Review of Mech. Systems
in Buildings

ART
Amateur Artist
Commercial Art
Commercial Cartooning
Illustrating with Options:
—Magazine
—Advertising Layout
—Illustration
Interior Decorating
Oil Painting for Pleasure
Show Card & Sign Prod.
Show Card Writing
Sign Painting & Designing
Sketching & Painting

AUTOMOTIVE
Automatic Transmission
Specialist
Automobile Body
Rebuilding & Refinishing
Automobile Electrical Tech.
Automobile Engine Tune-Up

Automobile Technician
Automotive Mechanic
Diesel-Gas Motor Vehicle
Engines
BUSINESS
Advertising
Basic Inventory Control
Business Administration
Canadian Business Courses
COBAL Programming
Condensed Bus. Practice
Direct Mail & Mail
Order Advertising
Industrial Psychology
Magazine & Newspaper
Advertising
Managing a Small Store
Marketing
Marketing Management
Marketing Research
Modern Exec. Management
Office Automation
Office Management
Production Management
Programming for Digital
Computers
Programming the IBM
1401 Computer
Programming the IBM
SYSTEM/360 Computer
Purchasing Agent
Retail & Local Advertising
Retail Bus. Management
Retail Merchandising
Retail Selling
Systems and Procedures
Analysis

CHEMICAL
Analytical Chemistry
Chemical Engineering
Chemical Engineering
Unit Operations
Chemical Laboratory Tech.
Chemical Process Operator
Elements of Nuclear Energy
General Chemistry
Industrial Laboratory
Analysis

**CIVIL
ENGINEERING**
Civil Engineering
Construction Eng'r'g
Technology
Highway Engineering Tech.
Principles of Surveying
Reading Highway Bl'pts
Reading Structural
Blueprints
Sanitary Engineering Tech.
Sewage Plant Operator
Structural Eng'r'g Tech.

Surveying and Mapping
Water Works Operator
**COLLEGE-LEVEL
LANGUAGES**
Calculus Economics History
DRAFTING
Aircraft Drafting
Architectural Drafting
Design Drafting
Drafting Technology
Electrical Drafting
Electrical Eng'r'g Drafting
Electronic Drafting
Introductory Mech. Draft.
Mechanical Drafting
Pressure-Vessel and Tank
Print Reading
Sheet Metal Layout for
Air Conditioning
Structural Drafting
ELECTRICAL
Electric Motor Repairman
Electrical Appliance Ser.
Electrical Contractor
Electrical Engineering
(Power option or
Electronic option)
Electrical Engineering Tech.
Electrical Instrument Tech.
Industrial Electrical Tech.
Power Line Design
and Construction
Power Plant Operator
(Hydro or Steam option)
Practical Electrician
Practical Lineman
Reading Elec. Blueprints

**ENGINEERING
(Professional Courses)
Refresher Courses)**
Chemical Civil Electrical
Engineering-In-Training
Industrial Mechanical
**ENGLISH AND
WRITING**
Better Business Writing
Free Lance Writing
for Fun & Profit
Introductory Technical
Writing
Modern Letter Writing
Practical English
Short Story Writing
HIGH SCHOOL
High School Business
High School (Canadian)
High School College
Prep. (Arts)
High School College Prep.
(Engineering & Science)
High School General
High School Mathematics

High School Secretarial
High School Vocational
LANGUAGES
(Edited by Berlitz)
French German
Italian Spanish
LEADERSHIP
Basic Supervision
Industrial Foremanship
Industrial Supervision
Modern Woman
as a Supervisor
Personality Development
Personnel-Labor Relations
Supervision

MATHEMATICS
Advanced Mathematics
Mathematics and Mechanics
for Engineering
Mathematics and Physics
for Technicians
Mathematics and Physics
for Engineers
Modern Elementary Stat.

MECHANICAL
Aircraft & Power
Plant Mechanics
Fortran Programming
for Engineers
Hydraulic & Pneu. Power
Industrial Engineering
Industrial Management
for Engineers
Industrial Eng'r'g Tech.
Industrial Instrumentation
Machine Design
Mechanical Engineering
Quality Control
Safety Eng'r'g Tech'g'y
Tool Design Value Analysis
Vibration Analysis
and Control

PETROLEUM
Natural Gas Production
& Transmission
Oil Field Technology
Petroleum Production
Petroleum Prod. Eng'r'g
Petroleum Refinery Oper.
Pipeline Engineering Tech.
PLASTICS
Design of Plastic Products
Plastics Technician
**PLUMBING,
HEATING, AIR
CONDITIONING**
Air Conditioning
Air Conditioning Maint.
Domestic Heating with
Oil & Gas
Domestic Refrig. Heat'g

Heating & Air Conditioning
with Drawing
Industrial Air Conditioning
Industrial Heating
Pipe Fitting Plumbing
Plumbing & Heating
Plumbing & Heating Est.
Practical Plumbing
Refrigeration & Air Cond.
PULP AND PAPER
Paper Machine Operator
Paper Making, Pulp Making
Pulp & Paper Engineering
Pulp & Paper Making
Sales Management
Salesmanship
Salesmanship
Salesmanship

SECRETARIAL
Clerk-Typist Commercial
Engineering Secretary
Legal Secretary
Medical Secretary
Professional Secretary
Shorthand Stenographic
Typewriting
SHOP PRACTICE
Drill Operator
Fountain Practice
Industrial Metallurgy
Lathe Operator
Machine Shop Inspection
Machine Shop Practice
Machine Shop Practice &
Toolmaking
Metalurgical Eng'r'g
Technology
Milling Machine Operator
Multitask Maintenance
Mechanic
Practical Millwrighting
Reading Shop Prints
Reading
Tool Eng'r'g Tech'g'y
Tool Grinder Toolmaking
Turned Lathe Operator
Welding Engineering Tech.
Welding Processes
**STEAM AND
DIESEL POWER**
Boiler Inspector
Industrial Building Eng'r'
Power Plant Engineering
Stationary Diesel Engines
Stationary Fireman
Stationary Steam Eng'r'g
TEXTILES
Carding
Garding and Spinning

Dyeing & Finishing
Loom Fixing Spinning
Textile Designing
Textile Mill Supervisor
Textile Technology
Textile Weaving
Warping and Weaving
TRAFFIC
Motor Traffic Management
Railway Rate Clerk
Traffic Management
**TV-RADIO-
ELECTRONICS**
Color Television Principles
& Servicing
Communications Techn'gy
Electronic Fundamentals
Electronic Fundamentals
(Programmed)
Electronic Fundamentals
with Electronic Equip-
ment Training
Electronic Instrumentation
& Servo Fundamentals
Electronic Principles for
Automation
Electronics and Applied
Calculus
Electronics Technician
First Class Radiotelephone
License
Fundamentals of Electronic
Computers
General Electronics
General Electronics with
Electronic Equip. Trng.
Hi-Fi Stereo and Sound
Systems Servicing
Industrial Electronics
Industrial Electronics Eng.
Industrial Electronics
Engineering Technician
Numerical Control
Electronics & Maint.
Practical Radio-TV Eng'r'g
Practical Telephony
Principles of Radio-
Electronic Telemetry
Principles of Semiconductor-
Transistor Circuits
Radio Servicing with
Equipment Training
Radio & TV Servicing
Radio & TV Servicing with
Equipment Training
Second Class Radiotele-
phone License
Sound Systems Specialist
Telephony, Electronics and
Radio Communications
TV Receiver Servicing
TV Technician

Clip coupon—and take your first big step to real success! I.C.S., Scranton, Penna. 18515 Accredited Member, National Home Study Council

INTERNATIONAL CORRESPONDENCE SCHOOLS I O S

Dept. 01189E, Scranton, Pa. 18515 * (In Hawaii: P.O. Box 418, Honolulu. In Canada: I.C.S. Canadian, Ltd. In other countries: I.C.S. World, Ltd.)
Without cost or obligation, rush me "HOW to SUCCEED," the opportunity booklet about the field I have indicated below, and a sample lesson.
New! Special Package for Women! Special Training Programs for Industry Convenient Payment Plan

Name of the course in which you are interested _____

Name _____ Age _____ Address _____
(Please indicate Mr. Miss Mrs.)

City _____ State _____ Zip Code _____ Working Hours _____ A.M. to _____ P.M.

Occupation _____ Employed by _____

Approved for veterans under new G. I. Bill.
Special rates to members of U.S. Armed Forces.

ELEMENTARY ELECTRONICS is published bimonthly at \$4.00 per year, by Science & Mechanics Publishing Co., 505 Park Avenue, New York, N.Y. 10022. Second class postage paid at New York, N.Y., and at additional mailing office. Copyright 1967 by Science and Mechanics Publishing Co.

elementary Electronics

JULY/AUGUST, 1967

THEORY

- 41 Transistor Bias Revealed
- 61 Using Unijunctions
- 67 FCC Q & A
- 74 Computer Digs Diagrams
- ☆ 75 A Is for Automatic
- ☆ 85 Those Swinging Rocks

FEATURES

- 12 Tapesters at Play
- 25 What the Sphinx Wouldn't Tell
- 34 The Weather Kids Them Not
- 48 Psychedelic Psyces
- 50 Computer Turns People Picker
- ☆ 81 DX on Ice

CONSTRUCTION

- 31 Reynolds Wrap Amp
- 36 Knight KG-640 Volt-Ohm-Milliameter
- ☆ 51 CB Control Combo
- ☆ 55 Experimenter's Simplex Motor
- 83 Heathkit TA-16 Portable Guitar Amplifier

ELECTRONICS SHORTIES

- 54 Hot Semicons Make the Cool Scene
- 60 Junior TVers Learn by Doing
- 66 The Laser that Makes Like a Rainbow
- 74 Zooks! An Electronic Lorelei!
- 95 Hams At Work—Cartoon Page

DEPARTMENTS

- 13 Positive Feedback—Editorial Chit-chat
- 16 DX Central Reporting—SWL News
- 18 En Passant—Chess Column
- 20 Hey Look Me Over—New Products Showcase
- 24 NewScan—Electronics in the News
- 30 Home Study Bluebook
- 86 Literature Library

☆ Cover Highlights

AUTHORS IN THIS ISSUE:

Len Buckwalter—K10DH/KBA4480, Jack Brayton, John W. Collins, Herb Friedman—W2ZLF/KBI9457, Charles Green—W6FFQ, Carl L. Henry, Jorma Hyypia, K.C. Kirkbride, Jim Kyle—K5JKX, Robert Levine, Gray Matthews, Jack Schmidt, Julian M. Sienkiewicz—WA2CQL/KMD4313, C.M. Stanbury II and the Elementary Electronics' Editorial Staff. ■

Cover Photo by Leonard Heicklen



**NOW — 150
RADIO SHACK STORES
IN 31 STATES!**

ARIZONA — Phoenix
ARKANSAS — Little Rock
CALIFORNIA — Anaheim,
Bakersfield, Covina, Downey,
Garden Grove, Glendale,
Inglewood, La Habra, Long
Beach, Los Angeles, Mission
Hills, Mountain View, Oakland,
Pasadena, Pomona, Reseda,
Sacramento, San Bruno,
San Diego, San Francisco,
Santa Ana, Santa Monica,
Torrance, West Covina
COLORADO — Denver
CONNECTICUT — Hamden,
Manchester, New Britain, New
Haven, New London, Orange,
Stamford, West Hartford
FLORIDA — Jacksonville,
Orlando
GEORGIA — Atlanta
ILLINOIS — Chicago
KANSAS — Wichita
LOUISIANA — New Orleans
MAINE — Portland
MARYLAND — Langley Park
MASSACHUSETTS — Boston,
Braintree, Brockton, Brookline,
Cambridge, Dedham,
Framingham, Lowell, Medford,
Natick, Quincy, Saugus,
Springfield, Waltham, West
Springfield, Worcester
MICHIGAN — Detroit
MINNESOTA — Minneapolis,
St. Paul
MISSOURI — Kansas City,
St. Joseph, St. Louis
NEBRASKA — Omaha
NEW HAMPSHIRE —
Manchester
NEW JERSEY — Pennsauken
NEW MEXICO — Albuquerque
NEW YORK — Albany,
Binghamton, Buffalo, New
York, Schenectady, Syracuse
OHIO — Cincinnati, Cleveland
OKLAHOMA — Oklahoma City,
Tulsa
OREGON — Portland
PENNSYLVANIA —
Philadelphia, Pittsburgh
RHODE ISLAND — Providence,
East Providence
TENNESSEE — Memphis,
Nashville
TEXAS — Abilene, Arlington,
Austin, Brownsville, Corpus
Christi, Dallas, El Paso, Fort
Worth, Houston, Lubbock,
Midland, San Antonio,
Sherman, Waco
UTAH — Salt Lake City
VIRGINIA — Arlington, Virginia
Beach
WASHINGTON — Seattle

SOLD ONLY BY RADIO SHACK®

See Opposite Page for Store Nearest You.

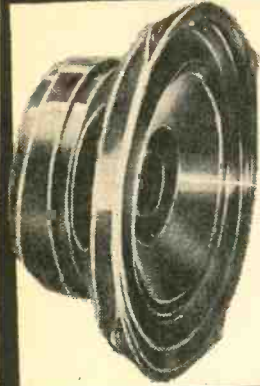

SUPER SPECIAL PURCHASE! HIGH-COMPLIANCE 4" SPEAKERS

For Acoustic Suspension Systems

Compare! Made in England by **EMI**

3⁹⁹
Ea.

Lots of 4-12 **3⁷⁷**
Ea.

Lots of 13-24 **3⁵⁵**
Ea.

Unbeatable low price! Use in custom hi-fi installations, as replacements in compact enclosures, or as extension speakers. Broad cone excursion; 13,000 gauss ceramic magnet; 50-15,000 cps response. Handles 15 watts music power. 8 ohms. #40-1908

Repeat of a Sellout! New Low Price!



6-TRANSISTOR MICRO RADIO

The same miniature portable that sold at \$4.99! Only 2½" square, 1¼" deep. Stunning black grain case, silvered front panel. #12-619

ONLY 4⁹⁹

DUOFONE™ HI-FI HEADPHONES



Wide-range dynamic (not magnet) headset; feather-light; cushioned earpieces. Stereo/mono switch in plug. Matches 4-16 ohms. #33-196

6⁹⁵

America's Only Switchable Stereo and Mono Headset!

5-WATT MOBILE CB TRANSCEIVER

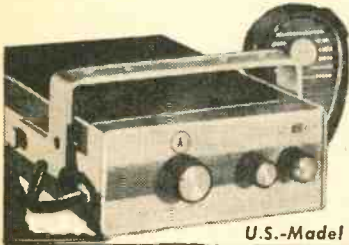

Model TRC-14

Only 79⁹⁵

8-channel operation; 100% modulation; adjustable squelch; ANL; 13 transistors, #21-032

U.S.-Madel

DUAL-Z DYNAMIC MIKE, STAND



• 250 or 50K Ohms! **7⁹⁵**
• New for 1967!

'Realistic' desk mike with stand. 40-13,000 cps response; 360° swivel joint; black molded body, base. Output: -55 db. #33-934

CLOSEOUT! MINIATURE 1½ VDC MOTORS

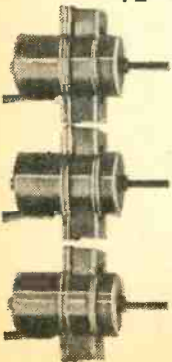

- Ideal for Hobbyists!
- Only 1½" x 2¾"!

3 For 99^c

Lowest price we've seen for miniature motors! Operate from 1½-12V flashlight battery; the greater the voltage, the greater the speed. Bronze bearings; 1/16" dia. shaft, ½" long. #273-232

MAIL THIS HANDY COUPON TODAY!

RADIO SHACK } East: 730 Commonwealth Ave., Boston, Mass. 02215 DEPT. RT
 } West: 1515 So. University Dr., Ft. Worth, Tex. 76107

- | | |
|---|---|
| <input type="checkbox"/> Send me FREE 1967 Radio Shack catalog. | <input type="checkbox"/> Stereo/Mono Headphones, 33-196 |
| <input type="checkbox"/> Micro-Radio, 12-619 | <input type="checkbox"/> TRC-14 CB Transceiver, 21-032 |
| <input type="checkbox"/> 4" Speaker, 40-1908 | <input type="checkbox"/> Dynamic Mike, 33-934 |
| | <input type="checkbox"/> Motors, 273-232 |

Please send me the items I have checked. I enclosed \$_____ plus \$1.00 to cover handling and postage anywhere in the U.S.A.; I understand any excess payment will be refunded promptly.

Name _____

Street _____

City _____ State _____ Zip _____

SHOPPING MART

Products available by mail. Money-back guarantee.
Order direct by Stock No. Send check or M.O.

GIANT WEATHER BALLOONS



Edmund Scientific Co., Barrington, New Jersey 08007.

"Balls of fun" for the kids, traffic stoppers for stores, terrific for amateur meteorologists. Create a neighborhood sensation. Great backyard fun. Exciting beach attraction. Amateur meteorologists use to measure cloud heights, wind speed and temp. Made of heavy duty neoprene. Inflate with vacuum cleaner or auto air hose; or locally available helium for high rise. 8' diam. \$2.00 Ppd. Order Stock No. 60,588EK.

HI-VOLTAGE ELECTROSTATIC GENERATOR



Edmund Scientific Co., Barrington, New Jersey 08007.

Van De Graf low-amp type. 200,000 volt potential, yet completely safe. Demonstrates lightning, St. Elmo's fire, repulsion of charges, electrostatic dust collection, many other electrical wonders. Motor, 110V, 60-cycle AC. Humidity range, 0-90%. Current, 1.5 to 2.5 microamps. Aluminum base, frame and charge collector. Unbreakable plastic insulating column. Ht. 17", dia. 6 3/4". Full instructions. \$43.50 Ppd. Order #70,264EK.

EXPERIMENTAL FUN WITH TESLA COIL



Edmund Scientific Co., Barrington, New Jersey 08007.

Now perform spectacular experiments without wires... as Nicola Tesla did 50 yrs. ago. Generator with coil, etc., transmits extremely high frequency electromagnetic radiation (millions of cycles per second)—through space. Lights fluorescent tube 2 ft. away, ionizes gases, performs total of 21 fascinating experiments. Incl. Neon Lamp, discharge electrode, 2 radiation antenna plates. Generates 5,000 V, for 110 V, 60-C. AC. Meas. 6"x6". \$44.00 Ppd. Order #70,301EK.

DUPONT PLASTIC LIGHT GUIDE KIT



Edmund Scientific Co., Barrington, New Jersey 08007.

Experiment with amazing new plastic fiber optic light guides. 1001 uses for teachers, experimenters, hobbyists. Use for exciting new projects and products. Guides transmit light same as wire conducts electricity. Use to illuminate remote areas, multiple locations from single source, confine light to small areas, conduct sensing and control systems. Inc. 2 gages, source lens, dyes, connectors. \$10 Ppd. Order #70,855EK.

NEW MODEL DIGITAL COMPUTER

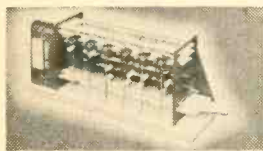

Edmund Scientific Co., Barrington, New Jersey 08007.

Solve problems, tell fortunes, play games with miniature version of giant electronic brain! Adds, subtracts, multiplies, shifts, complements, carries, memorizes. Colored plastic parts easily assembled. 12" x 3 1/2" x 4 3/4". Incld. step-by-step assembly diagrams, 32-p. instruction book covering operation computer language (binary system) programming problems & 15 experiments. \$5.98 Ppd. Order stock #70,683EK AD.

"FISH" WITH A MAGNET

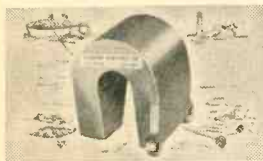

Edmund Scientific Co., Barrington, New Jersey 08007.

Go treasure hunting on the bottom! Fascinating fun & sometimes profitable. Tie a line to our 5-lb. Magnet—drop it overboard in bay, river, lake or ocean. Trawl it along bottom—your "treasure" haul can be outdoor motors, anchors, other metal valuables. 5-lb. magnet is war surplus—Army V Type—Gov't. cost \$50. Lights over 150 lbs. on land—much greater weights under water. \$12.50 Ppd. Order Stock #70,571EK.

GIANT FREE CATALOG



Edmund Scientific Co., Barrington, New Jersey 08007.

Completely new 1967 catalog. 148 pages packed with nearly 4,000 unusual bargains. Exciting new categories. Many new items. 100's of charts, illustrations. Many hard-to-get surplus bargains. Enormous selection of telescopes, microscopes, binoculars, magnets, magnifiers, prisms, photo components, etc. For hobbyists, experimenters, workshops. Shop by mail. No salesman will call. Write for Free Catalog. "EK" to

elementary Electronics

JULY/AUGUST 1967

Vol. 4/No. 3

Dedicated to America's Electronics Experimenters

JULIAN M. SIENKIEWICZ WA2CQL/KMD4313	Editor
RICHARD A. FLANAGAN	Managing Editor
W. KRAG BROTBY	Technical Editor
JIM MEDLER	Art Editor
HELEN PARKER	Editorial Assistant
ANTHONY MACCARRONE	Art Director
EUGENE F. LANDINO III	Associate Art Director
IRVING BERNSTEIN	Cover Art Director
BARBARA GABRIEL	Art Associate
JIM CAPPELLO	Advertising Manager
LEONARD F. PINTO	Production Director
CARL BARTEE	Production Manager
HELEN GOODSTEIN	Assistant Production Manager
DAVID COHN	Promotion Director
WILFRED M. BROWN	Kit Decision Manager

President and Publisher

B. G. DAVIS

Executive Vice President and Assistant Publisher

JOEL DAVIS

Vice President and Editorial Director

HERB LEAVY, KMD4529



ELEMENTARY ELECTRONICS, Vol. 4, No. 3 is published bi-monthly by SCIENCE & MECHANICS PUBLISHING CO., a subsidiary of Davis Publications, Inc. Editorial, business and subscription offices: 505 Park Ave., New York, N. Y. 10022. One-year subscription (six issues)—\$4.00; two-year subscription (12 issues)—\$7.00; and three-year subscription (18 issues)—\$10.00. Add \$1.00 per year for postage outside the U.S.A. and Canada. Advertising offices: New York, 505 Park Ave., 212-PL-2-6200; Chicago, 520 N. Michigan Ave., 312-527-0330; Los Angeles, 6253 Hollywood Blvd., 213-463-5143; Atlanta, Pirnie & Brown, 3108 Piedmont Rd., N.E., 404-233-6729; Long Island, Len Osten, 9 Garden Street, Great Neck, N. Y., 516-487-3305; Southwestern advertising representative: Jim Wright, 4 N. Eight St., St. Louis, CH-1-1965.

EDITORIAL CONTRIBUTIONS must be accompanied by return postage and will be handled with reasonable care; however, publisher assumes no responsibility for return or safety of manuscripts, art work, or photographs. All contributions should be addressed to the Editor, ELEMENTARY ELECTRONICS, 505 Park Avenue, New York, N. Y. 10022.

Second-class postage paid at New York, New York and at additional mailing offices. Copyright 1967 by Science and Mechanics Publishing Co.

RADIO

CIRCUITS AT HOME with the New Improved PROGRESSIVE RADIO "EDU-KIT"® A Practical Home Radio Course

only
\$26.95

Reg. U. S.
Pat. Off.



Training Electronics Technicians Since 1946

Now Includes

- ★ 12 RECEIVERS
- ★ 3 TRANSMITTERS
- ★ SQ. WAVE GENERATOR
- ★ SIGNAL TRACER
- ★ AMPLIFIER
- ★ SIGNAL INJECTOR
- ★ CODE OSCILLATOR

- ★ No Knowledge of Radio Necessary
- ★ No Additional Parts or Tools Needed
- ★ EXCELLENT BACKGROUND FOR TV
- ★ SCHOOL INQUIRIES INVITED
- ★ Sold In 79 Countries

**YOU DON'T HAVE TO SPEND
HUNDREDS OF DOLLARS FOR A RADIO COURSE**

The "Edu-Kit" offers you an outstanding PRACTICAL HOME RADIO COURSE at a rock-bottom price. Our Kit is designed to train Radio & Electronics Technicians, making use of the most modern methods of home training. You will learn radio theory, construction practice and servicing. THIS IS A COMPLETE RADIO COURSE IN EVERY DETAIL.

You will learn how to build radios, using regular schematics; how to wire and solder in a professional manner; how to service radios; how to work with the standard type of punched metal chassis as well as the latest development of Printed Circuit chassis.

You will learn the basic principles of radio. You will construct, study and work with RF and AF amplifiers and oscillators, detectors, rectifiers, and test equipment. You will learn trouble-shooting, using the Progressive Signal Tracer, Progressive Signal Injector, Progressive Dynamic Radio, & Electronics Tester, Square Wave Generator and the accompanying instructional material.

You will receive training for the Novice, Technician and General Classes of F.C.C. Radio Amateur Licenses. You will build Receiver, Transmitter, Square Wave Generator, Code Oscillator, Signal Tracer, and Signal Injector circuits, and learn how to operate them. You will receive an excellent background for television, Hi-Fi and Electronics.

Absolutely no previous knowledge of radio or science is required. The "Edu-Kit" is the product of many years of teaching and engineering experience. The "Edu-Kit" will provide you with a basic education in Electronics and Radio, worth many times the low price you pay. The Signal Tracer alone is worth more than the price of the kit.

THE KIT FOR EVERYONE

You do not need the slightest background in radio or science. Whether you are interested in Radio & Electronics because you want an interesting hobby, a well paying business or a job with a future, you will find the "Edu-Kit" a worth-while investment. Many thousands of individuals of all

ages and backgrounds have successfully used the "Edu-Kit" in more than 79 countries of the world. The "Edu-Kit" has been carefully designed, step by step, so that you cannot make a mistake. The "Edu-Kit" allows you to teach yourself at your own rate. No instructor is necessary.

PROGRESSIVE TEACHING METHOD

The Progressive Radio "Edu-Kit" is the foremost educational radio kit in the world, and is universally accepted as the standard in the field of electronics training. The "Edu-Kit" uses the modern educational principle of "Learn by Doing." Therefore you construct, learn schematic study theory, practice trouble shooting—all in a closely integrated program designed to provide an easily-learned, thorough and interesting background in radio.

You begin by examining the various radio parts of the "Edu-Kit." You then learn the function, theory and wiring of these parts. Then you build a simple radio. With this first set you will enjoy listening to regular broadcast stations, learn theory, practice testing and trouble-shooting. Then you build a more advanced radio, learn more advanced theory and techniques. Gradually, in a progressive manner, and at your own rate, you will find yourself constructing more advanced multi-tube radio circuits, and doing work like a professional Radio Technician.

Included in the course are Receiver, Transmitter, Code Oscillator, Signal Tracer, Square Wave Generator and Signal Injector Circuits. These are not unprofessional "breadboard" experiments, but genuine radio circuits, constructed by means of professional wiring and soldering on metal chassis, plus the new method of radio construction known as "Printed Circuitry." These circuits operate on your regular AC or DC house current.

THE "EDU-KIT" IS COMPLETE

You will receive all parts and instructions necessary to build twenty different radio and electronics circuits, each guaranteed to operate. Our Kits contain tubes, tube sockets, variable, electrolytic and ceramic and paper dielectric condensers, resistors, tie strips, hardware, tubing, punched metal chassis, Instruction Manuals, hook-up wire, solder, selenium rectifiers, coils, volume controls and switches, etc.

In addition, you receive Printed Circuit materials, including Printed Circuit chassis, special tube sockets, hardware and instructions. You also receive a useful set of tools, a professional electric soldering iron, and a self-powered Dynamic Radio and Electronics Tester. The "Edu-Kit" also includes Code Instructions and the Progressive Code Oscillator, in addition to the Radio Amateur License training. You will also receive lessons for servicing with the Progressive Signal Tracer and the Progressive Signal Injector, a High Fidelity Guide and a Quiz Book. You receive Membership in Radio-TV Club, Free Consultation Service, Certificate of Merit and Discount Privileges. You receive all parts, tools, instructions, etc. Everything is yours to keep.

PRINTED CIRCUITRY

At no increase in price, the "Edu-Kit" now includes Printed Circuitry. You build a Printed Circuit Signal Injector, a unique servicing instrument that can detect many Radio and TV troubles. This revolutionary new technique of radio construction is now becoming popular in commercial radio and TV sets.

A Printed Circuit is a special insulated chassis on which has been deposited a conducting material which takes the place of wiring. The various parts are merely plugged in and soldered to terminals.

Printed Circuitry is the basis of modern Automation Electronics. A knowledge of this subject is a necessity today for anyone interested in Electronics.

FREE EXTRAS

SET OF TOOLS

- SOLDERING IRON
- ELECTRONICS TESTER
- PLIERS-CUTTERS
- VALUABLE DISCOUNT CARD
- CERTIFICATE OF MERIT
- TESTER INSTRUCTION MANUAL
- HIGH FIDELITY GUIDE & QUIZZES
- TELEVISION BOOK & RADIO TROUBLE-SHOOTING BOOK
- MEMBERSHIP IN RADIO-TV CLUB
- CONSULTATION SERVICE & FCC AMATEUR LICENSE TRAINING
- PRINTED CIRCUITRY

SERVICING LESSONS

You will learn trouble-shooting and servicing in a progressive manner. You will practice repairs on the sets that you construct. You will learn symptoms and causes of trouble in home, portable and car radios. You will learn how to use the professional Signal Tracer, the unique Signal Injector and the dynamic Radio & Electronics Tester. While you are learning in this practical way, you will be able to do many a repair job for your friends and neighbors and charge fees which will far exceed the price of the "Edu-Kit." Our Consultation Service will help you with any technical problems you may have.

FROM OUR MAIL BAG

J. Statailis, of 25 Poplar Pl., Waterbury, Conn., writes: "I have repaired several sets for my friends, and made money. The "Edu-Kit" paid for itself. I was ready to spend \$240 for a Course, but I found your ad and sent for your Kit."

Ben Valerio, P. O. Box 21, Magna, Utah: "The Edu-Kits are wonderful. Here I am sending you the questions and also the answers for them. I have been in Radio for the last seven years, but like to work with Radio Kits, and like to build Radio Testing Equipment. I enjoyed every minute I worked with the different kits: the Signal Tracer works fine. Also like to let you know that I feel proud of becoming a member of your Radio-TV Club."

Robert L. Shuff, 1534 Monroe Ave., Huntington, W. Va.: "Though I would drop you a few lines to say that I received my Edu-Kit, and was really amazed that such a bargain can be had at such a low price, I have already started repairing radios and phonographs. My friends were really surprised to see me get into the swing of it so quickly. The Trouble-shooting Tester that comes with the Kit is really swell, and finds the trouble, if there is any, to be found."

PROGRESSIVE "EDU-KITS" INC.

1186 Broadway, Dept. 519DJ, Hewlett, N. Y. 11557

UNCONDITIONAL MONEY-BACK GUARANTEE

- Please rush my Progressive Radio "Edu-Kit" to me, as indicated below:
- Check one box to indicate choice of model
- Regular model \$26.95
 - Deluxe model \$31.95 (same as regular model, except with superior parts and tools plus a valuable Radio and Television Tube Checker).
- Check one box to indicate manner of payment
- I enclose full payment. Ship "Edu-Kit" post paid.
 - Ship "Edu-Kit" C.O.D. I will pay postage.
 - Send me FREE additional information describing "Edu-Kit."

Name
Address
City and State Zip

PROGRESSIVE "EDU-KITS" INC.

1186 Broadway, Dept. 519DJ, Hewlett, N. Y. 11557

Learn, Enjoy And Save . . . Build

Heathkit Rectangular Color TV's With Exclusive Self-Servicing



Kit GR-295
\$479⁹⁵*

(295 sq. inch viewing area)



Kit GR-180
\$379⁹⁵**

(180 sq. inch viewing area)

Exclusive Features That Can't Be Bought In Ready-Made Sets At Any Price!

All color TV sets require periodic convergence and color purity adjustments. Both Heathkit Color TV's have exclusive built-in servicing aids, so you can perform these adjustments anytime . . . without calling in a TV serviceman . . . without any special skills or knowledge. Just flip a switch on the built-in dot generator and a dot pattern appears on the screen. Simple-to-follow instructions and detailed color photos in the manual show you exactly what to look for, what to do and how to do it. Results? Beautifully clean and sharp color pictures day in and day out . . . and up to \$200 savings in servicing calls throughout the life of your set.

Exclusive Heath Magna-Shield . . . surrounds the entire tube to keep out stray magnetic fields and improve color purity. In addition, **Automatic Degaussing** demagnetizes and "cleans" the picture everytime you turn the set on from a "cold" start.

Choice Of Installation . . . Another Exclusive! Both color TV's are designed for mounting in a wall or your own custom cabinet. Our you can install either set in a choice of factory assembled and finished Heath contemporary walnut or Early American cabinets.

From Parts To Programs In Just 25 Hours. All critical circuits are preassembled, aligned and tested at the factory. The assembly manual guides you the rest

of the way with simple, non-technical instructions and giant pictures.

Plus A Host Of Advanced Features . . . a hi-fi rectangular picture tube with "rare earth" phosphors for brighter, livelier colors and sharper definition . . . **Automatic Color Control** and **Gated Automatic Gain Control** to reduce color fading and insure jitter-free pictures at all times . . . deluxe VHF **Turret Tuner** with "memory" fine tuning . . . **2-Speed Transistor UHF Tuner** . . . **Two Hi-Fi Sound Outputs** for play through your hi-fi system or connection to the special limited-field speaker . . . **Two VHF Antenna Inputs** — 300 ohm balanced and 75 ohm coax . . . **1-Year Warranty** on the picture tube, 90 days on all other parts . . . plus many more deluxe features. For full details, mail coupon for FREE Heathkit catalog.

*Kit GR-295, everything except cabinet, 131 lbs. . . . \$479.95

GRA-295-1, walnut cabinet (shown above) 56 lbs. . . 19" D. x 31" H. x 34½" W. . . . \$62.95

Deluxe contemporary walnut & Early American cabinets also available at \$94.50 & \$99.95

**Kit GR-180, everything except cabinet, 102 lbs. . . . \$379.95

GRA-180-1, walnut cabinet (shown above) 41 lbs. . . 18¼" D. x 28¼" W. x 29" H. . . . \$49.95

Early American cabinet available at \$75.00

12" Transistor Portable TV — First Kit With Integrated Circuit



Kit GR-104
\$119⁹⁵

Unusually sensitive performance. Plays anywhere . . . runs on household 117 v. AC, any 12 v. battery, or optional rechargeable battery pack (\$39.95); receives all channels; new integrated sound circuit replaces 39 components; pre-assembled, prealigned tuners; high gain IF strip; Gated AGC for steady, jitter-free pictures; front-panel mounted speaker; assembles in only 10 hours. Rugged high impact plastic cabinet measures a compact 11½" H. x 15¼" W x 9¾" D. 27 lbs.

Your Own Heathkit® Electronics!

60-Watt Solid-State Guitar Amplifier . . . All The Features Guitarists Want Most!



Kit TA-16
\$129⁹⁵

Worth \$300! Two channels, 4 inputs handle accordion, guitars, organ or mike. Variable tremolo & reverb. Two foot switches. Two 12" speakers. Line bypass reversing switch for hum reduction. Leather-textured vinyl cabinet of 3/4" stock. 28" W x 9" D x 19" H. Build in 12 hours. 52 lbs.

4-Speed Solid-State Portable Phonograph . . . Plays Anything From Beatles To Beethoven



Kit GD-16
\$39⁹⁵

Worth At Least 50% More! Assembles in 1 to 2 hours . . . just wire one small circuit board, mount the 4" x 6" speaker and plug in the preassembled changer! Features automatic mono 4-speed play; dual sapphire styli for 78's or LP's; 45 rpm adapter; olive and beige polyethylene over sturdy, pre-assembled cabinet; 117 v. AC operation. 25 lbs.

New Solid-State High Impedance Volt-Ohm-Milliammeter

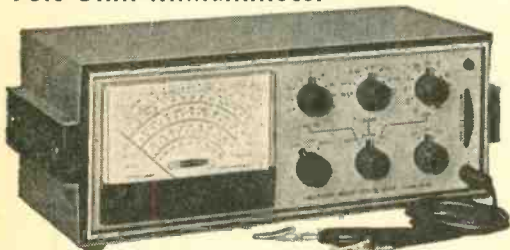

Kit IM-25
\$80⁰⁰ (Wired IMW-25 \$115)

Full scale ranges down to 150 mv & 15 ua, 10 ohms center scale; all-silicon transistors plus FET's; 6" 200 ua meter; ±3% accuracy on DC, ±5% on AC; 1% precision resistors; built-in 120/240 v. AC or battery power for portable operation; new unitized construction. 10 lbs.

New Low Price On Deluxe Transistor 10-Band AM /FM / Shortwave Portable . . . Save \$20!



Kit GR-43
Was \$159.95
Now
\$139⁹⁵

10 bands tune Longwave, AM, FM and 2 MHz to 22.5 MHz shortwave. Two separate AM & FM tuners and IF strips. 16 transistors, 6 diodes and 44 factory assembled and pretuned circuits. 4" x 6" speaker, earphone, time zone map, listener's guide. Build in about 10 hours. 19 lbs.

FREE



World's Largest Electronic Kit Catalog!

Describes these and over 250 kits for stereo/hi-fi, color TV, amateur radio, shortwave, test, CB, marine, educational, home and hobby. Save up to 50% by doing the easy assembly yourself. Mail coupon, or write Heath Company, Benton Harbor, Michigan 49022

HEATH COMPANY, Dept. 139-7
Benton Harbor, Michigan 49022

In Canada, Daystrom Ltd.

Enclosed is \$ _____, plus shipping.

Please send model (s) _____

Please send FREE 1967 Heathkit Catalog.

Name _____

Address _____

City _____ State _____ Zip _____

Prices & specifications subject to change without notice.

CL-288

TAPESTERS ...at play

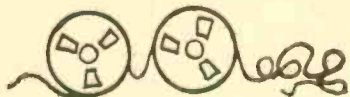

By Jack Schmidt



"Pinch 'im!"



"...if it's long playing you want..."



"How did he know we were taping him?"

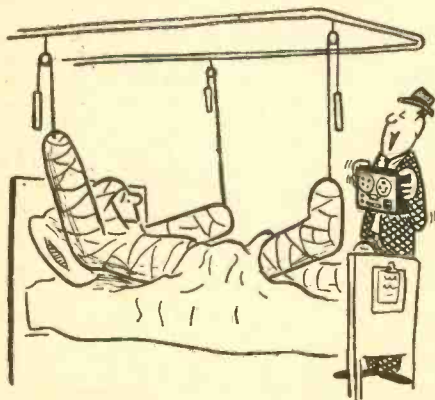

"It's from the party, Harry! You'll hear yourself going through the window!"



"Don't move, anyone!"



POSITIVE FEEDBACK

JULIAN M. SIENKIEWICZ, EDITOR

We have received many letters from our readers complimenting us on the 6-meter solid-state Walkie-Talkie project we published last year. (Plans for the complete receiver section appeared in the March-April 1966 issue of *ELEMENTARY ELECTRONICS*; those for the complete transmitter section in the April-May 1966 issue of *RADIO-TV EXPERIMENTER*.) Just how good was the Walkie-Talkie? Well, let one of our readers do the bragging for us. Take it, WA1VDO!

Dear Editor,
RADIO-TV EXPERIMENTER and **ELEMENTARY ELECTRONICS** are excellent magazines and I only wish I had time to build all the projects you publish.

I did build the ¼-watt, 6-meter transmitter and receiver and found it an excellent rig. Using a 5-element beam I immediately worked a station 70 miles distant (S3 report).

Everyone I talk to on the air says, "Beautiful audio!", "Broadcast quality!" (I'm sure it's not my voice, Hi.) Everyone is amazed and can't believe it. "¼ watt?" they say. "Wow!"

I sure have a lot of fun with it. What's more, I was elected "Builder of the Year" in the Area #1 of the Q.R.P.-A.R.C.--mostly for building your little ¼-watt rig, I guess.

I plan to do some mountain topping this summer, which should be fun. A transistorized VFO and a linear of about 5 watts would make this little rig perfect.

Keep up the fab work.

Best of 73's,
 Frank Gaudett, WA1DVO

Since our readers thought so much of our nifty Walkie-Talkie, we decided to feature it

now...a dozen tools for dozens of jobs in a hip pocket set!



Really compact, this new nut driver/screwdriver set features 12 interchangeable blades and an amber plastic (UL) handle. All are contained in a slim, trim, see-thru No. 99PS-50 plastic case which easily fits hip pocket. Broad, flat base permits case to be used as a bench stand. Ideal for assembly and service work.

7 NUTDRIVERS:

3/16", 7/32", 1/4", 9/32", 5/16", 11/32", 3/8" hex openings.



2 SLOTTED SCREWDRIVERS:

3/16" and 9/32" tips.

2 PHILLIPS SCREWDRIVERS:

#1 and #2 sizes.

EXTENSION BLADE:

Adds 4" reach to driving blades.

HANDLE:

Shockproof, breakproof. Exclusive, positive locking device holds blades firmly for turning, permits easy removal.



WRITE FOR CATALOG 162

XCELITE

XCELITE INC. • 80 BANK ST., ORCHARD PARK, N. Y.

Send Catalog 162 with information on 99PS-50

name _____
 address _____
 city _____ state & zone _____

on the cover of our brand-spanking-new construction annual—ELECTRONICS HOBBYIST. This 128-pager is chuck-full of many construction projects that were “reader selected” from ELEMENTARY ELECTRONICS and RADIO-TV EXPERIMENTER. By the time you see this, all the copies of the ELECTRONICS HOBBYIST will likely have been snapped off the newsstands. If you can't find a copy, just drop a check or money order for a buck and a quarter into an envelope with a short note saying, “Send me a copy of ELECTRONICS HOBBYIST.” (Don't forget to sign the check and be sure to include your address.) Do it today or you may have to go to your local black market dealer!

Anschluss No. 3? The Federal Communications Commission is at it again. Amateur radio operators dearly remember their loss of the 11-meter band—lost, never to be regained. Now the FCC may be giving away more than it can hold by the tail. There's talk that unused TV channels may be handed over to two-way mobile radio users, and it has gone past the chit-chat stage.

The FCC is planning to test two-way mobile communications in the Washington, D.C. area using the 82-88 MHz band (that's Channel 6, folks!). The FCC figures since Channel 6 is not used in the nation's capital, the Commission will run some tests in that area to determine whether two-way mobile operation will interfere with Channels 5 and 7. Additional tests will be carried out in other major cities if the Washington tests are successful.

This can only mean one thing to you and me, America's TV viewers—*interference*. No, you will not hear Dick Tracy and the neighborhood Keystones, but then, you may. Also, with thousands of low-power transmitters on a TV channel, who is to predict absolutely no skip to areas where the channel is used! Stand by, Channel 6 viewers, the next sound you hear may be the Batphone! ■

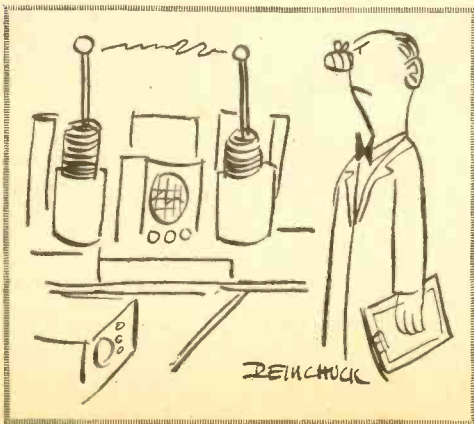

ELEMENTARY ELECTRONICS ETYMOLOGY

By Webb Garrison

To Galvanize

▲ Luigi Galvani, a noted anatomist of Bologna, Italy, set the world into a frenzy as a result of an accident. One day he hung the legs of some freshly killed frogs on a copper wire to dry. A gust of wind caused his specimens to bump against iron railings of his balcony—and each time contact was made, legs of the dead frogs twitched as though they were alive.

Galvani consulted a friend who had a great reputation as a physicist. He pondered the evidence and mistakenly concluded that twitching resulted from electric currents originating in legs of the frogs—set in motion by contact with a conductor.

Closer scrutiny showed that electricity from an outside source actually can trigger muscular reactions. Many researchers who studied “Galvani's phenomenon” considered it to hold the key to life itself. Not simply crackpots, but world-renowned scientists thought that the use of electricity would soon reveal ways to bring the dead back to life. In honor of Galvani, his name was used to indicate the process of imparting a shock.

It became commonplace for doctors to *galvanize* paralyzed persons—some of whom showed spectacular improvement as a result. As late as 1850 the attempt to restore corpses to life by means of electricity had not been entirely abandoned.

Since such treatment often produced abrupt reactions on the part of subjects, any source of stimulus—whether electrical or not—was said to galvanize its object into action. The figurative term was so widely used that it has stuck in language long after abandonment of galvanism as a medical procedure. Strangely, though, galvanism dimly foreshadowed today's use of electric shock treatment in mental disorders. ■

Cathode, Anode

▲ Michael Faraday's first great scientific triumph was achieved with seven halfpence, seven disks of sheet zinc, and six pieces of paper

moistened with salt water. Using this equipment, on July 12, 1812, he constructed a voltaic pile that actually yielded a flow of current.

Though he was interested in many fields, electricity remained his absorbing passion. Before 1830 he succeeded in sending current through a variety of liquids—proving that metallic conductors are not essential.

From Greek for “way up” he used *cathode* to name the positive pole through which current enters an electrolyte. And from “way down,” *anode* became his label for the pole (negative) into which current flows from an electrolytic fluid.

Arrangement of Faraday’s crude apparatus probably governed his choice of these names. Viewed against the background of today’s elaborate equipment, there is no reason whatever to think of current as flowing in a vertical pattern. Still, titles bestowed in the infancy of the electrical age cling to positive and negative poles of highly sophisticated devices. ■

Amplifier

▲ Though his name seldom appears in biographical dictionaries, John Ambrose Fleming (1849-1945) made many discoveries that affected the development of electronics.

A pioneer in radio, he found his work hampered by the fact that his best instruments

wouldn’t respond to weak signals. In order to detect current changes (and increase sensitivity of his receiving set), Fleming devised a tube with two electrodes. He succeeded in heating one so that electrons from it could evaporate into the vacuum, while keeping the other electrode cool.

This novel tube permitted electrons to pass from the cathode (hot electrode) to the anode—but not vice-versa. Since it worked somewhat like a check valve that establishes one-way flow in a water pipe, “Fleming’s valve” found many uses.

About 1906 Lee de Forest put a third electrode (in the form of a grid) between Fleming’s cathode and anode. Since power fed to this tube from an outside source made weak signals audible, de Forest called it an *audion*. But the name didn’t stick. Irving Langmuir perfected high-vacuum techniques for use with the audion and the modern *amplifier* was born—named from Latin for “to make large.” ■

What’s Your Poison? Well, just don’t sit there like a bump on a log! Let us know what words common to electronics you would like *etymologized*. Webb Garrison can fill the bill in his column much better if you write him in care of ELEMENTARY ELECTRONICS, 505 Park Avenue, New York, N. Y. 10022. Get it done today. ■



INTRODUCING THE NEW

Schober Theatre Organ

The only
Theatre Organ
available in kit form
—for only \$1350.

Build it yourself and
save over 50%

Combination Action Ten buttons select preset combinations of stops—actually move the stop tablets as in pipe organs.

Percussion Eight percussion stops provide exciting realism. Celesta, harpsichord, piano, mandolin, xylophone, chrysoglott, orchestral bells, single or reiterating, are played just like the real thing—and sound that way—alone or along with regular organ stops.

Free Information. Send today for your copy of Schober’s 16-page full-color booklet—plus free 7” recording.

You’ve asked for it and here it is — the NEW Schober THEATRE ORGAN that you assemble yourself. For the first time in kit form, a real Theatre Organ with that rich, full, old time theatre pipe organ sound. You create the organ, then you create the music!

The Theatre Organ features special voicing, curved console design, two 61-note keyboards, 2-octave radiating pedal clavier, 8 octaves of tone distributed over 5 pitch registers (including a 1-foot register), 35 speaking organ stops, 8 realistic percussion stops, 4 couplers, and vibrato tablet—48 tablets in all. And all at a truly remarkable low price...you save over \$1,500 (well over 50%) from comparable theatre organs.

Just follow easy step-by-step instructions written in everyday language which anyone can understand. You’ll have an unequaled pride when you’re finished that only can come from assembling it yourself.

The Theatre Organ starts at \$1,350. This price includes a beautiful walnut console or you can save further by building your own from plans. Options available include combination action, genuine reverberation, percussion, and amplifiers and speakers.

THE *Schober Organ* CORPORATION
43 West 61st Street, New York, N.Y. 10023

The Schober Organ Corp., Dept. EE-1
43 West 61st St., New York, N. Y. 10023

- Please send me Schober Organ Catalog and FREE 7-inch “sample” record.
- Enclosed please find \$2.00 for 12-inch quality LP record of Schober Organ music. (\$2.00 refunded with purchase of first kit.)

Name.....

Address.....

City..... State..... Zip No.....

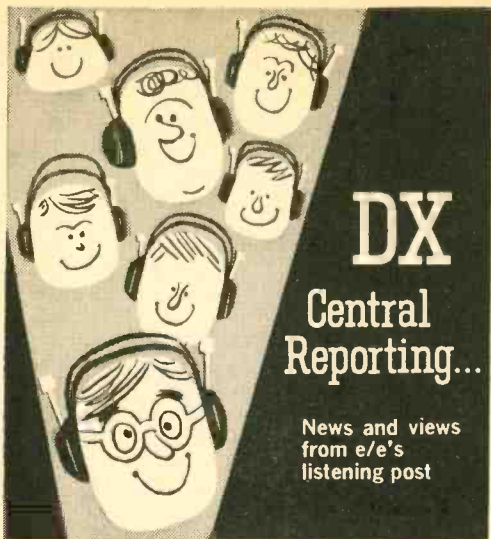

These days there are many handsome certificates available to SWLs. But one of the most unusual is the American SWL Club's "Tropical Area DX Award." What makes it so unique is that only countries which lie either entirely or in part between the Tropic of Cancer and the Tropic of Capricorn are eligible. Ironically, this includes all the world's hot spots: Vietnam, China (its southern edge, which borders Vietnam and Laos, makes this Red Giant eligible), Rhodesia, and Cuba.

The TADXA certificate comes in five classifications of 10, 25, 50, 75, and 100 countries, respectively. For each country claimed you must list full details; i.e., date and time logged, station name and frequency, and type of QSL received. (You must have a QSL for each country claimed.)

Your application, along with a 50¢ processing fee plus your name and address, should be sent to the ASWLC, 16182 Ballad Lane, Huntington Beach, Calif. 92647. And cheats beware. Phony entries will be rejected and the 50¢ processing fee won't be returned. All Tropical Area stations heard are eligible *except* Amateur, which the ASWLC considers as a completely separate hobby. Our "Easy 10 Tropical DX List" should help the beginner in his hunt for those first 10 tropical countries.

With one exception, all the stations listed can be readily heard throughout the evening and reports can be addressed simply by using the station name, city, and country. The exception is VOA Monrovia, which does not S/On until 2200 EST; reports for this station should be addressed to Voice of America, Washington, D.C. 20547. In addition to the countries listed, both R. Peking and R. Habana can be readily logged on a number of frequencies.

RTTY vs. CW. While tuning aircraft, ships, telephone stations, etc.—in other words, all the

voice stations between the SW Broadcast bands—the two major sources of QRM every DXer must face are radioteletype (RTTY) and Morse code (CW) stations. But do you know the difference between an RTTY (sometimes abbreviated RATT) and a CW sound? The SWLer who doesn't mark himself as a rank beginner.

Even DXers who aren't familiar enough with code to read it can make out a few individual dot/dash groups whenever a CW station is heard. RTTY groups are not based on dots and dashes at all and are so complex and sent so rapidly that there is no chance of the human ear making them out. Depending upon your code proficiency, a CW transmitter can be logged in a variety of ways. However, there is almost no chance of identifying RTTY without a teleprinter.

Because of the much greater volume of traffic it can handle in a short time, RTTY is gradually replacing CW even for high seas communications. Many veteran radio operators regard this change with grave suspicion. In 1962 an organization of Coast Guard radiomen calling itself Zeta Upsilon Tau (ZUT) was formed to, in effect, fight RATT. A paragraph in its first quarterly newsletter, "ZUTREP," read as follows:

"We may be a dying race, RATT may take over but at least let us be united in our last days and after the last 'shave and a haircut' is sent, let it be said we died with pride."

As it happened, ZUT almost died before CW. During 1966 the organization virtually fell apart with no ZUTREPs published at all. Now ZUT's HQ staff (at NMH CG Radio Washington; transmitter at Alexandria, Va.) are trying to reform the CW brotherhood and make it an organization interested in all the goals of CG communications—if the membership will let them. As a back up system, CW will be with us for many years to come, simply because it is much easier to receive a weak CW signal than one of the RTTY variety.

In any event, next time you log and send a report to NMH, address it to ZUT-626, and wish him luck!

CG Tropical DX. The most commonly used Coast Guard voice frequency is 2670 kHz and

EASY 10 TROPICAL DX LIST

Country	Station & City	Frequencies
Argentina	R.E.A., Buenos Aires	9690
Australia	R. Australia, Melbourne	15220, 17840
British Honduras	R. Belize	3300, 834 (BCB)
Colombia	R. Nacional, Bogota	4955
Dominican Rep.	R. TV Dominicana, Santo Domingo	9505
Ecuador	HCJB, Quito	9745
Haiti	4VEH, Cap Haitien	11835, 1035 (BCB)
Liberia	VOA, Monrovia	7280
So. Africa	R. RSA, Johannesburg	11900, 9675
Venezuela	Cadena Rumbos, Caracas	4970



Award issued by American SWL Club for DXing tropical-area stations is reproduced above.

on it you can hear a number of stations which count toward the ASWLC's Tropical Award. These include NMR CG Radio San Juan (Puerto Rico), NMR2 CG Radio St. Thomas (U.S. Virgin Islands), and CG Radio South Caicos (Turks and Caicos Islands). None of these countries has SWBC stations.

Another interesting CG tropical voice is NUZY, the Campeche Patrol Vessel. This one has regularly scheduled weather broadcasts at 1920, 0120, and 0720 EST. International Waters is considered the equivalent of one country and, if the station is in the Tropical Zone, it can be used to count toward this award. NUZY operates off the Yucatan Peninsula.

Most Coast Guard radiomen will verify a good reception report which is accompanied by a stamped, self-addressed envelope. Be sure to tell them the name of the station contacted or called to prove your reception. And oh yes, cross those fingers that the fellow who gets your report isn't a "SMUT." What's a SMUT? Why, that's the opposition party within ZUT!



"Oh, you're busy, dear. I'll just leave your lunch here on the table."

Live Better Electronically With

LAFAYETTE RADIO ELECTRONICS

1967 Catalog 670 **FREE!**

Now OFF PRESS BETTER THAN EVER Over 500 Pages

Stereo Hi-Fi • Citizens Band • Ham Gear • Tape Recorders • Test Equipment • TV and Radio Tubes and Parts • Cameras • Auto Accessories • Musical Instruments • Tools • Books

Featuring Everything in Electronics for

• HOME • INDUSTRY • LABORATORY

from the "World's Hi-Fi & Electronics Center"

LAFAYETTE Radio ELECTRONICS
Dept. DEEG-7 P.O. Box 10
Syosset, L.I., N.Y. 11791

Send me the FREE 1967 LAFAYETTE Catalog 670 DEEG-7

Name _____

Address _____

City _____ State _____

Zip _____
(Please Give Your Zip Code No.)

CTI AUTOMATION ELECTRONICS HELPS YOU CRACK THE \$12,000-A-YEAR BARRIER

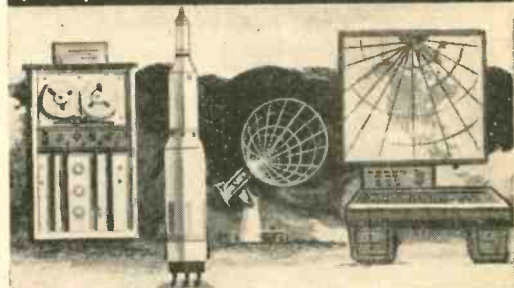

This is one of America's fastest growing industries! It offers higher pay, more job security and more job opportunities than most other fields. If you are 18 or over and want an exciting, big pay future in this dynamic field, CTI training is for you! Get the facts that can put more money in your pockets—fast! Use the coupon to send for the free CTI book—now!

APPROVED FOR GI TRAINING if you served since January 31, 1955 or are in service, check GI line in coupon

COMMERCIAL TRADES INSTITUTE—Dept. EE-867
1400 Greenleaf, Chicago, Illinois 60626

Name _____ Age _____

Address _____ Phone _____

City _____ State _____ County _____

Zip Code _____ Check for facts on GI Bill

C. T. I. is an Accredited Member National Home Study Council

EN PASSANT

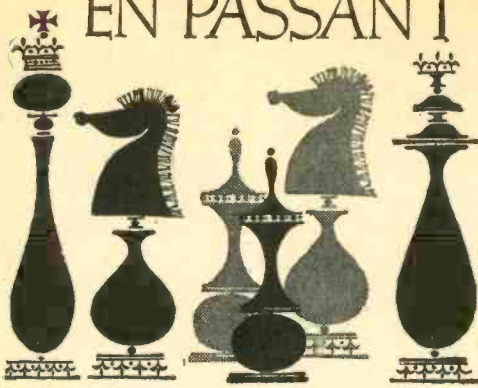

BY JOHN W. COLLINS

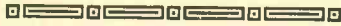

P The opening consists of the first ten or so moves, or the initial third of the game. Chronologically first, it is best studied last, after the ending and the middle-game. Its strategical aim is to develop the pieces quickly and harmoniously, to get control of the central squares and to prepare for the middle-game and ending. Although numerous, with numerous variations, some players are able to memorize the openings, learn them by heart. "A terrible thought," said Dr. Tarrasch. "On the contrary, one should seek understanding, should assimilate their principles and appreciate their inner significance." Here are some of the best known openings—

Ruy Lopez. This is an ever popular, major opening. Named after a Spanish clergyman who treated it systematically in his *Libro del Ajedrez* in 1561, it is characterized by the first three moves and its basic concept is a once-removed attack on the King Pawn. The Tchigorin Variation, one of the main ones, runs like this and results in the diagram position (see below):

Queen's Gambit Declined. Like many another famous old debut, this one dates back to the 1490 Gottingen Manuscript (the earliest known work on chess). Once considered dull, it has be-

Black

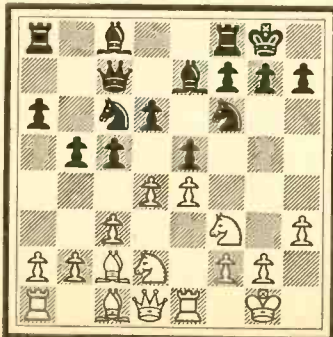

White

come the workhorse of most leading masters. The ideas behind it are an attack on the Queen Pawn, the opening of the Queen Bishop file and to force P-K4 to establish a dominating center. It runs:

- | | | | |
|---------|-------|--------|------|
| 1 P-Q4 | P-Q4 | 7 R-B1 | P-B3 |
| 2 P-QB4 | P-K3 | 8 B-Q3 | PxP |
| 3 N-KB3 | N-KB3 | 9 BxP | N-Q4 |
| 4 B-N5 | B-K2 | 10 BxB | QxB |
| 5 P-K3 | O-O | 11 O-O | NxN |
| 6 N-B3 | QN-Q2 | 12 RxN | P-K4 |

Black

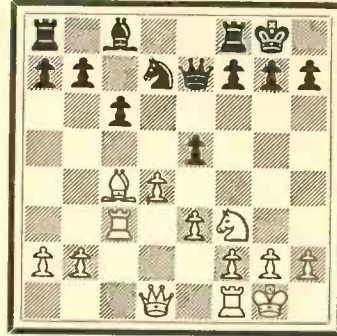

White

Sicilian Defense. This is one of the oldest and best-loved openings. Believed by many to be the most effective answer to 1—P-K4, it opens the Queen Bishop file, strikes at the center, allows a large choice of pawn formations and, by creating an asymmetrical position, produces a fierce fight. A standard line of it is the Scheveningen Variation (*moves top of next column*):

Black

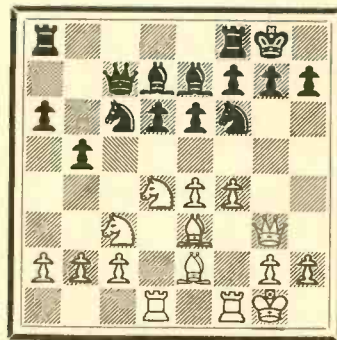

White

RUY LOPEZ

- | | | | |
|---------|-------|----------|-------|
| 1 P-K4 | P-K4 | 7 B-N3 | P-Q3 |
| 2 N-KB3 | N-QB3 | 8 P-B3 | N-QR4 |
| 3 B-N5 | P-QR3 | 9 B-B2 | P-B4 |
| 4 B-R4 | N-B3 | 10 P-Q4 | Q-B2 |
| 5 O-O | B-K2 | 11 QN-Q2 | O-O |
| 6 R-K1 | P-QN4 | 12 P-KR3 | N-B3 |



1 P-K4	P-QB4	7 O-O	N-B3
2 N-KB3	P-K3	8 B-K3	P-QR3
3 P-Q4	PxP	9 P-B4	Q-B2
4 NxP	N-KB3	10 Q-K1	B-Q2
5 N-QB3	P-Q3	11 R-Q1	O-O
6 B-K2	B-K2	12 Q-N3	P-QN4

King's Indian Defense. And this is one of the most used answers to 1 P-Q4. A standby of U.S. Champion Robert J. Fischer and former champion Samuel Reshevsky, its hypermodern concept is to permit White to establish a broad pawn center and then to hit at it with Pawns and pieces. The Classical Line, which follows, offers a good illustration of what it is all about.

1 P-Q4	N-KB3	6 B-K2	P-K4
2 P-QB4	P-KN3	7 O-O	N-B3
3 N-QB3	B-N2	8 P-Q5	N-K2
4 P-K4	P-Q3	9 N-K1	N-Q2
5 N-B3	O-O	10 N-Q3	P-KB4

Black

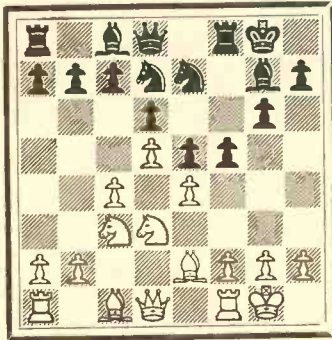

White

Problem 7

By Rev. Anton C. Suyker
Chamberino, N. M.

Black

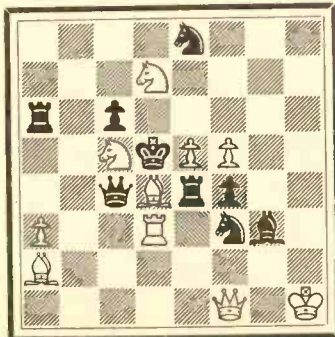

White

White to move and mate in two.
Solution in next issue.

(Continued on page 99)

Olson



*** FREE**

Fill in coupon for a **FREE One Year Subscription** to **OLSON ELECTRONICS' Fantastic Value Packed Catalog—Unheard of LOW, LOW PRICES** on Brand Name Speakers, Changers, Tubes, Tools, Stereo Amps, Tuners, CB, and other Values. Credit plan available.

NAME _____
ADDRESS _____
CITY _____ STATE _____
GIVE ZIP CODE _____

If you have a friend interested in electronics send his name and address for a **FREE** subscription also.

OLSON ELECTRONICS
INCORPORATED

595 S. Forge Street Akron, Ohio 44308

Tape this ad to the back of your TV or Radio Set

ALL TV-RADIO RECEIVING TUBES \$1 ea.

• ALL BRAND-NEW, First Quality. All Types Available. • Orders Shipped First Class Same Day Rec'd. • Unconditionally Guaranteed. • 24 Month Warranty. Send \$1 for ea. tube + 50c. postage & handling of entire order. **FREE:** Write for "do-it-yourself" TV Test Chart and Tube List to Dept. EE-77.

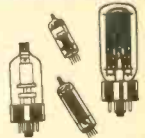

UNIVERSAL TUBE CO. Ozone Park, N. Y. 11417

Huge Nationwide Demand for

DRAFTSMEN

EARN UP TO \$4.58 AN HOUR

Take your choice of thousands of big pay jobs open to Draftsmen (see high salary drafting jobs listed every day in "help wanted" sections of metropolitan newspapers). Huge nationwide demand

U. S. Dept. of Labor reports not enough applicants to fill jobs available. Our easy "Quick-Learn" Method has helped hundreds toward good income, security and prestige as draftsmen. Why not you? Leading professional draftsmen guide you step-by-step. Spare time Home-Study Plan requires no drawing skill... many have succeeded with only grade school training. Send for **FREE "DRAFTING CAREER KIT,"** 20-page BOOK, "Your Future in Drafting" and **SAMPLE LESSON—BOTH FREE!**

NORTH AMERICAN SCHOOL OF DRAFTING
Campus Drive, Dept. 1357, Newport, Calif. 92660

BUY U.S. SAVINGS BONDS



☆☆☆

CBers and Hams Say Welcome!

Want a conversation piece outside your home or shack? You can have your name and call in 2½-in. high letters on a black, brown, green, or blue rubber door or floor mat. Measuring 18 x 28 in., the mat has space for up to 13 characters. It's made of durable rubber with 7,000 fingers that are said to be self-cleaning. Available for \$7.95, postpaid, from Herbert Salch & Co., Woodsboro MPR, Texas 78393.



Name Calling Doormat

Three for the Fringes

A new line of high-gain stereo antennas introduces the series-fed dipole concept to FM arrays. These Stereo-Probe FM antennas are designed to overcome the critical db loss in multiplex reception which has heretofore limited fringe area listeners to monophonic reception only. The Stereo-Probe's new phase relationship of end-fired, series-fed dipoles also results in ex-

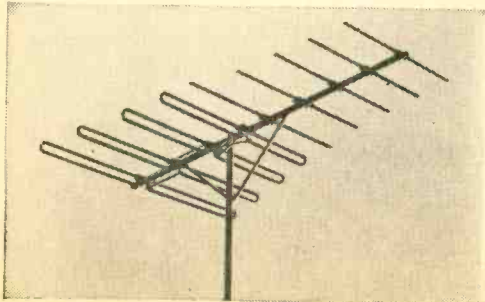

Channel Master Stereo-Probe FM Antenna

☆☆

tremely high front-to-back ratios, minimizing stray pick-up. Tip-to-tip distance across the elements is larger than a half wave, and capture area is greatly increased. Further, the more precise impedance match eliminates complex harnesses and matching stubs. Three models are available: Stereo-Probe 9 for fringe to deep-fringe (\$29.95); Stereo-Probe 6 for near-fringe to fringe (\$24.95); and Stereo-Probe 4 for suburban to near-fringe reception (\$14.95). For more on Stereo-Probe, write Channel Master Corp., Ellenville, N.Y. 12428.

Speaker on Each Hip

Craig Panorama has introduced its model 1502, an AM/FM stereo table radio which features 21 transistors, 11 diodes (plus silicon recti-

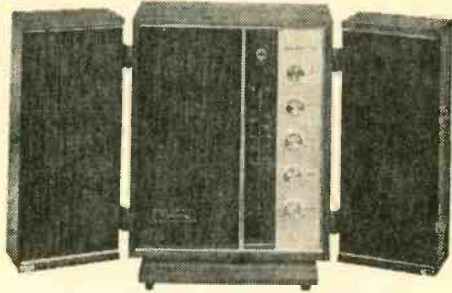

Craig Panorama, Model 1502 AM/FM Stereo Table Radio

fiers), automatic stereo selection with stereo-eye indicator, automatic frequency control, and slide-rule vernier tuning. There are separate balance and tone controls and stereo phono input jacks, which are also suitable for tape cartridge players. The two 7 x 4-in. PM speakers are detachable; the hand-rubbed walnut cabinet measures 11½ x 15 x 9½ in. The price is \$132.00, and you can write for further information to Craig Panorama, Inc., Dept. 347, 2302 E. 15th St., Los Angeles, Calif. 90021.

Solid-State Stereo Stack

"Two on the Aisle" is what Acoustech calls its pairing of the Acoustech VIII FM tuner and either the Acoustech V-A or VII integrated amplifier. The two components are stacked one



Stacked Acoustech VIII FM Tuner and VII Integrated Amplifier

above the other to fit into less than one cubic foot of space on a 10-in. home bookshelf. Because the system is entirely solid-state, there is no heat problem, which discouraged other space-saving combos in the past. Prices: \$299 for the VIII, \$399 for the V-A, \$249 for the VII amplifier. For the kit builder, the amplifier units are available in kit form (Acoustech XI—\$129.50 or XII—\$159.50). Further information from Acoustech Div. of Koss Electronics Inc., 2227 N. 31st St., Milwaukee, Wis. 53208.

Testing . . . Testing . . . Testing . . .
New is the EICO Model 636 tube tester, for quick-testing 800 types of radio/TV vacuum tubes (octals, loctals, 7- and 9-pin miniatures, novars, nuvistors, compactrons), load-testing of commonly used batteries (1.5 to 90 volts), and go/no-go continuity testing. Professional fea-

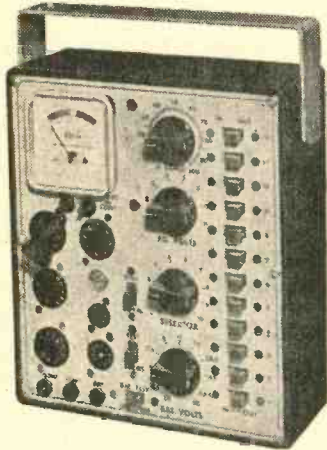

EICO Model 636 Tube Tester

tures include transformer isolation, 3-color meter, neon lamp short-indicator. The 636 is 8 3/8 x 7 1/2 x 3 1/8 in. small and weighs a mere 4 lb. Complete with bakelite case, handle, and tube data manual covering 800 types of tubes, the 636 goes for \$34.95 (wired only). See your electronic distributor, or write EICO Electronic Instrument Co., Inc., 131-01 39th Ave., Flushing, N.Y. 11352.

Go-Go 2-Meter Rig

Lafayette's new HA-144 is a 2-meter portable/mobile/fixed-station transceiver, using 18 transistors and 7 diodes. The design features a 144-148 MHz tunable, dual-conversion superheterodyne receiver with 1 microvolt sensitivity for 10 db signal-to-noise ratio. There is a 10.7-MHz mechanical filter which effectively reduces adjacent station QRM (selectivity: 40 db down at 30 kHz); the HA-144's push-pull high-level modulated transmitter delivers over 1 watt of RF output for 2.5 watts input. The front panel SO-239 coaxial connector accepts whip or ex-



COFFIN ON WHEELS?

Are we endangering the lives of children with poorly designed and poorly maintained school buses? Read the shocking results of safety tests on buses now in use all over the U. S., plus facts and figures on school bus accident and fatality rates. Be sure to read the explosive article, "Are School Buses Death Traps?" in next month's S&M.



Don't miss the July issue of S&M, on your local newsstand NOW!

SCIENCE & MECHANICS EE-767
505 Park Ave., N. Y., N. Y. 10022

12 issues \$4; 24 issues \$8; 36 issues \$12. (Foreign: Add \$1 a year)

Please enter my _____ year(s) subscription.
 I enclose \$ _____ Bill me.

Name _____ (Please Print)

Address _____

City _____ State & Zip _____

ALL BAND BATTERY SHORT WAVE RADIO KIT \$12.95



Listen around the world—Thousands of miles away! Ships—Aircraft—Voice of America—Russia—London—Australia—Amateurs—Police. Also USA Broadcast—5 Wave Bands 1/2 to 43 MC! Calibrated tuning dial. Wt. only 3 lbs. World wide reception.
SEND ONLY \$3.00 (cash Ck Mo) and pay postman \$9.95 COD pstx or send \$12.95 for PF del in USA. Bagle Kit as shown. Includes Plastic case and Bc coil FREE. Long Distance antenna. if you order NOW. Available only from Midway Radio, Dept. SE-7, Kearney, Nebr. 68847.

Can't find the key to electronics?

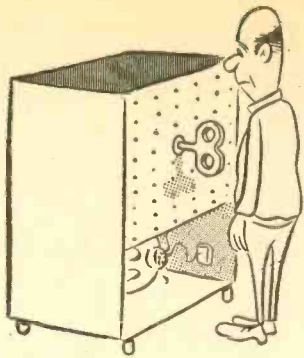

— then get your electronics cool with this introductory offer to the 2 leading electronics magazines!



ELEMENTARY ELECTRONICS

The magazine that serves up electronics theory in pleasant spoonfuls and reinforces the knowledge you gain with exciting and useful projects.

RADIO-TV EXPERIMENTER

The magazine dedicated to the hobbyist—the man who wants to obtain a fuller and broader knowledge of electronics through the applications of his hobby.



Now, both of these fine magazines will be delivered to your mailbox at the special subscription rate of just \$7.00 . . . you save \$2 from regular newsstand price.

DAVIS PUBLICATIONS, INC. EE-767
 505 Park Avenue/New York, N.Y. 10022

Yes! I want to find the key to electronics.
 Begin my subscription to both RADIO-TV EXPERIMENTER and ELEMENTARY ELECTRONICS at your special low-subscription rate of \$7.00

Bill me later. Check enclosed.

Name

Address

City State Zip

(Outside U.S.A. & Canada add \$1.50 pstg. & hndlg.)

HEY, LOOK ME OVER . . . ☆☆☆☆☆☆☆☆☆☆☆☆☆☆☆☆☆



Lafayette HA-144 2 meter Transceiver

ternal antenna. Priced at \$189.95, with leather carrying case, shoulder strap, whip antenna, mobile power cable, mobile mounting bracket, and 10 D size batteries. From Lafayette Radio Electronics Corp., 111 Jericho Tpke., Syosset, N.Y. 11791.

For the Young at Heart

Science and Space Experimental Kits is a brand-new line, created for boys (and girls) from 8 to 15. Kit 0001 makes a direct current motor for powering models and toys (\$2.95). Kit 0002 includes "Hi-Drive Motor" and all components to build a real generator (\$5.95). Kit 0003 has "Tiny Atom Motor" and an assortment of gears



Howard Industries Science Kits

that enable the user to develop speeds from 21 rpm to 1700 rpm in operating mechanical toys, flashers, turntables, model railroad and road racing accessories, etc. (\$4.95). Kit 0004 has the "Tiny Atom" and everything for making electric motor drives including pulley, gear and pinion; friction, gear and worm; and crown gear (\$9.95). From Howard Industries, 1760 State, Racine, Wis. 53404.

Transistorized VOM

Aul's Model TVOM4 transistorized millivolt-ohm-microammeter exceeds the most desirable features of conventional multimeters and vacuum tube voltmeters. The solid-state design achieves high input impedance, stability and sensitivity with a battery life approaching the battery's normal shelf life. The meter is said to be virtually burn-out proof. One percent resistors and a tautband meter movement together with a solid-state amplifier, the linearity of which is independent of supply voltage, insure accurate performance. The TVOM4 uses a

9-volt transistor-radio battery for its amplifier, and a 1.5 volt C cell in the meter. Cost is \$55.00 F.O.B. Long Island City, from Aul Instruments, Inc., 24-13 Bridge Plaza N., Long Island City, N.Y. 11101.



Aul Model TVOM4 Multimeter

Now You Can Rock "Weird"

To help the rock-and-roll guitarist create distorted sounds, the Kent Distorter is now available through music stores. Foot- or hand-operated, it enables the guitarist to get the weird and often harsh sounds that are not otherwise easily obtained in the hard-rock, folk-rock and pop-rock group. The Distorter has a tran-



Kent Musical Products Distorter

sistorized input booster circuit in a heavy-duty cast-aluminum case, with foot switch, separate volume and depth controls, jack for amplifier, jack for guitar, and a detachable shielded cord with a plastic phone plug on both ends. Size, 6 x 3 x 1 in.; price, \$39.95. Write for literature from Kent Musical Products, 5 Union Sq., New York, N. Y. 10003. ■



THE SUPERSENSITIVE DARKROOM METER

S & M MODEL A-3

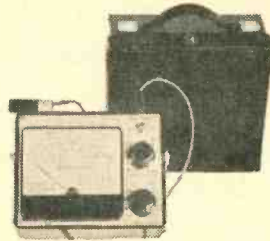

\$44.50
in kit form*

\$49.50
fully
assembled*

*Carrying Case
Included

Here is a precision instrument that meets the highest standards of any meter available today. The S & M A-3 uses the newest cadmium sulfide light cell to measure light levels from twilight to bright sunlight at ASA speeds of 3 to 25,000. This supersensitive darkroom meter is successfully used with movie or still cameras, microscopes, telescopes and it can also be set up for use as a densitometer.

The computer gives F stops from .7 to 90 and lists exposure time from 1/15,000 sec. to 8 hours; 4 range selection; EV-EVS-LV settings. The unit is also equipped with a large (4½") illuminated meter, paper speed control knob and a new battery test switch.

The S & M A-3 darkroom meter is ideal for darkroom and studio applications where accuracy is a necessity. It's available fully-assembled from the factory, or in easy to assemble kit form.

SCIENCE & MECHANICS — Kit Division
505 Park Ave./New York, New York 10022

EE-767

Please send the A-3 Supersensitive Darkroom Meter as checked below. I understand that if I am not satisfied, I may return the meter within 10 days for a complete refund.

Add 10% for Canadian and foreign orders
N.Y.C. residents add 5% for sales tax

- \$44.50 — in kit form \$49.50 — fully assembled
 Check or money order enclosed, ship post paid. Enclosed \$3.00 deposit, ship balance COD, plus postage and COD charges.
 A-3 Extra Carrying Case — \$4.95

NAME _____ (Please print)

ADDRESS _____

CITY _____ STATE _____ ZIP CODE _____



NEWSCAN

Great Balls of Fire

A sharply focused beam of electrons is being used by IBM scientists to perform tiny precision welds on critical electrical connections for computer memory arrays. This application of electron beam welding is believed by IBM to be the first such use of this technique in manufacturing computer memories.

The beam welder is used to connect the terminals of ferrite core planes with those immediately above and beneath them in a memory array. Using the electron beam technique, these precise welds can be done in a continuous operation. Conventional welding normally requires that each terminal be welded individually.

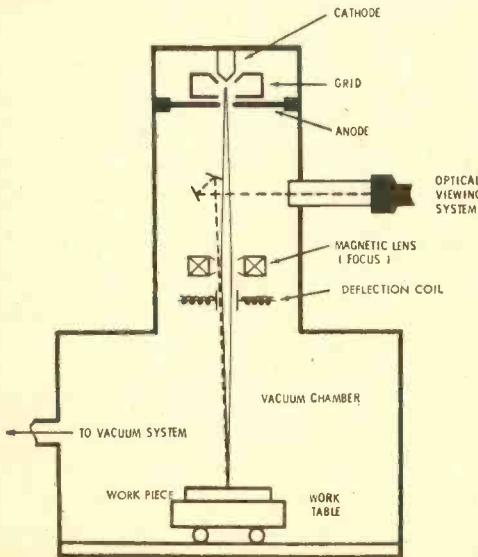

A basic operating schematic of the electron beam welder. As the beam passes vertically through and between the column of terminal pairs, it strikes the surface of the work piece. The work table, constructed of non-magnetic stainless steel, uses tungsten strips to absorb the energy of the beam and direct the heat away by conduction.

A ferrite core plane (containing thousands of tiny magnetic "donuts" wired together) is the basic assembly part of a computer's memory. A number of these planes, interconnected in stacks, makes up a memory array.

Welds produced with the electron beam process are uniform and look like ball-shaped nuggets. This uniformity of appearance makes it easy to spot a poor weld during quality control inspections.

Electrons are thermionically emitted from a cathode (a heated tungsten wire filament) and accelerated toward the anode by a high potential difference existing between these elements. A control grid, located between the cathode and anode, controls the density of the beam and shapes it so that it is directed toward a hole in the center of the anode. A wide variety of beam powers is available by selection of acceleration voltage and grid bias.

The accelerated electrons pass through the hole in the center of the anode and continue in a straight line path. Traveling downward, they pass through a magnetic lens and deflection coil. The magnetic lens focuses the beam to points from about one-half inch to 25 inches below the top of the vacuum chamber. The deflection coil is used to deflect the beam.

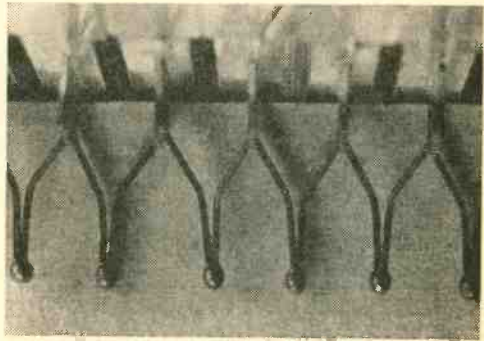

This is a magnified view of the welds made by the electron beam welder. The terminals are joined only at the tips with little or no material flow beyond the ball-shaped nugget.

Shooting Color

TV Colorgard, a new pistol-like instrument, cuts color television monitor set-up time (color balance) from hours to minutes. The hand-held, self-powered color comparator senses the red, green and blue colors displayed on the monitor screen. During set-up, the broadcast engineer simply adjusts the monitor controls for each color until the TV Colorgard meter indicates that the correct color balance is being displayed on the monitor. Using TV Colorgard, all color monitors are balanced by and to one standardized instrument.

Until now color monitor setup time has been a source of industry irritation. A broadcast engineer had to spend as many as two hours ad-
(Continued on page 98)

What the Sphinx wouldn't tell

For almost five thousand years man has sought answers to one of the most beguiling mysteries of all time. Did the two great Egyptian Pharaohs, Khufu and Khafre, conceal treasures that have yet to be found? In short, did these two kings of ancient Egypt (Continued Overleaf)

By
K. C. Kirkbride

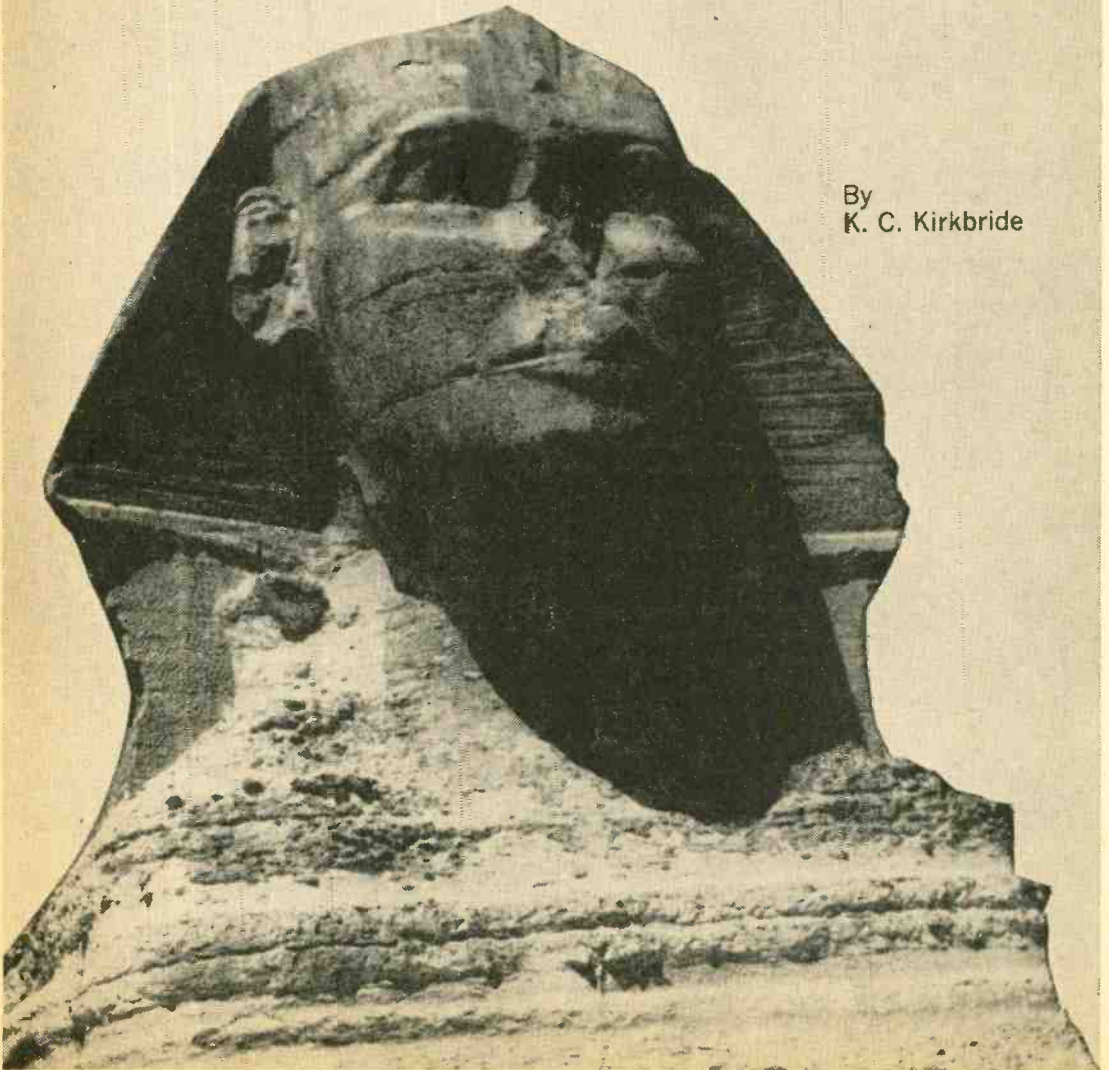

SKETCH OF APPARATUS FOR QUEENS CHAMBER EXPOSURE

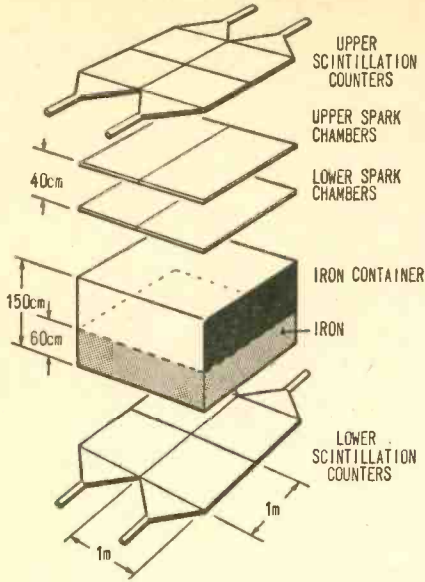

Sketch above shows construction of apparatus that will "x-ray" Egypt's two famous pyramids in search for secret rooms and treasures that may have been deliberately hidden inside. Experimental method involves use of cosmic-ray muons as "x-rays." Passage of muons through scintillation counters and spark chambers enables researchers to determine exact angle of passage (i.e., direction particle came from). In addition, muons that have passed through a void in the limestone—a hidden chamber, for example—will be relatively more frequent and energetic than those that have passed through solid rock.

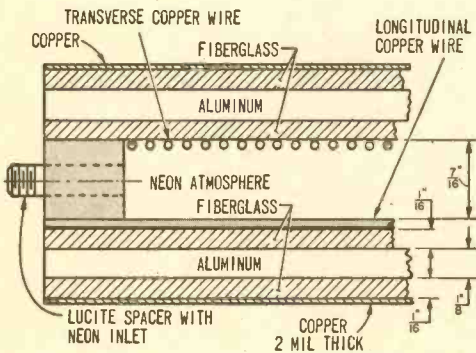

Cross-section of spark chamber construction reveals sandwich-like device which measures roughly 1-in. thick, 3-ft. wide, and 6 ft. long. Hollow interior is filled with neon gas which sparks whenever muon particle passes through. Since two spark chambers are spaced about 1 ft. apart, scientists believe it will be possible to detect any hidden chambers and pinpoint their locations within a few yards. Tunnelers could then bore to the indicated area and conduct a thorough investigation.

so hide their burial chambers and the accompanying funereal treasures that their pyramids have survived man's plundering through the ages?

In the centuries since that Fourth Dynasty, man has employed battering ram, gunpowder, and measuring stick to unlock the secrets of the two massive pyramids at Gizeh, but to no avail. Now, man's crude methods of the past may pave the way for electronics to discover what the Sphinx won't tell.

Optician's Precision. It was 2635 B.C. A lean Egyptian prince named Khafre stood watching lines of laborers and masons trudging up the causeway toward the rising peak of stone that would one day be the Great Pyramid and one of the Seven Wonders of the Ancient World.

Almost 100,000 men, working in shifts and with flawless organization, would labor 20 years hoisting massive rocks into position with ropes of palm fiber and machines of short wooden planks. And Khafre's

What the Sphinx wouldn't tell

father, the mighty Khufu (Cheops in Greek), had ordered every stone fitted so a knife blade could not slip between. With the precision of an optician today, almost six million tons of stone must be fitted into the one rising peak.

Inside would be elegant, granite-lined corridors and chambers, and a Grand Gallery. And through the Ascending and Descending Corridors men would carry fabulous stores of gold, jewelry, food, weapons, court furniture, and statues of the King to hold his *ka* (spirit), all representative of the great culture of the time.

For Khufu must not only preserve his body intact but carry the supplies he would need in the Field of Reeds (the Elysian Fields) if he were to meet the Sun God. And finally the mighty tomb must be sealed with granite plugs and covered with white limestone to mislead the stranger.

Stone Houses. For outwitting the grave-robbler had become an art in ancient Egypt. The kings and nobles of the First Dynasty built stone *mastabas* or elongated stone houses over their graves and ordered that their bodies be hidden deep in the rock beneath to deceive potential robbers.

Then King Zoser, second king of the

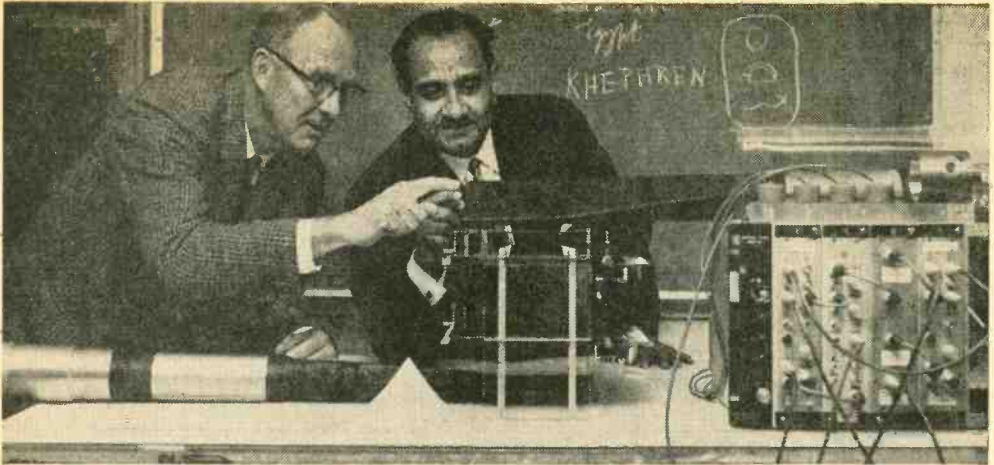

Dr. Luis Alvarez (left) of the University of California Lawrence Radiation Laboratory and Dr. Ahmed Ali Fakhry, authority on the Pyramids and visiting professor on U. of C. campus, inspect project's equipment.

Third Dynasty, hired the architect Imhotep to design his tomb. Imhotep piled mastabas atop each other like a wedding cake, then sealed them off with limestone. Thus the first pyramid, known as the Step Pyramid, was born. This was followed by ever more complicated "castles of eternity," most veritable masterpieces of maze-building.

But now the greatest tomb of all was being built. This one would cover 13 acres, rise 480 feet toward the sun, measure 755 feet on each side, and incorporate some 2,300,000 stones within its vast structure.

And Khafre the son wondered, should his tomb be the same highly intricate structure as his father's? Or should it be decep-

tively simple—so much so that every plunderer and adventurer throughout time would not be able to penetrate its secrets?

Whatever his decision, Khafre's tomb—the Second Pyramid—stands today just north of Khufu's at Gizeh in Egypt. And centuries of would-be plunderers have uncovered but one corridor, one chamber, beneath a mass of 470 feet of solid stone. The inscrutable Sphinx has stared unrevealingly all these 5000 years, and likewise has proven powerless to discover what—if anything—the Second Pyramid may still be hiding.

Sacked First. Less than two hundred years after Khafre's death, revolution raged through the land. The oppressed populace

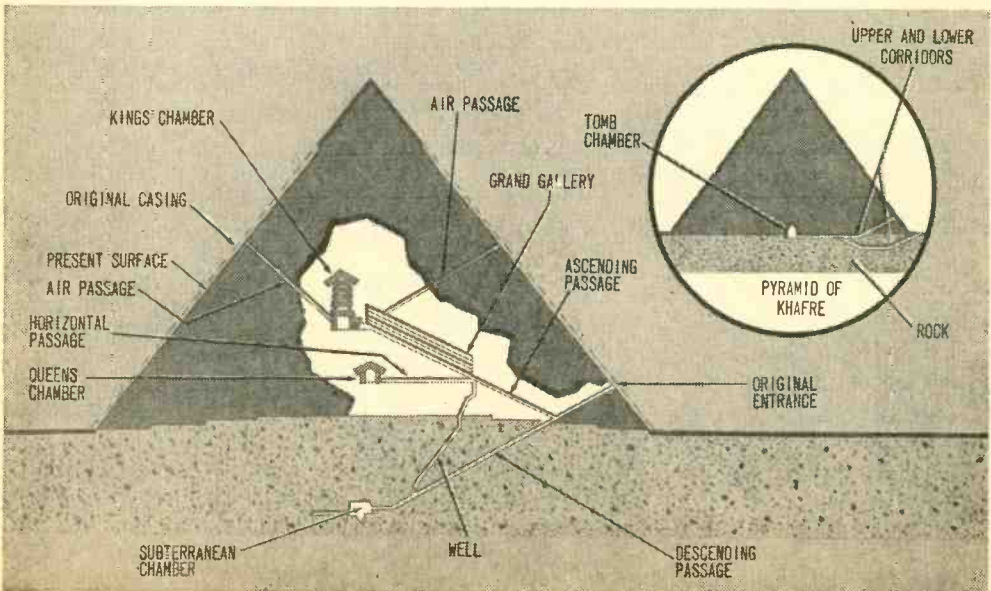

Drawing shows known interiors of Khufu's "Great Pyramid;" inset (circle) shows known interior of Khafre's.

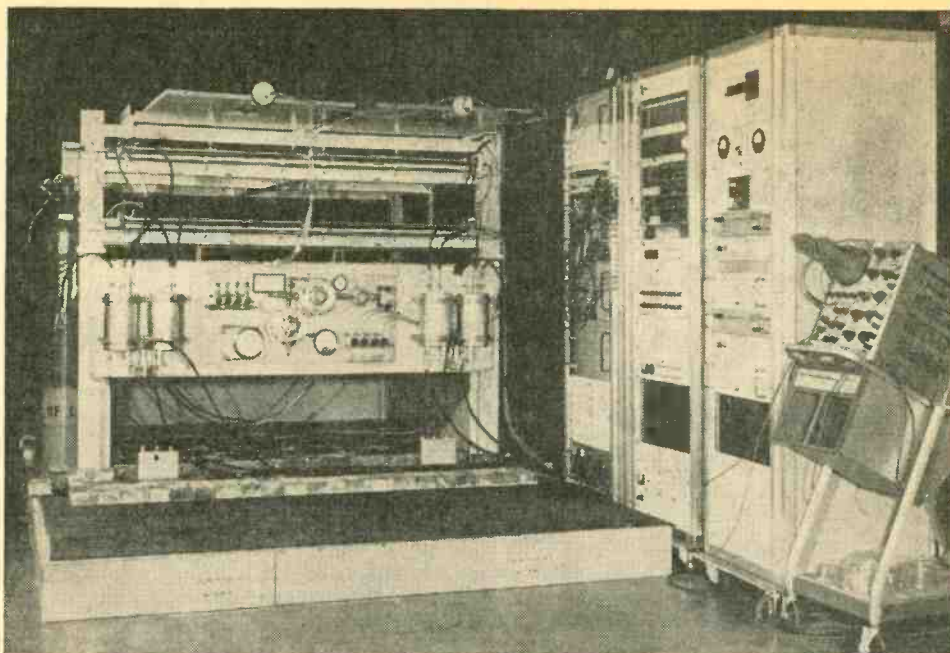

Photo courtesy University of California

Spark-chamber apparatus (at left) and some of equipment that will record and relay data to computer for storage. Ein Shams Computing Center in Cairo will analyze data; some findings may be available this fall.

What the Sphinx wouldn't tell

sacked their temples, and even the palaces and the tombs of their sacred kings. In their vengeance, they may have even clawed their way into the pyramids, dragged out the mummies, and tossed them to the desert's winds.

But this was only a prelude to the pillage to come. In all, 70 pyramids were known to have been built; most were only heaps of rubble after the Roman and Arab invasions. The fine granite capstones that gleamed in the sun were removed; the precious stone facings used as quarries to build Arab mosques.

Came the Ninth Century, and an adventurer violated the structures themselves. Lured by tales in the "Thousand and One Nights" and dreams of fabulous wealth, an Arab, Caliph El Ma-Mamun, set out for Cairo. There he hired Arab workmen and assaulted the Great Pyramid with the zeal of a fanatic. Brutally attacking the massive monument with a battering ram, his men finally jarred a great stone inside.

Guided by the sound of its fall, the workers tunneled until they found the first pas-

sages ever discovered. The Ascending Corridors lead to two chambers, both 18 feet high and later named the Queen's Chamber and the King's Chamber. The Descending Corridor lead to a subterranean chamber, which has yet to be named. But for treasure, Ma-Mamun found only bats.

An out-of-work circus weight-lifter was the second "discoverer" to pave the way toward today's electronic experiment. Arriving in Cairo in 1816, Giovanni Belzoni, like Ma-Mamun, was eager to plunder the reported wealth of the pyramids. Europe at the time was ancient-Egypt conscious after Napoleon's discovery of the Rosetta Stone in 1799. And Belzoni knew that treasure inside the pyramids well might let him return to Europe a wealthy man.

He spent five years in the effort. And with the aid of the British Consul, he managed to hire Arab workmen to help him in his quest. Removing sand from the sides of the Second Pyramid, they found the north side differed from the other faces. Ultimately, they uncovered the "forbidding mass of a granite portcullis (i.e., sliding door) one foot three inches thick."

Entrance At Last. Raising the heavy weight a little at a time, Belzoni and his men found an entrance some four feet high and large enough to squeeze through. Torch in hand, Belzoni rushed in. Surely he would

be the first of the adventurers to find a king's mummy! But like Ma-Mamun he found only corridors—and these more barren than the Great Pyramid's, with only a single chamber.

The most vicious attack was yet to come. Inspired by ancient writings, a British colonel, Richard Howard-Vyse, set out for Egypt in 1835. Upon his arrival, he blasted the Great Pyramid with gunpowder in an attempt to find a room above the King's Chamber. And when this failed, his men bored holes in the Sphinx to see if it was hollow. Still another group tore down the sliding door Belzoni had found.

This savage treatment of some of the world's most treasured monuments could only be condemned by archaeologist William Flinder Petrie, who surveyed the pyramids fifteen years later. But the actions of the three paved the way for his survey and to a large degree for the present-day electronic investigation.

Plug Stones Mysterious. Petrie's investigations revealed that the plug stones and the sarcophagus found in the King's Chamber could not have been moved up the Ascending Corridor. Both had to be placed in the Chamber before the corridor was built, which suggested that there were other corridors still undiscovered.

And he found, too, that plans had apparently been changed at the very time the pyramids were under construction, for some measurements didn't add up. Or did they? Or are many Egyptologists right in their belief that what man has so far found in the pyramids are simply ruses—ancient Egypt's version of the red herring? Their argument: the great monarchs deliberately designed their tombs to make them appear as if they had been robbed. If they're right, the real

burial chambers remain intact, still hidden within the massive structures.

Electronics Next. Physicist Dr. Luis Alvarez of the University of California's Lawrence Radiation Laboratory at Berkeley numbers among the deliberate-ruse group. Believing the men who have gone before him have found only "fake" chambers, Alvarez will now search for the real chambers electronically.

Working with an international team of scientists under joint sponsorship of the U.S. Atomic Energy Commission, the Smithsonian Institution, and the United Arab Republic, he is setting up muon-detection apparatus in the subterranean chamber of the Great Pyramid. First, he will gauge the muon count of the chambers known to exist. Then, having established these as "controls," he will continue to search for any that may be still hidden.

Drawing on experience gained measuring rock over a deep tunnel in the Snowy Mountains in Australia, rock of the same height as that over the Queen's Chamber, Alvarez will set up two spark chambers to detect cosmic ray muons coming through the rock from above. If a hidden chamber exists, an increased muon count will be indicated. Further, since two instruments are involved, it will be possible to pinpoint a hidden chamber's exact location.

For Alvarez feels confident that mu-mesons, or muons for short, born high in the earth's atmosphere from collisions between high energy primary cosmic rays and the nuclei of gasses, will have the energy to penetrate even the rock masses of the pyramids. And it is this penetrating ability of the muon that will enable Alvarez to "look through" the pyramid. If he observes an in-

(Continued on page 99)

HOME STUDY BLUEBOOK COUPON

(Turn page 77 details)

Age _____ Are you a Veteran? _____ Employed in Electronics? _____

Occupation _____ Male _____ Female _____ Single _____ Married _____

Are you a student? Full-time _____ Part-time _____ Home Study _____

Check the last school you attended: Circle schools you graduated:

Grade School _____ High School _____ College _____ Graduate School _____

Have you ever taken a Home-Study course? _____ Completed? _____

What school(s)? _____

What is your yearly income to the nearest thousand? \$ _____

(If your income is \$6745, write in \$7000)

HOME STUDY BLUEBOOK

e/e's Guide to selected
Home-Study Courses
now being offered by
Electronics Schools



☞ Home study is considered today one of the most effective approaches to education. More than two million enroll in home-study courses each year. This means that more people are investing in their future via the mail box than in all the colleges and universities combined. And this is easily understood when the exclusive advantages of home study are brought to mind. Some advantages are: you study at your convenience, you study at your own pace, you

develop self-starting qualities, your instruction is effective and you pay less for more training.

☞ Listed below are a few courses from several home study schools. For more information, circle those course numbers that interest you on the coupon below, and fill out both sides of the coupon. **ELEMENTARY ELECTRONICS** will forward your request to the schools and ask that additional data be sent to you directly. All courses listed are GI Bill approved.

9. Radio Servicing/AM-FM-Transistors. How would you like to build a shortwave/broadcast-band superhet receiver while studying to become a radio serviceman? Can do with *National Technical Schools* Project Method Course No. 4, which includes 61 lessons with 10 kits (including a factory-assembled multimeter). Among the lesson subjects are principles of radio electronics, vacuum tubes, diodes and transistors, alternating current, AM/FM transistor radio circuits, test equipment, basic and intermediate math. Tuition is \$155 cash or three time plans at \$12, \$15, or \$25 per month.

10. Industrial Electronics & Automation. Course No. 5 from the *Cleveland Institute of Electronics* prepares you to troubleshoot, repair, and maintain electronic devices used in industry. There are 51 *auto-programmed* lessons. Some subjects covered: computers, electronic heating and welding, industrial controls, industrial television, servo-mechanisms, and solid-state devices. The suggested rate of progress is one lesson per week, but you're allowed 24 months to do it in. *Cleveland* also offers Job Opportunities Services and lifetime job placement service. Tuition is \$320 or \$25 down and \$18.50 a month up to \$350.

11. Television Home Servicing. If you want to get started in home TV repair, *Coyne Electronics Institute* has a bargain course for you! With your own test equipment or borrowed units, *Coyne's* home training course is only \$135. There are over 100 well-illustrated lessons in theory and practice. *Coyne* claims you can start earning money after your first few lessons. There is also a Consultation Service free to students and graduates—for life. Time payments of \$5 down and \$5 a month come to \$165.

12. Radio Operator. *Central Technical Institute's* Course No. D.O.T. 193.282 is geared to get you a Second Class Radiotelephone license and prepare you for radio servicing. Non-high school graduates accepted, but one year of high school algebra is *required*. The course consists of 65 lessons, 65 examinations, 10 kits with which to perform 49 experiments in basic electrical circuits, a multi-range circuit tester, power supplies, and radio receiving circuits. The student will have a multimeter and an AM radio receiver to keep on completion of the laboratory work. Course must be completed in 14 months. Tuition is \$351; the monthly budget plan comes to \$390.

CUT HERE

ELEMENTARY ELECTRONICS, Dept. HS-2
505 Park Avenue, New York, N. Y. 10022

☞ Yes! I would like to know more about the electronics home study courses described above. I am interested in only the course numbers circled below.

9 10 11 12

Name _____ Age _____

Address _____

City _____ State _____ Zip _____

(Fill in facts on reverse side)

Reynolds Wrap AMP

Now you can kick the copper-clad habit!
Here's an exciting new way for you
to assemble simple projects
from household items!

By CHARLES GREEN, W6FFQ



In the early days of radio, most electronics projects were made out of household materials (remember the breadboard?). But nowadays, oatmeal box coils and tin-foil capacitors have gone the way of the Leyden jar and beeswax. In their stead are factory-made solid-state components and printed-circuit boards. But the joys and thrills of do-it-yourself-ism live on. To be sure, circuit boards are hard to fabricate, what with the (Continued Overleaf)

e/e REYNOLDS WRAP AMP

many rather tricky manufacturing processes involved in etching the copper-clad smoothies. But you can easily make your own inexpensive circuit boards using household aluminum foil cemented on cardboard or other stiff surface that is non-conducting.

The trick lies in a small quantity of rubber cement, which allows the board's circuits to be cut out with a razor blade. Mistakes are a cinch to rectify. Just remove the defective circuit, cement on a new section of foil, then recut the circuit. Component leads are fastened to the foil with metal eyelets available at notions counters in department stores.

A good intro to the aluminum-foil printed-circuit technique is our two-transistor Reynolds Wrap Amp. You'll find it fun to build and you'll discover plenty of places to put it to good use. Best of all, what better conversation piece can you imagine than a Reynolds Wrap Amp?

Construction. Begin by cutting out a 3 x 4¼-in. piece of heavy cardboard. Use a section of heavy bristol board, obtainable at any art supply store. Spread rubber cement on one side, making sure the cement is distributed evenly with no lumpy spots.

Next, take a roll of aluminum foil out of its box and lay a length on a flat surface. Take care not to wrinkle the foil. Spread rubber cement over the foil, covering a section a little larger in area than that of the cardboard. When the cement on both the cardboard and the foil is dry, carefully lay the cardboard on the cement-covered foil area and press firmly to make the two surfaces adhere. Trim the excess foil around the edges of the board with a single-edge razor blade, and set the foil-covered board aside.

Now make a tracing of the heavily outlined areas of the circuit-board drawing. Cut the tracing to size and tape or cement it to the edges of the foil covered board. Mark the approximate center of each of the ⅜-in. circles and the T1 squares through the tracing paper onto the foil. Also mark the Q2 cut-out center hole. Cut along the heavy outlines of the circuits with a razor blade. Make sure you cut through the foil, but not too deep into the cardboard.

Remove the tracing and carefully peel away the excess foil. Using the razor blade to lift the foil helps. Locate the ⅜-in. hole centers and punch the eyelet holes with a large ice pick. To prevent the board tearing, push the ice pick only partially through the board and finish the hole by punching through from the other side.

Cut the large center hole to clear the base

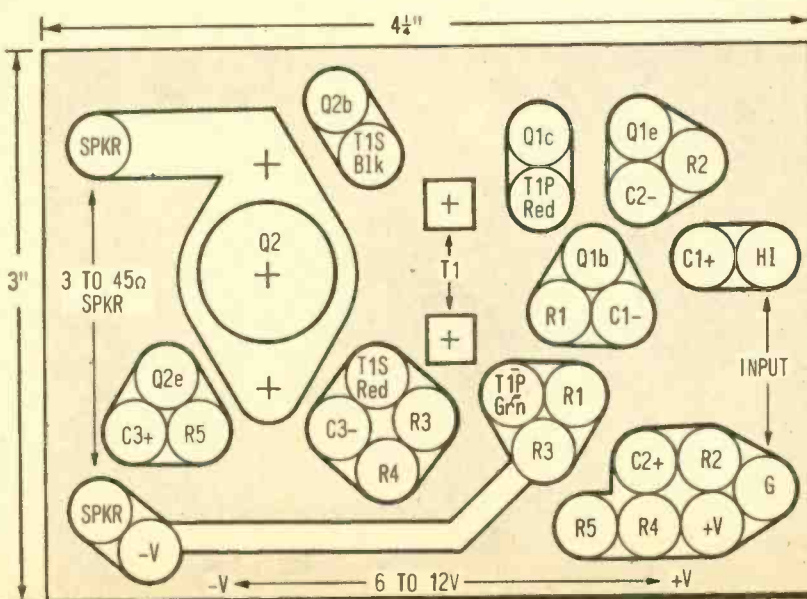

Template for making Reynolds Wrap Amp appears here approximately actual size (bristol board itself should measure 3x4¼ in. overall). See text for directions on how to use template.

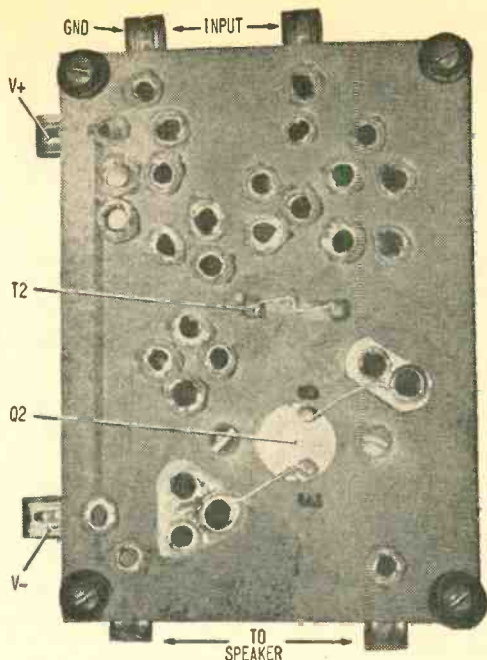
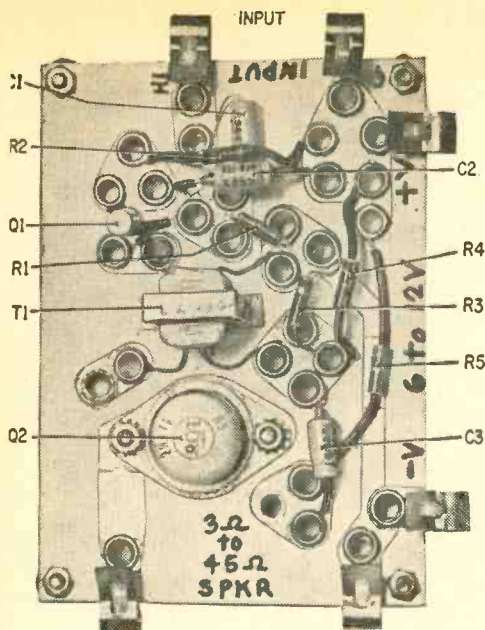

Top and bottom of completed Reynolds Wrap Amp. Fahnestock clips connect Amp to input and to speaker.

and emitter pins of Q2. Then locate the Q2-b and T1-S holes on the underside of the board. Cement a section of foil over the two holes and cut the foil to the shape of the top of the board foil section. Do the same for the Q2-e, C3+, and R5 hole group.

Punch small slots to fit the T1 mounting tabs, as marked in the squares. Fit T1 over the squares and push the tabs through the board. Solder a length of bare wire between the tab ends projecting through the board bottom and bend the wire to hold T1 tightly to the board.

Power Transistor Mounting. Locate the

mounting hole centers of Q2, punch the holes, and attach the transistor to the board with machine screws. Cut the base- and emitter-terminal leads to Q2 about 1/8-in. above the board's surface and solder lengths of AWG 22 bare wire to them.

Wrap one turn of the Q2-emitter lead around an eyelet and fasten the eyelet to the board by placing the end in the board over the rounded shank end of a large drill held in a vise. Then use a center punch and hammer on the top end of the eyelet to spread the eyelet and fasten it to the board.

(Continued on page 101)

PARTS LIST

C1, C2, C3—5-mf, 15-volt electrolytic capacitor

Q1—2N2613 pnp transistor

Q2—2N176 pnp power transistor

R1—1.2 megohm, 1/2-watt resistor

R2, R3—1000-ohm, 1/2-watt resistor

R4—330-ohm, 1/2-watt resistor

R5—33-ohm, 1/2-watt resistor

T1—Transistor interstage transformer; 10,000-ohm pri. to 2,000-ohm CT secondary (Philmore ST-21, Radio Shack B731378 or equiv.)

Misc.—Aluminum foil, cardboard (see text), bare hookup wire, Fahnestock clips, rubber feet, rubber cement (paper cement—Carter's Rubber Cement or equiv.), unpainted eyelets, etc.

Estimated cost: \$5.00

Construction time: 2 hours

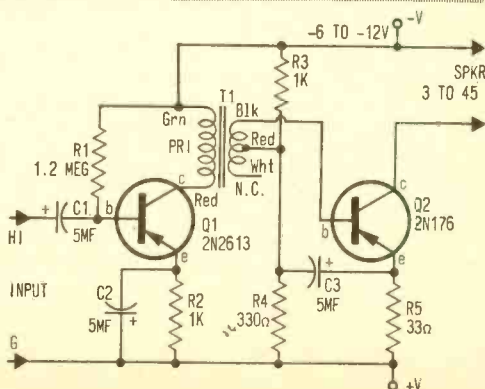

Amp schematic. Be sure to observe capacitor polarities.

Using table donated by U.S. Weather Bureau, Club members Phyllis Andruck and Bob Scherr (below) determine exact speed and direction of severe storm located over Great Lakes region. At right, member Carol Woolfe checks latest temperature, air pressure, and humidity to provide community weather forecast.

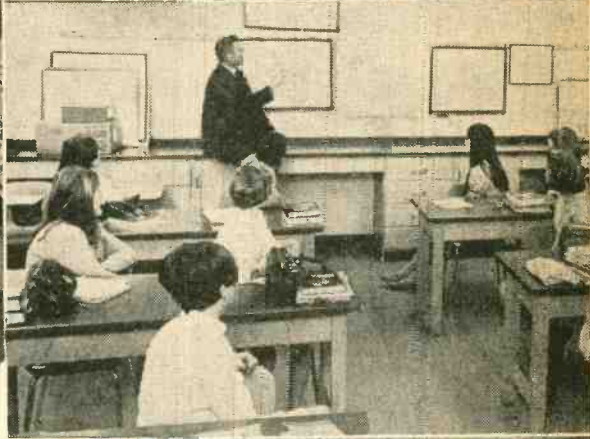

The Weather Kids Them Not

By ROBERT LEVINE

Unlike the rest of us, students at Lakeland High in Shrub Oak, N.Y., are doing something about the weather. They forecast it for days and weekends to come, not only for their own community but for the entire northeast. That they come out on top 85 per cent of the time rates them A plus on any weather forecaster's report card.

The students are members of the school's Weather Club, organized four years ago by science teacher James Witt. The Club meets every day, but full-fledged members arrive an hour before school opens and stay two hours after school is out to keep forecasts fully detailed and up to the minute. Their equipment, by the way, unofficially appraised as worth \$125,000, consists of parts salvaged from old bombers or donated by the Federal government. Cost to the school was nil. ■



On school roof, students hear teacher James Witt explain operation of electronic wind equipment; devices connect with recording instruments in classroom. Below, teacher Witt discusses probable weather conditions for community in days to come, while members Don Abrams and Bob Greico make last-minute revisions on weather board in school lobby.



Radar apparatus located on roof of school also feeds instruments in classroom. Biggest expense in running Club is yearly \$700 rental fee for teletypes to bring necessary background weather data from U.S. Weather Bureau to school.

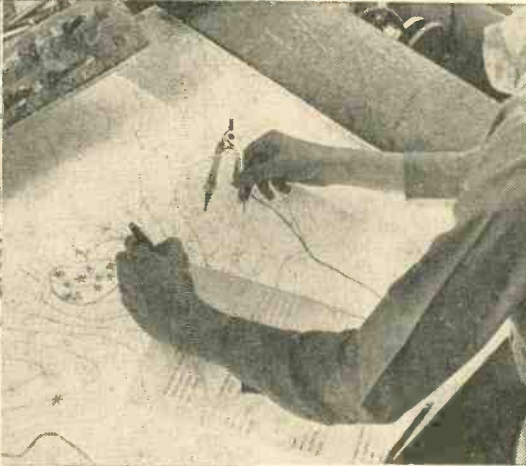

Students turned meteorology buffs dig for foul weather like ducklings and often turn out for the nastiest nor'easters. Above, member Carol Woolfe plots probable path of snowstorm; below, Karen Leiter (left) and Ken Krauter check teletype machines which continually issue data on the entire world's weather. Since machines spew out info at 100-wpm speeds, students are kept busy selecting pertinent data for weather maps they're preparing. The result: weather forecasts that edge the U.S. Weather Bureau's own for accuracy; students who amaze both themselves and their elders with their prodigious learning-by-doing.



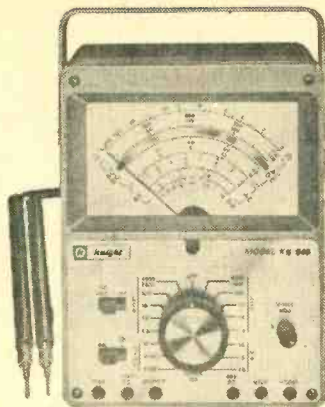

KNIGHT Model KG-640

57-Range

Volt-Ohm-Milliammeter

Instruction manuals for VOM's often specify that for maximum accuracy and convenience readings should always be taken from the top two-thirds of the meter's scale. Unfortunately, as most experimenters have learned, using the next lower range in an attempt to move the pointer upscale often results in the pointer being driven off-scale.

To get around the low-accuracy problem presented by readings taken from the lower part of the meter scale, and also to provide the convenience of additional meter ranges with a minimum of confusion, the *Knight-Kit* KG-640 VOM provides a *half-range* function switch that doubles the pointer position. For example, suppose the meter was set to the 16-VDC range. A 4-volt reading would appear at $\frac{1}{4}$ scale. But by using the half-range function the range would be changed to 8 volts, so that the 4-volt readings would appear at $\frac{1}{2}$ scale, rather than at $\frac{1}{4}$ scale deflection.

The Ranges. The basic ranges, that is, the ranges marked on the front panel, are as follows: DC volts—1.6, 16, 80, 400 and 1600/4000; AC volts—4, 16, 80, 400 and 1600/4000; DC current—0.16 ma., 0.8 ma., 16 ma., 200 ma., 400 ma., and 16 amperes; ohms—R x 1, R x 100 and R x 10k, with 12

ohms (and its multiples) at center scale.

A single set of jacks is used for most of the measurement functions. A separate jack, isolated by a capacitor, is used for measuring AC (output) in the presence of DC. Separate jacks are also used for the 4000-volt AC and 4000-volt DC ranges, as well as for the 16-ampere range. A panel-mounted switch reverses the internal meter connections for negative DC readings, thereby eliminating the need to reverse test prod connections when measuring negative DC voltages. A second panel switch provides the half-scale voltage-and-current measurements.

How Half-Scale Works. Unlike other 20,000 ohms-per-volt DC meters, the KG-640's input impedance (the load represented by the meter) is either 20,000 ohms-per-volt or 10,000 ohms-per-volt, depending on the particular range in use. Similarly, the AC impedance is 5000 or 2500 ohms-per-volt. It is the range indicated on the panel which is the lower impedance in each case. For example, the panel indicated scale of 16 VDC is 10,000 ohms-per-volt; the associated half-scale of 8 VDC is 20,000 ohms-per-volt.

The schematics show how the impedance depends on the half-scale switch. The ex-

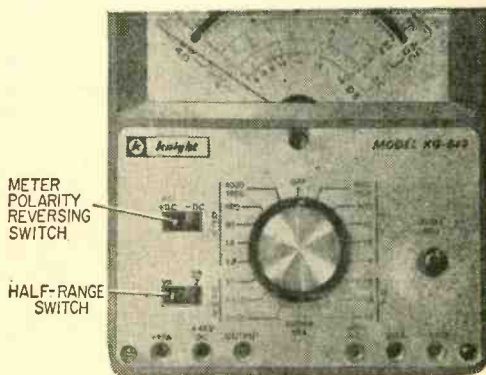

Two switches on the Knight KG-640 rarely appear on VOMs in its price class. Polarity-reversing switch effectively reverses test prods on DC measurements; half-range switch effectively doubles meter scale,

amples are simplified for ease of illustration and represent the theory but not the actual calibration of the KG-640.

Fig. 1 shows the basic meter circuit. Meter M1 (which has an internal resistance of
(Continued on page 40)

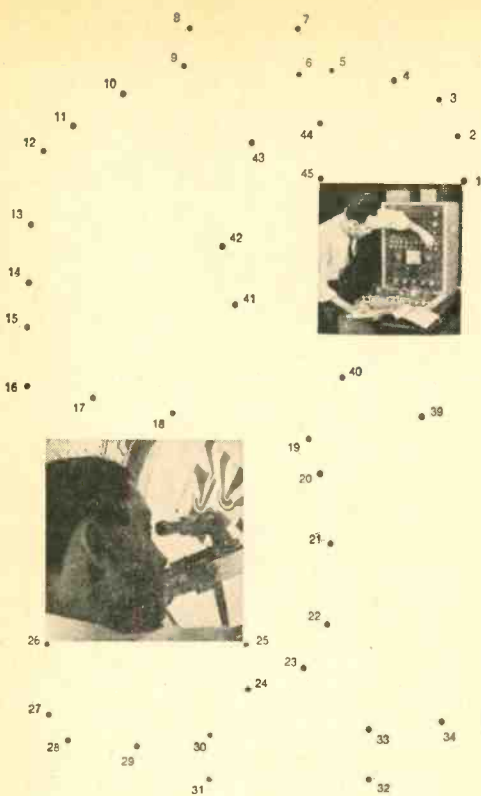

Connect the dots

And find out what
RCA INSTITUTES
 Home Training
 in electronics
 can do for you!

EXCLUSIVE RCA AUTOTEXT TEACHES ELECTRONICS FASTER, EASIER!

Beginner or refresher - AUTOTEXT, RCA Institutes own method of Home Training will help you learn electronics more quickly and with less effort, even if you've had trouble with conventional learning methods in the past.

THOUSANDS OF WELL PAID JOBS ARE OPEN NOW!

Every year, thousands of well paid electronics jobs go unfilled due to a lack of trained technicians. If you have an interest in electronics, RCA Institutes can help you qualify for these rewarding jobs.

CHOOSE "CAREER PROGRAM" BEST FOR YOU!

Start today on the electronics career of your choice. On the attached card is a list of "Career Programs" each of which starts with the amazing AUTOTEXT method. Look the list over, pick the one best for you and check it off on the card. RCA Institutes also offers specialized advanced courses which are described in the material you will receive.

PERSONAL SUPERVISION THROUGHOUT!

All during your program of home study, your training is supervised by RCA Institutes experts who become personally involved in your efforts and help you over any "rough spots" that may develop.

VALUABLE KITS, YOURS TO KEEP!

You receive a variety of valuable, specially engineered kits with your program, including, from RCA Institutes only, a Transistorized TV Kit for TV students, and a valuable oscilloscope—both at no extra cost and only from RCA.

UNIQUE TUITION PLAN!

You progress at the pace that is best for you! You only pay for lessons as you

order them. There's no long-term contract or large down-payment to lose. Even if you decide to interrupt your training, you don't pay a single cent more.

SEND ATTACHED CARD TODAY FOR FREE DESCRIPTIVE BOOK!

CLASSROOM TRAINING ALSO AVAILABLE. FREE CATALOG ON REQUEST. NO SALESMAN WILL CALL!

All courses and programs approved for veterans under new G.I. Bill.

RCA INSTITUTES, INC., Dept. EA-77
 350 West 4th Street
 New York, N.Y. 10014



The Most Trusted Name in Electronics

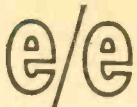

KNIGHT KG-640 VOM

Continued from page 36

10,000 ohms) indicates 50 μ a. at full scale. If you wanted to use this meter as a voltmeter indicating 5 volts at full scale, the resistance, R_s , connected in series with the meter resistance, R_m , must be of such value that the applied 5 volts will cause 50 μ a. to flow in the series circuit consisting of R_s and R_m . From Ohm's law, $R = E/I$, $R = 5 / .00005$, $R = 100,000$ ohms.

Since R_m is 10,000 ohms, R_s must be 100,000 ohms less 10,000 ohms, or 90,000

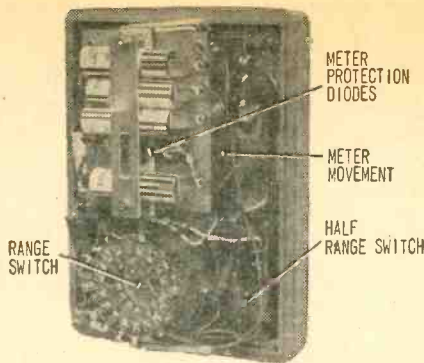

Rear view of KG-640, with rear of case removed. The unit is available both ready-wired and kit form.

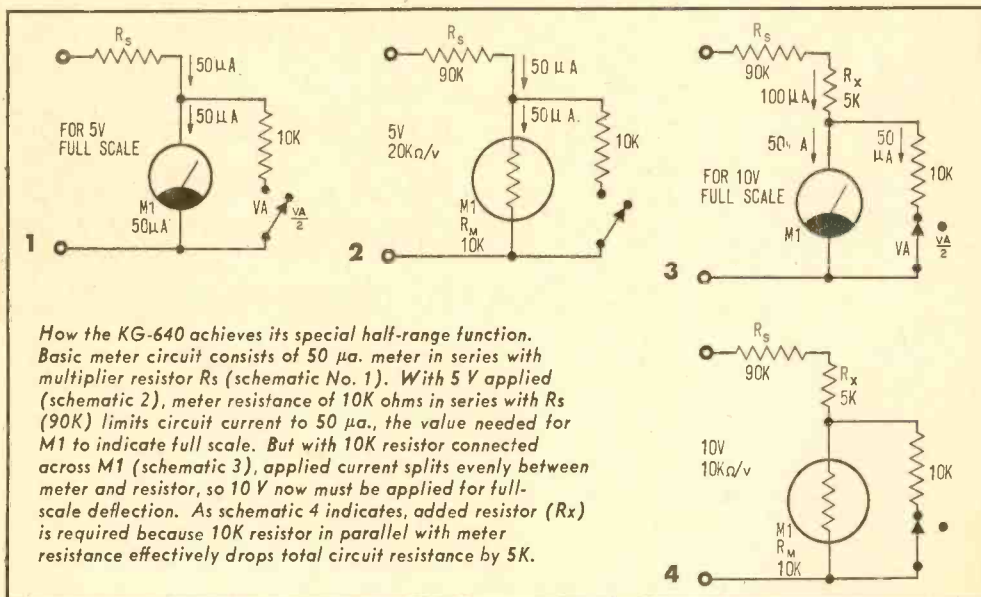

How the KG-640 achieves its special half-range function. Basic meter circuit consists of 50 μ a. meter in series with multiplier resistor R_s (schematic No. 1). With 5 V applied (schematic 2), meter resistance of 10K ohms in series with R_s (90K) limits circuit current to 50 μ a., the value needed for M1 to indicate full scale. But with 10K resistor connected across M1 (schematic 3), applied current splits evenly between meter and resistor, so 10 V now must be applied for full-scale deflection. As schematic 4 indicates, added resistor (R_x) is required because 10K resistor in parallel with meter resistance effectively drops total circuit resistance by 5K.

ohms (Fig. 2). Since the total resistance is 100,000 ohms for a range of 5 volts full scale, the value of resistance for each volt of full scale indication must be 20,000 ohms, and we say this circuit is 20,000 ohms-per-volt. To obtain the proper circuit resistance for any full-scale voltage it is only necessary to multiply the desired full-scale voltage by 20,000. As an example, if you want the meter to indicate full scale with 100 V applied the total series resistance, $R_s + R_m$, would have to be 100 x 20,000 or 2 megohms.

Now, suppose the half-scale switch shown in Fig. 3 was closed, thereby connecting a 10,000-ohm resistor in parallel with the meter. Since the resistor is equal to R_m , half the total current flowing in the circuit would flow through the meter and half through the resistor. To make up the dif-

ference in the resistance represented by the meter (which was originally 10,000 ohms), 5000-ohm resistor R_x is added in series as shown.

Note that though the total meter circuit resistance is the same as in Fig. 1, the same applied 5 V now causes the meter to indicate only half-scale, because $\frac{1}{2}$ the total current is bypassed around the meter by the 10,000-ohm resistor. It is now possible to double the applied voltage from 5 to 10 volts for a full-scale meter reading. But look what happens to the ohms-per-volt rating.

We now have the same total of 100,000 ohms in the meter circuit, but the applied voltage is 10 volts. From Ohm's law, there is 100 μ a. rather than 50 μ a. total circuit current—50 μ a. through the meter and 50

(Continued on page 101)



Transistor Bias REVEALED

By Len Buckwalter
K10DH/KBA4480

How a transistor's operating point is locked down can make one whale of a difference in how the little devil performs.

Transistors don't know when to stop.

Feed in a signal and the semiconductor might burn itself out trying to amplify. Or it could stop passing current too soon. The transistor could fail to amplify those weak signals and thereby snip away pieces of intelligence. This off-again on-again confusion is cured by bias. It's a steady voltage to hold an undisciplined transistor into a safe, predictable operating region.

By pinning down the transistor's *operating point*, bias keeps an audio amplifier free of distortion. In other circuits, bias creates distortion—but for good reason, like reducing power consumption. And solid-state receivers have a brand of self-adjusting bias that keeps the radio from overloading on strong signals, or mishandling weak ones.

Solid vs. Vacuum. Transistor bias snares techniques used for regular vacuum tubes. In each device, bias is applied to a controlling element: the grid in a tube, the base in a transistor. Yet there are differences. For one, tube bias is almost always a *negative*

voltage. Reason is that a tube with no bias on its grid often gulps current to the point of damage. In a transistor, bias voltage may be either positive or negative, depending on whether the semiconductor is a PNP or NPN type. And unlike the tube, a transistor will rarely destroy itself when no bias is applied; semiconductor action just about stops.

Another item that old-time tube men must get used to is what to call bias. Speak about it in a tube and it's a *voltage*. But in a transistor, bias is most often called a *current*. It's mostly a matter of degree. In a tube circuit, a grid may be biased to -8 volts, easily measured by a voltmeter. Grid-current flow is usually so small it's ignored (although there are exceptions). Unlike the tube, the transistor is a *current-operated* device. This simply means voltages are generally quite low, and currents through the semiconductor material relatively high.

In the manuals you'll find transistor bias often stated in microamperes. A small-signal semiconductor, for example, might require

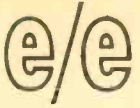

TRANSISTOR BIAS

50 microamperes flowing through its base-emitter circuit for correct bias. Voltage in this case (needed to push that current) is a mere fraction of a volt. Many recent-model voltmeters now feature an extra low-voltage range for trouble-shooting transistor circuits. But on the spec sheets you'll continue to see *bias* stated as *current*.

Keeping the Cool. Though tube and transistor bias resemble each other in purpose and principle, there's one huge difference. So long as a vacuum tube receives air circulation, it contentedly ignores ambient, or surrounding, temperature. Operating at a bulb temperature of several hundred degrees, it little matters to the tube whether the day is cool or hot. A glowing filament creates the tube's own thermal environment. Transistors enjoy no such independence.

With increases in temperature, a transistor passes more current. And it happens whether it's handling a signal or not. Heat energy raises the electrical activity of the semiconductor material. What's more, any heightened current flow through the transistor produces additional heating, which, of course, makes even more current flow through emitter-collector circuit. This rising-current sort of feeds on itself and the transistor current may quickly soar to the point of self-destruction. The condition is aptly called *thermal runaway*. This problem especially plagued early transistor auto radios operating in the hot confines under a car dashboard. It's a major task of bias, however, to protect against thermal runaway and other ill effects from heat. The technique is called *bias stabilization*.

Bases Loaded. Let's take a transistor,

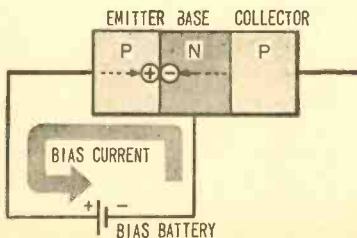

Fig. 1. Block diagram of a pnp transistor showing bias current flow between base and emitter junction. Negative side of battery connects to negatively charged base, positive side to emitter.

strap on bias, then watch the current flow. Shown in Fig. 1 is the three-chambered heart of a pnp transistor. To introduce bias it's necessary to get current flowing across the boundary between emitter and base elements. Oozing within these sections are electrical charges created during manufacture; the emitter is shot through with "holes," or areas of positive charge, while the base fairly drips with the negative charge of electrons. When the external bias battery is connected, attraction and repulsion occur. As you can see, the negative side (-) of the battery is nudging (repelling) a negative particle within the base toward the boundary, or junction.

Meanwhile, the positive battery terminal repels positive holes toward the same point. Mixing of charges at the junction reduces electrical resistance between base and emitter. Now an external battery current may circulate in a steady stream around the base-

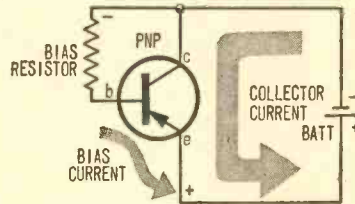

Fig. 2. Simplest way to bias a transistor calls for nothing more than a carbon resistor between base and battery. Transistor can now serve as amplifier.

emitter circuit. This lowering of resistance sets the stage for the transistor's ability to amplify.

In Fig. 2 is a basic transistor schematic. As before, emitter and base connect to positive and negative battery terminals. Only now a bias resistor is introduced. It's needed to reduce battery voltage and limit bias current to a safe value. Notice that the collector is also tied to the negative battery terminal. This transistor element attempts to send a whopping flow of current down to the emitter. Will it succeed?

It all depends on base bias. If enough current flows in the base-emitter circuit, there forms a wide-open gate for collector current to cascade down to the emitter. Remove bias current and the collector is isolated from the emitter by high resistance. Vary base bias and collector current obediently follows the variations, only at much-higher current levels. That's precisely what happens when a small signal is applied to the base. The signal adds and subtracts to existing bias

current. A boosted version of signal current then appears in the collector circuit (see Fig. 3.)

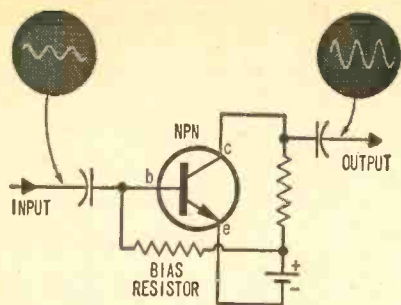

Fig. 3. Circles contain input and output waveforms of one-transistor amplifier using bias resistor as in Fig. 2. Transistor is npn, so battery connections are reversed.

There is, of course, a limit to how much collector current can flow. When the collector conducts to its maximum limit, it reaches a point known as *saturation*. On the other hand, least collector current flows when the transistor is biased to an operating region known as *cut-off*. As we'll see, bias can keep the transistor functioning between these two limits.

Putting on Specs. A look at an actual spec sheet from a transistor manual illustrates several of these points. It's reproduced in Fig. 4. Hidden behind that forest of figures and squiggles is the story of bias. The transistor is a 2N406, a small *pnp* semiconductor that might be driving the final audio amplifier in your portable radio.

Fig. 4

TRANSISTOR

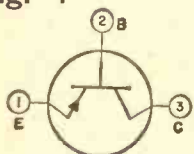

Germanium p-n-p type used in class A audio-frequency driver-amplifier applications in battery-operated portable radio receivers. JEDEC No. TO-1 package; outline 4, Outlines Section.

2N406

MAXIMUM RATINGS

Collector-to-Base Voltage (with emitter open)	-20 max	volts
Collector-to-Emitter Voltage	-18 max	volts
Emitter-to-Base Voltage (with collector open)	-2.5 max	volts
Collector Current	-35 max	ma
Emitter Current	35 max	ma
Collector Dissipation:		
At ambient temperatures up to 25°C	150 max	mw
At ambient temperature of 55°C	50 max	mw
At ambient temperature of 71°C	20 max	mw
Ambient Temperature:		
Operating	-65 to 71	°C
Storage	-65 to 85	°C

TYPICAL COLLECTOR CHARACTERISTICS

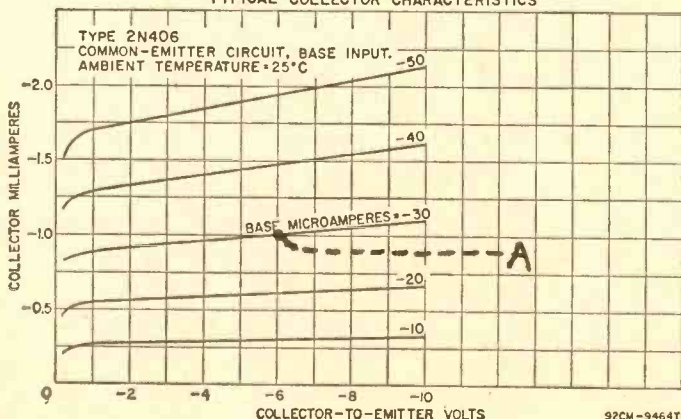

In Common-Emitter Circuit

DC Collector-to-Emitter Voltage	-6	volts
DC Collector Current	-1	ma
Power Gain (with load resistance of 8500 ohms and input resistance of 750 ohms)	43	db

e/e TRANSISTOR BIAS

Ratings," are the risky regions. Exceed those values and the semiconductor will quickly enter a state of irreparable shock. Notice, too, the ratings given for "Collector Dissipation." It dramatizes the temperature problem peculiar to a transistor. At 25 degrees C (about room temperature—approximately 77°F) the 2N406 can handle 150 milliwatts. But at a torrid 71°C (approx. 160°F) the manufacturer warns that you'd better cut power to a meager 20 milliwatts. This sensitivity to heat is countered by bias techniques described in a moment.

To find the bias needed by the 2N406 let's check what the manufacturer states for typical operating values. At the bottom of the spec sheet is how the transistor might operate in a common-emitter circuit, the usual amplifier circuit. It states that if DC collector-to-emitter voltage is -6 then DC collector current is -1 milliamperere. What isn't mentioned, though, is what the base bias should be.

Riding the Characteristic Curve. The graph in Fig. 4 tells it. If you find -6 volts along the bottom and -1 milliamperere at the side, you'll see these values converge at point A, which suggests a base current of -30 microamperes. (Negative signs in front of all numbers denote direction of current and voltage. They also reveal that the transistor is a *pnp* type. They are not used for an *nnp* type since values are all positive—exactly opposite from *pnp*.) To find how to obtain a base current of 30 microamperes let's con-

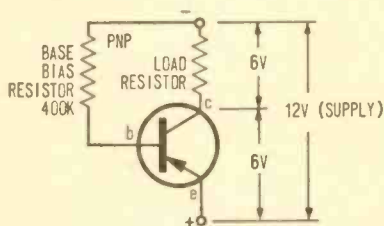

Fig. 5. Fixed bias circuit for one-stage amplifier using 2N406 pnp transistor. Value of bias resistor was computed from curves in Fig. 4 and Ohm's Law.

struct a circuit that operates on *fixed bias*, the first basic technique.

In Fig. 5, a 12-volt supply is powering the amplifier stage. Note that voltage divides exactly across the load resistor and transistor;

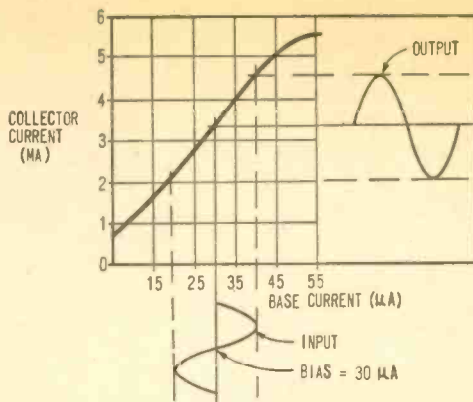

Fig. 6. Curve above reveals how input signal adds and subtracts from bias current of 30 μ a. Note how bias point falls in center of linear portion of curve.

6 volts corresponding to the collector-emitter voltage given earlier in the spec sheet. To make 30 microamperes flow through the base-emitter circuit a resistor is tied from the base to the negative side of the supply. This places the bias resistor across the full 12-volt supply. (The lower end of the resistor sees the positive terminal of the supply through the emitter.) Next, it is a matter of Ohm's Law to find the resistance value. Dividing supply voltage (12) by desired current (30 μ a) yields a resistor requirement of approximately 400 K. Now if a signal is applied to the base, it will swing bias current within a region which provides relatively undistorted amplification. This is apparent from the curve plotted in Fig. 6.

The system of fixed bias is simple. And you'll find it in many experimenter projects. For commercial and critical applications it isn't good enough. It is difficult to maintain desired bias current with one resistor value since transistors, even of the same type number, tend to vary in quality. Also, temperature variations threaten to upset current conditions within the transistor. Our next bias circuit is a step toward stabilizing a swaying semiconductor.

Self-Bias. Note in Fig. 7 that the bias resistor now connects directly to the collector, not to the negative battery source. Voltage picked off the collector, however, is still negative and thus energizes the base, as before. The advantage of direct collector connection is that bias now responds to collector current flow. If the transistor becomes hot, collector current will rise with it. But as this current rises, *collector voltage simultaneously drops*. This happens since more current is

sent through the load resistor and that resistor gulps a bigger share of the supply voltage. This is shown as a rise from 6 to 7 volts (in parentheses) across the load. Meanwhile voltage between collector and emitter drops to (5) from 6 volts.

Note what happens to base bias, tapped from the collector. Falling collector voltage reduces base bias and the circuit operates with a kind of built-in gain control. To a degree, self-bias opposes any undesired current due to heating effects. A chilly semiconductor would experience the opposite effect; falling current props up collector voltage so bias current raises collector current back to normal. There is slightly less transistor amplification with this bias method but it's often worth the protection.

Notice that in Fig. 7 the 200 K bias resistor is only half the resistance value of that used in the earlier circuit. That's because it is tapping voltage from the collector, not the power supply. Since this source provides only half the 12 volts from the power supply, the resistor must also be reduced to keep bias current at the specified 30 microamperes.

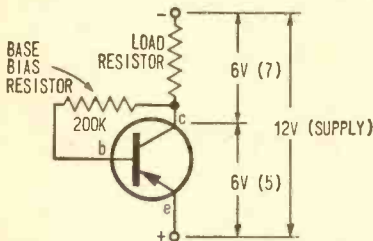

Fig. 7. In self-bias configuration, bias resistor connects directly to collector. Result is that transistor has less gain but added thermal protection.

A third method of biasing is the *bias network*. And we'll examine an actual circuit since this is the bias type commonly found in commercial equipment. In Fig. 8 is the audio driver stage in the Hallicrafters CB-10 transceiver. The stage amplifies a voice signal on the way to the rig's modulator. Three resistors are in the biasing network. Note that two form a voltage divider; R1 and R2, bridged across the positive and negative legs of the power supply. The transistor base is connected to the junction between them, where -2.9 volts appears. This voltage establishes proper bias. An advantage of the voltage divider as a bias source is reducing the amount of resistance in the base circuit. When resistance values are quite high, as in earlier methods, the transistor has a greater tendency toward thermal runaway. Fewer ohms help to keep the base well-tamed.

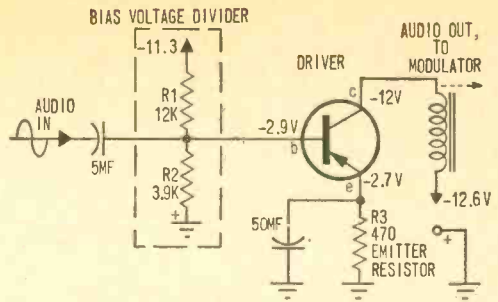

Fig. 8. Biasing circuitry in audio driver stage of Hallicrafters CB-10 transceiver is typical of that found in commercial gear. Three resistors (labelled R1, R2, and R3 above) enter into biasing network. Divider R1, R2 provides base bias; R3 biases emitter.

A third resistor, the 470-ohm unit (R3) in series with the emitter, makes a husky contribution to thermal stability. It works like the cathode resistor found in tube circuits. If current rises in the collector circuit, it causes a voltage increase at the top of R3. This elevates the emitter to a more negative voltage, which is equivalent to impressing a positive voltage on the base.

High-Power Protection. In the output stages of transistor amplifiers, there is usually additional protection. These semiconductors operate at high heat levels and their finned heat sinks (Fig. 9) may keep them only a step away from disastrous thermal runaway. One popular technique used in output stages of solid-state hi-fi amplifiers is a diode in the base-emitter circuit. Since the diode itself is constructed of the same material as that

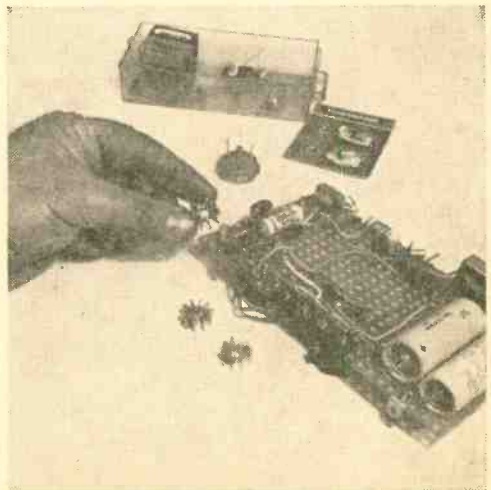

Fig. 9. Finned heat sinks installed under power transistors help dissipate excess heat, but bias alone has final control of thermal runaway. See text for discussion of esoteric anti-runaway biasing techniques.

e/e TRANSISTOR BIAS

used for the transistor, it also responds to heat variations on or near the chassis. In the next diagram we'll see that a heat-driven diode can develop a protective counter voltage.

In Fig. 10 is part of the output stage of the Heathkit AA-21 stereo amplifier. Note how a diode is connected between the transistor's base and emitter (through a winding on transformer T). Under normal heat conditions bias voltage developed at the base is measured as -1.5 volts. But when temperature around the diode and transistor begins to rise the diode, too, starts to conduct more current; its semiconductor material absorbs heat energy and becomes more active. This is the same as lowering the diode's electrical resistance. This ties the transistor base more closely to the positive side of the circuit. This reduces base bias and thus cuts down collector-current flow. As you may recall, a *pnp* transistor (as in this example) boosts collector current when biased negatively. The stabilizing bias diode reverses the action.

Another technique that's been used to produce a similar kind of bucking bias is with a *thermistor*. This heat-sensitive resistor operates like the diode to produce a similar effect. Many radios, in fact, do contain a thermistor. The diode method, however, does a better job in faithfully following temperature variations.

Classy Bias. As in tube circuits, the transistor depends on bias to determine the class of amplifier operation. In most low-level audio and RF circuits, amplifiers operate class-A. This provides the most accurate, distortion-free strengthening of an input signal. Bias is selected so collector current flows

continuously during the complete cycle of the signal. When no signal is present, the same average amount of collector current flows. Although the price of faithful amplification is lower transistor efficiency, this is usually ignored in low-level amplifiers (operating at a few milliwatts). Our scope photo in Fig. 3 shows how the complete signal emerges from a class-A amplifier.

The class-B amplifier requires that bias be adjusted so collector current is nearly at cutoff. Then, when an alternating signal is applied only half the waveform gets through (see scope picture in Fig. 11). If the transistor is a *pnp* type, only the negative part of the signal is amplified since a negative signal voltage is needed to drive the transistor out of cutoff where it is held by the bias. (For *nnp* transistors, only the positive part is amplified.)

The class-B amplifier is generally used in the output stages of both high- and low-quality amplifiers. In the inexpensive transistor portable, it conserves the battery. Unlike class-A, where collector current always averages out to some steady value, class-B collector current changes with loudness of the program material. Soft passages or the absence of audio drops battery drain to nearly zero since the stage is biased to the cutoff region when no signal is applied.

But it's not exactly at zero. The reason is that class-B operation in an audio circuit requires two transistors operated in push-pull fashion. Since a class-B amplifier slices away half the signal, two stages are needed to keep it whole. The reason for not adjusting bias for complete cutoff is due to a weakness in class-B amplification. It's termed *cross-over distortion*. Two transistors operating in push-pull don't form a perfect partnership and tend to warp the signal when it sinks to low levels. This is overcome by raising bias slightly and permitting a small amount of no-signal current to flow. This way distortion is held down.

Hi-fi amplifiers are often biased in or near the class-B category. Saving money on your electric bill, however, is not the reason—since the transistors develop less heat in class-B operation and this is an additional measure of transistor protection. Another important contribution of class-B for hi-fi is that push-pull operation automatically cancels out much harmonic distortion. Since this bias setting falls between class-A and class-B it is often called class-AB operation.

Most efficient, but least faithful, is class

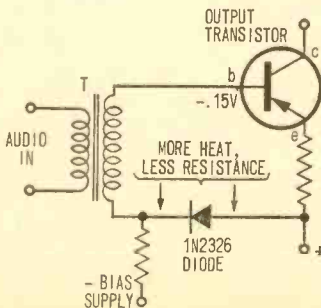

Fig. 10. Portion of output stage in Heathkit AA-21 amplifier, showing diode for prevention of thermal runaway. Diode lowers bias as temperature rises.

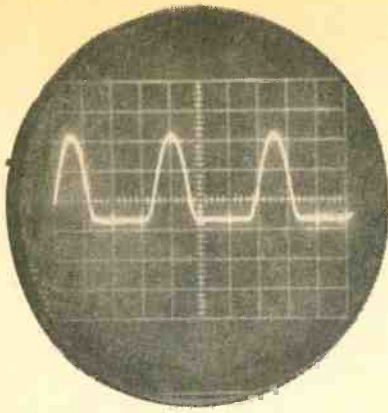
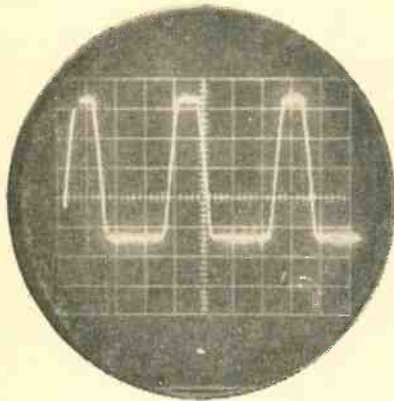

Fig. 11. Class B amplification as viewed on scope. Note that amplifier passes roughly half the signal.

Fig. 12. Below, Class C amplification as viewed on scope. Though signal is distorted, efficiency is high.



C (Fig. 12). An amplifier in this region passes collector current for less than one-half cycle of the input signal. This is no matter where pure radio frequencies are being amplified since there is no intelligence (modulation) to be distorted.

Home-made Bias. Transistor manuals are packed with useful charts on bias. But if you want to rig a simple amplifier stage on a breadboard without a lot of calculations, here's a rule-of-thumb. It permits you to take just about any general-purpose audio *pn*p transistor (like the 2N107, for example) and easily adjust bias for class-A operation. It can serve as an earphone amplifier for a crystal-detector receiver, an amplifier for a code-practice oscillator or other gadget that needs an audio boost. (If you have an *np*n transistor simply reverse all polarities.)

As shown the schematic in Fig. 13A hook the transistor to a 9-volt battery using a 2000-ohm resistor as a typical collector-load. With a VOM measuring voltage between collector and emitter, vary resistance between the base and the negative leg of the power supply, as shown in Fig. 13B. Bias will increase as resistance in series with the base becomes lower (but don't reduce it below 10 K for safety's sake). Adjust the potentiometer in circuit until you measure 4.5 volts (or one-half voltage) at the collector. When this happens, half the supply voltage appears across the transistor, the other half across the load resistor. It also means the transistor is biased approximately between cutoff and saturation, which is class-A operation. Now when you introduce a signal for amplification, the collector will swing over a region above and below 4.5 volts to produce an undistorted, amplified, output signal.

You can remove the potentiometer from the circuit; measure its resistance (across the portion that was in series with the base-emitter circuit) and then a fixed resistance of the closest value to that measured can be connected into the base circuit permanently.

Designing your own transistor amplifiers can be as simple as that. ■

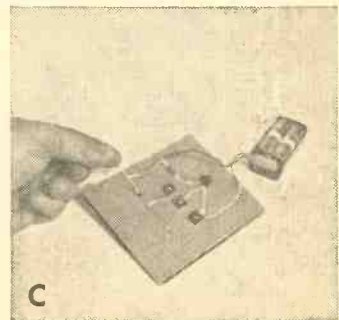
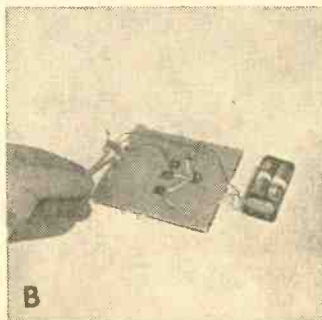
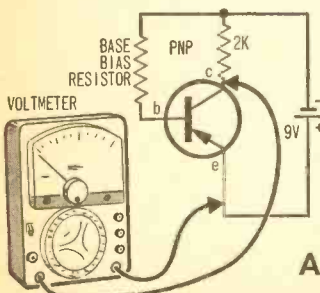
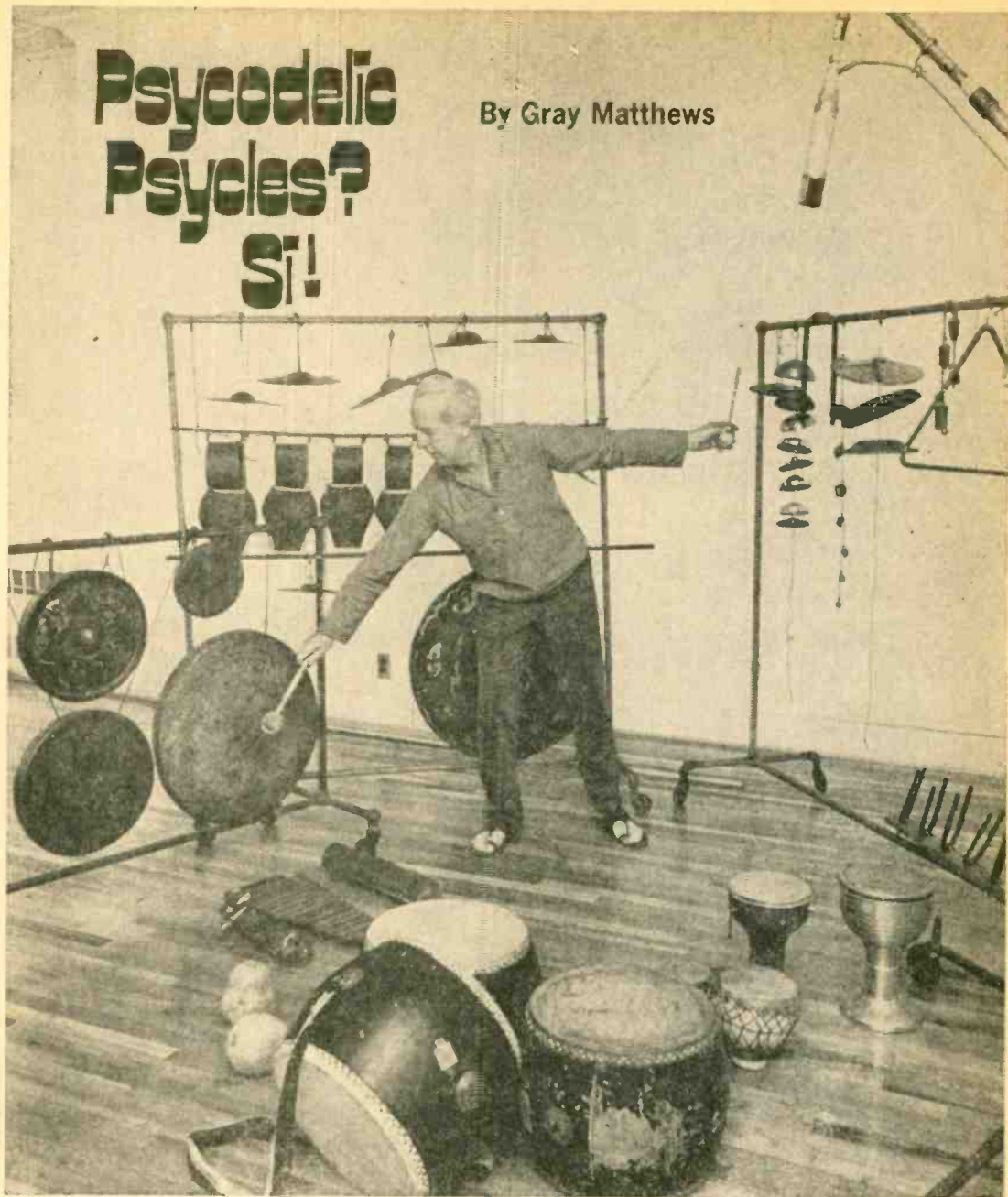

Fig. 13. To determine proper bias resistor in fixed-bias hookup, set up circuit as shown in A, but with pot connected in place of bias resistor. Vary pot until voltmeter reads exactly half the supply voltage (B), carefully measure its resistance, then replace it with a fixed resistor having approximately the same value (C).

Psychedelic Psyches? Si!

By Gray Matthews



The works choreographer Alwin Nikolais creates for his company's seasons at New York's Henry Street Playhouse might well have materialized in Aladdin's cave. For these other-worldly ballets are danced to sounds few humans have ever heard. As our photo above suggests, Nikolais doesn't hesitate to start with real-life instruments—antique cow bells and primitive

drums, say. But the bulk of his sounds originate with a Rube-Goldberg-ish electronic organ which delivers raw material for the specific "Psychedelic Psyches" (all right, *psychedelic cycles*) Nik digs.

Tape eventually takes over, since it can be spliced, erased, and otherwise toyed with in endless-loop fashion. The final product? "Psychedelic Psyches"—*mais oui!* ■

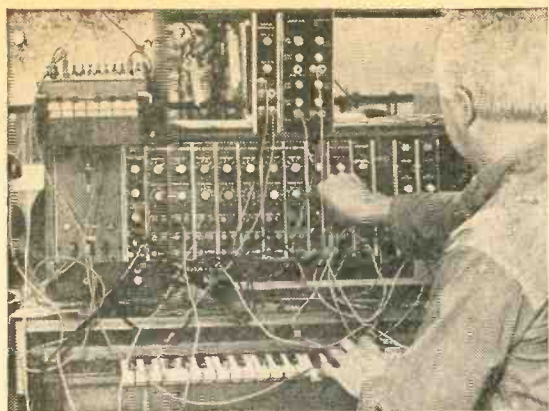

Heart of Nik's electronic music-making is this Rube-Goldberg-style organ, which, with its associated oscillators, networks, and patch cords, produces sounds so inconceivable they must be heard to be believed. Latest addition is a random generator which electronically composes its own sequences without so much as a nod from a human operator.

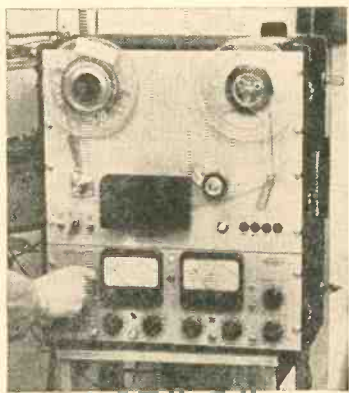
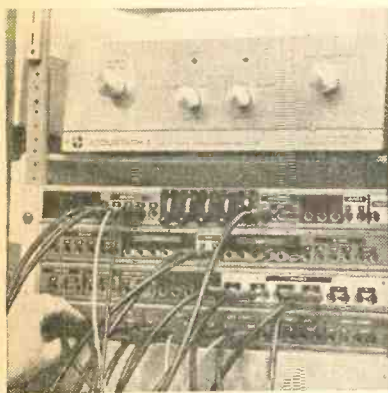
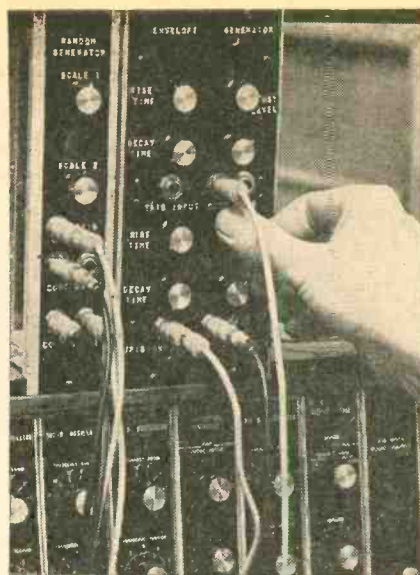

Patch panel is link between sound generators and recorders. Ultimate sounds are often so queer their own mothers wouldn't know them.



COMPUTER TURNS PEOPLE PICKER

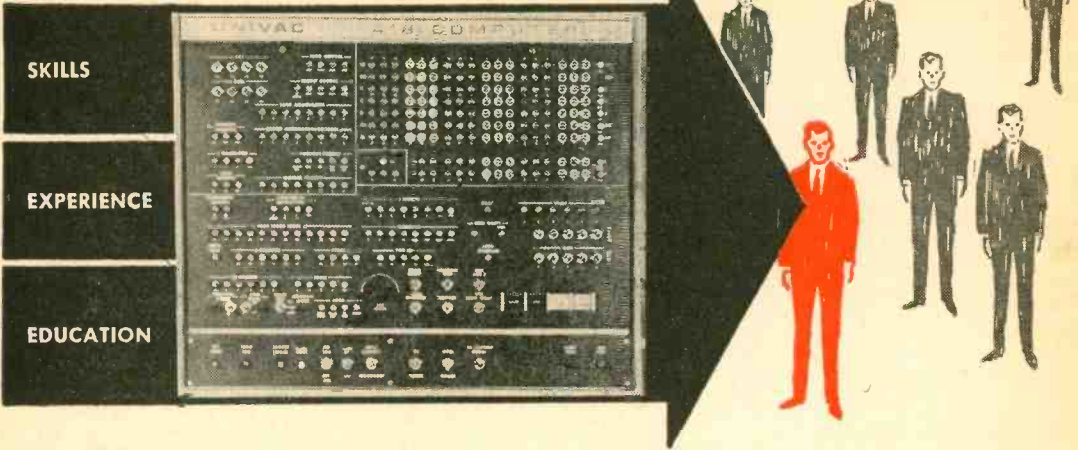

Automation means something like more-of-everything-for-everybody, and now it's reached the labor market. Western Union —of all people—has gone into the employment business, but with a difference. They call their service the Personnel Information Communications System, PICS for short. What it boils down to is that professionals and executives can pay a buck a month (employers pay most of actual cost) to rent time on Western Union's computer network. In turn, the network sits around all day

matching their skills against nationwide job opportunities as they occur.

All you do is fill out a comprehensive form —no resume—which the PICS people transfer to punch cards. Your skills, experience, and education are then matched by the computer against a potential employer's requirements. If the PICS computer says you fit the bill, you're *PICed*.

To jump on the people-picking bandwagon, just call your Western Union office. —Ron Mitchell.

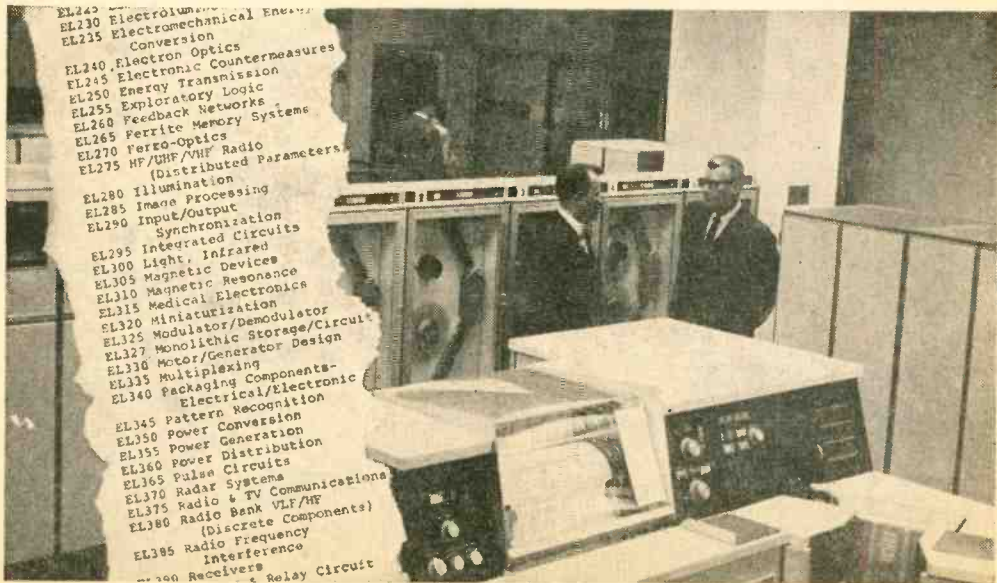

Most professionals and executives probably fit into one of the 1310 job categories covered by PICS. You just fill out a long form and a large batch of small flip-flops will attempt to put you in your place.



By Herb Friedman, KBI9457

You'll find happiness is togetherness with this CBers' his and hers

The next time you have to pass the mike over to your passenger, think how much better it would be if he (or she) had his own. After all, why should CB sets have only one mike? Most every one has two phones nowadays, so it's only reasonable to have two mikes for a CB set—one for Pa, and one for Ma. And it's easy to do if you put together our CB Control Combo.

All it takes is a few parts, one of those new-fangled FETs (field effect transistors), and some know-how. Once assembled, your Control Combo will make you the toast of Channel 9—until other CBers go copycat, that is.

The one-FET circuit lets you hook up two ceramic mikes to a high-impedance input network. Gain turns out to be unity, so the input signal to the CB set is the same as for one mike. And, if your CB rig uses a relay circuit in its press-to-talk operation, either mike can switch the rig to transmit.

Construction. Since the gain of the one-

stage FET circuit is unity (by design), parts placement is not critical. All parts except potentiometers are mounted on a 5 x 1 $\frac{3}{4}$ -in. perf-board. If you wish, use the photographs of the perf-board as a guide in your construction. Install leads from circuit points on the perf-board for connection to the front-panel potentiometers. Have these leads at least 3 in. long from where they break out from the bottom of the perf-board.

Be sure to install a power lead for connection to the CB set. This wire should be stranded with a tough plastic insulation. No fuse is needed in this lead since it will tap into the 12-volt power circuit fused in the CB set. Refer to the FET base diagram and Zener diode outline drawing in the schematic diagram to be sure you connect these parts correctly into the circuit.

Drill all necessary holes in the cover and chassis of the aluminum chassis box. Follow the detail drawing or go at it yourself; placement isn't critical, as already noted.

e/e CB CONTROL COMBO

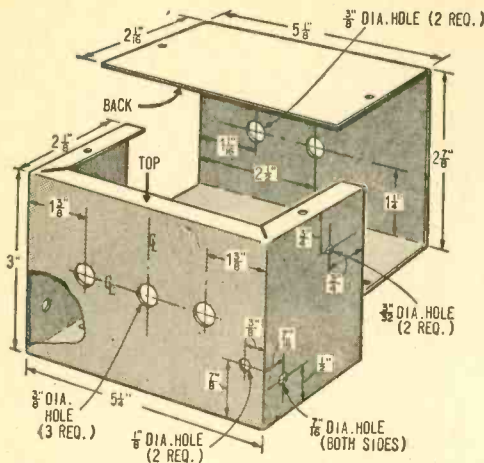

First step in building control combo is to lay out and drill chassis box. Perf-board (below) simplifies construction; be sure to heat-sink semiconductors when soldering.

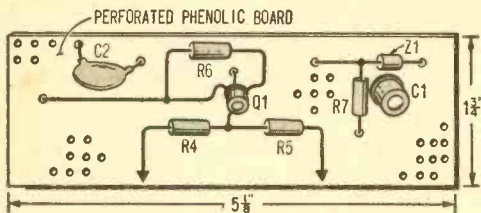

Now is the time to decide how the box will be mounted in the car. Drill the holes you will need—you may not be able to do it easily later on.

Mount controls R1, R2, and R3 with a ground lug located on the threaded section of R2 between the control body and the chassis. Use this lug as a common ground for all audio circuits. Insert the completed perf-board in place but do not secure it. Connect the leads from the perf-board to the controls' lug terminals. Now, connect the mike leads after passing the cable ends through the grommet holes provided in the sides of the unit.

Mind Your Colors. One mike is purchased and one is taken from the CB rig that is getting the CB Control Combo attached to it. Be sure to note the mike cable's color-coded wires so reconnection will be easier and there will be less chance of mistakes later on.

The new mike cartridge leads (white-hot, shield-ground) in the cable should be con-

PARTS LIST

- C1—50-mf, 15VDC electrolytic capacitor
 - C2—.05-mf, 15VDC or better disc capacitor
 - Q1—Field effect transistor, Motorola HEP-801
 - R1, R3—1-megohm, linear-taper potentiometer
 - R2—5000-ohm, linear-taper potentiometer
 - R4, R5—270,000-ohm, 1/2-watt resistor
 - R6—220-ohm, 1/2-watt resistor
 - R7—100-ohm, 1/2-watt resistor
 - Z1—Zener diode, 12-volt at 1-watt (Motorola HEP-105 or equiv.)
 - 1—Ceramic microphone with coiled cord and press-to-talk switch (Lafayette 99C-4562 or equiv.)
 - 1—Aluminum chassis box, 5 1/8 x 3 x 2 1/8-in. (Bud CU3006A or equiv.)
 - Misc.—Perf-board, solder lugs, nylon cable clamps, grommets, hardware, wire, mike, etc.
- Estimated cost, less mike: \$9.00
Construction time: 4 hours

nected immediately to the CB Control Combo to avoid confusion with press-to-talk leads. Refer to the specification sheet that comes with the mike to determine which colored lead goes where. The color references in the text and schematic diagrams agree with the leads on the Lafayette 99C-4562 push-to-talk ceramic microphone. If you use another microphone that is color-coded differently, write in the new colors in the diagrams before you proceed any further. Also, write in the colors for the original equipment mike if they are different.

Now secure the mike cables in place with 3/4-in. plastic or nylon cable clamps. Locate

ELECTRONIC SWITCHING

For transceivers employing electronic transmit-receive switching, the four leads on the microphone should be connected to the following points in the transceiver circuit:

- WHITE LEAD This is the "hot" lead; connects to the input circuit of the mike preamplifier stage.
- RED LEAD To line in receiver section which is grounded only on transmit.
- BLACK LEAD To ungrounded side of speaker voice coil or secondary of output transformer.
- SHIELD LEAD To chassis ground.

RELAY SWITCHING

For transceivers employing relay switching for transmit-receive, the four leads on the microphone should be connected to the following points in the transceiver circuit:

- WHITE LEAD This is the "hot" lead; connects to the input circuit of the mike preamplifier stage.
- RED LEAD To side of relay coil which is grounded only on transmit.
- BLACK LEAD No connection required to transceiver.
- SHIELD LEAD To chassis ground.

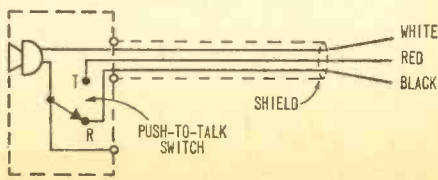

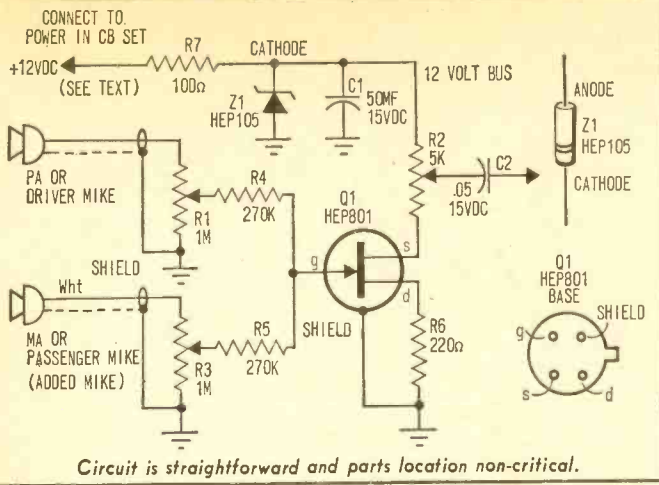

Circuit is straightforward and parts location non-critical.

kind of push-to-talk circuit your CB rig has—*electronic switching* or *relay switching*. If the mike on your present rig has only a three-wire cable (shield plus two other leads), your rig uses relay switching. You can check this out by looking for the relay. The manufacturer's specifications and the schematic diagrams will also give this information. If your rig has a four-wire cable (3 wires plus shield), the chances are the set is electronically switched, but don't bet on it. One wire may not be used; so check the rig carefully.

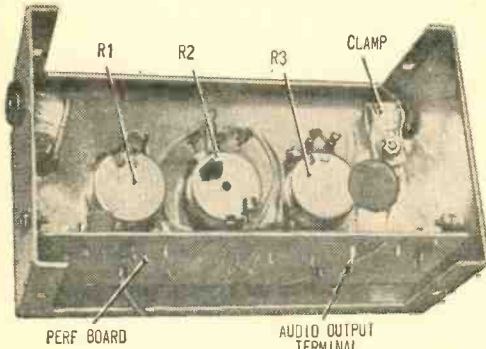

Plenty of room in chassis box for three pots and perf-board makes for easy work.

With relay switching in your rig, either mike can be used to switch the rig from *receive* to *transmit*. Wiring is easy; just connect the original mike and second press-to-talk leads in parallel to the corresponding leads in the cable to the CB rig. Now, either mike can switch the CB rig to the *transmit* mode.

Electronically switched sets can have only one mike in control of the press-to-talk operation. The press-to-talk leads of the extra mike are taped together and tucked in a corner of the chassis. Use the rig's original mike as a guide, and you should have no problem connecting the press-to-talk leads.

Now Finish It. Secure the perf-board in place, using two soldering lugs as brackets. Bolt each to the side of the chassis cover, then bend the open ends of the lugs straight out. The open ends of the lugs are secured to the perf-board with flea clips passed through the lugs and soldered. A quick-drying rubber-based cement can also be used. *(turn page)*

the clamps flush against the grommet holes. Use some washers to stand the clamps off the chassis bottom and centered over the grommet holes. The mike cable that connects the CB set and the CB Combo will not normally receive any tugs or yanks, so clamping isn't too demanding.

Push-To-Talk. You must determine what

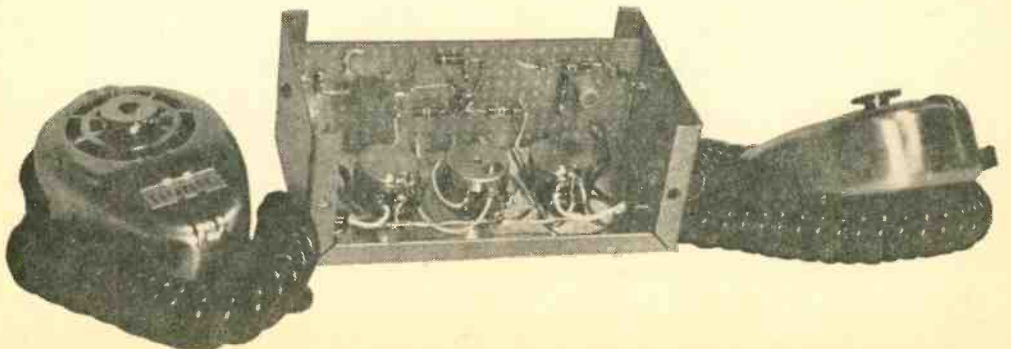

Completed control combo with both mikes attached. Just button it up and you're ready to go.

e/e CB CONTROL COMBO

The CB Control Combo is now ready for mounting in your car or base station. Depending on your mounting requirements, the chassis box is closed up now or after mounting.

Connect the mike cable from the CB Control Combo to the CB rig. This is not easy to do in the car unless practiced in a dry run on the workbench. The same holds true for the power lead. Be sure the power lead tap is made at the correct point so that the CB rig's on/off switch controls power and the fuse will interrupt power when removed from its holder.

Adjustments are simple! Use the master mike only (the original mike or drive-side

mike) to set the level of audio input to the CB set. Set the middle pot, R2, to mid-range. Then adjust the left pot, R1, until the rig is putting out a clear, undistorted signal that does not spill out into the adjacent channels. If you can check modulation with a scope (see "Checking CB Modulation," RADIO-TV EXPERIMENTER, Dec.-Jan. '67), adjust overall gain to 85% modulation.

Now adjust control R3 until the passenger's mike and the driver's both deliver identical output. If you can't get enough gain, increase the setting of R2. This will mean resetting control R1, because the driver's mike will be set too high. A little give-and-take between the controls will bring both mikes to the same level. If you wish, remove the knobs and lock the setting in place with a few drops of airplane glue. After all, once set, no further adjustments will be needed. ■



The dewar flask being removed from cryogenic cooler developed at NBS electron devices laboratories. Photo shows gas inlet tube, heat transfer coil, outlet tube, and heater. Device to be cooled is placed within plastic-foam frost shield, which prevents frost accumulation from occurring and interfering with the operation of the device.

HOT SEMICONS MAKE THE COOL SCENE

To super-cool small electronic devices without immersing them in liquid posed a problem for the National Bureau of Standards, so they came up with a little gadget to solve it. Normally, to operate semiconductor devices (light emitters, lasers, and photodetectors) at cryogenic (super-cool) temperatures, the device is placed on a metal rod which has one end immersed in liquified gas. If the device develops large amounts of heat, however, this method is unsatisfactory.

The Bureau's cooler works by directing a super-cool stream of gas at the object to be

cooled. Basically, it consists of a bottle of liquid gas, an evaporation heater, and a tube through which evaporated gas is carried beneath the surface of a liquid gas where it's cooled to the same temperature as the liquid. The cooled gas then leaves the bottle and is directed by a nozzle at the device to be cooled. By installing a heating element in the nozzle, a wide variety of temperatures can be obtained. The cooler is recharged by simply adding a pint or so of liquid gas, a pint of nitrogen being sufficient for up to 75 minutes typical operation. ■

COVER STORY

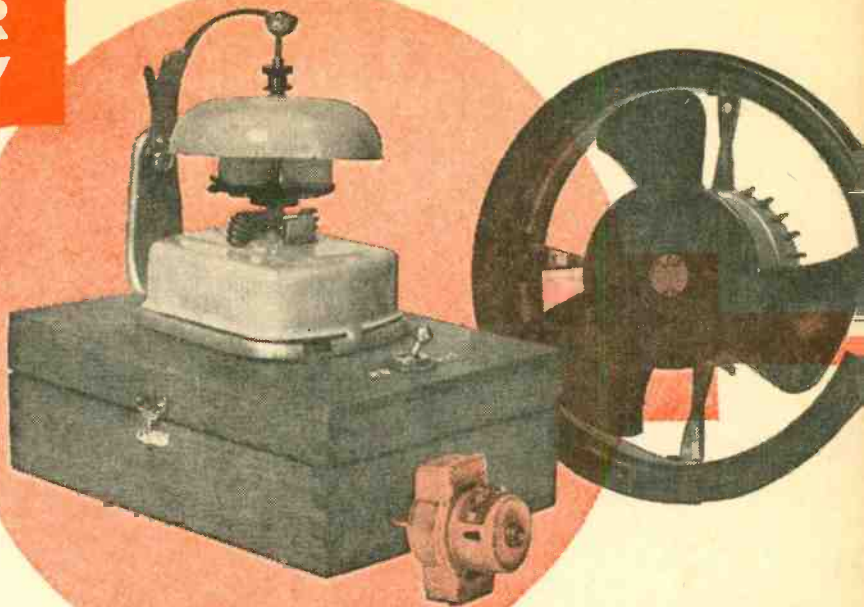

EXPERIMENTER'S SIMPLEX MOTOR

By Jorma Hyypia

You can make this novel DC motor in a few hours from an ordinary door bell, a magnetic cabinet-door catch and two discarded ballpoint pen ink tubes. Parts will cost you about two dollars—nearer three if you buy the box for holding three dry cells. The motor is ideal for demonstration purposes because it can be partly dismantled, in seconds, to reveal all working parts. It is also an attention-getting novelty suitable for display on your desk, in the den, and elsewhere.

Materials. The component parts for this motor are available in every town or community, and you need only simple hand tools to make the conversion from door bell to motor.

You could probably use almost any make of doorbell since they are all pretty much alike; however coil sizes are not all the same and you may have to do some redesigning if you use parts other than those specified.

The bell butchered here was picked up in a local hardware store. It's an Edward 2½ inch Nubel Exposed Gong, 6-8 volts AC, 3-6 volts DC, Catalog No. 740, made by the Edwards Co., Inc., Norwalk, Conn.

I swiped a magnetic cabinet-door catch from our kitchen cupboard, so I can't specify a particular brand or model number. But here's what to look for. Find a catch with the magnet poles spaced $\frac{3}{4}$ in. apart and oriented perpendicular, *not* parallel, to the long axis of the case. This spacing and orientation of the poles relate perfectly with the coils to be used, greatly simplifying construction. The catch shown has a plastic case measuring about 2 x $\frac{7}{8}$ x $\frac{1}{2}$ in. The width is quite important; it should not be greater than $\frac{7}{8}$ in. or you will have trouble fitting the catch inside the doorbell case unless you take it apart. If you can't find a comparable catch, try using a small alnico horseshoe or U-magnet (sold in hardware

e/e SIMPLEX MOTOR

stores). The poles should be about $\frac{3}{4}$ in. apart. Stay away from children's toy magnets—no poop at all in them.

Two ballpoint-pen ink tubes are used to make a low-friction ball-bearing armature shaft. Use the *thin*, $\frac{1}{8}$ in. diameter tubes, not the thick type. If you don't have used tubes on hand, your local stationer can probably save a couple for you when he refits customers' pens with refills. If you use unused tubes, heat them to make the ink flow out before using them for this purpose.

The wooden box used to house three D-size dry cells was obtained from a handcraft supply store for 80 cents. A box with inside measurements about 5 x 3- $\frac{1}{2}$ x 1- $\frac{1}{2}$ in. is ideal.

Dismantle Doorbell. Begin the project by carefully dismantling the various parts of the doorbell; you will use *all* parts except

one terminal screw, so try not to damage any parts.

Remove the gong by drilling away the rear of the rivet holding it on the mounting bracket. The two coils are mounted on an angle bracket projecting from the base; hacksaw this off near the base so that the coils remain fastened together as a unit. Pry the clapper off its rear mount taking care to leave the bronze flat spring still attached to the clapper arm. Remove both terminal screws—saving the insulated internally-threaded metal piece that takes one of the bolts. (You will use this as a handy wing nut.) Several small lugs will remain projecting from the base; hammer these flat.

Armature Shaft. The ball-bearing armature shaft is made from the ballpoint pen ink tubes as shown in Detail Drawing A. Carefully remove one of the tip sections from one tube. Use a very small file to file away some of the main ink tube just adjacent to the small collar (next to the thin section holding the ball). In this way the terminal section can be removed intact. You will

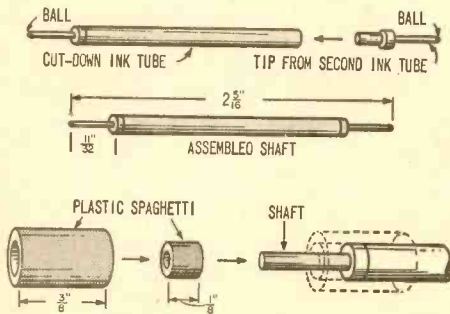

Detail Drawing A

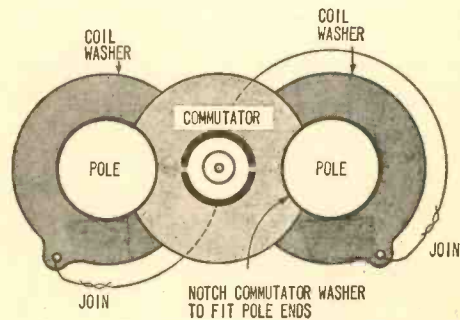

Detail Drawing C

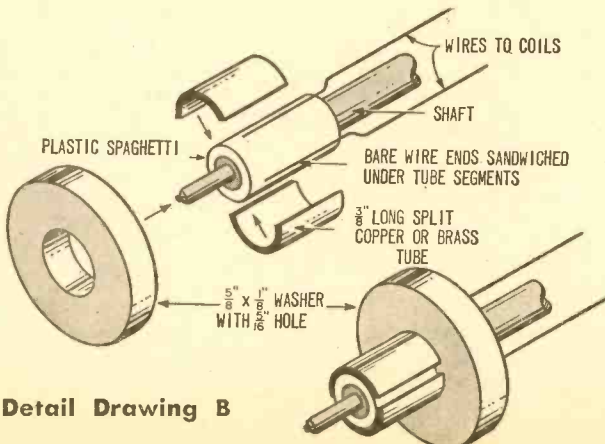

Detail Drawing B

Actual construction begins with preparing the two ballpoint pen ink tubes for use as the armature shaft. Assembly of the tubes is shown in A; plastic spaghetti should fit snugly over shaft. In drawing B, commutator is made by placing split halves of copper or brass tube on spaghetti and press-fitting fiber washer over halves; a good, tight fit here is necessary for best operation. Alignment of commutator to coil pole pieces and coil wiring is illustrated in drawing C.

probably damage the tip if you try to pull the section out by force.

Cut the main section of the other ink tube to such length that the entire unit—with a ball section fitted on each end—will measure about $2\frac{5}{16}$ inches. Start the second tip into the open end of the tube by hand, tapering the tip sleeve slightly with a file if necessary. Slide the end of the discarded tube (from which the tip was removed) over the tip so that it butts against the collar. By tapping lightly on the other end with a hammer, you can force the tip into the end of the tube. Take care to keep all parts aligned as perfectly as possible.

Before proceeding with construction of the commutator, test the fit of the shaft between the two coils. It may be necessary to file a small semi-circular notch in the center of the metal bracket holding the coils together in order to obtain perfect alignment of the shaft with the coils. Very small indentations also had to be filed into the fiber washers at each end of the coils—to give enough clearance for the shaft to pass be-

tween the coils. If you do this carefully, the fit will be so snug that the shaft will stay in place without soldering, using cement or other means of attachment. A very small jeweler's rattail file is very handy in this fitting job. Remove the shaft for the next step.

Commutator Assembly. The commutator sleeves are made by hacksawing a $\frac{3}{8}$ in. long, $\frac{5}{16}$ in. diameter copper or brass tube lengthwise down the middle. Tubing can be obtained from hobby supply shop if you don't have it on hand.

One end of the bearing shaft is built up with two pieces of plastic spaghetti (Detail Drawing A) to the proper diameter to support the split commutator. The smaller-diameter tube is first slipped onto the thin end of the tip to thicken it to $\frac{1}{8}$ in.—the same diameter as the main body of the tube. The larger piece of spaghetti (plastic tubing) slides over the smaller spaghetti and the main tube. The larger-size spaghetti used here was obtained from inside an aerosol spray can. (Turn page.)

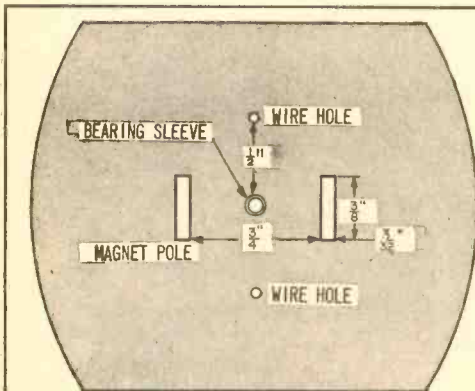

Detail Drawing D

BOX DIMENSIONS: $5'' \times 3\frac{1}{2}'' \times 1\frac{1}{2}''$ (INSIDE)

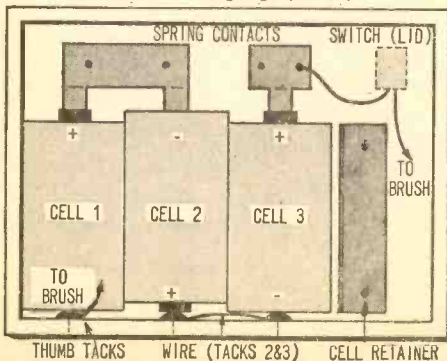

Detail Drawing E

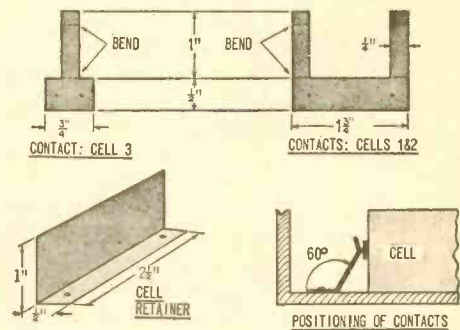

Detail Drawing F

Drawing D is the layout of holes cut in the doorbell cover to accommodate magnet poles, bearing sleeve and armature wires. Pole slots' size and position may have to be changed to suit magnet used. Drawing E gives cell arrangement, polarity and wiring. Cells are held in place by the spring contacts, which, along with the cell retainer, are fastened to the base with thumbtacks through the small holes indicated by black dots. Spring contacts are made of any light gauge sheet metal formed as illustrated in F.

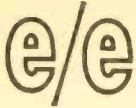

SIMPLEX MOTOR

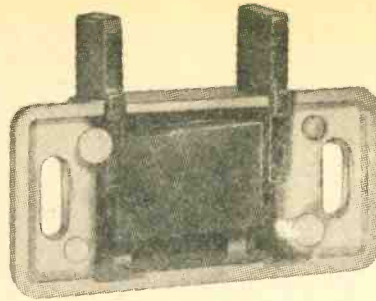
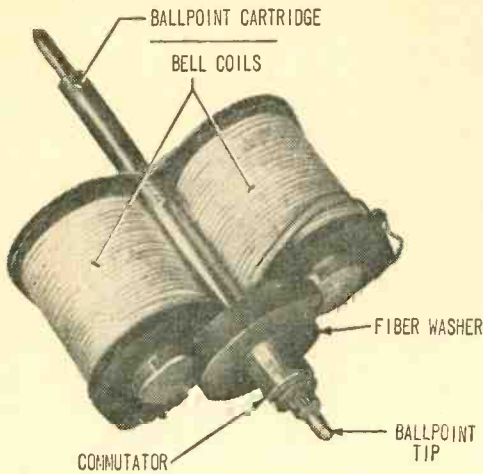

Completed armature assembly at left is ready for installation as soon as base and bearing assembly is finished. Efforts should be made to balance armature on shaft for optimum results. Field magnet above is made from magnetic door catch modified by extending pole pieces through slots to bring them closer to armature; the closer they are, the more motor zip.

(Warning: puncturing an aerosol can may be hazardous unless done properly. First relieve *all* pressure through the nozzle. Then turn the can upside down, cover with a thick rag, and puncture the bottom with an awl or nail. You can now remove the bottom safely with a can opener. *Don't use cans containing hazardous chemicals such as insecticides; used hair spray cans are plentiful.*)

Procure a $\frac{1}{8}$ in. thick, $\frac{3}{8}$ in. diameter fiber washer having a $\frac{5}{16}$ in. diameter hole. This washer is slipped over the assembled commutator (as shown in Detail B) to hold the parts together. The fit should be quite tight. Before assembling, sandwich the bared ends of two pieces of solid (single-strand) bell wire under the commutator sleeves.

Notch the retaining fiber washer with a rattail file (Detail C) to fit between the two metal poles projecting from the coils. This simple expedient keeps the coil unit from swivelling on the shaft.

After fitting the shaft back onto the coil unit, connect the wires leading from the commutator segments to the coil wires as shown in Detail C. Your armature is now completed.

Magnet and Brushes. Five holes are cut into the top of the doorbell cover (Detail Drawing D). The long slots are made just large enough to permit the extended ends of the door-catch magnet to project through

the cover for about $\frac{5}{16}$ in. The small holes on the sides are just large enough for insulated solid conductor bell wire.

A bearing sleeve is soldered in the exact center, between the two magnet poles. This sleeve is $\frac{1}{8}$ in. long, with an inside diameter just large enough to take the end of the armature shaft without binding or lateral wobble. *Do not cut a hole into the lid at this point* because the ball tip of the armature shaft must rest on the cover, inside the sleeve.

Pry the rear plate off the door catch. Slide both the magnet pole pieces about halfway out of the case and secure into this new position—use masking tape or cement. The original plate probably won't go back on; it can be discarded.

Place the modified catch inside the cover so that the pole pieces (ends) project out as shown. This brings them closer to the coils for more efficient operation of the motor. There is no need for special mountings to hold the catch inside the cover; the magnetic attraction of the magnet to the steel cover is sufficient to keep it in place.

See whether or not the cover can be replaced on the doorbell base, using the original snap lugs. You may have to carefully peen a concavity (dent) into the center of the base plate to provide a little more room for the magnetic catch. If this doesn't work, cut out enough metal from the base to make room for the catch.

Brushes. To make the two commutator brushes, wind small springlike coils near the ends of two pieces of solid bell wire. Allow about 1 in. of the bared end to project sideways from the springs to contact the commutator. About three or four turns of wire around the discarded ink tube will form a spring long enough to bring the bared ends to the proper height to contact the commutator.

Slide the wires through the holes snugly, and form a flat loop on each so that it lies against the inside of the cover top; tape to the top to keep the spring from turning. Properly adjusted, these springs will provide just the right amount of pressure against the commutator for good contact without excessive drag. The free ends of the wires can be brought out through a hole in the side of the cover for connection to external batteries, or they can be passed down into the box, if used.

Armature Bracket. The photograph shows how the bell clapper is used as a bracket to hold the upper end of the armature shaft. First bend the arm (which originally held the gong) into a vertical position; it should be about $\frac{3}{4}$ in. from the cover, and extend to a height of about 2 in.

Drill a hole through the bronze spring attached to the end of the clapper; bolt it to the hole in the gong arm using one of the doorbell terminal screws and a wing nut shaped from the small metal piece to which

the terminal screw was originally attached.

Before fastening the clapper in place, drill a small hole into the strike knob on the end of the clapper. This should be just wide and deep enough to hold the tip of the armature shaft without binding.

When the clapper is in place, bend the soft metal into a curve to bring the shaft hole into the proper position. The springiness of the clapper makes it easy to remove and install the armature at any time.

Install the armature and connect to three D-size dry cells for a test run. You may have to fiddle with the wire brushes a bit to make proper contact, but once adjusted they will function very well. Most of the time the motor will start on its own when the current is turned on; a slight turn of the armature may be required once in a while.

Gong Flywheel. The motor works without the flywheel which is used mainly to make the motor look more interesting and to protect the armature from damage. The motor will start up a little more slowly because of the added weight, but it soon builds up to a very respectable speed. Also, the flywheel will continue to spin for some time after power is removed.

Drop a $\frac{5}{8}$ in. diameter conical washer made from a faucet gasket onto the shaft so that it rests on the coil bracket. Place the gong into position. A retainer is made by thrusting a $\frac{3}{16}$ in. length of $\frac{1}{8}$ in. diameter plastic tubing inside a 1½ volt dry-cell

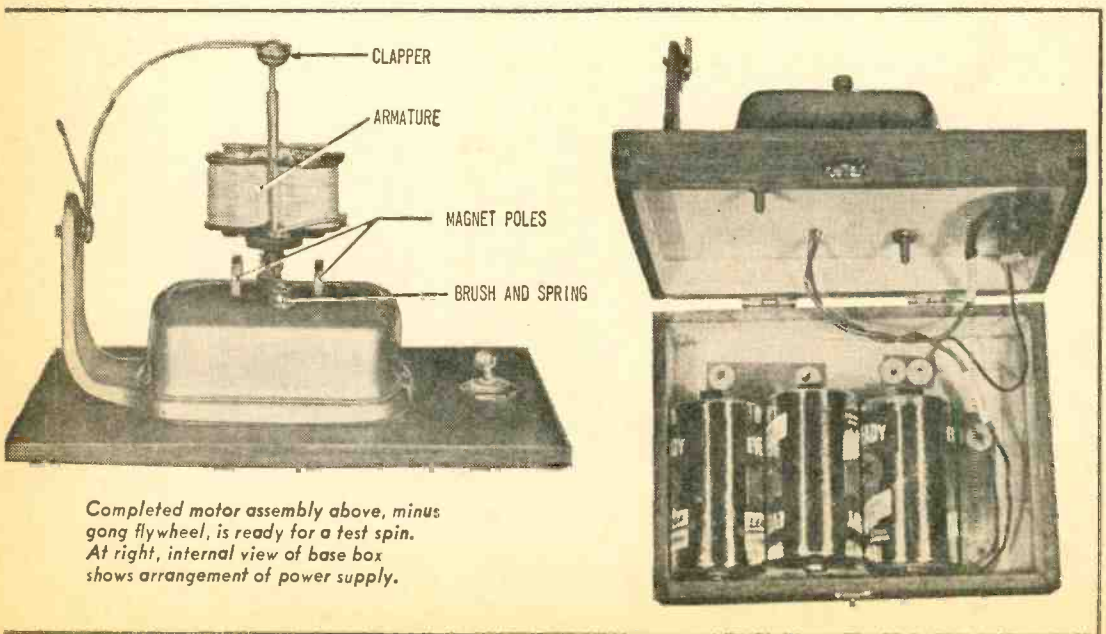

Completed motor assembly above, minus gong flywheel, is ready for a test spin. At right, internal view of base box shows arrangement of power supply.

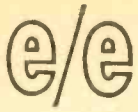

SIMPLEX MOTOR

terminal nut. Allow about $\frac{1}{16}$ in. of the tube to project from the end of the nut.

This should provide a snug sliding fit on the shaft. The projecting bit of plastic tubing goes into the hole in the gong which is otherwise a bit over-sized for the shaft. The gong should be centered on its shaft, and tight enough so that it cannot wobble as it rotates. This arrangement permits quick and easy removal of the flywheel at any time.

Box Fittings. You can make your own battery box, or obtain one (at low cost) from a handicraft supply store; these unfinished boxes are intended for decorating—to make jewelry boxes and the like. A box with hinges and a small clasp is ideal.

Place three D-size dry cells in the front of the box as shown in Detail E and mark the position of the terminals on the inside wall of the box. Wind a few turns of the bared ends of bell wire around the pins before pushing into place. The wire from tack 1 is connected to one of the wires leading from the commutator brushes. Tacks 2 and 3 are joined with a short length of wire. Use metal tacks, of course, removing any paint if necessary.

A double-pronged contact, fashioned from sheet metal, connects the opposite ends of cells 1 and 2. A single pronged contact to cell 3 has a wire attached which connects to the switch. Dimensions of the battery-

box contacts, and the method of bending for proper positioning are given in Detail F. A sheet metal "cell retainer" keeps the cells from rolling about in the box.

The toggle switch is mounted in the top of the box as shown in the photograph—not in the corner as it seems to be indicated in Detail Drawing E.

A light mahogany stain, followed by a coat or two of varnish converts the battery box and motor assembly into an attractive showpiece.

Suggested Modifications. Instead of using the simple *on-off* switch, you may want to install a cross-over reversing switch to run the motor in either direction at will. If you are satisfied with a single direction of rotation, have the commutator work *with* the wire brushes, not against them by switching the battery leads if necessary.

If your motor isn't perfectly balanced, and the speed seems a bit excessive for smooth rotation, try adding a small variable resistance as a speed control.

Of course you can cheat a bit. You can use a cigar box or a file-card box if you have a suitable one around. You don't have to go to all that work in making the contacts for the battery box—you can buy ready made ones listed in most catalogs or use a 6-volt battery with screw terminals.

You'll have a lot of fun building this motor and showing it off to others. And you may discover—as I did—that this novelty motor will even "ring the bell" with your wife; she will probably consider it "cute" enough for display in almost any part of the house! ■

Junior TVers Learn By Doing

An electronic window to the world in every classroom describes a new Sylvania closed-circuit TV system leased to Northern Highlands Regional High School in Allendale, N.J. This whiz-bang custom installation provides a host of features that makes it one of the most flexible, versatile systems now in use in schools: simultaneous five-channel operation from any one of 79 locations throughout the school, video recording equipment for future replay, 800-line resolution (compared with 525 lines in commercial TV), and portable recording equipment for use at outside events.

The six students who serve as operators and cameramen generally run the equipment without difficulty. They profit, meanwhile, by having on-the-job training in TV production techniques.

This television system hadn't been in use long



when the school staff became enthusiastic about it. And the students? Well, they never had it so good! ■

Using

Unijunctions

A few simple experiments and a couple of useful projects will reveal the secrets of this little-known semiconductor device.

by Jack Brayton

Although the unijunction joined the ever-growing group of solid-state devices a long time ago, it has been largely ignored by most experimenters. Indeed, most have only a vague idea of just exactly what the unijunction is and what it does. In view of the fact that it is one of the most interesting, versatile, and useful solid-state devices available there isn't any reason for this. Cost certainly isn't stopping anyone because, as we'll show, experimenting with the unijunction isn't expensive. Fact is, we'll show how to build a voltage trigger, variable sawtooth oscillator, automatic timer, and a staircase frequency divider which divides the line frequency (60 Hz) by 6, producing 10 precision timing pulses per second. And what is the cost of all this?

The part cost of the individual experiments range from \$3.75 to \$6.00 including the battery! And—better yet—if you want to build all of the experiments, using all new parts, it would only cost about \$8.50 since most of the parts are used in more than one experiment. Of course, even this low figure can be cut in half by raiding your junk box.

Instruments Needed. One of the experiments requires no instruments whatsoever; another requires either a VTVM or multimeter (VOM); two require a scope but even if you don't own a scope you can usually borrow a friend's or obtain permission to use one at a nearby school. Now let's discover the unijunction.

About The Unijunction. There are only a few things we need to know about the uni-

junction before we begin the experiments. First, the unijunction has three terminals called the *emitter*, *base-1*, and *base-2*. Its symbol and equivalent circuit are shown in Fig. 1. Note that the circuit between *base-1* and *base-2* terminals is equivalent to a simple series voltage divider ($Rb1$ and $Rb2$). Thus, if a negative voltage is connected to *base-1* and positive to *base-2* (as shown)

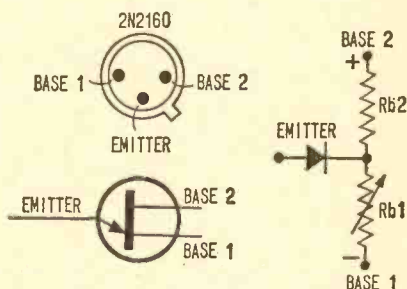
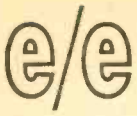

Fig. 1. Lead positions, schematic symbol, and equivalent circuit of the 2N2160 unijunction transistor all help you understand this device. As equivalent circuit suggests, device functions as a simple diode feeding a series voltage divider ($Rb1$ and $Rb2$).

part of the positive voltage would be developed at the top of $Rb1$ which is also the *cathode* connection of the "emitter diode." It's now apparent that, under these conditions, the "emitter diode" would be *reverse biased* if its anode (the emitter lead) was at any potential *less* than that developed at the junction of $Rb1$ and $Rb2$. However, the "emitter diode" *could* conduct whenever the emitter potential went *more* positive than the



resistor junction. This, then, is at least half of the unijunction secret. That is, its emitter junction will not conduct until a certain predetermined voltage has been reached and this voltage is always a *fixed percentage* of the base-1 to base-2 voltage. Of course, if this was all there was to the unijunction we could build one with a couple of resistors and a diode but there is more.

The characteristic which makes the unijunction really stand out is the fact that the emitter-to-base-1 (R_{b1}) resistance of the unijunction becomes much lower (goes negative) whenever the emitter diode is forward biased. And, up to a point, the larger the current in the emitter lead becomes the lower in value R_{b1} becomes. After the minimum value of R_{b1} has been reached, a further increase in the emitter current causes R_{b1} to go *positive* or to become larger in resistance again.

The negative-resistance region is most important and means that although the unijunction requires an emitter voltage larger than the reverse bias developed at the resistor junctions before its emitter will conduct, it will (once fired) continue to conduct even after the emitter voltage has fallen below the original firing voltage—this is particularly true if a large emitter current is maintained. Of course, the reason this occurs is because with R_{b1} becoming lower in resistance, less reverse bias is developed at the resistor junction which allows the “emitter diode” to conduct with a lower voltage applied. The minimum amount of emitter current needed to hold the unijunction in its negative resistance region is very small—typically only 5 to 25 microamperes.

The last thing which we'll cover before we start working with actual circuits is the *terms* which are applied to (and are unique with) the unijunction.

The voltage at which the emitter conducts is called the *peak-point voltage* and the *percentage* of the interbase voltage which this represents is called the *intrinsic stand-off ratio*. The *peak-point current* is the minimum emitter current required to fire the unijunction. And, finally, the *valley voltage* (or *valley current*) is the emitter voltage or current which causes the emitter-to-base-1 resistance (R_{b1}) to be at its lowest level.

One thing which should be mentioned is that the peak-point voltage or the minimum emitter voltage which causes a unijunction to fire varies widely between unijunctions with the same type number. That is, all type 2N2160 unijunctions do not have the same peak-point voltage. However, for any single unijunction, the peak-point voltage is *extremely stable and reliable*. Thus, the unijunction is an ideal device to use in a relaxation-oscillator, timer, voltage-trigger circuit, or any other application requiring this principle.

Voltage Trigger. The set up for the first experiment (Fig. 2) illustrates what we've

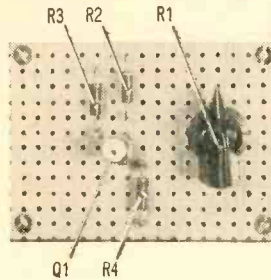

Fig. 2. Voltage trigger is first experiment which gives clue to unijunction's operation. Layout of parts on a perforated circuit board is simple and uncrowded.

already stated and lets us see how the unijunction can act as a voltage trigger. Looking at the schematic (Fig. 3) we can see that it is a simple circuit but, as we'll show, one that clearly demonstrates the action of the unijunction. Let's dig into some of the details.

PARTS LIST FOR VOLTAGE TRIGGER

- B1—6-volt battery (Burgess Z4 or equiv.)
- Q1—2N2160 unijunction transistor
- R1—5,000-ohm potentiometer (linear taper)
- R2, R3—470-ohm, 1/2-watt resistor
- R4—100-ohm, 1/2-watt resistor
- Misc.—Perforated phenolic board, push-in terminals, knob, hookup wire, solder, machine screws, etc.

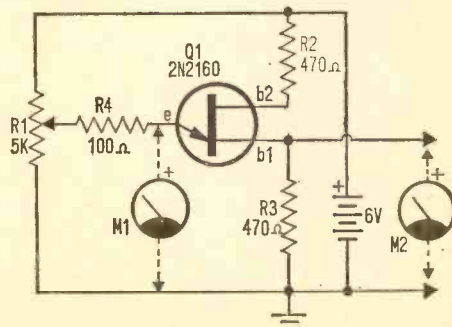

Fig. 3. Schematic diagram of the Voltage Trigger shown in Fig. 2. Because only DC is involved, the actual parts layout is not critical; see text for information regarding role of DC voltmeters M1 and M2.

Of course, 6 volts are applied across the unijunction's base-1 and base-2 terminals through R2 and R3. It's important to note that the *primary* function of these two resistors is *not* to limit the interbase current as might be assumed. In fact, since the unijunction has an interbase resistance of several-thousand ohms (4 to 12K) the interbase current is automatically limited. What then is the purpose of the base resistors?

In commercial circuits, resistors R2 and R3 provide temperature stability and develop the output voltages. Resistor R3 (in this particular circuit) also helps limit the *emit-*

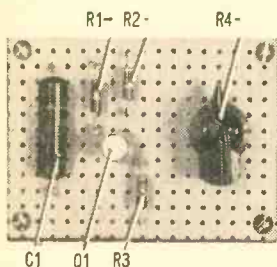

Fig. 4. Circuit board layout for Sawtooth Oscillator is not much different than that in Fig. 2. In addition to inclusion of a capacitor (C1), some parts values have been changed.

ter current which is further limited by R4. Naturally, R1 is used to adjust the emitter voltage from 0 to (positive) 6 volts.

By connecting (as shown in Fig. 3) a meter (M1) from the emitter to ground you can see how the unijunction works. Start with R1 set for zero emitter volts and slowly adjust R1 until the meter *dips* slightly. The voltage which the meter reads just *before* the dip is the emitter firing voltage. After the unijunction has fired, read the output voltage with M2.

Although this experiment is simple it is important because the theory which it demonstrates is used in all unijunction circuits.

Sawtooth Oscillator. The second experiment (Figs. 4 and 5) not only generates sawtooth waves but generates spikes as well.

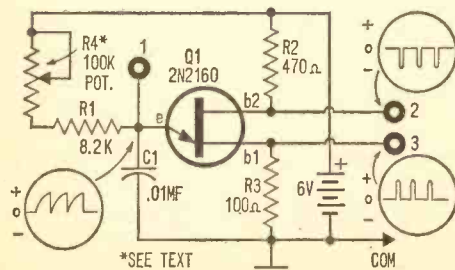

Fig. 5. Low frequencies in the Sawtooth Oscillator remove the possibility of unwanted effects occurring when using a different layout. Increasing value of C1 or of R1-R4 combination decreases operating frequency.

PARTS LIST FOR SAWTOOTH OSCILLATOR

- B1—6-volt battery (Burgess Z4 or equiv.)
- C1—.01-mf tubular capacitor, 6 WVDC
- Q1—2N2160 unijunction transistor
- R1—8,200-ohm, 1/2-watt resistor
- R2—470-ohm, 1/2-watt resistor
- R3—100-ohm, 1/2-watt resistor
- R4—100,000-ohm potentiometer (linear taper)
- Misc.—Perforated phenolic board, push-in terminals, knob, hookup wire, solder, machine screws, etc.

The frequency range of the original model extended from 1200 Hz to 13kHz. This, however, may go slightly higher or lower depending on the exact characteristics of the unijunction used.

Again 6 volts are applied across the base-1 and base-2 terminals through R2 and R3. Note that R3's value has been lowered to a more typical unijunction circuit value. Next, let's see what happens when power is first applied.

If capacitor C1 is completely discharged, it will offer almost no opposition to current flow during the first instant—it has no voltage drop across it and the emitter voltage of the unijunction will be zero. But, as the capacitor charges, (through R1 and R4) it offers more and more opposition to the flow of current. This being the case, the voltage across C1 becomes higher and higher until it reaches the emitter firing voltage. At this point Q1 conducts. When Q1 conducts this discharges capacitor C1—driving the unijunction into cutoff. One cycle is complete; another starts; and an endless sawtooth wave train is generated at the emitter. If a scope is connected between the different output points and ground (Fig. 5) wave shapes similar to those indicated will be seen. The frequency will depend on R4's setting.

Note that R4 could be replaced by a fixed resistor of any value between 0-ohms and 100K or by any potentiometer having less than 100K resistance. The frequency range would then, in the first instance, be fixed and, in the second, the frequency range would be restricted.

The positive- and negative-going spikes (which are available at the base-1 and base-2 outputs respectively) are very fast and leave only a dim trace on the scope. To see them it's best to sync your scope on the saw-tooth output then, without changing the scope controls, move the prob to either the base-1 or base-2 output. Since the spikes are caused by C1 discharging, they are at the same

e/e USING UNIUNCTIONS

Fig. 7. Schematic diagram of the Automatic Timer is much more complex than the previous circuits. Indicator I1 can be connected in series with either R5 or R6, depending on whether you want light to be normally-on or normally-off. Pushbutton S1 starts circuit operation.

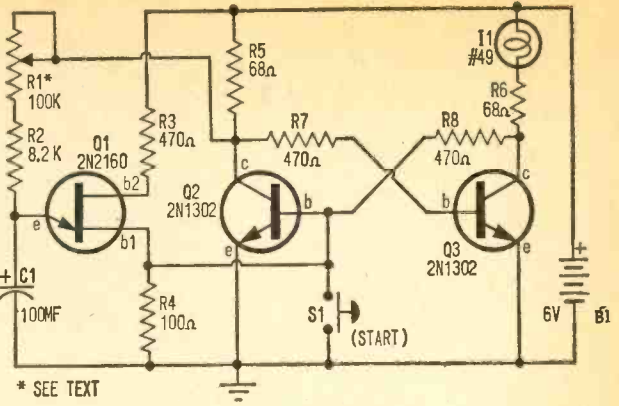

* SEE TEXT

repetition rate as the sawtooth—they occur when the sawtooth waveform drops toward ground potential.

Automatic Timer. The unijunction portion of the third experiment (Figs. 6 and 7) is very similar to the sawtooth-waveform relaxation oscillator which we covered above. In fact, there are only two differences. First, the value of C1 has been made very large; therefore it takes a much longer time (2 to 30 seconds) to charge. Second, the top of R1 isn't connected to the 6-volt supply. Instead it goes to Q2's collector. Thus, we can turn it *on* (positive 6-volts) or *off* (ground or 0-volts) simply by controlling the state (cutoff or saturation) of Q2. And Q2 and Q3 are wired to form a flip-flop. Their operation is similar to that of a latching relay. Starting from reset (this is automatic), let's see how the timer functions.

In the reset position, Q2 is saturated, thus,

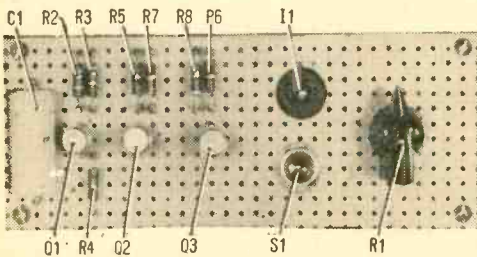

Fig. 6. Larger perforated circuit board is needed for circuit of third experiment. Automatic Timer includes two-transistor flip-flop—(Q2, Q3), four additional resistors, a pushbutton switch, and an indicator lamp.

its collector potential is near ground and C1 cannot charge. At the same time, Q3 is prevented from conducting because base resistor R7 is also grounded through Q2. Lamp I1 cannot light because Q3 is in cutoff. With Q3 in cutoff, its collector potential is at positive 6 volts which provides forward bias for Q2 through R8. The circuit will hold

PARTS LIST FOR AUTOMATIC TIMER

- B1—6-volt battery (Burgess Z4 or equiv.)
- C1—100-mf electrolytic capacitor, 6 WVDC
- I1—2-volt, 60-ma panel lamp (type 48 or 49)
- Q1—2N2160 unijunction transistor
- Q2, Q3—2N1302 npn transistor
- R1—100,000-ohm potentiometer (linear taper)
- R2—8,200-ohm, 1/2-watt resistor
- R3, R7, R8—470-ohm, 1/2-watt resistor
- R4—100-ohm, 1/2-watt resistor
- R5, R6—68-ohm, 1/2-watt resistor
- S1—S.p.s.t. pushbutton switch
- Misc.—Perforated phenolic board, push-in terminals, knob, hookup wire, solder, machine screws, etc.

these conditions until the *start* pushbutton is pressed.

Momentarily closing the circuit through the start switch shorts Q2's forward bias to ground driving it into cutoff—its collector potential changes from ground (zero) to positive 6 volts. Now three things happen simultaneously: (1) Q3 is forward biased through R7; (2) lamp I1 lights; (3) C1 starts to charge through R1 and R2.

Naturally, as C1 charges the unijunction's emitter voltage slowly climbs toward its firing point. How long this takes is determined by R1's setting and the values of R2 and C1 (and the leakage resistance of C1). With the values shown the time can be adjusted from approximately 2 to 30 seconds. If a 300 mf. capacitor is substituted for the specified C1 the charge time can be adjusted from 6 to 90 seconds.

After sufficient time has elapsed, C1 has charged to Q1's firing voltage causing its emitter-to-base-1 resistance to break down and a positive-going pulse to be produced at the top of R4. This, in turn, is coupled to the base of Q2 forcing Q2 to saturate and its collector voltage to drop to ground potential. With the collector of Q2 at ground

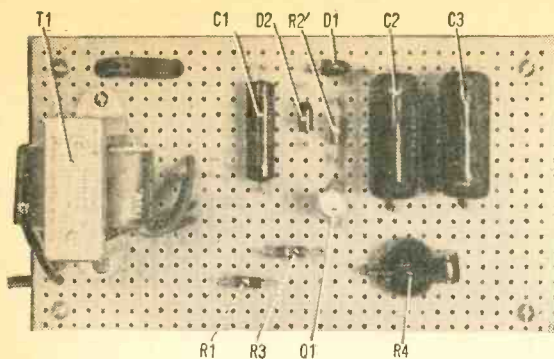

Fig. 8. Staircase Frequency Divider (experiment No. 4) needs an even larger perforated circuit board to contain all the components. Again, layout is not critical and could closely parallel schematic diagram.

potential, C1, as we've already mentioned, cannot charge; Q3 cannot conduct; and the lamp cannot light. Thus, the circuit is now in its original reset condition.

Although in this circuit the lamp is wired so it lights when the *start* button is pressed and goes *off* with the reset pulse, it can be made to go *off* when the start button is pressed and *on* with the reset pulse. This is done simply by wiring the lamp in series with Q2's collector instead of Q3's.

Staircase Frequency Divider. Figs. 8 and 9 show one of the newest applications of the unijunction. It's a staircase frequency divider which, in this instance, divides the 60-Hz line frequency by 6—producing 10 timing pulses per second. And, although it might *sound* complicated, it is easy both to build and to understand. We'll start with the transformer and work our way through.

Transformer T1 is a 6.3-volt filament transformer and can be of any type. The AC current drawn by the circuit is extremely low so even the lowest current rating will do. This, by the way, is also true of the rectifiers (D1 and D2).

The purpose of T1 is to couple a 60-Hz, low-voltage signal across resistors R1 and R4. A portion of this signal is then picked

off by R4's slider and passed through C1 to the rectifiers.

Rectifiers D1 and D2 along with capacitor C2 form a diode *pump* and it works in the following manner.

First, it is easy to see that the *negative* half of the AC line signal is shorted to ground (clamped) by D2. As a result, only the *positive* half of the signal appears at the junction of D1 and D2. This sine wave signal now looks like positive humps or pulses. It's also apparent that diode D1 is *forward biased* by these positive pulses. Thus, it conducts and the pulses are applied across C2.

The charge time of capacitor C2 is primarily determined by the total capacitance value, and the *reactance* of C1 at 60 Hz. And, in a diode pump it is always much *longer* than the pulses applied. Thus, the first pulse only *partially* charges C2. The next pulse, of course, charges it a little more and so on. This results in C2 being charged in *steps* as shown in Fig. 9 by the emitter waveform.

Of course, the unijunction conducts and produces an output pulse as soon as C2 has charged to its firing voltage. C2—discharged in the process—will start to charge with the next pulse.

PARTS LIST FOR FREQUENCY DIVIDER

- B1—6-volt battery (Burgess Z4 or equiv.)
- C1—.01-mf tubular capacitor
- C2—.33-mf tubular capacitor (may be two .15-mf units in parallel—C2 and C3 in photo upper left)
- D1, D2—Silicon rectifier (See text at right for details)
- Q1—2N2160 unijunction transistor
- R1—8,200-ohm, 1/2-watt resistor
- R2—470-ohm, 1/2-watt resistor
- R3—100-ohm, 1/2-watt resistor
- R4—5,000-ohm potentiometer (linear taper)
- T1—6.3-volt filament transformer (see text)
- Misc.—Perforated phenolic board, push-in terminals, knob, hookup wire, solder, machine screws, etc.

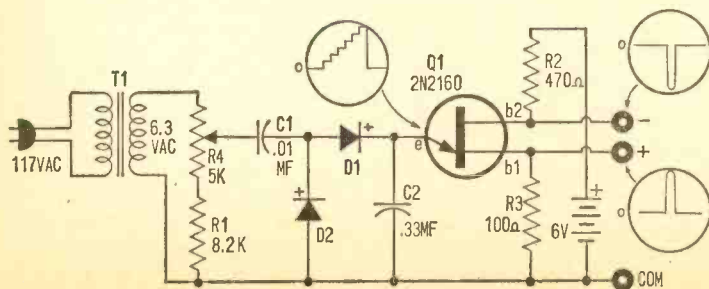

Fig. 9. Schematic diagram of Staircase Frequency Divider shows few parts are actually needed to generate the .1 sec. (1/10 sec.) pulses at output jacks. Divider gets its name from the waveform at the emitter of Q1; critical value is that of C2 which discharges through Q1 and R3.

SHOPPING LIST FOR UNIUNCTION EXPERIMENTS

- 1—2N2160 unijunction transistor
- 2—2N1302 npn transistors
- 1—5,000-ohm potentiometer (linear taper)
- 1—100,000-ohm potentiometer (linear taper)
- 1—8,200-ohm, 1/2-watt resistor
- 3—470-ohm, 1/2-watt resistor
- 1—100-ohm, 1/2-watt resistor
- 2—68-ohm, 1/2-watt resistor
- 1—2-volt, 60-ma panel lamp (type 48 or 49)
- 1—.01-mf tubular capacitor
- 1—.33-mf tubular capacitor (see text)
- 2—100-ma (or higher rated) silicon rectifier diodes
- 1—6.3-volt filament transformer (see text)
- 1—6-volt battery (Burgess Z4 or equiv.)
- Misc.—Perforated phenolic board, push-in terminals, knob, hookup wire, solder, machine screws, etc.

Estimated cost: \$8.50

The staircase waveform can be seen on a scope simply by connecting the scope across C2. However, with some scopes sync can be a problem. If sync is a problem, connect your scope across T1's secondary and set the controls so that 6 complete AC cycles are displayed. Then, switching to a lower voltage range (.5 volts/inch) but without touching the sweep setting, adjust R4 so the staircase is stable. There should be 6 steps. By moving your scope probe to base-1 or base-2 of the unijunction you will see that 6 steps (pulses in) result in 1 pulse out. The circuit has divided the line frequency by 6.

In the original model R4 could be set so the unijunction fired on as little as 4 pulses or on as many as 7. It, of course, accomplishes this by varying the amplitude of the input pulses.

Before we close we should mention that C2 can be a single .33-mf capacitor. Or any combination of capacitors (adding up to approximately this value) can be substituted. ■

THE LASER THAT MAKES LIKE A RAINBOW



□ Up to now, pumped-up lasers have shot out a nice beam of one-color light day in and day out with all the dull regularity of an old maid's solitaire game. Then IBM scientists grew weary of having their lasers endlessly squirting out the same old color and figured out a way to do something about it.

The result is they found out how to light-pump (lase) an organic dye in a water or alcohol solution; they also discovered that refilling the liquid laser with a different color dye changed the color of the output beam. Further, by increasing the concentration of the dye—red, for example, they were able to pump

out colors that much deeper. It's all done in a little quartz tube having polished ends and filled with the dye solution.

The big trick, scientists say, was to get an extremely short pumping flash, since the longer flash of standard gear won't lase the dyes. Success being predicated on constancy of purpose, they developed a special flash unit that achieves maximum brilliance in just 300 nanoseconds—this in contrast to the several hundred microseconds required by conventional flash gear.

There is no way of knowing, of course, but could the future of technicolor lasers be anything but bright? ■

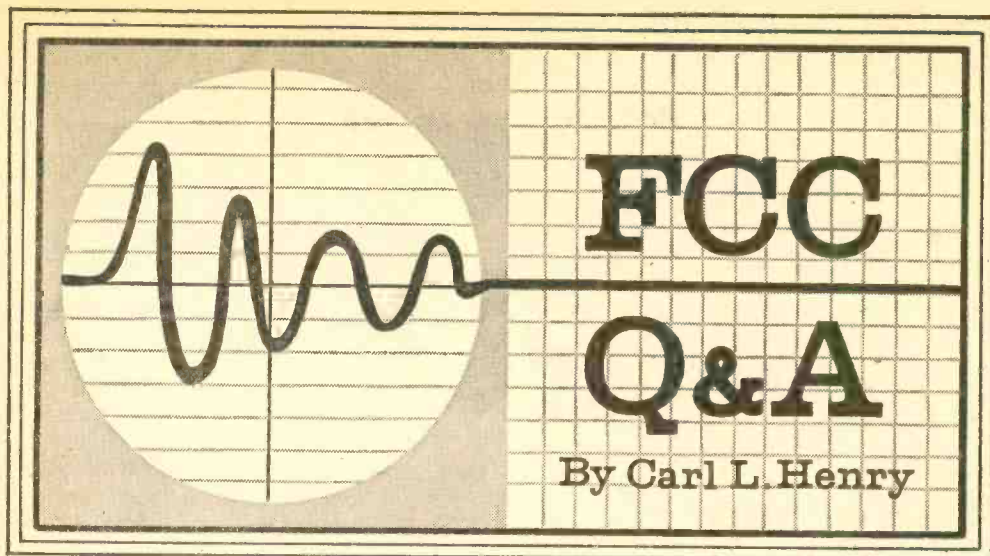

FCC Q&A

By Carl L. Henry

If you're planning on picking up a commercial ticket these days, you'll probably be faced with the why's and how's of TV. Ready?

What do you know about television? Not the Nielsen ratings, or the commercials that sometimes make you wish the thing had never been invented, but the television that is the bread and butter of the technical man. Television questions were being used on Federal Communications Commission exams as long ago as 1950. But today there is a correspondingly greater number of TV questions on these tests, since a large percentage of broadcast stations are now involved in television broadcasting.

When you take your FCC exam, the questions will be selected randomly from a large group. However, probably ten percent of your test will be concerned with some phase of TV broadcasting. My column this issue will therefore cover several typical TV questions. As usual, they will progress from the easier to the more difficult.

Q. Numerically, what is the aspect ratio of a picture as transmitted by a television broadcast station?

A. The aspect ratio is the ratio of the width to the height of a TV picture. When TV was first starting, this was chosen to be 4 to 3, the same ratio that was being used in motion pictures before the wide screen came on the scene.

Q. What is the frequency tolerance of a television broadcast transmitter?

A. The total tolerance for the channel is ± 5 kHz. However, the video carrier is actually allowed ± 1 kHz, and the sound carrier is allowed ± 4 kHz.

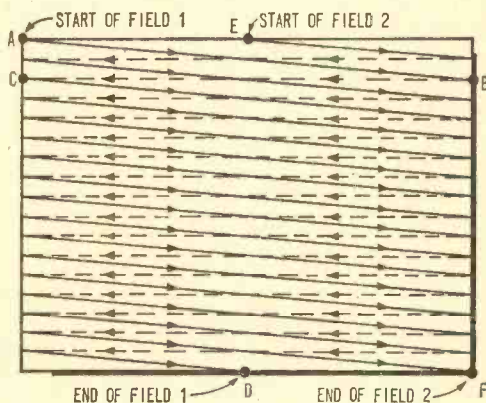

Interlaced scanning is used to prevent image flickering. One half of the picture is presented by field 1 (A through D), the other half by field 2 (E through F). Sixty fields are transmitted a second which combine into thirty complete frames (pictures). Horizontal scan lines are represented by solid lines and flyback (retrace), by dotted lines.

Q. What is the field frequency of a television broadcast transmitter?

A. The field frequency of a television transmitter is 30 frames per sec. Two fields make one frame with the horizontal scan lines of each field falling between each other to make a complete

frame. Hence, the frame occurrence is one half the field frequency, or 30.

- Q.** Does the video transmitter at a television broadcast station employ frequency or amplitude modulation? What method is used on the sound transmitter?
- A.** The video transmitter uses amplitude modulation. The aural (audio) transmitter uses frequency modulation. Generally, grid modulation is used, since the video portion of the signal has a wide bandwidth, about 5.25 MHz. Further, in order to amplify with such a wide bandwidth, a low impedance plate load must be used. This in turn means that plate modulation would be difficult since a very great amount of power would be necessary. The aural carrier is frequency modulated, 100% modulation being ± 25 kHz.

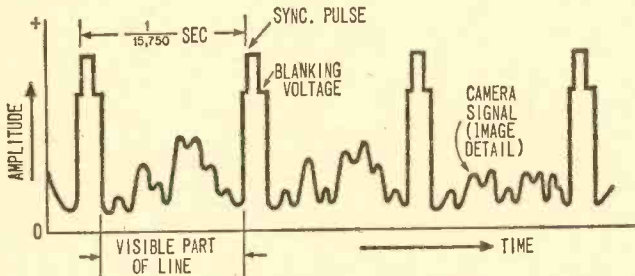

Composite video signal for black and white transmission contains synchronizing information which keeps the show on the road. Sync pulses line things up so camera information is re-presented as recognizable image on picture tube. Blanking voltage prevents flyback (retrace) from appearing on the pic tube.

- Q.** What is the effective radiated power (ERP) of a TV station if the output of the transmitter is 5000 watts, the transmission line used has a loss of 5 db, and the antenna has a 10 db power gain?

- A.** Our old friend the decibel is here again. As a matter of fact, it is impossible to figure anything in electronics without him. Memorize those formulas!

In this case we are discussing power, so we use the power formula, decibels

$$= 10 \log \frac{P_1}{P_2}$$

and asked to find the ratio. In other words, what logarithm when multiplied by 10 equals 5 decibels? A log of 0.5 satisfies this question. Using a log table, we find that the ratio is 3.16. Since this is a loss figure, we have 1580 watts delivered to the antenna. The antenna has a 10 db gain. By the preceding reason-

ing, a ratio of 10 is required. Therefore, the ERP of the antenna is 15,800 watts.

- Q.** What is the purpose of synchronizing pulses in a television signal?

- A.** A television signal must cause a receiving cathode ray tube to scan horizontally and vertically. In order that these scans are duplicates of the original studio scan, synchronizing impulses are sent along with the video information to the receiving set. A vertical sync pulse is sent for every field (or 60 per second), and a horizontal sync pulse is sent for each horizontal line (or scan), 525 lines per frame.

- Q.** Besides the camera signal, what other signals and pulses are included in a complete television broadcast signal?

- A.** The complete TV signal includes the following: **1**—Horizontal synchronizing pulses (525 per frame, 15,750 per second); **2**—Horizontal blanking pulses (525 per frame, 15,750 per second); **3**—Vertical synchronizing pulses (1 per

field, 2 per frame); **4**—Vertical blanking pulses (1 per field); **5**—Equalizing pulses (12 per field); **6**—FM aural carrier and sidebands; **7**—Video carrier frequency.

- Q.** For what purpose is a voltage sawtooth waveform used in a TV receiver?

- A.** To scan the CRT screen. Since almost all TV sets use electromagnetic deflection, the signal from a sawtooth waveform oscillator is converted into a current sawtooth to actually scan the CRT.

- Q.** If an 8-in. cathode ray tube in a TV receiver is replaced by a 12-in. tube, what will be the change in the scanning lines?

- A.** The scanning lines aren't dependent on the size of the CRT. Therefore, there will be no change.

- Q.** How many frames per second does a TV station transmit?
- Q.** There are 30 complete pictures per second or frames per second transmitted by the TV transmitter. *Interlace* scanning is used. That is, one-half the picture is sent in each field, and 60 fields are sent per second. This is done to prevent flickering in the viewed image. A repetition rate of 30 per second will seem to flicker, due to the shortness of persistence of vision in the human eye.

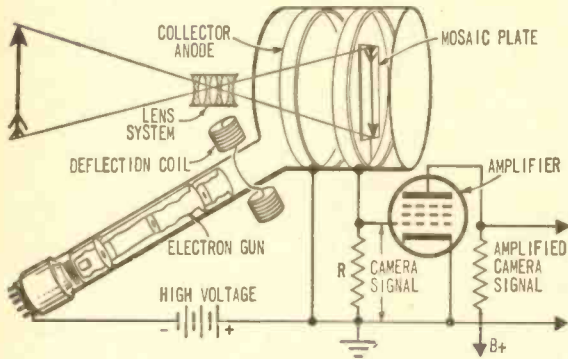

case the channel is 82 to 88 MHz, and the aural center frequency is therefore 88-0.25 or 87.75 MHz. The nominal center frequency of the video transmitter is always 1.25 MHz above the lower limit of the channel.

- Q.** What is meant by "antenna field gain"?
- A.** Antenna field gain is the ratio of the voltage induced into a receiving antenna under conditions where first a simple dipole is used (for reference) and second a complex antenna is used. The ratio between the two is con-

verted into decibels, and the complex antenna is specified to have so many db gain.

Q. What is a mosaic plate in a TV camera?

A. A mosaic plate is used in an iconoscope or a vidicon tube in a TV camera to convert the light image to an electrical signal. The mosaic consists of a mica plate that is generally very thin (1 to 2 thousandth of an inch). One side of the mica is coated with a fine silver oxide and baked. This produces a plate with many silver globules, insulated from each other by mica. During this process cesium is also formed on the silver globules, causing them to be photosensitive. The opposite side of the mosaic plate is coated with a colloidal graphite or some other electrical pickup system. A capacitive pickup is then possible that is dependent on the amount of light striking a particular silver globule. This subdivides the viewed scene into many bivalued signals (either light or dark). It is then possible to reproduce these light values electrically, by turning off and on the electron beam in a cathode-ray tube.

Q. What is meant by vestigial sideband transmission of a television station?

A. This is similar to Ham single sideband operation. The upper sideband is transmitted, but only a part of the lower sideband. This operation is used in the video transmitter only, and saves space on the TV channels, since each sideband carries the complete video information.

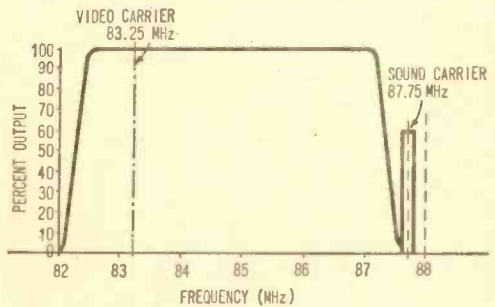

TV audio carrier frequency, bandwidth, and relative output power as compared with video carrier is illustrated. Frequencies are for channel six.

- Q.** If a television station transmits the video signals in channel 6, what is the center frequency of the aural transmitter?
- A.** The center frequency of the sound or aural carrier is always 0.25 MHz below the upper limit of the channel. In this

Q. How is the operating power of the sound transmitter determined?

A. The operating power is determined by the indirect method. That is, it is calculated by the formula,

$$\text{Power} = \text{Final Plate Voltage} \times \text{Final Plate Current} \times \text{Efficiency}$$

(specified by the manufacturer of the equipment).

Discover the excitement of learning Electronics with training kits NRI sends you

New Achievement Kit Custom Training Kits "Bite Size" Texts

Only NRI offers you this pioneering method of "3-Dimensional" home-study training. It's the result of more than half a century of simplifying, organizing, dramatizing subject matter. As an ambitious man you can effectively learn the Electronics field of your choice the NRI way. But NRI training is more than kits and texts. It's personal services, too, which have made NRI a 50-year leader in the home-study field.

YOU GET MORE FOR YOUR MONEY FROM NRI

Everything that you see here is included in just one NRI course. Other courses are equally complete, yet you'll be surprised at the low cost. Text for text, kit for kit, dollar for dollar—your best home study buy is NRI.

Available Under NEW GI BILL

If you served since January 31, 1955, or are in service, check GI line in postage-free card.



*Earn \$4 to \$6 an hour
spare or full time in*
**TV-RADIO
SERVICING**

Want to earn extra money? Looking for a good paying job? Interested in your own full-time business? Radio-TV Servicing is the branch of Electronics offering all these opportunities. In addition to teaching you the facts, NRI shows you how to earn while you learn.

You can learn quickly how to install, maintain and service tube and transistor home and auto radios, TV sets (including booming Color TV), hi-fi and stereo, public address systems. Like thousands of others, you can be earning \$4 to \$6 an hour in spare-time starting soon after you enroll.

*There's glamor and
success awaiting you in*
**BROADCASTING—
COMMUNICATIONS**

Good paying, fascinating positions await competent Communications Operators and Technicians. Broadcast stations, commercial stations, ships, aircraft, land vehicles all need men who know how to maintain and repair transmitting and receiving equipment. With closed-circuit TV, Facsimile, Microwave, Radar, Telemetry and all the communications needs of the Space Age, you can see how important training in this field has become. NRI training includes preparation for your First Class Radiotelephone FCC License. *And you must pass the FCC exam or NRI refunds your tuition in full!*

*Move ahead in America's
fast moving industry as an*
**ELECTRONICS
TECHNICIAN**

There is a serious shortage of qualified Electronics Technicians. Electronics has found its way into hundreds of areas not even dreamed of ten years ago: offices; manufacturing; medical and dental uses; transportation; space exploration; government and military equipment . . . there's no end of opportunity for trained men. This course stresses the basic principles around which most Electronic devices are built; prepares you for many current job openings. Prepare now. Learn Automation, computers, data processing, ultrasonics, telemetry. Whatever your interest in Electronics, you'll find an NRI training plan for you. Check the course of most interest to you on the postage-free card and mail it today for your free NRI Catalog. No obligation. No salesman will call. NATIONAL RADIO INSTITUTE, Washington, D. C. 20016.



**More than
50 years of leadership
in Electronics Training**

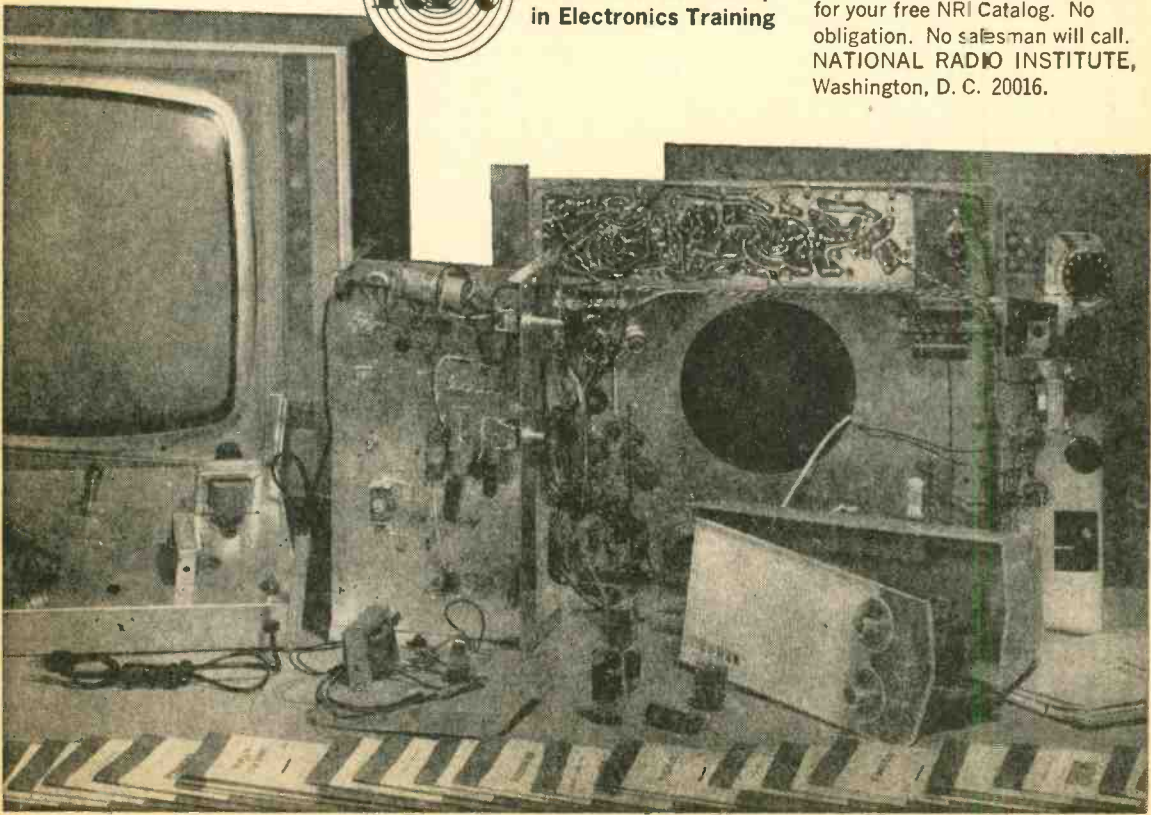

Zooks! An Electronic Lorelei!

□ An electronics firm whose most important product is not dresses has designed an all-electric *Astro Gown*. The dress is lined with 64-electroluminescent lamps—flat, cool, light sources whose surface glows. When its pretty wearer flicks a switch in her purse, her *Astro Gown* lights up in a star-spangled pattern of lights. The effect is electrifying (a shot of one electronic go-go girl appears in our pic at right). Unlighted, the dress looks like an ordinary frock.

Thin-as-a-dime electroluminescent lamps on the dress are a space-age product of the General Electric Company. You may have seen the flat lamps used in animated displays, night lights, clock and radio dials. An electroluminescent lamp looks more like a piece of cardboard than an ordinary lamp since it has no glass bulb, no filament and no base. It can be designed in any shape (by GE) and even bent in tight loops. Its no-moving-parts ruggedness makes it ideal for aerospace application.

How does it work? Light is created by applying electricity to a thin layer of phosphor powder sandwiched between two conducting surfaces. The phosphors absorb the electrical energy, converting it immediately into visible light. The lamps on the *Astro Gown* are lighted by a power pack which the pretty Miss carries in her handbag. A specially designed combination of batteries and a solid-state converter supply the necessary



GE's Lady of Light, Kathy Burns, is decked out in the all-electric Astro Gown—and it's switched on! A highly efficient solid-state converter carried by Kathy provides greater illumination than possible with 117-volt, 60-Hertz household current.

power to the lamp in the dress. A variable frequency control enables the Miss to vary the brightness of the lamps. GE engineers point out that they built safety into the dress, too. It has been insulated and fire-proofed. But who will protect the helpless male? ■



COMPUTER DIGS DIAGRAMS

■ Pictorial material “drawn” on its screen can be sensed and remembered by a new computer system developed by the National Bureau of Standards. Called MAGIC (for Machine for Automatic Graphics Interface to a Computer), the system is equipped to handle almost any type of diagram.

To operate the device, MAGIC's operator draws on its screen much as he might sketch a circuit for a fellow worker. When completed, the drawing can be placed in the computer's memory and recalled whenever requested.

Since pictorial material stored in MAGIC's memory can be revamped at any time, the computer is expected to prove especially useful for circuits and diagrams which are frequently subject to updating. ■

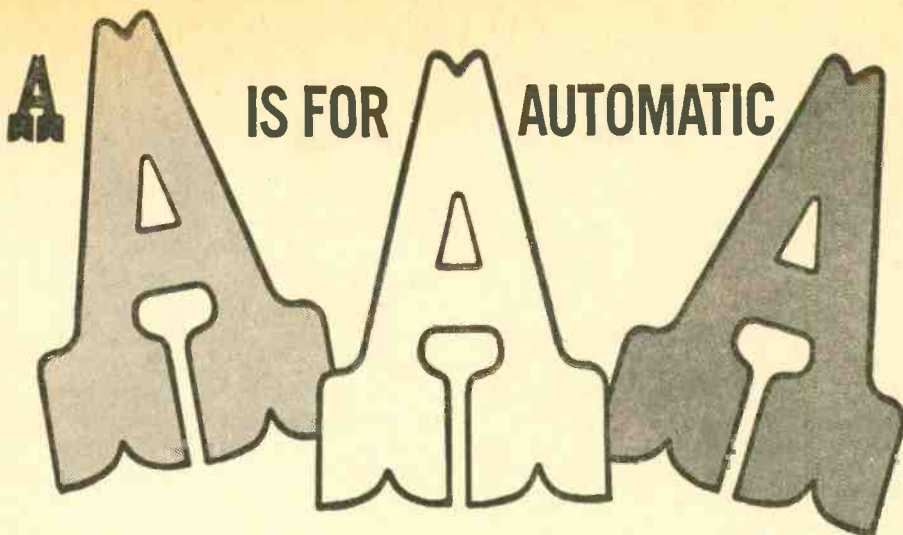

Think of triple A in some context other than electronics? Well, think again, because in this article you'll find electronics' own triple A.

By Len Buckwalter, K10DH

THE AAA of electronics is a trio of circuits that put automatic drive into radio and TV. They're unseen fingers behind the front panel that shove a receiver into high gear for weak signals—or throttle it back when the going is easy. Sound like *automatic volume control*?

You're right—if it's 1930 and you're listening to the A&P Gypsies. But these days AVC is practically an alphabet soup.

Now there's more—ACC, AGC and KAGC. The British add one called QAVC. But they all boil down to the Triple-A: *automatic volume control*, *automatic gain control* and a johnny-come-lately called *automatic color control*. As you look into these circuits you'll find that saying AVC may be as inappropriate as calling a refrigerator an ice box.

Four-in-Hand. AVC, as it was originally conceived, relieves the tension of being close to your radio. Its most important job is keeping volume constant as you tune across the band. Within a reasonable swing of signal strength, it automatically levels out RF signal strength differences between the strong and the weak. AVC tries to float feeble stations that sink into the noise, or knock down giant signals which might rip the spider off the speaker. In old texts on electronics, AVC is said to "cure speaker blasting."

Riding a turnpike is the second reason

for AVC. It fights fading signals in car-radio reception. AVC does the same for Ham and communications receivers picking up long-haul signals which skip through an unstable ionosphere. Even the megawatt signals emitted by Radio Moscow often wash into North America in fading 1-second surges. In all of these cases, AVC does much to tidy up wavering reception.

Further, AVC prevents most front-end overload—when excessive RF signals pound into a receiver's first stage. This condition makes audio sound like it's immersed in boiled farina.

Finally, since an AVC circuit can sense the amount of received signal, it's handy for operating secondary circuits—like a tuning meter, squelch or noise limiter. Although AVC tackles a variety of conditions which threaten volume, it is really controlling something else—or so declare the purists.

Radio Roundhouse. The block diagram of the AVC system in an AM receiver is shown in Fig. 1. After a signal is picked up by the antenna it is amplified in various stages—RF amplifier, and converter and IF amplifier. (For our purposes we can ignore the fact that the signal is stepped down in frequency by the Converter.) A close examination of the signal reveals it consists of an RF carrier that varies with the ripples of audio modulation. But note that the *average carrier level* is also varying, as

shown by a dotted line. That long-term shift (as compared with shorter audio variations) is the result of signal fading, or possibly a difference between strong and weak stations on the dial.

When the signal enters the detector stage it is converted to two output voltages: one is the audio signal, the other, a DC voltage which represents average carrier strength. That will become the AVC voltage. For tube-type receivers it's usually taken from the detector as a negative DC-voltage. Fed back to earlier receiver stages, it controls the negative bias at the grids of the various tubes. (See box: "How Signals Look in a Receiver.")

Let's assume a powerful carrier is entering the receiver. It might produce an AVC of -8 volts, which is applied to control grids in the earlier stages. Since tubes decrease their ability to amplify as grids grow increasingly negative, the strong signal is reduced in size. A weak incoming signal develops relatively little AVC and tube stages run wide open—near zero bias. It's also one reason why you hear noise between stations. With no AVC, the receiver is operating at high sensitivity. Then, when an incoming signal reduces amplification, noise apparently disappears.

Here, too, is the reason the name automatic volume control has been called a misnomer. Although its total effect is keeping

speaker volume constant, the precise reason is that AVC controls receiver gain, or sensitivity. Since AVC circuitry is applied in a number of non-volume applications, it is being supplanted by the more accurate term AGC (*automatic gain control*). Weight of tradition, however, keeps the term AVC in current use. (But it should never be used to describe the same action in a TV front-end or IF circuit since there it controls picture, not volume alone. So long as AVC is mentioned only in connection with a regular radio receiver, no one will raise an eyebrow.) Let's examine how AVC is developed in a receiver's detector stage, chart its performance and point out its problems.

AVC Detector. The simplified schematic in Fig. 2 shows how AVC voltage originates in a tube-type receiver. The action in transistor circuits is similar. The incoming carrier, alternating between + and -, reaches the diode plate. Since the tube can conduct current only when its plate is driven positive, the negative part of the signal is eliminated. Only positive pulses of carrier develop current flow in the diode's load resistor. That current flow, however, produces a negative voltage at the top of the load resistor; this voltage causes electron flow to ground, completing current path. The resulting voltage developed across the load resistor is proportional to strength of the carrier.

Although a carrier has been rectified from AC to DC, the DC output is far from useable as AVC voltage. Trouble is, it contains the audio-modulation ripples mentioned earlier. It's important for proper AVC action that a receiver respond only to changes

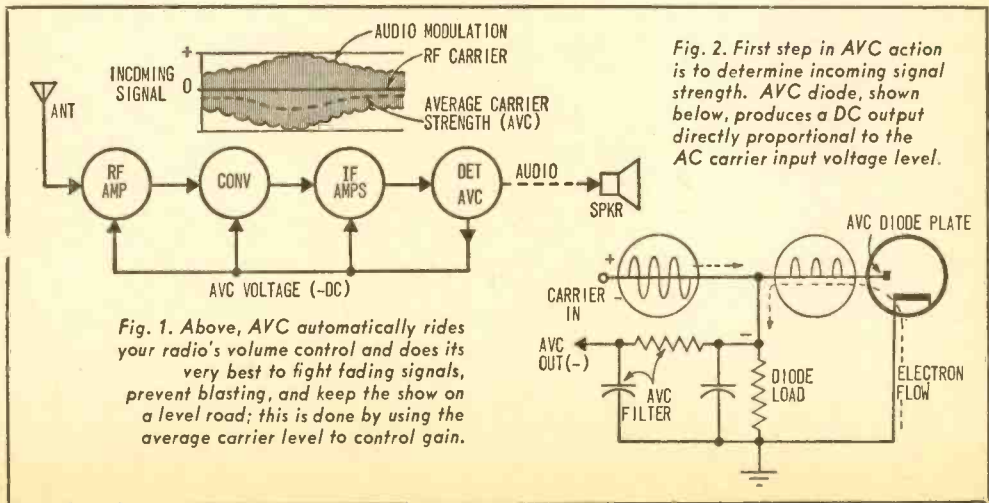



Some communications receivers employ AVC-defeat switch to aid weak-signal reception.

in carrier *strength*, not modulation. Otherwise receiver gain would change with the loudness of program material being transmitted.

A full orchestra, for example, would generate much AVC, but voltage would fall away during quiet passages. To eliminate audio as a controlling factor, the AVC circuit is fitted with a filter. Note the resistor and capacitor installed in the AVC line. Their values are carefully chosen to produce two important effects.

The resistor and capacitor form a time-constant circuit of about one-tenth second. This means that any voltage varying much faster than this rate is smoothed out. It happens as the resistor delays flow of current through the capacitor. Values are large: the resistor is often 2 or 3 megohms; the capacitor about .05 mf. The result is that audio modulation on the carrier, happening hundreds of times faster than one-tenth of a

second, is filtered out of the AVC line.

The designers of AVC picked a time constant of about one-tenth second for another good reason. As we've seen, it's slow enough to filter out the effects of audio. But the speed of AVC action is also a compromise. If you drive along in a car while listening to the radio, for example, the incoming signal might fade or flutter. If AVC action is too sluggish it might not react quickly enough to adjust receiver gain under these conditions. So they've selected an approximate one-tenth second value as an average which falls between the rates of audio modulation and fast fading.

To illustrate AVC in a commercial circuit, we've shown in Fig. 3 a partial schematic of a 5-tube radio. It's typical of millions of table radios produced over the last 30 years. The incoming signal is seen entering the IF amplifier from the left. (It is 455 kHz produced by the set's first stage, a Converter.) The signal is then amplified and applied through the IF transformer to a diode-triode tube, a triple-purpose stage. The diode section serves two functions; it converts the carrier to DC for AVC voltage and it simultaneously detects (recovers modulation from the carrier) the audio signal.

Both the pure audio and AVC voltages appear at the top of the volume control. Audio continues to the triode section contained in the same envelope, while AVC goes to the filter and back to control the early stages of the receiver.

This circuit has proved practical for inexpensive home radios. It produces AVC control action with little more than a resistor and capacitor. (The diode is needed for the audio detection process anyway.) Better receivers, especially those used in communications, often move up to a better version known as DAVC (delayed AVC).

Delaying the Control. A shortcoming of simple AVC is that it begins to feed back a negative, gain-reducing voltage even during very weak signals. And that's the time the receiver should run wide open and amplify every last bit of carrier. This can be done with DAVC, or *delayed automatic volume control*. The term "delay" doesn't mean a delay in time, but voltage. As we'll see, the circuit uses a second voltage which must be overcome before regular AVC action is

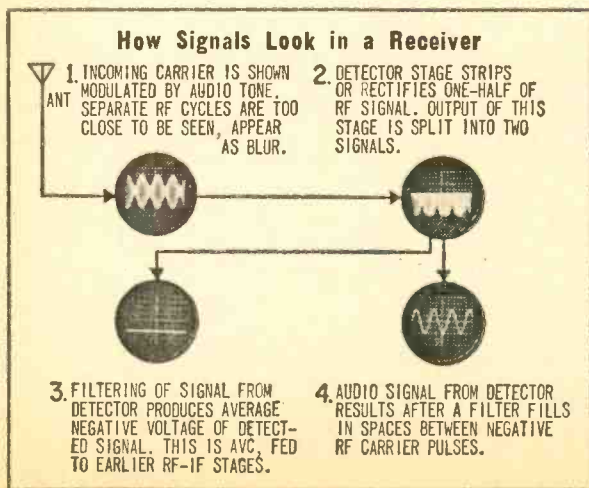

e/e A IS FOR AUTOMATIC

effective. Before examining that circuit, it should prove valuable to observe the dynamics of AVC on overall sensitivity of the receiver.

The graph in Fig. 4 reveals how much audio output reaches the loudspeaker when an incoming radio signal (measured at the antenna) swings over an enormous range of strength. The first curve, "No AVC" indicates what happens when the receiver (RF, IF and audio) is permitted to run at full amplification at all times. Note that the curve rises with signal strength. No speaker wattages appear beyond "1.5" because the audio section of these 5-tube receivers begin to overload at the 1.5-watt point and therefore produces no further useful output.

Consider, next, the lowermost curve—Simple AVC—the type of response in circuits we've been describing. Now an RF signal at the input can swing over the great range of about 100 to 100,000 microvolts. Audio in the speaker continues to remain

reasonably constant in the region of .015 watts.

But notice that in Simple AVC, output is reduced even before the signal attains a strength of 10 microvolts (lower left). This is the disadvantage of simple AVC: it starts to produce negative feedback (control) voltage in the extremely weak-signal region.

This doesn't happen at the curve marked "Delayed AVC." It's the same as "No AVC" until the input builds up to about 10 microvolts. Note that it begins to take effect at Point "A"—about 10 microvolts.

Obtaining delayed AVC can be done by the circuit in Fig. 5. It's based on the fact that for a diode to conduct current, its plate must be more positive than its cathode—electrons (negative charge) are attracted to the plate (positive charge). Notice that the cathode of the AVC diode in Fig. 5 is impressed (biased) with steady +3 volts.

This bias dictates that the potential on the diode plate must exceed +3 volts for diode current to flow. Thus the weak signal applying but +2 volts fails to draw current. Zero AVC voltage remains at the output. But the stronger signal that develops +4-volts over-

Fig. 3. AVC circuit at right is typical for table-model radios. Detector diode provides AVC voltage used to control gain of IF and converter stages of set. AVC filter changes pulsating voltage from detector to steady DC needed.

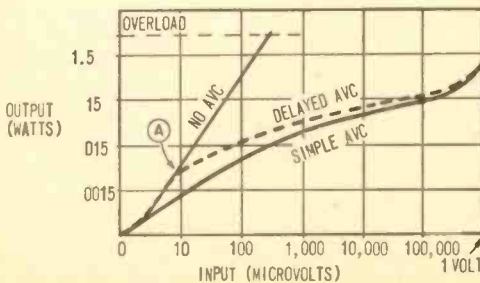
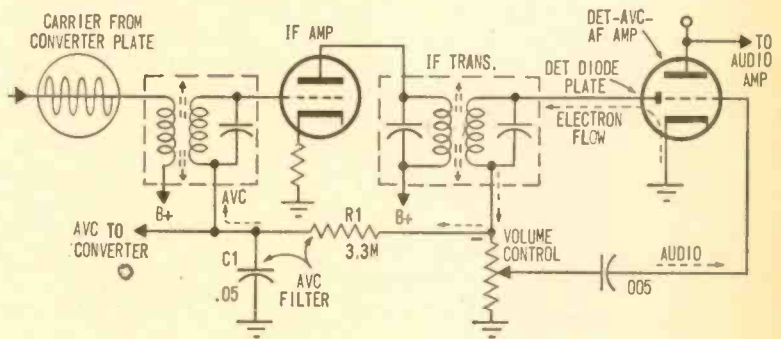

Fig. 4. Delayed AVC gives better receiver performance by not reducing receiver gain on weak signals as shown by graph above.

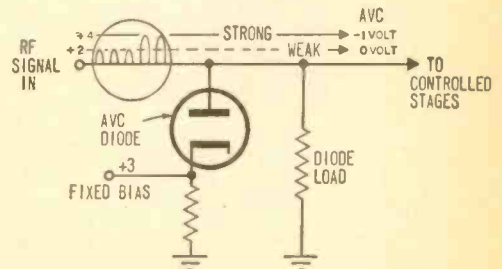

Fig. 5. Above, biasing cathode of AVC diode at 3 VDC prevents AVC voltage being developed—and receiver gain decreased—until RF input exceeds level of bias.

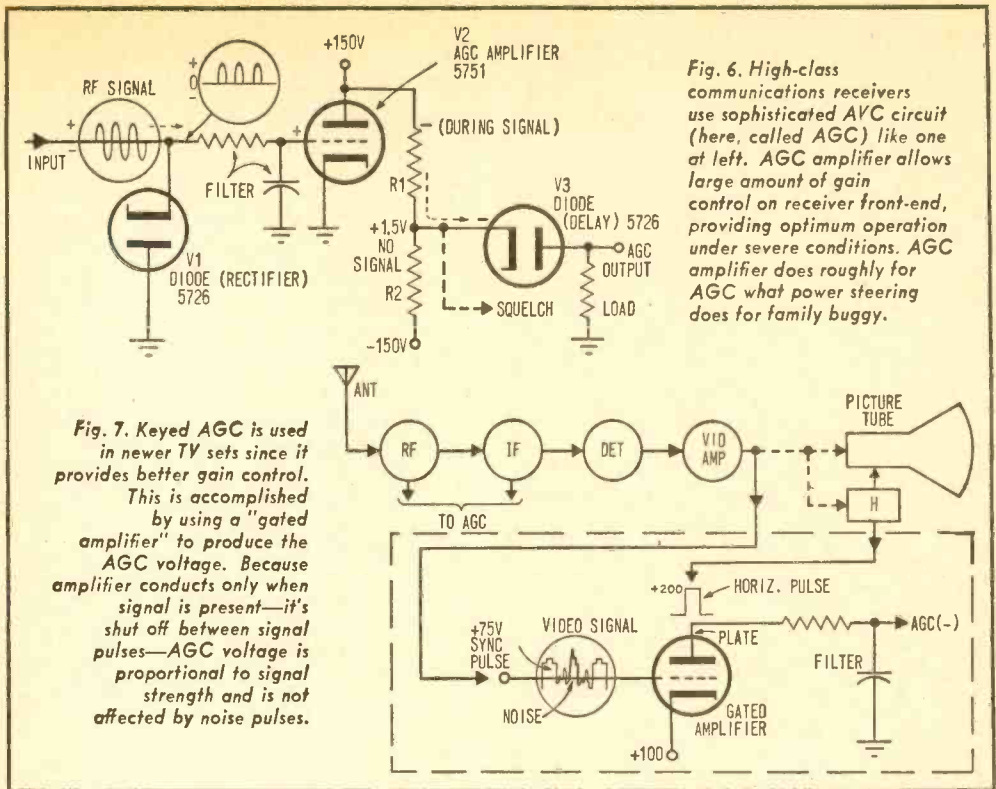

Fig. 6. High-class communications receivers use sophisticated AVC circuit (here, called AGC) like one at left. AGC amplifier allows large amount of gain control on receiver front-end, providing optimum operation under severe conditions. AGC amplifier does roughly for AGC what power steering does for family buggy.

Fig. 7. Keyed AGC is used in newer TV sets since it provides better gain control. This is accomplished by using a "gated amplifier" to produce the AGC voltage. Because amplifier conducts only when signal is present—it's shut off between signal pulses—AGC voltage is proportional to signal strength and is not affected by noise pulses.

comes the applied cathode bias and does develop AVC at the output.

This satisfies the condition that no AVC be developed during weak-signal reception. When a DAVC circuit is employed it usually uses a separate diode. Using the same diode as the one for the detection of audio is impossible since the delaying bias would interfere with the detection process.

A practical circuit recommended by the National Bureau of Standards to receiver manufacturers is shown in simplified form in Fig. 6. This hookup adds another bit of sophistication to the circuit. It not only delays the gain-control voltage until the input signal is strong enough (the Bureau uses the more modern term, AGC) but *amplifies* the DC control voltage as well. This circuit provides superb receiver control under the difficult (widely varying) signal conditions encountered in communications. The circuits covered earlier could generate voltages only as high as the input signal. The one in Fig. 6 will operate with carrier input signals of 0 to 7 volts and produce amplified AGC output from 0 to -35 volts.

To trace the circuit of Fig. 6, consider the RF carrier signal entering from the left.

Diode V1 provides the familiar rectifier function to convert the RF signal to a DC voltage corresponding to carrier strength. One difference from earlier circuits is that diode V1 is reversed in the circuit so the DC signal is positive. (Reason for the reversal is the phase reversal through the AGC amplifier—a triode tube which boosts the DC control voltage.) As the rectified signal voltage applied to the grid of V2 increases (becomes more positive), the current flow through the tube increases and amplification occurs. But as we mentioned, a signal passing through a conventional triode tube will reverse phase; the tube's output will have an amplified, but *negative*, voltage appearing at a point between resistors R1 and R2. (Ignore the +1.5 for a moment.)

The negative output voltage from V2 drives the cathode of V3 negative, allowing that tube to pass current. The net result is a negative AGC signal at the output.

Now let's return to that point between resistors R1 and R2. When no signal is being received, that point will appear to be +1.5 volts. This is due to the voltage supply: note that the resistors connect across a +150 and -150 volt source. The resistors

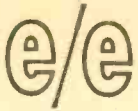

A IS FOR AUTOMATIC

divide the power supply so the junction becomes +1.5 volts. And that's the delay voltage to keep AGC from developing during weak-signal reception. The amplifier tube must overcome that bias before AGC can appear at the output.

Squelch. This circuit also supplies what's known in England as QAVC for Quieting Automatic Volume Control; here it's called *squelch*. It's a valuable feature which

picked up by the home receiver, it creates short bursts of energy which can demolish sync pulses. It can tear or jostle the picture. Even if this happens momentarily, it's far more annoying to the eye than is a crash of static from a speaker. Another weakness in TV reception relates to fading. Since TV waves are physically short they reflect from relatively small objects. An aircraft passing over the region readily reflects signals to the TV antenna. The antenna picks up two waves; a direct one from the TV station and the reflected signal from the aircraft. Since signals are out of step, some cancellation occurs. Early TV receivers were notorious

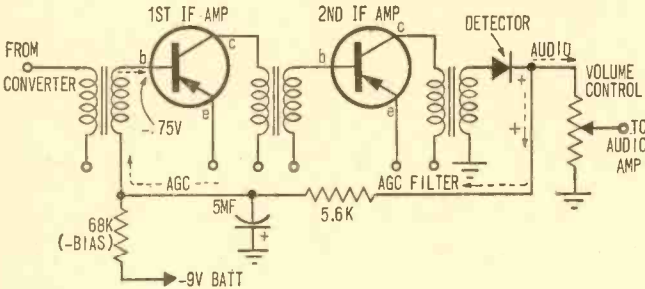

Fig. 8. AGC in transistor circuitry works on same principle as in tube sets, but DC polarity will be reversed when using PNP transistors. Typical AGC circuit used in transistor radios is shown at left; here AGC is applied only to first IF stage.

silences a receiver's audio stages when no signal is being received and prevents annoying static and other speaker noises from being heard. The difference between squelch and AGC is that squelch must work with switch-like action when an incoming signal of any usable strength is received. The squelch tube (not shown) is simply an amplifier that conducts heavily when driven by the +1.5 volt bias between R1 and R2. The squelch tube, in turn, develops a large negative output voltage which cuts off an audio stage. When an incoming signal wipes out the 1.5-volt bias, the squelch tube instantly "unlocks" the stage it's controlling. Unlike regular AGC, the squelch action is on-off.

Quiet Pictures. The reasons for control of volume (in a radio) are equally true for television pictures. To keep images at steady contrast while viewing or changing channels, TV receivers also require AGC stages. They follow the broad concepts already described. But two additional factors, affecting TV, call for more sophisticated AGC circuits. One is *noise*. A TV signal contains not only sound and picture signals, but synchronizing pulses as well. They keep the picture locked horizontally and vertically to images originating at the TV studio. When noise is

for losing picture synchronization for this reason. New sets are highly resistant to tearing and flicker with a circuit known as "keyed AGC."

Keyed AGC. In simple AVC systems, the incoming carrier is the reference around which a controlling DC voltage is created. In TV, the reference is the incoming sync pulses. It is a convenient voltage source since the pulses remain constant in height and don't vary with changes in picture content. The pulses, however, do vary height according to the strength of the incoming signal. This may be seen in the video-signal waveform near the center of Fig. 7. Each of the sync pulses triggers a horizontal scanning line across the picture tube. Between pulses you see the varying video voltages which encode the bright and dark part of one picture line. Our keyed-AGC system, however, ignores the video and concentrates only on the sync pulses.

How keyed AGC avoids fading and noise interference is shown in Fig. 7. It's done by introducing a *Gated Amplifier*, nothing more than a tube which conducts current only during controlled intervals. Notice that the grid of the gated amplifier receives the composite video signal—con-

(Continued on page 102)

DX ON ICE



Get your DX cool inside the Arctic Circle

By C. M. Stanbury II

How many stations have you logged which were inside the Arctic Circle? How many near the Arctic Circle? Unless you're a veteran DXer, chances are the answer is *none*. For the fact is that even the most experienced listeners have only few recorded in their log books and even fewer QSLs to back them up.

The big reason for this state of affairs, of course, is the earth's magnetic field. Every time there's a solar outburst, electrically charged particles are sent hurtling earthward. And when they reach our planet, these tiny bits of matter are attracted into the ionosphere around each magnetic pole.

As most of our readers already know, the ionosphere is a region of ionized gasses between 50 and 200 miles up which reflects radio waves back to and around the curvature of the earth. But the charged particles we mentioned, and changes in the earth's magnetic field which accompany them, make the ionosphere a poor reflector, especially at higher frequencies. Worse yet, they also tend to weaken or even absorb any signal which enters the contaminated *(continued overleaf)*



Arctic Aeronautical Frequencies*

kHz	Service	kHz	Service
2868	N. Atlantic	8913½	N. Atlantic
4731½	Thule	8939	N. Pacific
5499	N. Pacific	11228	Thule
5626½	N. Atlantic	11356½	N. Pacific
6730½	Thule	13274½	N. Pacific
8862½	N. Atlantic	13284	N. Atlantic
8905	Anchorage Weather	17966	N. Atlantic

*All stations except Anchorage Weather are A/G/A services

portion of the ionosphere. And this makes polar DX of any sort all the rarer.

Zeroing In. It so happens that absorption hits hardest at lower frequencies. Take, for example, the Soviet home service relay station at Arkhangelsk on 5930 kHz (S/On at 2100 EST). Though this station is actually below the Arctic Circle, and just below 49-Meter band, the absorption level up there is such that reception in North America is very rare. Logging it is absolutely impossible during solar eruptions and those general ionospheric disturbances (sometimes known as magnetic storms) which immediately follow. As the effect of these charged particles which have collected around the earth's magnetic poles gradually wear off (like a very bad hangover), chances of logging Arkhangelsk steadily improve—that is, unless the sun breaks loose again.

Abbreviations Used In This Article

A/G/A	Air-to-ground-to-air
DX	Long distance, distant (contact or country)
DXer	Hobbyist who seeks DX contacts
EST	Eastern Standard Time
kHz	Kilohertz (kilocycles)
PST	Pacific Standard Time
QRM	Noise and/or signals interfering with desired signal
R.	Radio (as in R. Norway)
S/on	Sign on (beginning of transmission)
SWBC	Shortwave broadcast
USAF	United States Air Force

At the opposite end of the problem is station KIS in Anchorage, Alaska. KIS, or Anchorage Aeradio as it is called, broadcasts weather reports at 20 and 50 minutes past

each hour on 8905 kHz. Though this station is almost in the middle of the shortwave broadcast spectrum, the Arctic ionosphere is so poor that it will not be reflected, or at the very best reflected inefficiently. Watch for it late afternoons and early evenings. If KIS is coming through, then you should immediately turn your attention to what could be even rarer polar DX.

Poles Apart. It should also be remembered that the magnetic poles do not quite coincide with the geographic poles. At present the northern magnetic pole is situated on the upper tip of Greenland. Thus, a station like the Canadian Department of Transport's Aeradio at Goose Bay, Labrador, though actually further south than Anchorage Aeradio, will be more difficult to hear.

During daylight hours DXers should try for "Goose" on 8913½ kHz and at night on 5626½ kHz. A third channel, 2868 kHz, can also be logged only at night and is by far the best catch of the three. (Incidentally, all of Goose's frequencies are used heavily by aircraft flying the North Atlantic routes and working such ground stations—Aeradios—as Gander, Newfoundland; Shannon, Eire; Santa Maria, Azores; Bermuda; and others. Therefore, don't think the first signal

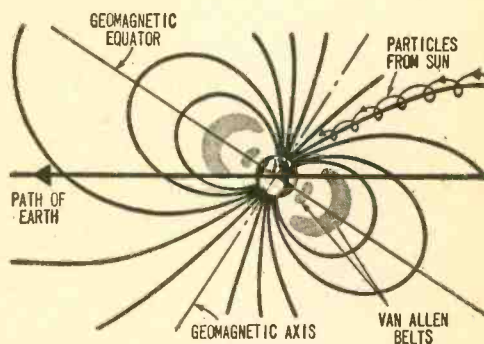

Simplified drawing shows lines of force from earth's magnetic field as well as associated Van Allen belts. Field tends to shield earth against particles arriving from sun, but effect is minimal near polar regions.

you hear is necessarily rare Goose Bay.)

On the other hand, you may, while monitoring these frequencies, bag some Arctic aeronautical stations even rarer than Goose Bay. These include Sondstrom (Greenland), Reykjavik (Iceland), and numerous aircraft flying near the Arctic Circle. As a matter of fact, direct flights from Los Angeles to Europe pass over the Arctic Ocean itself. Happily, aircraft regularly report their positions

(Continued on page 100)



HEATHKIT Model TA-16
Reverb-Tremolo
Portable Guitar Amplifier

Guitar amplifiers come in many shapes and sizes, with just as many price ranges. At the bottom end is a basic AC/DC amplifier priced in the neighborhood of \$25, while several hundred dollars will buy you one with virtually every imaginable feature short of a built-in beer spigot.

Usually, it's the extra-high-power output that runs the bill into the hundreds. But if you're willing to settle for a guitar amplifier having all the *pro* features but only enough power to fill the local school auditorium (rather than Yankee Stadium), you can lay claim to one of the best for just a little over \$100.

Priced at \$129.95 in kit form, Heath's TA-16 Solid-State Guitar Amplifier offers professional quality and features at almost a budget price. The block diagram shows the electronic features offered in the TA-16. First, there is a direct, *no effects* channel which Heath calls the *normal channel*. Any signal fed into the normal channel is amplified in a

Two completely separate channels explain the TA-16's remarkable versatility. Normal channel amplifies in straightforward manner; effects channel provides tremolo and/or reverb and will also function as second normal channel whenever desired.

straightforward manner, and only the volume, bass, and treble can be controlled (individual bass and treble controls are provided).

The second channel—the *effects channel*—is similar to the first in terms of input design and volume and tone control, but with the addition of a tremolo and echo generators. The tremolo and echo can be used separately, if desired, or together. Or the tremolo and echo can be disabled, allowing the *effects channel* to be used as a second *normal* channel.

Special Effects. The tremolo effect is obtained by using a low-frequency oscillator to vary the gain of the effects channel. First, the gain is varied at a rate equal to the oscillator frequency—which is user-selected between 4 and 14 Hz (cps)—this sets the vibration or tremolo rate. Secondly, by increasing the output of the tremolo oscillator circuit, the variation in effects channel gain can be varied from zero to about 80% (an almost-zero setting results in a slight “vibration,” while an 80% setting produces a deep, throbbing effect.)

Two controls are provided for the tremolo effect: one adjusts the rate of “vibration,” the second determines the amount (degree) of tremolo. A single control adjusts the amount of echo applied to the effects channel. A foot pedal with two switches, one for tremolo and one for echo, that plugs into a panel-mounted jack, keys the effects in and out.

The echo effect is obtained through the use of vibrating springs. A sample of the effects channel output is fed to a driver amplifier that causes a set of springs to vibrate. At the other end of these springs

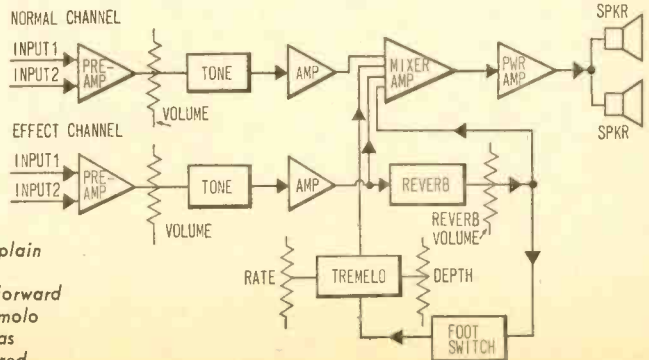

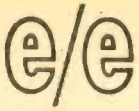

GUITAR AMPLIFIER

is another transducer—one that generates a signal voltage in step with the vibrations on the springs. This echo output—caused by standing waves and travelling waves bouncing back and forth on the springs—is amplified and fed, through isolating networks, to the mixer amplifier.

You Choose The Input. Either channel can be used, or both together. For example, you could plug your guitar into the effects channel and run the vocalist's mike through the normal channel. Or you could run the guitar through the effects channel and an accordion through the normal channel. Any combination can be applied to the two inputs; for an odd effect you might connect the guitar to the normal channel and put the vocalist on echo.

While Heath claims a 60-watt peak power, it is best to keep in mind that peak power is pure advertising gobbledygook. The continuous output-power rating is an honest 20 watts (25-watts music power). Coupled to the two high-efficiency music speakers supplied with the TA-16, it is enough to cause pain at 10 feet, certainly enough to fill an auditorium. (Yes, there is something called a music speaker—it can handle a lot of power without “break-up.”)

The overall sound quality was found to be exceptionally good. Distortion, even at unbearable volume levels, was notably low, with a good, *solid* sound.

Keeping The Hum Out. The hum level was very low, partly due to the *line-reversing power switch*. This switch has a center-off position. When flipped down power is applied. If hum is noticed, the switch is flipped up, thereby reversing the power cord connections. About the only unusual noise is a slight pulsation caused by the tremolo oscillator leaking into the power supply. How-

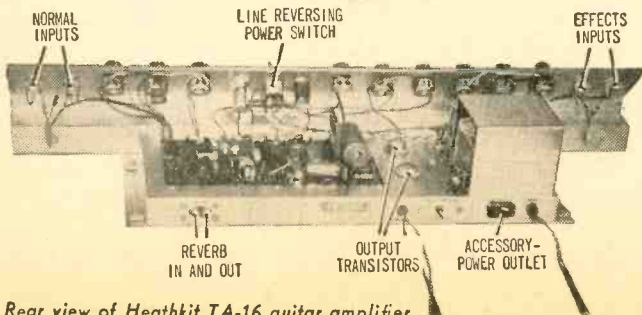

Rear view of Heathkit TA-16 guitar amplifier.

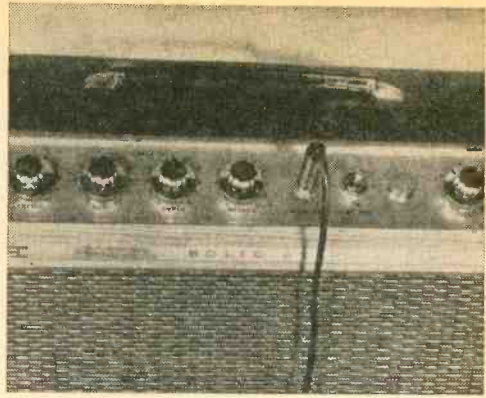

Foot switch controlling reverb and tremolo plugs into phone jack on front panel. Note the carrying handle.

ever, this effect is low, and can only be heard while close to the speakers.

Component quality appears to be good, at least equal to any other good commercially-built amplifier. And while the TA-16 is a kit, the connecting cables between the amplifier and the echo assembly are supplied prewired, with the plugs molded onto the cable.

Assembling The Kit. Though the overall cabinet size is large—due to the two 12-in. speakers and the long panel needed for all the controls, the amplifier itself is little more than a handful, most of it assembled on a printed circuit board. Connections between the front-panel controls and jacks and the amplifier are *direct*—generally in a straight line—and there is no octopus-like harness to confuse a beginner.

In case you do make a wiring error you don't have to worry about blowing expensive components. Two fast-acting circuit breakers are provided, one in the power-transformer primary and one in the transformer secondary at the rectifier.

A Trouble-Spot. While the amplifier is easily assembled, we did have one difficult troubleshooting session, which was totally unnecessary. When the amplifier was first completed we barely got a tremolo effect, though the tremolo should deliver a *deep pulsation*. After hours of work we could find nothing wrong, yet we still could not get the tremolo, so we had Heath send another set of tremolo transistors.

It turned out that though
(Continued on page 100)

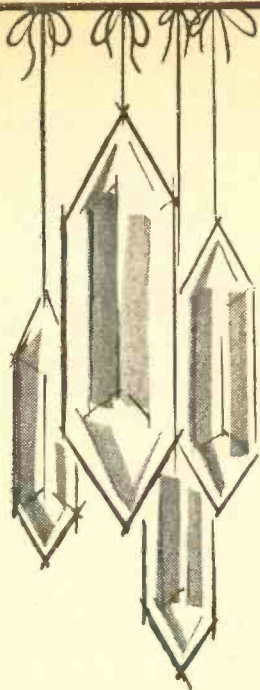

Those Swinging Rocks

by Jim Kyle, K5JKX

Those rock-steady crystals are that way by design—not accident. Here's why.

The CB operator who must keep his transmitter frequency within ± 0.005 percent of the assigned channel center, the broadcast-station engineer who must maintain the carrier within 20 Hertz of its assigned frequency, and the nuclear physicist who attempts to make time measurements to a billionth-of-a-second, all find themselves using a single basic component to fulfill requirements for precise frequency controls.

How can they all turn to the same quiet controllers to fill this need? Quartz crystals not only fix the frequencies of radio transmitters (from CB installations to multi-kilowatt-broadcast installations) and time events (from nanoseconds up to hours) but also establish the frequency of the source of operating pulses in most modern computers, and provide the exceptional selectivity required to generate and receive single-sideband signals in today's crowded radio spectrum. Yet this list merely touches upon the many uses of quartz crystals. No exhaustive list has ever been compiled.

This quiet controller is a substance surrounded by paradox. While quartz composes more than a third of the Earth's crust, it was one of the three most strategic minerals during World War II. And despite its plentitude, several semiprecious gems (including

agate and onyx) are composed only of quartz.

Unfortunately, quartz exercises its control in only a relative manner. When it's misused, the control can easily be lost. For this reason, if you use it in any way—either in your CB rig, your Ham station, or your SWL receiver—you should be acquainted with the way in which this quiet controller functions. Only then can you be sure of obtaining its maximum benefits.

What Is This Substance? One of the best starting points for a study of quartz crystals is to examine quartz itself. The mineral is also known as "silica," and is chemically silicon dioxide (SiO_2). It occurs in two broad groups of mineral forms, crystalline and non-crystalline. The non-crystal group is known to mineralogists as *chalcedony*—this group contains agate and onyx. We'll ignore it, since only the large crystal form of quartz is of use as a controller.

The crystalline group has many varieties, one of which is common sand. The variety which is used for control, however, is a large, single crystal, usually six-sided. The leading source of this type of quartz is Brazil. However, it also is found in Arkansas. Attempts have been made to produce

e/e SWINGING ROCKS

quartz crystals in the laboratory, but to date synthetic quartz has not proven practical for general use.

The property of crystalline quartz which makes it of special use for control is known as *piezoelectricity*. Many other crystals, both natural and synthetic, also have this property. However, none of them also have the hardness of quartz. To see why the hardness and the piezoelectric property combined make quartz so important, we must take a slight detour and briefly examine the idea of resonance and resonators.

Resonators and Resonance. Resonance is an idea which has come a long way from its original meaning. The word itself comes from two Latin roots: *re-* meaning *to repeat*, and *sonare* meaning *to sound*, and the original meaning was to echo. (The poetic word *resound* (as in resounding) is the direct English equivalent of *resonate*.)

From the meaning of *echo*, through the world of music, the idea of resonance was expanded to denote a building-up of sound. Typical examples of such resonances are the sounding board of a piano, or the hollow portions of such stringed instruments as violins or guitars. The guitar offers a particularly dramatic example of the build-up in sound accomplished by a resonator, when the unamplified sound volume of an electric guitar (which has no resonator) is compared with that of a classic guitar. The resonator-less instrument is virtually inaudible.

As physicists developed the science of radio (the basis for modern electronics) they borrowed the acoustic notion of resonance and applied it to electrical circuits which built up their electrical waves in a manner similar to an acoustic resonator. For instance, both coils and capacitors store energy, but each acts in a manner inverse to the other. Thus a coil and a capacitor can be connected as a resonator (more often termed a resonant circuit) and when AC of appropriate frequency is applied to the resonator, special things happen.

Pendulum Demonstrates. The principle involved is identical to that of a pendulum, which is itself a resonator closely similar in operation to our quartz crystals. You can hang a pendulum of any arbitrary length

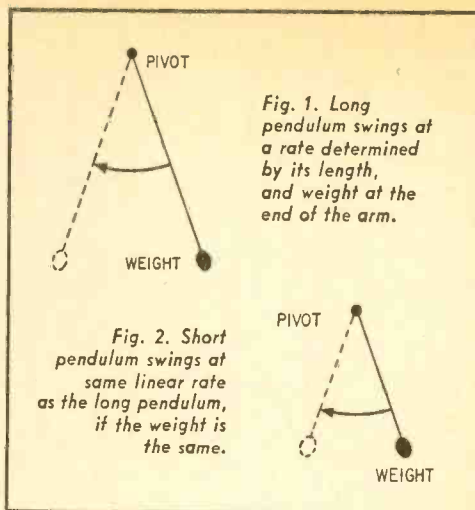

(Fig. 1), and start it swinging, then time its *period*—one complete swing or cycle. The number of such swings accomplished in exactly one second in the *natural* or *resonant* frequency of the pendulum in cycles per second (Hertz). (With pendulums of practical length, greater accuracy is attained by counting the number of swings in 10 seconds and then dividing the result by 10, since the frequency is quite likely to be less than one cycle per second.)

You can, by experiment, prove that the frequency at which the pendulum swings or oscillates is determined by the length of the pendulum. The shorter the pendulum (Fig. 2), the faster it swings (the greater the frequency). The weight of the pendulum has no effect on frequency, but has a marked effect upon the length of time the pendulum will swing after a single initial push. The heavier the pendulum, the greater number of cycles it will swing from a given initial start.

A Real Swinger. Once the pendulum begins to swing, very little effort is required to keep it swinging. Only a tiny push is needed, each cycle, provided that the push is always applied just as the pendulum begins to move *away* from the pushing point. If the push is given too soon, it will interfere with the swinging and actually cause the swing to stop sooner than it would without added energy, while if too late, added push will have virtually no effect at all. It is this principle—a tiny push at exactly the right time interval—which makes a resonator effect sound or AC waves. You can prove it with the pendulum by first determining

the resonant frequency of a pendulum, then stopping it so that it is completely still. A series of small pushes, delivered at the natural resonant frequency, (each too tiny to have more than a minute effect) will very rapidly cause the pendulum to swing to its full arc again. Pushes of the same strength at any other frequency will have little or no effect.

More Resonators—The Tuning Fork.

The pendulum is an excellent control mechanism for regulating a clock to keep time to the second, since the resonant frequency of the pendulum can readily be adjusted to be precisely one cycle per second (error can be made as small as desired by counting cycles over a long enough period of time—for example, to obtain 0.001% accuracy requires only that 100,000 swings of the pendulum be counted. If the swings require exactly 27 hours, 46 minutes, and 40 seconds, (27:46:40) the accuracy is exact. If the total time is between 27 hours 46 minutes 39 seconds (27:46:39) and 27:46:41, the accuracy is $\pm 0.001\%$).

However, for control of audio frequencies from tens of hertz (cycles per second) up to tens of thousands of cycles per second (kilohertz), or for radio frequencies ranging up to hundreds of millions of cycles per second (megahertz), the pendulum is too cumbersome a device.

In the audio range, the equivalent of the pendulum is the tuning fork. This is an extremely elongated U-shaped piece of metal (Fig. 3), usually with a small handle at the

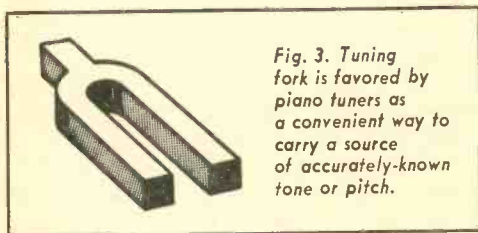

Fig. 3. Tuning fork is favored by piano tuners as a convenient way to carry a source of accurately-known tone or pitch.

base. When struck, it emits a single musical tone.

Shape and Size. The operating principle is exactly the same as the pendulum. Each of the arms or tines of the fork corresponds to a pendulum arm. But here the arms are extremely short, and are much heavier in proportion to their size than is the pendulum. (The shorter the arms of a tuning fork, the higher the resonant frequency in the audio range.) This greatly increased mass causes them to oscillate much longer when

initially started by striking the arms sharply.

Not all tuning forks operate precisely like pendulums. The pendulum principle is based upon a *flexing* of the arm upon its long dimension. While this is the most common operation, the fork *may* flex along any dimension. A recent design uses an H-shape rather than the U-shape, with the flexing taking the form of a twisting action at the crossbar of the H.

It's even possible for a single resonator (made of a solid substance), such as a tuning fork, to flex along several dimensions at once. A main part of the design of a good tuning fork is to be sure that only a single dimension flexes. In the language of resonators, only a single mode is excited.

Area Too. There's no requirement that the resonator be a completely solid substance. A mass of air, suitably enclosed, forms a resonator. This is the resonator that works on a classic guitar or violin. Here, single-mode operation is distinctly *not* desired. Instead, multiple-mode operation is encouraged, so that all musical tones within the range of the instrument will be reinforced equally.

Now, with the principles of resonance firmly established, we can return to the quartz crystal and its operation.

Quartz Crystals as Resonators. Like the tuning fork—or, for that matter, *any* sufficiently hard object—the quartz crystal is capable of oscillation when struck physically or otherwise excited.

But unlike the tuning fork, or indeed any other object except for certain extremely recent synthetic materials, the quartz crystal is not only sufficiently hard to oscillate at one or more resonant frequencies, but is piezoelectric.

Piezoelectricity. The piezoelectric property means simply that the crystal generates an electric voltage when physically stressed, or on the other hand will be physically deformed when subjected to a voltage. Other familiar objects making use of piezoelectricity include crystal and ceramic microphone elements, and phonograph cartridges.

This virtually unique combination of properties (sufficient hardness for oscillation and piezoelectricity) found in quartz crystals, makes it possible to provide the initial push to the crystal by impressing a voltage across it, and to provide the subsequent regular pushes by application of voltage at appropriate instants.

The use of quartz crystals in radio com-

SWINGING ROCKS

munications equipment is what made quartz such an important strategic mineral during World War II. Even today, no other substance is so suitable for frequency control as is natural crystalline quartz.

One point must be brought out before we progress. The pendulum and tuning-fork comparisons by which the principle of resonance has been established imply that the oscillation of a quartz crystal is due strictly to a *bending* action as shown in Fig. 4A. While this type of oscillation is widely used, other modes of oscillation are also important. One of the most important today is the *shear* mode. The mode of oscillation, excited for any particular crystal, depends upon many factors. The most important factor is the orientation of the crystal plate with regard to the axes of its "mother" crystal; we'll get into that later.

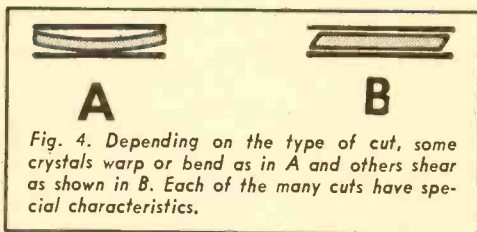

Fig. 4. Depending on the type of cut, some crystals warp or bend as in A and others shear as shown in B. Each of the many cuts have special characteristics.

The Quality Factor. Almost any discussion of resonance and resonant circuits (or for that matter, of inductance) eventually gets to the rather sticky subject which was labelled *quality factor* in the earliest days of radio, and is known universally as Q .

We've already met Q in practice, in the fact that a heavier pendulum swings for more cycles than a lighter one of the same period. Now, however, we must define the characteristic.

In The Swing. One method of defining Q (which is rather unconventional but has the virtue of being relatively easy to visualize) depends upon the two pendulums of identical frequency but different weight just referred to.

Let's assume that both have identical bearings, and offer exactly the same air resistance. In other words, just as much energy is lost to friction and air resistance by one as by the other. The *only* difference between

the two pendulums is their relative weights.

The mechanical operation of a pendulum depends upon the fall of an elevated weight from the extreme position toward the earth. When the pendulum reaches the center of its stroke the weight is as close to earth as it can get. From this point, the momentum of the moving weight carries it upward again to the other side of the arc, until *all* of the energy bound up by momentum is spent. This energy is spent in two ways. One is in overcoming the losses due to friction and air resistance. The other is in lifting the weight against the pull of gravity.

However, the energy "spent" (lost) in lifting the weight is actually only stored, since it provides the motive force for the next half cycle. *The only energy which is actually lost to the pendulum is that used to overcome friction and air resistance.*

Now the amount of energy represented by a weight lifted to a given height is directly proportional to both the weight and the height. In other words, the heavier the weight, the more energy is required to lift it to a given height.

Both our light pendulum and our heavy pendulum were assumed to start from the same full-swing position. This means, instantly, that the heavy pendulum is storing more energy than the light one. It now becomes obvious in theory as well as in experiment that the heavy pendulum will swing longer, since it starts with more stored energy and both heavy and light have identical losses. When the light one has used all its starting energy to overcome losses, the heavy one will still have energy with which to swing.

The essential difference between the heavy pendulum and the light one is, therefore, that the heavy one stores more energy.

Fairly obvious from theory, but not so easy to demonstrate by experiment, is the idea that if losses for the heavy pendulum were to be increased in the same ratio as the ratio of the weights, both would swing for the same length of time. The increased energy store of the heavy pendulum would be dissipated more rapidly in overcoming the increased losses. This leads us to a *quality factor*, Q , (if we assume that duration of oscillation is a *quality* worth measuring) which can be expressed as the ratio of energy stored per cycle to energy lost per cycle.

In the first instance, the heavier pendulum had higher Q . In the second (when losses were increased to make up for the ex-

cess energy) both pendulums had identical Q .

As used in radio and electronics, Q is usually defined by other means. Some of the definitions put forth at various times and places include:

The ratio of resistance to reactance in a coil,

The ratio of capacitive reactance in a resonant circuit to the load resistance,

The impedance multiplication factor, and others—even more confusingly worded.

All, however, come out in the end to be identical to the definition cited above: The Q of a resonator is the ratio of the energy stored per cycle to the energy lost per cycle.

In a resonator, high Q is desirable. The pendulum example shows that a resonator provides its own motive force, except for the energy lost to friction, resistance, and similar effects. Q is a measure of this energy loss. The less energy lost, the greater the Q of the circuit. Thus for greatest build-up, Q must be high.

Not so intuitively obvious (and rather difficult to prove without going into exotic mathematics) are some of the other effects of Q . A resonant circuit is never completely selective; frequencies which are near resonance but not precisely equal to the resonant frequency pass through also.

The greater the Q , the narrower the band of frequencies which can affect the resonator. Specifically, the so-called half-power bandwidth (Fig. 5) of a resonator (that

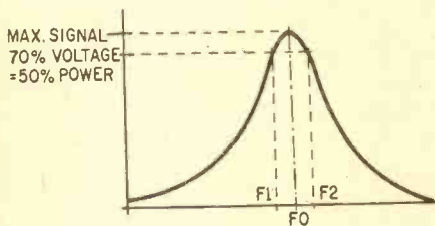

Fig. 5. Bandwidth characteristic of a typical tuned circuit shows the peak or maximum signal amplitude and the 70% voltage (50% power) points. This is the characteristic that determines overall selectivity.

band in which signals are passed with half or more of the power possessed by signals at the exact resonant frequency) is expressible by the fraction F_0/Q , where F_0 is the resonant frequency and Q is the circuit Q . Thus a 455-kHz resonant circuit with a Q of 100 will have a half-power bandwidth of 455/100 kHz, or 4.55 kHz. If Q is increased to 1000,

bandwidth reduces to 455/1000 kHz, or 4.55 Hz (cps). (This relation is an approximation valid only for single-tuned circuits; more complex circuits are beyond this basic discussion.)

The Q of Quartz Crystals. When we talk of the Q of conventional resonant circuits composed of coils and capacitors, a figure of 100 is usually taken as denoting very good performance and Q values above 300 are generally considered to be very rare.

The Q of a quartz crystal, however, is much higher. Values from 25,000 to 50,000 are not unheard of. Some handbooks rate the Q of a crystal at from 5 to 10 times those of the best L-C circuits but most authorities agree that 50 to 100 times are more accurate estimates.

The extremely high Q makes the crystal a much more selective resonator than can be achieved with L-C circuitry. At 455 kHz, for example, the bandwidth will be between 10 and 20 Hertz (cycles per second) unless measures are taken to reduce Q . Even in practice (which almost never agrees with theory), 50-Hertz bandwidths are common with 455-kHz crystal filters.

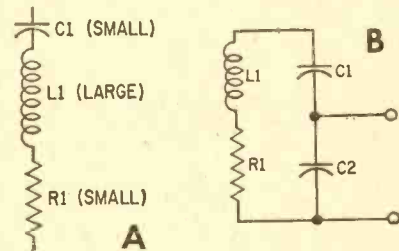
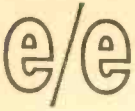

Fig. 6. Equivalent circuit of typical crystal (left) ignores capacitance of holder and wiring. Circuit is modified by addition of C_2 (right) which represents stray capacitance of wiring and of crystal holder.

So far as external circuitry is concerned, the crystal appears to be exactly the same as an L-C resonant circuit except for its phenomenal Q value. Fig. 6 shows this equivalent circuit; at A is the circuit of the crystal itself. When the unavoidable capacitance produced by the electrodes and holder is added to this circuit, the result is as shown in B.

Note from Fig. 6A that the crystal alone has the effect of a series resonant circuit. When the holder capacitance is added (6B), both series resonance and parallel resonance are present.

The frequency at which the mounted crystal is series-resonant and that at which parallel resonance occurs are not identical.



SWINGING ROCKS

The parallel-resonant frequency is always slightly (from 1.5 to 20 kHz) lower. Since this frequency is determined partially by the holder capacitance (C2), it will vary as the total capacitance across the crystal varies. We'll go into this effect later in some depth, since it offers both advantages and disadvantages to the crystal depending upon the particular application.

At series resonance, the crystal has very-low impedance. You may hear this effect referred to as a *zero* of the crystal. At parallel resonance, impedance is very high; this is sometimes called a *pole*. Fig. 7 shows

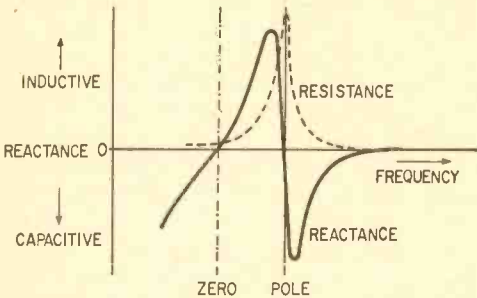

Fig. 7. Additional characteristic of quartz crystal is shown in the above graph. When slightly off the resonant frequency a crystal may exhibit inductive or capacitive reactance—just like an LC circuit.

a plot of *pole* and *zero* for a typical crystal. The special kind of crystal filter known as a half-lattice circuit matches the *pole* of one crystal against the *zero* of another, to produce a passband capable of splitting one sideband from a radio signal. Such filters are widely used in Ham, commercial, and to a lesser extent in CB transmitters.

When the crystal is used to control frequency of a radio signal or to provide a source of accurate timing signals, either the *pole* or the *zero* may be used. Circuits making use of the *pole* allow more simple adjustment of exact frequency, while those making use of the *zero* often feature parts economy. Later we'll examine several of each type.

From Rock to Finished Crystal. To perform its control functions properly, a quartz crystal requires extensive processing. The raw crystal of quartz must be sliced into plates of the proper dimensions and these plates ground to the precise size required.

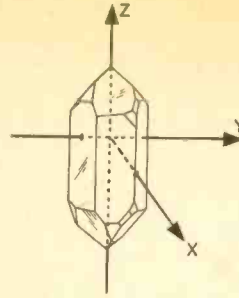

Fig. 8. Artist's simplified presentation of mother crystal shows X, Y and Z axes. Crystal is sliced into blanks, ground to frequency, polished and plated (on facing sides) to make permanent electrodes. All crystals are not perfect and must be examined and all axes determined, optically, before being sliced thin.

Parallel sides of the plates must be as close to precisely parallel, and as perfectly flat, as is possible to achieve. The electrodes must be in proper contact with the polished plate; in many modern units, the electrodes are actually plated directly onto the crystal surface.

The crystal plate is known as a *blank* when it is sliced from the raw crystal. The blank is cut at a precise angle with respect to the optical and electrical axes of the raw crystal, as shown in Fig. 8. Many of the *cuts* are shown in this illustration. Each has its own characteristics and is used for its own applications. Some, notably the X- and Y-cuts, are of only historic interest. The Y-cut was one of the first types of blanks used, but had a bad habit of jumping in frequency at critical temperatures. The X-cut did not jump, but still varied widely in frequency as temperature changed.

Today's crystals (Fig. 9) most frequently use the AT cut for frequencies between 500 kHz and about 6 MHz and the BT cut for the range between 6 and 12 MHz. Above 12 MHz, most crystals are specially processed BT- or AT-cuts used in *overtone* modes. While overtone (harmonic) operation was frowned upon when first introduced, modern overtone crystals are as stable as any other kind.

When especially small plates are required, the CT-, DT-, and GT-cuts may be used. These plates oscillate along the long dimension of the crystal, and are much smaller physically than are AT- or BT-cuts for the same frequency.

The blanks are cut only to approximate size. The plates are then polished to final size in optical lapping machines which pre-

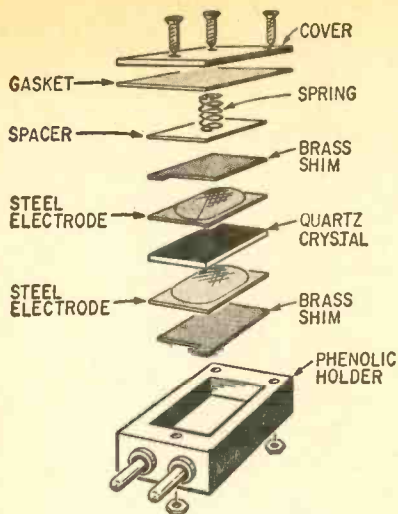

Fig. 9. Larger crystals (generally lower frequency) are assembled as above. Smaller ones, such as those used in CB walkie-talkies are sealed into metal cans only a $\frac{1}{4}$ -in. thick. Special crystals and those with internal heater are about size of frozen juice cans.

serve parallelism between critical surfaces. During the final stages of polishing, crystals are frequently tested against standard-frequency sources to determine exact frequency of operation.

If electrodes are to be plated onto the crystal surfaces, frequency cannot be set precisely by grinding since the electrodes themselves load the crystal slightly and cause a slight decrease in operating frequency. These crystals are ground just a trifle too thin for their intended frequencies, and the thickness of the electrodes is varied by varying plating time to achieve precision.

Accuracy. The precision which can be attained in production of quartz crystals is astounding. Accuracy of ± 0.001 percent is routine, and 10-time-better accuracy is not difficult. In absolute figures, this means an error of one cycle per megaHertz. In another frame of reference, a clock with the same accuracy would require more than 11 days to gain or lose a single second.

However, such accuracy can be achieved only when certain precautions are taken. For instance, the frequency of a crystal depends upon the circuit in which it is used as well as upon its manufacture. For accuracy of $\pm 0.005\%$ or greater, the crystal must be ground for a single specific oscillator, and must be tested in that circuit only if $\pm 0.001\%$ (or better) accuracy is required. Thus, CB transmitters are on the narrow

edge of being this critical. This is the reason that all operating manuals include cautions to use only crystals made specifically for the transmitter.

When one-part-per-million accuracy is required, not only must the crystal be ground for a single specific oscillator, but most often the oscillator circuit must then be adjusted for best operation with the crystal, and this round-robin adjustment kept up until required accuracy is achieved. Even then, crystal aging will make readjustment necessary for the first 12 to 18 months.

Frequency Variation — Causes and Cures. These possible variations in frequency stem from three major causes. *Cures* depend entirely upon the application; in some cases, variations are encouraged!

The most obvious cause of frequency variation is temperature. Like anything else, the crystal will change in size when heated and the frequency is determined by size. Certain cuts show less change with temperature than do others, but all have at least some change.

For most noncommercial applications, the heat-resistant cuts do well enough alone. For stringent broadcast-station and critical time-signal requirements, however, the crystal may be enclosed in a small thermostatically-regulated oven. This assures that the temperature is steady, and *cures* this cause of frequency change.

It's Wanted. Occasionally, temperature-caused variations in frequency prove useful. A case in point is one of the first OSCAR satellites; the designers wanted a comparison of satellite skin temperature in sunlight and in shadow. They placed two crystal oscillators aboard. The crystal of one was thermally insulated; that of the other was affixed to the satellite skin so as to undergo the widest extremes of temperature. The second oscillator was calibrated by temperature, to become in effect a remote-reading thermometer. To take the temperature, the difference in frequency between the two oscillators was measured. Results were better than expected.

The second well-known cause for variation of frequency is external capacitance. We've passed by this effect once or twice already (Fig. 6B). Some capacitance is always present, because the crystal electrodes form the plates of a capacitor with the crystal itself as dielectric. Most crystals intended for amateur use are designed to accommodate an external capacitance of 32- μ f., and

if external capacitance is either higher or lower than this the marked frequency may not be correct. Crystals for commercial applications are ground to capacitance specifications for the specific equipment in which they are to be used. CB crystals also are ground for specific equipment, although many transceivers employ the 32- μ f-standard set for Ham applications.

Varying Crystal Frequency. When utmost precision is required, a small variable capacitor may be connected in parallel with the crystal and adjusted to change frequency slightly. The greater the capacitance, the lower the frequency. Changes of up to 10 kHz may be accomplished by this means, although oscillation may cease when excessive changes are attempted.

Like temperature-caused variations, frequency variations due to capacitance may be useful in special cases. Hams operating in the VHF regions have obtained frequency modulation upon occasion by varying load capacitance applied to the crystal in their transmitters.

Netting. More useful is the adjustment known to commercial two-way radio installers as *netting*, which adjusts each transmitter and receiver in a complex system to operate upon exactly the same frequency. This is accomplished by varying load capacitance for the crystal in each transmitter in the system until all frequencies are identical.

The third cause for variation of frequency is a change in operating conditions in the associated circuit. This cause is more important with vacuum-tube circuits than with semiconductor equipment. As a rule, operating voltages for any vacuum-tube oscillator, or for any oscillator providing critical signals, should be regulated to prevent change.

Again, this cause can be used to provide FM (by deliberately varying voltages) or to provide remote indication of other conditions.

Crystal Aging. A final cause of frequency variation, so small as to be negligible in all except the most hypersensitive applications, is crystal aging. When a crystal is first processed, microscopic bits of debris remain embedded in its structure. These bits of debris work out during the first 12 months

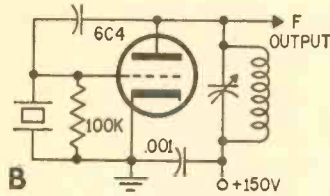
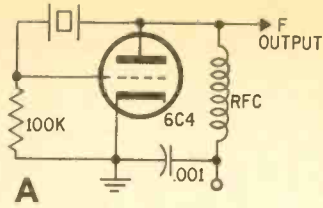

**MILLER OSCILLATOR
(FUNDAMENTAL OR OVERTONE)**

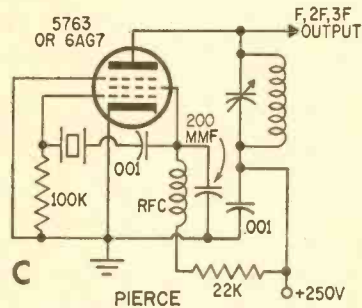

**PIERCE
ELECTRON-COUPLED CIRCUIT**

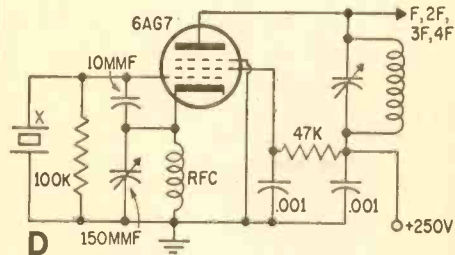

COLPITTS CRYSTAL OSCILLATOR

Fig. 10. Simplest crystal-oscillator circuit (A) is untuned. To change frequency all you have to do is plug in a different-frequency crystal. Miller oscillator (B) is almost as simple as the Pierce-type in A; tuned A circuit in output sets frequency of operation—harmonic can be used. Pierce electron-coupled oscillator (C) derives its feedback from the screen circuit, eliminating need for buffer amplifier in most cases. Saving one tube can be important in mobile transmitters. Colpitts oscillator (D) gets its feedback from cathode circuit. Variable capacitor in the grid-cathode circuit adjusts frequency for netting.

or so of use, but during that time the crystal's frequency changes by a few parts per million. Extreme-accuracy applications must take this change into account. For most uses, though, it may be ignored.

Using Quartz Crystals. After all the discussion of crystal theory, it's time to examine their uses through some typical circuits. While dozens of special crystal circuits have been developed for special applications, a sampling will suffice for discussion. Fig. 10 shows four typical vacuum-tube crystal oscillator circuits.

The simplest of these is the Pierce circuit, Fig. 10A. While at first glance this circuit appears to employ the crystal's *zero* to feed back energy from plate to grid, the *pole* is actually used through a mathematically-complex analysis. This circuit has one unique advantage; it contains no tuned elements except for the crystal, and therefore can be used at any frequency for which a crystal is available. This makes it an excellent test-signal source. The major disadvantage is that excessive current may be driven through the crystal if plate voltage rises above 90 VDC or so.

The Miller oscillator (Fig. 10B) is almost as simple to construct and operate as is the Pierce and has an additional advantage of operation with overtone crystals at up to the fifth overtone (harmonic). This is the circuit recommended by *International Crystal Mfg. Co.* for use with their overtone crystals. The capacitor of unmarked value between plate and grid is usually composed of the tube's grid-plate capacitance alone. The *pole* is used here also; energy feeds back through the capacitance, and the *pole* selects only that at the parallel-resonant frequency (shorting the rest to ground).

The electron-coupled Pierce circuit (Fig. 10C), is similar to the basic Pierce. The tuned circuit in the plate offers the possibility of emphasizing a harmonic—an RF choke may be used instead if freedom from tuning is desired and fundamental-frequency operation will suffice.

One of the most popular oscillators of all time is the Colpitts Crystal oscillator of Fig. 10D, sometimes known in Ham circles as the *grid-plate* oscillator. The feedback arrangement here consists of the two capacitors in the grid circuit; feedback is adjusted by means of the 150- μ f variable capacitor (the greater the capacitance, the less the feedback) until reliable oscillation is obtained. Like the other three oscillators, this

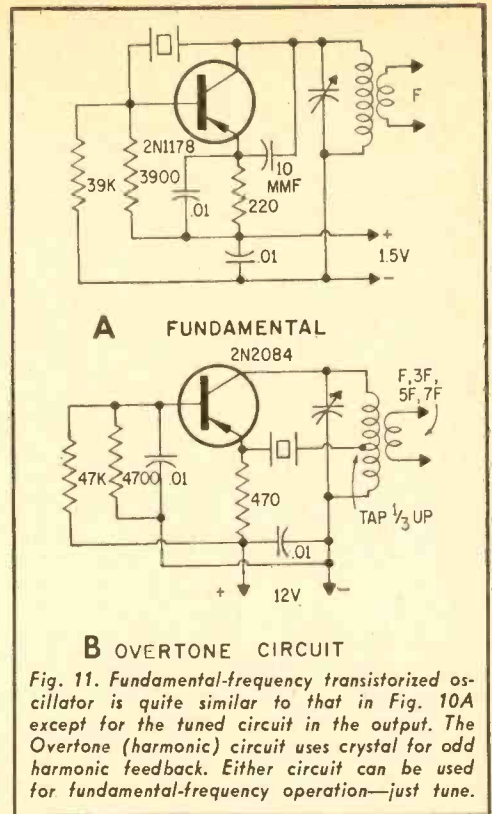

Fig. 11. Fundamental-frequency transistorized oscillator is quite similar to that in Fig. 10A except for the tuned circuit in the output. The Overtone (harmonic) circuit uses crystal for odd harmonic feedback. Either circuit can be used for fundamental-frequency operation—just tune.

circuit employs the crystal pole frequency.

Since all four of these oscillator circuits utilize the *pole* for frequency control, exact frequency adjustment capability may be obtained by connecting a 3-30 μ f. trimmer capacitor in parallel with the crystal.

Crystal oscillators may be built with transistors, too. Two typical circuits are shown in Fig. 11. Feedback mechanisms differ somewhat because of the basic differences between tubes and transistors. In general, transistorized oscillators are more stable.

As A Clock. To use a crystal as the timing element of a clock, an oscillator identical to those shown in Figs. 10 and 11 is the starting point. Crystal frequency is chosen at a low, easily-checked value such as 100 kHz. This frequency is then divided and redivided by synchronized multivibrators, to produce one-cycle-per-second pulses. These may then be counted by computer counting circuits.

In addition to being used as oscillators and timing elements, crystals find wide application in filters. Fig. 12 shows some typical crystal-filter circuits. While all circuits shown use vacuum-tubes, transistors may be substituted without modification of the filter

e/e SWINGING ROCKS

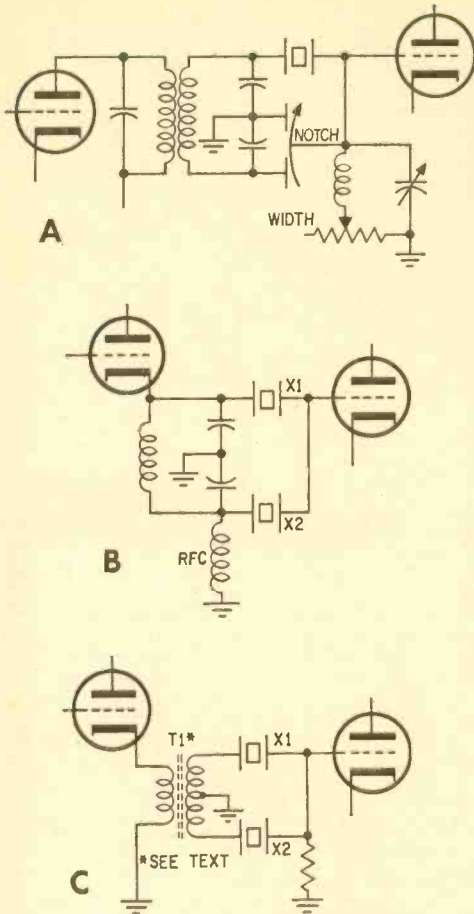

Fig. 12. Crystal filter used in the IF amplifier of a receiver sharpens the selectivity. Circuit in A uses special variable capacitor to adjust notch frequency and potentiometer to vary width (selectivity) of notch. Adding resistance lowers Q of crystal circuit which increases bandwidth. Two-crystal circuits are more expensive since specially-matched pairs are required. The mechanical filter gives the crystal-type a lot of competition where fixed bandwidth is wanted. Trifilar-wound transformer (T1 in C) can be wound by experimenters for home-brew receivers.

circuits themselves if the impedances are right.

The single-crystal filter circuit shown in Fig. 12A provides spectacularly narrow reception passbands. When the notch control is set to precisely balance out the crystal stray capacitance (C2 in Fig. 6B), the resonance curve of the filter is almost perfectly symmetrical. When the notch control is offset to one side or the other, a notch of al-

most-infinite rejection appears in the curve (the *pole*). The width control varies effective Q of the filter.

More popular for general usage today is the band-pass filter, shown as Figs. 12B and 12C. These filters pass a band of frequencies without excessive loss, and reject all frequencies outside this band. Both circuits make use of matched crystals (X1 and X2)—the *pole* of one must match the *zero* of the other for proper results. When this condition is met, the reactances of the two crystals cancel over the passband. The passband is roughly equal to the *pole-zero* spacing.

While the two circuits shown are virtually identical in operation, the transformer-coupled circuit of Fig. 12C is easiest for home construction. The only critical component is the transformer. It should be tightly coupled, with both halves of the secondary absolutely balanced. This is done by winding a trifilar layer of wire; the center wire becomes the primary winding and the remaining two wires become the secondary. The left end of one secondary half connects to the right end of the other, and this junction forms the center tap. The remaining two ends connect to the crystals. If you have sufficient patience to wind on it, a toroid form is recommended. The only absolutely critical requirement of the transformer, however, is that it have no resonant frequencies anywhere near the operating region.

Summing Up. Quartz crystals provide control for all branches of electronics, because of the combination of a hard crystal structure and the piezoelectric property. Although quartz is one of the most common substances on the face of the earth, the critical requirements placed upon its use in electronics make the quartz crystal a strategic item—especially since no synthetic substitute has ever been put into wide use.

Crystals are affected primarily by heat and by external capacitance, and because of this capacitance effect care must be taken in using them for critical applications. When frequency accuracy is essential, the crystal must be designed for the specific circuit and equipment in which it is to be used. Failure to respect this characteristic will result in off-frequency operation.

When used (with respect for their limitations and their quirks) crystals provide more precise control than can be achieved with any other type of component. For this reason, they will probably remain with us for many years to come. ■

HAMS ...at work

By Jack Schmidt

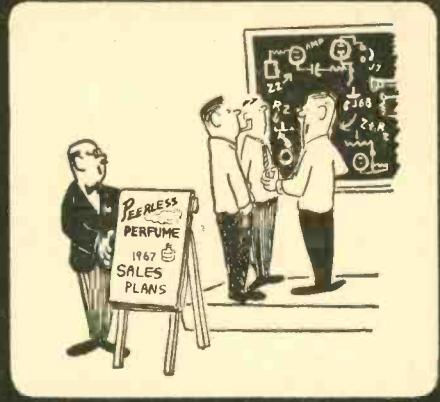

"If you gentlemen don't mind, we'd like to start this meeting!"



"Herbert, why don't you just take a coffee break the way the other men do?"

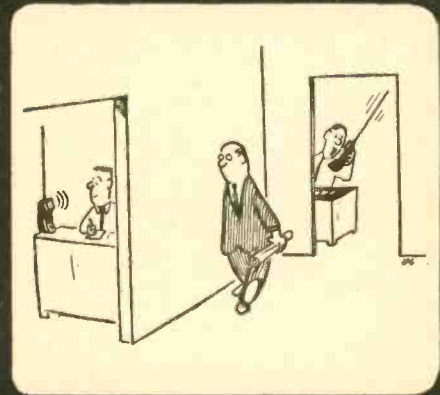

"Head's up, Ralph, the boss is coming!"

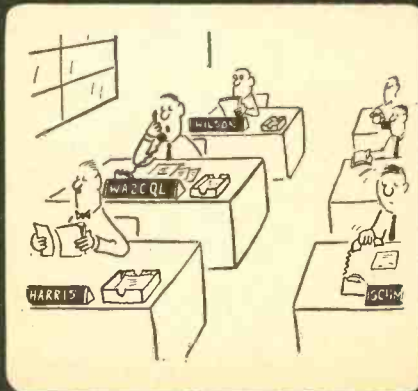

"Are you sure you gave me the right tape, Mr. Plunker. All I get are blips and blips!"



LITERATURE

★ Starred items indicate advertisers in this issue. Consult their ads for additional information and specifications.

LIBRARY



CB—AMATEUR RADIO— SHORTWAVE RADIO

121. Going CB? Then go *CB Center of America*. Get their catalog and discover the big bonus offered with each major product—serves all 50 states.

107. Get with the mobile set with *Tram's XL7100*. The new Titan CB base station, another *Tram* great, is worth knowing about.

116. Pep-up your CB rig's performance with *Turner's M+2* mobile microphone. Get complete spec sheets and data on other *Turner* mikes.

★93. *Heath Co.* has a new 23-channel all-transistor 5-watt CB rig at the lowest cost on the market, plus a full line of CB gear. See their new 10-band AM/FM/Shortwave portable and line of shortwave radios.

101. If it's a CB product, chances are *International Crystal* has it listed in their colorful catalog. Whether kit or wired, accessory or test gear, this CB-oriented company can be relied on to fill the bill.

48. *Hy-Gain's* new CB antenna catalog is packed full of useful information and product data that every CB'er should know. Get a copy.

111. Get the scoop on *Versa-Tronics' Versa-Tenna* with instant magnetic mounting. Antenna models available for CB'ers, hams and mobile units from 27 MHz to 1000 MHz.

45. Catering to 2-way radio buffs for 30 years, *World Radio Laboratories* has a new free catalog which includes the latest CB transceivers, etc. Quarterly fliers chock-full of bargains are also available.

115. Get the full story on *Polytronics Laboratories' latest CB entry—Carry-Comm*. Full 5-watts, great for mobile, base or portable use. Works on 12 VDC or 117 VAC.

50. Make your connection with *Amphenol*—tune in to the latest on CB product news with specs and pics on new gear. Keep informed on Amphenol's new products.

100. You can get increased CB range and clarity using the "Cobra" transceiver with speech compressor—receiver sensitivity is excellent. Catalog sheet will be mailed by *B&K Division of Dynascan Corporation*.

54. A catalog for CBers, hams and experimenters, with outstanding values. Terrific buys on *Grove Electronics' antennas, mikes and accessories*.

96. If a rugged low-cost business/industrial two-way radio is what you've been looking for, be sure to send for the brochure on *E. F. Johnson Co.'s* brand new Messenger "202."

103. *Squires-Sanders* would like you to know about their CB transceivers, the "23'er" and the new "55S." Also, CB accessories that add versatility to their 5-watters.

46. A long-time builder of ham equipment, *Hallcrafters* will send you lots of info on ham, CB and commercial radio-equipment.

KITS

★42. Here's a colorful 108-page catalog containing a wide assortment of electronic kits. You'll find something for any interest, any budget. And *Heath Co.* will happily send you a copy.

★44. *EICO's* new 48-page 2-color pocket-size short form catalog is just off the press. Over 250 products: Ham radio, CB, hi-fi—in kit and wired form—are illustrated. Also, discover *EICO's* new experimenter kit line.

ELECTRONIC PRODUCTS

66. Try instant lettering to mark control panels and component parts. *Datak's* booklets and sample show this easy dry transfer method.

108. Get the facts on *Mercury's* line of test equipment kits—designed to make troubleshooting easier, faster and more profitable.

67. "Get the most measurement value per dollar," says *Electronics Measurements Corp.* Send for their catalog and find out how!

92. How about installing a transistorized electronic ignition system in your current car? *AEC Laboratories* will mail their brochure giving you specifications, schematics.

109. *Seco* offers a line of specialized and standard test equipment that's ideal for the home experimenter and pro. Get specs and prices today.

ELECTRONIC PARTS

120. *Tab's* new electronics parts catalog is now off the press and you're welcome to have a copy. Some of *Tab's* bargains and odd-ball items are unbelievable.

117. Harried by the high cost of parts for projects? Examine *Bigelow's* 13th Anniversary catalog packed with "Lucky 13" specials.

1. *Allied's* catalog is so widely used as a reference book, that it's regarded as a standard by people in the electronics industry. Don't you have the latest *Allied Radio* catalog? The surprising thing is that it's free!

★2. The new 1967 Edition of *Lafayette's* catalog features sections on stereo hi-fi, CB, ham gear, test equipment, cameras, optics, tools and much more. Get your copy today.

★3. Bargains galore! Parts, tools, test equipment, radios and many more specials at ultra-low prices. *Progressive Edu-Kits* will send latest catalog.

★4. *Olson's* catalog is a multi-colored newspaper that's packed with more bargains than a phone book has names. Don't believe us? Get a copy.

★23. No electronics bargain hunter should be caught without the 1967 copy of *Radio Shack's* catalog. Some equipment and kit offers are so low, they look like misprints. Buying is believing.

★5. *Edmund Scientific's* new catalog contains over 4000 products that embrace many interests and fields. It's a 148-page buyers' guide for Science Fair fans.

★106. With 70 million TV's and 240 million radios somebody somewhere will need a vacuum tube replacement at the rate of one a second! Get *Universal Tube Co.'s* Troubleshooting Chart and facts on their \$1 flat rate per tube.

★8. Get it now! *John Meshna, Jr.'s* new 46-page catalog is jam packed with surplus buys—surplus radios, new parts, computer parts, etc.

6. Bargains galore, that's what's in store! *Poly-Paks Co.* will send you their latest eight-page flyer listing the latest in available merchandise, including a giant \$1 special sale.

10. *Burstein-Applebee* offers a new giant catalog containing 100's of big pages crammed with savings including hundreds of bargains on hi-fi kits, power tools, tubes, and parts.

11. Now available from *EDI (Electronic Distributors, Inc.)* a catalog containing hundreds of electronic items. *EDI* will be happy to place you on their mailing list.

★7. Before you build from scratch check the *Fair Radio Sales* latest catalog for electronic gear that can be modified to your needs. *Fair* way to save cash.

12. VHF listeners will want the latest catalog from *Kuhn Electronics*. All types and forms of complete receivers and converters.

HI-FI/AUDIO

26. Always a leader, *H. H. Scott* introduces a new concept in stereo console catalogs. "At Home With Stereo" offers decorating ideas, a complete explanation of the more technical aspects of stereo consoles.

85. Need a tuner? Preamp? Amp? Tape deck? Then inspect *Dynaco* for kits or wired units. It's worthwhile looking at test reports *Dynaco* sends your way.

119. *Kenwood* puts it right on the line. The all-new *Kenwood* stereo-FM receivers are described in a colorful 16 page booklet complete with easy-to-read-and-compare spec data. Get your copy today!

15. Besides sending specs on their famous speaker systems and turntable, *Acoustic Research* would like to give you a copy of their new "Stylus Force" booklet—must reading for hi-fi bugs.

16. Discover how Cueing Control, anti-skating and other *Garrard* features in the Lab 80 offer tops in audio listening. 32-page *Garrard* Comparator Guide will make you a wiser buyer—get it.

17. *Electro-Voice* has two new, pocket-size, four-color product guides for you. One covers speakers and components; the other, microphones and accessories.

19. *Empire* has made exceptional advances in speaker cabinet design you should read about. Also, *Empire's* successes in the turntable and cartridge fields are worth discovering.

24. Need a hi-fi or PA mike? *University Sound* has an interesting microphone booklet audio fans should read before making a purchase.

27. 12 pages of *Sherwood* receivers, tuners, amplifiers, speaker systems, and cabinetry make up a colorful booklet every hi-fi bug should see.

95. Confused about stereo? Want to beat the high cost of hi-fi without compromising on the results? Then you need the new 24-page catalog by *Jensen Manufacturing*.

99. Get the inside info on why *Acoustech's* solid-state amplifiers are the rage of the experts. Colorful brochure answers all your questions.

TAPE RECORDERS AND TAPE

113. *Scotch* is the product and it's made by *Minnesota Mining and Mfg. Co. (3M)*. Get a packet full of facts and tape data from *3M* and learn all about your tape recorder and the tape it needs.

31. All the facts about *Concord Electronics Corp.* tape recorders are yours for the asking in a free booklet. Portable, battery operated to free track, fully transistorized stereos cover every recording need.

32. "Everybody's Tape Recording Handbook" is the title of a booklet that *Sarkes-Tarzian* will send you. It's 24-pages jam-packed with info for the home recording enthusiast. Includes a valuable table of recording times for various tapes.

33. Become the first to learn about *Norelco's* complete Carry-Corder 150 portable tape recorder outfit. Four-color booklet describes this new cartridge-tape unit.

34. "All the Best from Sony" is an 8-page booklet describing *Sony-Super-scope* products—tape recorders, microphones, tape and accessories. Get a copy before you buy!

35. If you are a serious tape audiophile, you will be interested in the new *Viking of Minneapolis* line—they carry both reel and cartridge recorders you should know about.

91. Sound begins and ends with a *Uher* tape recorder. Write for this new 20 page catalog showing the entire line of *Uher* recorders and accessories. How to synchronize your slide projector, execute sound on sound, and many other exclusive features.

HI-FI ACCESSORIES

112. *Telex* would like you to know about their improved *Serenata* Headset—and their entire line of quality stereo headsets.

98. Swinging to hi-fi stereo headsets? Then get your copy of *Superex Electronics' 16-page* catalog featuring a large selection of quality headsets.

104. You can't hear FM stereo unless your FM antenna can pull 'em in. Learn more and discover what's available from *Finco's* 6-page "Third Dimensional Sound."

SCHOOLS AND EDUCATIONAL

114. Prepare for tomorrow by studying at home with *Technical Training International*. Get the facts today on how you can step up in your present job.

59. For a complete rundown on curriculum, lesson outlines, and full details from a leading electronic school, ask for this brochure from the *Indiana Home Study Institute*.

★61. *ICS (International Correspondence Schools)* offers 236 courses including many in the fields of radio, TV, and electronics. Send for free booklet "It's Your Future."

★74. Join the troubleshooters! Let *CIE (Cleveland Institute of Electronics)* train you to keep our electronics world running.

105. Get the low-down on the latest in educational electronic kits from *Trans-Tek*. Build light dimmers, amplifiers, metronomes, and many more. *Trans-Tek* helps you to learn while building.

TOOLS

118. Secure coax cables, speaker wires, phone wires, etc., with *Arrow* staple gun tackers. 3 models for wires and cables from 3/16" to 1/2" dia. Get fact-full *Arrow* literature.

★78. Need a compact screwdriver kit? *Xcelite's* 99PV-4 and 99PV-6 consists of handle, 3 and 5 blades, respectively, in "see-thru" zipper case. Get *Xcelite's* catalog 166.

TELEVISION

70. *The Heath Co.* now has a 19" color TV to complement their 21" and 25" models. A new B&W portable model will be a hot seller for the mobile set. Get the facts today!

97. Interesting, helpful brochures describing the TV antenna discovery of the decade—the log periodic antenna for UHF and UHF-TV, and FM stereo. From *JFD Electronics Corporation*.

ELEMENTARY ELECTRONICS,
Dept. 767
505 Park Avenue,
New York, N. Y. 10022

Please arrange to have the literature whose numbers I have circled sent to me as soon as possible. I am enclosing 25¢ for 1 to 10 items; 50¢ for 11 to 20 items to cover handling (no stamps, please). Maximum number of items—20.

1-10 items

11-20 items



CHECK ONE

maximum number of items = 20

Indicate total number of booklets requested

1	2	3	4	5	6	7	8	10	11
12	15	16	17	19	23	24	26	27	31
32	33	34	35	42	44	45	46	48	50
54	59	61	66	67	70	74	78	85	91
92	93	95	96	97	98	99	100	101	103
104	105	106	107	108	109	111	112	113	114
115	116	117	118	119	120	121			

NAME (Print clearly) _____

ADDRESS _____

CITY _____

STATE _____ ZIP _____

NewsScan

Continued from page 24

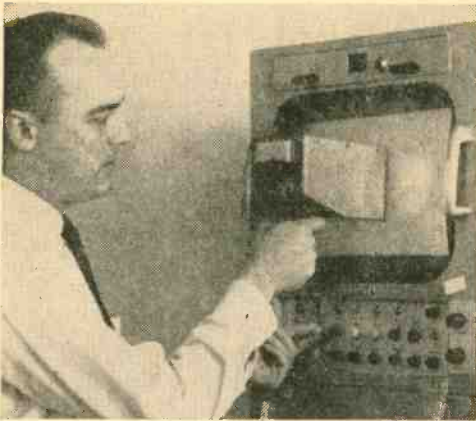

Technician shoots for true color using TV Colorgard, a color comparator developed by Gardner Laboratory of Washington, D. C. Operation is as simple as the photo indicates. Just hold the pistol-like unit against the monitor and twist a few knobs.

justing one monitor, using his own color value memory or color interpretation as the standard to obtain the illuminant "C" conditions. Obviously, this method caused color balance discrepancies among the various color monitors.

In operation, the instrument is held against the monitor screen as each color (red, green, blue) is displayed separately on the screen. Each color is filtered and then measured by the instrument. To obtain color balance on the screen, the color temperature (color is measured by its temperature) is varied by adjusting the monitor controls until the TV Colorgard indicates that the correct monitor setting has been achieved for each color. Each color is checked three times during the setup operation; for the high-end adjustment, the low-end and a repeat of the high-end adjustment. Now all we need is a low priced unit for the home serviceman. Obtaining a color balance in a home color TV receiver is worth five bucks.

DC Leaves DC

The national electrical standards are now located at the new Gaithersburg (Md.) laboratories of the National Bureau of Standards. The standards were carefully transported to new and larger Gaithersburg quarters under police escort from the old Washington (D.C.) laboratories of the Bureau.

From these basic electrical standards—for the volt, ohm, farad, and watt—NBS has derived other standards for all electrical quantities in use today. Thus the accuracy and reliability of all electrical equipment, devices, and meters used in this country depend upon the accuracy of these standards. An error of a fraction of a

percent in the determination of the ohm, for example, could cause errors of millions of dollars in the electric utility bills paid by industry and private householders.

The standards that were transferred included a group of very constant standard cells, from which the DC volt is obtained as an average value; standard resistances that provide the ohm; standard capacitors for the farad; and a standard wattmeter.

The most difficult part of the operation was the transfer of the delicate standard cells. These cells are sensitive to light, electric current, shock, and vibration, and are especially sensitive to temperature. A temperature change of a tenth of a degree would change a cell's electromotive force by about 5 microvolts. Normally, the cells are kept in a constant-temperature oil bath. Tipping a cell more than 45° or inadvertent contact of the terminals of a cell with each other permanently destroys the cell.



The national practical standard for DC voltage is the average value of a group of very stable saturated standard cells. NBS staff member is making a connection to one of the cells which are kept in an oil bath maintained within a few thousandths of 28° C.

Corning Goes Blank

A giant fused silica mirror blank, 144 inches in diameter, has been completed by Corning Glass Works for the European Southern Observatory (ESO). The mirror blank, the largest piece of fused silica ever fabricated, will serve as the primary optical element in one of the world's largest telescopes.

The European Southern Observatory is the culmination of an effort started in 1953 and leading to a state convention between Belgium, France, West Germany, the Netherlands and Sweden in 1962. The five nations agreed to establish a joint astronomical observatory in the southern hemisphere to study relatively uncharted areas of the heavens.

Nearly all of the world's present observatories with large optics are located in the northern hemisphere. ESO is one of several recent

programs to establish major observatories in the southern hemisphere. Construction of the observatory began in 1965 and will be completed in two stages—the first in 1968-9; the second, with the large telescope, in 1971-2.

The giant ESO telescope will be erected on the mountain of La Silla in Chile, about 40 miles north of Vicuna and 55 miles northeast of La Serena. The site, chosen after comprehensive studies of several areas in South Africa and South America, is 8,000 feet above sea level.

The two largest telescopes now in operation are the 200-inch Hale telescope at Mount Palomar in southern California, and the 120-inch telescope at Mount Hamilton near San Francisco. The 200-inch and the 120-inch primary mirrors were cast by Corning in 1934 of Pyrex brand borosilicate glass.

Corning Code 7940 fused silica is an even better mirror material. It is one of the purest of man-made materials, and its thermal expansion rate (5.6×10^{-7} in/in/ $^{\circ}$ C) is only about one-fifth that of the borosilicate glass used for the Hale telescope (expansion 26×10^{-7}). This means the

mirror will have minimal dimensional change under severe temperature changes, thus ensuring better images.

In a reflective telescope, light does not pass through the large glass disc. Rather the precision curve, polished to tolerances of a few millionths of an inch, is coated with a thin film of aluminum. The large mirrors used in such telescopes serve not so much to magnify, but to gather as much light as possible so that fainter astronomical objects can be studied.

Final optical grinding and polishing will be done in Europe by the firm of *Reosc* in Paris. This is expected to take two to three years. Corning performed the initial finishing operations to prepare the blank for final optical figuring and polishing. These included grinding the circumference round, cutting a center hole 28 inches in diameter, flattening the bottom of the disc, and contouring the top surface to the approximate curvature needed in the final mirror.

The 144-inch blank is the biggest piece of fused silica yet completed. Corning is now fabricating a 152-inch mirror for the Queen Elizabeth II Observatory in Canada. ■

En Passant

Continued from page 19

This fascinating two mover by Rev. Suyker was composed in 1948, when he was in Bolivia, and first appeared in "Maasbode," a Dutch publication.

Solution to Problem 6: 1 N-R3.

News and Views. An IBM 7090 computer programmed by Dr. John McCarthy at California's Stanford University defeated the computer of the Carnegie Institute of Technology in Pittsburgh in a transcontinental chess match started about a year ago. And now the Stanford computer is battling the transistors of the M-20 machine at Moscow's Institute of Experimental and Theoretical Physics! Games are played by telegraph.

Dr. Hans Berliner of Bethesda, Maryland, a

computer analyst, is competing in the Finals of the 5th World Individual Correspondence Chess Championship conducted by the International Correspondence Chess Federation. His opponents are 3 Czechs, 2 Germans, 2 Swedes, one each from Australia, Denmark, France and the USA and six from the USSR. All moves are sent via Air Mail.

Vancouver, British Columbia, defeated Calgary, Alberta, 6½-1½ in a match by teletype. Involved were 750 messages, sent in each direction.

International Grandmaster Arthur B. Bisguier, formerly with IBM and now an editor of "Chess Review," the picture chess magazine, scored 5½-½ to take first in the Empire City Open in New York.

Larry Kaufman, a USCF Master and a student at MIT, won the American Open at Santa Monica. Having tied at 7-1 with Robion Kirby, a professor of mathematics at UCLA, he was declared the winner on tie-breaking points. ■

The Sphinx Wouldn't Tell

Continued from page 29

crease from a particular direction, he will know the muons have passed through an empty space rather than a solid mass.

Alvarez' two spark chambers are each about 1-in. thick, 3 ft. wide, and 6 ft. long. They are hollow, have two layers of wires, and are filled with neon gas in which a passing particle causes a spark. Electronic equipment determines the angle of passage

and the direction from which each particle came.

For a period of 18 months, the round-the-clock recordings will be picked up at Gizeh each night and fed to the Ein Shams Computing Center in Cairo. In this way, it should be possible to cite the exact location of a hidden chamber. If that happens, one of the most beguiling mysteries ever posed may be solved. For the magic of electronics will have found what man's wits, battering rams, and gunpowder couldn't. And it will have discovered what the Sphinx through the ages wouldn't tell. ■

Heathkit TA-16 Guitar Amp

Continued from page 84

modulator transistor supplied in the kit had the same identification number as the replacement—417-110—the replacement was actually a different transistor. And once the replacement was installed, the tremolo worked well. The “defective” transistor had a second identification number of 624, in addition to Heath’s number of 417-110. The correct replacement carries the additional number of 625, so make certain you get the 625. If you don’t write to Heath immediately for the 625; don’t waste several hours

DX on Ice

Continued from page 82

so you’ll have no trouble determining exactly how close they are to the magnetic pole. Further, these flights, and Reykjavik, transmit on several frequencies not used by Goose Bay and Sondstrom. Some of the more promising ones are 17966, 13284 and 8862½ kHz.

Greenland Calling. The shortwave station closest to the earth’s north magnetic pole is the Strategic Air Command base at Thule, Greenland. With a great deal of patience and luck, you might hear it working USAF flights with single sideband on 11228 kHz (daytime only), or at night on 6730½ and 4731½ kHz—all regular USAF channels. However, 4731½ kHz frequency suffers QRM from an Ecuadorian SWBC station.

Greenland is also blessed with a shortwave broadcast station, Grønlands Radio at the territory’s capitol, Godthaab. It occasionally sneaks into the United States on 5980 kHz. DXers east of the Mississippi should watch for it when northern conditions are good around 1700 EST, while listeners further west should try around 1500 PST.

Another Arctic broadcast station using 49 meters is R. Norway’s home service relay at Tromsø, near the nation’s northern tip and transmitting on 6130 kHz. Best listening times are the same as those for Grønlands Radio.

Several major SWBC stations also operate from semi-Arctic locations. These are R.

(as we did) looking for a wiring error or some other miscellaneous boo-boo that really doesn’t exist.

Summing Up. Comparing performance against price, you won’t be disappointed. Even though the price is relatively low, performance is strictly first-class. The sound is very good by any standards; the tremolo is very effective and deep; and the echo is of long duration, cavernous when turned full on. We question whether one could discern any difference between the TA-16 and a factory-wired amplifier selling for twice its price.

For additional information on the TA-16, write to Dept. EB, Heath Co., Benton Harbor, Mich. 49022. ■

Sweden at Stockholm, R. Norway at Oslo, R. Finland at Pori, and various R. Moscow relays in Siberia. The first three can be heard at a variety of times and their frequencies will be found in White’s Radio Log, a regular feature of our sister publication, RADIO-TV EXPERIMENTER. Your best bet for an Arctic Siberian catch probably is the transmitter at Magadan on 9500 kHz. Watch for it around midnight, EST, relaying R. Moscow’s home service for Soviet seamen in the North Pacific; reports should be sent directly to Moscow.

Antarctic Way. Now, switching to the earth’s southern magnetic pole, the DX situation is even wilder. In the first place, conflicting territorial claims are so confused that all of Antarctica is counted as just one DX country. Further, all shortwave stations down here, except the Amateur variety, use CW.

However, the Argentine Naval station, LOE, at Deception Island (just off the Palmer Peninsula) has a weather broadcast every night at 1830 EST on 13050 kHz. Prior to such transmissions a short marker signal is always sent. This consists of the call repeated several times (--- ---) and interspersed with CQ’s (--- ---). Even with a minimum knowledge of the code you should be able to log markers with a little practice, especially when the time and frequency is known in advance.

One thing to bear in mind when you’re trying for these far out places: good equipment, and especially, a good antenna and ground are a must. Remember too, to orient your antenna in the direction you’re most anxious to receive. Now, warm up the rig, and let’s dig for some frozen DX. ■

Knight KG-640 VOM

Continued from page 40

ua. through the 10,000-ohm shunt resistor. The value of resistance for each applied volt is 100,000 ohms divided by 10 volts, or 10,000 ohms-per-volt. In short, though the meter scale has been *doubled*, the meter's sensitivity has been reduced from 20,000 to 10,000 ohms per volt—see Fig. 4.

Note that we have referred to *doubling* the meter scale whereas the Knight KG-640 has a half-range switch. Actually, the VOM's basic (indicated) ranges are the 10,000 ohms-per-volt ranges. Activating the half-range (VA/2) switch converts the circuit to 20,000 ohms-per-volt ranges. *Knight* could just as easily have indicated the change as a $V \times 2$ and changed the panel marking and scale calibrations accordingly. But it really doesn't make much difference.

Other Extra Features. The meter scale is mirrored, so that the user can line-up the meter pointer with its mirror image to eliminate parallax error. The meter movement is the taut-band type which is supposed to be extra rugged as there are no pivots or weights to go out of adjustment, the main

cause of the pointer to move off the zero position when the meter is placed standing up rather than on its back cover. This might all be true, but the taut-band meter on our KG-640 changed zero position just like a pivoted and balanced movement.

Kit or Wired. The KG-640 is available in kit form for \$39.95 or wired for \$59.95. You might as well save the wiring costs as the kit assembly, like any other VOM kit, is extremely easy and almost troubleproof. The photos give you the best idea of the assembly.

Performance. The performance of the KG-640 is equal to the performance of any other kit or wired VOM of equivalent price. If you have need for the extra ranges provided by the half-scale function, that of course is an advantage. However, keep in mind that the extra ranges means extra meter scales, and may be a bit confusing until you get the hang of it.

No fuse is provided, since the meter is protected with reverse-parallel diodes. Applying an overload of 5 times did not damage the meter movement, and there was no bending the pointer.

For additional information on the KG-640, write Allied Radio Corp., Dept. JR, 100 N. Western Ave., Chicago, Ill. 60680. ■

Reynolds Wrap Amp

Continued from page 33

Fasten the Q2 base terminal lead in the same way. Then turn the board over and fasten the other component leads to the board circuits, as designated in the $\frac{3}{8}$ -in. circles. (Make sure you use unpainted eyelets.) Since only half the T1 secondary is used, the lead can be clipped off.

We used Fahnestock clips attached to the circuit board with eyelets as amplifier input, output, and power-supply terminals. You can also use solder lugs (mounted the same way) as the terminals or even ordinary wire leads. Mount small rubber feet at the board corners.

A Look at The Schematic. Audio signals at the input terminals are fed through C1 to the base of Q1, and bias current for Q1 is supplied by R1. The amplified signal is coupled through T1 to the base of Q2. Bias current for Q2 is supplied by R3-R4 and the amplified audio is direct-coupled to an external speaker.

Maximum audio output is realized with a 45-ohm speaker and 12-volt power supply. The output drops with lower impedance speakers and lower battery or power-supply voltages.

Since there is no way to adjust gain, an external volume control with a 5K to 50K maximum value can be used at the input. ■



A Is For Automatic

Continued from page 80

taining the sync pulses. Those pulses are approximately +75 volts. (Since the tube's cathode is returned to a +100-volt point, only the sync pulses are strong enough to get through the tube. The weaker video signal, therefore, is rejected.) Observe that the tube plate is not connected to the usual source of B-plus voltage. The necessary plate voltage is being picked up from "H"—a point in the horizontal deflection circuit. That point feeds to the tube a series of high-voltage pulses that happen *exactly in step* with the sync pulses reaching the grid. This is the keying idea; sync pulses may ride through the tube only as the stage switches on. And that happens only when the plate receives a positive burst or pulse. The tube is dead during a powerful noise pulse shown riding on the video signal to the grid. For this reason, AGC at the output won't develop large voltages due to noise. It only follows the height of the sync pulse. Another benefit of keying is that the AGC filter can be of short time constant (low values of resistance and capacitance) and thus exercise rapid control of receiver gain—preventing picture flicker.

Solid Systems. Anyone working with AVC or AGC generally thinks in terms of a negative bias which reduces receiver gain. With the introduction of transistorized equipment this basic thinking must often do an about face since many semiconductors operate in reverse fashion—a negative voltage *increases* gain. Thus we have to reverse

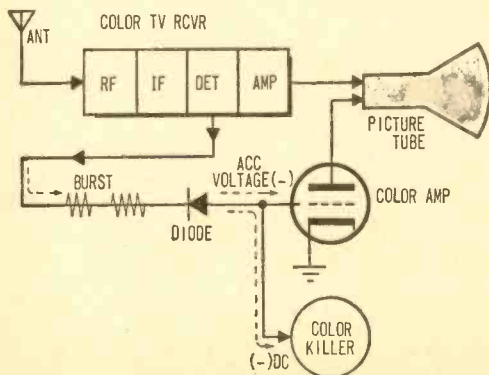

Fig. 9. Another application of AGC is in color TV. Called ACC—automatic color control, circuit keeps colors from shifting every time supply voltage changes.

some circuit polarities. To illustrate a solid-state version of AGC, we've shown a section of circuitry in a typical transistor portable.

As shown in Fig. 8, the detector (at the right) is simply a crystal diode. As the RF carrier passes through the diode it is rectified and audio is produced across the volume control. A portion of the carrier from the diode (now in the form of DC pulsations) is simultaneously applied to the AGC filter. Noted that detector output is marked "+"—the diode is connected in the circuit so the negative part of the carrier is eliminated. In contrast to earlier tube circuits, the detector signal is positive. Next the carrier is smoothed to pure DC (audio variations removed) in the AGC filter and applied to the first IF amplifier. If an incoming signal increases in strength, AGC correspondingly rises in the *positive* direction.

Color Too. Final member of the Triple-A is AGC, for *automatic color control*. Although a color-TV set contains a keyed AGC circuit to control overall sensitivity of the receiver, it is beneficial to add another AVC-like circuit. The use of AVC permits very close regulation of the color circuits to prevent annoying changes on the screen. No new principles are used but the signal source is exotic, as shown in Fig. 9. Note that a *color Burst* voltage is taken from the color-TV detector stage. This is the equivalent of the radio carrier or sync pulses described for earlier circuits. The burst signal, in fact, represents the carrier needed to transmit color—only it is sent in pieces in the interests of economy. (The burst is converted to a complete carrier in the receiver.) The main point is that a burst signal changes strength according to receiving conditions. Thus it can be applied to a diode, as shown, and emerge as a DC control voltage. It adjusts the gain of the color amplifier—just as AVC controlled an IF stage in the earlier examples.

This circuit also has a counterpart in another circuit described earlier; QAVC or squelch. Note in Fig. 9, that the same DC control signal is also applied to a *color killer*. This stage prevents blobs of color or "confetti" from appearing on the screen during a black-and-white program. When no color is transmitted, the burst is absent and no DC voltage appears at the diode and the *color killer* reacts by blocking the path of any spurious signals through the color circuits—just as a squelch silences a speaker in a radio when the carrier is missing. ■

CLASSIFIED Market Place

FOR BIGGER PROFITS! NEW CAREER OPPORTUNITIES!
READ AND REPLY TO THESE CLASSIFIED ADS

Classified Ads 55¢ per word, each insertion, minimum 10 words, payable in advance. To be included in the next available issue of **ELEMENTARY ELECTRONICS**, copy must be in our New York Office by July 10th. Address orders to C. D. Wilson, Manager, Classified Advertising, **ELEMENTARY ELECTRONICS**, 505 Park Ave., New York, N. Y. 10022.

ADDITIONAL INCOME

MAKE Your Classified Ad Pay. Get "How," To Write a Classified Ad That Pulls. Includes certificate worth \$2.00 towards classified ad in S & M. Send \$1.00 to C. D. Wilson, Science & Mechanics, 505 Park Ave., New York, N. Y. 10022.

BUSINESS OPPORTUNITIES

I MADE \$40,000.00 a year by Mailorder! Helped others make money! Start with \$10.00—Free Proof! Torrey, Box 318-T, Ypsilanti, Michigan 48197.

FREE Book "990 Successful Little-Known Businesses." Fascinating! Work home! Plymouth 111-L, Brooklyn, N. Y. 11218.

BE your own boss! Free details unusual business opportunities. Continental, Box 1323D Downtown Station, Omaha, Nebr. 68101.

For Business Opportunities—read Science & Mechanics, 12 issues \$4.00. Write Science & Mechanics, 505 Park Ave., New York, N. Y. 10022.

EARTHWORKS

BIG Money Raising Fishworms and Crickets. Free literature. Carter Farm-O, Plains, Georgia 31780.

EDUCATION & INSTRUCTION

CORRESPONDENCE Courses — B.Sc., Engineering, Electronics. Catalog \$1.00. Canadian Institute of Science & Technology, 263J Adelaide St. W., Toronto.

FCC License and Associate Degree correspondence/residence courses. School bulletin free. Grantham Institute of Electronics, 1505 N. Western Ave., Hollywood, Calif. 90027.

EMPLOYMENT INFORMATION

EMPLOYMENT—U.S. Engineers—Electrical, Mechanical, Chemical, Civil; Technicians, Technicians. Become your own boss, choose your own place to work and enjoy \$15,000 to \$40,000 a year, paid vacations per diem. Why settle for less, use your abilities to their fullest on a variety of government and commercial jobs. For complete details and lists of companies, send \$10.00 to: R & D Consultants, Box 596, Williamstown, Mass. 01267.

FOLDING, CAMPING, TRAVEL TRAILERS

ROLITE: Twelve Volt, Electric Raising. Dick Tanis, Eastern Distributor, Box 2181, Paterson, New Jersey 07509.

FOR THE HOME

EXOTIC, Novel Indoor Plants and Flowers. Details, Ed's International, 1608 —80th, Chicago, Ill. 60620.

INVENTIONS WANTED

WE either sell your invention or pay cash bonus. Write for details. Universal Inventions, 298-3, Marion, Ohio 43302.

MISCELLANEOUS

"HOW To Build A Still." Humorous, factual, illustrated, 50 pages. Includes distillation, fermentation, wine, homebrew, taxes, etc. Over 25 recipes. \$2.00. Buze, Box 490F, Norman, Okla. 73069.

THERE is no charge for the Zip Code. Please use it in your Classified Ad.

MONEYMAKING OPPORTUNITIES

HOW To Make A Home Operated Mail Business Pay! Details—Carpenter, 2907-J West 39th Place, Chicago, Ill. 60632.

DEALERS: Sell needed Zip Code Directories. Baker, 1000 McClusky, Jerseyville, Ill. 62052.

START Profitable Business in spare time. Investigate many money-making agency and franchise opportunities. Send 10¢ for sample copy of *Income Opportunities Magazine*, 505 Park Avenue, New York, 10022. Dept. S.

PERSONAL

BILL Problems? Poor credit no trouble. Not a loan company. Send for free application. Nationwide Acceptance, Dept. DC, 930 F. St., N.W., Washington, D. C. 20017.

PRINTING, MIMEOGRAPHING & MULTIGRAPHING

EMBOSSSED Business Cards 1000 only \$3.95 postpaid. Free samples. Discount Printing, 211A Church, San Francisco, Calif. 94114.

RADIO & TELEVISION

McGEE Radio Company. Big 1966-1967 Catalog Sent Free. America's Best Values. Hi-Fi, Amplifiers, Speakers, Electronic Parts. Send Name, Address and Zip Code Number to McGee Radio Company, 1901 McGee Street, Dept. EE, Kansas City, Missouri 64108.

CANADIANS—Giant Electronics Catalogs. Hi-Fi, Shortwave, Ham, CB. Rush \$1.00. ETCO, Dept. EZ, Box 741, Montreal, Canada.

BEGINNERS, Builder's Giant catalog—25¢, refundable. Laboratories, 12041-G Sheridan, Garden Grove, Calif. 92640.

SUPER Snooper, printed circuit kit \$5.95. Lextronix's, Box 42-A, Madison Heights, Mich. 48071.

C. B. BUYERS' Guide—A new magazine for the buyers of Citizen's Band Electronic Equipment. Includes a Test Report Section on 5-Watt C. B. Transceivers: How to Operate on C.B.; The Social Side of C.B.; FCC Regulations. Send \$1.25—includes Postage to C. B. Buyers' Guide, 505 Park Ave., New York, N. Y. 10022.

RUBBER STAMPS

FREE — 32 Page Catalog: Signature Stamps \$3.50. Youngers, Princeton, Iowa 52768.

SCIENCE EXPERIMENTS

"**LASER** Pistol"—\$1.00. Make a Laser Pistol, Instructions, Drawings, Parts Manufacturers, Addresses, Battery or Electric. Build a Continuous Laser, Laser Rifle, Chemical Laser, \$4.95 each. Laser Catalogue 25¢. Roy Davis Laboratories, Dept. SM, Drawer 17067, Jacksonville, Fla. 32216.

SCIENCE Experimenter—the magazine dedicated to the youth who is interested in experimentation, construction and Science Fair entries. Send \$1.00, includes Postage, to Science Experimenter, 505 Park Ave., New York, N. Y. 10022.

SPECIAL SERVICES

LOOK Men—especially Golf Players. Cut your shoe cost. Send 25¢ for details. Delph's Leather Products, Tamaqua, Pennsylvania 18252.

For Greater Classified Profits

WHY NOT TRY THIS NEW

combined classified ad medium

Your classified ad will appear in **SCIENCE & MECHANICS MAGAZINE** as well as in a minimum of three other **SCIENCE & MECHANICS PUBLICATIONS**. Write now for information to C. D. Wilson, Manager, Classified Advertising, **SCIENCE & MECHANICS**, 505 Park Ave., New York, N. Y. 10022.

Join "THE TROUBLESHOOTERS"

**They get paid top salaries
for keeping today's
electronic world running**

Suddenly the whole world is going electronic! And behind the microwave towers, push-button phones, computers, mobile radio, television equipment, guided missiles, etc., stand **THE TROUBLESHOOTERS**—the men needed to inspect, install, and service these modern miracles. They enjoy their work, and get well paid for it. Here's how you can join their privileged ranks—without having to quit your job or go to college in order to get the necessary training.

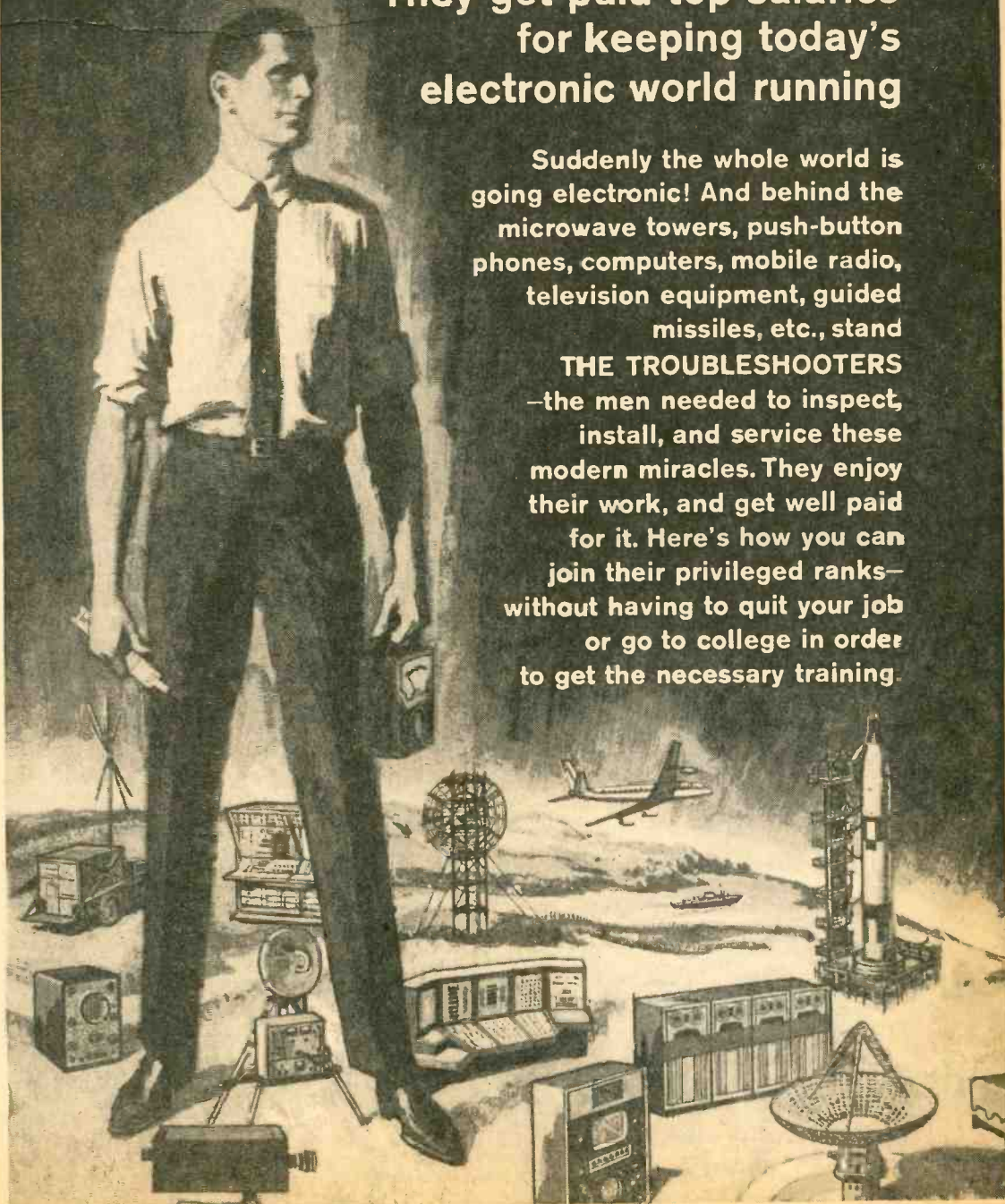

JUST THINK HOW MUCH in demand you would be if you could prevent a TV station from going off the air by repairing a transmitter...keep a whole assembly line moving by fixing automated production controls...prevent a bank, an airline, or your government from making serious mistakes by repairing a computer.

Today, whole industries depend on electronics. When breakdowns or emergencies occur, someone has got to move in, take over, and keep things running. That calls for one of a new breed of technicians—The Troubleshooters.

Because they prevent expensive mistakes or delays, they get top pay—and a title to match. At Xerox and Philco, they're called Technical Representatives. At IBM they're Customer Engineers. In radio or TV, they're the Broadcast Engineers.

What do you need to break into the ranks of The Troubleshooters? You might think you need a college diploma, but you don't. What you need is know-how—the kind a good TV service technician has—only lots more.

Think With Your Head, Not Your Hands

The service technician, you see, "thinks with his hands." He learns his trade by taking apart and putting together, and often can only fix things he's already familiar with.

But as one of The Troubleshooters, you may be called upon to service complicated equipment that you've never seen before or *can't* take apart. This means you have to be able to take things apart "in your head." You have to know enough electronics to understand the engineering specs, read the wiring diagrams, and calculate how a circuit should test at any given point.

Now learning all this can be much simpler than you think. In fact, you can master it without setting foot in a classroom and without giving up your job!

AUTO-PROGRAMMED™ Lessons Show You How

For over 30 years, the Cleveland Institute of Electronics has specialized in teaching electronics at home. We've developed special techniques that make learning easy, even if you've had trouble studying before.

For one thing, our AUTO-PROGRAMMED™ lessons build your knowledge as you'd build a brick wall—one brick at a time. Each piece rests securely on the one that came before it.

ENROLL UNDER NEW G.I. BILL

All CIE courses are available under the new G.I. Bill. If you served on active duty since January 31, 1955, or are in service now, check box on reply card for G.I. Bill information.

In addition, our instruction is personal. When your teacher goes over your assignment, no one else competes for his attention. You are the only person in his class. He not only grades your work, he analyzes it to make sure you are thinking correctly. And he returns it the day it's received so that you can read his comments and corrections while everything is fresh in your mind.

Always Up-To-Date

To keep up with the latest developments, our courses are constantly being revised. This year CIE students are getting new lessons in Laser Theory and Application, Microminiaturization, Single Sideband Techniques, Pulse Theory and Application, and Boolean Algebra.

In addition, there is complete material on the latest troubleshooting techniques including Tandem System, Localizing through Bracketing, Equal Likelihood and Half-Split Division, and In-circuit Transistor Checking. There are special lessons on servicing two-way mobile equipment, a lucrative field in which many of our students have set up their own businesses.

Your FCC License—or Your Money Back!

Two-way mobile work and many other types of troubleshooting call for a Government FCC License, and our training is designed to get it for you. But even if your work doesn't require a license, it's a good idea to get one. Your FCC License will be accepted anywhere as proof of good electronics training.

And no wonder. The licensing exam is so tough that two out of three non-CIE men who take it fail. But CIE training is so effective that 9 out of 10 of our graduates pass. That's why we can offer this warranty with confidence: *If you complete one of our license preparation courses, you'll get your license—or your money back.*

Mail Card for 2 Free Books

Want to know more? Mail the postage-paid reply card bound here. We'll send our 40-page catalog describing our courses and the latest opportunities in Electronics. We'll also send a special book on how to get a Commercial FCC License. Both are free. If the card is missing, just send us your name and address.

CIE

Cleveland Institute of Electronics

1776 E. 17th St., Dept. EL-3, Cleveland, Ohio 44114

Accredited Member National Home Study Council
A Leader in Electronics Training... Since 1934



MAIL
ORDER

SHOPPERS' PAGE

\$4.95

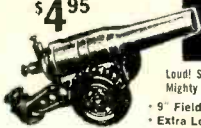

BIG BLAST CARBIDE CANNONS

Loud! Sounds like dynamite blast! Brilliant flash! Mighty roar echoes for blocks.

- 9" Field Cannon \$4.95 (Illustrated)
- Extra Loud 17" Modern Field Cannon \$9.95
- Mammoth 25" Field Cannon \$13.95

Ammo.
50¢/tube
4 tubes
\$1.50

Country Club
Products
310 W. 9th St.
Kansas City,
Mo. 64105

A selection of products available by mail for Elementary Electronics readers. All merchandise sold on a money back guarantee. Order directly from advertiser. Please include your zip code.

World Famed BREVETTATA TEAR GAS PISTOL

Appearance of this fine tear gas weapon is similar to real gun. It is ideal for people who work in lonely, dark locations and require protection. Men give this gun to wives and daughters for night security. Many industrial applications. Shooting of gun stops aggressor without permanently injuring him. Neither permit nor license is needed, but it is not sold to minors. It fires six cartridges without reloading. Each gun comes with six tear gas shells and six blanks for practice and is shipped prepaid. Gun unit prices include. 12 shells and all shipping costs.



- | | |
|---|---------------|
| <input type="checkbox"/> 1 Gun-unit at | \$13.07 |
| <input type="checkbox"/> 2 Gun-units at \$22.86 | (\$11.43 ea.) |
| <input type="checkbox"/> 3 Gun-units at \$29.94 | (\$ 9.98 ea.) |
| <input type="checkbox"/> 4 Gun-units at \$35.16 | (\$ 8.79 ea.) |

Extra boxes of ten tear gas shells at \$1.50 per box (prepaid with gun orders). Extra boxes of blanks at \$1.25 per box.

UNITED SAFETY SUPPLY CO.

349 Manufacturers Exchange, Dept. EE
Kansas City, Missouri 64105



No Fish Can Resist SPANISH FLY Bait Oil

ANCIENT FORMULA NOW LEGAL FOR FISHERMEN

Long a secret, nature product, this new aerosol spray formulation works on the most active sensory organs a fish possesses. Aroma like perfume attracts both male and female fish by working on the forces that control life itself. SPANISH FLY Bait Compound is legal in all states for fish attracting. Spray it on lures, bait, hooks, lines and sinkers. Emulsion spreads thru fresh or salt water in all directions and drives fish wild whether you troll, cast, spin or still-fish. \$4.95 in long-lasting aerosol spray can sent postpaid if cash accompanies order. Postage and handling charges added to COD orders. Satisfaction absolutely guaranteed.

CHEROKEE INSTITUTE
P.O. Box 7243A
Kansas City, Mo. 64113

4000 VOLTS at the End of a 10-oz. 29" Cane



FULLY
TRANSISTORIZED

Circuit converts electric into safe but huge voltage. No moving parts. Rugged. Absolutely guaranteed.

The Police "Sheek-Rod" has power to control the most stubborn adversary . . . is ideal protection from nasty dogs. Also effective in riot work.

Harmless to adversary. The current is tiny (from two small c-size cells) but high voltage gives kick. Shorty model same price as regular walking stick.

SAFE TO USER

\$14.95

ppd.
2 for \$27
Bats., Inc.



FREEMAN ELECTRIC CO.

Dept. EE

Freeman, Mo. 64746

WATCH RUST DISAPPEAR



NAVAL JELLY

is an extremely active new cleaner that removes rust by chemical combination . . . sticks to verticals and overheads. Brush it on, hose it off. Also removes rust stains from concrete, tile, etc.

- | | |
|---|--|
| <input type="checkbox"/> Use on pipes, fences, tools, tanks, cages, trucks, all machinery. Eliminates sand-blasting, scraping, etc. Easy and quick. | <input type="checkbox"/> 40# @ .65/lb. \$26 |
| | <input type="checkbox"/> 10# @ 1.50/lb. \$15 |
| | <input type="checkbox"/> 4# @ 2.00/lb. \$ 8 |
| | = 4 postpaid—other units FOB Cleveland |

MEREDITH SEPARATOR CO.
44 Tombrown St.
Cleveland, Mo. (Missouri) 64734



THE SUNGLASSES OF OUR ASTRONAUTS
You won't find Gemini sunglasses in stores. The lenses are guaranteed 100% distortion-free. Neutral grey with accurate color identification. Specially furnace-hardened, 12K, gold filled frames with contoured end pieces encased in translucent Satlon. The ultimate in protection for your eyes. \$12.94 Ppd. Also available in your prescription. \$24.95 single vision, \$29.95 BI-focal. Exclusive with us. Country Club Products. Dept. EE-7, 310 West 9th St., Kansas City, Mo. 64105.



\$70 AIR-GUN ONLY \$29.95

Complete with chisel, this 3 lb. Air-Gun rips into metal, chips concrete, drives pins, etc. Delivers 5500 2" strokes a minute. Operates on 3 to 5 hp. compressor. Made especially for gov't and manufacturer made too many. At only \$29.95 ppd. while they last, a \$70 value. Try it and see. Additional attachments for exhaust pipe cutting and other special uses—\$9.00. Meredith Separator Co., 44 Tom Brown St., Cleveland, Mo. 64734.



80,000 CANDLEPOWER BEAM LIGHTS

New, smooth, tough polypropylene. Uses 6 reg. flashlight cells in 3-cell length. Tremendous, piercing beam on land. Cuts thru fog & smoke. Made to pierce murky depths & withstand pressures of underwater operation. On land its beam leaps out for 20 miles. Illuminates objects a mile away. Used by skindivers, police, fire depts., etc. Rubber switches, blinker & unbreakable lens. \$8.39 ppd., 6 for \$5.95 each, ppd. Freeman Electric, Dept. EE, Freeman, Mo. 64746.