

# **ELEKTOR** **ELECTRONICS** **USA**

THE INTERNATIONAL JOURNAL  
FOR RECREATIONAL ELECTRONICS

MAY 1992

\$3.00 US  
CANADA \$4.00

## Special 200th Issue

**Digital Short-Range Radio**

**1.3GHz Prescaler**

**NICAM Decoder**

**GAL Programmer**

**Z80 Card**

**Audio-Video Processor**



A0026840  
William Kolas  
300 Sunset Rd  
Chester MD 21619



# OCEAN STATE ELECTRONICS

PROFESSIONAL, AMATEUR, OR COMMERCIAL — WE'RE YOUR ONE STOP ELECTRONIC SOURCE  
CALL OR WRITE FOR OUR FREE 112 PAGE CATALOG 1-401-596-3080



## MAGNET WIRE

Plain enamel Solid bare copper  
For winding coils, transformers and toroids Prices for 1/4 lb. spools.

MW14 3.25	MW24 3.70	MW34 4.80
MW16 3.30	MW26 3.75	MW36 4.90
MW18 3.35	MW28 3.85	MW38 4.95
MW20 3.55	MW30 4.00	MW40 5.10
MW22 3.65	MW32 4.40	

## TOROIDS

### IRON

T-25-2	.40	FT37-43	.60
T-25-6	.40	FT37-61	.60
T-37-6	.45	FT37-77	.60
T-37-12	.45	FT50-43	.75
T-50-2	.55	FT50-61	.75
T-50-3	.55	FT50-77	.75
T50-6	.55	FT82-43	1.00
T80-0	.75	FT82-67	1.00
T68-2	.75	FT82-68	1.00
T68-6	.75	FT114-61	2.15
T80-2	.85	FT140-43	4.10
T200-2	4.00	FT240-61	8.00

### FERRITE

WE STOCK A COMPLETE LINE OF TOROIDS AND BEADS.

## RECTIFIER DIODES

1N4001	1 AMP 50 PRV	.09
1N4002	1 AMP 100 PRV	.09
1N4003	1 AMP 200 PRV	.10
1N4004	1 AMP 400 PRV	.10
1N4005	1 AMP 600 PRV	.12
1N4006	1 AMP 800 PRV	.15
1N4007	1 AMP 1000 PRV	.17
1N5400	3 AMP 50 PRV	.20
1N5401	3 AMP 100 PRV	.20
1N5402	3 AMP 200 PRV	.20
1N5404	3 AMP 400 PRV	.25
1N5406	3 AMP 600 PRV	.25
1N5407	3 AMP 800 PRV	.25
1N5408	3 AMP 1000 PRV	.25

## REGULATED POWER SUPPLIES

13.8 VDC OUTPUT

Perfect for ham equipment, CB's, car stereo's and other 13.8 VDC items. LED on indicator, short circuit protection. Binding post output. Amp ratings are continuous 110V input.



38-383	3 AMP	\$31.50
38-384	4 AMP	\$39.50
38-386	6 AMP	\$46.50
38-381	10 AMP	\$79.50
38-382	20 AMP	\$119.50
XP-725	25 AMP	\$129.50

## DELUX CODE KEY

Adjustable, heavy duty brass base with ball bearing pivots. Designed for hard usage. 3/16" plated contacts.



70-378 .....\$11.75

## BUZZER

Produces steady high frequency signal. Excellent for code practice. Screw control for adjusting pitch. Uses standard 1 1/2V battery



70-375 .....\$4.99

## DIGITAL MULTIMETER



19 RANGES  
3 1/2 DIGIT LCD DISPLAY  
DVC - 1000  
ACV - 750  
DCA - 10A  
RES - 2 MEG  
DIODE CHECK  
DM301  
\$27.95

## Q-DOPE

Solution of pure polystyrene in solvents. Dries fast and leaves a clear, protective coating on toroids, coils and transformers, with no or minimal effect on inductive values. May also be used as a cement for molded or fabricated items made of polystyrene.



10-3702 (Bottle with Brush 2 fl. oz. 59 ml) .....\$3.75



## VERNIER DIALS

VD112-10	1-1/2" Diameter 0-10 Marking	\$8.25
VD112-100	1-1/2" Diameter 0-100 Marking	\$9.25
VD2	2" Diameter 0-100 Marking	\$10.25

## 200 WATT INVERTER

Plugs into your lighter and runs:

- Ham Equipment
- Lights
- Soldering Iron
- Computer
- Power Tools
- Shaver
- 13" TV with VCR
- MUCH MORE

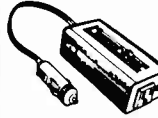

Model: POW 200  
Input: 10 to 15 volts DC  
Output: 115 volts AC true RMS  
Power: 400 Watts peak  
200 Watts for 5 minutes  
140 Watts continuously  
Size: 5" x 2.6" x 1.7"  
Weight: 15 ounces  
Warranty: 3 year  
POW-200  
\$119.95

## SWITCHING/GP DIODES

1N914	75V PRV 10MA	.07
1N4148	75V PRV 10MA	.07

## GERMANIUM DIODES

1N34A	100V PRV 200MA	.20
1N3600	50V PRV 200MA	.25

## MINIATURE TOGGLE SWITCHES

3A 125V Solder Terminals



11-201	.....SPDT	\$1.25
11-202	.....DPDT	\$1.50



## TWO PIECE CHASSIS ALUMINUM

Uses 4 machine screws, supplied. Gray baked enamel.

PART NO.	SIZE (IN.)			PRICE
	L	W	H	
1411B	2.7	2.2	1.6	4.46
1411C	3.2	2.2	1.1	4.78
1411D	3.2	2.2	1.6	4.90
1411F	4.0	2.2	2.7	5.66
1411G	4.0	2.2	1.6	5.04
1411H	4.0	2.2	2.2	5.47
1411K	5.0	2.2	2.2	5.82
1411L	5.0	4.0	3.0	7.53
1411M	6.0	3.0	3.0	8.02
1411N	5.0	3.0	2.1	6.30
1411P	6.0	5.0	4.0	9.86
1411Q	7.0	5.0	3.0	9.27
1411R	8.0	6.0	3.5	12.28
1411S	8.0	4.0	3.0	15.63
1411T	10.0	2.2	1.6	8.68
1411U	10.0	6.0	3.5	15.31
1411W	12.0	3.0	2.2	11.15
1411X	12.0	7.0	4.0	18.62
1411Z	17.0	5.0	4.0	20.10

## IC SOCKETS - LOW PROFILE

LP-8	8 PIN	.....10	LP-22	22 PIN	.....23
LP-14	14 PIN	.....11	LP-24	24 PIN	.....25
LP-16	16 PIN	.....12	LP-28	28 PIN	.....30
LP-18	18 PIN	.....17	LP-40	40 PIN	.....43
LP-20	20 PIN	.....21			

## COPPER CLAD PC BOARDS



PC4X6DS	.....4" x 6"	DOUBLE SIDED	.....\$99
PC3X6DS	.....3 1/4 x 6 3/4"	DOUBLE SIDED	.....89
PC6X6SS	.....6 1/2 x 6"	SINGLE SIDED	.....1.25
PC5X7SS	.....7 x 5"	SINGLE SIDED	.....1.50
PC8X7SS	.....8 x 7"	SINGLE SIDED	.....2.00

## 3/8" SQUARE TOP ADJUST TRIM POTS



OFA12	100KΩ	OFA24	20KΩ
OFA52	500KΩ	OFA54	50KΩ
OFA13	1KΩ	OFA15	100KΩ
OFA23	2KΩ	OFA25	200KΩ
OFA53	5KΩ	OFA55	500KΩ
OFA14	10KΩ	OFA16	1MΩ

SINGLE TURN .5 WATT  
LINEAR TAPER

\$1.10 EACH

## PANAVISE

INTERCHANGEABLE VERSATILITY!



PAN 303  
STANDARD HEAD  
\$20.99



PAN 300  
STANDARD BASE  
\$17.99

PAN 315  
CIRCUIT BOARD HOLDER  
\$23.99

## TRANSISTORS

PN2222A	.05
2N2222A	.35
2N3055	.69
2N3553	2.75
2N3563	.35
2N3771	1.95
2N3866	1.00
2N3904	.10
2N3906	.10
2N4401	.15
2N4403	.15
MPF102	.29

## LINEAR IC'S

MAX232CPE	4.05
LM311N	.45
LM339N	.35
LM386N	.99
NE555	.25
NE564	1.75
NE567	.99
NE602N	2.25
LM741N	.25
CD22402E	9.95
CA3126E	1.60
MC1350P	1.49

## VOLTAGE REGULATORS

7805	.39
7812	.39
7815	.39
7824	.39
7905	.49
7912	.49
78L05	.39
78L12	.39
LM317T	.69
LM338K	4.49
LM723	.65

## EPROMS

2708	4.25
2716	3.30
2732	3.85
2764	3.55
27C64(150ns)	3.85
27C28(150ns)	3.85
27C256	4.55
27C256(150ns)	5.55
27C512(150ns)	6.85
27C010(150ns)	9.85
27C1024(150ns)	14.85

## 2 3/8" FULL VIEW PANEL METER

Designed for modernistic equipment. Beautiful appearance, easy to read. D'Arsonval type movement, accuracy within 2%. Will mount in panels up to 3/8" thick, has zero adjustment screw. Size: 2 3/8" x 1 13/16" x 1 1/4" deep, including terminals and will mount into 1 1/2" hole.



PART NO.	METER READING	PRICE
M60-118	0-1MA	16.00
M60-121	0-15VDC	16.00
M60-122	0-30VDC	16.00
M60-125	0-150VDC	16.00
M60-127	50-0-50µA	16.00
M60-129	0-50µA	16.00
M60-130	0-100µA	16.00
M60-133	VU METER	16.00
M60-149	ILLUMINATION KIT	2.85

## TO ORDER

Call 1-800-866-6626 ORDERS ONLY

(Catalog requests can not be taken on toll free number.)

8 a.m. - 6 p.m. EST  
Monday through Friday  
10 a.m. - 2 p.m. Saturday

## OR WRITE TO:

Ocean State Electronics,  
P.O. Box 1458, Westerly, R.I. 02891

OR FAX TO: CATALOG REQUEST  
(401) 596-3590 (401) 596-3080

If paying by CREDIT CARD include Card No. and Expiration Date

Mail in orders please include \$4.00 S/H  
Minimum order \$10.00

R. I. Residents add 7% Sales Tax

ORDERS RECEIVED BY 1:00 PM EST  
— SHIP SAME DAY!

FREE SHIPPING ON ALL MAIL ORDERS  
OVER \$25.00.

Applies to UPS Ground in Continental U.S. Only.

PRICES SUBJECT TO CHANGE.

## CERAMIC DISC CAPACITORS 50V ± 20%

PART NO.	CAPµF	PRICE	PART NO.	CAPµF	PRICE
CD10-5	10PF	.12	CD180-5	180PF	14
CD12-5	12PF	.12	CD220-5	220PF	14
CD15-5	15PF	.12	CD270-5	270PF	14
CD18-5	18PF	.12	CD300-5	300PF	15
CD22-5	22PF	.12	CD330-5	330PF	15
CD27-5	27PF	.12	CD390-5	390PF	15
CD33-5	33PF	.12	CD470-5	470PF	15
CD39-5	39PF	.12	CD560-5	560PF	15
CD47-5	47PF	.12	CD680-5	680PF	15
CD56-5	56PF	.12	CD001-5	.001µF	15
CD68-5	68PF	.12	CD0047-5	.0047µF	15
CD75-5	75PF	.12	CD01-5	.01µF	15
CD100-5	100PF	.12	CD022-5	.022µF	15
CD120-5	120PF	.14	CD05-5	.05µF	20
CD150-5	150PF	.14	CD104-5	.1µF	20

## ELECTROLYTIC CAPACITORS - RADIAL 50V

PART NO.	CAPµF	PRICE	PART NO.	CAPµF	PRICE
CER47-50	.47	.17	CER47-50	47	.25
CER1-50	1	.17	CER100-50	100	.36
CER2-50	2.2	.17	CER220-50	220	.54
CER3-50	3.3	.17	CER330-50	330	.70
CER4-50	4.7	.17	CER470-50	470	.93
CER10-50	10	.17	CER1000-50	1000	1.45
CER22-50	22	.18	CER2200-50	2200	2.80
CER33-50	33	.22			

In next month's issue  
(among others):

- I<sup>2</sup>C display\*
- Plant warmer
- Review of Analyser III
- Medical laser technology
- Dealing with noise and interference
- Cellphones explained
- Opto-card for multi-purpose bus
- 8051/8032 assembler course Part 4

\* *It is regretted that, owing to circumstances beyond our control, this article has had to be postponed to our next issue.*

#### Front cover

Stereo TV is with us in the shape of NICAM, a system developed by the BBC and now also adopted in several other countries. Moreover, it is incorporated in a draft CCIR recommendation. In this issue, we give you the background of the system and also a practical NICAM decoder. The decoder is suitable for PAL B/I/G formats and can be built as a stand-alone unit or be incorporated in an existing TV receiver.

**ELEKTOR ELECTRONICS USA**  
(US ISSN 1051-5690) is published monthly except August at \$28 per year; \$50 for two years by Audio Amateur Publications, Inc., 305 Union St., Peterborough NH 03458 USA. Second class postage paid at Peterborough NH and an additional mailing office.

**POSTMASTER:** Send address changes to **Elektor Electronics USA**, Caller Box 876 Peterborough NH 03458-0876.

### AUDIO & HI-FI

- 43 PROJECT:** Audio-Video Processor  
An ELV Design

### COMPONENTS

- 55 PROJECT:** GAL Programmer  
Design by M. Nosswitz

### COMPUTERS & MICROPROCESSORS

- 14 PROJECT:** Multi-Purpose Z80 Card—Part 1  
Design by A. Rietjens

### GENERAL INTEREST

- 26** Elements of Passive Electronic Components—  
Part 1  
by Steve Knight

### POWER SUPPLIES & BATTERY CHARGERS

- 21 PROJECT:** Compact Mains Power Supply  
Design by A. Rossrucker

### RADIO, TELEVISION & COMMUNICATIONS

- 29** The NICAM System  
by our Technical Editor
- 34 PROJECT:** NICAM Decoder  
Design by Rob Krijgsman, PE1CHY
- 43 PROJECT:** Audio-Video Processor  
an ELV Design
- 50 PROJECT:** FM Tuner—Part 3  
Design by H. Reelsen

### SCIENCE & TECHNOLOGY

- 46** Digital Short-Range Radio  
by Brian P. McArdle

### TEST & MEASUREMENT

- 24 PROJECT:** 1.3GHz Prescaler  
Design by P. Esser

### MISCELLANEOUS INFORMATION

Electronics Scene 9-12; New Books 13; Letters 60-62;  
Readers Services' 61; Terms of Business 62;  
Advertisers' Index 63; Classifieds 63

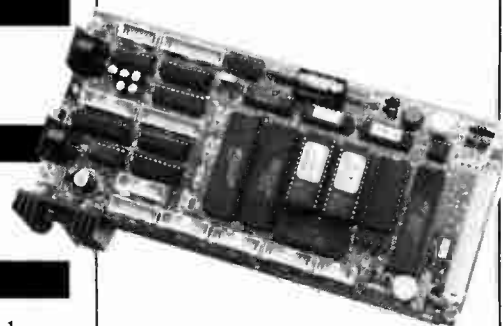

Multi-purpose Z80 card – p. 14



Compact mains power supply - p. 21

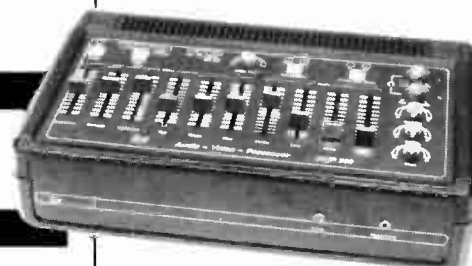

Audio-video processor – p. 43

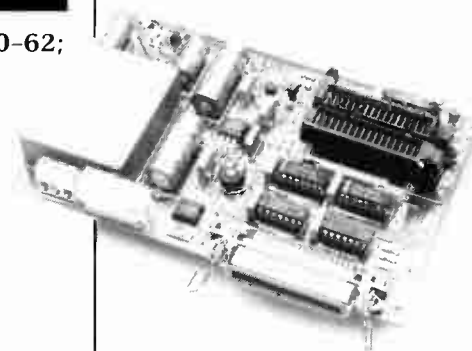

GAL programmer – p. 55

# ELEKTOR ELECTRONICS USA

## Subscriber Services

Complete the applicable  
section(s) below and  
mail to:

Elektor Electronics USA  
PO Box 876  
Peterborough, NH  
03458-0876

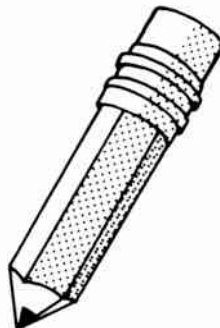

### WOULD YOU LIKE TO . . .

#### SUBSCRIBE?

YES! Just check the appropriate boxes in the  
"renew" section and fill in name and address.

#### RENEW?

Fill in the appropriate sections below. For  
faster service use your mailing label and  
subscriber number.

- 1 year at \$28       Check/MO enclosed  
 2 years at \$50       Charge MC/VISA

Canada add \$8 per year postage.  
Remit in US \$ only.

MC/VISA

EXP.

SUBSCRIBER NUMBER

NAME

STREET & NO

CITY

ST

ZIP

#### CHANGE YOUR ADDRESS?

Fill in your new address to the  
right and old address and subscriber  
number above.

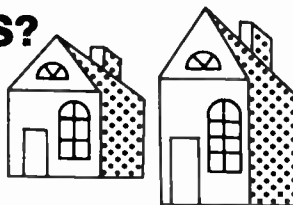

MY NEW ADDRESS:

NAME

STREET & NO

CITY

ST

ZIP

#### GIVE A GIFT?

What a thoughtful idea! Fill out your name and  
address above, the recipient's name and address  
to the right. We'll even send a gift card  
announcing your gift.



NAME

STREET & NO

CITY

ST

ZIP

#### TELL YOUR FRIENDS ABOUT US?

Print their names and addresses below or photocopy this form for them.  
We'll take care of the rest.

NAME

NAME

STREET & NO

STREET & NO

CITY

ST

ZIP

CITY

ST

ZIP

#### COMPLAIN ABOUT YOUR SUBSCRIPTION?

Yes, it sometimes happens. We try to avoid it at  
all costs, but if you have a problem, we want to  
know. Call or write with all pertinent information.



YOU CAN CALL US

(603) 924-9464

Subscription Department  
9-4 Business Days

Answering Machine  
All Other Hours

FAX: (603) 924-9467  
24 Hours



**THE WILLIAMSON AMPLIFIER**

D.T.N. Williamson

In April 1947, Williamson's power amplifier, using excellent-quality push/pull output tubes, a special output transformer, and a highly filtered power supply, became an overnight success. The author takes the reader deep into his design considerations, offering practical advice on how to build the units plus concise instructions on setting up the new amp. A cult classic.

Year 1947, 1990 Pages 40  
0-9624-1918-4 Softcover 8½ x 11 \$4.95

**AUDIO AMATEUR LOUDSPEAKER PROJECTS**

Audio Amateur Magazine

A collection of the 25 best speaker articles from Audio Amateur during the decade of the 1970s, proof that great designs are never out-of-date, a rich source of both theory and practice as well as design. The electrostatic and transmission-line pieces are particularly interesting and useful.

Year 1985 Pages 135  
0-8338-0193-7 Softcover 8½ x 11 \$20.00

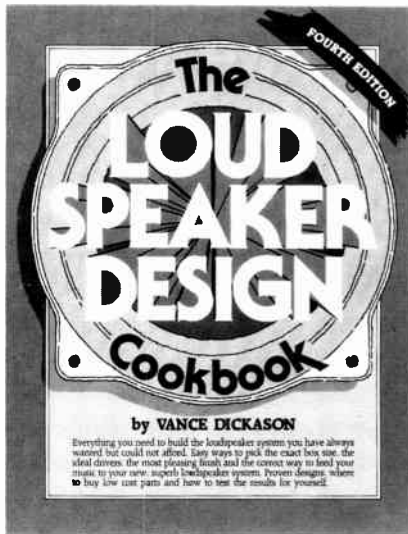

**THE LOUDSPEAKER DESIGN COOKBOOK**

Vance Dickason

This new fourth edition of speaker designing's "bible" is twice as big as its predecessors and features brand new chapters on how loudspeakers work and loudspeaker design software. Other chapters cover closed and vented boxes, passive radiators, transmission-line systems, cabinet construction, drivers, crossovers, and loudspeaker testing, plus a complete resources listing. By far, the best-selling book in the field.

Year 1991 Pages 152  
0-9624-1917-6 Softcover 8½ x 11 \$29.95

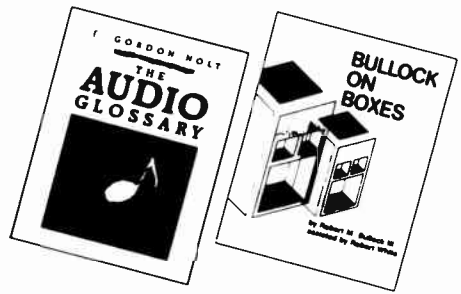

**THE AUDIO GLOSSARY**

J. Gordon Holt

Authored by the founder of Stereophile magazine, this new best seller is a comprehensive overview of over 1,900 technical and subjective audio terms explained in precise yet at times humorous fashion. Three editions: Softcover (S); Hardcover with Dust Jacket (H); and Limited, Autographed Hardcover with Gold-Embossed Binding and Dust Jacket (L).

Year 1990 Pages 152  
0-9624-1914-1(S) Softcover 5¼ x 7½ \$9.95  
0-9624-1914-1(H) Hardcover 5¾ x 8 \$17.95  
0-9624-1914-1(L) Limited 5¼ x 8 \$30.00

**BULLOCK ON BOXES**

Robert M. Bullock III, with Robert White

An easy-to-read guide to designing and building vented-box systems based on Thiele/Small models, this book is a collection of Dr. Bullock's Speaker Builder magazine articles. Includes theory, model descriptions, plus related information from numerous sources, especially computer modeling from the authors' BOXRESPONSE and BOXMODEL programs.

Year 1991 Pages 72  
0-9624-1915-X Softcover 8½ x 11 \$10.95



**LOUDSPEAKERS: THE WHY AND HOW OF GOOD REPRODUCTION**

G.A. Briggs

This easy-to-read classic, last revised in 1949, introduces the reader to concepts such as impedance, phons and decibels, frequency response, response curves, volume and watts, resonance and vibration, cabinets and baffles, horns, room acoustics, transients, crossovers, negative feedback, Doppler and phase effects, and much more. A provocative survey of the right questions about sound reproduction.

Year 1949, 1990 Pages 88  
0-9624-1913-3 Softcover 5½ x 8½ \$6.95

**KILLER CAR STEREO ON A BUDGET: AN EASY CURE FOR HO-HUM AUTO SOUND**

Daniel L. Ferguson

Providing quick and tested methods for upgrading your car's sound, this manual provides an excellent, easy-to-understand, hands-on treatment of the cost-effective design and installation of high-quality vehicle sound systems. Included are Getting Started; Sedan, Hatchback, and Pickup Truck Systems; Speaker Cabinet Design; Filter Crossovers; and Installation.

Year 1989 Pages 118  
0-9624-1910-9 Spiralbound 5½ x 8½ \$9.95

**HARD-TO-FIND AUDIO BOOKS—AND MORE!**



◆ASK TODAY FOR YOUR FREE CATALOG OF KITS, COMPONENTS, CABLE, SOFTWARE AND TEST CDs!  
◆MC/VISA WELCOME!

**OLD COLONY SOUND LAB**  
PO BOX 243, DEPT. E92  
PETERBOROUGH, NH 03458  
24-HOUR LINES:  
TEL (603) 924-6371  
FAX (603) 924-9467

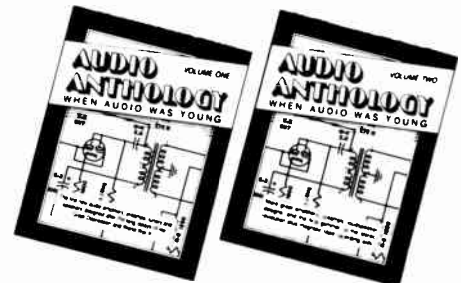

**AUDIO ANTHOLOGIES, VOLS. 1-4: WHEN AUDIO WAS YOUNG**

C.G. McProud, editor

These are the outstanding articles from Audio Engineering magazine during 1947-1957. Amps, pre-amps, tuners, speakers, and more. Vol. 1 covers 1947-50 and 38 articles. 2: 1950-1952, 45. 3: 1952-1955, 43. 4. 1955-1957, 34.

Year 1950, 1987 Pages 124  
0-8338-0195-3 Vol. 1 Softcover 8½ x 11 \$16.95  
Year 1952, 1989 Pages 124  
0-8338-0197-X Vol. 2 Softcover 8½ x 11 \$16.95  
Year 1955, 1990 Pages 124  
0-9624-1911-7 Vol. 3 Softcover 8½ x 11 \$16.95  
Year 1957, 1991 Pages 144  
0-9624-1919-2 Vol. 4 Softcover 8½ x 11 \$16.95

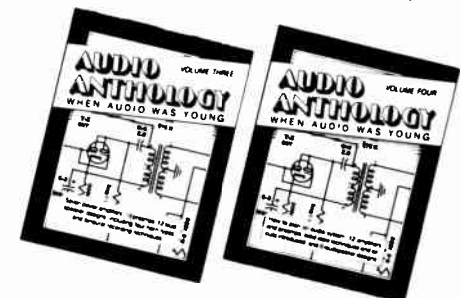





### IBM PC SERVICE CARD

This card was developed for assistance in the field of service, development and test. The card is used as a bus-extension to reach the measurement points very easy. It is also possible to change cards without having a "hanging computer".

Ready Assembled Module

**\$145**

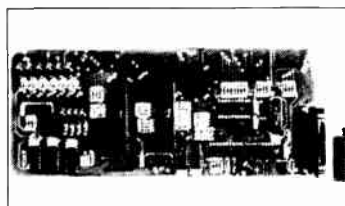

### IC TESTER FOR IBM-PC-XT/AT

With the ELV IC tester logic function tests can be carried out on nearly all CMOS and TTL standard components, accommodated in DIL packages up to 20 pin. The tester is designed as an insertion card for IBM-PC-XT/AT and compatibles. A small ZIF test socket PCB is connected via a flat band cable. Over 500 standard components can be tested using the accompanying comprehensive test software. Complete Kit including Textool socket, connectors, sockets, Flat band cable, PCB, Software.

Ready Assembled Module

**\$200**

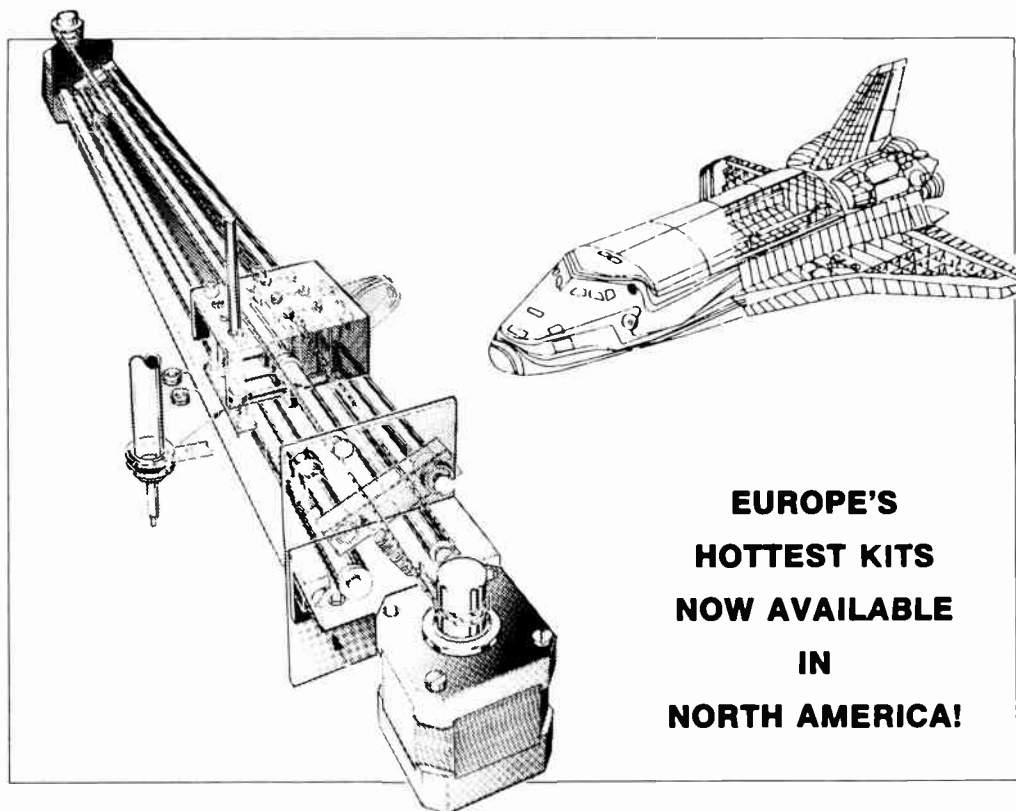

**EUROPE'S  
HOTTEST KITS  
NOW AVAILABLE  
IN  
NORTH AMERICA!**

### PLOTTER MARK-II

completely reworked version: see Elektor Electronics March 1990.

- Max. width 50 cm.
- All mechanical parts supplied ready-drilled, filed and tapped, so get going at once.
- Complete kit, including 2 stepper motors, 3 pen lift solenoids, HPGL software on disk (IBM), stepper motor control board

100.100 **\$275**

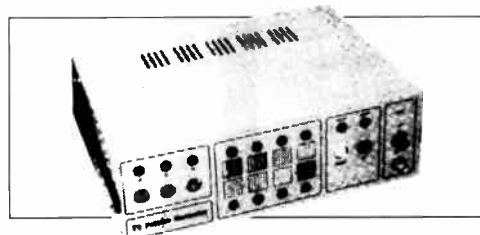

### COLOUR TEST PATTERN GENERATOR

A PAL-compatible colour video source that supplies a number of test patterns for aligning television sets.

A test pattern generator is virtually indispensable for troubleshooting in television sets because it supplies a video signal that is known to be stable, and thus easily displayed and synchronized on an oscilloscope.

Inc. case and front

100.111 **\$175**



### ELEKTOR P.C. i/o card

\* 220.007 **\$175**

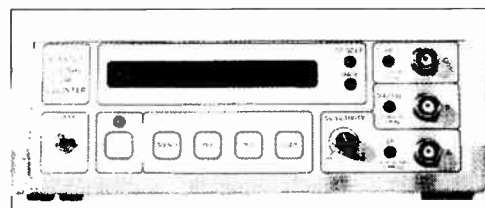

### MICROPROCESSOR-CONTROLLED FREQUENCY METER

A professional grade multi-purpose frequency meter, designed by Elektor Electronics, that can be built by many at affordable cost. Described in Elektor Electronics December 1984, January & February 1985. U665B-based prescaler.

- Frequency meter: 0.01 Hz to 1.2 GHz.
- Pulse duration meter: 0.1 to 100 s.
- Pulse counter: 0 to 10<sup>9</sup> pulses
- Period meter: 10 ns to 100 ns
- Sensitivity: Input A: 10 mV<sub>rms</sub> (Z<sub>in</sub> = 2 MΩ); Input B: TTL or CMOS compatible (Z<sub>in</sub> = 25 kΩ); Input C: prescaler input: 10 mV<sub>rms</sub> (Z<sub>in</sub> = 50 Ω).
- Auto-ranging and completely menu-driven.
- 6 or 7 digit accuracy.

Kit includes power supply, prescaler and enclosure.....100.112 **\$300**

**BASIC COMPUTER**  
With Intel 8052AH-BASIC

100.117  
**\$160**

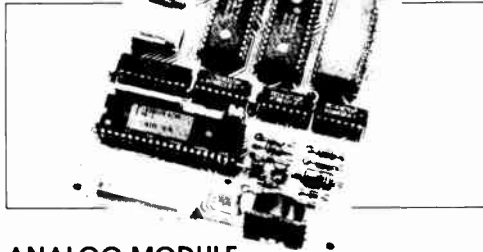

- ANALOG MODULE**  
eps 880162 100.113 **\$80**
- DIGITAL MODULE**  
eps 880163 100.114 **\$55**
- ADRESSEDECODER**  
eps 880159 100.115 **\$45**

**S-VHS/CVBS-TO-RGB CONVERTER**

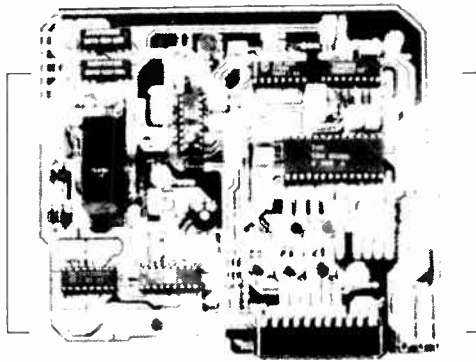

Following last month's introduction into the main characteristics of the Super-VHS system, we close off the article with details of a practical converter circuit that allows an S-VHS-VRC or camcorder to be connected to the RGB inputs of a colour TV or monitor. The circuit presented here forms a state-of-the-art approach to all-analogue picture standard conversion, and is based on the latest in IC technology available for this purpose.

220.039 **\$150**



**AVAILABLE FROM:**  
**OLD COLONY SOUND LAB**

PO Box 243, Dept E92  
Peterborough, NH 03458 USA  
24-Hour Lines:  
Tel. (603) 924-6371 FAX (603) 924-9467

- Check, money order, MC/VISA accepted.
- Please allow 6-8 weeks for delivery.
- **SHIPPING:** Airmail shipping to USA included in price. Others: Please inquire.
- **CUSTOMS:** USA residents may be required to pay 5-10% customs duty. Others may vary.

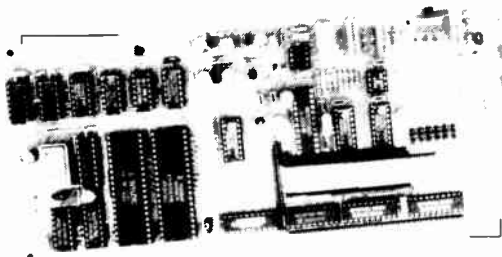

**MULTIFUNCTION MEASUREMENT CARDS FOR PCs**

The high-performance insertion card described in this article allows your IBM PC-XT, PC-AT or 100% compatible to measure direct voltage at 12-bit accuracy, as well as frequency and a host of other parameters related to pulse-shaped signals. The accuracy and versatility afforded by the card are of a level associated with much more expensive, industrially rated products. The menu-driven control software developed for this exciting project allows you to keep tabs on up to eight voltages quasi-simultaneously, while up to eight remaining inputs can be used for time-related measurements including frequency, duty factor and pulse duration, not forgetting the event counter. Connected to the sensors and timing devices of your choice, this card turns a PC into a powerful central controller in a complex measurement and control system.

220.040 **\$225**

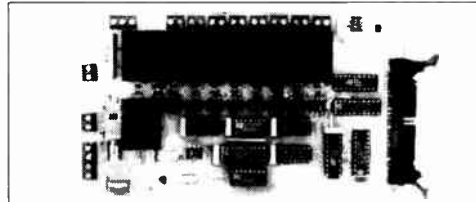

**MICROPROCESSOR-CONTROLLED TELEPHONE EXCHANGE**

The telephone exchange presented here allows up to eight pulse-dialling telephone sets to be connected, and has an option for connecting calls to or from an external (trunk) telephone line. The unit is controlled by the popular 8052-based BASIC computer we introduced a few years ago.

220.057 **\$190**

**MAIN FEATURES**

- 8 Internal lines
- 1 external line
- memory for 10 numbers
- internal through connections
- versatile computer control
- automatic hold for external line
- simple-to-extend
- can be interfaced to a PC
- selective external call acceptance
- shortcut dial codes for external number
- works with pulse-dialling telephone sets
- one optional relay for extra switching function

**MAIN SPECIFICATIONS**

- **Mode: Single**
  - one adjustable power supply with current and voltage controls
  - Output 0 - 40 V at 0 - 5 A
- **Mode: independent**
  - two identical, electrically separated, power supplies
  - Outputs 2 x 0 - 40 V at 2 x 0 - 5 A
- **Mode: Tracking**
  - two identical, series connected, power supplies
  - Outputs ± 0 - ± 40 V at 0 - 5 A
  - 0 - 80 V at 0 - 5 A
  - Voltage and current of slave follow master
- **Mode: parallel**
  - two identical, parallel connected, power supplies
  - Outputs 0.6 - 39.4 V at 0 - 10 A
- **Maximum output voltage:**
  - 0 - 40 V (at full load)
  - 48 V (no load)
- **Maximum output current:** 5 A
- **Ripple:**
  - 10 mV (no load)
  - 50 mV (at full load)
- **Voltage difference in tracking mode:** 50 mV

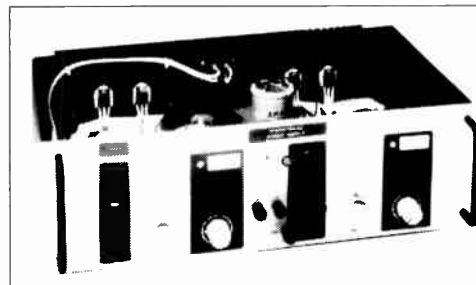

**400-WATT LABORATORY POWER SUPPLY**

Here is an all-purpose d.c. power supply for symmetrical as well as asymmetrical use, and capable of supplying high output currents and voltages. An all-analogue design based on discrete parts only, this 400-watt PSU deserves a prominent place on your work bench.

ex. case 220.036 **\$525**

**SPECIAL PARTS SERVICE**

We are the no. 1 suppliers of hard-to-find components for Elektor Electronics projects. Always contact us first if you see an unfamiliar component. Items include analogue & digital ICs (HCT, SMD), precision resistors (1%, 0.1%), capacitors (MKT/styroflex), inductors (Neosid, Toko), transducers, enclosures (Telet, OKW) and quartz crystals.

FOR FURTHER INFORMATION,  
PLEASE SEND A BUSINESS-SIZE  
SASE TO OLD COLONY SOUND LAB  
(ADDRESS ABOVE), ATTN: MEEK IT.

Courteous Service • Discount Prices • Fast Shipping

# ALL ELECTRONICS CORP.

P.O. Box 567 • Van Nuys, CA 91408

## INFRARED Remote A.C. SWITCH

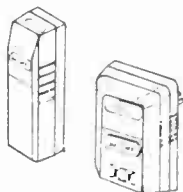

This infrared remote control device lets you turn on/off lamps, appliances or other 120 Vac devices using an IR transmitter similar to the one on your TV or VCR. Originally designed for use with a hydromassage unit, these transmitters and receivers will apparently operate most A.C. devices with 2 prong non-polarized plugs. Not recommended for use with heaters. Requires a 9 volt battery (not included).

## UV "Invisible" INK



When the ink dries the writing of these felt tip pens is visible only under a UV "black light". Originally for marking personal belongings in case of theft, these pens might also be used for writing secret messages or marking merchandise for inventory control. Large quantities available.

CAT# UVP 3 for \$1.00 - 100 for \$25.00

CAT# RC-1

**\$9.95**  
each

2 for \$17.00

## PC BOARD WITH RF MODULATOR (and lots of other parts)

We recently received a load of these PC boards which contain, among other things, a RF modulator. With a little desoldering you should be able to liberate a working unit from the board. Also contains 7805T voltage regulator with a couple of heatsinks, 20 ICs, capacitors, resistors, diodes and connectors. No hook-up information available on the modulator. CAT# VMB-1 \$2.75 each



## Electret MIKE

High efficiency, omni-directional, miniature electret condenser microphone element. Low current drain, good signal to noise ratio, operates on 2 to 10 Vdc. Ideal for telephones, tape recorders, noise-activated alarms and other applications. 0.39" dia X 0.31" high.

CAT# MIKE-10 85¢ each  
200 pcs \$150.00 (75¢ each)

## Surface Mount Green LED

Surface mount LED chip. Clear when off, green when lit.

Very tiny - whole unit is 0.115" X 0.055" X 0.05" thick. 1mm (0.04") lens diameter. Gold-plated mounting surfaces for superior conductivity. CAT# SMLD-2  
20 for \$1.00 • 100 for \$18.00  
1000 for \$140.00

## Electroluminescent BACKLIGHTS

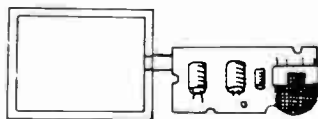

At last! A low cost electroluminescent glow strip and inverter. These brand-new units were designed to backlight small LCD TVs made by the Citizen Watch company. The inverter circuit changes 3 or 6 Vdc to approximately 100 Vac, the voltage required to light the glowstrip. Luminescent surface area is 1.7" X 2.25". The strip is a salmon color in its off state, and glows white when energized. The circuit board is 2.2" X 1". Glow strip and circuitry can be removed easily from plastic housing. Ideal for special lighting effects and backlighting. Two models available:

Citizen# 91TA operates on 3 Vdc CAT# BLU-91  
Citizen# 92TA operates on 3-6 Vdc CAT# BLU-92

**LARGE  
QUANTITY  
AVAILABLE** **\$3.50**  
each

10 for \$32.00 • 100 for \$275.00

## 6 VOLT D.C. MOTOR

Johnson Motor# HC613LG  
Ratings at 6 Vdc (no load):  
8,617 RPM, 0.84 amps,  
34.06 oz. in. torque,  
1.46" dia. X 2.24" long,  
0.125" dia. shaft. Threaded  
mounting holes in front  
on 0.982" centers.

CAT# DCM-29 \$3.50 each



## ULTRASONIC TRANSDUCER

Panasonic (Matsushita)#  
EFR RCBK40K54  
An ultrasonic microphone  
consisting of a bimorph type  
piezo electric ceramic vibrator.  
Nom. Freq. 40 kHz. Max input volts: 20 Volts.  
15/16" diameter X 3/8" high. 5/8" long leads.  
CAT# UST-1 \$1.00 each



**TOLL FREE ORDER LINES**  
**1-800-826-5432**

CHARGE ORDERS to Visa, MasterCard or Discover

TERMS: Minimum order \$10.00. Shipping and handling for the 48 continental U.S.A. \$3.50 per order. All others including AK, HI, PR or Canada must pay full shipping. All orders delivered in CALIFORNIA must include state sales tax (7.25, 7.5, 7.75, 8.25 or 8.5%). Quantities Limited. NO C.O.D. Prices subject to change without notice.

CALL OR WRITE FOR OUR FREE 64 PAGE CATALOG

**ALL ELECTRONICS CORPORATION**  
P.O. Box 567 • Van Nuys, CA • 91408

# ELECTRONIC ENCLOSURES

Everything to complete your project -  
From initial concept to finished product!

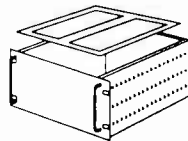

Rack Mount

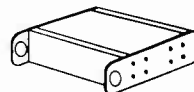

Universal

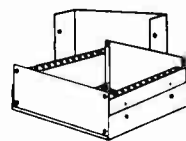

Split Case

Complete line of Enclosures in Aluminum, Steel or ABS, Hardware, Silkscreening, Tools, Custom Fabricating  
**Call for our FREE Full Color Catalog**  
(800) 800-3321 or (216) 425-8888 (216) 425-1228 Fax



Cage & Preamp  
Enclosures



Knobs & Parts

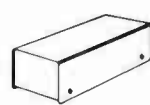

Linear



ABS



Die Cast

## Project Pro

1710 ENTERPRISE PKWY. TWINSBURG, OHIO 44087

## RECOMMENDED SOURCES FOR ELEKTOR ELECTRONICS USA EUROPEAN PARTS

### Borbely Audio

Erno Borbely  
Melchior Fanger Strasse 34A  
8031 Neu-Gilching  
Germany  
Tel 49-8105-5291  
FAX 49-8105-24605 (24H)

### EasyTech, Inc.

2917 Bayview Dr.  
Fremont, CA 94538  
Tel (800) 582-4044  
FAX (800) 582-1255

### ELV France

BP 40  
F-57480 Sierck-les-Bains  
France  
Tel 33-82-83-72-13  
FAX 33-82-83-81-80

### Meek It Electronics

Rob Planken  
Paveljoensgracht 35A  
2515 BL Den Haag  
The Netherlands  
Tel 31-70-609554  
FAX 31-70-397-9707

### Bull Electrical

250 Portland Road  
Hove  
Sussex BN3 5QT  
United Kingdom  
Tel 44-0273-203500  
FAX 44-0273-23077

### C-I Electronics

PO Box 22089  
6360 AB Nuth  
The Netherlands  
FAX 31-45-241877

### Technomatic

Technohouse  
486 Church Lane  
London NW9 8UF  
United Kingdom  
Tel 44-081-205-9558  
FAX 44-081-205-0190

### DIL Elektronika

Jan Lighthartstraat 59-61  
3083 AL Rotterdam  
The Netherlands  
FAX 31-10-4841150



**BASIC COMPUTER**  
With Intel 8052AH-BASIC

100.117

**\$160**

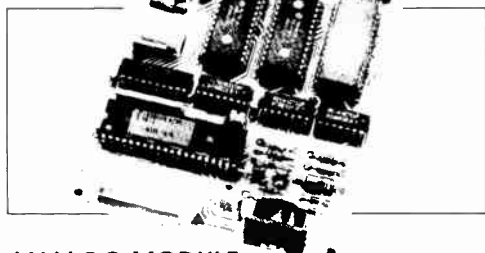

**ANALOG MODULE**

eps 880162

100.113 **\$80**

**DIGITAL MODULE**

eps 880163

100.114 **\$55**

**ADRESSECODER**

eps 880159

100.115 **\$45**

**S-VHS/CVBS-TO-RGB CONVERTER**

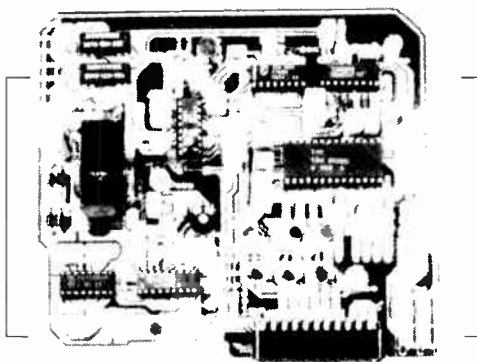

Following last month's introduction into the main characteristics of the Super-VHS system, we close off the article with details of a practical converter circuit that allows an S-VHS-VRC or camcorder to be connected to the RGB inputs of a colour TV or monitor. The circuit presented here forms a state-of-the-art approach to all-analogue picture standard conversion, and is based on the latest in IC technology available for this purpose.

220.039 **\$150**



THE HAGUE HOLLAND

AVAILABLE FROM:

**OLD COLONY SOUND LAB**

PO Box 243, Dept E92  
Peterborough, NH 03458 USA  
24-Hour Lines:

Tel. (603) 924-6371 FAX (603) 924-9467

- Check, money order, MC/VISA accepted.
- Please allow 6-8 weeks for delivery.
- **SHIPPING:** Airmail shipping to USA included in price. Others: Please inquire.
- **CUSTOMS:** USA residents may be required to pay 5-10% customs duty. Others may vary.

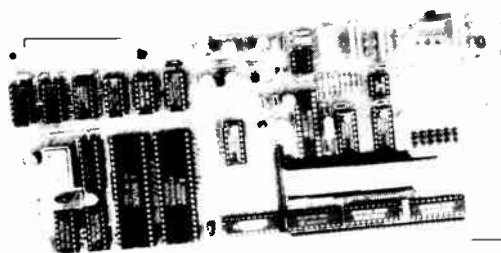

**MULTIFUNCTION MEASUREMENT CARDS FOR PCs**

The high-performance insertion card described in this article allows your IBM PC-XT, PC-AT or 100% compatible to measure direct voltage at 12-bit accuracy, as well as frequency and a host of other parameters related to pulse-shaped signals. The accuracy and versatility afforded by the card are of a level associated with much more expensive, industrially rated products. The menu-driven control software developed for this exciting project allows you to keep tabs on up to eight voltages quasi-simultaneously, while up to eight remaining inputs can be used for time-related measurements including frequency, duty factor and pulse duration, not forgetting the event counter. Connected to the sensors and timing devices of your choice, this card turns a PC into a powerful central controller in a complex measurement and control system.

220.040 **\$225**

**SPECIAL PARTS SERVICE**

We are the no. 1 suppliers of hard-to-find components for Elektor Electronics projects. Always contact us first if you see an unfamiliar component. Items include analogue & digital ICs (HCT, SMD), precision resistors (1%, 0.1%), capacitors (MKT/styroflex), inductors (Neosid, Toko), transducers, enclosures (Telet, OKW) and quartz crystals.

FOR FURTHER INFORMATION,  
PLEASE SEND A BUSINESS-SIZE  
SASE TO OLD COLONY SOUND LAB  
(ADDRESS ABOVE), ATTN: MEEK IT.

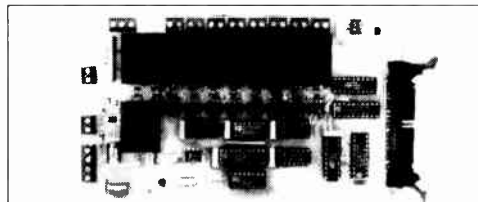

**MICROPROCESSOR-CONTROLLED TELEPHONE EXCHANGE**

The telephone exchange presented here allows up to eight pulse-dialling telephone sets to be connected, and has an option for connecting calls to or from an external (trunk) telephone line. The unit is controlled by the popular 8052-based BASIC computer we introduced a few years ago.

220.057 **\$190**

**MAIN FEATURES**

- 8 Internal lines
- 1 external line
- memory for 10 numbers
- internal through connections
- versatile computer control
- automatic hold for external line
- simple-to-extend
- can be interfaced to a PC
- selective external call acceptance
- shortcut dial codes for external number
- works with pulse-dialling telephone sets
- one optional relay for extra switching function

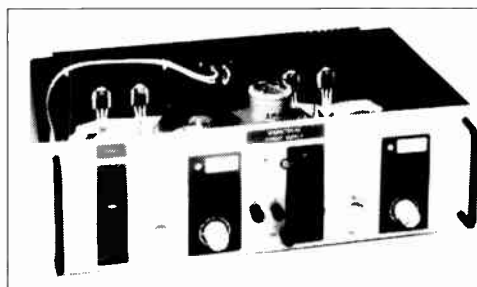

**400-WATT LABORATORY POWER SUPPLY**

Here is an all-purpose d.c. power supply for symmetrical as well as asymmetrical use, and capable of supplying high output currents and voltages. An all-analogue design based on discrete parts only, this 400-watt PSU deserves a prominent place on your work bench.

ex. case 220.036 **\$525**

**MAIN SPECIFICATIONS**

- **Mode: Single**  
- one adjustable power supply with current and voltage controls  
- Output 0 - 40 V at 0 - 5 A
- **Mode: independent**  
- two identical, electrically separated, power supplies  
- Outputs 2 x 0 - 40 V at 2 x 0 - 5 A
- **Mode: Tracking**  
- two identical, series connected, power supplies  
- Outputs ± 0 - ± 40 V at 0 - 5 A  
- 0 - 80 V at 0 - 5 A  
- Voltage and current at slave follow master
- **Mode: parallel**  
- two identical, parallel connected, power supplies  
- Outputs 0.6 - 39.4 V at 0 - 10 A
- **Maximum output voltage:**  
0 - 40 V (at full load)  
48 V (no load)
- **Maximum output current:** 5 A
- **Ripple:** 10 mV (no load)  
50 mV (at full load)
- **Voltage difference in tracking mode:** 50 mV

Courteous Service • Discount Prices • Fast Shipping

## ALL ELECTRONICS CORP.

P.O. Box 567 • Van Nuys, CA 91408

### INFRARED Remote A.C. SWITCH

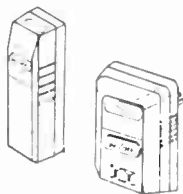

This infrared remote control device lets you turn on/off lamps, appliances or other 120 Vac devices using an IR transmitter similar to the one on your TV or VCR. Originally designed for use with a hydromassage unit, these transmitters and receivers will apparently operate most A.C. devices with 2 prong non-polarized plugs. Not recommended for use with heaters. Requires a 9 volt battery (not included).

### UV "Invisible" INK



When the ink dries the writing of these felt tip pens is visible only under a UV "black light". Originally for marking personal belongings in case of theft, these pens might also be used for writing secret messages or marking merchandise for inventory control. Large quantities available.

CAT# UVP 3 for \$1.00 - 100 for \$25.00

CAT# RC-1

**\$9.95**  
each

2 for \$17.00

### PC BOARD WITH RF MODULATOR (and lots of other parts)

We recently received a load of these PC boards which contain, among other things, a RF modulator. With a little desoldering you should be able to liberate a working unit from the board. Also contains 7805T voltage regulator with a couple of heatsinks, 20 ICs, capacitors, resistors, diodes and connectors. No hook-up information available on the modulator. CAT# VMB-1 \$2.75 each



### Electret MIKE

High efficiency, omni-directional, miniature electret condenser microphone element. Low current drain, good signal to noise ratio, operates on 2 to 10 Vdc. Ideal for telephones, tape recorders, noise-activated alarms and other applications. 0.39" dia X 0.31" high.

CAT# MIKE-10 85¢ each  
200 pcs \$150.00 (75¢ each)

### Surface Mount Green LED

Surface mount LED chip. Clear when off, green when lit.

Very tiny - whole unit is 0.115" X 0.055" X 0.05" thick. 1mm (0.04") lens diameter. Gold-plated mounting surfaces for superior conductivity. CAT# SMLD-2  
20 for \$1.00 • 100 for \$18.00  
1000 for \$140.00

### Electroluminescent BACKLIGHTS

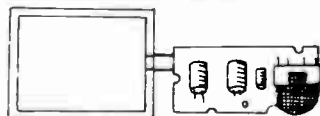

At last! A low cost electroluminescent glow strip and inverter. These brand-new units were designed to backlight small LCD TVs made by the Citizen Watch company. The inverter circuit changes 3 or 6 Vdc to approximately 100 Vac, the voltage required to light the glowstrip. Luminescent surface area is 1.7" X 2.25". The strip is a salmon color in its off state, and glows white when energized. The circuit board is 2.2" X 1". Glow strip and circuitry can be removed easily from plastic housing. Ideal for special lighting effects and backlighting. Two models available.

Citizen# 91TA operates on 3 Vdc CAT# BLU-91  
Citizen# 92TA operates on 3-6 Vdc CAT# BLU-92

**LARGE  
QUANTITY  
AVAILABLE** **\$3.50**  
each

10 for \$32.00 • 100 for \$275.00

### 6 VOLT D.C. MOTOR

Johnson Motor# HC613LG  
Ratings at 6 Vdc (no load):  
8,617 RPM, 0.84 amps,  
34.06 oz. in. torque.  
1.46" dia. X 2.24" long.  
0.125" dia. shaft. Threaded  
mounting holes in front  
on 0.982" centers.

CAT# DCM-29 \$3.50 each



### ULTRASONIC TRANSDUCER

Panasonic (Matsushita)#  
EFR RCBK40K54  
An ultrasonic microphone  
consisting of a bimorph type  
piezo electric ceramic vibrator.  
Nom. Freq. 40 kHz. Max input volts: 20 Volts.  
15/16" diameter X 3/8" high. 5/8" long leads.  
CAT# UST-1 \$1.00 each



**TOLL FREE ORDER LINES**  
**1-800-826-5432**

CHARGE ORDERS to Visa, MasterCard or Discover

TERMS: Minimum order \$10.00. Shipping and handling for the 48 continental U.S.A. \$3.50 per order. All others including AK, HI, PR or Canada must pay full shipping. All orders delivered in CALIFORNIA must include state sales tax (7.25, 7.5, 7.75, 8.25 or 8.5%). Quantities Limited. NO C.O.D. Prices subject to change without notice.

CALL OR WRITE FOR OUR FREE 64 PAGE CATALOG

**ALL ELECTRONICS CORPORATION**  
P.O. Box 567 • Van Nuys, CA • 91408

## ELECTRONIC ENCLOSURES

Everything to complete your project -  
From initial concept to finished product!

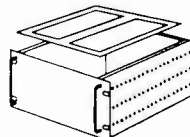

Rack Mount

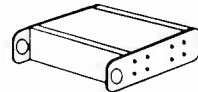

Universal

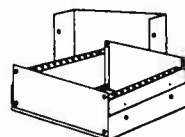

Split Case

Complete line of Enclosures in Aluminum, Steel or ABS,  
Hardware, Silkscreening, Tools, Custom Fabricating  
**Call for our FREE Full Color Catalog**  
(800) 800-3321 or (216) 425-8888 (216) 425-1228 Fax

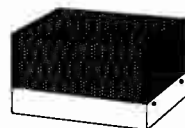

Cage & Preamp  
Enclosures



Knobs & Parts

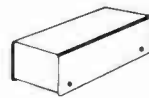

Linear



ABS

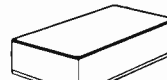

Die Cast

## Project Pro

1710 ENTERPRISE PKWY. TWINSBURG, OHIO 44087

## RECOMMENDED SOURCES FOR ELEKTOR ELECTRONICS USA EUROPEAN PARTS

### Borbely Audio

Erno Borbely  
Melchior Fanger Strasse 34A  
8031 Neu-Gilching  
Germany  
Tel 49-8105-5291  
FAX 49-8105-24605 (24H)

### EasyTech, Inc.

2917 Bayview Dr.  
Fremont, CA 94538  
Tel (800) 582-4044  
FAX (800) 582-1255

### ELV France

BP 40  
F-57480 Sierck-les-Bains  
France  
Tel 33-82-83-72-13  
FAX 33-82-83-81-80

### Bull Electrical

250 Portland Road  
Hove  
Sussex BN3 5QT  
United Kingdom  
Tel 44-0273-203500  
FAX 44-0273-23077

### Meek It Electronics

Rob Planken  
Paveljoensgracht 35A  
2515 BL Den Haag  
The Netherlands  
Tel 31-70-609554  
FAX 31-70-397-9707

### C-I Electronics

PO Box 22089  
6360 AB Nuth  
The Netherlands  
FAX 31-45-241877

### Technomatic

Technohouse  
486 Church Lane  
London NW9 8UF  
United Kingdom  
Tel 44-081-205-9558  
FAX 44-081-205-0190

### DIL Elektronika

Jan Lighthartstraat 59-61  
3083 AL Rotterdam  
The Netherlands  
FAX 31-10-4841150

## MULTIMEDIA APPLICATIONS

Analog Devices adds the AD1866 complete stereo 16-bit PCM audio DAC that operates from a single +5V supply for portable, low-power, and computer audio (multimedia) applications. It requires few external components to achieve rated performance, thereby reducing system complexity and cost. This complete IC is comprised of two precision references, output amplifiers, and 16-bit converters. DC bias pins that position the output signal at 2.5V midscale (1.5V-3.5V swing) eliminate the need for false-ground circuitry. The AD1866 is characterized to the EIAJ CP-307 test standards and is packaged in 16-pin plastic DIPs or SOICs. It costs \$10.50 in groups of 100.

Contact Analog Devices, Inc., 181 Ballardville St., Wilmington, MA 01887, (617) 937-1428, FAX (617) 821-4273 for literature.



## PATTERN-RECOGNITION SOFTWARE

Teranet IA, Inc. has released a new version of ModelWare—Version 1.1, a modeling or pattern-recognition software program with a variety of applications and support. Solve complex problems using quality control in manufacturing, advanced fault detection, customer retention analysis, financial prediction, and industrial signal validation. A demo version is available for \$45, which can be credited against the purchase price.

Contact Teranet IA, Inc., 1615 Bowen Rd., Nanaimo, BC, Canada, V9S 1G5, (604) 754-4223, FAX (604) 754-2388.

# ELECTRONICS SCENE

## PRO PCBs EN MASSE

PCBoards now offers a CAM driver (\$49) for Gerber and Excellon output. With it, you can send your PCB art, created with the PCBoards layout program, directly to the Gerber format and then to a circuit board house for production, either by modem or disk. Bound manuals are available with the purchase of the CAM driver or \$8 separately.

Contact PCBoards, 2110 14th Avenue South, Birmingham, AL 35205, (205) 933-1122.

## FREE SPICE WITH OP AMPS

Analog Devices' dual OP-282 and quad OP-482 are 4MHz unity gain bandwidth operational amplifiers that cost less than 55¢ per channel. Each amplifier draws a maximum supply current of only 250µA and their slew rate exceeds 7V/µs, with a settling time of 1.6µs to 0.01%. Offset voltage is only 3mV, for the dual OP-282 and 4mV, for the quad OP-482.

These devices offer a balanced set of guaranteed AC and DC specifications and feature a common-mode input range that includes a positive power supply and output swing to within 1.5V of each power rail. They are well-suited for power-restricted or battery-operated applications. Each model includes complete SPICE models and both are available in chip form. In a plastic DIP, the dual OP-282 costs \$1.05 and the quad OP-482 costs \$1.72 (thousands).

Contact Steve Sockolov, Analog Devices, Inc., PMI Division, 1500 Space Park Dr., Santa Clara, CA 95052-8020, (408) 562-7456.

## DIGITAL SNAP-AROUNDS

A. W. Sperry Instruments Inc., marketer of portable electrical and electronic test equipment, announces its new, economical line of DIGISNAP™ Digital Snap-Arounds: models DSA-400, -400A, -440, -440T, and DSA-450 TRUE RMS. Features include limited lifetime warranty, AC current, AC and DC voltage, resistance, diode test, continuity buzzer, frequency and temperature ranges, meeting IEC-348 Class II standards, data hold and data peak. Prices range from \$64.95-\$129.95.

Contact A. W. Sperry Instruments Inc., 245 Marcus Blvd., Hauppauge, NY 11788, (516) 231-7050.



Published by Audio Amateur Publications, Inc.

**Editor/publisher:** Edward T. Dell, Jr.

**Editorial Offices:**

305 Union St., P.O. Box 876  
Peterborough, NH 03458-0876 USA

Telephone: 603-924-9464 (National)

or +1 (603) 924-9464 (International)

FAX: (603) 924-9467 (National)

or +1 (603) 924-9467 (International)

**Advertising:** Maureen E. McHugh

Telephone: (603) 358-3756

FAX: (603) 924-9467

**Subscriptions:** Katharine Gadwah

Elektor Electronics USA

Post Office Box 876,

Peterborough, New Hampshire 03458

**Subscriptions** to *Elektor Electronics USA* are available **ONLY** in the fifty United States, Canada, Puerto Rico, the Virgin Islands and those Pacific territories administered by the United States of America.

**International Advertising:**

Uitgeversmaatschappij Elektuur b.v.

P.O. Box 75

6190 AB BEEK

The Netherlands

Telephone: +31 46 38 94 44

FAX: +31 46 37 01 61

**European Offices:**

Elektuur BV

Postbus 75

6190 AB BEEK

The Netherlands

Telephone: 011 31 4638 9444

Telex: 56617 (elekt nl)

FAX: 011 31 4637 0161

**Managing Director:** M.M.J. Landman

**Overseas Editions:**

**FRANCE**

Elektor sarl

Les Trois Tilleuis

B.P. 59; 59850 NIEPPE

**Editors:** D.R.S. Meyer

G.C.P. Raedersdorf

**GERMANY**

Elektor Verlag GmbH

Susterfeld Strasse 25

5100 AACHEN

**Editor:** E.J.A. Krempelsauer

**GREECE**

Elektor EPE

Kariskaki 14

16673 Voula—Athens

**Editor:** E. Xanthoulis

**HUNGARY**

Elektor Elektronikai folyoirat

1015 Budapest

Batthyany U. 13.

**Editor:** Lakatos Andras

**INDIA**

Elektor Electronics PVT Ltd

Chhotani Building

52C, Proctor Road, Grant Road (E)

BOMBAY 400 007

**Editor:** Surendra Iyer

**ISRAEL**

Elektorcal

P O Box 41096

TEL AVIV 61410

**Publisher:** M. Avraham

**NETHERLANDS**

Elektuur BV

Peter Treckpoelstraat 2-4

6191 VK BEEK

**Editor:** P.E.L. Kersemakers

**PAKISTAN**

Electro-shop

35 Naseem Plaza

Lasbella Chawk

KARACHI 5

**Editor:** Zain Ahmed

**PORTUGAL**

Ferreira & Bento Lda.

R.D. Estef-83-ni, 32-1°

1000 LISBOA

**Editor:** Jeremias Sequeira

**SPAIN**

Resistor Electronica Aplicada

Calle Maudes 15 Entio C.

28003 MADRID

**Editor:** Agustin Gonzales Buella

**SWEDEN**

Electronic Press AB

Box 5505

14105 HUDDINGE

**Editor:** Bill Cedrum

**UNITED KINGDOM**

Elektor Electronics (Publishing)

P.O. Box 1414

Dorchester DT2 8YH

England

**Editor/Publisher:** Len Seymour

Printed in the United States of America.

ISSN: 1051-5690

## ANTENNA GAIN

MFJ Enterprises announces the MFJ-1750,  $\frac{5}{8}$  wave, ground plane, 2M band antenna. Features include Rapid Tune Radiator™ with a spin-to-tune concept; handles 300W and covers an entire 2M band with SWR below one and one-half over the full 4MHz range. A shunt-fed matching network is included for lower SWR and discharging of unwanted static charges.

Contact MFJ Enterprises, Inc., PO Box 494, Mississippi State, MS 39762, (601) 323-5869, FAX (601) 323-6551.

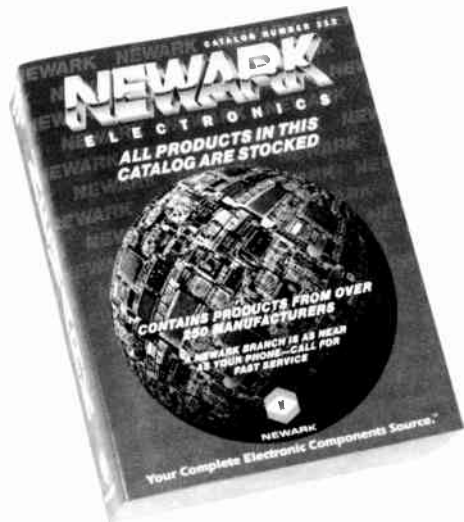

## BIG CATALOG

Newark Electronics publishes a 1,200-page catalog that contains detailed, technical information and dimensions on over 100,000 products from 250 manufacturers. Catalog 112 features an additional 20 manufacturers and more than 15,000 new products. To obtain your free copy, contact Newark Electronics, 4801 N. Ravenswood Ave., Chicago, IL 60640-4496, or call (800) 367-3573.

## CAPITAL ACQUISITION

Capital Electro-Circuits, manufacturer of multi-layer and double-sided PC boards, announces the addition of a GerbTool/386 CAM Station and an Everett/Charles Kryterion 500, bare-board electrical tester.

The CAM station can accept any Gerber output from customers and perform design rule checks, modifications and other improvements to circuit boards before plots are generated.

The Kryterion 500 can test up to 38,000, through-hole or surface-mount, test points on panel sizes of up to 18 x 24". Both acquisitions result in higher quality at less cost.

Contact Capital Electro-Circuits, Inc., 7845J Airpark Rd., Gaithersburg, MD 20879, (301) 977-0303.

## ELECTRONICS SCENE

### Errors Corrected

The headline in the first item of Electronics Scene (EEUSA 1/92, p. 12) should have read LOW-COST MIDI STARTER SET. On the same page, StarPC Instruments' PROGRAMMABLE COUNTER should have included mention that it was also a SIGNAL GENERATOR. The second paragraph of that item should have read "variable pulse width output." Our apologies to PAIA Electronics Inc., StarPC Instruments, and to our readers.

### CLASSIC REPRINT

Professional Audio Journals, Inc., announces *Acoustical Engineering* by Harry F. Olson, the first in a series of audio classics reprinted due to demand. With more than 700 pages and 500 illustrations, this new edition is printed on acid-free paper, has an introduction by Jesse Klapholz, an updated biography on Olson, and a bibliography of Olson's selected articles published between 1957 and 1980.

Coverage includes loudspeakers and microphones, measurements, sound reproduction, communication systems, underwater sound, and ultrasonics. Reviewers claim solutions to electroacoustical problems; audio professionals will find it a valuable reference.

The reprint costs \$49.95, plus shipping and handling; \$4 US, \$8 international. Contact Professional Audio Journals, Inc., PO Box 31718, Philadelphia, PA 19147-7718, (215) 465-1975, FAX (215) 336-7743.

### DIGITAL THERMO-HYGROMETER

A. W. Sperry Instruments announces the Model DTH-1A, a pocket-sized digital thermo-hygrometer with mini/max memory. Its ranges include 0-50°C, 32-122°F, and 2-98%RH with a feature that measures both humidity and temperature in degrees Centigrade and Fahrenheit simultaneously.

The Model DTH-1A is equipped with two 1.5V-button type batteries, case, and operating instructions for \$49.95. Contact A. W. Sperry Instruments, Inc., 245 Hauppauge, NY 11788, (516) 231-7050.

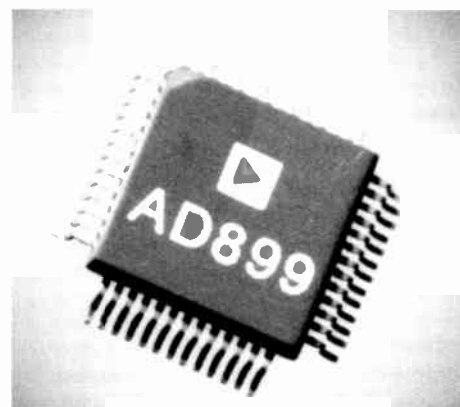

### READ-CHANNEL IC

Analog Devices has released the AD899, a hard-disk-drive read channel combined into a single +5V, 52-pin IC. It reduces space requirements, power consumption, and cost compared to other multiple chip solutions. By supporting data rates up to 32Mbits/s, the AD899 provides signal conditioning, data qualification, data synchronization, and RLL 1,7 data encoding/decoding with a minimum of components.

The AD899 is available in a 52-lead PQFP package and is priced at \$10 in OEM quantities. Contact Analog Devices, Inc., 804 Woburn St., Wilmington, MA 01887, (617) 937-2210.

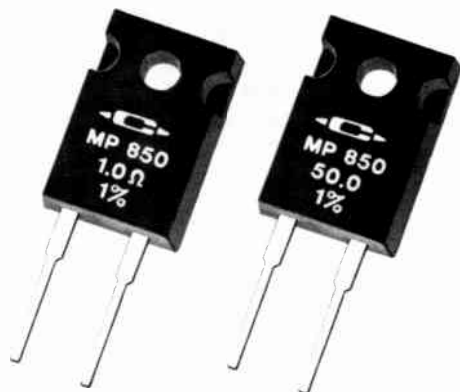

### POWER FILM RESISTOR

Caddock Electronics announces the Type MP850 Kool-Pak Power Film Resistor which uses its proven Micronox® resistance film system in an all-molded TO-220 Power Package to provide a 50W heatsink mountable resistor. The noninductive design makes this resistor ideal in power switching circuits.

The Model MP850, 10Ω at 2%, is 10,000 pieces/\$1.99 each. Contact Caddock Electronics, Applications Engineering, 17271 N. Umpqua Hwy., Roseburg, OR 97470, (503) 496-0700, FAX (503) 496-0408.

## ELECTRONICS SCENE

### NEW VIDEO STANDARD

The Work Group on Studio Video Standards for the Society of Motion Picture and Television Engineers has determined that the serial digital interface, for component and composite video signals, is an effective interface for digital equipment in television environments. If approved, the proposed standard, 259M, will be published in the *SMPTE Journal* along with related documents.

For further details, contact the Society of Motion Picture and Television Engineers, 595 West Hartsdale Ave., White Plains, NY 10607, (914) 761-1100.

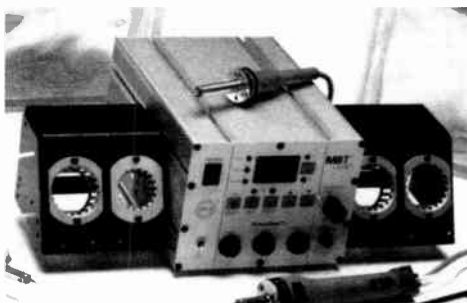

### PACE LINE

Techni-Tool, supplier of a variety of tools, now offers the full line of PACE® Products: the MBT-250 Solder Station, De-Solder Station, PRC-151 Bench-top Rework and Repair Center, ST-50 & ST 50-V, SMR-25/SMR-20 "Pulse Heat" SMD Reflow System, MBT-201, SMR-20 SMD Reflow System, SMR-25/SMR-20 Handpieces, MP-1 Portable Desoldering Station, PFP-40 Fuseset System, the HS-150 Hotspot, and more.

For a free catalog, contact Techni-Tool, 5 Apollo Rd., PO Box 368, Plymouth Meeting, PA 19462, (215) 941-2400, FAX (215) 828-5623.

### FREE 'SCOPE SEMINARS

Tektronix is offering free seminars to teach the latest oscilloscope measurement techniques. A one day training session, structured around common applications, consisting of formal presentations and hands-on lab work. The seminar is directed at engineering managers, test engineers, analog and digital designers, electronic service technicians and researchers. Oscilloscopes ranging from low-cost portables to sophisticated laboratory instruments with sampling rates to 2GS/sec will be discussed and demonstrated.

Call Tektronix, (800) 426-2200, ext. 579, to find the training center nearest you.

### EXPORTABLE RADIO

Harris Corporation's RF Communications Group introduces the multiband VHF/UHF radio transceiver designed to meet the multi-mission, multi-waveform requirements of international military defense forces. The AN/PRC-117D(E) is designed specifically for export, combines bands in one compact, and light-weight manpack radio set. This provides flexibility for ground-to-air, ship-to-ship, ship-to-shore, and ground-to-ground communications. The unit is interoperable with most tactical radios and with fielded AN/PRC-117A and AN/VRC-94A(V) series radios. When used with the built-in RF-3995 digital encryption option, which pseudorandomly generates algorithms with up to 10<sup>52</sup> possible combinations, the AN/PRC-117d(E) provides advanced communications security in data and voice modes.

Contact Harris Corporation, RF Communications Group, 1680 University Ave., Rochester, NY 14610, (716) 244-5830.

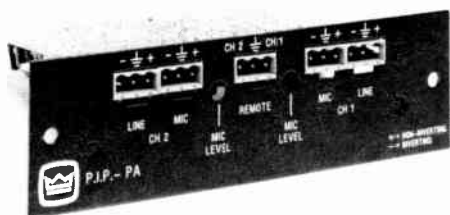

### CROWN PREAMP MODULE

Crown International, Inc. offers the P.I.P.-PA preamplifier module intended for use with P.I.P.-compatible amplifiers such as the Crown Macro-Tech and Com-Tech. Because it can be plugged directly into the back of the amplifier, the module saves rack space. It provides switchable, balanced low-impedance mike input and balanced line-level input on each amplifier channel. One feature prevents overdriving. Another which enhances the P.I.P.-PA's flexibility is an optional 6dB/octave bass rolloff at 150Hz. Designed for small systems, it is an alternative for outboard mixers and signal processors.

Contact Crown International, Inc., 1718 Mishawaka Rd., Elkhart, IN 46517, (616) 695-5948, FAX (616) 695-7623.

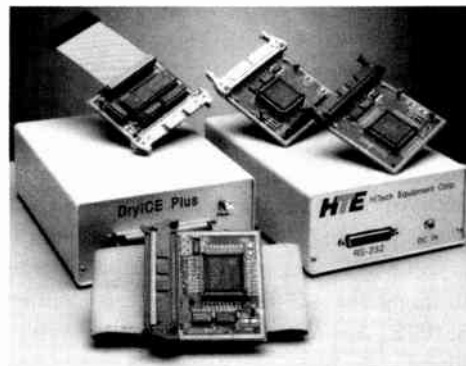

### IN-CIRCUIT EMULATOR

HiTech Equipment Corporation has added the DryICE™ Plus in-circuit emulator system to its DryICE family of low-cost 8051 emulators. The emulator unit (\$299) has its own power supply, control circuitry, 48K of user program memory, and an RS-232 interface to connect with the host computer. You choose an interchangeable emulation pod (\$149) from a list that includes Oki, Signetics, Siemens, and Intel. An 18" pod cable is included to plug into the user's target system in place of the target microprocessor. The DryICE accepts user code in Intel Hex format.

Contact HiTech Equipment Corp., 9400 Activity Rd., San Diego, CA 92126, (619) 566-1892, FAX (619) 530-1458.

### WAVEFORM ANALYZER

Sencore Electronics announces the SC3080 Waveform Analyzer that automates every conventional scope measurement for faster and more accurate waveform analysis. This includes a digital readout on both channels for PPV, DCV, and frequency. All measurements are made through one probe, eliminating any time-consuming hookup. Delta features include PPV, time, and 1/Time measurement capabilities for both input channels. Further, Sencore guarantees that if the added speed and accuracy of the SC3080 Waveform Analyzer do not at least double your testing and troubleshooting productivity during the first 30 days, the instrument may be returned for a full refund, including freight, both ways.

For information, contact Sencore Electronics, 3200 Sencore Dr., Sioux Falls, SD 57107, (800) SENCORE.

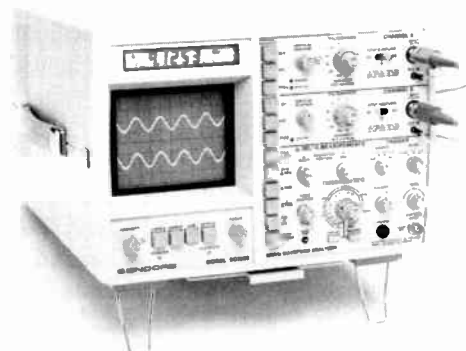



## IMAGING BOOK

**Society of Motion Picture and Television Engineers (SMPTE)** announces a 250-page book published from papers given at the 26th Annual Advanced Television and Electronic Imaging Conference held last February in San Francisco. It is available for \$20 to members; \$25 to nonmembers. Contact SMPTE, 595 West Hartsdale Ave., White Plains, NY 10607.

## TECHNICAL NOTES

**ARX Systems** is publishing a series of application notes, the first of which is about DI-6S, a versatile signal processing and routing device. While the notes are primarily intended for users of ARX Systems' products, the technical information they contain is applicable to other products of a similar nature. Available at no charge to those who send a self-addressed stamped envelope, the company expects to release one set of application notes a month.

Contact ARX Systems, PO Box 842, Silverado, CA 92676-0842, (714) 649-2346.

## TECHNI-TOOL CATALOG

Over 18,000 items from more than 850 manufacturers are featured in the new Techni-Tool Catalog. Their inventory of items include: electro-mechanical and assembly devices, aerospace production, computer maintenance, surface-mount technology, electronic, telecommunication, field service tool kits, static control and clean room items.

For details, contact Techni-Tool, 5 Apollo Rd., PO Box 368, Plymouth Meeting, PA 19462.

## INTELLIGENT SCANNING

**Future Scanning Systems** has released the software program SCAN, Version 2, for the AMIGA computer. This program performs intelligent scanning and controls Icom radio receivers that support Icom's CI-V port. Some of the programs features are: fully automated scanning, logging and receiving control, maximum scanning speed of over 2,000 channels per minute, and remote control tape recording. The control algorithms remove dead-tape time, the built-in mouse can edit channel parameters and the high-resolution graphics displays scan activity.

SCAN is fully multi-tasking and generates ASCII frequency files. It requires 1Mb of RAM and is Workbench-2 compatible. The single radio version is \$149; dual version is \$199. Shipping outside the US, include \$15. Contact Future Scanning Systems, PO Box 654, Bartlesville, OK 74005, (918) 333-7474.

## ELECTRONICS SCENE

### CHIP TEST ADAPTER

**Antona Corporation** offers the Model ANC-4028, which enables the circuit designer to test and monitor socketed 28-pin plastic leaded chip carrier (PLCC) type components. Complete with two LED status circuits, modular construction, easily reconfigurable to accommodate pin grid array (PGA) or leadless chip carrier (LCC), the test adapter is available in 52-, 68-, and 84-pin versions. Each unit costs \$117. Optional pluggable test adapters are \$24 each.

Contact Antona Corp., 1643½ Westwood Blvd., West Los Angeles, CA 90024, (310) 473-8995, FAX (310) 473-7112.

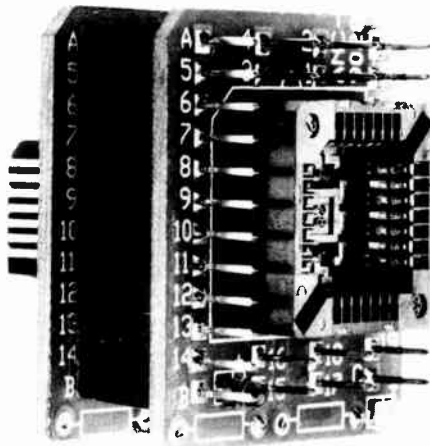

### BETTER BRAIN WAVES

**Synetic Systems, Inc.**, releases the Synergizer, a hardware/software combination that turns the IBM PC/XT/AT/386/486 or clone into a laboratory-grade brain-wave entrainment synchronizer. You can create sessions of almost any length and complexity, set eye and ear pulse rates independently, channel sound frequencies left and right. Multiple time ramps and sound light levels (300) can be included in one program session.

The Synergizer (\$495) requires DOS 3.0 or above, 512K of RAM, a mouse, and a hard drive. An external control is an additional \$95. Contact Synetic Systems, Inc., 3822 Stone Way N., Seattle, WA 98103, (206) 632-1722.

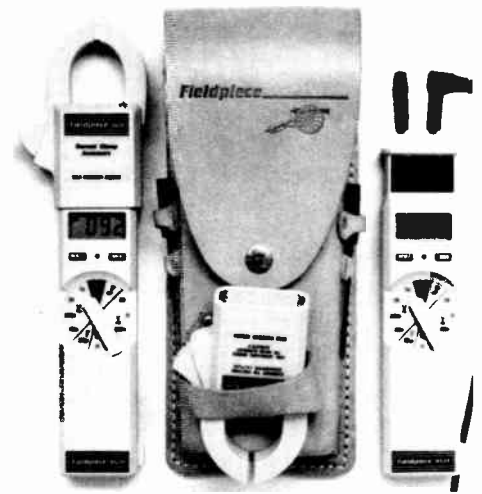
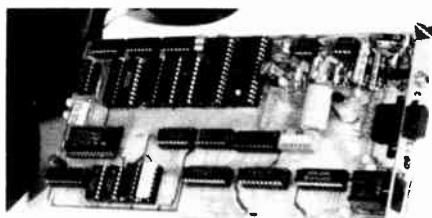

### HI-RES STICK DMM

**Fieldpiece** has developed the HS24 Digital Multimeter (DMM) to add ranges needed to display resolution to 0.1A AC and 0.1° using AC current (amp) clamps and temperature converters. This small, heavy-duty unit combines a digital multimeter, voltage checker, capacitance meter, continuity checker, and current clamp meter in a fully sealed, drop-proof, contamination-resistant Valox housing. Jacks emerge from the top to accept probe tips, test leads, alligator clips, or an accessory current clamp head.

The HS24 adds a 200mV AC and a 200mV DC range to the meters for 0.1mV resolution from converters that deliver 1mV AC or DC per unit of measure. Available either assembled (\$99) or as a kit (HS24K11 for \$159); the kit includes a customized leather tool belt.

Contact Fieldpiece Instruments, Inc., 8322B Artesia Blvd., Buena Park, CA 90621, Phone and FAX—(714) 992-1239.

### MINSQ SOFTWARE UPGRADE

**MicroMath Scientific Software** has listened to user input when re-engineering MINSQ, a system-modeling program for electronic, mechanical, and chemical applications. MINSQ II, 400% faster than its predecessor, takes general equations and derives parameter estimations to reflect how a system reacts to different forces.

The new interface includes a spreadsheet, pull-down menus and optional mouse support. Objects and text can both be manipulated for faster editing. Three new plot types include polar, box, and step. Additional features include: multiple x and y axes (five), on-line context sensitive help, expansion of printer drivers, and eight plot export formats. Files can also be imported and exported to Lotus, Quattro Pro, Excel, Dbase, DIF and ASCII. Upgrade cost is \$99.

Contact MicroMath Scientific Software, PO Box 21550, Salt Lake City, UT 84121, VOICE (801) 943-0290, FAX (801) 943-0299, BBS (801) 943-0397.

## NEW BOOKS

### **INTRODUCING DIGITAL AUDIO**

by Ian R. Sinclair

ISBN 1-870-775-22-8

Price \$10.95 + \$2 S/H (soft cover)

The second edition of this book, aimed at enthusiasts, technicians, and students, describes digital audio methods and circuits that are alien to the technician or keen amateur who has previously worked only with analog audio circuits. Principles and methods are explained, but the mathematical background and theory are avoided other than to discuss the end product.

New material includes Sony's Mini Disc, the Philips Digital Compact Cassette, and R-DAT, which is finding ever wider acceptance in professional recording studios. Moreover, the CD section now includes coverage of MASH and bitstream methods, and a glossary of terms.

Old Colony Sound Lab

PO Box 243

Peterborough, NH 03458

Tel (603) 924-6371

FAX (603) 924-9467

### **THE SATELLITE BOOK 2nd Ed.**

Edited by John Breeds

ISBN 1-872567-02-9

Price \$48.95 (soft cover)

The second edition of this popular book has been completely revised and updated, with new sections on the up-and-coming IF distribution systems, Eurocrypt technology, D2Mac, and an easy-to-follow troubleshooting guide for both established installers and newcomers to the satellite business.

Written by over 20 specialists in the field of satellite TV reception, the book has a remarkably large scope, covering just about everything you need to know from geostationary satellite positioning theory to the connection of a SCART cable. Its comprehensiveness and excellent subject presentation make this one of the better books on satellite TV reception.

Chapters of particular interest include those on practical equipment installation, customer care, and the MAC transmission standard. The latter chapter is written by Paul Gardiner (formerly of the then IBA), who has been known for years as an authority on that topic.

Interestingly, the book also has a chapter on ferrite polar selectors, which discusses

theory and practice of linear and circular polarization, a subject from microwave theory on which little has been published to date.

A minor criticism of the book is that it gives very little attention to scrambling systems other than the Videocrypt System and Eurocrypt for MAC. This is surprising, because analog scrambling systems are still being used on many satellite TV channels (at least those that are received in Europe).  
*Swift Television Publications*

17 Pittsfield

Cricklade SN6 6AN

England

United Kingdom

### **THE LASER GUIDEBOOK 2nd Ed.**

by Jeff Hecht

ISBN 0-07-027-737-0

Price \$44.95

Several good textbooks exist on the physics of lasers, but *The Laser Guidebook* is aimed at meeting the needs of the laser user. Consequently, the book concentrates on lasers that are available commercially or are otherwise important to laser users.

Starting with a concise introduction reviewing the fundamentals of lasers and optics, the book goes on to offer up-to-date, practical information on all major types of laser. For easy reference, chapters on each laser share a common structure that includes basic physics and optics, internal workings, beam characteristics and efficiency, operating requirements, reliability and maintenance, safety considerations, applications, and commercial availability. Each chapter is followed by an annotated bibliography and reference list.

*McGraw-Hill Inc.*

11 West 19th St.

New York, NY 10011

(212) 337-5025

### **LINEAR SYSTEM THEORY**

by F.M. Callier & C.A. Desoer

ISBN 3-540-97573-X

Price \$59.50

This book is intended for engineers in research and development and applied mathematicians, but will also prove useful for graduate students in linear systems with an interest in control. It provides a systematic

discussion of the main topics of linear state-space system theory in both the continuous-time case and the discrete-time case and also the I/O description of linear systems.

The work is self-contained: four mathematical appendices develop the many specialized mathematical results needed in the main text. In the development of Linear System Theory, emphasis is placed on careful and precise exposition of fundamental concepts and results.

The main topics of Linear System Theory are treated systematically: the dynamics of linear time-varying and time-invariant systems, stability, controllability and observability, realizations, linear feedback and estimation, linear quadratic optimal control, and unity-feedback MIMO systems. At various suitable places, basic computational issues and robustness issues are discussed.

*Springer-Verlag (New York), Inc.*

175 Fifth Avenue

New York, NY 10010

(800) 777-4643

### **DIGITAL SYSTEMS REFERENCE BOOK**

Edited by B. Holdsworth and G. R. Martin

ISBN 0-7506-1008-5

Price \$250 (hard cover)

This monumental reference book (which weighs six pounds) provides a comprehensive coverage of the field of digital systems in a concise and authoritative form. Concise as it may be, this reviewer and many of his engineering acquaintances, could not find anything missing that might be required during a normal day's work in the laboratory, college, or (technical writer's) office.

The work is divided into five parts: fundamentals, devices for digital systems, system design and techniques, system development, and applications. Each part contains several self-contained chapters, each of which has been written by an acknowledged expert from industry or academia.

As an up-to-date, authoritative, and comprehensive reference work, this book should meet the needs of everyone working in the digital field, including engineers, academics, and scientists.

*Butterworth Publishers*

80 Montvale Ave.

Stoneham, MA 02180-2422

(617) 438-8464

FAX (617) 438-1479

# MULTI-PURPOSE Z80 CARD

## PART 1: SYSTEM DESCRIPTION

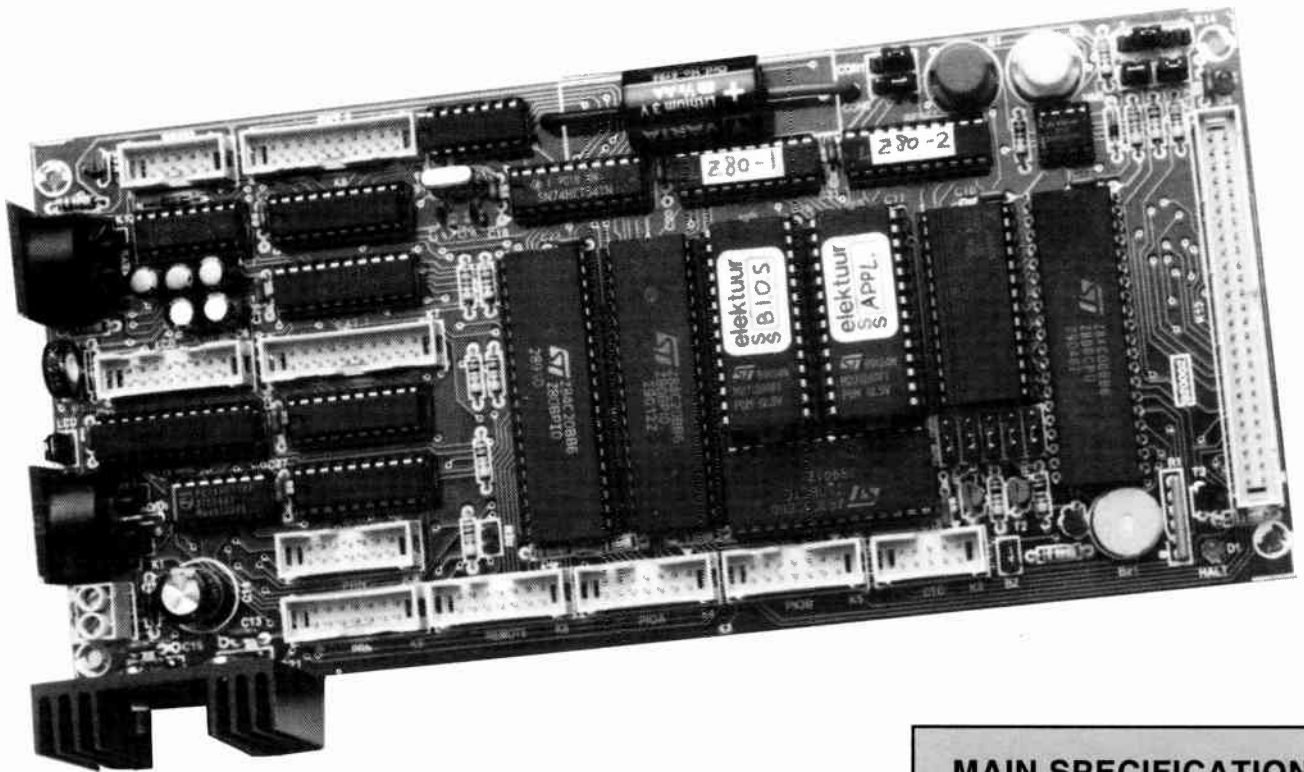

Although microcontrollers are now firmly established, we are pretty sure that the present Z80 processor card will appeal to many of you. Easy to use in combination with such options as a liquid crystal display and an infra-red remote control, and supported by a BIOS that takes the hassle out of I/O programming, this is the nineties-style way of dealing with an 'evergreen' 8-bit microprocessor.

Design by A. Rietjens

**T**HIS Z80 card is easy to use for a wide range of applications thanks to its solid base formed by a number of Z80-family ICs. Remarkably, the multi-purpose character of the card is not compromised in any way by the I/O options available. These options provide functions that normally call for the soldering iron to be switched on because you have to build them yourself, not even mentioning the effort that goes into writing suitable control software. The hardware and software proposed here ensures, in the best possible way, that non-used functions do not interfere with the ones that are used, or can be adapted easily for other purposes. An example of this is a PC-XT keyboard that may be used as an input device with the present card.

### Block diagram

As may be expected, a system as outlined above requires quite a bit of electronics. To keep you from losing track at this point already, have a look at the block diagram in Fig. 1. The Z80-CPU is used alongside two Z80-PIOs and one Z80-CTC. Together with the memory, these ICs form the heart of the Z80 card, which is completed with the usual I/O decoding and memory addressing logic. The latter supports the use of bank switching, so that up to 128 Kbyte may be addressed.

As you can see in the block diagram, there is no shortage of I/O and interfacing capacity: RS232, a parallel printer and a display are all catered for. The card receives

### MAIN SPECIFICATIONS

#### Hardware:

- Z80B-CPU running at 5 MHz
- 32 I/O lines, min. 8 and max. 16 for internal use
- 4 timers
- Up to 64 Kbyte RAM and 64 Kbyte ROM or EPROM
- 8-bit A-D/D-A converter
- Standardized RS232 serial interface; all standard baud rates between 50 and 38,400
- Centronics-compatible parallel printer interface
- Two connections for 'universal I/O interface' extension cards
- On-board watchdog
- Input device: PC/XT keyboard or RC5 infra-red receiver
- Connection for LC display with up to 2×40 characters
- On-board battery backup

#### Software:

- BIOS available to control and test all card functions
- BIOS is MSX-compatible
- Built-in test routines

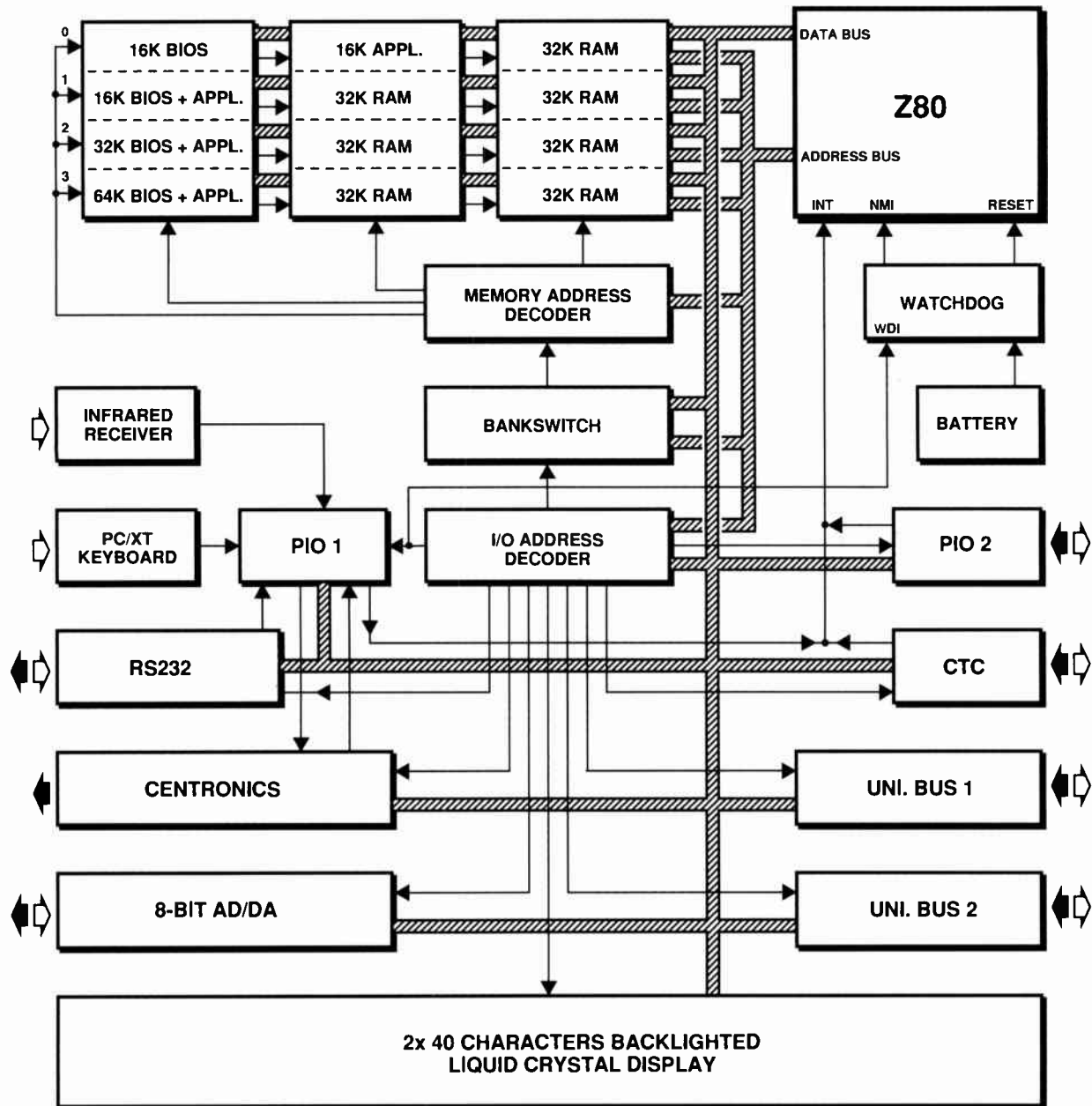

920002 - 1 - 12

Fig. 1. This block diagram clearly shows the structure of the Z80 card. The Z80-CPU is supported by two Z80-PIOs and one Z80-CTC. Together with the memory, these four ICs form the heart of the system.

data either from a terminal via the RS232 link, or more directly via an XT-compatible keyboard or any RC-5 compatible infra-red remote control. Apart from the digital interfaces, the card also offers an analogue interface in the form of an 8-bit ADC/DAC.

Those of you who require even more I/O capacity will be pleased to find two universal buses that carry the (buffered) databus, a select line and two address lines. This extension bus is readily connected to any peripheral device or card that does not require more than four addresses in the I/O range. Examples of cards that can be connected are the relay card for the universal bus (Ref. 1) and the opto interface card for the universal bus, to be published in a future issue.

The Z80 card has a watchdog that serves

to signal power supply failures. When such a failure occurs, it arranges for the 'current state of affairs' to be stored in time by issuing a non-maskable interrupt (NMI). It also serves to re-initialize the card by means of a reset after a software crash, and to switch between the battery and the power supply to prevent data loss when the system is switched on and off.

### Memory structure

To operate the Z80 requires an external memory in the form of an EPROM or a RAM. As shown in the block diagram, the present card offers four memory configurations. The standard system configuration consists of two 16-KByte PROMs and one 32-KByte

RAM. One EPROM contains the application program, the other the system BIOS (basic input/output system). The basic software available in the system allows an application program (stored in the first EPROM) to be started automatically. The other memory configurations allow the BIOS to be combined with user software run from a 27128, 27256 or a 27512, with a 64-KByte RAM in parallel. Further information on the exact memory and address allocations for each configuration may be found in Figs. 2a and 2b.

### The Z80 BIOS

A BIOS is basically a program structure that enables the basic hardware and software in a

CON0	0	1	0	1	
CON1	0	0	1	1	
BANK0	32K ROM	16K ROM	32K ROM	32K ROM	
	32K RAM	32K RAM	32K RAM	32K RAM	
BANK1		32K RAM	32K RAM	32K RAM	
				32K ROM	
IC1	27128	27128			00000H - 03FFFH
			27256		00000H - 07FFFH
				27512 1/2	00000H - 07FFFH
				27512 1/2	18000H - 1FFFFH
IC2	27128				04000H - 07FFFH
		43256	43256	43256	10000H - 17FFFH
IC3	43256	43256	43256	43256	08000H - 0FFFFH

920002-I-13

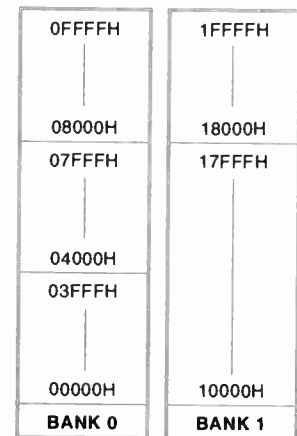

920002-I-14

Fig. 2. (left) The memory configuration is determined by the position of jumpers CON1 and CON2, and the associated ICs. (right) Bank switching is used to enable the processor to address up to 128 Kbyte of memory.

```

                                0059H
;*****
;name:          ldirmv
;function:      load increment repeat into memory from video
;
;input:         BC=length, DE=ram address
;               HL=display character pointer
;output:        none
;changes:       AF, BC, DE
;*****

```

920002-I-15

Fig. 3. Example of BIOS routine documentation.

microprocessor system to be upgraded without having to scrap or rewrite existing software. In most cases, the BIOS is a list of start addresses that are the same for each version of the software. A specific function of the system may be called by calling such a start address. The start address contains a jump to the real address of the subroutine required. Thus, the BIOS user must keep in mind:

- the function of the subroutine;
- the call address;
- the variables required, i.e., the use and content of certain registers;
- how the registers contents are changed upon returning from the subroutine.

Only when all these features are known, the BIOS becomes 'transparent', and the user need not have a detailed knowledge of the exact operation of the subroutine.

A BIOS subroutine may be described as shown in Fig. 3. This definition provides all the data on the subroutine required to use it without knowing exactly how it works.

## Memory and I/O address decoders

The selection signals of the main components in the Z80 system must be decoded to realize different memory configurations while avoiding conflicts. The configuration chosen and the bank switching information together affect the memory addressing. The configuration is selected before the system is started, and the bank switching is arranged by software. However, provision is made in a hardware to ensure that bank switching is possible only if allowed in the configuration used.

For those of you who do not know what bank switching is all about, the following explanation. Since the Z80 can only address 64 Kbytes of memory, certain provisions must be made if we want it to access a larger memory. In this case, we wish to address 128 KByte, divided into blocks of 32 Kbyte each. This means that there are four possibilities to select a total of 64 Kbytes of mem-

ory. Hence, two bits are required to implement bank switching — each bit selects two blocks of 32 Kbyte. When switching such a bit, we must take care not to switch off the block currently used by the CPU. Fortunately, the BIOS contains routines that make bank switching smooth and easy, as required, for instance, to access the RAM 'alongside' the BIOS EPROM in configurations 1, 2 and 3. The bank switching information is stored in a latch that can be written to via I/O addressing.

## PIOs: parallel I/O

The Z80 card has two PIO (parallel input/output) ICs, each of which contains two 8-bit ports. The PIOs are initialized to bit input/output mode, which means that each bit may be used individually as an input or an output. PIO1 is partly used for internal functions, while PIO2 is available to the user, and is programmed as an input (this can be changed as required via the BIOS).

One port of PIO1 is used for internal signals, and the other to decode the signals supplied by the infra-red receiver. When the IR receiver is not used, the port is, of course, free for other applications. Among the functions of the other port in PIO1 are Centronics handshaking, decoding the PC-XT keyboard, and detecting interrupt signals issued by the RS232 interface. Evidently, these port functions can not be redefined via the BIOS.

## CTC: four timers

The Z80-CTC on the present card contains three counters/timers. Of these, timer 3 is used to generate interrupts at 10-ms intervals during which time-dependent functions



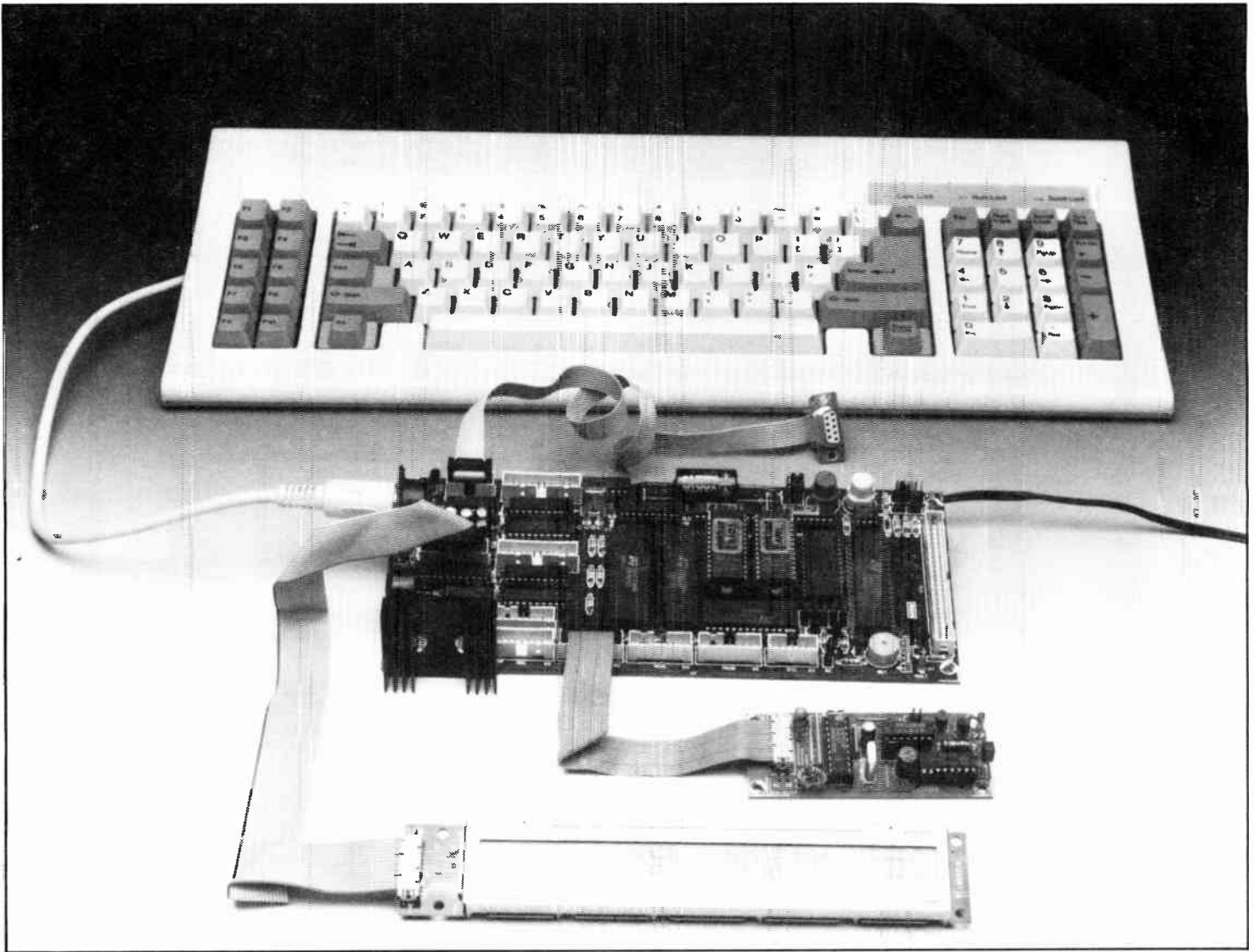

can be completed. A software 'hook' is provided to extend this interrupt routine with your own software. A hook is the software equivalent of a road diversion. The system area of the memory contains addresses that are filled with return instructions after the card is switched on. A number of BIOS routines start with a call to one of these addresses. Normally, this address contains a 'return' instruction to the BIOS routine. However, by replacing this return with a call to a user routine, the program can be diverted to an extension of the BIOS routine, which is thus 'hooked' to the basic one. Five addresses are available for each hook, which is sufficient to place a call and a return. If a jump instruction is used at the hook address, the extension subroutine does not return to the hook and the basic BIOS routine, which is then simply not executed. The diskette supplied with this project (order code ESS 1711) contains an example of the use of a hook.

Returning to the functions of the timers, the interrupt routine for Timer 3 counts down the 'on' time of the on-board buzzer, so that the software need not wait for this. Timer 0, Timer 1 and Timer 2 in the CTC are free for your own use.

## Keyboard and IR control

Parallel input to the Z80 card is furnished either by a PC-XT keyboard or the RC-5 code infra-red receiver described in Ref. 2. The PC keyboard is connected to the board via its curly cord and 5-way DIN plug. The Z80 card automatically detects the parallel input device at power-on.

Any type of RC-5 compatible IR transmitter may be used. The push-button with the number '1' on it is defined as the escape (ESC) key, while the other buttons are assigned an ASCII value equal to their code plus 32. The key definitions are stored in RAM, which allows them to be readily changed. The jumper marked REM was originally designed into the circuit to select remote control data tables. Its function has been scrapped, however, leaving it free for your own programming experiments.

## RS232 and Centronics interfaces

The RS232 and Centronics interfaces on the Z80 card enable it to be controlled from a distance, and to print data respectively. The RS232 interface is suitable for full-duplex

communication with a terminal (or a PC running communication software). The interface gives the Z80 card the function of DCE (data communication equipment) which means, among others, that the Z80 card will only 'do' something via the RS232 if so requested. The software contains routines that allow parts of the memory to be read or written via the RS232 interface. It is also possible to adapt the baud rate and the transmission format. The interface supports all standard baud rates between 50 and 38,400.

## Watchdog and battery backup

As already mentioned, the watchdog has a number of functions on the Z80 card. To begin with, it ensures the minimum required length of the CPU reset pulse when the card is switched on. In addition, the watchdog monitors the unregulated and the regulated supply voltages, and arranges the switching between the 5-V supply and the battery, and vice versa. The watchdog has an input that continually checks if the card has not 'crashed'. If a crash occurs, the watchdog resets the card. The latter function of the watchdog will be particularly valued with

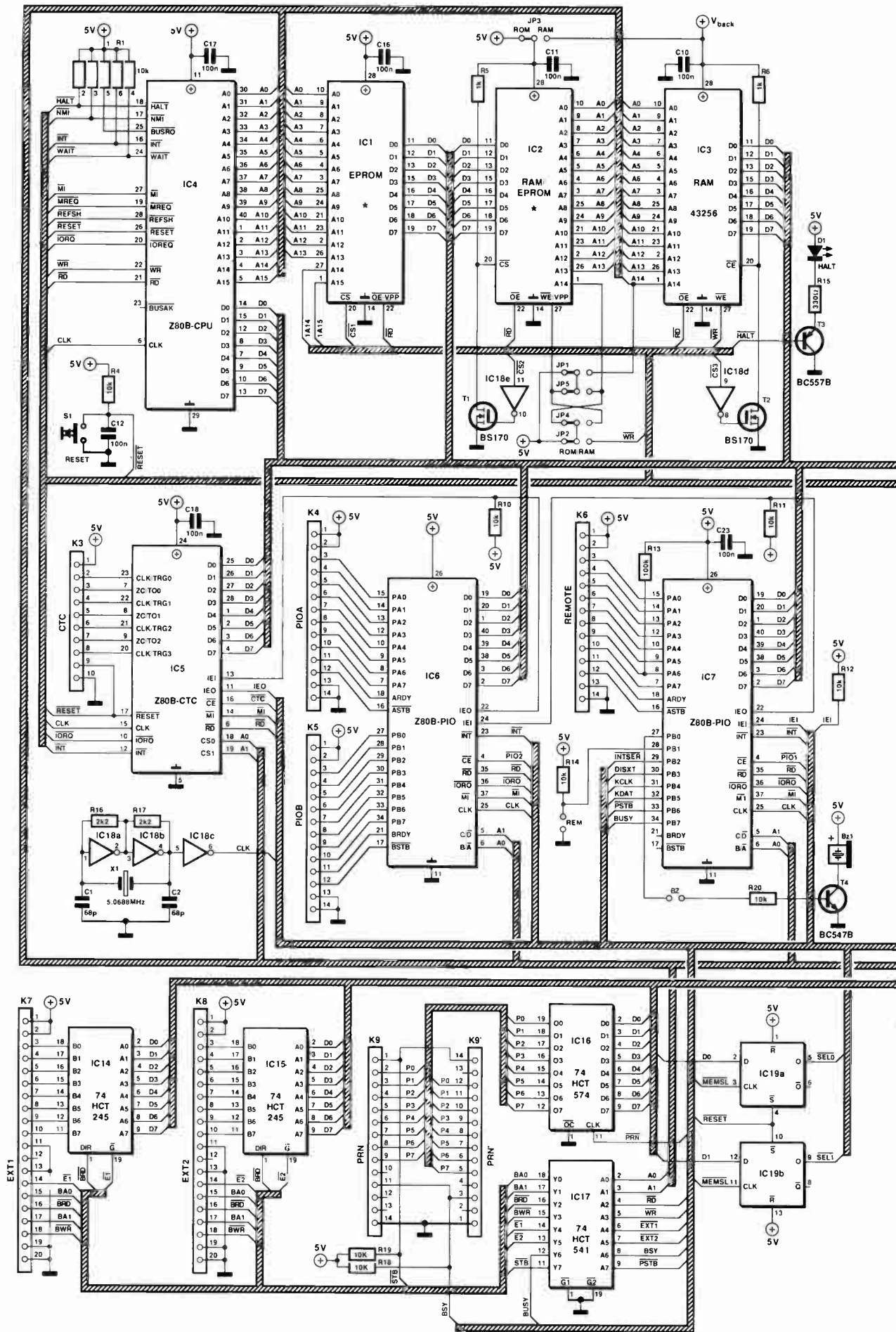

Fig. 4. Complete circuit diagram of the Z80 card. Among the advantages of using Z80-family components is their downright simple connection

measurement and control applications that run unattended.

### Liquid crystal display

The Z80 card offers the possibility of connecting a liquid crystal display (LCD) of the normal or back-lighted type. Although LCDs with up to 80 characters are supported, the preferred type has 2x40 characters. However, one-line and four-line LCDs may be connected also. Nearly all of these intelligent LCDs are based on the HD44780 display controller from Hitachi, and have basically the same connections, albeit that the pins are sometimes arranged differently.

### Circuit description

After a rather lengthy tour along the various functions shown in the block diagram of the Z80 card, it is time to see how these functions take on their practical shape.

The circuit diagram is given in Fig. 4. In the upper left-hand corner of the diagram we find the Z80B-CPU. A 6-MHz processor is used here because the system clock frequency is 5.0688 MHz. This frequency is used by the serial interface circuit to derive the standard baud rate series, starting at 50 bits/s.

The memory and I/O components are seen to the right of the Z80B-CPU and below it respectively. The I/O ICs are, of course, also B-versions because of the system clock frequency. The advantages of using Z80 family I/O components are basically that they are inexpensive, widely available, and extremely easy to implement. Essentially, once all the system and data lines of the components are connected, only the 'select' lines remain. Further, we must give some thought to the priority level assigned to each source that can generate an interrupt. This is arranged via the IEO (interrupt enable output) and the IEI (interrupt enable input) terminals, which are connected into a chain. The priority order is defined as follows: (1) IC7 (PIO1 for internal use); (2) IC6 (PIO2 for external use); IC5 (CTC).

In the basic software, only POI1 and the CTC generate interrupts. The PIO interrupts originate from the RS232 port and/or the PC/XT keyboard. The CTC generates an interrupt every 10 ms, during which, among others, the IR keyboard is checked. Without the pull-up resistor at pin 8, the keyboard buffer would be filled with random characters if the IR remote control is not used. Resistor R23 has a similar function, and prevents unwanted interrupts if IC12 is not fitted.

The connection of the EPROM(s) and the RAM(s) is not entirely straightforward because of the different memory configurations that are allowed. Position IC2 can hold either a RAM or an EPROM, which requires jumpers JP1 to JP5 to be set accordingly. The circuit diagram shows the jumpers set to the 'EPROM' positions (memory configuration '0').

Position IC1 accommodates one of three

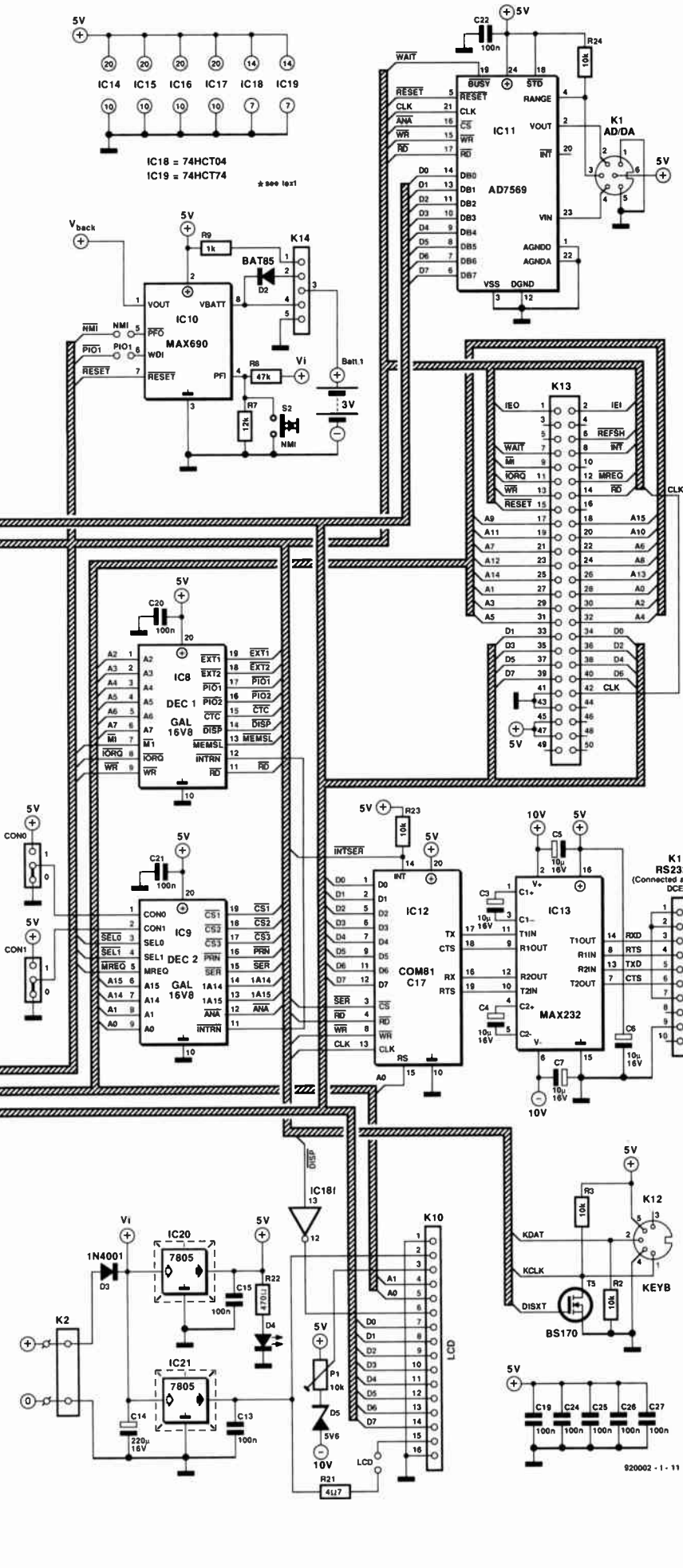

and low cost.

EPROM types: the 27128, 27256 or 27512, so that address lines A14 and A15 need to be given their appropriate level. These lines are controlled by the memory address decoder located in IC9, a GAL Type 16V8. The configuration is determined directly by the setting of connectors CON0 and CON1. These are pre-set to give the memory configuration shown in Fig. 2a, and determine whether or not address lines A14 and A15 are passed. The GAL also arranges the selection of the three memory components, which, apart from A14 and A15, also depends on the memory configuration and the SEL0 and SEL1 signals furnished by IC19. SEL0 and SEL1 allow you to switch between BANK0 and BANK1 in blocks of 32 KByte (see Fig. 5).

Transistors T1 and T2, and resistors R5 and R6, ensure that the RAMs do not remain selected at power-down, so that their data is available again when the system is switched on. The power supply connections of IC2 and IC3 are connected to pin 1 of IC10, which takes care of the battery backup switch-over function.

The MAX690 watchdog (IC10) switches between 5 V and the battery voltage,  $U_{batt}$ , as soon as the voltage at pin 2 drops below ( $U_{batt}-50$  mV), or rises above ( $U_{batt}+70$  mV). Further, watchdog types MAX690 and MAX694 generate a reset if the supply voltage drops below 4.65 V. Those of you who want a wider margin are advised to use the MAX692, which issues a reset at 4.4 V. Finally, the watchdog supplies a defined reset pulse at power-on (MAX690 and MAX692: 50 ms; MAX694: 200 ms). The input voltage to the card is monitored with the aid of R7 and R8. If the voltage at pin 4 of the watchdog drops below 1.3 V, output PFO goes low. Provided the NMI jumper is installed, this low level can trigger a non-maskable interrupt that allows the current situation to be saved before the supply voltage drops below 4.65 V, and IC10 resets the card. This option is supported only by a software hook coupled to the NMI.

Apart from monitoring the supply voltages, the watchdog is also capable of checking if the Z80 card is still running. The watchdog timer monitors the WDI input, to which a signal must be applied that changes at least every 1.6 ms. If this signal fails, the watchdog resets the card. The WDI input may be connected to the selection signal of IC7 via jumper PIO1. Since, if the BIOS is used, the CTC generates an interrupt every 10 ms, and the associated subroutine addresses IC7, the presence of the selection signal is a good sign that the card is still running.

A second GAL, IC8, contains the address decoding logic for the I/O circuits. Here, the advantage of a GAL is a drastic reduction of the chip count for an address decoder that allows the I/O ICs to be addressed fully and without 'image' areas elsewhere in the memory. An address overview of the I/O components is given in Fig. 6.

The analogue interface is built around an AD7569 8-bit A-D/D-A converter. This IC

Memory select	SEL0	SEL1
00000H - 07FFFH	1	x
08000H - 0FFFFH	x	1
10000H - 17FFFH	0	x
18000H - 1FFFFH	x	0

920002-I-17

Fig. 5. Memory selection by means of the SEL0 and SEL1 lines.

I/O addresses	
EXT1	0FCH - 0FFH
EXT2	0F8H - 0FBH
PIO1	0F4H - 0F7H
PIO2	0F0H - 0F3H
CTC	0ECH - 0EFH
DISP	0E8H - 0EBH
RS232	0E6H - 0E7H
PRN	0E5H
ANALOG	0E4H
MEMSEL	0E0H - 0E3H

920002-I-18

Fig. 6. Addresses of the I/O components that are realized with the aid of GALs.

was chosen because it is simple to interface, and reasonably fast: the D-to-A and A-to-D conversion times are 1  $\mu$ s and 2  $\mu$ s respectively. Since the  $\overline{\text{BUSY}}$  signal (which is low during the A-to-D conversion) is connected to the  $\overline{\text{WAIT}}$  terminal of the CPU, the ADC can be read simply with an IN instruction. Hence, the instruction

IN A,(ANALOG)

directly provides the input voltage as a hexadecimal value in the accumulator (provided, of course, that ANALOG equals the I/O address of the A-D/D-A converter), without the need to arrange the timing for this read operation. Writing to the DAC is equally simple: instruction

OUT ANALOG,A

puts the desired voltage on the output.

Depending on whether the range input is high or low, the input and output voltage range is from 0 V to 2.5 V, or 0 V to 1.25 V. The range input is held high via R24, and can be made low by connecting pin 3 of K1 to ground.

The RS232 interface consists of two ICs: a 20-pin UART (universal asynchronous receiver/transmitter) Type COM81C17, and a level converter Type MAX232. The COM81C17 contains everything to set up a serial interface quite easily. The system clock frequency used enables all standard baud rates between 50 bits/s and 38,400 bits/s to be programmed. In addition, the UART ar-

ranges the handshaking protocol on the serial link, which does away with the need for any software equivalents. The step-up converters contained in the MAX232 ensure RS232 signal levels of +10 V and -10 V, which will work in most, if not all, applications. Connector K11 is wired such that the Z80 card forms a DCE that is readily connected to a DTE (data terminal equipment; a computer in most cases) via a 9-way flat-cable.

At this point we have nearly completed our tour along the main components in the circuit diagram. Connector K12 serves to hook up a PC/XT keyboard. Such keyboards are widely available at very low prices from PC surplus outlets. If you happen to have a PC XT/AT type with automatic switching, the Z80 card ensures that it is set to PC XT mode. The keyboard is reset by software following a hardware reset. This is done via transistor T5.

The contrast of the LCD connected to K10 is controlled via preset P1. A back-lighted display may be used in low ambient light conditions. Because of the possible need for a back-light supply, and to keep display multiplexing noise away from the processor, the LCD is powered separately by IC21, while the rest of the circuit is powered by IC20. The back-light supply depends on the LCD type used. There are types that require a supply voltage of 5 V (replace R21 with a wire link), and types that require a certain current (in which case R21 must be given an appropriate value). The back-light connections are pins 15 and 16 of connector K10. The jumper marked 'LCD' provides a simple way of switching the back-light on and off.

The printer datalines are furnished by latch IC16, while the control signals to and from K9 and K9' are buffered by IC17. This IC also buffers the control signals to the two external bus connections. The databases are buffered by IC14 and IC15. The pinning of connectors K7 and K8 is compatible with the universal bus (Ref. 1).

That concludes the description of the Z80 card as far as its concept is concerned. Next month we will tackle the construction and testing of the card, as well as making use of the associated test software contained in the BIOS EPROM.  $\square$

#### References:

1. "Relay Card for Universal I/O Interface." *Elektor Electronics USA*, November 1991.
2. "Universal RC5-code Infra-red Receiver." *Elektor Electronics USA*, January 1992.

# COMPACT MAINS POWER SUPPLY

Design by A. Roßbrucker

THE proposed mains power supply is a versatile unit for use where a stable voltage, medium power and good parameters are required. The quality of its output is easily comparable to that of good-quality commercial products, but it is considerably less expensive than those units.

## The circuit

The circuit of the supply is just as compact as its mechanical design: a transformer, a rectifier, two ICs and some additional passive components are all that is required. The design is based on IC<sub>1</sub>, a 5-pin, voltage regulator Type L200 with integral, presettable current limiting and thermal overload protection.

To ensure correct regulation of the output voltage, the device has an internal 2.75 V reference source. The voltage at pin 4 is compared with the reference voltage to enable the correct level of output voltage,  $U_o$ , to be set with potential divider R<sub>3</sub>-R<sub>4</sub>-P<sub>1</sub>. With values as shown in Fig. 1, the output voltage can be set between 5 V and 26 V with P<sub>1</sub>.

It should be borne in mind that the maximum input voltage to IC<sub>1</sub> is 40 V and the maximum difference between its input and output voltage is 32 V. That means that the secondary voltage of the mains transformer must not exceed 24 V. This gives an unregulated voltage input into IC<sub>1</sub> of 32 V, resulting in a maximum output voltage of 24 V. To set P<sub>1</sub> for an output voltage >24 V would not be a good idea, because the regulation at fairly high output currents would then no longer function correctly, owing to the inadequate voltage reserve. The result would be an unacceptable 100 Hz ripple on the output.

To enable correct functioning of the integral current limiting, the voltage drop across R<sub>2</sub>, connected between pins 2 and 5 is monitored; when it reaches 450 mV, current limiting begins. The maximum output current,  $I_o$ , is therefore given by

$$I_o = 450 / R_2 \text{ (mA)}.$$

With R<sub>2</sub> = 0.22 Ω as in the diagram, the maximum output current is thus 2 A.

## Voltage monitoring

The voltage monitoring circuit is based on IC<sub>2</sub>. When the load draws too high a current, the current limiting in IC<sub>1</sub> operates, resulting in a drop in the output voltage. This reduction is detected by IC<sub>2</sub>, which then causes D<sub>3</sub> to light. Even very brief drops in the output voltage are indicated by this LED for a period,  $t$ , that depends on the capacitance of C<sub>5</sub> and may be calculated from



**Virtually all electronic circuits need some sort of power supply, often a high-quality one. For the latter, if an output current of not more than 1.5 A and an output voltage of 5–20 V are required, the supply described here is ideal. Its design is compact: even the transformer and heat sink are housed on the printed-circuit board. It provides overload indication, current limiting and protection against short-circuits.**

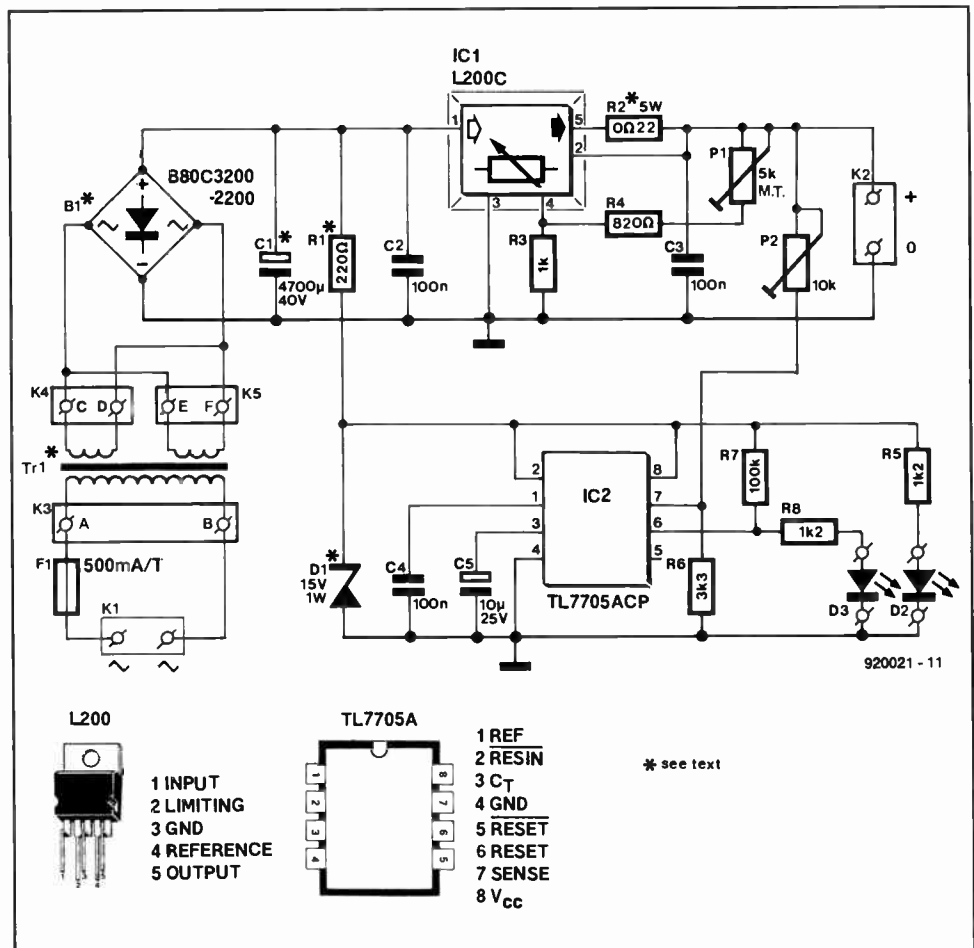

Fig. 1. Circuit diagram of the compact mains power supply.



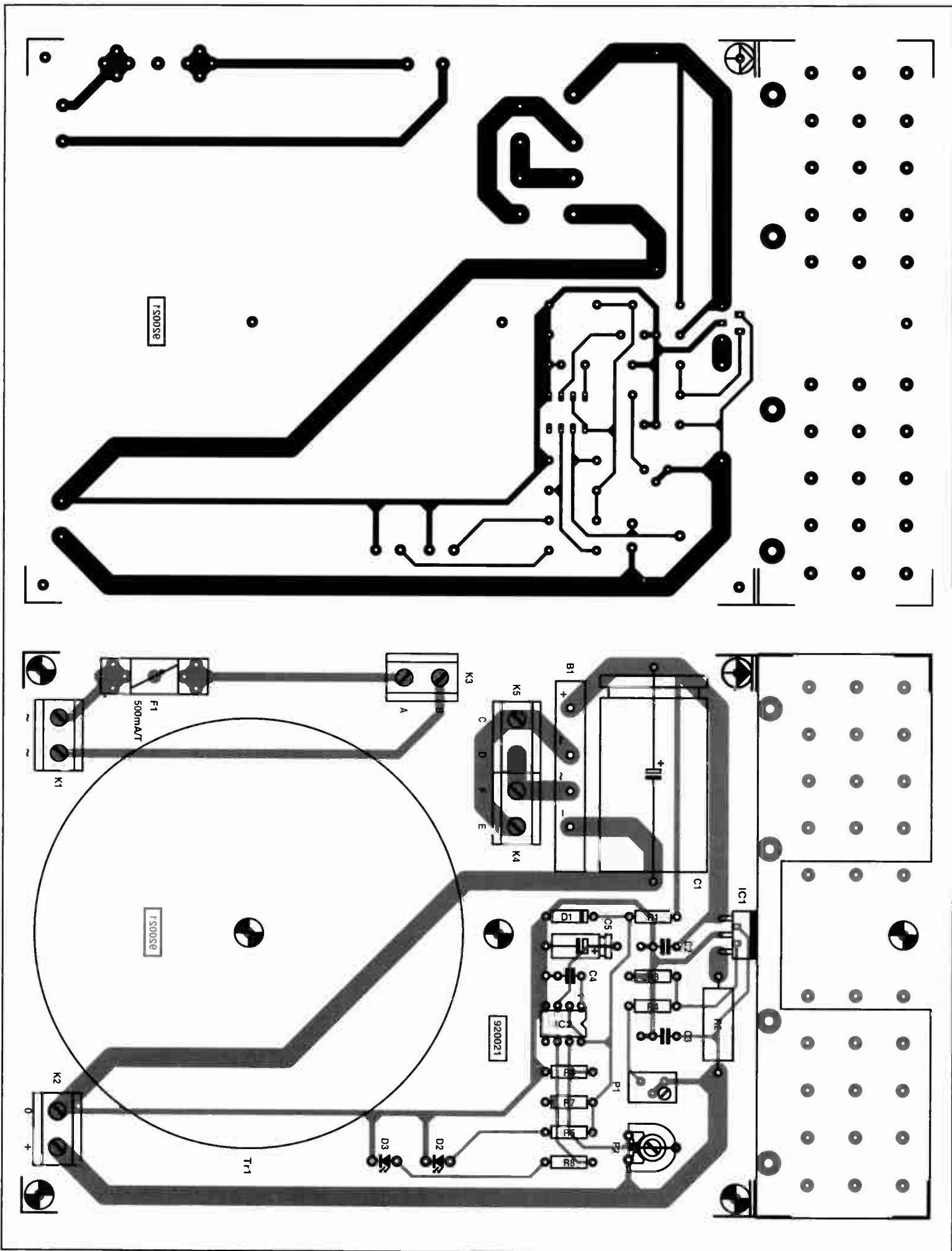

Fig. 2. Printed circuit board for the compact mains power supply.

$$t = 0.013C_5,$$

where  $t$  is in seconds and  $C_5$  in  $\mu\text{F}$ . With  $C_5 = 10\mu\text{F}$  as in the diagram, the LED will light for 0.13 s. If a longer period is required, the value of  $C_5$  must be increased.

In normal operation, the potential at pin 7 of IC<sub>2</sub> is 4.55 V. When that voltage drops below this value, D<sub>3</sub> lights. The level of the output voltage at which D<sub>3</sub> begins to light is determined by voltage divider R<sub>3</sub>-P<sub>2</sub>. With component values as in Fig. 1, the output voltage can be set to 4.55–26 V with P<sub>2</sub>.

Since IC<sub>2</sub> was originally designed for use in computers, it also causes D<sub>3</sub> to light briefly when the supply is switched on. Also because of its origins, the device must not operate with voltages above 18 V; that is why R<sub>1</sub>-D<sub>1</sub> limits the voltage to 15 V. That voltage results from transformer secondary voltages of 12 V and higher. If, therefore, a transformer is used with a 12 V secondary, D<sub>1</sub> may be omitted and R<sub>1</sub> replaced by a wire link.

Diode D<sub>2</sub> and series resistor R<sub>5</sub> serve purely to indicate whether the supply is switched on.

If neither voltage monitoring nor supply-on indication is required, IC<sub>2</sub>, D<sub>1</sub>-D<sub>3</sub>, R<sub>1</sub>, R<sub>5</sub>-R<sub>8</sub>, C<sub>4</sub> and C<sub>5</sub> may be omitted. The supply functions perfectly satisfactorily without these circuits.

## Transformer

Before the components for the mains supply are bought, it should be decided what level

of output voltage is, or will be, required. It would not make much sense to fit a 24 V transformer and then set P<sub>1</sub> permanently for 5 V output. The consequent dissipation in IC<sub>1</sub> would be high, whereupon load currents of up to 2 A would not be available, since the integral thermal protection circuit would limit the output current. Component values differing from those in the parts list and on the diagram are, therefore, given below for the most usually required output voltages.

### ■ 5 V:

Tr<sub>1</sub> = 8 V secondary; R<sub>1</sub> = wire link; D<sub>1</sub> is not required; C<sub>1</sub> = 16 V.

### ■ 6 V:

Tr<sub>1</sub> = 8 V secondary; R<sub>1</sub> = wire link; D<sub>1</sub> is not required; C<sub>1</sub> = 16 V.

### ■ 9 V:

Tr<sub>1</sub> = 9 V secondary; R<sub>1</sub> = wire link; D<sub>1</sub> is not required; C<sub>1</sub> = 25 V.

### ■ 12 V:

Tr<sub>1</sub> = 12 V secondary; R<sub>1</sub> = wire link; D<sub>1</sub> is not required; C<sub>1</sub> = 25 V.

### ■ 15 V:

Tr<sub>1</sub> = 15 V secondary; R<sub>1</sub> = 220  $\Omega$ ; C<sub>1</sub> = 25 V.

### ■ 18 V:

Tr<sub>1</sub> = 18 V secondary; R<sub>1</sub> = 330  $\Omega$ , 1/2 W; C<sub>1</sub> = 40 V.

It should be borne in mind when ordering the transformer that the alternating secondary current should be about  $\times 1.4$  the desired direct output current. At the same time, the value of R<sub>2</sub>, the rating of C<sub>1</sub> and the current rating of B<sub>1</sub> should be considered. Component values and ratings differing from those stated in the parts list or on the circuit diagram for a number of load currents are given below.

### ■ 500 mA:

Tr<sub>1</sub> = 700 mA; R<sub>2</sub> = 0.82  $\Omega$ , 1 W; C<sub>1</sub> = 1000  $\mu\text{F}$ ; B<sub>1</sub> = B40C1000.

### ■ 650 mA:

Tr<sub>1</sub> = 1 A; R<sub>2</sub> = 0.68  $\Omega$ , 1 W; C<sub>1</sub> = 2200  $\mu\text{F}$ ; B<sub>1</sub> = B40C1000.

### ■ 800 mA:

Tr<sub>1</sub> = 1.2 A; R<sub>2</sub> = 0.56  $\Omega$ , 1 W; C<sub>1</sub> = 2200  $\mu\text{F}$ ; B<sub>1</sub> = B40C1500.

### ■ 950 mA:

Tr<sub>1</sub> = 1.5 A; R<sub>2</sub> = 0.47  $\Omega$ , 1 W; C<sub>1</sub> = 2200  $\mu\text{F}$ ; B<sub>1</sub> = B40C2200/1500.

### ■ 1.15 A:

Tr<sub>1</sub> = 1.7 A; R<sub>2</sub> = 0.39  $\Omega$ , 1 W; C<sub>1</sub> = 2200  $\mu\text{F}$ ; B<sub>1</sub> = B40C3200/2200.

### ■ 1.35 A:

Tr<sub>1</sub> = 2 A; R<sub>2</sub> = 0.33  $\Omega$ , 5 W; C<sub>1</sub> = 4700  $\mu\text{F}$ ; B<sub>1</sub> = B40C3200/2200.

### ■ 1.5 A:

Tr<sub>1</sub> = 2.2 A; R<sub>2</sub> = 0.27  $\Omega$ , 5 W; C<sub>1</sub> = 4700  $\mu\text{F}$ ; B<sub>1</sub> = B40C3200/2200.

It is, of course, important that the transformer fits on to the PCB, which has been designed for a toroidal type. Apart from causing little or no interaction with adjacent components and circuits, this type of transformer fits more readily on to a PCB.

It is not necessary for the transformer to have only one secondary winding; indeed, toroidal transformers with two secondary

windings are often more easily available. For instance, a 12 V / 2 A supply would work perfectly well with 2 $\times$ 12 V / 1.4 A secondary windings, which are then connected in parallel. Provision for this is already made on the PCB (K<sub>4</sub> and K<sub>5</sub> in Fig. 1 and Fig. 2). Obviously, a transformer with 2 $\times$ 6 V / 2.8 A secondaries would also be fine: the secondaries are then connected in series.

## Construction and testing

When all the components have been selected and bought, construction can be started. Begin with the resistors and terminal strips, followed by the fuse holder, capacitors, diodes, rectifier and the two ICs. The transformer comes last. Make sure that the enamel has been removed from the ends of the wires that are inserted into the terminal strips.

Regulator IC<sub>1</sub> must be fitted on to a heat sink without insulating washer but with some heat conducting paste. The heat sink will be at earth potential, since the housing of IC<sub>1</sub> is internally connected to pin 3.

When the board is finished, set P<sub>2</sub> to maximum resistance, that is, fully anti-clockwise, as a precaution to prevent the potential at pin 7 of IC<sub>2</sub> exceeding the maximum permissible level of 10 V.

Connect the mains supply to the board, whereupon D<sub>2</sub> should light permanently and D<sub>3</sub> briefly. The output voltage can then be set to the desired value with the aid of P<sub>1</sub>.

The voltage monitoring circuit is preset by first turning P<sub>2</sub> until D<sub>3</sub> just lights and then turning it till D<sub>3</sub> just goes out. Because of the time-constant, P<sub>2</sub> should be turned very slowly.

If the transformer hums and the fuse blows, either C<sub>1</sub> is connected with incorrect polarity or the two secondary windings of Tr<sub>1</sub> have been connected in anti-parallel instead of parallel.

If there is no output voltage, it is likely that the two secondary windings of Tr<sub>1</sub> that should have been connected in series are, in fact, linked in anti-series.

Do not connect two of these power supplies in parallel. However, connecting them in series to obtain a higher output voltage is perfectly all right. It is also possible to use two power supplies to construct a symmetrical supply. ■

### PARTS LIST

#### Resistors:

R1 = 200  $\Omega$ \*  
R2 = 0.22  $\Omega$ \*  
R3, R5, R8 = 1.2 k $\Omega$   
R4 = 820  $\Omega$   
R6 = 2.2 k $\Omega$   
R7 = 100 k $\Omega$   
P1 = 10 k $\Omega$  multi-turn preset  
P2 = 10 k $\Omega$  preset for PCB mounting

#### Capacitors:

C1 = 4700  $\mu\text{F}$ , 40 V\*  
C2-C4 = 100 nF  
C5 = 10  $\mu\text{F}$ , 25 V, horizontal

#### Semiconductors:

B1 = B40C3200/2200\*  
D1 = zener diode 15 V, 1 W\*  
D2 = LED, green  
D3 = LED, red  
IC1 = L200, Pentawatt housing  
IC2 = TL7705

#### Miscellaneous:

K1-K5 = 2-way terminal block, 7.5 mm grid  
F1 = 500 mA fuse, slow acting  
Fuse holder for PCB mounting  
Tr1 = toroidal transformer\*  
Heat sink for IC1  
PCB Type 920021

\* See text

# 1.3 GHz PRESCALER

Design by P. Esser

**Not only do the majority of frequency counters found in smaller workshops and laboratories not operate above 10 MHz, but usually they cannot be modified to work at higher frequencies either. To overcome that problem, here is a prescaler that delivers a clean rectangular signal at TTL level at frequencies up to 1.3 GHz and which can be used with virtually any frequency counter.**

THE prescaler proposed here offers several advantages. Firstly, it increases the measurement range of the frequency counter to which it is linked and, secondly, it makes it possible to use a much shorter cable between counter and instrument on test—see Fig. 1. A disadvantage is, of course, that, to see the selected metering range, you must look at both the counter and the prescaler.

## Scaler ICs

A first scaling down of the input signal is effected by a chip specially designed for this purpose. This can be either the Telefunken Type U664B or the Siemens Type SDA4211. Block diagrams of these circuits are shown in Fig. 2.

The U664B was originally developed for use in the frequency synthesizer of a television receiver. Without any additional components, it divides by 64. In the absence of an input signal, it operates in the highest frequency range. Normally, the only external components required are two small capacitors.

The SDA4211 offers two scaling factors: 64 or 256, depending on the potential at pin 5. If that pin is at +5 V, the input signal is divided by 64; when the pin is at earth, scaling is by 256. On the PCB,—see Fig. 4— this selection is facilitated by a 3-way terminal strip and a jump link.

The two circuits are fully interchangeable as regards pinout and function, but not, of course, in scaling factor.

## Two paths

The measured signal (frequency  $f_s$ ) is split into two immediately after the input socket—see Fig. 3. One part is fed to the prescaler proper (lower part of the diagram) via  $C_4$ , while the other is taken to a processing and amplifying section (upper part of the diagram) via  $L_1$ .

Anti-parallel connected diodes  $D_2$  and  $D_3$  limit the level of the input signal to not more than  $\pm 700$  mV. The signal is then applied to pin 2 of IC<sub>3</sub>. The symmetrical input of this circuit is connected asymmetrically, since the second input, pin 3, is connected to ground via  $C_{11}$ . Jumper JP<sub>1</sub> is the earlier mentioned scaling selector if the SDA4211 is used. If the U664B is used, the 3-way terminal strip and

jump link are not required.

The measured signal (frequency  $f_s:64$ ) is available at pin 6, from where it is applied to potential divider  $R_7-R_8-P_1$ . From there it is fed to amplifier  $T_3$ , whose output is applied to the first of three cascaded Type 74LS90 decade counters, IC<sub>4</sub>, IC<sub>5</sub>, and IC<sub>2</sub>.

Each of these counters divides its input signal by 2.5. This somewhat unusual scaling factor comes about as follows. The upper half of the IC divides by 5. For every five input pulses, the  $Q_8$  output goes high twice; in other words, the  $Q_8$  output delivers an output pulse for every 2.5 input pulses. The out-

put of the cascaded threesome is thus a signal of frequency  $f_s:1000$ .

The other part of the input signal is applied via  $L_1$  and  $C_2$  to  $T_1$ , which, connected as a common-emitter circuit, behaves exactly like an inverting opamp. The voltage amplification of the stage is roughly the same as the open-loop amplification of the transistor, but it is dependent on the source impedance. Diode  $D_1$  limits the negative half of the signal to not more than  $-700$  mV.

The output of the stage is taken from the collector of  $T_1$  and then further amplified in  $T_2$ , which is also connected as a common-emitter circuit. It is then taken from the collector of  $T_2$  and applied to NAND Schmitt trigger IC<sub>1b</sub>, which, with the other three NAND gates, ensures clean edges and correct gating of the two signals. When switch  $S_1$  is open, the original signal ( $f_s$ ) is available at the output; when it is closed, the scaled down signal ( $f_s:1000$ ) is at the output socket.

## Construction

Populating the printed-circuit board shown in Fig. 4 is straightforward, but greater care than usual is required around the input socket where surface-mount components are used. Inductor  $L_1$  must be wound by the constructor. It consists of 2–3 turns enamelled copper wire (dia. 0.4 mm) on a small ferrite core.

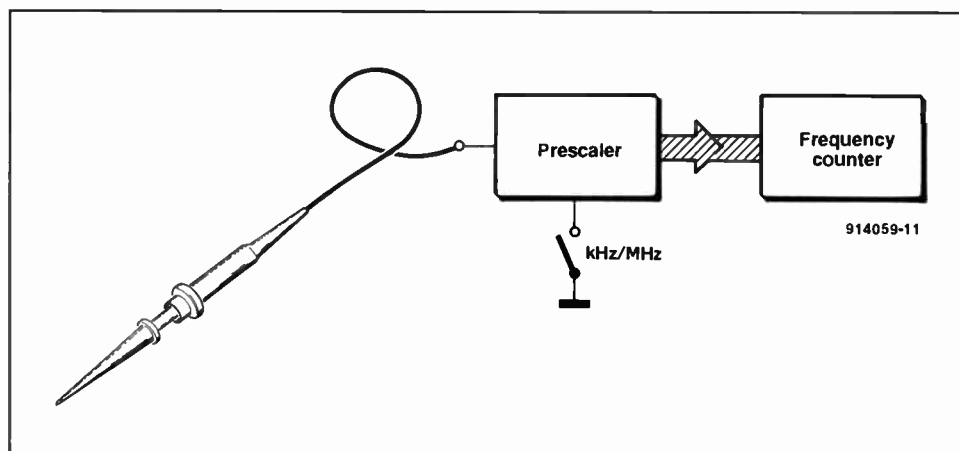

Fig. 1. Measuring set-up of counter, prescaler and probe.

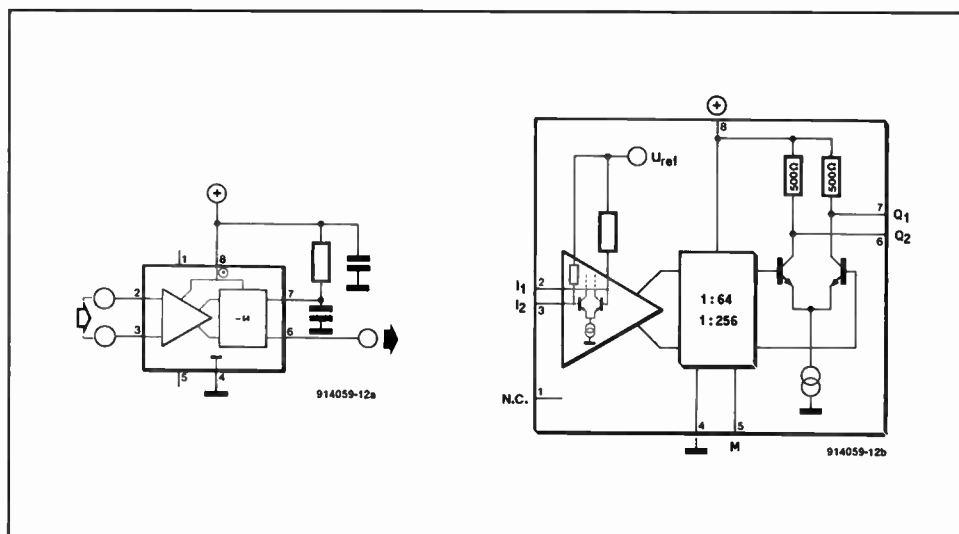

Fig. 2. Circuit diagram of the U664B (left) and the SDA4211 (right).

The input socket is a BNC type for PCB mounting; this obviates the need of screened cable at the input.

JP<sub>1</sub> should connect the +5 V line to pin 5 of IC<sub>2</sub>. If the U664B is used, the jumper should not be used. Nothing more can go wrong here than the scaling factor. ■

If the SDA4211 is used (IC<sub>3</sub>), the link at

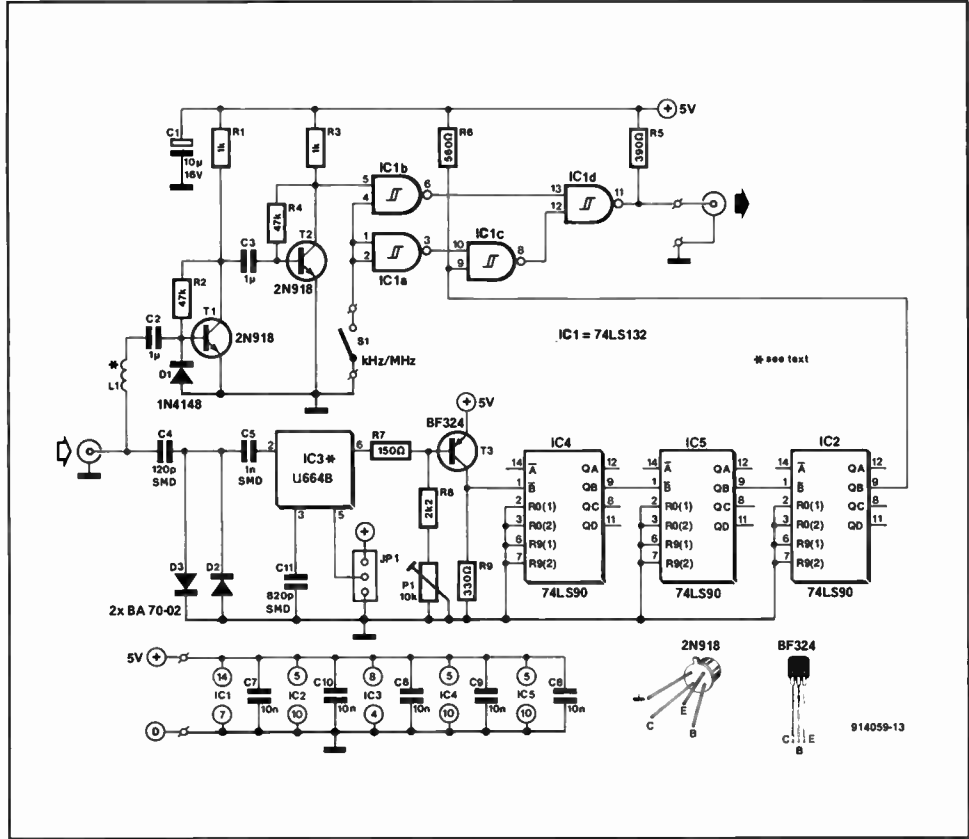

Fig. 3. Circuit diagram of the 1.3 GHz prescaler.

**Brief specification**

- Two switchable measurement ranges: 1:1000
- Upper frequency limit 1.3 GHz
- Input sensitivity <100 mV
- Compact, economical design
- Power supply 5 V
- Single board construction

Clock	74LS90 outputs			
	Q <sub>A</sub>	Q <sub>D</sub>	Q <sub>C</sub>	Q <sub>B</sub>
0	0	0	0	0
1	0	0	0	1
2	0	0	1	0
3	0	0	1	1
4	0	1	0	0
5	1	0	0	0
6	1	0	0	1
7	1	0	1	0
8	1	0	1	1
9	1	1	0	0

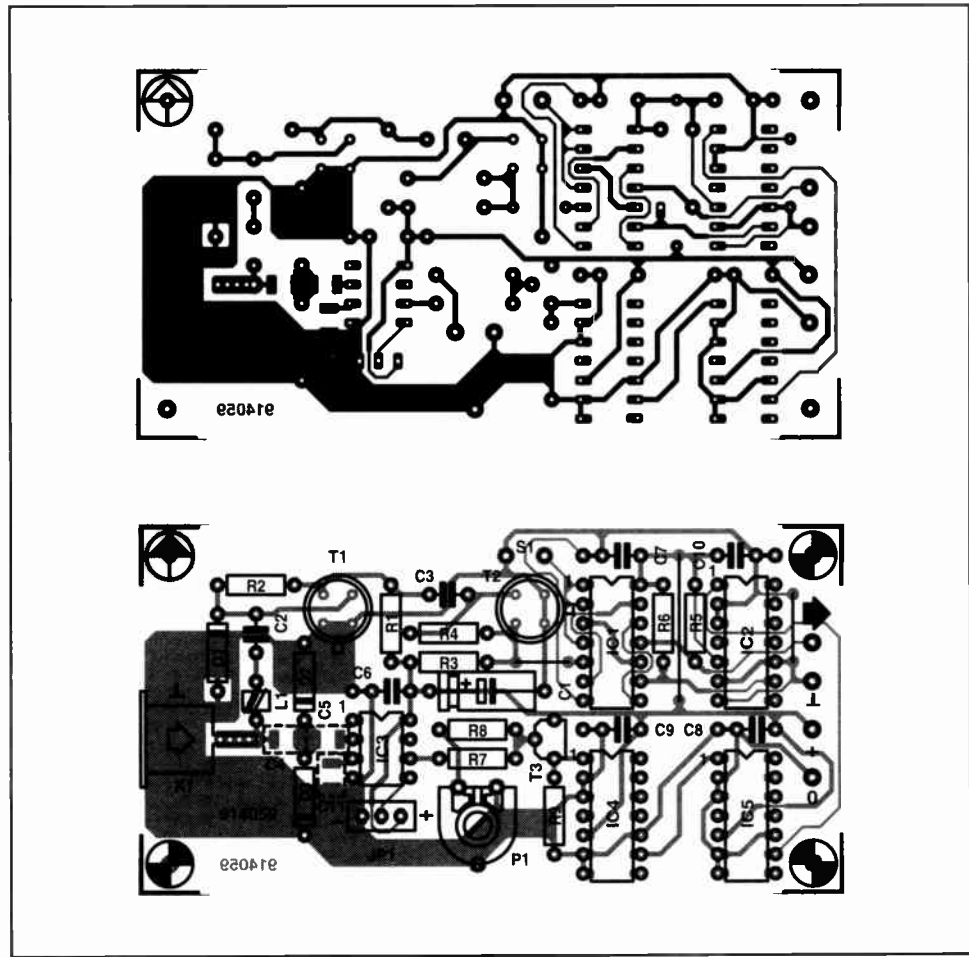

Fig. 4. Printed circuit board for the 1.3 GHz prescaler.

**PARTS LIST**

**Resistors:**  
 R1, R3 = 1 kΩ  
 R2, R4 = 47 kΩ  
 R5 = 390 Ω  
 R6 = 560 Ω  
 R7 = 150 Ω  
 R8 = 2.2 kΩ  
 R9 = 330 Ω  
 P1 = 10 kΩ preset, horizontal

**Capacitors:**  
 C1 = 10 μF, 16 V  
 C2, C3 = 1 μF  
 C4 = 120 pF, surface mount  
 C5 = 1 nF, surface mount  
 C6-C10 = 10 nF  
 C11 = 820 pF, surface mount

**Semiconductors:**  
 D1 = 1N4148  
 D2, D3 = BAT81, BAT82 or BAT83  
 T1, T2 = 2N918  
 T3 = BF324  
 IC1 = 74LS132  
 IC2, IC4, IC5 = 74LS90  
 IC3 = U664B or SDA4211

**Miscellaneous:**  
 L1 = see text  
 S1 = single-pole on/off switch  
 K1 = BNC socket for PCB mounting  
 JP1 = 3-way terminal strip  
 PCB 914059

# ELEMENTS OF PASSIVE ELECTRONIC COMPONENTS

## PART 1: THE INDUCTOR

by Steve Knight, B.Sc.

If you don't ponder things too deeply, it might appear as if the whole edifice of electronics is supported solely by the transistor and the chip, just as once it was supported by the thermionic valve. But a fat lot of good these dynamic components would be if it weren't for the passive Cinderellas of resistance, capacitance and inductance. In other words, a stick of carbon, two pieces of metal separated by some sort of dielectric and a length of wire fashioned into a helix. Not an impressive picture in terms of the actual make-up of these components, to be sure, but their physical behaviour, when examined carefully, more than makes up for their apparently simple physical construction.

Let us look particularly at the humble inductor, a much neglected component on the electronics scene, and see what properties it possesses to make it just as important as its often more glamorized partners.

When an electric current flows in a wire, one of its most important manifestations is the establishment of a magnetic field in the immediate vicinity of the wire. This field is composed of so-called lines of magnetic force or magnetic flux, which takes the form of concentric circles around the wire that lie both within and outside the conductor. Figure 1 shows the kind of field set up and how the directions of current and lines of force are related. Strictly, of course, the concentric circles are concentric tubes and the field is at its most intense, that is, has its greatest flux density, at the surface of the conductor. This intensity falls off as the distance from the conductor increases, which is indicated on a magnetic field diagram by the variations in line spacing. We notice, too, that lines of force always form closed loops whatever the situation. A magnetic line doesn't sud-

denly come to a stop with nowhere to go. The direction in which the magnetic force would act on an isolated north pole placed within the field is indicated by the arrowheads; this direction reverses if the current in the conductor is reversed. Keep in mind, of course, that the concept of lines is a conventional

2

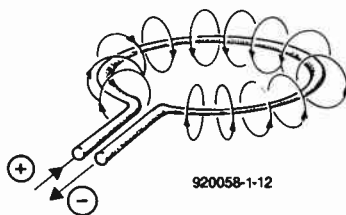

fiction; a real field does not have barren spaces between the lines. We simply use them as a convenient way of representing magnetic field densities and nowadays these are not measured in lines (as they once were) but in terms of the electromagnetic effect the field will produce.

If the wire carrying the current is formed into a loop, rather as shown in Fig. 2, the lines of force all pass through the loop in the same direction. A conventional coil of wire, or solenoid as it is usually called, is nothing more than a number of continuous loops, and a current flowing in such a coil establishes the lines of force in a lengthwise direction through the centre of the coil, emerging from the end and completing their circuits through the surrounding medium. Figure 3 shows how the concentric loops merge together to give a resultant field of considerable intensity, rather as the field surrounding a permanent bar magnet (of iron filings memory!) displays

its characteristic pattern. Like the bar magnet, too, the field around a current-carrying coil exhibits a north and a south pole; these poles change place when the current in the coil is reversed. The field vanishes when the current flow ceases.

It is the appearance—and the disappearance—of the field established around a current-carrying conductor that determines the whole phenomenon of electrical inductance.

### Self inductance

So, what do we mean by inductance, anyway? Well, let us return to Fig. 2. If the magnetic flux caused by the current in a single loop of wire is looked at closely, it is seen that every line must pass through the loop somewhere or, put into other words, every line must 'link' with the loop. The number of lines enclosing the loop in this way are referred to as the flux linkages and in this basic example the number of such linkages must be the same as the number of flux lines.

Now, thinking about the flux associated with the solenoid of Fig. 3, we see that the majority of the lines link with every turn of the coil, although there are those that link with a few of the turns only.

If we consider each turn separately, the total linkages with the coil consist of the summation of the number of lines linking each

1

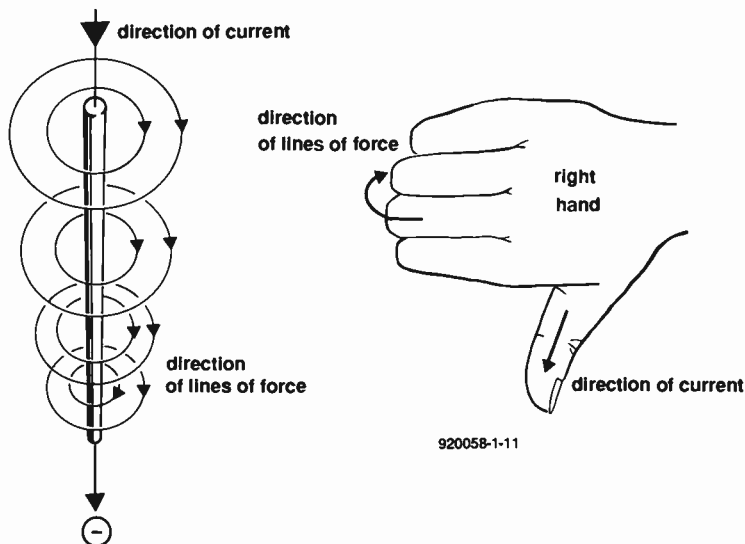

3

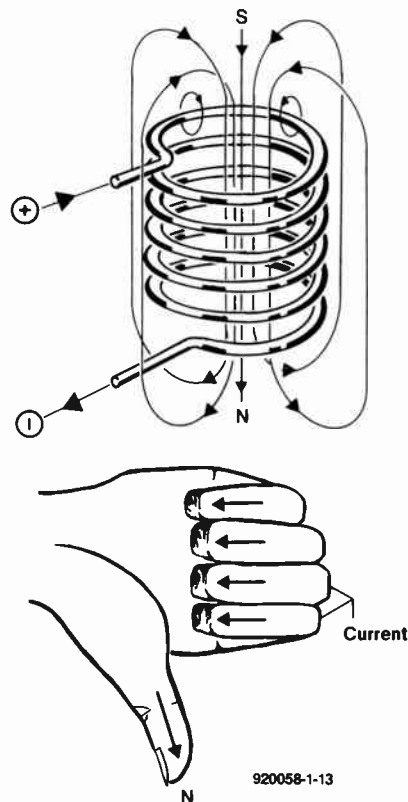



4

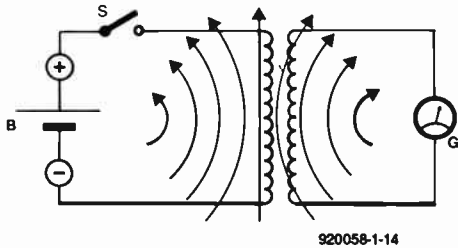

turn and it is now evident that this total is much greater than the number of flux lines. Flux linkage, then, is simply the flux multiplied by some constant that itself depends upon the shape, the closeness of the turns and the physical dimensions of the circuit, that is, the opportunities that exist for the flux to link with as much of the circuit as possible.

Since the total flux is proportional to the current, so also will be the total flux linkages; hence, we can say that the ratio flux-linkage to current is constant for any given circuit arrangement. This constant is the self-inductance of the circuit and is symbolized by the letter  $L$ .

Now, a bold statement of this sort is likely to leave the majority of us a bit frustrated. So, to get our teeth into the problem, let us have a brief look at the work of Michael Faraday and see what effect the electromagnetic field associated with a solenoid has on its surroundings.

## Mutual inductance

Faraday used a circuit rather like that shown in Fig. 4. Here we have the coil of Fig. 3 in a circuit consisting of a switch  $S$  and a source of e.m.f., battery  $B$ . We call this coil the primary winding. In close proximity to this primary winding there is another coil, the terminals of which are connected to a current sensing meter,  $G$ . This coil is the secondary winding. Faraday noticed that as long as a steady current was maintained in the primary winding, that is, as long as the field surrounding this coil remained constant, there was no deflection on the meter. When, however, switch  $S$  was opened or closed, there was a transient deflection, a momentary flick of the pointer that returned quickly to zero as the field either established itself to a constant value (switch closed) or collapsed from a value to zero (switch open). Faraday de-

duced that whenever flux linkages between the two circuits were changing, a current flowed in the circuit of the secondary winding, and this in turn implied that an e.m.f. must be acting on it. On top of this, the meter deflections were in opposite directions according as switch  $S$  was being closed or opened; that is, the current flowed (and the e.m.f. acted) in opposite sense according as the flux linkages between the coils were increasing or decreasing.

This little bit of electrical history, easy to appreciate in retrospect, illustrates the phenomenon of electromagnetic induction: the current in the secondary winding is an induced current and the e.m.f. producing it is an induced e.m.f. A changing field always sets up an e.m.f. in any conductor situated within the field.

On this basis, the question naturally arises as to whether any corresponding effect occurs when the magnetic field associated with the secondary winding, set up by the induced current, interacts with the primary winding. We have seen that the direction of the induced e.m.f. depends on whether the change in the mutual flux linkages is increasing or decreasing. The current induced in the secondary winding will set up a magnetic field of its own and this will provide linkages with the primary winding. These linkages may either increase or reduce the total linkage between the coils according to the direction of the secondary current. Now, it is found that when the mutual flux linkages caused by the primary current are increasing ( $S$  being closed), the secondary current flows in that direction which reduces the total mutual linkages. Conversely, when the current in the primary winding is falling ( $S$  being opened), the direction of the secondary current is such that the mutual linkage is increased. We can interpret this as an attempt by the current in the secondary coil to keep the flux linkage constant, whether the current in the primary is increasing or decreasing.

So, what we have in effect is a kind of electrical inertia; both a rise and a fall in the circuit current are resisted by the appearance of an induced voltage that works to maintain the existing conditions.

What about a single coil on its own? Does the same thing happen there? Consider the primary coil of Fig. 4 to be on its own. As soon as  $S$  is closed, the magnetic field builds

up and sweeps outwards from the turns of the coil; in doing this, it must induce a voltage in any conductors situated within the field and that includes the coil which is producing the changing field. Hence, as the linkages are increasing in the coil after the switch is closed, the induced e.m.f. acts so as to oppose the increase, that is, it opposes the e.m.f. of the battery which is endeavouring to send current through the coil. This effect is known as the back-e.m.f. of self-induction: as one of my teachers put it many years ago, all inductors have suicidal tendencies. Thus, the current in an inductive circuit does not assume instantaneously the value it would have if this were calculated by Ohm's law, that is, on the basis of the resistance of the inductor. This must not be confused with inductance.

Similarly, when the switch is opened, on an Ohm's law calculation, the current should fall immediately to zero, but this does not happen. As the current falls, the magnetic energy stored in the field must decrease proportionally, and an e.m.f. is induced in the coil that this time tends to prevent the reduction in flux linkages. The manner in which the current changes in the circuit for both switch-on and switch-off is illustrated in Fig. 5, which also shows the corresponding changes in a circuit containing pure resistance only.

## Conservation of energy

The effects of inductance accord with the principles of the conservation of energy. Nature never gives us something for nothing: every bit of energy in a system has to be accounted for in one way or another. In the coil, the magnetic energy is caused by the current and that current in turn is derived from the chemical energy stored in the battery. While the current is steady, the magnetic field and hence the magnetic energy stored in the field will remain constant and the only energy drawn from the battery is that of heat energy, which is dissipated in the resistance of the coil. If the battery voltage is increased, the current, in accordance with Ohm's law, should increase in proportion. This involves an increase in magnetic energy, but while this transformation from chemical to magnetic energy is taking place, all the chemical energy cannot change immediately into heat energy. Thus, the current cannot change immediately to a new level as dictated by Ohm's law, that is, on the grounds that all the energy supplied by the battery is converted to heat. The back-e.m.f. is consequently the effect that limits the current to a smaller value; once the magnetic field is established at its new level, the current reaches its greatest value and the back-e.m.f. vanishes.

In the same way, when the current is switched off, it should, in accordance with Ohm's law, fall immediately to zero, since no more energy is being supplied from the battery. But, as the current falls, the energy stored in the field must also fall proportionally, that is, it must be transformed into another form. This transformation is actually to heat energy in the circuit conductors and takes the form of

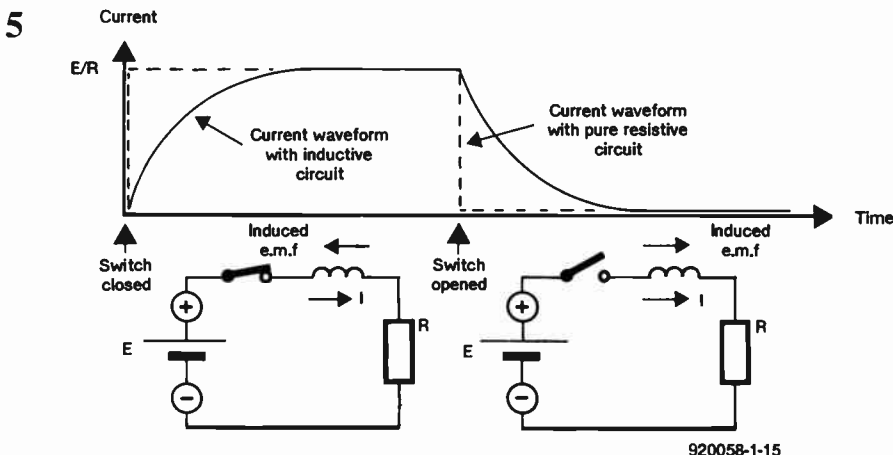

an e.m.f. that tends to maintain the current flow and permit the conversion to heat to take place.

It should be obvious that the greater the time rate at which the current changes, the more rapidly the corresponding changes in magnetic energy must occur and the greater the induced e.m.f. will be. This is embodied in Faraday's law which states that the induced e.m.f. is equal to the product of inductance and rate of change of current. The unit of inductance is the *henry*, H, named after Joseph Henry (1797-1878), the American physicist and pioneer of electromagnetism, who was a contemporary of Faraday. Sub-units are the millihenry, mH, and the microhenry,  $\mu\text{H}$ . A circuit has a self-inductance of 1 H when the current through it changes at the rate of 1 A  $\text{sec}^{-1}$  and causes an induced e.m.f. of 1 V.

### Types of inductance

Broadly speaking, inductances as found in general electronics may be classified as (a) coils that have very large inductance values in the minimum of space and reasonably large current-carrying capacity—these types usually have iron cores and take the forms of power transformer or choke, or armature and field coil in motors and generators; (b) coils used in circuits of radio and television receivers, small transmitters and general amplifier systems. The latter types generally consist of relatively small windings wound on non-ferrous supports such as paxolin or polystyrene tubing or, in some cases, as self-supporting coils in air. They have inductances of at most a few hundred millihenries and normally carry only small radio-frequency currents.

In the case of air-cored inductors, the inductance for a given configuration will be constant since the field is set up in a non-ferrous region, which cannot be 'overloaded' or saturated with magnetism. For coils wound on iron cores, the inductance is roughly constant for small values of direct current, but beyond a certain point, the iron saturates and there is no further increase in the field intensity with an increase in the magnetizing force. The inductance of iron-cored chokes is usually stated at a specified level of current, for instance, 10 H at 100 mA.

The other commonplace coil with a closed

iron core is the low-frequency transformer. This may use the conventional laminated stack of iron or be wound on a toroid or 'anchor' ring circuit.

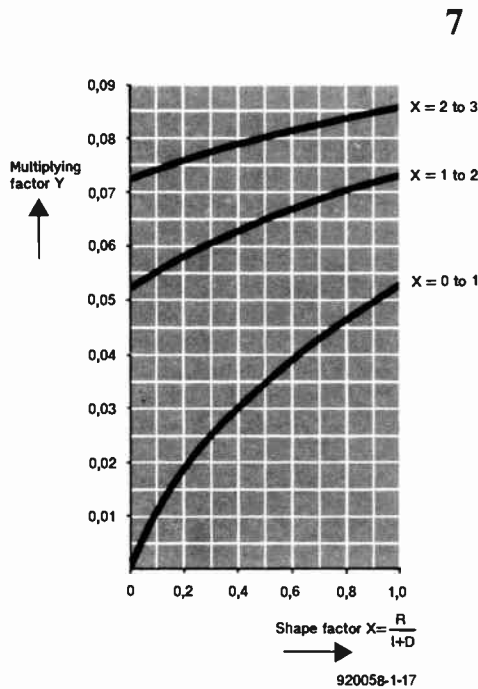

As in the case of Faraday's experiment, transformers depend for their action on mutual inductance. Two coils are wound in close proximity on a common core as shown in Fig. 6. If a current flows in the primary winding, some of the lines of flux established in the core will link with the turns of the secondary winding. The actual linkages between the coils will depend on the current in the primary winding and the positions of the two coils relative to each other. Because of the closed iron core, the linkages are very high and the field is confined closely to the iron circuit. The number of linkages with the secondary winding caused by the current in the primary winding is thus a mutual function of the two circuits.

Circuits of this sort have a mutual inductance of 1 H if the e.m.f. induced in one of them is 1 V when the current in the other is changing at the rate of 1 A  $\text{sec}^{-1}$ .

Iron cores act as conducting paths as far as the magnetic fields set up in the coils are concerned: hence, an e.m.f. is induced in the core material of a choke or transformer whenever it is operating from an alternating current, a.c., supply. This causes random (eddy) currents to circulate within the core, which in turn creates heating and, therefore, a loss of efficiency. Such currents are reduced by laminating the cores and re-

stricting the currents to small and isolated regions of the core.

In the years leading up to the Second World War, the tuning of circuits at radio frequencies was carried out almost universally by fixed inductors and variable capacitors. Owing to eddy current and other losses, it was then not practicable to use iron-cored inductors at high frequencies, although audio frequency range transformers were available with very thin 'radio metal' laminations and sectionalized windings. Low-loss cores, the so-called ferrites or 'dust-iron' cores, have since been developed and are now commonplace as tuning slugs, which make it possible not only to adjust the inductance, but also lead to very compact forms of r.f. tuning coil.

### Winding inductors

Unless there is an inductance bridge available, winding an inductor to a specified value of inductance is a bit of a hit-and-miss affair. Inductance is proportional to the square of the number of turns,  $N^2$ , so that, if the number of turns is doubled, the inductance increases four-fold. Other factors that affect the inductance are the length and diameter of the winding, the spacing of the turns, whether the coil is a single-layer or multi-layer type, and the core material.

Provided the coil is air-cored, it is not difficult to estimate with reasonable accuracy the inductance of a coil that is close-wound in a single or multiple layer. This is where the curves of Fig. 7 come in. These graphs take care of the factors relating to coil length and radius as well as the depth of the winding or the diameter of the wire. Figure 8 shows these measurements made with respect to a single-layer coil at (a) and a multi-layered one at (b).

To find the inductance of such coils, first of all work out the ratio  $R : (\ell + D)$ , where  $R$  is the radius of the coil,  $\ell$  is the length of the winding, and  $D$  is the diameter of the wire (single layer) or the depth of the winding (multi-layer). Whether you use metric or imperial measures is not important, since we are only seeking a ratio; nevertheless, metric is probably more practical. Call the ratio  $X$ . Look up  $X$  along the horizontal SHAPE axis of the graph and read off the corresponding value for the MULTIPLYING FACTOR  $Y$  on the vertical axis. The inductance can then be calculated from the formula

$$L = N^2 R Y \ (\mu\text{H}).$$

Next month's instalment will deal with the iron-cored transformer.

6

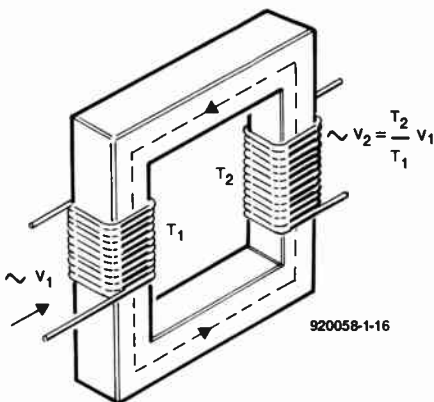

8

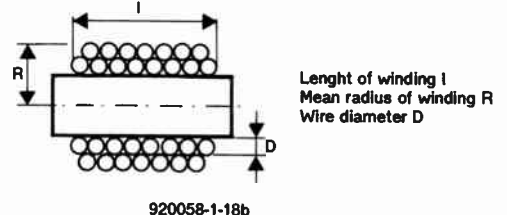
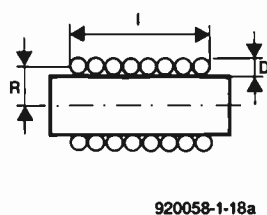

# THE NICAM SYSTEM

**Stereo TV sound has finally come of age with the progressive introduction over the past few years of a digital system called NICAM. This article aims at providing a background to the operation of the NICAM (near-instantaneously companded audio multiplex) system, which is now in use in most of the UK, Scandinavia, Belgium and Spain. NICAM-728, with subversions for PAL systems B/G and I, is also recommended by the EBU as the system for multi-channel sound transmission with terrestrial television. It has been adopted for use in several countries, including the UK, and now forms part of a draft CCIR recommendation.**

**By J. Buiting, technical editor.**

**W**HEN we talk about different television standards, the discussion is usually about different ways of conveying the picture to the viewer. Up to ten years ago, the sound was taken for granted, which is remarkable because the stereo age was well under way at that time. Following a German initiative, some European countries introduced stereo TV sound based on an auxiliary subcarrier above the main (mono) FM carrier. Although this works, the NICAM system offers superior sound quality at a roughly equal bandwidth requirement. Originally developed by the BBC, the NICAM-728 specification has been formally approved by the Department of Trade and Industry as the United Kingdom standard for two-channel digital sound with terrestrial television broadcasts.

## A brief history of stereo TV sound

Since 1979, a number of stereo TV sound systems have been introduced that were aimed at downward compatibility with the existing mono sound systems. Among the requirements for the new sound systems were:

- minimum interference and crosstalk between the channels;
- quality of existing (main) mono channel must not be affected;
- equipment to upgrade transmitters and receivers must remain as simple as possible.

The need of maintaining downward compatibility, as well as the limited bandwidth available for the new sound systems, have

forced the designers of analogue stereo TV sound systems to drop some of their target specifications, and agree on certain compromises that reduce the quality that could have been achieved in theory. Analogue stereo sound systems can be made downward compatible in two ways:

- by modifying the audio signal before it is modulated on to the carrier (single-carrier principle);
- by adding a second sound carrier just above or below the existing (mono) sound carrier (dual-carrier principle).

In both cases, a decoder matrix is required to separate the left and right channels, and

produce the stereo sound image. Some systems also require de-emphasis and/or de-compressing to improve the signal-to-noise ratio and the dynamic range.

The dual-carrier system is basically analogue, and offers quite reasonable sound quality. However, in this day and age of digital sound, it is not surprising that alternatives have been sought, based on the technology already familiar from CD players and the sound transmission standard developed for the MAC system. In particular the channel separation offered by NICAM is much higher than that achieved by any form of analogue dual-carrier system. Overall, the sound quality of a NICAM broadcast is so close to that of a compact disk that it is hard to tell the difference by just listening.

## NICAM-728 digital sound transmission

Strictly speaking, the NICAM-728 system should be classified as a dual-carrier system, because a second sound signal is introduced in the baseband spectrum (see Fig. 1). The spectrum shown is for PAL system-I as used in the UK, with the main sound carrier at 6.0 MHz above the vision carrier, and a total channel bandwidth of about 8 MHz. Most other European countries use PAL system B or G, where the main sound channel is at +5.5 MHz, and the channel bandwidth is about 7 MHz.

The NICAM signal is recovered from a QPSK (quadrature phase shift keying) spectrum with a bandwidth of about 600 kHz. The centre frequency of this

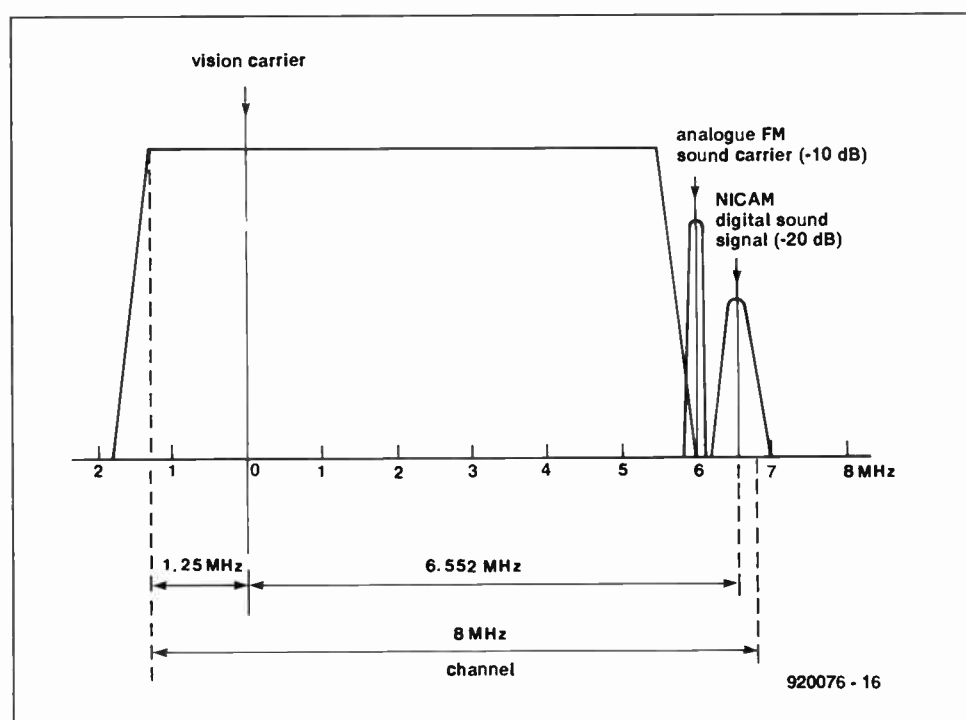

**Fig. 1. The frequency band occupied by the NICAM-728 digital sound signal in relation to the picture and mono (analogue FM) sound signal components in the TV baseband.**

'molehill' (that is what it looks like on a spectrum analyser) is +6.552 MHz (system I), or +5.850 MHz (system B/G). The level is about -20 dB with respect to the vision carrier. In the rest of this article, we will refer to the UK standard (PAL system-I) only.

Contrary to the analogue dual-carrier systems, the NICAM signal contains all the information necessary to reproduce the two stereo channels, i.e., it is completely independent of the main FM carrier at +6.0 MHz (except for the fixed frequency and phase relation), which is currently transmitted only to ensure downward compatibility with existing TV sets.

## Sound multiplex and sound coding methods

To understand how the NICAM system works, we will take a look at the structure of the serial data stream at the transmitter side.

### Frame structure and bit interleaving

As shown in Figs. 2 and 3, the data consists of 728-bit frames which are transmitted continuously without gaps. One frame is transmitted every millisecond, so the overall bit-rate is 728 Kbit/s, whence the system designation NICAM-728.

The 720 bits that follow the frame alignment word (FAW) have a structure that closely resembles that of the first-level protected, companded sound signal blocks in the systems of the MAC family. After the control bits and the additional data bits follows a block of 704 interleaved sound data bits. The interleaving pattern relocates data bits which are adjacent in the frame structure of Fig. 2 to positions at least 16 clock periods apart in the transmitted data stream.

### Energy dispersal scrambling

The transmitted bit stream is scrambled for spectrum-shaping purposes (remember the restrictions as regards the baseband bandwidth). The scrambling operates synchronously to the multiplex frame. The FAW is not scrambled, and used to synchronise the pseudo-random sequence generator used for descrambling in the receiver. Figure 4 shows the general layout of the scrambler. The following parameters apply:

- the bit that follows the FAW is the first scrambled bit, and is added modulo-two to the first bit of the pseudo-random sequence;
- the bit that precedes the FAW is the last scrambled bit;
- scrambling takes place immediately after interleaving (and descrambling is therefore prior to de-interleaving in the receiver);
- the pseudo-random sequence is defined by a generator polynomial  $x^9 + x^4 + 1$  and an initialisation word ('seed') 1 1 1 1 1 1 1 1.

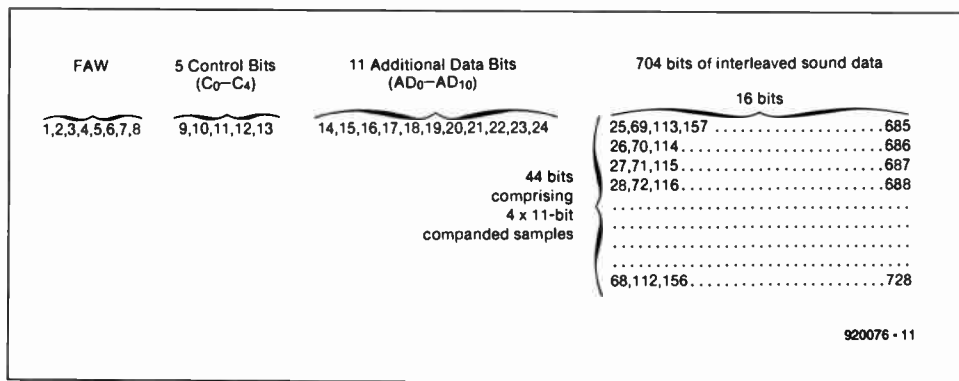

Fig. 2. Each frame consists of four groups of bits, each with its own function.

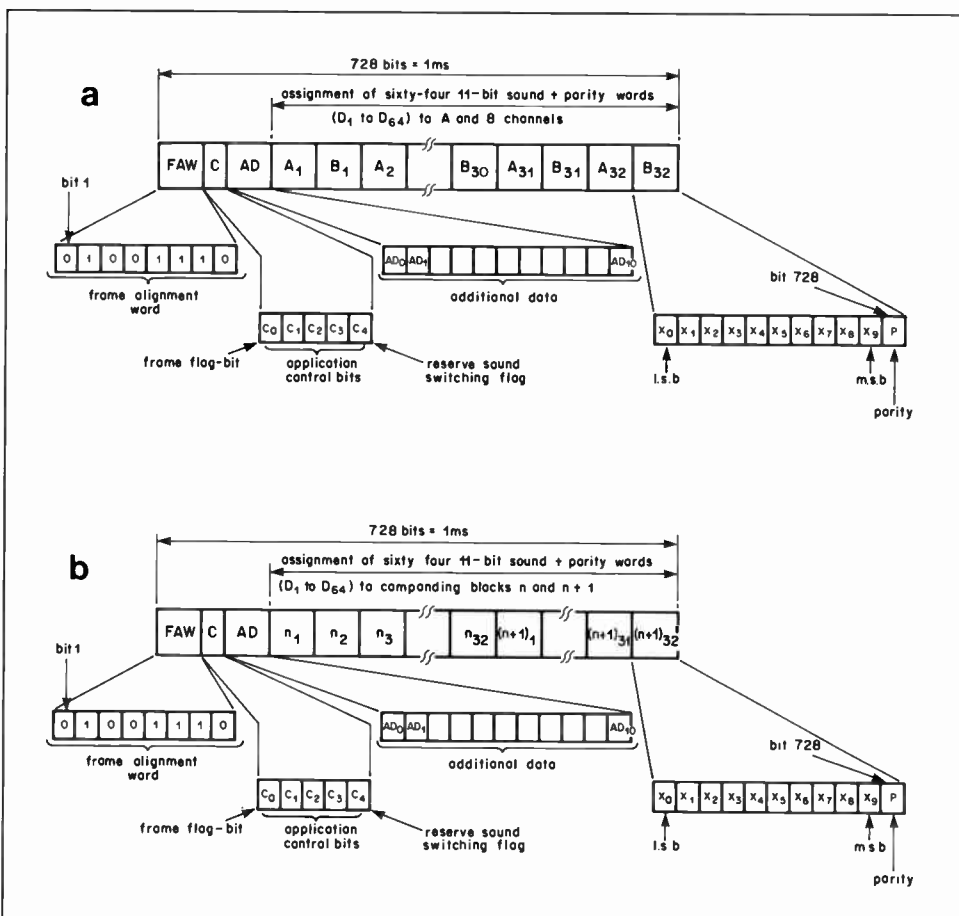

Fig. 3. (a) Structure of a 728-bit frame containing a stereo sound signal (before interleaving); (b) the same for a mono sound signal (also before interleaving).

Thus, with reference to Fig. 2, the sequence starts:

0000 0111 1011 1110 0010.

### FAW and control information block

The FAW is 01001110, which is a series of bits transmitted in that order. The control information converged to the receiver consists of a frame flag bit,  $C_0$ , three application control bits,  $C_1$ ,  $C_2$  and  $C_3$ , and a reserve sound switching flag,  $C_4$  (see Fig. 3). The frame flag bit,  $C_0$ , is set to '1' for eight successive frames, and to '0' for the next eight frames. The frames are numbered within the sequence as follows: the first frame (Frame 1) of the sequence is defined as the first of the eight frames in which  $C_0=1$ . Hence, the last frame (Frame 16) of the sequence is the last of the eight frames in which  $C_0=0$ . This frame sequence is used to synchronise changes in the type of information being carried in the

channel.

The function of the three application control bits,  $C_1$ ,  $C_2$  and  $C_3$ , is to define the current application of the last 704 bits in each frame, which may be used to convey either sound samples or data. The available options are shown in Table 1. When a change to a new application is required, these control bits change (to define the new application) on Frame 1 of the last 16-frame sequence of the current application. The 704-bit sound/data blocks change to the new application on Frame 1 of the following 16-frame sequence.

The reserve sound switching flag,  $C_4$ , contained in the control information block is used to switch back to the output of the conventional FM demodulator when the digital sound decoding system fails. This is, of course, acceptable only if the FM sound channel carries the same programme as the failing digital channel. The means to

Table 1. Applications of 704-bit sound/data blocks.

Application control bits			Contents of 704-bit sound/data block
C <sub>1</sub>	C <sub>2</sub>	C <sub>3</sub> *	
0	0	0	stereo signal comprising alternate A-channel and B-channel samples
0	1	0	two independent mono sound signals (designated M1 and M2) transmitted in alternate frames.
1	0	0	one mono signal and one 352-kBit/s transparent data channel transmitted in alternate frames.
1	1	0	one 704-Kbit/s transparent data channel.

\* C<sub>3</sub>=1 provides for signalling additional sound or data coding options. When C<sub>3</sub>=1, decoders not equipped for these additional options should provide no sound output.

inhibit such switching is incorporated in the control information. Control bit C<sub>4</sub> is set to '1' when the FM channel carries the same sound programme as the digital stereo signal or the digital, mono signal (where two digital mono signals are transmitted, this refers to the M1 signal only). When the FM channel is not carrying the same programme as the digital sound channel, C<sub>4</sub> is set to '0'. In this state, it can be used to prevent switching to the FM sound. Finally, C<sub>4</sub> has no meaning in the case of data transmission.

#### Additional data and the sound/data block

Data bits AD0 to AD10 (see Fig. 3) are reserved for future applications yet to be defined.

The last 704 bits in any frame form a block of either sound or data (the two types of information are not mixed within one frame). One frame contains 64 sound samples (D1 to D64). The structures of a stereo sound frame and a mono sound frame are shown in Figs. 3a and 3b respectively.

In stereo mode (AC: C<sub>1</sub>=C<sub>2</sub>=C<sub>3</sub>=0), the odd-numbered samples convey the A-channel, and the even-numbered samples the B-channel. Thus, 32 samples of each channel are transmitted in every frame.

If two independent mono sound channels, M1 and M2, are transmitted (AC: C<sub>1</sub>=0; C<sub>2</sub>=1; C<sub>3</sub>=0), M1 is transmitted in odd-numbered frames, and M2 in even-numbered frames.

If one mono sound channel is transmitted (AC: C<sub>1</sub>=1; C<sub>2</sub>=0; C<sub>3</sub>=0), it is contained in odd-numbered frames, and data are transmitted in even-numbered frames.

Thus, for mono sound signals, each frame with sound information in it contains 64 consecutive sound samples, which will span two complete companding blocks, shown as blocks *n* and (*n*+1) in Fig. 3. No format has yet been defined for data information.

## Sound signals

Sound signals are sampled at 32 kHz, and coded initially with a resolution of 14 bits

per sample. Near-instantaneous companding is used to reduce the number of bits per sample from 14 to 10, and one parity bit is added to each 10-bit sample word for error detection and scale-factor signalling purposes.

The companding process forms the 14-bit digital samples corresponding to each of the sound signals into blocks of 32. All of the samples in each 1-ms block are subsequently coded, using a 10-bit 2's complement code, to an accuracy determined by the magnitude of the largest sample in the block, and a scale factor code is formed to convey the degree of compression to the receiver. Figure 5 illustrates the coding of companded sound signals.

Prior to compression, a pre-emphasis to CCITT recommendation J17 (Ref. 2) is applied to the sound signals, either by using analogue pre-emphasis networks before digitisation, or by using digital filters with the digital signals.

For stereo transmissions, the signals of the left and right sound channels are sampled simultaneously. The Channel-A samples convey the left-hand (L) sound signal, and the Channel-B samples the right-hand (R) sound signal.

One parity bit is added to each 10-bit

Table 2. Coding/protection range selection.

Coding range	Protection range	Scale factor value		
		R <sub>2</sub>	R <sub>1</sub>	R <sub>0</sub>
1st	1st	1	1	1
2nd	2nd	1	1	0
3rd	3rd	1	0	1
4th	4th	0	1	1
5th	5th	1	0	0
5th	6th	0	1	0
5th	7th	0	0	1
5th	7th	0	0	0

sound sample to check the six most-significant bits for the presence of errors. The parity group so formed is even (i.e., the modulo-2 sum of the six protected sample bits and the parity bit equals 0). Subsequently, the parity bits are modified to signal the 3-bit scale factor word associated with each sound signal block.

In addition to signalling the coding range, the scale factor signals seven protection ranges. This information may be used in the receiver to provide extra protection for the most significant bits of the samples. Table 2 shows the coding ranges and protection ranges associated with each 3-bit scale factor word. The five coding ranges indicate the degree of compression to which the block of samples has been subjected for the near-instantaneous companding process. The 3-bit scale factor R<sub>2</sub>-R<sub>1</sub>-R<sub>0</sub> associated with each 32-sample sound block is conveyed by modification of the parity bits (see Fig. 5).

When a stereo sound signal is being transmitted, FE1 (facteur échelle; scale factor) is the scale-factor word R<sub>2A</sub>-R<sub>1A</sub>-R<sub>0A</sub> associated with the 'A' samples, and FE2 the scale-factor word R<sub>2B</sub>-R<sub>1B</sub>-R<sub>0B</sub> associated with the 'B' samples. If P<sub>i</sub> is the parity bit of the *i*<sup>th</sup> sample, this is modified

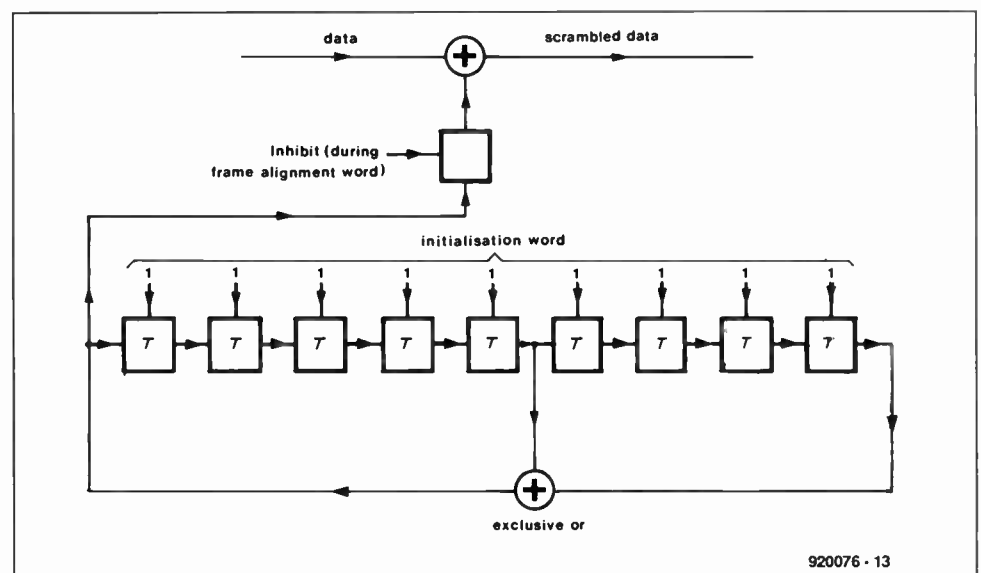

Fig. 4. Pseudo-random sequence generator (PRSG) for spectrum shaping (energy dispersal scrambling).

to  $P'_i$ , by modulo-2 addition of one bit of one of the scale-factor words according to the following relationship:

$$P'_i = P_i \oplus R_{2A} \text{ for } i = 1, 7, 13, 19, 25, 31, 37, 43, 49$$

$$P'_i = P_i \oplus R_{1A} \text{ for } i = 3, 9, 15, 21, 27, 33, 39, 45, 51$$

$$P'_i = P_i \oplus R_{0A} \text{ for } i = 5, 11, 17, 23, 29, 35, 41, 47, 53$$

$$P'_i = P_i \oplus R_{2B} \text{ for } i = 2, 8, 14, 20, 26, 32, 38, 44, 50$$

$$P'_i = P_i \oplus R_{1B} \text{ for } i = 4, 10, 16, 22, 28, 34, 40, 46, 52$$

$$P'_i = P_i \oplus R_{0B} \text{ for } i = 6, 12, 18, 24, 30, 36, 42, 48, 54$$

When a mono signal is being sent, FE1 is the scale-factor word  $R_{2n}-R_{1n}-R_{0n}$  associated with the first block of 32 samples in the frame, and FE2 is the scale-factor word  $R_{2n+1}-R_{1n+1}-R_{0n+1}$  associated with the second block of 32 samples in the frame. As in the case of stereo sound, the parity bit of the  $i^{th}$  sample,  $P_i$ , is modified to  $P'_i$  by modulo-2 addition of one bit of one of the scale-factor words. However, in the mono case, the modification of the parity bits relates to the block structure of the mono signal, as follows:

$$P'_i = P_i \oplus R_{2n} \text{ for } i = 1, 4, 7, 10, 13, 16, 19, 22, 25$$

$$P'_i = P_i \oplus R_{1n} \text{ for } i = 2, 5, 8, 11, 14, 17, 20, 23, 26$$

$$P'_i = P_i \oplus R_{0n} \text{ for } i = 3, 6, 9, 12, 15, 18, 21, 24, 27$$

$$P'_i = P_i \oplus R_{2n+1} \text{ for } i = 28, 31, 34, 37, 40, 43, 46, 49, 52$$

$$P'_i = P_i \oplus R_{1n+1} \text{ for } i = 29, 32, 35, 38, 41, 44, 47, 50, 53$$

$$P'_i = P_i \oplus R_{0n+1} \text{ for } i = 30, 33, 36, 39, 42, 45, 48, 51, 54$$

It should be noted that some of the scale-factor information in the second block of samples is conveyed in the parity coding of samples 28 to 32, which are in the first block. This conforms with the specifications for the MAC/Package family of transmission standards drawn up by the EBU (Ref. 1)

The scale-factor coding range and protection range information are extracted at the decoder by majority decision logic. Subsequently, the original parity is restored for the purpose of error concealment.

The control information described in Section 6.2.3 of Ref. 1 (Chapter 3, Part 3) is not used. However, other information could be transmitted by the same means, i.e., two information bits such that one modifies samples 55 to 59, and the other samples 60 to 64. NICAM receivers should be designed to take account of this facility.

### Modulation parameters

The characteristics of the AM vision (vestigial sideband) and FM sound are defined in the UK specification for PAL system-I transmissions (Ref. 3), with the exception that the FM sound carrier power is 10 dB down with respect to the vision carrier, instead of 7 dB. In the case of PAL system-B/G transmissions, the definitions given in CCIR Report 624-3 apply.

The NICAM signal in the baseband is classified as differentially encoded quadrature phase shift keying (DQPSK or 4-phase DPSK). This is a four-state phase

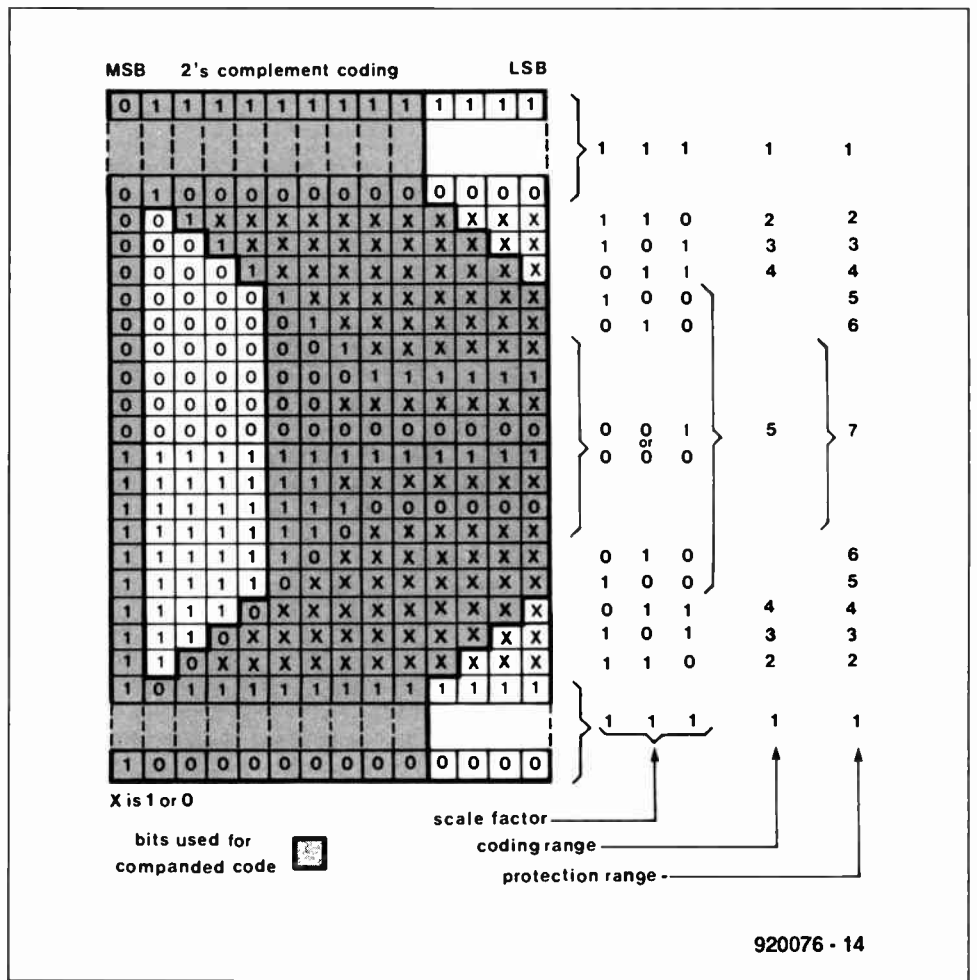

Fig. 5. Coding of companded sound signals.

modulation system in which each change of state conveys two data bits. The input data stream at the modulator is differentially encoded. This is done in two steps: (1) serial to two-bit parallel conversion, and (2) coding of the transmitted phase changes. The amounts of the changes of carrier phase which correspond to the four possible values of the input bit pairs ( $A_n-B_n$ ) are shown in Table 3.

Table 3. DQPSK carrier state changes.

Input bit-pair		Amount by which the carrier changes phase
$A_n$	$B_n$	
0	0	0° (no change)
0	1	-90°
1	0	-270°
1	1	-180°

Thus, the carrier phase can be at one of four rest-states which are spaced at intervals of 90° apart (Fig. 6a). An input bit-pair will shift the carrier phase into a different rest-state by the amount of phase change assigned to that particular value of bit-pair. The transmitted phase-changes and resulting carrier rest-states for the input bit-pair sequence 00, 01, 11 and 01 are illustrated in Fig. 6b. In the receiver, the transmitted datastream may be unambiguously recovered by determining the

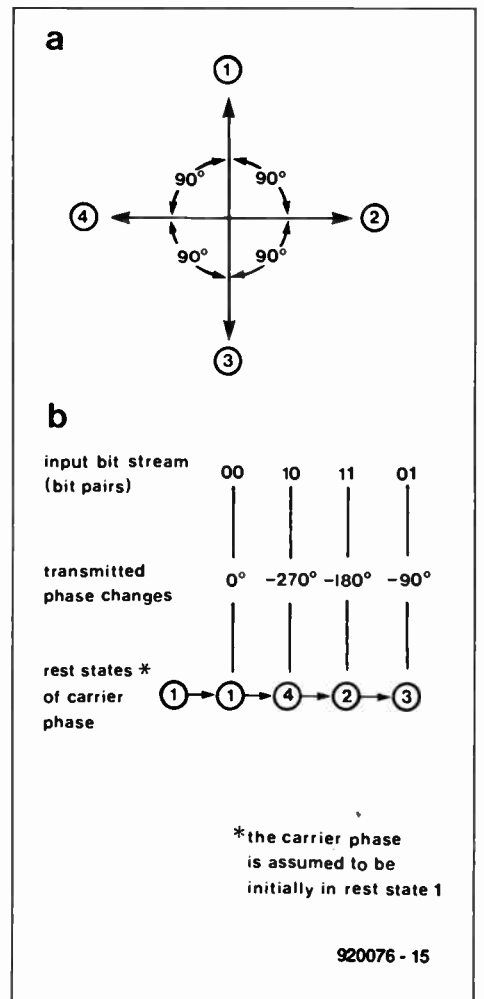

Fig. 6. DQPSK modulation principle.



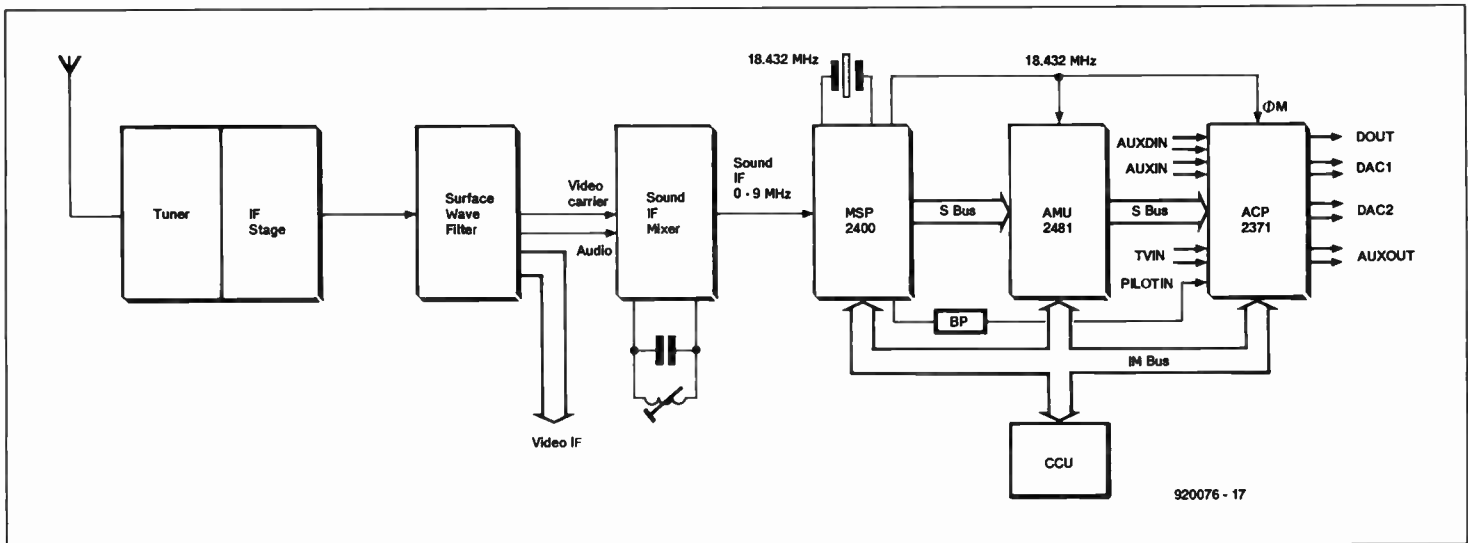

Fig. 7. NICAM decoder concept proposed by ITT Semiconductors.

phase-changes between one bit-pair and the next.

It was already mentioned that spectrum-shaping techniques are applied to keep the bandwidth of the NICAM signal in the baseband within limits. For best performance in the presence of random noise, the amplitude-frequency response of data spectrum-shaping filters at the receiver should be identical to that at the transmitter. The target amplitude frequency response,  $H_T(f)$ , is given by

$$H_T(f) = \begin{cases} \cos \frac{\pi f t_s}{2} & \text{if } 0 \leq f \leq \frac{1}{t_s} \\ 0 & \text{if } f > \frac{1}{t_s} \end{cases}$$

$$\text{where } t_s = \frac{1}{364,000} \text{ s}$$

and the filter has a constant group delay for all frequencies  $\leq 1/t_s$ . The filter made on the basis of the above transfer characteristic has a 100% cosine roll-off (for PAL systems B and G a filter with 40% cosine roll-off is required).

In the UK, the NICAM subcarrier is located at 6.552 MHz above the frequency of the vision carrier (see Fig. 1). This frequency is obtained by multiplying the transmitted bit-rate (728 Kbit/s) by 9. In countries where PAL system-B or -G is used, the subcarrier frequency is +5.850 MHz.

## NICAM decoder concepts

Among the IC manufacturers that have developed NICAM processors for use in commercial-grade receivers are ITT Semiconductors of Germany, and Micronas, Inc. of Finland. A decoder based on ICs from the latter manufacturer is described elsewhere in this issue.

ITT Semiconductors have integrated their NICAM processors, the MSP2400 and MSP2410, into the Digit 2000 TV system. Figure 7 shows the block diagram of

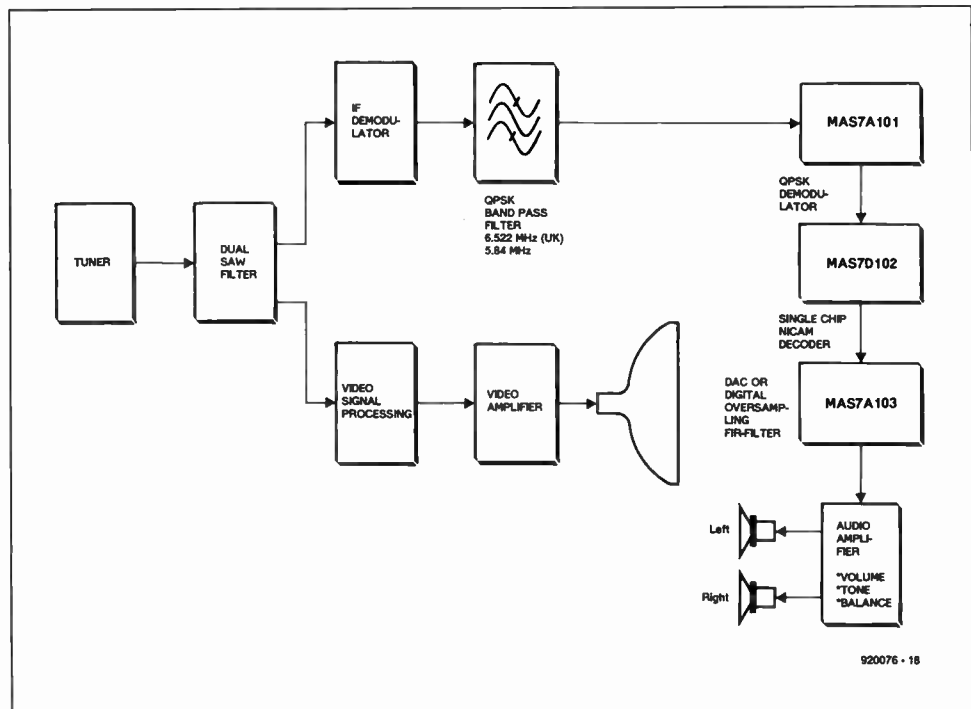

Fig. 8. NICAM decoder concept proposed by Micronas Inc.

the ITT approach. Apart from the MSP2400 or MSP2410, two additional ICs are required, the AMU2481 and the ACP2371. Remarkably, the MSP2400 has a digital filter to extract the NICAM information from the baseband spectrum (0 to 9 MHz). This is in contrast to the Micronas circuit (Fig. 8), which uses a conventional L-C bandpass filter tuned to 5.84 MHz (PAL system B/G) or 6.552 MHz (PAL system I). The ITT circuit has a number of interesting options such as multistandard sound processing and automatic standard recognition and switching. The configuration as shown in Fig. 7 is capable of handling mono FM, stereo FM (the German dual-carrier system) and all NICAM modes (a special version of the ACP2371 is available for satellite TV sound). The disadvantage of the ITT circuit is, however, that it can not work without control software, and this is where the Micronas system has the edge on the ITT system: it can work 'stand alone', and offers an op-

ditional way of computer control. ■

### Sources:

- (1) NICAM-728: specification for two additional digital sound channels with System-I television.
- (2) Document SPB 424, 3rd revised edition, European Broadcasting Union.

### References:

1. Specification of the system of the MAC/Package family. European Broadcasting Union (EBU) Technical Document 3285 (1986).
2. CCITT Red Book, Volume III, Fascicle III.4: Transmission of sound-programme and television signals, recommendation J.17 'Pre-emphasis used on sound-programme circuits'.
3. Specification of Television Standards for 625-line System-I transmissions in the United Kingdom. Department of Trade and Industry, Radio Regulatory Division, London, 1984.

# NICAM DECODER

The decoder described here is aimed at the experienced radio and TV enthusiast who wants to upgrade an existing TV set or video recorder with NICAM digital stereo sound. Suitable for PAL TV systems 'I' (UK) and 'B/G' (Scandinavia, Belgium, Spain and others), the decoder is a compact and simple to control circuit that can either be built as a set-top extension, or incorporated into a TV set.

**Design by Rob Krijgsman  
PE1CHY**

**T**HIS decoder is based on a NICAM chip set developed by Micronas Inc. of Finland. The set consists of the MAS7A101 QPSK demodulator, the MAS7D102 NICAM decoder, and the MAS7A103 dual D-A converter. The chip set allows two high-quality audio channels (stereo or dual-language mode) to be recovered from a NICAM signal at 5.85 MHz or 6.552 MHz (if broadcast, and depending on the PAL system used) in the TV baseband spectrum. All that is needed to be compatible with either of the two PAL systems is to fit the correct input filter, a jumper and a quartz crystal for the demodulator clock.

## Three ICs

As shown by the block diagram in Fig. 1, the upper part (say, above 5 MHz) of the TV baseband spectrum is first filtered to extract the NICAM signal centred around 5.85 MHz

(system B/G) or 6.552 MHz (system I). The insertion loss of the band-pass filter is compensated by an amplifier.

## MAS7A101 QPSK demodulator

The NICAM signal is applied to the MAS7A101 QPSK demodulator IC. This is a pretty complex integrated circuit, whose internal architecture is given in Fig. 2. The QPSK signal at the input is buffered before it is applied to a multiplier circuit which consists of analogue switches. The switches are opened and closed by a signal derived from a phase-controlled quartz crystal oscillator. The crystal frequency equals four times the NICAM subcarrier frequency, i.e.,

$$5.850 \times 4 = 23.400 \text{ MHz}$$

for PAL systems B and G, or

$$6.552 \times 4 = 26.208 \text{ MHz}$$

for PAL system I. The quartz oscillator is locked to the received NICAM signal by means of a PLL. The demodulated signal is



taken through a switchable low-pass filter, and subsequently split into two.

One signal is sent to a second PLL which serves to recover the 728-kHz NICAM bit clock from the demodulated signal. The crystal-controlled VCO in this PLL operates at eight times the NICAM bit clock, or 5.824 MHz. This VCO also provides the central clock signal for the other ICs in the decoder.

The other demodulated signal is sent to a slicer circuit where it is converted into a bi-

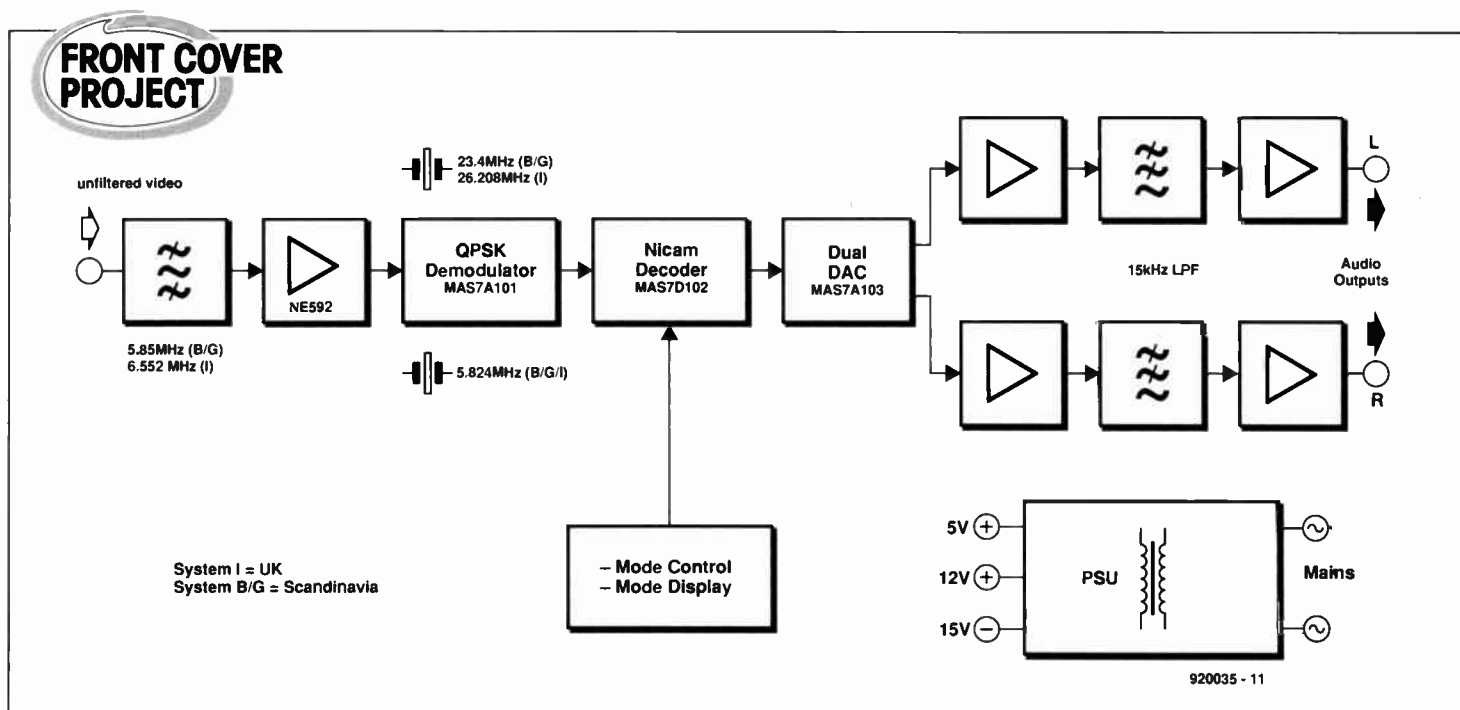

Fig. 1. Block diagram of the decoder.

nary digital signal. The recovered clock signal and the binary signal are available at the corresponding outputs of the MAS7A101.

**MAS7D102 NICAM decoder**

The MAS7D102 NICAM decoder (Fig. 3) uses the recovered NICAM bit clock to tackle the decoding proper of the bitstream supplied by the QPSK demodulator. The decoding process involves quite a lot: descrambling, de-interleaving, error detection and correction, and reconstruction of the original 14-bit sound samples in both channels. The MAS7D102 can be programmed or wired to supply digital output signals suitable for one of three different bus systems: the I<sup>2</sup>S-bus (Philips), the S-bus (ITT), or the DAC-bus (Toshiba). Many functions of the IC can be controlled either via an I<sup>2</sup>C link, or by means of external hardware. The latter option is exploited here, and has the advantage of obviating a microcontroller and a dedicated control program.

With reference to the IC architecture shown in Fig. 3, it is seen that the digital signal supplied by the QPSK demodulator is split into two. One signal is fed to a synchronisation logic section where the FAW (frame alignment word) is detected and extracted. The FAW is never scrambled. The other copy of the digital signal is sent to the descrambler circuit, which serves to counteract the energy dispersal (spectrum-shaping) scrambling applied at the transmitter. When the decoder chip is first switched on, it uses the standard descrambling initialisation word '11111111', which enables reception of non-encrypted NICAM broadcasts. External hardware is required to be able to change the initialisation word (or 'seed') 'on the fly' when the system is used for reception of Pay-TV transmissions using encrypted NICAM audio.

Returning to the operation of the MAS7D102, the control information bits C<sub>1</sub>-C<sub>2</sub>-C<sub>3</sub>-C<sub>4</sub> are extracted from the datastream. These bits enable the receiver to determine the type of programme material: i.e., dual-language or stereo. The decoded control bits are available in an I<sup>2</sup>C register as well as on an output port. The latter allows a simple display to be connected that indicates the receiver mode. The sound samples are fed to the de-interleaver, and from there to the error detection/correction circuit. Finally, they are de-companded to their original 14-bit resolution, and fed to the output of the IC according to the selected signal format (I<sup>2</sup>S-bus, S-bus or DAC-bus). The format selection is effected via the I<sup>2</sup>C bus, or via logic levels applied to the configuration (CONFIGx) pins, which in addition allow you to select between mono-A or mono-B during dual-language broadcasts. The functions of all registers contained in the MAS7D102, and the configuration options that can be set in hardware, are given on page 41.

**MAS7A103 dual DAC**

This IC converts the 14-bit sound samples furnished by the decoder into two analogue audio signals. Since the output datastream of

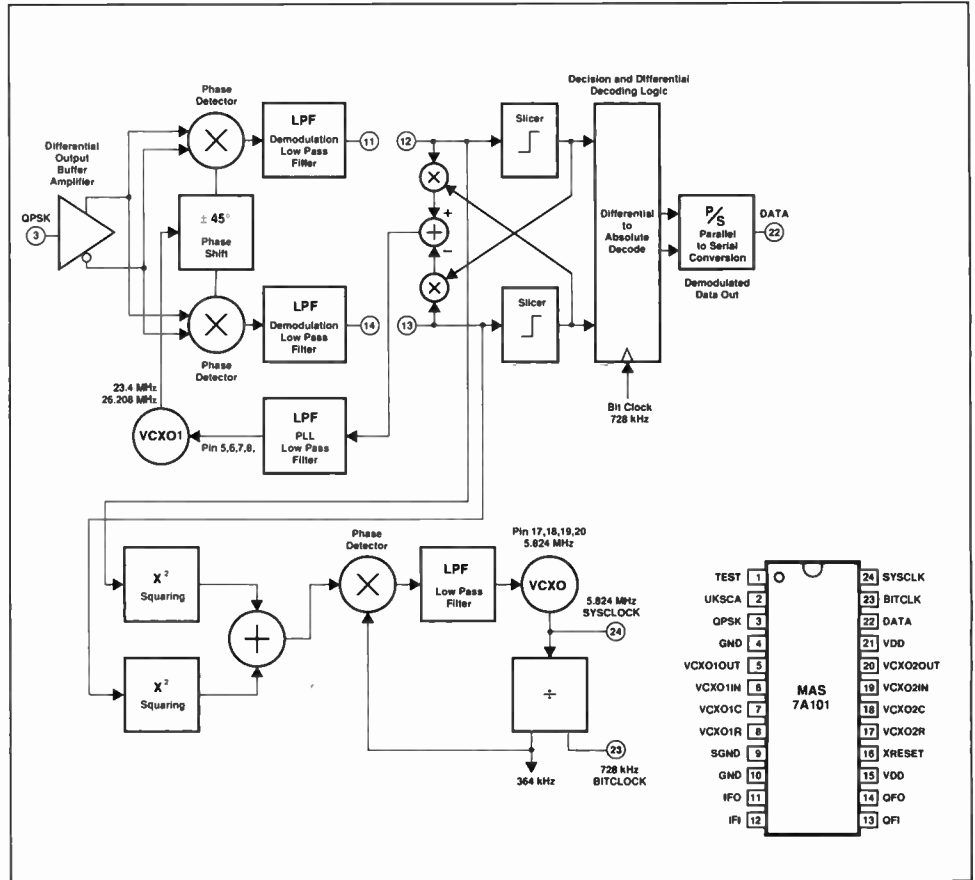

Fig. 2. MAS7A101 QPSK demodulator architecture and pinning.

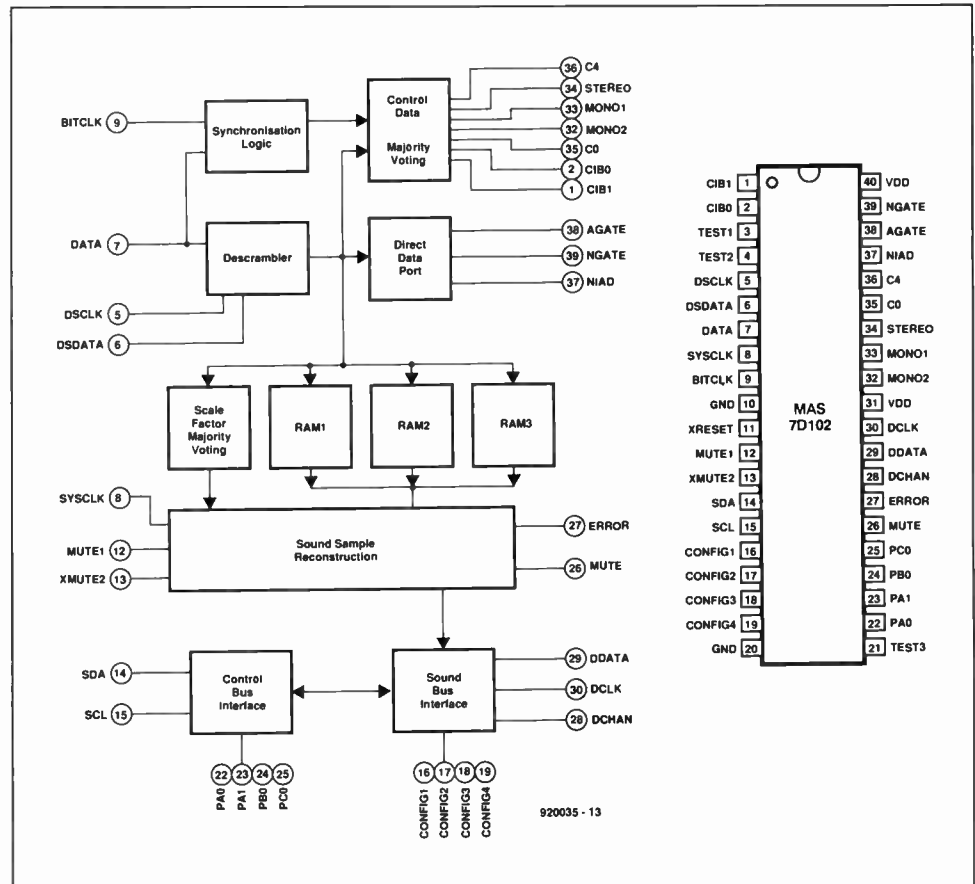

Fig. 3. MAS7D102 NICAM decoder architecture and pinning.

the decoder IC is multiplexed, the first task of the DAC is to extract and separate the information that belongs with each channel. Next, the two digital signals are converted into analogue ones by R-2R ladder networks. These supply output currents rather than

voltages, so that two external opamps are required to obtain audio signals that can be fed to an amplifier. Before that can be done, however, the audio signals need to be taken through a 15-kHz low-pass filter to remove the residue of the 32-kHz sampling signal.

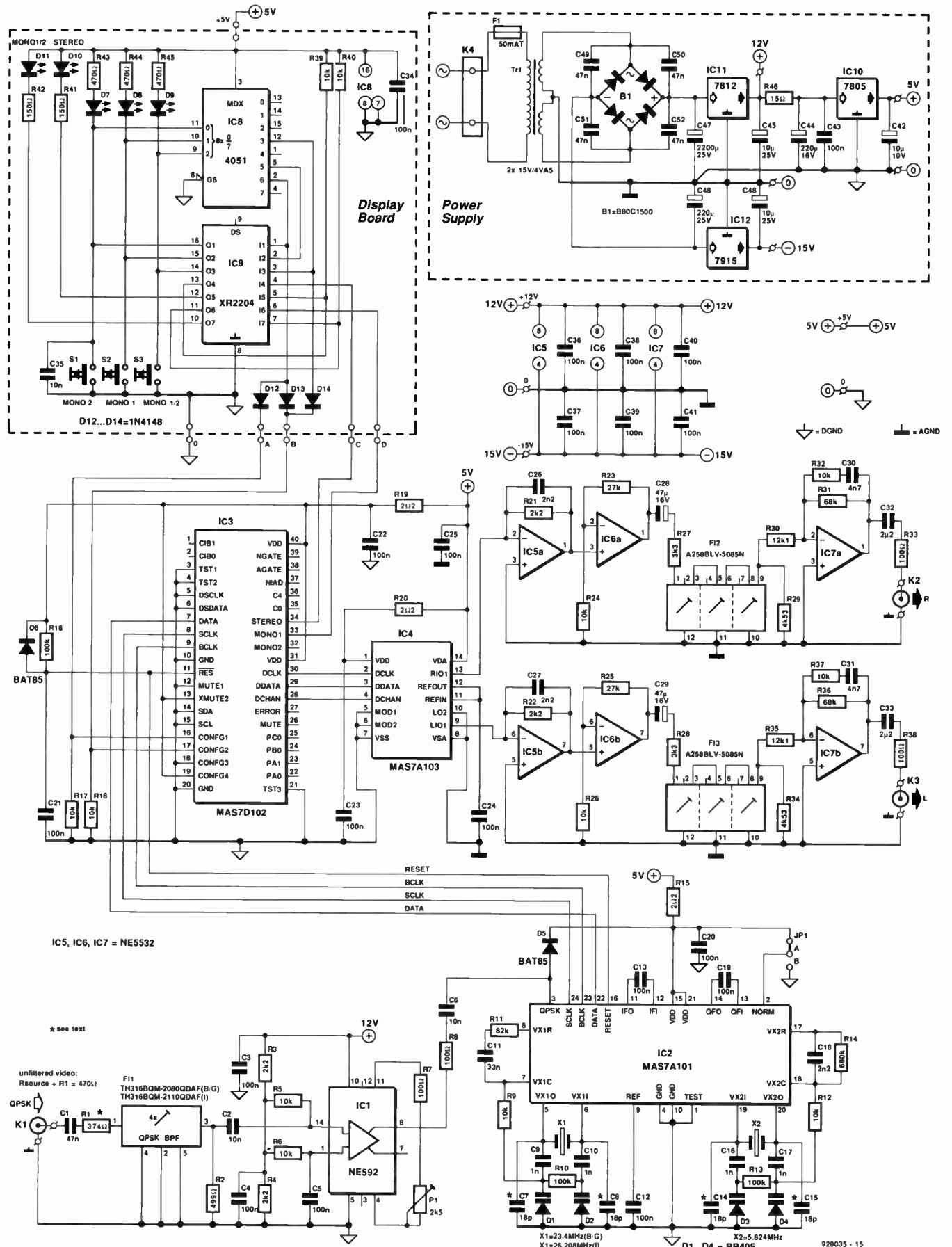

Fig. 4. Circuit diagram of the NICAM decoder.

Country	TV system	Stereo sound	Main sound subcarrier	Stereo subcarrier	QPSK filter FI1	Quartz X1	Jumper JP1
Scandinavia	PAL B/G	Digital; NICAM-B	5.5 MHz	5.850 MHz	TH316BQM-2080QDAF	23.400 MHz	A
United Kingdom	PAL I	Digital; NICAM-I	6.0 MHz	6.552 MHz	TH316BQM-2110QDAF	26.208 MHz	B
Germany; Switzerland; Benelux	PAL B/G	Analogue	5.5 MHz	5.740 MHz	—	—	—
Italy; Spain	PAL B/G	Digital; NICAM-B	5.5 MHz	5.850 MHz	TH316BQM-2080QDAF	23.400 MHz	A

Table 1. The choice of two components in the NICAM decoder, and the position of a jumper, depends on the country you live in.

This filter takes us back to the block diagram in Fig. 1, with the final remark that J17 de-emphasis is applied on the audio signals.

## Practical circuit

After studying some of the background theory on NICAM (to be found elsewhere in this issue), and having acquired samples and datasheets of the NICAM chip set, the author set out to work, and was able to design and build a simple NICAM decoder that was tested with the aid of NICAM broadcasts received from the Belgian national TV station BRT (these broadcasts were experimental at the time, and are currently regular). The BRT transmits NICAM-728 according to PAL standard B/G. Initially, the application circuits suggested by Micronas were built, and from there on further experiments evolved to produce a repeatable decoder.

The final result is an uncluttered circuit shown in Fig. 4. The unfiltered video signal taken from a suitable point in the TV tuner (more about this further on) is applied to the input of a four-section bandpass filter tuned to 5.85 MHz (6.552 MHz for the UK system-I). The input impedance of the decoder is about 900  $\Omega$ . To ensure that the input of the bandpass filter is correctly terminated, the sum of the source impedance and resistor R1 must be 470  $\Omega$ , as indicated in the circuit di-

agram. The Type TDA2541 demodulator IC, for instance, has an output impedance of about 100  $\Omega$ . The bandpass filter used is a ready-made, pre-aligned module from Toko (note that different types are required for systems B/G and system I). Its insertion loss lies between 8 dB and 16 dB. This is compensated by amplifier IC1, whose gain can be set as required with the aid of preset P1 to give a signal level of 200 to 800 mV<sub>pp</sub> at the input of the QPSK demodulator, IC2.

As indicated in the diagram, the frequency of quartz crystal X1 is determined by the PAL TV system used in your country. Jumper JP1 should also be fitted in accordance with the system used, to select the appropriate low-pass characteristic in the demodulator. Information on the options in the circuit depending on the TV system used is summarized in Table 1.

Depending on the characteristics of the crystals used in positions X1 and X2, the exact values of C7-C8 and C14-C15 may have to be changed from those shown in the circuit diagram. Given that the quartz crystals probably have to be cut to order (the frequencies being non-standard as far as we have been able to find out), some experimenting may be required to obtain the correct oscillator frequencies.

The demodulator, IC2, supplies the recovered 728-kHz bit clock, the digital

NICAM signal, and the 5.824-MHz system clock to the decoder, IC3. An R-C network, R16-C21, resets the demodulator and the decoder ICs at power-on.

Mode selection is effected with configuration bits config1 and config2. The available options are mono-2, mono-1 and mono-1/2 (dual language mode). The logic bit combinations required for these settings are supplied by IC8, IC9 and three push-buttons, S1, S2 and S3. The combination of these parts forms a kind of three-position flip-flop with a built-in latch function, a debounce circuit and an indication (on five LEDs). Capacitor C25 ensures that the 'mono-2' mode is automatically selected at power-on.

Diodes D12, D13 and D14 provide the required logic levels at the CONFIG inputs of the decoder IC. LEDs D10 and D11 indicate the currently transmitted mode: dual-language (mono-1/2) or stereo. This indication can not be changed by pressing the MODE switches.

Like the QPSK demodulator IC, the NICAM decoder, IC3, is used in a standard application circuit as suggested by the manufacturer. Similarly, few surprises are found in the link to the dual DAC, IC4, and the subsequent two-stage opamp-based current-to-voltage converters/amplifiers. It will be noted, though, that the opamps work from a symmetrical (+12 V/-15 V) supply. The gain of IC6a and IC7a in the right (R) output channel is set such that the loss introduced by the 15-kHz low-pass filter, Fl2, is overcome whilst ensuring an audio output level that is compatible with other equipment driving a amplifier 'line' input. The same goes, of course, for the corresponding components in the left (L) channel. The low-pass filters are, again, ready-made pre-aligned modules from Toko. Here, we are dealing with two A258BLV-5085N three-section L-C filters (the designer apologizes for the type numbers). Finally, the J17 de-emphasis networks in the right and left audio channels are formed by R32-C30 and R37-C31 respectively. The outputs of the NICAM decoder are capable of driving amplifier 'line' inputs.

## Construction

First, cut the printed circuit board (Fig. 5) into three to separate the power supply

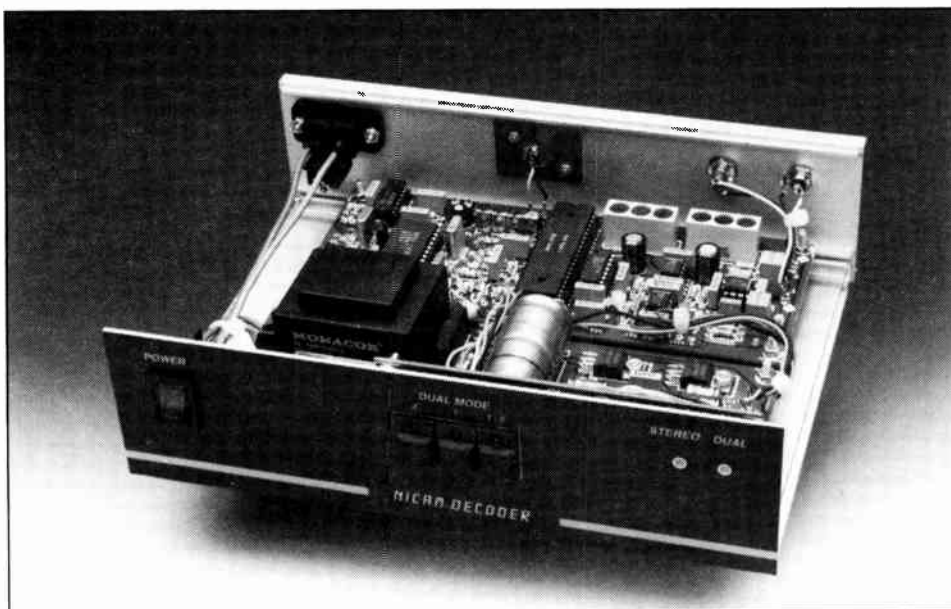

A look into the completed prototype of the decoder.





board, the decoder board and the keyboard. The population of these boards is entirely straightforward, and should not present problems. It is recommended to use IC sockets. The voltage regulators are bolted straight to the power supply board, and do not need heat-sinks. The fuse is fitted in a holder with a protective plastic cap. On the decoder board, the section with the blue (or red) core in the QPSK bandpass filter, Fl1, is at the side of the NICAM decoder chip, IC2.

The keyboard/display section of the printed circuit board has on it three Digitast press-keys with a built-in LED. The front panel of the enclosure for the NICAM decoder (if used) must be cut and drilled to allow the push-buttons and the two LEDs to the right of the board to protrude—more about this further on.

For an initial test, the completed boards are interconnected. Switch on, and check the presence of the correct supply voltages at a number of points. Press the keys and see if the associated LEDs light. If this works all right, stop, and start thinking very hard about

### Finding the input signal

The present NICAM decoder is intended as an upgrade for existing TV sets, set-top TV tuners or video recorders. In nearly all cases, this equipment will have to be opened or modified to find or create a point where the NICAM signal can be 'tapped' and fed to the decoder. The following points should be taken into account:

1. Opening your TV set or VCR in most cases voids your warranty on this equipment.
2. The chassis of most older TV sets is connected direct to the mains. **Never** work on such a TV set without using an isolating transformer.
3. Make sure you have the service documentation (or at least a circuit diagram) of the equipment.

The intrepid among you should be looking for a for a point at the input of the sound demodulator where a signal is available that contains as little video information as possible. In most cases, the input signal of the main FM demodulator (5.5 MHz for system-B/G, or 6.0 MHz for system-I) is taken through a ceramic band-pass filter to suppress the components in the video spectrum. In general, it is best to 'tap' the signal ahead of this filter. The minimum level of the signal to be fed to the NICAM decoder is about 50 mV. In all cases, the load presented by the input of the NICAM decoder should be as small as possible. This may require an emitter follower to be fitted as discussed below.

A little more complex, but certainly more convenient as far as the filtering is concerned, is a TV set or a VCR with a so-called quasi-parallel sound demodulator system. The designer used his HR-S5000E video recorder from JVC to supply the NICAM signal. After studying the service documentation that came with the VCR, it

## COMPONENTS LIST

### Resistors:

1	374Ω (see text)	R1
1	499Ω 1%	R2
4	2kΩ	R3;R4;R21;R22
12	10kΩ	R5;R6;R9;R12;R17; R18;R24;R26;R32; R37;R39;R40
4	100Ω	R7;R8;R33;R38
3	100kΩ	R10;R13;R16
1	82kΩ	R11
1	680kΩ	R14
3	2Ω	R15;R19;R20
2	27kΩ	R23;R25
2	3kΩ	R27;R28
2	4kΩ 5% 1%	R29;R34
2	12kΩ 1%	R30;R35
2	68kΩ	R31;R36
2	150Ω	R41;R42
3	470Ω	R43;R44;R45
1	15Ω	R46
1	2kΩ 5% preset H	P1

### Capacitors:

5	47nF ceramic	C1;C49-C52
2	10nF ceramic	C2;C6
20	100nF	C3;C4;C5;C12;C13; C19-C25;C34; C36-C41;C43
4	18pF	C7;C8;C14;C15
4	1nF ceramic	C9;C10;C16;C17
1	33nF	C11
3	2nF	C18;C26;C27
2	47μF 16V radial	C28;C29
2	4nF	C30;C31
2	2μF 50V solid MKT	C32;C33
1	10nF	C35
1	10μF 10V	C42
1	220μF 16V	C44
2	10μF 25V	C45;C46
1	2200μF 25V	C47
1	220μF 25V	C48

### Semiconductors:

4	BB405	D1-D4
2	BAT85	D5;D6
5	LED red 3mm	D7-D11
3	1N4148	D12;D13;D14
1	B80C1500	B1
1	NE592	IC1
1	MAS7A101	IC2
1	MAS7D102	IC3
1	MAS7A103	IC4
3	NE5532AN	IC5;IC6;IC7
1	4051	IC8
1	XR2204 or ULN2004	IC9
1	7805	IC10
1	7812	IC11
1	7915	IC12

### Miscellaneous:

1	3-way pin header with jumper	JP1
3	RCA (phono) socket	K1;K2;K3
1	2-way PCB terminal block; pitch=7.5mm	K4
3	Digitast push-button (narrow) with integral LED	S1;S2;S3
1	mains transformer 2x15V @ 4.5VA; Monacor (Monarch) type VTR-4215	Tr1
1	TH316BQM-2080QDAF *	Fl1
1	TH316BQM-2110QDAF **	Fl1
2	A258BLV-5085N	Fl2;Fl3
1	Quartz crystal 23.400 MHz *	X1
1	Quartz crystal 26.208 MHz **	X1
1	Quartz crystal 5.824 MHz	X2
1	Fuse 50mA slow; with PCB mount holder and cap	F1
1	Printed circuit board	910035
1	Front panel foil	910035-F
1	Metal enclosure Telet 55205	

\* PAL TV system B or G

\*\* PAL TV system I

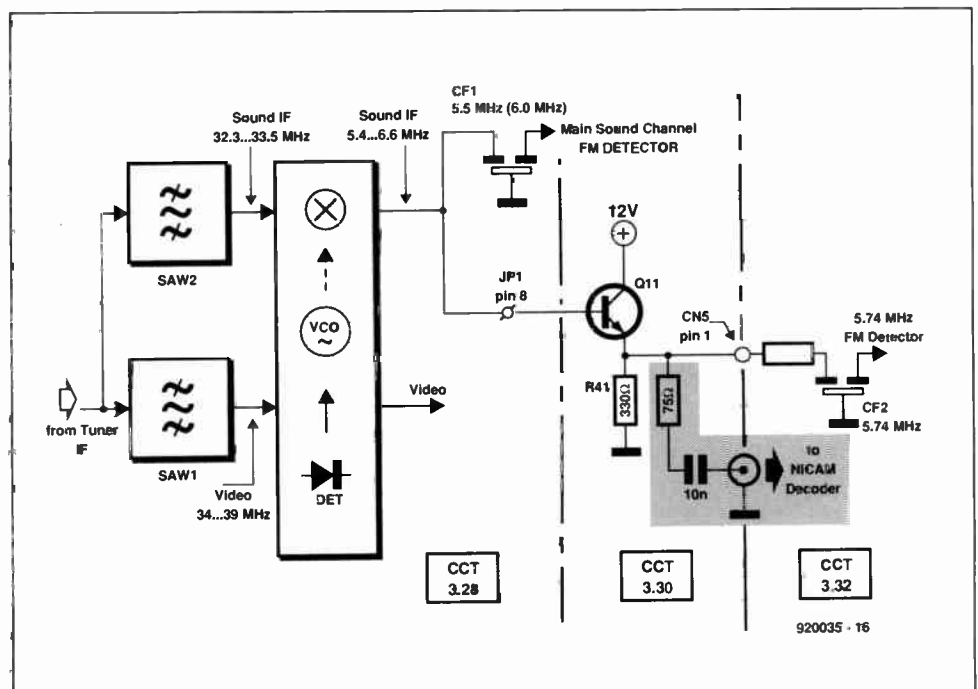

Fig. 6. This drawing illustrates how a suitable decoder input signal was found in the JVC HR-S5000E video recorder.

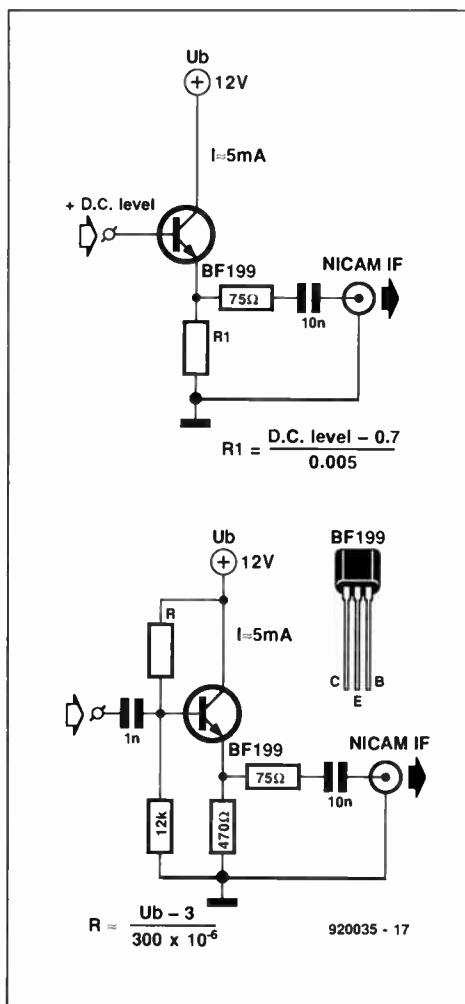

Fig. 7. Emitter followers for NICAM signals on a relatively small d.c. component (7a), and NICAM signals on a d.c. component so large that a.c. coupling is required (7b).

was decided to try the output signal of an emitter follower located between the 'sound IF' output and the input of the 5.74 MHz ceramic filter fitted for the German 'dual-language' demodulator. The search for this emitter follower, Q11, was complicated by the fact that it happened to 'reside' between three pretty large circuit diagrams. Figure 6 shows essentially what has been added to the VCR: one resistor, a coupling capacitor and a 'phono' socket do a perfect job.

As already mentioned, an emitter follower may have to be used to prevent the input signal of the sound demodulator disappearing when the NICAM decoder is connected. One of the circuits shown in Fig. 7 will be adequate. The first, Fig. 7a, may be used when the signal is superimposed on a d.c. level between 0.3 and 0.7 times the supply voltage. The other, Fig. 7b, has an input coupling capacitor, and is used in all other cases. Remember, you are dealing with signals of 5 MHz and higher here, so keep component wires as short as possible.

## Testing

The input impedance of the NICAM decoder is fairly high: about 900 Ω. This means that conventional coax cable with an impedance of 50 Ω or 75 Ω can not be used unless its length remains below 50 cm or so. Longer

## Micronas Inc. Representatives and Distributors

### Austria

EPI Obereder KG  
Bünkerstrasse 58  
9800 Spittal/Drau  
Tel. (04762) 5451  
Fax (04762) 4022

### Belgium

nv Arcobel  
Terlindenhofstraat 36  
2170 Antwerpen-Merksen  
Tel. (03) 646 70 48  
Fax (03) 646 45 12

### Denmark

Delco AS  
Hejrevang 13  
3450 Allerød  
Tel. (042) 277733  
Fax (042) 277770

### France

ASAP  
2 Avenue des Chaumes  
78180 Montigny le Bretonneux  
Tel. (16-1) 30438233  
Fax (16-1) 30570719

### Germany

Advanced Semiconductor Prod.  
Kapellenstrasse 9  
Unterhaching / München  
Tel. (089) 619076  
Fax (089) 619070

### Hong Kong

ESTCO  
A4, 11/F., Block A  
26 Kai Cheung Road  
Kowloon Bay, Kowloon  
Tel. (852) 7548520  
Fax (852) 7986669

### Italy

Eurelectronica S.p.A.  
Via E. Fermi 8  
20094 Assago (MI)  
Tel. (02) 4880022  
Fax (02) 4880275

### Japan

Global Industries Corp.  
33 Nando Cho

### Shinjuku-Ku

Tokyo, ZIP 162  
Tel. (03) 2686655  
Fax (03) 2353663

### Korea

Kyung Il Corp.  
701 Hosung Bldg., yeido-Dong  
Yeoungdeungpo-Ku  
Seoul 100-628  
Tel. (02) 7851445  
Fax (02) 7851447

### The Netherlands

Arcobel b.v.  
Griekenweg 25  
5342 PX Oss  
Tel. (04120) 30335  
Fax (04120) 30635

### Spain

Selco S.A.  
Paseo de la Habana 190  
28036 Madrid  
Tel. (01) 3264213  
Fax. (01) 2592284

### Switzerland

Anatec A.G.  
Sumpfstrasse 7  
6300 Zug  
Tel. (042) 412441  
Fax (042) 413124

### United Kingdom and Ireland

Microcall Ltd.  
Thame Park Road  
Thame  
Oxfordshire OX9 3XD  
Tel. (0844) 261939  
Fax (0844) 261678

### All other countries

please contact the head office:

Micronas Inc.  
Kamreerintie 2  
SF-02770 Espoo

FINLAND  
Telephone: +358 0 80521  
Fax: +358 0 8053213

cables of either type will cause reflections and serious mismatches, resulting in attenuation of the NICAM subcarrier. If you can not go round the use of a relatively long, low-impedance, coax cable between the TV set and the NICAM decoder, be sure to fit a terminating resistor across socket K1. This resistor prevents reflection and high-frequency loss to some extent. When a 50-Ω cable is used, fit a 52.9-Ω terminating resistor, and change R1 into 444 Ω. Similarly, when a 75-Ω cable is used, terminate it with 81.8 Ω, and change R1 into 431 Ω. In some

cases, ordinary screened cable as used with audio equipment, or car radio coax cable (if you can get it), is the best alternative. In any case, do not fit BNC or similar low-impedance RF sockets at the TV side and the decoder input. On the prototype we used an insulated 'phono' (RCA-style) socket for chassis mounting. An insulated socket is required to prevent an earth loop between the analogue and digital ground rails.

### Demodulator input level

Switch on the NICAM decoder, and tune the

# PROGRAMMING THE MAS7D102 NICAM DECODER

The bus format can be selected either by applying logic levels to pins Config4 and Config3, or by programming control bits Config4 and Config3 via the I<sup>2</sup>C microprocessor interface.

Config 4	Config3	DAC bus format
0	0	High-Z
0	1	S-bus
1	0	I <sup>2</sup> S bus
1	1	Toshiba DAC bus

The pins Stereo, Mono1 and Mono2 are active-low outputs that indicate the current NICAM transmission mode.

Stereo	Mono1	Mono2	Type of transmission
0	1	1	Stereo signal
1	0	1	Dual language transmission
1	1	0	One mono sound channel and 352 Kbit/s data channel
1	1	1	No sound signal. Transparent 704 Kbit/s data transmission, or no NICAM encoded transmission

During dual-language transmissions, the main language selection is controlled by input pins Config2 and Config1.

Config2	Config1	DAC bus	Sound sample order
0	0	I <sup>2</sup> S/Toshiba	M1 M1
0	1	I <sup>2</sup> S/Toshiba	M1 M2
1	0	I <sup>2</sup> S/Toshiba	M2 M1
1	1	I <sup>2</sup> S/Toshiba	M2 M2
0	0	ITT	M1 M1 M1 M1
0	1	ITT	M1 M1 M2 M2
1	0	ITT	M2 M2 M1 M1
1	1	ITT	M2 M2 M2 M2

The decoder has two addresses on the I<sup>2</sup>C bus. Address 4E (hex) is for writing to the decoder, and address 4F (hex) for reading from the decoder.

There are three status registers (read) and three control registers (write) that can be accessed. The three control registers can be addressed individually by the two most significant bits of each control word. The three status registers can be addressed as a complete set only.

Control register	D7	D6	D5	D4	D3	D2	D1	D0
1	0	0	Test1	Test2	MuteS	MuteA	x	Reset
2	0	1	x	x	Config4	Config3	Config2	Config1
3	1	Da	Db	Dc	Pa1	Pa0	Pb0	Pc0

- Test1 and Test2 are reserved for test purposes, and must be set low.
- The MuteS control bit mutes sound output. Active high.
- The MuteA control bit mutes sound output and resets the synchronisation of the decoder completely. Active high.
- The Reset control bit resets the decoder completely. Active high.

The function of the Da, Db and Dc control bits is to define external ports Pa, Pb and Pc as inputs or outputs, as shown below.

Da	Db	Dc	Pa1	Pa0	Pb0	Pc0
0	0	0	out	out	out	out
0	0	1	out	out	out	in
0	1	0	out	out	in	out
0	1	1	out	out	in	in
1	0	0	in	in	out	out
1	0	1	in	in	out	in
1	1	0	in	in	in	out
1	1	1	in	in	in	in

The status registers of the MAS7D102 have the following structure:

Status register	D7	D6	D5	D4	D3	D2	D1	D0
1	Osn	CI1	CI0	C4	C3	C2	C1	C0
2	Ser10	Ser9	Mute	TestS	Pa1	Pa0	Pb0	Pc0
3	Ser8	Ser7	Ser6	Ser5	Ser4	Ser3	Ser2	Ser1

- The Osn status bit goes high when the decoder is not synchronised.
- CI0 and CI1 are the two CI bits extracted from each NICAM frame.
- C4-C0 are the C bits associated with the current NICAM transmission, and they indicate the mode as shown below.

C1	C2	C3	NICAM transmission mode
0	0	0	Stereo transmission
0	1	0	Dual language transmission
1	0	0	One mono channel plus data transmission
1	1	0	One 704 Kbit/s data channel

- C0 is the Frame Flag bit that indicates the super frame pattern of the NICAM transmission.
- C4 is the Reserve Sound Switching flag, which goes high when the FM mono signal carries the same programme as the digital stereo signal.
- The Mute status bit goes high to indicate that the decoder has been muted for some reason.

- TestS is a test status indication bit reserved for test purposes.
- Pa1 and Pa0, Pb0 and Pc0 indicate the status of the corresponding external pins, when they are configured as input ports.

- The Ser10-Ser1 bits show the value contained in the sample error counter. This counter is incremented whenever an erroneous sample is detected. The control processor can read the error count at suitable time intervals, and take decisions depending on the error rate.

TV set or the VCR to a station transmitting NICAM sound. Use an oscilloscope to check the signal level at pin 3 of the QPSK demodulator, IC2. The level should be between 200 mV<sub>pp</sub> and 800 mV<sub>pp</sub>. If necessary, adjust preset P1 to achieve a level of about 500 mV<sub>pp</sub>.

#### QPSK demodulator PLL adjustment

Connect the scope to pin 11 of the QPSK demodulator IC. You should see a so-called 'eyes' waveform (which may be very difficult for the scope to trigger on). Adjust P1 so that the tops of the waveform are just below the supply voltage; i.e., they are just not clipped. This gives a signal level of about 5 V<sub>pp</sub>. Move on to pin 7 of IC2. This supplies the error voltage of the demodulator PLL. It is a fairly 'messy' signal superimposed on a direct voltage, which will look like a broad band on the scope. Tune to a non-NICAM station, and back to the NICAM station again, to see how the PLL responds by locking on to the NICAM signal. For best performance of the PLL, the d.c. component in the error signal should be at about half the supply voltage, i.e., 2.5 V. When it is too close to either 0 V or +5 V, change the crystal matching capacitors, C7 and C8, until the centre of the band is at about 2.5 V. Increase the capacitor values (to 22 pF or 27 pF) when the d.c. component is too low, and decrease them (to 15 pF or 12 pF) when the d.c. component is too high. Try to get as close to 2.5 V as you can. The exact oscillator frequency will be very difficult to measure at pin 5 of IC2 because the impedance is high locally. This means that any capacitive load, however small, formed by a test probe will detune the crystal oscillator to some extent.

#### Clock recovery PLL adjustment

The 5.824-MHz PLL for the NICAM clock signal recovery is adjusted in a similar manner to the QPSK PLL as discussed above. Connect the scope to pin 18 of IC2, and check that the error voltage has a d.c. component of about 2.5 V. If not, change the values of C14 and C15. It will be found that this error voltage is much 'cleaner' than the one used for

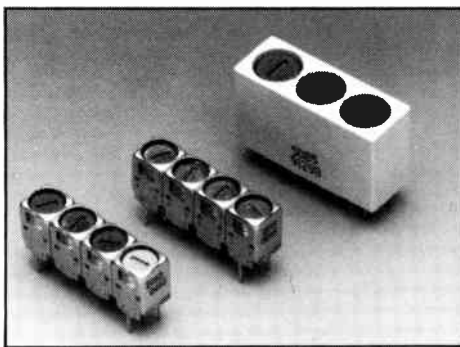

Fig. 8. The Toko QPSK bandpass filter (either for system I or B/G) and the 15-kHz low-pass filter used in the decoder.

controlling the first PLL. If the second PLL frequency is correct, pin 23 of the demodulator IC supplies a clock signal of 728 kHz, which is easily measured with a frequency meter.

That completes the adjustment of the NICAM decoder. If you have not already done so, connect a stereo amplifier to the outputs, and enjoy the programme!

### Finishing touch

Some of you may want to fit the decoder permanently inside a TV set, while others may want to use it as a self-contained unit.

The prototype of the decoder was housed in an aluminium enclosure Type 55205 from Telet. The decoder and supply boards were fitted on a perspex plate that could be slid horizontally into the railings provided along the inside of the front and rear panels.

The keyboard PCB and the mains switch are fitted on to the front panel, for which a ready-made self-adhesive foil is available. This foil is used as a template to determine the locations of the holes to be cut in the front panel. A jig-saw is used to cut the rectangular clearances for the mains switch and the three push-buttons.

The keyboard PCB is mounted on four screws of which the (countersunk) heads are glued to the inside of the front panel. Plastic

stand-offs are used to fit the PCB at the right distance behind the front panel.

The rear panel is drilled to hold the mains socket, the NICAM input socket and the two audio output sockets.

### Conclusion

The NICAM decoder described here has been in use for some time now, and provides excellent stereo sound on broadcasts received from BRT1 and BRT2. Regrettably, the unit could not be tested in the UK, although suitable components (a 6.552-MHz QPSK bandpass filter and a 26.208 MHz quartz crystal) were available.

Although the construction and adjustment of the unit are fairly simple, finding a suitable input signal may be daunting if you have little experience in TV and VCR technology. We feel, therefore, that it is fair to warn beginners not to undertake this project until a dedicated TV tuner is available, which will be described in a future issue of *Elektor Electronics*.

### Postscript for advanced users

As already mentioned, the MAS7D102 NICAM decoder has optional I<sup>2</sup>C control, which may be used to access most of the internal registers. The SDA and SCL inputs of this IC are TTL-compatible, and may be connected to an I<sup>2</sup>C bus via appropriate interfaces. If you have a PC available fitted with an I<sup>2</sup>C interface (Ref. 1), you may use the information given in the MAS7D102 inset to implement software control on the NICAM decoder.

The descrambler on board the MAS7D102 can be loaded with a descrambling key other than the standard 'seed' used for non-encrypted NICAM broadcasts. Changes to the scrambling keys must occur synchronously at the transmitter and the receiver(s). The NICAM decoder IC provides a serial data input, Dsdata (pin 6), and a clock input, Dsclk (pin 5) to access an internal shift register. This register contains the descrambler key that is loaded in parallel into the descrambler one per frame. The shift register contents can be updated at any time with a maximum clock rate of 5 MHz. The time interval between the falling edge of the Ngate signal (pin 39) and the rising edge of the Agate signal (pin 38) is not allowed for descrambler key updating. During this interval, Dsclk (pin 5) must be held static. Output signals C0 (pin 35), Agate and Ngate may be useful for synchronisation purposes.

Happy listening! ■

The co-operation of Mr. Matti Antman of Micronas Inc., Mr. Peter de Vroome of Arco-bel b.v., and our photo model Miss Diony Erven is gratefully acknowledged.

#### Reference:

1. "I<sup>2</sup>C Interface for PCs." *Elektor Electronics USA*, February 1992.

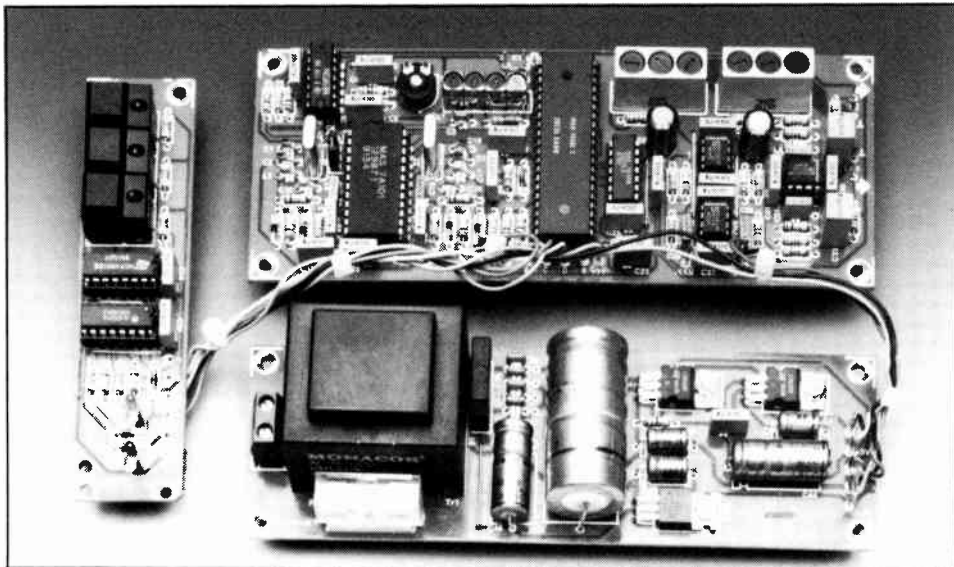

Fig. 9. Completed printed circuit boards: main decoder board, keyboard and PSU.

# AUDIO-VIDEO PROCESSOR TYPE AVP300 – PART 1

## An ELV design

**T**HE audio-video processor is best compared to the control amplifier in an audio system. That, too, gives a choice of input signals. Where required, the signal standard may be changed. The quality of the signal can be modified in a manner comparable to tone control. Finally, the signal is output in a number of ways (as in tape and line outputs).

The design of the processor can be seen in the block diagram in Fig. 1. In the first instance, this diagram will be analysed stage by stage; this will at the same time give a sort of user instruction. The technical aspects will follow naturally when the various circuit diagrams are discussed.

## Inputs and outputs

At the rear of the processor are no fewer than 16 different connectors—see Fig. 2. Which of these are required in any given situation depends on the type of termination of the relevant cable and on the available signal.

**Video 1/6** is an input with dual function via a SCART\* connector (also called Euroconnector). When used as Video 1 input, it is fed with a CVBS (Chroma, Video, Blanking, Synchronization) signal, which is sometimes just called composite video signal.

When used as Video 6 input, it accepts signals from an S-VHS recorder or camera. These signals consist of two components: chroma for colour information and VBS (black-and-white) for brightness.

The audio signals associated with these inputs are also applied via the Euroconnector.

**Video 2** is a SCART\* input for CVBS and RGB (Red, Green, Blue) signals; selection of either is effected by a slide switch. When the switch is in position CVBS, it is possible, with the aid of a computer and a genlock, to mix CVBS and RGB signals. It is planned to publish the design of a genlock later this year.

**Video 3** is a BNC input for a CVBS signal. The associated audio signal is input via the two audio sockets next to the BNC socket.

**Video 4** is a second SCART\* socket that can also be used to input a CVBS signal. Moreover, it provides CVBS and RGB output signals. This arrangement is intended primarily for the standards conversion. To that end, the socket should be linked to the SCART socket on the television receiver. The tuner of the receiver will

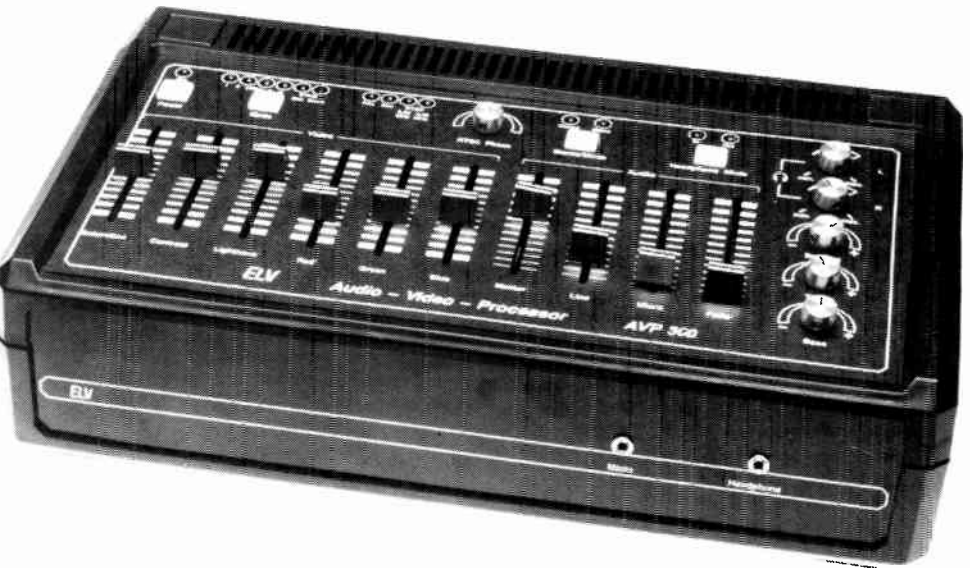

**The Type AVP300 audio-video processor is a multi-standard equipment that can be used almost anywhere in the world. It can translate between the three television standards (PAL, NTSC, and SECAM), hop from one type of signal to another (S-VHS, Hi-8, RGB, CVBS), and enables audio and video signals to be modified: video signals as regards colour saturation, contrast, brightness and the balance between red, green and blue, and audio signal(s) in respect of tone, balance and volume. Moreover, it has a (limited) facility for mixing signals.**

then provide the CVBS signal, whether NTSC, SECAM or PAL, to the processor. The processor translates this signal into an RGB signal and sends it to the TV receiver. At the same time, the blanking line is switched to arrange the TV receiver displaying the signal at the RGB inputs, that is, the converted signal, instead of that from its integral tuner. There is only one but: not all TV receivers, particularly older models, have RGB inputs on the SCART socket.

**Video 5** is a mini DIN socket for inputting S-VHS signals. The associated audio signals are fed to the processor via audio sockets.

**Video 7** is a mini DIN socket for outputting S-VHS signals. Again, the associated audio signals are output via standard audio sockets.

**Video 8** is another SCART\* socket for out-

putting CVBS or S-VHS signals: which one is determined by a switch adjacent to the socket. If the socket is used for S-VHS signals, nothing must be connected to Video 7, because of the terminating impedance of the S-VHS output. If a recorder or TV receiver is connected to Video 7, Video 8 may be used as a CVBS output only.

**Audio 1-8** are the audio inputs and outputs associated with the correspondingly numbered video inputs and outputs.

**Audio 9** (two sockets) is intended for feeding independent audio signals to the processor. These signals can either be mixed with the original sound or replace it.

**Audio 10** (3.5 mm jack socket) is a stereo microphone input.

\* Named after the French organization that proposed this 21-way connector in the early 1980s: Syndicat des Constructeurs d'Appareils Radiorécepteurs et Téléviseurs. The connector has since become a European standard.



**Audio 11** is a headphone output via which the signals before *and* after the control amplifier can be heard.

**Port** is an 8-way DIN socket, via which external equipment can be used to control various functions of the processor. It will enable, for instance, the inputting of yet-to-be-developed video effects in the future without any further work on the processor.

## Standards conversion

The processor can handle video signals of the following standards: PAL, SECAM, NTSC 3.58 MHz and NTSC 4.43 MHz. It is able to recognize these standards automatically and modify the chroma-VBS separation filter accordingly. Which standard is recognized is indicated by LEDs. Selection of positive or negative video signals is effected manually by a switch at the rear of the processor.

Also at the rear panel are the switches for setting the standard of the output signal, which is PAL or NTSC. In the case of NTSC, a further selection must be made of the colour carrier (3.58 MHz or 4.43 MHz). In the case of PAL, the switch *must* be set to 4.43 MHz.

Furthermore, the processor can be used to transform a conventional TV receiver into a multi-standard model (for relevant connections, see under Video 4).

## Formats conversion

Apart from video standards, the processor

can convert each of the signal formats S-VHS, RGB and CVBS to either of the other two. This is largely a matter of choosing the correct input and output connectors. Note that the CVBS/RGB-in switch (next to the Video 2 input) *must* be set to CVBS if an S-VHS or CVBS signal is input, irrespective of to which socket.

**S-VHS to RGB:** S-VHS signals can be input via the Video 5 or Video 6 sockets; the input switch must be set accordingly. The RGB signal is available at output Video 4: the CVBS/RGB-out slide switch must be set to RGB.

**S-VHS to CVBS:** S-VHS signals are input via the Video 5 or Video 6 sockets. The output may be taken from Video 4 or Video 8; both of these may be used simultaneously. The associated switch near these outputs must be set to CVBS.

**RGB to S-VHS:** RGB signals are input via Video 2. The corresponding RGB/CVBS switch must be set to RGB. If this switch is in position CVBS, it may be changed over to RGB by applying a voltage of 1–3 V to pin 16 (blanking). The S-VHS signal may be taken from Video 7 or Video 8 (*not* simultaneously). The switch associated with Video 8 must be set to S-VHS.

**RGB to CVBS:** RGB signals are input via Video 2. The CVBS signal may be taken from Video 4 or Video 8; both of these may be used simultaneously. The switches at both the outputs must be set to CVBS.

**CVBS to S-VHS:** CVBS signals may be input via Video 1, Video 2 or Video 3. The converted signal is available at Video 7 or Video 8.

**CVBS to RGB:** CVBS signals may be input via Video 1, Video 2 or Video 3. The converted signal is available at output Video 4; the associated switch must be set to RGB.

## Quality of converted formats

Retention of quality during the conversion from one format to another is ensured by special stages similar to those found in modern television receivers. However, in the case of conversion of CVBS signals, there may be a slight loss of quality. This is because the stripping of the chroma information from the signal tends to be troublesome: this, together with the limited bandwidth of standard VHS recorders, is the reason that the chroma and VBS components of the signal are kept separated in S-VHS recorders. In the conversion to a CVBS signal, there is no loss of quality. This assumes, of course, that the TV receiver and recorder connected to the processor are of good quality.

## Controls

A close look at the block diagram in Fig. 2 shows that the processor resembles a modern multi-standard television receiver less the RF and CRT sections. The video section is the largest and most interesting part of the processor. Input signals follow two paths to the video colour controller. RGB signals from Video 2 are fed directly to this stage, but S-VHS and

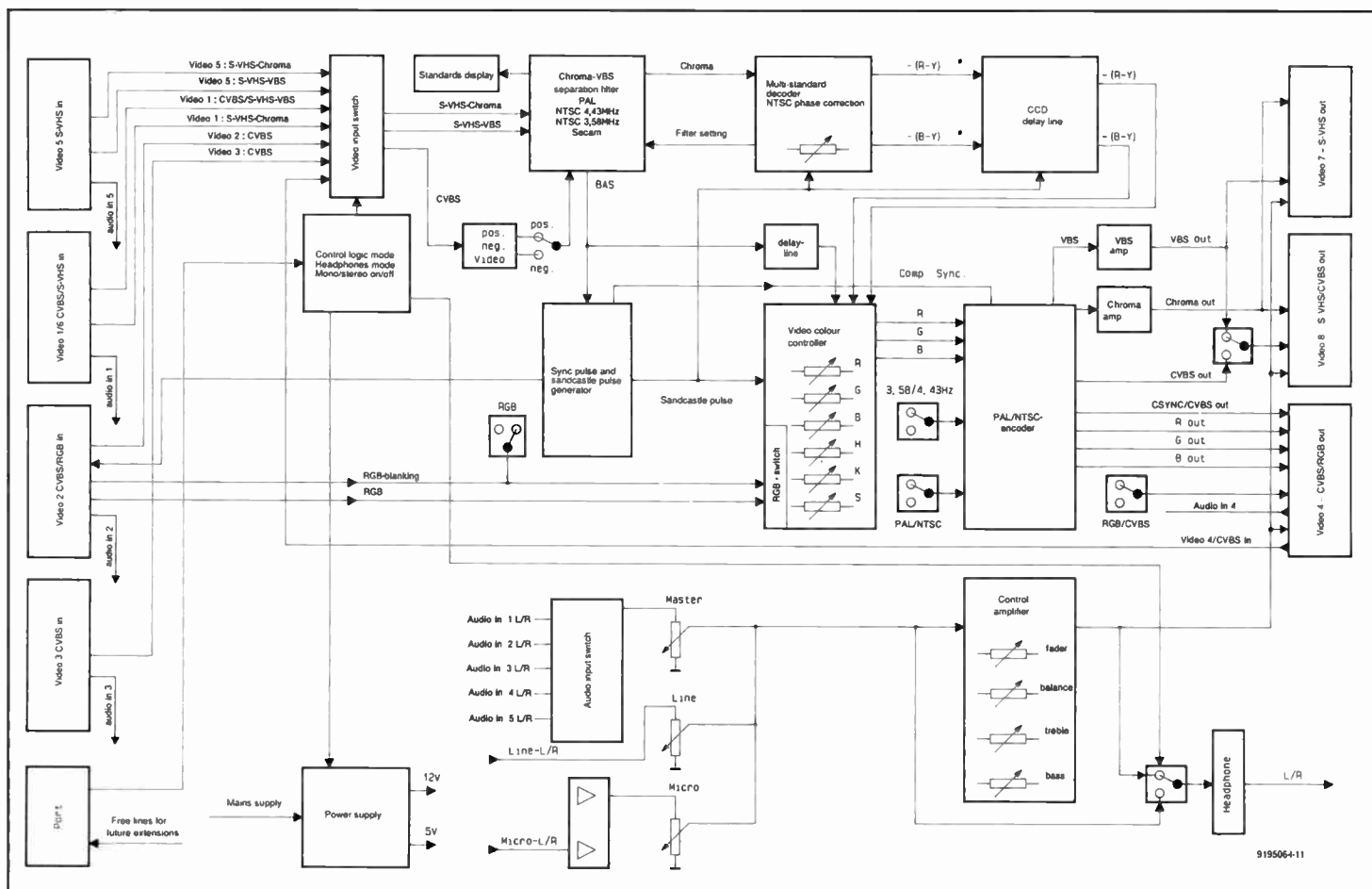

Fig. 1. Block diagram of the Type AVP300 audio video processor.





**Fig. 2. Rear view of the audio video processor showing the 16 input sockets and the various switches.**

CVBS signals must be decoded first. Switching between the decoded signals and RGB signals is carried out electronically in the decoder. The control signal for that is the RGB blanking signal. If the CVBS/RGB switch is set to position RGB, the output signals of the decoder relating to S-VHS and CVBS components are switched off by the controller. This is why it was emphasized earlier on that this switch must be set to CVBS.

S-VHS and CVBS signals are first applied to an input selector, an electronic switch that is operated by press button MODE on the processor. S-VHS signals are taken from the switch directly to the chroma-VBS separation filter. CVBS signals are first passed through a switchable inverter to enable positive as well as negative video signals to be processed. Normally, the switch is set to negative.

Readers may well ask why S-VHS signals are applied to the chroma-VBS separation filter, since these components are already separated in this format. That is, of course, so and with S-VHS signals the filter therefore serves as a buffer only. If, however, a CVBS signal is applied, the filter separates the sub-carrier and colour signal from the black-and-white (VBS) signal. The filter has two settings: one for PAL, SECAM and NTSC with a colour sub-carrier of 4.43 MHz and the other for NTSC with a colour sub-carrier of 3.58 MHz. The setting is determined by the multi-standard decoder as soon as this stage has detected which TV standard is used. At the same time, the type of standard is indicated by LEDs.

Following the filter, the chroma and VBS signals follow separate paths. To begin with, the VBS signal is applied to the sync pulse and sandcastle pulse generator, which derives new sync pulses from it. Separate line and field sync pulses, as well as sandcastle pulses, are fed to

the Video 2 input. Sandcastle pulses indicate the various stages of the line, field and blanking pulses by voltage levels.

The sandcastle pulse is also applied to the video colour decoder, the multi-standard decoder and the CCD (Charge Coupled Device) delay line to ensure that these stages perform their functions at the right moment.

The sync pulse and sandcastle pulse generator also provides a composite sync (BS or Blanking/Synchronization) signal. This is used to re-render the picture signal, after it has been processed, into a VBS or CVBS signal, and also serves as sync signal for the RGB output.

The black-and-white signal is applied not only to the sync pulse and sandcastle pulse generator, but also to the video colour controller. In its path there is a delay line that prevents it arriving too early at the controller: the chroma signal is also delayed during decoding.

The chroma signal is fed to the multi-standard decoder, where it is demodulated (stripped of the 4.43 MHz or 3.58 MHz sub-carrier) and split into two colour-difference signals. To give the correct colour to the colour-difference signals, the decoder needs a reference, and this is provided by the NTSC phase preset. That control is not required with PAL or SECAM, because signals in those formats already contain a reference. With NTSC signals, the preset needs to be adjusted until the colours appear natural or as natural as possible.

From the multi-standard decoder, the two colour-difference signals are applied to a CCD delay line. There, the incoming picture line is compared with the previous picture line stored in the delay line. This arrangement enables the removal of any errors in the colour-difference signals.

The input signals have then been processed to the stage where they can be applied to the

video colour controller—the heart of the audio video processor. Although the colour information has not been completely decoded at this stage, the video colour controller correctly converts the colour-difference signals to RGB (bear in mind that the controller is just one IC). The recaptured RGB signal is applied to the RGB switch of the video colour controller. This electronic switch enables the selection of either the S-VHS/ CVBS signal or the RGB signal. It is so fast that it is suitable for mixing the S-VHS/CVBS signal with the RGB signal. Although this requires external effects equipment, the actual mixing takes place in the video colour controller.

After the RGB signal has passed the RGB selector, the video colour controller lives up to its name: it enables changing the depth of each of the three colours (red, green and blue) by up to  $\pm 40\%$ ; it also has controls for adjusting the brightness, contrast and colour saturation.

After it has been processed in the video colour controller, the RGB signal must be re-ramped for transmission. That is simple if an RGB output is wanted: only a composite signal then needs to be added to it. If an S-VHS or CVBS is required, a modulator is needed: in Fig. 1, this is called PAL/NTSC encoder. That name already indicates that both PAL and NTSC signals can be provided. The standard of the output signals is determined with a switch. If that is set to NTSC, a second switch allows setting either of two frequencies for the chroma sub-carrier.

The audio section is arranged in a similar manner, but contains far fewer components. Audiosignals are also input via switches, which are operated together with those for the video signals. In that way, the audio signal at the master potentiometer is always associated with the present video signal.

There are also two inputs for independent audio signals that can be mixed with the original sound. If the master potentiometer is turned off, the audio signals at these inputs can be used as a new sound for the present picture.

One of the two inputs is for line signals, the other for microphone signals. Microphone signals are first amplified to the same level as other audio signals.

After the audio signals have been mixed with the aid of the three slide potentiometers, they are applied to the control amplifier. A fader allows the volume of the mixed audio signals to be altered gradually.

The control amplifier also has controls for high and low tones and balance, as well as a mono/stereo selector.

Audio signals can be listened to with headphones. These signals may be taken either from the input or from the output of the control amplifier: selection is by means of a switch. This enables the audio input to be monitored with the fader 'off'. ■

*Next month's instalment will describe the circuit of the video section.*

# SCIENCE & TECHNOLOGY

## DIGITAL SHORT-RANGE RADIO

by Brian P. McArdle

### 1. Introduction

An interim standard for Digital Short Range Radio (DSRR) has been approved recently by the European Telecommunications Standards Institute (ETSI). The institute was established by the European Community to assist with the harmonization of equipment specification and frequency allocations in member countries. The DSRR interim standard is one of its first radio specifications. It will go forward for public enquiry and, in due course, become a standard applicable in every community state. There could be modifications, but the interim standard will probably remain the basis of the final specification. After the standard has been finalized, no modifications can be introduced by individual states. In time, DSRR should become a true European radiocommunications system.

DSRR is a major advancement in business radio and should reduce many of the present problems. There are explained further in Section 2. The interim standard has a number of requirements in regard to control signalling and protocols which, at present, are not in general use. Because of developments in digital signal processing, these should not create major problems for manufacturers in the various countries. However, it also proposes the use of two frequency bands of 888–890 MHz and 933–935 MHz, known as the Low Band (LB) and the High Band (HB) respectively. The significance of two separate bands is explained in Section 3. This could result in difficulties, because EC countries are still far away from true frequency harmonization. Since the EC is committed to harmonization and the removal of trade barriers, it is considering a directive to all member states that, in order to reduce any problems in the introduction of DSRR, priority should be given to DSRR over other services in the proposed bands. At present, DSRR appears to be on target for wide use within a few years.

### 2. PMR channels

The channels are usually assigned for dual frequency operation, which means that a unit transmits and receives on different frequencies as in Fig. 1. If a base station has  $f_c$  and  $f_r$  as its transmit and receive frequencies, a mobile station operating to the base station must have  $f_r$  and  $f_c$  as its transmit and receive frequencies respectively. In the United Kingdom, equipment for this service must conform to the Performance Specification MPT1326. This is a fundamental specification and DSRR units must meet a similar specification—see Appendix 5. The difference is the method of operation and the use of the channels.

In the PMR (Private Mobile Radio) service, the main barrier to further development is the method of using the radio frequency

spectrum. In assigning channels to users, there is insufficient spectrum for every user to have his own channel. That means that a number of users must share the same channel. This, in turn, causes a nuisance effect and loss of confidentiality since every message on a channel is detected by every receiver irrespective of the intended destination. Tone control, like EEA or ZVEI, can be used to minimize this effect. At the start of a message a transmitter sends a specific sequence of tones. Only the intended receiver can identify the sequence and is activated from the point of the operator. If an incorrect sequence, that is, a sequence for a different receiver, is detected, the receiver remains deactivated. Unfortunately, this process does not solve the problem of channel sharing. A common occurrence is that two users wish to use the channel at the same time. Therefore, each user must monitor the channel to ascertain that it is free before he can commence operation. Queues often occur despite the fact that many channels are regularly idle. DSRR should reduce this problem by making more efficient use of the spectrum. It should also improve user confidentiality without the need of secrecy operations, that is, encryption procedures.

### 3. DSRR frequency bands

There are two bands of 2 MHz in which channels are assigned with 25 kHz channel spacing as follows.

Channel	High band	Low band
01	933.025 MHz	888.025 MHz
02	933.050 MHz	888.050 MHz
03	933.075 MHz	888.075 MHz
...	...	...
77	934.925 MHz	889.925 MHz
78	934.950 MHz	889.950 MHz
79	934.975 MHz	889.975 MHz

Channels 01 and 79 are used as control channels for selective signalling (SSC) and cannot be used to transmit or receive voice or data. The traffic channels are 02 to 78 inclusive: the usual type of operation illustrated in Fig. 2. Two units, A and B, operate to each other through a repeater or master unit. This is dual-frequency operation with repeaters and master units transmitting in the High Band and receiving in the Low Band. Units (mobiles) transmit in the Low Band and receive in the High Band. If A and B want to operate directly to each other, single frequency operation would be used. In this method, the units transmit and receive on the same channel in the same band: High Band.

In operation, a unit will scan and identify a free traffic channel which is subsequently used for voice or data. The number of the

1

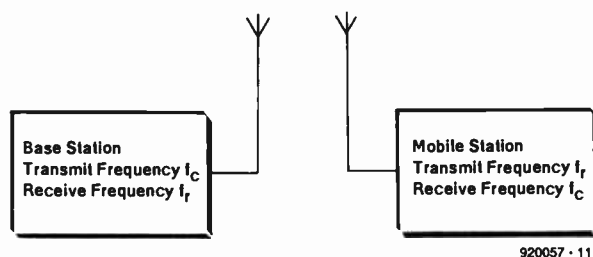

2

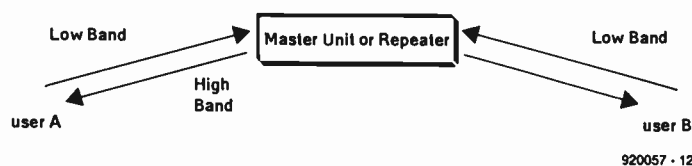

particular traffic channel plus certain control signals are transmitted to the intended receiver on the control channels. In order to avoid congestion, where a number of units would be considering the same traffic channel, there is a specific algorithm for channel spacing:

$$N_j = (N_{j-1} + 1) \bmod 77 + 2 \quad [\text{Eq.1}]$$

for  $j > 0$  where  $N_0$  is the seed. Thus, the mathematical operation is an additive congruence generator where  $N_j$  will only take values between 2 and 78 inclusive. The two control channels, 01 and 79, will be excluded automatically. If a different seed is used by different units, the chances of two or more units identifying and choosing the same channel would be greatly reduced. On switch-on, the seed is the least significant 7 bits of the call code (refer SSC). For successive seeds, the least significant 7 bits of the 16 check bits of the previous SSC is used. This is discussed in more detail in Section 5.

#### 4. DSRR modes of operation

There are three main modes of operation.

- In the *standby mode* a unit monitors 2 control channels for the appropriate control signals. It does not transmit or receive voice or data.
- In *call set-up mode* a unit transmits and receives control signals but no voice or data.
- In *communication mode* a unit is in full operation, that is, transmitting and receiving voice or data. Control signals are also transmitted and received in this mode.

Consider an example where user A wishes to contact user B in single-frequency operation. The main steps can be summarized by the following procedure, in which it has been assumed that A has just been switched on and is in the standby mode.

- A enters call set-up mode. The traffic channels are scanned to find a free channel. If no channel is available, the unit will return to standby mode.
- A transmits an SSC on the control channel to B. This code includes identifiers for A and B, number of proposed traffic channel, and so on. The format of the code words is discussed in Section 5. A switches to receive mode on the control channel.
- B transmits an ACK to A on the control channel and switches to receive mode on the traffic channels specified in the SSC from A. On receipt of the ACK from B, A switches to the traffic channel. If no ACK or another SSC different from ii) is received by A, a set of retry procedures is implemented.
- A transmits the call set-up SSC as in ii) on the traffic channel to B. B sends an ACK and both units enter communication mode. If no voice or data is transmitted after 10 seconds, or if the traffic channel has become busy between ii) and iv), or the SSC or ACK is not received, both units revert to standby mode.
- In communication mode, all transmissions are preceded by a full SSC. There is a limit of three minutes to the time in communication mode in order to avoid congestion. In addition, if no valid voice or data is received after a certain period (5 seconds, or 10 if the unit has just entered the mode), both units return to the standby mode.

This is a simplified description and the reader should consult the official standard for a proper explanation. For operation through repeaters or master units, the procedure must be varied. However, the entire operation is a major change from the present method for PMR. The digital signal processing as in the SSC and ACK control signals is central to the system.

#### 5. Selective signalling code

The selective signalling code (SSC) is a block of 568 bits which is fundamental to DSRR operation in all mode. It is sub-divided into the following blocks.

- Preamble of 256 bits of 1010...etc. (bit reversal) for bit synchronization of the decoder in the receiver.

- Frame synchronization of 16 bits to establish code word framing in the decoder of the receiver.
- Code word of 88 bits.

b) and c) are transmitted three times as in Fig. 3.



920057 - 13

The code word in c) is sub-divided further as follows.

SSC number	1	
Traffic channel code	7	
First call code	24	
Command code	4	
Reserved	2	
Code word counter	2	
Manufacturer's code	8	
Second call code	24	
Cyclic redundancy check	16	72 bits

The 16 check bits are generated from the 72 other bits by a (88, 72) cyclic code which has as its generator polynomial

$$x^{16} + x^{14} + x^{12} + x^{11} + x^9 + x^8 + x^7 + x^4 + x + 1.$$

This should be a factor of  $(x^{88} + 1)$  as per the mathematical conditions for cyclic codes. Refer to Appendix 1 for the various factors and other information. The code is supposed to have a *Minimum Distance* of 6 which will permit detection of up to five errors per word. This is the minimum number if differences in any two code words of 88 bits and is explained further in Appendix 2. The encoding operation can be summarized in the following steps.

- Code word ( $d_{72} d_{71} d_{70} \dots d_3 d_2 d_1$ ) before the check bits are generated.
- Code word

88 87 86 ... 19 18 17	16 15 14 ... 3 2 1
$d_{72} d_{71} d_{70} \dots d_3 d_2 d_1$	* * * ... * * *
Data bits	Check bits

- Code word can be written as a polynomial over GF(2) as follows:  
 $d_{72} x^{87} + d_{71} x^{86} + \dots + d_3 x^{18} + d_2 x^{17} + d_1 x^{16}$   
with the check bits taken to be zero in each of the terms from  $x^{15}$  to  $x^0$ .
- Polynomial in 3) is divided by the generator polynomial and the remainder, which is a polynomial of degree 15 with terms from  $x^{15}$  down to  $x^0$ , is added back to the original polynomial in 3) to produce the new revised polynomial of the final code word. The \* in each location from 1 to 16 has now been replaced by a '1' or '0' as appropriate.
- The final check bit corresponding to the coefficient of  $x^0$  is inverted in order to give protection against misframing in the decoding operation.

The format for the ACK signal is exactly the same as for the SSC, but there are some variations. For example, the First Call Code for the SSC becomes the Second Call Code for the corresponding ACK signal.

#### 6. Speech codec

Each speech frame of 20 ms is encoded into 76 speech parameters and this in turn is processed as a block of 260 bits. It should be noted that these bits are not of equal value. However, there is no need to examine this point. The codec is similar to that for the GSM

(Groupe Special Mobile formed by CEPT in 1982 to write a Pan European Digital Cellular Telephone Standard).

The 34 significant bits, known as Class 1 bits, from the 260 bit block are expanded to 39 by the addition of five parity bits. A cyclic code with generator polynomial  $(x^5 + x^2 + 1)$  produces the additional bits. The procedure is exactly the same as in Section 5 with the exception that the block size is 39. The generator polynomial should be a factor of  $(x^{39} + 1)$  as per the mathematical requirements. Refer to Appendix 1 for the various factors and additional information. The check bits represent the lower powers of the new polynomial for  $x^4$  down to  $x^0$ .

4



The 39 bit block is again expanded to 43 by four tail bits that are set to '0'. The positions are shown in Fig. 4. This new 43-bit block is re-ordered by a permutation operation as follows:

- position  $(n) \Rightarrow$  position  $(17+n)$  for  $n = 1$  to  $5$ ;
- position  $(n) \Rightarrow$  position  $(n/2-2)$  for  $n = 6, 8, 10, 12 \dots 38$ ;
- position  $(n) \Rightarrow$  position  $[42-(n-1)/2]$  for  $n = 7, 9, 11 \dots 39$ .

The positions in the actual standard are numbered from 0 to 42 and 0 represents the least significant location. The data bits are given as  $d(0)$  to  $d(33)$  with  $d(33)$  corresponding to the term  $x^{38}$  of the polynomial. Refer to Appendix 3 for the complete table.

The 43-bit block is expanded to 86 with a convolutional code as follows:

43-bit block  $(d_{43} d_{42} d_{41} \dots d_3 d_2 d_1)$

86-bit block  $(b_{86} b_{85} b_{84} \dots b_3 b_2 b_1)$

$$b_{2n} = (d_n + d_{n-3} + d_{n-4}) \text{ mod } 2$$

$$b_{2n+1} = (d_n + d_{n-1} + d_{n-3} + d_{n-4}) \text{ mod } 2$$

for  $n = 1$  to  $43$  and  $d_m = 0$  for  $m \leq 0$ .

5

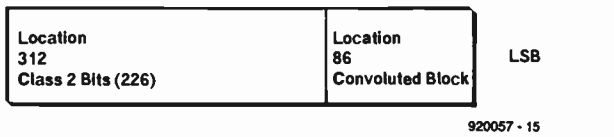

A new 312-bit block is formed by the 86 bits and the unused 226 bits, known as Class 2 bits, from the original block as in Fig. 5.

6

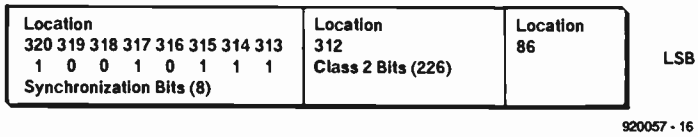

A new block of 320 bits is generated as in Fig. 6 by the addition of eight synchronization bits. The bits are re-ordered according to the equation

$$\text{position } n \Rightarrow \text{position } [16(k \text{ mod } 20) + \text{INTEGER}/(20 + 1)]$$

for  $k = 0$  to  $319$ .  $n$  refers to the position in the new block. The first bit ( $n = 1$ ) is transmitted first.

## 7. Summary

The overall situation can be summarized in the following points.

- (1) DSRR is more efficient in the use of spectrum since High Band and Low Band require a total of 4 MHz.
- (2) DSRR provides a higher level of confidentiality and protection for the average user. In business radio, each user is licensed for a specific channel that must be shared with other users. A channel could be unintentionally or deliberately blocked by an unmodulated carrier. The Co-channel Rejection Test in MPT 1326 (which was not in the previous specification MPT 1301) does reduce, but not eliminate, this problem. In addition, users can obtain low-cost scanning equipment to monitor messages to and from competitors. However, in DSRR, a user does not actually know the traffic channel that is chosen automatically by a scanning algorithm.
- (3) The DSRR Standard has no requirement for an encryption facility as in the GSM. The method of encryption for the GSM has not been made public, but is believed to be a stream cryptosystem. A pseudo-random binary sequence is generated by an arrangement of shift registers and applied to the sequence of data bits in an addition modulo 2 operation. For the DSRR, there is no reason that an encryption device, such as a scrambler, cannot be added, but this is not required to meet the standard.
- (4) DSRR has scope for further development and expansion. In business radio, a reduction in the channel spacing to  $6\frac{1}{4}$  kHz would provide more channels, but would not be considered an improvement.
- (5) The encoding operation for data other than voice transmission is left to the manufacturer. The decoding operation for control signals, voice and data is also left to the manufacturers.

## Appendix 1

The following factors were obtained using MATHEMATICA by Stephen Wolfram.

$$(x^{88} + 1) = (x + 1)^8 (x^{10} + x^9 + x^8 + x^7 + x^6 + x^5 + x^4 + x^3 + x^2 + x + 1)^8.$$

$$(x^{16} + x^{14} + x^{12} + x^{11} + x^9 + x^8 + x^7 + x^4 + x + 1) = (x + 1)^2 (x^7 + x^6 + x^3 + x + 1) (x^7 + x^6 + x^5 + x^4 + x^3 + x^2 + 1).$$

$$(x^{39} + 1) = (x + 1) (x^2 + x + 1) (x^{12} + x^{10} + x^9 + x^8 + x^7 + x^3 + x^2 + x + 1) (x^{12} + x^{11} + x^{10} + x^9 + x^5 + x^4 + x^3 + x^2 + 1) (x^{12} + x^{11} + x^{10} + x^9 + x^8 + x^7 + x^6 + x^5 + x^4 + x^3 + x^2 + x + 1).$$

$(x^5 + x^2 + 1)$  has no real factors.

The interim standard does not include an analysis of the generator polynomials and, consequently, the choice of the factors in each of the two cases is not known.

## Appendix 2.

Consider a simple 3-bit word that has an additional bit for even parity. Any two code words differ in at least one position in order to have distinct code word. When the parity bit on the right in the table is included, the minimum variation becomes 2. To correct a single error per word, the minimum variation would have to be 3.

0 0 0 0
0 0 1 1
0 1 0 1
0 1 1 0
1 0 0 1
1 0 1 0
1 1 0 0
1 1 1 1

This is known as the *Minimum Distance*. A typical example is the (7, 4) Hamming Code, which has four data and three check bits. A code of Minimum Distance 5 would be able to detect up to four errors per word or be capable of correcting up to two errors per word.

## Appendix 3.

## Permutation 1

Position	New position	Notation in DSRR Standard
1	18	0 p(0) 17
2	19	1 p(1) 18
3	20	2 p(2) 19
4	21	3 p(3) 20
5	22	4 p(4) 21
6	1	5 d(0) 0
7	39	6 d(1) 38
8	2	7 d(2) 1
9	38	8 d(3) 37
10	3	9 d(4) 2
11	37	10 d(5) 36
12	4	11 d(6) 3
13	36	12 d(7) 35
14	5	13 d(8) 4
15	35	14 d(9) 34
16	6	15 d(10) 5
17	34	16 d(11) 33
18	7	17 d(12) 6
19	33	18 d(13) 32
20	8	19 d(14) 7
21	32	20 d(15) 31
22	9	21 d(16) 8
23	31	22 d(17) 30
24	10	23 d(18) 9
25	30	24 d(19) 29
26	11	25 d(20) 10
27	29	26 d(21) 28
28	12	27 d(22) 11
29	28	28 d(23) 27
30	13	29 d(24) 12
31	27	30 d(25) 26
32	14	31 d(26) 13
33	26	32 d(27) 25
34	15	33 d(28) 14
35	25	34 d(29) 24
36	16	35 d(30) 15
37	24	36 d(31) 23
38	17	37 d(32) 16
39	23	38 d(33) 22
40	40	39 )
41	41	40 ) tail bits set to '0'
42	42	41 )
43	43	42 )

## Appendix 4.

## Permutation 2

Position	k	16(k mod 20)	Integer (k/20)	New position (n)
1	0	0	0	1
2	1	16	0	17
3	2	32	0	33
...	...	...	...	...
20	19	304	0	305
21	20	0	1	2
22	21	16	1	18
...	...	...	...	...
40	39	304	1	306
41	40	0	2	3
42	41	16	2	19
...	...	...	...	...
319	318	288	15	304
320	319	304	15	320

## Appendix 5.

## Radio frequency characteristics

## Transmitter

Frequency error	±2.5 kHz (maximum)
Carrier power	4 watts (maximum)
Adjacent channel power	≥70 dB below carrier power or 0.2 μW (maximum)
Spurious emissions	0.25 μW (maximum) 2 nW (maximum) in standby mode
Intermodulation attenuation	≥40 dB for any component

## Receiver

Sensitivity	6 dB μV e.m.f. (maximum) for a bit error rate of 10 <sup>-2</sup>
Co-channel rejection	-18 dB (minimum)
Adjacent channel selectivity	50 dB (minimum)
Intermodulation response	55 dB (minimum)
Spurious response rejection	60 dB (minimum)
Blocking	84 dB (minimum)
Spurious radiations	2 nW (maximum)

For the actual methods of measurement, the reader should consult the standard.

## PC BOARDS

• 24 hr. d.s./72 hr. m.l.  
• Prototype to Production  
FR-4, Plated-Thru Teflon, Polyimide  
UL Recognized



I.M.P.A.C.®



Call us for an instant quote  
24-hr. modem for easy transfer of  
Drill & CAD files.  
Free Tooling On First Order!  
Superior Quality at Competitive Prices!

## CAPITAL ELECTRO-CIRCUITS



7845-J Airpark Road  
Gaithersburg, MD 20879  
(301) 977-0303  
Fax: (301) 990-6715

HEAR EVERY SOUND  
OVER 1 MILE AWAY!

Simply attach the VT-75 microtransmitter to any 9V to 12V battery and you can hear every sound in an entire house over 1 mile away! Super-sensitive circuit on a single chip even picks up footsteps from across a large room. Tunable from 80 to 130 MHz.

Hear everything on any FM radio or wideband scanner tuned to the "secret" frequency you select. Unlimited uses for security, baby monitor, remote mic, etc. **Not a toy.** The VT-75 meets many U.S. Gov't Military Specs and with 100mW RF output, it is the smallest, most powerful miniature transmitter you can buy. Easily assembled even by a youngster in only 5 minutes and performs so well that it is the only miniature transmitter available *anywhere* that comes with a **full unconditional moneyback guarantee!** Complete kit includes VT-75 microtransmitter chip, miniature microphone, 9V battery connector and instructions - \$49.95 + \$1.50 S&H or save- buy 2 for \$45.00 each with free S&H! Call toll free or send money order, Visa, or MC acc't number for immediate shipping by U.S. Mail. COD's add \$4. Checks allow 21 days.

DECO  
INDUSTRIES®

BOX 607  
BEDFORD HILLS, NY  
10507

1-800-759-5553 (U.S. ONLY) ALL OTHER 914-232-3878

# FM TUNER

## PART 3: SYNTHESIZER (CIRCUIT DESCRIPTION) AND POWER SUPPLY (CONSTRUCTION)

The greater part of this month's instalment is devoted to the operation of the microprocessor-controlled synthesizer used to tune the RF board, and to program and memorize station presets.

When it comes to designing a tuning system for a high-quality FM receiver, we are faced with the choice between two evils: synthesizer tuning or variable capacitor tuning. The first is for ever and a day tied up with the problem of digital noise, the second with the problem of component availability, complex adjustment and repeatability. Bear in mind that a single tuning capacitor will not do here; what we require is a type with, say, six synchronized sections. Moreover, implementing a station preset facility on a tuner with a multi-section synchronized tuning capacitor is something that (we fear) is best left to instrument engineers. Also, most of you will not like the noise such a preset produces when a station is selected: it rather throws up memories of radios and TV sets used in the sixties and early seventies.

So, a synthesizer it will be. Although this does require special integrated circuits, these are by no means as costly and difficult to obtain as a six-way synchronized tuning capacitor. Since the tuner module used on the RF board is tuned by variable capacitance diodes (varicaps), there are no capacitors or

inductors to adjust. What's more, the synthesizer concept proposed here can work without any adjustment whatsoever. As to tuning noise and phase jitter, this will not pose limitations in modern synthesizer concepts, by virtue of the high working frequency of today's synthesizer ICs, and the use of high-performance phase detectors.

A possibly more serious problem, particularly in home-made receivers, is formed by the noise generated by the digital components in a synthesizer. Given the fact that the digital noise level is determined to a large extent by the number and length of printed-circuit board tracks, the advantages of a microcontroller (with on-chip ROM, RAM

and interfaces) over a system with external (E)PROM and peripheral ICs are fairly obvious. The only problem with mask-programmed microcontrollers is that they are produced in large quantities only. Hence, an alternative is used here in the form of a 80C32 microcontroller combined with an external EPROM that contains the control software. This has two advantages: first, the 80C32 is a low-power, inexpensive, and easily programmable device (witness our assembler course). Second, the external EPROM allows you to make changes to the control software should you so desire.

This leaves us with the problem of digital noise generated by the synthesizer. Unfortunately, such noise is hard to suppress completely, even when all the rules of RF screening are strictly observed. The solution to the problem is fairly drastic: switch off the source of the interference, i.e., the microcontroller, when it is not needed. This can be done with impunity because the microcontroller is active for very short periods as it changes or stores frequencies. During normal reception, the microcontroller is switched to the 'sleep' state, which also disables its clock oscillator.

### Functions

Although a single-chip solution is not feasible because of the above aspects, the circuit of the synthesizer (Fig. 11) is fairly simple. The main components of the synthesizer are a control loop amplifier (opamp IC412, a type TL082), a prescaler (IC410, a Type SP8795), and a synthesizer proper (IC409, a Type NJ8821). All other ICs in the circuit form part

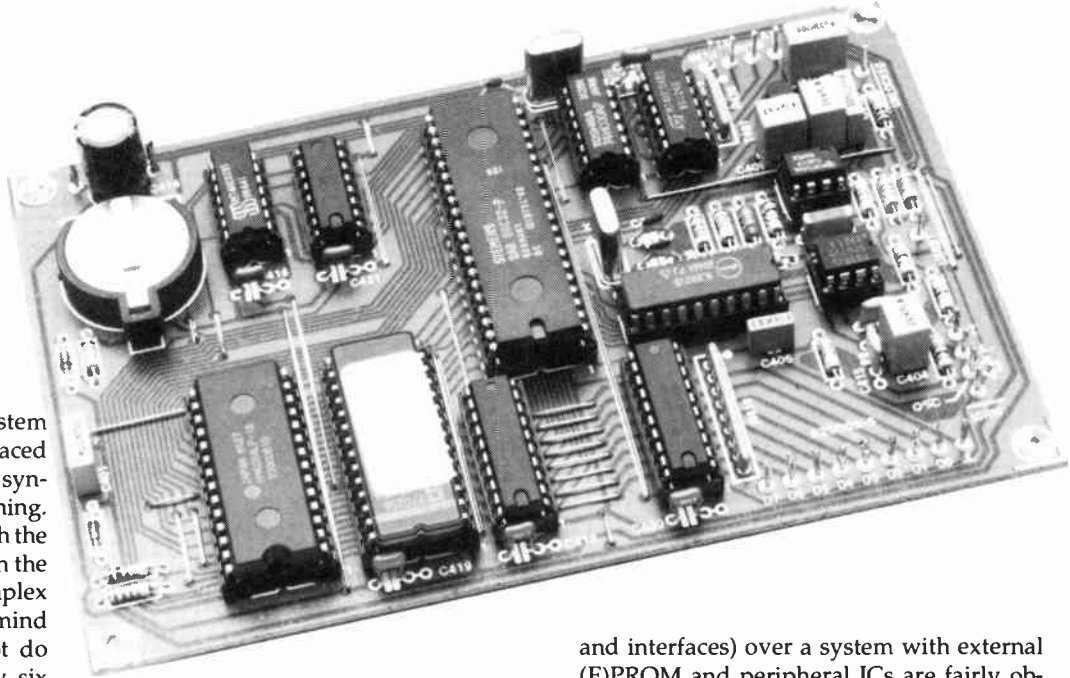



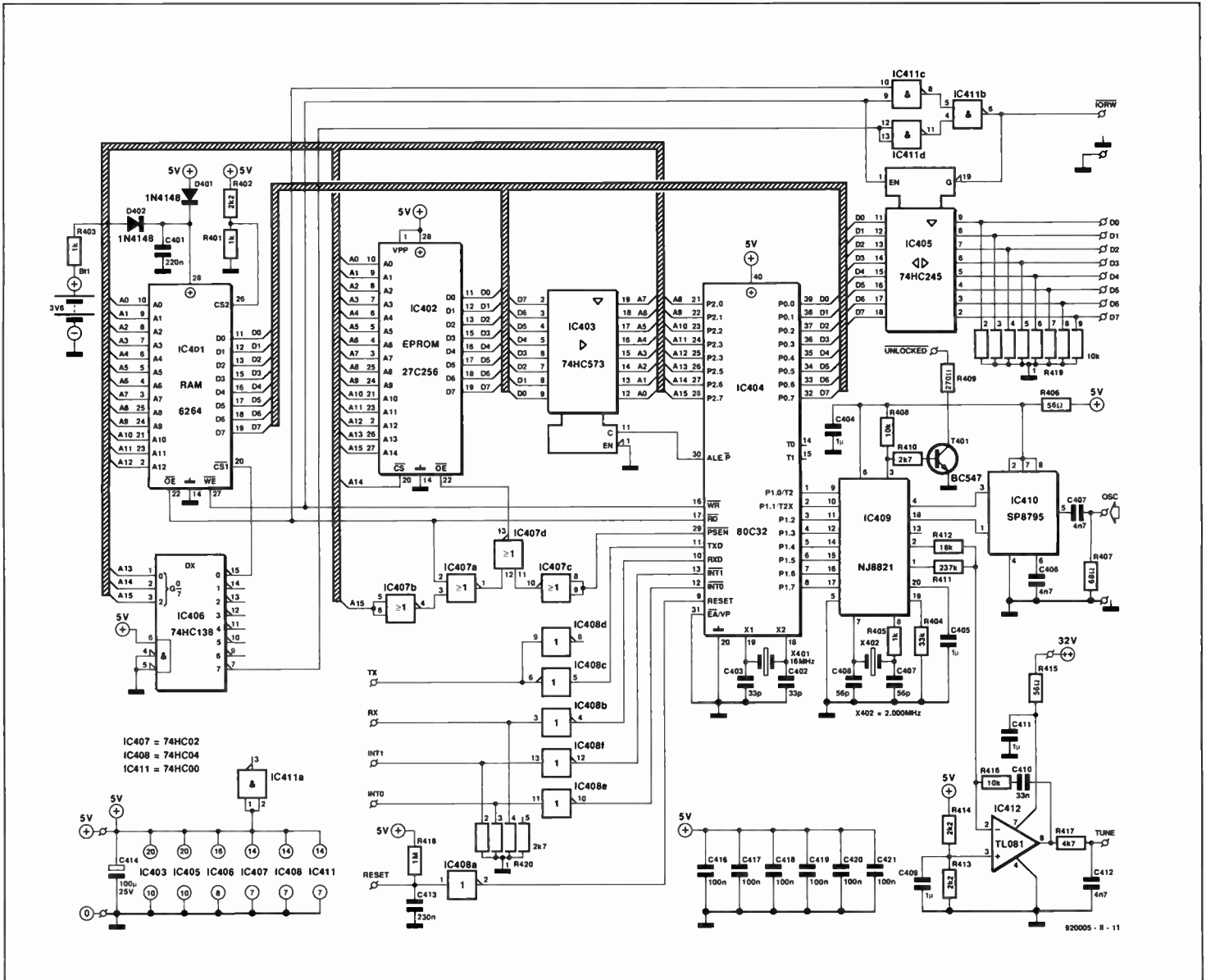

Fig. 11. Circuit diagram of the synthesizer board. The 'brains' of the receiver are formed by a 80C32-based microcontroller circuit.

of the microcontroller system, and serve to control the synthesizer, which offers a microcontroller interface via its pins 9 to 17. These pins convey the tuning frequency from the microcontroller to the synthesizer. This information is presented in binary form as eight datawords of four bits each. The function of the microcontroller is to gather all the data required to build these datawords, and also to store and display them.

One source for the tuning data gathered by the microcontroller is a 15-key keypad, which will be described in next month's installment. This keyboard is located on the single-sided 'controls' PCB, and is constantly scanned for activity. It has 10 numeric keys for direct entry of a frequency or a station preset number, as well as ENTER, STORE and EXECUTE keys to enter, store and call up station frequencies. The other two keys, UP and DOWN, allow the receiver to be tuned up or down in 50-kHz steps.

The station frequency and preset number are indicated on a large, bright, 7-digit, LED display that is also accommodated on the 'controls' board.

A single bisectional 8-bit port is used to scan the keys and drive the displays. This

function requires an output current of 5 mA to be supplied at the logic 'high' as well as the logic 'low' level. Figure 11 shows that this port is formed by a 74HC245 (IC405). The address decoder of the display is actuated by the IORW signal. The display driving function has priority over the keyboard scanning function. Hence, if a key is pressed while the display is being updated, the 1-kΩ resistors in the keyboard matrix function as pull-up resistors only.

### Enter the 80C32 SBC

The microcontroller system used here is basically a stripped-down version of the 80C32 single-board computer (Ref. 1) used for writing and testing the control software for the present FM tuner. The 80C32 is the ROM-less, CMOS, version of the 8052. One reason for using the 80C32 here is that it can be switched to a 'sleep' mode, which is necessary to prevent digital noise in the RF sections of the receiver. The external EPROM, IC402, is a 32-KByte type divided into two 16-KByte memory areas starting at 0000H and 8000H.

The static CMOS RAM, IC401, is a Type 6264LP-2. When the receiver is switched off,

the RAM is powered by a lithium battery, which ensures that stored frequencies remain intact for at least 10 years. The software allows you to enter up to 99 presets, which is more than the maximum number of stations that can be contained by the entire FM band, even if a 250-kHz raster were used.

To make sure that the RAM is timely disabled when the supply voltage drops, RAM input CS2 (pin 26) is held at a slightly lower voltage with the aid of resistors R401 and R402. This prevents the microcontroller writing random data into the RAM when the receiver is switched off.

IC406 decodes the address ranges for the RAM, and address 0E00H for the I/O port, IC405. The NOR gates contained in IC407 form the address decoder for the EPROM. Circuit IC403 demultiplexes the lower 8 address bits and the datalines.

The inverters contained in IC408 allow a serial interface (RS232) to be connected, if this can work with a voltage swing of 5 V. The interface may be modified as follows when it is to be connected to a device that works with ±12 V swings: fit a 3.3-kΩ resistor in series with the Rx line. Together with the 2.7-kΩ resistor in array R420, this forms a

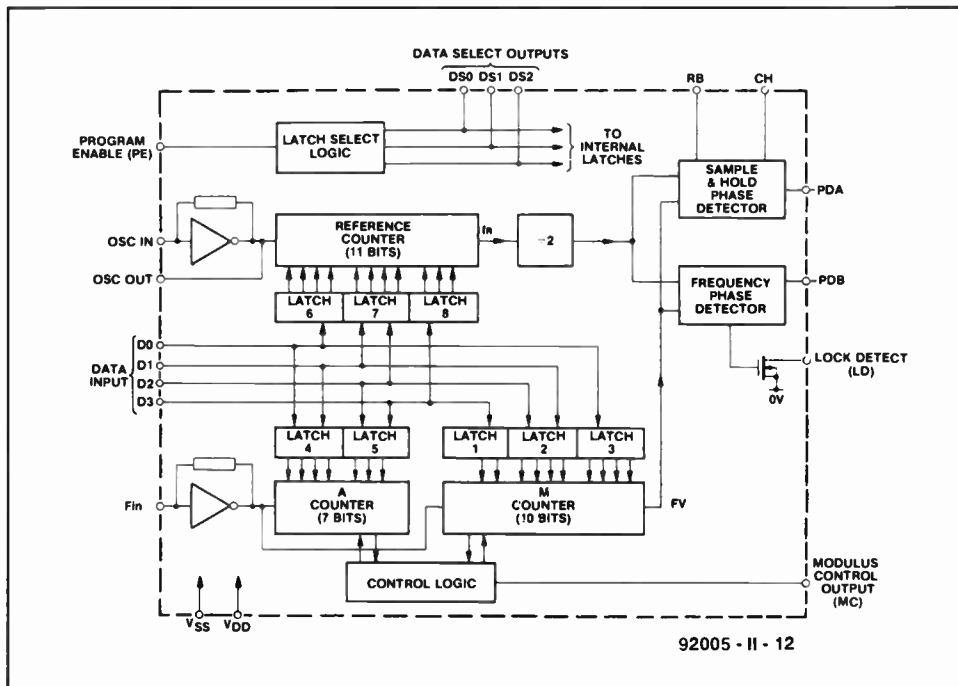

Fig. 12. Internal architecture of the NJ8821 synthesizer IC (courtesy Plessey Semiconductors).

voltage divider that changes +12 V to +5 V. To convert the negative (-12 V) level at the Rx input into (approximately) 0 V, connect a diode Type 1N4148 between the Rx line and ground. The cathode goes to Rx, the anode to ground.

The two interrupt inputs, INT0 and INT1, respond to logic 'high' signals, provided, of course, that interrupts are enabled (in software).

The processor is reset by applying a logic 'low' level to the RESET input of the synthesizer board. R-C network R418-C413 supplies the reset pulse at power-on.

The control software for the synthesizer is all machine code, and fast enough to scan the keyboard as a part of the normal program. Hence, an interrupt request is not required when a key is pressed.

### The synthesizer

The heart of the synthesizer is formed by the NJ8821, a CMOS IC from Plessey. This IC is

marked by a high-performance, high-frequency, phase detector, and low current consumption (3.5 mA typ.). In a PLL circuit, this IC allows excellent phase stability and low noise to be achieved.

Each PLL-based synthesizer consists of four basic components, whose function and materialization are discussed below.

#### Voltage-controlled oscillator (VCO)

This is contained in the FD12 tuner module on the RF board. Its output frequency is supplied to the prescaler in the synthesizer via the UOSC socket on the module.

#### Reference oscillator

As shown in Fig. 2, this is contained in the NJ8821. The oscillator works with an external 2-MHz quartz crystal, which is connected to the OSC IN and OSC OUT pins of the IC. The crystal operates in parallel-resonance mode, and is 'flanked' by the usual parallel capacitors to ground.

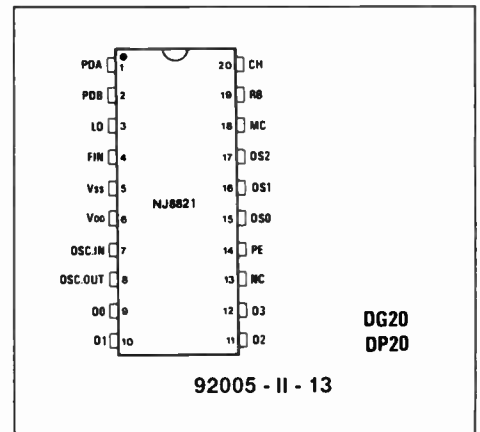

Fig. 13. NJ8821 pinning (courtesy Plessey Semiconductors).

#### Reference counter and prescaler

The reference frequency,  $f_R$ , is derived from the reference oscillator frequency by a programmable 11-bit counter (divider), whose divisor can be set between 6 and 4,094 in steps of 2. A binary (+2) scaler is connected to the output of the reference counter to achieve an output signal with a 50% mark/space ratio. This means that the total divisor is two times the programmed divisor.

The oscillator signal, which is to be compared to the reference signal, is supplied by the VCO in the FD12 tuner, and fed to the synthesizer input, FIN (pin 4), via a Plessey Type SP8795 prescaler. The prescaler output is divided by two programmable dividers in the NJ8821: a 7-bit divider, 'A', and a 10-bit divider, 'M'. Both are connected to the prescaler via the 'MC' signal at pin 18. The 'MC' signal is low at the start of a counter cycle, and remains low until counter 'A' has completed one cycle. Next, MC goes high, and remains high until counter 'M' has completed its cycle. Next, both counters are reset. The resulting divide ratio is

$$M \times N + A$$

where  $N$  and  $N + 1$  are the divisors of the prescaler controlled by the 'MC' signal.

The divisors that can be programmed are 0 to 127 for counter 'A', and 3 to 1,023 for counter 'M'. For this so-called modulo-2 counting principle to operate correctly, divisor  $M$  must always be greater than divisor  $A$ .

Port 1 of the 80C32 is used to program the

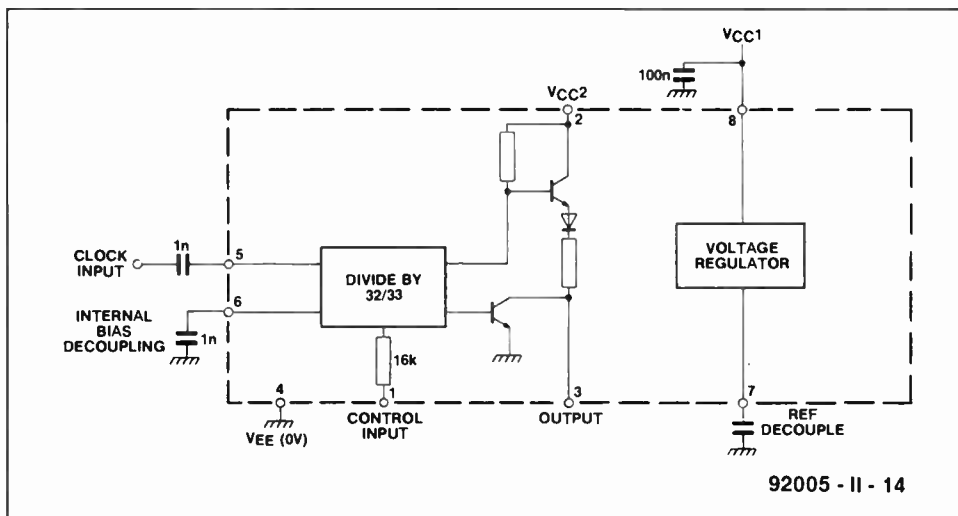

Fig. 14. Block diagram of the SP8795 prescaler (courtesy Plessey Semiconductors). The control input of the IC allows the divisor to be switched between 32 and 33.

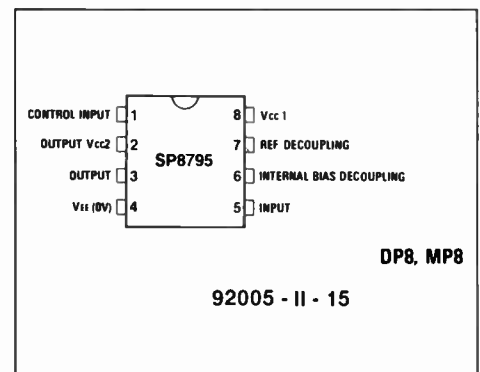

Fig. 15. SP8795 pinning (courtesy Plessey Semiconductors).

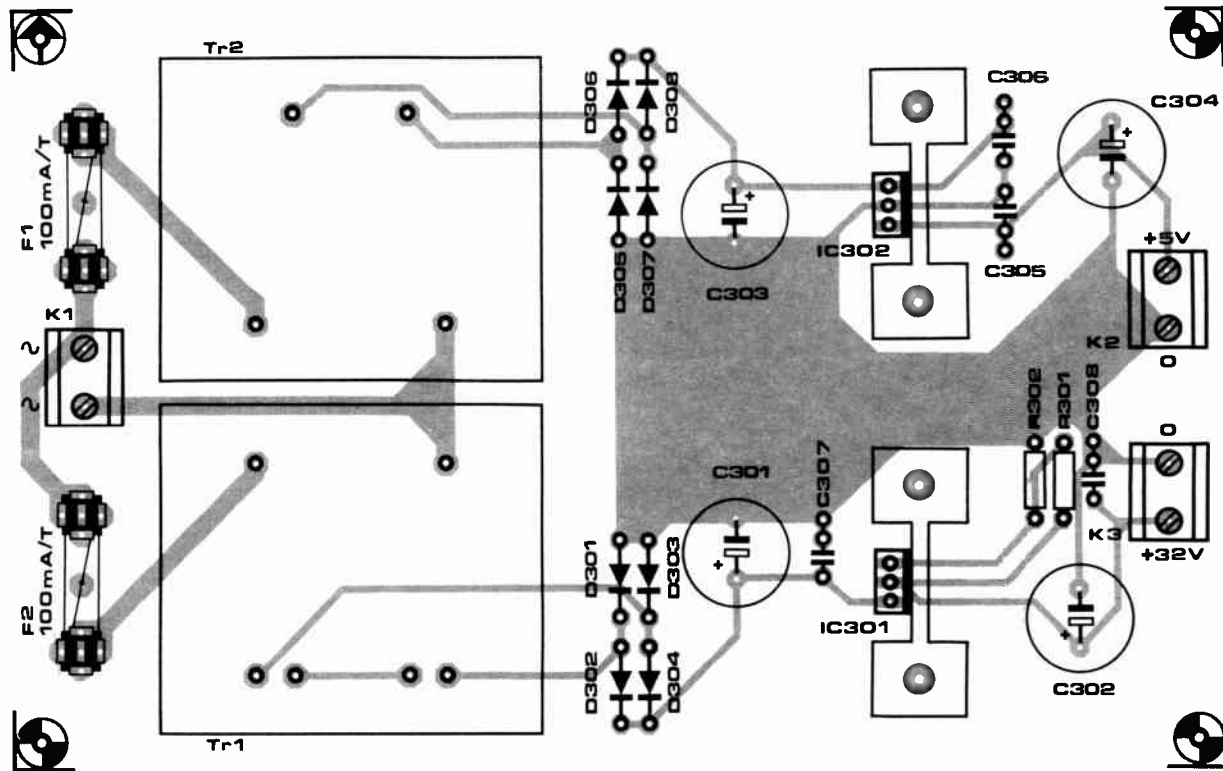
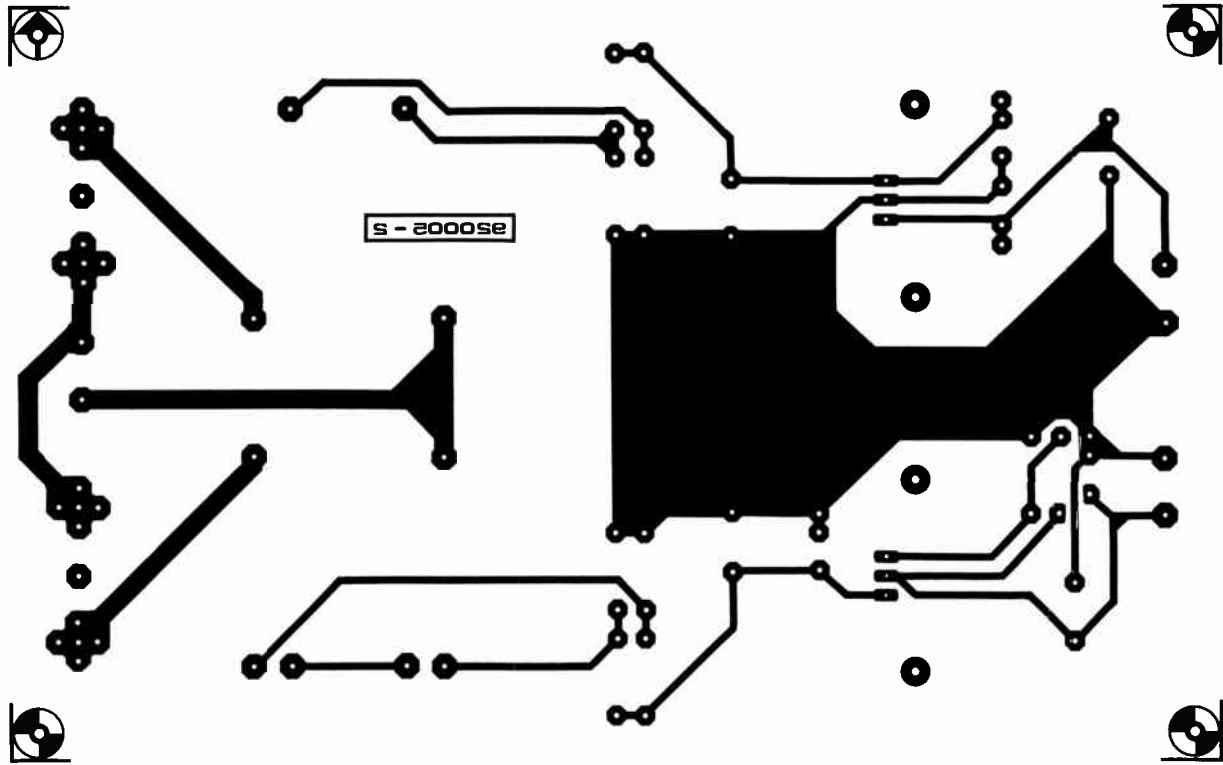

Fig. 16. Track layout (mirror image) and component overlay of the PCB for the power supply unit.

## COMPONENTS LIST

## Resistors:

1	150k $\Omega$ 1%	R301
1	3k $\Omega$ 5% 1%	R302

## Capacitors:

2	470 $\mu$ F 63V radial	C301;C302
2	1000 $\mu$ F 16V radial	C303;C304
3	220nF	C305;C307;C308

## Semiconductors:

8	1N4001	D301-D308
1	LM317	IC301
1	7805	IC302

## Miscellaneous:

1	Mains transformer 2 $\times$ 7.5V @ 18VA, e.g., Block VR7,5/2/18	Tr1
1	Mains transformer 1 $\times$ 7.5V @ 8VA, e.g., Block VR7,5/1/8	Tr2
3	3-way PCB terminal block	K1;K2;K3
2	Fuse 100mA	F1;F2
2	Fuseholder for PCB mounting, with plastic cap	
2	Heat-sink SK104 (Fischer)	
1	Printed circuit board	920005-2

such that the divider output frequency,  $f_v$ , equals the reference frequency,  $f_R/2$  (behind the binary scaler), given the desired oscillator frequency after prescaling at pin FIN.

## Phase comparator

The  $f_R/2$  and  $f_v$  signals are compared in a phase comparator, which is actually a two-stage phase detector. The first stage is a digital phase/frequency detector, which enables the PLL to lock fast by supplying a 'coarse' error signal that can signal one of three conditions: output PDB supplies positive-going pulses when the tuner oscillator frequency is too high ( $f_v > f_R/2$ ); negative-going pulses when the tuner oscillator frequency is too low ( $f_v < f_R/2$ ); or no signal (PDB switched to high impedance) when the two frequencies are equal or sufficiently close. In the latter case, the MOSFET at the LOCK output (pin 3) starts to conduct. Consequently, transistor T1 conducts also, and causes a LED to light, indicating that the PLL is locked. The inverted 'lock' signal may also be used to mute the receiver when the PLL is out of lock.

As soon as the PDB output of the digital phase comparator is at high impedance, an analogue sample-and-hold starts to work on the fine tuning. Its output signal, PDA (pin 1) is at about half the supply voltage when the PLL is locked. Starting at that level, the voltage rises when the phase of  $f_R/2$  lags that of  $f_v$ , and drops when  $f_v$  lags  $f_R/2$ . The linear range of the output voltage is determined by an external resistor, R404, connected to the RB terminal (pin 19). The RB output controls the amplification of the sample-and-hold comparator. The value of R404 is determined by the reference frequency used. The 'hold' capacitor is connected between the 'CH' terminal (pin 20) and ground.

The output voltages of the two phase comparators are added by two resistors at the inverting input of the control loop amplifier, opamp IC412. The opamp is wired in a so-called pi-configuration, and its non-inverting input is held at a well-decoupled level of +2.5 V, i.e., half the supply voltage. The speed of the control loop and the suppression of high-frequency components in

the comparator output signals are determined by the time constant formed by the feedback circuit, and a passive low-pass filter, R417-C412, at the output of the opamp. The opamp output signal is the synthesizer-generated tuning voltage for the FD12 tuner module on the RF board.

## Prescaler

It will be recalled that the FD12 tuner module is basically a superheterodyne receiver, in which the local oscillator (= VCO) frequency is 10.7 MHz higher than the receive frequency. This means that the VCO frequency range must be 98.7 MHz to 118.7 MHz to cover the entire FM band (88 MHz to 108 MHz). However, the synthesizer IC can handle frequencies up to about 15 MHz only, whence the need for a prescaler that reduces the VCO frequency to under 10 MHz.

Figures 14 and 15 show the block diagram and the pinning respectively of the SP8795 prescaler, whose input frequency range extends from 20 MHz to about 225 MHz. This prescaler is marked by high sensitivity (200 mV<sub>pp</sub>) and low current consumption (approx. 5 mA). An on-board voltage regulator enables the IC to be used with supply voltages between 6.5 V and 9.5 V. Alternatively, 5-V operation is possible by not using the on-board regulator. This option is used in the present circuit: pins 7 and 8 are connected direct to the supply voltage (pin 2).

A special feature of the SP8795 when used in combination with the NJ8821 is the modulo-2 divider, which can switch between divisors  $N$  and  $N + 1$ , where  $N$  equals 32, and is selected by a logic 'high' level at pin 1. When a 'low' level is applied, the IC divides by 33. Here, this means that the frequency range of the synthesizer input signal is about 3 MHz to 3.7 MHz.

## Power supply board

The power supply circuit discussed last month (Fig. 10) is constructed on the printed circuit board shown in Fig. 16. The fuses on this board are inserted into the mains lines, which requires plastic caps to be fitted on the holders. A double-pole mains on/off switch is connected between the mains inputs of the PSU board and the appliance socket on the rear panel of the tuner case.

To prevent confusion, note again that the +32-V output voltage at connector K3 of the PSU unit powers the entire RF board. This means that it is not required to connect separate wires from the PSU to the '+' and 'UABST' (tuning voltage) pins of the RF board. Instead, interconnect these two pins at the RF board, and run a single wire from K3 on the PSU board to the '+' pin on the RF board. The 5-V output of the PSU board is used to power the synthesizer circuit. □

*Next month we will tackle the construction of the synthesizer, and discuss the operation of the 'controls' board.*

counters. As shown in Fig. 12, a 4-bit dataword is applied to inputs D0 to D3 (pins 9 to 12 of the NJ8821). A dataword is copied into a counter latch when a logic 'high' strobe pulse is applied to the PE (program enable) input. The three data select inputs DS0, DS1 and DS2 are used to select the latch to which the dataword is written (DS0, DS1 and DS2 are erroneously marked as outputs in the block diagram, Fig. 12, which is reproduced here from an original supplied by Plessey).

To program the synthesizer, eight latches must be loaded successively with a 4-bit dataword. The transfer of all data from a latch to the associated counter occurs simultaneously with the loading of latch 1. This means that latch 1 is addressed as the last one when a different counter state (= tuning frequency) is required.

The counters are always programmed



# GAL PROGRAMMER



'Grab yer gal and hit the floor' is sure to take on a completely new meaning before long. Now while gals in the more traditional sense of the word are often pretty difficult to control, let alone to be forced into 'tailor-made' behaviour (which adds considerably to their charm), the electronic versions we are dealing with here (identified by three capital letters, GAL) are admittedly less exciting, but much more easy-going. The GAL programmer described in this article offers everything needed to burn complex logic functions into today's most popular GALs. The software used to control the programmer is menu-driven, and can be run on all IBM PCs and compatibles.

## Design by M. Nosswitz

**F**OLLOWING last month's introductory article on features and functions of GALs (general array logic) we now take more a practical look at things with the description of a powerful, low-cost, GAL programmer for use with PCs.

The advantages of GALs over discrete logic circuits are significant. At reasonable cost, you obtain a piece of programmable logic that can be erased, too! Apart from their remarkable flexibility, GALs offer the possibility to 'stamp' them electronically with an identification code, as well as to protect them from being read out (and copied). Further, GALs are pretty fast, A-versions achieving propagation delays of the order of 10 ns only.

The operation of the programmer described here is strictly controlled via the Centronics port of an MS-DOS compatible computer running the software developed for the programmer. The control software was developed with the aid of Turbo Pascal 6.0, and is capable of programming GAL Types 16V8, 20V8, 16V8A and 20V8A. The control software is available ready-programmed, and comes on a diskette supplied through the Readers Services.

The programmer and the computer communicate via the Centronics port, using a serial format to exchange data and commands. Remarkably, only five lines are required to handle all functions. At the programmer side, a shift register is used to convert the serial data into parallel. Despite this converter, the total circuit of the programmer is not too complex.

## MAIN SPECIFICATIONS

### Software:

- Programs 16V8, 20V8, 16V8A, 20V8A
- Protection against wrong GAL selection
- Simple to control
- Menu driven
- For XT/AT and compatible PCs
- Reads and writes normalized JEDEC-Files
- In colour
- Integrated line editor
- Hard copy of cell matrix on printer
- Configuration file to adapt software to personal needs
- Opal Junior™ EQN-to-JEDEC converter and GAL programming utilities supplied free of charge with control software ESS1701

### Hardware:

- Eurocard PCB 160 × 100 mm
- Communication via 5 lines on Centronics port
- Internal power supply
- Only one ZIF socket required
- Based on standard components only

### GAL:

- Electrically erasable and reprogrammable logic
- Maximum flexibility for complex logic design
- Read protection
- Electronic signature
- Speed: 10ns maximum propagation delay (A-Types)
- Inexpensive

## The hardware

Just like almost any other electrically programmable component, a GAL needs a programming voltage that is higher than the normal supply voltage. As shown in the circuit diagram (Fig. 1), this has been taken into account in the design of the power supply of the programmer, which caters for the normal board supply voltage of 5 V as well for an auxiliary voltage of 16.5 V. Preset P1 serves to adjust the latter voltage accurately. Fortu-

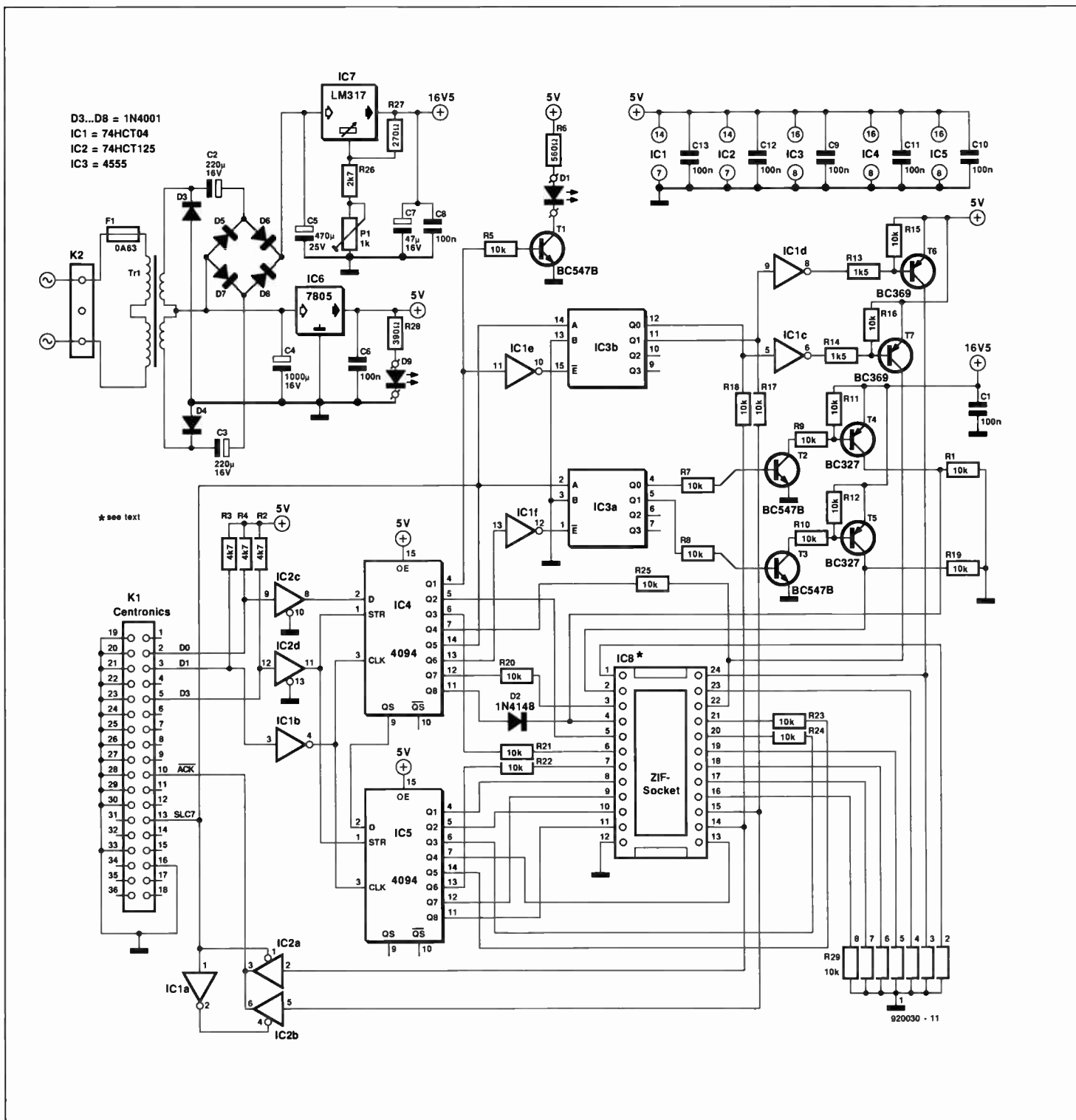

Fig. 1. Circuit diagram of the GAL programmer. The programmer communicates with the computer via the Centronics port using a serial protocol.

nately, the current consumption of the programmer is low, so that a small (4-VA) mains transformer may be used, while the two regulators can make do without heat-sinks.

The control signals needed for shift registers IC4 and IC5 are supplied via three of the eight data lines on the Centronics interface. Dataline D0 carries the serial data, while D1 and D3 supply the shift register clock and strobe signal respectively. Pull-up resistors R2, R3 and R4 ensure correct signal levels during the data exchange. The two shift registers are connected in series via the serial output QS (pin 9 of IC4) and the data input (pin 2 of IC5). The three-state outputs of IC4 and IC5 are always active because the OE

(output enable) inputs are tied to +5 V. The 16 databits at the parallel outputs Q0-Q8 of IC4 and IC5 determine the operation of the rest of the circuit.

One half of a dual 2-of-4 decoder, IC3b, switches the supply voltage via transistors T6 and T7. The other half, IC3a, controls the presence of the programming voltage at the respective pins of the GAL socket, via transistor pairs T2-T4 and T3-T5. This is possible only if the decoder outputs have been enabled beforehand by a low level at the ENABLE (E) inputs.

Resistors R20-R25 reduce the short-circuit currents at the register and GAL outputs to safe values when these are switched to the

read mode. R1, R19 and R29 are the pull-down resistors needed for the programming mode. Diode D2 protects output Q8 of IC4 against the programming voltage.

The computer can read the GAL data matrix via Centronics handshaking line ACK. This requires a selection operation via the select (SLCT) signal. By virtue of SLCT, the software is capable of checking if the programmer hardware is connected, and if a GAL is fitted. If desired, this function may be switched off by modifying the file GAL.CFG (Fig. 6). If hardware checking is not required, the SLCT line may be omitted.

The GAL is fitted into a zero-insertion force (ZIF) socket. Finally, LED D9 lights



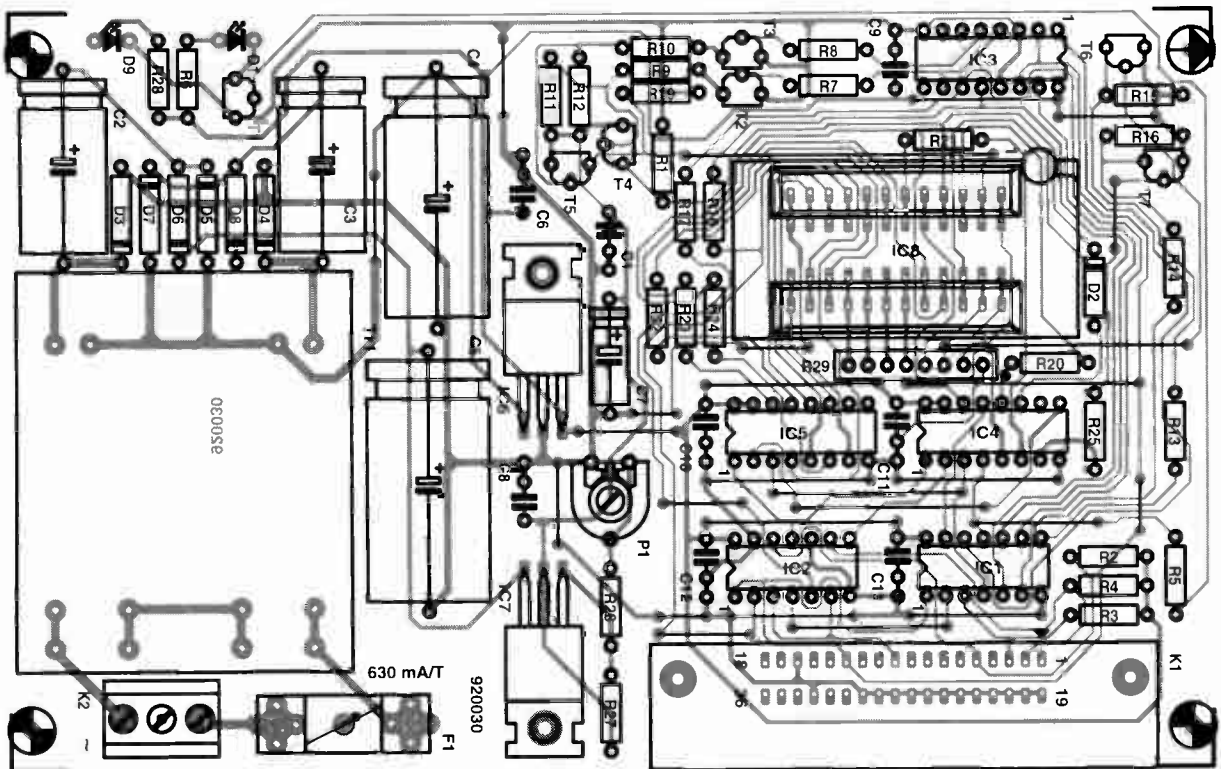
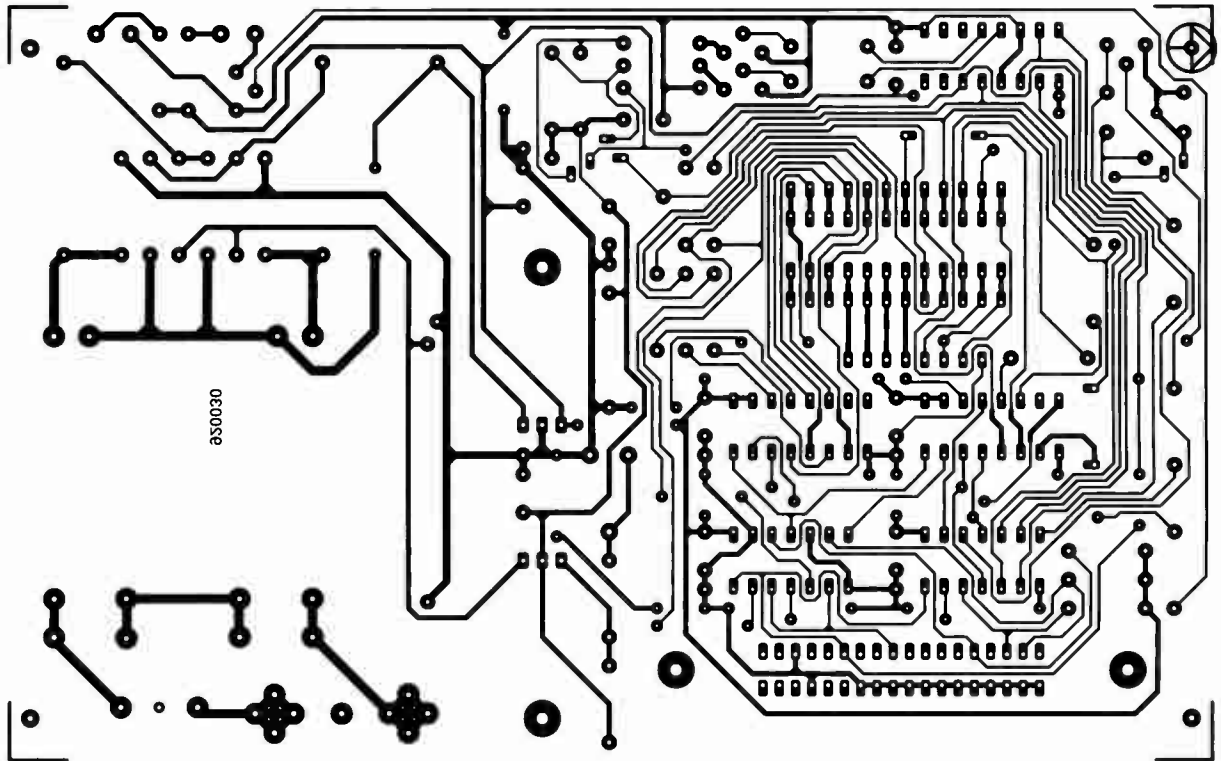
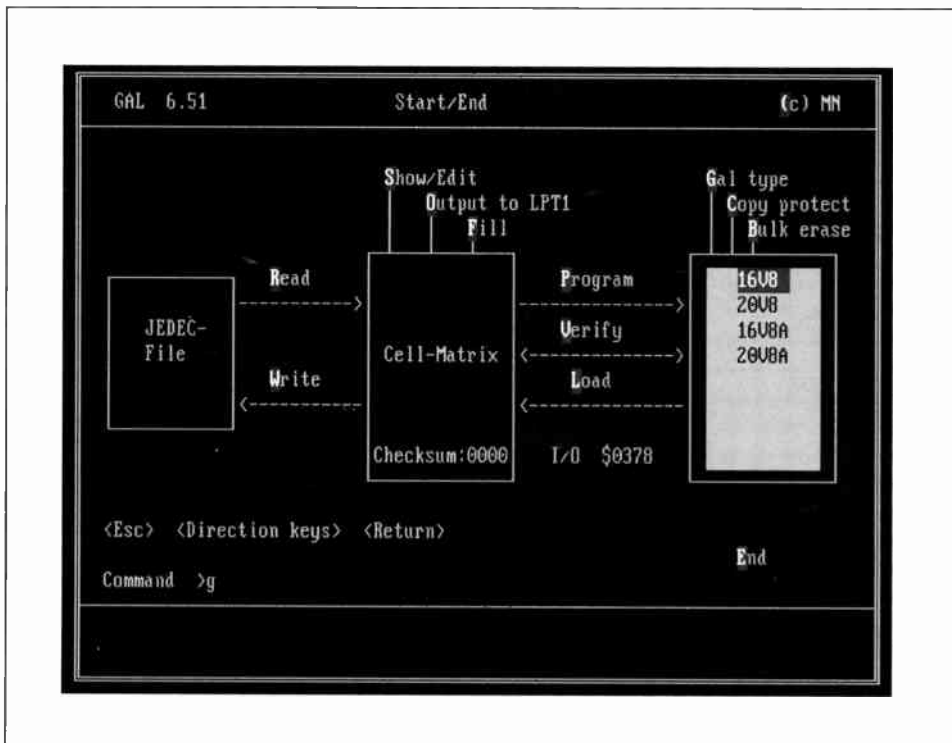

Fig. 2. Track layout (mirror image) and component mounting plan of the single-sided PCB for the GAL programmer.



when the programmer is active, and D1 when the GAL receives its supply voltage. It is recommended to insert the GAL only when D1 is out.

## Software development for GALs

To begin with, use any ASCII-compatible word processor to produce an equations file that describes the desired function of the GAL. 'GALDEMO.EQN' (Fig. 3) contained on the disk supplied for this project is such a

file, and may serve as an example. Basically, variables are assigned to the inputs and outputs, and the logic function is described by a Boolean equation. If desired, an 8-bit identification code ('signature') can be burned into the chip.

Next, run a check on the program syntax. This requires an auxiliary program such as 'EQN2JED' included in the Opal Junior™ GAL programming software package from National Semiconductor (this package is supplied free of charge with your GAL programmer software, how's that?). When no errors are detected, EQN2JED generates the

documentation file GALDEMO1.DOC (Fig. 5), and the associated JEDEC file, GALDEMO1.JED (Fig. 4). The JEDEC file produced with the aid of EQN2JED contains all information on the cells contained in the GAL, and serves to actually program the device.

## The software

After starting the control program, GAL651AE.EXE, the screen shows the start and end indicators. Further, the screen graphics indicate three blocks: the JEDEC file, the matrix memory and the GAL's hardware environment. The command names are shown in between the blocks, and can be selected by typing the highlighted letter. Command abbreviations may also be used. An error 'beep' sounds when you enter a non-existing command.

The GAL TYPE command allows you to select the device type to be handled. This selection must be completed before the GAL is inserted into the ZIF socket on the programmer board. While executing the GAL commands, the software automatically checks if the right GAL type is being used.

The READ command is used to transfer the JEDEC file into the matrix memory. After entering '1' and a return, the listing is displayed of the JEDEC file in the selected sub-directory. Alternatively, you may enter the full path and file name. After requesting a file list (for instance, A:\*.\*) the screen shows all JEDEC files found. The desired file is selected by moving to it using the PageUp and PageDown keys and the arrow keys. The return key activates the selected command, which then operates on the selected file.

The use of the WRITE command is similar to that of the READ command described above. An 'overwrite?' alert is shown if you save a file under a name that is already in use in the selected (sub-) directory. All file names are automatically saved with the '.JED' extension appended.

Selecting PROGRAM from the menu

COMPONENTS LIST			
<b>Resistors:</b>			
19 10kΩ	R1;R5;R7-R12;	2 BC369	T6;T7
	R15-R25	1 74HCT04	IC1
3 4kΩ7	R2;R3;R4	1 74HCT125	IC2
1 560Ω	R6	1 4555	IC3
2 1kΩ5	R13;R14	2 4094	IC4;IC5
1 2kΩ7	R26	1 7805	IC6
1 270Ω	R27	1 LM317	IC7
1 390Ω	R28	1 24-way ZIF socket *	IC8
1 7-way 10kΩ SIL	R29	<b>Miscellaneous:</b>	
1 1kΩ preset H	P1	1 36-way Centronics socket for PCB mounting	K1
<b>Capacitors:</b>			
8 100nF	C1;C6;C8;C9-C13	1 3-way PCB terminal block	K2
2 220μF 16V	C2;C3	1 Mains transformer 2×6V @4VA, e.g., Monarch (Monarch) FTR46	Tr1
1 1000μF 16V	C4	1 Fuse 630mA slow, with PCB mount holder and cap	F1
1 470μF 25V	C5	1 Printed circuit board	920030
1 47μF 16V	C7	1 Control software package	ESS1701
<b>Semiconductors:</b>			
1 LED 3mm red	D1	* Aries Electronics. Distributor info from Aries Electronics (Europe), Unit 3, Furtho Court, Towcester Road, Old Stratford, Milton Keynes MK19 6AQ. Tel. (0908) 260007, Fax (0908) 260008.	
1 1N4148	D2		
6 1N4001	D3-D8		
1 LED 3mm green	D9		
3 BC547B	T1;T2;T3		
2 BC327	T4;T5		

```

title Basic gate
pattern GATES
revision A
author Nosswitz
Date 05.02.92

chip GATES GAL16V8

;pin 1 2 3 4 5 6 7 8 9 10
      C D F G M N P Q IX GND
;pin 11 12 13 14 15 16 17 18 19 20
      JX KX L RX O H E B A VCC

@UES MB123456

equations
  B = /A
  E = C * D
  H = F + G
  L = /IX + /JX + /KX
  O = /M * /N
  RX= P * /Q + /P * Q

; end of GATES

```

Fig. 3. Example of a GAL equation file.

```
GAL16V8
EQN2JED - Boolean Equations to JEDEC file assembler (Version V003)
Copyright (R) National Semiconductor Corporation 1990,1991
Assembled from "galdemol.eqn". Date: 2-19-92
title Basic gate
pattern GATES
revision A
author Nosswitz
Date 05.02.92
*
QF2194*QP20*F0*
L0256
11111101111111111111111111111111*
L0512
01011111111111111111111111111111*
L0768
11110111111111111111111111111111
11111110111111111111111111111111*
L1024
11111111111101110111111111111111*
L1280
11111111111111111111101110111111
11111111111111111111101101111111*
L1536
11111111111111111111111111111011
11111111111111111111111111111110
111111111111111111111111101111*
L2048
01111110*
L2056
0100110101000010001100010011001000110011001000011010100110110*
L2120
10000001*
L2128
00000000100000001000000011000000100000001100000000000000*
L2192
10*
C2B31*
0000
```

Fig. 4. JEDEC output file produced by the EQN2JED utility from National Semiconductor.

```
EQN2JED -- Boolean Logic to JEDEC
file assembler (Version 1.00)
Copyright (R) National Semiconductor
Corporation 1990
```

Document file for galdemol.txt  
Device: 16V8

Pin	Label	Type
1	C	com input
2	D	com input
3	F	com input
4	G	com input
5	M	com input
6	N	com input
7	P	com input
8	Q	com input
9	IX	com input
10	GND	ground pin
11	JX	com input
12	KX	com input
13	L	pos,com output
14	RX	pos,com output
15	O	pos,com output
16	H	pos,com output
17	E	pos,com output
18	B	pos,com output
19	A	com input
20	VCC	power pin

```
EQN2JED -- Boolean Logic to JEDEC
file assembler (Version 1.00)
Copyright (R) National Semiconductor
Corporation 1990
```

Chip diagram (DIP)

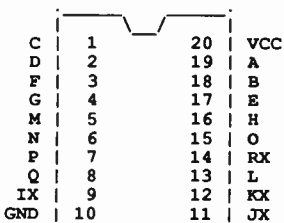

Fig. 5. Example of a documentation file produced by EQN2JED.

sets off a sequence of activities. First, a 'bulk erase' operation is performed. Next, the device is programmed. Finally, the contents of the GAL are verified against the program file. If an error is found, the relevant cell in the GAL is indicated, along with the relevant data in the GAL and in the file.

```
GAL.CFG
{licence number}
{user number}
$378 Address of Centronics port for GAL data exchange
2000 error display time in ms
2000 error beep frequency in Hz
75 beep length in ms
1 Check if GAL hardware accessible no=0 yes=1
0 Switch for general RESET (EPROM, PROM, GAL) no=0 yes=1
1 Basic GAL type selection 16V8=1, 20V8=2, 16V8A=3, 20V8A=4
1 Background colour: Text (blue)
7 Foreground colour: Text (bright grey)
5 Background colour: Error reports (magenta)
7 Foreground colour: Error reports (bright grey)
5 Background colour: Letters (magenta)
15 Foreground colour: Figures (white)
7 Background colour: Selection window (bright grey)
1 Foreground colour: Selection window (blue)
5 Background colour: Selection bar (magenta)
14 Foreground colour: Selection bar (yellow)
4 Background colour: Changed cells (red)
7 Foreground colour: Changed cells (bright grey)
12 Line distance to upper paper edge (printing)
12 Line distance between page 1 and page 2 (printing)
20 Empty lines after page 2 (printing)
8 Character distance from left-hand paper edge (printing)

Addresses of Centronics ports
LPT2: 278H
LPT1: 378H
LPT1: 3BCH (on Hercules-compatible card)
```

Fig. 6. The control program for the GAL programmer reads 25 parameters from a configuration file called GAL.CFG. This file can be produced or edited with any simple word processor, such as EDLIN or the one in PCTools. All 25 parameters must be present in the order shown here. The meaning of the values is apparent from the comment in each line.

The COPY PROTECT command may be used to actuate the copy protection ('security bit') in the GAL. When the security bit is set, it is impossible to read anything from the GAL except the identification code and the GAL configuration.

The BULK ERASE command may also be used on its own, i.e., not as part of a programming sequence, to clear the contents of a GAL. This obviates the need for an erase operation before programming.

OUTPUT TO LPT1: directs the matrix contents to a printer connected to the LPT1: output of the PC. Needless to say that hard copy of the matrix contents may be very useful for documentation purposes.

The SHOW/EDIT command allows you to examine, on the screen, the content of the selected location. If a specific cell is selected, the cursor starts to flash at this location. At the same time, the identification code, if given in the source code, is shown in hexadecimal as well as ASCII notation.

The F10 key takes you to the edit mode, which makes it possible to change the cell contents with the aid of the cursor keys. The 'Fill' function may be used to fill a block in the GAL with ones or zeroes.

Selecting the Program, Verify or Load commands causes the number of programmed cells, the GAL manufacturer, and the checksum to be shown in the GAL symbol on the screen.

The function of the End command will be obvious.

Finally, any command entered may be terminated with the aid of the ESC (escape) key. ■

## LETTERS

ELECTRONIC CONTROL OF  
ASTRONOMICAL INSTRUMENTS

In response to S. J. Dearden's letter (Readers' Corner, *EEUK* 2/92), let him know that Terry Brooks of Cambridge University Press is writing a book on CCD cameras with PCBs available.

G. Ginn  
Cambridge, UK

## FOR ASTRONOMICAL USE

We are writing in response to your inquiry in Readers' Corner (*EEUK* 2/92) concerning an accurate telescope control system operated by a remotely located microcomputer. We have developed such a system from your "Universal Stepper Motor Controller" (*EEUK* 1/87). On a single PCB we have incorporated the capability to drive two stepper motors to control the two axes of the telescope. The board also incorporates a temperature-controlled oscillator to enable

the telescope to track the sky, limit switches and hall effect positioning sensors. The compact unit houses the power supplies for the system. Software has been developed to run on an IBM PC.

We have high quality documentation generated by a CAD system plus complete technical information. A similar system has also been used in the department for an X-Y translation table for astronomical use.

John Cutts  
Head of the Electronic Workshop  
Department of Physics  
University of Queensland  
Brisbane, Australia

*Editor replies:*

*We thank both Mr. Ginn and Mr. Cutts for their information and interest. The informa-*

*tion and drawings supplied by Mr. Cutts have already been forwarded to Mr. Dearden.*

## CALLING TI-99 USER GROUPS

We, the TIUP (Texas Instruments TI-99 Users of Perth) are celebrating our 10th Anniversary. We already exchange our group's newsletter, *TIUP Tit Bits* with other TI-99 User Groups in Australia and the USA, but would be interested to hear from other TI-99/4A User Groups anywhere in the world.

Our compliments on the continuing high standard of your publication and on the interesting articles it contains.

Geoff Warner, Sec.  
TI-99 Users of Perth Inc.  
PO Box 8083  
Perth, Stirling St.  
Western Australia 6849

*Editor replies:*

*Any readers or clubs anywhere interested in contacting TIUP, please use above address.*

ELEKTOR  
BINDERS

Keep your valuable copies in perfect condition in these Elektor Binders. Each binder holds 11 issues with wires so you don't have to punch holes in your magazines.

High quality, book binder cloth construction. The logo is stamped in gold on a dark green background.



each \$12  
three or more, \$10 each

Shipping: Postpaid in US.  
Canada and Caribbean, please add \$4 for one, \$2 for each additional binder.  
Overseas, please add \$4 per binder.

	<b>KELVIN PRO 400</b>	<b>30 DAY MONEY BACK GUARANTEE!</b>
	<b>\$69.95</b>	
	FREQUENCY COUNTER TO 20MHz IDEAL FOR TROUBLE SHOOTING AC/DC VOLTAGE RANGES AC/DC CURRENT RANGES 5 FREQUENCY RANGES 5 CAPACITANCE RANGES	LOGIC TEST CONTINUITY TESTER/BLUZZER DIODE CHECK TRANSISTOR hFE TEST LED TEST VERIFY GOOD/BAD DISPLAY - 3 1/2 DIGIT LCD ACCURACY - 0.5% IMPEDANCE - 10 Mega Ohm
	PROTECTIVE CARRY CASE for PRO 400 Stock No. 990094 \$9.95 ea	<b>2 YEAR WARRANTY</b>
<b>BEST BUY ..... NEW Series II</b> <b>FLUKE 79</b> with Capacitance ..... \$169 <b>FLUKE 87</b> True RMS ..... \$289 <b>NEW! SCOPEMETER™ 90 SERIES</b> HAND HELD, 50 MHz, DUAL CHANNEL <b>FLUKE 93</b> ScopeMeter ..... \$1095 <b>FLUKE 95</b> ScopeMeter ..... \$1395 <b>FLUKE 97</b> FULLY LOADED ..... \$1695		
 10 Hub Drive, Melville, NY 11747 (516) 756-1750 • 1 (800) 645-9212 • FAX (516) 756-1763		 <b>AUTHORIZED DEALER</b>

## MAKE CIRCUIT BOARDS THE NEW, EASY WAY

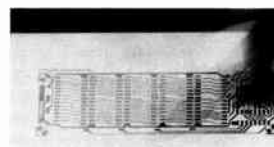

## WITH TEC-200 FILM

## JUST 3 EASY STEPS:

- Copy circuit on TEC-200 film using any plain paper copier or laser printer
- Iron film on to copper clad board
- Peel off film and etch

## SATISFACTION GUARANTEED

convenient 8 1/2 x 11 size  
5-Sheets for \$3.95 10-Sheets only \$5.95  
add \$1.50 postage NY res. add sales tax

**The MEADOWLAKE Corp.**  
Dept G, P.O. Box 497, Northport, NY 11768



# TERMS OF BUSINESS

## PRICING

Prices, except as noted, include shipping in the continental USA. The minimum order is \$10. A \$2 service charge will be added to orders of less than \$10. Prices are subject to change as our costs change. WE RESERVE THE RIGHT TO MAKE PRICE CHANGES WITHOUT NOTICE.

## TELEPHONE ORDERS

Telephone orders are welcome between the hours of 9:00 a.m. and 4:00 p.m. EDT, Monday-Friday. Orders for parts are to be made on the ORDER FORM provided. Payment for telephone orders is by MC/VISA only. Our TELEPHONE ORDER NUMBER IS (603) 924-6371 or 924-6526. Our answering machine for MC/VISA orders during non-business hours is (603) 924-6371. FAX: (603) 924-9467 (24 hours).

## PAYMENT

All remittances **MUST BE IN US FUNDS DRAWN ON A US BANK**. Payment for telephone orders must be made by MasterCard or VISA. Mail order payment may be made by MC/VISA, money order, cashier's check or personal check. If payment is made by personal check, allow up to 2 weeks for clearance before order is shipped. Should check be returned for any reason, there will be a \$10 charge.

## SHIPPING

Unless noted, freight is prepaid by Old Colony. All orders shipped USPS first class mail or by UPS. Allow two to three weeks for delivery. Please inquire about appropriate funds for special handling (UPS next day or second day). UPS requires a street address. If you cannot receive UPS delivery, please in-

clude an extra \$2 for insured service via Parcel Post. We cannot accept responsibility for safety or delivery of uninsured Parcel Post shipments. **Absolutely no COD shipments.**

## BOOKS, RECORDINGS, CDs, and SOFTWARE

The shipping/handling charge for the US is \$2.00, plus 75¢ each additional item. In Canada, please add \$4.50 for the first item, 75¢ each additional. For orders to be shipped outside North America, add 20% to the total order to cover shipping. **No returns.** According to the Connecticut Dept. of Revenue Services, Regulation #27, Section 12-426-27, in order to sell software to residents of Connecticut, we must register with the department as well as collect taxes for the state from the purchaser. We regret to inform customers that we will not sell software to anyone from Connecticut. ■

# BOOKS FROM ELEKTOR ELECTRONICS USA

## 301 CIRCUITS

This book follows the theme of the first in this series, *300 Circuits* (now out of print). It contains over 300 assorted circuits first published in the 1979, 1980, 1981 summer issues of *Elektor Electronics*.

The circuits range from the simple to the more complex and are described and explained in straightforward language. The book is a comprehensive source of ideas and construction projects for anyone interested in electronics.

ISBN 0-905705-12-2  
BKAA11 Price \$12.50

## 302 CIRCUITS

The popularity of this book is shown by its having been reprinted no fewer than three times. It offers a selection of the most interesting articles from the 1982, 1983, 1984 summer issues of *Elektor Electronics*.

In it you will find circuits for audio and video; car, cycle, and motorcycle; home and garden; receivers and aeriels; hobbies and games; measuring and testing; oscillators and generators; current sources and power supplies; microcomputers and music electronics; and a miscellany of other interesting subjects.

ISBN 0-905705-25-4  
BKAA12 Price \$12.50

## 303 CIRCUITS

Like its predecessors, *303 CIRCUITS* offers a comprehensive collection of practical ideas, concepts, and developments in the gamut of electronics. Unlike its predecessors, the book is arranged in 11 subject sections to make it easier for the reader to find that long-sought circuit.

In well over 300 pages, the book offers 32 Audio and Hi-Fi projects; 14 circuits for Car and Bicycles; 43 Computer & Microprocessor circuits; 11 Electrographic projects; 24 HF and VHF circuits; 16 circuits for a number of hobbies and pastimes; 54 projects for Home and Garden; 29 Power Supply circuits; 29 circuits for Test and Measurement equipment; nine TV and Video projects; as well as 42 Design Ideas.

ISBN 0-905705-62-2  
BKAA13 Price \$15.90

## 304 CIRCUITS

The latest in *Elektor's* famous "300" series, BKAA18 contains 304 innovative circuits and descriptions broken down as follows: 36 audio/video, 19 high frequency, 36 hobby, 36 home and garden, 9 music/electrophonics, 32 computer/microprocessor, 19 generator/oscillator, 33 test and measurement, 30 power supply, 13 car electronics, and 41 miscellaneous. Arranged by subject for ease of use.

ISBN 0-905705-34-3  
BKAA18 Price \$19.95

## DATA SHEET BOOK 2

Like its predecessor (now out of print), this book offers concise, relevant, and rapidly accessible information, which is both practical (e.g., the pin-out of a device) and informative.

The book contains data on integrated circuits as well as on discrete transistors and diodes. Moreover, it gives an introduction to fast (HCMOS) devices and a review of the new symbolic logic as laid down in British Standard BS3939: Section 21 (IEC Standard 617-12).

The final part of the book deals with a number of computer chips, such as memory devices (including programming information for these) and I/O circuits. This section also includes data on a number of non-digital discrete and integrated devices, such as op amps, as well as on some microprocessor peripherals (e.g., the 6522 VIA, the 6580 ACIA, and the 8355A PPI).

ISBN 0-905705-27-0  
BKAA14 Price \$16.50

## DATABOOK 3: PERIPHERAL CHIPS

This book lists the most important design data of peripheral chips whose type numbers and functions relate them unambiguously to a microprocessor in the same family. All listed devices form part of families based on widely used microprocessors or microcontrollers. Their most evident application will therefore be in conjunction with the associated microprocessor. This should, however, not be taken to mean that a peripheral cannot be used in another application. Far from it, as witness the familiar type MC146818A real-time clock and the type MC6845 cathode-ray tube controller. It deserves a place on the bookshelf of anyone concerned with the design, maintenance and servicing of microprocessor-controlled electronic equipment.

ISBN 0-905705-30-0  
BKAA15 Price \$17.95

## MICROPROCESSOR DATA BOOK

This book has come about because of a need by *Elektor Electronics* engineers, technicians, and editorial staff of a ready reference work on the most important microprocessors. This implies that it does not only contain information on the latest devices, such as the transputer, but also on older, well-established types, such as the Z80 and the 6800.

A general description, hardware block schematic, software structure, DC characteristics, and instruction sets are given for over 70 microprocessors. To prevent the book from becoming unwieldy (and to keep costs down), timing diagrams and AC characteristics have, however, been omitted. The detailed information on all manufacturers mentioned will, however, enable any additional information to be obtained quite readily.

Included in the book are, among others, the 68000 series; the 6502 family; the Z80, 8080, and 8085; Intel's 8086, 80188, 80188, 80286, and 80386; the NS32XXX series, and the INMOS transputers.

ISBN 0-905705-28-9  
BKAA16 Price \$17.90

## DATABOOK 4: PERIPHERAL CHIPS II

This further volume in *Elektor Electronics' Microprocessor Data Book* series deals with general peripheral chips that, at least as far as their type-coding is concerned, do not belong to a specific family of microprocessors. There are so many of these, however, that only a portion of them can be dealt with in one book. Those contained in this collection have been chosen carefully on the basis of their practical application and frequency of use. Complete data are given for coprocessors from the 80 series (AMD, Cyrix, ITT, Intel, Weitek); real-time clocks from MEM, OKI, Statek, National Semiconductor, and Dallas Semiconductor; transmitters and receivers of serial interfaces RS232, 422, 423, 485 from Motorola, Newport Components, Maxim, Texas Instruments, National Semiconductor, Dallas Semiconductor, and Linear Technology; UARTS, DUARTS, and QUARTS (i.e., programmable ICs intended for data transfer); and the CS8221 set of ICs from Chips & Technology that are used in a great number of PC mother boards (also included is the data sheet of associated software LIM 4.0 for the management of the Extended Memory System).

Apart from the actual data, the book contains much other useful information, such as comparisons between and second sources for all important IC families; addresses of manufacturers and their representatives; and overviews of all peripheral chips (including many that could not be included in this book) that are available from various manufacturers.

ISBN 0-905705-32-7  
BKAA17 Price \$17.95

## DATABOOK 5: APPLICATION NOTES

This book presents a series of application notes and design briefs that cover a wide variety of subjects. Apart from a number of applications related to specific components, the book also includes articles on basic design theory and the practical use of certain components. For example, there is an article reprint from *Advanced Micro Devices* that provides information on programming the motion of a stepper motor with the aid of a PAL (programmable array logic). Similarly, an article reprint from *Motorola* presents an overview of protocols and conventions used for serial communication between computers.

The application notes complement the theoretical sections by discussing the use of components related to current electronics technology. In a number of cases, this technology is ahead of the practical application, and the product is so new that an application note has not yet been published by the manufacturer—for examples, *Analog Devices' description of a Continuous Edge Graphics (CEG) digital-to-analog converter (DAC)*, and that of a *NICAM (near instantaneous companding audio multiplex) decoder chip developed by Micronas of Finland*. Given the complexity of the practical circuits that could be developed on the basis of these ICs, all the relevant data sheets are included for easy reference. The book also includes a short list of manufacturers' logos that should be helpful in identifying unknown components, as well as a worldwide address list of manufacturers and distributors/representatives for the products which are discussed.

ISBN 0-905705-33-5  
BKAA24 Price \$17.95

## SPECIALS!

BKAAZ/1 BKAA11, 12, 13, 18: all 4 for **\$49.00** (Save \$11.85!)  
BKAAZ/2 BKAA14, 15, 16, 17, 24: all 5 for **\$74.95** (Save \$13.30!)  
BKAAZ/S Complete *Elektor* library: all 9 for **\$114.95** (Save \$34.15!)

These books are all available direct from *Elektor Electronics USA* through the Readers Services, from a number of bookshops and electronics retailers in the US and Canada, and from selected bookshops throughout the world. Special prices are those of *EEUSA* only.



# TRADE

**VCR REPAIR FOR PROFIT.** The professionals' training course. Specially modified VCR training unit, marketing plan, manual, all brands, \$290. Details, **PETER KARATA Ph.D.**, 165 Ithaca Rd., Horseheads, NY 14845. T6/92

**PC BOARDS** etched and drilled for .70 square inch. **JM ELECTRONICS**, Box 150454, Altamonte Springs, FL 32715-0454, (407) 767-8196. T5/92

**KITS**, sound, light effects and high tech. **JM ELECTRONICS**, Box 150454, Altamonte Springs, FL 32715-0454. T5/92

# CLUBS

**CONNECTICUT AUDIO SOCIETY** is an active and growing club with activities covering many facets of audio—including construction, subjective testing, and tours of local manufacturers. New members are always welcome. For a copy of our current newsletter and an invitation to our next meeting, write to: Richard Thompson, 129 New-gate Rd., E. Granby, CT 06026, (203) 653-7873.

**For Advertising Information,**  
call Maureen McHugh at  
**(603) 358-3756**

or write

**ELEKTOR ELECTRONICS**  
Audio Amateur Publishing Group  
PO Box 876  
Peterborough, NH 03458

# CLASSIFIEDS

**PIEDMONT AUDIO SOCIETY** Audio club in the Raleigh-Durham-Chapel Hill area is meeting monthly to listen to music, demonstrate owner-built and modified equipment, and exchange views and ideas on electronics and speaker construction. Tube and solid state electronics are of interest and all levels of experience are welcome. Kevin Carter, 1004 Olive Chapel Rd., Apex, NC 27502, (919) 387-0911.

**MEMPHIS AREA AUDIO SOCIETY** being formed. Serious audiophiles contact J.J. McBride, 8182 Wind Valley Cove, Memphis, TN 38125, (901) 756-6831.

**NEW JERSEY AUDIO SOCIETY** meets monthly. Emphasis is on construction and modification of electronics and speakers. Dues includes monthly newsletter with high-end news, construction articles, analysis of commercial circuits, etc. Meetings are devoted to listening to records and CDs, comparing and A-B-ing equipment. New members welcome. Contact Bill Donnelly, (201) 334-9412, RD2, Box 69D, Miller Dr., Boonton, NJ 07005; or contact Bob Young, (908) 381-6269, or Bob Clark, (908) 647-0194.

## INDEX OF ADVERTISERS

All Electronics Corporation	8	ARX Systems	12
Capital Electro-Circuits	49	A.W. Sperry Instruments, Inc.	9, 10
Deco Industries	49	Caddock Electronics	10
Kelvin Electronics	60	Capital Electro-Circuits, Inc.	10
Meadowlake Corporation	60	Crown International, Inc.	11
Ocean State Electronics Corporation	CV II	Fieldpiece Instruments, Inc.	12
OLD COLONY SOUND LAB		Future Scanning Systems	12
Books	5, 61, 62	Harris Corporation/RF Communications Group	11
EPROMS, Etc.	61	HiTech Equipment Corporation	11
Front Panel Foils	61	MFJ Enterprises	10
Meek-It Kits	6, 7	MicroMath Scientific Software	12
Parts Sources	8	Newark Electronics	10
Printed Circuit Boards	61	PC Boards	9
Software	61	Professional Audio Journals, Inc.	10
Project Pro	8	Sencore Electronics	11
Radio Shack	CV IV	SMPT	11, 12
		Synetic Systems, Inc.	12
		Techni-Tool	11, 12
		Tektronix	11
		Teranet IA, Inc.	9

<b>ELECTRONICS SCENE/NEW PRODUCTS</b>	
Analog Devices, Inc.	9, 10
Analog Devices, Inc./PMI Division	9
Antona Corporation	12

## ELEKTOR ELECTRONICS CLASSIFIED ORDER FORM

### RATES

75 cents per word. Deduct 10% for a 6x contract. \$10.00 minimum for charge card orders.

### HOW TO COUNT WORDS

**Definition of a word:** A series of letters with a space before and after. Count words, not letters. Hyphenated words count as one word (i.e. first-rate).

**No ads will be taken over the telephone. No questions taken over the phone. Prepayment must accompany ad. No Billing.**

### Categories (please check just one)

- Audio for Sale
- Books & Periodicals
- Business Opportunities
- Cable & Satellite
- Conferences, Fairs, Seminars
- Components, Parts & Supplies

- Computer Hardware For Sale
- Computer Software For Sale
- Computer Systems For Sale
- Education
- Home Automation
- Kits
- Miscellaneous

- Optoelectronics
- Plans & Schematics
- Professional Services
- Radio Communications
- Security
- Test Equipment
- Video

- Clubs
- Wanted To Buy

**Ads in these two categories are free to subscribers. Attach your mailing label to form for verification. Limit 50 words.**

1	2	3	4	5	6	7	8	9	10
11	12	13	14	15	16	17	18	19	20
21	22	23	24	25	26	27	28	29	30
31	32	33	34	35	36	37	38	39	40
41	42	43	44	45	46	47	48	49	50

Please run this ad \_\_\_\_\_ times.  
**Advertisement will be inserted in first available issue.**

- Check/Money order enclosed
- Please charge to my Master Card/Visa

MC/MSA	EXP. DATE
NAME	COMPANY
STREET	
CITY	ST ZIP
PHONE NUMBER	

# RADIO SHACK

## THE PARTS PLACE<sup>SM</sup>

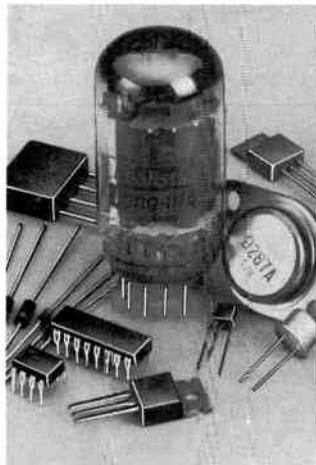

### Try Our Exclusive Postage-Free Parts "Hotline"

Your Radio Shack store stocks over 1000 electronic components, and another 15,000 items are available fast from our Special-Order warehouse. Selection includes ICs, transistors and diodes, tubes, crystals, phono cartridges and styli, all sorts of accessories, SAMS<sup>SM</sup> service manuals and MUCH more. You pay no postage—we send your order direct to your nearby Radio Shack.

- (1) **Portable Shortwave Antenna.** DX grabber! Clips to portable's rod antenna. 23-ft. wire element stores on pocket-size reel. #278-1374 . . . . . 8.95
- (2) **Dial Cord Repair Kit.** Radio Shack exclusive! Includes six feet of high-strength dial cord and three tension springs. #274-435 . . . . . 99¢
- (3) **3" Brushless 12VDC Fan.** Exclusive! Brushless design and DC operation make it a great choice for cooling mobile equipment and circuits that are sensitive to hum or noise. 27 CFM airflow. #273-243 . . . . . 14.95
- (4) **UL-Recognized Power Transformer.** Exclusive! 120VAC primary. Center-tapped secondary provides 12VAC at 1.2A. #273-1352 . . . . . 5.99

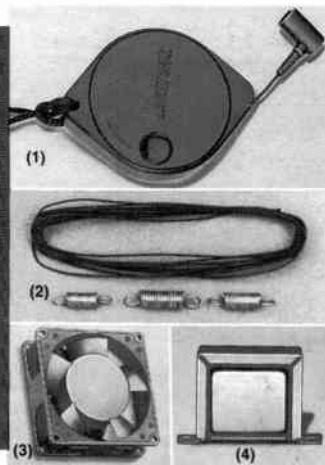

**Micromini Toggle Switches.** Reliability at low cost. Rated 3A at 125VAC. 1/4"-dia. stem.

SPST. #274-624 . . . . . 2.29  
 SPDT. #274-625 . . . . . 2.39  
 DPDT. #274-626 . . . . . 2.59

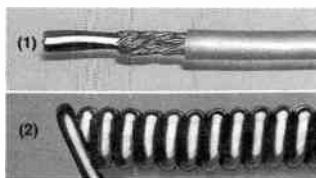

(1) **Double-Shielded, 4 Conductor Cable.** For data or audio. The best! 30 ft. #278-777 . . . . . 7.95

(2) **Coiled Mike Cable.** Replace CB, ham, marine radio cords. 4 conductors. 5 ft. #278-358 . . . . . 2.99



(1) **1N914/4148 Switching Diodes.** Popular silicon type. Rated 75 PIV. #276-1122 . . . . . Pkg. of 10/99¢

(2) **1N34 Germanium Diodes.** Hard-to-find signal diodes. Rated 60 PIV. #276-1123, Pkg. of 10/99¢

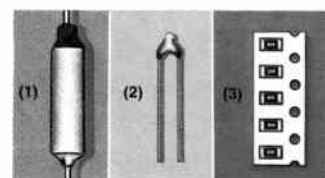

(1) **Thermal Fuses.** 128° C., #270-1321. 141° C., #270-1320. 228° C., #270-1322 . . . . . Each 1.19

(2) **Thermistor.** Resistance is proportional to temperature. #271-110 . . . . . 1.99

(3) **Surface-Mount Resistors.** 200 pieces, 15 popular values! Rated 1/8 watt, 5%. #271-313 . . . . . Set 4.99

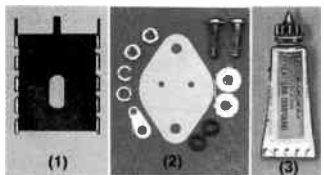

(1) **TO-220 Heat Sink.** Ideal for PC board use. #276-1363 . . . . . 89¢

(2) **TO-3 Mounting Hardware.** Complete kit. #276-1371 . . . . . 99¢

(3) **TO-220 Mtg. Kit.** #276-1373 . . . . . 99¢

(3) **Heat Sink Grease.** Assures maximum heat transfer. #276-1372 . . . . . 1.59

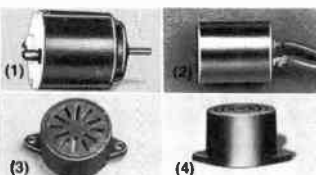

(1) **1 1/2 to 3VDC Motor.** Use in solar power demos. #273-223 . . . . . 99¢

(2) **Electret Element.** #270-092, 2.99

(3) **12VDC Magnetic Buzzer.** A more pleasing tone! #273-026 . . . . . 2.19

(4) **"Ding-Dong" Chime.** Classy entry alert. 6 to 18VDC. #273-071 . . . . . 8.99

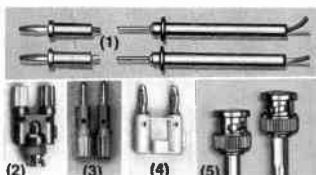

(1) **Coiled 6-Ft. Test Leads.** Why put up with tangles? #278-750 . . . . . Set/4.99

(2) **Posts to BNC.** #274-715 . . . . . 8.95

(3) **Posts to Bananas.** #274-716, 4.95

(4) **Stackable Dual Inline Banana Plug.** Versatile! #274-717 . . . . . 2.99

(5) **6-Ft. BNC-to-BNC.** #278-964, 5.99

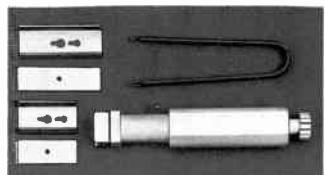

**IC Inserter/Extractor Kit.** Why risk bending or breaking pins on expensive chips? This kit makes it easy to install and remove any DIP-style IC from 6 to 40 pins. Both tools are groundable to prevent static "zaps". #276-1581 . . . . . 6.95



**UL-Listed DVM.** Micronta<sup>®</sup> makes electronics testing a snap! Autoranging, 1/2" LCD digits, bar graph to spot peaks, data hold to freeze display, continuity sounder, diode-check. #22-186 . . . . . 69.95

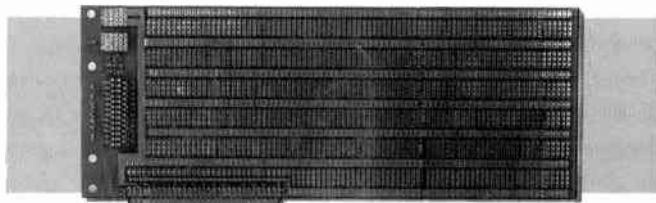

**PC/XT Experimenter's Circuit Card.** This premium-quality prototyping board fits a computer's XT expansion bus connector. Features durable epoxy glass construction and plated-through holes on standard 0.100" centers. Accepts D-sub connector shown at right. 37/8 x 10 1/16 x 1/16". #276-1598 . . . . . 29.95

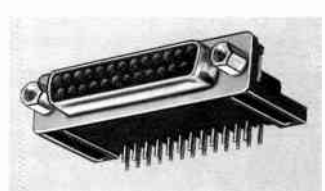

**Right-Angle D-Sub 25 Female Connector.** Ideal for use with PC/XT circuit card at left. Radio Shack also stocks a big selection of D-sub and IDC-type connectors for computer hookups. #276-1504 . . . . . 2.49

Since 1921 Radio Shack has been the place to obtain up-to-date electronic parts as well as quality tools, test equipment and accessories at low prices. Nearly 7000 locations are ready to serve you—NOBODY COMPARES

Prices apply at participating Radio Shack stores and dealers. Radio Shack is a division of Tandy Corporation

**Radio Shack<sup>®</sup> SINCE 1921**  
**AMERICA'S TECHNOLOGY STORE<sup>SM</sup>**