

JULY 20, 1957

# electronics

## business edition

A MCGRAW-HILL PUBLICATION • VOL. 30, NO. 7B • PRICE FIFTY CENTS



## Radarmen Sight New Markets

True-motion radar makes big  
bid for civilian business . . . . . p 13

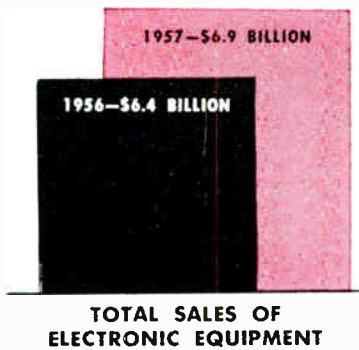

## The Electronics Industry—1957

Special Market Report shows  
sales up 7.3% over 1956 . . . . . p 24A

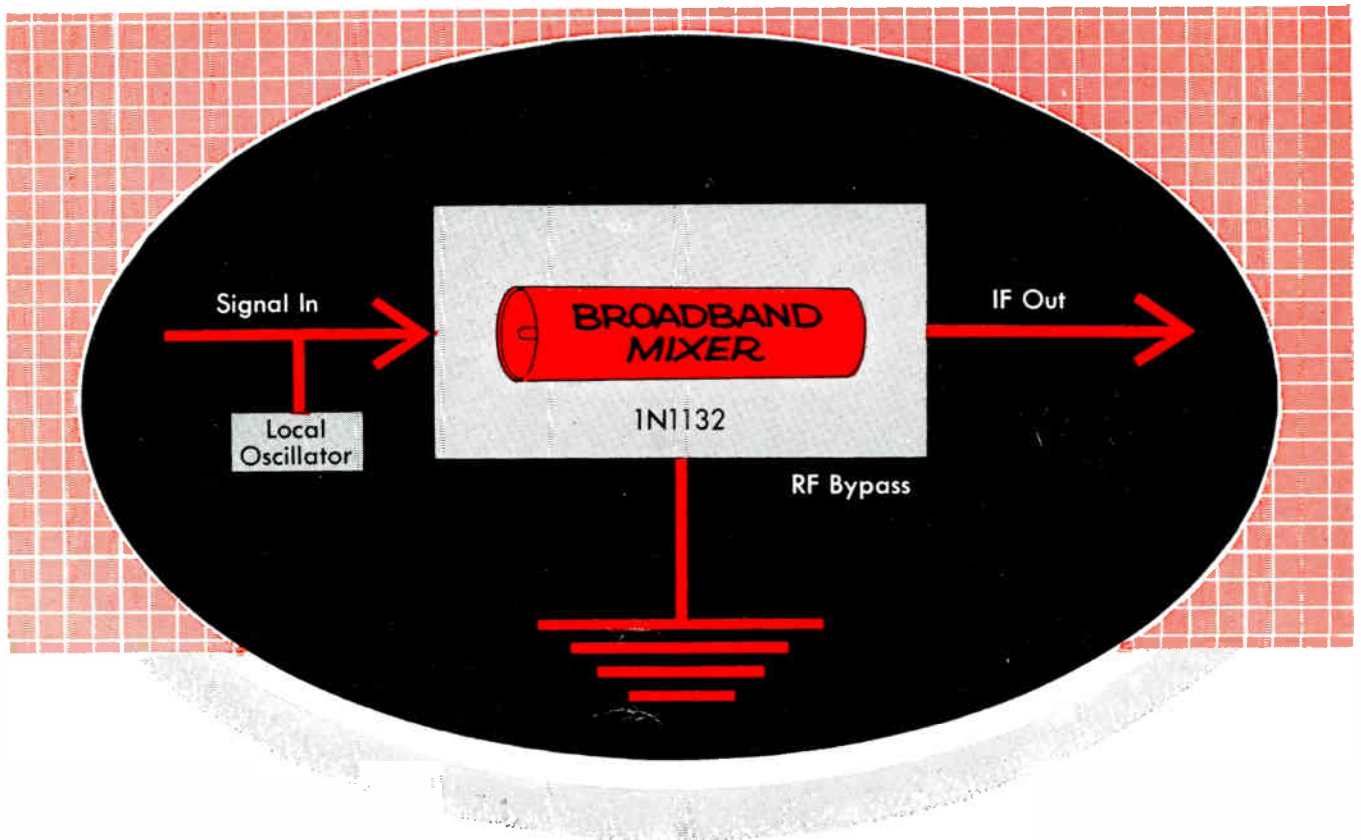

**Now—in Sylvania's exclusive  
Tripolar Design...**

## **New Broadband Mixer Diode**

Sylvania's new tripolar mixer crystal covers the frequency range from 3 kmc to 12.4 kmc in a single coaxial holder. The new 1N1132 matches the inherent broadband characteristics of coaxial cable for simplified front-end design.

The new broadband crystal diode which is the mixer counterpart of the low-level tripolar video detector offers these five features:

- **Input covers any frequency from S through X-band**
- **Built-in RF bypass capacitor**
- **Separate output terminal for IF eliminates RF chokes**
- **Simplified low-cost mount design**
- **Low Noise Figure over broadband**

These features of the 1N1132 contribute to simplified, more compact radar applications. Other broadband video types are available. Contact your Sylvania representative for information on the full line. Write for Sylvania's new four-page booklet covering the ratings, characteristics and applications of microwave crystal diodes.

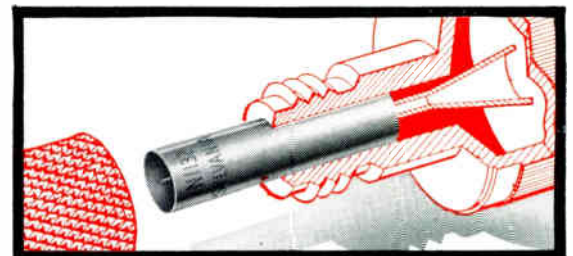

(Specifications 25° C)

Frequency Range . . . . .	3-12.4 kmc
Overall Noise Figure (max.) (1, 2) . . . . .	9.5 db
IF Impedance (2) . . . . .	100-200 ohms
RF Impedance (VSWR max.) (2) . . . . .	2.0
Ambient Temperature . . . . .	-40°C to +70°C

Note 1. Measured as follows:  $NF = L (N_{IF} + N_r - 1)$   
where  $N_{IF} = 1.5$  db

Note 2. With local oscillator input of 1.0 milliwatt, d.c. bias current of 0.75 ma, dc load resistance of 100 ohms and ac load impedance of 150 ohms. A holder which provides a transition from 50-65 ohms has been designed for use with this unit.



SYLVANIA ELECTRIC PRODUCTS INC.  
1740 Broadway, New York 19, N. Y.  
In Canada: Sylvania Electric (Canada) Ltd.  
Shell Tower Bldg., Montreal

LIGHTING • RADIO • TELEVISION • ELECTRONICS • ATOMIC ENERGY

# electronics business edition

A MCGRAW-HILL PUBLICATION • VOL. 30, NO. 7B • JULY 20, 1957

## NEWS AT A GLANCE

H. W. MATEER, *Publisher*

W. W. MacDONALD, *Editor*

*Managing Editors:* Vin Zeluff, John M. Carroll.

*John Markus, Feature Editor.*

*Associate Editors:* John M. Kinn, Jr., Frank Leary, Michael F. Tomaino, Howard K. Janis, Sylvester P. Carter, David A. Findlay, Haig A. Manoogian.

*Assistant Editors:* William P. O'Brien, George Sideris, Lawrence Kamarck, Edward DeJongh, John F. Mason.

*Pacific Coast Editor (Los Angeles)*

Harold C. Hood; *Midwestern Editor (Chicago)* Harold Harris; *New England Editor (Boston)* Roland J. Charest.

*Harry Phillips, Art Director.*

Roy Thompson, Barbara Ellwood.

*John C. Wright, Jr., Production.*  
Jean L. Matin.

*Editorial Assistants:* Gloria J. Filippone, Arlene Schilp, Bernice Duffy, Barbara Hearst, Noreen Hennessy, Phyllis A. Cronin, Barbara Habermann.

**JAMES GIRDWOOD**, *Advertising*

*Sales Manager.* R. S. Quint, *Assistant Advertising Sales Manager and Buyer's Guide Manager.* Fred Stewart, *Promotion Manager.* Frank H. Ward, *Business Manager.* George E. Pomeroy, *Classified Manager.* Jean Heiges, *Research.* Wallace B. Blood, *Market Consultant.*

*New York:* Donald H. Miller, Henry M. Shaw, Martin J. Gallay. *Boston:* Wm. S. Hodgkinson. *Philadelphia:* James T. Hauptli. *Chicago:* Bruce Winner, Walter M. Luce. *Cleveland:* Warren H. Gardner. *San Francisco:* T. H. Carmody, R. C. Alcorn. *Los Angeles:* Carl W. Dysinger, Russell H. Antles. *Atlanta:* M. Miller. *Dallas:* Gordon L. Jones. *London:* Herbert Lagler.

Keith Henney, *Consultant.*

**Radarmen Sight New Markets.** Small craft and light planes make a tempting commercial market. Will new easy-to-use radar help pry it open? . . . p 13

**Twt's Join Magnetrons.** New traveling-wave tubes excite microwave designers. Magnetrons still lead in microwave tube sales. . . . . p 15

**Organization: Rx for R&D.** Is your research team organized by functional specialty, engineering field or product? Each setup has its peculiar advantages . . . . . p 17

**Packaging Cuts Costs.** Profits can be made or lost in the shipping room. Perhaps new packaging aids like uniform pallets, foam blocks and plastic bags can save your firm money. . . . . p 19

**Store-Bought Electronic Circuits.** Here's a trend that could in time rock the components business. Makers predict a \$25-million annual demand for packaged circuits . . . . . p 20

**Transistor Switching.** New telephone switch using transistors can help existing facilities serve more subscribers. Devices could cut new cable needs 75 percent . . . . . p 23

**The Electronics Industry—1957.** A look ahead at mid-year sees sales up 7.3 percent. Military takes half of output as industry heads for \$7 billion . . . . . p 24A

**Panel Shows Images.** Flat electroluminescent panel now displays information. Could this be a first step towards picture-on-the-wall television? . . . . . p 25

**Toll-Tv Test Looms.** Pay-as-you-see television trials are still a hot potato in Washington. But there are signs of a full-scale test this fall. . . . . p 33

**Exporters See More Sales.** Upward trend in electronics sales abroad should continue this year despite ever stiffening foreign competition. . . . . p 35

Published three times a month, with an additional issue in June, by McGraw-Hill Publishing Company, Inc., James H. McGraw (1860-1948), *Founder, Executive, Editorial, Circulation and Advertising Offices: McGraw-Hill Building, 330 W. 42 St., New York 36, N. Y., Longacre 4-3000.* Publication Office: 99-129 North Broadway, Albany 1, N. Y. See panel below for directions regarding subscriptions or change of address. Donald C. McGraw, *President;* L. Keith Goodrich, *Vice President and Treasurer;* John J. Cooke, *Secretary;* Nelson Bond, *Executive Vice President, Publications Division;* Ralph B. Smith, *Vice President and Editorial Director;* Joseph H. Allen, *Vice President and Director of Advertising Sales;* A. H. Venezian, *Vice President and Circulation Coordinator.*

Single copies 75¢ for Technical Edition and 50¢ for Business Edition in United States and possessions, and Canada: \$2.00 and \$1.50 for all other countries. *Buyer's Guide* \$3.00. Subscription rates—United States and possessions, \$6.00 a year; \$9.00 for two years. Canada, \$10.00 a year. All other countries \$20.00 a year. Three-year rates, accepted on renewals only, are double the one-year rate. Entered as second-class matter August 29, 1936, at the Post Office at Albany, N. Y., under act of Mar. 3, 1879. Printed in U. S. A. Copyright 1957 by McGraw-Hill Publishing Co., Inc.—All Rights Reserved. Title registered in U. S. Patent Office. BRANCH OFFICES: 520 North Michigan Avenue, Chicago 11; 68 Post Street, San Francisco 4; McGraw-Hill House, London, E. C. 4; National Press Bldg., Washington, D. C. 4; Architects Bldg., 17th & Sanson Sts., Philadelphia 3; 1111 Henry W. Oliver Building, Pittsburgh 22; 1510 Hanna Bldg., Cleveland 15; 856 Penobscot Bldg., Detroit 26; 3615 Olive St., St. Louis 8; 350 Park Square Bldg., Boston 16; 1321 Rhodes-Haverty Bldg., Atlanta 3; 1125 West Sixth St., Los Angeles 17. ELECTRONICS is indexed regularly in the Engineering Index.

**Subscriptions:** Address correspondence to Subscription Manager, Electronics, 330 W. 42nd St., New York 36, N. Y. Allow one month for change of address, stating old as well as new address. Subscriptions are solicited only from persons engaged in theory, research, design, production, maintenance and use of electronic and industrial control components, parts and products. Position and company connection must be indicated on subscription orders.

POSTMASTER: Please send form 3579 to ELECTRONICS, 330 W. 42nd St., New York 36, N. Y.



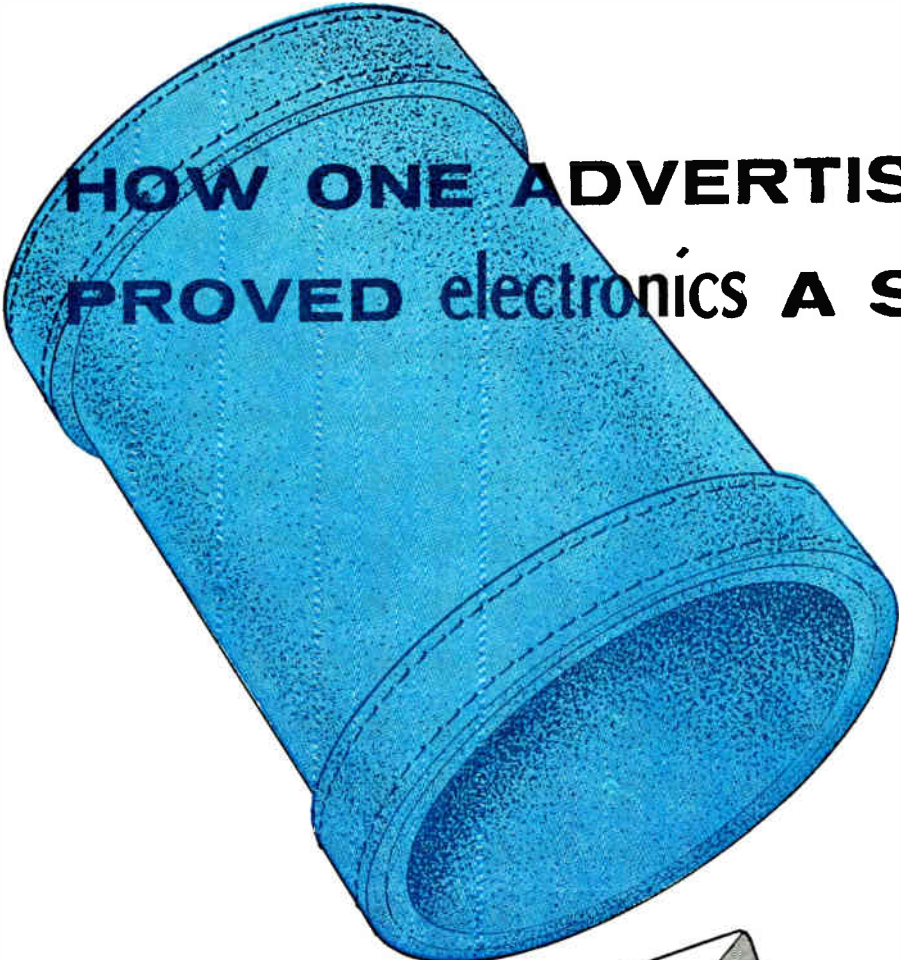

# HOW ONE ADVERTISER PROVED electronics A SURE BET

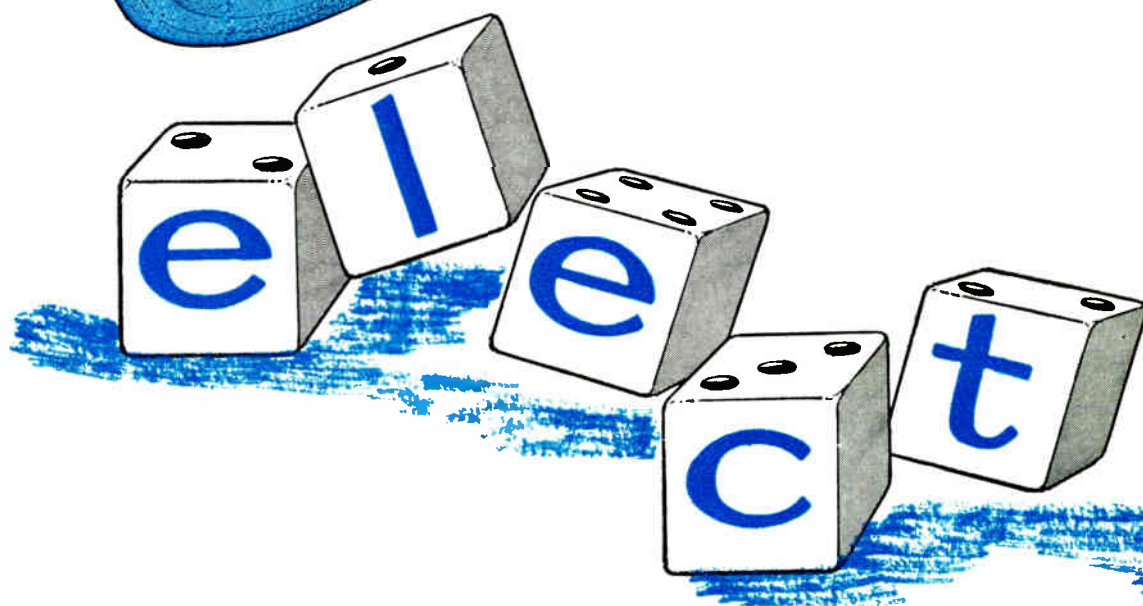

*"A regular schedule in the business editions as well as in the established technical edition"*



A M c G R A W - H I L L P U B L I C A T I O N . . . 3 3 C



MEMO TO: Sales Representatives

From : Frank H. Rockett

Subject: Current Advertising

November 26, 1956

This (the geographic distribution of inquiries from electronics\*) indicates that the quality of inquiries from electronics, because they come proportionally from all market centers, is high. The tabular results also show that the circulation of electronics reaches as representative a cross section of the electronic market as do the other magazines combined. For this reason, we will continue to use electronics as the main stay of our advertising in 1957. This will include a regular schedule in the new business editions as well as in the established technical editions.

*\*These conclusions of Mr. Rockett, Advertising Director for Airpax Products Company, result from an analysis of inquiries from advertisements and press releases over an 18-month period (January, 1955 through June, 1956).*

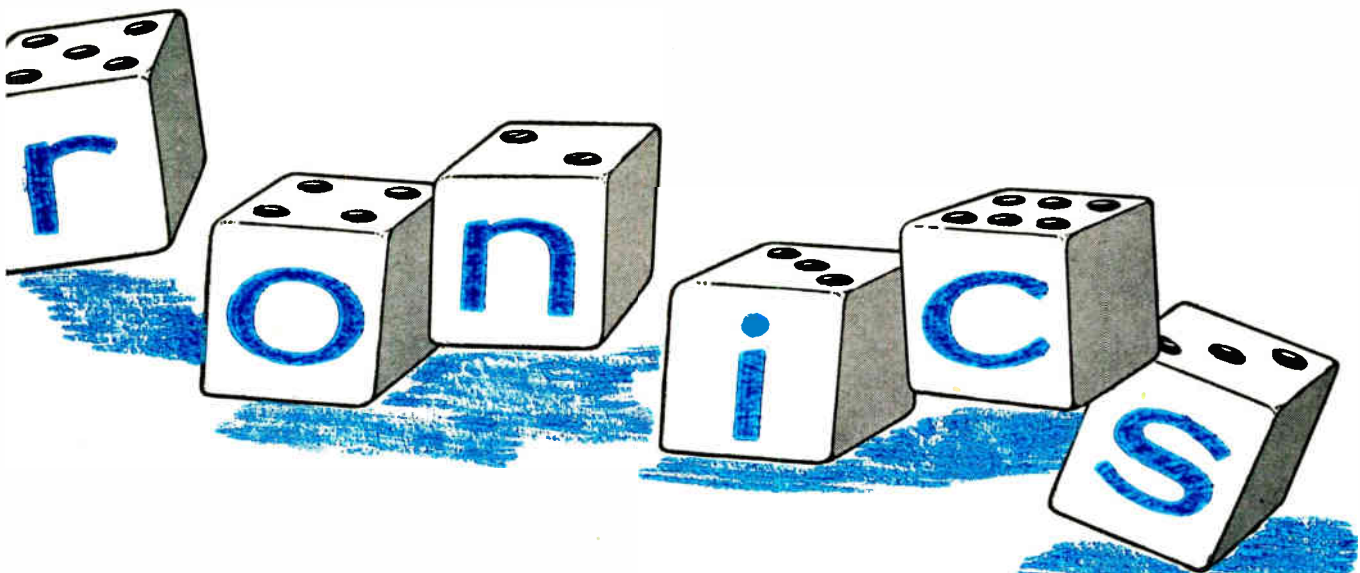

EST 42ND STREET . . . NEW YORK 36, N. Y.

ELECTRONICS business edition — July 20, 1957

Your business is in the Age of Electronics

## Your engineers

swift paced geni - or technical drones?

You see more and more electronic measuring equipment in industry's laboratories for a very simple reason. Electronic instruments make engineering measurements faster and more accurately. They give your engineers precision short cuts through tedious measuring problems - common and uncommon. They save hours, even days, for the creative engineering that so directly affects your progress and competitive position.

Over 130 Hewlett-Packard field engineers and 300 different -hp- instruments are today helping company after company eliminate obsolete, time-wasting measurement methods. A letter from you will assure an -hp- engineer in touch with your technical people - immediately.

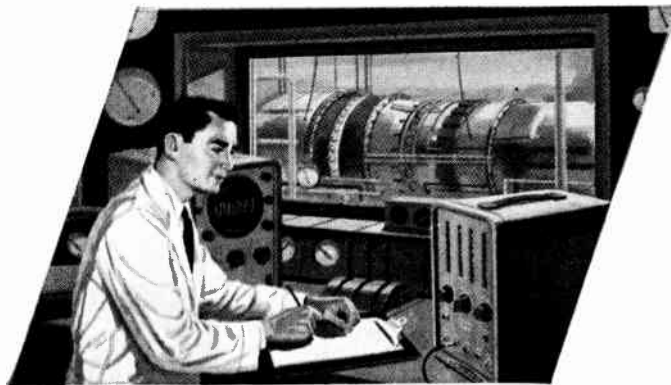

Versatile, low cost -hp- 521A Industrial Counter measures frequency, speed, RPM and RPS - counts events occurring at random within selected time periods. With special transducers, also measures weight, temperature, pressure, acceleration, etc. Time-saving production and research tool. \$475. Make sure your next instrument requisition specifies -hp- equipment.

### HEWLETT-PACKARD COMPANY

4344A PAGE MILL ROAD PALO ALTO, CALIFORNIA

*Field application engineers throughout the world*



*world leader in electronic measuring instruments*

# Sales up 20%

**Navy survey shows electronics firms raising production 20 percent in expectation of higher sales**

ELECTRONICS manufacturers expect 1957 sales will be 20 percent greater than 1956. They expect military sales to be 22 percent higher.

This information is revealed by an Office of Naval Materiel survey of 549 firms which account for a substantial portion of industry volume. Their single-shift productive capacity in 1956 was \$11.3 billion.

The group plans production of \$8.5 billion in 1957, 20 percent more than sales of \$7.1 billion in 1956. Military sales are expected to increase to \$4.2 billion, about 22 percent higher than \$3.5 billion in 1956. These estimates, based on plant production capacity, include intra-industry sales. Conventionally, such sales are subtracted out from gross industry product figures.

Proportion of military business to all business in 1956 was 49 percent. The same proportion is expected for 1957.

At the beginning of 1957 military contract backlogs were 22 percent higher than at beginning of last year. However, subcontract backlogs declined eight percent over the period while prime contracts increased 30 percent.

There is a small trend towards an intermixture of

civilian and military business. Number of companies concentrating exclusively on either military or civilian business is declining. Among the 549 manufacturers surveyed, the number concentrating exclusively on military business declined from 99 in 1956 to 92 in 1957. Number concentrating exclusively on civilian business declined from 97 to 87.

Survey information of employee data shows the group had 494,805 employees in 1956, about 12 percent more than in 1955.

Average sales per employee in 1956 varied from \$12,982 for companies with 2,001 to 5,000 employees to \$15,367 for companies with 1,001 to 2,000 employees. Average sales per employee for all 549 firms was \$14,376.

Of the 549 companies surveyed 187 had been issued certificates of necessity since Oct. 1950. More than 50 had outstanding V loans.

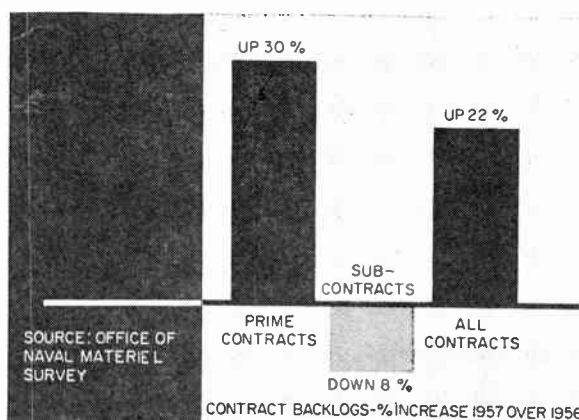

Military prime contract backlogs rise in 1957 while subcontracting dips

## SHARES and PRICES

MAGNETIC amplifiers find increasing applications in military and industrial electronics. They can be substituted for tubes and transistors in many cases.

Reliability of performance and freedom from maintenance are characteristic of magnetic amplifiers. They have no moving parts and generate little heat.

They find wide use in military electronics, computers and automation equipment where reliability and maintenance advantages are of particular significance.

Typical Magnetic Amplifier Manufacturers	Recent Price	1956 Dividends	Percent Yield	Earned per Com. Share		Traded	1957 Price Range
				1956	1955		
Aerovox Corp. ....	4¾ <sup>2</sup>	....	....	d-1.05	0.55	OTC	.....
American Electronics.....	15¼	0.50	3.3	0.73	0.51	ASE	11 -15¾
Electronic Communications <sup>1</sup> .....	9¾	....	....	0.25 <sup>3, 4</sup>	0.07 <sup>3, 4</sup>	ASE	8 -11¾
International Resistance.....	5	0.20	4.0	0.39	0.40	ASE	4¾ - 6¾
Magnetics, Inc. ....	4¾	....	....	0.08	0.05	OTC	.....
Magnetic Amplifiers.....	5¾ <sup>2</sup>	....	....	0.31	0.28 <sup>5</sup>	OTC	.....
Norden-Ketay. ....	11¾	....	....	d-0.39	d-0.18	ASE	7 -11¾
Servo Corp. of America.....	6	0.20	3.3	0.41	0.55	ASE	4¾ - 6½

<sup>1</sup> formerly Air Associates

<sup>2</sup> bid

<sup>3</sup> disregarding preferred arrears

<sup>4</sup> fiscal year

<sup>5</sup> unaudited

# More Programmers

5,000 from N. E. alone next year  
via educational alliance, says MIT

**NEXT YEAR** New England alone will produce 5,000 computer programmers—10 times the number it turned out this year.

A new alliance of 25 educational institutions in the six-state area will produce the history-making manpower pool. This will be the biggest supply of computer-programming experts in the nation. California universities and colleges may launch a similar program next year.

MIT officials make these forecasts as the new computation center there—equipped with an IBM 704—begins operating. A prime objective of the MIT facility is to supply, quickly, more advanced computer programmers to the electronic industry.

MIT is the heart of the new drive. Faculty members and students from the 25 institutions use the center. Engineers get from 300 to 2,200 hours of computer training.

Eleven special computer courses are being offered at MIT alone. Cooperating institutions are installing or expanding courses in computers. Graduates are qualified to program projects on all computers.

The demand for computer programmers is spiraling upward at a fantastic rate. According to conservative sources, it's estimated 40,000 to 100,000 programmers will be needed in five years.

Computer "missionaries" are active at the 25 institutions. They come from the ranks of professors, instructors, and graduate students. They spend 50 percent of their time at the MIT center, learning to use the big computer. On campus, they influence future engineers, act as consultants, assist in programming problems from staff members.

No classified work will be done on MIT's huge computer. It's reportedly the only one in the country specifically set aside for training and free use.

The 704, plus auxiliary equipment, was given rent-free to MIT by IBM, which also provides up to \$60,000 yearly to pay research personnel. The National Science Foundation donated \$35,000 for the coming year. The Rockefeller Foundation gave \$98,000 for use over three years.

---

## MERGERS, ACQUISITIONS and FINANCE

• **Gulton Industries**, Metuchen, N. J., privately places 100,000 shares of common stock through Wertheim & Co. This marks first sale of Gulton stock to other than company executives and directors. Proceeds of approximately \$1.4 million will be used for expansion and development of ultrasonic and automated systems.

• **Minneapolis-Honeywell** acquires 100-percent interest in Datamatic Corp. of New Highlands, Mass. It purchased Raytheon's 40-percent interest in the jointly-owned data-processing venture for \$4.5 million. Raytheon was prompted to sell out because of the need of additional capital to fully develop Datamatic. Management and personnel of Datamatic will continue as before.

• **Benrus Watch** issues 27,500 shares of \$1 par common stock at about \$8 a share through Ralph E. Samuel & Co. and L. F. Rothschild & Co. Proceeds are to go to seven selling stockholders. The watch company also makes guided-missile and precision-instrument components.

• **Magnetic Amplifiers**, N. Y., offers 90,000 shares of 50-cent par common stock at \$3.25 a share through D. A. Lomasney & Co. Proceeds will be used to retire \$50,000 bank loan and for general corporate purposes.

• **Philips Electronics**, Mount Vernon, N. Y. and **A. Hollander & Sons** of New York City plan to merge. Philips manufactures glass-to-metal seals for electronic components, industrial x-ray diffraction and spectrographic equipment. It is a subsidiary of Philips Industries, owned by a Hartford bank in trust for Philips Incandescent Lamp Works of Holland. Once in furs, Hollander now distributes chemicals through its subsidiary, Brook Chemical. Philips shareholders will receive 652,951 new shares of Hollander in exchange for their Philips holdings. They will have a controlling interest of over 70 percent. The 243,921 shares held by present Hollander shareholders will remain unchanged. Pieter van den Berg, president of Philips, is expected to be made president of the merged company. Stockholders of

both companies vote on the merger later this month. After approval, the name of Hollander will be changed to Philips Electronics, Inc.

• **Baker & Co.**, Newark, N. J. acquires controlling interest in **Nuclear Corp. of America**. Baker is a member of **Englehard Industries**, refiner and fabricator of precious metals. Sam Norris will continue as Nuclear's president. The new relationship is expected to double capital of Nuclear Corporation. Research, scientific and other technical facilities of Englehard Industries will also be made available.

• **Tele-Beam Industries**, Napa, Calif. antenna manufacturer, is planning its first public financing. Money will be used for additional working capital and to acquire more equipment.

• **Emerson Electric Manufacturing** issues \$3.4 million of convertible, subordinated debentures. Common stockholders receive rights to subscribe to \$100 of principal amount for each 20 shares held. Proceeds will be used for additional working capital.



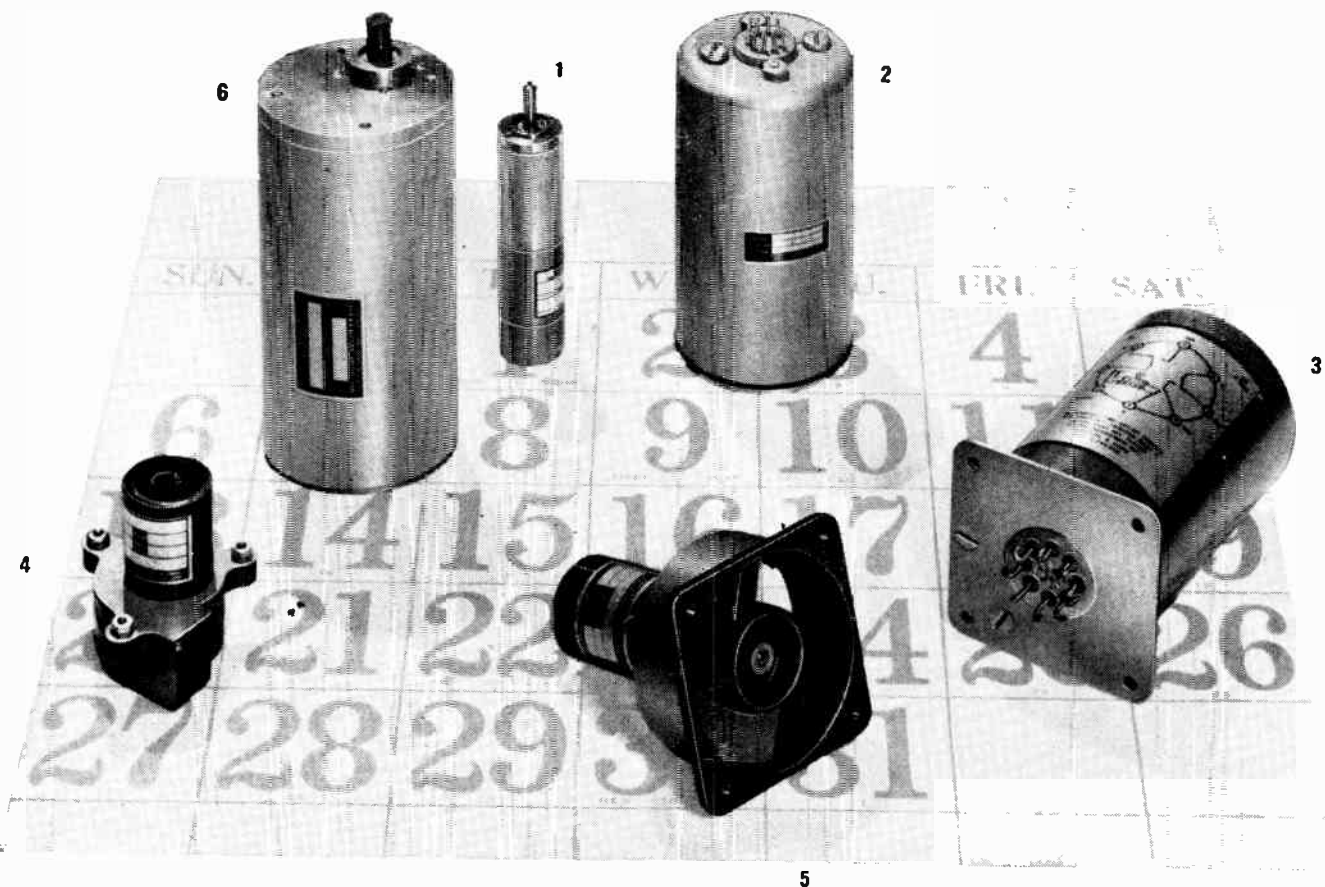

# FROM SPECS TO PROTOTYPES---FAST

Globe Industries makes to special order all of the miniature motorized devices shown on this page. But so do a lot of other companies. The difference lies in your design freedom.

At Globe you can set the specs and get prototypes in a few weeks. Our special order department builds these under the direction of the engineering department. And production orders are delivered in a few months because Globe maintains enormous inventories around which most custom designs are based.

Globe's broad base of standard parts has helped earn a reputation for earliest prototype delivery, fast production, reasonable price, aircraft standards, and repeat-business quality. Parts for your servo, timing, control, power, or air moving systems may be in Globe's inventory now. MIL specs and special development (including temperatures to  $+500^{\circ}$  F.) are routine at Globe Industries.

Catalog sent to qualified firms; please request it on your letterhead. Inquire now about products which interest you. Get a Globe proposal on your next design.

## 1. GEAR REDUCED MOTORS

6 basic AC and DC motors, 2 basic gear types with 112 odd and even ratios, as well as various brakes, clutches, shafts, governors, windings and mountings. Above unit powered by SS motor. Inventoried parts for SS motors can be combined in  $6 \times 10^{17}$  different ways.

## 2. RATE GYROS

5-10 cps. is natural frequency. Provides adjustable damping and control contacts, withstands 60Gs for 11 milliseconds repeatedly. Above unit powered by MM motor. Inventoried parts for MM motors can be combined in  $10^{18}$  different ways.

## 3. TIMERS

AC or DC operated timing cycles to order, from a few seconds to many minutes, adjustable or non-adjustable, multiple switching actions. Can be powered by any motor, such as the LL. Inventoried parts for LL motors can be combined in  $8 \times 10^{17}$  different ways.

## 4. CENTRIFUGAL BLOWERS

Many standard models with typical air delivery of 22 cfm. at 1" back pressure. Unit above is SC. Inventoried parts for SC motors can be combined in  $10^5$  different ways.

## 5. AXIAL BLOWERS

Many standard models with typical air delivery to 58 cfm. in above configuration and over 300 cfm. with open axial fan. Above unit powered by MC motor. Inventoried parts for MC motors can be combined in  $12 \times 10^6$  different ways.

## 6. ACTUATORS

3 standard models around which custom units are designed, with intermittent torques up to 2500 oz. in. Above unit powered by FC motor. Inventoried parts for FC motors can be combined in  $10^5$  different ways.



**GLOBE INDUSTRIES, INC.**

Dayton 4, Ohio • Phone: HEmlock 3741

# WASHINGTON report

THE ELECTRONICS industry may have little to fear from the anti-trust men if statistics recently compiled from the Census of Manufacturers for the Senate Anti-Monopoly Committee are an important criterion.

This new and updated information is supposed to show whether or not large electronics firms dominate the markets in which they compete. It will be part of the raw material for the Kefauver Committee, which is looking into "administered pricing" in a variety of industries.

The figures purport to show the percent of a given market which is held by the largest manufacturers in an industry.

The figures for radios and related products show that 1,612 firms in 1954 shipped \$2.1 billion of products, compared to 709 firms in 1947 shipping \$773 million. In 1954 the four largest firms (unnamed) shipped 24 percent of the total, whereas the big four shipped 26 percent in 1947. The next four largest firms had 11 percent of the market in 1954, 9 percent in 1947.

Generally, electronics seems to be a widely spread business. In 1954, the top four manufacturers of household radios and phonographs had only 38 percent of the market. Among manufacturers of electronic components for communications equipment, the top four companies had only 13 percent of the business.

But the report does have other and more detailed figures which indicate that a small number of firms may have captured a more substantial chunk of more narrowly defined markets. Thus, the four largest makers of electron tubes in 1954 had 63 percent of the business. The four largest cathode-ray-tube makers had 58 percent of the total shipments. The four largest makers of tv receivers had 45 percent of 1954 shipments.

- The highly-touted Cordiner Plan to boost pay and privileges for military and civil service scientists, engineers and skilled technicians in the Defense Dept. hasn't gotten off the ground. The plan was proposed by a citizens committee headed by GE President Cordiner to help the military hold on to scarce technical personnel.

The administration has put the damper on Pentagon attempts to carry out the key Cordiner proposals because of what President Eisenhower fears would be the inflationary effect resulting from increased federal expenditures. Up to now, the Pentagon has been allowed to grant only "proficiency pay bonuses" of about \$30 monthly to enlisted technicians with the most critical skills—radar repairmen, fire control specialists, missile maintenance men, radio mechanics, and the like.

But the Cordiner issue is being kept alive by wide-scale politicking of military partisans. At least two bills have been introduced in Congress to authorize most of the Cordiner proposals, and the Senate has ordered an investigation of the report.

- A long-time political hot potato—military procurement—is once again an immediate congressional issue. A House subcommittee headed by Rep. F. Edward Herbert (L., La.) has attacked the high volume of military buying awarded through private negotiations (92 percent of the dollar value last year) and the relatively small amount awarded under advertised competitive bidding. Herbert has proposed legislative changes to restrict the amount of negotiated procurement and increase the volume of buying under formal advertised bidding. Dollarwise, negotiated contracts cover a big chunk of electronics procurement.

No waveform distortion

from G-E Inductrol\*  
Voltage Regulators

Unlike many other types of voltage regulators, General Electric Inductrols introduce no waveform distortion.

Featuring drift-free controls, Inductrols maintain the a-c or d-c voltage powering electronic circuits within  $\pm 1\%$ ; are small and light.

They have long life and require little maintenance because *they use no brushes!*

For more information, write Section 425-6, General Electric Co., Schenectady 5, N. Y., or contact your G-E sales office or agent.

\*General Electric Trade Mark for Induction Voltage Regulators.

*Progress Is Our Most Important Product*

**GENERAL  ELECTRIC**



"SCOTCH" Brand No. 39 Tape is used to anchor both start and finish windings. This flatback paper tape has high adhesion, is thin, resists edge tear and is non-corrosive.

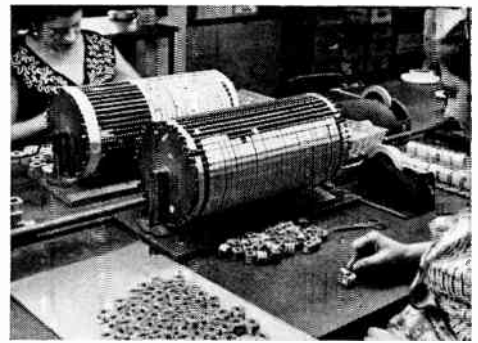

"Lead saddle" base is formed by "SCOTCH" Brand No. 26, which protects lead from windings. An acetate film cloth, No. 26 has high dielectric strength and excellent adhesion.



"SCOTCH" Brand No. 26 completes "lead saddle". No. 26 anchors lead solidly, resists edge tear and puncture.



Finish wrap on Woodward-Schumacher transformer coils is made with "SCOTCH" Brand No. 28 acetate cloth tape. Thermosetting adhesive holds tight, giving good conformance and neat appearance. Completed coil is then varnished.

## How Thermosetting Tapes Raise Quality...Lower Costs

Woodward-Schumacher Electric Corporation relies on "SCOTCH" Brand Electrical Tapes with true thermosetting adhesives. Here's why: Tapes with 3M Thermosetting adhesive hold under extreme operating heat without softening . . . have high bond strength for anchoring leads. Adhesive bakes dry to prevent throw-out . . . resists solvent action of waxes and varnishes.

The complete line of "SCOTCH" Brand Electrical Tapes with true Thermosetting pressure-sensitive adhesives, offers you the right tape to solve your holding or insulating needs.

REG. U. S. PAT. OFF.  
**SCOTCH**  
 BRAND  
**Electrical Products**

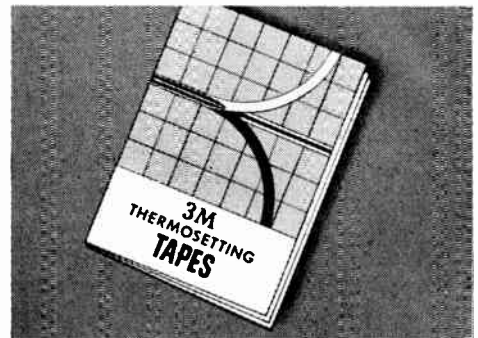

Send for free booklet illustrating and describing "SCOTCH" Brand Electrical Tape with true 3M Thermosetting Adhesive. Just write on your letterhead to 3M Co., St. Paul 6, Minn., Dept. CA-77.



The terms "SCOTCH" and "3M" are registered trademarks of Minnesota Mining and Manufacturing Co., St. Paul 6, Minn. Export Sales Office: 99 Park Avenue, New York 16, N.Y. In Canada: P. O. Box 757, London, Ontario.



# need high vacuum components?

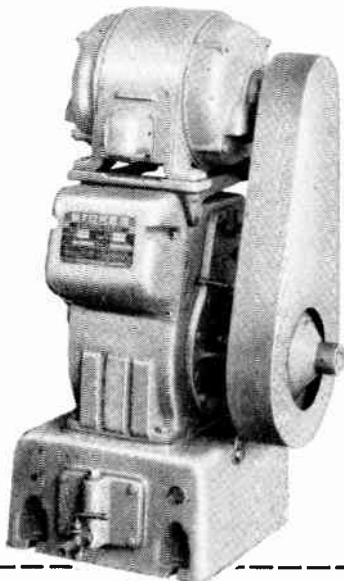

The Stokes Model 149 Microvac Pump has displacement of 70 cu. ft./min. . . . is a water-cooled unit. This pump cuts floor space requirements . . . measures less than 2 feet on a side. This model and all pumps in the Stokes Microvac line, 17-500 cfm capacity, are tested to produce vacuums of 10 microns or better on blank suction.

**S**TOKES makes a complete line of vacuum components . . . advance-designed and engineered to help make your vacuum systems more productive. Each unit reflects Stokes' unparalleled experience, pioneering leadership and wealth of basic vacuum technology.

The product list includes: Diffusion Pumps, Vapor Booster Pumps, Mechanical Pumps, Mechanical Booster Pumps, Vacuum Gages, and Valves.

Send for technical data on any or all . . . without obligation.

High Vacuum Division  
F. J. STOKES CORP.  
5500 Tabor Road, Phila. 20, Pa.

## STOKES

Want more information? Use post card on last page.

## EXECS in the News



### ATP's Fetter: no patience

FREE Enterprise Award for Horatio Alger-type success in electronics goes to Charles H. Fetter, president of American Time Products Inc. Fetter, who will be 62 on Aug. 1, built his company from scratch on a single product: reliable frequency standards in the less-than-megacycle range.

Genial and soft-spoken, Fetter grew up in Hopewell, N. J., studied "chemistry, football and vaudeville" in high school. He took a Penn State BSEE to Western Electric in 1917, later worked as electrical engineer in a coal mine. Then for a time he peddled vacuum cleaners and "gasoline savers" for automobiles. Finally in 1919 he went to work for AT&T's research department.

"From then until 1937," he remarks, "there was hardly a thing I did that wasn't connected with some new idea." He worked on keeping telephone crosstalk off the radio (a problem in those days), antennas and transmission systems, sound systems for the infant motion picture business.

When he returned from a European assignment, he "puttered around with precision timing," built a photofinish mechanism first used in the 1932 Olympics. Later he developed machines for timing watches. When Mother Bell curtsied out of this activity in 1937, Fetter picked up the chips and started American Time Products.

He's still restlessly active ("I like music but haven't got the patience to sit still and listen"), learned to fly in 1952 but figured he'd better not practice the hobby. "So I went back to golf. My score, though, is a state secret."

## Strictly PERSONAL

That Sun Furnace

Re "Sun Power Takes First Steps" (Apr. 10, p 20) . . .

The photograph accompanying this article is . . . of a solar furnace designed and manufactured by our company and currently installed at Arizona State College, Tempe, Ariz., at which location the photo-

graph was made. The gentleman standing nearest the reflector is Ralph White, our chief physicist.

We are flattered that you used a photograph of one of our instruments, but it would have been even more heart-warming to have it properly identified . . .

With the Pittsburgh Des Moines

Steel Co., we are currently contractors for design and construction of a solar furnace for the Air Force, which will have a paraboloidal reflector of approximately 110 ft. in diameter. This furnace will be erected at Cloudercroft, N. M.

JOSEPH KALLA

J. W. FECKER INC.  
PITTSBURGH 6, PA.

#### More OASI on Tape

Your article "Tape Links Office Systems" (May 20, p 17) was excellent.

In addition to GE, three other companies are now making their wage reports on tape: IBM, Consolidated Edison of N. Y., and Consolidated Telegraph and Electric Subway Co. Ford Motor Co. is all set up to make its next report on tape.

CHARLOTTE CRENSON  
SOCIAL SECURITY ADMINISTRATION  
BALTIMORE 2, MD.

#### A Small Point

The brief article "IRC Hires Two Sales Managers," (May 10, p 46) mentions that Otho C. Lindsey was hired away from our organization. Mr. Lindsey has not worked for Erie Resistor Corp. since July 27, 1949, when he left our employ for personal reasons.

I realize that this is a small point, but I did want you to know that Mr. Lindsey has not been associated with us for some time.

ROBERT W. SPARKS  
ERIE RESISTOR CORP.  
ERIE 6, PA.

#### Digitronics Revisited

I wish to correct some statements in your article "Digitronics Gets Under Way" (May 20, p 38) . . .

Digitronics is not operating from the Underwood plant in Long Island City. The company . . . officially vacated the Long Island City plant on May 21.

Slaw and Auerbach had nothing to do with the formation of Electronic Computer Corp. . . . They were both hired . . . after the formation of the company.

YALE JAY LUBKIN  
JACKSON HEIGHTS  
NEW YORK

## COMMUNICATIONS -- *Half the Battle!*

Will today's communications help win tomorrow's battles? For a good answer, take a look at how the U. S. Army Signal Corps is keeping ahead of the fast-changing techniques of military operations — by providing tomorrow's communications systems today.

Look, for example, at the Signal Corps' completely miniaturized, all-transistor carrier system for cable or microwave communication in the field. It is fully portable, takes up less than a cubic foot of space, weighs only 65 pounds (compared to 500 for comparable World War II equipment). It provides 4 separate channels, offers highly reliable operation under severe conditions ranging from Arctic cold to tropic sun.

Lenkurt was selected as prime contractor for the development of this carrier because of its capacity and experience as a specialist in telecommunications systems for public and private use. The answer to your most complex communications problem may be found in Lenkurt's unique facilities for research, development and precision production of carrier and microwave.

*Lenkurt*

ELECTRIC

San Carlos, Calif. • Mexico, D.F. • Vancouver, B.C.

Lenkurt products are distributed to public utilities by **AUTOMATIC ELECTRIC**





# THESE ARE SPRAGUE'S TWO OUTSTANDING HIGH-TEMPERATURE MAGNET WIRES



FOR CONTINUOUS OPERATION  
AT HOTTEST SPOT  
TEMPERATURES UP TO **200°C**

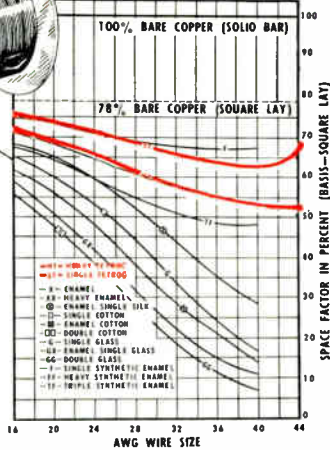

COMPARATIVE SPACE FACTOR OF MAGNET WIRES

# Tetroc®

FOR CONTINUOUS OPERATION  
AT HOTTEST SPOT  
TEMPERATURES UP TO **250°C**

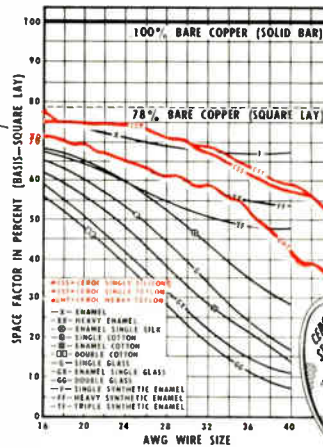

COMPARATIVE SPACE FACTOR OF MAGNET WIRES



# Ceroc®

SPRAGUE offers you a choice of 2 truly high-temperature magnet wires:

TETROC is recommended for continuous operation at hottest spot temperatures up to 200°C (392°F) and up to 250°C (482°F) for short periods of time. Tetroc, a teflon-insulated wire is available in both single and heavy coatings.

CEROC is recommended for continuous operation at hottest spot temperatures up to 250°C (482°F) and up to 300°C (572°F) for short periods of time. Ceroc wire insula-

tion consists of a ceramic base with either single or heavy Teflon overlays—combining the best properties of both materials.

Both Tetroc and Ceroc Magnet Wires provide extremely high space factors.

FOR COMPLETE DATA  
WRITE FOR ENGINEERING  
BULLETIN 405 (TETROC  
WIRES) 400A (CEROC  
WIRES).



ELECTRIC COMPANY • 35 MARSHALL ST. • NORTH ADAMS, MASS.

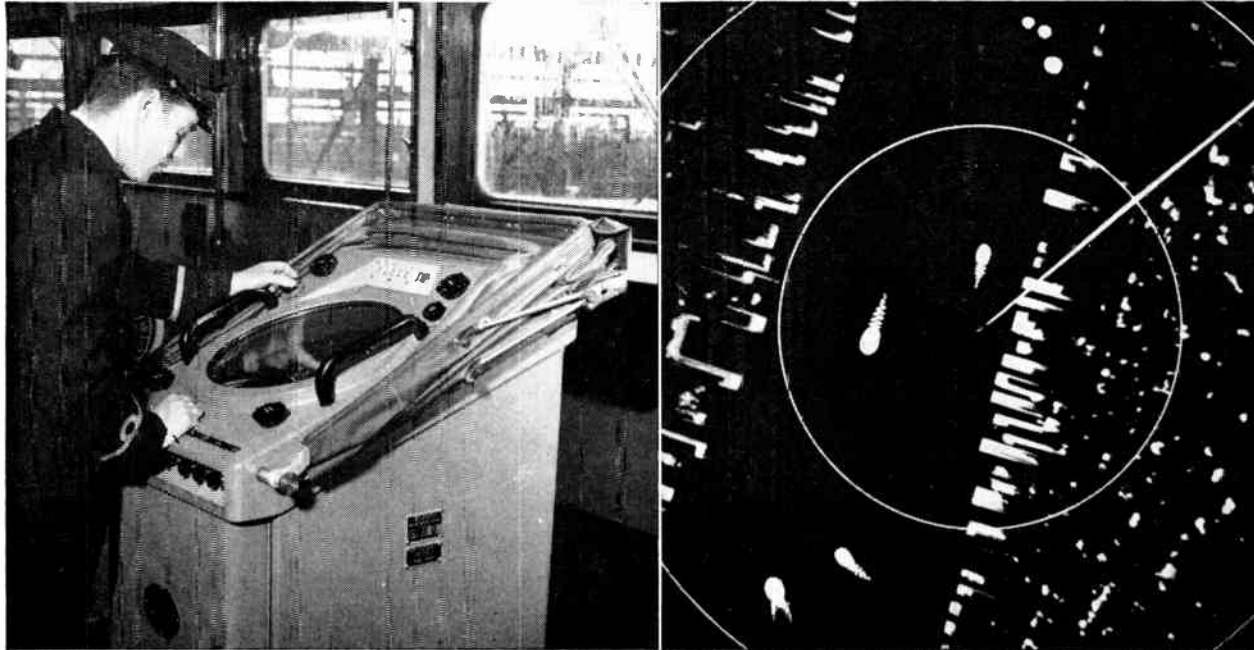

## Radarmen Sight New Targets

**They're making radar simpler to use, extending its coverage, cutting its price. Reason's clear—there are 36,000 small craft and 63,000 small planes, a good market for simple, cheap sets. One new development: true-movement radar (above)**

LAST Wednesday, Sperry Gyroscope's reconverted sub-chaser *Wanderer* (cover) wandered up the Hudson River. As it moved, the ppi scope on its Mark III radar showed newsmen a novel picture—a fixed map of the area, with a moving blip representing the ship itself picking its way upriver.

This true-movement radar makes it easy for untrained observers to figure out where they are and where they're going. It could make life simpler for skippers of small commercial vessels, who frequently have to operate the equipment themselves.

In another development, CAA early this month started a shakedown test of Haller Raymond & Brown's narrow-band video transmission system, Rafax. The agency has a test installation at New York's Idlewild Airport, wants to find out if Rafax can be used to extend radar coverage over all of a

controller's area of responsibility. CAA controllers now can see only part of the area for which they're responsible.

These two developments, geared to civilian uses of radar, point up a continuing trend on the part of a number of radarmakers to pry open other than military markets for their products.

Sperry's true-movement system will be a \$3,000-4,000 modification added to the firm's \$13,000-15,000 Mark III radar. Britain's Decca Radar is also making a "true-motion" system; as is Marconi. Raytheon is readying one, may use bright-face tv-type display to get a bright, persistent trace.

To make the land stand still and the ship itself move on the ppi display, radarmen make the set keep track of ship's bearing and speed. A small computer

figures out the course, adjusts starting point of the sweep to compensate.

Repeater on the gyro compass provides bearing information. A pitot tube or taffrail log sends in either synchro data or tachometer voltage proportional to speed. Sperry will also provide a corrector for drift if anybody wants it. The radar figures out plots of moving targets, provides true indication of actual position and movement.

**The Rafax system transmits coded radar video from remotely located sets to central control station, where it is decoded for ppi presentation. CAA is testing to see if it can live with two problems:**

- Loss of fidelity resulting from narrow-band transmission.
- Problem of registering radar information from several sources onto a single scope.

Rafax uses telephone lines, at about 1/100 the cost of microwave or coaxial cable. Scan frequency of the pickup is 1/10 that of the remote radar. CAA feels at this point that the fidelity loss is no real barrier.

**Commercial market for radar divides neatly into two groups in both sea and air.**

- Big commercial carriers: the 3,300 ocean-going liners, coastwise ships, tankers and other 1,000-gross-tons-and-up vessels, plus the commercial airlines.
- Small-craft sea and air fleet: fishing vessels, river boats, tugs, harbor craft, plus business and pleasure aircraft.

Small maritime vessels outnumber large more than ten to one. In the air, where the need for radar is greater, the difference is even more marked. There are 63,000 private aircraft now flying, compared to about 1,000 commercial air carriers, and this number is expected to grow to 100,000 private planes in the next twenty years.

Tighter control over air traffic will mean more radar in business and private planes—or else those planes will have to stay out of controlled airspace. But the sets will have to be cheap. Small operators can't afford \$10,000-and-up gear.

## Germans Build Radar

**New air traffic control equipment will have normal range of 137 miles**

WEST GERMANY is now back in radar development work after almost ten years during which activity in the field was forbidden. German radar activity became apparent with the recent announcement that three middle-range radar installations are being built

by the German AEG subsidiary, Telefunken.

The installations will be completed early in 1958 for air traffic control use in the areas around Munich, Frankfurt and Hanover. They range as high as 50,000 feet and as far as 137 mi. Up to now, radar used for German civil air traffic control ranged only a distance of 56 mi.

New antennas are 47 ft wide, 22 ft high, weigh 24.6 tons; they make six rotations a minute, have a pulse repetition frequency of 500 ppm and a two-microsecond pulse width.

Telefunken says that by using all of its reserve power the radar's range can be extended to over 322 mi and its height to 75,000 ft. For this range, the antenna would make 4.5 rotations a minute, pulse width would be 3.3 microseconds and the pulse repetition frequency 250 ppm.

## PPI Map Aids Pilots

**Electronics and photography produce real-time moving-strip transparency**

RADAR OBSERVERS, both airborne and ground based, can now watch a 20-second-old, moving transparency strip map of the radar scope.

Advantages of consulting a photograph rather than the scope itself are that the transparency is automatically corrected for the presentation's altitude distortion and that the photographed map is permanent, not temporary like the scope display.

Called a Radar Strip Recorder, the device, once switched on, requires no operator. High-sensitivity film processed continuously in a single liquid bath results in a slowly moving transparency strip which is viewed on a translucent 9 by 12-in screen. Speed of film can be set to correspond to airplane velocity.

Reconnaissance pictures can be brought back to the base for study and the navigator can check back to a picture of any moment of his flight.

Used with ground surveillance radar, a permanent record can be made of the flight path of a missile, air traffic control conditions, or of data telemetered back from flying aircraft.

Manufacturer Hycon sees additional application in civilian and military telemetering systems on the ground. Also, electronic computers can make efficient use of the almost-real-time, yet permanent, recording characteristics of the machine.

Manual controls allow setting plus or minus twelve degrees wind drift into the machine, providing in most cases a photograph that can be compared to a topographical map or aerial photograph. If a 45 by 60-mile area is scanned, the resulting photographic map will have a scale of 1 to 500,000. If a 22½ by 30-mile area is chosen, then the map presented will have a scale of 1 to 250,000.



# Twt's Join Magnetrons

- **Traveling-wave tubes prove interesting to radar designers, supplementing magnetrons in special applications**
- **Velocity-modulated tubes — twt's, maggies, klystrons — rise from \$4 million to \$70 million in 10 years**

ASK a microwave development engineer what's new today and he's likely to start talking about traveling-wave tubes.

Where military needs justify added expense and systems size, ground-excited oscillators such as the magnetron are giving way to traveling-wave tubes in broadband amplifier chains.

To date, switch to traveling-wave systems is primarily in ground radar. Even here, manufacturers state, sales of magnetrons will remain high through the replacement market. Most of the radar equipment dating back to World War II is built around magnetrons.

A satisfactory substitute for magnetrons in airborne equipment is not yet on hand, says W. T. Welsh, Raytheon microwave and power tube sales

v-p. "Pound for pound, magnetrons give more power," he explains.

Raytheon is concentrating development on amplitrons driving traveling-wave tubes as one way to provide high microwave power. Amplitrons have the magnet as a circuit component, not in the tube.

Traveling-wave tubes are now finding their way into microwave communications gear and other places where klystrons have been used. It is not yet a high volume application, according to E. G. Cameron, Varian Associates tubes v-p. World klystron sales, he believes, are gaining faster overall than sales lost to traveling-wave tubes.

Big potential markets for magnetrons are in instruments, microwave cooking and diathermy. High-power klystrons have prospects in x-ray and radiation



## New Nuclear Reactor Gets Dry Run

Controls of AEC's organic moderated reactor are checked out by North American Aviation technician.

AEC will use reactor, nearing completion in Idaho, in search for economical power from atomic energy

food and drug sterilization equipment.

Manufacturers aren't sure traveling-wave tubes or klystrons will ever topple magnetrons from sales dominance. But most are riding two or three horses just in case. Some are investigating semiconductors and ferrites as long-range insurance.

The way radar, missile guidance, countermeasures and other microwave applications are growing, makers of velocity-modulated tubes, including magnetrons, klystrons and twt's, see a 10 to 20-percent annual increase for at least five years.

NEMA members reporting their figures sold \$37 million of magnetrons and other velocity-modulated tubes in 1952, \$55 million in 1954 and \$62 million in 1956. Census reports, which have a broader base and include in-plant use, show total production of \$4 million in 1947, \$60 million in 1954, including \$50 million for magnetrons. Estimate for 1956 is about \$70 million.

Transmit-receive tubes and boxes, mainly used to duplex radar antenna systems, have been slowly declining in dollar volume, according to NEMA sales reports. Gaps and t-r boxes were an \$8-million item in 1952, \$5 million in 1956.

Transmit-receive tubes may give way to solid-state ferrite switches in the next few years. These can be made to perform the t-r job by rotation of polarity. They can't yet match some t-r tubes in power handling, however.

Tubes like the amplatron, which have no reverse attenuation, can boost use of ferrite t-r's. The t-r can be placed on the low power side of an amplatron where it won't have to withstand the tube's entire power output.

Much of the current microwave tube work is concentrated on tougher, more versatile and lighter tubes and tube systems.

Voltage-tunable magnetrons are in volume production this year. Backward-wave magnetrons, Sylvania reports, combine a magnetron's advantage, power, with electronic rather than mechanical tuning.

Metal envelopes today avoid some of the structural problems of glass tubes, help meet military demands for reliability.

Sylvania has a twt system which it says is 80 percent lighter than some other systems. It expects this to spur aircraft and commercial use of twt's.

Several portable battlefield radars are on tap.

## PRODUCTION and SALES



## Missiles Seize Military Lead

GUIDED MISSILES now lead in military electronics spending.

The big birds took first place from aircraft in the third quarter of fiscal year 1957. Missile electronics expenditures totaled \$311 million in the quarter compared with \$258 million for aircraft. Missiles received 33 percent of the \$952 million spent on all military electronics while aircraft received 27 percent.

Cumulative total for the first

three fiscal quarters show missile electronics expenditures leading aircraft electronics \$775 million to \$741 million.

Electronics expenditures for the full fiscal year should total about \$1 billion for missiles and \$950 million for aircraft.

Seven years ago missile electronics expenditures amounted to only \$11 million, representing but 1½ percent of all military elec-

tronics. Aircraft expenditures then amounted to \$314 million or 42 percent of total military electronics expenditures.

Share of missile spending going to electronics creates the present picture. Total aircraft procurement is still many times total missile procurement. But, electronics portion of all missile expenditures averages 55 percent compared 13 percent for aircraft.

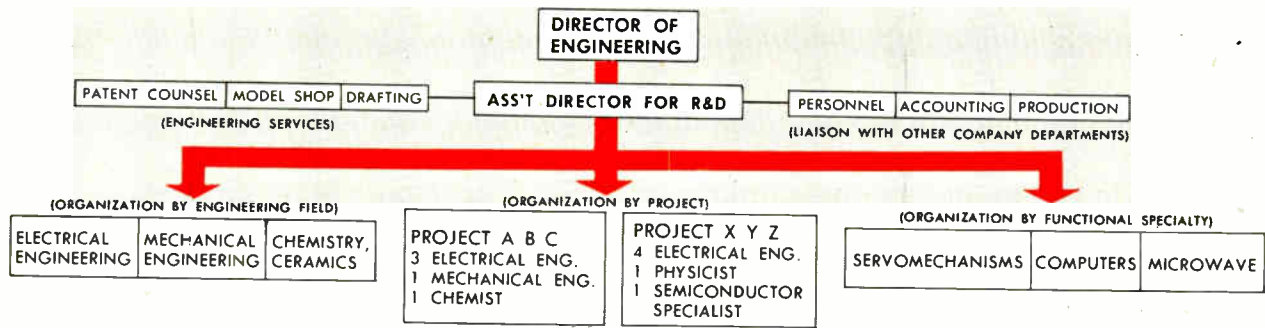

# Organization: Rx for R&D

- Group effort is key to R&D achievements in today's competitive situation. Organizing the effort is the problem
- Organizing the effort is dependent on product, number of people involved and their experience

RESEARCH and development is like a growth hormone to electronics industry. Organization alone won't guarantee a good R&D department, but it helps.

"Today, group effort has become more and more the key to scientific and engineering achievement," said one executive recently. "The day of the lone wolf in research or engineering has long passed." And group effort requires organization.

Research and development activities can be organized in any of several ways. More frequently combinations of the basic structure are used.

Despite relative advantages of different types, best organization for a particular operation depends on size and type of product, number of people involved, training and experience of personnel. Basic types are:

**Engineering field.** Electrical engineers, mechanical engineers, chemical engineers each are put in a separate group. Portions of project requiring talent of a particular group are assigned to that group.

**Functional.** Engineers specializing in a field, such as servomechanics, computers, are grouped. Part of a complex project may be assigned each group.

**Project or product.** All engineers needed for a project work as a team. Other projects have their own teams.

Organizing by engineering field is not common in electronics. In electronics firms there are usually many more EE's than anything else.

**Functional organizations encourage specialization.** Because of the ever increasing complexity of electronic gear, it is impractical to expect one man to be

familiar with all areas of the field. But individuals in the functional setup are not identified with specific projects and team spirit is difficult to develop.

With a functional structure, portions of a project are likely to be modified versions of what was used on another project, rather than designed specifically to fill the needs of the project at hand.

The project-type structure develops team spirit but may lead to overlapping of effort. Competing groups may be developing circuits that are just as suitable for other projects.

Many electronics firms prefer a tailor-made combination that combines teamwork of the project setup with the flexibility of the functional structure.

Anton Electronics Laboratories, subsidiary of U. S. Hoffman Machinery, for example, classifies its personnel by engineering field and draws upon these pools for specific projects.

The man whose field is dominant in a project takes charge of engineering. A chemical engineer might head development of a scintillation-crystal counting device, coordinating assistance of other sections as needed.

Kearfott, for example, organizes its engineering division by product lines, but each man in R&D usually works on more than one project.

Big, long-range projects, however, require what almost amounts to a separate engineering department.

Managers of various sections and projects operate like they are running their own businesses. They outline target dates and costs, buy staff services, maintain a vendor-to-customer relationship with management as well as with customers.



*Richmond-Petersburg-Hopewell*

# IRGINIA

*Captain West's land bargain paved the way for your plant*

At the cost of "somme olde copper," Captain Francis West bought the land at the Falls of the James. That was in 1610. Today, this area forms the heart of the Richmond-Petersburg-Hopewell triangle. And, though Captain West never profited from his shrewd buy—you can! For you'll find here some of the nation's best industrial site bargains.

Here, close to Northern markets, you enjoy the competitive advantages of Southern manpower and climate. Five major airlines speed your business trips, and mail.

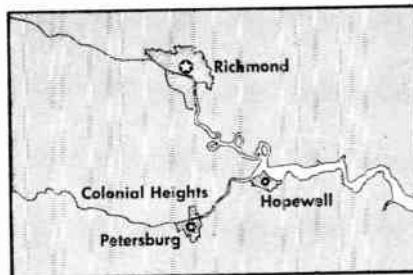

Five main line railroads and 56 truck lines put you within overnight reach of New York, Atlanta, Pittsburgh . . . with favorable rates to the Mid-West. And the James River deepwater channel brings world shipping to your door.

Abundant, low-cost electricity flows from VEPCO's modern power network. Capability is already 1,362,000 kilowatts . . . and it's building to 2,000,000 kilowatts by 1959. You have natural gas on tap. Coal, wood, basic chemicals, marine and vegetable oils roll in at short-haul savings.

For full facts about industrial water and waste disposal . . . taxes, zoning . . . education, recreation, housing . . . or for confidential site finding help . . . write or phone VEPCO, serving "The Top of the South."

SEE SIGHTS AND SITES!  
Visit Jamestown Festival, up to  
Nov. 30, 1957 . . . and, see some  
of Virginia's plant sites, too!



## VIRGINIA ELECTRIC and POWER COMPANY

Clark P. Spellman, Director—Area Development  
Electric Building, Richmond 9, Virginia • Phone: 86-1411

# Packaging Cuts Costs

- Packaging technique lowers labor costs at shipping and receiving ends, reduces freight charges
- Uniform pallets, foam plastic blocks are two ingredients. Military is deep in packaging research

New packing techniques for electronic gear are cutting costs, providing better protection for equipment. Right now many manufacturers are overhauling their shipping practices.

Methods lower labor costs at the shipping and receiving ends, pare freight charges. Plastic bags are keeping apparatus dry; embedding in foam plastic block is protecting it from shock. New humidity indicators cut cost of determining moisture content.

**Pallets are key to much of the savings. These platforms, usually made of wood, permit handling a number of individual pieces as a single unit.**

Bendix ships goods in a telescoping box on a pallet. Sixteen of these boxes fill a ten-ton truck. One driver and a fork truck can load a truck in 45 minutes. Job used to take 4 man hours.

Bendix also likes pallets at the receiving end. Packaging engineer E. K. Gustin says 30 percent more material is being received with a third less manpower. Suppliers help by using pallets that fit Bendix's materials-handling system.

About 50 million wooden pallets were produced in all during 1956. They sold for about \$120 million. The pallets may be designed for specific gear or may be general purpose types.

Plastic products can reduce costs as well as protect gear. R. E. Chrisman of Bendix Pioneer-Central division says instruments used to be wrapped in polyethylene-coated kraft paper supplied in roll form. To save time in estimating material lengths, polyethylene bags in three stock sizes were substituted. Customers can reuse the bags.

Electronics firms are using more transparent polyethylene bags with tongue-and-groove type plastic zippers. W. N. Reimann, manager, plastics division, Kennedy Car Liner and Bag says zipper bags serve as dustproof, leakproof, airtight, watertight covers.

Packaging in transparent, flexible plastic bags is growing by leaps and bounds, will reach an estimated consumption in 1960 of close to 700 million pounds worth almost \$382 million. By 1965 production of flexible packaging films may exceed the billion pounds a year mark.

For shock resistance electronic parts can be buried

in a protective block of urethane foam plastic by the Pak-N-Foam system. A machine was designed and built by the Freeman Chemical Corp. for the job.

Before foaming, the item is enclosed in a polyethylene bag. Raw materials are metered to machine's mixing head according to the formula used. Then material is dispensed into a corrugated carton so that it surrounds the bagged apparatus. In two to three minutes foam can withstand normal handling of the package. Machine will be leased for \$1,900 a year on a three-year basis.

The elements have always caused packaging problems. Humidity in particular is a natural enemy of electronics.

U.S. Dept. of Defense will soon issue a coordinated specification for an electronic humidity sensing system to determine moisture content of sealed packages. A recent Defense Dept. exhibit showed one in action.

Average cost of determining moisture in a large sealed package used to be \$75. A new resistance-type sensor with electronic amplifier does it for 17 cents. U.S. Engineers Corps says one man using this system can check up to 100 packages per hour.

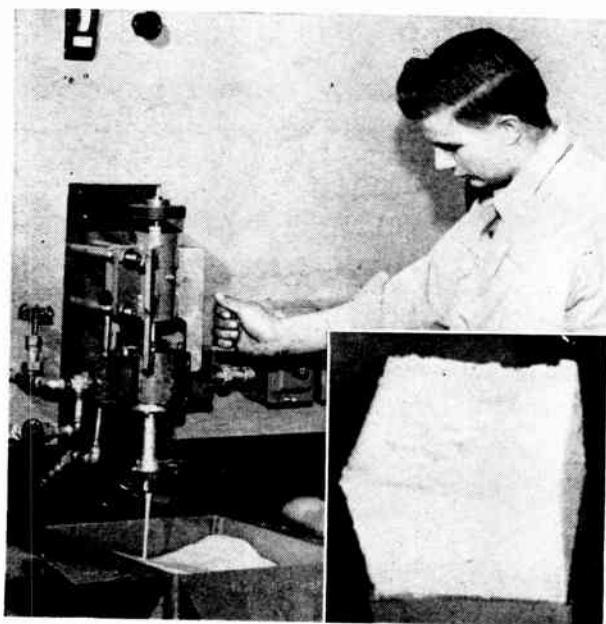

Operator fills corrugated carton with urethane foam to make protective block (insert). Plastic bag surrounds equipment, keeps foam out of the works

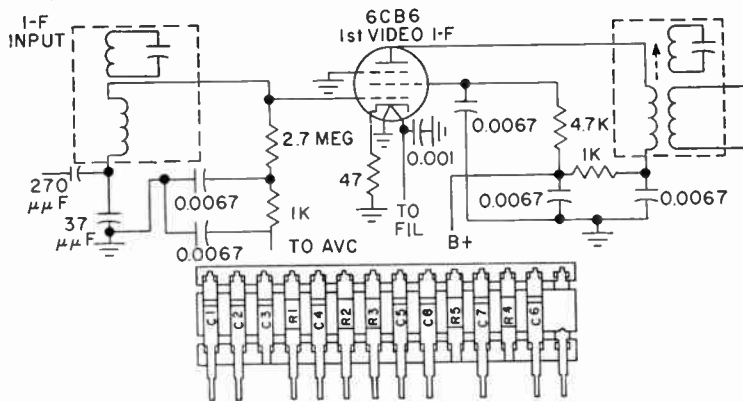
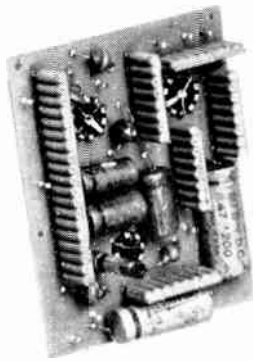

## Encapsulated packaged circuits, and . . .

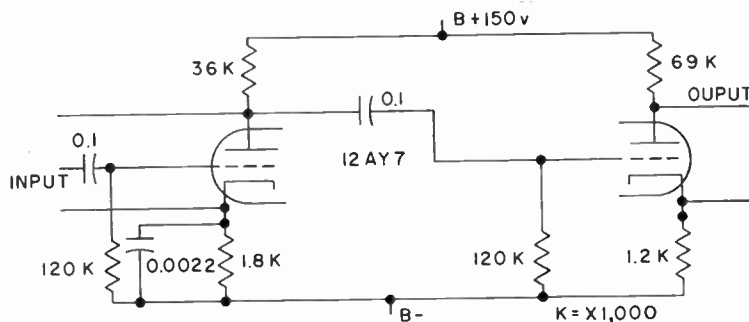
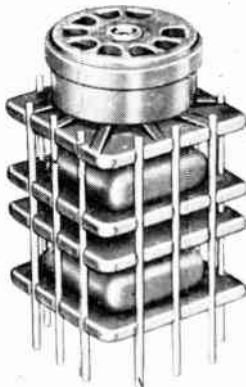

## wafer modules, two approaches to . . .

# Store-Bought Electronic Circuits

**Packaged circuits cut equipment assembly time and sometimes cost less than components bought separately. Component makers see a \$20-25 million demand for packaged circuits in 1957 and a rapidly expanding market as the idea catches on**

AN ASSEMBLER at a midwest plant last week picked up something looking like a match folder on legs and slipped the legs into holes in a printed-wiring board. A 13-part network had just joined a half-assembled radio.

The scene was repeated in substance at many radio and tv plants across the country. In some, the units looked more like combs and in others, like little skyscrapers

Combining typical electronic components such as resistors and capacitors into combination components has become big business and is getting bigger. Makers culled about \$15 million last year, can take \$20 to \$25 million in 1957.

Figure includes modules and some packaged cir-

uits. Modules are networks, often printed on ceramic wafers, made into standard-sized parts which can be stacked.

Packaged circuits use conventional electronic components, wired to plug into a circuit board.

Both modules and packaged circuits are assembled almost completely automatically. Raw materials are fed into complex machines to produce the units. Circuits may then be encapsulated.

Ultimately, three-fourths of the two billion resistors and capacitors used annually in radio, tv and phonographs may come in modules and packaged units.

More radio and tv firms are reported coming into the fold and sales to the old customers are increasing.

Motorola will use about a million modules and packaged circuits this year in portable radios and 17-inch tv sets. This is 75 percent over 1956.

**Combination components are also branching out into computer subsystems, military gear, auto headlight dimmers, electronic organs, commercial transceivers.**

Reasons are:

- Stacking modules vertically saves space, particularly on printed-wiring boards.
- Modules and packaged circuits foster uniformity, place some of the parts handling, testing and assembly burdens on the component makers.
- Packaging complete circuits helps unclutter complex systems, aids in miniaturization.
- Trouble shooting need only go down to the group of component in the unit, not the part.

**Prices vary widely. One firm sells a simple resistor-capacitor combination for seven cents, a complete oscillator for \$14. Average markup over cost of components purchased separately appears to be five to 20 percent. Higher first cost is overcome in savings on the buyer's assembly line.**

Some modules and packaged circuits made from

raw materials or partially finished components are actually cheaper than materials purchased separately. One nine-part circuit sells for 21 cents; the parts separately, 24 cents.

Makers expect the day will come when all combination components generally are cheaper than total cost of components separately.

**Use today is restricted mainly to circuits made to order in big lots. High volume is needed to absorb design and machine setup costs. One firm says the minimum practicable order is 1,000, unless repeat orders are assured.**

Some component makers see the questions of cost and volume answered by standardized circuits sold from stock. One firm now offers 15, from a linear amplifier at \$2.75 to a d-c regulator at \$13.55.

Modules and packaged circuits, even 10 years ago, were not new but another way of selling components. Makers realize they must reckon with the trend.

Business has stayed in the main with firms well established in the parts field—firms like ACF, Acrovox, Centralab, Eric Resistor, GE, Speer Carbon, Sprague and others.

Jack Speer points out that you have to know resistors and capacitors before you can adapt them to packaged circuits. Modules can put parts makers into a second market area, circuit assembly.

---

## Technical DIGEST

• A pure lead cylinder 2 inches in diameter and 4 inches long is the basis of a new airborne electronic countermeasures system for foiling hostile electromagnetic radiations. It is held at 4 to 7 deg K in a flask of liquid helium insulated with liquid nitrogen. This new application of superconductivity, under development by FTL's electronics countermeasures lab for the Air Force, shows promise of reducing weight requirements appreciably, since only one 5-liter helium flask is needed per plane. Associated electronic circuitry is similarly light.

• New metal detector is based on transient change in Q of resonant circuit. Developed by ASFA in Sweden, it can be used with various input heads to detect and sort materials having high dielectric losses, as well as ferrous and non-

ferrous metals. Applications include automatic sorting of slate from coal, grading of copper ore and detection of valuable nickel, chromium and stainless steel in slag. Circuit uses only three tubes plus neon voltage regulator.

• New blue-recording Lorenz MS 17-21 cathode-ray oscilloscope tube uses electron beam to produce blue-violet trace on thin mica plate. Plate is lined inside with potassium chloride and has transparent conductive layer outside. Trace will last several days but can be extinguished in seconds by sending heating current through conductive layer. Up to 12 different lines of waveforms can be recorded one under the other for comparison. Traces can be photographed at leisure.

• Calibrated moving-coil relay developed by Smith's Industrial Instruments Ltd., England, gives snap-action operation with operat-

ing voltages or currents within 1 percent of rated value. Construction resembles that of permanent-magnet loudspeaker. Moving contact and soft iron disk are attached to voice coil, which moves between two pairs of pole pieces. Operating power is 30 mw.

• Synchronous spot wobble gives greatly improved resolution on British 405-line television pictures. Electron-beam spot is electromagnetically wobbled at camera pickup tube to fill in spaces between lines, and receiver spot wobbler voltage is synchronized in frequency and phase. Spot-wobble frequency of 6 mc gives excellent results but demands video bandwidth of at least 6 mc.

British engineers A. E. Sarson and P. B. Stock suggest transmission of several cycles of spot-wobble frequency as burst on back porch of existing line sync pulse, much as in NTSC color tv, to sync receivers.



*“Our greatest challenge . . .  
the development of men”*

Ralph Cordiner, President, General Electric Company

*“Few expenditures we can make are more important than those for education. A well-educated person produces more and consumes more, makes wiser decisions at the polls, mounts a stronger defense against aggression, and is better able to perform the grave responsibilities of American citizenship.*

*“Freedom needs educated people. So do business and industry. I earnestly ask you to support the college or university of your choice in its planning for expansion and a stronger faculty. The returns will be greater than you think.”*



If you want more information on the problems faced by higher education, write to: Council For Financial Aid To Education, Inc., 6 E. 45th Street, New York 17, New York



*Sponsored as a public service, in cooperation with the Council for Financial Aid to Education*



# Transistor Switching

**Electronics used in new phone switch;  
Remote unit operates on pole or wall.  
Need for new cable may be cut 75%**

TRANSISTORS and other electronic components are making a serious bid this year to take over important electromechanical functions in existing telephone switching systems.

Electronic telephone switching unit small enough for pole or wall mounting and a system using ten of these units have been developed by Bell Telephone Laboratories.

Advanced transistors and semiconductor diodes make new switching units or line concentrators feasible in places where more and more telephone users must be connected to switching centers.

New line concentrator system has been tested and is undergoing final field trials preparatory to manufacture by the Western Electric Co.

Use of electronics in this system suggests vast future telephone demand as companies move toward more electronic switching.

One line concentrator contains 196 transistors, 302 diodes.

Telephone office unit handling 10 concentrators contains 755 transistors, 1,630 diodes.

Many 10,000-line offices have more than \$1 million in cable and wire connecting customers with the offices, more than \$100 per line.

An electronic line concentrator system may reduce cable needs 75 percent as new telephones are installed and mean substantial dollar savings to telephone companies.

Other factors point up the system's advantages, says Bell.

Sizable annual charges for maintenance of customer lines are presently required. Periodic copper shortages coupled with telephone plant expansion have made it difficult to meet cable demands.

Reduction of lines takes advantage of telephone traffic statistics. Present switching systems are engineered to handle 15-20 percent of customer lines connected to it; average customer uses his telephone

only 5-10 percent of time during busiest hours.

Bell Labs says concentrators were not previously profitable largely due to size and weight, lack of component reliability and high system costs. Recent transistors, semiconductor diodes, dry-reed glass-sealed switches and nickel-cadmium batteries now make line concentrator systems economically feasible, says Bell.

Transistors and other devices reduce average power drain per concentrator to about 5 watts, but peak power needs are much higher. Sealed nickel-cadmium storage batteries, therefore, supply peak loads. They are kept charged with dc from telephone office, also provide standby power in case regular supply is cut off.

Each line concentrator is slaved to central office equipment called a line-link frame. Pulses sent from frame to concentrator cause a four-times-per-second sampling of lines. When user picks up telephone next sampling of his line detects it. Service request signal then goes to telephone office. Time position of this signal in sampling cycle identifies calling line.

Other switching steps follow until customer hears dial tone from 260 to 520 milliseconds later, depending on line's position in sampling cycle.

## Movies Expand Magnetic Sound

MAGNETIC recording on motion-picture film is gaining in versatility. New techniques expected to spur use were described at Society of Motion Picture and Television Engineers convention in Washington.

Technique described by George Lewin of the Army Pictorial Center uses a magnetic sound track which is superimposed on optical sound

track without affecting the optical track. Quality of sound reproduction is believed higher than that gotten with the usual method of giving a half track each to magnetic and optical recording.

The trick is to use projectors with lead-sulfide photoconductive cells and infrared lighting. Magnetic stripe passes infrared rays which are modulated by the optical track. Lead-sulfide is infrared-sensitive.

Method may foster multilingual films. Army is already using the technique, which works well in most Army projectors. Other projectors may require modification.

CBS-News is switching from optical to magnetic sound tracks in 16-mm news and documentary film. Magnetic stripe is applied before exposure and a magnetic recording unit on the camera records during filming.

Minnesota Mining & Manufacturing recently announced a lamination method of applying magnetic oxides to 8-mm and 16-mm film. The stripe can be applied before or after exposure, or can put a new track on an old film.

## Assembly Line Straightener

ELECTRONICS assembly line workers at Rollins Electronic, Lewes, Del., have over the past year been put through two rigorous tests.

Results of the tests: Revised job assignments, increased production, lower assembly line costs, higher salaries, less turnover of employees.

Instituted and administered by Patten Management Engineers, tests are common aptitude types. One is called the Purdue; other is known as the McQuarrie.

The first measures dexterity while the other checks mechanical ability. The tests take only a half hour and cost on the average of \$1 per employee.

Using the results, workers with best all around scores were put in control spots on assembly line. Others were fitted in as per talent.

Each line became a smooth production unit. Level of production of one line was maintained under this system even though workers were reduced from six to four.

# Texas Star Ascends

In Dallas-Fort Worth area, thriving electronics business takes on proportions of a major boom. Four firms boast total \$46 million backlog

SIGNIFICANT expansion of the electronic instrumentation industry goes back 10 years in Texas' Dallas and Fort Worth area. But the past few years have seen an exceptional boom. Today four electronics firms have piled up a \$46 million total in backlog orders.

One part of the electronics picture is the growing aircraft industry in the Dallas-Fort Worth area.

Still another part is in instrumentation for the oil industry.

Texas Instruments, Dallas, is considered by some to be symbolic of the area's growth. It has grown twenty-fold in the last ten years and is now constructing a \$4-million plant.

Sales for the apparatus division of TI which produces complete electronic and electromechanical systems—primarily for military use—were \$12.8 million last year. Company has a military backlog of \$25 million.

Texas Instruments sales reached \$45,699,358 in 1956 as compared with \$28,684,653 in 1955. President J. E. Jonsson predicts that sales may reach \$65,000,000 in 1957.

Shaw and Estes is another of the firms hitting pay dirt with technological skill in the booming instrumentation picture of the area. It engages in research, development and construction of test systems for the Air Force, Navy, Atomic En-

ergy Commission, and commercial and military manufacturers in aircraft and other industries.

Organized in 1945 Shaw and Estes sales last year totaled \$5 million. They have an \$11-million military backlog.

Varo Manufacturing Co., Inc., located at Garland, northeast of Dallas, does a \$6-million business in the utilization of electronic controls on power conversion equipment.

Continental Electronics Mfg. Co. of Dallas has a backlog of \$6 million. Their sales last year reached \$2.5 million.

A Fort Worth firm, Westronics, does contract work, industrial instrument manufacturing and oil-field electronics.

The Texas Division of Collins Radio, Dallas, recently picked up a \$3.1-million Civil Aeronautics Administration contract for 22 microwave radio relay installations. The firm has 2,150 employees in the area.

The four aircraft firms in the area are Convair of Fort Worth, Chance Vought Aircraft of Dallas, Temco Aircraft of Dallas and Bell Helicopter of Fort Worth. All are in electronics to varying degrees.

Besides a number of other electronics firms, there are numerous engineering firms which get into electronics. These design oil refineries and petrochemical plants.

## Fax Sends Polaroid Prints

FACSIMILE equipment unveiled last month by the Army handles  $3\frac{1}{4}$  by  $4\frac{1}{4}$  in. Polaroid prints and can fit into the back of a jeep.

Army Signal Engineering Laboratories at Fort Monmouth developed the set for rugged field use. GI's merely push a print into the slot and a flip switch. Five minutes after the photographer first clicks his camera shutter, a photo with

200 lines per in. resolution rolls out of a facsimile receiving unit miles away. This includes one minute at each end for printing Polaroid film.

Polaroid picture goes into facsimile machine vertically, not on the usual rotating drum. Revolving mirror scans the print.

Times Facsimile has built two pairs of experimental machines. Air

Force weathermen are testing one pair. Other services are interested too, but waiting for further studies to determine full military usefulness.

Weather Bureau and the Air Force might be interested in transmitting radarscope hurricane pictures. Polaroid film is said to save at least 40 valuable minutes otherwise lost in developing, printing and drying. This might be significant in giving advance warning of storm or battle.

## UK-China Trade Uncertain

BRITISH electronic firms are uncertain what benefits will come from last month's relaxation of complete embargo on trade with Red China. Several large companies in the past received orders as a result of visits by businessmen to Peiping, but shipments were never made because of the embargo.

Observers believe firms with such contacts will push delivery. Others will try to make contacts. Four years ago 50 instrument makers organized an exhibit of the Scientific Manufacturers Association for a visiting group from the China National Import and Export Corp. (CNI&C).

It's known the Chinese Communists are interested in communication systems, especially ssb transmitters and receivers, and standard laboratory equipment such as vacuum-tube voltmeters and oscilloscopes.

But one industry source feels trade in electronic gear on the freed list will not reach anything like a boom. The list of prohibited items is still formidable, same as that prohibited for the Soviet Union for many years.

Britain's exports to Red China amount to only one to two percent of total exports. Assuming electronics could build up to the same percentage as other exports, this may mean a market of \$1 to \$2 million. But, add British trade observers, this is just speculation—nobody would be surprised if the figure is not reached or, alternatively, if a single firm got a single order amounting to that much.

**SPECIAL  
MARKET  
REPORT**

# ELECTRONICS INDUSTRY-1957

- **Manufacturers sales of electronic equipment and replacement parts will reach \$6.914 billion, up 7.3 percent over 1956 sales**
- **Military electronics will take nearly half of total; industrial electronics sales show rapid growth**

**M**IDYEAR is a good time to check earlier market estimates and see just how well our industry is actually doing.

It is doing very well. Manufacturers sales of electronic equipment and replacement parts for 1957 should reach \$6.914 billion.

Strongest part of market is the military business, with the burgeoning guided-missile program leading the way. On the civilian side, the replacement parts market shows exceptional strength.

Even prosperity is not without some pain, however. Some weakness is still evident in monochrome television sales and the home radio market. Shifting emphasis from piloted aircraft to guided missiles is causing some readjustment among defense producers. But in general the trend is up and the future looks good.

The figures in this midyear estimate are based on manufacturers sales and estimated sales of electronic end equipment and replacement parts only. They exclude broadcasting revenue, distribution income and intra-industry sales of parts and components.

In the various industrial and commercial sales categories, we have subtracted sales of off-the-shelf items to the armed forces. These sales are included in the military electronics category.

**MILITARY**—The electronics industry continues to be heavily dependent on defense spending. This year 47.7 percent of manufacturers sales will prob-

ably be to the armed forces, as against 47.5 percent in 1956.

Military sales for 1957 should total \$3.303 billion, up 8.2 percent over 1956 sales of \$3.052 billion.

Heaviest spending will be for missile guidance:

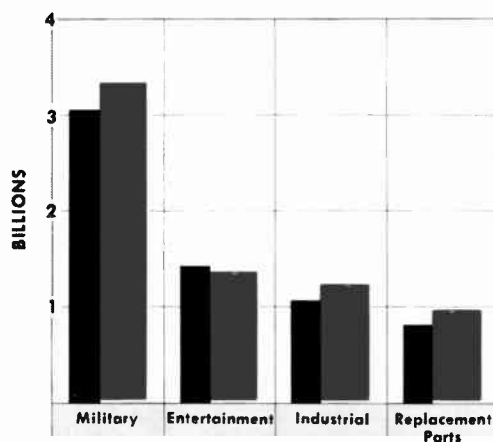

**TOTAL SALES:**

**1956 \$6.444 BILLION**  
**1957 \$6.914 BILLION**

**MANUFACTURERS SALES OF ELECTRONIC EQUIPMENT & REPLACEMENT PARTS — 1956/1957**

**SALES OF MILITARY ELECTRONIC  
EQUIPMENT AND REPLACEMENT PARTS  
1956/1957**

	1956	1957
HOME RADIO	\$ 113,800,000	\$ 106,600,000
AUTO RADIO	126,400,000	139,300,000
PORTABLE RADIO	64,000,000	74,000,000
COLOR TELEVISION	42,000,000	52,000,000
MONOCHROME TELEVISION	864,600,000	843,300,000
PHONOS, TAPE RECORDERS ETC.	135,100,000	150,000,000
MISCELLANEOUS	175,000,000	100,000,000
<b>TOTAL SALES</b>	<b>\$1,520,900,000</b>	<b>\$1,465,200,000</b>

**MANUFACTURERS SALES OF ELECTRONIC  
ENTERTAINMENT EQUIPMENT  
1956/1957**

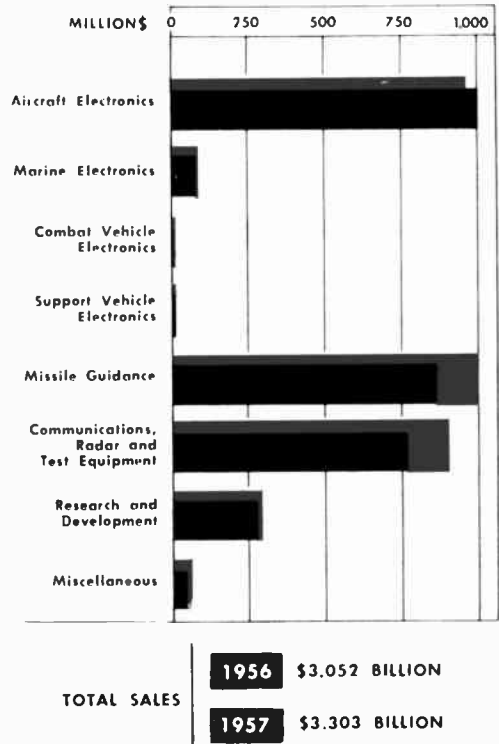

\$1 billion. This is the largest single item of the whole electronics industry. It makes up 30.3 percent of military spending for electronics, 14.4 percent of total industry sales.

Drop in aircraft electronics spending, \$960 million in 1957 as against \$1 billion in 1956, reflects increasing emphasis on guided missiles. Total spending for both aircraft electronics and missile guidance, however, is up \$93 million for 1957 over 1956 figures.

**ENTERTAINMENT**—The giant radio-tv set manufacturing business has been widely publicized as the momentarily sick man of the electronics industry. However, factory shipments of monochrome television sets may be down only 2.4 percent in 1957 over 1956 shipments. Factory sales of home radios may be down less than 6.3 percent. These declines could be almost offset by gains in automobile and portable radio sales.

Color television is showing an encouraging, although by no means spectacular, gain.

Generally the future looks good in the overall electronic entertainment equipment business too.

Sales for 1957 should be down only 3.7 percent from 1956.

**PARTS**—Fastest growth this year has been in replacement parts. Sales will be up 16.5 percent over 1956 by the end of this year, in all probability. The replacement parts business, at factory-door prices, is nearing the \$1-billion mark.

Sales of monochrome picture tubes point the way, with \$137 million expected for 1957 against \$118 million in 1956. Sales of replacement receiving tubes and other parts are also climbing.

**INDUSTRIAL**—The industrial and commercial market, if experience thus far this year is projected, shows a 13.3 percent rise in 1957 over 1956 sales. However, much of this growth is fostered by the defense effort.

Four big segments, data processing, test instruments, industrial control and atomic instrumentation, depend to some extent on the military business. Companies often buy such equipment to get ready for big military production and R&D contracts. These four categories somewhat dependent on military spending amount to \$587 million out of a total

**MANUFACTURERS SALES OF INDUSTRIAL AND COMMERCIAL ELECTRONIC EQUIPMENT 1956/1957**

	1956	1957
BROADCAST EQUIPMENT	\$ 87,000,000	\$ 91,000,000
MOBILE RADIO	85,000,000	89,000,000
MICROWAVE RELAY	30,000,000	31,000,000
MARINE EQUIPMENT	15,000,000	16,000,000
AVIATION EQUIPMENT	30,000,000	31,000,000
OTHER COMMUNICATIONS	15,000,000	16,000,000
DATA PROCESSING	100,000,000	200,000,000
TEST INSTRUMENTS	186,000,000	194,000,000
INDUSTRIAL CONTROLS	150,000,000	157,000,000
X-RAY	85,000,000	88,000,000
ATOMIC INSTRUMENTATION	35,000,000	36,000,000
ELECTRONIC HEATING	30,000,000	31,000,000
INDUSTRIAL TELEVISION	3,000,000	4,000,000
COMMERCIAL SOUND	175,000,000	182,000,000
THEATER EQUIPMENT	15,000,000	15,000,000
MISCELLANEOUS	20,000,000	21,000,000
<b>TOTAL SALES</b>	<b>\$1,061,000,000</b>	<b>\$1,202,000,000</b>

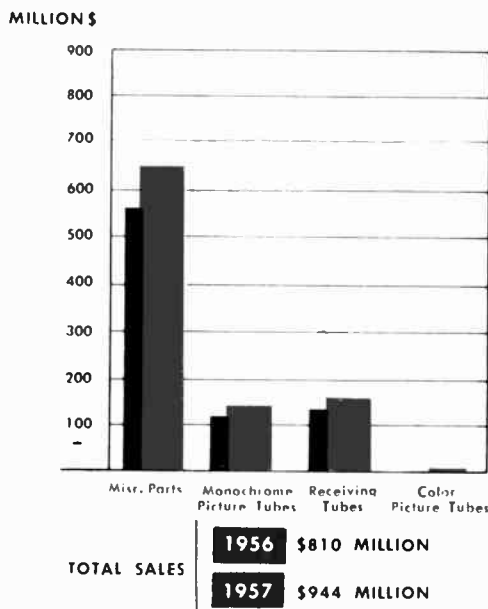

**MANUFACTURERS SALES OF REPLACEMENT PARTS 1956/1957**

industrial and commercial market of \$1.202 billion.

Strongest single portion of the industrial market will perhaps be electronic data processing, \$200 million based on orders currently booked by manufacturers. Next comes test instruments with \$194 million.

Commercial sound is a large part of the market: \$182 million. This will grow in step with increasing construction of schools, factories, stores, offices and public buildings.

Mobile radio provides a substantial market. The \$89-million sales forecast for 1957 includes not only new systems but replacement of obsolete and obsolescent equipment for existing systems.

Big growth is in the works for civilian aviation electronics. CAA wants \$810 million for new airways facilities, and this figure may be revised upwards. However, the time lag in getting the civil-airways program underway will probably hold aviation electronics sales to about \$31 million in 1957.

Microwave relay and atomic instrumentation both have exciting futures. But a spectacular rise in either field seems unlikely in what remains of 1957.

**FUTURE**—Increasing use of electronic control devices by industry indicates industrial electronics sales will grow at least as fast as total capital goods spending by industry. Perhaps faster in the near future, since this spending is now primarily for production equipment and modernization, where electronics plays an increasingly important part.

Proportion of electronics in defense is gaining as weapons become more complex. Rate of annual increase in military electronics spending is approaching 10 percent.

Substantial growth in radio-tv business awaits advances such as low-price color tv or fully transistorized battery-operated tv. Otherwise, this part of our industry will probably grow at about the same rate as the rate of new household formation.

A conservative estimate of manufacturers sales of electronic equipment and replacement parts for the year 1965 would be \$12.5 billion. This presupposes neither a bettering nor worsening of the world situation. Nor does this long-range estimate consider the possible effect of some substantial advance in the tv home receiver business.



## All business is specialized

*... and nothing specializes on your business like your business paper*

Here's a smart business man. He spends his time where every sitzmark parks a prospect at his feet. It's simple sense: He *specializes* . . . and it *pays*!

Your business is specialized, too . . . and so is your business paper. The time you spend with it pays . . . for its editors are experts in your specialty. They scout the field . . . report what's good that's new . . . find ideas that worked . . . suggest methods to keep you a leap ahead of competition.

The ad pages are as specialized as the editing. They, too, tend strictly to business . . . your business. They bring you data on new products, new materials . . . gather in one place a raft of ideas on where-to-buy-what, or how to make (or save) a dollar.

That's help you can't find concentrated into such quick reading time *anywhere* else! It's help that puts many a man out front in his field, as a specialist who knows what's what today . . . sees what's coming tomorrow. It's simple sense to read every page, every issue.

This business paper in your hand has a plus for you, because it's a member of the Associated Business Publications. It's a paid circulation paper that must earn its readership by its quality . . . And it's one of a leadership group of business papers that work together to add new values, new usefulness, new ways to make the time you give to your business paper still more profitable time.



A copy of this quick-reading, 8-page booklet is yours for the asking. It contains many facts on the benefits derived from your business paper and tips on how to read more profitably. Write for the "WHY and HOW booklet." Room 2710.

**McGraw-Hill Publishing Company**  
330 West 42nd St., New York 36, N. Y.



One of a series of advertisements prepared by THE ASSOCIATED BUSINESS PUBLICATIONS

# Panel Shows Images

Mixing techniques of electroluminescence and photoconductance, Sylvania makes flat image-producing panel. Military probes applications



Flat electroluminescent panel stores image of letter "H" drawn on its face by a beam of light

COMBINING the techniques of producing light by exciting phosphors in an electrical field (electroluminescence) and influencing by light the flow of electricity through a solid (photoconductance), Sylvania has created a flat image-producing panel that it calls Sylvatron.

Last week this mixture of electroluminescence and photoconductance was being studied in Army, Navy and Air Force research laboratories and a handful of private laboratories. Sylvania was sending out hand tooled models "to get guidance in applications."

The state of development is in the area of future promise rather than present reality. Sylvania sees the panels as having "important possibilities" in radar, air traffic control, computers, and instrumentation.

On announcement of its discovery this month, Sylvania had in hand five different panels. There were three basic types and two combinations.

Panel sizes at this stage are either two inches by two inches square or four by four. Thickness is around one-eighth of an inch. Light pro-

duced on the panels is either greenish or bluish.

- First type is an electroluminescent panel on which the position of a mobile dot of light can be manipulated electrically.

A flat plate made of glass is alternately coated with horizontal conductive strips, an electroluminescent layer and vertical conductive strips. Switching a-c power to the horizontal and a vertical contacts causes the panel to light up where energized strips cross.

- Second type is display panel which reproduces optically the track of a mobile spot of light. The image thus created can be stored in visible form on the panel.

The basic glass panel has a conductive and an electroluminescent coating. On the electroluminescent film is a mosaic of stubs each separated from the others by a matrix of black glass. Each stub has a conductive cap on both top and bottom. A photoconductor layer is applied over the top cap. A top conductor or metal mesh is cemented to the photoconductor layer of each stub. A-c power is applied to the conductive coating below the electroluminescent layer and to the mesh on top. This sets the panel for operation. A quick spot of light flashed from in front or back to any stub makes the photoconductive layer conduct and lights up the electroluminescent film under the stub.

- Third type is an electroluminescent panel which can reproduce optically a motion picture with good resolution and rapid response. Presently it is a frequency converter for light waves, changing red or infrared light into blue or green light.

Conductive glass is coated with electroluminescent layer, a photoconductive layer and an electrically conductive layer. By applying alternating current to the conductive layers the panel is made ready to accept a light image flashed on the

back of the panel. This image or picture is reproduced on the front of the panel in dots of light.

One combination panel combines the first two types. It can convert electrical data into pips or a track of light and store this luminous information on the panel.

## Rocket Computer Center Opens

A \$3-MILLION electronic computer center that will serve as the brains for tracking the Earth satellite when it is launched sometime within the next 18 months was opened recently in Washington, D. C.

Actually, the new IBM computing center will devote only some 15 percent of its time to tracking the satellite. Primarily it is a demonstration center for prospective computer users.

However, for the first few weeks after the satellite is launched as part of the International Geophysical Year program, an IBM 704 computer at the new Vanguard computing center will be a key factor to successful observation of the satellite. It is the job of the computer to keep track of the path the satellite is traveling and to predict its future path so that observation stations around the world will be able to watch.

After the satellite is launched, it will transmit radio signals from a battery-powered subminiature radio transmitter.

These signals will be picked up by some nine tracking stations around the world and data will be transmitted to Naval Research Laboratory in Washington within 20 minutes after reception.

From here, the information will be fed by teleprinter to the computer center where it will be processed and the flight of the satellite recorded. Based on this information, the computer then figures the flight path and predicts the satellite's future movement at one-minute intervals so that observation stations are alerted to when the satellite will be passing over.

The IBM 704 is magnetic-tape operated. Information flows in and out of the central unit at the rate



# New McGraw-Hill Books to give you

- help in solving knotty problems
- new ways of handling tomorrow's posers

*Just Out!*

Up-to-date 9th Edition

## STANDARD HANDBOOK FOR ELECTRICAL ENGINEERS

Here's an encyclopedia of facts and figures, definitions, conversion factors, physical and mathematical principles, accepted formulas, and experimental data—all brought up-to-date to help you meet today's requirements. This handbook offers the essential electrical engineering information you want in compact, easy-to-use form that ensures quick, fingertip reference on any problem you meet.

Ninth Edition includes important advances made in the electrical arts during the past decade, plus changes that have occurred in certain long-standing practices. New material on plastics and resins, electrical measurements, nuclear power, transistors, power distribution, protective devices, etc. Edited by A. E. Knowlton, Consulting Editor, *Electrical World*. 2230 pp., illus., \$19.50

### System Engineering

Brings together for the first time a description of the tools and methods of system design. Provides the necessary technical background to enable the engineer to become a member of a system design team. Describes such new tools as computers, queueing theory, linear programming, cybernetics, simulation, etc.; and discusses new systems like  $\pm 5$  crossbar (telephone), blind landing, air traffic control, etc. By H. M. Goode and R. E. Machol, U. of Michigan. 545 pp., 202 illus., \$10.00

### Microwave Measurements

This practical guide gives you modern methods and essential information for readily making precise microwave measurements. Full scope of the field is covered, beginning with generation and detection of microwave signals and progressing through measurement of impedance, wavelength, frequency, and other major topics. Scores of clear drawings and photos show details of modern laboratory equipment. By Edward L. Ginzton, Stanford U. 514 pp., 375 illus., \$12.00

### Electronic Components Handbook

For the designer of military and commercial electronic equipment. Furnishes data on resistors, capacitors, relays and switches as an aid in selecting and applying the best unit for a particular job so that maximum reliability of the end product results. Gives effects of heat, humidity, high altitude, low pressure, shock, and other environmental factors. Electronic Components Lab., Wright Air Devel. Ctr. Edited by Keith Henney and Craig Walsh, 224 pp., illus., \$9.00

### Handbook of Industrial Electronic Control Circuits

Here are the circuits (over 400) you need for sorting, timing, measuring, and counting; for sweep control, triggering, and hundreds of other industrial uses—each with concise description, component values, performance characteristics, etc. By John Markus and Vin Zeluff, *Electronics*. 352 pp., 412 diagrams, \$8.75

### Engineering Electronics

Gives you sound knowledge of electronics theory for effectively designing and working with modern electronic equipment for industry. From basic facts on vacuum tubes as circuit elements to more advanced topics such as switching circuits, computing amplifiers, power rectification, and electronic motor control, this big, 666-page book covers a broad area in a way that is clear, concise, and useful. By John D. Ryder, Dean of Engrg., Michigan State U., 666 pp., 796 illus., \$9.50

### Handbook of Industrial Electronic Circuits

A companion volume to the above. Contains 433 different industrial electronic circuits for immediate practical use. Each circuit has a clearly drawn diagram, component values brief, comprehensive description. Stroboscopic, telemetering, ultrasonic, metal-locating, are some of the circuits described. By Markus and Zeluff. 272 pp., 433 diagrams, \$7.50

**EXAMINE ANY BOOK 10 DAYS FREE**

McGraw-Hill Book Co. Dept. L-7 327 W. 41st St. New York 36

Send me book(s) checked at right for 10 days' examination on approval. In 10 days I will remit for book(s) I keep, plus few cents for delivery costs, and return unwanted book(s) postpaid. We pay delivery costs if you remit with this coupon—same return privilege.

(PRINT)

Name .....

Address .....

City ..... Zone..... State.....

Company .....

Position .....

For price and terms outside U. S., write McGraw-Hill Int'l, N.Y.C.

Knowlton—Standard Hdbk., \$19.50

Goode & Machol—System Engrg., \$10.00

Henney & Walsh—Elect. Components Hdbk., \$9.00

Ryder—Engrg. Electronics, \$9.50

Ginzton—Microwave Measurements, \$12.00

Markus & Zeluff—Indust. Elect. Control Circ., \$8.75

Markus & Zeluff—Indust. Elect. Circ., \$7.50

FL 7-20

of 2,500 words per second. As many as three tapes can be read at once.

Linked with the computer in the Vanguard center will be an IBM 780 cathode-ray-tube display unit that will show visually the orbit of the satellite.

## Microwave Device Is Ferromagnetic

EXPERIMENTAL ferromagnetic amplifier with possibilities as a pre-amplifier in a microwave repeater has research physicists of Bell Telephone Laboratories excited.

The new device suggests a new class of solid-state devices which can amplify at microwave frequencies.

Researchers have reason to believe the noise level will be small in comparison to conventional microwave amplifiers. But noise, power, voltage and gain values have still to be verified.

Experiments thus far raise hope for a variety of microwave uses. The device's ability to pick up weak microwave signals might make it useful in development of longer range radar, longer over-the-horizon transmission paths and in radio astronomy.

Ordinary ferrite such as that used in isolators is mixed and sintered, ending up as hard ceramic. This is put in a microwave cavity which is simultaneously resonant at two signal frequencies. Pumping power equals the sum of two resonant frequencies. A d-c magnetic field, properly oriented and of sufficient intensity to cause gyromagnetic resonance at this sum frequency, must also be applied.

Through nonlinear coupling in the ferrite, amplification or oscillation will occur at one frequency. This depends on input and output characteristics and where pickup is located in the cavity.

In one Bell Labs experiment two signal frequencies were each about 4,500 mc. Pumping power of 9,000 mc was fed into the resonant cavity, signal power taken in and out by coaxial cable. With sufficient pumping power, oscillations took place at 4,500 mc; with reduced pumping power, amplification was observed at 4,500 mc.



# Better Equipment Wanted

**Military asks for efficient, reliable equipment. Immediate need: advanced tubes for ECM, radar.**

"ELECTRONIC products have to be more efficient, more reliable and far simpler from the maintenance point of view than anything yet offered. And they have to come faster than in the past." These statements were made by Air Force Deputy Chief of Staff for Materiel, Lt. Gen. C. S. Irvine at a recent National Convention on Military Electronics.

One specific area where rapid improvement is needed, Irvine says, is certain critically needed tubes, "especially those required by our electronics countermeasures program, our advanced radar system and our next stages of communication."

Needed immediately are less complex oscillators and amplifiers using traveling-wave tubes. Widespread use of this equipment was anticipated ten years ago. Availability is still not expected for several years.

"While we have known the theory, we haven't gotten very far," Irvine says. "And that's the job in front of you and your companies. It is essential that you convert your formulas and equations into hardware—something we can sink our testing teeth into."

One reason companies have been reluctant to move into this field, according to Irvine, is fear that equipment designed for AF would not have direct commercial application. "I am certain that advanced amplifiers and oscillators will have wide commercial

application, and will appear on the foreign market, perhaps, before they do here."

Specific recommendations:

- Strive for greater simplicity: "Equipment has been over-designed, over-priced for performance of military missions. Perhaps we should approach commercial standards and simplicity."

- Improve the critically serious problems of reliability and efficiency of operation: "Incompatibility of interrelated subsystems in our defense communications network has resulted in serious deficiencies."

- Ruggedize marginal components: Specification ratings too often allow too slim a margin, so that supply voltage variations or even manufacturing variations cause malfunctions in the installed equipment.

- Eliminate after-manufacture adjustments: "Present system of black boxes is essential to us because all too often our maintenance people are not engineers and therefore cannot set controls as accurately as you can in your laboratories."

- Achieve better management on part of AF and industry: AF should not ask for too much nor should industry promise prematurely.

- Improve systems engineering: "Inadequate coordination exists between the different engineering staffs responsible for related components or companion subsystems."

- Develop components for reliable operation at speeds of mach 10 and at high altitudes.

## MILITARY electronics

- Automatic prediction of radar failure is announced by American Machine & Foundry. Developed under contract with Rome Air Development Center, the equipment detects probable failures in a radar system before they occur and alerts the operator to take preventive action.

- Bombing system, developed by Lear, is being evaluated by AF and Navy.

- Bell Aircraft's automatic carrier landing system, modified from system used on land by adding

Reeves' stabilization computer and a stabilized version of the radar antenna mount, will be sea-tested this month.

New stabilization unit feeds into flight-path computer data on roll, pitch and yaw of the carrier.

- Talos, Navy's long-range surface-to-air guided missile, will be added to arsenal of US fleet early next year. Although designed for shipboard installation, Talos is under consideration by Army for land use in Continental Air Defense system. Bendix has \$27 million production contract.

## CONTRACTS awarded

Army Signal Supply Agency in Philadelphia is contracting:

Hazeltine for beacons and radios, AN DPN-31, totaling \$216,529.

Bomac Labs for miniature, turnable C-band magnetrons, \$194,103.

Admiral for amplifier power supplies, \$516,712.

Lewyt for receiver-transmitters, RT-66 GRC and RT-67/GRC, \$4,210,468.

RCA for services, facilities and

catalog your  
products in the  
**ELECTRONIC  
ENGINEERS  
MASTER**

for on-the-spot  
product representation  
...when 9 out of 10  
orders are placed

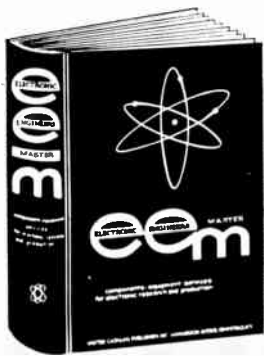

a companion volume to  
*The Radio-Electronic* **MASTER**

EEM, the industry's only combined master catalog and buying directory of products and services sold direct to industrials.

9 out of 10 orders for industrial products are originated by buyers rather than sellers, states a National Industrial Advertisers Association survey. This means that unless your salesman, literature or advertising are on-the-spot at the critical buying moment ... you are not fully represented when 90% of all orders are placed.

EEM, the industry's only master catalog and buying directory, assures your products on-the-spot representation when 50,000 engineers and purchasing agents are ready to specify and buy. Here's how:

- EEM catalogs manufacturers' data in product sections for easy reference and comparison
- Combines industry-wide catalog information with a buying directory
- Keeps catalog information up-to-date with new product supplements plus new industry-wide filing system

Increase your sales...Cut your selling costs...Catalog your products in EEM.

Get complete details...Write to: E-7  
**ELECTRONIC ENGINEERS MASTER**  
60 Madison Avenue, Hempstead, N. Y.

Want more information? Use post card on last page.

materials for 18 months to conduct R&D program on ruggedized S-band pulse triode transmitting tubes, \$155,891.

Kleinschmidt Labs for teletypewriter sets, AN/FGC-25, \$217,544, and for teletypewriter sets, AN/AGC-1. Total \$117,065.

Raytheon for services, facilities and materials for 12 months for R&D program on X-band communication 10-watt traveling-wave tube, \$233,697.

Stromberg Carlson division of General Dynamics for electronic switching equipment using solid state devices for automatic central switchboard, \$508,238.

Gilfillan Bros. for 13 radar sets, AN/FPN-33, \$858,000.

Grien Industries for 2,163 frequency meters, AN/URM-32, \$992,764.

Stanford Research Institute gets \$148,936 contract with AF Cambridge Research Center for theoretical and experimental investigations directed toward mechanical and electronic methods of scanning the narrow beam of a large fixed antenna.

Maxson will sell azimuth and switch assemblies applicable to the K-4 bombing computer to Warner Robins Air Materiel Area for \$179,998.

Machlett Labs will sell 10,000 electron tubes to Dayton AF Depot for \$170,500.

Autonetics division of North American gets Army Ordnance contract for design and fabrication of three portable, general purpose digital computers, three sets of test equipment and design and fabrication of tooling for the test equipment.

Aerosonic Instrument gets a \$267,342 contract with AMC for rate of climb indicators.

Otis Elevator will sell bombing and navigational trainers, spare parts, engineering and maintenance data,

special tools and installation and calibration services to AMC under \$2,230,547 contract.

Sperry gets a \$1,854,000 contract with AMC for radio sets, AN/ALQ-5.

IBM will lease a 704 computer to SAC under \$590,444 contract with Rome AF Depot.

Raytheon will sell to BuShips 300 radio sets, AN/GRN-9, under \$4,878,850 contract.

American Machine & Foundry wins \$165,776 contract with Ogden Air Materiel Area for modification kits and data for APG-11A trainers.

Maryland Electronic Mfg. gets \$3,395,588 contract with Rome AF Depot for radio transmitting sets, AN/MRN-7 and -8.

Eclipse Pioneer division of Bendix will sell radio remote controllers to Aviation Supply Office totaling \$1,048,954.

GE and Eitel McCullough will sell ceramic electron tubes to Dayton Air Force Depot totaling \$225,000 and \$220,800 respectively.

Lewyt will supply Signal Corps with radio sets for combat vehicles under \$4,210,468 contract.

Northeastern Engineering will sell Naval Aviation Supply Office high-speed electronic frequency counters amounting to \$1 million.

Ling Electronics will sell Astronautics division of Convair an electronically driven random motion vibration system for testing ballistic missile and jet aircraft components. Contract: \$221,000.

Instruments for Industry wins a contract modification with USAF amounting to \$152,000 for carrying out advanced developmental studies on wide-band radio-frequency transmitting equipment.

Sperry Gyroscope will provide magnetic azimuth detectors for use on fighters, trainers and cargo aircraft to AMC under \$915,645 contract.

# Amplifiers Cover the Spectrum

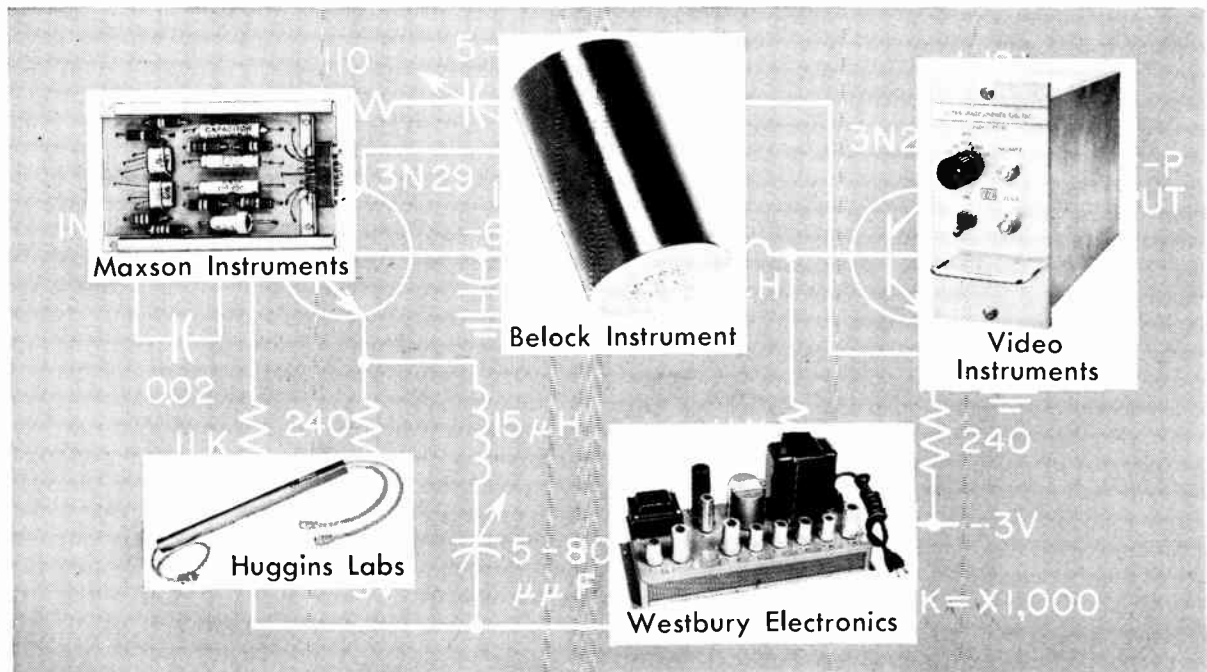

## Use Transistors, Twt's

AMPLIFIERS using conventional tubes, traveling-wave tubes and transistors are announced. Differential d-c amplifiers by **Video Instruments** (P1) feature maximum drift of 3 microvolts over temperature range of  $-50$  to  $120$  F. **Belock Instrument** (P2) offers a silicon-transistorized amplifier for use as a summing or inverting amplifier in 400-cps computing systems.

Broadband r-f amplifiers have been designed by **Westbury Electronics** (P3) for community, industrial and hotel tv for channels 2 through 6. Transistorized series-summation amplifiers are announced by **Maxson Instruments** (P4) for use with 400-cps resolvers. Broadband traveling-wave amplifiers announced by **Huggins Labs** (P5) are said to provide high-gain low-noise amplification as a first stage in microwave receivers.

Four-gram magnetic pickups produced by **Electro Products** (P6) translate movement of ferrous objects into a-c voltage. . . . Synchronous motors in size 10 frames are offered by **Luther Mfg.** (P7) for computer mechanisms, timing devices and programmers. . . . Capacitors wrapped in  $\frac{1}{8}$ -inch abrasion-resistant Mylar are available from **Good-All** (P8) in a variety of values and voltage ratings.

A series of 4, 6 and 8-contact plug-in coaxial connectors are available from **Danbury-Knudsen** (P9) for rack and panel applications. . . . **Raytheon** (P10) offers the CS-84 diode mount for high-voltage and high-altitude applications of stud-type silicon diodes, rectifiers and power transistors.

**Dunson** (P11) announces a laboratory transistor tester to measure

small signal beta of *pnp* and *npn* low-power junction transistors. . . . Two-axis vertical reference data is provided in the form of synchro output signals by **Waltham Watch's** (P12) vertical gyro. . . . Five sub-miniature metal-cased pulse transformers are available in kit form from **CBC Electronics** (P13) for use in impedance matching and blocking oscillators.

Shielded magnetron shipping containers offered by **Perfection Mica** (P14) are said to meet military specifications. . . . S-band ferrite isolators are being produced by **Airtron** (P15) to provide unidirectional magnetron-to-load isolation for high-powered radar systems. . . . Ratings of 140 amperes per cell are available in silicon rectifiers announced by **GE** (P16).

Cylindrical slide rules are announced by **Arthur F. Smith Co.** (P17) to solve problems involving multiplication, proportion, roots and powers. . . . **Baldwin-Lima-Hamilton's** (P18) strain indicators feature printed circuits and transistors. . . . Analog quantities that can be converted to frequencies,

For more information use **READER SERVICE CARD**



## CRYSTALS FILTERS

Compact, rugged, hermetically-sealed and stable, JK Crystal Filters (band pass filters) have a Frequency Range: 20 kc to 17.5 mc., and are available for special filtering purposes to 150 mc. Band Width at 6 db: 0.01% to 4% of nominal on most frequencies, up to 12% for certain frequencies. Write for complete data.

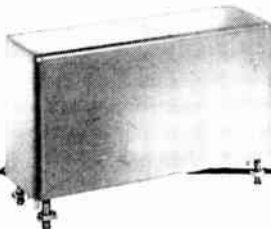

The  
**JAMES KNIGHTS COMPANY**  
Sandwich 1,  
Illinois

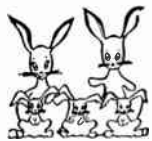

## IT TAKES TWO

### DISPLAY ADVERTISING

- Arouses Interest

- Creates Preference

### DIRECT MAIL

- Gets Personal Attention

- Triggers Action

After your prospect has been convinced by Display Advertising, he still must act. A personalized mailing piece, is a powerful action-getter. Send for our Industrial Direct Mail Catalogue, 150 lists available.



**Mc GRAW-HILL**  
DIRECT MAIL LIST SERVICE

Direct Mail Division,  
McGraw-Hill Publishing Co., Inc.  
330 West 42 St., N. Y. 36, N. Y.

Please forward my free copy of the McGraw-Hill "Industrial Direct Mail Catalogue."

Name \_\_\_\_\_

Company \_\_\_\_\_

Address \_\_\_\_\_

City \_\_\_\_\_ State \_\_\_\_\_

Want more information? Use post card on last page.

such as flow, speed, pressure, can be measured with Systron's (P19) digit-set universal counter.

An all-transistorized audio-video voltmeter has been announced by Kay Electric (P20). . . . Octal, loctal, 7 and 9-pin miniature tubes can be checked for gas, leakage, grid emission, shorts and tube worth on American Scientific Development's (P21) model A-1000 tube tester. . . . Airborne recording of closed-circuit tv signals on magnetic tape can be made with Minnesota Mining and Manufacturing's (P22) recording system.

Columbia Research Labs (P23) announces an accelerometer with a range from 0.03 g to 40,000 g over frequencies from 0.05 cps to 20,000 cps. . . . Attenuation and related power measurements may be made with Narda's (P24) broadband disk bolometers for coaxial detectors over the frequency range of 500 to 10,000 mc.

Transistorized power inverters by Modern Industries (P25) convert 26 to 30 volts d-c to 115-volt, 400-cps square waves for gyro motor excitation. . . . A line of Swiss-made ammeters and voltmeters is

available from Physics Research Labs (P26).

Magnetic-tape data-recording systems by Minneapolis-Honeywell (P27) are designed for recording analog data on as many as 15 channels. . . . Dual continuously variable transistorized power supplies offered by Harrison Laboratories (P28) produce outputs from 2 to 30 volts and ripple of less than 500 microvolts. . . . Voltage check panels have been designed by Western Gear (P29) for use as null-type calibrators for strain-gage power supplies.

Ace Electronics (P30) announces subminiature precision wire-wound trimming potentiometers with tabs for printed-circuit applications. . . . A 400-mc 10-lb receiver is offered by Bell Aircraft (P31) for use in missile and guidance systems where vibration is a problem. . . . Called Ecosorb MP, plastic rod and sheet material available from Emerson & Cuming (P32) is said to be easily machinable for use in waveguide or coaxial line as absorbers, attenuators, terminations.

Four-channel recording oscilloscopes by Electronic Tube (P33) is



## Taping Shake, Rattle and Roll

Engineers of Ford's Lincoln division use hi-fi tape recorder to capture sounds of engine, road, tires and body. Tape helps evaluate sound-control materials

feature a 4-gun tube with 5-inch flat face for recording on moving film. . . . The type 6977 subminiature indicator triode with fluorescent anode has been designed by Amperex (P34) for visual monitoring of transistorized computer circuits. . . . GE (P35) announces four *upn* type transistors for entertainment electronics which have been designed for use in printed-circuit boards.

Coil turn counters by Sunshine Scientific Instrument (P36) count numbers of turns on coils wound on nonmagnetic forms for production testing. . . . Isotope Developments (P37) announces the Gamma Switch for level control, density and liquid interface detection and flow-failure detection. . . . Infrared-sensitive multiplier phototubes are announced by RCA (P38) for use in infrared spectrometry, infrared ranging, astronomical measurements.

Single and double tv outlet boxes available from Blonder-Tongue (P39) feature 17-db isolation for signal distribution in hotels, schools, laboratories. . . . Laboratory power supplies are offered by Western Gear (P40) which furnish zero to 300 volts d-c at 150 ma, zero to -150 volts d-c at 5 ma and 6.3 volts a-c at 8 amperes.

Applications in missiles, radar and mobile equipment are expected for Daven's (P41) ceramic switches that can be ganged with up to 8 decks. . . . Low-pass filters by Flow Corp. (P42) provide a sharp cutoff to eliminate high-frequencies from amplifiers used with strain gages, anemometers, vibration pickups.

Said to be highly reliable, Pyramid Electric's (P43) type TQ electrolytic capacitors have been designed for use in electronic industrial control equipment. . . . Soundscribers' (P44) magnetic tape recorder-reproducer features slow tape speeds to permit 24 hours of voice-circuit monitoring without tape change.

Gaging, sorting and size control is accomplished on the pro-

**O**ur service is tailored to provide all the working capital any qualified client needs, without increased borrowing, diluting profits or interfering with management.

Information available for any manufacturer or distributor with \$500,000 or more annual sales.

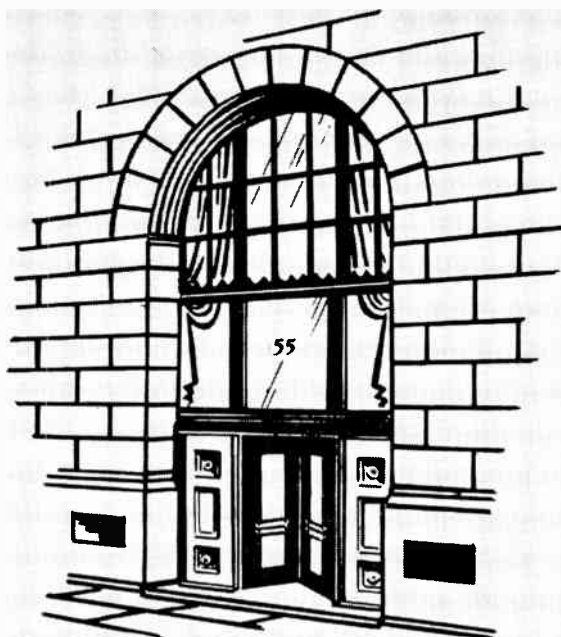

## Textile Banking Company

55 Madison Avenue, New York 10, N. Y.

*Providing operational financing for the  
apparel, electronics, furniture, leather,  
plastics and textile industries.*

### Subsidiaries:

T. B. C. Associates, Inc., New York

Southwest Texbank, Inc., St. Louis



## How to keep informed on the “with what” part of your business

AT YOUR FINGER TIPS, issue after issue, is one of your richest veins of job information — advertising. You might call it the “with what” type — which dovetails the “how” of the editorial pages. Easy to read, talking your language, geared specifically to the betterment of your business, this is the kind of practical data which may well help you do a job quicker, better — save your company money.

Each advertiser is obviously doing his level best to give you helpful information. By showing, through the advertising pages, how his product or service can benefit you and your company, he is taking his most efficient way toward a sale.

Add up all the advertisers and you've got a gold mine of current, on-the-job information. Yours for the reading are a wealth of data and facts on the very latest in products, services, tools . . . product developments, materials, processes, methods.

You, too, have a big stake in the advertising pages. Read them regularly, carefully to keep job-informed on the “with what” part of your business.

**McGRAW-HILL  
PUBLICATIONS**



duction line with an electronic control system offered by Daytronic (P45). . . . Fin-cooled power transformers made by Zenith Radio (P46) for tv receivers are said to weigh less and disperse heat better. . . . Gasoline-engine driven 400-cps power supplies are being produced by Motor Generator (P47) for checking aircraft electronic equipment.

Scintillation well counters for measurement of gamma-emitting liquid or solid radioactive samples are announced by Nuclear-Chicago (P48). . . . Transistors and printed circuits are used in intercom systems offered by Webster Electric (P49). . . . Hickok (P50) announces a tv sweep and marker alignment generator featuring an all-electronic sweep.

### New Product Makers

- P 1: Video Instruments, 2430 Sawtelle Blvd., Los Angeles 64, Calif.
- P 2: Belock Instrument, 111-01 14 Ave., College Point, N. Y.
- P 3: Westbury Electronics, Westbury, N. Y.
- P 4: Maxson Instruments, Long Island City, N. Y.
- P 5: Huggins Laboratories, 711 Hamilton Ave., Menlo Park, Calif.
- P 6: Electro Products, 4501 N. Ravenswood Ave., Chicago 40, Ill.
- P 7: Luther Mfg., 7312 Varna Ave., North Hollywood, Calif.
- P 8: Good-All Electric Mfg., 112 W. First St., Ogallala, Neb.
- P 9: Danbury-Knudsen, 15-25 Thorpe St., Danbury, Conn.
- P10: Raytheon, Foundry Ave., Waltham 54, Mass.
- P11: Dugson Co., 10116 National Blvd., Los Angeles 34, Calif.
- P12: Waltham Watch, Waltham, Mass.
- P13: CBC Electronics, 2601 N. Howard St., Philadelphia 33, Pa.
- P14: Perfection Mica, 1322 N. Elston Ave., Chicago 22, Ill.
- P15: Airon, 1101 W. Elizabeth Ave., Linden, N.J.
- P16: General Electric, Schenectady 5, N. Y.
- P17: Arthur F. Smith Co., 311 Alexander St., Rochester, N. Y.
- P18: Baldwin Lima-Hamilton, 42 4 St., Waltham, Mass.
- P19: Systron, 2055 Concord Blvd., Concord, Calif.
- P20: Kay Electric, 14 Maple Ave., Pine Brook, N. J.
- P21: American Scientific Development, 331 8. Main St., Ft. Atkinson, Wis.
- P22: Minnesota Mining and Mfg., 2075 S. Barrington Ave., Los Angeles 25, Calif.
- P23: Columbia Research Labs., McDade Blvd. and Bulleno Lane, Woodlyn, Pa.
- P24: Narda, 160 Herricks Rd., Mineola, N. Y.
- P25: Modern Industries, 2601 Colorado Ave., Santa Monica, Calif.
- P26: Physics Research Labs., P. O. Box 555, Hempstead, N. Y.
- P27: Minneapolis-Honeywell, 10721 Hanna St., Beltsville, Md.
- P28: Harrison Laboratories, Berkeley Heights, N. J.
- P29: Western Gear, P. O. Box 182, Lynwood, Calif.
- P30: Ace Electronics, 103 Dover St., Somerville 41, Mass.
- P31: Bell Aircraft, P. O. Box 1, Buffalo 5, N. Y.
- P32: Emerson & Cuming, 869 Washington St., Canton, Mass.
- P33: Electronic Tube, 1200 E. Mermaid Lane, Philadelphia 18, Pa.
- P34: Amperex, 230 Duffy Ave., Hicksville, N. Y.
- P35: GE Semiconductor Products, Syracuse, N. Y.
- P36: Sunshine Scientific Instrument, 1810 Grant Ave., Philadelphia 15, Pa.
- P37: Isotope Developments Ltd., Finsbury Pavement House, 120 Moorgate, London, England.
- P38: RCA, 30 Rockefeller Plaza, New York 30, N. Y.
- P39: Blunder-Tongue, 9-25 Alling St., Newark 2, N. J.
- P40: Western Gear, P. O. Box 182, Lynwood, Calif.
- P41: Daven Co., Livingston, N. J.
- P42: Flow Corp., 85 Mystic St., Arlington 74, Mass.
- P43: Pyramid Electric, North Bergen, N. J.
- P44: Samsorber Corp., New Haven, Conn.
- P45: Daytronic, 216 S. Main St., Dayton 2, Ohio
- P46: Zenith Radio, 6001 W. Dickens Ave., Chicago 39, Ill.
- P47: Motor Generator, Water St., Troy, Ohio
- P48: Nuclear-Chicago, 223 W. Erie St., Chicago 10, Ill.
- P49: Webster Electric, Racine, Wis.
- P50: Hickok Electrical Instrument, 10527 Dupont Ave., Cleveland 8, Ohio

# Toll-Tv Test Looms

**Commission okay is believed imminent. Major test of one system alone would cost over \$2 million**

SEPTEMBER of this year is the time industry sources expect the FCC to make a decision on toll tv. After more than two years of considering the question, the commission is believed to be leaning in favor of testing the technique.

Latest FCC move is conclusion that it has jurisdiction to make a decision. Some members of the Commission and of Congress felt that acceptance or rejection of toll-tv required legislation.

However, move has not stopped Congressional action. A bill is now before the House Interstate and Foreign Commerce Committee that will outlaw toll-tv. A similar bill is rolling in the Senate.

Investment involved in any major test of any one of the systems would be large. Skiatron Television Corp. wants a test to take in 100,000 subscribers.

Three companies which have asked for authorization from the Commission, Skiatron, Zenith and International Telemeter, all have in common systems which will telecast a program in a form requiring decoding before it becomes comprehensible.

Skiatron tests in New York used a decoding card. Zenith has run tests in Chicago using telephone facilities to provide inaudible signal which straightens out picture and sound. Telemeter used coin box technique in tests in California.

Skiatron has already made agreements with several firms to manufacture electronic decoders, which cost about \$20 each. Subscribers would rent the units, rather than buy them.

Arguments for toll-tv are primarily on programming side, that it would stimulate telecasting things like first-run movies. Incentives for broadcasters, the pros say, are: it would promote tv stations where advertising money can't support them; and it would give uhf-tv stations a new source of income.

Arguments against tolling television focus on the nature of broadcasting, hold that toll-tv intrudes on the public's rights to free service. According to this argument, a private communication takes place between set owner and station to the exclusion of all others unless the fee is paid.

One tv network executive who has publicly stated his opposition to toll-tv says privately: "In a way I'd like to see it given the green light. I'm convinced that the American public will reject it in operation and end the question forever."

## FCC actions

- Grants ABC Radio Network authority to transmit network programs to stations of Canadian Broadcasting Corp.

- Amends f-m station allocation table, adds channel 284 to Oxnard, Calif., substitutes channel 236 for 284 at Santa Barbara, Calif., and channel 273 for 236 in Santa Maria, Calif.

- Schedules only one Commission meeting during August, and that on August 1. No hearings or oral arguments will be held during August.

- Extends to September 6 date for interested parties to furnish data in response to inquiry into radio spectrum between 25 and 890 mc.

- Approves publication of "Conclrad Manual or Guide for

Experimental Radio Services." Manual explains how stations in these services may be alerted and operated in accordance with Conclrad rules.

- Proposes to make available on a 24-hour basis the frequency pair 2,466 kc (coast) and 2,009 kc (ship) for use in the Tampa, Fla., area.

- Orders extension of time in comments on split channel and other frequency proposals to September 3.

- Adds television channel 12, Farmington, N. M., to table of assignments.

- Grants authority to WTVN, Columbus, Ohio, to transmit baseball broadcasts from Jet Stadium to CKAC and CFCL, Montreal, Canada.

## STATION moves and plans

WHTN-TV, Huntington, W. Va., increases power to 316 kw, puts up 1,000-foot tower costing about \$400,000.

WSPD-TV, Paducah, Ky., goes on the air.

WCLM-FM, Chicago, Ill., goes on the air.

WMNS, Olean, N. Y., goes into operation.

WHWL, Nanticoke, Pa., begins to operate transmitter by remote control.

WRDB, Reedsburg, Wis., makes changes in antenna system, increases height.

KCOP-TV, Los Angeles, Calif., goes on the block for \$4 million.

**Compact Oscillator Drives 400 CPS Chopper**

Uses standard or ruggedized vacuum tube

4 3/16" OVERALL

1 1/2"

Circuit components are potted for long life

Plugs into octal socket

Enables you to obtain advantages of high-frequency chopper in equipment powered from 60 CPS or from batteries, is small, self-contained.

- Operates from conventional filament and plate voltages
- Separates chopper frequency from hum frequency
- Gives faster response to chopper amplifier

**AIRPAX**  
PRODUCTS COMPANY  
DESIGNERS

ENGINEERS  
CAMBRIDGE DIVISION  
JACKTOWN ROAD  
CAMBRIDGE  
MARYLAND



A copy of this quick-reading, 8-page booklet is yours for the asking. It contains many facts on the benefits derived from your business paper and tips on how to read more profitably. Write for the "WHY and HOW booklet."

**McGraw-Hill Publishing Company, Room 2710, 330 West 42nd St., New York 36, N. Y.**

Purchaser is group composed of Kenyon Brown, Bing Crosby, George L. Coleman and Joseph A. Thomas. Seller is Copley Press.

**KLAK**, Lakewood, Colo., installs old main transmitter as auxiliary transmitter.

**KBCS**, Grand Prairie, Tex., changes name from Grand Prairie Broadcasting to Three Cities Radio.

**KPOK**, Scottsdale, Ariz., increases power from 1 kw to 5 kw.

**KBHS**, Hot Springs, Ark., increases power from 1 kw to 5 kw.

**KSPO**, Spokane, Wash., changes frequency from 1,340 kc to 1,230 kc.

**KTRC**, Sante Fe, N.M., is bought by Garfield C. Packard for \$50,000.

**KSTB**, Breckenridge, Tex., changes hands from Coy Perry and C. M. Hatch to Hugh M. McBeath for \$50,000.

**WKYB**, WKYB-FM, Paducah, Ky., is sold by WKYB, Inc. to The Barrington Company of Kentucky for \$150,000.

**KORD**, Pasco, Wash., increases power from 500 watts to 1 kw.

**KLFY** Lafayette, La., changes hands from Canellia Broadcasting to Pelican Broadcasting. Price was \$140,000.

**WEGO**, Concord, N. C., is sold by Cabarrus Broadcasting to Concord-Kannapolis Broadcasting for \$102,000.

**KGKB**, Tyler, Tex., becomes property of Ron Litteral Enterprises. Former owner, Lucille Ross Lansing, gets \$150,000.

**KENO**, Las Vegas, Nev., control transfers from Edward Oncken, Merl Sage and Ralph O. Dow to Howard F. Andersen, Frederick Von Hofen, Gordon B. Sherwood, Jr., and C. E. McLaughlin for \$6,000.

**KDMS**, El Dorado, Ark., plans to install new transmitter as auxiliary.



# Exporters See More Sales

**Electronics exports continue to rise despite stiffening competition from foreign companies**

MANUFACTURERS look to a continued upward spiral in electronics exports this year. First quarter export figures are encouraging although still inconclusive.

Exports in the first three months amounted to \$72.8 million, compared to \$72 million in the same period last year. Electronics exports in 1956 were 24 percent above the 1955 level. Last year's total was \$331 million, according to RETMA'S international division.

Nonbroadcast heavy electronic equipment exports last year amounted to about \$110 million, compared with \$88 million in 1955.

Higher exports are especially encouraging to the industry in the face of stiffer foreign sales efforts. Strongest competition is coming from German, British, Japanese and Dutch manufacturers.

Demand is increasing for receiving tubes, crystal diodes and transistors, says RETMA. Large quantities of parts continue to be shipped abroad; picture tube exports declined in 1956.

Battery-operated transistor radios are likely to increase in significance as an export item. Potential customers cover vast underdeveloped areas of the world where entertainment and communications are wanted but little power is available.

Microwave equipment, radar and marine and air navigational aids will probably be strong export commodities for some time to come.

According to RETMA, the U. S. has felt the impact of increased foreign sales efforts. American imports of radio apparatus and parts were valued at about \$8.5 million in 1956, compared with \$3.4 million the year before. A sharp upturn was noted in U. S. imports of record players.

Britain's Radio Industry Council notes that the U. S. was Britain's best hi-fi customer, reports more American buyers attended the Radio and Electronic Component Show in London than ever before.

## Developments ABROAD

- **England's EMI Electronics** has developed equipment for measuring eye movements to give data on improving visual efficiency and eliminate eye strain of persons performing exacting tasks. Admiralty Research Laboratory has placed first order, will use equipment to find the best display of dials in a ship installation. Eye position and movement is recorded by detecting small d-c potentials from skin surface around the eye socket. Response appears as blip on cathode-ray tube.

- **London firm Stone-Chance Ltd.** has developed an electronic fog detector for marine and air-field use. It's said to give accurate assessment of visibility within 3 miles by night or day in fog, rain and snow.

- **Norway's NRK** broadcasting company plans to introduce tv in four stages over 12 years, and reach 80 percent of the population by then. Progress is hampered by tech-

nical difficulties due to the country's ridgeline land mass.

- **In England General Electric Co. Ltd.** develops periphonic loud-speaker system for reproducing high quality sound. System uses two metal cone speakers, one inside and one in a V-shaped enclosure outside cabinet.

- **Britain's National Coal Board** is using tv to watch a conveyor-belt system carrying coal into Manvers Coal Preparation Plant at Wath-on-Deane. A Marconi vidicon camera, control unit and 14-in. monitor are used. This allows control engineer to observe obstructions or system failures, take immediate action before tons of coal spill.

- **French Society of Radio Engineers** will organize international conference on uhf circuits and antennas in Paris Oct. 21-26. Object: international exchange of ideas on various aspects of uhf technique among radio engineers.

## EXPORTS and IMPORTS

In Colombia the fate of electronics contracts worth millions of dollars is still uncertain in the wake of the ousting of the Rojas-Pinilla government last May.

Distributors and company representatives feel some contracts may have to be renegotiated to extend dollar payments over longer periods.

Cancellations are considered unlikely because of need for the equipment ordered and advantageous terms reportedly obtained.

Contracts for government broadcasting facilities may be affected; one with Telefunken for \$2.5 million may have to be renegotiated. International General Electric has contract to supply radiotelephone equipment for Cundinamarca Department.

Similar contract was signed by Valle del Cauca Department with Telec, local RCA distributors; RCA also has subcontract for nationwide radiotelephone and telegraph system. Audophone of Switz-



he's  
working  
for you

**THIS FELLOW IS TRAINED IN YOUR BUSINESS. His main duty is to travel the country — and world — penetrating the plants, laboratories and management councils . . . reporting back to you every significant innovation in technology, selling tactics, management strategy. He functions as your all-seeing, all-hearing, all-reporting business communications system.**

**THE MAN WE MEAN IS A COMPOSITE of the editorial staff of this magazine. For, obviously, no one individual could ever accomplish such a vast business news job. It's the result of many qualified men of diversified and specialized talents.**

**AND, THERE'S ANOTHER SIDE TO THIS "COMPOSITE MAN," another complete news service which complements the editorial section of this magazine — the advertising pages. It's been said that in a business publication the editorial pages tell "how they do it"—"they" being all the industry's front line of innovators and improvers—and the advertising pages tell "with what." Each issue unfolds an industrial exposition before you — giving a ready panorama of up-to-date tools, materials, equipment.**

**SUCH A "MAN" IS ON YOUR PAYROLL. Be sure to "listen" regularly and carefully to the practical business information he gathers.**



**McGraw-Hill PUBLICATIONS**

erland has military contract for teleprinter equipment.

In Britain two new electronics firms are formed by four long-established ones. New jointly owned British Radio Corp. merges radio and television interests of Electrical and Musical Industries (EMI) and Thorn Electrical Industries. Firm expects to account for more than 15 percent of Britain's tv sales and 10 percent of radio sales.

Siemens Brothers and Edison Swan Electric Co. form Siemens Edison Swan Ltd. which will manufacture cathode-ray tubes, telephone gear and other products.

In Mexico electronic and communications equipment manufacturers have organized the National Chamber of Commerce of the Electronic and Electrical Communication Industry. One aim: conserve foreign exchange by making a larger proportion of the equipment now obtained outside Mexico.

In Brussels a new company, Picker X-ray & Electronics, S. A., represents a \$1.25-million American investment. It was established by Picker X-ray Corp., Waite Manufacturing division, Cleveland, O., and Sanborn Co., Waltham, Mass. Belgian-staffed firm will provide service facilities for lines of parent companies, including medical electronic equipment.

Australian Air Force gets five portable magnesium antenna towers made by Magnesium Products of Milwaukee, microwave equipment for towers from Collins Radio. Tower weighs 1,400 lb, can be cranked to 150 ft height from 12 ft. Equipment will form part of Royal Australian Air Force communications network.

West German a-m/f-m shortwave radios—a table model and a console—will be marketed under an RCA International label.

British firm Mercia Enterprises Limited of Coventry is interested in representing U. S. manufacturers of electronic components, industrial equipment, measuring and test gear in Britain.

# PLANTS and PEOPLE



## Old House Makes New Hq

IF YOU'RE looking for a new office, why not think about an old home? That's what Technicraft Laboratories, Thomaston, Conn., is now using temporarily. Plans for new construction (being checked in the picture by facilities planner Thomas Matthews, right, and plant maintenance chief) are in the works, but meantime the house that's not a home is paying off.

Technicraft bought a 50-acre tract of land near its main plant as elbow room for expansion. On the site were two barns and an 18-room 19th-century farmhouse.

Rather than waste the buildings during costly growth period, the firm put the barns to use as warehouses, put the general offices in the house. Advantages, says president Francis T. Eddy, far outweigh drawbacks:

- Former office space in the firm's main plant was immediately put to use for production.
- Officers didn't have to wait for new plant facilities to go up; they moved right in to comfortable quarters.
- Top people in sales, research, accounting, have quiet homelike atmosphere to work in.
- Work is seldom interrupted.

Few passersby know that the sprawling house near the river is the heart of a business.

There are a couple of attendant difficulties. Mail distribution is a problem, and communications were rough until a central switchboard went in. But, says Eddy, "coming into this old house for a while has been a sound move for us."

## British Plant Makes Transistors

FIRST British semiconductor manufacturing plant is now gearing into production at Millbrook Trading Estates, Southampton. Recently

### Business MEETINGS

Aug. 16-18: Radio-Television-Electronic Service Industry Convention, Sheraton Hotel, Chicago.

Aug. 20-23: Western Electronic Show and Convention (Wescon), Cow Palace and Fairmount Hotel, San Francisco.

finished 75,000-sq ft section, a third of Mullard Ltd.'s total planned expansion at Southampton, houses development and manufacturing facilities. Complete plant will employ 1,500 to 2,000 people, have an annual output of several million semiconductors by 1958.

Mullard figures on carrying out basic transistor research at facilities located elsewhere in England, will do applied research, product development and applications research at the new plant.

## New Officers at Bailey Meter

IN Cleveland, O., Bailey Meter Co., instrument-making subsidiary of Babcock & Wilcox Steel, gets some new officers.

Factory manager C. E. Sutherland moves up to become v-p in charge of manufacturing. Auditor E. O. Stern is new treasurer and assistant secretary.

Engineering vice president H. H. Gorrie got a seat on the board of directors in the same election. All three are longtime Bailey men.

## Sylvania Builds R&D Center

MULTIMILLION-DOLLAR R&D center for Sylvania's electronic systems division is going up in Amherst, N. Y. The 100,000-sq ft center will consolidate development of military gear, computers and controls. Plant will be completed in February of next year. Meanwhile R&D on passive defense system for B-58 Hustler and other contract work will go on in 170,000-sq ft plant Sylvania now leases in nearby Buffalo.

Vice president Robert E. Lewis, who is also president of Sylvania's Argus Camera division, takes on added duties as assistant to president Don Mitchell. He'll be a special troubleshooter on inter-divisional projects.

New general sales manager of firm's semiconductor division is Ernest H. Uhm. He moves up

from job of product sales manager in electronic products sales.

## Midwest Firm in Record Move

CHICAGO telephone maker Automatic Electric is settling into new quarters in suburban Northlake, Ill.

In what Chicago's Movers Association says is the largest move ever undertaken in the Midwest, Automatic's complete production facilities move from 17 locations scattered over the city's west side into one plant on a 167-acre site in Northlake. New plant has 1,520,000 sq ft of floor space under one roof.

Automatic's president Leslie H. Warner says new facilities will permit the firm to double production. Building will also house facilities of General Telephone Laboratories. Both Automatic and the Labs are part of the General Telephone System.

## RCA Accents Components

COMPONENTS division of RCA gets some new executives in a general reemphasis. Managing new product and market development is Jay J. Newman. Edmour P. Giguere steps in from a sales vice-presidency of Clevite Transistor to fill newly created slot of manager for new market coordination. T. F. Scott steps up from market planning research to administer division's advertising and sales promotion.

Victrola's Canonsburg, Pa., plant gets a new manager as Malvern B. Still steps up from the manufacturing manager's office there.

## Bay State List Shows Growth

NEW directory of electronics and nucleonics companies in Massachusetts lists 532 firms, an increase of 82 in the last twenty months. In reporting this 18 percent

growth, the directory, published by Associated Industries of Massachusetts, chronicles a healthy technology in New England, once monopolized by textile business.

Research expenditures are up 45.7 percent; payrolls are 32.3 percent higher. Employment is up 12.9 percent, with the rolls of production workers growing 4.7 percent. Total sales have increased 27.3 percent since 1955, with non-defense products having a slight edge in this rise.

## Computermakers Turn Educator

Two big computermakers are setting up education departments for coordinating customer education and helping colleges teach computer technology.

IBM moves Roger M. Bury in as director of customer and sales education department. Bury was manager of new product introduction for firm's data-processing division. He will coordinate training activities at IBM's 17 education centers and at plant locations.

Remington Rand's Univac educational department is headed by Alan D. Meacham, onetime member of business education faculty at University of Michigan. Meacham's department will conduct six-week computer courses at company centers in New York and Los Angeles, at Babson Institute, Boston, and at the Universities of Pennsylvania, Chicago and Houston. Courses will be given to college faculty members.

## New Center to Test Radomes

TESTING facilities to evaluate aircraft radomes for radiation efficiency are being constructed in Gardena, Calif., by Zenith Plastics, wholly-owned subsidiary of Minnesota Mining & Manufacturing.

Four-story test center and several testing towers are going up at a cost of \$200,000. Another \$100,000 will go for test gear. Sam Oleesky, Zenith's chief electronics scientist, will direct the new opera-

tion, with Charles Peach as chief engineer. Building will be finished next month.

## Motorola Moves

COMMUNICATIONS and electronics division of Motorola is settling into a new West Coast regional headquarters in Burlingame, Calif. Office handles all customer administration for a ten-state area including the Pacific and Mountain states. Eastern regional headquarters for division moves into a 4,500-sq ft office building in Ridgefield, N. J., expanding out of former Ft. Lee quarters.

Both expansions follow growth in industrial sales for the Chicago firm.



MIT opens Compton Lab as . . .

## Colleges Push Expansion

SOME of the country's leading colleges are pushing plant expansions in an effort to meet challenge of the engineering manpower shortage.

Armour Research Foundation is now moving into a \$1.25-million industrial research laboratory housing a nuclear reactor and other physical and electrical engineering research facilities. Lab is the 20th new structure on campus of Illinois Institute of Technology in the last decade. It's part of a \$45-million program to develop Technology Center, IIT's mushrooming south Chicago campus.

MIT recently opened its \$4-million Compton Laboratory. This five-story building adds 125,000

sq ft of floor space to MIT's facilities, houses research labs in electronics, nucleonics and computational science. Equipment includes a \$2.7-million IBM 704 computer, facilities for study of cosmic rays and radio waves.

University of Pennsylvania's Moore School is preparing to build a \$500,000 addition. Added plant will house a control and instrumentation lab, accommodate increases in enrollment and research work.

## PLANT Briefs

**GENERAL** Cable subsidiary New England Cable is putting up a 25,000-sq ft addition. Increased production facility will cost \$500,000.

**Permoflux Products** division of Linlar Inc., maker of sound systems and allied gear, now works out of a 31,000-sq ft plant in Glendale, Cal.

**Shepard Instrument** division of Savage Industries Inc. is now making telemetering equipment in its new plant in Phoenix, Ariz.

## EXECUTIVE Moves

RCA moves **Theodore A. Smith** into executive vice presidency for industrial electronic products. **Arthur L. Malcarney**, former general manager for commercial products, succeeds Smith as exec v-p for defense electronics. **Victor Records** division v-p **Lawrence Kanaga** resigns, and division operations manager **George R. Marek** moves up to take his place.

**Bendix Aviation** moves former aircraft products general manager **Charles D. Mauhart** into job of staff director for military and government sales.

**Cinch Mfg.** adds three men to its roster of vice presidents: **Leonard Hyale**, controller and assistant treasurer; **John Todd**, legal affairs, and **Stewart Pfannstiehl**, in charge of sales.



### DISPLAYED

The advertising rate is \$25.25 per inch for all advertising appearing on other than a contract basis. Contract rates quoted on request.

An advertising inch is measured 3/4" vertically on a column—3 columns—30 inches to a page.

Subject to agency commission.

## EMPLOYMENT OPPORTUNITIES

The Advertisements in this section include all employment opportunities—executive, management, technical, selling, office, skilled, manual, etc.

Positions Vacant  
Positions Wanted  
Part Time Work

Civil Service Opportunities  
Selling Opportunities Wanted  
Selling Opportunities Offered

Employment Agencies  
Employment Services  
Labor Bureaus

### RATES

\$2.40 per line, minimum 3 lines. To figure advance payment count 5 average words as a line.

Box Numbers—counts as 1 line.

Discount of 10% if full payment is made in advance for 4 consecutive insertions.

Not subject to agency commission.

### UNDISPLAYED

Send **NEW ADS** or Inquiries to Classified Adv. Div. of **ELECTRONICS**, P. O. Box 12, N. Y. 36, N. Y.

# SCIENTISTS ENGINEERS

## The University of Michigan

Offers unusual opportunities for experienced men at The University of Michigan's Willow Run Laboratories.

Research Engineers and Physicists with advanced degrees and/or experience in the fields of:

Digital Computer Logical Design  
Infrared • Acoustics  
Digital Computer Programming  
Electromagnetic Theory  
Communications • Circuit Design  
Radar • System Design  
Operations Research  
Countermeasures

Opportunity for graduate studies while working full time. Liberal vacation policy along with other fringe benefits. U. S. Citizenship required.

Write, giving details of education and experience to  
Technical Personnel Representative  
The University of Michigan  
Willow Run Laboratories, Ypsilanti, Michigan

### SELLING OPPORTUNITY OFFERED

**European Agencies required well known**  
Danish Audiometer Manufacturers seek agencies for other Medical or Surgical Products. please contact A/S Helix, Assens, Denmark.

### NEED ENGINEERS?

An employment advertisement in this **EMPLOYMENT OPPORTUNITIES** section will help you find the engineers you need. It's an inexpensive, time saving method of selecting competent personnel for every engineering job in the electronic field. The selective circulation of **ELECTRONICS** offers you an opportunity to choose the best qualified men available.

## How do you sell to the electronic market?

Engineers specify products on the drawing board. When design is approved, and mass production goes into full speed, the specified products are, in most instances, bought in quantity. Therefore, to get mass sales in the electronic industry, advertise in the magazine that is read by working engineers . . . .

## ELECTRONICS . . . . of course!

A McGraw-Hill Publication, 330 West 42nd St., N. Y. 36, N. Y.

# Hi-fi Hikes Rep Profits

PRETTY close to half of the nation's electronics manufacturers' reps handle hi-fi gear, according to REPM figures. In some areas of the Midwest the percentage approaches 90 percent. Most reps who've handled the special equipment any length of time feel that the hi-fi market is a fairly lush one.

Harman-Kardon merchandises its high-fidelity line in upper New York State and Virginia through Hoboken, N. J., rep partners **Sonny and Jack Simberkoff**.

New rep for Bogen-Presto hi-fi and sound systems in western Canada is **Chas. L. Thompson**, North Vancouver, B. C.

**A. A. Peters**, Allentown, Pa., now distributes the tape recorders and stereophonic gear of Thompson Products subsidiary Bell Sound Systems Inc.

Aerovox Corp. will distribute all its sound components through factory reps working out of its West Coast division in Burbank, Cal.

Electronics division of Curtiss-Wright Corp. sells its instrument line in north Jersey and Metropolitan New York through **Ringer-Mezger Co.**

New reps for Rotron Mfg. Co.'s line of cooling equipment are **Components Inc.**, Cleveland; **W. E. Fry & Co.**, Kansas City, Mo.; **Don V. Hamilton**, Minneapolis.

New York instrumentmaker Herman H. Sticht Co. appoints Los Angeles rep **Frank A. Emmet** to cover southern California.

**Gerard G. Leeds** gets the nod as rep for Electronic Tube Corp., Philadelphia, in the mid-Atlantic region and metropolitan New York.

Philadelphia rep **William I. Duncan** takes on the semiconductor products of United States Dynamics Corp. in the mid-Atlantic area.

## INDEX TO ADVERTISERS

Airpax Products Co. ....	33
Bomac Laboratories Inc. ....	3rd cover
Electronic Engineers Master. ....	28
General Electric Co. ....	8
Globe Industries Inc. ....	7
Hewlett-Packard Company ....	4
Knights Co., James. ....	30
Lenkurt Electric Co. ....	11
McGraw-Hill Book Co. ....	26
Minnesota Mining & Mfg. Co. ....	9
Radio Corporation of America. ....	4th cover
Sprague Electric Co. ....	12
Stokes Corp., F. J. ....	10
Sylvania Electric Products Inc. ....	2nd cover
Textile Banking Company. ....	31
Virginia Electric & Power Co. ....	18
•	
CLASSIFIED ADVERTISING	
F. J. Eberle, Business Mgr.	
EMPLOYMENT OPPORTUNITIES. ....	39

## Coming in Our August 1 TECHNICAL Edition . . .

- **Heartbeat recorder.** A pen recorder amplifier that provides a transformerless system for recording 3-cps heart signals is described by McKinley and Richards of the National Research Council. Modification of feedback circuit provides an audio amplifier with up to 5 watts maximum output, flat within 0.2 db from 20 cps to 20 kc.

- **Designing Magnetic Amplifier.** A procedure described by Roberts and Horstman of Westinghouse simplifies magnetic amplifier design. It uses results of dynamic tests made on core material prior to winding and provides proper interpretation of standard test values of circuit constants. Normalized design equations for the most common magnetic amplifiers are given.

- **Two-faced tube.** A new type of crossed-field microwave tube that resembles a magnetron but has no internal resonant circuit is de-



**Basic Platinotron showing 11-vane construction. Glass-insulated heater leads are at right**

scribed by William C. Brown of Raytheon Manufacturing Co. Operating frequency is determined externally. Tube may be used as broadband amplifier or frequency-stabilized self-excited oscillator giving over 60-percent efficiency at output of 2 megawatts. In amplifier operation, radar beam can be

scanned without moving reflector.

- **Recon aid.** E. J. Oelbermann of Haller, Raymond and Brown, Inc., describes a system under development that determines differences in two photos taken from same point in space at different times. It produces a standard width line at each point of contrast change as scanner passes over pattern. Applications include aerial surveys and growth study of microscopic organisms.

- **Slow Motion.** John Wilner of WBAL-TV demonstrates that by oscillating the lens board of a tv camera at a slow rate, image orthicon burn-in can be reduced as much as 90 percent. Modifying the camera horizontal centering circuit cancels resultant horizontal motion to give a stationary picture. Details of circuit modification and results of tests on previously discarded tube are given.

# electronics READER SERVICE CARD

FOR ADDITIONAL INFORMATION ON ADVERTISEMENTS AND NEW PRODUCTS

Additional postage **MUST** be added to cards for all FOREIGN MAILINGS

## Here is How to Use the Card!

### WANT MORE INFORMATION ON ADVERTISEMENTS?

For more information on an advertisement, circle page number of advertisement in section A on the reader service index.

If there is more than one advertisement on the page, the position of the ad will be indicated by letters following the page number. The letters following the page number will indicate the ad's positions: R-Right, RT-Right Top, RB-Right Bottom, L-Left, LT-Left Top, LB-Left Bottom, M-Middle, MT-Middle Top, MB-Middle Bottom (i.e. 230L). Diagrams on back of this page show how to use the key.

On pages with no number such as bleed pages, count from the last numbered page to find the number. Inserts

are numbered using last numbered page plus A, B, etc. If you are not sure of a page number, consult the advertisers index.

### WANT MORE INFORMATION ON NEW PRODUCTS?

Each New Product item in ELECTRONICS has a number (P1, P2, etc.). Circle the corresponding number in section B of the Reader Service Card (below).

### YOUR ACCURACY ASSURES CORRECT REPLIES

There are two cards for your convenience. Use one, or both if necessary. Print carefully, then tear off and mail. We are unable to process cards where name and address is illegible.

See Fractional Page Diagram on Other Side of This Page!

FILL IN NAME,  
POSITION, COMPANY  
& ADDRESS HERE



**JULY**  
**20-57**  
CARD EXPIRES  
OCT. 20TH

• **electronics** • **READER SERVICE CARD**  
Please Print Carefully

NAME \_\_\_\_\_ POSITION \_\_\_\_\_

COMPANY \_\_\_\_\_

ADDRESS \_\_\_\_\_

#### SECTION A

4	9	12	28	34T	4th Cover
7	10	18	30T	2nd Cover	
8	11	26	31	3rd Cover	

#### SECTION B

CIRCLE FOR NEW PRODUCTS HERE

P1	P6	P11	P16	P21	P26	P31	P36	P41	P46	P51	P56	P61	P66	P71	P76	P81	P86	P91	P96
P2	P7	P12	P17	P22	P27	P32	P37	P42	P47	P52	P57	P62	P67	P72	P77	P82	P87	P92	P97
P3	P8	P13	P18	P23	P28	P33	P38	P43	P48	P53	P58	P63	P68	P73	P78	P83	P88	P93	P98
P4	P9	P14	P19	P24	P29	P34	P39	P44	P49	P54	P59	P64	P69	P74	P79	P84	P89	P94	P99
P5	P10	P15	P20	P25	P30	P35	P40	P45	P50	P55	P60	P65	P70	P75	P80	P85	P90	P95	P100

TEAR HERE

FILL IN NAME,  
POSITION, COMPANY  
& ADDRESS HERE



**JULY**  
**20-57**  
CARD EXPIRES  
OCT. 20TH

• **electronics** • **READER SERVICE CARD**  
Please Print Carefully

NAME \_\_\_\_\_ POSITION \_\_\_\_\_

COMPANY \_\_\_\_\_

ADDRESS \_\_\_\_\_

#### SECTION A

4	9	12	28	34T	4th Cover
7	10	18	30T	2nd Cover	
8	11	26	31	3rd Cover	

#### SECTION B

CIRCLE FOR NEW PRODUCTS HERE

P1	P6	P11	P16	P21	P26	P31	P36	P41	P46	P51	P56	P61	P66	P71	P76	P81	P86	P91	P96
P2	P7	P12	P17	P22	P27	P32	P37	P42	P47	P52	P57	P62	P67	P72	P77	P82	P87	P92	P97
P3	P8	P13	P18	P23	P28	P33	P38	P43	P48	P53	P58	P63	P68	P73	P78	P83	P88	P93	P98
P4	P9	P14	P19	P24	P29	P34	P39	P44	P49	P54	P59	P64	P69	P74	P79	P84	P89	P94	P99
P5	P10	P15	P20	P25	P30	P35	P40	P45	P50	P55	P60	P65	P70	P75	P80	P85	P90	P95	P100

FOR ADDITIONAL  
INFORMATION ON  
AN AD, CIRCLE  
CORRECT NUMBER  
IN SECTION A



NEW PRODUCT  
INFORMATION?  
USE SECTION B



# DIAGRAMS BELOW SHOW HOW TO USE THE KEY ON PAGES WITH MORE THAN ONE ADVERTISEMENT

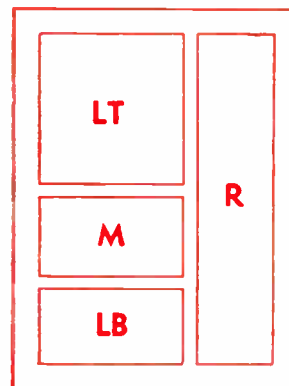
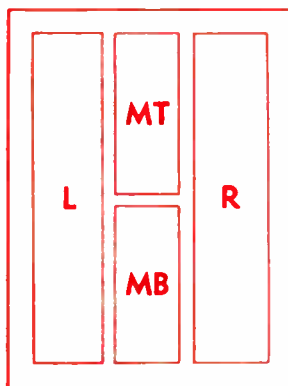
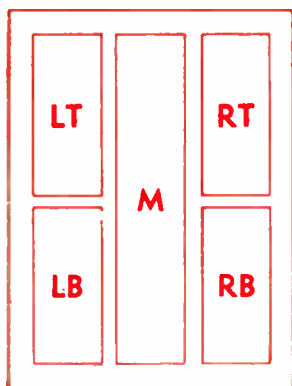

**NOTE: additional postage MUST be added for mailing from FOREIGN COUNTRIES**

**FIRST CLASS  
PERMIT NO. 64  
(Sec 34.9 P.L.&R.)  
NEW YORK, N. Y.**

**BUSINESS REPLY CARD**  
NO POSTAGE STAMP NECESSARY IF MAILED IN THE UNITED STATES

4¢ Postage Will Be Paid By

**ELECTRONICS**

Reader Service Dept.  
330 West 42nd Street  
New York 36, N. Y.

**FIRST CLASS  
PERMIT NO. 64  
(Sec 34.9 P.L.&R.)  
NEW YORK, N. Y.**

**BUSINESS REPLY CARD**  
NO POSTAGE STAMP NECESSARY IF MAILED IN THE UNITED STATES

4¢ Postage Will Be Paid By

**ELECTRONICS**

Reader Service Dept.  
330 West 42nd Street  
New York 36, N. Y.

On pages with more than one advertisement, the page number PLUS the correct letters (as shown above) are necessary to indicate the POSITION of the advertisement.

You must circle the page number with the correct letters after it (i.e. 240 L, which means page 240 Left).

**USE THIS KEY:**

- R—Right
- RT—Right Top
- RB—Right Bottom
- L—Left
- LT—Left Top
- LB—Left Bottom
- M—Middle
- MT—Middle Top



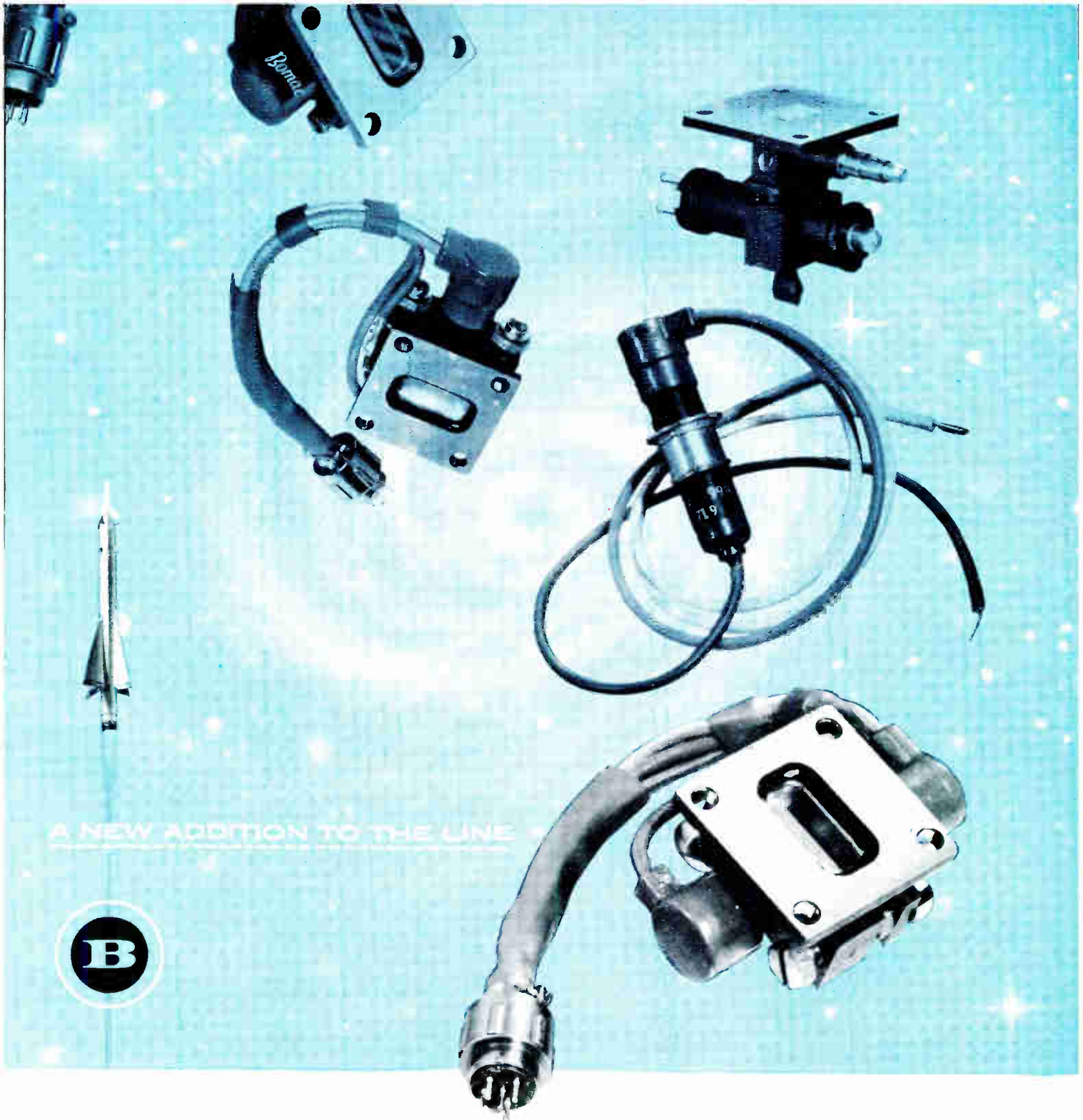

A NEW ADDITION TO THE LINE



## THE BOMAC BL-803 REFLEX KLYSTRON FOR X-BAND

Improved performance? You can count on it with the new BOMAC BL-803 Reflex Klystron for X-band applications. Here's why:

- *New tuning ease* . . . BOMAC's positive, self-locking, single-screw tuning\* assures accuracy and re-setability under all operating conditions.
- *Added resistance to vibration and shock* . . . proven in many field tests
- *Low microphonics*
- *Electrical uniformity, mechanical stability* . . . assured by rigid test procedures

The new BL-803 is one of a complete line of BOMAC Reflex Klystrons, any of which can be tailored to your specific system requirements. Write today for complete information.

Write for BOMAC's 6-page, 16-size folder containing details and specifications on more than 500 different microwave tubes and components.

\*Patent applied for

***BOMAC*** LABORATORIES, INC.,  
Dept. E-7 Beverly, Mass.

Offices in major cities: — Chicago • Kansas City • Los Angeles • Dallas • Dayton • Washington  
Seattle • San Francisco • Toronto Export: Maurice I. Parisier, 1860 Broadway, N. Y. C.

# Transistorization of computers now a reality!

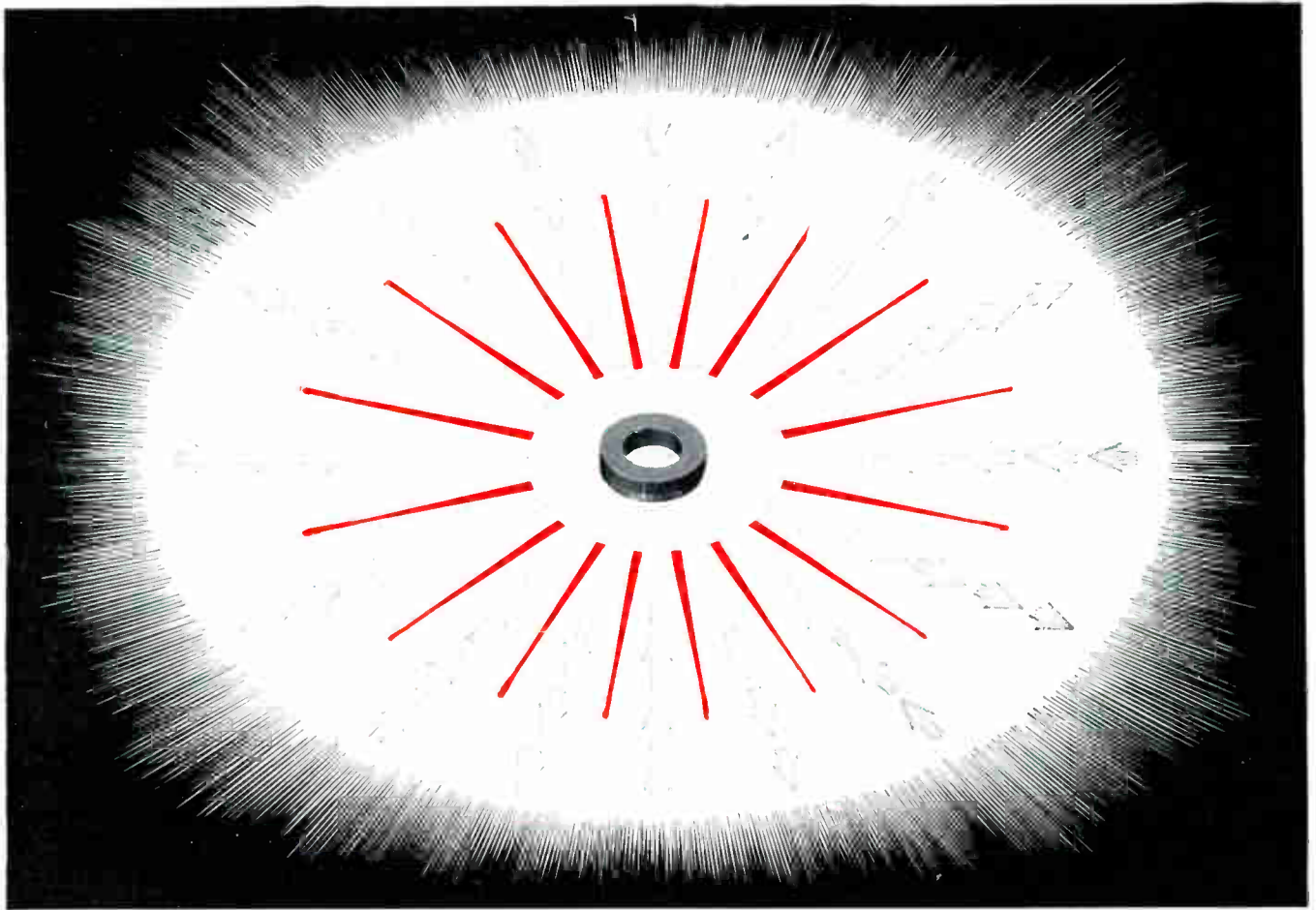

## NEW...RCA 222M2 FERRITE MEMORY CORE

**FASTER** turnover time . . . **HIGHER** output signal . . . **LOWER** drive requirements

Faster turnover . . . higher output . . . all of this with an .080" O.D. core which operates with driving currents in the range of 300-500 milliamperes!

The RCA 222M2 is comparable to high drive cores in its ability to withstand large disturbing current pulses without reversing its flux state.

Write today for technical data and availability information on samples.

**RCA TRANSELEXORS** . . . a developmental memory device utilizing a ferrite core with two apertures and exhibiting a nearly rectangular hysteresis loop. It can control the transmission of ac power according to a level established by a single setting pulse and furnishes an output determined by the stored pulse for an indefinite length of time. Once set, the TRANSELEXOR does not require an input command to furnish output intelligence.



**RADIO CORPORATION of AMERICA**

COMPONENTS DIVISION

CAMDEN, N. J.