

Electronics

BUSINESS / TECHNOLOGY PERSPECTIVES FOR GLOBAL ELECTRONICS MANAGEMENT

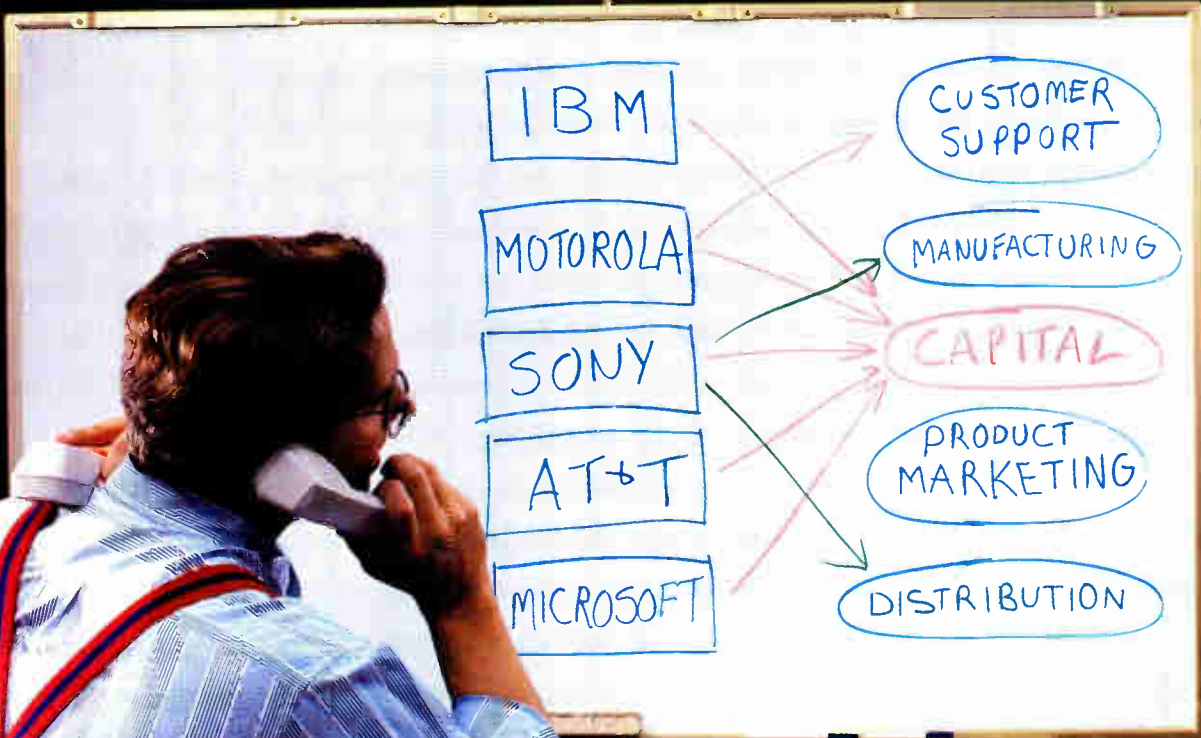

TECHNOLOGY FOR SALE

THE PRICE OF STRATEGIC ALLIANCES

PAGE 46

TRW PRESENTS A
GROWING LINE OF COLOR PALETTE DACs.
(BET YOU NEVER KNEW WE HAD SUCH A COLORFUL PAST.)



Years ago, TRW pioneered the technology for the DACs of today. And for decades, our name has been synonymous with the highest quality products. So it seems only natural to apply TRW's legendary standards to a growing line of Monolithic Color Palette D/A Converters, for high definition color graphics applications.

Take for example our third Color Palette DAC in the last year – the TMC0458. This stand-alone triple 8-bit DAC doesn't require a costly companion synchronization chip. Yet it's pin-compatible with the industry-standard 458's.

It provides pixel rates up to 135 MHz, with a 256 x 24 color palette and a 4 x 24 overlay palette – thereby supporting up to 256 simultaneous colors from a 16.8 million color palette. So CRTs of high performance graphics systems will have it made in the shades.

The red, green and blue channel analog outputs of the TMC0458 are RS-343A compatible. And its color palette can be queried by the host computer asynchronously with respect to pixel data. Plus you get the benefits of CMOS technology. And of course we have

full MILSTD-883 compliant processing.

All with the quality orientation that is to be expected from TRW LSI – whose high standards in video technology earned an Emmy award in 1989.

Our growing line of Color Palette DACs also includes the industry-standard triple 6-bit TMC0171 and TMC0176, for low-cost VGA graphics. Plus, all these products have the full spec performance that is synonymous with TRW standards.

Ask for the data sheets, applications and other information on our Color Palette DACs today. From the company

whose pioneering spirit has always made us a shade better.

Call or write: TRW LSI Products Inc.,
Park City Mizonokuchi A-901
379-1 Mizonokuchi, Takatsu-ku
Kawasaki City, Kanagawa Prefecture 213
044-844-5673 FAX 044-844-4679



TRW's dedication to quality always stands up to the test.



The TMC0458 provides superb resolution and colors required for high performance applications.

1990 Senera Technologies

San Diego Zoo Photo: Ron Garrison

TRW LSI Products Inc.

STANDARDS SET. STANDARDS TO BE MET.

MINIATURE PHOTODETECTOR POWER SUPPLIES

For
Photomultiplier Tubes & Photodiodes

Short Circuit & Reverse Polarity Protected
Mounts On Printed Circuit Boards
Input & Output Floating
Small & Lightweight
Excellent Stability
Low Ripple

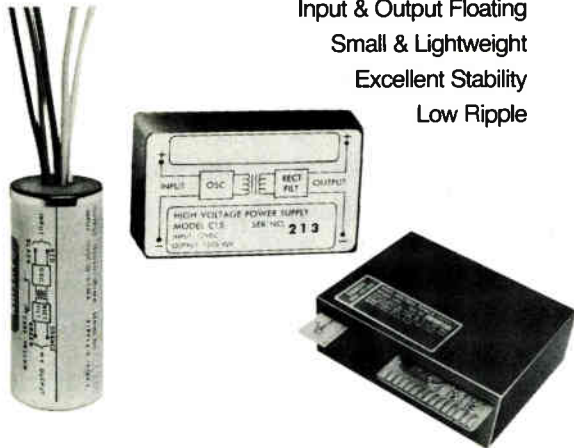

Ferranti Venus

399 SMITH STREET, FARMINGDALE, N.Y. 11735
(516) 293-4100 • TWX: 510-224-6492 • FAX: 516-752-7976

CIRCLE 210

LEISTER Contact-free soldering and de-soldering

of SMD, DIP and pin grid components and connectors in a matter of seconds with the Leister-Labor "S" hot-air tool. Electronic control of temperature and air supply, ESD safe. Over 400 special nozzles available.

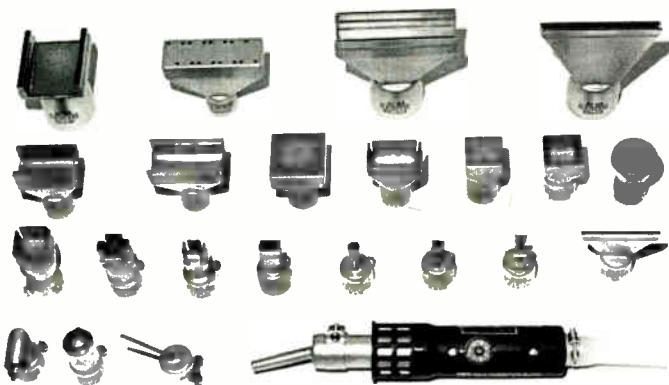

Ask for free brochure UW 160

Brian R. White Co. Inc., 313 Henry Station Road
Ukiah, CA 95482 phone: (707) 462-9795
Farmingdale, NJ 07727 phone: (908) 938-2700

CIRCLE 191

ELECTRONICS • NOVEMBER 1991

2
World Radio History

Electronics

EDITOR

Jonah McLeod
MANAGING EDITOR
Howard Wolff
SENIOR EDITOR
Lawrence Curran
EDITOR-AT-LARGE

Samuel Weber
914-428-3596

ASSISTANT MANAGING EDITOR

Jacqueline Damian
DEPARTMENT EDITORS

Communications:

Jack Shandle
201-393-6228

System Technology:

(San Jose) **Jonah McLeod**
408-441-0550

EDITORIAL PRODUCTION MANAGER

April Messina

ASSOCIATE ART DIRECTOR

Tony Vitolo

STAFF ARTIST/DESIGNER

Anthony White

BUREAUS

Boston: **Lawrence Curran, Manager**
508-441-1113

Midwest Correspondent: **Francis J. Lavoie**

Mid-Atlantic: **Jack Shandle, Manager**
201-393-6228

Frankfurt: **John Gosch, Manager**

011-49-61-71-53834

France Correspondent: **Andrew Rosenbaum**

011-331-4236-1867

Italy Correspondent: **Andrew Rosenbaum**

011-331-4236-1867

Japan: **Shin Kusunoki, Consultant,**

Nomura Research Institute

011-81-45-336-7064

UK Correspondent: **Peter Fletcher**

011-443-226-64355

Electronics Index: **Mark Parr**

VICE PRESIDENT-EDITORIAL

Perry Pascarella

GROUP ART DIRECTOR

Peter Jeziorski

EDITORIAL ADMINISTRATION

Bradie S. Guerrero,

Tina A. Montone

Director of Circulation: **Bruce Sprague**

Manager of Circulation: **Bob Clark**

Production Manager:

Doris Carter

(201) 393-6259

FAX: (201) 393-0410

Order Entry

Beverly Desbiens

PUBLISHER

John G. French

617-890-0891

November 1991 Volume 64, Number 11

Electronics (ISSN 0883-4989) is published monthly by Penton Publishing, Inc., 1100 Superior Ave., Cleveland, OH 44114-2543. Second class postage paid at Cleveland, OH, and additional mailing offices.

Editorial and advertising addresses: Electronics, 611 Route #46 West, Hasbrouck Heights, NJ 07604. Telephone (201) 393-6060. Facsimile (201) 393-0204. San Jose, Calif.: Telephone (408) 441-0550. Circulation (1100 Superior Ave., Cleveland, OH 44114-2543); (216) 696-7000.

Title registered in US Patent Office. Printed in U.S.A. Copyright © 1991 by Penton Publishing, Inc. All rights reserved. The contents of this publication may not be reproduced in whole or in part without the consent of the copyright owner.

Permission is granted to users registered with the Copyright Clearance Center Inc. (CCC) to photocopy any article, with the exception of those for which separate copyright ownership is indicated on the first page of the article, for a base fee of \$1 per copy of the article plus 50¢ per page paid directly to the CCC, 27 Congress St., Salem, MA 01970. (Code No. 0883-4989/91 \$1.00 + .50) Can. GST #R126431964.

Microfilm of issues or articles can be ordered from University Microfilms, Ann Arbor, Mich. 48103. Telephone: (313) 761-4700.

Subscriptions free to qualified managers. All others: \$60 for one year in the U.S.; \$70 in Canada; \$136 in all other countries. For subscriber change of address and subscription inquiries, call 216-696-7000.

POSTMASTER: Please send change of address to ELECTRONICS, Penton Publishing, Inc., 1100 Superior Ave., Cleveland, OH 44114-2543.

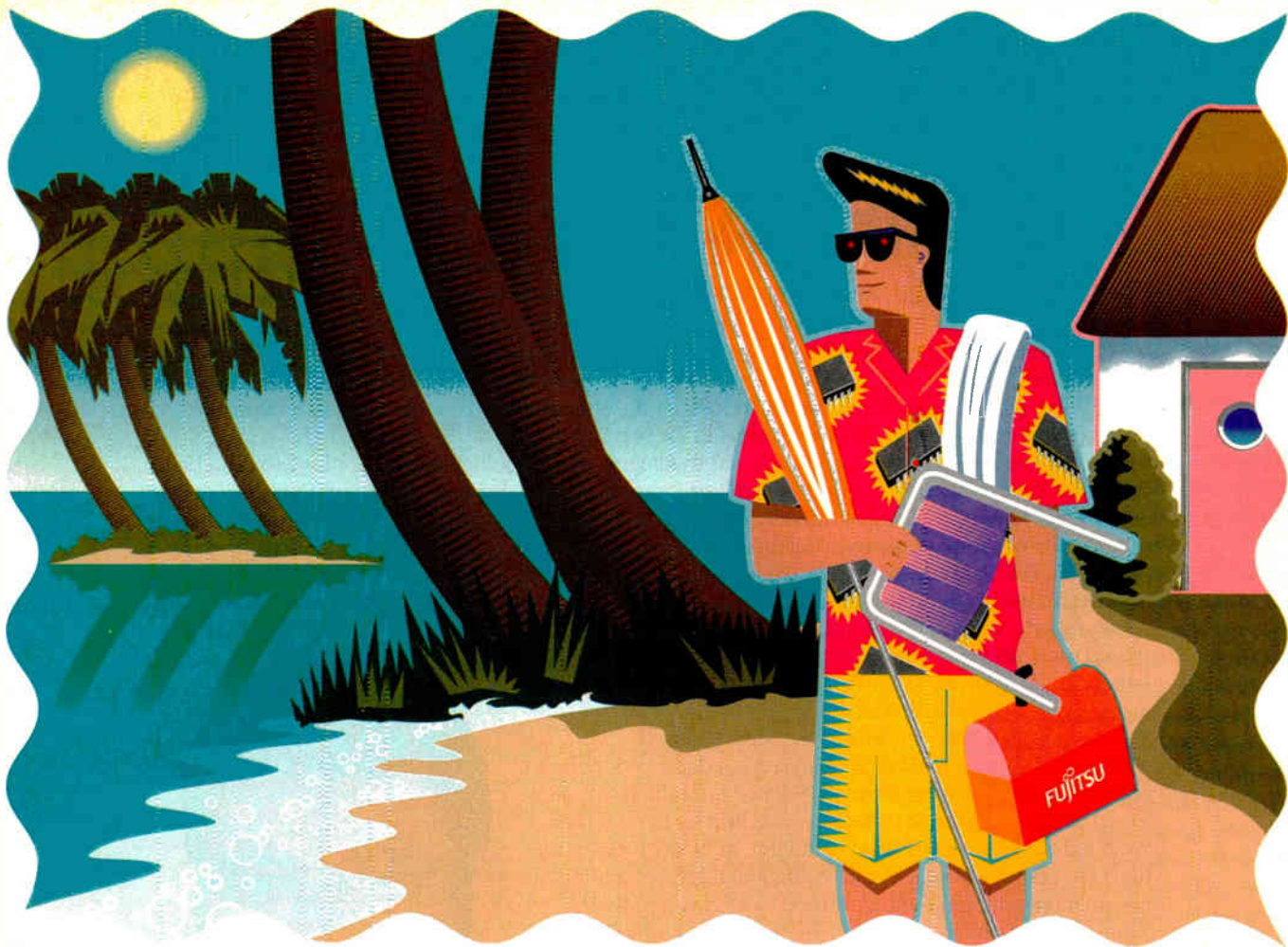

Finally, a SPARC chip set that comes equipped with everything you need for the Sun.

VISIT
BOOTH #1018
AT
WESCON

Now, from the Advanced Products Division of Fujitsu Microelectronics — something new under the Sun. A SPARC® chip set that offers the world's most advanced, cost-effective solutions for Sun-compatible workstation designs and specialized, compute-intensive applications. Including voice response, medical imaging and pattern recognition systems.

Our new SPARC chip set is packed with all of the advanced features you need to differentiate your systems from Sun and yesterday's Sun clones. Such as higher integration. More system flexibility. Clock speeds of up to 40 MHz. And graphics options. All at a price to help



you outshine the competition.

Plus, to get you to market faster, we offer three distinct hardware designs: Busless, Sbus and VME bus. What's more, from our alliance with INTERACTIVE Systems Corporation — the premier independent UNIX® source — comes the latest SunOS™ 4.1.1 ported to each design.

And with comprehensive documentation and training, you'll find your place in the Sun more quickly.

So equip yourself with everything you need to develop the highest performance SPARC-based systems. Call us at 1-800-523-0034. And discover why our new SPARC chip set is the perfect Sun set.

FUJITSU

Delivering the Creative Advantage.

FUJITSU MICROELECTRONICS, INC., Advanced Products Division, 77 Rio Robles, San Jose, CA 95134-1807. Ph: 408-456-1161 Fax: 408-943-9293.
 FUJITSU MICROELECTRONICS ASIA PTE LTD. (Head Office, Singapore): Ph: 65-336-1600 Fax: 65-336-1609. HONG KONG SALES OFC: Ph: 852-723-0393 Fax: 852-721-6555.
 TAIPEI SALES OFC: Ph: 886-2-757-6548 Fax: 886-2-757-6571. JAPAN SALES OFC: Ph: 81-3-3216-3211 Fax: 81-3-3216-9771. KML CORP. (Rep., Korea): Ph: 82-2-588-2011 Fax: 82-2-588-2017.
 PACIFIC MICROELECTRONICS, PTY. LTD., (Rep., Australia): Ph: 61-2-481-0065 Fax: 61-2-484-4460.
 FUJITSU MIKROELEKTRONIK GmbH (Dreieich-Buchsschlag, Germany): Ph: 06103-6900 Fax: 06103-690122.
 SPARC is a registered trademark of SPARC International. UNIX is a registered trademark of UNIX Systems Laboratories, Inc. SunOS is a trademark of Sun Microsystems, Inc.

WCIRCLE 194ry

CONSUMER AS METAPHOR

If there is one segment of the electronics industry that may serve as a metaphor for the new world economic order, it is consumer electronics. It was this market that gave rise to the Japanese economic miracle, this market that developing Asian countries have zealously pursued. Now, with computers getting smaller and cheaper, they too are becoming consumer-like, mass-market products. Why Japan came to dominate this industry is the subject of two current books, both produced by anthropologists at the University of Arizona in Tucson.

Anthropology? "The approach I took was to integrate anthropology and technology to get a better picture of how technology affected our culture," says Michael B. Schiffer, author of *The Portable Radio in American Life* (University of Arizona Press). But Schiffer's book also sheds light on how U.S. companies lost the consumer business. "All the big U.S. consumer electronics companies built competitive radios in the U.S. to compete with Japan head-on," he says. "They succeeded, at first, but as prices fell, they began using Japanese parts and then started sending the manufacturing offshore." Finally, the U.S. relinquished commodity products altogether to concentrate on items that required more added-value technology. Implicit in this strategy was the belief that Japan would always lag behind U.S. technology. But Japan soon surpassed the U.S. in consumer technology.

That part of the story is told in the second book, *Japanese/American Technology Innovation*, edited by Schiffer's colleague David Kingery (Elsevier Science Publishing Co., New York). Kingery argues that America was hurt by its own lone-wolf, individual-inventor R&D paradigm. In Japan, by contrast, R&D is a consensus process, allowing much greater sharing of information, with more minds turned to solving a problem. Kingery wryly points out that while the U.S. has more Nobel Prize winners, Japan has better chip manufacturers.

The two anthropologists are voicing what many others have said before: the U.S. is good at creating technology, but Asian companies excel at quickly cloning it and overwhelming the market with lower-cost offerings. If the U.S. is to regain some ground in consumer electronics (see p. TK), Schiffer believes HDTV may be the vehicle. However, given the vast head start of overseas companies, he suggests that U.S. firms be given some home-market exclusivity for a period of time—say, five years—during which no overseas suppliers could introduce competitive products in the U.S. After that, the market could operate unfettered.

We think this suggestion has merit. It would encourage American companies to make the large investments needed for HDTV, knowing they would be allowed a period of time to recoup their investments. If consumer electronics remains the bellwether of economic growth, then the U.S. must take steps to make a stand. □



JONAH McLEOD
EDITOR



Risky Business



In today's competitive business climate, product development is a perilous journey. One slip can mean lost opportunity... or worse. You've got to plan intelligently, execute on time, and use the best available technology. If you don't, your competitors undoubtedly will.

Why put up with risks and shortcomings associated with obsolete power technologies... bulky, one-of-a-kind designs; program delays; agency approval cycles; last minute surprises; and unproven field reliability. Vicor's power component approach has been proven by thousands of users to be the fastest and most predictable path to successful power system development. And Vicor's complete line of "plug and play" power system building blocks offer unprecedented design flexibility and result in smaller, cooler, more cost-effective products.

Tired of power development cliffhangers? The solution is right at your fingertips... just give us a call.



Component Solutions For Your Power System



23 Frontage Road Andover, MA 01810
TEL: (508) 470-2900 • FAX: (508) 475-8715

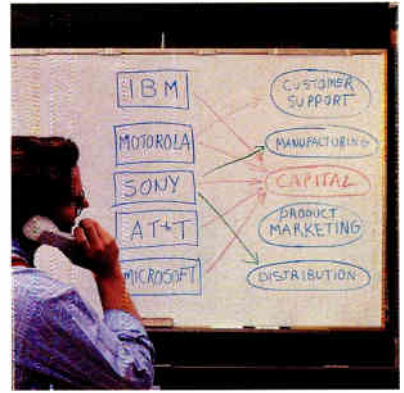

COVER STORY PAGE 45
PHOTO: JOOK P. LEUNG

Electronics

FEATURES

42

Executive Briefing: The next wave
 Managers wondering about the future of integrated circuit technology will get some hints at the IEDM.

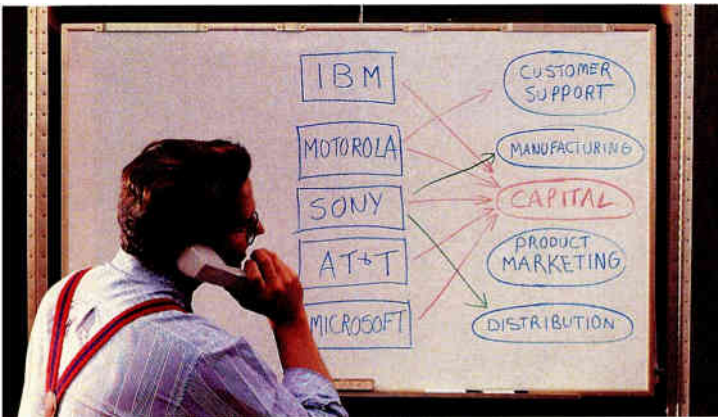

PAGE 45



PAGE 52

52

Can the U.S. get back into consumer?
 After losing the industry to Japan, some companies—notably Tandy, with its digital compact cassette—are giving it a shot.

45

COVER: TECHNOLOGY FOR SALE
What price strategic alliances?
 How small companies can find partners without selling their souls—or losing their intellectual property.



PAGE 41



PAGE 58

58

The war against Intel: the RISC crowd moves in
 MIPS's partnership announcement is the latest attack on the venerable x86 architecture; but Intel remains unflappable.

DEPARTMENTS

- 4 Up Front
- 12 Letter from Brussels
- 22 Face-Off: R&D tax credit
- 73 Information Center
- 77 Advertisers' Index
- 78 Electronics Index
- 80 The Last Word

NEWS ROUNDUP

16

News Front

- Wireless telecom: a coming \$230 billion business
- Multichip modules: \$10 billion by 2000?
- Home is where the phones are
- The story behind the Cadence-Valid merger

20

Products to Watch

- Mini gyroscopes seek out big markets
- VMEbus simulator makes for easier system modeling
- A quick way to port Windows applications to TCP/IP nets
- AMD launches 32-ns military PLDs
- Pocket token-ring adapter handles 4 and 16 Mbits/s

41

European Observer

- Will Europe '92 be open or closed?
- Jessi and Sematech make it official
- Philips to begin selling photo CD players
- Siemens and IDT will turn out 32-bit controllers

WORLDWIDE NEWS

25

Computers

As demand builds for high-performance network servers, Data General digs in

28

Semiconductors

The discovery of photoluminescent silicon opens the way to a new class of ICs

31

Networks

Technical, legal, and financial barriers stand in the way of a pan-European computer network

COMMENTARY

60

Michael Borrus Speaks Out

With the onset of globalization, conflicts over technology access will define the 1990s just as market access defined the 1980s

Companies covered in this issue, indexed to the first page of the article in which each is mentioned.

3M Co.....	52	Microsoft Corp.....	20
Accel Partners.....	45	Millicom Corp.....	32H*
Advanced Micro Devices		MIPS Computer Systems	
Inc.....	20, 45, 58	Inc.....	58
Alcoa Electronic		Mitsubishi Corp.....	42
Packaging.....	32E*	Motorola Inc.....	25, 42, 52
AMP Inc.....	45	National Semiconductor	
Apple Computer Inc.....	58	Corp.....	52
Bull SA.....	12	NEC Corp.....	42, 58
Cadence Design Systems		Network Research Corp.....	20
Inc.....	16	Opinion Research Corp.....	45
Chips & Technologies		Philips Electronics NV.....	12, 52
Inc.....	32E*, 58	Philips Research Labs.....	42
Computer and Business		Pyramid Technology Corp.....	25
Equipment Manufacturers		Quality Semiconductor	
Association.....	22	Corp.....	45
Computer Systems Policy		Research Center Jülich.....	32E*
Project.....	45	Sandia National Laboratory.....	45
Dallas Semiconductor Corp.....	45	Santa Cruz Operation.....	58
Data General Corp.....	25, 58	Sequent Computer Systems	
Deico Electronics.....	52	Inc.....	25
Disk/Trend Inc.....	52	Siemens AG.....	12, 42, 58
ElectroniCast Corp.....	16	Siemens Matsushita	
Fraunhofer Institute for		Components.....	12
Solid State Technology.....	28	Sony Corp.....	52
Fujitsu Ltd.....	42	Sun Microsystems Inc.....	25, 58
Go Video Inc.....	52	Tandem Computer Inc.....	58
Gyratation Inc.....	20	Tandy Corp.....	52
Harris Corp.....	16	Technology Investments.....	45
Hewlett-Packard Co.....	45	Teradyne Inc.....	52
Hitachi Ltd.....	42	Texas Instruments Inc.....	42, 58
IBM Corp.....	45, 58	Thomson SA.....	12
Ing. C. Olivetti & Co. SpA.....	12	Toshiba Corp.....	42
Intel Corp.....	45, 58	Valid Logic Systems Inc.....	16
Intellon Corp.....	45	Xilinx Inc.....	22, 45
LETI.....	42	Xircom Corp.....	20
Logic Automation Inc.....	20	Yankee Group.....	16
Los Alamos National		Zetex Semiconductors plc.....	32E*
Laboratory.....	45	Zilog Inc.....	52
Matsushita Electric Industrial		Zoran Corp.....	52
Co.....	42		
Mentor Graphics Corp.....	45		

* International only



Jesse H. Neal
Editorial Achievement Awards

1956 Merit, 1965 First
1975 Merit, 1976 Merit
1977 First, 1978 First
1988 Merit, 1990 Merit



DEPARTMENTS

- 4 Up Front
- 12 Letter from Brussels
- 22 Face-Off: R&D tax credit
- 73 Information Center
- 77 Advertisers' Index
- 78 Electronics Index
- 80 The Last Word

NEWS ROUNDUP

16

News Front

- Wireless telecom: a coming \$230 billion business
- Multichip modules: \$10 billion by 2000?
- Home is where the phones are
- The story behind the Cadence-Valid merger

20

Products to Watch

- Mini gyroscopes seek out big markets
- VMEbus simulator makes for easier system modeling
- A quick way to port Windows applications to TCP/IP nets
- AMD launches 32-ns military PLDs
- Pocket token-ring adapter handles 4 and 16 Mbits/s

41

European Observer

- Will Europe '92 be open or closed?
- Jessi and Sematech make it official
- Philips to begin selling photo CD players
- Siemens and IDT will turn out 32-bit controllers

WORLDWIDE NEWS

25

Computers

As demand builds for high-performance network servers, Data General digs in

28

Semiconductors

The discovery of photoluminescent silicon opens the way to a new class of ICs

31

Networks

Technical, legal, and financial barriers stand in the way of a pan-European computer network

COMMENTARY

60

Michael Borrus Speaks Out

With the onset of globalization, conflicts over technology access will define the 1990s just as market access defined the 1980s

Companies covered in this issue, indexed to the first page of the article in which each is mentioned.

3M Co.....	52	Microsoft Corp.....	20
Accel Partners.....	45	Millicom Corp.....	32H*
Advanced Micro Devices Inc.....	20, 45, 58	MIPS Computer Systems Inc.....	58
Alcoa Electronic Packaging.....	32E*	Mitsubishi Corp.....	42
AMP Inc.....	45	Motorola Inc.....	25, 42, 52
Apple Computer Inc.....	58	National Semiconductor Corp.....	52
Bull SA.....	12	NEC Corp.....	42, 58
Cadence Design Systems Inc.....	16	Network Research Corp.....	20
Chips & Technologies Inc.....	32E*, 58	Opinion Research Corp.....	45
Computer and Business Equipment Manufacturers Association.....	22	Philips Electronics NV.....	12, 52
Computer Systems Policy Project.....	45	Philips Research Labs.....	42
Dallas Semiconductor Corp.....	45	Pyramid Technology Corp.....	25
Data General Corp.....	25, 58	Quality Semiconductor Corp.....	45
Deico Electronics.....	52	Research Center Jülich.....	32E*
Disk/Trend Inc.....	52	Sandia National Laboratory.....	45
ElectroniCast Corp.....	16	Santa Cruz Operation.....	58
Fraunhofer Institute for Solid State Technology.....	28	Sequent Computer Systems Inc.....	25
Fujitsu Ltd.....	42	Siemens AG.....	12, 42, 58
Go Video Inc.....	52	Siemens Matsushita Components.....	12
Gyratation Inc.....	20	Sony Corp.....	52
Harris Corp.....	16	Sun Microsystems Inc.....	25, 58
Hewlett-Packard Co.....	45	Tandem Computer Inc.....	58
Hitachi Ltd.....	42	Tandy Corp.....	52
IBM Corp.....	45, 58	Technology Investments.....	45
Ing. C. Olivetti & Co. SpA.....	12	Teradyne Inc.....	52
Intel Corp.....	45, 58	Texas Instruments Inc.....	42, 58
Intellon Corp.....	45	Thomson SA.....	12
LETI.....	42	Toshiba Corp.....	42
Logic Automation Inc.....	20	Valid Logic Systems Inc.....	16
Los Alamos National Laboratory.....	45	Xilinx Inc.....	22, 45
Matsushita Electric Industrial Co.....	42	Xircom Corp.....	20
Mentor Graphics Corp.....	45	Yankee Group.....	16
		Zetex Semiconductors plc.....	32E*
		Zilog Inc.....	52
		Zoran Corp.....	52

* International only



Jesse H. Neal
Editorial Achievement Awards

1956 Merit, 1965 First
1975 Merit, 1976 Merit
1977 First, 1978 First
1988 Merit, 1990 Merit



World Pacific History

Life without the telephone would be unimaginable today. It is truly the pulse of business and personal life.

Now, as ISDN creates new possibilities, the need for Anritsu capabilities is greater than ever.



Ensuring the quality that people like you depend on every day is Anritsu's special area of expertise.

From local pay-phones to international communications, we cover every aspect to guarantee instant access with reliable connections. Whether it's high-speed data or the most intimate proposal.

ital, optical and other measurement technologies to support peak communications performance.

We also produce miniature relays, hybrid ICs and efficient industrial auto-



At the Heartbeat of Communications

Dedicated to Preserving the Connections Between People



This is no small accomplishment considering the increases in speed, volume, media and services offered by today's networks.

We meet each of these challenges with the most advanced dig-

mation equipment.

Anritsu has consistently pioneered new standards in speed, precision, and reliability.

That's how Anritsu support ensures clear, reliable performance in any network.

Anritsu

ANRITSU CORPORATION 10-27, Minamiazabu 5-chome, Minato-ku, Tokyo 106, Japan Phone: Tokyo 03-3446-1111, Telex: J34372

Redefining Microelectronics: End users under-

stand best what they want from microelectronics to give

Power control in automotive systems



their products a competitive edge. We know because

we are end users. So is our parent,



Power regulation in telecommunications

Daimler-Benz Group. What makes us



unique is that we're also a leading supplier. We're dis-

Analog signal processing in test and measurement equipment



tinguished, as well, by our century of industry experience



Motion control in hard disk drives

and our worldwide infrastructure. Our Telefunken heritage

instills us with European precision, while French-based



Antiskid braking control unit

Matra MHS and Silicon Valley-based Siliconix keep

Semiconductor components for microwave, cellular phone and optical fiber communication



us on technology's cutting edge. The combination

ADDED

delivers added value – not only through



Multichip modules with chip-on-silicon

innovation and performance, but

durability and longevity. Call (908) 231-8405 to see how

AEG can redefine microelectronics for you.

Power management in portable computers



AEG Corporation.

AEG

Member of the Daimler-Benz Group

BRUSSELS

EC HEARINGS ON JAPAN TRADE TAKE ON ASPECTS OF HIGH DRAMA
THE PLAY'S THE THING

BY PETER FLETCHER

The play's the thing wherein we'll catch the conscience of the king.—Hamlet

Shakespeare's hero set out to entrap a murderer by staging a play replicating the circumstances of the crime. In watching it, Hamlet reasoned, the murderer would be overcome with remorse and confess. In the context of the electronics industry circa 1991, for "king" substitute "Japanese," change "play" to "public hearing," and you have just described the opening maneuver in the European Community's strategy to redress its balance of trade with Japan.

Of course no EC official is going on record to accuse the Japanese of murder. But concern is growing at the increasing gap between electronic imports from Japan and exports there from Europe. The EC is also worried over the rate at which the Japanese are increasing their market domination, taking control of the means of production of components and some high-volume systems. Some even go so far as to pre-

dict that unless something is done, Europe will no longer have any independent electronics firms in 10 years' time.

With 1992 and the fusion of the 12 member states into a unified market barely two months away, Europe still has no coherent industrial policy of any sort, let alone one to deal with specific issues relating to one international trading partner. So the European Parliament decided to stage a play.

In September, the Parliament's Committee on External Economic Relations called a series of public hearings at its headquarters in Brussels, Belgium. The intention: "to collect information and evidence on the possibilities of taking an active approach by European industry to the Japanese market as well as on the difficulties and opportunities encountered by European firms in attempting to operate in that market."

This is the first time that the Parliament has opened an issue to public debate. This type of information gathering has always been carried out privately, with debates taking place behind closed doors. That was the way the last report

on trade relations between Japan and the EC was handled in 1986.

This time, though, around 200 people from 15 countries showed up at the Parliament Building—a nondescript concrete office block in the Belgian capital—to take part. Some were members of the European Parliament, some represented special interests such as the labor unions, and some were from industry. But three had come to listen intently, take notes, and, the Parliament hoped, go away and think hard. They were from the Japanese Mission to the EC.

"You have to realize that it is an exercise between the opinion formers in both Japan and Europe," said a Parliament official who declined to be named. "It is a somewhat subtle debate in which the main audience is the Japanese. The whole thing is very carefully monitored by the Japanese—they are extremely sensitive to reaction and, we expect, will be guided in their future policy decisions to some extent by the reactions they sense from industry and others." The expectation was that the European mood would be conveyed to the Japanese Ministry for International Trade and Industry (MITI). "At the least, [MITI] might put a brake on activities for a while," the official said.

The hearings mark a small step forward in the process of unifying Europe. "My purpose was to adopt a more open and investigative approach similar to that used by the U.S. Congress," says James Moorhouse, the member of Parliament who convened the hearings and who will produce the final report for Parliament debate. The group will then pass on its recommendations to the Commission of the European Community (CEC) for possible implementation. "This is not so very different from the U.S. system and the way in which the Congress interacts with the President," Moorhouse says, adding that this was the first occasion on which the Parliament has actually "put witnesses on the spot—quite a departure for us."

There were just four witnesses to listen to. First, Commission Vice President



Some 200 people—including a delegation of Japanese—gathered at European Parliament headquarters in Brussels for the hearings.

One Shop Stopping.



For vendor reduction. Think about it—ROHM has the broadest product line in the industry. Broader than any other major supplier.

We've got the resistors, capacitors, and discretes you need every day, with AQLs in parts-per-billion. You can wring out your costs and save mountains of time.

But we're more than a jellybean store. Just look at our dense hybrids, with component counts up to 50/cm². And our modules, printheads, flat panels and displays—subassemblies that can shave precious days off your time-to-market, or ease the hit on development budgets.

ROHM puts you in the super-market!

	Monolithic Hybrid ICs	Laser Diodes	Optoelectronics	Transistors	Diodes	Resistors	Capacitors	Gauge FETs	Thermal Printheads	LED Printheads
ROHM	✓	✓	✓	✓	✓	✓	✓	✓	✓	✓
ALLEN BRAD.	x									
ALPS	x									
BOURNS										
DALE										
FUJITSU	x	x	x	x	x		x			
GE	x									
GI										
HITACHI	x	x	x			x			x	
HOKURIKU	x									
HP										
ITT	x								x	x
KOA										
KYOCERA		x								
LITE-ON	x								x	x
MITSUBISHI	x	x	x	x	x					
MOTOROLA	x								x	
NATIONAL	x	x								
NEC									x	x
OPTREX										
PANASONIC	x									
PHILLIPS	x									
SHARP	x									
STACKPOLE									x	x
STANLEY										
TDK	x	x							x	
TOSHIBA	x									
TRW	x									



ROHM Corporation
 ROHM Electronics Division
 3034 Owen Drive
 Antioch, TN 37013
 Telephone (615) 641-2020
 FAX (615) 641-2022

©Copyright 1991, ROHM Corporation

RF/MICROWAVE COMPONENTS ACROSS THE COMMUNICATIONS SPECTRUM



Semiconductors to Supercomponents

When it comes to high performance, high volume, and high frequency, no one matches Avantek. For over 25 years, we've been the leader in developing new levels of circuit performance for communications systems across the spectrum. Avantek provides cost effective solutions for the most particular design requirements. Our product line is continuously growing both in process and application leader-

ship. We offer both Si and GaAs based products providing the best performance/price choice for any high-frequency design. Discreet devices, ICs, hybrids, or system subassemblies, Avantek has the broadest line of standard components—literally thousands—for kilohertz to Gigahertz applications, and lightwave components too.

- Surface-mount plastic integrated circuits
- Low-noise amplifiers
- High-power amplifiers

- Active and passive mixers
- DRO, VCO, and YIG tuned oscillators
- Limiters
- Attenuators
- Switches
- Frequency converters
- Multiplexers

engineer makes the design-in process fast, reliable, confident, and affordable.

The Largest RF/Microwave Component Distribution Network

With over 20 major stocking locations, and a worldwide trans-shipment operation, Avantek delivers millions of parts every month. We meet the demands of the most demanding JIT program, or supply a critical single prototype with the same matchless service and support. Call us today to hear how we can support your great designs.

Call 1-800-AVANTEK

We Can Help Today

Your local Avantek sales engineer is an *engineer*, trained and experienced in critical RF/microwave design-in situations and uniquely qualified to support you. Ready to provide design literature, CAD modeling software, or prototype samples. Backed by application engineering teams, your Avantek sales

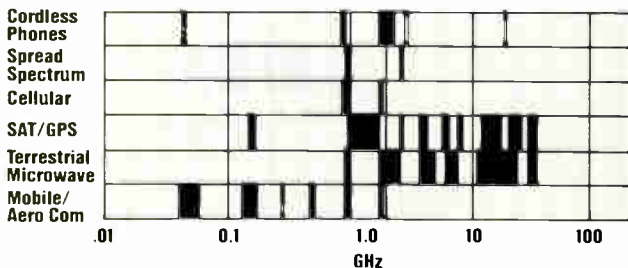

Filippo Maria Pandolfi, a full-time CEC appointee with special responsibility for technology, set out the quantitative nature of the problem—a European trade imbalance of more than \$35 billion in electronics in 1989, most of it in favor of Japan. The Japanese industry clocked up an impressive \$57 billion surplus that year, the CEC says.

Next, Clyde V. Prestowitz, the former U.S. Trade Representative and now director of the Economic Strategy Institute in Washington, described the U.S. experiences in dealing with similar problems. Finally, the European giants Philips Electronics NV and Siemens AG testified on behalf of industry. The two put forward a depressing view of the state of European electronics.

It was Philips, based in Eindhoven, the Netherlands, that predicted the industry could disappear within 10 years unless some firm action is taken soon. The testimony—presented by F.H. Wishaupt, managing director of Philips Components, and U. de Haan, head of purchasing for the Philips Consumer Electronics Division—said the European industry will have been put out of business by rivals from the Far East and North America, or taken over by them.

The Philips managers pointed out that in international markets only two European computer companies—Italy's Ing. C. Olivetti & Co. SpA and France's Bull SA—managed to stagger into the world's Top 10 league. In other important sectors, European firms made a poor showing. In semiconductors, Philips rates itself the largest European producer but only makes 10th spot worldwide. In consumer electronics it fares better, at third overall. France's Thomson SA ranks sixth, but the remaining eight companies are Japanese.

The one area where European firms still have a chance is telecommunications, in Philips's view. Of the top 10 telecom companies, Alcatel ranked second, Siemens third, Ericsson sixth, Philips eighth, and Robert Bosch ninth.

Structural differences between Japanese and European industry contribute to Japan's dominance, said K. Ziegler, president of Siemens Matsushita Components, a successful alliance between

the German and Japanese companies to make passive components. For example, he said, the average Japanese employee works 700 more hours per year than the average worker in Europe. Also, the industry witnesses said, Japanese companies enjoy low interest rates, better long-term planning, and greater collaboration between industry and government.

And all those pointers give a clue to a deeper meaning for the Brussels meeting. Europe's electronics producers want the CEC to come up with a coherent industrial policy that will help them develop manufacturing technology while reducing labor costs. They want long-term research and development projects, and a beneficial fiscal policy. In bringing their wish list to Brussels, they were hoping to influence the Parliament, which has veto power over the way the CEC spends its budget.

Will the play ploy work? Prestowitz noted that the reason negotiations between the U.S. and Japan seem to fail is because of a misinterpretation of the Japanese way of doing business. "We assume that because Japan is an industrial democracy they are the same as us—but in fact the two systems are different," he said. "I'd say that the present attempts to open up Japanese markets should be abandoned, because the present effort...consists of first accusing them of being unfair. We say they cheat, they're crooks, and then we go to negotiate with them."

Understandably, said Prestowitz, the Japanese "don't like this method of negotiation. They don't think they are unfair—and in fact they are not unfair. It's not that they are playing the game unfairly—it's just that they are playing a different game. The Japanese are playing American football, and Europe is playing cricket or baseball." It's absurd to tell Japan to stop playing football, he said. "They are very successful playing football; so why should they stop?"

Football and cricket aside, the European Parliament is counting on the fact that the Japanese love of theater may make them receptive to the Belgian show. The question is, does *Hamlet* translate into Kabuki? □

NO WAITING AVANTEK DELIVERS TODAY



North American Distributors

Northwest

Nu Horizons
(617) 246-4442 MA
Sickles Distribution Sales
(617) 862-5100 MA

East Central

Applied Specialties, Inc.
(301) 595-5395 MD
Nu Horizons
(301) 995-6330 MD
(201) 882-8300 NJ
(516) 226-6000 NY
(215) 557-6450 PA
Penstock East
(800) 842-4035 NJ
(516) 368-2773 NY
(215) 383-9536 PA

Southeast

Penstock, Inc.
(404) 951-0300 GA
Nu Horizons
(305) 735-2555 FL

North Central

Penstock Midwest
(708) 934-3700 IL
(317) 784-3870 IN

South Central

Insight Electronics, Inc.
(800) 677-7716 TX
Penstock, Inc.
(214) 701-9555 TX

Northwest

Insight Electronics, Inc.
(800) 677-7716

Penstock, Inc.
(800) PENSTOCK
(206) 454-2371 WA

Southwest/Rocky Mountain

Insight Electronics
(800) 677-7716
Sertek, Inc.
(800) 334-1217

Canada

Sertek, Inc.
(800) 548-0409

International Distributors

Europe

Italy
BFI-Ibexsa SpA
(39) 2-331-005-35 Milan
(39) 6-8088191 Rome
Germany/Switzerland/Austria
BFI-Ibexsa Elektronik GmbH
(49) 89-3195135
France/Belgium
Scie Dimes
(33) 1-69-41-8282
Sweden/Norway/Finland
BFI-Ibexsa Nordic AB
(46-8) 626-99-00
U.K.
BFI-Ibexsa Electronics LTD.
(44) 62-288-2457

Asia and Far East

Japan
Yamada Corporation
(81) 03-3475-1121

Correction

In the Letter From Denmark (August 1991, p. 12), Danish tax law was mis-

stated. Income tax rates for U.S. research personnel there are substantially lower than those for Danes, but the Americans are not exempt. □

Putting Microwave Technology to Work for You



FRONT

PASS THE WORD: '\$230 BILLION'

When a family friend advised Dustin Hoffman's character in the movie *The Graduate* to get into the plastics industry, he was giving sound early 1960s advice. Today, however, the advice is more likely to be, "wireless personal communications." And with good reason: even though some significant barriers must be surmounted before the dreams of product managers solidify into real sales and profits, the people who divine the future of the industry are optimistic.

One, ElectroniCast Corp., a San Mateo, Calif., market-re-

search firm, declares that the worldwide market for wireless products, services, and software is likely to grow tenfold by the end of the century: from 1991's \$23.36 billion to \$74.07 billion in 1995 and \$230.13 billion by 2000. The greatest growth will be in Europe, which will have 19% of the market this year but 28% in 2000 for an average annual growth rate of 19.1%.

Meanwhile, the speed and mobility that make wireless communication so appealing has some of the industry's heavy hitters revving up. Among those taking on the

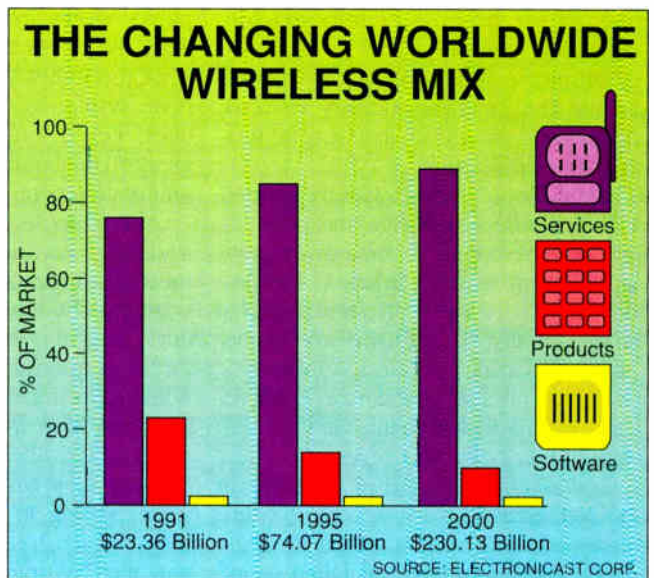

The most impressive growth in the world market for wireless communication will be in service charges.

major obstacles—lack of frequencies and standards—are Apple, Motorola, and NCR,

as well as Nippon Telegraph & Telephone in Japan [*Electronics*, March 1991, p. 45]. □

HOME IS WHERE THE PHONES ARE

Don't ignore the home office. Another study has come along to point up the burgeoning importance to information-technology marketers of the people who do at least some work at home.

Previous market forecasts focused on personal computer sales [*Electronics*, December 1990, p. 19]. But now the Yankee Group predicts that the 32 million home-office households will accelerate demand for enhanced communication services—such as Custom Local Area Signaling Service, or Class—and advanced messaging services. Moreover, the Boston consulting firm predicts that work-at-home activity, including telecommuting, will provide the wedge for mass-market penetration by such advanced services as Class. □

TECHNOLOGY AND STOCK OPTIONS SPURRED THE CADENCE-VALID MERGER

The merger of Cadence Design Systems Inc. and Valid Logic Systems Inc., both of San Jose, Calif., caused a stir in the design-automation industry mostly because it finally happened. Cause of the wait: no compelling need, says Robert Herwick, managing director of technology research at San Francisco venture capital firm Hambrecht & Quist Inc.

But rapid acceptance of system-level design presented one. Also, Valid's stock-option program, with top management paying just over \$1 a share, makes the long-term viability of Valid more important than who will be in charge.

The result is greater than the sum of the two parts. In top-level system design, Cadence's Verilog has been beating Valid's RapidSIM high-level simulator, Herwick says. Valid president Doug Hadjar had to decide if

he could battle not only Verilog but Mentor Graphics Corp. and Intergraph-Dazix.

The same goes for Cadence. Joe Costello, president, has been frustrated in making Prance, the board-

layout package Cadence acquired with Automated Systems, a competitor for Valid's Allegro. Now, the combined company has a world-class system-level simulator as well as a board package. □

MULTICHIP MODULES: \$10 BILLION BY 2000?

Is the multichip-module market going to reach the heady levels of printed-circuit boards? At least one (admittedly partisan) insider predicts that by 2000 sales in the MCM world will total \$10 billion, which is what pc boards will reach this year.

That forecast comes from Tony Mazzullo, director of CAD at the Scientific Calculations Division of Harris Corp. in Fishers, N.Y. Mazzullo has just joined Harris, moving over after it acquired the assets and staff of TASK Technologies Inc., an MCM

CAD firm, where Mazzullo was president.

Mazzullo believes MCMs are in the first stage of a three-stage maturation process. "The market is only in the \$100 million range," he says, "with defense and government—attracted by speed, density, and light weight—the early adopters. But in 1992, computer makers will start coming on board." The final stage, MCM's emergence as a \$10-billion-a-year technology (\$650 million of that for CAD), awaits lower prices. □

Master Designer 5.0, the shortest distance from concept to reality.

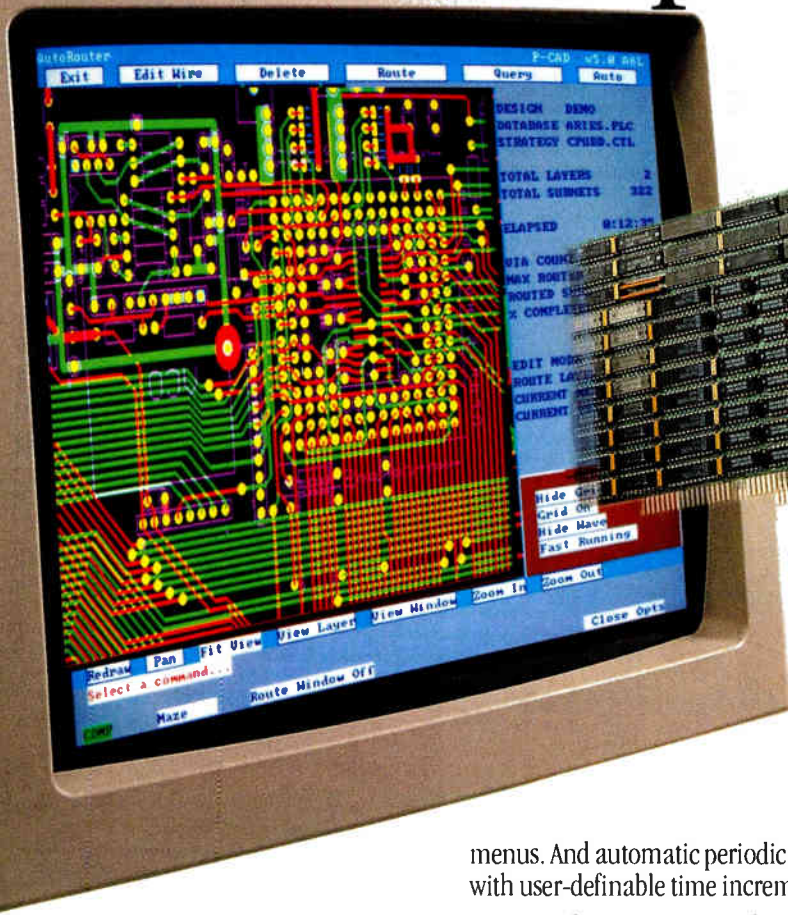

Master Designer™ 5.0 is the shortest distance from PCB design concept to reality. And the fastest, most productive and reliable way to get your designs to market using an IBM® or compatible PC.

And now Master Designer 5.0 has been enhanced with more than 100 new features, requested by PCB master design engineers like you.

New features, more productivity.

Master Designer 5.0 shortens the entire design cycle with new features like extended memory for 4-times larger designs. Automatic real-time on-line design rule checking. User configurable

menus. And automatic periodic file save with user-definable time increments.

First with 19,000 PCB designers.

You can rely on Master Designer 5.0 for the quality and dependability that has made it the choice of more than 19,000 PCB designers worldwide.

Master Designer 5.0 gives you the interactive support of Master Layout™ to handle surface mount, analog, and digital technology. The flexibility of Master Schematic™, fully automated optional Rip-n-Route, and our optional Master Placer™. Not to mention the plus of a consistent menu-driven interface.

With Master Designer 5.0, you're backed by CADAM, the world's leading CAD/CAM/CAE software supplier, and

the international network of expert P-CAD Value Added Resellers.

Your finished designs are a lot closer than you think and so is your free P-CAD Demo Disk.

Here's how to get all the details on Master Designer 5.0, and shorten the distance between your next great concept and reality. Just call P-CAD toll-free today and we'll send your free Master Designer 5.0 Demo Disk absolutely free.



1-800-255-5710

World Class PCB CAD Productivity

p-cad®

PRODUCTS FROM CADAM, AN IBM COMPANY

IBM is a registered trademark of International Business Machines Corp. P-CAD is a registered trademark and Master Designer, Master Layout, Master Schematic, and Master Placer are trademarks of Personal CAD Systems, Inc. P-CAD/CADAM, 1935 N. Buena Vista St., Burbank, CA 91504. ©1991 CADAM INC.

CIRCLE 213

See us at Wescon Booths #1235 to 1238

*Putting high-performance power distribution
on the fast track.*

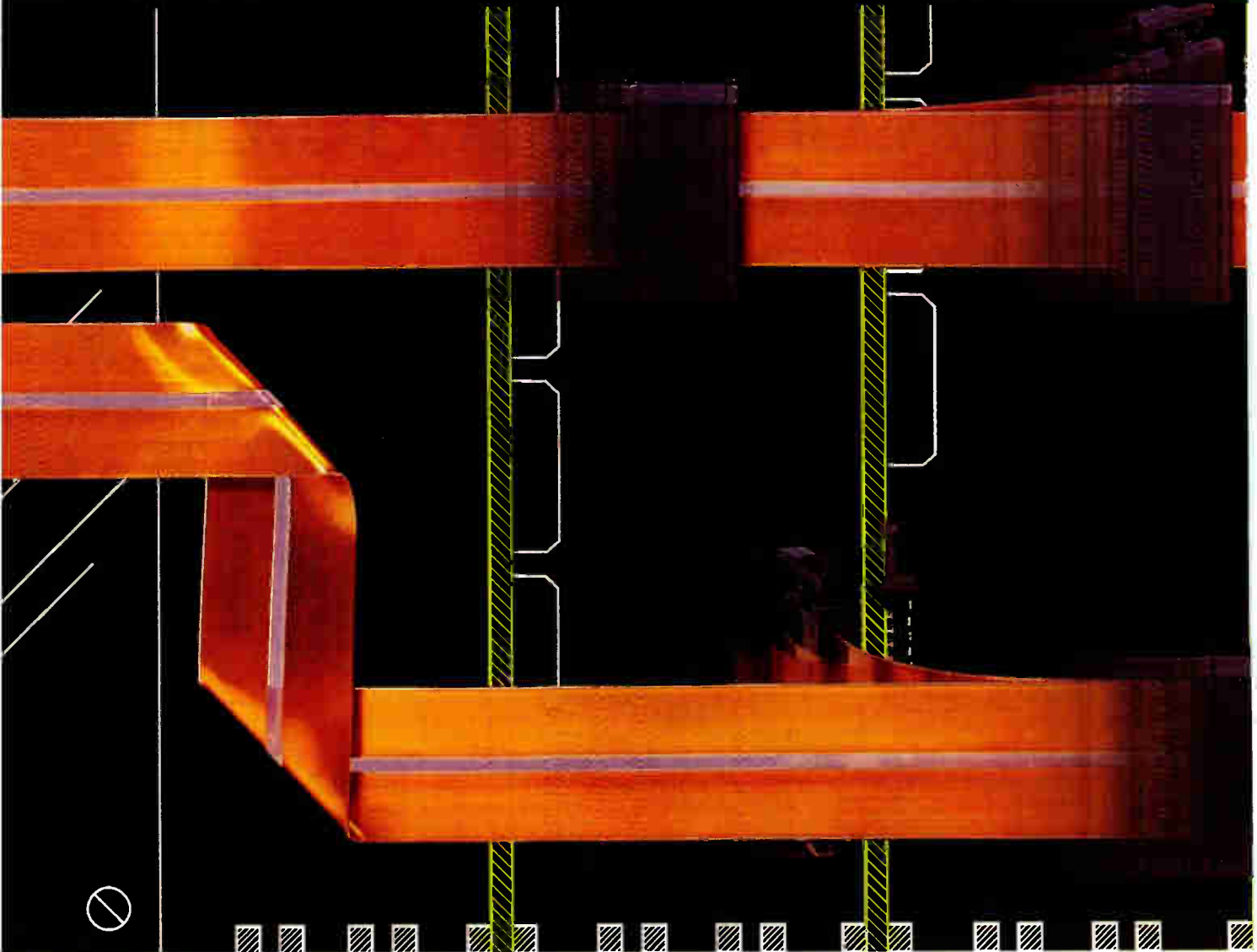

THIS IS AMP TODAY.

Designers of today's high-performance power distribution systems (PDSs) need a practical way to take advantage of the compact size, thermal efficiency, and low inductance of insulated flat copper power cable.

Our newest invention not only makes flat conductors practical, it adds powerful new options to the way you can design your 'flat power' PDS.

AMPOWER Wave Crimp

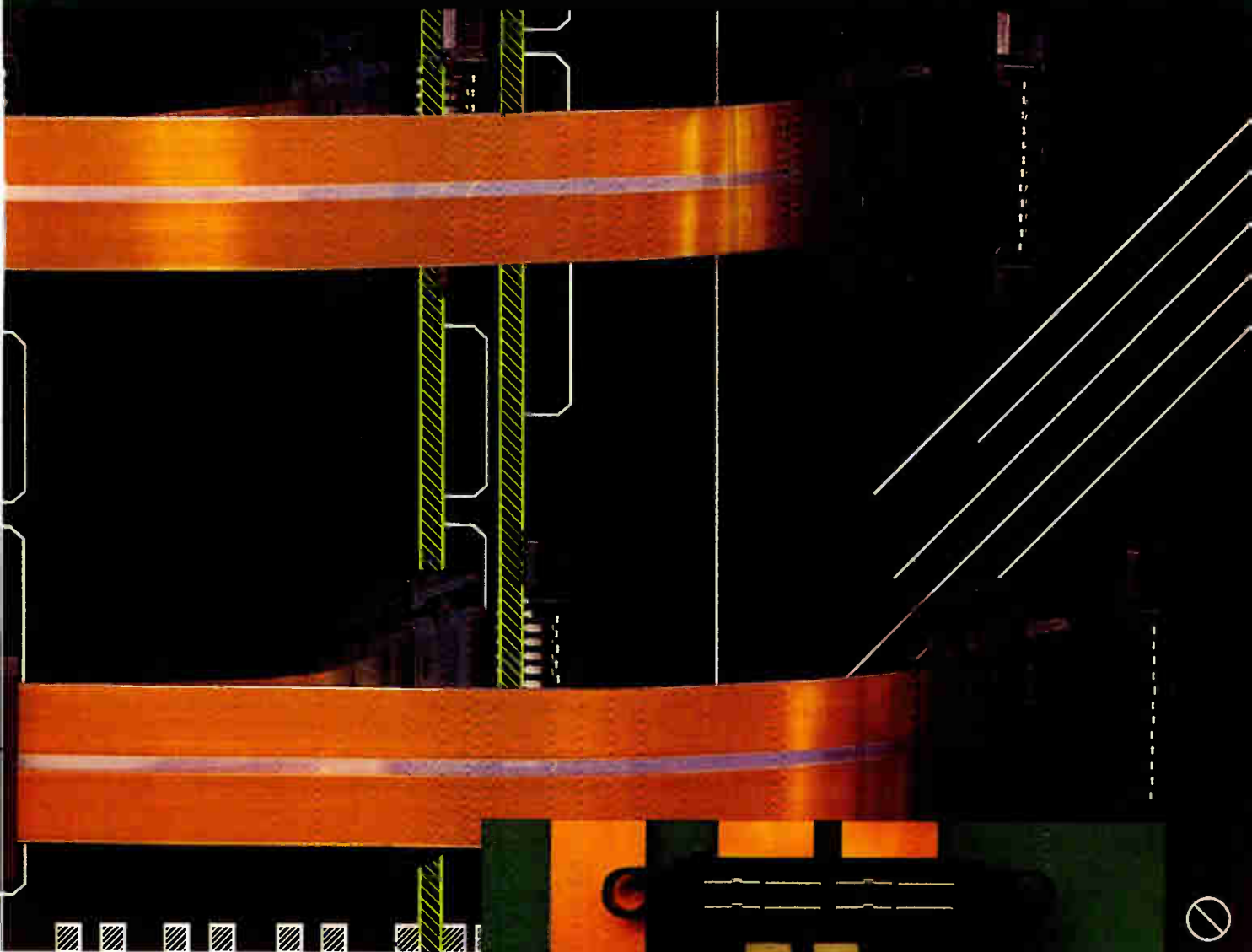

Assemblies let you specify direct taps on flat cable wherever you'd like, for efficient branching. And they give you a true modular approach to power—with separable printed circuit board connectors and sequenced Blind Mate drawer connectors—for fast assembly, and easy service and upgrade.

The exclusive crimp termination contacts an area 50% greater in cross section than the conductor itself. Result: no thermal penalties,



Flat conductor PDS made practical.

no current restrictions, no compromise in the inherent low-noise properties of flat conductors. Electrical characteristics are consistently predictable.

To realize all the new opportu-

nity in flat power right now, call 1-800-522-6752 (fax 717-561-6110) and ask about AMPOWER Wave Crimp Assemblies. In Canada call 416-475-6222. AMP Incorporated, Harrisburg, PA 17105-3608.

TO WATCH

MINI GYROS HUNT FOR BIG MARKETS

By drastically reducing the price, size, weight, and power consumption of gyroscopes, Gyration Inc. has opened the door to incorporating 3-d position sensing in a broad range of electronic products from auto navigation systems to camcorders.

The key technology innovations in the Saratoga, Calif., company's GyroEngine are its use of optics to sense movement and polycarbonate plastic for most components. The optical implementation replaces heavier electromagnetic systems and



Gyration's mini gyroscope weighs 1.2 oz. and offers real-time response for computer applications.

has the added advantage of producing a digital output. Plastic parts mean the system can be injection-molded, strong, and light. The device is 1.75 in. tall, 1.25 in. in diameter and consumes 0.1 W.

Although Gyration's proof-of-concept product is a pointing device that can be used to manipulate 3-d images on CAD workstations, it sees its engine primarily as an enabling technology for innovative electronics firms.

A developer's kit will be available to original equipment manufacturers in the fourth quarter for \$1,000. □

VMEBUS SIMULATOR MODELS SYSTEMS

System-level simulation on the VMEbus will be easier, faster, and more accurate thanks to Logic Automation Inc.'s SimuBus, the first commercially available model of a standard bus.

The model conforms to the IEEE's VMEbus specification. It supports system and master/slave configurations, as well as all critical VMEbus operations including read, write, read-modify-write, interrupts, block reads, block writes, and arbitration.

It is controlled using the Beaverton, Ore., company's Processor Control Language, a C-like language used in the company's SmartModel products. The model provides error checks including, set-up, hold, and pulse width on bus transactions. Available now, a single-user SimuBus license is priced at \$10,000 in the U.S. Site licenses are \$25,000. □

HERE'S A QUICK WAY TO PORT WINDOWS APPLICATIONS TO TCP/IP NETS

Companies looking for a TCP/IP network interface for their Microsoft Windows applications need look no further than a developer's kit from Network Research Corp.

The Oxnard, Calif., company's Fusion developer's kit provides its network and transport services through support of Windows' Dynamic Link Library. The kit is compatible with Microsoft Corp.'s Software Development Kit for Windows. It includes a set of modules that isolate the differences between TCP/IP's socket-oriented communications protocol and Windows' message-based protocol. By resolving these differences, it considerably speeds product development.

Long the de facto industry connectivity standard for large networks, TCP/IP is quickly migrating into the microcomputer world. But since it is in the public domain, it has little documentation and support. Network Research

markets a commercial version of TCP/IP with full support.

The Fusion Windows Developer's Kit requires Fusion TCP/IP for DOS, priced at \$295. The cost of a year's support is \$100. Source code starts at \$15,000. □

AMD LAUNCHES 32-NS MILITARY PLDs

Advanced Micro Devices Inc. has migrated the first of its MACH line of programmable logic devices to military grade.

The MACH110 offers 32 microcells and 44 pins, which is roughly equivalent to 900 logic gates. It is the first of AMD's MACH family

to qualify under MIL-STD-883C, says the Sunnyvale, Calif., company.

The remaining members of the military MACH family will be qualified over the next six to eight months. The MACH110-22/BXC is available now priced at \$74.45 in 100-unit quantities. □

POCKET TOKEN-RING ADAPTER HANDLES 4- AND 16-MBIT/S NETS

Following up on its release in June of an Ethernet adapter small enough to fit in a pocket, Xirecom Corp. has unveiled a Token Ring pocket adapter that handles both 4 and 16Mbit/s.

The adapter connects to a standard PC parallel printer port. Models are available for both IBM-specified shielded and unshielded twisted-pair wiring. Its accompanying software sup-

ports more than 20 network operating systems. Drivers are preconfigured for all popular networks.

The Los Angeles, Calif., company has priced the adapters at \$895. □

The Microprocessor & License to Create Your Own Industry



Western Design Center backs you with the world's leading installed 8-bit microprocessors and the industry's most workable business arrangements.

The technology that started the personal computer and video game revolution.

The Western Design Center (WDC) W65C microprocessors are the core of some of the world's most popular microcomputers, peripherals and video games...and the heart of some of the health care industry's most important life preserving devices. In fact, with the largest installed microprocessor-based technology, WDC has been the secret to the success of many of the world's most

widely used products. Our leading edge technology is only one reason.

You can get a license to succeed.

WDC's unique licensing agreement guarantees you total control over product development, manufacturing and proprietary information - total control over your future. You have Freedom of Manufacturing. That means you can work with any one of several foundries throughout the world. Plus, you have the confidence of knowing your parts are second sourced. With a WDC license, you have the industry's most workable business arrangement because *you drive development.*

Investigate the real secrets to success.

Want the technology that can shift your product development into high gear? The license that can put you in the driver's seat? Send for more information about our 8-bit, 16-bit and 32-

bit microprocessors and microcomputers. Find out how to qualify for free device samples and a look at our innovative license agreements.

- High performance, low cost, low power, low voltage microprocessors
- Core[®] standard product and ASIC product licenses
- Hi-Rel, scaled and worldwide manufacturing
- Freedom of Manufacturing
- Second Sourcing



"Founded in 1978, Licensing since 1981."

The Western Design Center, Inc.
2166 East Brown Road,
Mesa, Arizona 85213
602.962.4545
FAX 602.835.6442

To get a good idea of what a great idea we have in Image Watches... paste your color logo here.



NEW!
Thin
Water-Resistant
Case

OR EVEN BETTER

Send us your color logo

(Any size letterhead, photo, brochure, artwork which need not be returned)

along with **U.S. \$14.50 each***

*(Tax, shipping included.)

(special below-cost introductory offer)

and we'll rush you a personalized working quartz watch sample as our convincer!

Your company logo in full color on the dial of a deluxe, water-resistant wristwatch. 18K Goldplated case, water-resistant leather strap, battery powered quartz movement with a 1-year no-service-charge warranty (battery included). Men's and women's styles. Remarkably inexpensive even in small quantities.

* * * * *

The Image Watches, Inc. staff of 180 people in California are dedicated to serving you with uncompromising product quality, on time delivery and superior customer service.

To dispel any confusion from imitators we stamp our name on the back of each watch.

Please look for this seal of excellence



Catalog sheet and details on request.
Limit: 2 samples per company @ \$14.50 each

IMAGE WATCHES,™ INC.

400 S. Atlantic Blvd., Suite 302
Monterey Park, CA 91754

Attn: Mr. Wheaton (213) 726-8050

9am - 5pm Mon. - Fri.
Pacific Coast Time

Logo Watch
Leader for over
10 Years

© Image Watches,™ Inc.
all rights reserved

Unconditional Money Back Guarantee

CIRCLE 3

FACE

OFF

THE R&D TAX CREDIT: LET'S

Most large information-technology producers are publicly traded companies that operate in the global marketplace. This description implies significant challenges related to their research and development programs—challenges the current R&D tax credit does not address.

First, as highly visible, publicly traded companies, they feel the pressure of quarterly accountability. It is difficult for such companies to gain support for long-term R&D projects from shareholders, analysts, and reporters who obsessively track short-term profits. In establishing R&D budgets, a company is

almost compelled to invest for a short turnaround time, funding activities that involve less risk instead of highly innovative, multiyear programs. To the extent that an R&D tax credit influences the availability of funds for industrial R&D, however, it boosts a company's resources.

Second, the fact that leading U.S. high-tech manufacturers operate globally makes it imperative that they sustain vigorous R&D programs in order to market competitive products. Yet their foreign competitors may have a sizable advantage in the form of significant tax incentives from their governments. Japan clearly acknowledges R&D as a core business activity and provides ongoing tax credits: for increases over the previous year's R&D expenditures; for research and testing costs, including materials, payroll, and other expenses incurred in the improvement of manufacturing or technology; and for the purchase of equipment related to basic research.

One result is that the private sector funds more than 70% of the R&D in Japan, compared with about 50% in the U.S. To highlight the discrepancy even more, for the past two decades, the U.S. has allocated about the same amount—2.5%—of its economic output to R&D while Japan's R&D allocation has grown steadily during this period. Since 1983

Japan has surpassed the U.S. percentage.

For their part, U.S. manufacturers deal with a temporary R&D tax credit, enacted in 1981, designed to encourage continuing annual increases in corporate R&D spending. Unfortunately, it is, in effect, an after-the-fact "reward" that companies cannot count on because of the annual uncertainty of its renewal by Congress. Truly meaningful R&D tax policies cannot be "temporary." To be an effective incentive, an R&D tax credit must acknowledge that breakthrough projects generally are multiyear efforts linked to considerable risks for an individual company; it must be structured to offer long-term and dependable incentives.

Compounding the problem is a U.S. tax code provision that is actually an incentive for U.S. multinational companies to conduct R&D offshore. Under Section 861, if a company claims R&D expenses as a business deduction, it must allocate a portion of its domestic R&D expenses to



JOHN L. PICKITT

foreign-source income. Thus Section 861 encourages multinational companies to move R&D sites to other countries where they can claim their expenses as business deductions. It can have the same effect on the cottage industry of R&D subcontractors.

The current R&D tax credit and a compromise that has reduced the adverse impact of Section 861 both expire at the end of this year. Extending them will provide modest encouragement to major U.S. technology manufacturers to continue domestic R&D programs. But effecting permanent measures equivalent to those enjoyed by competitors in other countries will do more to ensure that U.S. companies retain the means of producing leading-edge technologies.

We call upon Congress to take sensible, timely action by enacting and funding a permanent credit and a permanent solution to Section 861.—*John L. Pickitt, president, Computer and Business Equipment Manufacturers Association*

MAKE IT PERMANENT

U.S. companies are in competition not only with foreign corporations but also with foreign governments. A number of countries have implemented policies designed to make their companies successful against foreign competition. These policies often include restricting markets to foreign companies, subsidizing research, and encouraging joint production and marketing efforts. Historically, Americans have shunned restrictive policies because they conflict with our concepts of free markets and economic fair play. On the other hand, U.S. companies do need some help if they are going to successfully compete with the coordinated efforts of foreign corporations and their governments. One way Congress has found to offer help is the R&D tax credit.



BERNARD VONDERSCHMITT

The credit is very important to a high-technology company such as Xilinx, which is currently spending approximately 13% of its revenues on research. Xilinx invented field-programmable gate arrays and we are the world's leading supplier of CMOS programmable logic. Xilinx is a young company, only seven years old, and a relatively small one, with revenues of under \$150 million. For a company like ours, the current R&D policy presents some problems.

Despite the Congressional mandate for the R&D credit, the Treasury approach to its administration and audit is adversarial, both in terms of regulations defining the qualifications for the credit and in the auditing of companies that qualify for it. This attitude is of particular concern because it conflicts with the cooperative attitude that foreign companies enjoy from their governments.

The Treasury poses difficult standards concerning which activities qualify as research, and dramatically limits the scope of those activities. Xilinx is not always certain which activities will qualify, and our engineers have considerable difficulty with tax concepts and

definitions that differ from engineering concepts and definitions. To determine the amount of the credit, we have found it necessary to launch an expensive and time-consuming effort by engineering, tax, and accounting professionals to determine whether the activities of each of our engineers meet the confusing proposed requirements. This is a major effort outside of the company's normal accounting systems and represents a cost and time burden.

The calculation of the credit should be simplified and made more intuitive. Today's credit is based on current expenditures over base-period expenditures. The idea is that the credit should only be given for increasing expenditures. This is not realistic in times of economic slowdown. It is also difficult for engineers to determine what the credit will be for specific projects, because the credit is calculated on the company's overall R&D spending. As a result, a manager cannot, in advocating a project, quantify the amount of credit it will generate.

The credit should also be expanded to deal with infrastructure problems. U.S. companies are faced with a shortage of trained manpower as a result of the failure of our education system. Companies are taking on training burdens that our competitors in other countries do not face. These costs should be included in the expense base for the R&D tax credit.

Finally, the credit should be made permanent. Since its enactment, corporations have never known if the credit would be extended or repealed and therefore cannot make long-term plans based upon it. Congress should indicate that the credit is here to stay and instruct the Treasury to make its administration easier. After all, it is in the best interest of both the government and business for U.S. industry to be competitive internationally.—Bernard V. Vonderschmitt, president, Xilinx Inc.

PICO Transformers & Inductors

PLUG-IN SURFACE MOUNT AXIAL INDUCTORS TOROIDAL INSULATED LEADS

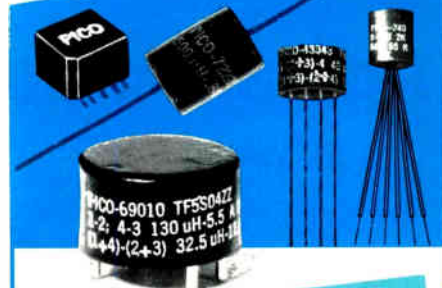

TRANSFORMERS

QPL standards available MIL-T-27/103-1 thru 16, MIL-T-27/172-1 thru 50, MIL-T-27/357-1 thru 114, MIL-T-27/358-1 thru 123, MIL-T-27/359-1 thru 147

- Audio Transformers ranging in size from 1/4" x 1/4" to 3/4" x 1 1/4". 20 Hz to 250 KHz. Up to 3 watts.
- Pulse Transformers .05μSEC to 100μSEC miniaturized construction.
- Ultra-miniature DC-DC Converter Transformers. 40 watts.
- Miniaturized Switchmode Inverter Transformers. 60 watts.
- 400 Hz Power Transformers. Primary voltages of 115V or 26V. Plug-in construction. Ultra-miniature
- Microphone/Transducer Audio Input.
- MIL-STD-1553 Interface Multiplex Data BUS Pulse Transformers.

POWER INDUCTORS

QPL standards available MIL-T-27/356-1 thru 63

- Inductance values to 20mH with DC currents to 23 amps

COMMON MODE INDUCTORS

HIGH "Q" INDUCTORS

See EEM or send direct for FREE PICO Catalog

PICO Electronics, Inc.

453 N. MacQuesten Pkwy. Mt. Vernon, N.Y. 10552

Call Toll Free **800-431-1064**

IN NEW YORK CALL **914-699-5514**

FAX **914-699-5565**

Actual size

Actual output

20 WATTS

Now AC to DC

Actually meets

MIL-STD-2000
MIL-STD-810C
MIL-S-901C
MIL-STD-461C
MIL-STD-704D
NAVMAT GUIDELINES

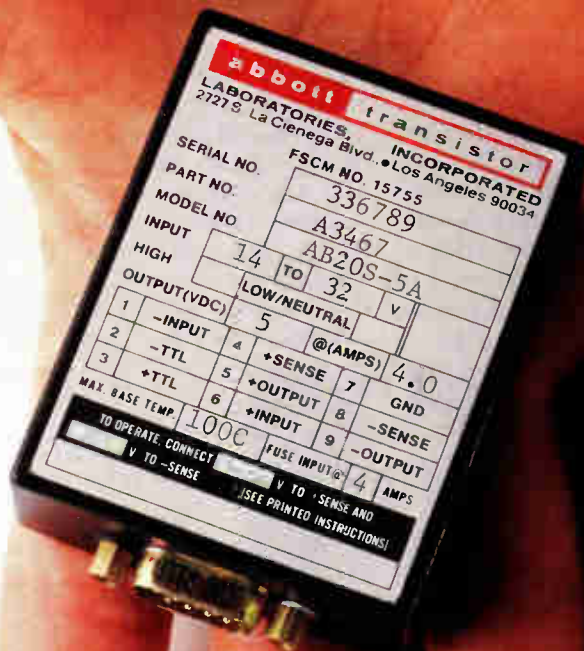

Mil/Pac™ high-density military power supplies.

Now you can order Abbott's full mil-qualified compact power supplies in both DC and AC input models.

Mil/Pacs come in 20W, 35W and 50W configurations, with single (5, 12, 15, 24, or 28V) or dual ($\pm 12V$; $\pm 15V$) outputs.

DC-to-DC models accept input from 14V to 32V. AC-to-DC models accept 103.4 to 126.5V rms, 47-440 Hz single phase.

All Mil/Pacs operate at temperature extremes from

-55°C to +100°C. All are designed with a field-proven topology that has been verified by rigorous environmental stress screening.

Mil/Pacs are available with or without MIL-STD-2000. Either way, the specs are worth reading. Just write us at 2727 South La Cienega Bl., Los Angeles, CA 90034. Or call (213) 936-8185.

abbott
WHEN RELIABILITY IS IMPERATIVE.™

AS DEMAND BUILDS FOR HIGH-PERFORMANCE NETWORK SERVERS, DATA GENERAL DIGS IN

SMP IS THE TICKET

BY JONAH McLEOD

Serving notice that it is going to stay ahead of the next wave of network server architecture, Data General Corp. has bulked up its muscular family of Aviiion servers by filling in the low end. At the same time, that wave is building momentum behind the Westboro, Mass., company.

Data General's edge is SMP, for symmetric multiprocessing architecture. SMP utilizes multiple processors that not only divide a task, as with parallel processing, but cooperate on solutions. The upshot is speed and, perhaps more important, easy scalability—processors can be added quickly. That's in sharp contrast to the traditional uniprocessor approach that most of the rest of the industry has stayed with.

The thinking of the traditionalists, among them Sun Microsystems Inc., was to wait for a standard Unix for SMP. But Data General decided to take the bull by the horns and invest in the necessary R&D to develop its own Unix. And either by design or fortuitous timing, Data General also had the good fortune to offer up high-performance servers to commercial customers that were just beginning to discover the need for them (see p. 58). Commercial customers wanted to find ways to get more productivity out of their installed computer bases of PCs and workstations on the desktop, and mainframes in the data processing centers.

The result: "Data General was aggressive in SMP because it allowed an easy way to sell a low-cost server and then upgrade it by simply adding processor boards over time for added price/performance as user needs rise," says Alan Jennings, vice president for Aviiion development.

Also behind the decision, says

William Zastrow, vice president of Aviiion marketing, was Data General's eagerness to get into the workstation business without committing corporate suicide. "We looked at the commercial market and realized that to get into the workstation business in

COMPUTERS

any other RISC central processing unit," he adds.

Jennings ticks off the 88000's pluses. "It has hardware logic to handle cache contention and consistency: if one CPU updates the cache you need to ensure it is consistent for all other CPUs. It also

contains hardware to do register scoreboard, where a task is split up into smaller routines and each routine is given to different processors in a multiprocessor system. Processor A produces a result that Processor B must have to complete its task. Register scoreboard logic in the 88000 ensures that Processor B gets the results it needs in a register used by the two CPUs to communicate before Processor B completes its task."

Finally, Jennings says, Data General liked the superscalar architecture of the 88000. "This is a religious conviction," he admits, "since computer architects tend to hold strong beliefs about which type of computer architecture—superscalar or superpipeline—is the best for providing scalability." For example, MIPS Computer Systems Inc. of Sunnyvale, Calif., uses superpipelining on the R4000 "and swears it is a much better way to get scalability in performance," says Jennings.

As a result, says Zastrow, "our server offerings are stronger than [those of] any of the other big four." He cites benchmarks from AIM to back up his claim. Indeed, AIM Technology of Santa Clara, Calif., an independent testing house doing performance benchmarks on workstations and servers for commercial applications, shows Data General winning first and second places in the AIM benchmark for the "best \$50,000-\$100,000 price performers by user loads" and first and fourth in the "best \$100,000-\$500,000 price performers by user loads." □



The AV 310c desktop workstation is one of the Aviiion server family, based on SMP architecture.

direct competition with the big four would only court disaster," recalls Zastrow. "So instead of going head to head in the workstation arena, we decided to concentrate on servers."

The same strategy—relying on SMP-based servers—has been followed with some success by Pyramid Technology Corp. of Mountain View, Calif., and Sequent Computer Systems Inc. of Beaverton, Ore., but not enough to cause those playing the waiting game to get off the dime. However, things are changing.

Now the industry is going after workstation servers as an integral part of the strategy for enterprise network computing. In that business, power is essential and the more power the better. And guess where the potential for considerable power resides: that's right, in good old SMP architecture.

But SMP carries its own design bag-

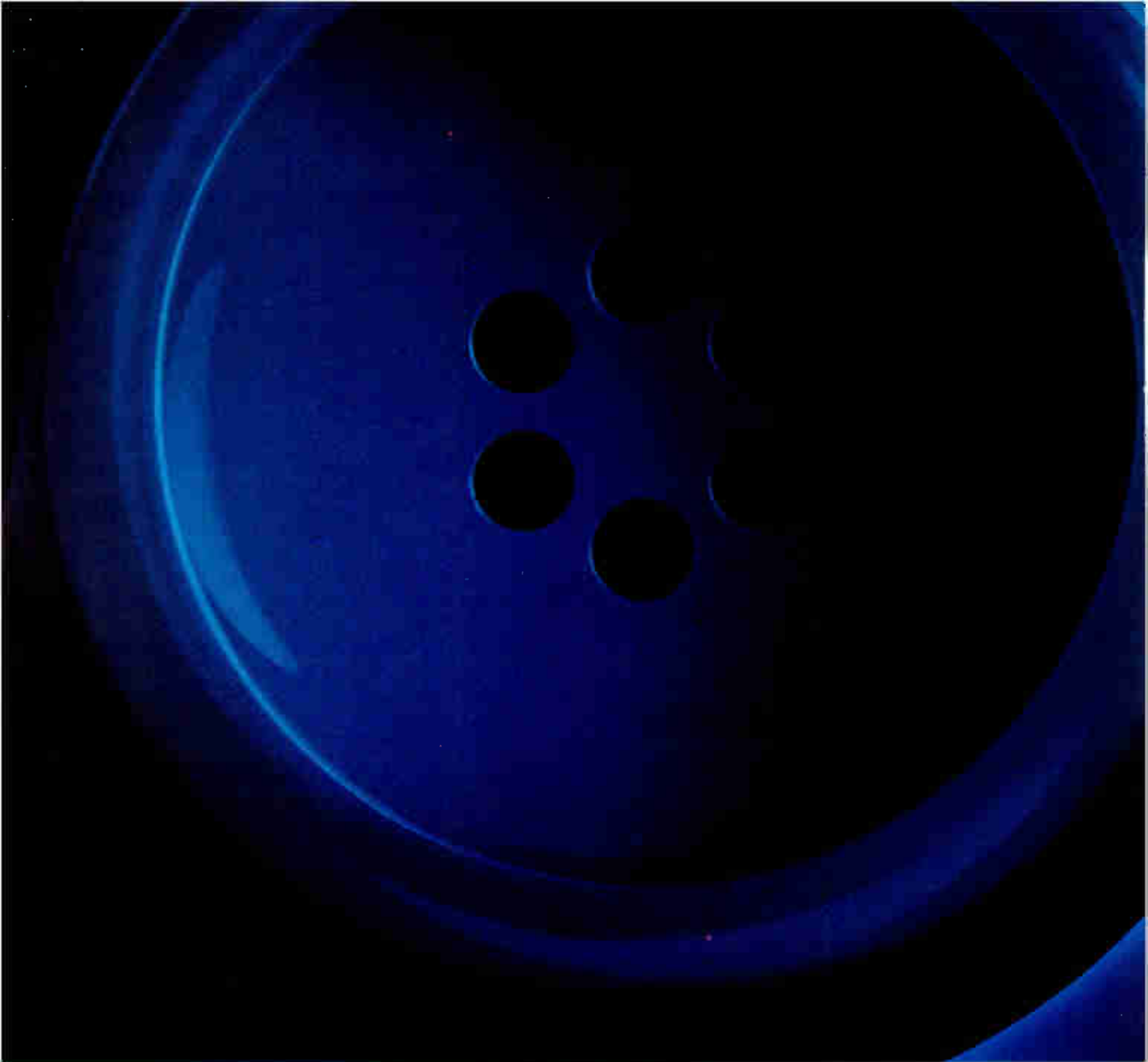

How Teradyne helps Northern Telecom

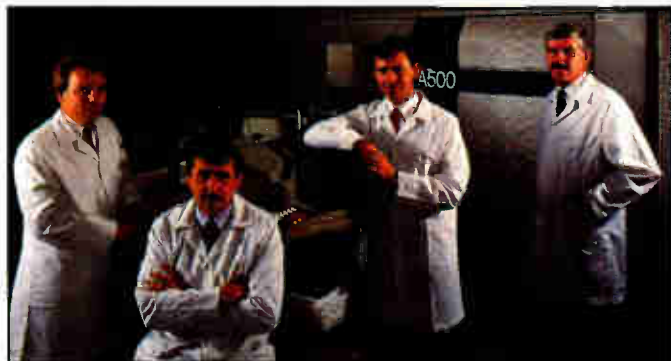

John Haydon, Ken Bradley, Gary Hobin, Terry Caves of Northern Telecom Electronics, Ottawa.

"To us, time is a strategic tool, a way of getting the edge it takes to gain a leadership role in world markets. With Teradyne testers, test development and manufacturing setup times are shorter, and actual test performance is far superior."

KEN BRADLEY, General Manager

Northern Telecom believes a quality message begins with a commitment: to deliver the highest performance products at the lowest cost – quickly and on time.

That's why Northern Telecom Electronics chose the Teradyne A500 Family of systems to test its most advanced mixed-signal chips. Pushing the performance envelope can be risky, but Teradyne is helping Northern Telecom avoid the pitfalls.

"Our Norstar key system is extremely silicon intensive. The A500 provided virtually unlimited test capability and reduced test time."



send the world a quality message.

I believe without it, the entire project would not be nearly as successful as it is."

GARY HOBIN, Manager,
Test & Product Engineering

Because the A500 Family's IMAGE™ programming environment permits full tester simulation at off-line workstations, test program development parallels design. That cuts product development times dramatically. And because test data is fed back quickly and early in the process, Northern Telecom engineers can eliminate bottlenecks, enhance manufacturability, and accelerate time-to-market.

"Teradyne helps us meet our high-volume production goals — on time. And they perform beyond our expectations in terms of operating costs; tester maintenance cost is 80% lower than budget — and tester uptime measures in the 98%-plus range."

JOHN HAYDON, Business Unit Manager,
Test Operations

Teradyne's A500 Family testers run reliably, producing the accurate, repeatable results that let Northern Telecom engineers ramp up fast to high-yield, high-volume production. So when a customer needs devices, Northern Telecom Electronics is ready to deliver quantity as well as quality.

"Teradyne's service continues after the sale. It's as if they take our priorities as their own. That's helped us achieve the quality it takes to succeed in such highly competitive markets as the U.S., U.K., Germany, and Japan."

TERRY CAVES, Director of Operations

Teradyne's A500 Family of Test Systems. Helping companies like Northern Telecom send their customers the right message. To see how we can help you, call Beth Sulak at (617) 422-2746. Or write today to:

Teradyne, Inc.,
321 Harrison Ave.,
Boston, MA 02118.

TERADYNE

DISCOVERY CAN OPEN WAY TO A NEW IC CLASS

THE GLOW OF SILICON

BY JOHN GOSCH

Although silicon is the most thoroughly studied material used in electronics, it continues to astound its

investigators. One of the latest surprises: in its porous form, silicon will emit light not only if exposed to ultraviolet radiation but also when a voltage is applied to it. The dis-

SEMICONDUCTORS

covery could lead to a new world of component and system applications.

Until recently, the emission of light from semiconducting material was thought to be possible only with expensive compound semiconductors such as gallium arsenide and indium phosphide. Then last summer two European research groups, at the UK's Defense Research Agency in Malverne and at the Central Research Laboratories of Germany's Siemens AG in Munich, showed that rather cheap silicon can also be made photoluminescent.

But now scientists at the Fraunhofer Institute for Solid State Technology, also in Munich, have discovered that porous silicon emits light not only under UV radiation but also when a voltage is applied to it. This means that silicon is electroluminescent as well.

"In actual applications, light emission induced by a voltage is more practical than when it's triggered by ultraviolet radiation," says Hermann Sandmaier, head of the Fraunhofer department carrying out the "luminating silicon" project. The big advantage of voltage-induced light emission is that it's easy to change electrical signals into optical signals.

Cheap and easy to process, silicon could replace the expensive and difficult-to-handle GaAs and other compound semiconductors in optical applications. And with detectors already made of silicon, a light emitter that also uses silicon would mean a much higher level of integration than is possible when using different materials for the detector and emitter.

Silicon light sources on silicon chips could even trigger a revolution in optical signal transmission, the Fraunhofer researchers declare. Replacing metal connections between chips with light paths could considerably increase a system's data-transmission speed.

Furthermore, flat displays and monitors could be combined with ICs on a silicon basis. And the integration of optical and electronic technology on silicon would open new perspectives for computer architectures. A system could be built that uses electrons for computing and photons for data transmission.

However, before light-emitting silicon finds such applications, much work lies ahead, cautions Axel Richter, a member of the Fraunhofer team. Although the process involved in fabricating the devices presents no problem,



TADIRAN LITHIUM BATTERIES

NO OTHER PRIMARY BATTERY OFFERS YOUR PRODUCT DESIGNS ALL THESE ADVANTAGES

HIGHEST CELL VOLTAGE — More than twice the voltage of other batteries. 3.6V open-circuit, 3.4V operating.

HIGHEST ENERGY DENSITY — 4 times as great as other batteries. Up to 420 Wh/kg and 800 mWh/cm³.

LONG SHELF LIFE — More than 10 years at room temp.

WIDE OPERATING TEMP. RANGE — -55C to +85C. Applications outside this range also possible.

FREE SAMPLES AND CATALOG AVAILABLE — Hermetically-sealed, UL-recognized.

SAFE — Optimum cost-efficiency — Thru reduced size and weight. Low cost per unit of energy.

CALIFORNIA
Phone (408) 727-0300
Fax (408) 727-0560

TEXAS
Phone (817) 430-1242
Fax (817) 430-1243

40 Seaview Blvd.
Port Washington, NY 11050
Phone (516) 621-4980
Fax (516) 621-4517

ACKNOWLEDGED LEADER IN LITHIUM BATTERY TECHNOLOGY THE WORLD OVER.

TADIRAN LITHIUM BATTERIES POWER YOUR PRODUCTS INTO THE 21st CENTURY™.

TADIRAN ELECTRONIC INDUSTRIES, INC.



TO-5 RELAY

The Unforgettable Maglatch TO-5

- **Non-destructive memory**
- **Low power consumption**
- **Inherently bi-stable pulse operation**
- **CMOS compatible Centigrad[®] version**



The Maglatch TO-5. It's a legend in its own time. The little magnetic latching relay that just won't forget. It can't. Because once you set it with a brief pulse of coil voltage, it simply stays in that state until reset. Even if the system loses power.

In applications where power drain is critical, the Maglatch TO-5 is unbeatable. Since no holding power is needed, it uses less energy than any other type of relay on the market.

The Maglatch's inherently low intercontact capacitance gives it high isolation and low insertion loss up through UHF, making it ideal for RF switching applications. And its tiny footprint makes it ideal for high density printed circuit boards.

The Maglatch TO-5 comes in commercial/industrial versions as well as military versions qualified to "L," "M" and "P" levels of MIL-R-39016. And now it comes

in a CMOS compatible version as well. This version can be driven directly with CMOS level signals, with no outside amplification. That cuts down on the number of components and connections, for even greater system reliability.

The Maglatch TO-5. It's the world's smallest relay with indestructible memory. Call or write today for complete information.

 **TELEDYNE RELAYS**
Innovations In Switching Technology

Teledyne Relays, 12525 Daphne Avenue, Hawthorne, California 90250 • 213-777-0077, FAX: 213-779-9161.

European Headquarters: W. Germany: Abraham Lincoln Strasse 38-42, 6200 Wiesbaden • Belgium: 181 Chaussee de la Hulpe, 1170 Brussels • U.K.: The Harlequin Centre, Southall Lane, Southall, Middlesex, UB2 5NH • Japan: Taikoh No. 3 Building, 2-10-7 Shibuya, Shibuya-Ku, Tokyo 150 • France: 85-87 Rue Anatole-France, 92300 Levallois-Perret.

CONNOISSEUR

C L A S S

BERTH OF A NEW ERA.

It's comforting news. Our state of the art business class seats, with adjustable footrests, are wider than ever before. Just seven per row on the 747, and 6 per row on the 767.

Equally comforting is the fact that many of our new seats are available on the smoke-free upper decks of our vast 747 fleet.

Connoisseur Class,SM offered only by United. Where attention to detail elevates international business class to its highest form of civility. Available now on all trans-Atlantic and most trans-Pacific flights.

Come fly the airline that's uniting the world. Come fly the friendly skies.

 **UNITED AIRLINES**

SGS-THOMSON is amongst the world's leading suppliers of ICs for the merchant telecom market and is ranked number 1 for analog ICs. The company's product range serves major telecom applications with devices like linecard chip sets, single chip telephones and modems through to sophisticated systems like DSP based specific ICs for GSM to complex multi-chip solutions for advanced ISDN systems. In fact

SGS-THOMSON's product portfolio is able to meet the needs of telecommunications manufacturers worldwide.

There is hardly any harsher electronics environment than the car and no one meets it better than SGS-THOMSON with a portfolio of technologically advanced but rugged devices ranging from power transistors through smart power ICs.

SGS-THOMSON's total chip solutions for automotive multiplex systems, for instance, are state-of-the-art and are helping dramatically reduce the miles of cable used in today's cars while allowing even more advanced features to be added. At the same time SGS-THOMSON's range of dedicated microcontrollers is enabling auto engineers to add new features, while our advanced protection devices are keeping all the in-car electronics safe from damage.







SGS-THOMSON's state-of-the-art devices are bringing new levels of performance to PCs and peripherals. The company has been chosen by IBM to produce the XGA chip set and is the world's number one supplier of CLUTs for VGA, while the transputer, with its power and scalability, is winning market share in applications such as radar and laser printers. SGS-THOMSON is also a leading supplier of Sea of Gates offering devices with over 200,000 usable gates for computer applications. The company's wide range of dedicated devices for disc drive and image compression applications aimed at multimedia stations are also leading the market. And of course, it is a leading supplier of non-volatile memories with 4 Megabit EPROMs in production, 16 Megabit prototypes diffused, and a major development push already well under way on flash memories for advanced products like silicon discs.

**“No advanced industrial
society can exist without
controlled access to an
advanced electronics
industry...”**

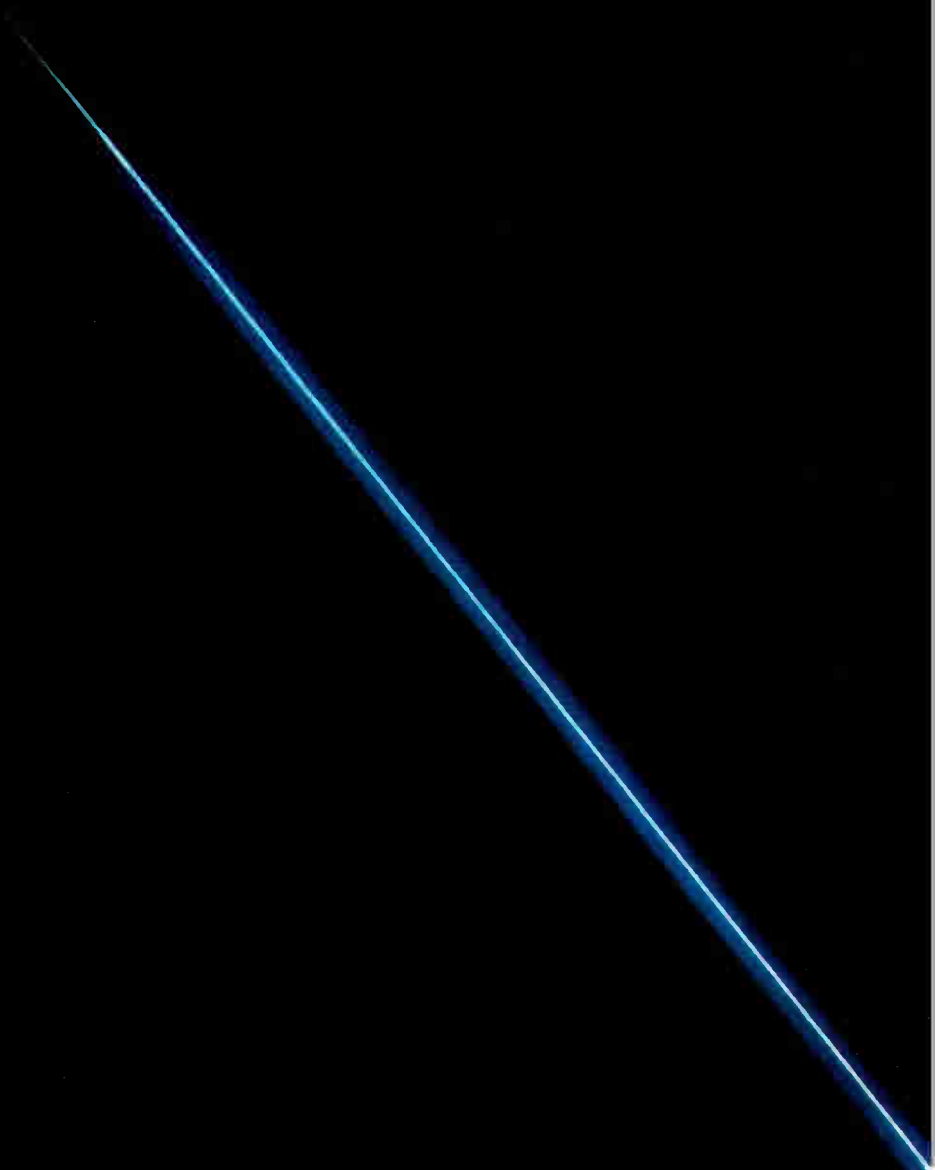



With more than one billion chips delivered to the consumer industry, SGS-THOMSON offers both continuity and innovativeness to an industry that demands a special blend of advanced technology with cost effective silicon. SGS-THOMSON's video product range, for example, satisfies almost every need in television, monitor, VCR and related applications while new and advanced products are already in production for the latest HDTV applications.

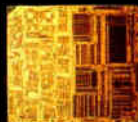

 **SGS-THOMSON**
MICROELECTRONICS
access to technology

“...No advanced electronics industry can exist without controlled access to an advanced microelectronics industry.”

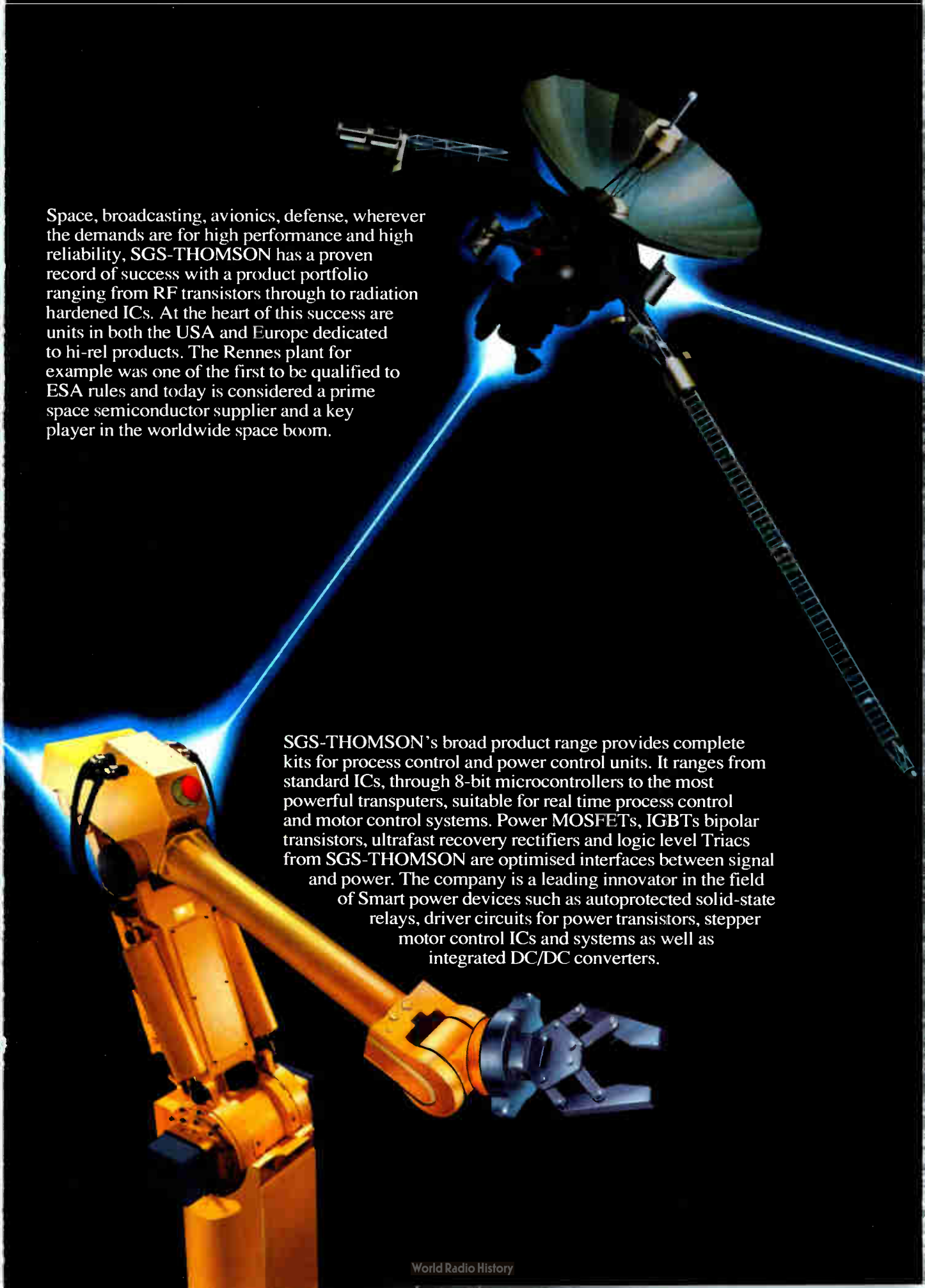

Space, broadcasting, avionics, defense, wherever the demands are for high performance and high reliability, SGS-THOMSON has a proven record of success with a product portfolio ranging from RF transistors through to radiation hardened ICs. At the heart of this success are units in both the USA and Europe dedicated to hi-rel products. The Rennes plant for example was one of the first to be qualified to ESA rules and today is considered a prime space semiconductor supplier and a key player in the worldwide space boom.

SGS-THOMSON's broad product range provides complete kits for process control and power control units. It ranges from standard ICs, through 8-bit microcontrollers to the most powerful transputers, suitable for real time process control and motor control systems. Power MOSFETs, IGBTs bipolar transistors, ultrafast recovery rectifiers and logic level Triacs from SGS-THOMSON are optimised interfaces between signal and power. The company is a leading innovator in the field of Smart power devices such as autoprotected solid-state relays, driver circuits for power transistors, stepper motor control ICs and systems as well as integrated DC/DC converters.

The world's twelfth largest semiconductor manufacturer and number two among European manufacturers, SGS-THOMSON has earned its leading position in the world semiconductor market with a blend of advanced technology, highly effective worldwide production resources and an exceptionally broad product range which covers all sectors of advanced electronics.

The combined forces of the group total over 18,000 employees, 8 advanced research and development units, 25 design and regional technology centers, 17 production locations, 50 sales offices in 20 countries and over 500 distributors and representatives throughout five continents.

A broad-based semiconductor manufacturer, SGS-THOMSON's product range includes over 34,000 device types from simple diodes through to complex digital signal processing microelectronic systems.

To guarantee continued technological development and consistently offer customers true leading edge products, SGS-THOMSON each year invests approximately 20% of its sales revenue in R&D and is a key player in Europe's advanced technology research programs.

IBM is a registered trademark of the International Business Machines Corporation.

XGA is a trademark of IBM Corporation.

ST is a registered trademark of the SGS-THOMSON Microelectronics Group.

© 1991 SGS-THOMSON Microelectronics. All rights reserved.

Printed in the United States.



SGS-THOMSON Microelectronics GROUP OF COMPANIES

Australia - Brazil - France - Germany - Hong Kong - Italy - Japan - Korea - Malaysia - Malta - Morocco -
The Netherlands - Singapore - Spain - Sweden - Switzerland - Taiwan - United Kingdom - U.S.A.

EUROPE '92: OPEN OR CLOSED?

A dispute is brewing in the European Community over how to counter the Japanese threat in information and communications technology in Europe's Unified Market, which will become a reality on Jan. 1. Worried that they will lose out in a free-for-all market for high-tech products, some countries—notably France, Italy, and Belgium—are pushing for a common European industrial policy firmly anchored in the EC.

The question is just how far to go. France is leading the wall-building faction and Germany and its followers are pushing for a more open market. In a memorandum for the EC, the French government earlier this year outlined its policy, and in it industry observers see a clear call for protectionism. The memo says in effect that Europe's electronics industry can be saved only when, in addition to R&D funding, production and marketing are also regulated.

Taking an opposite position are the Germans. Bonn's Ministry for Research and Technology has drawn up a 10-point memorandum stating that maintaining Europe's



competitive stance should be left to private enterprise. All the EC Commission and the individual governments should do is create an industrial climate favorable to the industry, says the document.

For the ministry it is of strategic importance that Europe is assured free access to microelectronics as a base technology. In the long run, this problem cannot be solved solely on a European level. What's needed is not

European isolation but worldwide cooperation, the ministry says.

Europe accounts for only 10.5% of global IC production. Japan has 49.5% and the U.S. 36.5%. Besides lack of global cooperation, the Germans say Europe has fallen behind via inefficient intra-European technology transfer, incompatible R&D policies, and not enough cooperation between industry and university researchers. □

PHILIPS TO SELL PHOTO CD PLAYERS

Philips Interactive Media Systems plans to market dedicated photographic compact-disk players beginning next summer. To be sold in the U.S., Japan, and Europe, the equipment will play not only photo CDs but audio CDs as well. Photo CD is compatible with the Dutch electronics company's CD-I (Compact Disk-Interactive) family of consumer gear.

Meanwhile, Philips's long-awaited CD-I players—heralded as one approach to multimedia in the home—are being introduced in the U.S. this fall and will later go to market in Japan and, in mid-1992, in Europe. This means that by the time the photo CDs are introduced, there will already be a base of players on which to use them. □

SIEMENS, IDT JOIN ON 32-BIT CONTROLLERS

Munich-based Siemens AG and Integrated Device Technology Inc. of Santa Clara, Calif., have agreed to cooperate in the production of 32-bit microcontrollers based on the MIPS Computer Systems Inc. R3000 architecture. The two parties will jointly develop 32-bit RISC controller derivatives for peripherals and embedded-control applications as well as second-source each other's products.

Standard products as well as custom designs will be developed for applications such as office automation, industrial control, telecommunications, and multimedia equipment. The world market for MIPS-based RISC controllers is expected to exceed the \$100 million mark in 1995. □

JESSI AND SEMATECH AIM AT 0.25-MICRON MANUFACTURING

After the informal contacts of the past two years, the Joint European Submicron Silicon Initiative and Sematech in the U.S. will now work together on a formal basis. The goal of the cooperation is clear: to put themselves in a better competitive position vis-à-vis the Japanese in semiconductor manufac-

turing technology. The two parties recognize the need to speed up the development of state-of-the-art manufacturing processes, equipment, and materials—something that calls for the integration of development activities.

Cooperation will be project by project in fields allowing more effective use of invest-

ments and personnel to save time and avoid duplication of effort. Specifically, cooperation will be in two areas: projects with shared activities such as standards, competitive technology analysis, and common equipment qualifications; and the exchange of know-how leading to 0.25- μ m manufacturing technology. □

BRIEFING

MANAGERS WONDERING ABOUT THE FUTURE OF CHIPS WILL GET SOME HINTS AT THE IEDM

THE NEXT WAVE IN ICs

BY SAMUEL WEBER

What technologies are coming—and going—in the device business? The likely answers will be on view at the International Electron Devices Meeting, slated to convene in Washington on Dec. 8 and long known as a forum for presentation of advanced research and development concepts in electronic devices. Unlike its sibling, the annual International Solid State Circuits Conference, IEDM is not the place to introduce products about to debut in the marketplace. Rather, it affords a glimpse at technology that will likely change the face of electronics three to five years in the future.

Using that yardstick, then, this year's IEDM program foretells some exciting advances. Among them:

- Solid-state charge-coupled-device imagers with pixel density that's good enough for high-definition TV.

- Silicon bipolar transistors with cutoff frequencies rivaling that of gallium arsenide, which is much more difficult to handle.

- Three-dimensional ICs formed by stacking multiple chips from different wafers on top of each other with oxide in between.

- Very thin color cathode-ray tubes based on field-emitter technology.

- 16-Mbit flash electrically erasable programmable read-only memories that operate at 5 V instead of the 12 V currently required, and structures that could lead to 64-Mbit flash EEPROMs.

- A move to below-0.5 μm CMOS and biCMOS technology.

The first step toward a solid-state HDTV camera has been taken in the Netherlands by researchers at Philips Research Labs in Eindhoven. Their new CCD

imager is a frame-transfer device conforming to the European Eureka HDTV standard. It has twice the line density and 2.2 megapixels—four times the number in other CCD imagers. It's a very large chip—240 mm^2 —and yields a diagonal image of 16 mm.

Researchers at Hitachi Ltd. have developed their silicon 64-GHz bipolar transistor using a phosphorous-doped polysilicon emitter technology. It is said to yield the highest performance ever obtained for a conventional silicon device. It could lead to high-speed computer performance without the need for exotic materials.

A new 3-d IC fabrication technique may be emerging from NEC Corp.'s Kanagawa laboratories. It uses a chip-on-chip approach where ICs made from different wafers are sandwiched on top of each other and separated by an oxide.

Meanwhile, French researchers from LETI, in Grenoble, weigh in with what they call a microtips display, essentially a 6-in. CRT only 2 mm thick. It's a matrix array of field-emitter cathodes deposited on a plate facing an anode front plate covered with a phosphor. Lighter and smaller than conventional CRTs, it also vies with liquid-crystal displays in brightness and better viewing angle.

Papers from LETI, Matsushita, Mo-

torola, Siemens, and Texas Instruments all foreshadow the arrival of sub-0.5- μm technologies. A Toshiba Corp. paper will show that company is looking ahead toward 256-Mbit dynamic random-access memories and beyond, while Fujitsu, Mitsubishi, and NEC ready technologies for 16-Mbit static RAMs. Also in memories, both Xicor Corp. and Sharp Corp. will reveal flash EEPROM cell designs for 5-V-only operation. NEC's symmetrical sidewall cell is designed to boost flash memory to the 64-Mbit level.

This year's IEDM program also exhibits an uncharacteristic emphasis on manufacturing technology. "There seems to be much concern relating to manufacturing, the ultimate bottom line if a novel technology is to make a real-world impact," says Jesus del Alamo, associate professor of electrical engineering at MIT and this year's IEDM publicity chairman. In addition to more than 20 papers describing various aspects of device fabrication and process technologies, the conference is also scheduling a plenary session and a short course on manufacturing.

In the plenary session, Pallab Chatterjee, vice president and director of TI's semiconductor process and design center in Dallas, points out that to take advantage of the unprecedented marketing opportunities that are afforded by ultralarge-scale integration, or ULSI, technology, the chip industry must meet the manufacturing challenges of density, performance, reliability, and cost. He says the mounting costs of IC manufacturing will require major changes in the way ICs are made.

Chatterjee believes that the ASIC movement represents a model for the required transition. Key in ASICs, he says, are reuse, modularity, standards, and automation, and they can play a role in improving IC manufacturing. He advocates increased use of single-chamber processes, reuse of modular elements, and the use of model-based feed-forward feedback control to complement material-handling automation and dynamic scheduling. Such techniques can almost double factory utilization, Chatterjee believes. □

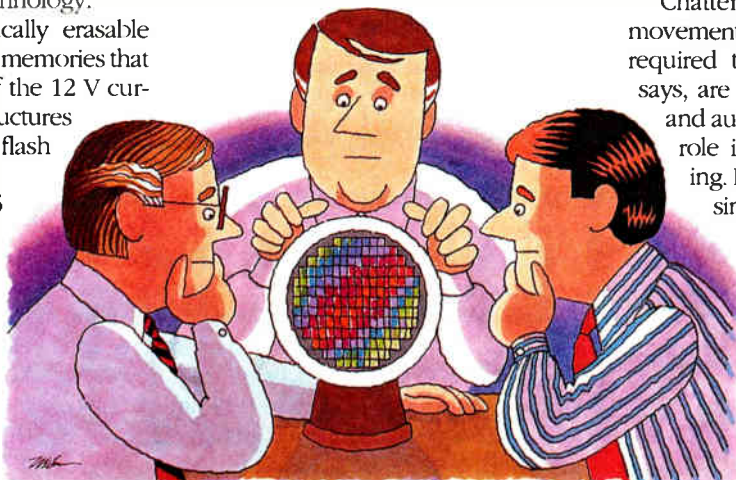

the characteristics they exhibit, particularly their brightness and efficiency, aren't yet good enough for practical use in the near future. The Fraunhofer experts say first applications could come in this decade.

The recent rush of progress comes after more than 40 years of work by researchers around the world trying to manipulate silicon so that it would emit light. But all previous efforts failed: occasional reports of success were dismissed.

But then AT&T Co. in the U.S. and a team in Grenoble, France, confirmed last year's findings of Leigh T. Canham of the UK's Defense Research Agency. Now the scientific world recognizes UV-induced light emission from silicon as a breakthrough of sorts.

Since then, researchers have been trying to get silicon to emit light also under voltage application. The Fraunhofer people did it in less than a week after they started to work with light-emitting silicon last summer. As far as they know, they are the first to make silicon electroluminescent.

The Munich institute got involved because of its know-how in sensors using porous silicon, a form of the material that is a prerequisite for light emission. The porosity is obtained in an etching process known since the 1950s but employed in semiconductor tech-

nology only in fringe applications such as fabricating thick silicon oxide. Basic to the process is the use of hydrofluoric acid as the etching agent.

As Richter explains it, the process etches atomically small pores into a silicon wafer until a fine mesh of silicon needle structures about 10 atom layers thick is left. When exposed to UV radiation, these structures emit light. By altering the etching process in such a way that the structures' dimensions change, the light's wavelength changes. This produces light from yellow and orange to glowing red.

Just why porous silicon becomes photoluminescent is not fully understood, Sandmaier says. "It's probably because under certain conditions silicon behaves much like a semiconductor with a direct transition between the conduction and valence bands, as is the case for gallium arsenide."

In addition to raising efficiency and brightness, continued work at the Munich institute is aimed at determining the spectral distribution and the device response time as well as gaining a better understanding of what's going on in the silicon. In the institute's luminating silicon project, these are small, yet important, steps to get the ubiquitous and inexpensive material to shine with sufficient brightness and efficiency in practical applications. □

THERE ARE TECHNICAL, LEGAL, AND FINANCIAL BARRIERS TO A PAN-EUROPEAN COMPUTER NET

A LONG WAY TO GO

BY ANDREW ROSENBAUM

The agreement signed with much fanfare by Bull, Olivetti, and Siemens-Nixdorf to create a so-called European Nervous System remains a largely abstract, undefined project that has little chance of ever being realized, European industry analysts say.

Although the Commission of the European Communities would like to create such a pan-European computer link among government services in all 12 of the EC nations, none of the daunting

technical, legal, or financial barriers to building those networks has yet been surmounted.

Talk about the link is not new [*Electronics*, August 1990, p. 139]. Last August the commission called for urgent action to link agencies responsible for customs, value-added taxes, animal health, and other issues. As cross-border trade increases with the creation of the Single Internal Market in 1992, governments will have to be able to exchange information efficiently in such areas. Significantly, the commission did not say that the Bull-Olivetti-

NETWORKS

High Voltage DC-DC Converters

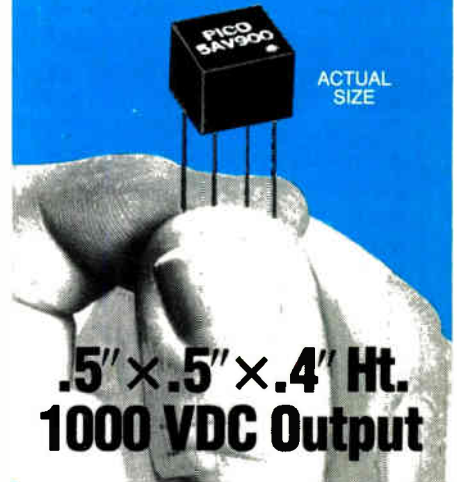

- **New Series AV—**
56 Standard Models
- **100 VDC to 1000 VDC Output**
- **Ultra-miniature Size**
Weight: 4 Grams
0.1 Cubic Inch Volume
- **Standard Input Voltages**
5, 12, 24 and 28 Volts DC
- **Operating Temperature**
Standard: -25°C to +70°C
Optional: -55°C to +85°C
- **MIL-STD-883**
Screening Available
- **Isolated: Input to Output**
up to 1500 VDC

PICO also manufactures over 800 regulated and isolated DC-DC Converters and AC-DC Power Supplies and over 2500 standard ultra-miniature Transformers and Inductors.

Delivery—
stock to
one week

SEE EEM,
THOMAS REGISTER
OR SEND DIRECT FOR
FREE PICO CATALOG

PICO
Electronics, Inc.

453 N. MacQuesten Pkwy. Mt. Vernon, N.Y. 10552
Call Toll Free **800-431-1064**
IN NEW YORK CALL **914-699-5514**

Siemens-Nixdorf consortium would be favored for such projects. Moreover, the technology for building any networks is not yet ready.

"The problems that are posed by managing networks of this size are only just beginning to be addressed," says Dennis Exton, an electronics industry analyst with Merrill Lynch in London. "Such a project would clearly call for the extensive use of neural networking and expert systems. The software is not yet ready, and the capacity to link the systems of the different countries has not yet been achieved."

Exton points to the example of the UK. "Britain has just finished linking up the computers of the Inland Revenue Service [Britain's Internal Revenue Service], the social security system, and the police," he says. "But the project required 10 years. Imagine the time that would be required for one this size."

Executives at both Bull SA in Paris and Ing. C. Olivetti & Co. SpA in Ivrea, Italy, refuse to specify what technology would be used by the proposed project. A spokesman for Siemens-Nixdorf AG in Munich says that committees have

THE EC MEMBERS ARE UNLIKELY TO EARMARK LARGE SUMS OF MONEY FOR THE NERVOUS SYSTEM IN THE NEAR FUTURE

been set up by the three companies to make more specific proposals.

The spokesman for Siemens-Nixdorf did give an example of one project that was being planned, a link between the environmental services that monitor the Rhine River in Germany and Switzerland, the country through which it

flows. But the spokesman could not say where the money for such a project would come from, or under what auspices it would be presented to the powers that be at the EC.

Funding is a serious problem. While the EC Commission has committed itself to an unspecified amount of financing, EC countries are unlikely to earmark large sums in the near future. In southern Europe, France, Italy, and Greece are all cutting government spending. In the north, Germany is pressured by the need to restructure what was East Germany, and the UK and the Netherlands are beset by recession. Political observers say it is unlikely that any of these governments will make a major investment in the proposed projects for some time.

Even if funding were to be found, the legal status of the project would present serious difficulties. It is not clear—and none of the three companies could say—how the consortium would be able to present projects for the proposed networks to the EC Commission.

"The Commission has completed extensive legislation on public procurement projects," points out Alisdair Geater, a Brussels-based lawyer specializing in EC legislation. "This legislation ensures that competitors from every EC nation will have the right to bid for public contracts." In fact, prying open the markets for public works was one of the priorities of the 1992 plan.

Geater points out that the Bull-Olivetti-Siemens-Nixdorf consortium would be only one of a number of possible bidders if the projects were to be funded by national governments. "It is difficult to see how the consortium could reserve such projects to themselves," he adds.

Analysts say that it is unlikely that other companies—most notably IBM Europe—would permit the consortium to bid without competition.

"The companies in the consortium would be better advised to work on becoming more competitive, and winning a bigger market share in Europe, than to continue to depend on government-funded initiatives as they have in the past," says Merrill Lynch's Exton. Notably, the CEOs of the three companies, speaking at an electronics seminar in Venice in September, joined in a call for a larger share of national defense contracts. Apparently, Europe's reigning national champions are still hoping for government support. □

Statement of Ownership, Management and Circulation of ELECTRONICS (ISSN 0883-4989) for October 1, 1991 compliance. Published monthly at 1100 Superior Avenue, Cleveland, Ohio 44114-2543 (Cuyahoga County).

The publisher of ELECTRONICS is John G. French located at 400 Fifth Avenue, (Boston) Waltham, MA 02154; the editor is Jonah McLeod; and the managing editor is Howard Wolff. They are located at 611 Route 46 West, Hasbrouck Heights, NJ 07604.

ELECTRONICS is owned by Penton Publishing, Inc., 1100 Superior Avenue, Cleveland, Ohio 44114-2543, a wholly owned subsidiary of Pitway Corporation, 200 So. Wacker Dr., Suite 700, Chicago, Illinois 60606.

The known bondholders, mortgagees, and other security holders owning 1% or more of total bonds, mortgages, or other securities are: none.

EXTENT AND NATURE OF CIRCULATION	AVERAGE NO. COPIES EACH ISSUE DURING PRECEDING 12 MONTHS	ACTUAL NO. COPIES OF SINGLE ISSUE PUBLISHED NEAREST TO FILING DATE
A. TOTAL NO. COPIES (Net Press Run)	104,594	101,833
B. PAID AND/OR REQUESTED CIRCULATION 1. SALES THROUGH DEALERS AND CARRIERS, STREET VENDORS AND COUNTER SALES	-0-	-0-
2. MAIL SUBSCRIPTION (Paid and/or requested)	98,447	97,025
C TOTAL PAID AND/OR REQUESTED CIRCULATION (Sum of 10B1 and 10B2)	98,447	97,025
D. FREE DISTRIBUTION BY MAIL CARRIER OR OTHER MEANS SAMPLES COMPLIMENTARY, AND OTHER FREE COPIES	3,280	3,086
E. TOTAL DISTRIBUTION (Sum of C and D)	101,727	100,111
F. COPIES NOT DISTRIBUTED 1. OFFICE USE, LEFT OVER, UNACCOUNTED, SPOILED AFTER PRINTING	2,867	1,722
2. RETURN FROM NEWS AGENTS	-0-	-0-
G. TOTAL (Sum of E, F1 and 2—should equal net press run shown in A)	104,594	101,833

SUBSCRIPTION RATES
U.S. 1 Year \$60.

I certify that the statements made by me above are correct and complete.

Sal F. Marino, Chairman and CEO, Penton Publishing, Inc.

their way.



our way.



Here's how to turn a relay with 2 changeover contacts into one with 4.

The MT4, our new relay with 4 changeover contacts, hardly occupies more board space than the MT2, our relay with 2 changeover contacts.

So if you need 6 twin changeover contacts on your board, simply install an MT2 and an MT4. Two relays of virtually identical size.

And the expensive space you formerly needed for a third MT2 is now free for other important functions.

Plus: less testing, less component cost, less assembly effort, greater reliability.

What more can you want?

(The new MT4: Power consumption at 20°C 300 mW. Temperature range -55°C to 85°C. Space occupied per contact 12 M².)

I'm interested in the new MT4 relay. Please send me your literature.

Company _____

Name _____

Address _____

Telephone _____

Alcatel STR AG

CH-8055 Zurich/Switzerland, Friesenbergstrasse 75

ELE 11/91



CIRCLE 190
World Radio History

Still the Leader

in DOS based Electronic Design

Introducing Schematic Design Tools version 4.10

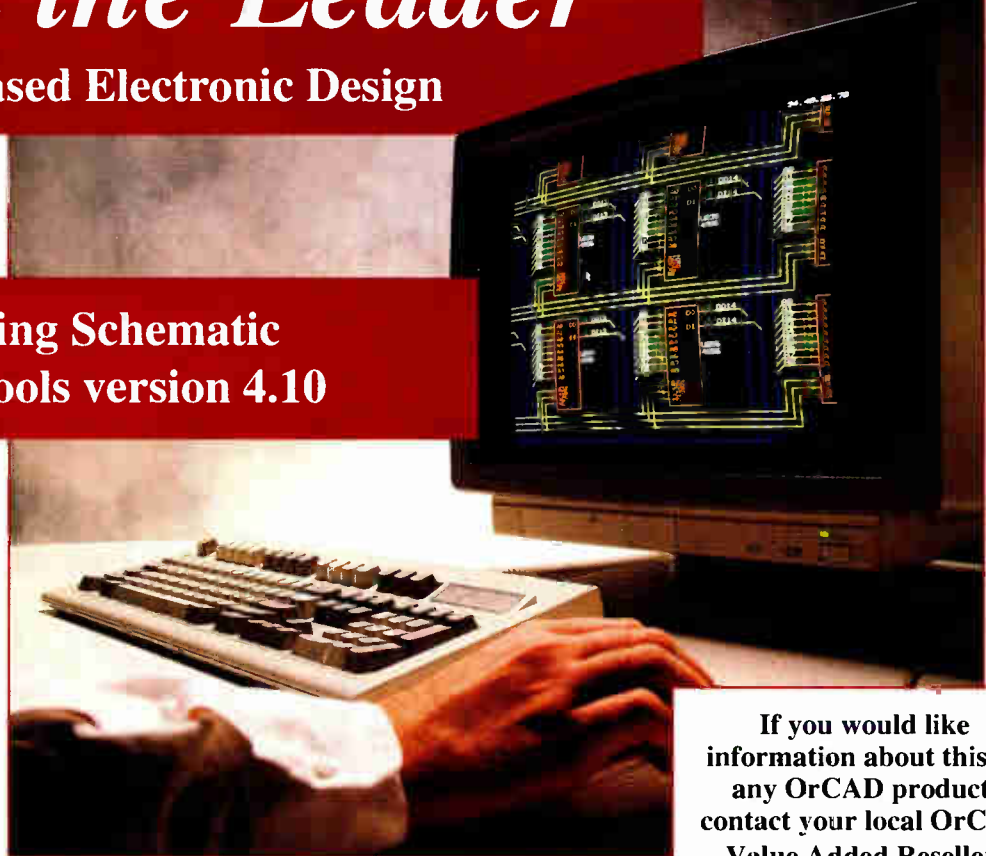

The leader in PC based EDA tools.

Why? Because we never stop improving our products. One example is our world famous *Schematic Design Tools* package with the *ESP framework*.

OrCAD has just released version 4.10 with these new features.

- dramatic increase in capacity
- utilities like netlist output have increased speed
- introducing new "hotkeys" in the ESP framework

The ESP Framework

The *ESP framework* is the first PC based framework that allows seamless integration between OrCAD tools and those of third party vendors. ESP framework is a part of Schematic Design Tools; no need to pay extra.

The OrCAD Difference

Schematic Design Tools still comes with the features you'd expect to pay more for:

- A library of over 20,000 unique parts you can browse through in a breeze.
- Utilities to generate Bill-of-Materials, electrical rules check, create custom library parts.
- Support for over 30 netlist formats.
- Over a hundred supported display adapters, 50 printer drivers, a dozen plotter drivers.
- User definable "smart" macros

As ever, all OrCAD products come with one year of product updates, telephone technical support and 24 hour BBS, and a subscription to The Pointer newsletter.

If you would like information about this or any OrCAD product, contact your local OrCAD Value Added Reseller.

WA, OR, MT,
ID, AK, WY
Avcom/EDA
(206) 462-4040

N. CA, HI, Reno
NV
Elcor Associates
Inc.
(408) 980-8868

So. CA
Advanced Digital
Group
(714) 897-0319

Las Vegas NV,
UT, AZ, NM,
CO
Tusar Corporation
(602) 998-3688

TX, OK, AR, LA
Abcor, Inc.
(713) 486-9251

ND, SD, MN,
MI, WI, IL, IN,
OH, KY, WV,
W. PA, NE, KS,
IA, MO

MacKellar
Associates, Inc.
(313) 335-4440

VA, TN, NC,
SC

Tingen Technical
Sales
(919) 870-6670

E. PA, NJ, NY,
DE, MD, DC
Beta Lambda,
Inc.

(800) 282-5632

CT, RI, MA,
VT, NH, ME
Tri-Logic
(508) 658-3800

CANADA
Pegasus Circuits
(416) 567-6840

Call (503)690-9881
or write today for your
FREE demo disk!

OrCAD  [®]

3175 N.W. Aloclek Drive
Hillsboro, OR 97124
FAX (503)690-9891

CIRCLE 181

World Radio History

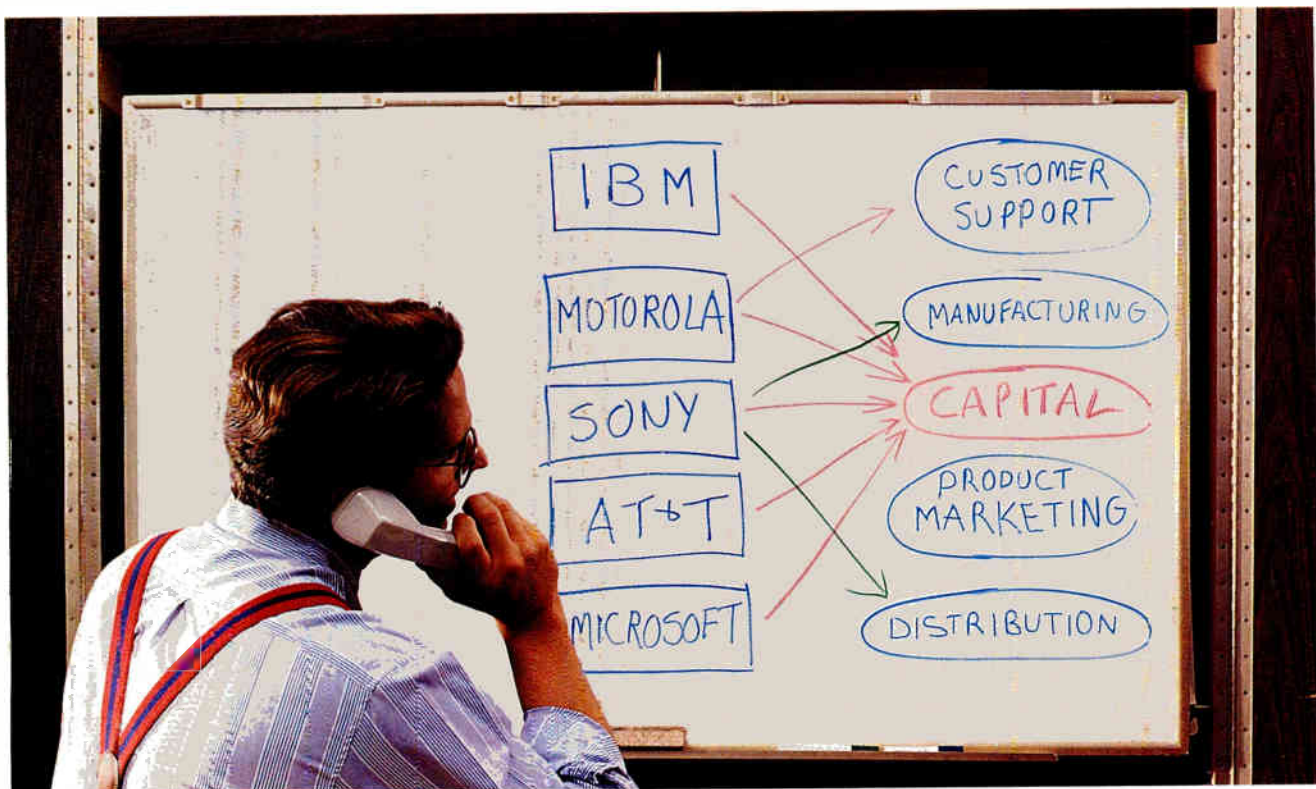

TECHNOLOGY FOR SALE: WHAT PRICE ALLIANCES?

HOW SMALL COMPANIES CAN FIND PARTNERS WITHOUT SELLING THEIR SOULS—OR LOSING INTELLECTUAL PROPERTY **BY JACK SHANDLE**

Jim VanderMey might be sitting on a gold mine. His little company, Intellon Corp. of Ocala, Fla., holds the key patents in a technology that could spark an industry. If the Electronic Industries Association chooses Intellon's spread-spectrum-carrier scheme as the power-line signaling standard for the consumer-electronics bus, Intellon will have a built-in market in every modern office, factory, and home.

Intellon has a head start on fortune, but just how much the 10-employee startup prospers will also depend on the strategic decisions Vander Mey makes over the coming months and years. The potential size of the CEBus market

makes for a dramatic rags-to-riches story, but the same choices are being mulled in corporate offices of small and midsize electronics companies across the nation and around the world. For them, the art of the deal is leveraging technology into capital: capital for product development, manufacturing, and distribution channels. Their daunting problem is to accomplish it without selling the company's soul—its intellectual property—to a partner that will drive them out of business in a few years.

These firms have three basic options: private investors, venture capitalists, and strategic partners. Since the first two are

COVER STORY

hard to come by these days, partnerships have taken on added allure, and the concept seems well on its way to becoming a fundamental business practice in the 1990s. "Synergy in the relationship is important," says Vander Mey, who is looking for a partner that understands Intellon's technology. "We are giving them a competitive edge and they have to bring something besides cash."

But equity investments carry pitfalls as well as benefits. Typically, large corporate partners want more than an investment opportunity, which is good news or bad news depending on how the management team finesses the ne-

gotiations. "They want to manufacture and market the small company's product," says Bernard V. Vonderschmitt, president of Xilinx Inc., a leading maker of programmable gate arrays based in San Jose, Calif. Sometimes this spells red ink for a small company that has spent heavily on research, design, and market development. Vonderschmitt estimates the bottom-line cost advantage to the big company at 40%, a fact he learned from bitter experience.

Soon after Xilinx introduced its products in 1985, customers deluged the firm with demands that it find a second source, and Vonderschmitt thought he had a good match in Monolithic Memories Inc. But when Advanced Micro Devices Inc. of Sunnyvale, Calif., acquired MMI, it took full advantage of that 40% edge. By 1990, Xilinx's balance sheet was bleeding badly enough for Xilinx to cut a deal. "We offered to let them buy 20% of us providing they got the hell out of the business," he says. After the March 1990 deal, prices stabilized.

If a deal is the only way to solve a capital problem, he advises, "do multiple arrangements and don't give anybody the right to very much. If you have 20 products in your portfolio, split it among three or four partners." Vonderschmitt's Rule No. 2 for chip makers is to license the patents without licensing the product, and to make the acquiring partner pledge not to manufacture pin-compatible parts. For chip makers, a partnership with a systems house tends to avoid such problems. IBM Corp.'s equity investment of 12% years ago was an important factor in Intel Corp.'s success, says Jack Carsten, a former Intel executive who now runs the venture-capital firm Technology Investments in Los Altos, Calif. "It was perceived as a vote of confidence in Intel's ability to deliver superior technology," he says.

Cutting a deal with a big company is not the only way to solve capital problems. Firms that need money for specific research and product development might try a national laboratory (see p. 48). Those with a leading-edge technology that need capital to expand into foreign markets should consider a government-subsidized technology park (story at right). Venture money is another option, and choosing between venture and corporate partner often turns on the smaller company's maturity. VCs offer guidance in management, finance, and

FOREIGN EXCHANGE

For some companies, striking a deal with a foreign government can solve problems that might otherwise require an infusion of capital. Industrial development authorities around the world have cash to lend large and midsize companies, and even small firms can take advantage of science and technology parks subsidized by foreign governments—if they have the right technology profile.

The deals seldom entail transferring technology directly to a possible competitor. Nations eager to nurture indigenous high-tech industries have set their sights on creating labor pools with advanced skills. They are also keenly interested in creating jobs and offer significant economic incentives to foreign companies that will help. From familiar names such as Taiwan, Hong Kong, and Singapore to lesser-known programs in the People's Republic of China, India, Egypt, and Malta, nations are drawing high-tech talent by setting up science and technology parks.

Although technology parks can be a good bootstrapping technique for young companies, there are other alternatives, says venture-capitalist Jim Swartz, a general partner in Accel Partners, Princeton, N.J. Cheap real estate, shared resources, and coaching are offered by full-service VCs as well, he points out. "We might arrange for a young company to have office space at another company in our portfolio."

Nations with established high-tech industries, such as Taiwan, use the parks to jump-start new technologies that complement their long-range technology policies. That country, for example, is well along the road toward a park devoted entirely to soft-

ware development, says John O'Boyle, vice president of Opinion Research Corp.'s High Technology Practice. Based in San Francisco, O'Boyle helps governments identify strategic technologies, often recommending matches with companies that have them. Parks are one way to bring the two together with indirect government support.

Parks are often set up along the same general formula as a shopping mall. One or two large companies act as "anchors" by committing substantial resources to the site. Smaller companies share the park's infrastructure resources and enjoy cross-fertilization with the large company and with one another.

Hong Kong, Singapore, and Korea all have incentive programs of one kind or another to develop new business channels, says O'Boyle. Companies that would feel more comfortable in an occidental culture might consider Australia, which is planning a major technology city that it will call Technopolis.

Other nations need to jump-start technologies and entrepreneurial activity across the board, says O'Boyle. The People's Republic of China, for example, has selected real estate for an electronics park. China's market potential is well known, but the depth of its technical competence is not. Of Beijing's 11 million people, 10% have college-level technical degrees, he says.

India is in the process of deciding which technologies to choose for its park. Monitors, printers, and ICs are all under consideration. Egypt is well along in plans for its Pyramid Technology Valley near Giza, and the island of Malta will open a park as well.—J.S.



Technology parks can lure high-tech talent, bringing nations the strategic technologies they need with indirect government help.

**CONSULTANT
JOHN O'BOYLE**

GenRad is about to change your thinking about low-cost board test.

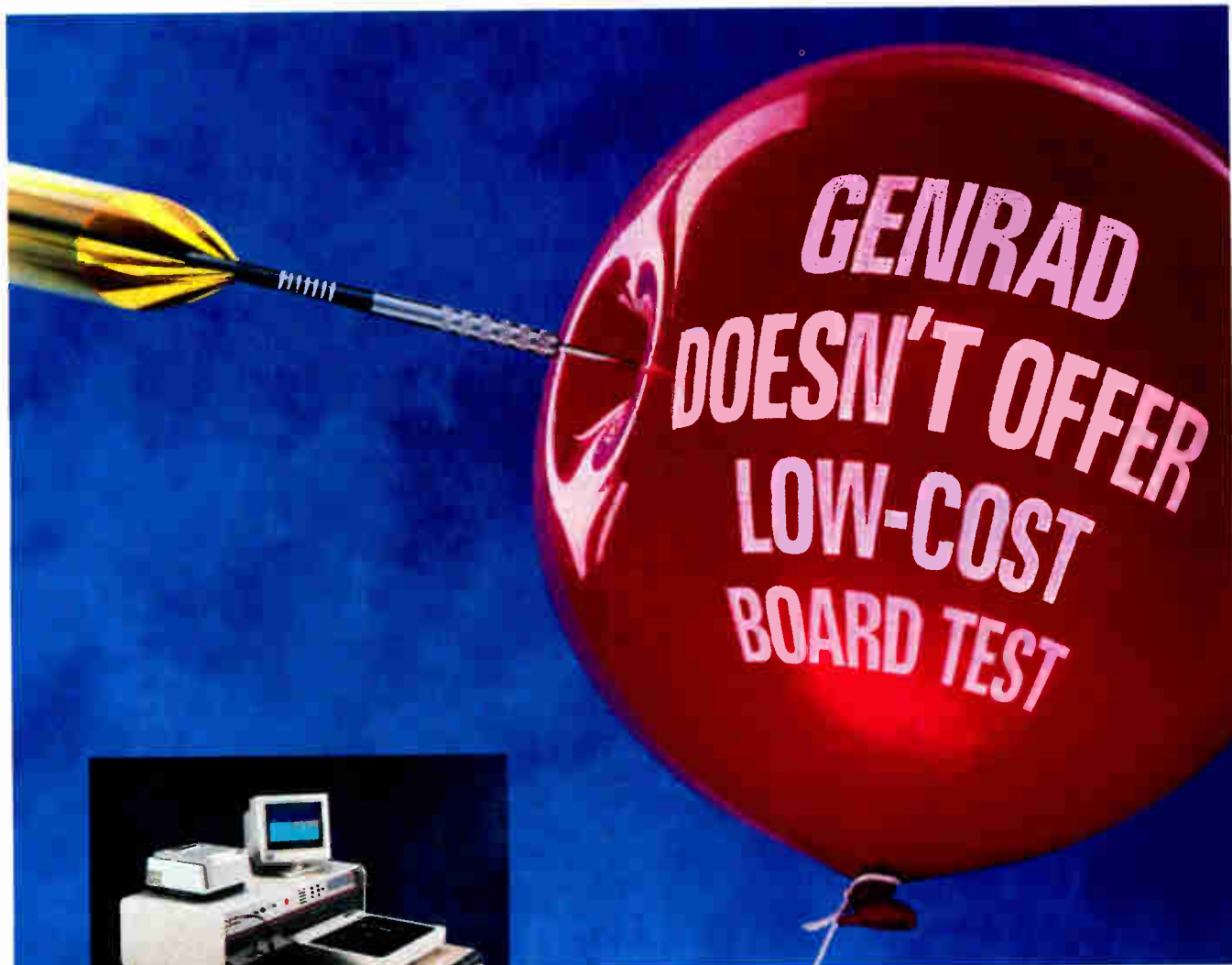

We've always had a reputation for the best board testers in the world. That's why we've maintained the world's leading market share for more than twenty years.

Unfortunately, too many people associate the best with high price.

Not so. Our new Essential Test Collection (ETC), for example, a powerful, versatile software and hardware package, brings you new ease-of-use in high throughput board test. And the price is *lower* than other systems with less capability.

ETC puts powerful new automation tools at your fingertips to simplify and speed the whole process from test program development to data collection. Now you can have the very best in low-cost test for your complex boards. Even those with ASICs, SMT, Boundary Scan and other new technology you thought required expensive test systems.

It's time to take another look at the best in test. We have something new for you to think about in low-cost board test.

Call your local GenRad office or 1-800-4-GENRAD for more information about the new ETC package.

 **GenRad**

A New Way of Thinking

CIRCLE 185

World Radio History

GOT INNOVATIVE TECHNOLOGY? UNCLE SAM WANTS YOU

Ever think about a partnership with the U.S. government for technology development? Uncle Sam will spend close to \$4 billion in R&D next year, and the idea of getting a piece of the pie may not be as far-fetched and red-tape ridden as you might expect.

Even small high-technology corporations can tap into the wealth of expertise and R&D capital equipment that resides in the national laboratory system by entering a cooperative research and development agreement (CRADA) with the Department of Energy. CRADAs have been around since Congress passed the National Competitiveness Technology Transfer Act in 1989. Not many companies have taken advantage of them, partly because they have not been widely advertised. Time is another problem. It used to take as long as 18 months to negotiate a CRADA with a national laboratory.

For computer companies at least, that could soon be cut considerably by a model CRADA now being developed by the Computer Systems Policy Project in Washington and the Department of Energy. The computer-in-

dustry CRADA will provide the legal and administrative framework for a broad range of computer companies to negotiate small-scale programs in a fraction of the time it takes now, says project spokesperson Michele Norman. The generic CRADA will provide an avenue of entry for small computer companies that cannot spend the time and money negotiating a unique contract with the federal government.

Financial arrangements with a national laboratory do not have to be painful, and there is built-in protection against giving technology to a competitor. "The company pays its part and we pay our part," says Jan Haerer, deputy director of Los Alamos National Laboratory's Industrial Applications Office, Los Alamos, N.M. Companies do not have to place employees at Los Alamos, she says, and any marketable

technologies that result from the CRADA are subject to a separate licensing agreement. In fact, the corporation can go to market without a licensing agreement with the lab. But if it does, the lab could license the jointly developed technology to other companies. The obvious way around this is to negotiate an exclusive license with the lab.

The act that created CRADAs puts restrictions on participation, most notably in a strong U.S.-preference clause, says Haerer. Products must be

developing the technology prior to the CRADA, "we are not likely to give them exclusive title to a new technology." An alternative would be an exclusive license for a specific field of use, with the lab retaining licensing rights in other fields.

The Department of Energy has 90 days to accept, reject, or ask for modifications in the proposal. Approval is a green light for preparing the CRADA, which is work that may have gone on concurrently with the work-statement proposal. Sandia has announced four

CRADAs so far totaling \$6.5 million, about half of which is corporate funding. Four more will be announced this month and more than 50 are in process. "We have the capacity for hundreds of CRADAs a year," Graham says. "We did not get the green light from DoE until June 1991."

Sandia has six core competencies: systems engineering; engineered materials; high-performance computing; microelectronics and photonics; engineering sciences and simulations; and test and evaluation. Earlier this year, Sandia established an affiliates program so that U.S. industry can take advantage

of its state-of-the-art Microelectronics Quality/Reliability Center. Sandia's long history of supporting R&D of extremely reliable semiconductors and circuits began in the 1960s with its invention of laminar-flow clean rooms. It has a cooperative agreement with Sematech to develop a Semiconductor Equipment Technology Center.

Core competencies at Los Alamos include superconductivity, high-performance computing, laser technology, materials science, and electronics-related environmental technologies. Materials science expertise includes mixed-halide semiconductors, which are being investigated for solar cells. Environmental research includes the use of supercritical carbon dioxide to clean circuit boards. Laser-technology research has already pushed the envelope of microlithography.—J.S.

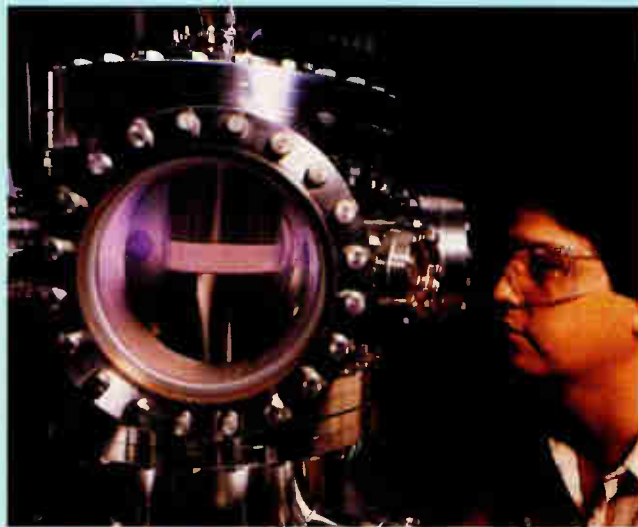

CAPITAL-INTENSIVE

Plasma etching research equipment at Sandia.

substantially manufactured in the U.S. and jobs must be created in America.

The first step toward a CRADA is a phone call to the lab's technology-transfer office. For electronics companies, this is probably either Los Alamos or Sandia National Laboratories in Albuquerque. Once the lab's technical staff is confident that the research is appropriate for that particular lab, a joint work-statement proposal is prepared for the Department of Energy, says Gordon Graham, supervisor of the Partnership Agreements Division at Sandia. The proposal sets the scope of work and assigns rights for intellectual property. It "determines if there will be joint ownership of inventions," says Graham. "Any kind of mix is possible, and it is totally negotiable."

He points out, however, that if millions of tax dollars have been spent

This microcomputer software lets you program using natural mathematical notation

Wouldn't it be nice if you could solve your mathematical problems by simply typing them into your PC just as you would write them down on paper? With **TKSolverPLUS** you can do just that.

- You just enter the set of equations you want to solve using natural math symbols,
- Define the variables you know,
- Specify the units of measurement you want,
- Press the solve key.

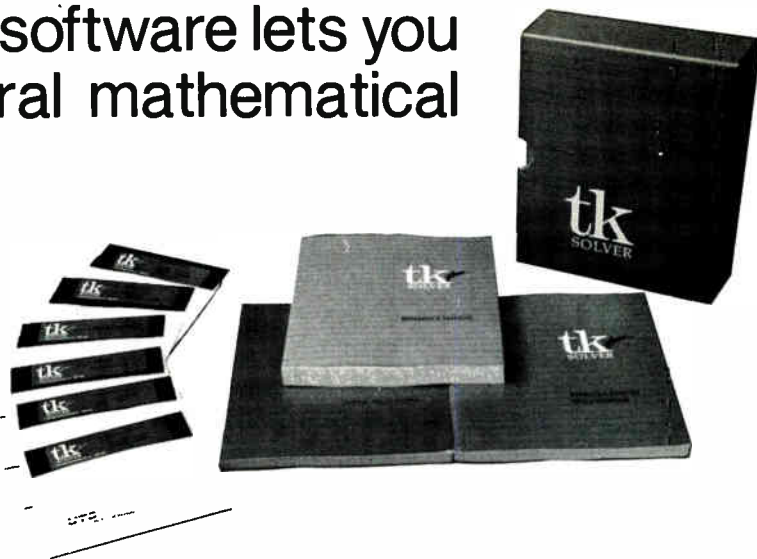

Then see your solutions in tabular form or plot the results on the screen or printer.

TK can do reverse calculations, or goal seeking! This powerful feature is best explained with this simple example.

Suppose you're buying a \$15500 car and you want to compute your loan payments. You're paying \$3500 down and planning a 4-year, 12½% loan. You enter the equations below, plug in the values and find your monthly payment is \$318.96.

$$\text{price} - \text{down} = \text{loan}$$

$$\text{payment} = \text{loan} * (\text{rate} / (1 - (1 + \text{rate})^{-\text{term}}))$$

But suppose you'd rather pay \$350 per month and shorten the term of the loan. Just enter your preferred payment and tell **TK** to solve for the new loan term — without you having to rearrange the equations.

Or perhaps you'd like to shop for a new interest rate. **TK's** iterative solver will compute the interest rate you need to pay off the loan in 3½ years paying \$350 per month.

This ability to *backsolve* makes **TK** incredibly easy to use and saves you countless hours of programming time.

Of course not everyone wants to compute loan payments. But the benefits are the same no matter what type of problems you have to solve . . . business, engineering, statistics, or science.

Solve dozens of linear, non-linear or differential equations simultaneously * backsolving * if, then, else rules * iterative solving * complex numbers * automatic plotting * Automatic unit conversion * over 300 built-in functions and library routines * math co-processor support * store equation models for later retrieval and use * not copy protected.

TKSolverPlus disks and full documentation \$395
Satisfaction Guaranteed! Or return the program within 30 days for full credit or refund.

System Requirements: IBM PC line or 100% compatibles; 384K min memory; DOS 2.0 or higher; CGA, EGA, or Hercules graphics

Chargecard users order toll-free 800-321-7003
 (in Ohio 216/696-7000)

Penton Education Division
 1100 Superior Avenue
 Cleveland, Ohio 44114

CORPORATE PARTNER	VENTURE CAPITALIST	NATIONAL LABORATORIES	FOREIGN GOVERNMENTS
<p>A relatively patient source of capital with valuable sales and distribution channels. A small company can benefit from the prestige an equity investment by a large company can bring, but it must take steps to preserve its operational autonomy and intellectual property rights.</p>	<p>Supplies financial, administrative, and marketing expertise for fast-growing small companies. Can arrange a deal with a large corporate partner for additional capital. VCs are usually focused on the short-term goal of taking the company public, however, and making four to 10 times their original investment.</p>	<p>Partnerships are limited to technology-transfer agreements, but can be viewed as pseudo-capital investments because the labs provide state-of-the-art capital equipment for a small company as well as consultancy at low cost. A broad spectrum of intellectual property arrangements can be negotiated and small companies can participate. The labs have very specific technology interests, however, and offer no help at all in building a business infrastructure.</p>	<p>Small to midsize companies can partner with foreign governments by moving into partially subsidized science and technology parks, where real estate is cheap, many administrative costs are shared, and intellectual cross-fertilization is common. Although the parks want to attract companies with valuable technologies, the host government also generally has restrictions of some type on foreign companies.</p>

marketing as well as access to a network of key people. But the price is high, says Carsten.

"The VC is primarily interested in making four to 10 times his money invested, so he won't pay a high price [for stock]. An industrial partner will always be a preferable alternative, provided he is not going to steal your secrets," he says.

But another VC, Jim Swartz of Accel Partners in Princeton, N.J., holds that corporate capital is more expensive in the long run, because once a young company signs on, it forecloses many options. The best alternative may be a mixture of the two. In fact, Accel's VCs spend a good chunk of their time finding corporate matches for their portfolio companies. They find eager potential partners in such industry behemoths as AT&T, IBM, Intel, Microsoft, Motorola, and the cash-rich Bell holding companies. For those with no VC connection, consultants can broker a deal.

In making the deal, it is important to know just how crucial the technology can be to a large company. "It could save one or two years in development time, and in a resources-contracting environment there might be circumstances where it would not be done internally," says Tom Uhlman, director of corporate development for Hewlett-Packard Co., Palo Alto, Calif. HP's strategic investments are in the 5%-to-12% range, and "we probably consider two to three times more [deals] than we do," he says.

Partnering with European or Asian companies presents added problems because they tend to be vertically inte-

grated and often have governments with aggressive technology policies. Vertical integration makes the threat of uncontrollable technology transfer immediate and real, but there are also more subtle problems. Small companies must consider their customers' reactions, says Carsten. "If the big partner being considered competes with your customers, they may view it negatively. If the foreign government has an industrial policy that subsidizes or controls companies, customers may see the large company as part of a team that does not play fair." Then too, Europeans and Japanese usually want to exercise more control over the small company than a U.S. partner, says Accel's Swartz.

Dealing with the Japanese takes the most patience and caution, says Chun Chui, president of Quality Semiconductor Corp., Santa Clara, Calif. But "if you can protect yourself, there is no reason not to take the money," he says. Chui's protective shield begins with the necessity of setting up a long-term relationship: "You have to know the intention of your partner, so they can grow with your technology and you can grow with their manufacturing." Chui does not give up intellectual property rights and chooses partners that are unlikely to reverse-engineer his technology. That rules out the major chip houses, which "can kill you in no time at all if you give them your technology."

Not all companies include an equity position as part of their definition of a strategic investment. When the product is software, R&D costs are low and capital not nearly so critical a factor, so cul-

tural compatibility rises in importance. Mentor Graphics Corp., Wilsonville, Ore., has structured a number of partnerships on this basis, says David Chen, vice president of marketing. It has played the roles of both large company acquiring technology and small company selling it. Before entering a deal with a large firm, Mentor must be convinced its technology is strategically important to the partner. "If you are a \$20 million company, you have to remember that IBM does that amount of business in just one sales office," he says. When Mentor plays the role of large company, it tries to set up win-win situations, where both sides have the same goal and a common road map.

Still another point of view is voiced by Vin Prothro, president of Dallas Semiconductor Corp., who thinks partnerships work best in joint development projects. The Dallas company does not enter equity-based partnerships on its battery-backed memory products. "We feel the companies that want alliances really want our technology," he says. Prothro's only partner is AMP Inc., the Harrisburg, Pa., connector giant. Joint developments are pursued project by project, and the contract is a statement of goals, not details.

Despite the potential land mines, partnerships are now a fact of life. Corporate giants see them as a way of getting better product focus and shorter time-to-market. For smaller companies, "It is a legitimizing strategy, a source of capital and revenue," says Accel's Swartz. "But it is not a panacea." □

The Management Collection

Books selected to help you approach difficult business situations more knowledgeably.

LEADERSHIP

R75 Surviving the Crisis of Change — Honing Your Management Skills

In today's fast-paced business world it is not always easy to find the best answers to difficult questions. This series of forty articles is a collection of Industry Week's best information dealing with change that affects managers' professional as well as personal lives. You'll learn how to gain control over difficult problems that you encounter every day. Articles include . . . Expand Your Career by Expanding Yourself; The Politic Game; Surviving a Takeover; When Values Collide; and many more.

124 page . . . softbound . . . \$22.50

R85 How to be a Better Leader

Frederick Herzberg, Daniel Yankelovich, Charles Day, Perry Pascarella and others in classic articles about the changing expectations of today's workforce and how to deal with them. Included are: Selecting Your Management Style, Dealing With Your Subordinates, Motivating Your Workers, and more.

98 pages . . . softbound . . . \$17.50

R09 Your Toughest Tests As A Manager

This book guides you in assessing your own management skills and helps you to develop the strong leadership capabilities you need to be a more effective manager. Articles include: Developing a Flexible Management Style, Motivating Without Manipulating, Handling Creative Staff Members, Dealing With Conflict, Delegating Without Losing Control, and many more.

57 pages . . . softbound . . . \$15.00

R87 the Unhealthy Executive and Some Practical Cures

Managing in an age of anxiety can drive executives into dangerous responses. This book keys on emotional awareness. It shows you how to recognize potential problems and how to deal with them.

72 pages . . . softbound . . . \$16.00

R89 Future Focus: Advancement and Leadership Strategies

Should you plan your career — or just let it happen? Are you using strategies that build success or deter advancement? These are a few of the topics you'll find discussed in a series of articles ranging from career planning to executive management skills.

117 pages . . . softbound . . . \$18.00

MOTIVATION

R88 Herzberg on Motivation

What can the manager do for himself and for his subordinates to overcome the "burnout" caused by the increasing abstraction of work and work relationships? Why is scientific management not the answer to increasing productivity? This book answers all these questions plus many more . . . from problems that might surface in trying to make participative management work to effective leadership in a period of psychological depression. . . this book has it all.

80 pages . . . softbound
third printing . . . \$22.50

LEGAL

R80 Right Off The Docket

This book is an invaluable reference source of more than 140 industrial accident and occupational illness claims. The index provides a cross-reference for each case by type of injury and the judicial ruling set forth so that you can quickly turn to those cases of particular interest.

130 pages . . . softbound . . . \$10.00

Order your review copies now!

Call toll-free
800-321-7003

(in Ohio 216/696-7000)

MANUFACTURING

R72 Strategic Manufacturing

This complete series of twenty-four articles analyzes some of the key issues management must face in developing effective strategies in the years ahead. The articles discuss "how" to link manufacturing with all of the functional departments of an organization so they work with a broad, corporate view of their goals. Articles include . . . Ten Ways to Mismanage Technology; Learning From Foreign Strategies; CIM . . . Walking Through Fire; Challenging Tradition; and much more.

94 pages . . . softbound . . . \$19.50



FINANCE & ACCOUNTING

X38 Managerial Accounting for Non-Financial Managers

You'll work as a company controller in this programmed learning course. You'll learn to properly record all the company's business transactions . . . sales, inventory purchases, operating expenses, depreciation, equity changes, disposal of assets. When the company's fiscal year ends, you'll prepare the annual report, balance sheet, income statement, and the statement of source and application of funds. When you've finished the course, you'll understand better the role of accounting and how to use the information accounting gives you to be a more effective manager.

Two volumes—course book and workbook . . . \$27.50

X29 How To Read a Financial Report

Written in programmed learning format, this book will review the accounting process, tracing the steps from the actual sale to the appearance of the transaction on the financial statements. Then you'll learn how to assess financial position and performance of your company through the use of ratio analysis—analyzing liquidity, activity, profitability, and coverage ratios.

140 pages . . . spiral bound . . . \$19.50

BUSINESS STRATEGY

R70 Strategic Management

Getting a fix on your competitive position. Establishing a clear purpose for the corporation. Meshing the corporate purpose with the individual goals of your people, and Getting their commitment. This collection of ten articles will help show you ways to foster greater vision of your corporate purpose and techniques for combining the human and technological factors needed for good decision-making.

34 pages . . . softbound . . . \$7.00

To order these books, just fill out the coupon below and mail to:

Penton Education Division
1100 Superior Avenue
Cleveland, Ohio 44114

Please send the books indicated. I understand that I can review them for 15 days and, if not satisfied, return them for full refund or credit.

Item #	Quantity	Item #	Quantity
R09	_____	R87	_____
R70	_____	R88	_____
R72	_____	R89	_____
R75	_____	X29	_____
R80	_____	X38	_____
R85	_____		

Orders under \$15.00 must be prepaid.

- My payment is enclosed for postage-free shipment in the U.S. and Canada.
 Bill my company and include postage and handling charges. My purchase order is enclosed.
 Charge my Mastercard Visa American Express Card

Account No. _____ Exp. Date _____

Name _____

Company _____

Address (not P.O. Box) _____

City _____ State _____ Zip _____

Signature _____

Penton Education Division
1100 Superior Avenue • Cleveland, Ohio 44114



CAN THE U.S. GET BACK IN?

AFTER LOSING THE CONSUMER INDUSTRY TO JAPAN, SOME FIRMS ARE GIVING IT ANOTHER SHOT **BY JONAH McLEOD**

For the first time in years, the U.S. consumer market is about to receive a new audio technology manufactured not in Japan, not in Korea or any other Asian nation, and not in Europe. The digital compact cassette, a digital recording machine lower in price than the new breed of competing digital-audio-tape players, will be introduced in mid-1992 by Tandy Corp.

of Fort Worth, Texas, which is manufacturing the units in partnership with the Dutch giant Philips Electronics NV.

The news is noteworthy only in light of history, which reveals that U.S. companies lost the consumer electronics industry to Japanese competitors years ago because of failures in manufacturing, unfair Japanese business

practices, or other reasons that vary depending on whom you talk to. Now invigorated with a religious fervor for manufacturing excellence, some American companies are giving the huge consumer market—worth \$34 billion this year in the U.S. alone—a second look.

They may find an opportunity in the fact that some see Japan stumbling over digital-audio-tape technology. Once vaunted as the next wave in audio, the initial DAT products are high-priced and have other drawbacks that may delay consumer acceptance. Tandy is hoping buyers will flock to its digital-audio alternative instead.

In addition, U.S. semiconductor companies are selling large numbers of integrated circuits to Asian suppliers of consumer gear. Combine this with a heavy U.S. development of digital-signal-processing technology, and American companies have products that Asian firms need to create next-generation consumer equipment. All told, these trends suggest a possible resurgence of U.S. companies in the consumer arena.

The time may be ripe, asserts Fred Van Veen, vice president of corporate relations at Teradyne Inc. in Boston. Japanese cost of capital is coming close to that of the U.S., he says, just as American companies have learned how to manufacture quality products at competitive prices. Add to that the technology base that resides in the U.S., and America may have its best shot yet at regaining a position in this market, Van Veen says.

To answer the question "Can the U.S. regain a position in consumer electronics?" requires an understanding of how the U.S. lost its position in the first place. The answer raises yet another question: have U.S. companies learned enough from their past mistakes to effectively compete not only against aggressive Japanese concerns but also against equally competitive consumer-electronics companies in Korea, Taiwan, Singapore, and Hong Kong?

According to Michael Schiffer, the author of *The Portable Radio in American Life*, the history of the portable radio mirrors the U.S. consumer downfall. American companies at first did not see the value of the small, low-cost radios Japanese manufacturers began shipping in 1957, says Schiffer, a professor of anthropology at the Uni-

Looking for a function generator
with all the bells and whistles,
like direct digital synthesis,
arbitrary waveforms,
and modulation,
that doesn't cost an arm and a leg?



100 000 000 001

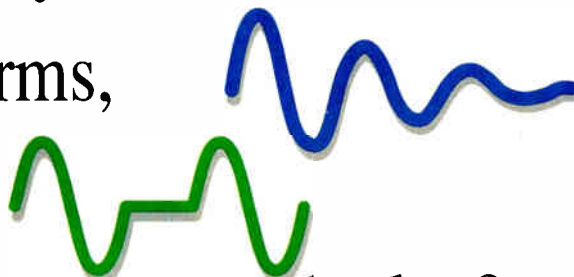

Take a look at the
DS345 from SRS.



At \$1895, it's the only function generator you need.

It's a general purpose signal generator with standard waveforms, frequency sweeps, and synthesized accuracy. It's a 40 Msample/sec arbitrary waveform generator with 16k points of non-volatile memory. It's a complex signal source with amplitude, frequency, and phase modulation, complete with synthesized modulation waveforms. It's a remarkably agile source capable of making phase continuous frequency jumps in only 25 ns. And it's all available at the touch of a button.

What other generator has everything you want, and more?
For more information about the DS345, call SRS at
(408) 744-9040.

- 30 MHz direct digitally synthesized source
- 1 μ Hz resolution
- 12 bit arbitrary waveforms
- Fast phase continuous frequency switching
- Low phase noise and distortion
- Sine, square, ramp, and triangle waveforms
- Linear and log sweep with markers
- Frequency, amplitude, and phase modulation
- Arbitrary and burst modulation
- Optional GPIB/RS232 interfaces with Arbitrary Waveform Composer Software



STANFORD RESEARCH SYSTEMS

1290 D Reamwood Avenue, Sunnyvale, CA 94089 TEL (408)744-9040 FAX 4087449049 TLX 706891 SRS UD

PENTON CONTINUES COMMITMENT TO RECYCLING



Penton Publishing's Camera Department started recycling chemicals from film wastewater 25 years ago... long before the ecologically-smart idea was widely recognized.

For almost as many years, the Penton Press Division has been recycling scrap paper, obsolete inventory, and printing press waste materials. In 1991, Penton Press will recycle some 5500 tons of paper, 9 tons of aluminum plates, and 3 tons of scrap film negatives. Furthermore, the Press Division has invested \$500,000 in air pollution control equipment.

Company-wide, the recycling spirit has spread from Cleveland headquarters to offices throughout the country. Penton employees are enthusiastic participants in expanding programs to re-use paper, aluminum cans, and other waste materials.

Penton Publishing believes these practices make a significant quality-of-life difference for people today... and will help create a safer, healthier environment for generations to come.

Penton Publishing

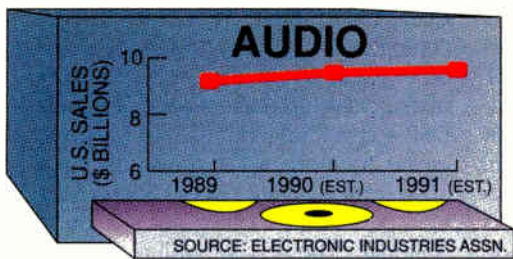

versity of Arizona in Tucson. "Earlier models from U.S. companies did not find acceptance, because adults felt listening to the radio through the single earphone made them appear as if they had a hearing aid," he says.

What U.S. manufacturers failed to anticipate was the impact of rock and roll on the demand for transistor radios among a whole new class of consumers: teenagers. Schiffer says the transistor radio and the burgeoning youth culture had a synergistic relationship, rock creating a demand for radios and radios for rock.

Though slow to cotton to this trend, U.S. manufacturers were quick to get into the market once it became obvious. "In 1959, every U.S. radio company began offering shirt-pocket radios for the youth market," Schiffer explains. But as fierce competition drove prices down, American manufacturers turned to lower-cost Japanese components and by the 1960s had opted to build their products offshore.

The impetus, says Schiffer, was the vast difference in labor costs. Japanese assembly workers made one seventh of what their U.S. counterparts made. Motorola Inc. attempted to compete by automating its production process, but that didn't make up for the lopsided labor costs. Finally, "Motorola went the way of other U.S. companies by having Toshiba build all its lowest-cost transistor radios," Schiffer says, "though, to its credit, Motorola did continue building more expensive transistor radios in the U.S."

However, labor costs don't go far enough in explaining Japan's advantage, which ultimately rested with manufacturing. Continuous refinement of the production process is what affords Japanese companies their manufacturing prowess, says Jim Porter, president of the market-research firm Disk/Trend Inc. in Mountain View, Calif. Porter, who now follows hard-disk drives, was involved in the

1970s with a consumer electronics company attempting to sell a cartridge TV.

What Japanese and other Asian companies understood was how to squeeze cost and waste out of manufacturing, says Ingrid Moos, founder and president of Deico Electronics of San Jose, Calif. As an example, she cites the movement toward mounting chips on a board instead of using more expensive plastic or ceramic packages.

Like Porter, Moos has a consumer background. In the 1970s, she worked as an engineering consultant to a large Santa Clara, Calif., IC company that was attempting to build digital watches and calculators. She was contracted to improve the yield of the company's production line, which was an abysmal 52%—the company was throwing away as many watches as it was shipping. In examining the operation, says Moos, she learned there was total lack of communication between engineering and manufacturing. Engineering had designed a watch that manufacturing could not build, and manufacturing was not cooperating with engineering to resolve the problem.

This scenario is not unusual, says David Kingery, another University of Arizona anthropologist, who believes there is a cultural basis for the difference. The U.S., which values individualism, tends to organize businesses that are highly compartmentalized, with departments failing to communicate and cooperate. By contrast, he says, Japanese companies are consensus-driven, with widespread cooperation among the various groups within an enterprise.

But whatever the cultural and manufacturing climate, some U.S. observers believe the Japanese won the consumer in-

dustry by means of unfair business practices. Japanese firms acquired U.S. technology and then dumped products made with it onto the U.S. market at depressed prices, charges R. Terren Dunlap, president and chief executive officer of Go Video Inc. in Scottsdale, Ariz. Dunlap, who was involved in a well-publicized trade dispute with several Japanese vendors over his company's dual-head video cassette recorder, says it was this kind of ruthlessness that accounted for Japan's ability to eliminate U.S. competitors.

However, Porter of Disk/Trend says U.S. companies that cry foul about unfair Japanese practices have it all wrong. "You only have to look at the hard-disk-drive industry to see that U.S. companies can effectively compete against highly efficient Japanese manufacturers," he declares. "U.S. drive companies own 70% of the \$24.2 billion worldwide [drive] industry," he says. "Like the Japanese, they moved manufacturing to use the price-competitive labor anywhere in the world. They built world-class quality and they have beaten the Japanese to the market in every successive generation of drive product." The implication: the U.S. consumer industry was not as Darwinian as the drive industry is today.

Nor is it true that Japanese firms simply copy U.S. technology and then flood the market with it, says Schiffer. In the 1960s, "there was some reverse engineering, but Japan pioneered solid-state circuits for TV." Sony Corp., for example, "made significant contributions to the state of the art even before U.S. R&D began in television." At a time when Sony was "investing in developing new TV technology," analyst Porter recalls, "U.S. manufacturers such as RCA, General Electric, and Admiral were spending money on developing distribution channels and making their stockholders happy."

How the Japanese carry out R&D provides them another advantage over their U.S. counterparts, Kingery asserts. "In the U.S., scientists tend to specialize in original research," he explains. In Japan the scientist, engineer, and technician work collaboratively, making for "more interdisciplinary development." Kingery is quick to point out that he now sees U.S. companies also implementing collaborative R&D.

Despite the large-scale loss of consumer-product manufacturing in the

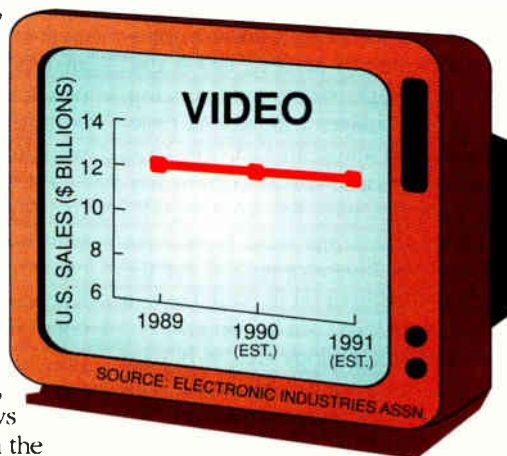

U.S., a few companies stayed the course and met the Japanese head on. Tandy is one of them. "We have 8% of the U.S. audio market," says Ed Juge, director of market planning at Tandy, which also builds home computers, among other products. "We are the largest supplier of telephone equipment outside of AT&T, and we are among the top three suppliers of telephone answering machines."

Juge asserts that manufacturing know-how is the only way to compete in consumer electronics. "You have to have the lowest cost of manufacture," he declares. "You have to source components from the world market to get the highest quality at the lowest price. You have to make products that can be manufactured in high volume, but you can't make them in highly automated plants because product life is much too short. Nor can you make bad products, because you can't afford to fix them." Less than half of 1% of the products Tandy makes fail, he asserts.

Another company that matched Japan Inc. in the manufacturing game is the 3M Co. of St. Paul, Minn. Michael J. Stevens, business operations manager, cites the fiercely competitive consumer tape and floppy-disk business. In the early 1970s, he says, worldwide pricing of floppy disks came under severe pressure as Japanese companies attempted to build market share. Casualties of this squeeze include Dysan, Kodak, Verbatim, and Xidex.

"We made the massive investments in capital equipment and new production techniques to remain competitive," says Stevens. "Today we own over 28% of the world floppy-disk market, and we are the market leader worldwide in the face of competitors like Maxell, Fuji, TDK, Sony, and BASF."

In a curious twist, the next wave of consumer electronics products require not only original R&D, but market development as well. Consumer electronics manufacturers have been evolving analog products into higher-tech digital units. The record changer was replaced by the compact disk. Analog audio on cassette tape will soon be replaced by digital audio in some form. Still picture cameras are likewise going all digital.

But the cost of going digital is part of the problem Japanese manufacturers face. Digital audio tape sounds just like a compact disk, but with the first players priced at over \$1,000, few buyers are

going to rush to the stores, says Tandy's Juge. He believes it will take the Japanese too long to bring the cost of DAT into the \$200-to-\$300 price range needed for mass sales. Tandy is betting that Philips, headquartered in Eindhoven, the Netherlands, has a much more cost-effective solution in the digital compact cassette, or DCC. Philips and Tandy have joined to manufacture DCC for the U.S. market. The initial units will probably cost \$600 to \$700, Juge says, but he expects prices to drop with manufacturing volume.

Juge says DCC has all the benefits of DAT and none of the drawbacks. DAT tape must be recorded at the same speed as the tape is played. DCC can be

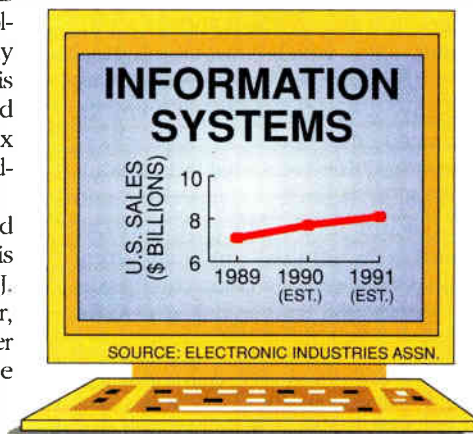

recorded at 30 times faster than playback speed, so manufacturing is cheaper. DAT helical-scan mechanisms are sensitive to shock and vibration, so a portable DAT player could be expensive to build. DCC records in linear tracks, so players need be only as rugged as a cassette player.

The DCC player also uses electronics to compensate for mechanical imperfections, so the unit can be made of plastic at a very low price. The new device uses DSP technology and compression techniques to achieve CD sound quality at near-cassette tape pricing. And the DCC player will play all existing analog cassettes. In fact, the DCC cassette is the same size as current analog cassettes, a plus for retailers who won't have to change store layouts for the new tapes. Juge is optimistic that the next hot consumer item will have a "Made in the U.S.A." sticker on it.

It is DSP technology that is putting many U.S. companies back in the consumer electronics business—sort of. National Semiconductor Corp. of Santa

Clara, for example, is selling ICs containing DSP capability to Japanese and other Asian consumer electronics manufacturers. Chip makers are embedding DSP software algorithms into silicon to create solutions such as the all-digital answering machine, says Giora Yaran, vice president of office automation at National. "The way we will compete is to continue developing more unique algorithms to create a wide variety of niche products," he says. National's newest combined microprocessor and DSP chip, the AM160, has been designed into an all-digital answering machine from a major supplier.

Much of the DSP expertise flowing into consumer electronics products today was developed in Israel for the military, says Levy Gerzberg, president and CEO at Zoran Corp. in Santa Clara. Zoran's unique DSP algorithms, and an associated application-specific IC to run them, are designed into next-generation all-digital still-picture cameras being developed by Fuji Photo Film Co. Ltd. of Tokyo.

Gerzberg says this generation of camera will provide quality equivalent to that of 35-mm photography, something not possible with earlier models. Moreover, these cameras can plug into a personal computer to handle image display and processing. "By the end of this decade, our total available market is the 4.2 million single-lens-reflex 35-mm cameras currently in the market," says Isaac Shenberg, imaging products-line manager at Zoran.

With the current Semiconductor Trade Agreement between the U.S. and Japan requiring Japanese companies to buy American, it's hard to tell what buying is for quota and what is on product merit. "Japanese manufacturers have a quota of U.S. electronics they must purchase," says Mark Levi, vice president of analog marketing at National. But there are others in Asia looking to U.S. companies for semiconductor components in consumer products, especially in Taiwan, Korea, Hong Kong, and Singapore.

Ed Sacks, president of Zilog Inc. in Campbell, Calif., says Asian companies want a diversity of supply for consumer electronics. He says companies such as Korea's Samsung are looking for semiconductor sources outside Japan. They prefer to buy from chip makers that are not consumer competitors, which eliminates many of the huge, vertically integrated Japanese suppliers. □

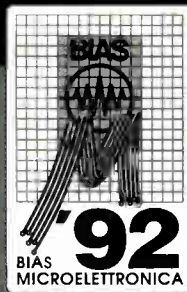

Milan Fairgrounds
January 28 - February 1, 1992

24th International Conference-Exhibition
of Automation, Instrumentation
and Microelectronics

BIAS Microelectronics '92

"Total Quality" Objective

Over 2,300 Exhibiting Firms

Total Display Area: 70,000 square metres

• Electronic components and subsystems • Telecommunications systems and subsystems • Minisystems, microcomputers, OEM peripherals, personal computers, software and accessories • Electronic Laboratory Instruments for scientific and applied research, for production and maintenance • Automatic design systems for the electronics and electrotechnical industries • Production, automatic testing and maintenance systems and instruments for the electronic and electrotechnical industries • Printed circuits: equipment, materials, technology • Specialized publications and technical documentation •

BIAS Microelectronics '92
Two special events



BIAS Fortronic '92

International exhibition
and exchange for
electronics sub-suppliers

In collaboration with the
Vicenza Fairgrounds Authority



BIAS Sensors '92

Exhibition devoted to
sensors, transducers,
transmitters, recorders and
displays

In collaboration with GISI (Italian
Instrumentation Manufacturers Group)

BIAS promotions

Entrances: Porta Meccanica & Porta Edilizia

Non-stop exhibiting hours for qualified visitors: 9 a.m. - 6 p.m. (Saturday, 1 February 9 a.m. - 3 p.m.)

Exhibition Secretariat:

E.I.O.M. Ente Italiano Organizzazione Mostre: Viale Premuda, 2 - 20129 Milan - Italy
tel (+39-2) 55181842, 55181844, 55181922 - telex 382110 BIAS I - fax (+39-2) 5400481

WAGING WAR ON INTEL: THE RISC CROWD MOVES IN

MIPS'S PARTNERSHIP ANNOUNCEMENT IS THE LATEST ATTACK ON THE X86 ARCHITECTURE; BUT INTEL REMAINS UNFLAPPABLE **BY SAMUEL WEBER**

When MIPS Computer Systems Inc. trotted out five semiconductor partners in San Francisco last month, all of them ready to market versions of the powerful 64-bit MIPS R4000 RISC processor, it signaled another assault on the relentless and profitable grip that Intel Corp. has held on the CPU market

PROCESSORS for more than ten years. Almost simultaneously, Chips & Technologies Inc. announced several of its own compatible versions of the 386 chip that has helped Intel dominate the huge DOS-based PC market [*Electronics*, October 1991, p. 52]. With Advanced Micro Devices Inc. already having broken Intel's 386 monopoly, the combined assault could foretell a decline in Intel's market share for the aging but still viable 386.

But what the MIPS crowd and others plying reduced-instruction-set computing are eyeing hungrily is not personal computers but the potentially huge commercial workstation market represented by Fortune 1,000 companies. With low-end workstations costing as much as high-end PCs, these vendors hope the new RISC machines will displace Intel's 80x86 as the architecture of choice for the desktop.

For now, though, the PC vastly outnumbered the workstation in both commercial and scientific or engineering applications, RISC's initial stronghold. "As to the people ganging up on us—the MIPS



"We'll ship more 486 processors this quarter than all the RISC processors in all the designs shipped from the beginning of time."

GORDON MOORE, INTEL

thing, for example—one thing you have to look at is the relative market size you are serving," says Gordon Moore, chairman of the board at Intel. "We'll ship more 486 processors this quarter than all the RISC processors in all the designs shipped from the beginning of time."

But the RISC chip vendors and system manufacturers are trying to force a

change. Besides MIPS and its customers, they include Sun with its Sparc architecture, Motorola and its 88000, Hewlett-Packard's Precision Architecture, and IBM with its R6000 workstation. Because of recent price breaks bringing workstations into the \$5,000 range, most of them now can compete head-on with high-end PCs. What they face, however, is increasingly narrower margins being squeezed by the intense competition.

MIPS's hopes for its R4000 rest on a strategy designed to pit it directly against Intel's 486 and 586 processors. "It's a single-chip approach," says Dane Elliot, director of component marketing for the Sunnyvale, Calif., company. "Its intended position is in the cost range of the high-end Intel 486 and 586 type of product," he says. "It's not quite as high in performance at its current clock rate as the HP and IBM [solutions], but it is clearly in that domain." And it outperforms the next-generation Sparc offering from Sun Microsystems Inc., which is currently under development in association with Texas Instruments Inc., according to MIPS.

MIPS hopes to gain many design wins through its affiliation with the Advanced Computing Environment (ACE), an industry consortium seeking to set standards for next-generation PCs and workstations. As the ACE architecture gains desktop precedence, it will represent a \$50 billion market, says Chester J. Silvestri, vice president and general

manager of the technology products group at MIPS. Silvestri anticipates seeing a large number of companies at the upcoming Comdex show exhibiting ACE machines. But with the R4000 chip alone bearing a hefty price tag of \$1,000, why will buyers be deflected from conventional PCs? Silvestri's answer: the constraints imposed by the DOS operating system. Most PCs are designed for the single-user, single-task environment. Thus, networking and high-resolution graphics, found embedded in workstation motherboards, still require add-in cards for most PCs. Building a Unix-based PC with both networking and graphics onboard pushes the cost too high for most users.

A big driving force behind MIPS is the five partners the company has licensed to manufacture the chip. They include Japan's NEC Corp. and Germany's Siemens AG, two semiconductor giants capable of driving down the cost of the R4000 and developing enhanced versions. All five partners believe the processor's price will drop to around \$200 by 1993. NEC is already developing systems based on the

chip, says Hajimo Sasaki, senior vice president of NEC in Tokyo. He foresees the R4000 ending up embedded in office equipment, industrial control, and other applications.

Sasaki says the ACE initiative is pushing a common operating system in Japan, which until now has been served by incompatible, multivendor PCs. Besides NEC, other ACE members—such as Sony, Sumitomo Denko, and Kubota—are building ACE computers capable of running the two ACE operating systems: OS/2 with Windows, or the Santa Cruz Operation's version of Unix.

Another plus for MIPS is that the company already has a foothold in corporate enterprise-wide computing, where Sun is beginning to make a major push. Then too, MIPS landed a

major design win when Tandem Computer Inc. of Cupertino, Calif., chose its chips for two new versions of the company's Cyclone/R and CLX/R computers. The first systems rolled out late last month based on the R3000 processor, but R4000 versions are promised soon.

On another front, Data General Corp. of Westboro, Mass., has been quietly making impressive inroads in the corporate arena with its RISC-based Avion servers built around the 88000 CPU from Motorola Inc. The architecture boasts 1,800 commercial applications, says William Zastrow, vice president of Avion marketing. This gives Data Gen-

chips in the fourth quarter, he says. "Take a million RISC processors...[and] then you have to divide that by the number of different RISC architectures, and in the case of MIPS you have to divide that by the number of suppliers. You don't get a very big market for any of those guys."

Says Moore: "I don't want to play down the competition as something we don't have to worry about. But I really don't think the economics are going to work out as well as some of these people are expecting. I don't see any scenario at all with the volume of MIPS processors expanding dramatically over the next two years.

They'll be fighting their way into some of the high-end workstations. But what we'll be introducing next year in the next generation of 486s will have the same ballpark performance as MIPS is talking about."

Moore also points to Intel's huge installed base. "What the software developers see is something like 80 million PCs out there with our architecture, compared with half that many Apples and a factor of ten lower yet of everything else," he says. "Any software guy looking at an architecture to run his

software on wants to hook onto that 80-million base." This fact isn't lost on competitors, says Moore.

"Look at ACE—it's MIPS and Intel," he says, noting that ACE has chosen Intel's x86 architecture and the MIPS approach as the two hardware roads to the future. "This Pink thing...is IBM and Intel," he continues, referring to the plans of IBM Corp. and Apple Computer Inc. to codevelop an object-oriented operating system—code-named Pink—to run on both the Macintosh and IBM's x86-based PCs. "Sparc's Solaris group is now porting its software onto our architecture. So everyone out there sees the advantage to being on our base. We understand why we are a target for everyone to shoot at." □

Additional reporting by Jonah McLeod

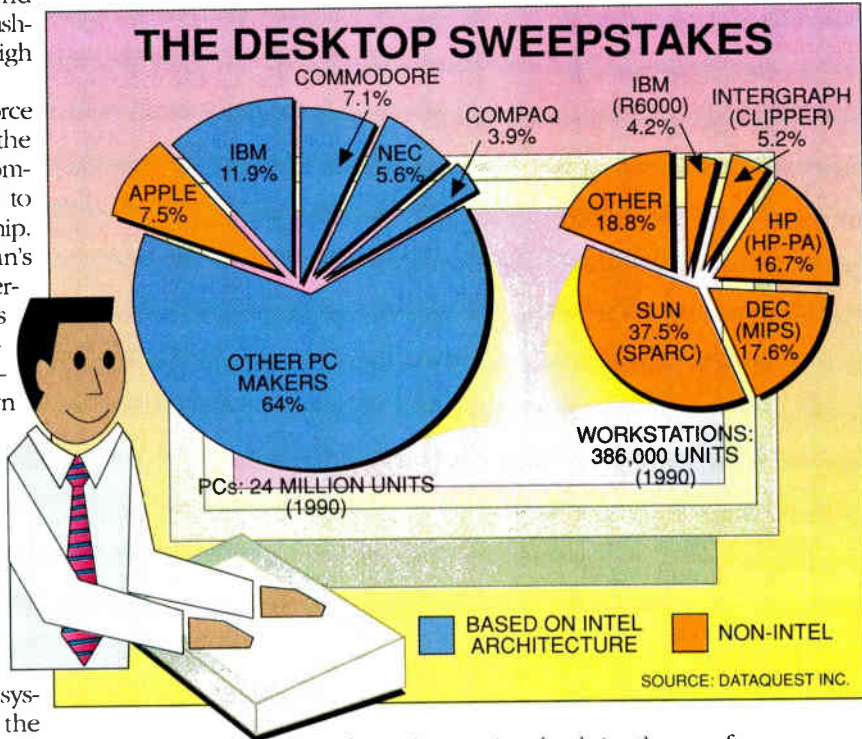

eral an impressive lead in the server market—another contender taking a bite out of Intel's pie.

For its part, the target of all these maneuverings appears unperturbed by the gathering competition. The Santa Clara, Calif., company is now completing an impressive midrise complex that will house a huge new advanced-development facility plus administrative offices. In a recent interview there, Moore refused to concede the game. "As we look at the next generation of products," he says, "we are adding capacity at very high rates in order to accommodate that."

As to the competition, Moore says the economics of their position is not very promising. Intel—which has a \$1 billion capital budget this year and next—expects to ship a million 486

SPEAKS OUT

GLOBALIZATION? NOT WITHOUT ACCESS

The electronics industry is globalizing, or so we're told. Yet the more we agree on the premise, the less clear its meaning. Are we talking about one big world market served by common products—a world car embedded with world chips sporting a cellular world phone? Perhaps we are entering the age of stateless corporations that operate in similar ways regardless of ownership or local politics. For firms struggling with strategy or for policymakers whose reach attenuates at national borders, is there any sense to be made of these global alternatives?

Like Bruce Springsteen, modern electronics was born in the U.S.A., and for most of its short life the industry has been dominated by U.S.-owned firms. That era's gone. It packed its bags when consumer electronics passed out of U.S. hands, and waved goodbye with the relative decline of American components and high-volume manufacturing skills. It's been replaced by globalization.

In light of that genealogy, two different interpretations of the global era are possible. The first is simple and has the force of current market trends behind it: the Japanese supplant U.S. leadership and going global means going to Asia, where the major action is. The alternative is more complex but less parochial: distinctive competencies emerge in distinct regions. For example, high-volume manufacturing and component skills concentrate in Asia, novel architectures and networked systems in the U.S., industrial systems and precision skills in Europe. In this vision, going global implies the need for firms in one region to access the skills and opportunities in the others.

Access is already the name of the new global game. When electronics know-how, activities, and markets cluster regionally, and progress is driven by scale and learning, whoever has the broadest access to all three regions will likely end up dominant. In the bygone era of U.S. dominance, access was not much of an issue: the relevant markets were mostly competitive and open, as was the science and technology community. In the new era, by contrast, there are signifi-

cant asymmetries in where technology and know-how reside and how easily they can be accessed. Such differences matter mightily in market competition. Fujitsu can purchase ICL to get access to European skills and distribution channels. But Compaq (or Apple or Sun), unable similarly to acquire Japanese know-how, must instead ally with Citizen Watch (or Sony or Toshiba) and in the process sacrifice some autonomy. Asymmetries also help to determine whether interregional alliances will be mutually beneficial or one-sided. In general, unless protected as intellectual property, the software or novel design that a U.S. firm offers is far easier for its partner to appropriate than the manufacturing know-how collectively embedded in an Asian firm's personnel and practices.

For all of those reasons, the emerging global era will boast a great deal of political conflict over access to foreign skills, technologies, and investment opportunities. Conflict over technology access is likely to define the rest of the 1990s much as the issue of market access defined the 1980s. Like it or not, those conflicts will push the electronics industry toward strict reciprocity of access—and toward managed trade to achieve it. They will also force the Japanese to move more than assembly operations into the U.S. and Europe.

Ironically, then, as the global era in electronics dances toward center stage, it will drag national policies and industrial practices back into the limelight. Borderless world markets? Stateless corporations? Maybe when the Nintendo generation's children take power, but not anytime soon.

MICHAEL BORRUS is codirector of the Berkeley Roundtable on the International Economy (BRIE)

TECHNOLOGY
ACCESS WILL
DEFINE THE
1990s MUCH
AS MARKET
ACCESS DID
THE 1980s.



PRODUCTRONICA



For the electronics industry's production community, the center of the universe this month is Munich. There, Productronica '91 will be a feast of manufacturing technology for 80,000 visitors.

bounds, both in terms of exhibition area and the number of exhibitors and visitors. Productronica '89, the show's eighth edition, attracted to the Bavarian capital some 1,606 directly exhibiting companies—plus 262 firms showing their wares on other companies' stands—from 29 countries. About half the firms came from abroad. Roaming the 20-odd halls with a total floor space of nearly 1 million square feet on Munich's sprawling fairgrounds were 80,359 visitors from around the world.

Officials of the Munich Fair Corp., organizer of the city's trade exhibits, are confident this year's show will match, if not surpass, the numbers scored by its forerunner. "It should again prove itself as the leader among the world's shows devoted to production technology," says Gerd vom Hövel, the corporation's managing director and creator of Munich's six high-tech fairs held at two-year intervals.

Contributing to Productronica's attractiveness are joint exhibits from a number of countries, among them France, Israel, Italy, the Netherlands, the UK, and the U.S. These exhibits, at which firms from each country display their products on "community" stands sponsored by the respective governments or national industry associations, have become a permanent part of the show.

Other factors that have made Productronica a success are an optimum fair service (provided by banks, restaurants, customs offices, travel agencies, communication facilities, and press centers), as well as a clear segmentation of the exhibits according to product groups. This saves visitors much time

Rohde & Schwarz is another name for precision

TSAS modular test workstation aims at boards and modules

At Productronica, test and measuring instruments will figure prominently. One test system that's certain to catch the attention of showgoers is the test workstation TSAS from Rohde & Schwarz GmbH. Developed for testing boards and modules in production and service, the TSAS is modular in construction and can be expanded into a system with up to 1,088 hybrid in-circuit test pins with a 10-MHz test data rate (or up to 512 channels, also with a 10-MHz rate).

The company behind TSAS, R&S, is one of Europe's major equipment and systems manufacturers in measuring and communications technology. Mention precision instruments and what comes to mind in the laboratory, in the field, in training, and on the production line is R&S. The company's quality assurance program has the stamp of approval from the industry, government authorities, and civil organizations. The program complies with NATO's AQAP-1 requirements.

The Munich-based company has 5,000 employees, operates manufacturing plants in Germany and Italy, and is represented in more than 80 countries, including the U.S. Annual sales are close to \$10.5 billion, with exports accounting for half the total. The firm invests about 12% of sales in R&D.

Sales are in four main fields: measuring instruments and systems; sound and TV broadcasting equipment; radio-monitoring and radio location gear, and radio communication systems. After-sales service covers field installation, training, maintenance and repair, documentation, and calibration to international standards.

In instruments, R&S offers solutions to all tasks involved in generating signals from audio frequencies up to very high frequencies and into the microwave range. As regards field strength measurements, spectrum analysis and interference-measuring equipment for testing components and boards are the company's forte.

In broadcasting systems, R&S is the world's only supplier with a complete range of fm radio and TV broadcasting equipment—radio data systems to turnkey transmitting stations—from a single source. Trunked radio and mobile radio systems for commercial, administrative, and government services are also part of the comprehensive spectrum of radio communications equipment from R&S, as are complete radio systems for land vehicles, aircraft, and ships, and for air-traffic control as well as for stationary networks. R&S radio systems for communications, monitoring, and radio location are installed at all German and many international airports. They are also in use at embassies, coastal radio stations, broadcasting companies, and government authorities. ■

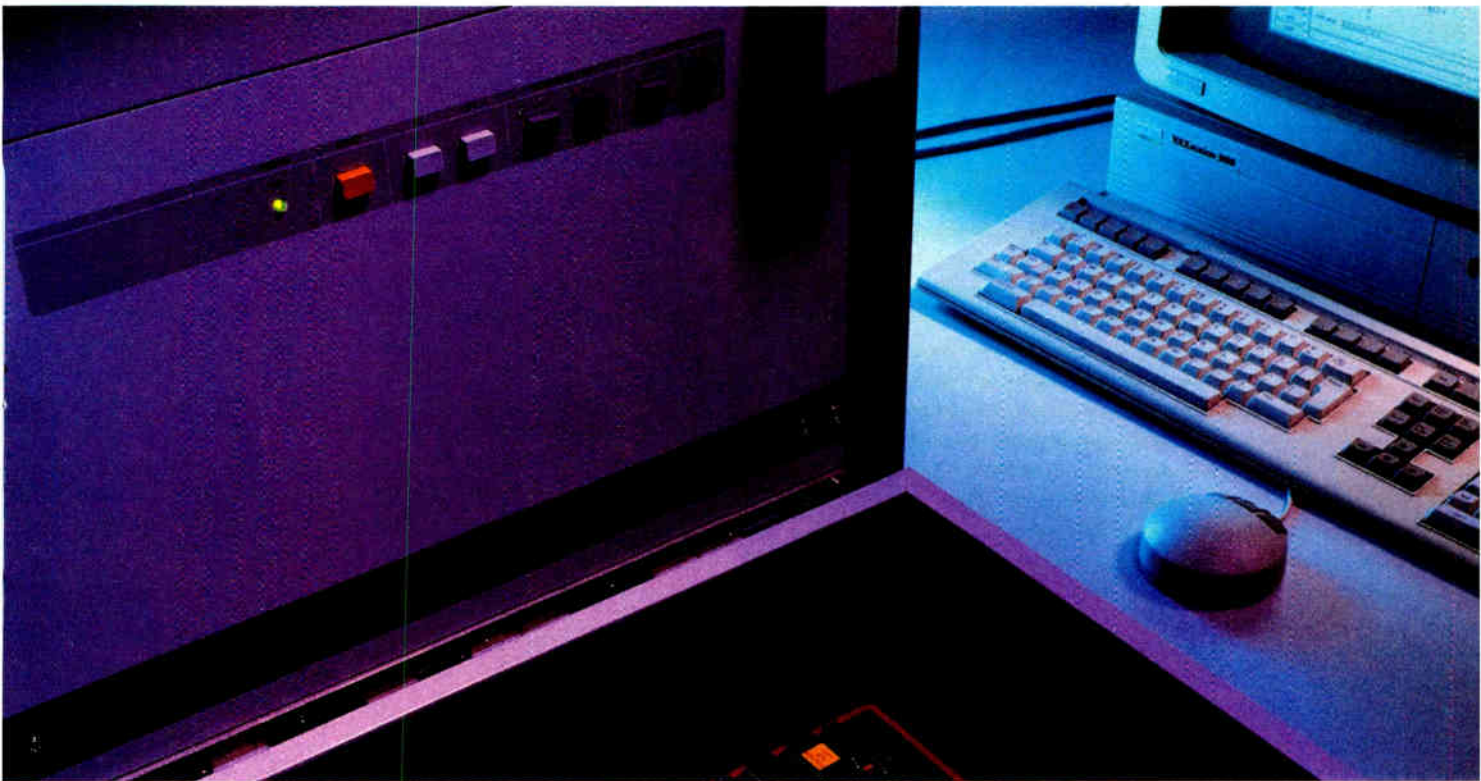

How much testing technology do you get in the lower price range?

Such a lot!

Incredible – economic operation takes on a new dimension: the introduction of the test workstation TSA by Rohde & Schwarz means that a small tester is now available with almost all the features of a large testing station. Analog and hybrid in-circuit tests, for example, or analog and digital functional tests and a combinational test. Not all at once however, but individually configurable – the same principle as a building block! Added to this is the powerful software for automatic program generation, high-speed fault diagnosis, paperless repair and quality control. The TSA moreover has a networking capability and is compatible with the TSI, TSIC and TSP testing stations, so that it can also be used to implement CIM systems. The TSA – a small testing station with the performance of a huge system.

Last but not least:

The TSA is the smallest member of the Rohde & Schwarz family of testing stations. It can be combined without difficulty with the TSI, TSIC and TSP testing stations, either to relieve the load on them or to solve special problems. Its masterly testing technology is accompanied by an effective back-up system, including training, documentation, application support and a hotline, and not least the know-how and

experience of one of the best-known manufacturers of electronic precision. The TSA – a small testing station with the background of a giant.



See our TSA brochure for further details. A phone call guarantees return of post delivery!

**QUALITY CAN BE MEASURED
QUALITY CAN BE TESTED**

CIRCLE 202



ROHDE & SCHWARZ



Pick up the pieces and put them

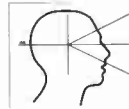

PCB flowlines represent a significant investment in the future. You therefore need a flowline supplier who has a ***view of that future*** as well as an excellent track record.

We are that kind of supplier. Philips' SMD placement systems are at work in our electronics factories around the world. They are also found in many other companies. For example, in the computer, telecommunications and automotive industries.

Our ***experience in automated flowlines*** goes back ten years, to the very beginning of the SMD technology. It's found in today's systems, with their proven ability to meet a comprehensive range of manufacturing needs.

Flexibility is a key issue in a modern manufacturing and this is reflected in the modular design of our systems... a design that ensures productivity, quality and profitability... both today and tomorrow.

Philips' PCB flowline systems are supported world-wide and are backed with consultancy services plus installation, training and maintenance. Need to know more? Contact Philips Industrial Automation.

It takes more than machines to make you competitive.

Philips Electronic Instruments Company, Industrial Automation Division,
2975 Court Yards Drive, Norcross GA 30071, USA, Tel.: +1 404 368 4420,
Fax.: +1 404 368 4450.



PHILIPS

CIRCLE 172

Philips spotlights its surface-mount manufacturing

As a major IC maker, the company offers production expertise too

Philips Industrial Electronics, with headquarters in Eindhoven, the Netherlands, is one of the leading exhibitors at the big biennial production and assembly equipment exhibition and show, Productronica '91, to be held Nov. 12-16 in Munich. As a leading manufacturer of components, Philips is a pioneer in surface-mount-device products and technology. And for consumer electronics, Philips is a major user of surface-mount components.

The importance of surface-mount technology is not to be minimized. The technique has come on rapidly in the past few years and has become the method of choice in more and more applications. And for Philips, the link between the two activities—manufacturing surface-mount components and using them—is surface-mount assembly lines.

For almost 10 years, the people at the giant Dutch company have been supplying such lines to companies in a wide range of industries. For example, in the automotive sector there is Ford Motor Co.; among consumer electronics manufacturers there is, in addition to Philips itself, Grundig AG; and in the broad computer field there is Seagate Technology, the U.S. disk-drive manufacturer.

Not only that, but Philips Industrial Electronics has supplied hundreds of surface-mount placement systems as subcontractors and for in-house production facilities in virtually every conceivable field of electronics assembly. Its main products are equipment for printed-circuit board handling, screen printers, glue applicators, placement machines for surface-mount devices, curing and reflow ovens, and test equipment.

At Productronica, Philips will display an array of the latest equipment at two stands: No. F12 in Hall 19 for industrial automation, and No. B02 in Hall 24 for test and measurement. Philips Industrial Electronics will show its complete capability in the field of machines and systems for the electronics manufacturing industry, as well as a number of innovations in test and measurement instrumentation and in assembly. There will be new placement systems, boundary scan test products, and ScopeMeter, a combination oscilloscope-multimeter.

The company's Industrial Automation Business Unit will demonstrate flow-line systems comprising a selection of its electronics manufacturing equipment. The complete range includes component-placement systems, in-line test equipment, dispense units, screen printers, curing and reflow ovens, board handling and transport systems, etc.

An integral part of the Philips capability in the electronics manufacturing field is its range of advanced software packages, which allow virtually complete automation of flow-line operation. The functions handled include production prepara-

tion, flow-line control, and production evaluation. These software packages, together with all the necessary technology know-how and support, allow Philips to offer complete and effective solutions for a wide range of electronics manufacturing requirements.

Not only is the company prepared technologically to handle any aspect of the production and assembly picture, but it is also well positioned geographically. Sales offices are situated in Europe, at corporate headquarters in Eindhoven; in the U.S., they are in the Atlanta suburb of Norcross, Ga.; and to cover the needs of nations of the Pacific Rim, Philips has an office in Singapore.

To be on display at Productronica, products in the CSM Compact Surface Mounter line will include the new CSM 168 "Chipshooter" for the mounting of SMDs. With the ability to handle up to 168 different component types, and the capacity to place up to 12,000 components per hour, the CSM 168 fills the gap between the smaller CSM placement machines and the high-capacity MCM systems.

The family also includes the recently introduced CSM 84V and CSM 66, accepting up to 84 and 66 8-mm tape feeders, respectively. These machines meet the latest needs in pc-board assembly, permitting increased throughput with more SMD types per board. The CSM 84V on flow-line demonstration is equipped with a Vision System, enabling placement of a wide variety of fine-pitch components such as OFPs.

The High Speed Dispenser will also be on show. This unit can be equipped with up to three dispense heads, and can place up to 18,000 glue or solder paste dots per hour.

Large-scale production requirements are met by the new MCM 8 PCB placement machine, which is the world's fastest software-controlled chipshooter. With extensive capabilities for large-chip placement, this highly flexible system can place up to 30,000 components per hour, and handles a wide range of components with high accuracy.

The design of the MCM 8 includes a Vision System, as well as a Component Sequence Robot for tray feeding of components. Advanced features of this system speed changeover, greatly simplify operator intervention, and ensure maximum uptime during production.

The Philips Industrial Automation capability also includes in-line test facilities for integration in automated pc-board assembly lines. A new addition to this range is the MDA 8000 Manufacturing Defects Analyzer, developed to meet the latest test requirements. The MDA 8000 can be integrated into existing board flow-line environments, and its in-circuit tests allow fast feedback to be obtained on assembly-related faults.

On show on the Philips Test and Measurement Business Unit stand (No. B02, Hall 24) will be the complete capability of the Philips and Fluke alliance in Electronic Manufacturing Test (EMT). A wide range of solutions are offered for off-line test applications, covering requirements from process test and assembly fault diagnosis, using Manufacturing Process Testers (MPTs), right through to functional testing of complete products and assemblies. The range includes the 9100-Series Digital Test System for functional testing and fault isolation in digital circuits; the 9400-Series Manufacturing Process Tester, which provides a very low-cost method of detecting and correcting defects induced in loaded boards during the manufacturing process; and the 2000 Series Manufacturing Defects Analyzer (MDA). ■

in looking for the products that interest them. For their part, exhibitors are assured that their wares are seen by connoisseurs, the specialists, instead of the merely curious. Fair officials expect interest from East European countries to be up sharply this year compared with 1989, a result of the political changes sweeping that region.

This year, the world of electronics manufacturing will be divided into four product groups, each dealing with a particular technology. The first group concentrates on "Manufacturing Microelectronic Components" and focuses on artwork generation and data base processing; materials, process chemicals, and semifinished goods; thin-film deposition and precision etching; wafer treatment and handling; and internal interconnections and encapsulation.

The second group concerns "Manufacture of Printed-Circuit Boards and Hybrid Integrated Circuits." It zeroes in on materials and semifinished goods for circuit carriers; circuit layout and printing; mechanical processing; chemical treatment and electroplating; and heat treatment and lamination.

The third group treats "Assembly Operations and Electronic Packaging." It concentrates on auxiliary

materials and precision parts; semifinished goods for interconnections and wiring; coiled products; assembly preparation and prefabricated parts; mounting and assembly; and material flow and methods of disposal. The fourth group deals with "Measuring and Test Equipment for Quality Assurance." It focuses on sensors for basic and complex measurements; data display and monitoring; visual inspection; automatic test gear; and specialists' equipment for the laboratory and the test bed.

Aside from these product groups, Productronica

this year will also feature a "Chemical Products for Electronics" center. This area covers raw materials and substrates; process chemicals including curing agents, gases, and solvents; photoresists and materials for substrate processing; and systems for waste disposal and clean rooms.

As Munich fair officials like to point out, their shows always reflect the very latest in technology. To underscore

Productronica's up-to-date quality, they call attention to the large number of exhibitors that return to the show every other year. Almost 90% of the 1989 exhibitors said they would participate again in 1991. One reason: nearly all had made new business contacts at the 1989 affair.—John Gosch



T&M line offers digital multimeter, timer/counter, function generator

Among the newly introduced test and measurement instruments from Philips that will be on show at Productronica '91 are the PM 6680 high-performance timer/counter, the PM 5135 economy function generator, and the PM 2530 system digital multimeter.

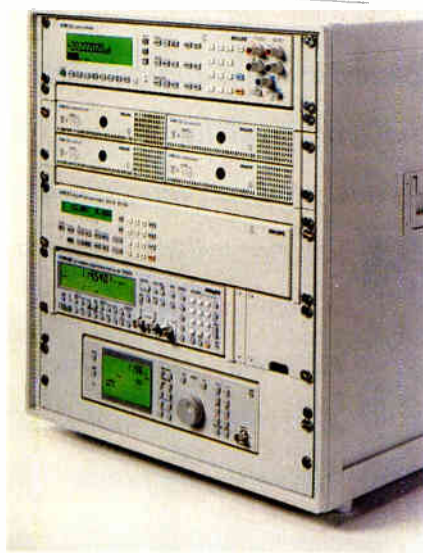

The PM 6680 timer/counter offers a 500-ps single-shot time resolution, with frequency measurements from dc to 225 MHz (and optionally up to 1.3 or 2.7 GHz). Measurement functions include phase, duty factor, rise and fall times, and peak voltages, plus six totalizing modes. Measurement rates can be as high as 2,000 readings/s, enabling tests like high-speed jitter.

The PM 5135 function generator combines a complete specification and a modern, ergonomic design for very simple operation, making it ideal for many general-purpose applications

such as education and training, audio and electronics service, and production testing. Sine, triangle, and square waveforms are pushbutton-selectable; the frequency range is 1 to 2 MHz.

The PM 2530 system digital multimeter offers the high throughput required in automated test applications, with the ability to make up to 1,000 measurements/s, which can be transferred via the interface, or up to 50,000 measurements/s, which can be stored in internal memory. The PM 2530 incorporates the IEEE-488.2 interface, and uses the SCPI (Standard Commands for Programmable Instruments) programming language, thus ensuring compatibility with instruments from other leading T&M manufacturers. ■

Scopes feature four-channel display

Another important introduction by Philips Test and Measurement at Productronica '91 is the new PM 3094 series of real-time oscilloscopes. The top models in this range offer real-time signal display on four channels simultaneously, an important benefit in situations where the relationships between two or more signals need to be exam-

ined, or for differential measurements between inputs.

The range comprises four models with a choice of 100- or 200-MHz bandwidths. The purchaser has a choice of either four individually attenuated inputs or the conventional 2 + 2 input system, in which the channels are grouped into two pairs. ■

A total test solution in boundary scan

Meeting increased industry demands for boundary scan test, Philips Test and Measurement will show at Productronica '91 four new test systems that together serve to address virtually all of the requirements for digital board testing throughout the entire life cycle of a product.

Making up the quartet of systems are the PF 8683/36 intelligent disassembler package; the PF 8660-30 hardware

adapter module and software package for the PM 3580 logic analyzer; the 9430 Boundary Scan Test facility option for the Fluke 9400 Manufacturing Defects Analyzer; and the PM 3720 low-cost boundary Scan Test option, which is based on a personal computer.

All these new Philips T&M products comply completely with the latest IEEE 1149.1 Test Access Port and Boundary Scan Architecture. ■

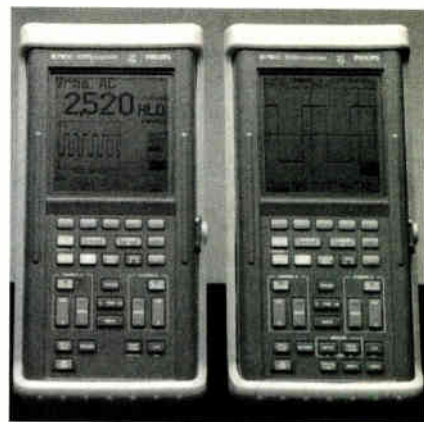

Marrying a scope to a multimeter

Shown on the Philips Test and Measurement stand will be the new ScopeMeter. This handheld unit combines the functions of a digital storage oscilloscope and digital multimeter in an economically priced instrument. With its 50-MHz bandwidth, 25 MS/s sampling rate, and extensive multimeter functions, it handles many field, workshop, and general-purpose tasks. ■



HUNGRY? TRY PIG KNUCKLES WITH SAUERKRAUT

Munich's many restaurants offer traditional Bavarian dishes, international fare

After a busy day at the Productronica show, the first thing you probably want to do is find a good place to eat. Munich has its share of restaurants that offer international cuisine—Italian, French, Mexican, Hungarian, Malaysian, Russian, or Yugoslav. It also boasts 20-odd McDonalds. But if it's your first visit to Germany, you may want to try German specialties or—since you are in the capital of Bavaria—Bavarian dishes.

Calf or pig knuckles served with sauerkraut or dumplings is a favorite Bavarian dish, but you can also find food that isn't as heavy on the stomach. For example, leberkäs, which is similar to meatloaf, grilled Nuremberg bratwurst (small sausages), or just a schnitzel make tasty yet light meals.

You'll find plenty of Bavarian restaurants on or around Marienplatz (St. Mary's Square) in the pedestrian zone in the heart of Munich. There's the Ratskeller (at Marienplatz 8), where you can dine under vaulted arches or in a cosy and *gemütlich* corner, or the Donisl (Weinstrasse 1), which is popular with the locals. Excellent too, and inexpensive, are Zum Spöckmeier (Rosenstrasse 9), Zum Bögner (Im Tal 72), and Haxnbauer (Sparkassenstrasse), which bills itself as the world's biggest calf- and pig-knuckles eatery.

Munich has six major breweries, and each not only has a beer hall but also its own restaurant serving Bavarian food. Near the Marienplatz is the Spatenhaus (Residenzstrasse 12) and the Augustiner (Neuhauser Strasse 16). A bit farther out are the Mathäuser-Bierstadt (Bayerstrasse 5, near Central Station), the Salvator-Keller (Hochstrasse 77), and the Löwenbräukeller (Nymphenburgerstrasse 2).

No listing of Bavarian restaurants in Munich would be complete without mention of the Hofbräuhaus (Am Platzl 9). This is where you may find the stereotypical Valkyrie-style waitress carrying five liter mugs of beer in each hand. Downstairs, where there's a brass band playing oom-pah-pah Bavarian music, you may find yourself sitting at a long wooden table swapping tales with a drunken tourist. In the restaurant upstairs the atmosphere is more sedate.

Just across the street is the Platzl (Am Platzl 8), another beer establishment

where you'll find fewer tourists. Along with Bavarian food, you can get a taste of Bavarian slapstick—small folk-theater groups offering sketches with sarcastic, sociopolitical commentary. Don't worry if you don't understand what the actors are saying; many non-Bavarian Germans have a hard time with the thick-as-syrup Bavarian accent too.

Places like the Hofbräuhaus and the Platzl may not be what you're looking for if you want to engage in serious conversation with your business partners or associates. Much more elegant—and more expensive—restaurants are the Aubergine (Maximiliansplatz 5), which serves impeccable French food; the Daitokai (Kurfürstenstrasse 59), a Japanese steak house; the Königshof (Karlsplatz 25), with its fine selection of international dishes; and the Piroshka (Prinzregentenstrasse 1) for excellent Hungarian food. For fish, try La Mar (Schraudolphstrasse 24) and for delicious pasta, the Galleria (Sparkassenstrasse). It's advisable to make reservations at these better restaurants.

In the medium-to-expensive price category are Le Gourmet (Ligsalzstrasse 46); the Weinhaus Schwarzwälder (Hartmannstrasse 8), which dates to 1657 and is noted for its game dishes and extensive wine list; and the Käfer-Schänke (Prinzregentenstrasse 73), a deli-style restaurant that offers everything from lobster to marinated mushrooms and *urunstsalad*.

The big turn-of-the-century hotels like the Vier Jahreszeiten, or Four Seasons (Maximilianstrasse 17), and the Bayerische Hof (Promenadenplatz 2-6) have excellent restaurants too. In the former there's the Restaurant Walterspiel, and in the Bayerische Hof there are Trader Vic's (Polynesian) and the Montegelas Palais restaurants. Here, too, reservations should be made.

For night life, check out Munich's Schwabing area with its many discos, or the nightclubs of major hotels such as the Bayerische Hof or the Sheraton (Arabellastrasse 6)—both expensive and frequented by the see-and-be-seen crowd. Jazz fans will enjoy the Domicile (Leopoldstrasse, next to McDonald's) for the progressive jazz and jazz-rock it offers, or the Allotria (Türkenstrasse) for its Dixieland jazz.

If you are taking a day off from the show and plan to visit Munich's museums, the city has a lot to offer. The technology-minded shouldn't miss the Deutsches Museum (Museums-Insel 1), where you can easily spend a whole day—going down into a coal mine, inspecting replicas of famous scientists' labs, eyeing various types of aircraft and a World War I submarine, and watching different physics demonstrations.

The art-minded should visit the Alte Pinakothek (Barerstrasse 27) with the world's largest collection of paintings by Rubens. It also has works of other Flemish and Dutch masters as well as Italian, Spanish, and German painters up to the 18th century. The Neue Pinakothek (Barerstrasse 29) features modern European art including paintings and sculptures of the 19th and 20th centuries.

Other outstanding museums are the Glyptothek (Königsplatz 2) for Greek and Roman sculptures; the Staatliche Graphische Sammlung (Meiserstrasse 10) for printed graphics of the past five centuries; the Staatliches Museum für Völkerkunde (Maximilianstrasse 42) for art and culture of Africa, China, India, and Japan; and the Bayrisches National Museum (Prinzregentenstrasse 3) for Bavarian folk art.

Among other places to visit in or near Munich are the 1972 Olympic Grounds, Nymphenburg Castle, the Schwabing artists' quarter, the Royal Residence and Crown Jewels, the English Gardens, the Marienplatz, and the Town Hall with its glockenspiel. Some may wish to visit the Dachau Concentration Camp, which is about 25 minutes by train from Central Station.

On your day off you may also want to rent a car to see the area around Munich, where many small towns have a fairy-tale quality. Leave early because it may take up to two hours to reach some of the sights. A must on your list of places to visit should be Neuschwanstein, one of "mad" King Ludwig II's castles. It's about 40 km west of Oberammergau, a postcard-pretty town noted for its many woodcarvers' shops and for its presentation of the Passion Play every 10 years (the next one is in the year 2000).—*John Gosch*

Success = Ideas x Energy.

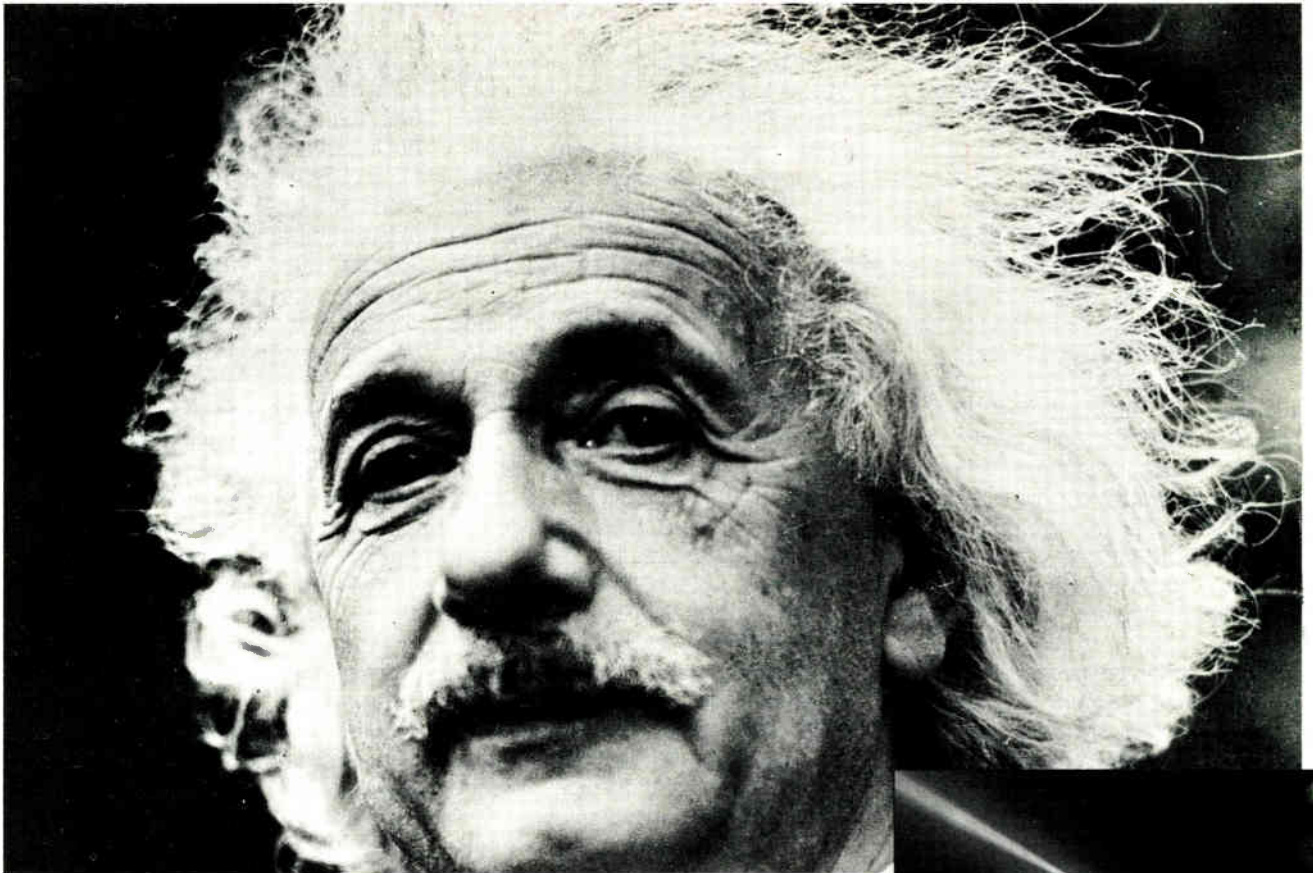

Albert Einstein, physicist, was born in today's "science city" of Ulm, Baden-Wuerttemberg.

Medical applications for laser technology are developed at Ulm.

His ideas laid the foundation for our present understanding of the physical world. His name is recognized around the globe. Albert Einstein, born in the city of Ulm, Baden-Wuerttemberg, established the theory of relativity. His formula $E = mc^2$ made possible the development of atomic energy.

Great as he was, Einstein is just one of many bold, innovative minds working in science and engineering in Baden-Wuerttemberg. Leading edge industries and research centres have found a supportive environment around the unique science city of Ulm and the Karlsruhe Atomic Research Centre to its west. An entrepreneurial, practical spirit runs through all this research and development activity. Companies that locate

or invest in Baden-Wuerttemberg benefit from the stimulus of constant innovation, share in the latest technology, and have a hot-line to suppliers and technological partners who will keep them on the cutting edge of success.

A century of remarkable achievements makes Baden-Wuerttemberg the hi-tech centre of the Federal Republic of Germany. Many of the world's leading manufacturers have chosen Baden-Wuerttemberg for its environment of success and its easy access to all of Europe. Will you join us too?

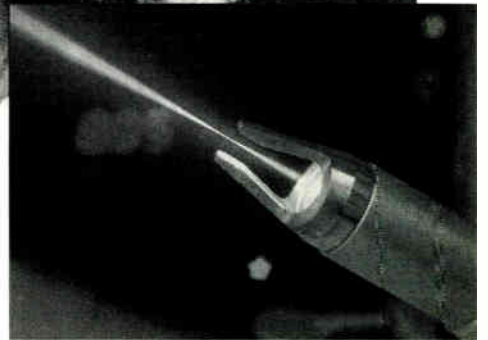

For more information about Baden-Wuerttemberg (Germany), please contact:

*Agency for International Economic Cooperation
Baden-Württemberg (GWZ)*

Mr Jens Janik

Willi-Bleicher-Strasse 19, 7000 Stuttgart 1, Germany

Telephone (+ 49-711) 2 27 87 20, Fax (+ 49-711) 2 27 87 22



Baden-Württemberg
South West Germany

CIRCLE 230

World Radio History

2025 Gateway Place, Suite 354
San Jose, California 95110

(408) 441-0550.....(408) 441-6052FAX

Sal F. Marino.....Chairman and CEO
Daniel J. Ramella.....President and COO
James D. Atherton.....President, Electronics Group
John G. French.....Publisher

BUSINESS STAFF

Ken Long.....Research Manager
Kathy Torgerson.....Promotion Manager
Bob Clark.....Circulation Manager
Doris Carter.....Ad Serv/Production Manager
Brian Ceraolo.....Cards and Quick Ads Manager
Mary Lou Allerton.....Reader Service Manager

SALES OFFICES

Regional Vice Presidents:
David M. Woodward.....Cleveland
Chandler C. Henley.....New York
Richard B. Curshall.....Chicago
Harmon L. Proctor.....Atlanta
George M. Horrigan.....Los Angeles

GENERAL MANAGER, EUROPEAN OPERATIONS:

John Allen
Four Seasons House
102B Woodstock Rd., Witney,
Oxford OX8 6DY England...0993-778-077 FAX: 44-993-778-246

SAN JOSE

Tina Ireland (N. California)
Blair Heath (N. California/Northwest/N. Canada)
2025 Gateway Place, Suite 354
San Jose, CA 95110.....(408) 441-0550 FAX: (408) 441-6052

LOS ANGELES

Chuck Crowe (S. Calif/Arizona/Colorado/Utah)
(Orange County/San Diego County)
16255 Ventura Boulevard, Suite 300
Encino, CA 91436.....(818) 990-9000 FAX: (818) 905-1206
CHICAGO (Midwest/Dallas)

Julie Harter

2 Illinois Center Building, Suite 1300
Chicago, IL 60601.....(312) 861-0880 FAX: (312) 861-0874

BOSTON

John J. Fahey (New England/Eastern Canada)
400 5th Avenue
Waltham, MA 02154.....(617) 890-0891 FAX: (617) 890-6131

NEW YORK

Rit Teeling (Mid-Atlantic Region & Southeast)
Brian Ceraolo (Direct Connection Ads)
611 Route 46 West
Hasbrouck Heights, NJ 07604.....(201) 393-6060
FAX.....(201) 393-0204

JAPAN

Hirokazu Morita, Japan Advertising Communications Inc.
New Ginza Building, 3-13 Ginza 7-Chome, Chuo-Ku Tokyo
104 Japan.....FAX: 81 3 5718710

AUSTRIA, GERMANY, SWITZERLAND

Friedrich K. Anacker, Intermedia Partners GmbH
Katernberger Strasse 247
5600 Wuppertal 1, West Germany.....(02) 271-1091
FAX.....49 202 712431

FRANCE

Claude Brill, IDG Communications France
Cedex 65 92051, Paris 14 DEFENSE-France.....(04) 9047900
FAX.....33 149 047800

HOLLAND

W.J.M. Sanders, S.I.P.A.S.
Oosterpark 6-P.O. Box 25
1483 ZG DeByp, Holland.....(02) 997-1303
TELEX: 13039 SIPAS NL.....FAX: 31 2 997 1500

ITALY

Cesare Casiraghi, Via Cardano 81
22100 Como, Italy.....031/536003 FAX: 031/536007

KOREA

Young Sang Jo, President, BISCOM
K.P.O. Box 1916, Seoul, Korea.....FAX: 82 2 7323662

TAIWAN

Charles C.Y. Liu, General Supervisor
United Pacific International, Inc.
No. 311, Nanking E. Rd., Sec. 3
Taipei, Taiwan, R.O.C.....FAX: 886 2 7169493

UNITED KINGDOM, SCANDINAVIA

John Maycock
Huntons Bldgs, 146 West Street
Sheffield, S1-1ES, England.....742 759186 FAX: +44 742 758449

CHINA

CCI Asia - Pacific Ltd.
Sic 905, Garden House, 32 Oi Kwan Rd.
Happy Valley, Hong Kong.....FAX: 852 834 5620
Media Developments Ltd.
13/F Jung Sun Commercial Bldg.
200 Lockland Rd., Hong Kong

INFORMATION CENTER

Use the postage-paid card on the facing page; circle the number of each company you would like to know more about.

BATTERIES

199 - Tadiran—Lithium: no other primary battery offers all these advantages.

CAE/CAD

181 - OrCAD—Still the leader in DOS-based electronic design.
213 - P-CAD—Master Designer 5.0, the shortest distance from design to reality.

CHIP SETS

194 - Fujitsu—Finally, a Sparc chip set that comes equipped with everything you need for the Sun.

COMPONENTS

190 - Alcatel—Here's how to turn a relay with two changeover contacts into one with four.
206 - Pico—Plug-in surface-mount axial inductors toroidal insulated leads.
206 - Pico—High-voltage dc-to-dc converters.
192 - Rohm—One-stop shopping for the broadest product line in the industry.
184 - Teledyne—The Maglatch TO-5 relay, a legend in its own time.

CONNECTORS

186 - AMP—Putting high-performance power distribution on the fast track
209 - Harting—Our Connector Division has won the Oscar: DIN ISO 9001 certificate.

CONVERTERS

182 - TRW—Presenting a growing line of color palette DACs.

CPUs

196 - Integrated Device Technology—The next world standard for embedded systems.

EXHIBITIONS

171 - BIAS Microelectronics '92—Milan, Jan. 28-Feb. 1: over 2,300 exhibiting firms.

LOCATIONS

214 - Arizona—The microprocessor and license to create your own industry.

MANUFACTURING

172 - Philips—A PCB flow-line supplier with a view of the future and an excellent track record.

MANUFACTURING TOOLS

191 - Brian R. White—Contact-free soldering and desoldering with the Leister-S hot-air tool.

MICROWAVE COMPONENTS

187 - Avantek—RF/Microwave components across the communications spectrum with no waiting; Avantek delivers today.

POWER DEVICES

219 - Abbott—Mil-pac high-density military power supplies now ac to dc; actual output 20 W.
177 - Vicor—The solution to power-development cliffhangers.

POWER SUPPLIES

210 - Ferranti Venus—Miniature photodetector power supplies for photo-multiplier tubes and photodiodes.

SEMICONDUCTORS

180 - AEG—As both end user and leading supplier of microelectronics, we know what end users want.

TEST & MEASUREMENT

185 - GenRad—We are about to change your thinking about low-cost board test.
202 - Rohde & Schwarz—How much testing technology do you get in the lower price range?
173 - Stanford Research Systems—The DS345 function generator, at \$1,895 it's the only one you'll ever need.
189 - Teradyne—How Teradyne helps Northern Telecom send the world a quality message.

Electronics

DIRECT

CONNECTION

ADS

New and Current
Products Presented
By the Manufacturer

To Advertise Call Brian Ceraolo (201) 393-6260

68HC11

PC-based emulator for 68HC11

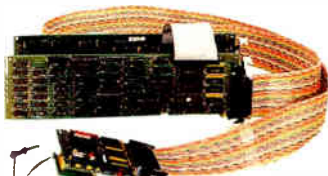

SEE EEM 91/92
Pages 1300-1303

- PC plug-in or RS-232 box.
- Pull-down menus with full window support, combined with command-driven User Interface.
- Up to 16 MHz real time emulation.
- No intrusions to the 68HC11's resources.
- 64 bit wide 16K deep trace. All functions usable without disturbing emulation. Time stamping. Two level trigger.
- Symbolic and C Source Level Debugging, including in-line assembler and disassembler.
- Supports A, D, E, F, G, J, K and L parts

Prices: 64K Emulator and pod \$2590*, 4K Trace \$1995* (*US only)

CALL OR WRITE FOR FREE DEMO DISK!

Call 408-378-2912
Nohau's 24-hour
information center to
receive info via your FAX

NOHAU CORPORATION
51 E. Campbell Avenue
Campbell, CA 95008
FAX (408) 378-7869
(408) 866-1820

PLEASE SEE US AT WESCON BOOTH #460 CIRCLE 153

☆☆☆☆
"The Best 8051 Emulator"

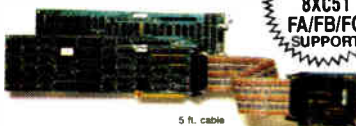

5 ft. cable

FULL
8XC51
FA/FB/FC
SUPPORT

8051

SEE EEM 91/92
Pages D 1300-1303

PC based emulators for the 8051 family

- 8031, 8032, 8051, 8052, 80C152/754/3214/514/52/51FA/51GB/51S/5178/32S/537/552/562/652/851, 80532, 83C431/65/52/52751/752/851, 8344, 87C451/552/751/752, 8751, 8752, 938000 + CMOS ... more.
- PC plug-in boards or RS-232 box.
- Up to 33 MHz real-time emulation.
- Full Source-level Debugger w/complete C-variable support.
- 64 bit wide, 256K deep trace, with time stamp.
- Bond-out/hooks pods for 8051, 83C552, 83C451, 83C652, 83C751, 80C515/80C517, 83C752, 83C51FA/FB/FC, and more.

Prices: 32K Emulator 8031 \$1790*, 4K Trace \$1495* (*US only)

CALL OR WRITE FOR FREE DEMO DISK!

Ask about our demo VIDEO

NOHAU CORPORATION
51 E. Campbell Avenue
Campbell, CA 95008
FAX (408) 378-7869
(408) 866-1820

Call 408-378-2912
Nohau's 24-hour
information center to
receive info via your FAX

SEE US AT WESCON BOOTH #480 CIRCLE 161

Analog Circuit Simulation

SPICE FOR THE PC (XT, AT, 386, 486)

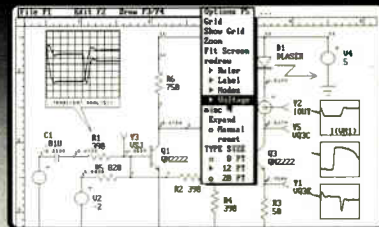

- Schematic Entry • SPICE Simulation
 - Model Libraries • Waveform Graphics
- Intusoft has it all at an Affordable Price!

INTEGRATED, EASY TO USE SIMULATION ENVIRONMENT, FEATURING:
A powerful SPICE (IsSpice) simulator performing AC, DC, Transient, Noise, Fourier, Distortion, Sensitivity, Monte Carlo, and Temperature analyses, Extensive model libraries, Schematic entry, and Waveform processing. Starting at \$95 for IsSpice, complete systems are available for \$890.

Call Or Write For
Your Free Demo and
Information Kit!
intusoft P.O. Box 710 San Pedro,
CA 90733-0710
Tel. 213-833-0710 Fax 213-833-9658

INTUSOFT

CIRCLE 117

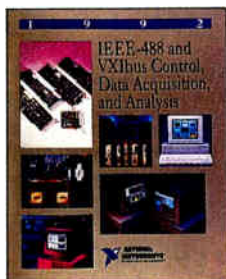

Instrument Control and Data Acquisition

Free 1992 catalog of instrumentation products for PCs, workstations, and more. Features IEEB-488.2 interfaces and software, plug-in data acquisition boards, VXIbus controllers, DSP hardware and software, and signal conditioning accessories. Application software for complete acquisition, analysis and presentation of data, including graphical interfaces. Application tutorials and training classes also detailed.

National Instruments

6504 Bridge Point Parkway, Austin, TX 78730
(512) 794-0100 (800) 433-3488 (U.S. and Canada)
Fax: (512) 794-8411

NATIONAL INSTRUMENTS

CIRCLE 131

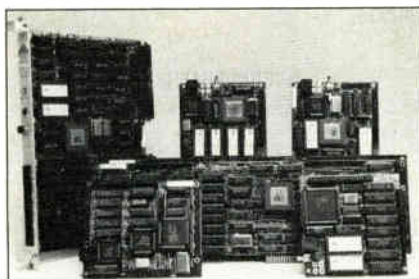

SC/FOX™ Embedded-System Computers

SC/FOX VME SBC (Single Board Computer) 18 MIPS, 60 MIPS burst, general-purpose, slot-1 Master/Slave System Controller. Up to 512K bytes 0-ws memory, 1 SCSI, 1 ptr, 2 serial ports. Uses 16-bit Harris RTX 2000.

SC/FOX PCS (Parallel Coprocessor System) 15 MIPS, 50 MIPS burst, general purpose PC/AT/386 plug-in board, 32k to 1M byte 0-ws static memory, multiple PCS operation, SCSI option. Uses Harris RTX 2000.

SC/FOX SBC (Single Board Computer) 18 MIPS, 60 MIPS burst, Stand-alone operation, Eurocard size, 1 ptr, 1 serial port, up to 512K bytes 0-ws memory, 2 50-pin user connectors, SCSI option. Uses Harris RTX 2000.

SC/FOX PCS32 (Parallel Coprocessor System) 32 15 MIPS to 70 MIPS, general-purpose PC/AT/386 32-bit plug-in board with 64K to 1M byte 0-ws static memory. Uses 32-bit SC32 Forth microprocessor.

Ideal for embedded real-time control, data acquisition, or high-speed processing. Forth software and utilities included, C optional. OEM pricing.

SILICON COMPOSERS INC. (415) 322-8763
208 California Avenue, Palo Alto, CA 94306

SILICON COMPOSERS

CIRCLE 118

YOUR AD HERE

Black and White?
Or Full Color?

Now the choice is yours.

Simply send us your copy.

54 characters per line X 10 lines Max.

Plus a black and white glossy, color print, slide, or transparency and a two-line headline, max. 30 characters per line. We'll do the rest. Or you can do it all and send us your complete, 23/16" w X 3"d Negatives (B/W or 4/C).

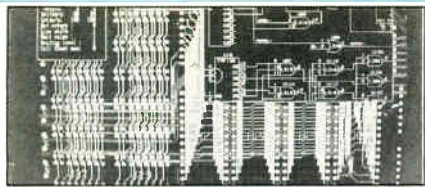

SCHEMATIC CAPTURE TO PCB LAYOUTS \$795
 Before buying P-CAD, PADS-2000, PROTEL, etc you owe it yourself to check out our End-to-End **ONE SYSTEM** Solution.

Compare Specs for yourself...

GUARANTEED to out-perform other PC based systems costing much more with Superior Analog, SMT & Digital features such as:

- Integrated Schematic Capture & 2 Sided SMT support (Not an add-on)
- Integrated 2-D Drawing editor for mechanical, Outline, Fab, etc dwgs.
- Design PCB from a host of Nelist formats, or on the fly without a nelist.
- Unfile grids, pads & trace sizes; GND plane shapes, 1 μm resolution etc
- Curved & straight traces. Parts, Blocks, etc rotation in 1° increments.
- Forward & Backward annotation, On-line DRC, SCH/PCB diff. check etc
- Dynamic EMS memory support (Not 640K Limited) for large designs.
- User definable Menus, Keys, & Macros; Gerber & Laser plots included.
- A choice of 3 optional powerful Autrouters assures 100% completion.

✓ **FULL FUNCTION** evaluation package with over 850 pages of well illustrated manuals (5 books) for \$75 (USA & CANADA ONLY)
 ✓ 30 (45 int.) days Money back Guarantee.

INTERACTIVE CAD SYSTEMS

2352 Rambo Ct, Santa Clara, CA 95054
 Call: (408) 970-0852 Fax: (408) 986-0524

INTERACTIVE CAD SYSTEMS CIRCLE 166

DISPLAY UNITS

for R.O.S. Systems, Computers, Wicket Windows, Equipments, etc.



Stand-alone, attractive units with serial or parallel interfaces, bright green display, 1 or 2 lines of 8, 16, or 20 characters. Scroll, line blink, Msg. MEM, pass-through features. Can be mounted on equipment or poles.

Inquiries from overseas distributors are also welcome!



Advanced Digital Machines Ltd.
 610 McMurray Road, Waterloo,
 Ontario N2V 2E7 Canada
 Tel (519) 888-6811 Fax (519) 888-6256

ADVANCED DIGITAL MACHINES CIRCLE 114

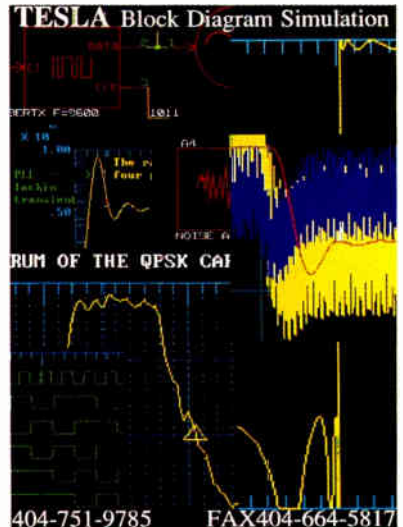

TESOFT CIRCLE 147

DOES THIS 1/9th PAGE AD GET ATTENTION?
Yes it Does.
You've just proved that.

Increase your sales leads without spending a lot of money by advertising your product or service in **ELECTRONICS DIRECT CONNECTION ADS.**

For further information call:
BRIAN CERAOLO
(201) 393-6260



Easy Emulator Pods & Adapters

- Plug your PLCC and LCC packages into your PC board in minutes, with these easy-to-use adapters.
- Emulator/logic analyzer users: Adapt-a-Pod™ converts one package type to another (LCC, PLCC, PGA, and DIPs).
- Emulator pods and adapters are available in all standard pin counts, with ribbon or ribbon cable headers.
- Custom engineering services and do-it-yourself emulator pod converters. Free catalog.



Emulation Technology, Inc.
 2344 Walsh Ave. Santa Clara, CA 95051
 Phone: 408-982-0660 FAX: 408-982-0664

EMULATION TECHNOLOGY CIRCLE 110

RAINBOW LED
 CREATE ANY COLOR OF THE RAINBOW
 (470-660nm)

● COMBINES RED, GREEN & BLUE CHIPS

- SPECTRUM ANALYSIS
- LARGE AREA DISPLAYS
- SCANNER LIGHT SOURCE
- PHOTIC SIMULATION • MOVING DISPLAYS
- 300" (8mm) DIFFUSED OR CLEAR PACKAGE
- ALL CHIPS ACCESSIBLE • T1 1/4 (5mm) PACKAGE

LEDTRONICS, INC.
 4009 PACIFIC COAST HWY. • TORRANCE, CA 90505
 TEL: (213) 549-9995 • FAX: (213) 549-4820 • TOLL: 499-8450

LEDTRONICS CIRCLE 116

EPROM PROGRAMMER

\$750

8 ZIFs
 20 Key Keypad
 20x4 LCD

- Quick pulse pgms eight 1 Mbit EPROMs in 40 sec.
- Stand-alone or PC-driven
- RS-232, parallel in & out ports
- Binary, Intel hex, & Motorola S formats
- 100 user-definable macros
- Information, call (916) 924-8037
- 1 Megabit of DRAM
- Made in U.S.A.
- A9 Identifier
- 2 year warranty
- Single pgmr. \$550

NEEDHAM'S ELECTRONICS
 4539 Orange Grove Ave. • Sacramento, CA 95841
 (M-F, 8-5 PST)

NEEDHAM'S ELECTRONICS CIRCLE 112

AAC American Aerospace Controls, Inc.

CURRENT, VOLTAGE, POWER, TRANSDUCERS

Featured in this catalog are AC and DC current sensors, AC and DC current level detectors, frequency transducers, AC voltage sensors, watt and var transducers, bidirectional current sensors. Specifications, descriptions, photos of these units are provided as well as application and ordering information.

AMERICAN AEROSPACE CONTROLS, INC.
 570 Smith Street, Farmingdale, N. Y. 11735
 Phone: (516) 694-5100 Fax: (516) 694-6739

AMERICAN AEROSPACE CONTROLS CIRCLE 133

OPTICS FOR INDUSTRY

ROLYN OPTICS COMPANY

OPTICS CATALOG

Free 130-page catalog from largest supplier of "off-the-shelf" optics. Product descriptions, photos, data, graphs, ordering information for lenses, prisms, optical flats, reticles, mirrors, etc.

ROLYN OPTICS, 706 Arrow Grand Circle, Covina, CA. 91722-2199 (818) 915-5707, FAX: (213) 915-1379.

FREE CATALOG CIRCLE 143

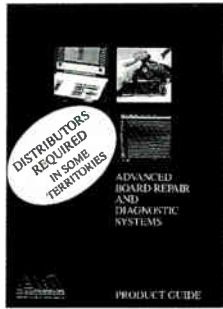

ABI Electronics—Master Range

ABI presents the latest in Advanced Board Repair and Diagnostic Systems.

From the ChipMaster, for testing up to 40-pin digital ICs, to the BoardMaster 4000 with advanced fault diagnosis capabilities, the fully portable Master Range is the solution to board fault finding problems for the 90's.

ABI Electronics Ltd.

Barnsley, S74 9TG, United Kingdom

Tel: +44 226 350145 Fax: +44 226 350483

Telex: 547938 EXPERT G

ABI ELECTRONICS

CIRCLE 139

Interactive/Real-Time

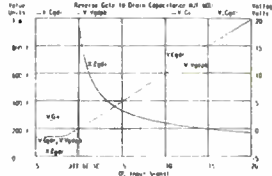

ECA-2
Engineering a Better Way

Analog Circuit Simulation

- AC, DC, Transient, Fourier, Temperature, MonteCarlo and/or Worst-Case Analysis • Interactive or batch modes
- Full nonlinear simulation • On-line real time graphics
- Multiple plots • 2 to 50 times faster than SPICE
- Component optimization sweeping • New 424 pg. manual

**All the Features, Twice the Speed
at Half the Cost**

Call for FREE DEMO!



3917 Research Park Dr. B-1, Ann Arbor, MI 48108
313-663-8810

TATUM LABS

CIRCLE 132

**DOES THIS 1/9th
PAGE AD
GET ATTENTION?**

**Yes it Does.
You've just proved that.**

Increase your sales leads without spending a lot of money by advertising your product or service in ELECTRONICS DIRECT CONNECTION ADS.

For further information call:

**BRIAN CERAOLO
(201) 393-6260**

SBC196

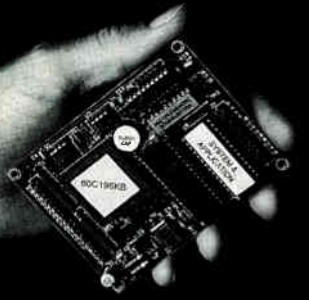

- Low Power • Small, 3"x4" • Low Cost
- 8x10b A/D • 2 Ser Chan • Forth-83196
- I²C/Wire • LCD/Key • w/80K ROM Apps
- R'time Clk • Support • EEPROM to 2K

vesta technology, inc.

Voice: (303) 422-8088, FAX: (303) 422-9800, BBS: (303) 278-0364

VESTA TECHNOLOGY, INC.

CIRCLE 123

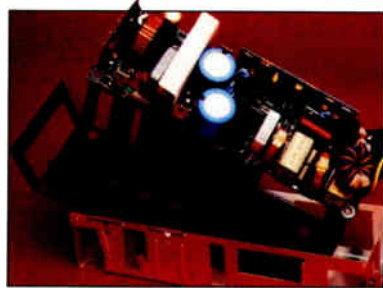

**High Performance
Lexan® FR700 Film
For Barrier Insulation**

- UL94 V-0 rated at .010" • High heat resistance of 275°F • Excellent dielectric strength • Easy fabrication—sharp folds, intricate die-cut shapes • Competitively priced • Call for free information: (800) 451-3147



GE Plastics
Structured Products

© Registered Trademark of GE.

GE STRUCTURED PRODUCTS

CIRCLE 120

**VOLTAGE SELECTABLE
INTERNATIONAL SYSTEM**



Z-LINE TPC 884

The TPC, a voltage-selectable power distribution and control system, can have either 120 or 240 volt input and output. Designed with IEC-, UL-, CSA- and VDE-approved components, operating up to 16 amps in Europe and 20 amps in North America. Size: 19.0" x 1.75" x 7.0". EMI/RFI filtering, spike/surge suppression and overload curcuit breaker protection are standard. Remote on/off is optional.

Pulizzi Engineering, Inc.
3260 S. Susan St.,
Santa Ana, CA 92714

714/540-4229 FAX: 714/641-9062

PULIZZI ENGINEERING

CIRCLE 129

SPOTLIGHT: DESIGN & DEVELOPMENT ■

Finally, attendees determined the most impressive product of the show was CAD Software's PADS.

Each vendor presented a bench... PEDI News @ 90 on CAD Showdown Results

**PADS SETS
THE STANDARD**

for CAE/CAD design on Personal Computers
Complete thru-put logic capture and board design functionality including:

- A true multi-sheet database for Schematic capture with hierarchical design capability
- Both automatic and interactive PCB layout tools
- Most complete set of autorouters for Analog, Digital and SMD designs
- Cam outputs including database ASCII In and ASCII Out format
- **NEW!** PADS-2000, board designs with no system limits. 1 micron database, copper pouring, T-routing. Workstation capability at PC prices!

Call today for a free demonstration package, and for your local Authorized PADS Reseller.



Call Today!

Inside MA: (508) 486-8929
Outside MA: (800) 255-7814

119 Russell Street, Littleton MA 01460

CAD SOFTWARE

CIRCLE 126

SAVE MONEY IN 1992

Plan your Direct Connection Ad schedule
NOW and qualify for **Early Bird Discounts.**

For More information, call Brian Ceraolo at
(201) 393-6260

EMPLOYMENT OPPORTUNITY

Electronics Engineer: Design and repair of sophisticated electronic machinery, specifically warp knitting machinery as well as direct and indirect warpers. Working knowledge of textile fabrics and fibers required. Direct engineering personnel in fabrication of test control apparatus and equipment, and determine procedures for testing products. Evaluate operational systems and recommend design modifications to eliminate causes of malfunctions or changes in system requirements. Travel overnight approximately 50% of working time in order to oversee installation, servicing, and repair of all textile equipment at client mills, as well as to educate clients in proper use and maintenance of textile machinery. Supervise 4 employees. 40 hrs/wk, B-5, \$35,500/yr. Requirements: BSc Engineering; major-electronics. 5 yrs experience as an electronics engineer in the textile industry. Apply: Job Service, 2005B S. Elm-Eugene St., Greensboro, NC 27406, or nearest Job Service Office. Refer: Job order Number - NC4010897, DOT Code - 003.061-030.

Speech Recognition Research Engineer: Will engage in advanced research & design of PC-based real-time large vocabulary speech recognition systems. 9-5. 40hrs/wk. \$57,000/yr. Requires Ph.D. (foreign or domestic) in Electronics Engineering (or its equivalent), 3 yrs. of research exp. in the development of very large vocabulary speech recognition (inside or outside graduate programs), & strong skills/abilities in Assembly programming for micro-processors; C language; numerical analysis; linear predictive coding; random process; speaker adaptation; digital signal processing; digital circuit design; & neural networks. 2 resumes to J.O. # 11031, P.O. Box 8968, Boston, MA 02114.

FOR SALE

UNIVERSAL MICROPROCESSOR SIMULATOR/DEBUGGER 1.2 each set \$55. Simulates popular micro-processors. Features line assembler, disassembler, and debugging utilities. **The ROMY-8 EPROM EMULATOR (32K, 8-bit)** works with simulator \$135 only. J&M Inc., 83 Seaman Rd., W Orange, NJ 07052, TEL: 201-325-1892.

CONSULTANTS

Power Supply Design Service

Custom switching power supply design, from concept to production. Competitive rates. Low and high voltage. AC-DC, DC-DC, DC-AC, UPS. Please call for more information (9-5 EST).

PEDA®

Tel. : 519-837-1646
Fax : 519-763-2742

SOFTWARE

RELIABILITY PREDICTION SOFTWARE

ARE YOUR ELECTRONIC PRODUCTS RELIABLE?
RelCalc 2 automates MIL-HDBK-217E on your IBM PC!
Very easy to use. Try our Demo Package today for \$25.

T-CUBED SYSTEMS 31220 La Baya Drive, #110
(818) 991-0057 Westlake Village, CA 91362
FAX: (818) 991-1281

CIRCLE 258

FAX YOUR ORDER!

To Advertise in
Penton Classifieds,

FAX: (216) 696-1267

Looking for
MANAGERS
Across the OEM
Marketplace?

more than

85,000

read

Electronics

Every Month

To reach them with a
recruitment ad Call

Penton Classifieds
at 216-696-7000
ext.2520

Advertiser's Index

Abbott Electronics.....	26
ABI Electronics.....	76
Advanced Digital Machines.....	75
AEG Corporation.....	10-11*
Alcatel Str AG.....	43
American Aerospace Controls.....	75
AMP, Inc.....	18-19
Anritsu Corporation.....	8-9
Avantek Corporation.....	14, 15,
BASF AG.....	32F-32G**
CAD Software.....	76
Cypress Semiconductor.....	Cov IV
E.I.O.M.....	57
Emulation Technology.....	75
Ferranti Venus.....	2
Fujitsu, LTD.....	51**
Fujitsu Microelectronics.....	3
GE Plastics.....	76
GenRad, Inc.....	47
Graphica Computer Corp.....	54**
GWZ.....	72
Harting Elektronik GMBH.....	63
Image Watches, Inc.....	22
Integrated Device Technology.....	Cov III
Interactive Cad Systems.....	75
Intusoft.....	74
Karl Leister.....	2*
Ledtronics, Inc.....	75
National Instruments.....	74
Needham's Electronics.....	75
Nohau Corporation.....	74
OrCAD.....	44
P-CAD.....	17a-b
Philips Industrial Automation.....	66-67
Philips Semiconductors.....	32A-32C**
Philips Test & Measurement.....	49**
Pico Electronics, Inc.....	23, 31
Preci-Dip SA.....	32D
Pulizzi Engineering.....	76
Rohde & Schwarz.....	65
Rohm Corporation.....	13*
Rolyn Optics.....	75
Samsung Electronics.....	10-11**
SGS Thomson.....	33-40
Siemens AG.....	13**
Silicon Composers.....	74
Stanford Research.....	53
Tadiran Electronic Ind.....	28*
Tatum Labs, Inc.....	76
Teledyne Relays.....	29
Teradyne, Inc.....	26-27
Tesoft, Inc.....	75
TRW LSI Products.....	Cov II- Pg 1
United Airlines.....	30
Vesta Technology.....	76
Vicor.....	5
The Western Design Center.....	21

* Domestic only
** International only

The advertisers' index is prepared as an additional service. ELECTRONICS does not assume any liability for errors or omissions.

INDEX

IF RECESSION IS OVER, WHERE IS THE FUEL FOR RECOVERY?

The recession may be over, but fuel needed to drive the recovery into a modest acceleration is scarce. Industry patterns in September remained lackluster, with semiconductor figures about the same as August's. Industrial production has leveled off after a modest spring recovery, adding to purchasing managers' caution. Consumers are not buying more; even the federal government's ability to jump-start the economy through increased spending is severely limited.

Still, commodity prices have shown recent signs of strength. This may imply that end demand is finally beginning to improve, or it could merely be pipeline filling to replenish depleted inventories. However, the Fed may be unwilling to lower interest rates further if it feels the risk of higher inflation is accelerating. A new federal economic agenda calling for some modest tax cuts and incentives to boost housing and personal investment could help by the middle of next year.

Electronics industry executives are correctly responding to the normal cyclical pressures that recession and intense price competition cause in any capital-goods industry. Cost-cutting measures, capital spending focused on productivity enhancements, and continuing aversion to inventory accumulation appear to increase the profit potential of corporate America once economic trends improve. Near term, the toll on the average electronics company employee may seem onerous. Longer term, competitive position may be enhanced, affording the opportunity for global electronics output to consolidate back into the U.S.

One good sign is that further deterioration now seems unlikely. And with 1992 a presidential election year, federal action to boost economic growth seems probable. □

By Mark Parr, McDonald Securities Inc., Cleveland (216-443-2379)

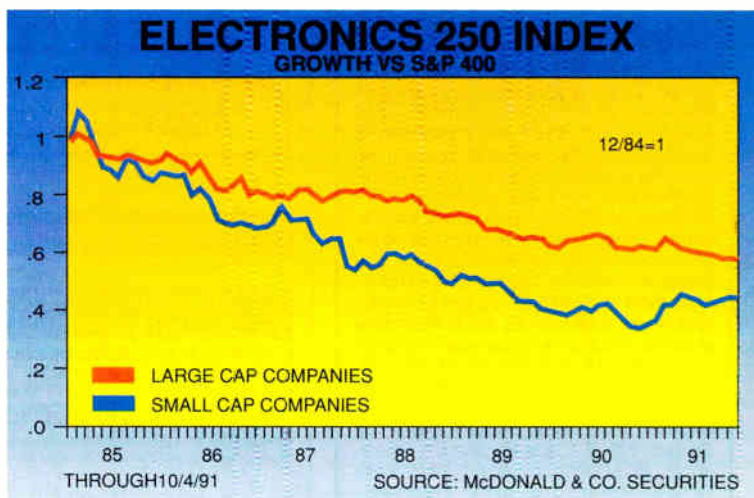

Overall, September's industry growth was lackluster. The chip industry reported sales about the same as those for August.

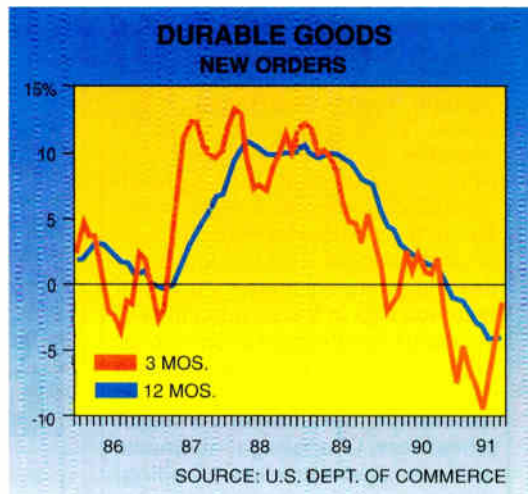

The short-term outlook for durable goods continued to strengthen.

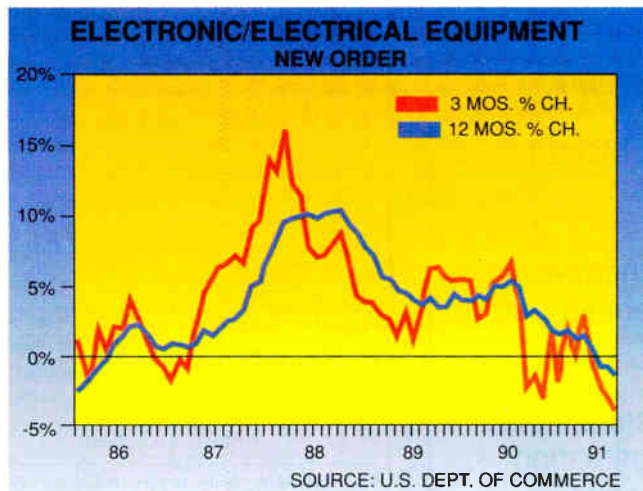

Orders for equipment continue to lag as companies keep a sharp eye on inventories and capital spending.

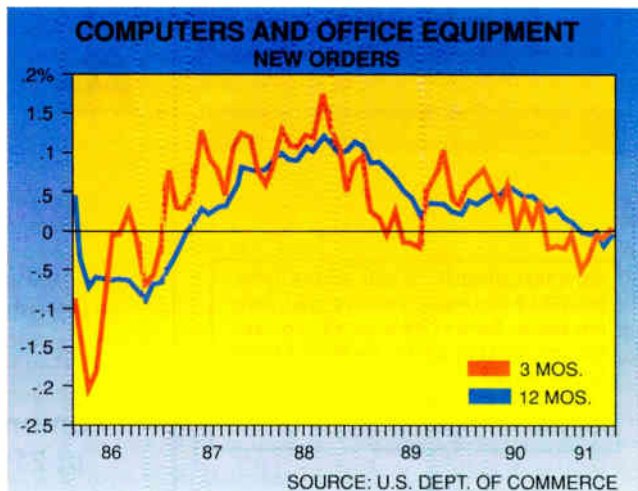

The focus on cost cutting and improvements in productivity should help computer orders.

Put Our List On Your List

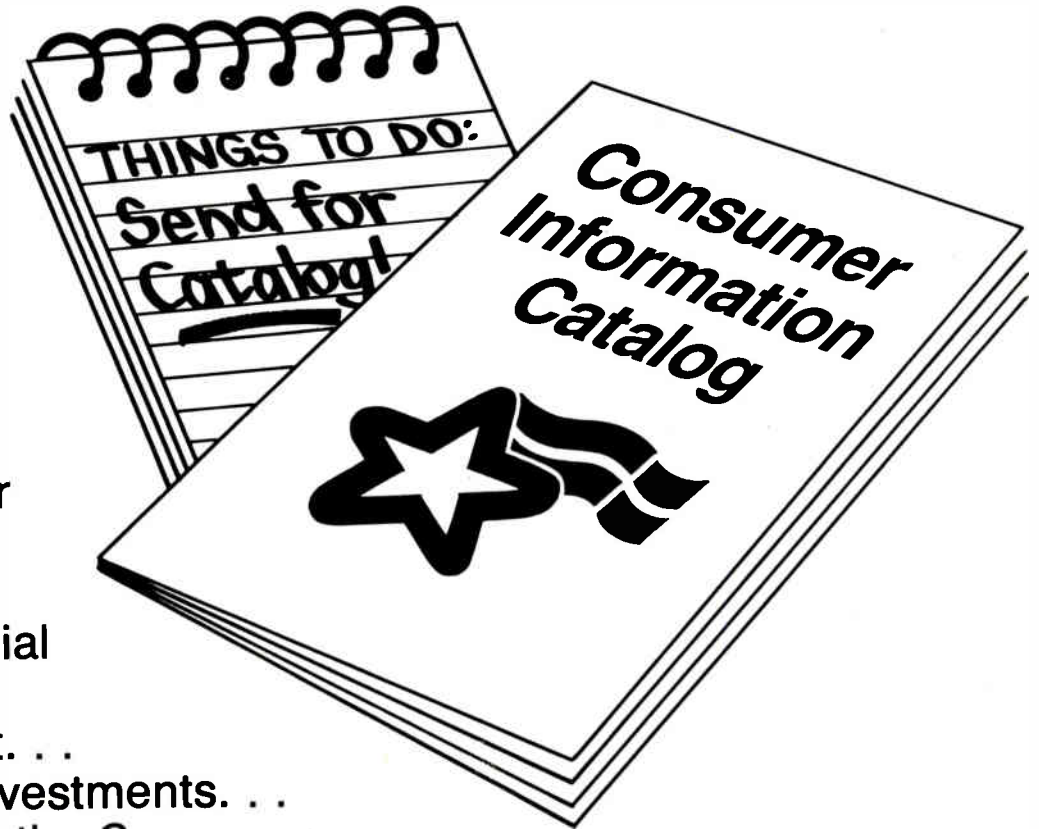

Our list can help you do the other things you have on your list. Such as buy a car. . . estimate social security. . . start the diet. . . check out investments. . .

Our list is the *Consumer Information Catalog*. It's free and lists more than 200 free and low-cost government booklets on employment, health, safety, nutrition, housing, Federal benefits, and lots of ways you can save money.

So to shorten your list, send for the free *Consumer Information Catalog*. It's the thing to do.

Just send us your name and address. Write:

**Consumer Information Center
Department LL
Pueblo, Colorado 81009**



A public service of this publication
and the Consumer Information Center
of the U.S. General Services Administration

LAST WORD

IGNORE THOSE FORECASTS AND SELL

On March 6, the Dow Industrial Average rose briefly above 3,000. As this is being written, it is still right around 3,000. In the meantime, though, the Fed has cut the federal-funds rate five times, from 6.5% to 5.25%, and long-term interest rates have also declined, although only slightly less than 0.5%. At least in 1991, falling interest rates have had absolutely no positive effect on the prices of stocks.

That doesn't bother some gurus, who predict that we are now set for another blast-off in prices, based on the Rule of Three Fed Cuts and a Fried Egg, or whatever it is called. Of course, if nothing else had changed, lower interest rates would boost stock prices. However, this simplistic rule, and others of its ilk, consistently ignore one important fact: other factors also affect stock prices—notably, corporate profits. Indeed, the only reason the Fed keeps easing is that real growth continues to come in below the board's estimates. That, in turn, virtually guarantees that profits will also come in below consensus estimates.

The price/earnings ratio of the market (using the Standard & Poor's 500 figure) is currently above 20. That exalted level has been surpassed only three previous times in the past 45 years—late 1961, early 1973, and mid-1987. On each occasion, after that notable achievement, stock prices fell shortly afterwards by 30%, 50%, and 40%, respectively.

If the underlying rate of inflation is 5%, the equilibrium P/E ratio ought to be about 15. All right, so you are one of those congenital optimists who really thinks the inflation rate is only 4%; in that case, the P/E ratio ought to be about 16. But the truth is that either way, stocks are currently far overvalued by this measure.

Of course, "intelligent" analysts never value stocks based on past earnings, but on what future earnings will be. By that measure, using projected 2000 earnings, stocks are a positive bargain at today's levels.

That's not fair to those highly intelligent, insightful analysts; they only go one year out into the future. And

because this is the beginning of a recovery, and since profits usually rise most rapidly following the cyclical upturn, they will increase at least 25% next year. Which means stocks aren't overvalued at all. See how simple it is?

As readers of this page are all too well aware, forecasters do make mistakes from time to time, and so perhaps one should not criticize the consensus analysts for their predictions that the picture will be so rosy come 1992. However, there is more to the story than that.

Several recent studies have shown that the consensus forecasts are always too high at the beginning of recoveries. It seems that analysts, not willing to badmouth their favorite stock—and not wishing to have an irate client demand that they be fired—take the safer road and predict healthier earnings than are reasonable. After all, if "everyone" does it, what's the crime? Besides, if bad forecasting were a crime, a lot of my close friends would be joining me behind bars.

However, we are dealing with a different phenomenon in this case. It takes the shape of nothing less than a conscious effort to hype profit forecasts so that they are above the numbers that analysts themselves think are correct.

According to my forecast, real growth will average 1.5% to 2% over the next four quarters—with the risk that this is too optimistic, given the recent decline in retail sales, home sales, shipments of capital goods, and net exports. However, assuming that real growth does fall in that range, profits would increase no more than 10%. And with a little bad luck, they might not rise at all. That means stocks are following suit—which means the stock market is sharply overvalued.

MICHAEL K. EVANS is president of Evans Economics Inc. and Evans Investment Advisors, both in Washington.

**STUDIES
SHOW THAT
CONSENSUS
ANALYSES GO
TOO HIGH AT
THE START OF
A RECOVERY.**



The Next World Standard for Embedded Systems

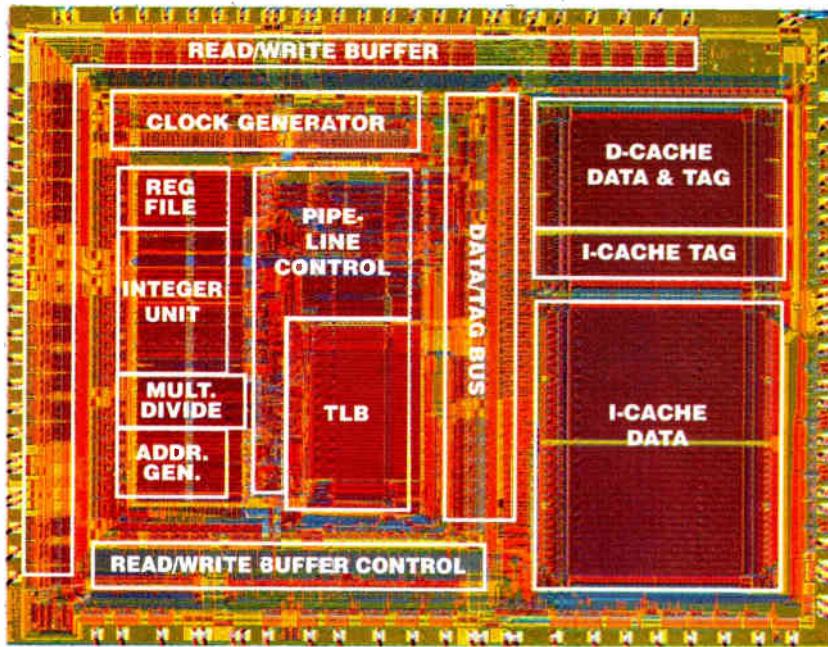

IDT's R3051 RISController™

MIPS® RISC for \$30

The 32-bit R3051™ outperforms the i960 and AMD29K, and has everything you need in a high-performance, low-cost CPU:

- **Larger Cache**—up to 10KBytes of I and D cache on-chip for PostScript®, networking, or X protocols.
- **4-Deep Read and Write Buffers**—allow the CPU to run at full speed, even in low-cost DRAM designs.
- **Multi-Sourcing**—provides form, fit, and function interchangeable products at competitive prices.
- **Development Support**—100% software compatible with low-cost MIPS and IDT development tools on PC, SPARC, MIPS, and Macintosh® host platforms.
- **In Production Now!**



"We selected the R3051 for its outstanding performance at remarkably low cost."

John Wakerly
Vice President of Engineering
Alantec, Leader in internetworking systems

Evaluate the R3051 Today

For a limited time, we're offering a complete R3051 Evaluation Kit, including an evaluation board and software, for \$595 (an \$895 value).

Call our toll-free hotline to get an IDT RISC Product Roadmap and complete information on the R3051 Evaluation Kit, so you can evaluate the next μ P standard for embedded systems today.



Integrated Device
Technology, Inc.

(800) 345-7015 • FAX: 408-492-8674
ASK FOR KIT CODE 5071

HOW SUN SNAPPED UP THE LEAD IN SPARC MULTIPROCESSING.

Sun Microsystems's[®] new 90 SPEC thruput multiprocessing SPARCserver is powered by our new SPARCore Modules.

We have consistently delivered a performance advantage in SPARC RISC chipsets. Now, we are introducing SPARCore™ high-performance uniprocessing and multiprocessing Modules. Cypress modules provide you (and Sun) with significant competitive advantages based on innovative technology:

1. Short-Cut to Market. With this much complexity running at 40+MHz speeds, there are non-trivial issues to integrating the CPU chipset. Using our fully integrated, tested SPARCore modules, you save time, not to mention manufacturing and testing costs. We deliver fully tested modules, with MPU, FPU, MMU, and Cache, for the price of the chipset.

2. Plug and Play on MBus. You design your system to the MBus standard, and you can plug in modules offering a range of speed/power options, to keep your product current without major redesign. This modular approach provides a designed-in upgrade path to keep you on the leading edge.



*CYM6001K Uniprocessor
SPARCore Module*



*CYM6002K Dual Processor
SPARCore Module*



*CYM6003K Uniprocessor
SPARCore Module for
Multiprocessing systems*

**Call for your Free SPARCore
Whitepaper and Data Sheets.
Hotline: 1-800-952-6300.*
Ask for Dept C9W.**



**CYPRESS
SEMICONDUCTOR**

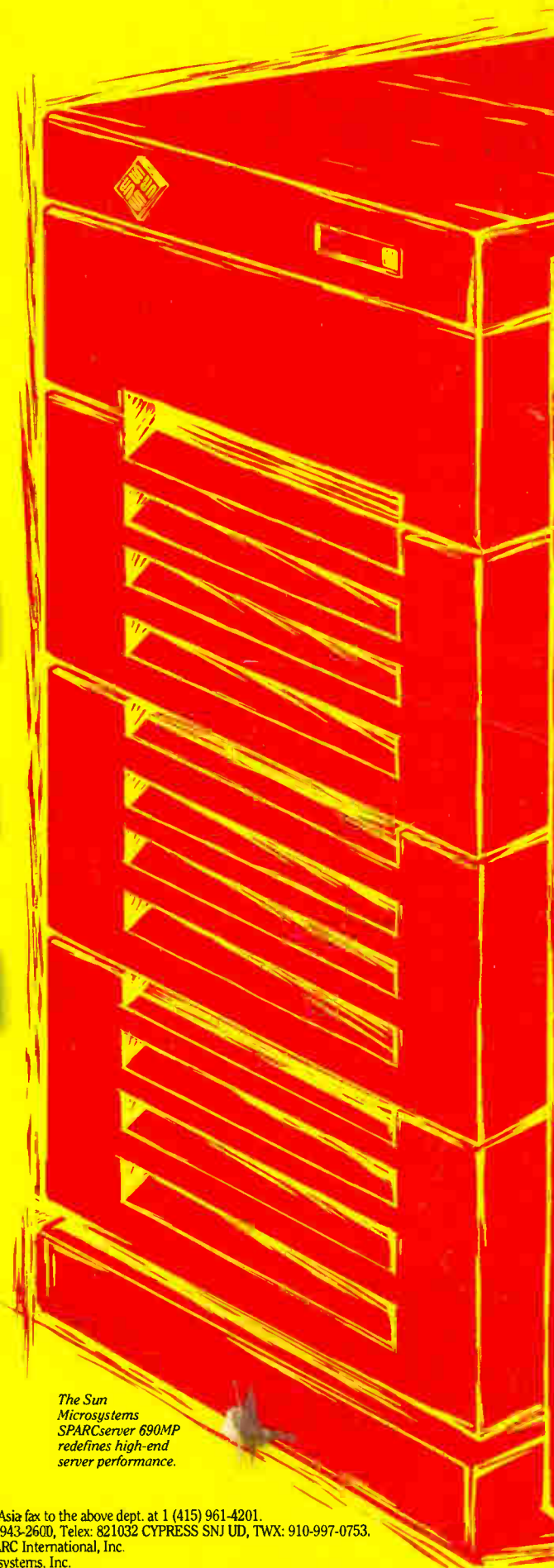

*The Sun
Microsystems
SPARCserver 690MP
redefines high-end
server performance.*

*In Europe fax your request to the above dept. at (32) 2-652-1504 or call (32) 2-652-0270. In Asia fax to the above dept. at 1 (415) 961-4201.
© 1991 Cypress Semiconductor, 3901 North First Street, San Jose CA 95134. Phone: 1 (408) 943-2600, Telex: 821032 CYPRESS SNJ UD, TWX: 910-997-0753.
SPARCore is a trademark of Cypress Semiconductor. SPARC is a registered trademark of SPARC International, Inc.
Products bearing the SPARC trademark are based on an architecture developed by Sun Microsystems, Inc.