

A PENTON PUBLICATION

AUGUST 1991

Electronics

FIRST MAGAZINE OF GLOBAL ELECTRONICS MANAGEMENT

THE BATTLE FOR THE SOFTWARE VENDOR

PAGE 44





**GIVING
OUT-OF-THIS-
WORLD REALISM TO
DIGITAL IMAGING
SYSTEMS.**

Out of the
darkness of
space, the
dance of
the planets

comes alive in brilliant
detail, thanks to signal
processing and power
control components from
Harris Semiconductor.

Signal processing and
power control is our specialty.
It involves gathering real-
world signals — signals like
temperature, pressure and light
— processing them, and
driving devices that perform
real-world tasks. And no one has
more experience and expertise in doing
this than Harris, combining the technologies of analog,
mixed signal, DSP and power semiconductors.
For digital imaging, Harris supplies a

S I G N A L P R O C E S S I N G A N D



complete
range of prod-
ucts, including high-
speed op amps and
video multiplexers,
flash A-D converters,
convolvers and image
filters, and output drivers.
Helping to provide images
with out-of-this-world
clarity, whether your system
spans millions of miles of
space or the floor space of a
recording studio. And that's
just one way Harris supplies
expertise for a whole
universe of signal processing
and power control applications.

From aerospace to medical,
automotive, computers and manufacturing. So
how can we help you? For more information, call
1-800-4-HARRIS, Ext. 1120.

POWER CONTROL FROM HARRIS.



JOIN THE GOLD CROWN CLUB® AND GET EVEN MORE OUT OF AMERICA.

Every time you stay at any Best Western across America, you could be earning Gold Crown points* towards room night awards, Avis rental car awards, dining certificates, auto club memberships, college C.D.'s, and, of course, U.S. Savings Bonds. And the only thing that's easier than earning awards is joining the Gold Crown Club. Just call 1-800-USE-GOLD. We'll send your free Gold Crown Club card and Directory so you can get more from the over 1800 independently owned and operated Best Westerns across America. **AS INDIVIDUAL AS AMERICA ITSELF**

*Gold Crown points are awarded for rooms purchased at the regular rate. Points will not be awarded for discounted room rates.



To apply for Gold Crown Club membership call 1-800-USE-GOLD, ext. P004.

CIRCLE 4

ELECTRONICS • AUGUST 1991

2

World Radio History

Electronics

EDITOR

Jonah McLeod
MANAGING EDITOR

Howard Wolff

SENIOR EDITOR

Lawrence Curran

EDITOR-AT-LARGE

Samuel Weber

914-428-3595

ASSISTANT MANAGING EDITOR

Jacqueline Damian

DEPARTMENT EDITORS

Communications:

Jack Shandle

201-393-6228

System Technology:

(San Jose) **Jonah McLeod**

408-441-0550

EDITORIAL PRODUCTION MANAGER

April Messina

ASSOCIATE ART DIRECTOR

Tony Vitolo

STAFF ARTIST/DESIGNER

Anthony White

BUREAUS

Boston: Lawrence Curran, Manager

508-441-1113

Midwest Correspondent: Francis J. Lavoie

Mid-Atlantic: Jack Shandle, Manager

201-393-6228

Frankfurt: John Gosch, Manager

011-49-61-71-53834

France Correspondent: Andrew Rosenbaum

011-331-4261-0538

Italy Correspondent: Andrew Rosenbaum

011-331-4261-0538

Japan: Shin Kusunoki, Consultant,

Nomura Research Institute

011-81-45-336-7604

UK Correspondent: Peter Fletcher

011-443-226-64355

Electronics Index: Mark Parr

VICE PRESIDENT-EDITORIAL

Perry Pascarella

COMPUTER SYSTEMS ADMINISTRATOR

Anne Gilio Turtoro

GROUP ART DIRECTOR

Peter Jeziorski

EDITORIAL ADMINISTRATION

Bradie S. Guerrero, Tina A. Montone

Director of Circulation: **Bruce Sprague**

Manager of Circulation: **Bob Clark**

Production Manager:

Doris Carter

(201) 393-6259

FAX: (201) 393-0410

Order Entry

Beverly Desbiens

PUBLISHER

John G. French

617-890-0891

August 1991 Volume 64, Number 8

Electronics (ISSN 0883-4989) is published monthly by Penton Publishing, Inc., 1100 Superior Ave., Cleveland, OH 44114-2543. Second class postage paid at Cleveland, OH, and additional mailing offices.

Editorial and advertising addresses: Electronics, 611 Route #46 West, Hasbrouck Heights, NJ 07604. Telephone (201) 393-6060. Facsimile (201) 393-0204. San Jose, Calif.: Telephone (408) 441-0550. Circulation (1100 Superior Ave., Cleveland, OH 44114-2543): (216) 696-7000.

Title registered in US Patent Office. Printed in U.S.A. Copyright ©1991 by Penton Publishing, Inc. All rights reserved. The contents of this publication may not be reproduced in whole or in part without the consent of the copyright owner.

Permission is granted to users registered with the Copyright Clearance Center Inc. (CCC) to photocopy any article, with the exception of those for which separate copyright ownership is indicated on the first page of the article, for a base fee of \$1 per copy of the article plus 50¢ per page paid directly to the CCC, 27 Congress St., Salem, MA 01970. (Code No. 0883-4989/90 \$1.00 + .50)

Microfilm of issues or articles can be ordered from University Microfilms, Ann Arbor, Mich. 48103. Telephone: (313) 761-4700.

Subscriptions free to qualified managers. All others: \$60 for one year in the U.S.; \$70 in Canada; \$136 in all other countries. For subscriber change of address and subscription inquiries, call 216-696-7000.

POSTMASTER: Please send change of address to ELECTRONICS, Penton Publishing, Inc., 1100 Superior Ave., Cleveland, OH 44114-2543.

BURR-BROWN

The Only Words You Need To Know In DSP



Easy, Plug-In Solutions

The world of DSP is far from simple. You need a secret code book to wade through its bevy of acronyms, a doctorate in mathematics to create its complex algorithms, and years of signal processing expertise to develop the necessary hardware.

Or you need Burr-Brown. We've developed a line of easy, painless, plug-in solutions that let you concentrate on your application instead of the hairy details.

From Chips to Systems

- Need a direct interface ADC or DAC for one of today's DSP processor chips?
- Need a DSP processor for your VME or PC platform?
- Need one with high speed, high accuracy data conversion, single channel or multi-channel, or high dynamic range?
- Need an easy way to create and execute DSP algorithms?
- Need an inexpensive and simple approach to analyzing your analog signals?
- Need a custom solution?

We have your solution waiting, in most cases, from off-the-shelf.

Over 30 Years of Signal Processing

Ask around. We've been making and delivering high performance precision microelectronics for over 30 years to a worldwide customer base. We're known for the highest performing data conversion products for signal processing available, and since 1986, engineers have known us for some of the best DSP tools around.

For more information about our product line or for a copy of our free brochure, call **1-800-548-6132**, contact your local salesperson, or write:

Burr-Brown Corporation
P.O. Box 11400
Tucson, AZ 85734
Fax (602) 741-3895

BURR - BROWN®
BB

Signal Processing Solutions

JUSTICE DELAYED AND DENIED

Today's battle over intellectual-property rights has all the contentiousness of 19th-century battles over land. Instead of hired guns facing one another across a line drawn in the dirt, well-groomed lawyers eye each other in an open courtroom. But many property owners believe they are being done in by this form of redress and are beginning to demand relief [*Electronics*, February 1991, p. 51]. Michael C. Maibach, director of government affairs at Intel Corp. and an announced candidate for the U.S. House of Representatives seat from California's 14th district, says that intellectual-property owners face formidable foes who have time on their side. The volume of lawsuits going through U.S. District Courts delays speedy resolution by years, a large part of the life cycle of many high-tech products. An owner's complaint is that violators unlawfully use intellectual property for years before a court hands down a ruling that directs them to stop and to compensate the injured party. Meanwhile the violator can charge a lower price for products based on the property while the owner—to stay afloat in the market—must eat the costs of expensive R&D and meet the violator's price.

There is no more glaring example than the recent spate of suits and countersuits between SGS-Thomson Microelectronics Inc. of Carrollton, Texas, and Seiko Epson Corp., Epson America Inc., and SMOS Systems Inc. over SRAM patents. "We have signed 15 out of the top 20 semiconductor makers as licensees" for this technology, says Mark O'Molesky, vice president of business development at SGS-Thomson, "and we were negotiating a license with Seiko. Then, out of the blue, Seiko filed suit in San Francisco U.S. District Court asking for a declaratory judgment to determine if they were infringing SGS patents." In effect, Seiko was asking the courts to determine if it had to pay for a license. Seiko chose district court in San Francisco because its heavy docket could mean a four-to-five-year wait until the case was heard. SGS-Thomson got a change of venue to district court in Dallas-Fort Worth, where the docket is less crowded. The case will be heard in February 1993.

The suit revolves around four patents involving poly-resistance loads to trim SRAM cell size from six transistors to four.

But O'Molesky believes the real motive is that the Japanese company is trying to coerce SGS-Thomson to cut the price of the license fee. American law firms are advising

Japanese clients to sue first to extract better settlements from U.S. companies. SGS-Thomson has taken a step to help itself. Besides SRAMs, Seiko was negotiating licenses on several other technologies SGS-Thomson owns. It has filed suit against Seiko for violations of patents on color-palette chips in the federal court in Midland-Odessa, Texas, where the docket is even shorter than in Dallas.

Seeking out less crowded federal courts in which to file suit is not the solution to the basic problem of speedy justice. Intel's Maibach believes one remedy is to fill the 125 vacancies in district courts nationwide, a move that would ease the logjam of lawsuits now clogging the system. "The Senate and Justice Department need to get these vacancies filled," Maibach says. We agree. The old axiom that justice delayed is justice denied has particular relevance in high-tech industries where market windows are open for only a couple of years at most. Filling court vacancies would be one way to provide some short-term relief. □

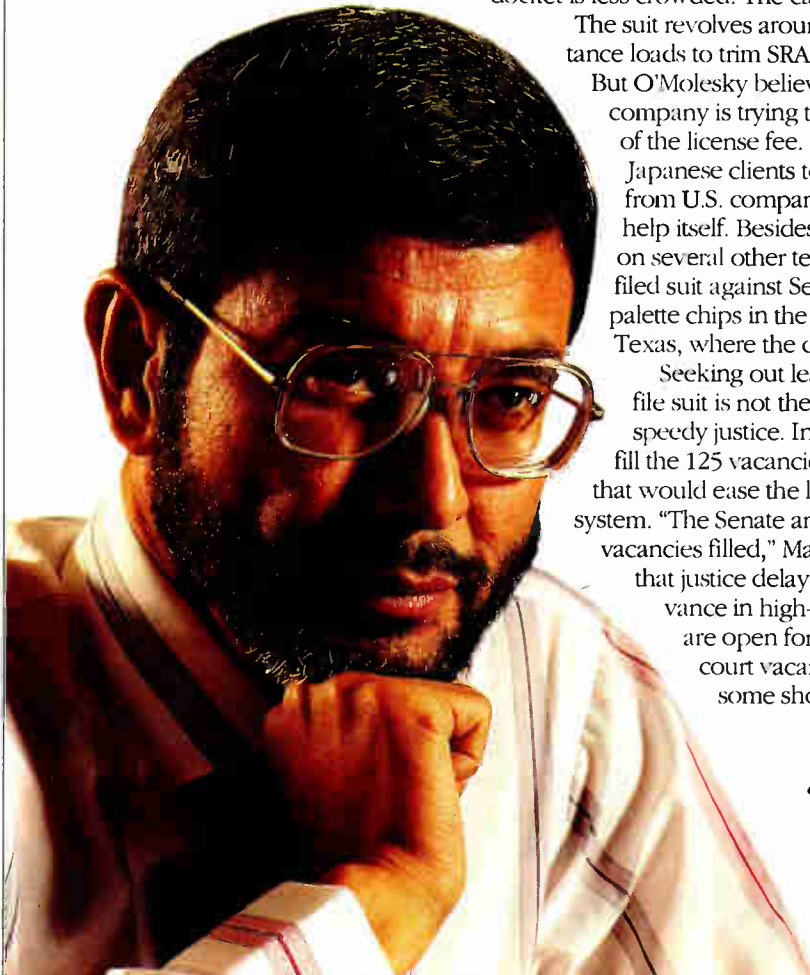

Jonah McLeod

JONAH McLEOD
EDITOR



The secret to better Ethernet is NICE. And simple.

Introducing NICE™. The new MB86960 Network Interface Controller with Encoder/Decoder from the Advanced Products Division of Fujitsu Microelectronics.

With the unveiling of NICE, Ethernet LAN technology reaches a new level of integration.

Now LAN system designers can have an Ethernet controller, buffer management unit and 10 Mbit per second Manchester encoder/decoder on a single chip. So you can now develop high-performance LAN boards more cost effectively than ever before.

For instance, design adapter cards for high-performance buses using just two Ethernet chips instead of the usual three. Simply combine NICE with our new MB86962 10BASE-T transceiver, the most advanced solution for twisted-pair needs. Or choose our MBL8392A if you need a coax interface.

And used with our MB86953 PC Bus Interface Unit, NICE can further reduce costs and complexity when developing

PC XT/AT® adapter cards. Replacing the need for up to ten separate parts.

All in all, NICE has some impressive features to enhance your LAN's entire performance. Such as a data bus transfer rate of 20 Mbytes per second. A low-power standby mode. And bus compatibility for most standard microprocessors.

But what's really nice is our understanding of the marketplace. As Fujitsu's American arm, we know what it takes to get you there a lot faster. With greater cost effectiveness.

So now that the secret is out, call us at 1-800-866-8608. And discover NICE. The world's most advanced, highly-integrated Ethernet solution.

FUJITSU

Delivering the Creative Advantage.



NICE is a trademark of Fujitsu Microelectronics, Inc. XT and AT are trademarks or registered trademarks of IBM Corp. © 1991 Fujitsu Microelectronics, Inc.
FUJITSU MICROELECTRONICS, INC., Advanced Products Division, 77 Rio Robles, San Jose, CA 95134-1807.

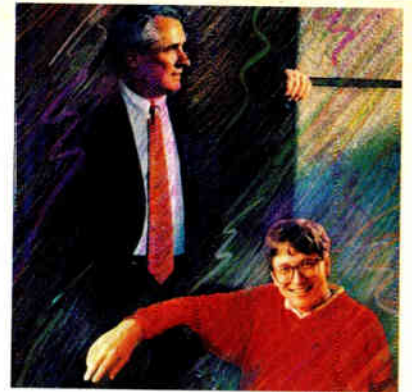

COVER STORY PAGE 44

Electronics

FEATURES

37

Executive Briefing: Anatomy of "coopetition"
 HP's 95LX palmtop computer is the fruit of a remarkable partnership among erstwhile rivals, and may signal a new paradigm for the way complex product development is handled.

49

In Europe, DOS leads but OS/2 is gaining
 Computer vendors are hoping the two operating systems will one day merge; "a fragmentation of the OS market will only hurt the [PC] industry," says a German executive.

44

COVER: FRIEND OR FOE?
Life on the front lines of the great OS war
 Microsoft has laid down the gauntlet to IBM as the two giants in their fields do their best to woo independent software vendors to their dueling, next-generation operating systems.



PAGE 51



PAGE 44

51

The PC war may spur a showdown in LANs
 If Microsoft is right, the desktop OS winner could impact network operating systems as well—but don't tell that to competitor Novell.



Jesse H. Neal
 Editorial Achievement Awards

- 1956 Merit, 1965 First
- 1975 Merit, 1976 Merit
- 1977 First, 1978 First
- 1988 Merit, 1990 Merit



PAGE 16

DEPARTMENTS

4 Up Front

12 Letter from Denmark

20 Face-Off: An ACE or a joker?

41 Information Center

58 Advertisers' Index

59 Electronics Index

60 The Last Word

NEWS ROUNDUP

16

News Front

- Compaq and its rivals pounce on Intel's 50-MHz 486 chip
- Commerce's LCD ruling: "a bullet in the head" for laptop vendors
- Now OEMs are looking under the hood of hard-disk drives

22

Products to Watch

- Intel unveils a rugged, rack-mounted 386 PC
- Micro Linear's chip set links Ethernet to fiber
- Dallas chips read or write at the touch of a probe
- Sun's newest Sparc powers a 21-mips diskless workstation
- Benchmarq's chip maximizes battery life

33

European Observer

- As ASIC sales boom, alliances are forming among European chip makers
- Another IBM deal: making 16-Mbit DRAMs with Siemens
- SGS-Thomson Microelectronics enters 16-Mbit EPROM club

WORLDWIDE NEWS

27

Computers

With its IBM alliance, Apple is taking on a Big Blue hue; what shade will their joint venture and joint operating system be?

30

Supercomputers

A small German firm called Parsytec is making a splash with its GC line of parallel processors

32

CAE/CAD

Mentor starts shipping part of its 8.0 tools on Sun's Sparc workstations

WHITE PAPER

A1

The Dawning of Digital Video

A new information age is about to be launched, and the catalyst is digital video—the merging of computers and TV technology

Companies covered in this issue, indexed to the first page of the article in which each is mentioned.

Acer America Corp.16	Lycom.....15
Apple Computer Inc.16, 27, 44, 49, 51, 59	Mentor Graphics Corp.....32
Ashton-Tate.....44	Micro Linear Corp.....22
Associated Computers Experts.....30	Microsoft Corp...20, 37, 44, 49, 51
AT&T Co.15	MIPS Computer Systems Inc...20
Banyan Systems Inc.51	Motorola Inc.15, 37
Benchmarq Microelectronics Inc.....22	Naval Research Laboratories...30
Canopus Research.....27	Nordiske Kabel-og Traadsfabrikker.....15
Casio.....37	Novell Inc.44, 51
Cisco Systems Inc.51	Oracle Corp.44
Compaq Computer Corp.16, 20, 49, 51	Orcad Inc.32
Dallas Semiconductor Corp.....22	Parsytec GmbH.....30
Dataquest Inc.....49	Philips Components33
Digital Equipment Corp.51	Planar Systems Inc.....16
Epson America Inc.4	Protools Inc.....51
Frank Lynn & Associates Inc. ..27	Santa Cruz Operation.....20
Gartner Group.....27, 51	Science Support Laboratories.....30
GEC Plessey Semiconductors.....33	Seiko Epson Corp.....4
General Electric Co.15	SGS-Thomson Microelectronics Inc.....4, 33
Grid Systems Corp.....16	Sharp Corp.....37
Helios Corp.....16	Siemens AG33
Hewlett-Packard Co.37, 51	Siemens Nixdorf Informationssysteme AG49
IBM Corp.16, 27, 33, 44, 49, 51	Silicon Structures33
IBM Denmark15	SMOS Systems Inc.4
Inmos Ltd.....30	Sony Scandinavia.....15
Intel Corp.4, 16, 22, 37	Stomo.....15
Intergraph Corp.....32	Sun Microsystems Inc...20, 22, 32
International Data Corp.....27, 44, 49	SunSoft Inc.....20
Lightning Computers.....16	Tandy Corp.....16
Lotus Development Corp...37, 44	Unix Systems Laboratories.....51
	Wang Laboratories Inc.16
	Wharton Information Services Ltd.....49

How Orbit's Fores Out of IC Deve



ight Takes the Bite lopment Costs.

Foresight Makes Silicon Affordable.

Lower your ASIC development costs with Foresight, the multi-project wafer service with guaranteed quick turnaround.

Foresight is Available:



In 36 different CMOS Processes

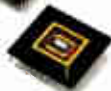

With feature sizes down to 1.2 microns

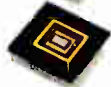

CCD Processes

Take the Bite Out of Mixed Signal IC Design.

Partition your analog/digital ASICs — and separately design and verify critical segments through fabrication — with Tiny Chips. You'll dramatically reduce NRE costs and move confidently and quickly from prototypes into production.

Ready. Set. Fab.

Foresight runs start every two weeks, so you can meet even the tightest deadlines — whatever your design rules.

Foresight Run Schedule: 1991		
Apr 10, 24	May 8, 22	Jun 5, 19
Jul 3, 17, 31	Aug 14, 28	Sep 11, 25
Oct 9, 23	Nov 6, 20	Dec 4, 18

Save Time and Money.

Call Orbit Semiconductor for the information you need to get started. Contact Technical Marketing, Orbit Semiconductor, 1230 Bordeaux Dr., Sunnyvale, CA 94089. Or call (408) 744-1800 or (800) 331-4617. In CA (800) 647-0222. Fax (408) 747-1263.



A subsidiary of Orbit Instrument Corporation.

What others promise, we guarantee.

CIRCLE 212

WAS
SERIES



ARE ON DEMAND
ED DOLLARS

You have to build a to build just

The new Tek TDS Series

More than a million Tektronix oscilloscopes have all been leading up to this: the most powerful, versatile, and intuitive instruments ever developed for the mainstream of test and measurement.

The new TDS 500 Series is the culmination of everything Tek has learned in the design, manufacture and use of digitizing oscilloscopes. It's an achievement made possible only by the unique integration of acquisition functions and combinational trigger logic onto a single board.

Only by the development of a milestone multiprocessor architecture.

Only by the addition of Tek's TriStar™ Digital Signal Processor (DSP).

Only by Tek's capacity for taking the hard work out of high performance.

The TDS Series performs, *live*, up-

dates and measurements that inhibit most other digitizing scopes. Its real-

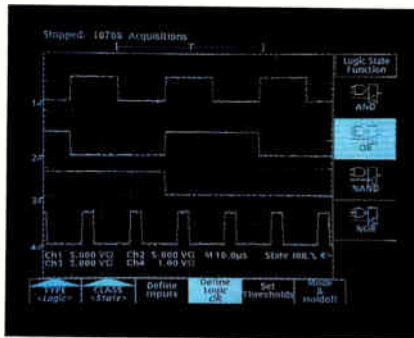

time DSP lets you perform single-shot averaging and extend resolution to 12 bits. The TDS Series arms you with up to four full-featured channels. 500 MHz bandwidth. Up to 1 GS/s sampling and 4 ns peak detect.

Up to 50K record lengths. Time interval,

2 ns glitch, runt, pattern and

state triggers. With acquisition sensitivity and fast overdrive recovery bringing greater waveform detail within your grasp.

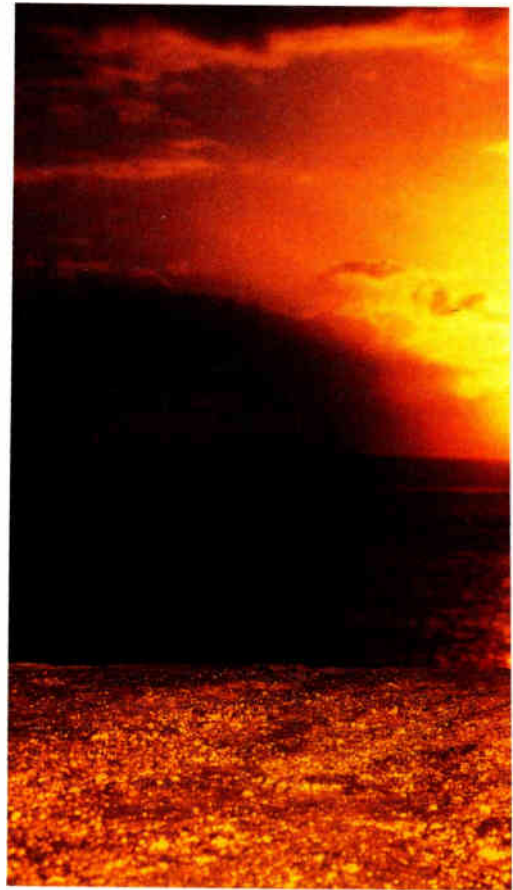
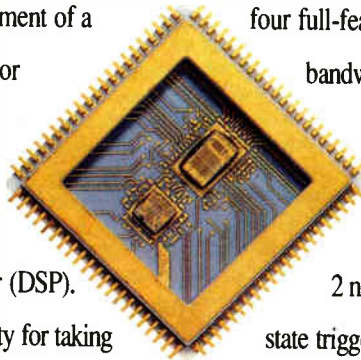

And if you think oscilloscopes aren't as easy to use and comprehend as they

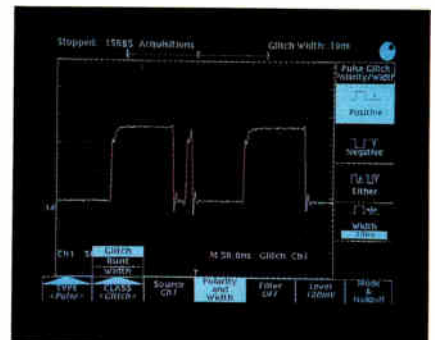

million oscilloscopes one like this.



could be, you owe yourself a demo of the TDS. Its simplified front panel, VGA-quality display resolution, on-line help text, innovative icons that instantly differentiate menu functions — all add up to a scope that makes the user's manual more a formality than a necessity.

The TDS Series signals the start of a new generation of friendlier, more

powerful instruments from the world's leading supplier of digitizing and analog oscilloscopes. To get a first-hand feel for why performance like this only comes along about once in a million scopes, contact your Tek sales engineer or call **1-800-426-2200**.

One company measures up.

Tektronix
World Radio History
COMMITTED TO EXCELLENCE

CIRCLE 176

55A-18606

DENMARK

WORKERS ARE WELL EDUCATED, AND ALMOST ALL SPEAK ENGLISH A COUNTRY WHERE EVERYTHING WORKS

BY HOWARD WOLFF

When executives of electronics manufacturers let it be known that they are shopping for overseas locations, they can depend on at least one thing: a veritable blizzard of literature, videotapes, and marketers from nations east and west. All of them extoll proximity to markets, high-quality infrastructure, and economies of operation; to varying degrees, they're all correct.

But amid all the salesmanship, there are places that seem to have about them an air of quiet competence; they are nations whose people go about their business steadily and confidently year after year. One of these is Denmark.

To the average American, the word "Denmark" conjures up "The Little Mermaid," Hans Christian Andersen, and sleek, spare design. However, the small Scandinavian nation has quietly established among international managers a solid reputation as a nation where everything works.

The list of blue-chip global electronics producers that have established branches in Denmark contains some impressive names. Among them are AMP, Data General, Digital Equipment, Hewlett-Packard, Intel, IBM, Motorola, National, Raytheon, Sony, and Texas Instruments. All told, there are now 250 to 300 U.S. companies in Denmark; General Electric Co., which established itself there before World War II, was the first. The largest is, unsurprisingly, IBM Corp. It builds minicomputers and writes software and manuals; revenue last year was \$1.2 billion with 25% of that coming from exports.

Now the Danish government is aim-

ing its efforts at smaller companies: those with annual sales in a range starting at \$20 million to \$30 million and going up to \$300 million to \$400 million. Such companies would have products that satisfy a need in Europe: they also would have decided to focus on the European Community rather than the Pacific Rim. For them, Denmark would become the ideal assembly and distribution center, a gateway to Scandi-

never considered Denmark the home market; rather, they look to all of Europe as their domestic market."

The result is that 90% of goods manufactured in Denmark is sent elsewhere. Of that, the largest single amount, 20%, goes to Germany (with the newly united Germany, totals for 1991's first quarter are up 25% over last year's period). Following are, in order, the UK, Sweden, France, Spain, and the U.S.

The country offers no financial incentives as such—no tax exemptions or low-interest government loans. "You must be competent from the beginning," says Hoyer. However, "We feel our other advantages more than make up for that," he says.

What are they? Denmark is known as "the country of the thinking worker," where 90% of the population speaks fluent English—"it's our second language," says Hoyer. Moreover, the country has a sound economy, low inflation (2.6%), low communications costs, low corporate taxes (38%), and favorable depreciation schedules.

Hourly wages, normal for a skilled European industrial worker, average \$14 or \$15—but that includes all fringes, which in other places can cost the employer 10% to 15% on top of the salary. Personal

income taxes are high, as are the imposts on cars and cigarettes, and there is a value-added tax. But those levies take care of many government-provided services, such as day care, that must be paid for by individuals in the U.S.

However, Americans engaged in research and living in Denmark are exempt from income tax. In addition, the legislature is considering lowering the

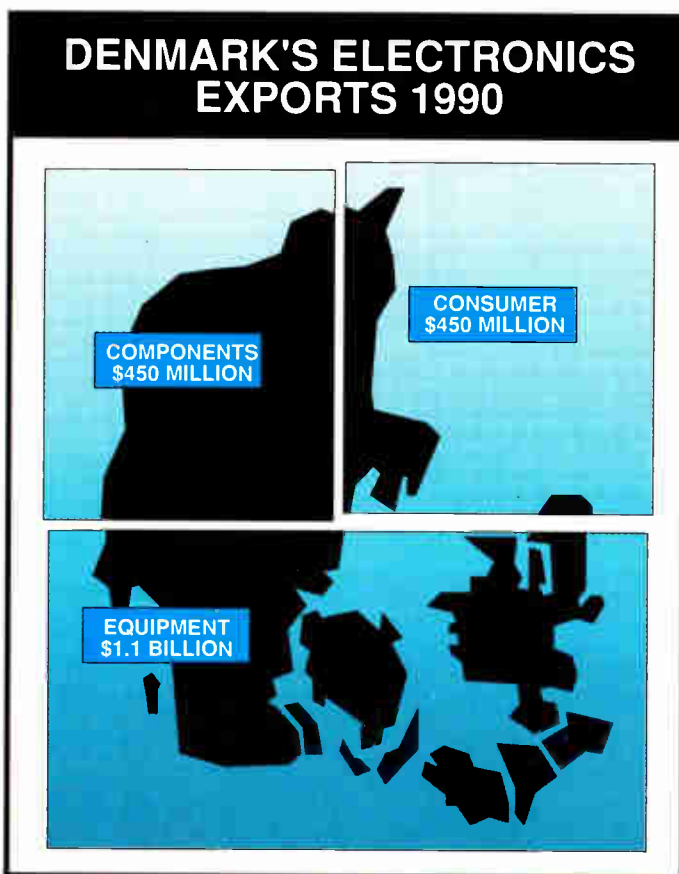

navia, the Baltic area, and Germany.

And that's where Danish officials believe they have an advantage: the Danes are experienced exporters. "Denmark's population is only 5 million [about the same as Massachusetts], so the so-called home market doesn't amount to much," says Niels S. Hoyer, commercial counselor at the Danish consulate in New York. "Actually, Danish manufacturers

We make it stick.

When quality depends on calibration, depend on HP.

If the quality of your product depends on the quality of your measurements, you have to be absolutely sure of the calibration of your test equipment. And the best way to do that is with HP Calibration Services. We'll help you develop a solid calibration program that fits your production requirements and calibration cycles, and complies with all the standards you have to meet.

You'll have the security of knowing that Hewlett-Packard stands behind you, with complete, thorough data reports, tracking procedures, and certification to help you pass audits with ease. Calibrations are performed at customer service centers in over 40 countries. We can also provide them at your site. And we move fast. The HP ExpressCal program reduces downtime by completing most scheduled calibrations in 24 hours.

So, for calibration you can depend on, call **1-800-835-4747**. Ask for Ext. 418, and find out how HP can help you put a complete calibration program firmly in place.

There is a better way.

 **HEWLETT
PACKARD**

©1991, Hewlett-Packard Company WCS91101

CIRCLE 186

World Radio History

PENTON CONTINUES COMMITMENT TO RECYCLING



Penton Publishing's Camera Department started recycling chemicals from film wastewater 25 years ago... long before the ecologically-smart idea was widely recognized.

For almost as many years, the Penton Press Division has been recycling scrap paper, obsolete inventory, and printing press waste materials. In 1991, Penton Press will recycle some 5500 tons of paper, 9 tons of aluminum plates, and 3 tons of scrap film negatives. Furthermore, the Press Division has invested \$500,000 in air pollution control equipment.

Company-wide, the recycling spirit has spread from Cleveland headquarters to offices throughout the country. Penton employees are enthusiastic participants in expanding programs to re-use paper, aluminum cans, and other waste materials.

Penton Publishing believes these practices make a significant quality-of-life difference for people today... and will help create a safer, healthier environment for generations to come.

Penton Publishing

tax rate for American executives.

U.S. companies also may maintain dollar accounts in Danish banks; there is no penalty for profits that are repatriated back to America. Similarly, money earned in other nations may be deposited in Danish banks and then sent back to the U.S. without penalty.

Also, for companies that choose to locate in two less-developed areas of Denmark—Aalborg in the north and Lolland in the south—which have been hurt by shipyard closings, EC Industrial Revenue Bonds are available. These are guaranteed by the government.

Still, Denmark has not been immune to the current economic bad news. The banking business in particular has seen some hard times, and last year five banks were merged into two large ones, the better to compete in a unified Europe and to weather the downturn. "There are structural weaknesses in the Danish economy caused by foreign debt and high income tax," acknowledges Hyer. "The public sector is too big; we should strengthen our industrial base."

The general mood in the country is upbeat. "In the 1980s," says Hoyer, "we had a huge foreign debt. But now there is a surplus in the balance of payments. So if you had talked to many Danes in the '80s, you would have detected an underlying pessimism: there was a high unemployment rate. But now the mood is more optimistic. Though raises have been low, the man in the street understands that that's what keeps inflation down. Today's low inflation rate contrasts with conditions in the 1960s and 1970s, when the rate ran 8% to 12% and it was necessary to grant huge raises to keep pace."

For Bernard R. Smedley, senior vice president of Motorola Inc., and general manager of the Radio-Telephone Systems Group, one of Denmark's attractions is its work force. His company acquired the Danish manufacturer Stomo of Copenhagen in 1986 in a move designed to strengthen Motorola's presence in Europe prior to the scheduled unification in 1992.

Smedley says Denmark was selected for the experience and quality of the company's engineers and because of Stomo's involvement in EC research and development programs on mobile radio technology. "The Danish education system turns out very competent engineers and technicians. Work disci-

pline is high here too, and time schedules are critically important in large R&D projects," says Smedley.

At IBM Denmark, assistant general manager John Meldgaard agrees, adding, "In general, Denmark provides superior public services and has well-developed public utilities and communication systems. And education levels are very high," he says.

And now IBM, with bases in Copenhagen, Allerød, and Lynby, will be able to help make those communication systems even better. The company has formed a joint venture with KTAS, the Danish telephone company, to provide domestic subscribers with new telecommunications services.

Other qualities attracted AT&T Co. In 1987, it established in Copenhagen a joint-venture company with Nordiske Kabel-og Traadsfabrikker (NKT), a Danish-based European market leader in the fiber-optic industry. The new company, Lycom, develops, produces, and markets optical fibers, primarily for customers in Europe and the Third World.

Among the reasons AT&T chose to work with NKT is its state-of-the-art production facilities and technology, which match AT&T's.

"Denmark is a leading country in optical fibers," says Howard Wells, president and chief executive of Lycom, "with the highest per capita utilization rate in Europe. And Denmark is a member of the EC, but is geographically situated so that we can give the best service to our customers within the Nordic countries as well."

Wells is bullish on life in Denmark. "Also important for us is the high quality of life here—it is easy to have a good social life in Denmark," he says. That almost everyone speaks English makes things easier."

Perhaps summing up best is Kat-suichi Morii, president of Sony Scandinavia in Copenhagen. "Denmark was chosen as the base of our operations in the Nordic area for a variety of reasons," he says. "Logistics, for one thing, are well-developed: there's easy access from here both to our suppliers around Europe and to customers throughout Scandinavia. The high educational level of the Danish work force was a particularly important consideration given the nature of our operations. It's also easy to arrange financing in Denmark." □

ULTRA-MINIATURE

DC-DC Converter Transformers

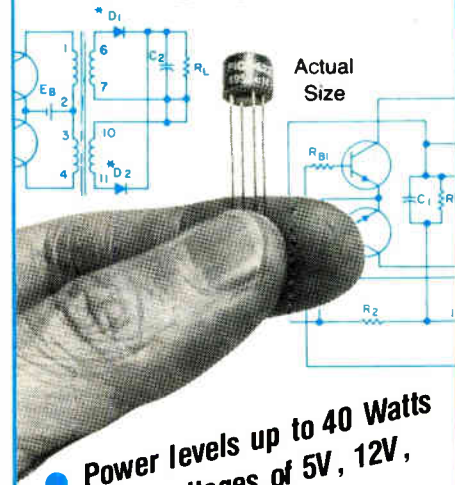

- Power levels up to 40 Watts
- Input voltages of 5V, 12V, 24V and 48V
- Standard output voltages up to 300V (special voltages can be supplied)
- Can be used as self-saturating or linear switching applications
- Operation over ambient temperature range from -55°C to +105°C
- All units meet MIL-T-27 (TF5S40ZZ)
- Secondary can be connected for full-wave or dual bridge
- All units are magnetically shielded
- Schematics and parts list provided with transformers
- Delivery-stock to one week

SEE EEM.
THOMAS REGISTER
OR SEND DIRECT FOR
FREE PICO CATALOG

PICO
Electronics, Inc.

453 N. MacQuesten Pkwy. Mt. Vernon, N.Y. 10552

Call Toll Free **800-431-1064**

IN NEW YORK CALL **914-699-5514**

Send for PICO's new catalog featuring
Ultra Miniature Transformers/Inductors/
DC-DC Converters

COMPAQ AND ITS RIVALS ARE READY

A raft of alert computer vendors was ready and waiting when Intel Corp. of Santa Clara, Calif., introduced the 50-MHz version of the 486 microprocessor. Heading the list was Compaq Computer Corp. of Houston, like the other manufacturers attracted to the chip in question, called the 486 DX, by its blazing speed: it is 50% faster than the 33-MHz version. Intel says the new microprocessor will be in full production in the fourth quarter.

Three models of Compaq's

Deskpro 486/50L using the processor, described by the company as its most powerful PCs to date, are available, with prices beginning at \$11,299.

Compaq was among about a dozen other computer vendors that jumped on the 486/50 bandwagon when Intel unveiled it in late June. The others include Acer America Corp. of San Jose, Calif.; Lightning Computers of San Francisco; and Wang Laboratories Inc. of Lowell, Mass.

Intel says the 486/50 is compatible with major PC



Compaq's new Deskpro 486/50h is the most powerful desktop machine yet from the Houston company.

operating systems, including MS-DOS, OS/2, Windows 3.0, and Unix. It's intended for "power-PC" systems and

servers, used extensively in networks, graphics, and multiprocessing applications. The chip sells for \$665. □

COMMERCE'S RULING: 'A BULLET IN THE HEAD' FOR LAPTOP VENDORS

The U.S. computer industry will be holding its collective breath until late August, when the International Trade Commission decides whether a stiff antidumping tariff on active-matrix LCDs will or will not be levied. The Commerce Department last month recommended a 63% duty on the screens, a Japanese-made component that observers say will be widely used in coming generations of laptop computers. Now the ITC must rule by Aug. 23 on whether the U.S. flat-panel industry has been injured by the artificially low Japanese prices; if so, the duties will go into effect.

Representatives from Apple, Compaq, IBM, Grid, and Tandy all crowded into the ITC injury hearing in mid-July. Their basic message: if the tariff is levied, "we quite probably will have to move all our portable [computer] manufacturing outside the

U.S.," says William P. Fasig, manager of international and government affairs for Apple Computer Inc. in Washington. "The flat-panel display vendors get nothing out of this," he says. "We get virtually a bullet in the head."

The computer makers have argued since the dumping complaint was first filed that they have no choice but to use Japanese products, because no U.S. vendor is manufacturing production quantities of active-matrix LCDs or the other types of screens named in the suit.

The seven small U.S. display makers that brought the complaint counter that low prices have cornered the market for the Japanese and kept the Americans out. "How can you expect any rational business person to go into the business with that level of dumping going on?" asks James M. Hurd, president and CEO of Planar Sys-

tems Inc. in Beaverton, Ore., one of the complainants. Hurd says the duties would offer "a new lease on life" for the U.S. industry, since more costly Japanese screens would be less attractive.

However, Lawrence Walders, counsel for the Japanese manufacturers, pointed out in his ITC testimony that the big U.S. companies that devised active-matrix LCDs exited the field, leaving the Japanese to bear the R&D burden of bringing the technology to market.

Active-matrix technology is the preferred choice for upcoming laptop and notebook PCs, so a large duty on these products could be crippling for U.S. computer makers. Apple is the only U.S. vendor now using such displays in its portables; most of the current crop rely on passive-matrix LCDs, on which the Commerce ruling proposes no duties. □

NOW OEMs LOOK UNDER THE HOODS

A new phenomenon is taking hold among computer manufacturers that buy hard-disk drives. These large corporate purchasers are beginning to characterize the production drives received from their suppliers despite the fact that incoming inspections show yields that average 99.8%.

Because drives are a major component on every computer shipped, explains Rich Freedland, president of Helios Corp. of Sunnyvale, Calif., if supply is disrupted, an OEM stands to lose \$1 million to \$5 million a day. By characterizing the drive, the OEM is evaluating the manufacturing process of the supplier. Using a specially configured servo writer from Helios, the OEM can evaluate how well a drive stays on track. □

Delco Electronics Corporation



**COMPETITORS ARE NOT ONLY GETTING FASTER;
THEY'RE GETTING BETTER.
CAN YOU STAY AHEAD ON BOTH FRONTS?**

Speed and quality are just two of the dynamics affecting your ability to compete in new markets. Or to hold your ground in established ones. And that's where the manufacturing expertise of EDS can become an invaluable resource.

**HOW CAN YOU INCREASE SPEED
TO MARKET?**

At EDS, our understanding of manufacturing comes from firsthand experience. We've helped many customers develop shorter lead times, accelerate delivery schedules, and even improve stringent quality standards. Through carefully planned, tailored solutions, EDS can assist you with an unmatched combination of manufacturing consulting and technology services aimed at improving your bottom line.

CAN EDS HELP YOU?

Companies of all sizes and needs benefit from the manufacturing support EDS provides. To discuss how to get your manufacturing operations moving at a more competitive pace, call 1-800-365-8232.



TAKE ADVANTAGE OF CHANGESM

EDS is a registered trademark of Electronic Data Systems Corporation. ©1991 EDS



© 2000

World Radio History

**SOMETHING
AWFUL
WILL HAPPEN
IF YOU'RE
OUT OF TOUCH
WITH
TODAY'S BUYER.
NOTHING.**

Salesmen who don't sell.

Marketers who miss the mark.

They're becoming more common in today's changing business marketplace, along with managers who can't, communicators who don't, and customers who say "bye" instead of "buy."

It seems that business is changing faster than minds are. So says an important new study sponsored by one of America's most prominent business-to-business communication companies, Penton Publishing.

Among the study's key findings: Today's business buyer is a moving target. People will have as many as four careers during their work life, often taking on responsibilities for which they have little experience or training. To sell to them, the research recommends specific new skills and new messages.

This study is available for you to study. It's titled "Know the Buyer Better," and that's just what it can help you do.

The research, conducted by an independent research firm, is a fact-based snapshot of today's changing marketplace based on field interviews with today's changing buyers. It's the kind of global view that most sellers are too busy to get, yet need more and more desperately.

Three points of perspective make "Know the Buyer Better" especially valuable to you.

It's focused on business. It's organized by people who really know their ABCs about SICs.

It's focused on the buyer. The study relates often confusing trends in investing, demographics, personal improvement, and others to one specific industry activity: buying.

It's focused on practicality. It's based not on what speculators or editorializers say, but what buyers themselves say.

If you market products or services business-to-business, this study will show you how to market and sell more, and more effectively.

Find out more about "Know the Buyer Better" today. Calling this toll-free number, 1-800-258-8787, ext. 100, costs nothing.

Not knowing the buyer better will cost a lot more.

Penton Publishing

Our issues address the tough issues.

ACE: THE '90s SOLUTION...

From the broadest perspective, the Advanced Computing Environment (ACE) initiative is about setting a standards framework that encompasses the entire computer industry. In the 1980s, standardization and broad industry support for software and hardware fueled the availability of choices, leading to the explosive growth of the PC market. ACE will establish a foundation for the standardization needed to make advanced networked computing systems the dominant solution of the '90s.

There is little disagreement over the direction of computing solutions that will be required in the future: advanced networks of desktop and server computers; and open, cost-effective multi-vendor systems offering a safe, evolutionary path for long-term planning. Users have told us they want to be able to choose from a variety of hardware and software to increase the flexibility and security of their computing investments. And they want the wide applications availability that comes from a broadly supported standards-based environment. The ACE initiative brought together, for the first time, all the critical elements crucial to accomplishing this total solution.

There's no way one hardware platform and one operating system can meet the entire range of needs of a typical medium or large company. There's also no way a solution that is not standards-based and supported by a broad base of vendors can meet all their needs. To satisfy all these very important customer requirements, the five dozen ACE companies are establishing a standards framework that includes two hardware architectures and two operating systems—with the maximum degree of compatibility, flexibility, and interoperability among systems. The two key ACE elements are:

• **Dual hardware architectures:** In addition to building upon the existing x86-based PC standard for hardware, ACE provides an open-standard speci-

fication for MIPS RISC-based hardware. The ACE initiative is fully open to all computer companies and has standardized on nonproprietary microprocessors that are commercially available to all vendors developing compatible systems and add-on products.

• **Two operating systems:** At the software level, ACE will provide two powerful, advanced, and standardized operating systems, one Unix-based—the Santa Cruz Operation's Open Desktop—and one PC-based, OS/2 3.0, a powerful 32-bit operating system based on Microsoft Corp.'s New Technology foundation. Just as standard PC operating

systems helped foster a wide range of personal productivity applications, we expect these standardized operating systems to attract a large base of applications for mission-critical computing. Open Desktop supports all major Unix standards and incorporates the best available technologies, including the Open Software Foundation's Motif

graphical user interface and Sun Microsystems Inc.'s Network File Sharing System. OS/2 3.0 will support more than 35,000 existing PC applications as well as new 32-bit Windows applications.

Because both of these operating systems are supported by the five dozen ACE companies, there is no doubt that we will see the development of thousands of new applications in addition to the 40,000 existing PC and Unix applications—all running on standard platforms defined by ACE. Products for end users will be available in 1992.

The net result is that customers will have the broadest selection of choices to meet their computing needs. ACE has all the right pieces in place to meet customer needs more effectively than any other available approach. For this reason, I believe that ACE will become the predominant standard in the industry for advanced computing within this decade.—*J. Rod Cannon, president and CEO, Compaq Computer Corp.*



Joseph R. (Rod) Cannon

Husband. Grandfather. Great American Investor.

When Bob Lawrence joined the railroad nearly 30 years ago, he began buying U.S. Savings Bonds for his retirement. Now he buys them for his grandkids. "Bonds pay good strong rates and they're simple to purchase," he says. Become the next Great American Investor. Call us to find out more.

U.S. SAVINGS BONDS



THE GREAT AMERICAN INVESTMENT

1-800-US-BONDS

A public service of this publication.

...OR MIXED-UP CONFUSION?

There is a general belief in the industry that the way to create the next-generation platform and operating-system standards is to form a consortium and declare that a standard has been made. This is what the Advanced Computing Environment is trying to do. But in reality, only the market creates a standard. There are three reasons why initiatives such as ACE have the potential for failure. First, they claim to be standard and open but are neither. Second, they lack a committed evangelist with a deep-seated desire to make the effort a success. Finally, such initiatives lack a well-defined focus. They define a hodgepodge of products that the customer must make sense of.

They also have difficulty clearly defining the terms "standard" and "open," thereby creating confusion in the marketplace. A standard is created when purchasers buy a large number of a given product. However, not all standards are open. One prime example is the Apple Macintosh. It is a recognized standard platform, but no one would ever say that the Macintosh is open. Customers must purchase the hardware and software from Apple alone. ACE talks about a standard, yet to date, no product has been purchased by customers or even shipped.

These consortia confuse the market in their claims to be open. Not so. Open means multivendor. It means that all software and hardware application-program interfaces are defined, are free of legal restrictions, and have little or no costs associated with them. With ACE, only the five consortium leaders are privy to the group's specifications. MIPS Computer Systems Inc. controls the hardware and chip specs. All others must pay a steep licensing fee and bind themselves to develop ACE-compliant hardware in order to build a product. That is as proprietary as you can get.

Contrast this with the Sparc/SunOS platform. There are 190 members of

Sparc International with more than 30 companies shipping diverse products. All of this volume supports the SunOS operating system as a standard. At last count, there were over half a million installed Sparc/SunOS systems, making it the third-largest volume platform in the industry and a de facto standard.

In addition, Sparc/SunOS is open and multivendor. Any hardware vendor can acquire the Sparc specifications and build a compatible system. Chips are readily available on the open market from at least seven semiconductor vendors, each designing and developing its own Sparc implementation. No one is

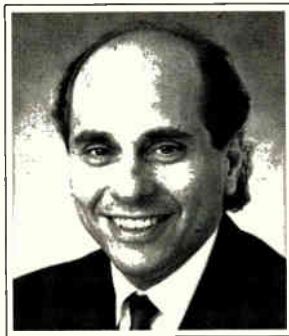

Ed Zander

waiting for Sun Microsystems Inc. to issue a mask set for the next version of the hardware. In addition, SunSoft as well as others market SunOS, independent of Sun Microsystems. Another reason that Sparc has been successful is similar to the reason that IBM, Microsoft, and Intel—and, for that matter, Apple—have been successful in the PC arena. These companies have bet their futures on supporting a standard set of technologies and continuously innovating upon them. It is this lack of a clear commitment by member companies in consortia like ACE that makes it difficult for them to succeed.

Today, ACE endorses two hardware architectures and multiple software architectures. But what customers want is simplicity. Customers and software vendors do not want infinite choices. They want a clear direction on a company's products and business strategy. They want to know that a given technology is the one to which a company will devote its best minds and resources for the delivery of powerful and easy-to-use products. Standards bodies have a place in guiding the standards process in the industry. But there is no reason for the existence of vendor-driven initiatives that serve the needs of consortium members at the expense of the end user.—Ed Zander, president, SunSoft Inc.

Now up to
100V DC Output

PICO DC-DC Converters

Wide Input Range
5 to 72V DC



Regulated 5 to 30 Watts

- 365 Standard Models
- Single, Dual & Triple Output
- Remote Disable Pin Standard
- Up to 100V DC Output now Standard
- 500V DC Isolated Input to Output
- All Units Shielded

MIL-STD-883 UPGRADES AVAILABLE

- Expanded operating temp. (-55°C to +85°C)
- No Heat Sink Required
- Stabilization Bake (125°C ambient)
- Temperature Cycle (-55°C to +125°C)
- Hi temp., full power burn in (100% power, 125°C case temp.)

PICO also manufactures over 850 standard DC-DC converters and over 2500 ultra-miniature transformers, inductors and new AC-DC power supplies.

Delivery—
stock to
one week

See EEM or
FAX 914-699-5565
or send direct for
FREE PICO Catalog

PICO
Electronics, Inc.

453 N. MacQuesten Pkwy. Mt. Vernon, N.Y. 10552

Call Toll Free 800-431-1064
IN NEW YORK CALL 914-699-5514

TO WATCH

INTEL UNVEILS RUGGED PC

A rugged, rack-mountable microcomputer from Intel Corp.'s Systems Group in Hillsboro, Ore., strikes a happy medium between garden-variety PCs and expensive machines that meet military specifications.

Priced at \$4,000 and designed for original-equipment manufacturers, the model 302i is based on a 25-MHz Intel 386 microprocessor. It comes in a standard 19-in. rack-mountable chassis. Positive-pressure, filtered air flow keeps dust out. Its hard disk is shock-mounted for vibration protection and add-in cards are held in place by a locking bar to keep them from detaching if the computer is in a vibration-prone environment.

The 302i also offers a high



Intel's rack-mountable unit makes designing PCs into industrial systems easier and less costly.

level of serviceability. Any component in the system can be replaced in less than eight minutes with a screwdriver. The CPU board is tray mounted and special connectors are used to make servicing easier.

Other features include 64-Kbytes of cache memory, eight expansion slots, a 230-W power supply, two serial ports, one parallel port, and PC-AT compatibility. The 302i began shipping in late July. □

CHIPS READ OR WRITE AT TOUCH OF A PROBE

A new way of tagging and identifying parts and products has been developed by Dallas Semiconductor Corp.

The MicroCan Touch Memory data carrier embeds a rewritable memory chip in a steel can the size of a dime and reads it with a probe using a 1-wire signaling scheme. Up to 4-Kbit versions of the DS199X are available, says the Dallas, Texas, company.

Data transfer takes place at 16 Kbits/s and a cyclic redundancy check (CRC) algorithm based on a 48-bit serial number assures data integrity, especially during write cycles. Secure versions of the devices with 64-bit passwords are also available. An evaluation kit costs \$75 and the devices about \$3 each. □

SUN'S NEWEST SPARC POWERS A 21-MIPS DISKLESS WORKSTATION

A new Sparc microprocessor delivers the higher performance in two workstations from Sun Microsystems Inc., Mountain View, Calif.

The low-end Sparcstation ELC replaces the SLC at the same \$4,995 price for a diskless version, but offers almost twice the performance. The ELC's 33-MHz processor executes 21 million integer instructions/s or 3 million floating-point operations/s vs 12.5 mips and 1.2 megaflops for the SLC [*Electronics*, June 1990, p. 75].

The monochrome ELC is for entry-level applications such as database management, document-image processing, and computer-aided software development. In contrast, the Sparcstation IPX is an accelerated-graphics desktop unit that sells for \$13,495 in a configuration

with a color monitor, GX graphics accelerator and 207 Mbytes of mass storage.

A 40-MHz CPU in the IPX enables it to deliver 28.5 mips and 4.2 mflops. respec-

CHIP SET LINKS ETHERNET TO FIBER

Micro Linear Corp. is pushing the frontiers of Ethernet into fiber optics with a highly integrated chip set that significantly reduces design time and cost.

Before the San Jose, Calif., company's two-ship solution, systems houses had to design their own fiber-optic interface to Ethernet using discrete devices. The transceiver consists of the ML4661, a fiber-optic interleaver link (FOIRL) transceiver, and the ML4621 fiber-optic quantizer. Together, they provide all the functionality needed to implement an IEEE 802.3 FOIRL media-attachment unit.

Available now, the ML4661 is \$21 each and the ML4621 is \$6.50 each in 1,000-unit purchases. □

BENCHMARQ'S CHIP MAXIMIZES BATTERY LIFE

A power-management chip from Benchmarq Microelectronics Inc. is designed especially for battery-operated computers, cellular phones, and instruments.

The bq2001 Energy Management Unit provides accurate, reliable power metering, fast charge control, and sophisticated system-management services, says the Carrollton, Texas, company. Battery-conditioning routines, for example, can restore lost capacity resulting

from extended storage or mistreatment and inhibit the so-called memory effect that plagues NiCd batteries.

Fabricated in 18-V bi-CMOS, the bq2001 operates at 5V but handles systems up to 12V. It consumes 700 nA. An internal micro regulator powered by the main battery provides backup for a clock and other low-current ICs. When a system's battery is removed, a small lithium cell powers the bq2001. It costs \$10 each. □

This microcomputer software lets you program using natural mathematical notation

Wouldn't it be nice if you could solve your mathematical problems by simply typing them into your PC just as you would write them down on paper? With **TKSolverPLUS** you can do just that.

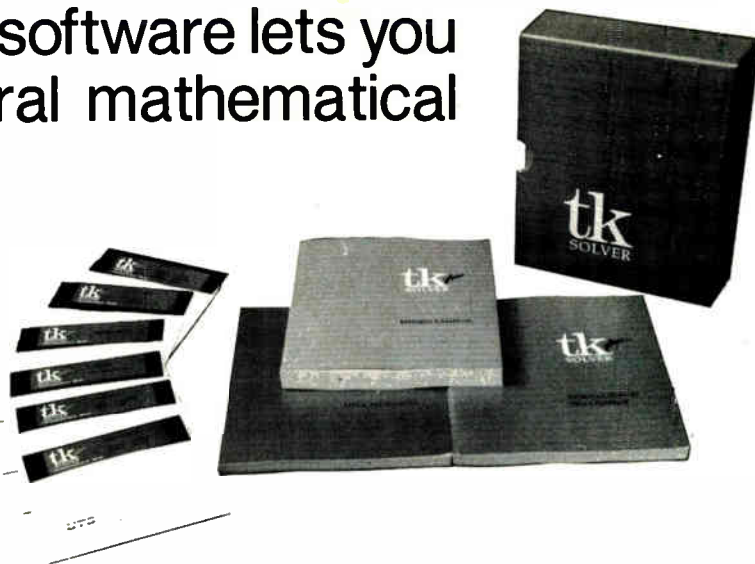

- You just enter the set of equations you want to solve using natural math symbols,
- Define the variables you know,
- Specify the units of measurement you want,
- Press the solve key.

Then see your solutions in tabular form or plot the results on the screen or printer.

TK can do reverse calculations, or goal seeking! This powerful feature is best explained with this simple example.

Suppose you're buying a \$15500 car and you want to compute your loan payments. You're paying \$3500 down and planning a 4-year, 12½% loan. You enter the equations below, plug in the values and find your monthly payment is \$318.96.

$$\text{price} - \text{down} = \text{loan}$$
$$\text{payment} = \text{loan} * (\text{rate} / (1 - (1 + \text{rate})^{-\text{term}}))$$

But suppose you'd rather pay \$350 per month and shorten the term of the loan. Just enter your preferred payment and tell **TK** to solve for the new loan term — without you having to rearrange the equations. Or perhaps you'd like to shop for a new interest rate. **TK's** iterative solver will compute the interest rate you need to pay off the loan in 3½ years paying \$350 per month.

This ability to *backsolve* makes **TK** incredibly easy to use and saves you countless hours of programming time.

Of course not everyone wants to compute loan payments. But the benefits are the same no matter what type of problems you have to solve . . . business, engineering, statistics, or science.

Solve dozens of linear, non-linear or differential equations simultaneously * backsolving * if, then, else rules * iterative solving * complex numbers * automatic plotting * Automatic unit conversion * over 300 built-in functions and library routines * math co-processor support * store equation models for later retrieval and use * not copy protected.

TKSolverPlus disks and full documentation \$395
Satisfaction Guaranteed! Or return the program within 30 days for full credit or refund.

System Requirements: IBM PC line or 100% compatibles; 384K min memory; DOS 2.0 or higher; CGA, EGA, or Hercules graphics

Chargecard users order toll-free 800-321-7003
(in Ohio 216/696-7000)

Penton Education Division
1100 Superior Avenue
Cleveland, Ohio 44114

*Our six-row connector
lets you change the ground rules.*

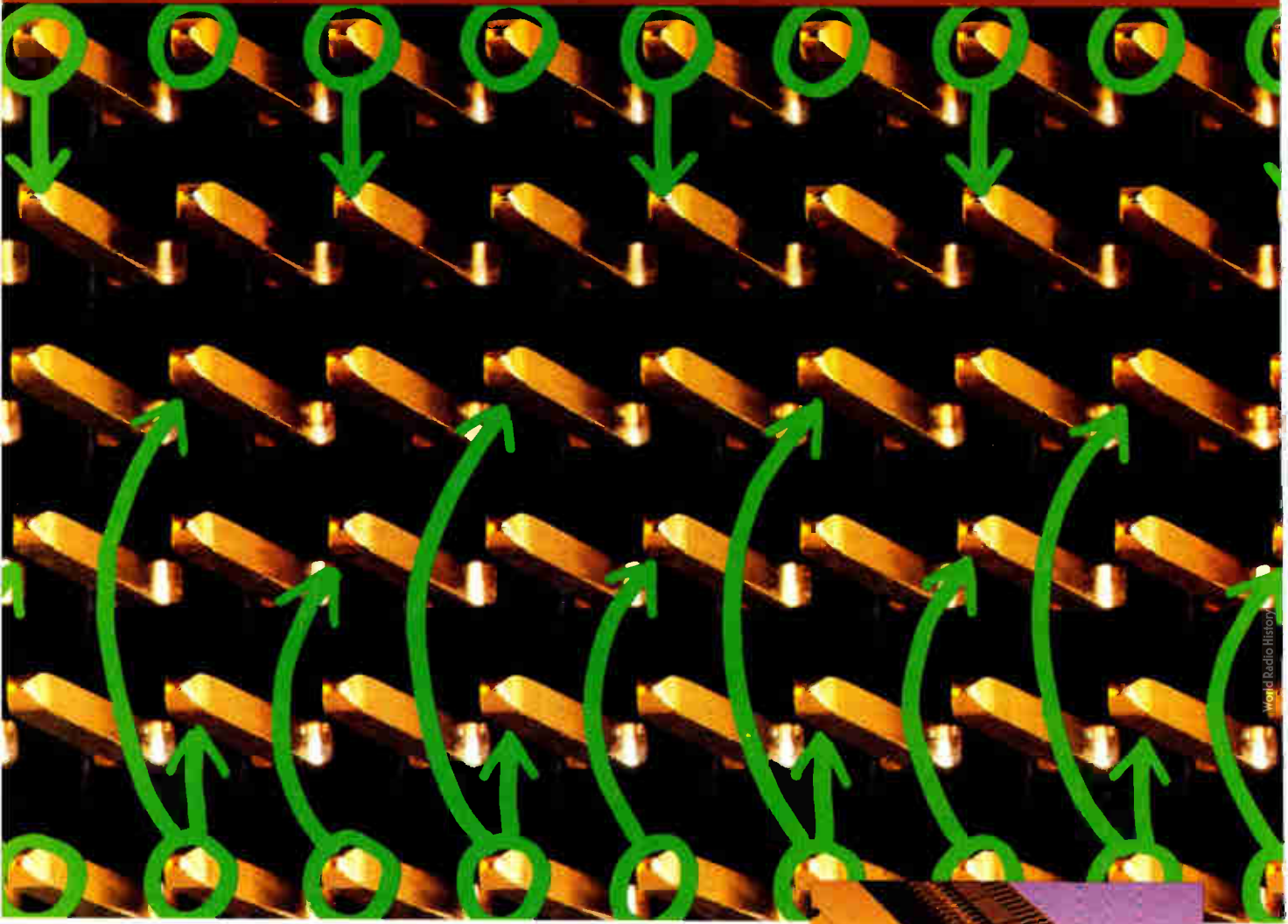

THIS IS AMP TODAY.



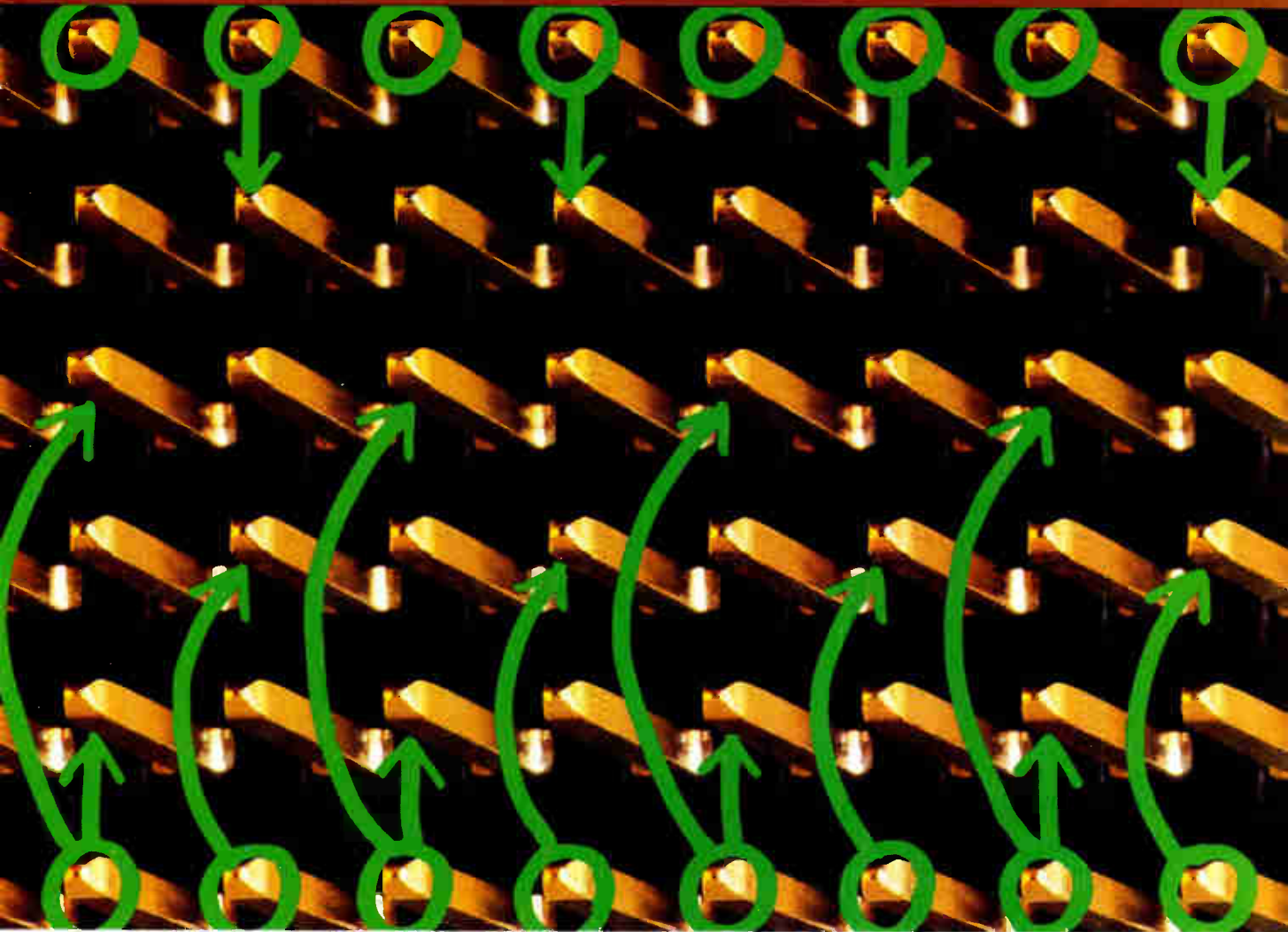

AMP TBC Plus connectors give you complete freedom in ground and signal assignment, so you can write your own 'ground rules' for outstanding electrical performance in high-speed, high-density backplane applications.

Because they are true 6-row connectors and you assign ground where you need it, near end and far end noise voltage figures in the <10 ns risetime range are far below connectors that limit ground to the outer rows or 'planes' (TBC Plus performance is even better when configured the same way!).

Our economical twin-beam receptacle design is unique in offering greatly reduced

inductance in the outermost 'long' row of pins, and matched propagation delay in all lines. Capacitance is a mere 2pf, max, line-to-line.

Note performance of AMP TBC Plus connectors with evenly dispersed 'checkerboard' grounding: some competitive styles don't allow this.

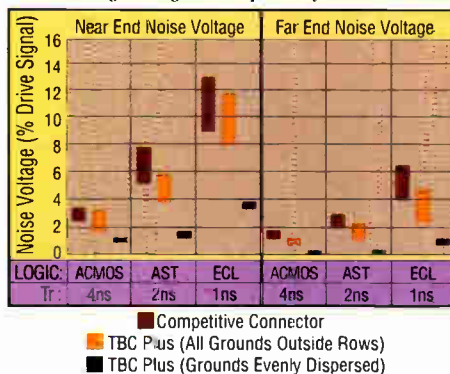

Modular configuration (90- and 120-position sections) provides 'building block' flexibility, with applications to 810 positions or more.

Header posts in staggered heights allow four-level sequenced mating.

For the Plus in high-speed performance, call our Product Information Center at 1-800-522-6752 (fax 717-561-6110). In Canada call 416-475-6222. AMP Incorporated, Harrisburg, PA 17105-3608. For design assistance in characterized backplane assemblies, contact AMP Packaging Systems Inc., P.O. Box 9400, Austin, Texas, 78766. Phone 512-244-5100.

Actual size

Actual output

20 WATTS

Now AC to DC

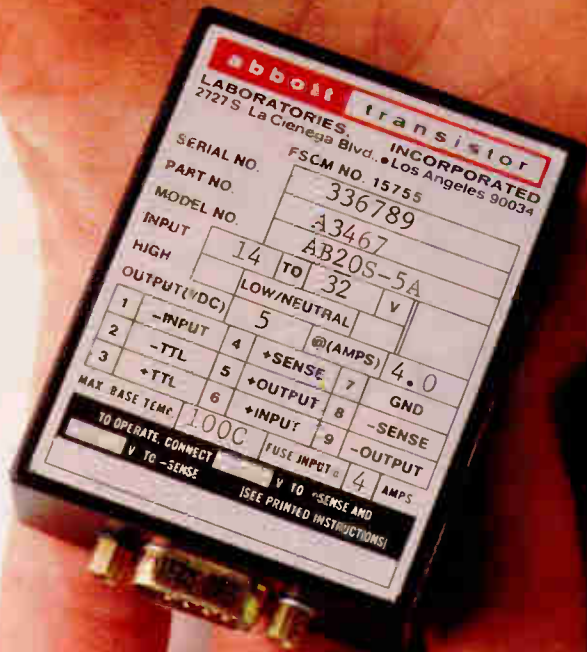

Actually meets

- MIL-STD-2000
- MIL-STD-810C
- MIL-S-901C
- MIL-STD-461C
- MIL-STD-704D
- NAVMAT GUIDELINES

Mil/Pac™ high-density military power supplies.

Now you can order Abbott's full mil-qualified compact power supplies in both DC and AC input models.

Mil/Pacs come in 20W, 35W and 50W configurations, with single (5, 12, 15, 24, or 28V) or dual (±12V; ±15V) outputs.

DC-to-DC models accept input from 14V to 32V. AC-to-DC models accept 103.4 to 126.5V rms, 47-440 Hz single phase.

All Mil/Pacs operate at temperature extremes from

-55°C to +100°C. All are designed with a field-proven topology that has been verified by rigorous environmental stress screening.

Mil/Pacs are available with or without MIL-STD-2000. Either way, the specs are worth reading. Just write us at 2727 South La Cienega Bl., Los Angeles, CA 90034. Or call (213) 936-8185.

abbott
 WHEN RELIABILITY IS IMPERATIVE.™

CIRCLE 219

NEWS

ALLIANCE WITH IBM WOULD ESTABLISH A NEW COMPANY AND OPERATING SYSTEM

A BIG BLUE HUE FOR APPLE

BY LAWRENCE CURRAN

The second shoe may not drop for months in the wake of the agreement by Apple Computer Inc. and IBM Corp. to launch a joint venture, but this alliance has a better chance to succeed than some other industry affiliations because millions of each firm's customers want it to work. It's also clear that one of the reasons for the alliance is that Apple, in Cupertino, Calif., and IBM, based in Armonk, N.Y., want to provide some counterbalance against the howling success of Microsoft Corp.'s Windows environment on personal computers.

A key provision of the agreement is establishment of an independently managed, jointly owned company to develop an object-oriented operating system. That software will run on a variety of Apple and IBM computers, and will also be sold to other hardware vendors.

Besides the joint company, another part of the July accord will have Big Blue and Apple joining to develop hooks that more easily integrate the Apple Macintosh PC into IBM client-server networks. Other elements of the agreement would enable Apple to adopt in future Macintosh PCs single-chip versions of the IBM RS/6000 Power PC architecture, and unite the two firms to develop and license software to stimulate multimedia technology.

The RISC chip work also involves Motorola Inc., which will join with IBM to design and fabricate a single-chip version of IBM's RISC architecture, then will serve Apple, IBM, and other computer vendors as a foundry for the advanced RISC family.

Products stemming from the partnership would reach the market "over the next two to three years," says Paul Bergevin, IBM spokesman on the al-

liance. "We're well down the road to completing contracts. We expect to have them done by the end of the year," he says.

Bergevin says of the planned joint-venture company that "it will be its own entity. The intent on funding is to have 50-50 participation between the two of us." No details are available about its location or staffing.

Alliances in the computer industry have a spotty history. The once-friendly relationship between IBM and Microsoft has erupted into warfare over disagree-

hopes, and because "a lot of customers are rooting for this to work."

The two firms share "a deep and abiding concern about Microsoft's role that may serve to unite them," Yarnis maintains. "And the relationship is based on more than the two saying 'let's get together and do lunch.' Apple is well along on an object-oriented operating system" in its so-called Pink Project, Yarnis says. "People at Apple maintain that this is real stuff; there's computer code behind it."

Object-oriented programming facilitates the development of programs that interact with one another. For example, changes in a spreadsheet imported to a word-processing program would be reflected automatically back in the original spreadsheet.

Frank Lynn, president of Frank Lynn & Associates Inc., a market-research firm in Chicago, says that another reason that object-oriented techniques will be a boon to hardware vendors is that they will greatly ease the chore of porting software applications to new versions of an operating system and hardware platform. This will cut the cost for a software vendor to support a new version of an operating system—say, OS/2.

As for Apple and IBM customer backing, Yarnis points out that "customers are saying that if Apple and IBM can work together, that would meet our wildest dreams. These users also wouldn't mind if this alliance serves to break Microsoft's monopoly," he adds.

For his part, Peter Burris, senior IBM analyst at International Data Corp., the Framingham, Mass., market-research organization, says the company to be formed by the two is pivotal to the success of the alliance. "How that company is formed will provide the first clues to how successful this arrangement will be," Burris says.

Will Zachmann, president of Canopus Research, a Duxbury, Mass., market-research firm, says the joint-venture company is less important than some near-term benefits both Apple and IBM

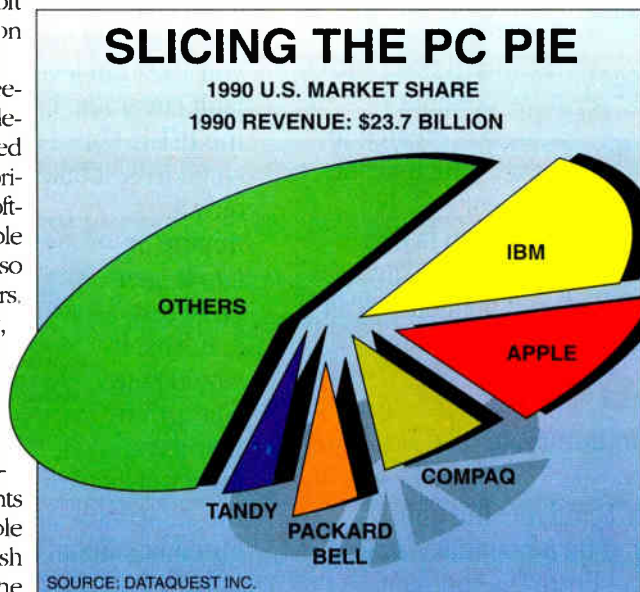

IBM had 16.9% and Apple 12.1% of the U.S. market for PCs last year.

ments between the two about PC operating systems (see p. 44). But this partnership has a better chance, says Jonathan Yarnis, vice president for personal computing at the Gartner Group, the Stamford, Conn., computer industry market-research firm.

Yarnis cites three reasons for his view: the significant threat to both Apple and IBM in Microsoft's growing strength on the desktop, the fact that the relationship is based on more than just

People say boundary in low cost, high quality Now you can test that



Find common manufacturing faults without test pattern libraries or physical test access with boundary-scan design and VICTORY software.

Increasing device complexity. Rising pattern development costs. High density packaging. Disappearing nodal access. These are the board test problems boundary scan was created to solve. Which is fine in theory. Only problem is there hasn't been any way to put boundary scan to the test. Until now.

Delivers high fault-coverage.

Whether you're testing one boundary-scan part or boundary-scan networks, VICTORY software automatically gives you 100% pin-level fault coverage. Using the IEEE 1149.1 and BSDL standards, it takes VICTORY only a minute or two to generate test patterns. It would take a programmer days, even weeks to deliver the same fault coverage for conventional designs.

Concurrent engineering takes on new meaning when you use VICTORY's Access Analyzer to optimize board layout for testability and cost-efficiency.

Now you can find stuck-at faults, broken wire bonds, wrong or missing components—even open input pins—all without manual diagnostic probing. VICTORY's fault diagnostics clearly spell out both fault type and fault location. And that's just the manufacturing process

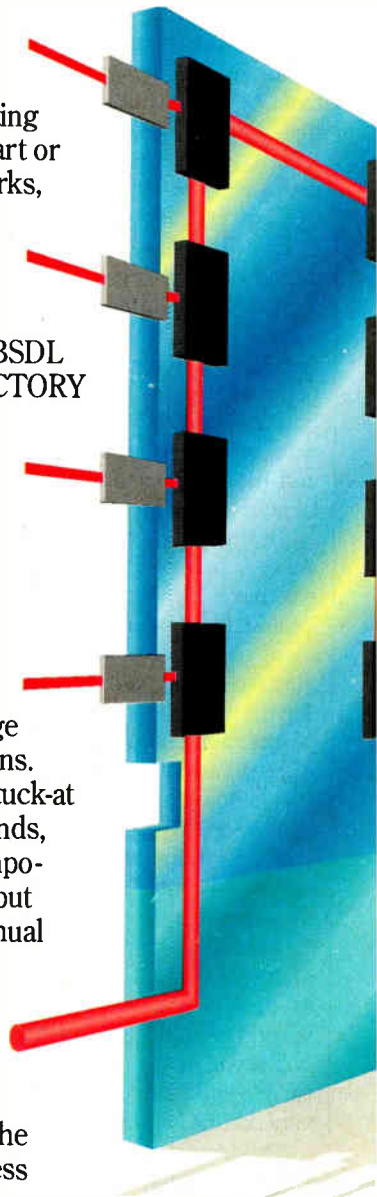

VICTORY—the first software to automate boundary-scan testing.

Introducing VICTORY™ from Teradyne: the only software toolset ready to help you turn boundary-scan theory into a practical advantage. From the moment your first boundary-scan device is designed in, VICTORY starts to simplify the testing of complex digital boards. And the more boundary-scan parts you have, the more time and money you save.

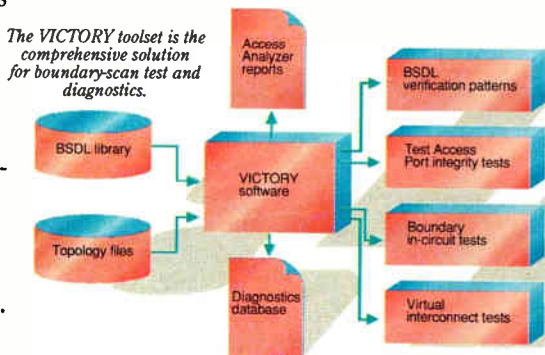

scan is a breakthrough board testing theory.

feedback you need to eliminate defects where it's most cost-effective—at the source.

Helps solve the test access problem.

With boundary-scan design and VICTORY software, you won't need bed-of-nails access on nodes where boundary-scan parts are interconnected. That means fewer test pads. Fewer test probes.

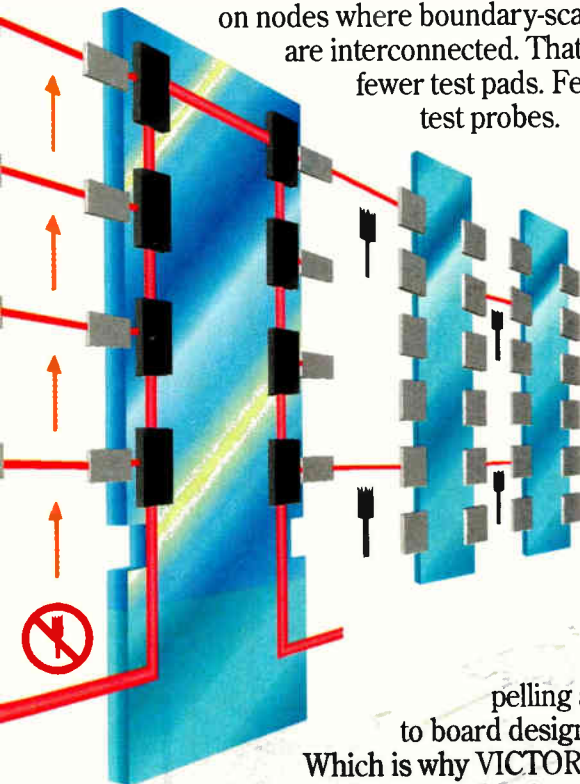

That's a compelling advantage to board designers.

Which is why VICTORY's Access Analyzer was developed. With this concurrent engineering tool, designers get testability information early in the design process. They can easily see where test points are required for visibility and where they can be dropped, for opti-

mized board layout without lowering fault coverage.

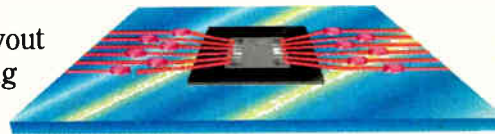

Good for the bottom line.

Boundary-Scan Intelligent Diagnostics identify faults by type and location without physical probing – even on high-density SMT assemblies

Shorter test programming time. Higher fault coverage. Lower PC board and test fixture costs. The bottom line on VICTORY is how positively it will affect your bottom line. And because VICTORY works with all Teradyne board testers, you're free to tailor a test process that's cost-effective for both your boundary-scan and non-scan boards. No matter what your test objectives. For example, with our new Z1800VP-series testers, a complete solution for in-circuit and boundary-scan testing starts at well under \$100,000.

Make the next logical move. Call today.

Boundary scan is the design-for-test breakthrough that promises lower cost, higher quality board testing. But don't take our word for it. Call Daryl Layzer at (800) 225-2699, ext. 3808. We'll show you how, with VICTORY software and Teradyne board testers, you can test this theory for yourself.



Get high fault coverage at low cost when you test boundary-scan boards with our new Z1800VP system and VICTORY software.

TERADYNE

may reap. Affiliation with IBM may give Apple "badly needed momentum in large corporate accounts," Zachmann says. And IBM gains a hedge against the possibility of Apple winning its copyright lawsuit against Microsoft.

Apple contends that Windows copies elements of the Apple Macintosh graphical user interface. If Apple wins, the huge momentum behind Windows could be squelched, leaving IBM and countless Windows users vulnerable. "I can't imagine that IBM would conclude such an agreement without getting the rights to something that allows them to incorporate Mac-like features into the AIX shell," Zachmann maintains. AIX is IBM's version of Unix.

To succeed, the alliance partners will have to subordinate two dissimilar corporate cultures to the common good. IDC's Burris says a cultural merger is important. "I'm not inculcated into either culture, but looking at it from the outside, it seems the two are very different. The biggest potential impediment to the [joint firm] is whether or not the Apple rank and file buy into the alliance." □

PARSYTEC IS MAKING A SPLASH WITH ITS GC LINE OF PARALLEL PROCESSORS

WELCOME TO THE CLUB

BY JOHN GOSCH

A small, \$13.5-million German computer company, with the look of a successful Silicon Valley-style startup, has wedged into the select club of supercomputer builders alongside the likes of Cray Research, IBM, Intel Supercomputer Systems, and Thinking Machines. And what has propelled Aachen-based Parsytec GmbH to a top position in this field is a line of parallel supercomputers sporting performance figures that are nothing less than landmark characteristics.

Parsytec's GC family of multiple-instructions-multiple-data machines spans a computing power range of 0.4 to 400 gigaflops—that's up to 400 bil-

lion floating-point operations/s. The largest configuration packs some 16,384 32-bit microprocessors, which makes it what the company says is the first "supermassive" parallel system to go to market.

And check **SUPERCOMPUTERS** the price-performance ratio: an average Parsytec system offers 1 gigaflops for about \$280,000.

The machines are Europe's entry into the field of true supercomputing, and their remarkable performance is not only a triumph for Parsytec but also for the European computer industry: the microprocessors are T9000 Transputers from Inmos Ltd., the UK affiliate of the Italian-French semiconductor maker SGS-Thomson Microelectronics

CRT POWER SUPPLIES

CUSTOM DESIGNED
MULTI OUTPUT
SHORT CIRCUIT PROTECTED
REVERSE POLARITY PROTECTED

MONOCHROME
PENETRON
SHADOW MASK
HEAD UP DISPLAYS



MILITARY / COMMERCIAL / MEDICAL POWER SUPPLIES

- "Off-the-Shelf" Availability
- Competitive Pricing

Ferranti Venus

399 SMITH STREET, FARMINGDALE, N.Y. 11735
(516) 293-4100 • TWX: 510-224-6492 • FAX: (516) 752-7976

CIRCLE171

Moving?

1. For FASTEST service, you must attach old mailing label in space below.

If mailing label is not available print your old company name and address in this box.

Please allow
6 weeks for
change to
take effect

2. Print your New business address here.

NAME _____ TITLE _____
COMPANY _____
ADDRESS _____
CITY _____ STATE _____ ZIP _____

3. Mail to:
Electronics
Penton Publishing, Inc.
1100 Superior Ave.
Cleveland, OH 44114

which has headquarters in Milan and Paris. And the Dutch compiler specialist Associated Computer Experts (ACE) in Amsterdam is providing an optimizing Fortran 77 compiler for the system's software. The software itself was developed at a number of European software houses working closely with the Aachen company.

Parsytec, with 130 employees and sales offices in the U.S. and UK, will unveil GC prototypes at the Systems '91 computer show to be held in Munich in October. Deliveries will start in the first quarter of 1992.

The company already has orders for six machines, three from Germany and three from the U.S. Of the machines headed across the Atlantic, two are for the Naval Research Laboratories in Washington and one is to be installed at the Science Support Laboratories in Ford Ord, Calif. The bill those three systems will total \$3 million. Each of the six machines will be equipped with up to 256 microprocessors delivering 6.4 gigaflops.

The market that Parsytec is playing in is expanding by leaps and bounds. The present worldwide supercomputer market, for both parallel and classical vector types, is about \$1.65 billion, according to figures from market researcher Dataquest Inc. of San Jose, Calif. Of that, massively parallel machines account for only \$150 million, but their sales are growing stronger—the increase is up to 50% a year compared with only 2% for vector systems. It's in that fast-growing parallel computer sector that Parsytec hopes to become a market leader with its supermassive GC engines.

With today's computing resources, says Falk D. Kübler, Parsytec's founder and managing director, many problems are difficult, if not impossible, to solve. For example, simulating both global and local atmospheric flow phenomena in climate research cannot be efficiently done even with today's most powerful computers. Other tasks such as simulating combustion processes in engines to optimize their fuel consumption are also difficult to handle.

What's needed, Kübler says, "are computers from 100 to 1,000 times faster and more powerful" than the systems now available. Conventional vector computers now perform between 1

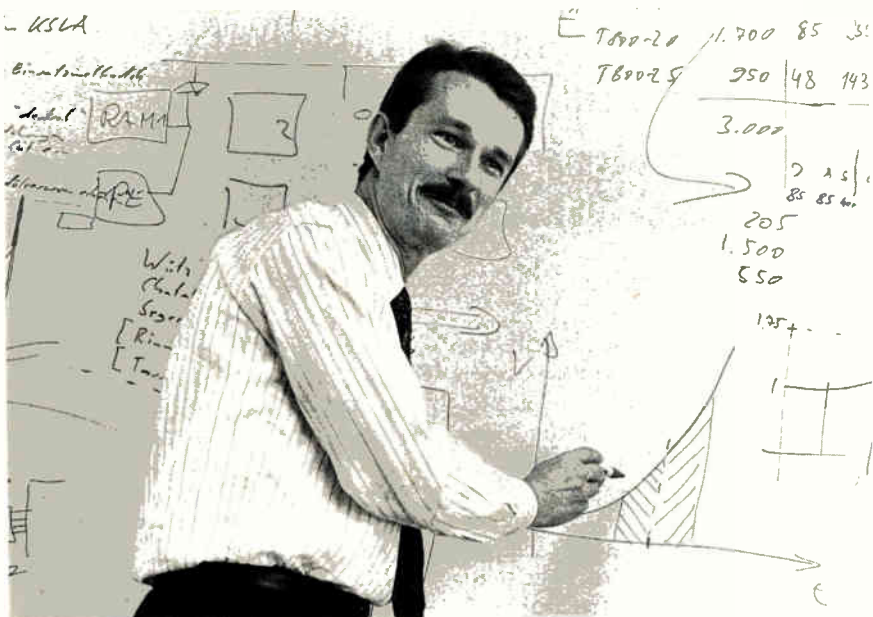

Falk D. Kübler, founder and president of Germany's Parsytec GmbH, believes the GC series meets the need for enormously powerful machines.

and 10 gigaflops; the next generation will probably rate between 10 and 25 gigaflops. That's not enough to cope with the enormous simulation challenges of the future. "The power required to meet these challenges can be achieved only through parallel processing," Kübler says.

For optimum results, parallelism should be coupled with a maximum of microprocessors in a computer. Although there is a tenfold increase in processor power every three and a half years, greater advances can be made at the systems level, Kübler explains. The size of the system—that is, the number of nodes or microprocessors it contains—can be increased tenfold every two years.

Only parallel processing can best exploit the increase in both processor power and system size and produce the benefits resulting from multiplying these two factors. Consistent with these considerations, the Parsytec GC family opens the field of supermassive multiple-instructions-multiple-data parallel computers that can face the computing and simulation challenges of the future. (The company's name, Parsytec, is a contraction of "parallel systems technology." The "GC" in the new family's designation stands for "grand challenges.")

The Parsytec GC series is the first parallel computer family to provide fail-safe operation through redundant processors, error-correcting memory, and an error-tolerant communication struc-

ture, says Friedrich Lücking, product planning manager. Of considerable significance, too, is the family's large scalability of 1 to 1,000 (derived from 0.4 gigaflops to 400 gigaflops).

Such scalability means that if the available computational power does not suffice for a particular task, then it can be successively raised by using additional processors. Because of limitations in construction, most of today's parallel computers can be expanded only up to a certain size and cover a performance range of little more than 1 to 10.

The GC line's wide scale is made possible by a connecting structure whose complexity remains the same with increasing numbers of processors. This, Lücking points out, is the only way to ensure consistent and efficient handling of all configurations in the GC series and to minimize the hardware and software investments.

The various models in the family consist of a three-dimensional network of up to 8 by 8 by 16 building blocks or clusters, each with 16 Transputers interconnected by a number of links. This results in a platform for applications that profit from the large scaling potential and require dedicated topologies. Four clusters arranged in a 3-d formation are integrated in a so-called GigaCube housing, and the GigaCubes can be connected as needed for a particular application. □

MENTOR STARTS SHIPPING PART OF ITS 8.0 TOOLS ON THE SPARC WORKSTATIONS

SUN COMES UP BIG AT DAC

BY JONAH McLEOD

If there was one winner at the late spring Design Automation Conference in San Francisco it was Sun Microsystems Inc. The Mountain View, Calif., workstation maker scored big when Mentor Graphics Corp. of Beaverton, Ore., made the official announcement that it is now shipping portions of its System 8.0 CAE/CAD tools software on Sun's Sparc-based workstations.

"Sun platforms now have a 45% share of the design-automation market," declared Tom Bruggere, chairman and CEO of Mentor. He noted that Mentor's customers prefer the Sun platform over clone systems, a finding that no doubt

made the day for Scott McNealy, president of Sun.

But the Mentor backing wasn't the only support for Sun that surfaced at the conference. Still another major CAE/CAD vendor, Intergraph Corp. of Huntsville, Ala., announced that it was porting all of its software over to the Sun platform. Intergraph has acquired most of the assets of the former Dazix last December, and that CAD vendor had already ported most of its tools to the Sun platform.

What's more, Intergraph is adapting all of its mechanical, mapping, and architectural system software for the Sun machines. For Intergraph, this represents a significant about-face because the company originally had purchased

the Clipper RISC microprocessor from Fairchild to ensure a CPU for its proprietary family of workstations.

The Intergraph and Mentor announcements firmly positioned Sun as the preeminent workstation supplier in the design-automation market. However, the announcement that could trigger the greatest number of shipments was the one that took the wraps off an agreement between Sun and Orcad of Hillsboro, Ore.

The reason, says Orcad president John Durbetaki, is that Sun's biggest-selling software package now accounts for sales of something less than 250 units a month. "We expect to be accounting for unit sales of 500 workstations a month," he says.

Durbetaki says he expects that Orcad software will help ship 45,000 units over the next five years. That is considerable since Orcad currently has 60,000 installed PC seats. Others already on the Sun platform or planning to port include Cadence Design Systems, Racal-Redac, Valid Logic, Viewlogic, and Aldec. □

CAE/CAD

Advertisement

Small Company's New Golf Ball Flies Too Far; Could Obsolete Many Golf Courses

Pro Hits 400-Yard Tee Shots During Test Round

Want To Shoot An Eagle or Two?

By Mike Henson

MERIDEN, CT — A small golf company in Connecticut has created a new, super ball that flies like a U-2, putts with the steady roll of a cue ball and bites the green on approach shots like a dropped cat. But don't look for it on weekend TV. Long-hitting pros could make a joke out of some of golf's finest courses with it. One pro who tested the ball drove it 400 yards, reaching the green on all but the longest par-fours. Scientific tests by an independent lab using a hitting machine prove the ball out-distances major brands dramatically.

The ball's extraordinary distance comes partly from a revolutionary new dimple design that keeps the ball aloft longer. But there's also a secret change in the core that makes it rise faster off the clubhead. Another change reduces air drag. The result is a ball that gains altitude quickly, then sails like a glider. None of the changes is noticeable in the ball itself.

Despite this extraordinary performance the company has a problem. A spokesman put it this way: "In golf you need endorsements and TV publicity. This is what gets you in the pro-shops and stores where 95% of all golf products are sold. Unless the pros use your ball on TV, you're virtually locked out of these outlets.

TV advertising is too expensive to buy on your own, at least for us.

"Now, you've seen how far this ball can fly. Can you imagine a pro using it on TV and eagle-ing par-fours? It would turn the course into a par-three, and real men don't play par-three's. This new fly-power forces us to sell it without relying on pros or pro-shops. One way is to sell it direct from our plant. That way we can keep the name printed on the ball a secret that only a buyer would know. There's more to golf than tournaments, you know."

The company guarantees a golfer a prompt refund if the new ball doesn't cut five to ten strokes off his or her average score. Simply return the balls — new or used — to the address below. "No one else would dare do that," boasted the company's director.

If you would like an eagle or two, here's your best chance yet. Write your name and address and "Code Name S" (the ball's R&D name) on a piece of paper and send it along with a check (or your credit card number and expiration date) to National Golf Center (Dept. S-110) 500 S. Broad St., Meriden, CT 06450. Or phone 203-238-2712, 8-8 Eastern time. No P.O. boxes, all shipments are UPS. One dozen "S" balls cost \$24.95 (plus \$3.00 shipping & handling), two to five dozen are only \$22.00 each, six dozen are only \$109.00. You save \$55.70 ordering six. Shipping is free on two or more dozen. Specify white or Hi-Vision yellow.

© Bost Enterprises, Inc. 1991

A SPECIAL SUPPLEMENT TO ELECTRONICS

DATAQUEST/ELECTRONICS

WHITE PAPER ON DIGITAL VIDEO

A REVOLUTION IN VIDEO



This White Paper was developed
by Dataquest Inc. and Electronics
and written by Samuel Weber

*IBM video guru Brad Beitel
surveys the company's
AudioVisual Connection products*

THE DAWN OF A New Age

A new information age is about to be launched, built on the already profound changes the TV and the personal computer have wrought in our world. The catalyst is digital video, the merging of computers and TV technology. Digital video gives users of desktop computers unprecedented power to capture and manipulate still or moving images. Users can share the displayed information, interact with it, edit, store, and transmit it.

ADDING A NEW DIMENSION

Digital video will bring a new dimension to human communications by combining text, audio, and still or motion pictures in an integrated multimedia presentation on the desktop. The potential impact on business, education, science, medicine, sales, and entertainment is so great that chip makers, systems houses, and software designers are racing to develop components, equip-

Fluent Machines' Fluency system



ment, and applications for this exciting new market, says a recent survey by Dataquest Inc., the San Jose, Calif., market-research house.

MOVING FROM ANALOG TO DIGITAL



Images from RGB Spectrum's Videalink 1600U scanner

Just what is digital video? There are various technical definitions, but a good general one is the digital processing of still and motion pictures that may originate in analog form.

Sources could be TV broadcasts or cable inputs, video cassette recorders,

video cameras, CD-ROMs, or laser discs. Conversion to an appropriate digital format permits users to manipulate, edit, or enhance the displayed images on a PC, TV, workstation, or video game. Additional processing also can bolster image clarity and quality by eliminating ghosts, snow, or other distortions.

However, there are fundamental incompatibilities between a broadcast TV signal and the ability of a computer or workstation to display it. For starters, there are three TV standards to contend with, each significantly different from the other: NTSC in the U.S. and Japan, PAL in most of Europe, and Secam in France and the USSR. Moreover, a TV receiver display creates a picture using interlaced scanning, in which an electron beam scans every other horizontal line on the screen. Modulating the intensity of the beam produces the image that the viewer sees.

By contrast, computer displays use progressive-scanning techniques in which every horizontal line on the screen is scanned. Differences in screen refresh rates, resolution, and color-encoding methodologies multi-

U.S. DESKTOP DIGITAL VIDEO MARKET

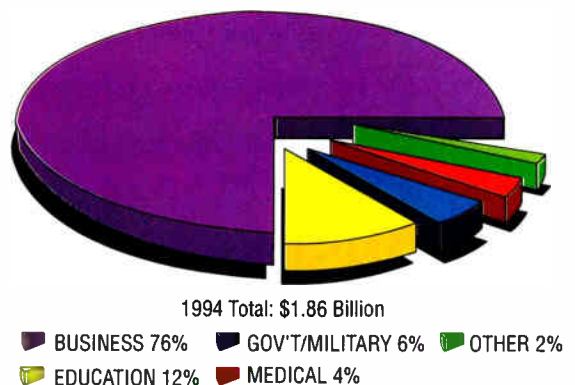

1994 Total: \$1.86 Billion

■ BUSINESS 76%
 ■ GOV'T/MILITARY 6%
 ■ OTHER 2%
■ EDUCATION 12%
 ■ MEDICAL 4%

(Excludes Video Teleconferencing)

SOURCE: DATAQUEST INC.

ply the complexity of the conversion. To make PCs and video compatible takes special decoding and processing circuitry. The system can be seen as a model partitioned into input-, feature-, and output-processing sections.

HOW THE PROCESSING HAPPENS

The input processor, chosen for the desired broadcast standard, comprises an analog-to-digital converter that handles both video and color (chroma) inputs; and a decoder that accepts digitized video, performs horizontal and vertical synchronization, and outputs the monochrome and color—or luminance and chrominance—data. The final link is a clock generator to lock the video’s sync signal with the system clock.



Windowed images from VideoLogic’s DVA-4000/ISA digital video adapter

The feature-processing section accepts the luminance and chroma data, interpolates samples, and converts them to red-green-blue signals as it performs necessary corrections. It provides large high-speed storage of the digital signal in buffer memory for recall later, or at a different frequency. For specific video requirements, processes such as filtering, storage, data compression, or picture-size manipulation can be included

U.S. CONSUMER DIGITAL VIDEO MARKET

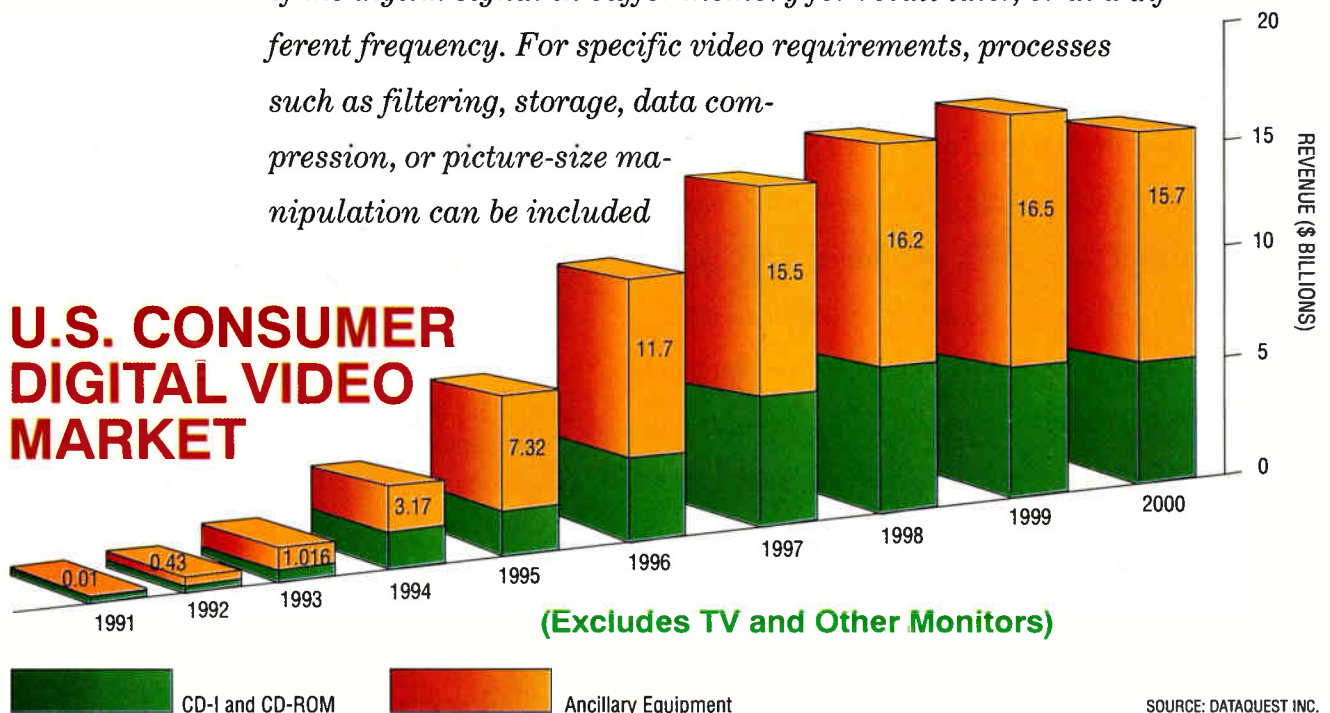

SOURCE: DATAQUEST INC.

Simply defined,
digital video is
the digital
processing of
pictures that
may originate in
analog form.

W

**E TOOK THE VISION
OUT OF TELEVISION...**



Signetics

Philips Semiconductors



PHILIPS

A AND GAVE IT TO COM



PUTER GRAPHICS.

PHILIPS DELIVERS DIGITAL VIDEO NOW.

Real world images communicate with exceptional power. That's why they're now being integrated into the PC and workstation world through digital video — the fusion of video and computer technologies. Wherever you now find computer graphics, in fact, you'll soon find video images easily captured and smoothly integrated with graphics, text and sound. Philips' Digital Video Architecture, DIVA, can bring the excitement of multimedia applications to any user's desktop.



Already, DIVA has opened up active markets for makers of engineering workstations, personal computers, test equipment and medical systems. It's helping to expand applications in desktop publishing, presentations, training, CAD, scientific visualization, video conferencing, networking — and building a foundation for a whole new era of multimedia applications.

OVERCOMING TECHNOLOGY DIFFERENCES.

Merging video and computer technologies would seem to be perfectly natural. But it's still not easy. In video, for example, color is encoded into brightness (luminance) and color (chrominance), whereas in computers it's done in an RGB color

space. Scanning, too, is a problem: video pictures are created with interlaced horizontal lines, while computers typically use progressive scan. Vertical and horizontal resolutions may also vary. And screen refresh rates differ: video uses 50 or 60 Hz, while computers may use higher rates. These and other fundamental incompatibilities have multiplied the complexity of merging these technologies.

THE PHILIPS SOLUTION.

Philips' Digital Video Architecture offers a complete family of digital video components that provide the critical enabling technology for the next generation of multimedia systems. Now, for the first time, designers have access to complete front-to-back hardware links between computers and the myriad of video display, broadcast and recording equipment.

MEETING THE DESIGN CHALLENGES.

Philips' DIVA meets all four of the essential design criteria necessary to fully integrate video and computer technologies:

International standards.

The Philips chipset supports all major international broadcast standards — NTSC, PAL and SECAM — plus the CCIR601 digital video standard (known in the U.S. as D1).

All digital. The Philips implementation is fully digital, operating at 5 volts, with on-chip digital filters. This results in adjustment-free systems.

Distortion-free images. These components can process, display and print video images without distortion. They use a line-locked clocking scheme to produce clean digital conversion from both highly accurate broadcast signals, as well as VCRs, videodiscs, and still/video cameras, which often have large time-base errors.

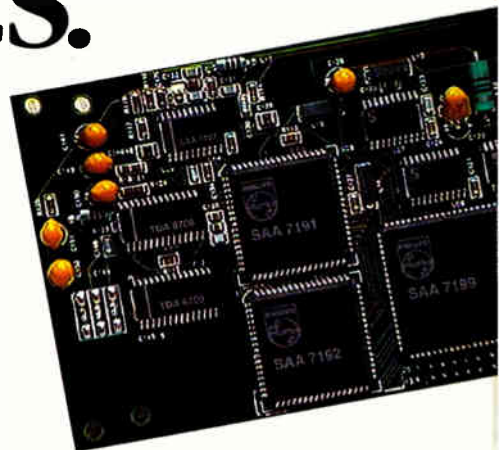

Open architecture. The concept of building blocks supports an open architecture that makes it easy to implement and upgrade systems. DIVA (shown below) neatly partitions designs into input, output and feature — processing subsystems, allowing data to be easily manipulated for specific video requirements.

Beyond these essential criteria, Philips Digital Video Architecture offers a variety of features and price/performance alternatives, making it easy to tailor solutions for high-end industrial and business/professional applications, as well as low-end consumer products. DIVA supports existing video compression standards and allows portability across platforms.

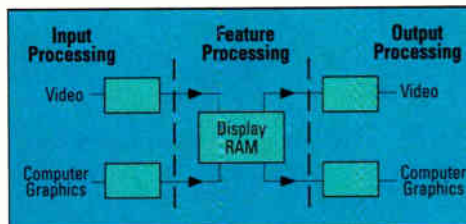

Philips Digital Video Architecture enables easy upgrading of performance and addition of features.



I N DIGITAL VIDEO, TI

incoming analog signal's horizontal line-sync pulse. Internal discrete time oscillators are used to synchronize the pixel clock to horizontal sync and to deoculate the chrominance. This combination of quartz stability and adaptive handling of video line frequency delivers picture elements that are in identical positions in each frame, for exact processing of horizontal (X), vertical (Y) and time (T)

Analog-to-digital converter. With a unique folding and interpolating architecture, Philips A/D converters are specifically designed for digitizing composite video. The TDA8708 handles source select, clamping, and automatic gain control, and provides drive for external low-pass filters. The TDA8709 also offers separate chroma inputs for S-VHS applications.

Digital multi-standard decoders. Philips' family of 7- and 8-bit digital multi-standard decoders accepts digitized

IN DIGITAL VIDEO, TIMING IS EVERYTHING.

One of the major challenges in combining computer and video technologies has been timing, particularly when the video signal originates from a non-broadcast source. Timing errors can result in pixel jitter, rendering the video image unusable for display, storage, processing and compression.

To solve these problems, Philips uses a sample clock that locks onto the

dimensions. This line-locked clock approach eliminates pixel jitter, "tearing" and loss of color, even under adverse conditions.

Orthogonal Sampling Structure

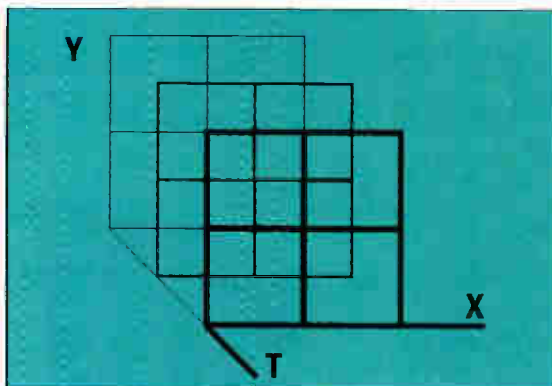

Processing in the horizontal (X), vertical (Y), and time (T) dimensions requires that picture elements are in identical positions in each frame. Philips' unique line-locked-clock implementation satisfies this requirement.

DIVA BUILDING BLOCKS.

Philips offers a powerful chipset that includes an 8-bit A/D converter, clock generator circuit, digital multi-standard decoders, digital color space converters and digital encoders — everything you need for high-performance video.

composite video and performs horizontal and vertical synchronization. They decode the signal into luminance (Y) and chrominance (U,V) outputs for further processing or compression. The SAA7191 decoder, for instance, uses frequencies and pixel counts that provide square pixels, which prevent distortion of on-screen images, and maintain precise WYSIWYG matches of hard-copy printout and displayed video. The SAA7151A decoder is compatible with CCIR601 and provides support for the SCART connector commonly used in Europe.

Digital color space converter. The SAA7192 digital color converter accepts Y:U:V input from the color converter; interpolates samples and digitally converts Y:U:V to R:G:B color. This output can be manipulated as color graphics or directly converted into analog red, green, and blue through D/A converters.

Digital video encoder. The newest member of the Philips digital family,

at this stage. The output of RGB signals in digital form can be manipulated as digital graphics, or luminance and chroma (Y-U-V) signals, which can be converted to RGB in the output stage for acceptance by a computer. In turn, in the output processor they can be transformed back into analog—after filtering and digital-to-analog conversion—for subsequent display.

PRODUCTS ARE HERE AND NOW

Chip sets and boards to accomplish these functions are becoming widely available, testimony to the burgeoning of this exciting technology. Products play on a variety of platforms, including the Apple Macintosh, IBM-compatible PCs, and Commodore's Amiga computer as



Screen produced by Matrox's Illuminator 16 board with Windows 3.0 driver

well as Sun and NeXT workstations. Boards may be simple frame grabbers that capture individual TV frames for manipulation on a computer, or complex units that handle the windowing of full-motion color video and other images. Other boards and software permit editing, titling, and special effects for the production of presentations for commercial, or consumer use. Encoders permit the storage of the enhanced or edited computer graphics for display on a TV monitor or to be saved on videotape.

A SIGNIFICANT TECHNICAL HURDLE

There is another significant technical hurdle that arises if the user wants to store images for future use or transmit them over a network: these are tasks that consume huge amounts of memory and bandwidth if the quality of the image is to be maintained. Storing a single digitized color photo may consume 25 Mbytes, while a 1-min., full-motion video sequence would require about 2 Gbytes.

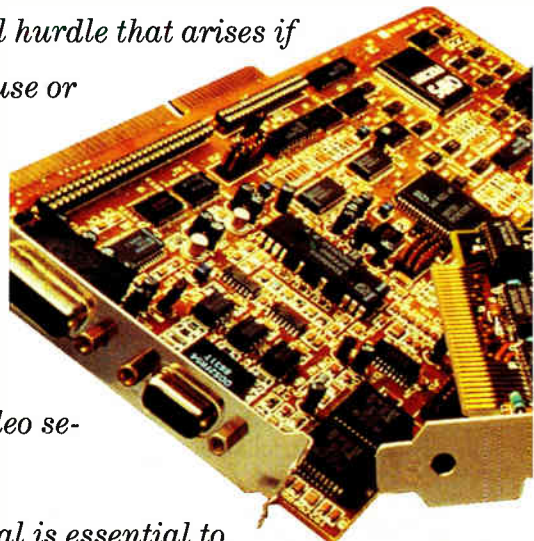

Thus, compression of the digital signal is essential to

Video chip sets
and boards are
now widely
available, a
testament to the
future of this exciting
new technology.

effectively utilize digital video over existing communication lines or to store images in memory of reasonable size. First into the marketplace with compression techniques were Philips Electronics with Compact Disc-Interactive (CD-I) and Intel Corp. with Digital Video Interactive (DVI).

QUEST FOR STANDARDS

Both companies started with proprietary compression schemes but are now actively involved in the international standards-making process being handled by two organizations: the International Consultative Committee for Telegraph and Telephone (CCITT), which is working on video phones, and the International Standards Organization (ISO), which is working on computer images. The ISO initiative rests with two groups, the Joint Photographic Experts Group (JPEG) and the Moving Picture Experts Group (MPEG), which are focusing on still and full-motion video methodologies, respectively. A third important compression standard, H.261 (commonly called Px64), is under development by a CCITT working group for video conferencing and telephones. In the U.S., teleconferencing equipment is available from several companies and is being used by business, education, and government. Most of it is designed to be ultimately compatible with the final international standard.



Primroses from Computer Friends' ColorSnap 32+ video board

Sometime next year, at least one U.S. manufacturer of teleconferencing equipment plans to introduce mass-produced video phones for business and consumer use.

Dataquest market analysts have classified the digital video market into three categories or levels. Level 1 systems operate from analog or digital video inputs derived from broadcast TV, laser discs, or videotape. The systems will accept

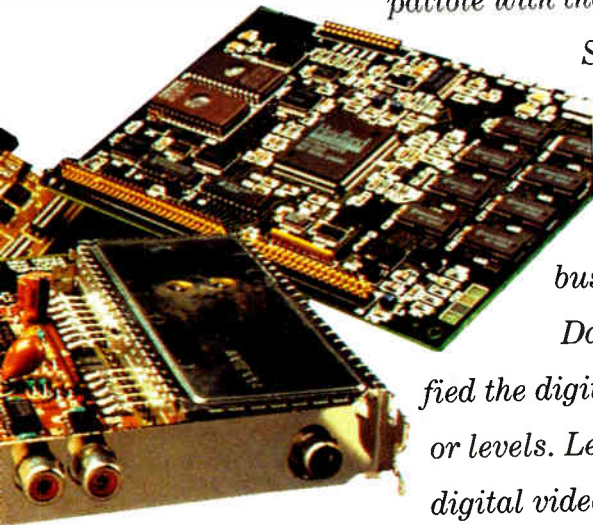

Super Video Windows board from New Media Graphics



IBM's Audio Visual Connection

any of the standard TV formats—NTSC, PAL, or Secam. Level 1 displays live motion on a desktop PC and captures still frames in memory. It permits the addition of stills and titles for presentations, desktop-publishing documents, or other applications involving limited distribution. Level 1 systems require no compression, and the vast majority of products now on the market are in this category.

PLAYBACK-ONLY SYSTEM

Level 2 is a playback-only system that derives its precompressed

inputs from off-line compression techniques. The content is in the form of CD-ROMs. Intel's DVI and Philips's CD-I are primarily Level 2 systems, but DVI offers an edit-level algorithm that operates in real time as well as an off-line, presentation-level algorithm. Level 2 provides random access of archival video data, such as catalogs or encyclopedias. Educational, entertainment, and training programs are among the products being developed.

The most powerful of all the categories is Level 3. With full real-time compression and decompression, this type of system can display, store, and transmit full-motion video. It permits complete authoring of multimedia programs as well as video communication, simulation, entertainment, video conferencing, and other sophisticated applications. This is not a consumer market; users will most likely be the skilled professionals who create mass-produced multimedia packages.

All indications are that the digital video market looms as huge. The technology will impact every segment where video is used and can intersect with computer technology. In addition to the business and commercial world, digital video will make its mark on such con-



Imaging Technology's frame grabbers in action

The technology will impact every segment where video can intersect with the world of computers.

sumer hardware as video cameras, VCRs, video-disc players, color TVs, and electronic games. Advertising, cable TV, VCR rental, and film box-office revenues will be affected.

SURGING DEMAND FROM PRIMARY USERS

Dataquest forecasts that, starting from a relatively small base this year, the U.S. desktop digital video market for business, health care, government, and educational applications will surge to \$1.86 billion by 1994, excluding video teleconferencing equipment.

Dataquest estimates that \$1.6 billion—86%—of this market will be primary users of delivered material on Level 1 or Level 2 systems.

The rest—\$257 million—will be in production types of Level 3 equipment.

On the consumer side, digital video consists today of a hobby market worth \$40 million to \$60 million and comprising video-disc playback equipment, software, and ancillary gear, including embedded computers sold as part of a complete entertainment system. There are numerous add-in products being advertised, at an average selling price of \$750, in consumer video magazines for Commodore, IBM, and Apple computers that let users connect VCRs and camcorders into their PCs. Today's digital video market is not unlike the \$300 million PC market of 1979, when hobbyists and programmers, with no popular software available, were working on VisiCalc-type applications on a mere 370,000 PCs. Like the PC market then, the digital video market will skyrocket, garnering

a whopping \$3.17 billion in U.S. revenues by 1994, says Dataquest. And that doesn't include TV receivers or monitors, which may see a growth spurt under the impetus of this new technology.

As for teleconferencing and video phones, Dataquest estimates that



Commodore's "Multimedia Live" Amiga 3000 model





The multimedia-capable NeXT Computer System

the U.S. market will hit \$716 million by 1994.

Already, professional producers of videos for broadcast and advertising are enhancing their creative skills with the new digital capabilities.

Dataquest anticipates that about a quarter of the 11,400 U.S. sites now en-

gaged in high-end production are using Level 2 digital video techniques. By 1994, that will expand to between 50% and 75%. At Fortune 500 companies, Dataquest says, in-house groups are using digital video to produce highly effective management, sales, and training presentations. Dataquest estimates that less than a tenth of these more than 18,000 U.S. "information-grade" sites currently use digital video technology; this will grow to 50% by 1994.

HERE COME THE 'EARLY ADOPTERS'

In the next wave, the technology will be picked up by so-called "early adopters"—sophisticated corporate users of desktop computers, employing video to publish documents or enhance in-house communications. Dataquest says less than 5% of the 464,000 sites with multiple PCs are now using digital video; by the end of 1994 the penetration should be 28%. Finally, an explosion will take place when the technology begins to penetrate the market represented by the millions of general business users of PCs; sales here should exceed \$1 billion by 1994.



Digital F/X's desktop video production system

Digital video will rebound across a broad front of human endeavor. Through the use of libraries combining print, video, and sound, people can absorb or convey knowledge. Through video teleconferencing, they can collaborate from remote locations. Businesses will enhance communication, cut travel costs, and save time by adding the visual element to the telephone. Salespeople will get dramatic new promotion tools. Electronic mail will take on new meaning when video is added; and consumers will enjoy new forms of home entertainment.

Fortune 500 companies are using digital video to create highly effective management and sales tools.

A survey by Dataquest of a group of large and small companies marketing digital video products reveals intense development activity over a broad swath of applications. Ranking high on the list are desktop publishing; multimedia PCs; computer-aided design and engineering; medical, education, and training; travel and real estate; plus advertising, presentations, insurance, and entertainment. Teleconferencing and video phones figure in relatively few product plans, but they loom large for the future.

About half the respondents are designing products to the JPEG standards, 15% to MPEG, and the rest to proprietary and other standards. Most companies are designing for IBM and Macintosh platforms, fewer for workstations. The end-user price for most products ranges from \$500

to \$2,500, according to the survey.

Most of the respondents expect relatively few units to be shipped this year, with volume building into the hundreds of thousands by 1993. One unnamed company that anticipates it has a hot product on its hands projects sales in the millions beginning next year.



THE BEST IS YET TO COME

It is obvious that digital video technology and its potential applications are still at the start of the learning curve. Thinking has not moved beyond the obvious, but as usually happens when a new technology appears, unimagined applications will soon appear and beget new ideas. Meanwhile, reliable hardware is here now; software lags but is rapidly being developed. The major problem is cost: to conform to the numbers forecast by Dataquest, chips and boards will need to become ubiquitous and cheap. Memory cost must come down as well, and mass-produced software will have to be priced within the reach of the average consumer. And above all, the perceived need for these products must be obvious and their operation simple. Nevertheless, the promise is already starting to be fulfilled. The digital video age has begun.

As usual when a
new technology
first appears,
unimagined
applications will
arise and beget
more new ideas.

Philips - a worldwide company

- Argentina:** PHILIPS ARGENTINA S.A. Div. Philips Components, Vedia 3892, 1430 BUENOS AIRES, Tel. (01) 541-4106
- Australia:** PHILIPS COMPONENTS PTY Ltd, 34 Waterloo Road, NORTH RYDE, N.S.W. 2113, TEL. (02) 805-4455
- Austria:** OSTERREICHISCHE PHILIPS INDUSTRIE G.m.b.H., UB Bauelemente, Triester Str. 64, 1101 WIEN, Tel. (0222) 60 101-820
- Belgium:** S.A. PHILIPS PROF. SYSTEMS - Components Div., 80 Rue Oes Deux Gares, B-1070 BRUXELLES, Tel. (02) 5256111
- Brazil:** Philips Do Brasil Ltda Rua Do Rocio, 220-SAO PAULO-SP, CEP 04552, P.O. Box 7383, Tel. (011) 829-1166
PHILIPS COMPONENTS (Passive Devices & Materials)
Av. Francisco Monteiro, 702 - RIBEIRAO PIRES-SP, CEP 09400, Tel. (011) 459-8211
- Canada:** PHILIPS ELECTRONICS LTD., Philips Components, 601 Milner Ave., SCARBOROUGH, Ontario, M1B 1M8
Tel. (416) 292-5161
(IC Products) SIGNETICS CANADA LTD., 1 Eva Road, Suite 411, ETOBICOKE, Ontario, M9C 4Z5, Tel. (416) 626-6676
- Chile:** PHILIPS CHILENA S.A., Av. Santa Maria, Casilla 2687, SANTIAGO, Tel. (02) 077-3816
- Colombia:** IPRELENSO LTDA., Carrera 21 No. 56-17, BOGOTA, D.E., P.O. Box 77621, Tel. (01) 2497624
- Denmark:** PHILIPS COMPONENTS A/S, Prags Boulevard 80, PB1919, OK-2300 COPENHAGEN S, Tel. (01) 883333
- Finland:** PHILIPS COMPONENTS, Sinikalliontie 3, SF-02630 ESPOO
Tel. 358-0-50261
- France:** PHILIPS COMPOSANTS, 117 Quai du President Roosevelt, 92134 ISSY-LES-MOULINEAUX Cedex, Tel. (01) 40938000
- Germany (Fed. Republic):** PHILIPS COMPONENTS UB der Philips G.m.b.H., Burchardstrasse 19, D-2 HAMBURG 1, Tel. (040) 3236-1
- Greece:** PHILIPS S.A. HELLENIQUE, Components Division, No. 15, 25th March Street, GR 17778 TAVROS, Tel. (01) 4894339/4894911
- Hong Kong:** PHILIPS HONG KONG LTD., Components Div., 15/F Philips Ind. Bldg., 24 Kung Yip St., KWAI CHUNG, Tel. (0)-4245 121
- India:** PEICO ELECTRONICS & ELECTRICALS LTD., Components Dept., Block 'A' Shiv Sagar Estate, Dr. Annie Besant Road, P.O. Box 6598, BOMBAY-400018 Tel. (022) 493-8541
- Indonesia:** P.T. PHILIPS-RALIN ELECTRONICS, Components Div., Setiabudi II Building, 6th Fl., Jalan H.R. Rasuna Said (P.O. Box 223/KBY) Kuningan, JAKARTA, Tel. (021) 515690
- Ireland:** PHILIPS ELECTRONICS (IRELAND) LTD., Components Division, Newstead, Clonskeagh, DUBLIN 14, Tel. (01) 693355
- Italy:** PHILIPS S.p.A., Philips Components, Piazza IV Novembre 3, I-20124 MILANO, Tel. (02) 6752.1
- Japan:** PHILIPS JAPAN LTD., Components Division, Philips Bldg. 13-37, Kohnan 2-chome, Minato-ku, TOKYO (108), Tel. (03) 3740-5000
- Korea (Republic of):** PHILIPS INDUSTRIES (KDREA) LTD., Components Division, Philips House, 260-199 Itaewon-dong, Yongsan-ku, SEOUL, Tel. (02) 794-5011
- Malaysia:** PHILIPS MALAYSIA SON BHD, Components Div., No. 76 Jalan University, 46200 PETALING JAYA, Selangor Malaysia
Tel. (03) 7575511
- Mexico:** PHILIPS COMPONENTS, Paseo Triunfo de la Republica, No 215 Local 5, Cd Juarez CHIHUAHUA 32320 MEXICO, Tel. (16) 18-67-01/02
- Netherlands:** PHILIPS NEDERLANDO B.V., Marktgroep Philips Components, Postbus 90050, 5600 PB Eindhoven, Tel. (040) 783749
- New Zealand:** PHILIPS NEW ZEALAND LTD., Components Division, 2 Wagener Place, C.P.O. Box 1041, AUCKLAND, Tel. (09) 894-160
- Norway:** NORSK A/S PHILIPS, Philips Components, Box 1, Manglerud 0612, OSLO, Tel. (02) 74-10-10
- Pakistan:** PHILIPS ELECTRICAL CO. OF PAKISTAN LTD., Philips Markaz, M.A. Jinnah Rd., KARACHI-3, Tel. (021) 725772
- Peru:** CADESA, Av. Pardo y Aliaga No. 695, P.O. Box 5612, LIMA 27, Tel. (14) 707-080
- Philippines:** PHILIPS ELECTRICAL LAMPS INC., Components Div., 106 Valero St. Salcedo Village, MAKATI, P.O. Box 911, METRO MANILA, Tel. (63-2) 810-0161
- Portugal:** PHILIPS PORTUGUESA S.A.R.L., Av. Eng. Duarte Pacheco 6, 1009 LISBOA Codex, Tel. (01) 68-31-21
- Singapore:** PHILIPS SINGAPORE, PTE LTD., Components Div., Lorong 1, Toa Payoh, SINGAPORE 1231, Tel. (65) 3502000
- South Africa:** S.A. PHILIPS PTY LTD., Components Division, 195-215 Main Road, P.O. Box 7430, MARTINDALE Tel. (11) 470-5911
- Spain:** PHILIPS COMPONENTS, Balmes 22, 08007 BARCELONA, Tel. (03) 3016312
- Sweden:** PHILIPS COMPONENTS, A.B., S-11584 STOCKHOLM, Tel. (08) 7821000
- Switzerland:** PHILIPS A.G., Components Dept., Allmendstrasse 142, CH-8027 ZURICH, Tel. (01) 4882211
- Taiwan:** PHILIPS TAIWAN LTD., 581 Min Sheng East Road, P.O. Box 22978, TAIPEI 10446, Taiwan, Tel. 886-2-500-5842
- Thailand:** PHILIPS ELECTRICAL CO. OF THAILAND LTD., 283 Silon Road, P.O. Box 961, BANGKOK, Tel. (02) 233-6330-9
- Turkey:** TURK PHILIPS TICARET A.S., Philips Components, Talatpasa Cad. No. 5, 80640 GULTEPE/ISTANBUL, Tel. (01) 1792770
- United Kingdom:** PHILIPS COMPONENTS LTD., Mullard House, Torrington Place, LONDON WC1E 7HD, Tel. (01) 5806533
- United States:** (Color Picture Tubes - Monochrome & Colour Display Tubes) PHILIPS DISPLAY COMPONENTS COMPANY, 1600 Huron Parkway, P.O. Box 963, Ann Arbor, Michigan 48106, Tel. (313) 996-9400
(IC Products) SIGNETICS COMPANY, 811 East Arques Avenue, Sunnyvale, CA 94088-3409, Tel. (800) 227-1817 X900
(Passive Components, Discrete Semiconductors, Materials and Professional Components) PHILIPS SEMICONDUCTORS, Discrete Products Division, 2001 West Blue Heron Blvd., P.O. Box 10330, Riviera Beach, Florida 33404, Tel. (407) 881-3200
- Uruguay:** LUZIELECTRON S.A., Avda. Uruguay 1287, P.O. Box 294, MONTEVIDEO, Tel. (91) 56-41/42/43/44
- Venezuela:** MAGNETICA S.A., Calle 6, Ed. Las Tres Jotas, CARACAS 1070A, App. Post. 78117, Tel. (02) 241 7509
- Zimbabwe:** PHILIPS ELECTRICAL (PVT) LTD., 62 Mutare Road, HARARE, P.O. Box 994, Tel. (4)47211

For all other countries apply to: Philips Semiconductors Division, Strategic Accounts and International Sales, P.O. Box 218, 5600 MO Eindhoven, The Netherlands. Telex 35000 phtnl, Fax 23753 ADS88 ©Philips Export B.V. 1991

All rights are reserved. Reproduction in whole or in part is prohibited without the prior written consent of the copyright owner.

The information presented in this document does not form part of any quotation or contract, is believed to be accurate and reliable and may be changed without notice. No liability will be accepted by the publisher for any consequence of its use. Publication thereof does not convey nor imply any license under patent - or industrial or intellectual property rights.

DIGITAL VIDEO ARCHITECTURE FROM PHILIPS

98-19100-1_00

©1991 NAPC. Printed in U.S.A. 1030V/6M/FP/0791

Signetics

Philips Semiconductors



PHILIPS

AS ASIC SALES BOOM, ALLIANCES FORM

Application-specific ICs are selling in Europe like electric fans in August, especially mixed-signal types for the booming telecommunications equipment market.

But ASICs are design specific, so each chip maker tends to produce only a few. The upshot is that European companies are forming joint ventures to broaden their product range.

Two significant moves were made last month. One is a joint venture between binationals SGS-Thomson Microelectronics and GEC-Plessey Semiconductors. The other is an accord under which Philips Components of the Netherlands and French-based European Silicon Structures, known as ES2, will jointly develop a 0.7- μ m CMOS-logic technology for industrial use by both companies.

Last month the Italo-French SGS-Thomson and the English GEC-Plessey announced an agreement that said they would pool re-

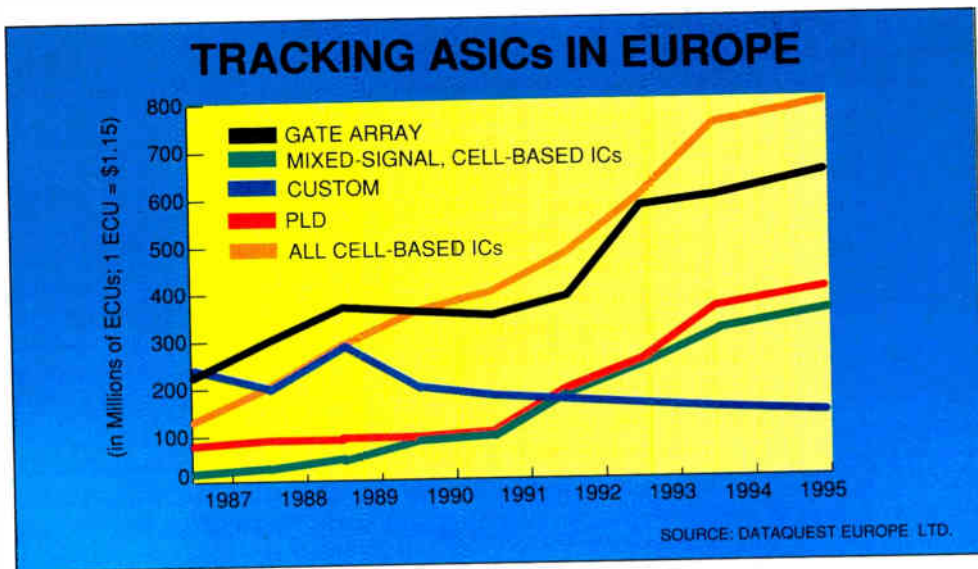

sources for semicustom versions, claiming that the move will increase their combined share of the world market for ASICs. The agreement covers ASICs based on a standardized cell library and 0.7- μ m CMOS technology, which should greatly improve time to market for OEMs. "This is a crucial problem area for electronics manufacturers," says James Eastlake, a semi-

conductor industry analyst with Dataquest Europe Ltd. in London, "and it explains OEMs' lack of satisfaction with ASICs."

For Philips, the partnership with ES2 means a specialized, fast-turnaround source of prototypes for standard products and application-specific ICs. In turn, ES2 has, through Philips, a volume source for its prototypes. □

SGS-THOMSON ENTERS 16-MBIT EPROM CLUB

SGS-Thomson Microelectronics is the first non-Asian producer to enter the exclusive club of companies that are manufacturing 16-Mbit erasable programmable read-only memories. The chip, a result of the Joint European Submicron Silicon Initiative program, better known as Jessi, is also the first of its kind to use European technologies only.

The company already produces the world's fastest 4-Mbit EPROM and, according to Dataquest Inc., commands nearly 11% of global EPROM sales. The San Jose, Calif., market research firm estimates that the market amounted to \$1.4 billion in 1990. SGS-Thomson's new device integrates more than 16 million transistors on a 129 mm² chip. It uses 0.6- μ m technology with advanced isolation and tungsten plug metalization techniques for the 8 million contacts made in each device. □

ANOTHER IBM DEAL: MAKING 16-MBIT DRAMS WITH SIEMENS

IBM Corp., still a restless giant after its accords with Apple Computer Inc. and Wang Laboratories Inc. (see p. 27, has agreed to collaborate with Siemens AG of Munich to manufacture 16-Mbit dynamic random-access memories. The two had joined forces early last year to develop 64-Mbit versions.

The chips will be produced at an IBM plant in Corbeil-Essonnes, near Paris, with both firms sharing the cost, which should come to several hundred million dollars. Other companies will participate if capacity is available.

Several factors provided impetus for the union. One is the enormous cost of starting up high-density memory production; the other is the risk involved in advanced technologies with new process steps. Also drawing the two together are the many years of expertise they have acquired in DRAMs on their own—both companies independently showed 16-Mbit samples last year—as well as the successful cooperation in 64-Mbit DRAM chips, which were manufactured at IBM's facilities at East Fishkill, N.Y.

For IBM, the agreement ties

in with its strategy of entering alliances in an effort to recover from its financial doldrums and regain markets that have been lost to Japanese and American competitors. For Siemens, the deal strengthens its technological base and guarantees its customers long-term availability of key components.

Following what IBM executives call a "very aggressive schedule," fabrication will begin at the end of this year. It is predicted that the first devices will come off the production lines around mid-1992. □

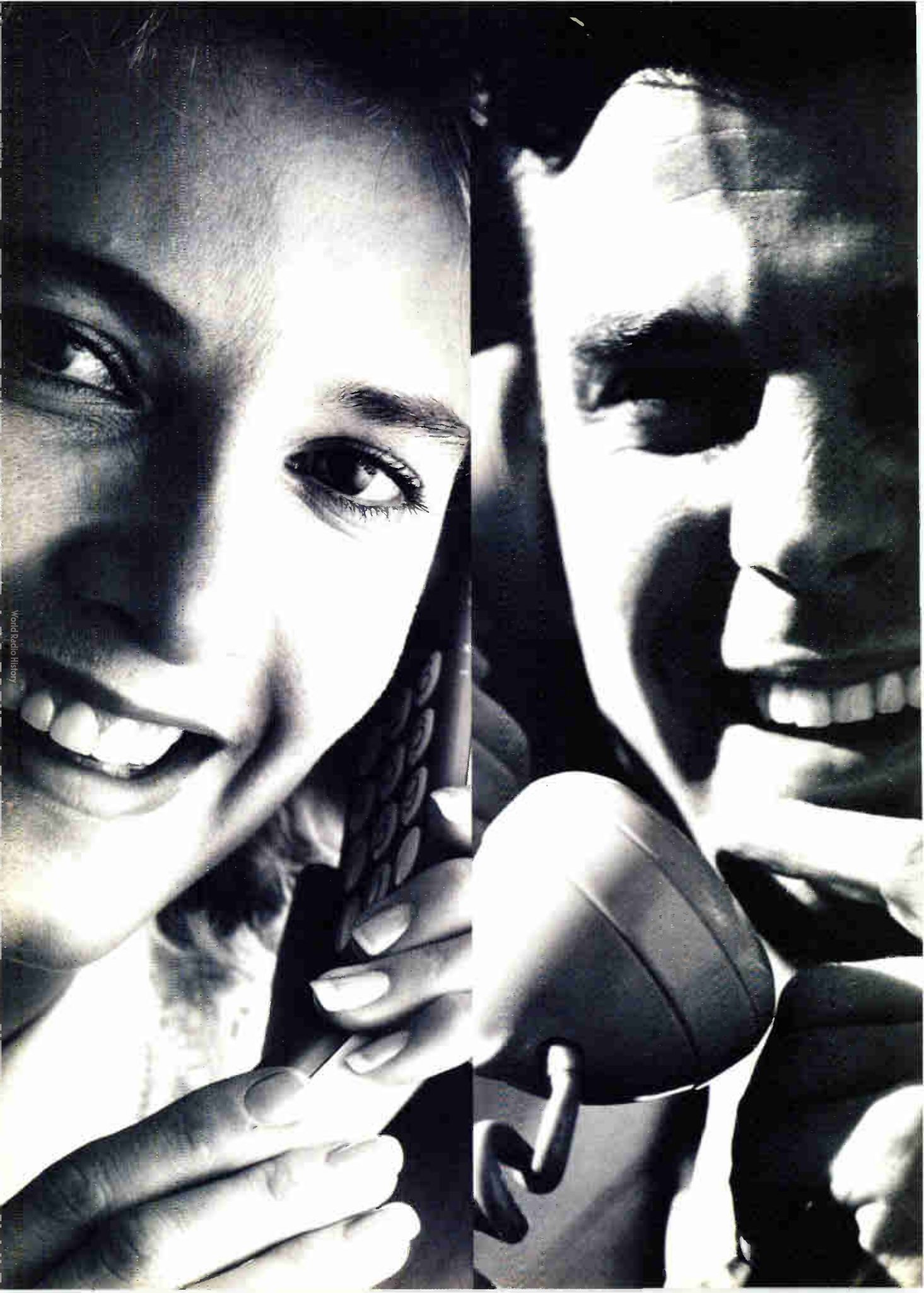

World Photo History

Life without the telephone would be unimaginable today. It has become the pulse of business and personal life.

Now, as ISDN creates new possibilities, the need for Anritsu measurement capabilities is greater than ever.



As the infrastructures of telecommunications expand and progress worldwide, they depend on increasing speed and volume to serve the rapidly growing traffic volume.

Anritsu has consistently responded to these changes with leading-edge technologies to pioneer industry standards in speed, precision and reliability.

Systems require constant evaluation to ensure peak transmission quality, guaranteeing that anyone, anywhere can communicate clearly and easily.

This is the type of advanced testing that is Anritsu's expertise.



At the Heartbeat of Communications

Dedicated to Preserving the Connections Between People



Anritsu also covers more than just one specialized niche. We design and manufacture everything from public coin and card telephones to digital test equipment for any type of system.

Today's sophisticated telecommunica-

It guarantees the instant access that people take for granted.

Anritsu provides key technical support behind the scenes to ensure that these vital networks always come through clearly and reliably for you.

Anritsu

ANRITSU CORPORATION 10-27, Minamiazabu 5-chome, Minato-ku, Tokyo 106, Japan Phone: Tokyo 03-3446-1111, Telex: J34372

CIRCLE 181

World Radio History

BRIEFING

HP'S 95LX PALMTOP IS FRUIT OF A REMARKABLE ALLIANCE AMONG ERSTWHILE RIVALS

ANATOMY OF 'COOPETITION'

BY SAMUEL WEBER

When Hewlett-Packard Co. introduced its 95LX palmtop computer in April, it not only celebrated the debut of a remarkable product, it also sent two significant signals to the global electronics community. First, by forming a unique alliance with four major corporate partners who often compete fiercely, HP established a paradigm for the way complex product development may be conducted in the future. The 95LX is a prime example of what one industry wag has dubbed "coopetition." Second, it showed that the U.S. still has the capability to out-innovate and one-up the Japanese in developing unique products.

HP's unprecedented alliance with software mavens Lotus and Microsoft, and hardware heavyweights Intel and Motorola, resulted in the 95LX moving to market just 15 months after it was defined. Lotus Development Corp. contributed its 1-2-3 spreadsheet and a suite of organizer tools, plus file-transfer and management utilities. Microsoft Corp. furnished a read-only-memory version of DOS 3.22 for the operating system. Intel Corp. provided a custom ASIC chip that handles all the PC-compatible peripheral functions, such as display and keyboard control, and special features like sound and low-battery-power detection. And Motorola Inc. added a new dimension to portable computing in the form of DataStream, its miniature data receiver and nationwide data-broadcasting service to be available in the fall. It will enable HP's palmtop to receive data messages anywhere in the continental U.S.

With the full functionality of a PC XT (but 2.5 times faster), the 11-oz palmtop

packs these extras plus advanced calculator functions and broad communications capabilities—all for less than \$700. With its built-in spreadsheet, appointment book, phone book, and memo editor, it has a big edge over such other personal organizers as Sharp Corp.'s Wiz-

PARTNERSHIPS

Terpack holds. "In a world in which a whole host of elements have to come together—hardware, software, distribution, communications technology—it's extremely important to leverage other people's expertise and not try to duplicate that," he says. "None of us has unlimited resources and none of us can make the investment necessary to have the world-class capability that you can have if you choose world-class partners."

This sentiment is echoed by Jerry Erickson, 95LX R&D section manager. "It took us about 15 months to get from where we actually committed to the project and [when we] were able to start manufacturing and delivering it. This is remarkable when you consider that it was a brand-new architecture for our division, a new IC set, and a new software set," he says. The key, Erickson says, "was the ability to leverage industry expertise that existed."

In the world according to Intel, "It's almost an idea where you're supplanting the idea of

partnerships with 'co-travelers,'" says Mike Eisele, Intel's program manager of subnotebook PC products in Chandler, Ariz. "Global markets require integration of multiple technologies. You combine where there is a mutual interest. In one area companies may compete, and in others cooperate. In terms of managing risk and especially time to market, this kind of cooperation will be more the pattern in the future."

The "coopetition" that went into the creation of the 95LX was to some degree a result of serendipity. Both HP and Lotus had developed similar concepts for such a product at about the same time. "I had been working on some ideas of getting Lotus into the consumer electronics business," says Leon Navickas, general manager of R&D at Lotus in Cambridge, Mass. "The people at HP instantly picked up on my proposal, as they had similar things going on in their lab." Lotus, says Navickas, wanted "to try and expand [its]

com-pet-i-tion \kəm-pə-'ti-
[LL competition-, com-
petitūs, pp. of com-
(1605) 1: the act of
competing:
RIVALRY 2:
a contest betw-

co-op-e-ti-
(1991) ne-
a commo-
same oth-

co-op-er-ate \kō-'ap-
[LL cooperatus, pp. of coo-
co-operari to work-more at
OPERATE] (1616) 1: to act or wo-
with another or others; act together
2: to associate with another or
other for mutual benefit-
co-op-er-a-tion \-'rā-shən\

co-op-e-ti-tion \kō-'āp-pə-'tish-ən\
[cooperation-, competition] (1991)
neologism to define the act of working
with others toward a common goal
with the intention of competing against
those same others once the goal has
been attained.

ard and Casio's Boss. And because it is built around DOS 3.22, it can interact with a desktop PC, which market research told HP was an important feature to prospective users.

The backing of the 95LX by such an imposing lineup of partners almost instantaneously legitimizes the palmtop in an emerging market characterized by disparate products with nonstandard operating systems and somewhat limited capabilities. Perhaps as important, it indicates a growing trend toward intra-industry cooperation, where mutual interests exist, to cut costs and time to market.

"In today's market you have to be very fast moving," says Dan Terpack, general manager of HP's Corvallis, Ore., Division, "and I don't think any one company can do it all by themselves, especially at the pace that it has to be done." To compete requires alliances.

market beyond traditional PCs. I set down specs of what was sort of the 95LX and took them on the road to the Far East and the West Coast. I spoke with about a half dozen leading consumer electronics companies to gauge their interest in partnering with Lotus," with the software giant's role defined as the licensing of embedded technology. Navickas likens the approach to the Dolby stereo business. "Every cassette deck has Dolby in it, an essential piece of functionality. We thought that Lotus 1-2-3 and our personal-organization tools could be the same kind of essential applications for palmtops."

As far as prospective partners, Navickas says Lotus had "an embarrassment of choices" but felt the greatest kinship with HP. "A lot of light bulbs went off, and they recognized this was the right thing," he says. "For our part, we recognized immediately that they were the easiest people to work with, the best people in the world to partner with to establish this new category of computing instrument. They had the hardware-design know-how to build it and support it, and they had the sales and marketing infrastructure in consumer electronics and calculators to distribute the product. It was a win-win situation."

For HP, the product evolved out of a desire to expand the market for the Corvallis Division, whose mainstay products were handheld sophisticated calculators. In this mature business, says Terpack, "To get significant growth you have to take significant market share from other players—not the easiest thing to do when the market is that mature." But Corvallis managers had "seen things like personal organizers come to market and the expansion of functionality of handheld products," Terpack says. "We began to think about how we could put together something consistent with what we've done in that arena to come up with a highly functional, premium, best-in-class product."

To reach that apogee, it became obvious that communications were one essential ingredient and a link to the desktop in a PC with integrated applications another. From other companies' marketing plans, "We knew it was going to be an arena that represented an opportunity," Terpack says. "We wanted to be in with the first product that really began to establish this market and stake out a leadership position; that was

one of the things that drove us to form alliances." Lotus's arrival may have involved ESP: "They called us a week before we would have called them," Terpack says.

Upon Lotus's entry, says HP product manager Kent Henscheid, "we went out and did some research targeted at Lotus users showing a more specific rendition of the product concept, with a number of alternatives." They found enough interest to make the project a go, and then turned their attention to Motorola. The wireless-messaging capability that company had announced would be important to laptop users, HP believed. "We showed them what we were doing in handhelds," says Henscheid, "and they really jumped on that."

The next duck to line up in the row was Intel, which HP hoped would weigh in with the crucial ASIC. This device, along with a NEC Corp. V20 processor, forms the heart of the 95LX. "We have a lot of in-house IC expertise," Terpack says, "but what we don't have is standard cells and a PC architecture." With HP's concepts and the design savvy of Intel, "we jointly developed and implemented" the IC.

Its creation was no walk in the park for the chip maker, says Intel's Eisele. Intel engineers had to create some new cells to accommodate HP's definition. "They were trying to achieve a very high level of integration to reach their power and size requirements," he says. "In parallel with the shared chip development, we had to define a custom cell that became part of the library used to execute the chip." Despite HP's aggressive schedule, he adds, "engineering samples of silicon were delivered within one day of the schedule." Intel has a vested interest in the 95LX because of its own stake in the portable computer market, says Eisele. "Up to now the focus has been notebook systems, but we're also trying to bring the benefits of the open DOS architecture with the appropriate standards that apply to palmtops. So we're

**"BY OFFERING
A STANDARD
SPREADSHEET
AND OS,
THE 95LX
LEGITIMIZES
THE MARKET."**

very pleased to support HP and cooperate in that standardization and market-development effort."

For a standard OS that would provide seamless interaction with desktop PCs, HP turned to Microsoft. The Redmond, Wash., company's role was supplying the ROM version of DOS 3.22, which it was already marketing in the Far East and in non-PC applications where a hard disk doesn't play a role, says Sergio

Pineda, product manager of the DOS group. Such applications include point-of-sale and data-collection terminals. Microsoft saw the 95LX as an opportunity to broaden its market, Pineda says.

He adds that the machine will offer some much-needed standardization in a palmtop market where each vendor has so far had its own proprietary operating system and very specific applications. "By offering a standard spreadsheet and operating system, and a shell that's compatible with every desktop PC, it legitimizes the market," Pineda says. Microsoft is already working on a ROM version of the recently introduced DOS 5.0 for this market, says Pineda.

So far this improbable roundelay of competitors cooperating on a proprietary product promises a happy ending for everyone. Intel's Eisele sums it up this way: "Motorola is the leader in communications technology and Intel is the leader in computing technology. It's not surprising that both [of them] benefit in the growth of the palmtop market, as opposed to fighting over it. We envision a huge market that really takes off once we have the ability to economically integrate computer and communication technology. So we view the HP project as a very cooperative synergistic effort."

From the software side, "There's no question that MS-DOS is the standard operating system, and having that available on the HP 95LX is a benefit to customers," says Lotus's Navickas. "We don't do operating systems, but there's no argument that we have the de facto standard in spreadsheets with Lotus 1-2-3. I don't see any threat from Microsoft in that area." □

Tools

Design Tools

Virtual Simulation Tools

PC Board Layout Tool

EDIT/ESP

Design Management Tools

OrCAD[®]



Schematic

Editors

Draft

Edit File

View Reference Material

Configure Schematic Design Tools

Category: Electrical Rules Matrix

i i o
n / u
o t

Input Pin

Input/Output Pin

Output Pin

Open Collector Pin

Passive Pin



CIRCLE 204
World Radio History

JOHN -
THIS LOOKS LIKE
ORCAD ON THE SUN
SPARC STATION.
CALL (503) 690-9881
AND LOOK INTO IT.
T.



INTRODUCING SOME OF OUR LATEST CONTRIBUTIONS TO TECHNOLOGY DEVELOPMENT.

In Florida, we understand a company's need to have a highly trained workforce in place when a new facility opens.

That's why we offer customized vocational training programs to meet the needs of new and expanding firms. And why our community colleges and universities offer many specialized, technology-oriented courses designed to help Florida's industry maintain a competitive edge.

Give us a call. Or write to the Florida Department of Commerce, Division of Economic Development, 310 Collins Building, Rm. ELE, Tallahassee, FL 32399-2000. We'll show you that, when it comes to picking a new company location, nobody gets better grades.

FLORIDA

The perfect business climate from
coast to coast to coast

(904) 488-5507, Ext. 761.

CIRCLE 194

World Radio History

FREE INFORMATION

Use this card to receive free information on the products featured in this issue.

Name _____
 Title _____
 Company Name _____
 Company Address _____
 City/State/Zip _____

USE ADDRESS LABEL HERE OR PRINT IN CLEARLY

CIRCLE NUMBERS FOR MORE INFORMATION

1	21	41	61	81	101	121	141	161	181	201	221	241	261	281	301	321	806
2	22	42	62	82	102	122	142	162	182	202	222	242	262	282	302	322	807
3	23	43	63	83	103	123	143	163	183	203	223	243	263	283	303	323	808
4	24	44	64	84	104	124	144	164	184	204	224	244	264	284	304	324	809
5	25	45	65	85	105	125	145	165	185	205	225	245	265	285	305	325	810
6	26	46	66	86	106	126	146	166	186	206	226	246	266	286	306	326	811
7	27	47	67	87	107	127	147	167	187	207	227	247	267	287	307	327	812
8	28	48	68	88	108	128	148	168	188	208	228	248	268	288	308	328	813
9	29	49	69	89	109	129	149	169	189	209	229	249	269	289	309	329	814
10	30	50	70	90	110	130	150	170	190	210	230	250	270	290	310	330	815
11	31	51	71	91	111	131	151	171	191	211	231	251	271	291	311	331	816
12	32	52	72	92	112	132	152	172	192	212	232	252	272	292	312	332	817
13	33	53	73	93	113	133	153	173	193	213	233	253	273	293	313	333	818
14	34	54	74	94	114	134	154	174	194	214	234	254	274	294	314	334	819
15	35	55	75	95	115	135	155	175	195	215	235	255	275	295	315	335	820
16	36	56	76	96	116	136	156	176	196	216	236	256	276	296	316	801	821
17	37	57	77	97	117	137	157	177	197	217	237	257	277	297	317	802	822
18	38	58	78	98	118	138	158	178	198	218	238	258	278	298	318	803	823
19	39	59	79	99	119	139	159	179	199	219	239	259	279	299	319	804	824
20	40	60	80	100	120	140	160	180	200	220	240	260	280	300	320	805	825

Electronics
 READER SERVICE CARD
 08/91/490

TELEPHONE NUMBER
 () _____

Check your one principal job function.

- 01 Corporate & Operating Mgt.
- 07 Engineering Mgt.
- 03 Manufacturing Mgr.
- 04 Purchasing Mgt.
- 05 Marketing & Sales Mgt.

How many people are employed in your entire organization?

- 1 10,000 or more
- 2 1,000-9,999
- 3 100-999
- 4 Less than 100

FREE INFORMATION

Use this card to receive free information on the products featured in this issue.

Name _____
 Title _____
 Company Name _____
 Company Address _____
 City/State/Zip _____

USE ADDRESS LABEL HERE OR PRINT IN CLEARLY

CIRCLE NUMBERS FOR MORE INFORMATION

1	21	41	61	81	101	121	141	161	181	201	221	241	261	281	301	321	806
2	22	42	62	82	102	122	142	162	182	202	222	242	262	282	302	322	807
3	23	43	63	83	103	123	143	163	183	203	223	243	263	283	303	323	808
4	24	44	64	84	104	124	144	164	184	204	224	244	264	284	304	324	809
5	25	45	65	85	105	125	145	165	185	205	225	245	265	285	305	325	810
6	26	46	66	86	106	126	146	166	186	206	226	246	266	286	306	326	811
7	27	47	67	87	107	127	147	167	187	207	227	247	267	287	307	327	812
8	28	48	68	88	108	128	148	168	188	208	228	248	268	288	308	328	813
9	29	49	69	89	109	129	149	169	189	209	229	249	269	289	309	329	814
10	30	50	70	90	110	130	150	170	190	210	230	250	270	290	310	330	815
11	31	51	71	91	111	131	151	171	191	211	231	251	271	291	311	331	816
12	32	52	72	92	112	132	152	172	192	212	232	252	272	292	312	332	817
13	33	53	73	93	113	133	153	173	193	213	233	253	273	293	313	333	818
14	34	54	74	94	114	134	154	174	194	214	234	254	274	294	314	334	819
15	35	55	75	95	115	135	155	175	195	215	235	255	275	295	315	335	820
16	36	56	76	96	116	136	156	176	196	216	236	256	276	296	316	801	821
17	37	57	77	97	117	137	157	177	197	217	237	257	277	297	317	802	822
18	38	58	78	98	118	138	158	178	198	218	238	258	278	298	318	803	823
19	39	59	79	99	119	139	159	179	199	219	239	259	279	299	319	804	824
20	40	60	80	100	120	140	160	180	200	220	240	260	280	300	320	805	825

Electronics
 READER SERVICE CARD
 08/91/490

TELEPHONE NUMBER
 () _____

Check your one principal job function.

- 01 Corporate & Operating Mgt.
- 07 Engineering Mgt.
- 03 Manufacturing Mgr.
- 04 Purchasing Mgt.
- 05 Marketing & Sales Mgt.

How many people are employed in your entire organization?

- 1 10,000 or more
- 2 1,000-9,999
- 3 100-999
- 4 Less than 100

Subscription Dept.



Affix Proper POSTCARD RATE Postage

Electronics

A Penton Publication
 P O BOX 985008
 CLEVELAND OH 44198-5008
 USA



Reader Service Dept.



NO POSTAGE
NECESSARY
IF MAILED
IN THE
UNITED STATES

BUSINESS REPLY MAIL
FIRST CLASS MAIL PERMIT NO. 25029 CLEVELAND, OH

POSTAGE WILL BE PAID BY ADDRESSEE

Electronics

A Penton Publication
1100 SUPERIOR AVENUE
CLEVELAND OH 44197-8058

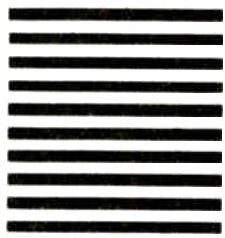

Reader Service Dept.



NO POSTAGE
NECESSARY
IF MAILED
IN THE
UNITED STATES

BUSINESS REPLY MAIL
FIRST CLASS MAIL PERMIT NO. 25059 CLEVELAND, OH

POSTAGE WILL BE PAID BY ADDRESSEE

Electronics

A Penton Publication
1100 SUPERIOR AVENUE
CLEVELAND OH 44197-8118



Electronics **SUBSCRIPTION AUTHORIZATION**
*Prepayment is Required Payment enclosed

Name _____
Company _____
Address _____
City/Province _____
State/Country/Postal Code _____
Telephone Number _____

Charge my subscription to:
 American Express Visa
 Mastercard . . . Interbank# _____
Account# _____
Date Card Expires _____
Signature _____
Date _____

Subscription Rates* . . . 1 year 2 years		
U.S.	\$ 60.00	\$100.00
CANADA	\$ 70.00	\$120.00
INTERNATIONAL	\$125.00	\$225.00

*Be
Competitive
Subscribe to
Electronics
Today!*

*PAY BY CREDIT CARD
OR PUT IN ENVELOPE
WITH YOUR CHECK,
MAIL ORDER OR BANK
DRAFT IN U.S. FUNDS.

2025 Gateway Place, Suite 354
San Jose, California 95110

(408) 441-0550.....(408) 441-6052FAX

Sal F. Marino.....*Chairman and CEO*
Daniel J. Ramella.....*President and COO*
James D. Atherton.....*President, Electronics Group*
John G. French.....*Publisher*

BUSINESS STAFF

Ken Long.....*Research Manager*
Kathy Torgerson.....*Promotion Manager*
Bob Clark.....*Circulation Manager*
Doris Carter.....*Ad Serv/Production Manager*
Brian Ceraolo.....*Cardecks and Quick Ads Manager*
Mary Lou Allerton.....*Reader Service Manager*

SALES OFFICES

Regional Vice Presidents:

David M. Woodward.....*Cleveland*
Chandler C. Henley.....*New York*
Richard B. Cutshall.....*Chicago*
Harmon L. Proctor.....*Atlanta*
George M. Horrigan.....*Los Angeles*

GENERAL MANAGER, EUROPEAN OPERATIONS:

John Allen
Four Seasons House
102B Woodstock Rd., Witney,
Oxford OX8 6DY England...0993-778-077 FAX: 44-993-778-246
SAN JOSE

Tina Ireland (N. California)
Blair Hearsh (N. California/Northwest/N. Canada)
2025 Gateway Place, Suite 354
San Jose, CA 95110.....(408) 441-0550 FAX: (408) 441-6052
LOS ANGELES

Chuck Crowe (S. Calif./Arizona/Colorado/Utah)
(Orange County/San Diego County)
16255 Ventura Boulevard, Suite 300
Encino, CA 91436.....(818) 990-9000 FAX: (818) 905-1206
CHICAGO (Midwest/Dallas)

Julie Harter
2 Illinois Center Building, Suite 1300
Chicago, IL 60601.....(312) 861-0880 FAX: (312) 861-0874
BOSTON

John J. Fahey (New England/Eastern Canada)
400 5th Avenue
Waltham, MA 02154.....(617) 890-0891 FAX: (617) 890-6131
NEW YORK

Ric Teeling (Mid-Atlantic Region & Southeast)
Brian Ceraolo (Direct Connection Ads)
611 Route 46 West
Hasbrouck Heights, NJ 07604.....(201) 393-6060
FAX.....(201) 393-0204

JAPAN
Hirokazu Morita, Japan Advertising Communications Inc.
New Ginza Building, 3-13 Ginza 7-Chome, Chuo-Ku Tokyo
104 Japan.....FAX: 81 3 5718710

AUSTRIA, GERMANY, SWITZERLAND
Friedrich K. Anacker, Intermedia Partners GmbH
Katernberger Strasse 247
5600 Wuppertal 1, West Germany.....(02) 271-1091
FAX.....49 202 712431

FRANCE
Claude Bril, IDG Communications France
Cedex 65 92051, Paris LA DEFENSE-France.....(04) 9047900
FAX.....33 149 047800

HOLLAND
W.J.M. Sanders, S.I.P.A.S.
Oosterpark 6-P.O. Box 25
1483 ZG DeRyp, Holland.....(02) 997-1303
TELEX: 13039 SIPAS NL.....FAX: 31 2 997 1500
ITALY

Cesare Casiraghi, Via Cardano 81
22100 Como, Italy.....031/536003 FAX: 031/536007
KOREA

Young Sang Jo, President, BISCOR
K.P.O. Box 1916, Seoul, Korea.....FAX: 82 2 7323662
TAIWAN

Charles C.Y. Liu, General Supervisor
United Pacific International, Inc.
No. 311, Nanking E. Rd., Sec. 3
Taipei, Taiwan, R.O.C.....FAX: 886 2 7169493
UNITED KINGDOM, SCANDINAVIA

John Maycock
Huntons Bldgs., 146 West Street
Sheffield, S14ES, England.....742 759186 FAX: 44 742 758449
CHINA

CCI Asia - Pacific Ltd.
Site 905, Garden House, 32 Oi Kwan Rd.
Happy Valley, Hong Kong.....FAX: 852 834 5620
Media Developments Ltd.
13/F Jung Sun Commercial Bldg.
200 Lockland Rd., Hong Kong

INFORMATION CENTER

Use the postage-paid card on the facing page; circle the number of each company you would like to know more about.

ACCOMMODATIONS

4 - Best Western—Join the Gold Crown Club and you will get even more out of America.

LOCATIONS

194 - Florida—The perfect business climate from coast to coast to coast.

CAE/CAD

204 - Orcad—Design automation.

MANUFACTURING

200 - EDS—Develop shorter lead times, accelerate delivery schedules, and even improve stringent quality standards.

COMMUNICATIONS

181 - Anritsu—As ISDN creates new possibilities, the need for Anritsu measurement capabilities is greater than ever.

177 - Fujitsu—The secret to better Ethernet is NICE, the MB86960 Network Interface Controller with Encoder/Decoder from Fujitsu.

MICROCONTROLLERS

211 - Philips—The highest innovation rate in 8-bit microcontrollers—and the lowest power 80C51 on the market.

POWER DEVICES

190 - Vicor—Over 2,500 standard models add up to your power-system solution.

219 - Abbott—Mil-pac high-density military power supplies now ac to dc; actual output 20 W.

COMPONENTS

175 - AMP—Our six-row connector lets you change the ground rules.

196 - Fujitsu—New relays cut pickup power consumption up to 70%.

207 - Harris—Signal processing and power control are our specialty.

206 - Pico—Ultraminiature dc-to-dc converter transformers.

206 - Pico—Dc-to-dc converters, now up to 100-V dc output.

201 - Teledyne—Our FB Series military solid-state relay features high speed and low off-state leakage.

SEMICONDUCTORS

173 - Analog Devices—Of all the mid-size companies in the Dataquest customer survey, one consistently came out on top in all five categories: Analog Devices.

TEST & MEASUREMENT

185 - GenRad—Boundary scan is coming, and GenRad's been working out solutions.

186 - Hewlett-Packard—When quality depends on calibration, depend on HP.

178 - National Instruments—More choices, more answers for data acquisition and instrument control.

217/218 - PhotoResearch—(217 for salesman; 218 for literature) The SpectraScan SpectraRadiometer brings near-real-time testing to the production line.

176 - Tektronix—The new TDS Series: you have to build a million oscilloscopes to build just one like it.

199 - Teradyne—People say boundary scan is a breakthrough in low-cost, high-quality board testing. Now you can test that theory.

CONTRACT MANUFACTURING

212 - Orbit—How Foresight takes the bite out of IC development costs.

DATA CONVERSION

192 - Burr-Brown—A line of easy, painless plug-in solutions that let you concentrate on the application.

DISPLAYS

189 - Contraves—LED-line is a modern electronic analog display that can be mounted vertically or horizontally.

NEC NEWSCOPE



GLOBAL VISION: FOR INTERNATIONAL CORPORATE INFORMATION NETWORKS.

Today's multi-national corporations require an efficient network for international information exchange. NEC responds with Global VISION (Versatile Solution-Oriented Network), a sophisticated private network that can be tailored to specific corporate needs.

NEC provides total support for network construction. Our services range from problem analysis to system design, installation and maintenance.

We even offer system operation and management.

Global VISION is a high-quality, multi-media network that integrates telephone/facsimile, data and images. For international networking, it leases cost-effective, high-speed digital circuits on satellites or submarine cables. Global VISION connects to domestic private networks and, where regulations permit, to public switched-telephone networks.

Global VISION opens the full range of advanced services. Facsimile and voice mail eliminate time zone problems. Distances disappear with international teleconferencing, remote CAD and high-speed file transfer.

High-quality NEC products form the heart of Global VISION systems. These include our advanced multi-media multiplexers, PBXs, packet switches and facsimile mail systems.

NEC invites consultation from corporations interested in Global VISION to reduce communications costs and improve productivity.

READY FOR SDH/SONET DIGITAL NETWORKS.

The goal of worldwide telecommunications is free exchange of information throughout the global community. But North America, Europe and Japan all have different digital communication standards, and the digital networks of the nations involved cannot freely interconnect.

The network node interface (NNI) operating in the synchronous digital hierarchy (SDH) offers a clear solution. SDH is recommended by CCITT/CCIR and sets an international standard for high-speed digital transmission. SDH is the key to flexible broadband networks that feature efficient operation, administration and maintenance.

NEC is prepared to enter the SDH arena with new fiber optic transmission systems (FOTS) and digital radio products. The primary multiplexer combines tributary signals of 1.5, 2, or 6.3Mbps to 51.84 or 155.52Mbps. The high-order multiplexer bundles these composite signals up to 2.4Gbps. Cross-connector functions are also offered. SDH digital radios include 4/6GHz–150Mbps systems for long-haul use and an 18GHz–150Mbps system for short-haul use.

FOTS and digital radios with NNI are already in commercial service in Japan. FOTS based on SONET (the U.S. version of NNI) have been on field trial in the U.S. since 1990. SONET digital radios will go on trial this year in Australia and the U.S.

LATEST SHOWCASE OF SKYSCRAPER INTELLIGENCE.

The NEC Super Tower, our new 180m, 43-story skyscraper in Tokyo, is a living model for next-generation smart buildings. The tower provides a comfortable environment for 6,000 headquarters personnel and supports them with integrated communications, information processing and television systems.

The Super Aladdin system supports 20-plus services including electronic processing of business forms, electronic mail and filing, electronic secretary, and a company-wide electronic cabinet. Super Aladdin links 7 distributed power servers with workstations or 2,000 PCs in a LAN.

Telephone Aladdin, designed for



our Open Application Interface, is a completely new OA system that integrates a digital PBX and a computer. Utilizing a telephone terminal with liquid crystal display, users can take advantage of message/paging services and an on-line telephone directory for over 35,000 extensions.

TV Aladdin can broadcast strategic business information to 105 offices across the country. It also provides

teleconferencing with three NEC subsidiaries in the U.S.

A super-large building automation system offers integrated control for all facilities and manages even such aspects as crime prevention and disaster preparedness. The sophisticated office and building automation systems

in the tower are supported by a 622.08Mbps trunk fiber optic LAN, and a unique integrated voice and data LAN on each floor of the tower.

Super Aladdin: Available only in Japan.

NEW LD MODULE FOR CATV DISTRIBUTION.

NEC's answer to the growing need for fiber optics in the CATV industry is a 1.3 μ m distributed-feedback, laser-diode module. The OD-8339 improves picture clarity by reducing noise and distortions in analog CATV distribution.

Higher performance comes from two internal isolators working in tandem. They deliver 50dB isolation—

tops in the industry. In 40-channel AM/FDM CATV transmission with 4mW output power, our LD module offers: CSO \leq –60dB, CTB \leq –65dB, and RIN \leq –150dB/Hz.

The OD-8339 comes with a single-mode fiber and a fine FC-PC or D4-PC connector. It provides stable operation over ambient temperatures from 0°C to 55°C.

NEC

FRIEND OR FOE? LIFE ON THE

TENSIONS MOUNT AS IBM AND MICROSOFT DRAW BATTLE LINES AND WOO INDEPENDENT SOFTWARE VENDORS

BY LAWRENCE CURRAN

A battle is raging between IBM and Microsoft for control of the desktop personal computer market, and the chief weapon is the operating system. For the moment, Microsoft Corp. has a huge lead, thanks to the runaway success of Windows 3.0.

But IBM Corp. is pushing hard to jump-start its OS/2; a centerpiece of its strategy is recruitment of independent software vendors (ISVs) to port applications to the new OS/2 2.0.

So if you face a decision about which desktop OS to choose for the long term, be advised that Microsoft's MS-DOS/Windows 3.0 and its upgrades likely will maintain their lead for the next few years. But the first little cracks are developing in Windows, and it's never a good idea to dismiss IBM, especially when Big Blue makes a commitment to a product the way it has to OS/2 2.0.

The once-congenial relations between IBM and Microsoft have become sorely strained over the wrangling. The leak in June of an internal memo from Bill Gates, founder and chairman of the Redmond, Wash., software house, to his executive staff identifying IBM as a foe focused public attention on the long-rumored stress between the two giants in their fields. Until then, their battles had remained beneath the surface.

The announcement last month of an alliance between Apple Computer Inc. and IBM undoubtedly will widen this rift (see p. 27). Among other things, the two computer makers will codevelop an object-oriented operating system to run on both PCs and Macintoshes. It will be crafted by an independent company to be jointly owned by Apple, which is based in Cupertino, Calif., and IBM, headquartered in Armonk, N.Y. Since products won't be out for at least three years, most industry analysts don't expect this development to have any near-term market impact—which

leaves IBM and Microsoft as the chief PC operating-system combatants until the mid-1990s.

Analysts vary in their operating-system projections for the period through 1995, but most expect MS-DOS/Windows 3.0 to be the leader by far on the desktop. Nevertheless, some chinks are beginning to show in Microsoft's armor, and IBM could upset the estimates if it does as good a job of implementing OS/2 2.0 as it is in promoting it. Version 2.0 is due out late this year.

While DOS with Windows will remain dominant, "OS/2 will make some gains by the mid-'90s," says Nancy McSharry, an analyst in market-research firm International Data Corp.'s Mountain View, Calif., office. In fact, McSharry says Microsoft may be vulnerable because of user disappointment over Windows, which can't handle some of the more complex functions that OS/2 can. For example, Windows is not good for networking, she points out.

"A lot of people may feel they've been duped by Microsoft," McSharry says. "They thought [Windows] would be the be-all and end-all on the desktop, but you really need a systems integrator to make it work. So if OS/2 2.0 does what IBM says it does, a lot of ISVs could take another look at it." The result might be a desktop split, McSharry adds. "OS/2 may be used as an access front end for corporate data, with Windows 3.0 being used for personal productivity programs," such as word processing and spreadsheets. Such a take on the future is widely held in Europe (see p. 49).

The most important measure of a PC operating system's success is the number of application programs it can run, such as word processors, spreadsheets, and data bases. The wooing of ISVs that both IBM and Microsoft continual-

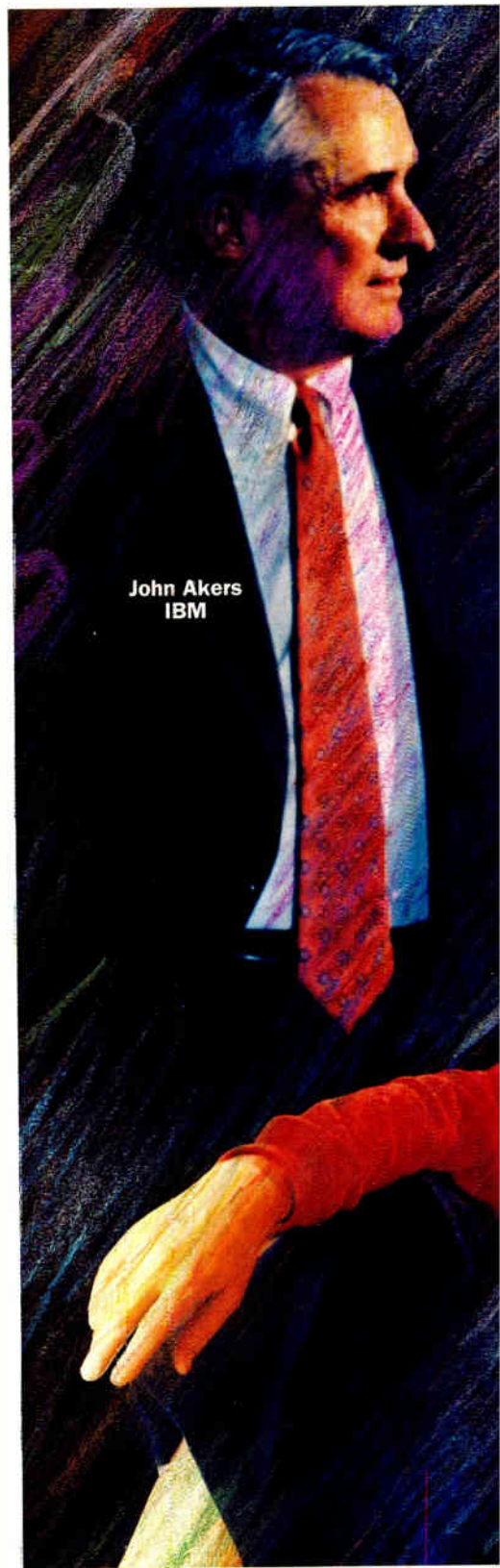

John Akers
IBM

FRONT LINES OF THE OS WAR



ly mount is to have them port those all-important applications to their respective operating systems.

IBM is working hard to court vendors; Big Blue expects to have more than 24,000 programs to show for the 32-bit operating system by the time it is delivered. Microsoft is quick to point out, however, that 22,000 of those are existing DOS applications that already run under Windows 3.0. Further, Jonathan Lazarus, Microsoft's general manager of system software marketing, says another 1,300 new applications were specifically written for Windows, a number that could reach 2,000 soon.

The days of cooperation and fraternal competition between the two firms are over. IBM and Microsoft worked together to develop OS/2-Presentation Manager, IBM's graphical user interface. But OS/2 2.0 is primarily IBM's development, and Big Blue finds a rival in Microsoft's own version, OS/2 3.0. This advanced operating system, due out in 1992, will roll DOS, Windows, and OS/2 into a single environment but won't be compatible with 2.0.

The Gates memo paints IBM as an archrival. Among other things, Gates wrote that "making sure Windows is the winning [PC] OS is our highest priority. Eventually, we need to have at least a neutral relationship with IBM. For the next 24 months, it may be fairly cold." IBM's response to the memo's publication in industry journals has been typically subdued. John Soyring, director of OS/2 software developer programs based mainly in Austin, Texas, remarks laconically: "It's interesting reading, and a lot of inquiring minds will want to know about it."

Microsoft's Lazarus acknowledges in the wake of this infamous document that "the relationship [with IBM] is strained. We're on very different courses. There have been arguments in the past, but they were always 'under the covers.' This one is out in the open."

Whether the IBM-Microsoft relationship is running hot or cold, "DOS will be a leading PC operating system well into the '90s," according to IDC analyst McSharry. "DOS is aided by the predominant strength of Windows 3.0,

which is predicated on DOS, and also by the fact that OS/2 had its troubles in its formative years," McSharry says. "There was no clear migration path for OS/2. ISVs had to learn how to write new applications while learning a new operating system." McSharry projects that while the installed base of non-Windows DOS will grow at a compound annual rate of just 17% between 1990 and 1995, MS-DOS/Windows 3.0 will hit 41% over the same period. IDC estimates that the growth rate for all versions of OS/2 will be even higher, but from a much smaller base.

Despite such bearish projections for OS/2, some of the key ISVs have a different view of the battle. "We think OS/2 is a lot stronger than many people think right now," says Matt Miller, director of technical marketing for the Desktop Group at Oracle Corp. in Redwood Shores, Calif. Miller, whose group provides data-base application software and related software tools, looks for DOS/Windows to increase in market share, but because of an OS/2 surge "not as much as many were saying a few months ago. We ported everything we had to both DOS and OS/2 [IBM's version], but OS/2 applications sold much less until a few months ago. People went to Windows for a while," says Miller, then found it wasn't the best OS for all applications. "Now they're all back asking about OS/2."

For example, Miller says that in a network where a data base resides on a server, "it's not acceptable to boot data bases from the server to the desktop client a couple of times a day to run under Windows," a logistical headache that is now required. This limitation and others like it will combine with IBM's aggressive OS/2 2.0 push to boost that operating system to a 25% to 30% market share in the next five years, Miller predicts. Non-Windows DOS will have about 25%, while MS-DOS/Windows 3.0 will have most of the remainder.

Another believer is James Neiser, director of data-base product management at Ashton-Tate, a Torrance, Calif., supplier of data bases. "A lot of [application] vendors know they have to devel-

op programs for Windows first, then ask 'what can we do for [IBM's] OS/2?' after that," Neiser says. For his part, Paul McNulty, director of marketing for the 1-2-3 spreadsheet at Lotus Development Corp., Cambridge, Mass., says, "I hear good things about OS/2 2.0. Eighteen months ago, OS/2-Presentation Manager was said to be dead. Now I hear from customers that they see the benefits of a graphical user interface such as Windows, but OS/2 2.0 could be a longer-term answer for multitasking."

Meanwhile, IBM is nothing if not bullish on OS/2. The company won't release its sales projections, but it has thrown all of its considerable weight behind making the operating system a major market force. Although OS/2-Presentation Manager was widely seen as near-moribund not long ago, IBM breathed new life into it with version 1.3. Now it's promoting 2.0 as only IBM can. For example, Soyering says that at \$150, IBM has priced version 1.3 some \$15 below the list price of the new DOS 5.0, Microsoft's update of the venerable PC operating system. Big Blue is offering customers a free upgrade to OS/2 2.0 if they buy 1.3 before the end of this year, when 2.0 is to be ready.

"We want to establish OS/2 as the 32-bit operating system of choice," Soyering says. Some of the moves to reach that goal involve marketing deals, a five-day OS/2 2.0 demonstration earlier this year, and marketing support for ISVs. The ISV relationships include an accord with Borland International Inc. to develop its ObjectVision visual programming tool for OS/2 2.0 and one with Lotus that lets IBM sell Lotus Notes and cc:Mail, both of which will be ported to 2.0. What's more, LAN leader Novell Inc. of Provo, Utah, is developing network-server software for OS/2, and Micrografx Inc. of Richardson, Texas, will provide a program that lets OS/2 run Windows programs from Presentation Manager.

All of this will help IBM overcome OS/2's current key limitation—the lack of a large body of application programs. Soyering estimates that of the 24,000 programs that will run under OS/2 2.0, more than 20,000 will be existing 16-bit-DOS programs. Of the rest, some 2,600 will be proprietary programs from corporate developers and—importantly—some 1,300 will be Windows programs that will run without rebooting.

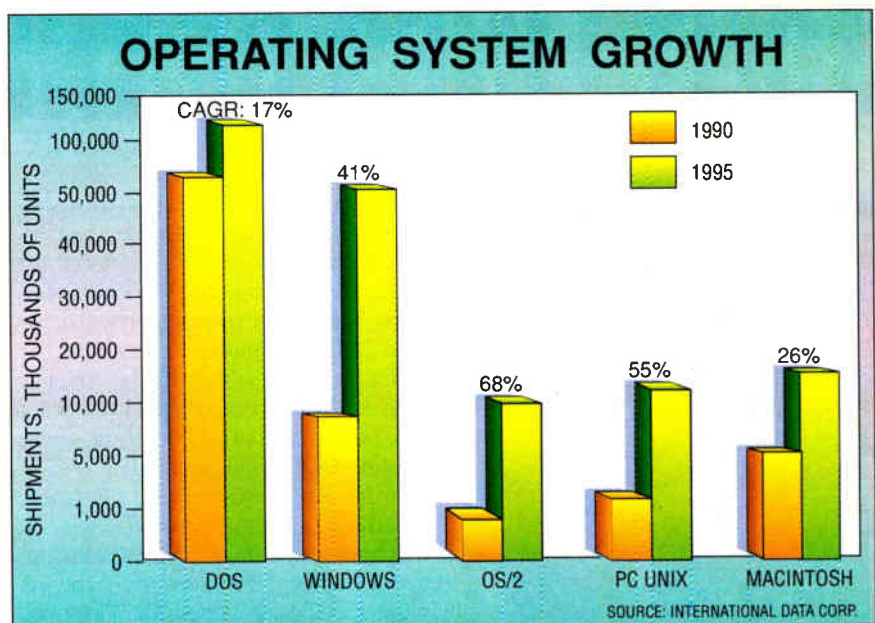

But if sheer numbers tell the tale, Microsoft can crow loudly about the onrush of Windows 3.0. Lazarus cites figures from the Software Publishers Association in Washington showing first-quarter Windows sales at \$205 million, with DOS at \$725 million and OS/2-Presentation Manager at just \$25 million. "We're forecasting a 1991 run rate of 4.5 million to 5 million units," says Lazarus. "We've simply seen no parallel to the success of Windows." Windows 3.1 is in beta testing now in preparation for release this year, he says.

As for recruiting ISVs, rumors have surfaced that IBM is paying them to port programs to OS/2, which Soyering denies. "There's always competition for the budget resources of applications producers, but the biggest motivating factor is their view of the market opportunity," he says. "We've shared our views of the future of OS/2 2.0 and are seeing a significant shift" in ISV direction, he says. IBM offers ISVs 10% rebates on IBM hardware, discounts on software-development tools of up to 40%, and marketing support. "A lot of ISVs view a relationship with IBM as a strong plus," Soyering says.

Microsoft's Lazarus says he's heard the rumors about IBM paying ISVs "from reliable sources, and we're operating on the basis that they're true. IBM has done it before, but we haven't. We don't have to pay people to write applications" for DOS and Windows. "Our message to ISVs is simple: write a Windows applica-

tion and it will run on OS/2, too. We'll make sure we move you forward to Windows 3.1 and beyond."

Ashton-Tate's Neiser says it's becoming fairly common for vendors of PC hardware and operating systems to court ISVs with financial support. "Several companies have come to us and offered to help support development," he says. While he won't name them, "they're all major vendors." But Oracle's Miller says he is unaware of payment offers. "I've never heard of that," he says, although "they'll wine and dine you when a new version of an operating system is coming."

Miller does, however, sense mounting stress between IBM and Microsoft. "The Gates memo declares war on IBM, and IBM has tacitly declared war on Microsoft. There's a huge amount of tension between the two, and Microsoft seems paranoid" about IBM, he says. "Their partnership has never worked well, and now Microsoft has to shoot down OS/2 2.0 in order to sell OS/2 3.0." He points out that Microsoft continues to emphasize OS/2 3.0, "which is not a direct lineal descendant from 2.0."

IDC analyst McSharry also cites the incompatibility of 2.0 and 3.0 as a source of stress. "They're two different operating systems. The 3.0 nomenclature implies that it's an upgrade of 2.0, and it really isn't. The two aren't source-code compatible, and the specs for 3.0 make it sound like a Unix variant more than anything else," she says. "It may get Microsoft into the workstation market." □

B

oundary Scan. Don't panic.

Boundary Scan is coming. The standard is set.

It's a very complex issue. And you can't ignore it.
But don't worry.

GenRad's been working out solutions with many of the leading-edge proponents and users of boundary scan design concepts.

As a result, the GR228X and GR275X Board Test Systems are designed to support boundary scan testing based on the IEEE 1149.1 standard.

Owners of these GenRad systems can look forward to boundary scan without fear of system obsolescence.

If you're ready for a new way of thinking about boundary scan, request your copy of "Perspectives On Boundary Scan Impact on Board Test Strategies."

Call 1-800-4-GENRAD in the U.S., or the GenRad office nearest you in Austria, Canada, England, France, Germany, Italy, Japan, Singapore, Switzerland.



GenRad

A New Way of Thinking

CIRCLE 185

Data Acquisition Boards

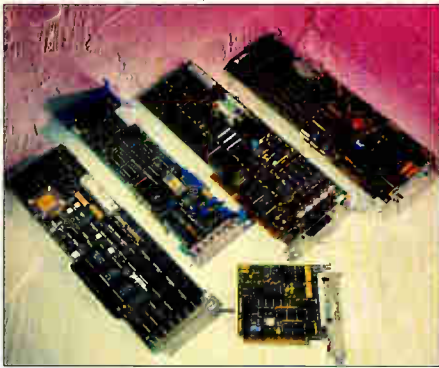

DSP Hardware & Software



Technical Support



LabVIEW

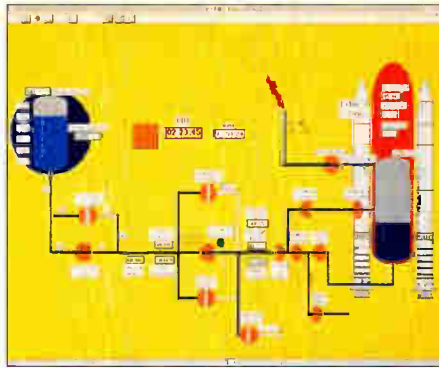

VXI Controllers

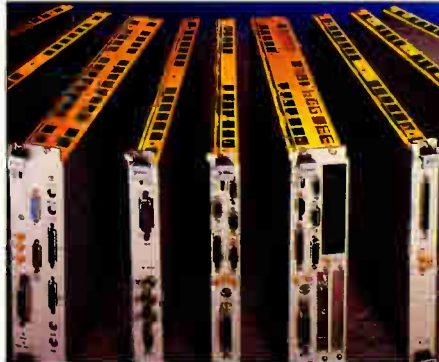

LabWindows

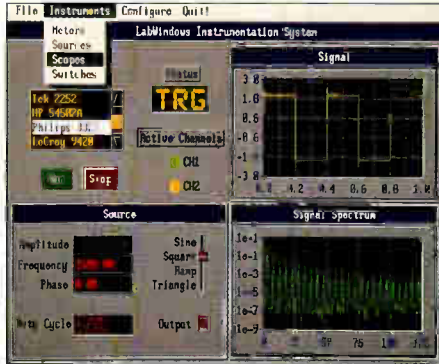

Training



IEEE-488.2 Interfaces



GPIB Support Products



MORE CHOICES, MORE ANSWERS for data acquisition and instrument control



In the complex world of data acquisition and instrument control, National Instruments gives you choices. With our diverse range of products, you can choose the type of instrumentation you want to use, how to analyze your data to extract meaningful information, and how to present your data so that it makes sense. These choices give you more than a single answer to your application needs.

Our products—your choices—are part of a revolution in instrumentation technology, a revolution in which scientists and engineers use industry-standard computers running powerful software to build their own virtual instruments. These modular instruments are more cost-effective, more flexible, and adapt more readily to changing needs than the instruments of the past.

To find out more about your choices, call for our free catalog. Or, better yet, speak with

one of our application engineers. He or she will help you find the answers to your specific data acquisition and instrument control problems.



6504 Bridge Point Parkway
Austin, TX 78730-5039
(512) 794-0100
(800) 433-3488

National Instruments Branch Offices: in: Australia (03) 879 9422, Denmark (45) 76 73 22, France (1) 48 65 33 70, Germany (089) 714 5093, Italy (02) 4830 1892, Japan (03) 3788 1921, Netherlands (01720) 4576, Norway (03) 846 866, Spain (908) 504 304, Switzerland (056) 45 58 82, U.K. (0635) 523 545

© Copyright 1991 National Instruments Corporation. All rights reserved.

CIRCLE 178
World Radio History

DOS LEADS, BUT OS/2 IS GAINING

EUROPEAN PC MAKERS ARE HOPING THE TWO SYSTEMS WILL ONE DAY MERGE **BY JOHN GOSCH**

The battle between MS-DOS/Windows 3.0 and OS/2 1.3 (see p. 44) has made its mark on Europe's PC industry. Clearly dominating the market at present is MS-DOS, and predictions from the San Jose, Calif., market-research firm Dataquest Inc. are that it will continue to do so in the years ahead, although OS/2 may come to narrow the DOS lead somewhat.

While the two systems are in competition, "I would not call this a battle, nor a serious confrontation," says Joachim Feldmann, senior director at Siemens Nixdorf Informationssysteme AG (SNI) in Munich. In fact, Feldmann believes the two will one day merge, with successors to Windows 3.0 from Microsoft Corp., Redmond, Wash., ever more closely meshing with IBM Corp.'s version of OS/2-Presentation Manager.

Perhaps as soon as the mid-1990s, Feldmann says, there will be just one user interface. "A merging of the competing systems is in everybody's interest, as that would spur PC sales," he says. "A fragmentation of the OS market will only hurt the industry."

As in Germany, PC operating systems in France, Spain, and Italy are largely the domain of Microsoft, says Martin Milautzki, an analyst at International Data Corp. in Kronberg, Germany: "The installed base of PCs in these countries is 80% MS-DOS. Mi-

crosoft got in early and has remained strong." About 250,000 copies of Windows have been sold in France, 120,000 in Italy, and 90,000 in Spain, Milautzki says. But Presentation Manager is beginning to win converts in banking and finance, he notes. Companies like France's Groupe Bull and Italy's Ing. C. Olivetti & Co. offer it. In this regard the Continent is ahead of Britain. "In the UK, OS/2 is nowhere," says Keith Wharton, head of Wharton Information Services Ltd., London, who claims OS/2 market penetration is "certainly less than 1%."

Although IBM is said to be pushing its system hard, there are several reasons why OS/2 sales

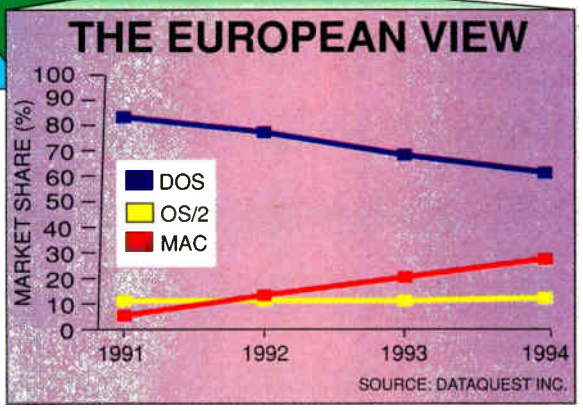

lag. For one thing, OS/2-based PCs require more memory capacity than DOS machines. For another, there isn't enough software available to lure users to such PCs. Finally, the 1.1, 1.2, and 1.3 versions of OS/2 do not fully exploit the capabilities that Intel Corp.'s 386 and 486 CPUs offer. However, IBM's upcoming OS/2 2.0 has an edge over DOS in that it offers such features as

multitasking, memory protection, and virtual addressing. So in the near term, "unless Microsoft succeeds in eliminating MS-DOS's weak spots, OS/2 will gain in acceptance and market share," SNI's Feldmann predicts.

But Feldmann does not expect a complete reversal of the DOS-to-OS/2 ratio any time soon. One indicator is that European software houses are spending far more money developing and porting applications to MS-DOS/Windows than to OS/2, he says. Much in the news in Europe these days is MS-DOS 5.0, the OS Microsoft announced in June. The firm's German subsidiary expects steady 15% annual growth in German-speaking areas alone for the next few years. Microsoft will also offer an update package enabling many of the world's more than 60 million DOS users to upgrade their computers.

Independent software vendors are few and far between in Europe, and active mainly in niche markets. Because U.S. ISVs of the likes of Borland International, Lotus, and Microsoft operate globally and hence command volume, they can easily exert their influence on European markets. PC users in Europe mostly depend on U.S. shrink-wrapped applications sold with the equipment.

"But Europeans have a good chance to get active in the software supply market," says SNI's Feldmann; and his company is a good example. For its PCs SNI offers what it calls Comfo Products, a Windows 3.0-based program that includes editors, queries for data bases, and gateways for networking. To date Comfo Products has won several major financial and industrial contracts.

Standing apart from the DOS-OS/2 joust is Apple Computer Inc., which is doing particularly well in the UK. Indeed, Wharton analysts expect that when figures for May are released, they will show that the Macintosh has ousted market leaders Compaq Computer Corp. and IBM out of the top-supplier spot for the month.

Though IBM and Compaq watched their UK shipments drop dramatically in the first quarter, Apple itself is more modest about its fortunes. "We are certainly in the top three now and very close to both IBM and Compaq," says spokeswoman Judith Coley. She says Apple's share is around 15%, compared with about 20% each for IBM and Compaq. □

With additional reporting by Peter Fletcher and Andrew Rosenbaum

It's nice when your customers think the world of you.



Recently, the purchasing experts at several hundred of the world's largest electronics companies were asked by Dataquest, a leading international research firm, to rate semiconductor suppliers. The rating applied to the very specific and demanding areas of price, on-time delivery, quality, technical support and attention to customer service.

Of all the mid-size suppliers these people could have chosen as best in all five areas, one company consistently came out on top – Analog Devices.

We're proud of that, and of the Dataquest Globe that symbolizes being named Supplier of the Year.

But we're not resting on our laurels. We're working just as hard as ever to keep our customers happy. Because after all, they mean the world to us.



Analog Devices, Inc., One Technology Way, P.O. Box 9106, Norwood, MA 02062-9106. Headquarters: (617) 329-4700. Offices, applications support and distribution available worldwide.

CIRCLE 173

World Radio History

PC OS WAR WILL SPUR A LAN SHOWDOWN

THE DESKTOP WINNER COULD IMPACT NETWORK OPERATING SYSTEMS, BUT DON'T TELL THAT TO NOVELL **BY JACK SHANDLE**

The battle for control of the desktop might just be spilling over into the local-area network. The big, unanswered question is to what extent the desktop winner—which at this point seems to be Microsoft Corp.'s DOS 5.0 with Windows—will have on determining market share among network operating systems. Microsoft thinks desktop and network operating systems are going to be based on a single OS kernel. If that is the scenario, the desktop winner will matter a great deal. Novell Inc.—with 70% of installed nodes, the leader in the network OS (NOS) market—thinks the crowning of the desktop king will not matter one whit. The company holds that the desktop world is too heterogeneous for a monolithic networking solution.

At the heart of the debate are contrary perceptions of the future computing environment. A distributed-processing model, in which tasks are spread evenly across the network irrespective of which desk they originate on, will require tighter and tighter coupling between the microcomputer's operating system and the network's. This is Microsoft's view, and if true it could mean that the Windows vs. IBM OS/2 duel (see p. 44) will have an impact on NOS market share. But if most processing remains on the desktop where the task originated, then there is no need for a homogeneous OS and the network can concentrate on providing connectivity. That is Novell's belief.

Two things seem certain. First, the NOS shakeout will continue with Novell Netware, Microsoft's LAN Manager, and Banyan Systems Inc.'s Vines all but excluding the other NOS players. These also-rans include IBM Corp.'s LAN Server and Digital Equipment Corp.'s Pathways. Second, this technology consolidation will spur even more partnerships between system vendors and NOS companies. One such alliance that made a big splash this year is IBM's agreement with Novell to sell and service Netware.

Besides underscoring IBM's shift from dependence on Microsoft, the accord opens the door for Novell to gain

NETWORKING

Fortune 500 accounts the Provo, Utah, company had not been able to crack on its own, says Bill Redman, vice president of the Gartner Group, a Stamford, Conn., market-research company. In late June, Novell followed up with an international announcement: it had begun shipping a Japanese version of Netware supported by Fujitsu, NEC, Sony, and Toshiba.

In Redman's view, the contest for market share will depend as much on strategic partnerships of this sort as it does on superior technology. "System vendors will increasingly take on the role of NOS value-added reseller," he says. Companies like IBM and Hewlett-Packard Co. "will be offering several seemingly competitive products to obtain the desired systems or hardware sale."

Microsoft, based in Redmond, Wash., has already licensed LAN Manager to 24 original-equipment manufacturers, says LAN product manager Rich Barth. And Banyan, in Westboro, Mass., scored a coup late last year by signing a joint integration agreement with Compaq Computer Corp. But even with the help of the Houston hardware giant, most observers think Banyan needs more marketing clout. "Banyan has the best NOS technology of any of the three vendors," says Frank Costa, president of Protocols Inc., a Beaverton, Ore., developer of integration software. "No one outside Novell and Microsoft is likely to challenge that. But this is not about technology. It is about market



PLUGGING IN

The Big Three—Novell, Microsoft, and Banyan—are jousting for sockets in the networks of the '90s.

muscle and partners." All three companies—Novell, Microsoft, and Banyan—share some basic strategies. Each is busy signing up independent software vendors to support its products. And all three have to give the best possible support to application-program interfaces (APIs) for both Microsoft's Windows and IBM's OS/2 PC operating systems.

The Gartner Group is one of the leading proponents of the distributed-processing view of the world. It has forecast that the uses of networked PCs will change radically in the next five years. Monolithic applications, in which all processing is done on a desktop, will drop from 70% to 35% of total PC use by 1995, Gartner says. Distributed functions—such as having a compute server do the calculations and return an answer to the desktop—will increase from 5% in 1990 to 21% in 1995, predicts the firm.

This can only be accomplished if the NOS products enhance their functionality. When LANs did little more than transport files from one computer to another, tight coupling between the PC's operating system and the NOS was a low priority. But the NOS of the future will have to be closely coupled with the desktop OS, in the world

according to Gartner, as multiple applications begin running on a single compute server, electronic mail is widely used, and security becomes a priority. Advanced NOS functions will include expanded directory services, network management, resource allocation, synchronization, remote procedure calls, security, and accounting, says analyst Redman.

Directory services, for example, are required to locate distributed resources. If properly implemented, they should shield applications developers, users, and administrators from geography and network topology. Management services integrate and oversee the physical and logical network. Resource allocation gives the NOS the ability to allocate such system resources as file and application servers and communications according to peak demand or priority. Syn-

chronization services provide a mechanism for consistent timekeeping for data-file integrity. Standardized remote procedure calls allow portable distributed applications development. Security services provide, as near as possible, the security level available on a mainframe network. Accounting services show an administrator which users are taking advantage of which resources.

The enhanced NOS functionalities are a tall order, and how they will be implemented between the NOS and the

perservers, it will also run on MIPS Computer Systems Inc.'s R4000 reduced-instruction-set-computer platform, which was selected by the Advanced Computing Environment consortium as a processing highway to the future. Eventually, says Barth, the NT kernel will support other RISC processors and will someday have a Posix-compliant subsystem.

The first step toward NT is not far off. Microsoft plans to release its WIN 32 development kit of 32-bit programming interfaces to software developers later this year. With 2 Gbytes of addressable memory, it will support programs with 16-bit Windows APIs plus the upcoming 32-bit Windows applications. Although Microsoft is betting the ranch on Windows, NT will also accommodate rival OS/2. "WIN 32's APIs are structurally very similar to OS/2's APIs," says Barth. "So you should be able to convert all your OS/2 applications to run under NT."

From Barth's perspective, Novell has a much more difficult task in front of it. "Novell has said it will implement Netware as an OS/2 server," he says, "but it has not said when. LAN Manager was built on OS/2 and already

does that, which illustrates the fundamental difference between Novell and Microsoft." Barth believes Netware must pay a price in the 1990s for the success it enjoyed in the 1980s, when file sharing was the dominant NOS function. "It dedicates huge resources to file sharing, so Netware is very fast," he says. "But Novell's architecture is not conducive to migration to a multitasking, multiprocessing operating system. We are going beyond file sharing to enhanced services."

Novell's view of its own future is quite different. "From our perspective, we cannot be aligned with any particular desktop," says Kanwal Rekhi, Novell's executive vice president for product development. "We think the desktops will adapt to the network rather than vice-versa." Novell's technology thrust is toward greater connectivity, reliability,

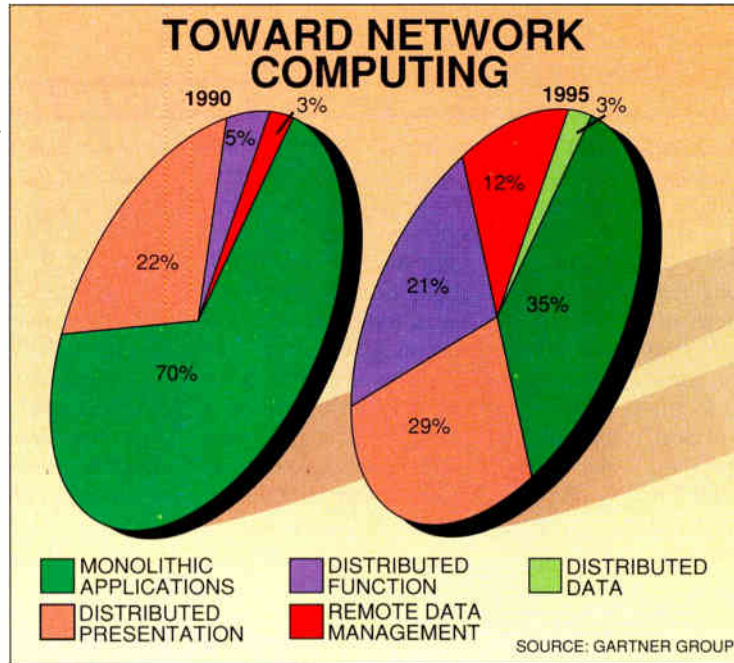

Some observers say the use of desktop computers linked to networks will change dramatically by 1995.

desktop will be the primary differentiator for NOS vendors. Microsoft is in the unique position of having control of both the OS and the NOS. "The priority is to extend Windows and support OS/2," says Barth. The bridge between Windows and the upcoming heir to LAN Manager—Microsoft will not give it a name—is a 32-bit OS kernel that Microsoft calls NT, for New Technology. In short, the same NT kernel will reside on the desktop and in the NOS.

"A huge portion of the desktop market is heading toward Windows," Barth says, "because it is matched to today's hardware. NT will take existing applications and go the next step forward. It is a logical extension of Windows." The NT kernel will run on the traditional Intel Corp. 80x86 microprocessor platforms. But of particular interest to makers of computers used as network su-

SOLID STATE RELAY

Our FB Series military solid-state relay features high speed and low off-state leakage.



ACTUAL SIZE

Here's what you get:

- Availability to pending DESC drawing 89116 with screening to "W" and "Y" levels of MIL-R-28750.
- High-voltage output
- Very-low leakage current (200 nA)
- DC or bi-directional power FET output (see wiring diagrams)
- Ideal for ATE applications
- Optical isolation
- Fast switching speed
- Adjustable turn-on times
- Low profile 6-pin mini-DIP
- Cost efficiency

Review the electrical characteristics below and call us for immediate application assistance:

INPUT ELECTRICAL CHARACTERISTICS (-55° to +105° unless otherwise noted)			
	Min	Max	Units
Continuous Input Current (I_{IN})	10	50	mA_{DC}
Input Current (Guaranteed On)	10		mA_{DC}
Input Current (Guaranteed Off)		100	μA_{DC}
Input Voltage Drop at (I_{IN}) = 25mA		3.25	V_{DC}

OUTPUT ELECTRICAL CHARACTERISTICS (-55° to +105° unless otherwise noted)				
Part Number	FB00CD	FB00FC	FB00KB	Units
Bidirectional Load Current (I_{LOAD})	± 1.0	± 0.50	± 0.25	A_{DC}/A_{PK}
DC Load Current (I_{LOAD})	2.0	1.0	0.5	A_{DC}
Bidirectional Load Voltage (V_{LOAD})	± 80	± 180	± 350	V_{DC}/V_{PK}
DC Load Voltage (V_{LOAD})	80	180	350	V_{DC}
ON-Resistance (R_{ON}) at (I_{LOAD}) max.	0.72	1.8	12.9	Ohms
Turn-On Time (T_{ON})	800	800	500	μS
Turn-Off Time (T_{OFF})	300	600	500	μS

Notes: 1. A series resistor is required to limit continuous input current to 50mA (peak current can be higher).
 2. Rated input current is 25mA for all tests.
 3. Loads may be connected to any output terminal.
 4. ON resistance shown is for the bidirectional configuration. The DC ON resistance is 1/4 of these values.

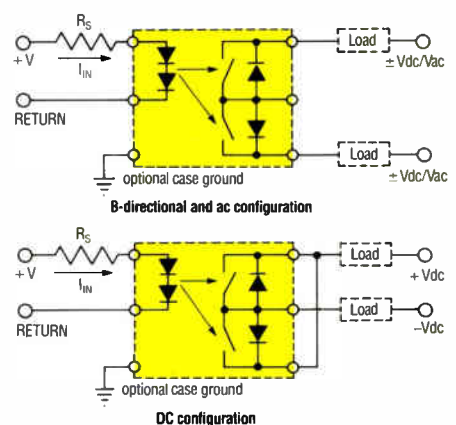

“CREATING THE STANDARD OF THE FUTURE”

TELEDYNE SOLID STATE
A Division of Teledyne Relays

*For immediate application assistance call 1-800-284-7007 or FAX us at 213-779-9161.

Teledyne Solid State, 12525 Daphne Avenue, Hawthorne, California 90250.



The New SpectraScan® SpectraRadiometer® Brings Near Real-Time Testing To The Production Line. Now you can perform precise spectroradiometric measurements in near real-time in production test and inspection environments.

- Determine the spectral and photometric/colorimetric output of displays.
- Test automotive panels and displays for correctness and uniformity of color.
- Make accurate measurements of reflectance/transmittance, source color temperatures and flash lamp spectra.

And that's just the beginning!

The SpectraScan's new system software is easy to use, requires minimal training, and allows maximum system flexibility. The software's six basic functions make it simple to define hardware and software measurement parameters. Our optional SpectraView™ Software package includes all the capabilities of the standard software plus such added capabilities as CIE LUV/LAB calculations, reflectance/transmittance measurements, user-defined ("Hot") function keys, and more.

The SpectraScan SpectraRadiometer is truly a "Head for the future." It is fully compatible with your PC or equivalent computer, with a variety of new features including optional dual apertures, pressurized detector chamber, expanded spectral range, and a wide variety of objective lenses.

Call or write today to find out how you can head for the future with near real-time spectroradiometry.

**HEAD
FOR THE
FUTURE.**



PHOTO RESEARCH®

The Light Measurement People®

Division of **KOLLMORGEN**

9330 DeSoto Avenue, P.O. Box 2192, Chatsworth, CA 91313-2192 USA

(818) 341-5151 FAX: (818) 341-7070 TLX: 69-1427 Cable: SPECTRA

Circle 217-Please have salesman call

Circle 218-please send literature

International Sales Representatives: AUSTRALIA HADLAND PHOTONICS Ph: (03) 560-2366 BELGIUM ANALIS SA Ph: (81) 225085 CANADA OPTIKON CORPORATION Ph: (519) 885-2551 FRANCE INSTRUMAT S.A. Ph: (1) 69-28-27-34 GERMANY OPTTEMA ENGINEERING GmbH Ph: (2) 126-7352 HOLLAND INTECHMIJ B.V. Ph: (20) 50-96-611 INDIA PHOTONICS INTERNATIONAL Ph: (812) 363-573 ISRAEL ANKOR Ph: (03) 571-3305 ITALY PHOTO SYSTEMS SAS Ph: (29) 532-1363 or (29) 532-1366 JAPAN KYOKKO TRADING COMPANY Ph: (03) 586-5251 SPAIN INSTRUMATIC ESPANOLA SA Ph: (1) 555-8112 SWEDEN SAVEN AB Ph: (8) 792-1100 SWITZERLAND MACTECH SA Ph: (21) 28-91-77 U.K. MICRON TECHNIQUES LTD. Ph: (202) 841-261

All trademarks are property of Kollmorgen.

NEW SERVICES AHEAD

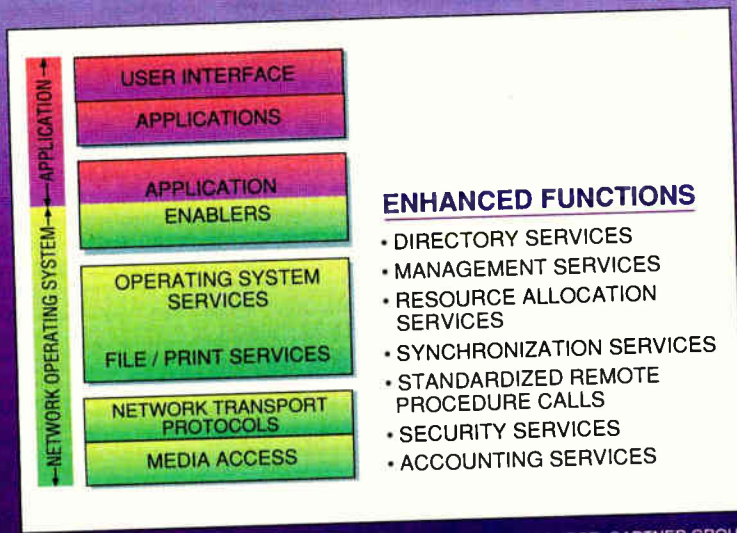

SOURCE: GARTNER GROUP

Changes in the corporate computing model will dictate the need for enhanced services for network operating systems.

robustness, and performance, he says.

Unlike Microsoft, Novell does not have a grand unifying plan. It sees the need to connect computers running DOS, OS/2, Unix, and Macintosh System 7 as the major challenge for NOS vendors. Such a heterogeneous world brings with it a great deal of complexity, and Novell believes the best place to deal with that complexity is in the network server—not in the PC. But this does not mean Novell is uninterested in consolidation, particularly in the Unix environment. It bought a major stake in Unix System Laboratories and is actively promoting that company's flavor of Unix, although Netware will support other versions as well.

The third member of the NOS trika, Banyan, shares Microsoft's vision of distributed processing but lacks its rival's access to the desktop. Its architecture accommodates desktop systems rather than trying to re-create them. By consistently promoting a "top-down," strategic-implementation scenario of a corporation-wide computing environment, says Gartner's Redman, Banyan has taken a share of the Fortune 500 accounts that were willing to break away from IBM. Because of its advanced technology, he says, the company will have a chance to double its market share to 20% in coming years. But to do so, Banyan must break out of its self-de-

finied role as a niche player, he adds.

Although the consolidation of the NOS market will be the major dynamic driving the LAN industry during the 1990s, it is overly simplistic to conclude that it will lead to a relatively homogeneous environment. Companies that were built on stitching together heterogeneous networks—such as Cisco Systems Inc., Menlo Park, Calif., and Protocols—will have plenty of work to do. "Over the next five years, I do not see consolidations affecting us much at all," says Protocols' Costa. "Our customers have a large installed base, and there is no move afoot to rip the old networks out."

Consolidation will actually help companies like Cisco, which specializes in bridge and router hardware and software, says Doug Tsui, marketing manager. As a wide-area-networking company, Cisco connects LANs and keeps track of what is going on among them. "Consolidation means we can focus on more advanced support for a smaller number of network types," Tsui says. Cisco's software will soon be able to handle security functions as well as going into much greater detail on network statistics than is now possible.

Consolidation on the DOS side of the desktop is also important because it leaves more room to support Apple Computer Inc.'s AppleTalk. "People don't talk very much about AppleTalk," Tsui says, "but it is very important. We

see 10% to 20% Macintoshes in our networks." Protocols' Costa agrees: Apple "is not a dynamic—it is a given," he says. "Apple is going to be an 8% to 10% player, but it will be on the short list of the four or five NOS we have to support." Unix will play a somewhat similar role, he says, by cutting into the total size of the NOS market—but only when the various versions become binary-compatible, which will lead to shrink-wrapped software. "We'll support [Unix] in the same paradigm we support DOS and OS/2," he says, "as a relatively low-cost, shrink-wrapped business."

Some see Unix as a competing NOS that might well be added to the list of Netware, LAN Manager, and Vines. It has the advantage of being a computer operating system and a NOS rolled into one. It also has the advantage of being portable—the same Unix that runs on a PC can run on a mainframe or minicomputer. But Novell's Rekhi points out that Unix networking is based on a peer-to-peer model that was common for mainframes and minis. The client-server model dominates PC LANs.

"In our view," he says, "the peer-to-peer model does not work in the PC environment because every individual controls his desktop, not sharing its resources with others." If Unix has any ambition to be on the desktop, "it will have to give up the peer-to-peer model."

It is probably an understatement to say that the future direction of the networking world is uncertain. But it is safe to say that with consolidation under way, a complex mosaic of corporate interests is now forming. Backing up Novell, Microsoft, and Banyan are the traditional NOS value-added resellers along with a new crowd of systems integrators and platform vendors, such as DEC, HP, and IBM. Many of these ancillary players have their own NOS; as recently as a few years ago, offering a competing NOS would have been unthinkable.

Further out on the fringe are big PC companies like Acer, AST, Compaq, Dell, and Tandy. With no NOS of their own, they do not want to be left at a disadvantage as the IBMs, DECs, and HPs become more deeply enmeshed with NOS vendors. Floating above the scene are interoperability consortia such as ACE, which aim to broaden the reach of work-group computing into RISC platforms. By 1995, networking will be the name of the game in business arrangements no less than in technology. □

Electronics

New and Current
Products Presented
By the Manufacturer

**DIRECT
CONNECTION
ADS**

To Advertise Call Brian Ceraolo (201) 393-6260

PAL™/PLD SOFTWARE
Sets The Standard



CUPL™ PLD compiler, the most powerful language for state machine logic design, now allows front end design entry with popular schematic capture packages such as OrCAD, P-CAD, Schema or Hi-Wire. CUPL supports all PLDs and carries the most extensive update program. Available on MS-DOS™, Apollo™, Sun™ VAX™ and most UNIX™ based platforms.

LOGICAL DEVICES, INC.
Dealer and Distributor Inquiries welcome

1201 N W 65th Place
Ft. Lauderdale, FL 33309
305-974-0967
FAX 305-974-8531
1-800-331-7766

LOGICAL DEVICES

CIRCLE 134

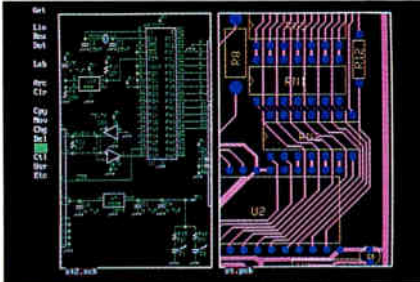

NEW SCHEMATIC AND PCB SOFTWARE

With support for extended and expanded memory, HiWIRE II can handle your most demanding schematic and PCB designs quickly and easily. The unique HiWIRE editor allows you to display and edit schematics and PCBs simultaneously, using the same commands for each. HiWIRE II is \$995, and is guaranteed.

WINTEK CORPORATION
1801 South Street, Lafayette, IN 47904
(800) 742-6809 or (317) 448-1903
WINTEC CORP.

CIRCLE 110

☆☆☆☆
"The Best 8051 Emulator"

NEW
83CL410
SUPPORT

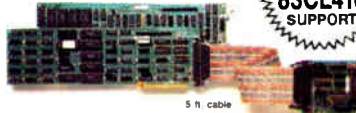

8051 SEE EEM 90/91
Pages D 1320-1323

PC based emulators for the 8051 family

8031, 8032, 8051, 8052, 80C152/154/221/451/452/51FA/51GB/51S/517/53S/537/552/562/652/851, 80532, 83C451/552/652/751/752/851, 8344, 87C451/552/751/752, 8751, 8752, DS5000 + CMOS ... more.

- PC plug-in boards or RS-232 box.
- Up to 30 MHz real-time emulation.
- Full Source-level Debugger w/complete C-variable support.
- 48 bit wide, 16K deep trace, with "source line trace."
- "Bond-out" pods for 8051, 83C552, 83C451, 83C652, 83C751, 80C515/80C517, 83C752.

Prices: 32K Emulator 8031 \$1790; 4K Trace \$1495* (*US only)

CALL OR WRITE FOR FREE DEMO DISK!

Ask about our demo VIDEO

NOHAU CORPORATION
51 E. Campbell Avenue
Campbell, CA 95008
FAX (408) 378-7869
(408) 866-1820

Call 408-378-2912
NoHau's 24-hour
information center to
receive info via your FAX

NOHAU CORP.

CIRCLE 161

SPOTLIGHT: DESIGN & DEVELOPMENT ■

Finally, attendees determined the most impressive product of the show was CAD Software's PADS.
Each vendor provided a bench!

PEAJ News 6/90
on CAD Showdown Results

**PADS SETS
THE STANDARD**

for CAE/CAD design on Personal Computers

Complete thru-put logic capture and board design functionality including:

- A true multi-sheet database for Schematic capture with hierarchical design capability
- Both automatic and interactive PCB layout tools
- Most complete set of autorouters for Analog, Digital and SMD designs
- Cam outputs including database ASCII In and ASCII Out format
- **NEW!** PADS-2000, board designs with no system limits. 1 micron database, copper pouring, T-routing. Workstation capability at PC prices!

Call today for a free demonstration package, and for your local Authorized PADS Reseller.

CAD Software, Inc.
Call Today!

Inside MA: (508) 486-8929
Outside MA: (800) 255-7814

119 Russell Street, Littleton, MA 01460

CAD SOFTWARE

CIRCLE 125

SBC196

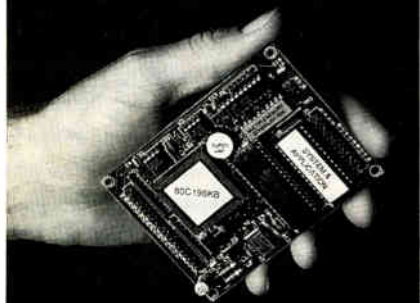

- Low Power
- Small, 3"x4"
- Low Cost
- 8x10b A/D
- 2 Ser Chan
- Forth-83i96
- I²C/ μ Wire
- LCD/Key
- w/80K ROM Apps
- R'time Clk
- Support
- EEPROM to 2K

vesta technology, inc.

Voice: (303) 422-8088, FAX: (303) 422-9800, BBS: (303) 278-0364

VESTA TECHNOLOGY, INC.

CIRCLE 123



**RUGGED AND HIGH PERFORMANCE COMPUTER SYSTEMS
WITH FOLD DOWN KEYBOARD AND VGA MONITOR
FOR RACK, BENCH OR PORTABLE APPLICATIONS**

STANDARD FEATURES INCLUDE:

- 12 SLOT PASSIVE BACK PLANE, 250W POWER SUPPLY
- 80386 CPU CARD AT 20/25/33 MHz, UP TO 8MB OF ZERO WAIT STATE RAM
- SONY TRINITRON TUBE, HIGH RESOLUTION VGA (640X480) MONITOR AND CARD
- ROOM TO MOUNT THREE HALF HEIGHT DRIVES
- 2 SERIAL, 1 PARALLEL PORT, MS DOS/GW BASIC

ALSO AVAILABLE WITH 80486 OR 80286 CPU CARDS IN VARIOUS CONFIGURATIONS, FOR FURTHER DETAILS CONTACT:

IBI SYSTEMS INC., 6842 NW 20 AVE.
FT. LAUDERDALE, FL 33309, 305-978-9225
FAX: 305-978-9226 TELEX: 529482 IBI SYSTEMS
IBI SYSTEMS

CIRCLE 128

Modula-2

For 8051!

The Power of PASCAL with the speed and flexibility of Assembly.

- Mod51 Optimizing compiler for 87C51/87C552 87C528 & 80x51 targets.
- Includes Pascal & C to Modula-2 translator.
- Fast and Tight code rivaling assembler.
- 20% less compiled code than "C"!
- Includes Assembler, Simulator, editor.
- Compatible ROM/ICE available option.
- Debug Evaluation Euro-Board for 80/87C552.
- 87C751 gang programmer option.
- 8052 In-Circuit Real Time Emulators.

VST Inc. (305) 491-7443

VST INC.

CIRCLE 136

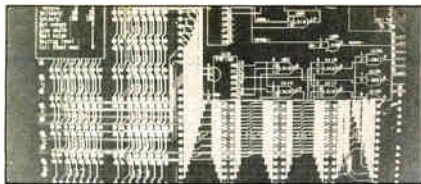

SCHEMATIC CAPTURE TO PCB LAYOUTS \$795

Before buying P-CAD, PADS-2000, PROTEL, etc you owe it yourself to check out our End-to-End **ONE SYSTEM** Solution.

Compare Specs for yourself...

GUARANTEED to out-perform other PC based systems costing much more with Superior Analog, SMT & Digital features such as:

- Integrated Schematic Capture & 2 Sided SMT support (Not an add-on).
- Integrated 2-D Drawing editor for mechanical, Outline, Fab, etc dwgs.
- Design PCB from a host of Neist formats, or on the fly without a neist.
- Unfit grids, pads & trace sizes; GND plane shapes, 1 μm resolution etc
- Curved & straight traces. Paris, Blocks, etc rotation in 1° increments.
- Forward & Backward annotation, On-line DRC, SCH/PCB diff. check etc
- Dynamic EMS memory support (Not 640K Limited) for large designs.
- User definable Menus, Keys, & Macros; Gerber & Laser plots included.
- A choice of 3 optional powerful Autrouters assures 100% completion.

✓ **FULL FUNCTION** evaluation package with over 850 pages of well illustrated manuals (5 books) for \$75 (USA & CANADA ONLY) 30 (45 int.) days Money back Guarantee.

INTERACTIVE CAD SYSTEMS

2352 Rambo Ct, Santa Clara, CA 95054

Call: (408) 970-0852 Fax: (408) 986-0524

INTERACTIVE CAO SYSTEMS

CIRCLE 166



INTRODUCING RACK MOUNT AND RUGGED SUN SPARC WORK STATION

Standard Features include:

- Spark Engine 2 CPU with 16MB RAM
- 207 MB Hard Disk, 150MB Tape Drive
- 644 MB CDROM, Removable Hard Disk
- 1.44 MB Floppy, 2 RS-232 and S Bus Ports
- SCSI-2 and Ethernet Interface
- 16-inch Rack Mount Color Monitor
- Keyboard, Mouse and SunOS 4.1

For further details contact:

IBI Systems Inc., 6842 NW 20M Ave., Ft. Lauderdale, FL 33309, 305-978-9225, Fax: 305-978-9226

IBI SYSTEMS

CIRCLE 142

30-day money back guarantee!

TESLA

formerly TESS

PC Block Diagram Simulator

Modems, DSP, satcom, nav, controls...
Times are tough: shorter schedules, fewer engineers. TESLA can help you:

- Detect problems before breadboarding.
- Do proposals that sell with perf. data.
- Find the best design alternatives fast.
- Bring specs to life in a working model.
- Show junior engineers the big picture.
- Put a lab in your laptop for just \$695!

Demo disk. 404-751-9785 Fax: 404-664-5817
TESOFT_{INC} Box 305, Roswell, GA 30077

TESOFT

CIRCLE 118

**Analog Circuit Simulation
SPICE FOR THE PC**

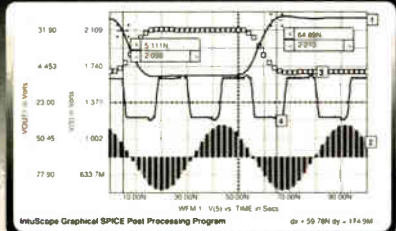

IntuScope Graphical SPICE Post Processing Program
• Schematic Entry • SPICE Simulation
• Model Libraries • Waveform Graphics
Intusoft has it all at an Affordable Price!

INTEGRATED, EASY TO USE SIMULATION ENVIRONMENT, FEATURING:
A powerful SPICE (IsSpice) simulator performing AC, DC, Transient, Noise, Fourier, Distortion, Sensitivity, Monte Carlo, and Temperature analyses, Extensive model libraries, Schematic entry, and Waveform processing. Starting at \$95 for IsSpice, complete systems are available for \$815.

Call Or Write For
Your Free Demo and
Information Kit!



P.O. Box 710 San Pedro,
CA 90733-0710
Fax 213-833-9658

INTUSOFT

CIRCLE 111

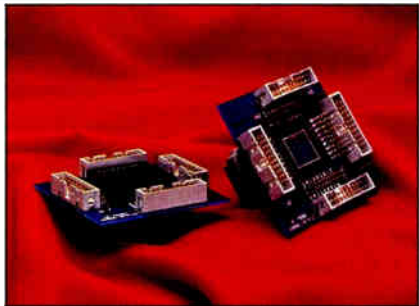

Attn: HP Logic Analyzer Users

- PQFP, PLCC, PGA, and DIP pre-processor interfaces for 1650 and 16500 Series HP logic analyzers.
- Available for Intel, Motorola, Mips, Zilog, and IDT microprocessors.
- Plugs between the analyzer and the target CPU socket or surface mount pads.
- Inverse assembler and configuration files included. Call for a free catalog.

Emulation Technology, Inc.
2344 Walsh Ave. Santa Clara, CA 95051
Phone: 408-982-0660 FAX: 408-982-0664



EMULATION TECHNOLOGY

CIRCLE 130

**SUPER FAST STAND-ALONE
GANG PROGRAMMER**

\$1295

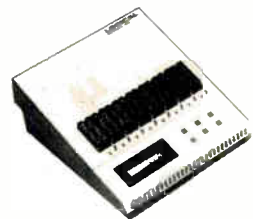

GANGPRO-8+™ provides all the basic needs in gang programming EPROMs and EEPROMs. Fast RS-232 master file download, remote control, stand-alone via front panel control and all the necessary device functions such as load, program, verify and blank check.

For more information,
call 1-800-331-7766.



LOGICAL DEVICES

CIRCLE 138

**Universal
Emulator
Assembler**

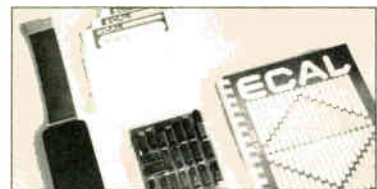

Over 170 different microprocessors are supported in this high-performance software/hardware environment for assembly language development. Call Today For a FREE ECAL Demo Disk.

VST Inc. (305) 491-7443

VST INC.

CIRCLE 140

**VOLTAGE SELECTABLE
INTERNATIONAL SYSTEM**



Z-LINE TPC 884

The TPC, a voltage-selectable power distribution and control system, can have either 120 or 240 volt input and output. Designed with IEC-, UL-, CSA- and VDE-approved components, operating up to 16 amps in Europe and 20 amps in North America. Size: 19.0" x 1.75" x 7.0". EMI/RFI filtering, spike/surge suppression and overload circuit breaker protection are standard. Remote on/off is optional.

Pulizzi Engineering, Inc.
3260 S. Susan St.,
Santa Ana, CA 92714
714/540-4229 FAX: 714/641-9062

PULIZZI ENGINEERING

CIRCLE 129

**VDS compact size
VGA color monitors**

VDS offers wide selection of VGA color monitors.
10" (9" V); CH-10702MVG; AC 90-132/198-264V,
0.26mm dot pitch
9"(7.5" V); CH-9742VGZ; DC-24V, 0.26mm dot pitch
9"(7.5" V); CH-9702UVG; AC 90-132V, 0.26mm dot pitch
7"(6" V); CH-7742VGZ; DC-24V, 0.21mm dot pitch
Also VDS offers monochrome 14" 12"/9" VGA monitors with DC-12V.



VICTOR DATA SYSTEMS CO., LTD
A subsidiary of JVC
608 Kashiwagaya, Ebina-shi, Kanagawa-ken,
Japan Tel. 81-462-32727 Fax: 81-462-33382

VICTOR DATA SYSTEM

CIRCLE 145

EMPLOYMENT OPPORTUNITY

Electronics Engineer: Design and repair of sophisticated electronic machinery, specifically warp knitting machinery as well as direct and indirect warpers. Working knowledge of textile fabrics and fibers required. Direct engineering personnel in fabrication of test control apparatus and equipment, and determine procedures for testing products. Evaluate operational systems and recommend design modifications to eliminate causes of malfunctions or changes in system requirements. Travel overnight approximately 50% of working time in order to oversee installation, servicing, and repair of all textile equipment at client mills, as well as to educate clients in proper use and maintenance of textile machinery. Supervise 4 employees. 40 hrs/wk, 8-5, \$35,000/yr. Requirements: BSc Engineering; major-electronics. 5 yrs experience as an electronics engineer in the textile industry. Apply: Job Service, 2005B S. Elm-Eugene St., Greensboro, NC 27406, or nearest Job Service Office. Refer: Job order Number - NC4010008, DOT Code - 003.061-030.

BUSINESS SERVICES

**OUR LAWYERS
CAN COLLECT FOR YOU
FASTER THAN A
COLLECTION AGENCY.**

We are a unique management firm with a Network of Collection Attorneys specializing in collection law.

**INNOVATIVE NETWORK
1-800-348-DEBT**

SOFTWARE

**RELIABILITY PREDICTION
SOFTWARE**

ARE YOUR ELECTRONIC PRODUCTS RELIABLE?
RelCalc 2 automates MIL-HDBK-217E on your IBM PC!
Very easy to use. Try our Demo Package today for \$25.
T-CUBED SYSTEMS 31220 La Baya Drive, #110
(818) 991-0057 Westlake Village, CA 91362
FAX: (818) 991-1281

CIRCLE 258

CONSULTANTS

Power Supply Design Service

Custom switching power supply design, from concept to production. Competitive rates. Low and high voltage. AC-DC, DC-DC, DC-AC, UPS. Please call for more information (9-5 EST).

PEDA® Tel.: 519-837-1646
Fax: 519-763-2742

Advertiser's Index

Abbott Electronics.....26	NEC Corporation42-43
AMP, Inc.24-25	Nohau Corporation56
Analog Devices50	Orbit Semiconductor8-9
Anritsu Corporation34-35	OrCAD.....39
Best Western2	Philips Semiconductors17-19**
Burr Brown Corporation3	Philips Test & Measurement23**
CAD Software.....56	Photo Research54
Contraves Intersys AG30**	Pico Electronics15, 21
Cypress SemiconductorCov IV	Pulizzi Engineering57
EDS.....17*	Signetics.....A5-A9, A16
Emulation Technology.....57	Tektronix, Inc.10-11
Ferranti Venus30	Teledyne Relays.....53
Florida Economic Development40	Teradyne28-29
Fujitsu, LTD.....14**	Tesoft, Inc.57
Fujitsu Microelectronics.....5	Vesta Technology56
GenRad47	Vicor36
Harris SemiconductorCov II-1	Victor Data Systems.....57
Hewlett Packard13	VST Inc.56, 57
IBI Systems.....56, 57	Wintek.....56
Integrated Device TechnologyCov III	
Interactive Cad Systems57	* Domestic only
Intusoft.....57	** International only
Logical Devices56, 57	
National Golf Center32	
National Instruments.....48	

The advertisers' index is prepared as an additional service.

ELECTRONICS does not assume any liability for errors or omissions.

INDEX

INDUSTRY AWAITS A COMEBACK AFTER A VOLATILE YEAR

Economic news is increasingly positive, and there appears to be little doubt at this point that the economy will return to an expansionary mode before the end of this year. Auto and housing demand are increasing, indicating that the consumer has returned to the marketplace. The industrial sector is still lagging, but trends should improve by the fourth quarter.

The electronics industry has suffered greater than usual volatility this year. The end of the war in the Middle East, the general economic slowdown, PC price wars, and microprocessor and memory product transitions have all contributed to this trend. The summer doldrums arrived one month earlier than usual, as the semiconductor book-to-bill ratio peaked in April. The normal fall pickup for component demand could arrive early if further PC price cuts stimulate unit volume growth.

Industry-wide order patterns in May and June suggested continuing recession. Computer-related orders worsened in May compared with April, but inventory trends remain surprisingly positive. However, there has been some evidence of inventory building in June, particularly at Apple Computer Inc. This could further intensify industry pricing pressure. Component orders continued to show modest improvement through May, but June trends at the distribution level were characterized as weak. Early July patterns suggest a continuation of this trend thus far.

After showing some signs of recovery in April and May, communications equipment orders weakened again in May. Electrical and electronic capital-equipment trends also deteriorated slightly in May from April. Indications regarding June activity suggest more weakness, particularly in industrial-related end markets. □

By Mark L. Parr, McDonald Securities Inc., Cleveland (216-443-2379)

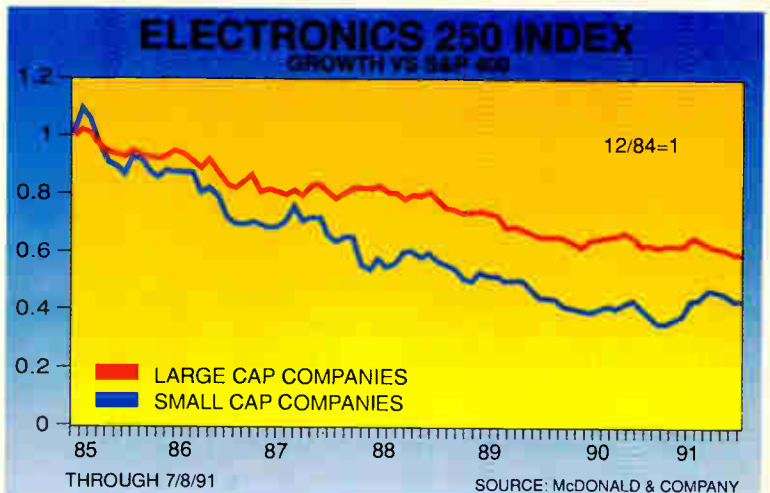

Overall, order patterns in May and June pointed to a continuation of the recession. However, the economy has taken a turn upward.

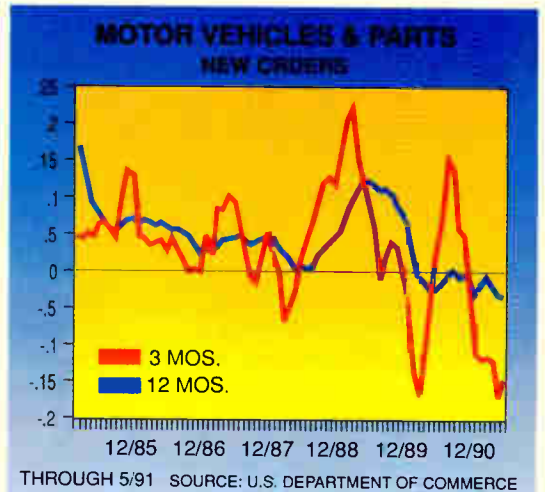

Auto demand is increasing, which could result in a good summer for electronics suppliers.

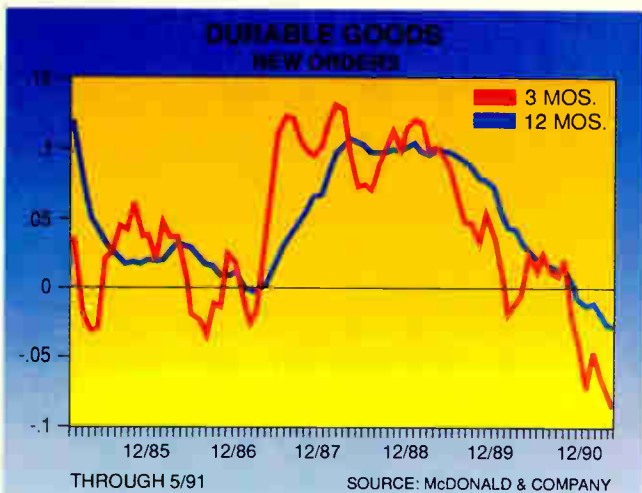

Durable goods activity stayed depressed through May, but a pickup in housing and automotive sales should help.

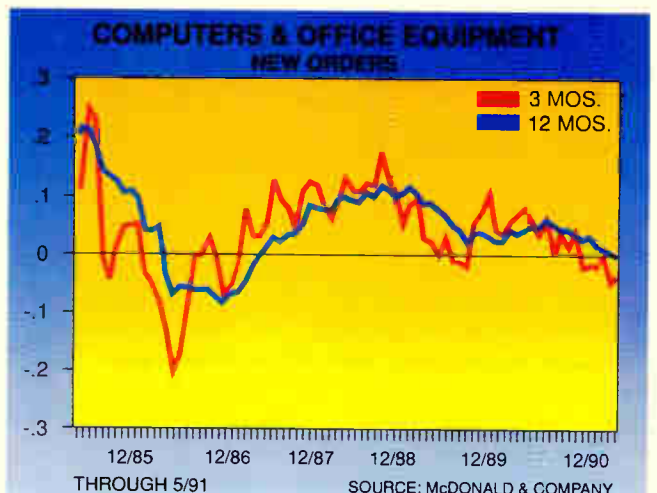

Computer-related orders were down in May from the April level, but inventory trends are encouraging.

LAST WORD

THE COMING INTEREST-RATE ENIGMA

In mid-June, the yield spread between long- and short-term interest rates approached 3%, near its record-high level. Perhaps it may seem that a statistic as arcane as the yield spread might not be of compelling interest, but in fact this development holds the key to predicting where both short-term and long-term rates—and hence the economy itself—will be heading over the next few quarters. The unusually large rise in the yield spread, which was slightly negative as recently as mid-1989, is due to the following:

1. Realization that the recovery will be more robust than the previous consensus outlook.
2. Fear of higher inflation in the months ahead.
3. Awareness that the "silent partner," the huge government deficit, will present increasing demands on financial markets for the rest of this year and in 1992.
4. The likelihood that (1) and (3) will cause the Fed to tighten significantly, although probably not until next year.

Over the past 40 years, the yield spread has averaged about 1%; hence it is now about 2% above normal. Currently the real short-term rate is about 1% *below* its long-term average, while the real long-term rate is *above* its long-term average.

It is possible that the spread could remain at 3% indefinitely; it did from 1983 through early 1988. However, that was a highly unusual period, since it represented an unprecedented—and probably unrepeatable—attempt by Paul Volcker to bring inflation to its knees. Also, the Federal budget deficit was much larger then as a percentage of gross national product, reaching 6%, compared to about 3% now (excluding the Resolution Trust Corp. payments).

Thus, it is virtually a foregone conclusion that the yield spread will narrow somewhat in the coming quarters. However, there is no consensus at all about which way rates will move.

If our overall forecast is correct—3% real growth for the next four quarters, accompanied by an increase in the inflation rate to the 5.5%-to-6% range—real short-term rates are far too low relative to their historical average. Even if inflation stabilizes at 5% and does not rise to the 5.5%-to-6% range, short-term rates will rise at least 1% once the recovery is well established.

If inflation does rise to our predicted levels, that would send short-term rates up 2%. Only if inflation were to decline to 4% could the current level of short-term rates be justified in a nonrecessionary environment. True, that is the consensus forecast, but until release of the latest batch of economic statistics, the consensus also believed that

the recovery would not start until well into the second half of the year.

However, the fact that short-term rates must rise does not answer the question of where long-term rates are heading. There is no reason whatsoever to believe that long-term real rates will move below their long-term historical average of 3%. In other words, if inflation does rise to 5.5% to 6%, the equilibrium bond yield would be 8.5% to 9%—i.e., where bond yields are currently. Apparently, bond traders are not fooled into believing the consensus forecast that inflation will be only 4% this year.

Since current bond yields now reflect 5.5% inflation, that could mean that if the Fed were to tighten rates, long rates would not rise at all. However, the situation is probably more lugubrious than that. Given the size of the budget deficit, long-term rates are likely to remain above their average historical levels. Thus, our forecast calls for at least another

0.5% rise in bond yields, or a minimum of 9% for Treasuries and 9.5% for Aaa corporate rates, with the possibility of 9.5% and 10% levels being reached by late next year.

In sum, the yield spread is so wide because Fed policy is currently too easy. Bond traders realize inflation will rise, and have priced the long end of the market accordingly. The Fed, on the other hand, is still smarting from the criticism of having failed to ease quickly enough—an unwarranted claim that nonetheless had chairman Alan Greenspan worried about his job. However, he was reappointed in July. As a result, current short-term rates are barely above what we predict will be the inflation rate later this year.

In the past, whenever real short-term interest rates have turned zero or negative, the result has always been substantially higher inflation. No exceptions to this rule. Thus we are fairly sure interest rates will have to move higher some time in the next year. The Fed can either move now to head off the next round of inflation, or it can wait until higher prices are already a reality, and then react after the fact. Either way, interest rates will be substantially above current levels a year from now—and the economy, though still moving forward, will be struggling. □

MICHAEL K. EVANS is president of Evans Economics Inc. and Evans Investment Advisers in Washington. His views will appear regularly on this page.



LOOK FOR RATES
TO RISE NEXT
YEAR EVEN AS
THE ECONOMY
STRUGGLES
TO MOVE
FORWARD

Smash the Cache Barrier

IDT's 64K BiCEMOS™ TTL I/O Static RAMs are the ideal solution for high-density cache systems, and are the perfect match for optimizing the high-performance needs of RISC and CISC processors. These 8ns and 10ns SRAMs provide the highest system speed without sacrificing system chip count or increasing power consumption.

Smash the barrier to efficient cache operation at the highest clock speeds. Call today and ask for **Kit Code 1041** for free samples of our new 16K x 4 and 8K x 8 TTL SRAMs.

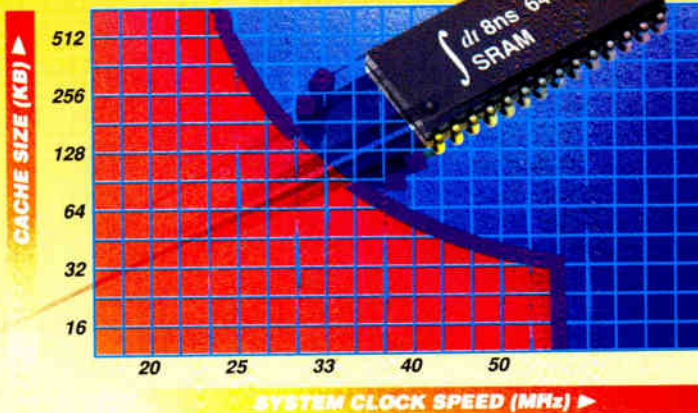

COUNT ON IDT

35MIPS RISC COMPONENTS AND MODULES

R3000A, the most MIPS at any MHz. The R3051 integrates CPU, cache, and buffers on one chip. RISC modules, eval. boards, and software complement our family of **mips™**-based RISC products. Your RISC solution is a phone call away!

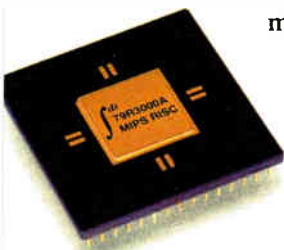

4ns LOGIC: WORLD-CLASS SPEED

The industry leader. FCT-AT and FCT-CT CEMOS families achieve the fastest speeds with 40% less noise.

Everything you need for high-performance designs can be found in the *Logic Data Book*.



HIGHEST-PERFORMANCE MEMORIES

Fast FIFOs, dense dual-ports, BiCEMOS ECL, and modules for every system. Over 120 of the fastest FIFOs and multi-port memories. 5ns ECL SRAMs, as well as standard and custom memory modules. Get the specs in the *Specialized Memories Data Book*.



12ns 256K SRAMS

Fastest cache solutions for RISC and CISC processors. More than 36 ultra-high-speed sub-micron SRAMs for 33MHz processing and beyond. Read all about them in the *SRAM Data Book*.

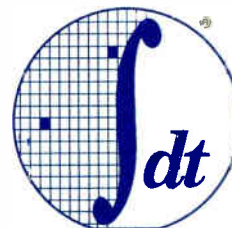

Call today for your new IDT data books with complete technical specifications and application information.

When cost-effective performance counts.

(800) 345-7015 • FAX: 408-492-8454

CIRCLE 183

World Radio History

Integrated Device
Technology, Inc.

FULL SPEED AHEAD.

Faster circuits for faster systems: Here's the good book.

The 1991 Cypress Semiconductor Data Books are hot off the presses. Highlights include:

- **SPARC® RISC Microprocessors.** The fastest CMOS available. From embedded control to full chipsets.
- **Highest Speed PLDs.** Broad selection, from standards at rocket speeds to functionally specialized systems.
- **Static RAMs.** Biggest selection of high-speed devices, including our 10ns BiCMOS 64Ks.
- **VME Bus Controllers.** The space-saving solution for a broad range of processors.
- **CMOS PROMs.** The broadest line of

high-performance PROMs, to 512K densities. We'll fill your order fast.

- **Specialty Memories.** Including ultra-high-speed FIFOs.
- **Multichip Modules.** Including 32-bit space and time savers.
- **And much more.** All in our new Data Book.
- **Call for your copy today.**

**1991 Data Book Hotline:
1-800-952-6300*.** Ask for Dept. C9R

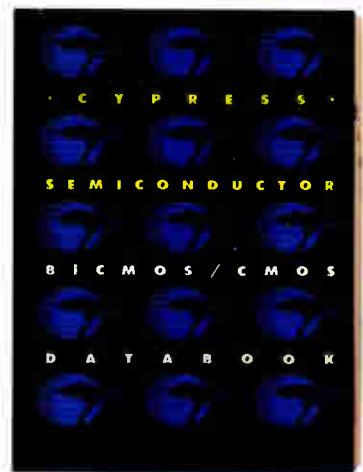

*1 (800) 387-7599 in Canada. (32) 2-652-0270 in Europe. ©1991 Cypress Semiconductor, 3901 North First Street, San Jose, CA 95134. Phone: 1 (408) 943-2600, Telex: 821032 CYPRESS NJ UD, TWX: 910-997-0753. SPARC is a registered trademark of SPARC International, Inc.



CYPRESS
SEMICONDUCTOR