

**PHILIPS FINDS A BETTER WAY TO DO ANALOG CONVERSION/79
AN LCD THAT OUTSHINES CRTs GOES INTO PRODUCTION/90**

A MCGRAW-HILL PUBLICATION

SIX DOLLARS

OCTOBER 1, 1987

Electronics®



FERMENT IN MICROCONTROLLERS

**• NEW OFFERINGS,
NEW PLAYERS
STIR UP THE
COMPETITION/55**

**• INTEL'S RADICAL
16-BIT REDESIGN IS
TWICE AS FAST/59**

The Series 32000 family. First. Lasts. All ways.

STILL THE ONLY COMPLETE, FULLY COMPATIBLE 32-BIT SYSTEMS SOLUTION FOR A FULL RANGE OF APPLICATIONS

A 32-bit microprocessor isn't just a purchase. It's a commitment.

It's a commitment *by* you to a particular microprocessor architecture.

And it's a commitment *to* you by the microprocessor's manufacturer not to abandon that architecture for some more "innovative" approach — and abandon you and your software in the process.

Without the second commitment, you shouldn't make the first.

And no one has made a larger, longer, more consistent commitment to 32-bit technology than National.

FIRST: FULL 32-BIT ARCHITECTURE

In 1982, we introduced the world's first commercial 32-bit microprocessor.

Later this year, we'll be introducing the world's most advanced 32-bit microprocessor, the NS32532, with integrated data and instruction caches, integrated memory management, and a four-stage instruction pipeline.

In between, we introduced five other microprocessors, including the NS32332, a hard-working, practical 15-MHz engine that delivers 2-3 times the performance of its predecessor NS32032, and not only offers cache-memory support and bus-error retry features, but also pioneered the use of burst-mode memory transfers in microprocessors. With its variable bus-sizing capability, the NS32332 can address the needs of over 90% of the applications in use

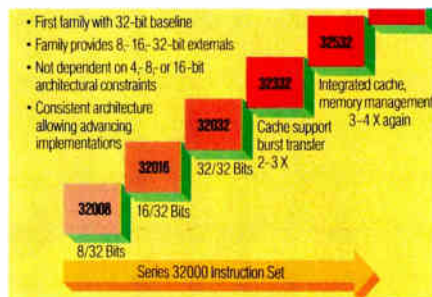

The Series 32000 performance pathway. An integrated family of CPU's with full upward and downward software compatibility.

today, yet it is fully software compatible with the next-generation NS32532.

Five years. Seven CPUs. Interfaces from 8 to 16 to 32 bits. Performance from 0.75 to 15 MIPS peak (VAX® 11/780 MIPS). And all without having to re-engineer your software at any level.

That's remarkable performance continuity. And the reason for it is simple: National's commitment to a full 32-bit architecture from the very beginning.

Every CPU in our Series 32000® family shares the same 32-bit internal implementation. The same orthogonal architecture. The same highly symmetrical instruction set.

So you can spend your time designing new products, rather than re-designing old ones.

LASTS: FULL SYSTEM COMPATIBILITY

Any microprocessor, of course, is only as good as the tools that help you put it to work.

That's why our CPUs are supported by 141 other products — slave processors, peripherals, development tools such as the fully integrated DB332-PLUS Development Board, OEM boards, software-support products — to provide you with a coordinated, integrated, *complete systems solution* for 32-bit design.

So you can design products faster, build revenues sooner, turn profits longer.

ALL WAYS: FULL APPLICATION FLEXIBILITY

Ultimately, however, any microprocessor has to be evaluated against a single criterion: How well does it meet *your* cost-performance targets in *your* application.

That's why the Series 32000 family offers you a full range of design options (including 883C, 38510 and rad-hard military versions):

NS32008:	8-bit interface for embedded control
NS32016:	16-bit interface for office peripherals
NS32032:	32-bit interface, 24-bit addressing for cost-effective real-time applications
NS32C016/ NS32C032:	Compatible low-power CMOS versions with P _D (MAX) = 350mW
NS32332:	32-bit interface, 32-bit addressing for real-time and multiprocessing applications and UNIX™-based multitasking, multiuser environments
NS32532:	The next-generation Series 32000 CPU. A highly integrated engine offering 8-10 MIPS average performance, 15 MIPS peak, and employing unique architectural features for real-time and multiprocessing environments.

So you can match your microprocessor to your needs, rather than having to adapt your needs to your microprocessor.

All of which means that our commitment to the Series 32000 family gives you something else you won't find in any other 32-bit approach.

True design freedom. First, last, and always.

National Semiconductor
Series 32000 Systems Solutions
P.O. Box 58090
Santa Clara, CA 95052-8090



Circle 1 on reader service card

Series 32000 is a registered trademark of National Semiconductor Corporation.
UNIX is a registered trademark of AT&T.
VAX is a registered trademark of Digital Equipment Corporation.

© 1987 National Semiconductor

WHAT TOP DESIGNERS SAY ABOUT T1



Leading designers say the Mitel MT8976 is the most advanced single chip T1 solution on the market. This 28-pin CMOS T1 link interface has more features than multi-chip solutions - ESF, two-frame elastic buffer, system level maintenance features and pin compatibility with European CEPT interface MT8979. It all adds up to a simple design solution in less board space at lower power levels. No one else even comes close. Call today for a complete information package on the entire Mitel family of T1 and ISDN components.

United States San Diego CA (619) 276-3421 • San Jose CA (408) 249-2111 • Oakbrook IL (312) 574-3930 • Boca Raton FL (305) 994-8500
Europe Denmark +45 1-612566 • West Germany +49 711-7701522 • United Kingdom South Wales +44 291-423355
Canada 360 Legget Drive Kanata Ontario Canada K2K 1X5 (613) 592-5630

Circle 2 on reader service card



EDITOR-IN-CHIEF

Robert W. Henkel

EXECUTIVE EDITORS

Samuel Weber (technical), Arthur Erikson (news)

MANAGING EDITORS GROUP

Bernard C. Cole, Lawrence Curran, Tom Manuel, Benjamin A. Mason, Jonah McLeod, Stan Runyon, Howard Wolff, Jeremy Young

SPECIAL PROJECTS

Stan Runyon

ART DIRECTOR

Fred Sklenar

DEPARTMENT EDITORS

CAD/CAE: Jonah McLeod (San Mateo)

Communications: Tom Manuel

Components: Samuel Weber

Computers & Peripherals: Tom Manuel

Jonah McLeod (San Mateo)

Lawrence Curran (Boston)

Industrial & Consumer: Wesley R. Iversen (Chicago)

Military/Aerospace: Tobias Naegele

Packaging & Production: Jerry Lyman

Semiconductors: Bernard C. Cole (San Mateo)

Software & Microprocessors: Tom Manuel

Test Instruments: Jonah McLeod (San Mateo)

NEWS DEPARTMENT

Features Editor: Jeremy Young

Front of the Book: Howard Wolff

New Products: Jack Shandle

Assistant News Editor: Katherine T. Chen

EDITORIAL PRODUCTION & COPY DESK

Benjamin A. Mason (Director)

Production

Charles D. Ciatto (Mgr.)

Copy Editors

Larry King (Chief), George Ellis

ART

Karla Toning (Associate Director)

NEWS BUREAUS

Boston: Lawrence Curran (Mgr.), Paul Angiolillo

Chicago: Wesley R. Iversen (Mgr.)

Dallas: J. Robert Lineback (Mgr.)

Los Angeles: Larry Waller (Mgr.), Ellie Aguilar

New York: Tobias Naegele (Mgr.)

San Mateo: Jonah McLeod

Frankfurt: John Gosch (Mgr.)

Tokyo: Charles L. Cohen (Mgr.), Ayako Hayashihara

Paris correspondent: Jennifer Schenker

United Kingdom correspondent: Peter Fletcher

EDITORIAL ADMINISTRATION

Lisa Costenbader, Ina Gruber

PUBLISHER

Laurence Altman

Regional Sales Managers

Paul Mazzacano (Western)

Matt Reseska (Eastern)

Business Manager: David M. Yake

Director of Circulation: Daniel McLaughlin

Production Director: Thomas Egan

Manager of Sales Administration: Evelyn Schmidt

Jack Shandle is getting in deeper, and he couldn't be happier. Jack, who has been our hard-working New Products editor for a year, managed to find the time between producing that section to turn out the two articles in this issue about the Integrated Services Digital Network—a progress report on the long-awaited technology and a report on the ISDN data-protocol controller chip from Advanced Micro Devices Inc.

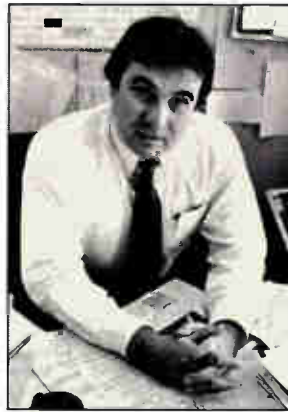

SHANDLE: The best of both possible worlds for a journalist.

"After a year of grappling with the entire breadth of the electronics industry, it was a challenge as well as a satisfying experience to get into a subject in depth," says Jack. "I didn't realize how much I missed the dynamic reporting side of the business, as opposed to the more static planning and managerial functions that go with being an editor. Doing them both seems to me to be the journalist's idea of utopia.

"It's also good to have an opportunity to dig deeply into the telecommunications area, because with ISDN beginning to come on, it will probably be one of the most dynamic and fast-changing fields in electronics," Jack adds. And as he points out in his overview of ISDN, there will be a lot to write about as designers more accustomed to dealing with equipment for the computer environment struggle to master the complexities of the telecom milieu.

Jack is one of those hard-to-find professionals, the engineer-journalist. He has his EE degree from the University of Pennsylvania and his master's in journalism from Temple University,

both in Philadelphia. From that one might gather that Jack has an affinity for the City of Brotherly Love. He has spent the bulk of his professional life in the city or its suburbs, as an engineer for the Philadelphia Electric Co. and as a reporter and columnist for the *Bucks County Courier Times* in Levittown, Pa. Even now that Jack works in New York, he makes the long daily commute from bucolic Bucks County.

Jack says of his dual specialties, "I like them

both. This business of covering the industry is the only one I know of where I can use both at the same time."

It's nice to be neighborly, and the folks in Texas have developed the technique into a fine art as well as a tradition. Now a bunch of electronics people—suppliers of semiconductors, original-equipment manufacturers, distributors, and reps—are putting their culinary skill on the line "to promote goodwill with design and purchasing personnel in the local electronics community."

That's what it says in the latest prospectus of the world famous and highly respected North Texas Electronics Chili Council, which is going to show what heat dissipation really means on Oct. 3 with the Electronics Industry Chili Cook-Off. It starts at noon at Farmers Branch, which is five miles east of the Dallas-Fort Worth Airport.

But if they want to be really neighborly, how about some of those good ol' boys comin' on up to New York and showin' us what real prize-winnin' Texas chili can do for a Yankee's disposition?

October 1, 1987 Volume 60, Number 20
142,358 copies of this issue printed

Electronics (ISSN 0893-4989). Published biweekly by McGraw-Hill Inc. Publication office: 1221 Avenue of the Americas, N.Y., N.Y. 10020; second class postage paid at New York, New York and additional mailing offices. Postage paid at Montreal, P. Q. Registration Number 9034.

Executive, editorial, circulation, and advertising addresses: Electronics, McGraw-Hill Building, 1221 Avenue of the Americas, New York, N.Y. 10020. Telephone (212) 512-2000. Teletype 12-7960 TWX 710-581-4879. Cable address: MCGRAW HILL NEW YORK.

Officers of McGraw-Hill Information Systems Company: President: Richard B. Miller; Executive Vice Presidents: Frederick P. Jannot, Construction Information Group; Russell C. White, Computers and Communications Information Group; J. Thomas Ryan, Marketing and International. Senior Vice Presidents-Publishers: Laurence Altman, Electronics; Harry L. Brown, BYTE; David J. McGrath, Engineering News-Record. Group Vice President: Peter B. McCuen, Communications Information. Vice Presidents: Robert D. Daleo, Controller; Fred O. Jensen, Planning and Development; Michael J. Koeltter, Human Resources; Talat M. Sadig, Systems Planning and Technology.

Officers of McGraw-Hill Inc.: Harold W. McGraw Jr., Chairman; Joseph L. Dionne, President and Chief Executive Officer; Robert N. Landes, Executive Vice President, General Counsel and Secretary; Walter D. Serwatka, Executive Vice President and Chief Financial Officer; Shel F. Asen, Senior Vice President, Manufacturing; Robert J. Bahash, Senior Vice President, Finance and Manufacturing; Frank D. Pengilase, Senior Vice President, Treasury Operations; Ralph R. Schultz, Senior Vice President, Editorial; George R. Eisinger, Vice President, Circulation.

Title registered in U.S. Patent Office; Copyright 1987 by McGraw-Hill Inc. All rights reserved. The contents of this publication may not be reproduced in whole or in part without the consent of copyright owner.

Where necessary, permission is granted by the copyright owner for libraries and others registered with the Copyright Clearance Center (CCC), 21 Congress Street, Salem, Mass. 01970, to photocopy any article herein for the base fee of \$0.50 per copy of the article plus \$0.25 per page. Payment should be sent directly to the CCC. Copying done for other than personal or internal reference use without the express permission of McGraw-Hill is prohibited. Requests for special permission or bulk orders should be addressed to the publisher. ISSN 0893-4989/87 \$0.50 + .25.

Editorial department phones: Administration (212) 512-2645, News and New Products (212) 512-2685, Technology (212) 512-2666. Bureaus: Boston (617) 262-1160, Chicago (312) 751-3811, Dallas (214) 644-1111, Los Angeles (213) 480-5234, New York (212) 512-3322, San Francisco/San Mateo (415) 349-4100, Washington (202) 463-1650, Frankfurt 72-5566, London 493-1451, Paris 42-89-03-80, Tokyo 581-9816.
Business departments: (212) 512-6435 (Business departments follow the Advertisers' Index).

Electronics

NEWS	INSIDE TECHNOLOGY
<p>Newsletters</p> <p>Electronics, 21</p> <ul style="list-style-type: none"> • SIA wants sanctions to continue; U. S. share of Japan's IC sales falls • Seymour Cray puts the heat on supercomputer rivals <p>International, 48</p> <ul style="list-style-type: none"> • Seven finalists vie for Japan's extended-definition TV standard . . . • . . . as Japan sets up R&D firm for high-definition TV displays 	<p>COVER: Ferment in microcontrollers, 55</p> <p>New offerings and new players are stirring up the competition in microcontrollers. Most of the action is at the high end as 16-bit parts are rocketing along at a 90% growth rate after a slow start</p> <ul style="list-style-type: none"> • Intel's radical 16-bit redesign doubles 8096 throughput, 59 Pin-compatible with the earlier chip, the new 12-MHz 80C196 has enhancements that boost execution speeds as much as 100% • National is rolling out a 16-bit standard cell, 61 The core of the 30-MHz HPC16000 16-bit controller series is being made available as a megacell in National's CMOS standard-cell library <p>It's design-in time for ISDN: OEM's find the going rough, 63</p> <p>They find many chip sets but with incompatible interfaces that complicate mixing; to get designs moving faster, chip makers are turning out more evaluation boards</p> <ul style="list-style-type: none"> • AMD's \$18 controller chip executes ISDN's key protocol, 66 Other jobs include linking non-ISDN terminals and arbitrating bus access <p>SPECIAL REPORT: Gap between CAE and ATE narrows, 72</p> <p>Test-gear makers are readying software that translates CAE files to an intermediate format so they can be used to produce test programs</p> <p>Ethernet or Starlan? This controller does both jobs, 77</p> <p>Fujitsu's chip includes logic to implement both Ethernet and StarLAN. It also takes over part of the supervisory burden from the host CPU</p> <p>Philips finds a new way to boost ADC chip performance, 79</p> <p>The 8-bit flash-converter family is more accurate yet has less circuitry</p> <p>TI to roll out its first family of products made with BiCMOS, 81</p> <p>The interface ICs are made in a process the Dallas company is convinced will be its technology driver in the 1990s</p> <p>How Micro Switch's new kind of air-flow sensor does it, 85</p> <p>The silicon sensor uses micromachined, thermally isolated bridges to measure flow rates as low as 1 cm³/min</p> <p>Technology update, 89</p> <p>VTI is launching a second-generation design tool. . . Sierra's simulator is on a roll in ASIC design</p> <p>Military gets active-matrix LCD that outshines a CRT display, 90</p> <p>Alphasil's LCD matches CRT performance at 20% of the power</p>
<p>Memories, 31</p> <p>Honeywell puts thin-film magnetic arrays on a chip; days may be numbered for plated-wire memories</p> <p>Distribution, 32</p> <p>Will the Arrow deal with Ducommun start a merger frenzy?</p> <p>Telecommunications, 32</p> <p>Rockwell ups the ante in 9,600-baud dial-up modems</p> <p>Integrated circuits, 33</p> <p>The competition soars in PC AT clone chips</p> <p>Instrumentation, 33</p> <p>The fast Fourier transform meets its match in Chirp Z</p> <p>Recognition systems, 34</p> <p>How Siemens is using a laser beam to 'see' in an object-recognition system</p> <p>Displays, 36</p> <p>The LCD race in Europe gets hot as firms take on the Japanese</p> <p>Microprocessors, 36</p> <p>How Fairchild's Clipper chips will fit in at new owner Intergraph</p> <p>Computers, 40</p> <p>The implications of the IBM-Fujitsu agreement may be more important than the agreement</p>	<p>PROBING THE NEWS</p> <p>New twist on an old idea takes Kodak deeper into electronics, 43</p> <p>It's funding startups proposed by its employees—and then it folds the successful ones back into the parent company</p>

FERMENT IN MICROCONTROLLERS

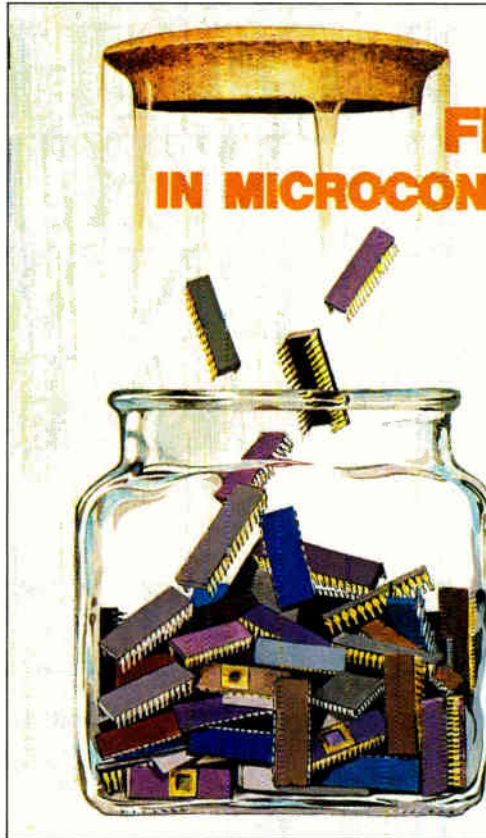

PAGE 55

NEW PRODUCTS

Newsletter, 25

- NEC chip set boosts TV resolution up to 40%
- Control Data crams 1.236 gigabytes on its latest 8-in. drive
- KLA wafer-inspection system works faster, detects smaller defects
- Matrox PC AT accelerator does shaded polygons, 90,000 3-d vectors/s
- Philips two-chip set does all stereo decoding for CD player

Computers & Peripherals, 96

- Network Systems plugs its Hyperchannel into the open-systems world with a router that handles 50-Mbit/s operation
- Package gives twentyfold I/O boost to Floating Point Systems' 64-bit minisupercomputers

Semiconductors, 100

- AMD's five-chip implementation of a fiber-optic networking standard will deliver 200 Mbytes/s
- GaAs arrays from TriQuint boast 1-GHz toggle rate and 3,000 equivalent gates

Military/Aerospace Newsletter, 93

- Congress will try to hold back early deployment of SDI
- The DOD pushes to boost the density of rad-hard GaAs static RAMS . . .
- . . . and looks forward to a 200-MHz GaAs microprocessor
- Magnavox readies anti-jamming communications system
- Star Wars office eases access to unclassified technology

DEPARTMENTS

Publisher's Letter, 3

How New Products editor Jack Shandle put together this issue's package on the Integrated Services Digital Network

FYI, 8

The 32-bit world may have more players than Motorola and Intel predict; with semicustom and RISC coming on strong, there may be room for more, not fewer

Letters, 10

People, 12

Why Giordano Associates' Robert Noble aims to close the gap in military ATE

Electronics Week, 106

- Sematech gets the nod from SEMI . . .
- . . . and from the Congressional Budget Office
- Western Digital and AT&T broaden their digital CMOS pact
- Inman plans a second acquisition in 1987

TO THE MILLIONS OF WORDS THAT HAVE BEEN WRITTEN ABOUT ISDN, WE'D LIKE TO ADD A NEW ONE.

COMPLETE.

For years, you've read about the incredible new products you can design when ISDN becomes a reality. And now, you can stop waiting and finally get started. Because our 29C53 ISDN Kit delivers what most people have only been writing about. A complete ISDN solution.

There's our 29C53 "S" Transceiver, which transmits



and receives data at the ISDN basic rate of 192 kbps. And fully implements Open Systems Interconnection (OSI) Layer 1. There's our programmable 29C48 Voice

Conversion Chip. And our 80188 CPU, which performs protocol processing.

But that's just the beginning. What really puts you ahead is our ISP188 software, which completes OSI layers 2 and 3.

Co-developed with DGM&S, ISPI88 is made up of literally thousands of lines of code. And it's ready to run today. As a result, you save man-years in development time and get to market quicker.

When you use this complete package, it will take care of the most common design issues associated with ISDN protocols and standards. So you can focus your resources on making your product the best of its kind. No matter what you're designing, from a low end terminal adaptor, to PCs, to PBXs. Or even the first products of an entirely new kind.

What about industry standards? We're working on compatibility issues with the world's largest telecommunications equipment suppliers. In fact, we've recently concluded an agreement with AT&T that ensures interoperability between our devices and theirs.

As a result, you can begin to design with this kit right away. And be certain of compatibility with ISDN systems today and tomorrow.

And now that standards are set, the opportunities are wide open. To help you make the most of them, we also offer a full range of development tools, such as our Terminal Evaluation Kit, and our Line Card Evaluation Kit.

So if you've been waiting for ISDN, the wait is over. We have samples and software available now. Call (800) 548-4725 and ask for Literature Department W-369 for more information. And we'll show you the one word about ISDN that's worth a million.

Complete.

The Intel logo, consisting of the word "intel" in a lowercase, sans-serif font with a registered trademark symbol (®) to the upper right of the letter "l".

THE SOFTWARE PROBLEM SOLVERS

If you were ITT and had to automate power monitoring and control systems for telephone power plants, who would you turn to? And what if you were Bell Canada and your purpose was to automate the company's trouble reporting, analysis, and control procedures? Or suppose you were the Allright Parking Company and had to automate the data acquisition and distributed control of a large number of parking facilities?

If you knew what those companies know, you would do what they did. You would turn to FORTH, Inc. because you'd know that they have the real-time software capabilities that such automation programs require—as well as Custom Applications, Software/Hardware Inte-

gration, Installation and Training, Ongoing Maintenance, and Hot Line Support.

And if yours is not a custom application, FORTH, Inc. also offers its powerful family of polyFORTH software and

related hardware products. These interactive development tools are compatible with the most popular computers from microprocessors to super-minis.

So, for applications-oriented products or expert help with your automation project, do what the major corporations are doing. Turn to FORTH, Inc., the "software problem solvers" who understand such real-time applications as process control, robotics, digital signal processing, machine vision, data acquisition and analysis, and networking.

FORTH, Inc. gives you the option—product or custom services. FORTH will do it all for you, or provide you with a product to solve your problem. You make the decision.

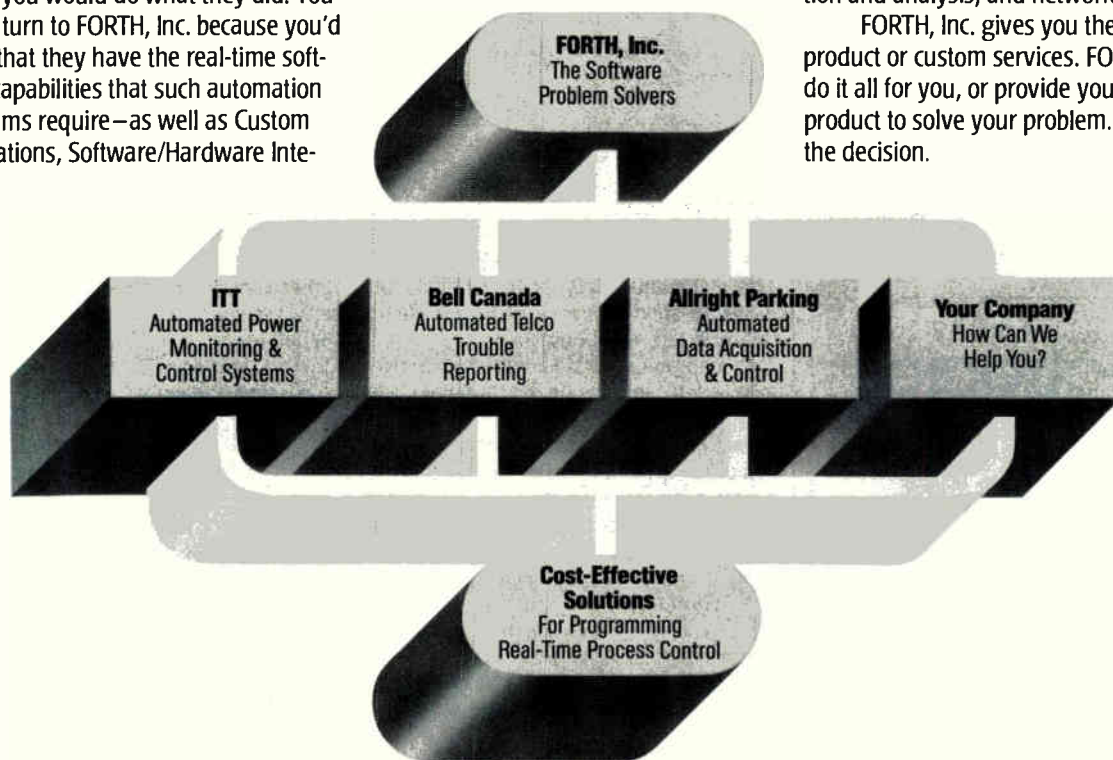

Please send me your brochure that describes the polyFORTH family of products and your custom services.

I have an application in mind, which is _____

Have a salesman call me.

Name/Title

Company/Division

Address

City

State

Zip

Phone

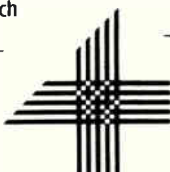

FORTH, Inc.

FORTH, Inc., 111 N. Sepulveda Blvd., Manhattan Beach, CA 90266.

Phone: 800-55-FORTH. Inside California: (213) 372-8493.

Circle 9 on reader service card

In the grand design of VME, where do we fit in?





performance that lasts. Because our standards are based on NATO guidelines. And our Q/A policies are merciless. Every board is 100% in-circuit tested. Then 100% functional tested. And, as if that's not

enough, they're put through 100% dynamic burn-in. No wonder our return rate is less than 0.9%. And dropping fast.

Support you can count on.

As you might expect, our support is as uncompromising as our quality. Take our documentation. It's the most thorough and detailed in the business. Applications support? No one else delivers it faster or better. Just need a question answered? Call Force and you'll get somebody who's really qualified to help.

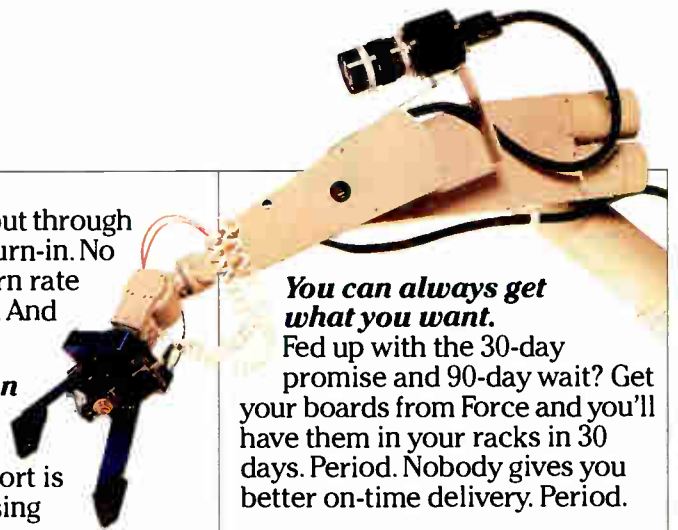

You can always get what you want.

Fed up with the 30-day promise and 90-day wait? Get your boards from Force and you'll have them in your racks in 30 days. Period. Nobody gives you better on-time delivery. Period.

We'll throw the book at you.

If you've got a VME problem, Force has the solution. Nobody offers more. Give us a chance to prove it. Call today and we'll send you our free 380-page data book. You'll find that for your application, we'll fit in quite well.

Call toll-free: 1-800-BEST VME. In California, 1-800-237-8862.



FORCE COMPUTERS, INC.
727 University Ave. Los Gatos, CA 95030
Phone (408) 354-3410
Telex 172465 Telefax (408) 395-7718
FORCE COMPUTERS, GmbH
Daimlerstrasse 9 D-8012 Ottobrunn
Telefon (089) 60091-0 Telex 524190 forc-d
Telefax (089) 6 097793

© 1987 Force Computers, Inc. FORCE is a registered trademark of FORCE COMPUTERS, Inc. UNIX is a trademark of AT&T/Bell Laboratories. PDOS is a trademark of Eyring Research Institute, Inc.

Circle 15 on reader service card

Give Yourself Technology With Perspective. Electronics. FREE, if you qualify.

Qualification is based on answers to *all* questions. Please fill out carefully.

Name _____

Title _____

Company _____

Div. or Dept. _____

Address _____

City _____ State _____ Zip _____

Check here if you wish publication to be sent to home address

Street _____

City _____ State _____ Zip _____

- YES, begin my **FREE** subscription to **Electronics** magazine, if I qualify.
- No, I am not interested in this free offer.

Signature _____ Date _____

Please Note: Company affiliation and address must be given. Application must be signed and dated.

TO QUALIFY, you must answer all questions. The publisher reserves the right to serve only those individuals who qualify for a free subscription. This application becomes void if improperly completed.

1. The primary end product (or service performed) at your plant, and the product (or service) that is your own work. (Insert one code for each)

- Plant Own work

- A. Computers, data processing and peripheral equipment, office and business machines
- B. Communications, data communications, telecommunications systems and equipment
- C. Navigation and guidance, aircraft and missile systems and equipment (oceanography)
- D. Test and measurement equipment
- E. Consumer products (TV, radio, hi-fi, recorders, home computers, appliances)
- Q. Medical systems and equipment
- R. Industrial control systems and equipment
- G. Semiconductor production equipment (component insertion, coil winding, etc.)
- H. Electronic sub-assemblies, components and materials (active and passive components, ICs, discretes, hybrids, power supplies)
- I. Other manufacturers using electronic equipment as part of their manufacturing process (machine tools, chemicals, metals, plastics, pharmaceuticals, etc.)
- J. Government and military
- K. Independent research and development laboratories or consultants
- L. Research and development organizations which are part of an educational institution
- M. Independent software developers
- N. Operators of communications equipment (utilities, railroads, police, airlines, broadcasters, etc.)
- O. Educational: 2-4 year colleges, universities
- P. Other (please describe) _____

2. Your principal job function: (Insert one code only)

- A. Corporate management (owner, partner, president, VP, etc.)
- B. Operating management (general manager, group manager, division head, etc.)
- C. Engineering management (project manager, chief engineer, section head, VP of engineering, VP of research and development, VP of quality control, etc.)
- D. Software engineering
- E. Systems engineering/integration
- F. Quality control engineering (reliability and standards)
- G. Design engineering
- H. Engineering support (lab assistant, etc.)
- I. Test engineering (materials, test, evaluation)
- J. Field service engineering
- K. Research and development (scientist, chemist, physicist, etc.)
- L. Manufacturing and production
- M. Purchasing and procurement
- N. Marketing and sales
- O. Professor/instructor at _____
- P. Senior student at _____
- Q. Graduate student at _____
- Z. Other (please describe) _____

3. Your principal responsibility: (Insert one code only)

1. General management 3. Engineering
2. Engineering management 4. Other

4. Estimated number of employees at your location: (Check one box only)

- 1 to 49 50 to 249 250 to 999 1,000 or more

5. Your engineering function: (Check all that apply)

- A. I design or develop electronic products and systems (hardware and/or software)
- B. I supervise electronic design or development engineering work
- C. I set standards for, evaluate, test and/or support the manufacture of design components, systems and materials
- D. Other function (please describe) _____

6. In your company or organization, do you participate in: (Check all that apply)

- A. Business planning and forecasting C. Technology planning
- B. Product planning D. No involvement in planning

7. Your involvement in the following stages of product development: (Check all that apply)

- A. Evaluate the need for new products E. Select Vendors
- B. Develop device specifications F. Approve purchases
- C. Evaluate suppliers G. Place orders
- D. Review prices and availability H. No involvement

8. What is your title? (Insert one code only)

- Operations Management**
01. President/Chairman/Owner/ Partner 03. Vice President of Engineering
02. Vice President 04. Product Marketing Manager
- Engineering Management**
11. Technical Director 19. Senior Test Engineer
12. Chief Engineer 20. Senior Field Test Engineer
13. Principal Engineer 21. Manufacturing/Production Manager
14. Research Director 22. Group Leader
15. Section Head 23. Department Head
16. Project Engineer 24. Other Management (please explain) _____
17. Senior Engineer
18. Software Manager
- Design or Standards Personnel**
31. Systems Engineer 38. MTS
32. Software Engineer 39. Consultant
33. Test Engineer 40. Scientist
34. Field Test Engineer 41. Physicist
35. Manufacturing Engineer 42. Other Staff (please explain) _____
36. Production Engineer
37. Engineer

9. Products that you specify or authorize purchase of: (Check all that apply)

- ICs and Semiconductors**
01. Digital ICs 27. Semiconductor production equipment
02. Linear ICs 28. Robotics components/equipment
03. Microprocessors 29. Microprocessor development systems
04. Semiconductor memories
05. Custom/semicustom ICs
- Components**
11. Resistors and capacitors
12. Interconnections
13. Switches and relays
14. Optoelectronic components
15. Readout and display devices
16. Fiber-optic components
17. Printed circuits
- Equipment**
21. Power supplies
22. Test and measurement equipment
23. Automatic test equipment
24. Field service test equipment
25. Analog/digital panel meters
26. Cabinets and enclosures
- Computer-based Systems and equipment**
31. CAE hardware/software
32. CAD/CAM hardware/software
33. Minicomputers
34. Microcomputers
35. Computer terminals
36. Computer boards
37. Disk/tape memories
38. Graphic displays
39. Software packages/services
40. Printers/plotters
41. Computer peripherals
42. Modems
43. Communications equipment
44. None of the above

10. Your degree of profit accountability: (Check one box only)

- A. I have direct profit responsibility C. I have no profit responsibility
- B. I share profit responsibility with others

11. Your level of sign-off or purchase approval authority for your company or organization: (Check one box only)

- A. None C. \$1,001 to \$ 5,000 E. \$10,001 to \$25,000
- B. Less than \$1,000 D. \$5,001 to \$10,000 F. More than \$25,000

12. Other publications that you read regularly (3 out of 4 issues): (Check all that apply)

- A. Electronic Design D. Electronic News
- B. Electronic E. Electronic Business
- Engineering Times F. Computer Design
- C. EDN G. Electronic Products
- H. None of the above

**Have You Completed the Questionnaire to
Qualify for Your *FREE* Subscription to
Electronics Magazine?**

FOLD HERE

FOLD CARD AND SEAL ALL EDGES FOR MAILING



NO POSTAGE
NECESSARY
IF MAILED
IN THE
UNITED STATES



BUSINESS REPLY MAIL
FIRST CLASS PERMIT NO. 42 HIGHTSTOWN, N.J. 08520

POSTAGE WILL BE PAID BY ADDRESSEE

Electronics

McGraw-Hill Publications Company
P. O. Box 641
Hightstown, NJ 08520-9985

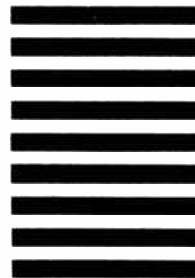

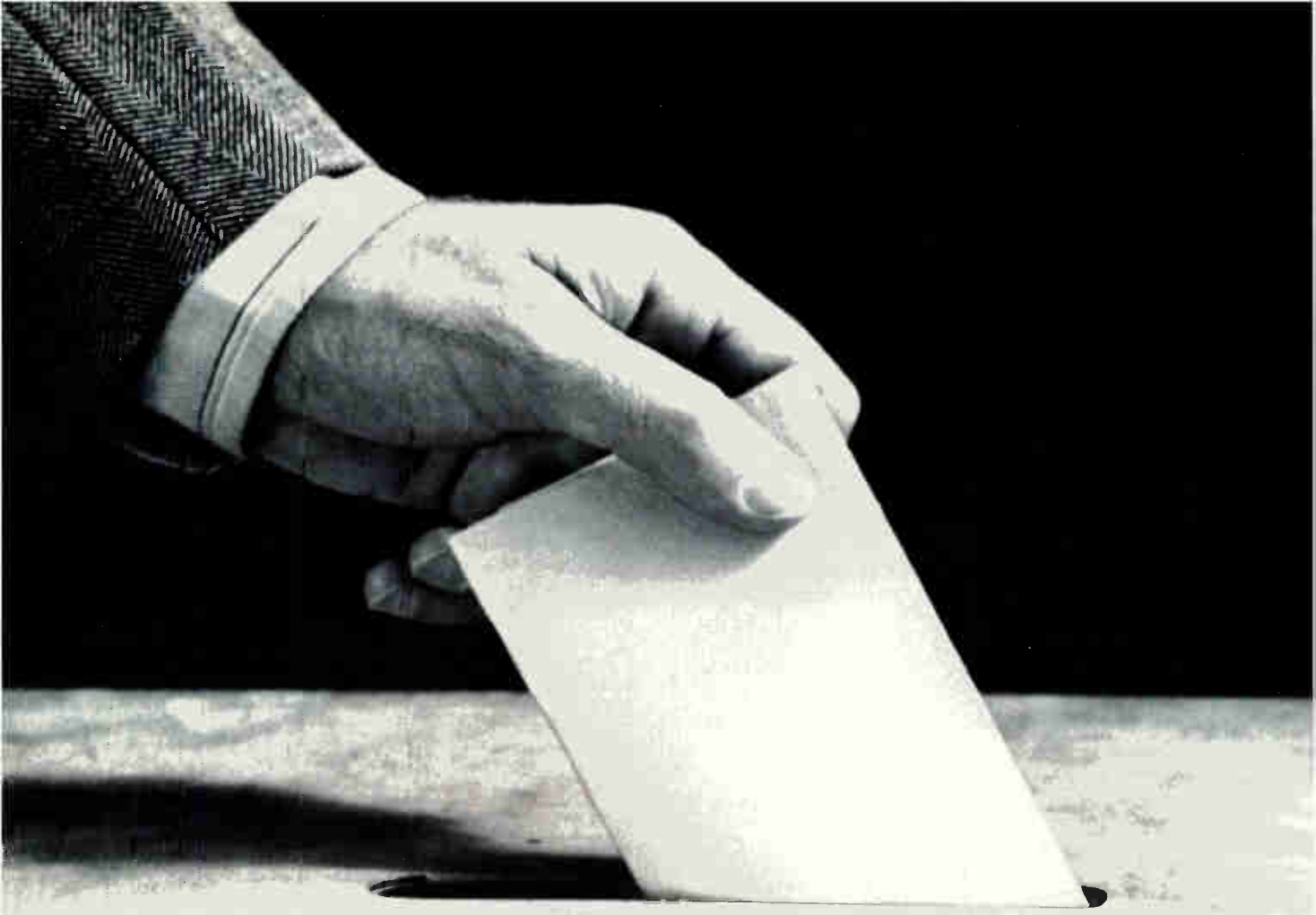

In Costa Rica, we believe in regularly scheduled revolutions.

We've held free and fair elections in Costa Rica every four years ever since the founding of our modern democracy nearly four decades ago. That's what's made us the safest, most stable country in the Caribbean.

And it's also part of what's made us the ideal offshore location for U.S. manufacturers.

The other parts include generous incentives and tax holidays, such as duty-free import of raw materials and production equipment and tax-free export earnings; duty free access to American markets for 4,000 products under the Caribbean Basin Initiative; an established, affordable infrastructure featuring abundant hydroelectric energy, excellent transportation,

and modern telecommunications; and a government that works with industry to set business policies, not against it.

And with a literacy rate of 93 percent—the highest in the region—businesses have no trouble finding workers able, and willing, to learn their work.

When it comes to business, Costa Rica is a revolutionary revelation. For more information, contact the nearest Costa Rican Investment Promotion Office.

COSTA RICA
The Right Business Climate

Northeast: 36 Hunting Lane, Suite A-1, Stamford, CT 06902 • (203) 968-1448. ☐ Midwest: 221 N. LaSalle Street, Suite 1808, Chicago, IL 60601 • (312) 346-0626.
Southeast: 235 Peachtree Street, Suite 1617, Atlanta, GA 30303 • (404) 223-5708. ☐ West Coast: 17910 Sky Park Circle, Suite 101, Irvine, CA 92714 • (714) 250-0146.

SEEKING THE ULTIMATE MICROCODE DEVELOPMENT SYSTEM?



Bit Slice

CPU
Design

ASIC

VHSIC

Bipolar
Processors

DSP

YOUR SEARCH IS OVER!

Speed, support and satisfaction. That's the HILEVEL approach to meeting *your* microcode development systems needs, *without compromise*.

Microprogram development and debug is fast and easy, thanks to highly-productive software development tools combined with the most powerful hardware available. We back each system with unmatched service and support, and *the longest warranty in the industry*.

- **Guaranteed Access Time at Target Side of Pod.**
- **Most Powerful Logic Analyzer, with Exclusive Trace Waveform Display.**
- **Most Advanced Macro-Meta Assembler in the Industry.**
- **Toll-Free Applications Assistance.**
- **Memory Board Exchange Credit.**

And, we'll demonstrate an ease-of-use that invites comparison with any other system on the market.

Avoid compromises. Demand the finest. Call today.

DIAL TOLL FREE:
1-800-HILEVEL
In California, call
1-800-752-5215

HILEVEL
TECHNOLOGY, INC.

18902 Bardeen, Irvine, CA 92715 • Phone: (714) 752-5215 • TELEX 655316 • TELEFAX (714) 752-0724

Circle 129 for "LITERATURE ONLY"

World Radio History

Circle 20 for "TOPAZ DEMO"

ELECTRONICS NEWSLETTER

SIA WANTS SANCTIONS TO CONTINUE; U.S. SHARE OF JAPANESE IC SALES FALLS

President Reagan is being urged to continue and, if necessary, stiffen sanctions against Japanese chip makers in response to what the Semiconductor Industry Association says is a lower U. S. market share in Japan one year after the two countries agreed to a major semiconductor-trade pact. SIA officials say the U. S. share of Japanese chip markets fell to only 9% in the second quarter of 1987, compared with 9.4% in early 1985. The SIA, issuing its first report on the trade pact, gives it a mixed review. SIA leaders complain that Japan disrupted supplies of key semiconductor products with production controls and minimum floor prices, imposed last April in response to chip-dumping charges by the U. S. The group says chip dumping has eased, but Japan's controls on production and prices are stifling the competitive spirit sought by the trade pact. □

SEYMOUR CRAY PUTS THE HEAT ON SUPERCOMPUTER RIVALS

Cray Research Inc. founder Seymour Cray plans to keep the throttle open despite last month's cancellation of the MP supercomputer project and the departure of project leader Steve Chen [*Electronics*, Sept. 17, 1987, p. 21]. Cray says that the Minneapolis company is ahead of schedule with the 16-processor, 16-gigaflops, GaAs-based Cray 3, and that work will begin next year on the Cray 4, which could appear as early as 1992. That machine will rely on LSI GaAs chips, 64 processors, and 1-ns cycle times to achieve 128 gigaflops. If Cray hits its targets for the Cray 3 and 4, it could spell trouble for Chen, who plans to start his own company, and for Cray's crosstown rival, ETA Systems Inc. "If Seymour's got a machine that will run 16 gigaflops by the end of next year, that's got to put some pressure on ETA," says Gary Smaby, an analyst at Piper, Jaffray & Hopwood Inc. in Minneapolis. The first ETA¹⁰ was delivered early this year but has still not hit its target 10-gigaflops peak speeds. And the Cray 4 is "going to make it more difficult for Chen to differentiate his product strategy from Seymour's," Smaby says. □

LSI LOGIC LAUNCHES TWO-CHIP SET FOR 1750A PROCESSOR

Applications for 1750A microprocessors should get a fillip from LSI Logic Corp.'s new two-chip set, which implements all the functions called for in the military instruction-set specification. The chip set consists of a central processor and a memory management unit—the first dedicated peripheral chip that can handle all memory management chores, according to Randy Rasmussen, program manager for standard products for the Milpitas, Calif., company. The 1.5- μ m HCMOS chips run at 15 MHz, 20 MHz, and 25 MHz, and are priced at \$1,250, \$1,450, and \$1,750, respectively. □

INTEL'S CHIP FOR MILITARY 1553 BUS WILL INTEGRATE NEW FEATURES

Designers working with the Pentagon's MIL-STD-1553B avionics bus will soon have two monolithic interfaces to choose from, now that Intel Corp. of Santa Clara, Calif., is stepping in to compete with the United Technologies Microelectronics Center in Colorado Springs [*Electronics*, June 9, 1986, p. 13]. Intel claims a number of features for its M82553 Protocol Management Unit that the UTMC part does not have, such as a bus-monitor mode that allows it to extract information passed on the bus for later use, without responding to bus signals. In this mode, the chip can be used to implement a flight recorder or a warm-backup system in a fault-tolerant configuration. The M82553, built in 1.5- μ m CMOS, acts as a smart interface between the 1553 bus and a microprocessor-based system. It is optimized to work with 8086-type processors and most chips meeting the MIL-STD-1750A standard. □

NoiseKen

NEW



**MODEL
FVC-1000**

¥250,000

FCC CISPR VDE

EMI Noise Sensor catches the source of EMI.

In this electronics age, troubles of electronic equipments by EMI tend to increase in various fields of industry. In order to solve this problem, it is necessary to take the following two measures simultaneously:

One is to enhance the noise immunity of electronic equipment itself for preventing malfunction, and the other is to suppress the source of EMI which may be produced from electric and electronic equipments.

The EMI Noise Sensor is designed to search for the source of interfering electro-magnetic wave and to indicate its intensity by LED bar graphs approximately according to each frequency band classified based on the FCC, CISPR, VDE standards, so you can monitor the effectiveness of noise countermeasures you have taken in your products.

Compact design and lightweight construction allow you to take the most effective countermeasures at any time and anywhere.

Before testing your products in a large-scale open site, thoroughly study the effective countermeasures for EMI in your factory. The EMI Noise Sensor sharply cuts the time and cost required for passing the approval test.

<FEATURES>

- FVC-1000 indicates the intensity of interfering electro-magnetic wave approximately according to each frequency band classified based on the FCC, CISPR, VDE standards.
- No necessity for a shielding room or RF anechoic chamber.

NOISE LABORATORY CO., LTD.

2662-1, NOBORITO, TAMA-KU, KAWASAKI CITY, KANAGAWA PREF, 214 JAPAN
TEL(044)933-4311 TELEX 3842777 NOISEL FAX(044)932-4511



NOISE[®]
NOISE LABORATORY CO., LTD.

Circle 23 on reader service card

PRODUCTS NEWSLETTER

NEC CHIP SET BOOSTS TV RESOLUTION UP TO 40%

Look for television picture quality to take a quantum leap forward with a chip set from NEC Corp. that uses digital-signal-storage and processing techniques to implement the Improved-Definition TV standard. IDTV delivers a 30% to 40% improvement in resolution—the best picture possible from current NTSC signals. It features 60 noninterlaced frames with twice as many scanning lines as the 60 interlaced fields used in conventional NTSC TV, as well as advanced techniques for separating chroma and luminance signals. A key chip in the Tokyo company's set is the μ PD42270C field buffer. There are seven of these in the kit, each providing almost 1 Mbit of storage—263 lines by 910 pixels by 4-bits. Signal processing is done by six 1- μ m CMOS chips. Also included are 11 μ PD41101C line buffers, two analog-to-digital converters, and three digital-to-analog converters. Samples will be available in December for \$347, with full production set for early 1988. □

CONTROL DATA CRAMS 1.236 GIGABYTES ON ITS LATEST 8-IN. DRIVE

Control Data Corp. has upped the ante in the 8-in. disk-capacity competition to 1.236 gigabytes with its Sabre 1230—a 65% increase over its industry-leading 750-Mbyte Sabre IV series. The Sabre 1230 integrates thin-film media and thin-film heads to achieve the greater capacity, and it can be equipped for any of three interfaces: SMD (Storage Module Drive), IPI-2 (Intelligent Peripheral Interface), or SCSI (Small Computer System Interface). It features a data-transfer rate of 3.02 Mbytes/s and average seek times of 16 ms. Customer evaluation units with SMD or IPI-2 interfaces will be available in the fourth quarter, while SCSI evaluation units will be available in the first quarter of next year. Production deliveries will begin in the second quarter. The Sabre 1230 costs \$6,470 in volume purchases. □

KLA WAFER-INSPECTION SYSTEM WORKS FASTER, DETECTS SMALLER DEFECTS

Chip makers can hunt down defects as small as 0.6 μ m up to 15 times faster with KLA Instruments Corp.'s Model 2028 inspection system than with the company's 2020—itsself a pioneer in automating wafer-defect inspection with image-processing technology. Quick inspection turnaround and high precision mean fab processes can be tweaked earlier to eliminate many defects and increase yield—savings that mean the machine can pay for itself in six months to a year, says the Santa Clara, Calif., company. KLA achieves the performance boost chiefly by adding an operating mode especially tailored for repeating circuit patterns such as memory arrays. The 2028 inspects wafers at a rate of 6.5 min./cm² in its repeating mode, compared with 98 min/cm² for the single-mode 2020. Available in the second quarter of 1988, the 2028 will cost \$875,000. □

MATROX PC AT ACCELERATOR DOES SHADED POLYGONS, 90,000 3-D VECTORS/S

Users of IBM Corp. PC ATs and compatibles based on Intel Corp.'s 80386 microprocessor can get 50% better 3-d solids-modeling performance for less than \$7,000 with Matrox Electronic Systems Ltd.'s single-board graphics accelerator. The SM-1281 can perform 90,000 3-d vectors/s and 20,000 shaded 3-d polygons/s, while competing products offer 60,000 3-d vectors/s and no shaded-polygon feature. The SM-1281 implements 3-d rendering with a pipelined architecture and five dedicated microprocessors. Among them is a special VLSI "tile" processor that permits high-speed rendering. The SM1281 must be teamed with the Dorval, Quebec, company's PG-1281 color-display processor board. Available in November, the SM-1281 costs \$6,995; the PG-1281, introduced in July, sells for \$3,495. □

Our customers
don't bother testing
our products anymore.

They don't have to.

ITT Cannon's track record for near zero defects has been so consistent that our connectors go directly onto many of our customers' assembly lines without costly testing or handling.

At Cannon, we build quality standards right into our manufacturing process so performance is assured each step of the way. Not just at the end of the assembly line.

On top of that, our state-of-the-art Materials and Processing Lab is constantly inventing and testing new compounds to create even more reliable interconnects.

With greater efficiency and higher standards prerequisite, you can expect reduced lead times, lower inspection costs and fewer customer returns with Cannon products.

Quality assurance. Part of the new story at Cannon.

Talk to us.

*Worldwide Headquarters
10550 Talbert Ave.
Fountain Valley, CA 92708
Or call (714) 964-7400*

ITT CANNON
*We're making progress.
Not excuses.*

Circle 27 on reader service card

Introducing the complete ISDN device solution.

AT&T, a recognized leader in ISDN, is proud to announce the UNITE™ ISDN Family of Devices, specifically designed to provide a total ISDN solution.

AT&T gives you all the essentials for true ISDN performance—a complete set of Basic Rate and Primary Rate devices—all in low-power CMOS. Just what you'd expect from one of the principal architects of ISDN.

Basic Rate technology. Our T7250A S/T Interface Chip is integrated directly into phone and computer terminals to deliver full duplex/digital capabilities from point-to-point or point-to-multipoint configurations—and conforms fully to CCITT I.430 recommendations. The chip exchanges voice and data traffic at 192 Kb/s over a 4-wire digital subscriber loop.

Our *proven*, filter-equipped, T7500 Codec can be directly interfaced with the T7250A S/T Interface Chip.

For high performance HDLC formatting, our T7111 Synchronous Packet

Data Formatter (ANT) is today's fastest single-channel device. It operates at a maximum serial data rate of 4 Mb/s, more than any other CMOS data formatter, yet requires only a 5-volt supply.

More of the Basics.

The AT&T T7112 Asynchronous Receiver/Transmitter Interface (ARTI) is the first asynchronous interface device to offer on-chip speed matching. This eliminates 95 percent of the software and the 3 to 4 logic chips normally required to handle different data rates. And coupled with the T7111 ANT, it makes a very efficient ISDN terminal adapter solution.

Network termination functions are handled by our T7252 User-Network Interface Termination for Switches (UNITS). It provides a full I.430 interface for 2B + D applications in digital switches and features a programmable, dual-bus, time-division multiplexed highway at the system interface.

Primary Rate devices.

AT&T's LC1046 Digital Signaling Interface (DSI) offers full duplex transmit/receive interfacing between either DS-1 or DS-1C cross connects in central office switching and terminal equipment circuits.

Finally, the AT&T T7110

Synchronous Protocol Data Formatter (SPYDER-S) provides HDLC frame level formatting for 8 time-multiplexed channels with a serial data rate of up to 2 Mb/s. Plus, an on-chip DMA Controller allows data transfer without host CPU intervention.

More Communication ICs.

What's more, AT&T experience is available in a full line of state-of-the-art Communication ICs, including X.25 Protocol Controllers, PCM and High Precision Codecs, Digital Encryption Processors, and Clock Recovery Circuits.

For more information, call AT&T at 1 800 372-2447, or mail the coupon.

In Europe, call AT&T Microelectronics in Munich at 089/95970. In Canada, call collect at 215 266-2975.

© 1987 AT&T

AT&T, Dept. LT, 555 Union Blvd., Allentown, PA 18103

EL 10/1/87

In Europe: AT&T Microelectronics GmbH,
Freischützstrasse 92, 8000 Munich 81, West Germany

- Please send me literature on AT&T's complete ISDN solution.
 Please have a sales representative contact me.

Name _____

Title _____

Company _____

Address _____

City _____ State _____ Zip _____

Phone (_____) _____



AT&T

The right choice.

Circle 29 on reader service card

computer Products Inc. of Norcross, Ga., sell for more than \$1,100.

The board, to debut at this week's Tele-Communications Association Show in San Diego, represents "a complete change in technology—not just scaling up from 2,400 b/s," says Frank Micheletti, the Rockwell division's director of engineering. For starters, the jump in speed from 2,400 bits/s called for a major boost in modem signal processing, which Rockwell has handled by going to a 2- μ m CMOS process; the company had

used 3- μ m n-MOS before. The resulting C53SPX processor has doubled the clock speed, to 24 MHz, and halved the instruction-cycle time, to 167 ns.

But perhaps the most notable advance in the R9696 modem is its one-chip echo canceler—also in 2- μ m CMOS. The new modem must not only deal with superimposed signals, but also distinguish a received signal from interfering echoes caused by transmission through telephone-network switches. Rockwell calls its solution an algorithm-specific signal

processor that performs up to 20 million arithmetic operations per second. It has a 32-bit architecture, a clock rate of 12 MHz, and is programmable for varying degrees of near and far echoes.

Rounding out the R9696 improvements is the integrated analog front end, built in 3- μ m CMOS, that interfaces with telephone equipment. The chip's flexibility permits the new board to operate with existing modems at 300 to 4,800 b/s. Shipments will start in three to six months. —Larry Waller

INTEGRATED CIRCUITS

COMPETITION SOARS IN PC AT CLONE CHIPS

SUNNYVALE, CALIF.

A late-summer burst of activity by semiconductor makers has brought new zest to the market for IBM Corp. PC AT-compatible chip sets, which Chips and Technologies Inc. has dominated for the past two years.

The Milpitas, Calif., company opened the summer festival in August with a new four-chip solution called NEAT. Faraday Electronics Inc. followed suit with a five-chip set. Then came LSI Logic Corp., which is spinning off an affiliate to market its three-chip solution.

These three companies, along with Zymos Corp., VLSI Technology Inc., and Taiwan's United Microelectronics Corp., are chasing a sizable market. Robert Andrews, technical marketing manager of Zymos, estimates that some 3.5 million PC AT-compatibles based on Intel Corp.'s 80286 central processor were sold this year, with about the same number in the offing for 1988. In addition, some 800,000 personal computers with more powerful 80386 processors will plump out the market, Andrews says.

SPINOFF. For its bid to join the group of PC AT-clone chip suppliers, LSI Logic, Milpitas, formed a new subsidiary, G-2 Inc., and named William O'Meara, a former vice president of marketing and a cofounder of the parent company as its president.

The new company's charter is to identify marketplaces for customizable standard products built with its semicustom tools. And the first such opportunity it identified is, not surprisingly, the PC AT-clone market. At the same time its existence was made known—the company was actually formed about six months ago—G-2 announced it had developed a three-chip set that, in conjunction with 10 peripheral circuits, will reduce by nearly 90% the number of standard, non-memory glue logic circuits now required to build an AT PC clone.

What G-2 is offering to the market is a three-chip solution to integrating the PC AT motherboard, plus a systems control-

ler and an address/data buffer. The chips are fabricated using LSI Logic's 1.5- μ m CMOS process; and the firm expects to be turning out production quantities of a 12-MHz version of the chip set by the end of the year, with a 16-MHz version to follow.

G-2 will price the set at \$65 in 10,000 unit quantities. At first glance, that appears to make it the price leader: Faraday prices its five-chip set at \$95 in quantities of 1,000; Chips and Technol-

ogies sells the 12-MHz version of its four-chip NEAT set for \$108.90 in quantities of 100. Direct comparisons of raw chip-set prices, however, are misleading because each set needs a different complement of standard devices. "The name of the game is performance and board cost," say Zymos's Andrews. All of the players insist, of course, that their game is the best one for clone-makers to play.

—Bernard C. Cole

INSTRUMENTATION

FAST-FOURIER TRANSFORM MEETS ITS MATCH IN CHIRP Z

DANVERS, MASS.

The Chirp Z transform algorithm for evaluating finite-duration phenomena, such as radio signals, is well known in mathematics. Now, for the first time, it has been implemented in an instrument by the Data Precision division of Analogic Corp. The company's engineers did the job by reducing the complex math to an algorithm that can be executed by a Motorola Inc. 68000 microprocessor.

The Danvers, Mass., division has added the capability in the form of an erasable programmable read-only memory to the Data 6100 universal waveform an-

alyzer, which itself was introduced in May. The Chirp Z algorithm provides 65 times greater resolution in time-to-frequency conversions than does a fast Fourier transform, one of today's most popular methods for making the conversion, for the same sampling rate and number of input points (see figure). The accomplishment could make Data Precision a potent competitor for makers of dedicated FFT spectrum analyzers, says Galen Wampler, president of Prime Data, a San Jose, Calif., market analyst.

In resolution, for a sampling period of 1 μ s, the frequency of an input signal with 512 data points can be resolved to

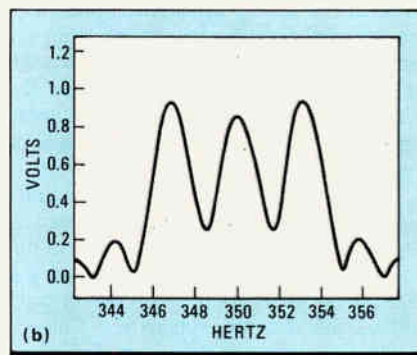
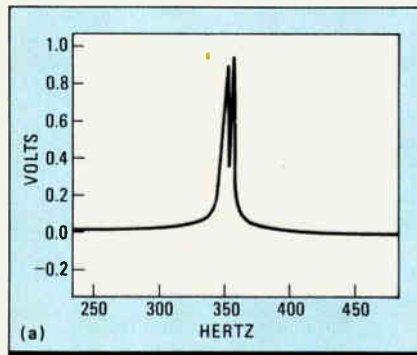

TRANSFORMED. The conventional fast Fourier transform of a waveform (a) has much lower resolution than the Chirp Z version, as implemented by Data Precision (b).

We're growing with speed and resolution.



Introducing the best spectral performance available in 14 and 16-bit sampling ADC's.

Step-by-step, Analog Solutions is covering all key points on the speed/resolution scale.

We already have the largest line of high performance 16-bit ADC's. Now, in response to customer needs, Analog Solutions is introducing significant new products in a growing family of sampling A/D converters.

Leading off is the ZAD2764. This 14-bit sampling ADC offers a better combination of speed and resolution than anything you've seen before. The ZAD2764 features a 500 kHz sampling rate and a built-in ultra-linear sample and hold. Spectral performance is fully specified and guaranteed. Harmonic distortion, intermodulation distortion, S/N ratio and frequency response are specified under worst-case conditions. When you design the ZAD2764 into your telecommunications, medical imaging or ATE system, performance will not be compromised.

is the ZAD2846, a 300 kHz sampling 16-bit ADC with the best linearity and lowest noise and harmonic distortion available. With its low drift and guaranteed specs, the ZAD2846 satisfies the most demanding applications. The FFT diagram shows the actual performance.

Both new products use the latest technology and Analog Solutions' proprietary digital correction sub-ranging architecture.

Both are packaged in Analog Solutions' rugged, shielded metal case with low insertion force sockets and are pin-to-pin compatible with each other. So you can change system performance by simply swapping modules.

And both are 100% tested and documented to guarantee that published specifications are met.

If you need the performance that exceeds monolithics, hybrids, or your own ADC/sample and hold design, give us a call.

And watch us respond with speed and resolution.

For more information, please address Analog Solutions, 85 West Tasman

Drive, San Jose, CA 95134. Phone (408) 433-1900. FAX (408) 433-9308.

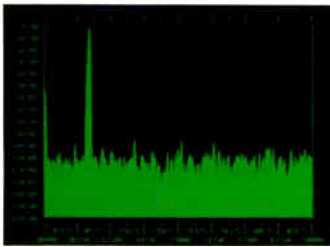

Actual spectral performance of ZAD2846

 **ANALOG SOLUTIONS**

A subsidiary of Silicon General.

Circle 37 on reader service card



test system computer with external reference test equipment connected to the channel outputs on the test station.

The results of the measurements are datalogged and summarized. And a final overall summary provides the six critical values that correlate directly to the system's published specifications. So you have absolute verification of your devices by absolutely precise edge placements.

This unique system of verified accuracy is available with all Teradyne test systems. Which is why Teradyne—and only Teradyne—can guarantee your guarantees.

If you are evaluating automatic test equipment, you know that every system claims to be accurate. But how many will

deliver on that claim with an external reference that is NBS traceable? The only ones we know of have our name on them. And if you'd like us to put your name on one of those, contact us today. Teradyne, Inc., 30801 Agoura Road, Agoura Hills, CA 91301. Or call (818) 991-2900.

the Ultra-Linear Timing System and Digitally Resynchronized Accuracy.

But Teradyne test systems don't stop after achieving precise accuracy. They go the next step: they verify edge placement accuracy with an external reference that's traceable to an independent standard, certified by the National Bureau of Standards. It's another Teradyne proprietary feature: Timing System Test. So you don't merely believe the testing is accurate.

You are guaranteed that it is. With NBS traceability.

Timing System Test provides a precise—and independent—measurement of the placement of all timing edges. And that means every single edge, not merely a sampling. Timing System Test links the

test system computer with external reference test equipment connected to the channel outputs on the test station.

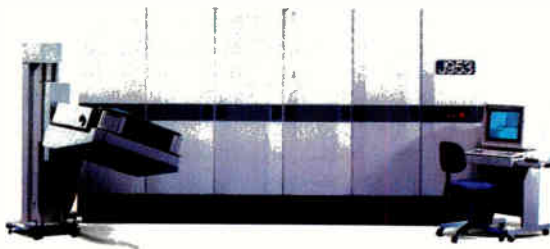

TERADYNE

We measure quality.

Circle 39 on reader service card

There ought to be a better way to test bus-structured boards.

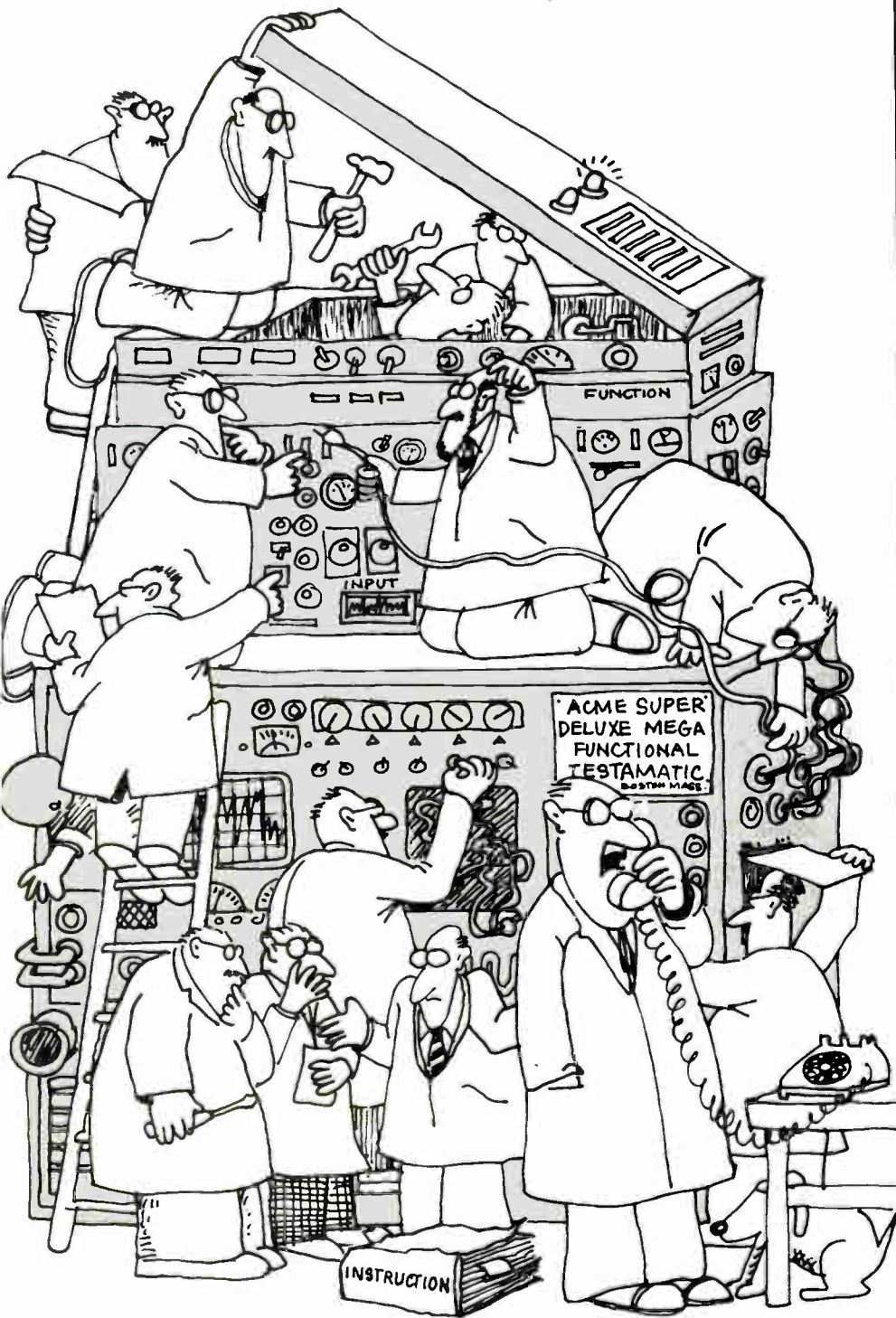

"Sure, sure... no problem, we'll have this baby up and running any day now... yep, just a few more days now... coming right along... heck of a tester... just a few more days more or less... yep, sure... no problem..."

Installing and programming some new testers can be almost comical.

Unless of course, it's *your* tester.

Fortunately, the Zehntel 3200 shrinks installation and programming time from months to *weeks*.

What's more, the Zehntel 3200 can test the full range of bus-structured boards. Even with multiple microprocessors.

The Zehntel 3200 has diagnostics that track faults right to the root cause of failure—normally, in less than 3 minutes. And you get reliable, 99% yield.

Now consider this.

The Zehntel 3200 delivers all this capability for about one-third the cost of some other functional testers.

Just write or call for complete information today.

Otherwise, you're just wasting your time.



The Zehntel 3200 performance tester. Up and running in weeks.

Zehntel®

E 10/1/87



FREE POSTER

To get this free poster, call (800) 457-8326 or attach your business card

here and send to:
ZEHNTTEL
 2625 Shadelands Drive
 Walnut Creek, CA 94598

Offer expires December 31, 1987.

Circle 41 on reader service card

Siemens Components invites you to THE ISDN Seminars



ISDN SOLUTIONS TO THE DESIGN CHALLENGE

The age of the Integrated Services Digital Network is here. And Siemens, a world leader in VLSI component technologies for advanced ISDN applications, cordially invites you to attend one of our two-day seminars on the latest ISDN advances.

Each seminar will feature different speakers, and cover a range of topics including:

- Field Trials
- VLSI solutions for ISDN—basic and primary rate access
- Future ISDN ICs
- Design specific presentations
- Applications presentation and demonstrations on new ISDN evaluation boards
- Software-Level 1 front end drivers, Level 2 LAPD, and Level 3 Call Control (both generic and switch specific)
- ISDN testers

Siemens Seminars... Where and When for ISDN

Boston, MA	-	October 26 & 27
Los Angeles, CA	-	November 3 & 4
Chicago, IL	-	November 10 & 11

For additional information on the seminar of your choice and for hotel details call the number below.

Registration Fee of \$125 per person also includes comprehensive literature packet (copies of presentation, technical product information, and more): continental breakfasts, luncheons, and dinner with keynote speaker. Seating is limited, so don't delay!

**Register today for the
Siemens ISDN seminar nearest you:
CALL 1-800-227-1817 Ext.96**

PROBING THE NEWS

NEW TWIST ON AN OLD IDEA MOVES KODAK DEEPER INTO ELECTRONICS

IT FUNDS STARTUPS, THEN FOLDS SUCCESSFUL ONES BACK INTO COMPANY

by Alan Burdick

ROCHESTER, N. Y.

Question: how does a diversified \$11 billion giant move faster and deeper into the electronics industry? One answer: set up an in-house venture-capital group that funds startup operations proposed by employees and then fold these embryonic units back into the parent once they're successful. That new twist on an old idea is just what Eastman Kodak Co. has been trying.

It all started four years ago when Kodak's top managers asked themselves: "How do we make ourselves known as an electronics force?" recalls William Messner, the company's venture portfolio manager. "There are so many people who think of Kodak as a yellow box." The company's answer was to create its own electronics ventures—but at arm's length. This venture thrust is still going through some growing pains, but Kodak managers think on the whole it is well worth the effort.

In-house venture groups are not new, of course. These older "intrapreneurial" operations are being done with varying degrees of success at a handful of electronics manufacturers, including Westinghouse Electric Corp. and Control Data Corp. Kodak's approach, modeled on those plus techniques from the venture-capital world, is part of a "recent trend toward decentralization," says George Stojavljevic of BIS-Mackintosh, a Boston consultant. The advantage, says Richard Hill, of Tektronix Inc.'s four-year-old Technology Development Co., is that big companies can introduce technologies too uneconomical to address with a large infrastructure. It also affords an early glimpse of the growth potential of the business.

For Kodak, that means trying to keep hands off the venture companies it spins off, allowing them autonomy and keeping them tied only loosely to the parent. The unique as-

pect of the Kodak effort comes after several years in the marketplace. At that time, the venture is evaluated: if it fits corporate strategy and is commercially viable, it is folded back under the Kodak wing; if not, it's sold or closed.

All of the venture companies that Kodak has funded in the last four years were proposed by employees and more than half of them specialize in electronic technology. So far, one has been closed, two have been merged with Kodak business units, and the rest are still operating as independent concerns (see table).

Total cost has been about \$60 million so far. But that doesn't faze top Kodak executives, who believe the venture route is one way for the company to broaden its impact in the electronics industry as it faces stiffer competition and slower growth in its core photographic businesses. "These are future businesses that Kodak wants to be in," affirms market analyst Eugene Glazer of Dean Witter & Co. in New York. "They want the first crack at the market."

One example is Videk, born when Ko-

dak employee Ghassan Kahwati decided he wanted to start a company specializing in machine vision equipment. Kodak offered him backing, and the result is now a thriving three-year-old boasting two products: the Megaplus camera and the RM1000 vision system, both originally designed for use at Kodak.

The Rochester giant's strategy is to seek markets with high growth potential that complement existing Kodak interests, which include office-automation and disk-memory businesses [*Electronics*, May 14, 1987, p. 38]. The new companies specialize in such products as batteries, photo-image-management systems, and molded printed-circuit boards. Many of these, like Videk's machine vision equipment, were originally used in the production of other Kodak devices.

"We had a unique technology to draw from Eastman Kodak," says Videk president Paul Hauler (Kahwati is chief technical officer). "If this had run in normal channels, the bureaucracy would have hampered it."

Kodak considers its most promising venture to be Edicon, a late-1986 startup that recently unveiled its first product line, a photo-image-management system. The Edicon system digitally displays and stores color images—including color prints—transmitted from a video camera, and integrates the data with text and graphics to create photo-image files. Merrill Lynch in New York uses it to handle security and personnel information, and the Los Angeles Police Department is designing a data base of mug shots.

Like the technologies of Kodak's other ventures, Edicon's is aimed at a market too narrow for a large firm to address efficiently, says Robert Tuite, director of new opportunity development. But Kodak's Venture Board of eight senior executives gives it more control over the startup's market di-

WHERE KODAK IS PUTTING ITS VENTURE CAPITAL

1984	
Eastman Communications	Telecommunications software
Videk	Machine-vision products
Ultra Technologies*	High-performance batteries
1985	
Estek	IC wafer-cleaning and inspection equipment
Edicon	Computerized photo-imaging systems
Fastek	Filtration products
Discus	Electronic training products
Beta Physics	Photoconductive films
1986	
Sayett Technology*	LCD overhead projectors
LVT	Digital color-image writer
1987	
KRS Remote Sensing	Remote sensing equipment
Pathtek	Molded printed-circuit boards
K Technologies	Injection-molding product control
* Merged into a business unit of Kodak	

Get to the test mode fast!



In fact, twice as fast.

If you're developing automated test procedures for microprocessor-based digital circuit boards, we'd like to introduce you to the concept of speed.

Fast Programming

With the 9100A Test Programmer's Station, you can generate powerful and detailed test programs in half the time it takes with other emulative-type systems. Weeks instead of months.

Easy-to-use software: The 9100A features a high-level programming language, syntax-checking editor and source-language debugger all designed specifically for writing digital test and diagnostic routines.

Built-in decision tree: Enter board information in straightforward database format. Add stimulus routines. The 9100A then produces comprehensive test programs for Guided Fault Isolation (GFI) almost automatically. A special fault-tracing algorithm makes all the choices about the troubleshooting sequence.

Fast Troubleshooting

Here's where Fluke's new system really takes off!

Because the programs you develop on the 9100A can be executed on the production line or in service by any number of low-cost 9105A Digital Test Stations. All of them with these features.

Full board coverage: This system isolates digital hardware faults down to the node level on all digital circuitry, SSI to ASIC, at rates up to 40 MHz.

Automated Fault Isolation: Lightning-fast functional tests for the entire μ P kernel—BUS, RAM and ROM—are pre-programmed, and activated by simple keystrokes. Beyond the kernel, your GFI programs guide an operator right to the faulty node quickly, with diagnostics in plain English.

Advanced circuitry interface: Fluke's new Parallel I/O Modules let you test as many as 160 pins simultaneously at up to 10 MHz. Helping to isolate faults faster than you ever thought possible.

High-Performance Support

Fluke backs its full line of board test equipment—9100A Digital Test System, 9000A Micro-System Troubleshooter, 3200B Manufacturing Defects Analyzer and 3050B Functional Test System—with all the service, training and application support you need.

Fast answers

Call Fluke at **1-800-426-0361** to get up to speed fast!



From the world leader in emulative board testing.



Circle 45 on reader service card

AN EXECUTIVE PLANNER TO USE WITH PRIDE.

Electronics magazine is pleased to offer its readers a distinguished, elegant Desk Planner and Pocket Diary Set for 1988 that is packed full of useful information and traveling tips, in addition to providing you with an easy-to-use 1988 planning format.

A great gift idea.

This beautiful book makes an ideal gift for friends and business associates. It's a gift that people will really appreciate receiving. Because it's a gift from you that they'll use all year long.

Make it personal.

And you can order your name, or the name of anyone you are giving the book to, embossed in gold on the padded front cover.

Act now and place your order today.

Order your copy today. And copies to give friends and business associates for the holidays. It's also a great gift idea for anyone who travels—or dreams of traveling. Write to us at Electronics Desk Planner, P.O. Box 5505, Peoria, Illinois 61601. Or call 1-800-845-3636.

HERE ARE JUST SOME OF THE GREAT FEATURES.

QUALITY WORKMANSHIP

- Large 8½" x 10½" page size
- Handsome textured cover with padded front
- 2 silken ribbon markers for easy reference
- Highest quality paper for smooth writing capability
- Gilt-edged pages
- Inexpensive personalized embossing

WITH CONVENIENT FEATURES

- Week-at-a-glance appointment guide with 12-month calendar on each spread and plenty of room for reminders
- Special 4-page 1988 planner and 4-page 1989 forward planner for highlighting special events
- Easy-to-read 6-year calendar
- Ample room for notes

AND HANDY INFORMATION

- Convenient metric conversion table and weights and measures table for quick reference
- International dialing codes

GREAT FACTS AND TRAVELING TIPS

- 22 beautiful full-color world maps, including time zones, air routes and sea routes
- International airports and distances from key cities
- Detailed guides for 117 countries and cities, weather, hotels, selected restau-

- rants, banks, credit cards, tipping information, sight-seeing, and much more
- International entry and exit requirements
- Air distances and flying times between countries
- Detailed maps of major foreign cities

ORDERING INFORMATION

Prices include cost of surface delivery. Add local sales tax.

Desk Planner & Pocket Diary Set	\$39.95
Desk Planner only	\$31.95
Pocket Diary only	\$16.95
Gold Stamping full name on each item	\$ 4.50
Handling/Packing per item	\$ 1.50
Gift Box (optional)	\$ 1.00

OPTIONAL AIRMAIL SURCHARGES

Shipped from New York to:	Set or Planner	Diary Only
Canada	\$ 5.00	\$ 3.50
Central America	8.50	1.50
South America	14.00	2.00
France, England, Spain	14.00	3.50
Singapore, Japan, S. Africa, Australia	19.50	5.00

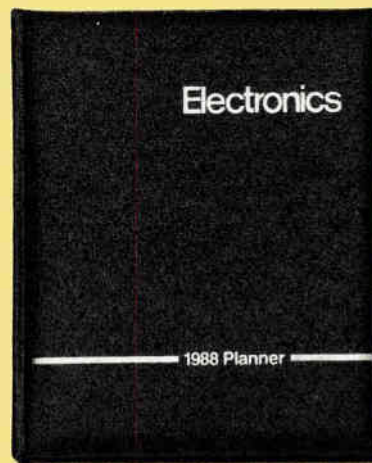

DESK PLANNER AND POCKET DIARY SET

ONLY \$39.95

All major credit cards are accepted. To order send check or money order to Electronics Desk Planner, P.O. Box 5505, Peoria, Illinois 61601. Or call toll-free

1-800-845-3636

Electronics

53.6 Reasons to Choose P-CAD for CAE and PCB design.



• End-to-end PCB design • Workstation performance • 53.6% market share* • New! SMT support



• Low cost schematic design • Auto place & route (45°) • Large board capacity • ASIC design kits



• Operates on standard hardware • Full range of system interfaces • 3000+ component library



• Design rule checking • Absolute data security • 3rd party software & services • 24-hour on-line support



• Local sales & training



To find out why 53.6% of engineers using PC-based CAD systems choose P-CAD® for workstation level performance, call toll-free:

800-523-5207 U.S.
800-628-8748 California

p-cad[®]
PERSONAL CAD SYSTEMS INC.

Personal CAD Systems, Inc.
1290 Parkmoor Avenue
San Jose, California 95126 USA
Telex: 371-7199 FAX: 408-279-3752

*Source: Dataquest, Inc.
P-CAD is a registered trademark of Personal CAD Systems, Inc.
Generation 2.0 is a trademark of Personal CAD Systems, Inc.

Circle 49 on reader service card

New! State-of-the-art
Generation 2.0™

VMEbus IMAGE PROCESSING

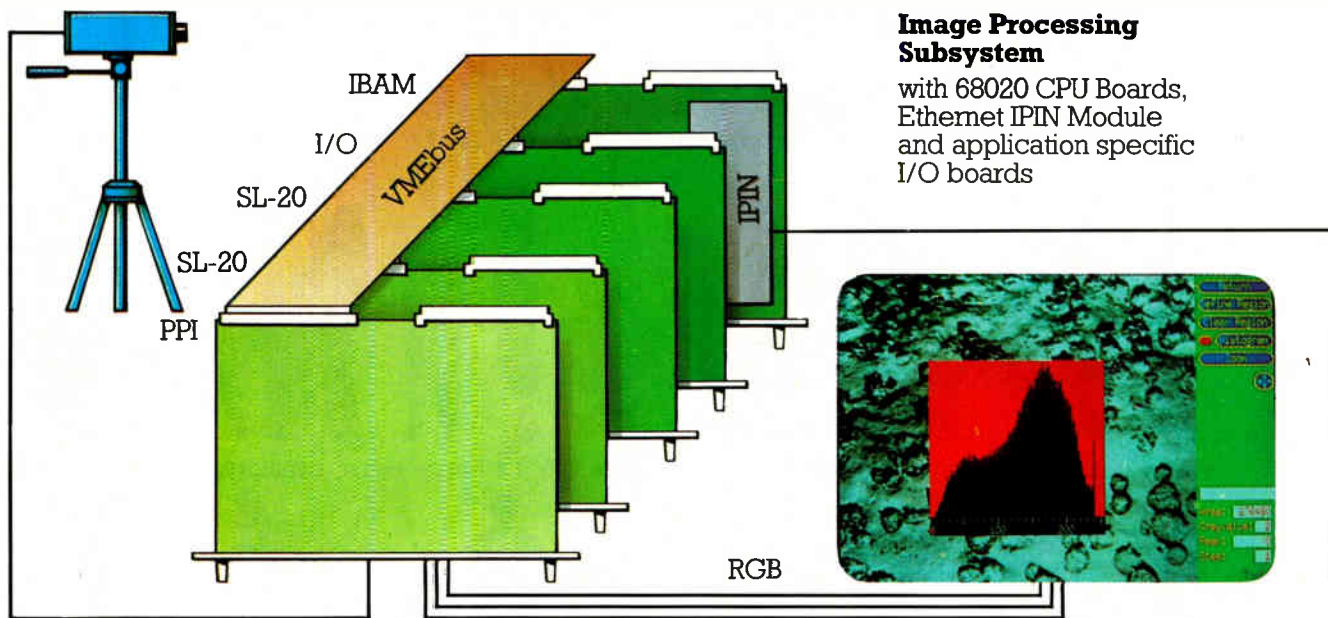

Image Processing Subsystem

with 68020 CPU Boards,
Ethernet IPIN Module
and application specific
I/O boards

Ethernet/Cheapernet
TCP/IP protocol

PPI

Image Acquisition Board Set
Standard Video Input for
CCIR or EIA video sources
Analog-digital conversion
with 6 or 8 bits up to 20 MHz
Control Monitor Interface for
direct connection of a mono-
chrome or color monitor (via
look-up table 256 scales
possible)
On board memory up to
2 MByte
Internal or external synchroni-
zation facility
Local Bus (Video Image
Bus - VIB) for fast data
transfer to CPU-board
SL20 or additional
image preprocessing
Software support via image
processing package TopPic
(more than 700 modules)

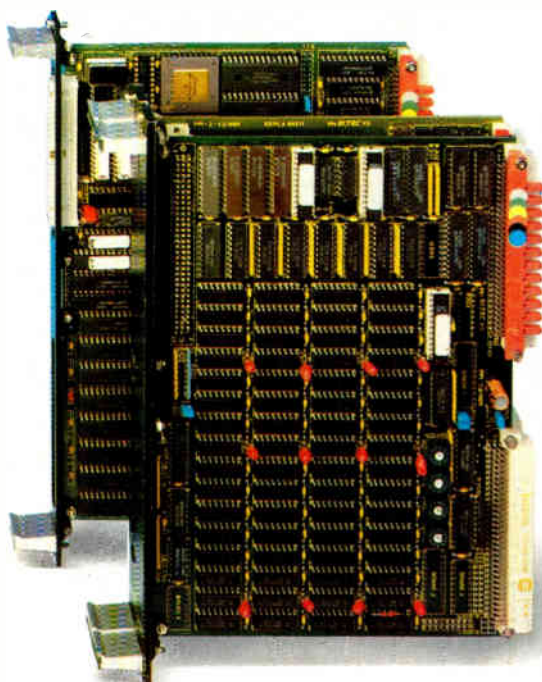

SL20

Image Processing CPU-board with 68020
chip
In connection with the PPI-board set builds
a high speed image processing unit
With PPI board image data can be brought
directly to the image memory of the SL20
1 MByte of dual ported Video RAM for
image data
128 KByte of Static RAM or 256 KByte
EPROM
32 Bit VMEbus interface
Connection to PPI via local
VIB-bus (for data transfer)
and IGA-bus (for local control
of the PPI without VMEbus
burden)
Transparent software devel-
opment due of local OS9 on
SL20

Circle 50 on reader service card

ELTEC
elektronik mainz

American Eltec Inc.
569 South Marengo Avenue, Pasadena
CA 91101, Tel. (818) 4 49-1558

Eltec Elektronik GmbH · Galileo-Galilei-Straße 11 · D-6500 Mainz 42
(West Germany) · P. O. Box 65 · Tel. 06131/5063-0
Telex 176131955 · Teletex 6131955 = Eltec · Fax 06131506344

The outlook for West Germany calls for continued world leadership

Again in 1987, West Germany will keep its front-running position as the world's leading exporter. Sales abroad will remain high, although world trade is slowing, protectionism is increasing, and

currency tensions are continuing.

German companies are staying competitive because they have generously invested in new plant and equipment, make high-quality products, use state-of-the-art technology, provide

fast service, and have stable prices. On the other hand, the volume of imports will rise as the West German market looks more and more attractive, especially to US, Asian, and other European countries. Foreign firms also

PEP's analog-to-digital converter fits on a Eurocard

With the VMEbus analog-to-digital interface, PEP Modular Computers GmbH of Kaufbeuren introduces a high-performance converter module designed on a single-height Eurocard for the VMEbus. The VADI is a low-cost versatile module assigning digital values to process automation, data acquisition, and monitoring and control systems. It is designed to interface directly to sensors or analog signals and to convert the inputs into standard digital data commonly used in computer systems.

The VADI module consists of 16 single-ended channels for analog input or eight channels of differential mode, jumper selectable. The board contains a standard base module with input voltage protection of ± 20 V and three optional piggybacks, software programmable gain, selectable input ranges, and a fully software programmable VMEbus interrupt.

In addition, the board has a 2-Kbyte FIFO for fast on-board data collection and is pin-compatible with Analog Devices Inc.'s series 3B and 5B signal conditioning modules.

The VADI offers a number of features:

- The VADI piggybacks allow tailoring of the VADI to the application needs and protect valuable investments.
- The FIFOs of the VADI speed up on-board data collection and allow the system CPU to work without many interrupts.
- The VADI's single-height Eurocard design greatly improves reliability

and ruggedness and keeps size to a minimum.

The VADI provides a compact and cost-effective solution for industrial applications where analog voltages or currents must be measured with high accuracy in fast sample mode, like in operating machine tools, controlling processes, or observing chemical analysis.

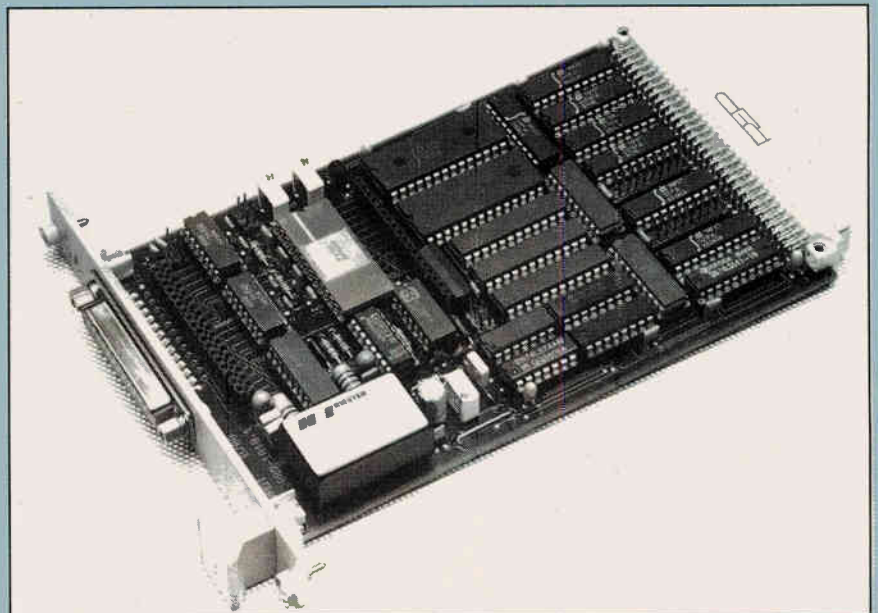

The VADI supports 16 single-ended or 8 differential inputs.

er Supply Inc.

Features

Digital TV

Circle 101 on reader service card

From now on, ask yourself the following question about LED lamps:

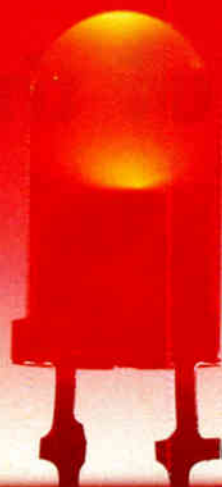

STANDARD?

The standard version of Toshiba's LED lamps has proved itself repeatedly in practice as being just what's needed in most applications. Nonetheless a new generation of Toshiba LED lamps means that you should reconsider your requirements.

OR SUPER?

The brightness of Toshiba's new generation of LED lamps is striking: up to 1,000 times brighter than the standard version. So light, so brilliant that optimum luminosity is guaranteed from every viewing angle. As for application, be it stadium or Hi-Fi displays, Toshiba's ultra-bright LED lamps are ideal.

All of this is backed up by Toshiba's know-how, service and production capacity. Find out more by sending us this coupon.

Please send me more information on the new generation of Toshiba LED lamps.

Name:	Company:
Tel.:	
Address:	

In Touch with Tomorrow
TOSHIBA

Circle 102 on reader service card

TOSHIBA EUROPE (I.E.) GMBH, Görlitzer Str. 5-7, 4040 Neuss 1, Tel.: 0 21 01/1 57-0; München, Tel.: 0 89/92 80 91-0; Stuttgart, Tel.: 0 71 52/210 61-66 · TOSHIBA UK LTD, Tel.: 00 44 2 76/6 22 22 · TOSHIBA EUROPE I.E. GMBH, Paris, Tel.: 00 33 1 48 55/56 56 · TOSHIBA ELECTRONICS ITALIANA S.R.L., Milano, Tel.: 00 39 39/63 88 91 · TOSHIBA ELECTRONICS SCANDINAVIA AB, Stockholm, Tel.: 00 46 8/14 56 00

One of the world's best surv

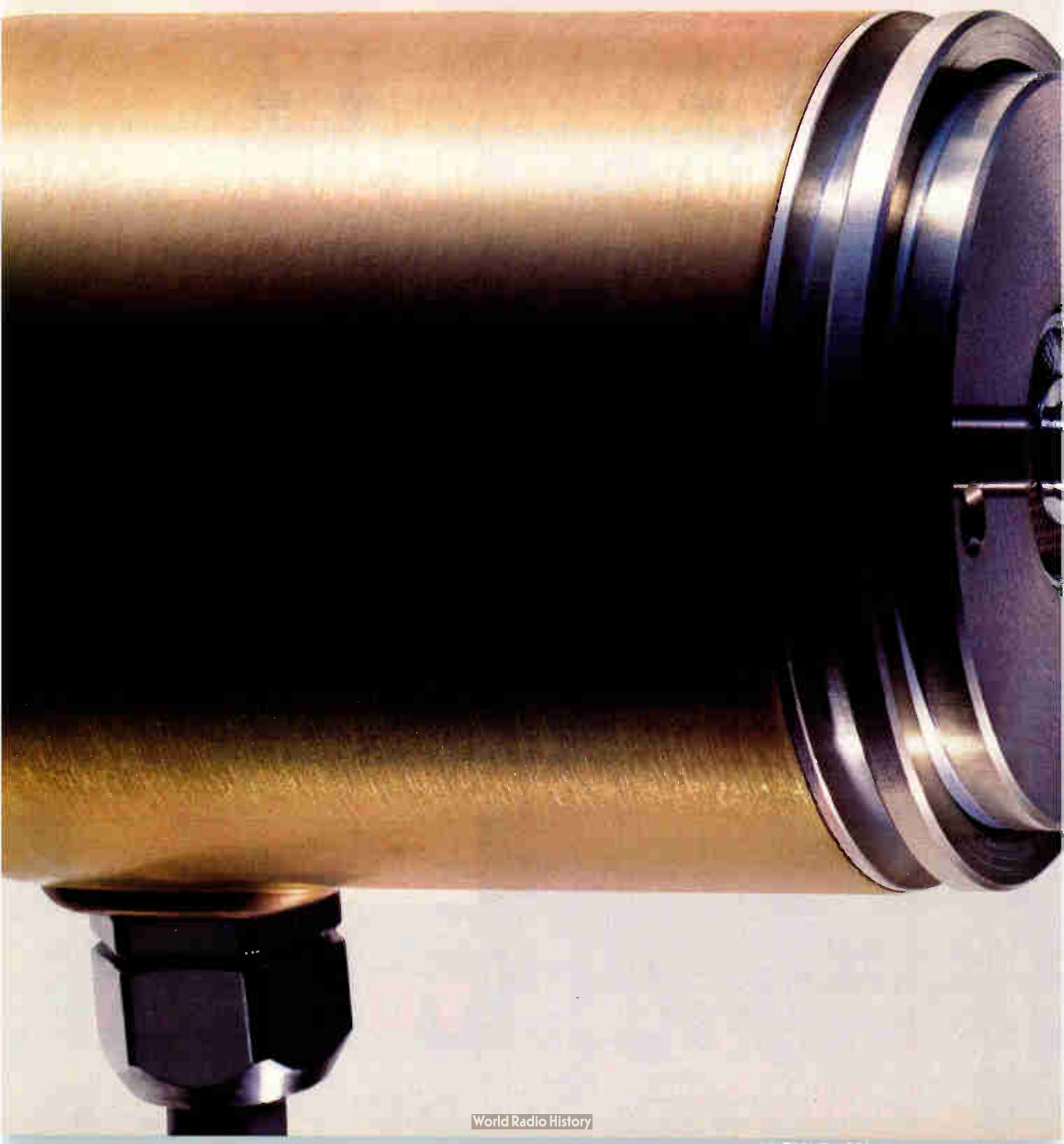

Balance systems

PLEASE
VISIT US
E M O
M I L A N



14.10. -
22.10.87
hall 12 B
stand M02/P03

When under severe operating conditions other systems have long given up the HEIDENHAIN shaft encoder keeps on performing with clockwork precision. Reliably giving you exact, valuable intelligence as always.

Quality and dependability

Since we never rest on our laurels, we at HEIDENHAIN meticulously double- and triple-check everything in Quality Assurance and Control. This starts with a comprehensive range of stress tests, functional inspections of all key operational components, and continues right down to such details as shock-proofing of the long-life miniature lamp.

Even in electrical fields, HEIDENHAIN shaft encoders operate with absolutely trouble-free reliability. And their safe, sure lifetime dirt- and splash-proofing provides uncompromising under-cover security in even the most hazardous operations.

High shock resistance: ROD 428

If your machines not only generate dust but vibrate as well, it particularly pays to look into the HEIDENHAIN ROD 428 - an incremental shaft encoder delivering performance comparable to that of the HEIDENHAIN standard model, but capable of withstanding shock and vibration parameters many times as great. With vibration tolerance of up to

300 m/s² and maximum shock resistance of 5000 m/s², the ROD 428 is just the right instrument for all machines that take heavy punishment. For example, sheet metal processing machines or presses.

And should even its ultra-high capacity limits happen to be drastically exceeded, an ROD 428 does not simply fail. Rather, it reports the trouble so that the machine may be shut down instantly if desired, in many cases sparing you costly machine damages.

Shaft encoders for every application

What we cannot spare you with HEIDENHAIN shaft encoders is the difficulty of choosing from the vast array of different models. Your options include units for standard applications, for high rpms or high resolution, for a broad temperature range, or for severe operating conditions. As well as encoders with hollow shaft or synchro flange, with integrated coupling and hollow shaft, or in kit form.

We can, however, smooth the way, with our new ROD catalogue, a free copy of which we will gladly forward to you on request.

Telephone: (0 86 69) 31-540



HEIDENHAIN

DR. JOHANNES HEIDENHAIN GmbH
D-8225 Traunreut · Postfach 12 60

Circle 103 on reader service card

Rapid movement in the stock

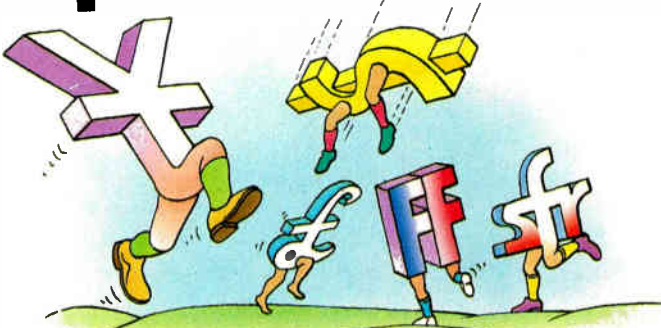

markets, today's production figures,

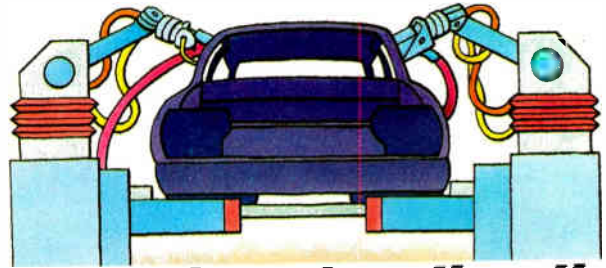

confirmed passenger and freight loading lists,

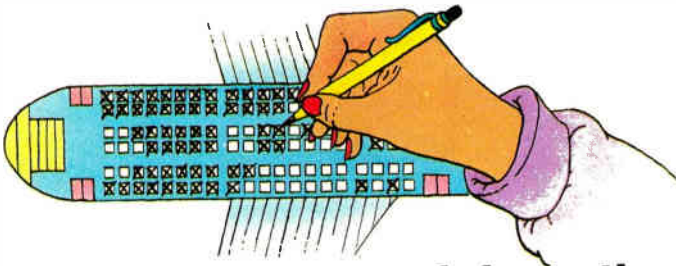

whatever information you are transmitting:

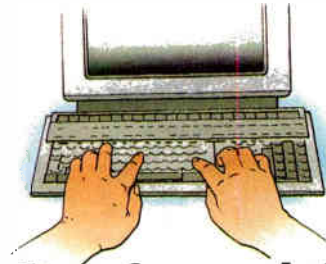

DNE systems increase the availability of your data network.

Different organisations, different applications, but the same problem: data communications must be reliable, economical and always available. This can be achieved by constant monitoring, measurement and maintenance of the system. Decades of meeting customers' needs in comms test equipment have given Wandel & Goltermann the experience to develop the DNE system – tech control, network control and network management systems. DNE allows you to react quickly to a problem and reduce down time no matter what the size of your network. Send off the coupon for more details about DNE and the W & G datacoms test sets.

Visit us at SYSTEMS '87, Munich, Oct. 19th - Oct. 23rd, Hall 16, Stand E 22
Visit us at Telecom '87, Geneva, Oct. 20th - Oct. 27th, Hall 2, Stand 2.242

Wandel & Goltermann, Dept. VMW, Pf. 12 62, D-7412 Eningen, FRG
Tel.: +(49) 71 21 86-0 · Telex 729833 · Fax: +(49) 71 21 8 84 04

Please send me a free copy of
 the DNE colour brochure the data test equipment product guide

Name _____

Company _____

Address _____

Postcode _____ Telephone _____

Circle 104 on reader service card

**Light stable,
flame retardant
plastics?**

**Take a tip
from Bull:**

Talk to Bayer.



**The Bull Questar 210 computer cabinet
made of Bayblend**

If you're looking for the right material, why not do as Bull's design engineering department did: talk to Bayer!

For the cabinet of the Questar 210, Bull now use the PC/ABS blend Bayblend. This is a thermoplastic noted for its high light stability, good flame retardance and high heat resistance.

**Bayer has one of the world's biggest
ranges of high-performance engineer-
ing plastics:**

®Apec (PAR), ®Bayblend (PC + ABS),
®Bayfol (PC blend film),
®Baygal/®Baymidur (PUR casting resins),
®Desmopan (TPUR), ®Durethan (PA 6,
PA 66), ®Leguval (GR-UP), ®Lekutherm
(EP), ®Makroblend (PC blends),
®Makrofol (PC film), ®Makrolon (PC),
®Novodur (ABS), ®Petlon (PET),
®Pocan (PBT), ®Tedur (PPS).

Whether it's light stability, flame retardance or some other property you need:

**Talk to Bayer, and together we'll find
the answer to your material problems.**

For more information write to:
Bayer AG, AV-Informationsvermittlung
Postfach 80 0149, D-5000 Köln 80

Plastics Business Group

Bayer 

Circle 105 on reader service card

The Pacemaker

in Sputtering

and Evaporation



L 560 - The One Pumpdown Solution for R&D

012.7.61.61.014.02

L. H. once again offers a versatile compact coating system with almost unlimited applications.

It sputters: equipped with various RF or DC magnetron sputtering sources from 3" to 8" in diameter.

It evaporates: with different Electron Beam sources or thermal evaporators for sequential and simultaneous evaporation.

It measures and controls: the processes are easily monitored by advanced diagnostics such as: quartz crystal monitor, optical monitor or ellipsometer.

All this without breaking the vacuum!

And that's not all! The box-coater can be equipped with a turbomolecular- or cryopump. Suited for a clean room installation.

Meet the strictest requirements for R & D in optics and electronics with the L 560 system!



LEYBOLD AG
Wilhelm-Rohn-Str. 25
P.O. Box 1555
D-6450 Hanau 1

If the standard connectors don't suit you then try the Series Gds A complementary ones. As required!

There are applications where you need connectors which cannot be covered by the ordinary DIN-standard types. In order to meet the special requirements of our customers we have developed printed-circuit connectors which complement the standard, in harmony with practical applications. It means you can always make the perfect connection - functional, fast and reliable. For instance, BUS connections.

You'll find our complementary connectors in Series Gds A both for Types B and C and for D, E, F and H, whether it be the Gds A-MH combined connector, the interface connector or the extensive, well-conceived housing range for all the DIN Types.

A comprehensive range you'll only find at HARTING. Solutions with practical applications in mind are simply part of our philosophy.

By the way, all Gds A connectors are now available under the new classifications according to DIN 41612, Part 5. Clearly defined qualities will also save you money. Check your specifications and select the right connectors to suit your requirements - it's worth it!

We're helping you to reduce expense by increasing the number of Types available and insisting on first-class quality.

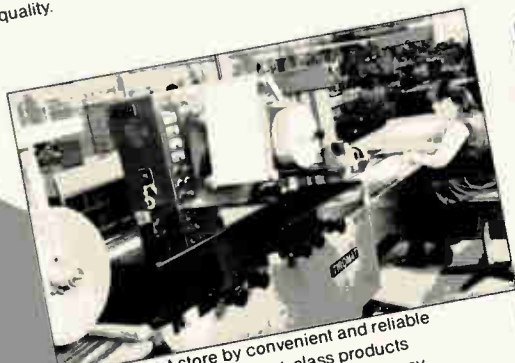

We set great store by convenient and reliable packaging so that our first-class products reach you in perfect condition and are easy to handle.

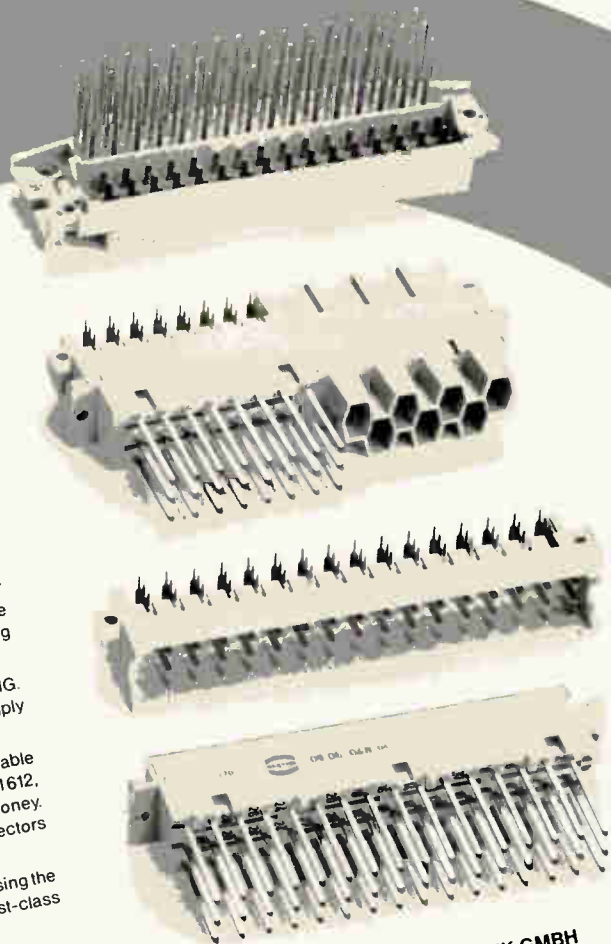

HARTING ELEKTRONIK GMBH
Postfach 1140 · D-4992 Espelkamp
☎ (0 57 72) 47-1
T x 9 72 310-14 he d
Telefax (0 57 72) 33 02

HARTING - The Experienced Electronic
Component Specialists.

Subsidiary companies:

Austria: HARTING elektronische Bauelemente Ges. m.b.H., Himberger Straße 25, A-1100 Vienna. Belgium: N. V. HARTING ELEKTRONIK S. A., Industriezone Doornveld, Schapenbaan, B-1730 Relegem. France: HARTING ELEKTRONIK S.A.R.L., BP 24, F-94121 Fontenay-sous-Bois Cedex. Great Britain: HARTING ELEKTRONIK Ltd., GB-Biggin Hill, Kent TN 16 3 BW. Italy: HARTING ELEKTRONIK S.P.A., Via Como, 2, I-20096 Pioltello (Milano). Japan: HARTING ELEKTRONIK Co., Ltd., Nishi-Gotanda K-1 Bldg. 4F, 2-2, Nishi-Gotanda 8-chome,

Shinagawa-ku, Tokyo 141, Japan. The Netherlands: HARTING ELEKTRONIK B.V., Mon Plaisir 89 D, Industrieterrein Vosdonk, NL-4879 AM Elten-Leur. Norway: HARTING ELEKTRONIK A/S, Nils Hansens vei 13, Bryn, N-0506 Oslo 6. Sweden: HARTING ELEKTRONIK AB, Fagerstagatan 3, S-163 53 Spånga/Stockholm. Switzerland: HARTING ELEKTRONIK AG, Eschenstrasse 2, CH-8603 Schwerzenbach.

Foreign representatives:

in Australia, Brazil, Denmark, Finland, Spain, South Africa, Comecon.

DATA GRABBER.

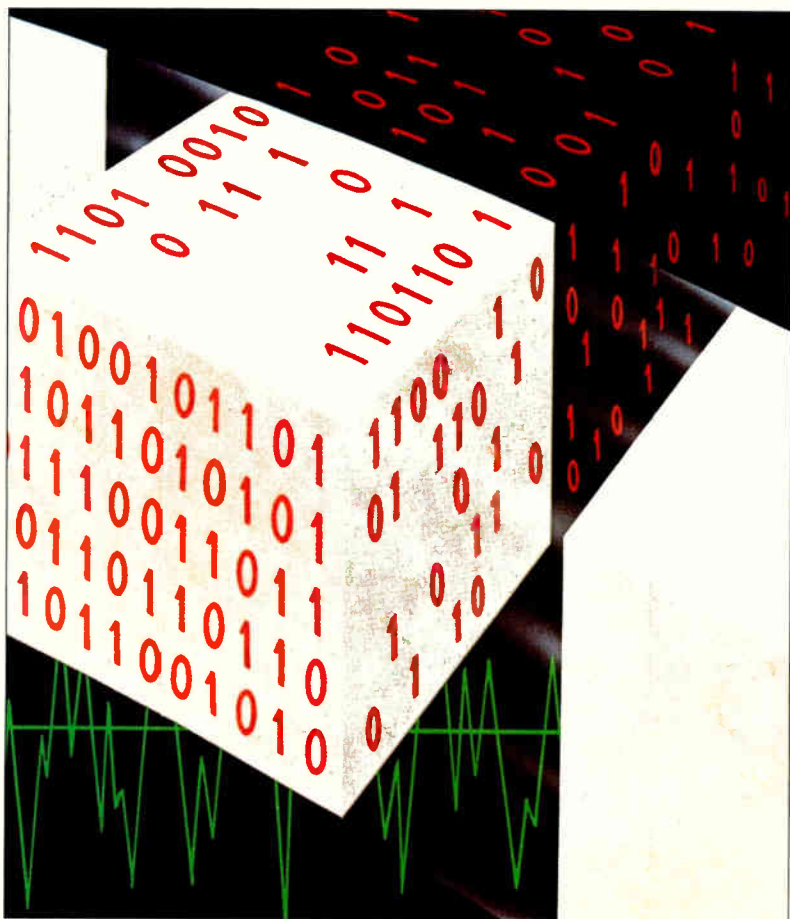

Zoran's vector digital signal-processing chip with 70,000 transistors requires only three instructions to do a 1,024-point fast Fourier transform in 2.4 ms.

Zoran Extends The Range Of Monolithic DSP Applications.

“ A speedy new single-chip contender is getting set to make a splash in DSP. Zoran's ZR34161 uses vector-handling techniques to gulp down blocks of data, rather than picking off a single data input at a time. Vector processing alone is a big speed booster, and Zoran enhances it with embedded signal-processing algorithms that radically pare down system overhead.

The company's 16-bit CMOS VSP is the first monolithic signal processor to utilize the powerful vector-handling techniques employed for scientific data processing in large vector computers and minicomputer array processors...”

Excerpted from an exclusive article in the July 24, 1986 issue.



Electronics

THE LEADER IN NEW TECHNOLOGY COVERAGE

Spectrum Analyzer FSA

100 Hz to 1.8 (2) GHz

The Spectrum Analyzer FSA features not only low inherent noise, 10 dB better than comparable instruments, but it also sets new standards regarding phase noise, dynamic range, intermodulation, level and frequency accuracy.

A state-of-the-art microprocessor concept ensures measurement versatility combined with ease of operation.

IEC 625 Bus
IEEE 488



- Amplitude-measurement range -145 dBm (-150 dBm typ.) to +30 dBm
- Phase noise < -114 dBc/Hz at 1 kHz from carrier
- Resolution bandwidths 6 Hz to 3 MHz quasicontinuously variable
- 9-inch colour monitor
- Optional tracking generator for 100 Hz to 1.8 GHz with built-in attenuator

REACHING OUT FOR THE LIMITS OF TECHNOLOGY

Please ask for the data sheet
Spectrum Analyzer FSA

Rohde & Schwarz
Postfach 80 14 69
D-8000 Muenchen 80
Federal Republic of Germany
Telex 523 703 (rus d)
Tel. internat. + (49 89) 41 29-0



ROHDE & SCHWARZ

Circle 111 on reader service card

VITROVAC® -

Amorphous cores for high frequency power electronics

VAC
VACUUMSCHMELZE



VAC offers new opportunities for inductive components in switch mode power supplies. The performance of amorphous tape wound cores exceeds, by far, all other core materials. You achieve:

- *High frequency transformers with highest efficiency and smallest physical size.*
- *High frequency saturable reactors with lowest losses.*
- *RFI suppression chokes with almost constant attenuation over a wide frequency range.*

Use the advantages of VITROVAC. VAC delivers both ready components and a wide variety of toroidal cores of amorphous alloys.

M-107 e

VACUUMSCHMELZE GMBH

Grüner Weg 37, D-6450 Hanau 1 · Telephone: (0 61 81) 362-1 · Telefax: (0 61 81) 362 645 · Telex: 4 184 863
Rhenianastr. 9/17, D-1000 Berlin 20 · Tel.: (030) 3320 051 · Telefax: (030) 3320 051 Ext. 04 · Tx.: 182 815

RISING STAR.



The instrument cards from Wavetek plug vertically into a VMEbus backplane and are controlled by the microprocessor.

Wavetek's Card-Based System Could Set An ATE Standard.

“A young contender is pushing its way to the forefront of the emerging market for instruments on cards. The 680 system from Wavetek Corp. uses cards in a package that can replace a rack of conventional instruments—and Wavetek's approach is already making a strong bid to become a de facto standard in its market.

Wavetek has been joined by Racal-Dana and Datron in a campaign promoting the 680's design as a standard for high-performance, instrument-on-a-card systems. If successful, it could make Wavetek a major player in the instrument-on-a-card segment of the ATE market—particularly the military segment, where growth has been hampered by a lack of standards...”

Excerpted from an exclusive article in the April 16, 1987 issue.

Electronic

**THE LEADER IN NEW
TECHNOLOGY COVERAGE**

Why don't these new measurement instruments have any control elements?



MS-DOS
operating system



Now, you can skip unwieldy operating procedures when using measurement instruments. Why? Because Siemens has developed new measurement instruments that cooperate with personal computers over an IEEE 488 bus. And that eliminates, for example, your reliance on cumbersome keys and dials when using transient recorders. Adjusting parameters, ranges, and functions is easier than ever... with the PC keyboard and mouse.

What's more, our standard software accepts only instrument-specific and logically-structured entry data. So that you get top quality results every time. And since each instrument includes pre-programmed operating instructions, there's no more flipping through time-consuming manuals to get to the point. Whenever you're uncertain about how to proceed, the instrument itself provides the plaintext answer. A click of the mouse is enough... for calling up instructions or executing commands that put you firmly in control of up to 15 measurement instruments. From function/pulse generator to digital multimeter.

All this adds up to less routine, more attention to what really counts – and better results. The kind of convenience that's fast becoming the hallmark of advanced measurement technology. From Siemens.

**Measurement's never been easier.
With PC instruments from Siemens.**

Want to know more about our PC instruments? Just contact your local Siemens office or drop a line to:

Siemens AG
Infoservice 213-Z027 eE
Postfach 23 48, D-8510 Fürth
Federal Republic of Germany

A19100-E686-Z4-V1-7600

Circle 115 on reader service card

INTERNATIONAL PRODUCTS

SIGNATURE ID SYSTEM DELIVERS TOP SECURITY AT HALF THE COST

USING BIOMETRIC VARIABLES, IT EQUALS FINGERPRINTING FOR ACCURACY

The Sign/On signature verification system from Alan Leibert Associates Ltd. boasts identification accuracy that equals fingerprint readers—good enough for military applications—but costs just half as much. It also has the advantage of being more socially acceptable than fingerprinting, which means it can be integrated into a much broader range of applications, such as retail sales.

Sign/On foils would-be forgers by statistically evaluating 13 biometric characteristics of a signature, instead of measuring the shape of the written characters. Because it bases pass/fail decisions on a statistical analysis, users can make the system more or less strict, depending on its application. In its most stringent mode, suitable for military-security applications, Sign/On has a false rejection rate of 1%. In less stringent applications, such as retail sales, the rate is 5%. Testing to determine the false acceptance rate is not complete, but should be about 2%, the company says. Fingerprint-based systems can have false rejection and acceptance rates as high as 10%.

The system costs £850 (\$1,360 U.S.) and issues a pass/fail evaluation in 3 seconds. Fingerprint readers generally take 3 to 5 s and typically cost \$3,000 or more.

THREE MODULES. Sign/On uses Zilog Corp.'s Z80 microprocessor and the Pascal programming language. The system consists of a low-profile 8.5-by-11-in. digitizing tablet on which the user signs his name with an electromagnetic pen, plus a control unit that can store up to 100 signatures. This control unit also houses the power supplies and the communications interface. The controlling computer can be an IBM Corp. Personal Computer or compatible, a minicomputer, or a mainframe, depending on the application. The data stream can be encrypted as a further security option if required.

Sign/On's biometric data base is proprietary, but it includes the amount of



PROGRAMMABLE. Sign/On can tighten pass/fail evaluations for military applications and loosen them for other uses such as retail sales.

time that the pen spends in the air between surface contacts, the pen's acceleration and deceleration, and the total amount of time taken to complete the signature.

"It is relatively easy for a forger to duplicate a signature visually," says Alan Leibert, Managing Director of the Pinner, Middlesex, UK firm, "but it's virtually impossible to duplicate the way in which a signature is made." He adds that using a signature as a sure means of identification is also "socially acceptable," making the technique more attractive than, say, fingerprinting to a wide range of markets.

"The allowable parametric spread of the 13 characteristics that are measured during the making of a signature can be narrowed or widened, depending on the application," Leibert says. "For example, the parameters could be left wide when the system is being used for retail transactions, but could be narrowed if the system is used to protect highly sensitive data."

Although the end-user's identification system will vary somewhat, depending on the OEM's configuration with peripheral hardware and software, Sign/On's general operation begins with an authorized user registering his name—using the electromagnetic pen—and signing several times on the digitizer tablet. The signature is then stored in a statistically

based template in a numbered reference file either in the system itself, on a computer, or on an external mechanism such as a smart card or a magnetic-strip card. When the user next needs to access whatever Sign/On is protecting, he claims identity by submitting a numbered credit card, for example. This causes the appropriate signature template to be loaded. He then signs his name, and within three seconds the newly written signature is checked against the one stored in the reference file and verified.

Sign/On was conceived and developed in the UK by Leibert's development team, but it will be manufactured in the U.S. by Signify Inc. of Columbia, Md. Signify will also be responsible for marketing to systems integrators in North America.

MASS MARKETS. Leibert forecasts applications in mass-production markets, such as financial and retail sectors, and in the computer industry. "Banking organizations and electronic-funds-transfer equipment manufacturers have been exploring signature dynamics, fingerprinting, and other biometric identification devices as being potentially more reliable alternatives to memorized personal identification numbers and passwords," he says. "Sign/On has been designed to work with EFT applications, such as share transactions and home banking."

Other potential markets include retail-store chains that issue their own credit and charge cards and major international credit-card companies, such as Visa and MasterCard; it may take two or more years for them to adopt standards, though, says Leibert.

He expects to succeed where other purveyors of signature verification systems have failed on two counts: computer connectivity and price. Others failed because "they did not offer interfaces to other computer products," he says. "Sign/On has been designed to make it easy for manufacturers to systemize the



PHILIPS

Tailor your own system set-up!

TEST & MEASUREMENT - INSTRUMENTATION SYSTEMS

Philips **System 21** - a highly flexible modular system for automatic test and measurement providing versatile I/O and switching functions controlled via the GPIB.

So you can get easily configure - and reconfigure - your own small to medium-sized GPIB instrumentation set-up.

Simply and economically.

Occupying only a single GPIB bus address, **System 21** comprises a master GPIB interface/power supply module, and a range of slave modules for: switching (up to 18GHz); digital I/O; A/D conversion, and a user-adaptable module for customized functions.

And our commitment to hard- and software development ensures that **System 21** will continue to grow up without ever growing old!

Product Credibility in technology, technique, quality and service, too, is assured because **System 21** is backed by the resources of one of the world's largest electronics companies.

MADE TO MEASURE

Write to: Philips I&E, T&M department, Building HKF70, 5600 MD Eindhoven, The Netherlands or call your local supplier: **Austria** (222) 629 141; **Belgium** (2) 5256692/94; **Denmark** (1) 572222; **Finland** (0) 5257225; **France** (1) 49428000; **Germany** (561) 5010; **Great Britain** (0223) 358866; **Ireland** (1) 693355; **Italy** (39) 3635 240/8/9; **Netherlands** (40) 782808; **Norway** (2) 680200; **Portugal** (1) 683121; **Spain** (1) 4042200; **Sweden** (8) 7821800; **Switzerland** (1) 4882211.

**Advanced technology
made to measure**





High luminous intensity on just 2 mA

 What do you do when switched and operating states have to be indicated, surfaces and script are to be illuminated from behind but there's just no more space for elaborate LED driver devices?

 The solution's called low-current LED. Just 2 mA is enough to make the new low-current LEDs from Siemens beam out with typically 2 mcd. LED drivers are superfluous: you can drive them directly from a CMOS microprocessor, a gate or LS-TTL device. That not only saves you space, it also cuts assembly costs.

And there's another benefit: the use of low-current LEDs in mobile equipment lets your batteries serve longer. That results from the especially low power dissipation in the driving electronics and the LEDs themselves.

 Siemens low-current LEDs come in super-red, yellow and green, in 3 mm, 5 mm and SOT 23 packages, and there's our new "Argus" LED for background illumination of surfaces, script and symbols.

 For full details of Siemens new low-current LEDs, just write Siemens AG, Infoservice 12/Z014, Postfach 2348, D-8510 Fuerth, quoting "Low-current LED".

Circle 117 on reader service card



THE COMPLETE COMPONENT COMPANY

Philips Electronic Components and Materials Division, 5600 MD Eindhoven, The Netherlands

Universal driver/detector pumps data directly across 150 metres of twisted-pair lines

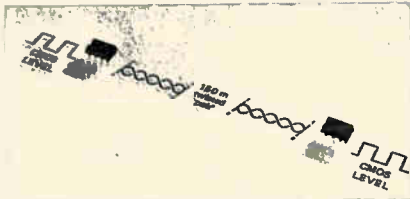

Our SAA1045 universal driver/detector IC transmits data directly across twisted-pair lines up to 150 m long – this is the farthest distance covered by a currently available circuit, most existing drivers being limited to a few metres. As well as connecting directly to our D²B (digital data bus), the CMOS SAA1045 can implement other bus protocols with data rates up to about 1 Mbit/s. The driver/detector suits office, home, and factory applications, and can be used to connect up all the electronic circuits in a car. The bus provides for a response time within 2 ms, and the twisted-pair wire format makes it inexpensive to implement.

Together with a microcontroller and a bus controller, the SAA1045 provides a serial transmission link between multiple stations (several devices can be paralleled to implement parallel buses). The circuit is small, coming in an 8-pin DIL or SO package, yet contains the detector, driver, digital filter, and analog circuits.

In D²B systems, the SAA1045 can be cascaded to span any distance and works at rates up to 100 Kbits/s. This can be increased to about 1 Mbit/s in non-D²B systems by disconnecting the on-chip digital filter.

The IC can work in single-master I²C bus systems, extending the length of this bus to 20 m. The I²C bus performs a similar function to the D²B, but for ICs within a piece of equipment. It is a two-wire serial link that transmits data across a few metres at speeds up to 100 Kbits/s.

The SAA1045 has a power-on reset circuit for proper initialization. When active, the IC dissipates a maximum of 300 mW from a 5 V supply and works between -20 and +80 °C.

193

Philips announces sampling of first advanced CMOS logic devices featuring new pinning concept

Philips is now sampling the first advanced CMOS logic (ACL) ICs to selected customers. The first devices of the planned family are the 74AC/ACT11002 quad 2-input NOR gate, the 74AC/ACT11020 dual 4-input NAND gate, the 74AC/ACT11027 triple 3-input NOR gate, the 74AC/ACT11030 8-input NAND gate, the 74AC/ACT11074 dual D-type flip-flop with set and reset. Type numbers starting 74AC are for CMOS input-level logic operation and those with 74ACT are for TTL input-level operation.

The devices combine very high speed and high output drive currents comparable to the most advanced TTL families currently available. As an illustration of performance: propagation delay for the 74ACT11002 is just 3,5 ns and the output current is 24 mA.

The devices feature a new concept in logic

device pinning: the supply voltage and ground pins are placed in the centre of the packages. Inputs surround the supply pins and outputs the ground pins; control pins are strategically located at the ends of the packages. The new configuration eliminates various faults as lead lengths are shorter and inductance effects less. The ACL family therefore enables designers to implement simultaneous switching applications while allowing maximum performance to be obtained.

Operating temperature range for all the devices is -40 to +85 °C. All the devices in the ACL range will be available in small-outline packages for surface mounted assembly or in dual-in-line packages.

194

Precision SMD resistors boast low temperature coefficient plus 1 % tolerance

Philips is announcing a new series of precision SMD (surface mounted device) resistors with a specification based upon that of conventional 1 % leaded resistors. Besides having a tolerance of $\pm 1\%$, the RC-02 series features a temperature coefficient of ± 50 ppm, a stability of below $\pm 0,25\%$ during soldering, and a stability of $\pm 0,5\%$ after 1000 hours operation.

Until now, competitors could normally only supply SMD resistors with 1 % tolerances by rigorous selection of 5 % types. However, these were not true precision resistors, since the other elements of the specification did not comply with the 1 % tolerance on initial resistance value (the temperature coefficients, for example, are 100 ppm and above). Manufacturers needing precision types for surface mounting had to turn to MELF resistors. Although these meet the highest requirements all through the specification, they have several disadvantages when compared with SMD resistors, not least of which is the difficulty of handling them on pick-and-place machines.

The tighter tolerances of the RC-02 series stem from improvements in the materials and manufacturing process of the resistors.



The resistors have a maximum dissipation of 0,125 W, and withstand r.m.s. voltages up to 200 V: temperature range is from -55 to +125 °C. The resistance range goes from 100 Ω to 1 M Ω . They are supplied in bulk, or on 8 mm paper or blister tape, and suit all soldering methods.

195

PHILIPS

Don't risk missing the Comdex show excitement.

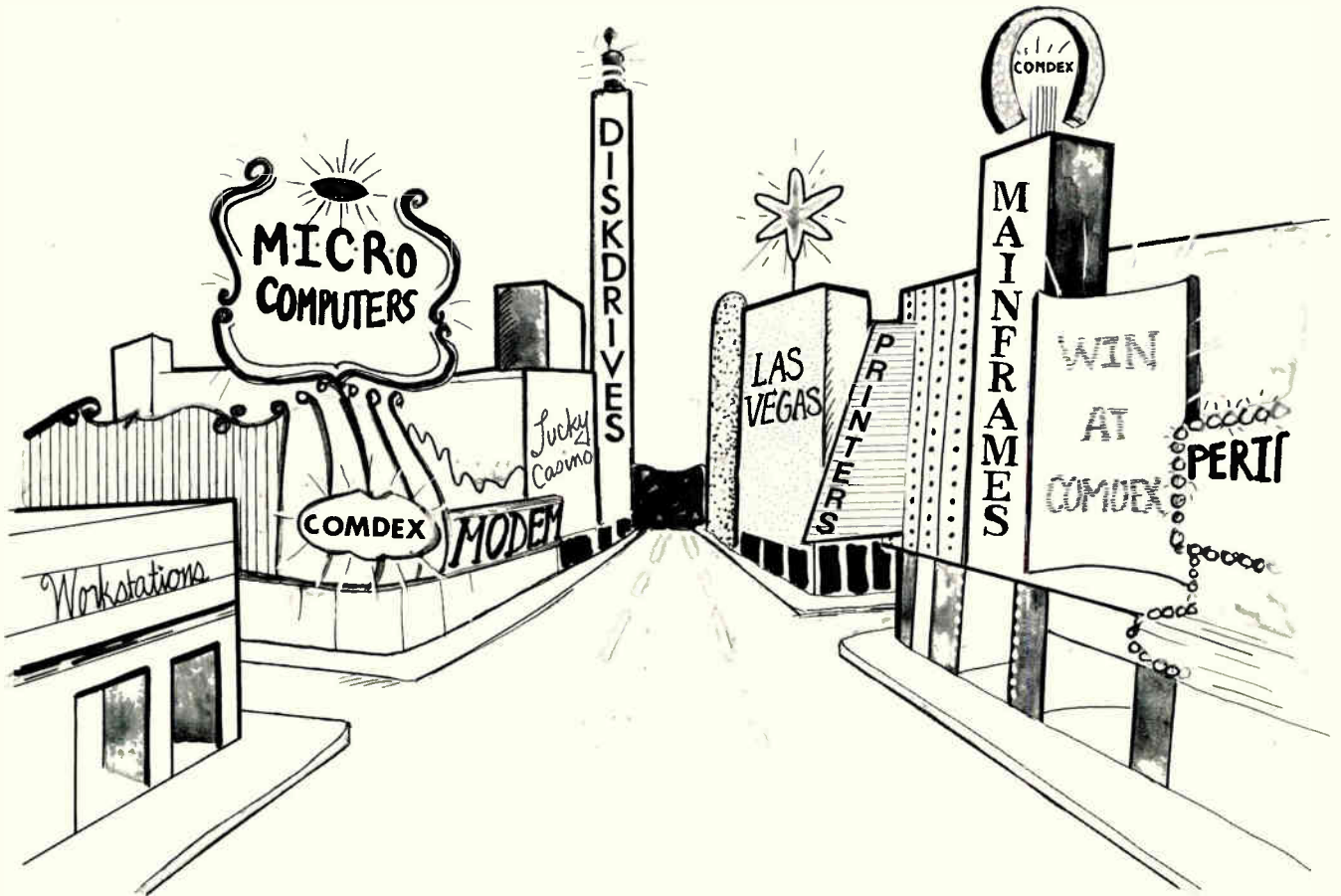

In the October 29th issue, the editors of *Electronics* magazine will preview Comdex Fall '87 being held in Las Vegas.

In this special issue, which will be distributed at the show, our editors bring all the excitement to you. Reporting on the major announcements being made at Comdex, important new products, and the host of new peripherals, micro-computers, disk drives, mainframes,

terminals, modems, workstations, and printers being introduced.

If you're planning to attend Comdex, it's a sure bet to help you put all that's happening at the show in perspective.

If you won't be attending, the odds are that reading this issue is the next best thing to being there.

And, if you're an advertiser, the issue is a natural—a chance to have your advertising message read by 131,000 technical

managers and senior engineers who'll be reading every word of this winning issue. Or if you're exhibiting at Comdex, direct people to your booth with an ad.

So call and reserve your space today. Don't gamble on missing a great opportunity.

Ad Closing: Oct. 5, 1987

Recruitment Closing: Oct. 9, 1987



Electronics

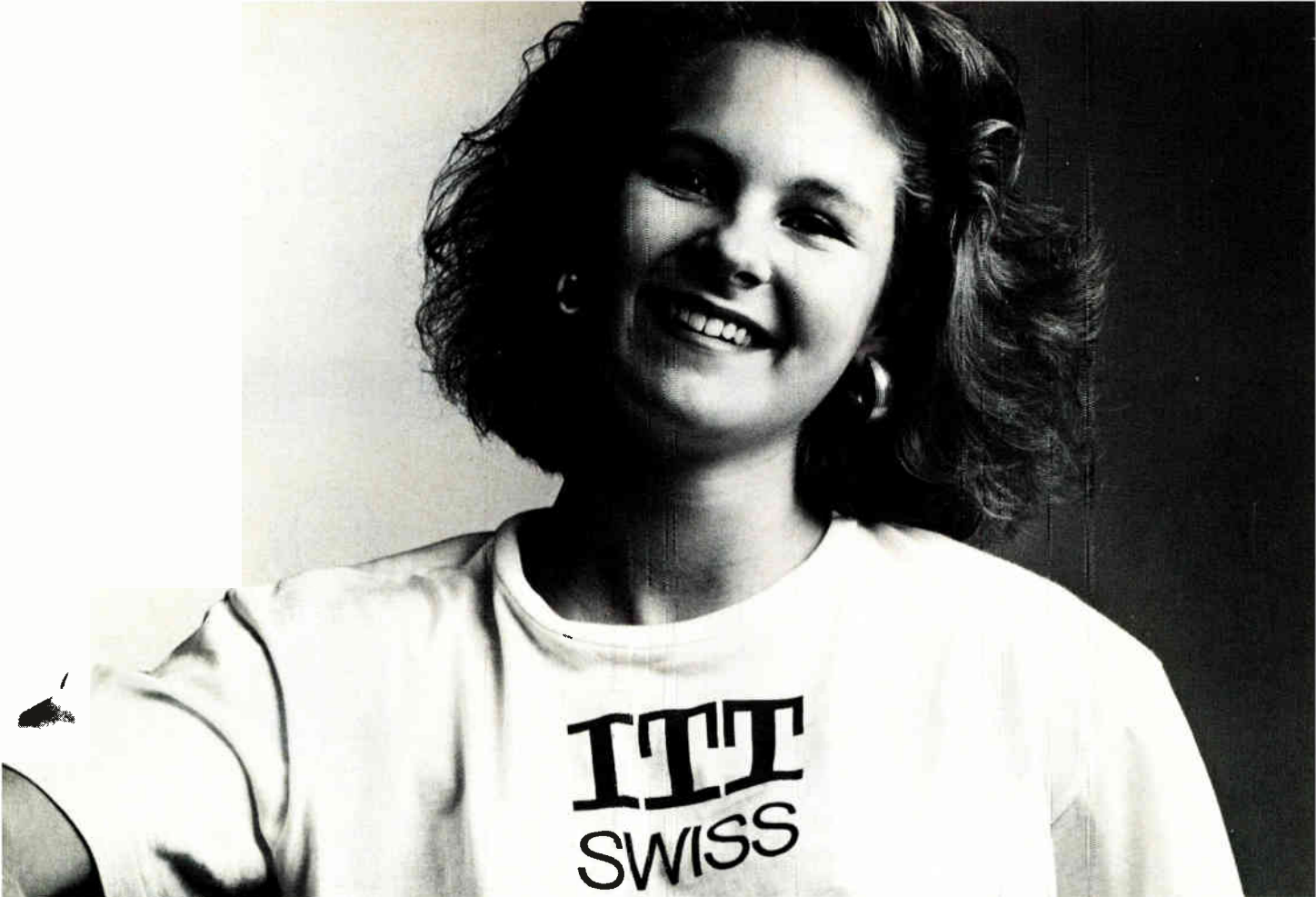

**THE ONLY DIFFERENCE
BETWEEN AN
ITT SWISS RELAY AND AN
ALCATEL SWISS RELAY
IS THE NAME.**

But you probably already knew that. ITT Swiss relays now have another name on the front. You can't miss it. The name Alcatel Swiss is in the same place where ITT Swiss was.

So, what's different? Not much. And definitely less than our competition would have liked.

Some details: Alcatel: Despite its youthfulness, this European association of enterprises has become quite well known.

Alcatel's goals have always been set quite high, a fact which is not really surprising when we consider the competition from America and Japan—not to mention that from the Far East.

So it must be clear that our competence in the manufacture of relays is a matter of great importance in this situation. We can offer a list of plus points which will continue to be available in the future, of course.

Indeed, these plus points are precisely those points necessary to meet the competition of today and tomorrow. Therefore they will be changed very little.

Our relay customers know what we mean. If you are not one of them, then this information will be even more important for you. Allow us to make a few points:



Dr. Juchli 780 ST

PZ Relay: a wonderful example of our pioneering in this field. This was the first relay which could be soldered directly into P.C. boards. This is the only series in the world with a choice of 2, 4 or 6 changeover contacts.

SM Relay: Another typical pioneering effort of our relay laboratories featuring extremely flat profile and an extremely quiet operation. Completely plastic coated, this unit exhibits (in contrast to the competition) exceptionally good anti-shock and anti-vibration characteristics as well as resistance to tropical and wet conditions.

MT Relay: a monostable relay that has no peers. Non-polarized. Suitable for very high packing density. Compatible. Never needs re-adjustment. A guaranteed 10 million changeovers under dry conditions. Functionally guaranteed within a temperature range of -55 to $+70$ degrees centigrade. Failure ratio guaranteed to be under 0,5% over the lifetime of the relay. Can be supplied for coil voltages up to 48V and 150 mW capacity!

We are sure you will agree that is an impressive list of relay plus points.

Now it should be clear just why, except for the name, it is the same old range of products. After all, they are still the latest state of the art.

Everything you have always wanted to know about relays but didn't know where to find the information, has been compiled in the new STR Relay Handbook. A competently written indispensable practical aid for everyone who wants to be on top of everything in the world of relays. We would be happy to send you one—free of charge, of course.

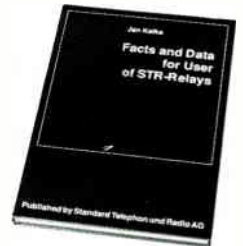

Company

Address

Responsible Party

EW 10/1

Standard Telephon und Radio AG, CH-8055 Zurich
Friesenbergstrasse 75, Switzerland



Circle 53 on reader service card

68000™

FAMILY UPDATE NO. 2

OEMs CAN NOW OFFER HIGH-END, LOW-COST 68000 FAMILY COMPATIBLE PRODUCTS WITH 16 MIPS UNIPROCESSOR PERFORMANCE

By any measure, the 2000 Series VME™ board set recently unveiled by Edge Computer represents a quantum leap in 68000-compatible computing. Designed to fill the microprocessor high-end performance gap, the EDGE 2000 has driven performance costs down to about \$1K per MIPS (OEM quantities). The 2000 Series is available in a VME 3 high eurocard, 4 board set for easy product integration.

The EDGE 2000 is actually a CISC machine that operates with RISC-like efficiency. The specs are impressive. The uniprocessor version of the EDGE 2000 delivers 16 MIPS sustained performance and 60 MB/sec I/O bandwidth. At 1.4 cycles per instruction, the EDGE 2000's AIT (average instruction time) is lower than any other computer on the market today. Quad configurations of the powerful 2000, which supports scalable, transparent multiprocessing with one to four CPUs, are rated in excess of 56 MIPS sustained performance. The modular 2000 Series is based on a proprietary high-speed EDGEbus structure that offers 64 bit, 128 MB/sec parity protected transfers. Global memory can range from 8 MBytes to 1 GByte. Up to four standard or proprietary secondary I/O busses can be supported through dual I/O controllers. In spite of its incredible price/performance characteristics, the EDGE 2000 features a very small footprint (17"W x 29"H) to fit in a normal office environment.

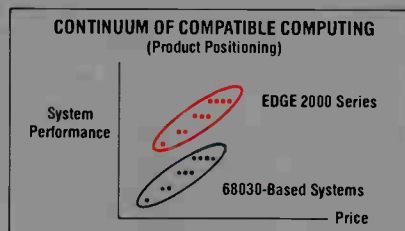
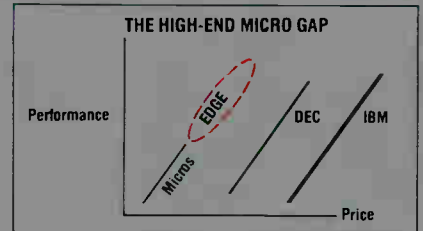

EDGE SOLVES COSTLY SOFTWARE PORTING AND ARCHITECTURAL COMPATIBILITY PROBLEMS

Those OEMs and System Integrators with 68000-based products looking to develop high-end products outside of the 68000 family must overcome a number of costly, lengthy software compatibility obstacles. Porting the operating system, utilities and application software for target hardware, designing I/O interfaces and compilers are among the most formidable. The ongoing costs for support and maintenance of two architectures are equally important considerations. 68000-compatible products developed by Edge Computer let OEMs and System Integrators move ahead with a high-end compatible 68000 architecture to eliminate substantial software porting expenditures while still maintaining architectural compatibility.

EDGE COMPUTER FORMS SWISS SUBSIDIARY

Edge Computer Corporation has formed a European subsidiary in Lausanne, Switzerland. The new company was established to capitalize on the rapidly growing European demand by OEMs, System Integrators and Value-Added Resellers for compatible high-end Motorola 68000-based products. The subsidiary will be headed by Heiner Krapp, vice president of international operations.

**EDGE
COMPUTER** 

Compatible With Your Future

For more information, contact Pamela Mayer, Edge Computer Corporation, 7273 E. Butherus Drive, Scottsdale, AZ 85260, 602/951-2020. European Sales Office contact Heiner Krapp, 5, Avenue des Jordils CH 1000 Lausanne 6 Switzerland, 41-21-275315.

68000 and VME are trademarks of Motorola Corporation.

Circle 54 on reader service card

INSIDE TECHNOLOGY

FERMENT IN MICROCONTROLLERS NEW OFFERINGS, NEW PLAYERS STIR UP THE COMPETITION

The market for microcontrollers is going like a house afire as the number of applications explodes for these cost-effective devices. Semiconductor vendors from around the world, as a result, are investing major resources into a potpourri of new and improved products. And they are developing a wide variety of new strategies and technologies to set off their new chips from the crowd and grab as much market share as they can.

Worldwide sales of single-chip controllers now stand at 500 million units worth \$1.6 billion; after a gradual rise to 555 million units and \$1.77 billion in 1988, the market will begin to overcome design-in lag and could shoot to 1.25 billion controllers worth almost \$3 billion by 1991, estimates Dataquest Inc. of San Jose, Calif.

The most exciting segment of the market is the high end, the 16-bit parts for computationally intensive real-time jobs. This segment got off to a slow start in the early 1980s but is now rocketing at a compound annual growth rate of over 90%, and the number of alternatives the customer has to choose from is expanding quickly. Until last year, Intel thoroughly dominated the 16-bit microcontroller market with its 8096; the only other major competitor was Mostek's MK68200. Since then, however, 16-bit chips have appeared from Harris, NEC, and National Semiconductor. Texas Instruments is expected to jump in, and it already has some design wins for controller applications handled by its 320-series digital signal processor. Intel is looking to defend its market position with the new 80C196 (see p. 59).

But the market for the older 4- and 8-bit microcontrollers is not being neglected; its growth prospects are still considerable. There are many more players already working this territory, so they are scrapping it out, looking for ways to reduce the cost, speed up the programming turnaround time, and enhance both the performance and flexibility of their offerings. There is a trend toward parts optimized for particular applications and market segments, both in terms of hardware features and modified instruction sets. There is also a growing movement toward incor-

Most of the action is at the high end; while these 16-bit parts got off to a slow start in the early 1980s, they're now rocketing along at a 90% growth rate

by **Bernard C. Cole**

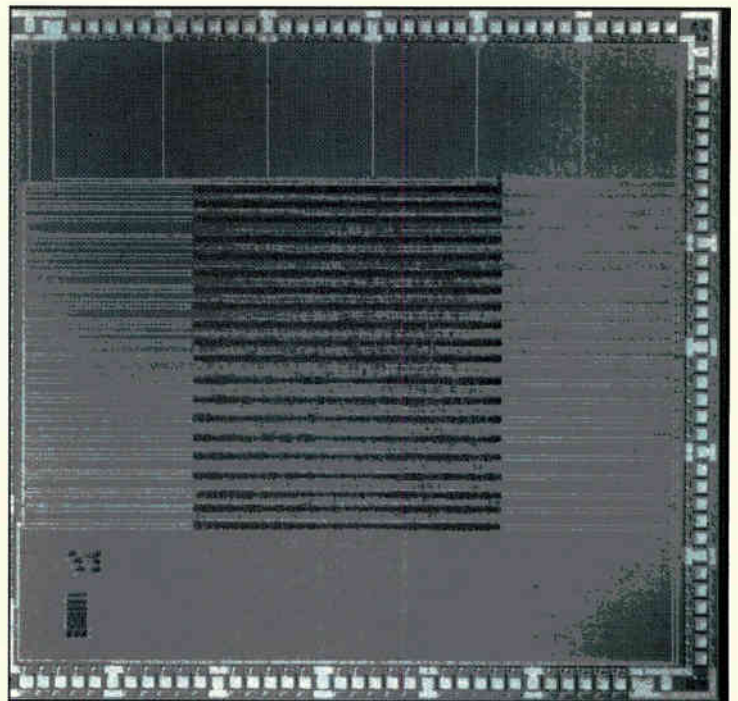

1. FORTH CORE. Harris Semiconductor's reduced-instruction-set core cell for microcontrollers is optimized for executing software written in Forth.

IT'S DESIGN-IN TIME FOR ISDN: OEMs FIND THE GOING ROUGH

The gestation period is over for the Integrated Systems Digital Network. Labor pains have begun, and much of the agony is being suffered by computer designers more familiar with modems and networks tailored to the computer environment than with telecommunications.

ISDN confronts them with the telecommunications world's high voltages and complex protocols and interfaces. To compound the problem, over the past two years chip makers have fielded ISDN chip sets implemented in differing architectures. While ISDN establishes standard interfaces at certain levels, chip-to-chip communication—that is, communication between the chips built for the standard interfaces and the rest of the electronics in the equipment in question—remains nonstandard. That's a dilemma for original-equipment manufacturers, who must ponder which architecture is best for their applications.

The array of options has helped keep OEMs waiting on the sidelines for a clear choice among chip makers' families to emerge. So now chip makers are beginning to field evaluation boards and development software in the hopes they will attract designers. Chip offerings have also continued; for example, AMD is introducing an ISDN controller chip that takes on many functions from the host processor (see p. 66).

The stakes are considerable, now that ISDN is starting to take off. The use of digital switches in local exchanges in the U.S. is a prerequisite for the implementation of ISDN, and Ovum Inc. predicts that will grow from a 25% base in 1987 to 64% in 1995. With the exception of France, where 55% of local exchanges are already digital, Europe will go digital at a slower rate, says the Princeton, N. J., market researcher. By 1995, Germany and Italy will have converted 50% of their switches, and France 95%.

The swing to digital exchanges will pave the way for steadily growing markets for ISDN products. Ovum projects an \$8.6 billion U.S. market for ISDN products in 1992—including feature phones, work stations, and private-branch-exchange equipment—up from \$5.3 billion in 1987 (see table, right). It predicts that the European market will grow from \$1.1 billion in 1987 to \$4.1 billion in 1992 (see table, p. 64). Japan is seldom included in ISDN market pro-

Too many architectures with incompatible interfaces make mixing chip sets difficult; to get designs moving faster, chip makers are turning out more evaluation boards

by Jack Shandle

jections: it has opted to take its own route to digital communications, and Japanese companies have not participated in ISDN standards making.

Designed to bring digitized voice and high-speed data directly to a user's desk, ISDN sets standards for two services: A 192-Kbit/s basic-rate service is for small companies and individual subscribers; and a primary-rate service of either 1.544 Mbit/s in the U.S. or 2.048 Mbit/s in Europe typically will serve *Fortune* 500 companies. Each service level entails its own family of interfaces.

In basic-access service, the 192-Kbit/s channel divides into two data channels—designated B channels—and one 16-Kbit/s signal channel—designated the D channel. The division point is called the U interface. The link between the customer's phones and terminals and his internal distribution is called the S interface.

In the primary-access service, the S₁/S₂ interface provides the connection between the network and the subscriber's line, and the T1 interface provides the connection between the individ-

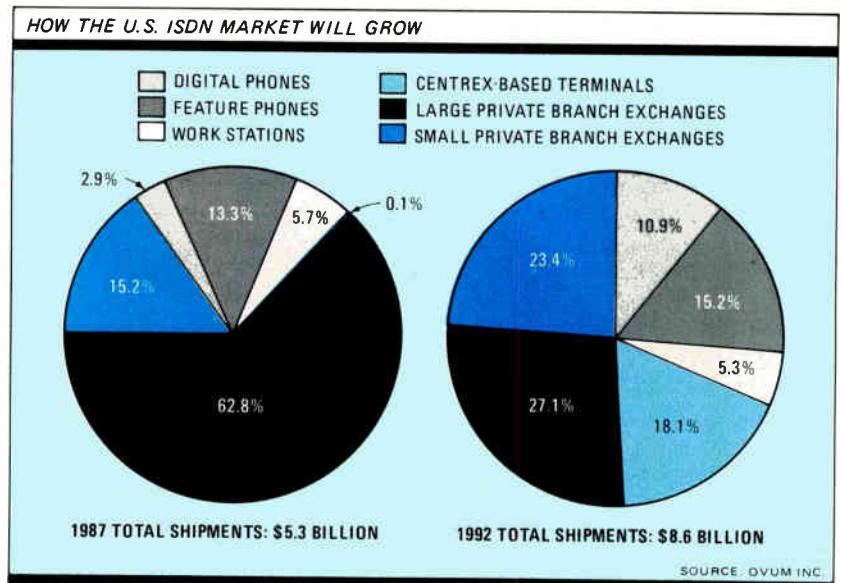

AMD'S \$18 CONTROLLER CHIP EXECUTES ISDN'S KEY PROTOCOL

Its other jobs include linking non-ISDN terminals and acting as bus arbitrator

by Jack Shandle

Locking a complex telecommunications protocol into silicon at a time when the standards for the Integrated Services Digital Network are still evolving can be a tricky business. But Advanced Micro Devices Inc. has pulled a price-performance rabbit out of its hat with a chip sample-priced at \$18 that delivers big dividends by executing ISDN's key protocol, plus integrating components of an ISDN terminal.

The Am79C401 Integrated Data Protocol Controller (see fig. 1) handles the protocol that establishes, maintains, and terminates data-link connections. It also integrates a universal synchronous/asynchronous receiver/transmitter as a link to non-ISDN terminals via an RS-232-C port. Still another functional module—the dual-port memory controller—acts as a bus arbitrator in shared-memory, multiple-processor applications—allowing system designers to use low-cost static random-access memory instead of dual-port memory.

The chip's primary mission, however, is execut-

ing selected portions of ISDN's still-evolving LAPD (Link Access Procedure-Version D) protocol. Its modular architecture accomplishes that goal efficiently, reducing processing time by up to 40%, compared to systems in which the system's microprocessor executes LAPD completely in software, says Terry Lawell, ISDN strategic development manager of the Sunnyvale, Calif., company. By offloading the processor, the 79C401 gives it more time to handle other aspects of LAPD that could change as standards committees complete their work and are therefore better handled in software. It implements handshake procedures, checking data validity, and monitoring the bit stream for special characters that require the microprocessor's intervention.

Some competing chip makers have put more of the protocol's functions on-chip, but these devices cost up to five times the 79C401's sample price. AMD contends complex chips costing \$50 to \$100 are saddling system developers with undue risk because the LAPD protocol is still evolving.

LAPD is a subset of the International Organization for Standard's HDLC (High-Level Data Link Control), which in turn was derived from IBM Corp.'s SDLC (Synchronous Data Link Control). These protocols manage network data in numerous ways, including frame delimiting, error correction, addressing, and signaling. Since the protocols are similar, the 79C401

also supports applications using pre-ISDN protocols such as IBM's SNA (Systems Network Architecture), AT&T's DMI (Digital Multi-band Interface), and the CCITT's X.25 protocol.

In ISDN applications, the 79C401 supports data calls at the S-interface—the point where computers and dumb terminals connect to the ISDN environment. S-interfaces consist of two 64-kbit/s data channels—called B channels—and one 16-kbit/s signaling channel called a D channel. The 79C401 can support multiple logical connections on one B channel. Two chips can be used in parallel to support both B channels.

Situated at the chip's doorway to the S-interface, the data-link controller does the on-chip protocol work. To reduce the number of microprocessor interrupts and their latency time, incoming data

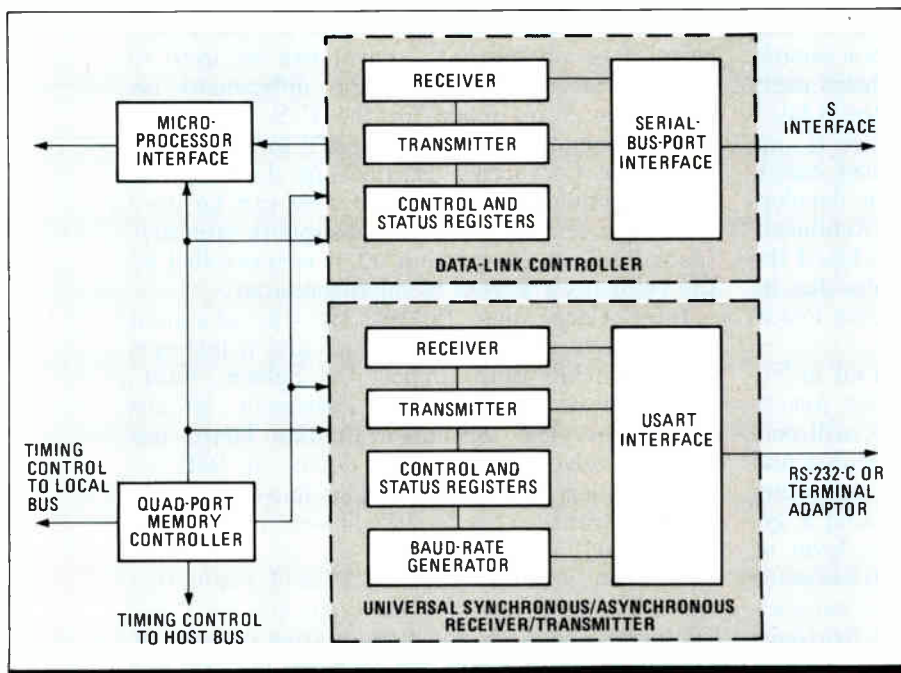

1. MULTIPROTOCOL. AMD's 79C401 controller chip was designed to execute the ISDN data-link protocol, but it also can handle SNA, X.25, and other bit-oriented protocols.

is parceled into status and control registers and then stored in a 32-byte-deep first-in, first-out memory. In the process, the hardware checks the validity of the data by handling error recognition procedures, flag recognition and generation, and abort recognition and generation. "Many parts out there today spend 30% to 40% of their time trying to find out what shape the data packet is in," says Lawell. One reason is that these chips must interrupt the processor more frequently for instructions that will help determine the data packet's status. The 79C401 handles these duties by executing fewer instructions from the processor.

The data-link controller operates in multiplexed or nonmultiplexed modes. In the multiplexed mode required by ISDN, it interfaces with AMD's Am79C30 digital subscriber controller or Am79C32 data controller (fig. 2), providing access to any of the 64-Kbit/s time slots on the 192-Kbit/s serial bus. The 79C30 or 79C32 can then assign time slots to any of the 64-Kbit/s channels on the S interface. In nonmultiplexed operation, the 79C401 supports full-duplex transfers up to 2.048 Mbit/s.

The chip's USART executes a superset of the industry-standard National Semiconductor Corp. 8250 UART used in Hayes Corp.'s SmartModem and in IBM Corp.'s Personal Computers. It operates in full-duplex mode up to 56 Kbit/s with a baud rate set internally by external clocks—making it a good match for integrating non-ISDN terminals into a network. A bonus feature to save software developers time is a special-character recognizer that checks for command characters arriving in the USART's 4-byte FIFO that require intervention by the microprocessor. Up to 127 character patterns can be programmed into the chip.

Special characters activate a status-tracking circuit so the character can be identified when it becomes resident in the 79C401's output data register. This saves the designer the effort of writing software to locate special characters and offloads the processor because it doesn't have to execute the software.

The chip's dual-port memory controller is used only in applications where multiple processors share memory. A typical application would be an ISDN adapter board for a PC in which the computer would have to pass commands and parameters to a local processor on the plug-in card. The controller arbitrates the use of shared RAM on the card by the processors. When both processors request the bus simultaneously, access is given to the local processor. When both processors need to access a common area of memory

such as command or status mailboxes, a set of interrupt pins and a semaphore register are provided to manage the sequence of accesses. The memory controller lets systems designers implement shared RAM with low-cost static RAM instead of expensive dual-port RAM.

The 79C401's microprocessor interface performs timing control to the external processor,

The Am79C401 can determine the status of ISDN data packets on its own; other controllers spend up to 40% of their time querying the host processor for this data

does the address decoding for module selection, and performs the internal synchronization for the chip's other three modules and the external bus. AMD optimized the bus interface for Intel Corp.'s 80188 processor, but its characteristics are general enough to interface to almost any microprocessor, says Lawell. Internal registers are memory-mapped, allowing the processor to address them directly. This aspect of the chip's architecture was implemented for ease of software development. "Since each register has its own address, designers can make this point look like normal memory locations for read and write techniques," says Ron Ruebusch, director of telecommunication-product marketing.

For most ISDN products, software development ties up 10 times more labor than hardware development; so the 79C401 comes with a rich software dowry. It includes the low-level device drivers and LAPD protocol to support ISDN's data-carrying B channels and signaling D channel. □

For more information, circle 485 on the reader service card.

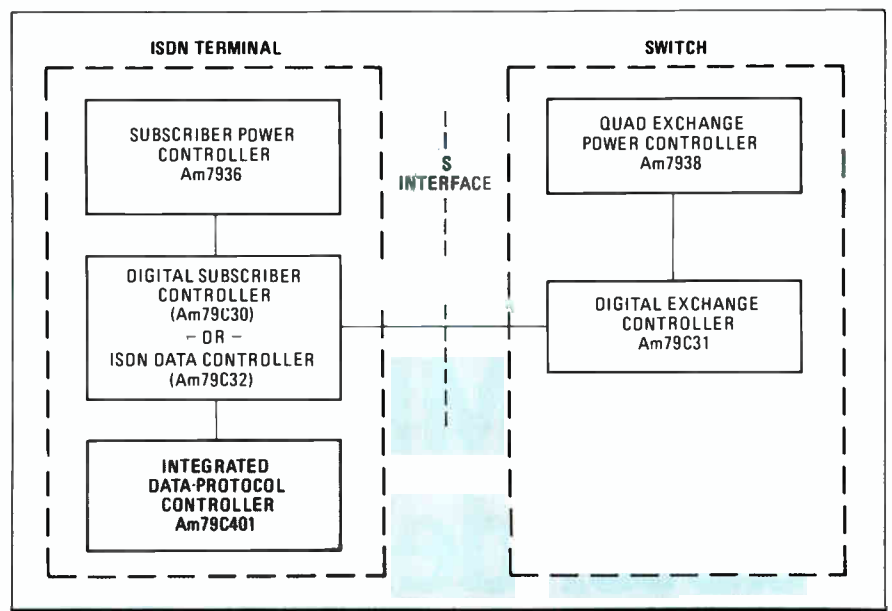

2. FULL HOUSE. The 79C401 completes AMD's chip set for the ISDN S interface; it handles the data-link protocol, offloading these tasks from the host microprocessor.

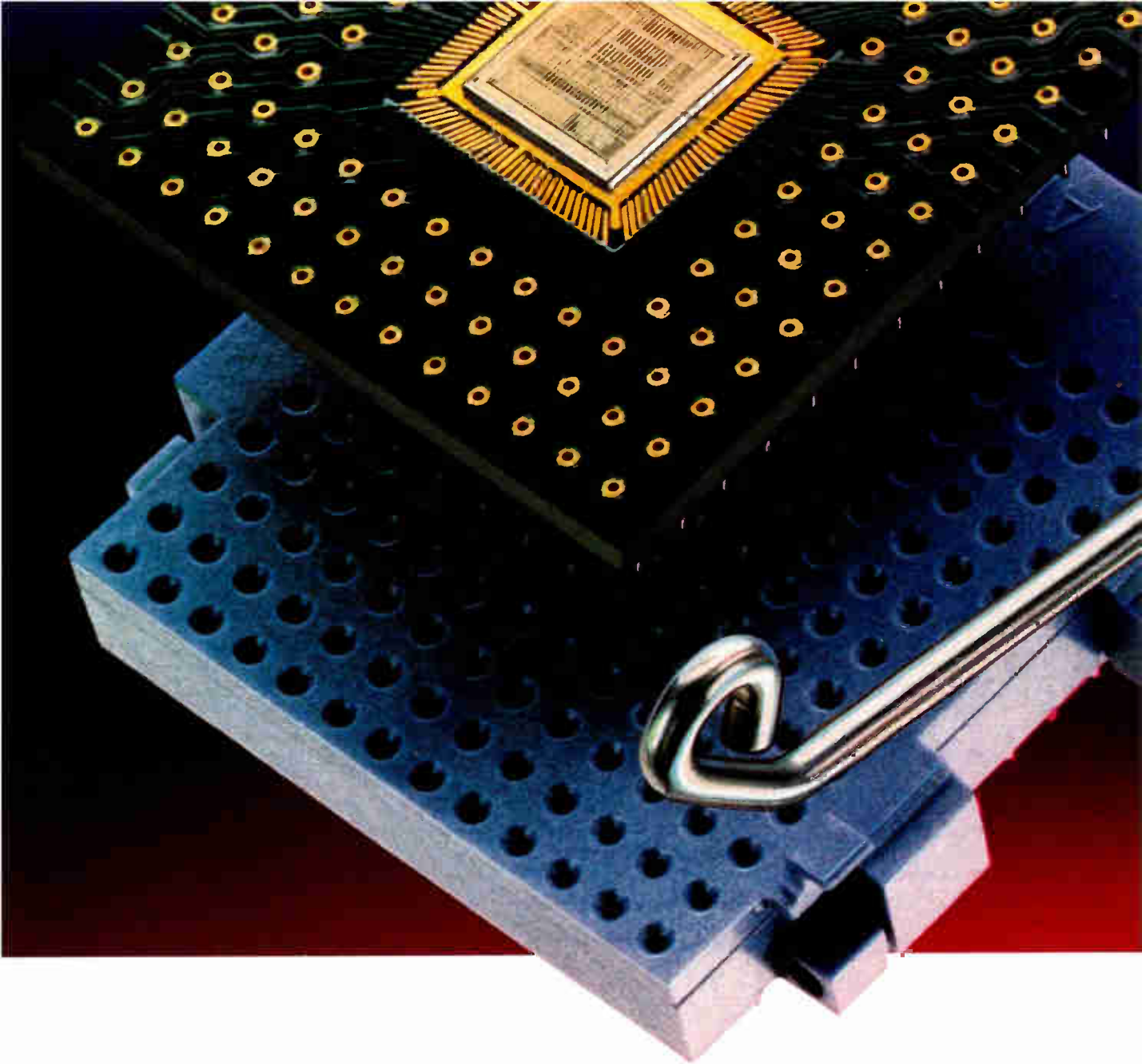

**Easy loaders.
Faster test and burn-in
with AMP sockets.
Faster delivery from AMP.**

Q: EACH ROW OF THIS UNIQUE MOUSETRAP HAS BEEN SCRAMBLED. THE PARTS IN EACH ROW ALWAYS REMAIN IN THAT ROW. CAN YOU RETURN THEM TO THEIR PROPER POSITIONS SO THEY MAKE THE RIGHT CONNECTIONS AND TRAP THE MOUSE? THE FIRST PIECE, 1, IS ALREADY IN THE RIGHT PLACE.

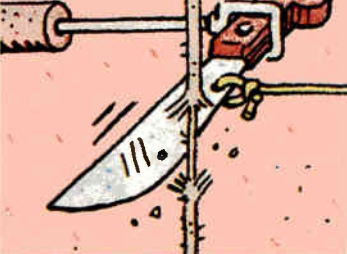
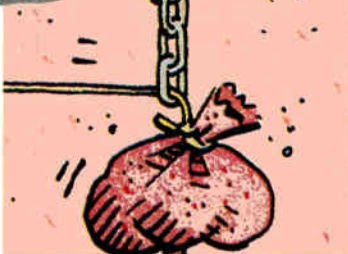
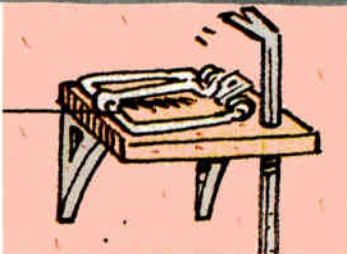
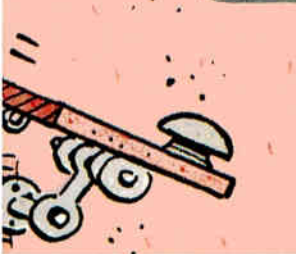

22

23

24

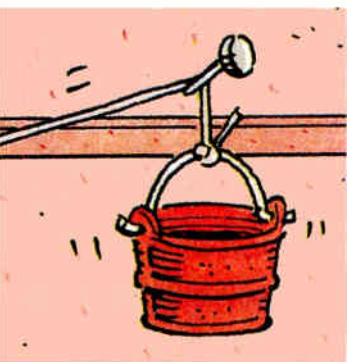
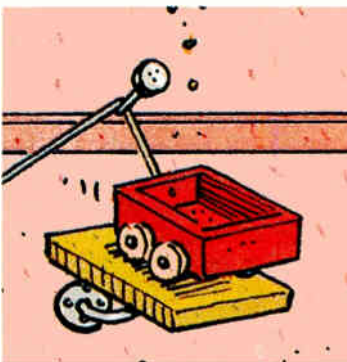

14

15

16

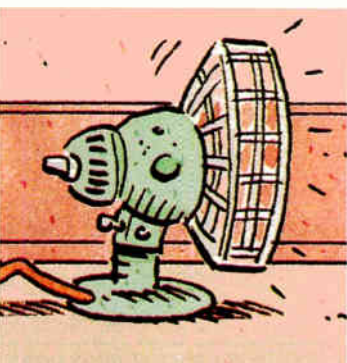
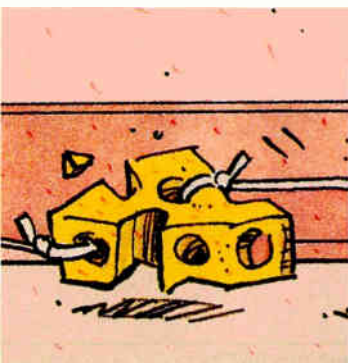
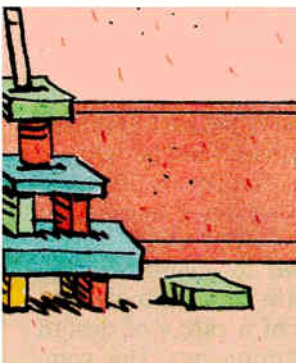

6

7

8

GAMES MAGAZINE Copyright © 1986

single source solution to a multi-source problem. EZ-NET is a compatible group of networking information products, designed to create an information and control solution custom-made for you. So the right people have the right information at their fingertips, to help turn raw data into money-making decisions.

If you'd like to develop an integrated tester environment that truly maximizes the strengths of your people and equipment, LTX can put it all together. We can also put together the mousetrap brain tester above. Just call your nearest LTX sales office.



TEST YOUR LIMITS

SPECIAL REPORT: GAP BETWEEN CAE AND ATE IS NARROWING

Test-gear makers are readying software that translates files developed on CAE systems to an intermediate format so they can be used to produce test programs

by Jonah McLeod

The links between automated design and automated testing of chips and printed-circuit boards are rapidly falling into place. Duplication of effort is being pared away, so that the test engineer developing test vectors no longer has to replicate a large part of what the designer did to simulate the circuit in the first place.

The ability to use the stimulus patterns from design simulation to produce test-system programs is a crucial one, because the amount of effort that goes into test engineering is rising rapidly as the level of chip integration goes up, and the increasing numbers of unique application-specific integrated circuits means more and more unique test programs must be generated. Furthermore, pressures are increasing to move ICs and pc boards to market quickly, as design cycles and product lifetimes shorten.

But the simulators that run on computer-aided engineering systems used for chip and board design do not produce stimulus files that can be passed directly to test systems; there are many incompatible design simulators producing output in different formats, and each test system has unique input needs. Some makers of automatic test equipment have set about developing translation programs that bridge the gap between their systems and design simulators.

The most flexible approach to this task involves the use of common intermediate file structures, such as those from Zehntel and Sentry Schlumberger. Programs can then be written to move files from various simulators into the intermediate format, and other ones to produce test programs from the intermediate-format files. Tools can be developed to operate on the data while in the intermediate format, tools that work despite the use of a range of design simulators or test environments. One company, Test System Strategies Inc. of Beaverton, Ore., offers neither CAE nor ATE equipment, but specializes in versatile software for producing test programs for many different ATE systems from the output of many different CAE systems—a big advantage for end users with more than one kind of test system.

The software environments developed by the ATE companies themselves offer less universality in their approaches but a tighter integration path between CAE and ATE. GenRad, Teradyne, Tektronix, and Hewlett-Packard, among others, are developing such links.

One major reason why there has been

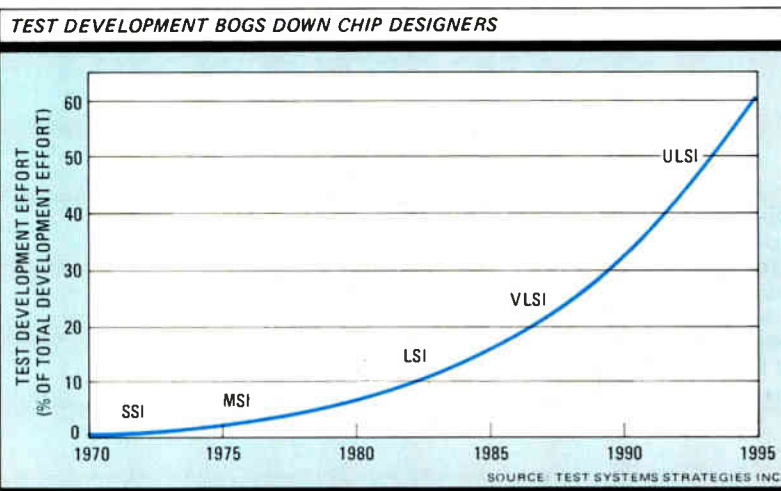

more emphasis of late on improving the design-to-test connection can be seen in the increase in ASIC design starts. The number of ASICs designed will grow from 6,000 in 1985 to over 90,000 in 1990, according to Technical Insights Inc., an Englewood, N. J., market-research firm. At the same time, "design windows have shrunk from 12 to 15 months down to 6 to 9 months," says Robert Castellano, president of The Information Network, a San Francisco research firm.

ASICs find their way onto pc boards, which are also on tight schedules. "From the time a board is started to the time it is shipped, no more than 15 months have elapsed, and once the product is on the market, it may have no more than 9 months of product life," says Castellano.

While CAE design tools have reduced the time required to design a chip or board, until recently there has been no commensurate reduction in the time it takes to create a test program for them. The problem is aggravated by the fact that as levels of integration rise, test-development times become a much larger portion of the total time to produce a chip (see chart, opposite).

A partial solution has been for the design engineer to provide the test engineer with data files containing the schematic and the vectors used to verify the design. Then the test engineer must convert the vectors into a form that can be used by the test system.

Many ATE suppliers now offer translator programs for various design simulators. For example, Zehntel Inc. of Walnut Creek, Calif., offers its Simlink, which converts the output of the Daisy Logic Simulator from Daisy Systems Corp. of Mountain View, Calif., and the Hilo simulator versions 2 and 3 from GenRad into test patterns that can be used by the company's Model 875, 850, and 3200 testers.

"Simlink converts the simulator data into an intermediate TVF [test vector format]," says Koorosh Mazifi, marketing product manager at Zehntel. "It then converts the TVF into a test program for a specific tester." This intermediate format helps minimize the number of translators that a CAE system must provide to accommodate different test systems.

The experience of Sentry Schlumberger of San Jose, Calif., with its intermediate file structure, the Computer-Aided-Design Data-Interchange Format, illustrates how this minimization works. "In our use of this capability, the output of a popular commercially available simulator is preprocessed and converted into Caddif," says Neil Richardson, Schlumberger director of advanced ATE products. "The Caddif file is then converted into tester-specific test vectors," he adds (see fig. 1). Interfaces to Cad-

dif currently support Lasar, Hilo, Cadat, and Te-gas simulators, as well as the simulators from Daisy Systems and Mentor Graphics.

Once in the intermediate format, software tools can edit and compress the data. Thereafter, a separate tester-interface translator program converts the Caddif file into patterns that can be used by a target tester.

However, the ATE buyer is faced with a proliferation of intermediate file formats, each from a different test-system manufacturer. Test-system buyers want a standard, one intermediate file structure common to all vendors' simulators and ATE equipment, rather than having a unique intermediate format they must use for a specific brand of ATE gear. The best chance of achieving such a standard rests with SEF (standard events format), the format developed by Test Systems Strategies. The company has also written programs to convert stimulus files from most simulators into patterns which can be used by most ATE equipment. The company's offering has primarily served ASIC designers, but at the International Test Conference held in Washington, D. C., in September, it broadened its offering to include pc-board design-to-test links as well.

SEF and its associated software go beyond providing a common interface between design simulators and test systems. The company's Test Development Series (TDS) software tools, for which SEF is the data-base file structure, helps the test engineer create a final test program in other ways (see fig. 2). After a converter program translates the logic-simulator file into the SEF format, the Simulation Rules Checker produces a report for the test engineer of conflicts between the tester capability and the capabilities called for by the stimulus patterns. For example, the patterns might ask a 5-ns-wide pulse of a tester that can produce a pulse no narrower than 10 ns.

Another TDS tool, the Test Resource Allocation Manager, checks for other kinds of tester-specific incompatibilities. It looks at the intent of the

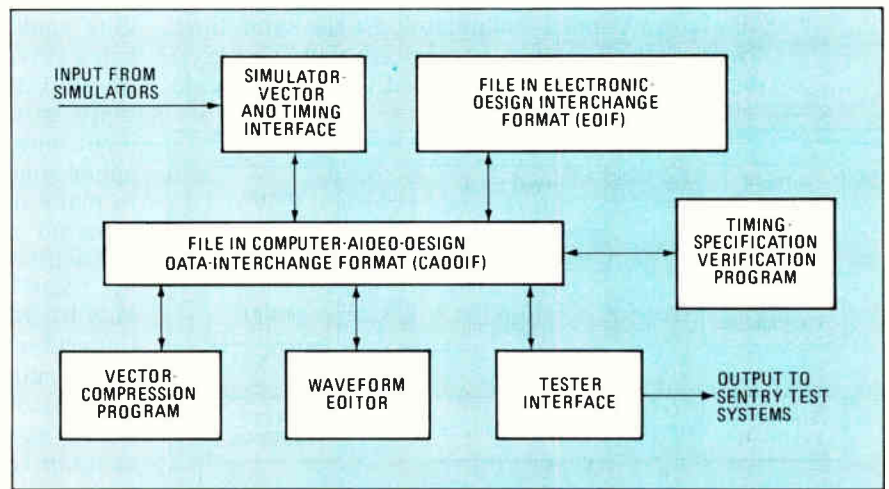

1. IN BETWEEN. Sentry Schlumberger's CADDIF is typical of the intermediate file formats ATE vendors use to convert vectors from a variety of design simulators into tester-specific patterns.

Sapphire tip
Usability at 5000 bars
hole \varnothing 0.08 to 2.00 mm

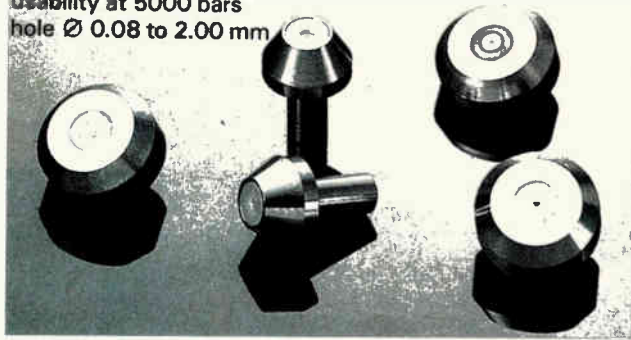

When others give up, these nozzles keep on

Seitz nozzles: unbeatable for long life and accuracy in water-jet cutting.

A real «liquid laser»: pressures of 5000 bars, jet speed of Mach 2.

Sapphire tip: virtually absolute resistance to wear and corrosion, impeccable guidance and cohesion of the jet.

New horizons for new materials



Products and components in hard materials



Division Seitz
Grand-Rue 27
CH - 2416 Les Brenets
Switzerland
Tel. 039/32 11 12
Telex 952 331 seiz ch
Telefax 039/32 18 57

Comadur - a company of **SMH**

Circle 95 on reader service card

AVAILABLE! 1986-'87 Electronics Buyers' Guide



Order your copy today for the industry's
most often-used directory:

- It's three directories in one easy-to-use volume.
- Includes more than 4,000 product listings (approx. 700 pages)
- Contains over 5,000 company listings (approx. 400 pages) including:
 - Company name, address and phone number.
 - Name and title of contact for sales information.
 - Number of engineers at plant and number of employees.
 - Annual dollar sales volume.
 - Local sales offices and manufacturers representatives.
 - Local distributors.
 - Instant referral to company's advertisements.
- Offers FREE current catalog retrieval service (approx. 1300 catalogs)

**Price: \$40 USA &
Canada
\$50 elsewhere**
(add \$30 for airmail)

Send order with payment to:
Regina Hera
Electronics Buyers' Guide
1221 Avenue of the Americas,
New York, NY 10020



Electronics/October 1, 1987

ADVANCE DIRECTLY TO YOUR PCB

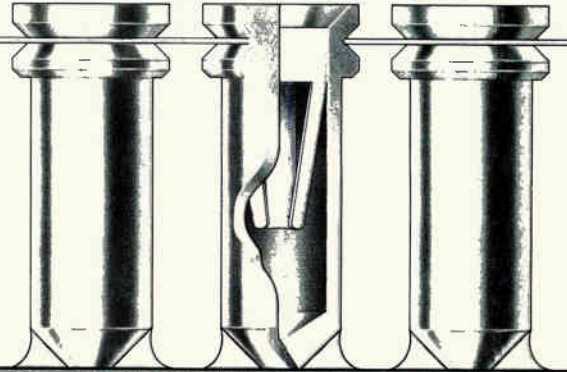

PCB

WITH SURFACE MOUNT SOCKETS FROM ADVANCED INTERCONNECTIONS

- Sockets surface mounted to PCB
- Surface mount sockets allow for top and bottom PCB mounting
- Mixed technology provides flexibility of using leaded devices on a surface mount PCB
- Available in molded polyester, high temperature Rynite® and Kapton® Peel-A-Way™ terminal carrier
- High reliability screw machine terminals with multiple finger beryllium copper contacts
- Tapered entry for ease of insertion
- Closed end construction for 100% anti-solder wicking
- Available with solder preforms

AVAILABLE SURFACE MOUNT OPTIONS

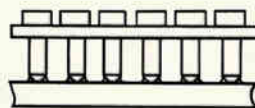

**MOLDED BODY
SURFACE MOUNT SOCKETS**

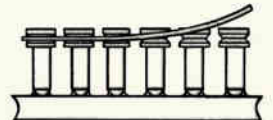

**PEEL-A-WAY™
SURFACE MOUNT SOCKETS**

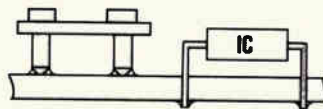

**MIXED SURFACE MOUNT
THRU HOLE TECHNOLOGY**

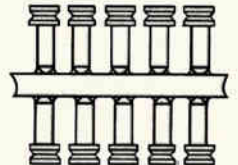

SURFACE MOUNT TOP/BOTTOM

Peel-A-Way™ covered by patent rights issued and/or pending. Mylar®, Kapton® and Rynite® are Trade names of The Dupont Co.

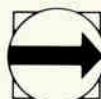

**ADVANCED
INTERCONNECTIONS**

5 Energy Way, West Warwick, Rhode Island 02893
Tel. 401-823-5200 • FAX 401-823-8723 • TWX 910 2403454

Circle 75 on reader service card 75

ETHERNET OR STARLAN? THIS CONTROLLER DOES BOTH JOBS

Designers looking to develop local-area-network boards and subsystems for work stations and personal computers will no longer have to choose between chips that implement one of the two main communications protocols, Ethernet or StarLAN. Fujitsu Microelectronics Inc. has come up with a controller, the MB86950 Etherstar, that tucks both protocols within one chip (see fig. 1).

As a bonus, the chip's architecture has been enhanced to reduce the host central processing unit's supervisory responsibilities by 10% to 20%—a major consideration, since with most network schemes the CPU devotes up to 20% of its time overseeing the flow of network information. The enhancements include a larger buffer memory and a serial-in, parallel-out first-in, first-out memory block. Fabricated in 1.5- μ m double-metal, double-polysilicon CMOS, the 40,000-mil² chip consumes only 500 mW.

"Basically there are two ways to look at what we are offering the system designer and board manufacturer with the Etherstar chip," says Don W. Lake, director of marketing for the Santa Clara, Calif., company's Advanced Products Division. "On the one hand we are offering a LAN controller that will reduce the supervisory load and increase performance, with the bonus of easily implementing either StarLAN or Ethernet. Alternatively, we can also be viewed as offering an all-in-one protocol chip, with the additional benefit of increasing system performance by 10% to 20%."

Samples of the Etherstar chip are available for \$35 each in quantities up to 100. For larger orders, the price drops to about \$12. Volume production should begin in the first quarter of 1988.

Fujitsu's new IC also takes over part of the supervisory burden from the host CPU

by Bernard C. Cole

Currently, Ethernet accounts for some 40% of all LAN protocols (about 250,000 to 350,000 units per year) and StarLAN for about 30%. "Previously these two markets were pretty well differentiated into two segments," says Lake. These are "high-performance work stations and minicomputers requiring the higher speed" of Ethernet, which reaches a 10-Mbit/s transmission rate; "and 8- and 16-bit personal-computer systems, for which the lower-speed [1 Mbit/s] StarLAN protocol is more than adequate." But the emergence of lower-cost personal computers and work stations based on the new 32-bit microprocessors has systems designers demanding a cost-effective single-chip solution in the higher-performance LAN arena. This is where the new

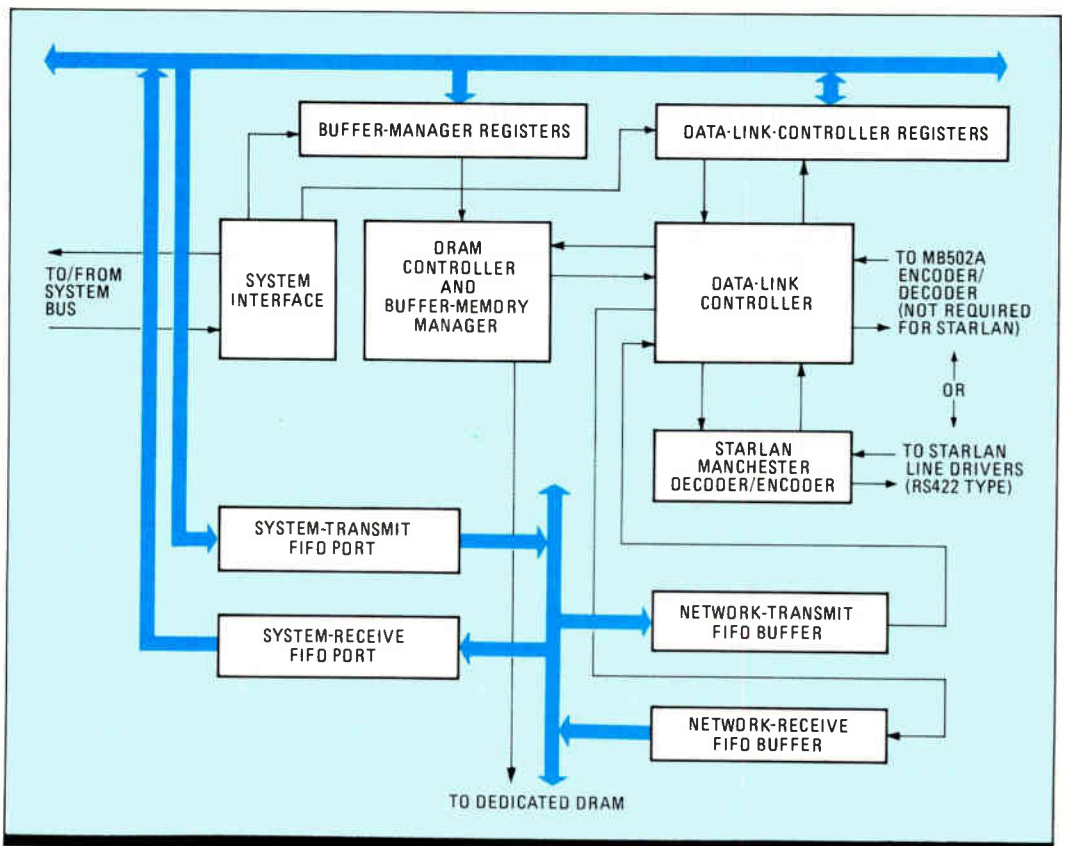

1. DUAL MODE. Fujitsu's CMOS MB86950 Etherstar chip includes the logic to implement both the Ethernet and the StarLAN protocols. The chip consumes only 500 mW and includes features to offload a host CPU.

Fujitsu 86950 device will excel, says Lake.

The main buyers, he says, will be vendors who supply LAN plug-in boards to systems designers. Since it will no longer be necessary to design different boards and different sets of software for each protocol, these suppliers will benefit from reduced development costs, he says. With Etherstar, it's possible to devise a single-board solution in which most of the hardware and software are common to both protocols (see fig. 2). "The only additional development work is the programming effort involved in writing the routines necessary to interface to either of the protocols," says Lake.

The Etherstar chip is configurable for use on both 8- and 16-bit-wide bus interfaces, says Albert Chiang, LAN applications engineer at the Advanced Product Division. It incorporates a data-link controller, a 1-Mbit/s Manchester encoder/decoder for StarLAN applications, a dynamic-random-access-memory controller, a buffer memory controller, and associated FIFO buffers. To switch between the two modes, says Chiang, all that is necessary is to toggle a single pin—to high for Ethernet, to low for StarLAN. The only external component required is an analog-to-digital encoder/decoder, used to implement Ethernet's analog collision-detection scheme (StarLAN uses a digital technique).

The data-link controller provides for automatic generation and stripping of the 64-bit preamble, as well as cyclic redundancy checking, serial and parallel data conversions, and contention resolution and address recognition for both protocols. The DRAM controller handles data-packet transfers between a system's main memory and the buffer memory, and between the buffer memory and the LAN. It transfers 1.5-Kbyte data packets from the LAN to a receive buffer memory without host-system intervention.

A number of architectural enhancements boost

the chip's performance with either protocol, says Chiang. First, having the buffer-memory controller on-chip eliminates the need for an external microcontroller, which was necessary in earlier single-chip implementations for either StarLAN or Ethernet. The chip contains registers for receive/transmit control, status count, node identification, and port status, so the buffer manager together with the DRAM-controller block can handle all data transfers back and forth between host and network. This setup reduces the overhead processing usually handled by the CPU or the external microcontroller.

The receive-and-transmit FIFO memory further reduces the time the CPU spends with LAN communications. "In other designs, the FIFOs are very small, with only enough room for the 64-bit header preamble of each block of data," Chiang says. "So once the device determines that the block of information has a destination-code match, the CPU must drop its other activities, immediately service such requests, and move the data to external local memory." Such a scheme takes the CPU away from its primary chores, reducing throughput on the user end. It also increases the possibility of losing data if the CPU does not respond quickly enough.

The Etherstar chip overcomes these problems in two ways. First, Fujitsu has increased the size of the internal FIFOs two to three times—to 4 Kbytes in the transmit section and up to 60 Kbytes in the receive section. Second, the chip incorporates logic that allows automatic transfer of 1.5-Kbit data packets into external buffer memory, relieving the host CPU of this task.

To further improve throughput, Fujitsu designers have moved away from the traditional serial-in, serial-out approach to the internal FIFO, going instead to a serial-in, parallel-out architecture. Deserializer logic is incorporated into the receive and transmit FIFO blocks, says Chiang, and it converts the serial data stream into an 8-bit parallel format while automatically moving it to the buffer memory.

A final modification is an external input/output bus structure with separate address and data pins. "Going to a separate data and address scheme increases the number of pins from 48 to 80," says Chiang. "The tradeoff is that this bus scheme is easier to implement in most high-performance microprocessor designs, where the data and address buses are also separate."

While the numbers may vary from system to system, Lake says that the result of all these architectural enhancements is an overall 10% to 20% improvement in the host CPU performance. The actual figure will depend on the characteristics of the particular network scheme and bus utilization. □

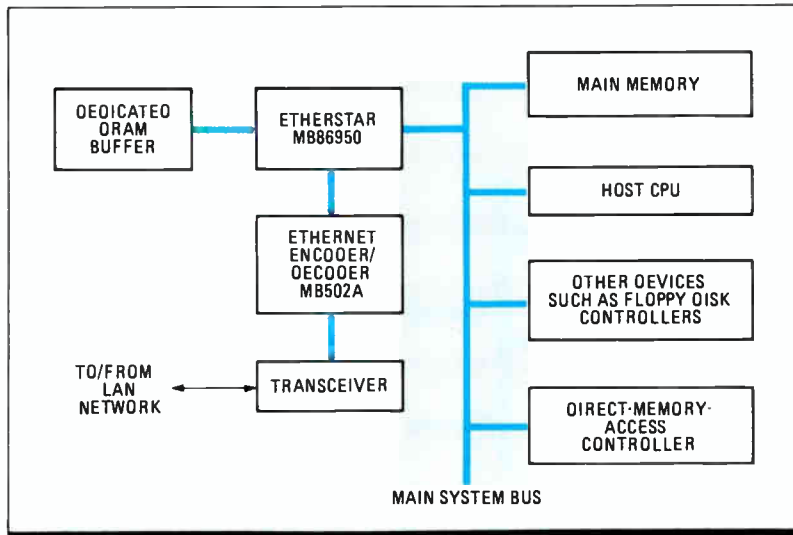

2. LOWER COST. With the Etherstar chip, designers can considerably reduce development time and the cost of local-area networking boards.

For more information, circle 481 on the reader service card.

PHILIPS FINDS A NEW WAY TO BOOST ADC CHIP PERFORMANCE

A three-year development effort at the Philips Research Laboratories in Eindhoven, the Netherlands, has culminated in a family of monolithic 8-bit flash analog-to-digital converters that run rings around other 8-bit competitors. Initially aimed at consumer applications such as digital TV and satellite TV, the converters' performance has proven so good that Philips expects them to find wide use in industrial applications such as radar and sonar gear, test and measuring systems, and image-processing and medical equipment.

The bipolar ADCs, which will be marketed as the TDA/TDE family, are the first such devices to use conversion principles based on folding and interpolation techniques, Philips says. Made in an oxide-isolated process with minimum features of 1.7 μm , they boast parameters that the Dutch company considers far superior to those of competing ADCs, in a design that drastically reduces component count and chip size. For example, Philips has slashed the number of latches from the 255 typically found in an 8-bit ADC to a mere 16. And the number of comparators has been reduced from 255 to 64.

These cuts have enabled the company to squeeze the new ADCs onto a 2-by-3-mm chip (see fig. 1)—about one fifth the size of competing ADCs. What's more, the reduced number of components means a dissipation of less than 300 mW, or one tenth the power consumed by the best available bipolar converters, says senior research scientist Rob van de Grift.

Samples of the new converters, three of which will be available by the end of the year, will start at \$12 apiece. But after production gets into high gear early next year, the Philips devices will undersell competing 8-bit ADCs by up to 50%, promises Wil Adriaans, international product-marketing manager for bipolar ICs at the company's Electronic Component and Materials Division—Elcoma, for short.

1. SQUEEZE. The number of components in Philips's TDA/TDE family of 8-bit flash ADCs is dramatically reduced thanks to its new "folding and interpolation" techniques. The result: a chip only 2 x 3 mm in size.

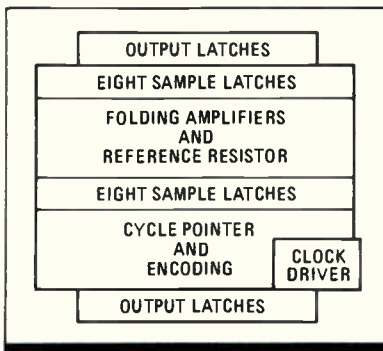

Result: An 8-bit flash-converter family that's more accurate yet has less circuitry

by John Gosch

Two of the first converters out of the pipeline are for industrial uses and the third is for video. They will differ only in temperature range, package type, and output configuration. At the same time, Philips will also have available digital-to-analog converters suitable for systems using the new ADCs; the DACs are being built using standard techniques, which can easily meet the less stringent requirements of digital-to-analog conversion.

The new ADCs sport an accuracy of $\pm 1/4$ least significant bit, which compares with $\pm 1/2$ LSB for the best on the market. Their 8-bit effective resolution is at 8 MHz, which means that up to that input frequency, the converter performs to its full specifications. That spec, too, is better than what the competition achieves, says research scientist Ivo Rutten.

For example, when composite video signals must be digitized, available 8-bit ADCs are often down to 4 or 5 effective bits of resolution at the color-subcarrier frequency: 4.4 MHz for the PAL transmission standard and 3.58 MHz for NTSC. "What's more, [these devices] use lots of power,

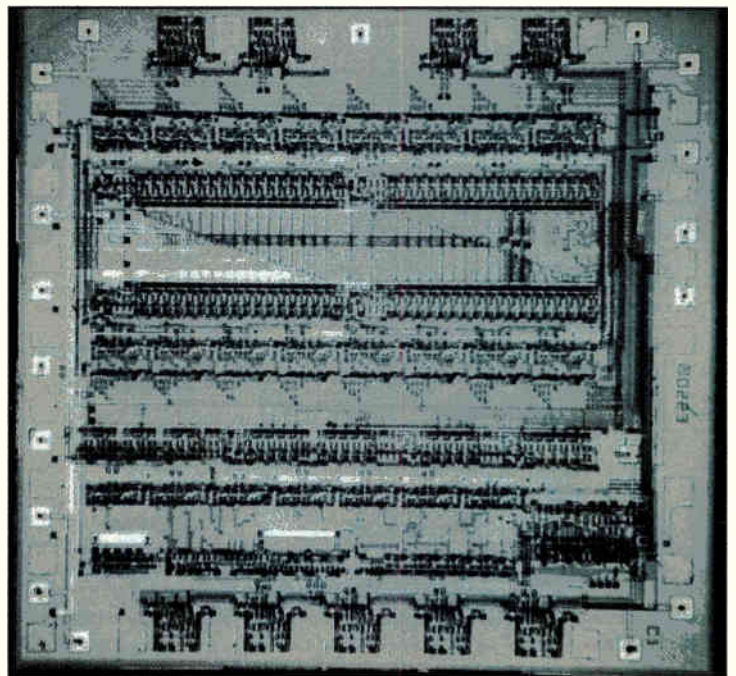

TI TO ROLL OUT ITS FIRST FAMILY OF PRODUCTS MADE WITH BiCMOS

Texas Instruments Inc. is all set to begin shipping a brand new family of interface chips that are notable for two important reasons: These ICs run cooler than any other high-performance interface chips, delivering bipolar speeds at CMOS power levels. More importantly, at least to TI, they're the first family of products from the Dallas chip maker to be made by its flavor of biCMOS, a process that TI is convinced will be its technology driver of the 1990s. It is not alone: although there are relatively few suppliers or customers of biCMOS circuits as yet, chip makers are rushing to jump on the bandwagon.

The devices are made with a new process based on Impact, TI's mainstream high-performance bipolar technology, which has been modified to accept CMOS on the same substrate. The result is Impact CS (see fig. 1). The company has big plans for its biCMOS process: it will use it across the board, building memories, gate arrays, application-specific ICs and even linear circuits.

"The benefits of such a process for interface logic are twofold," says William A. Thompson Jr., strategic marketing manager, Bipolar and CMOS Advanced Logic Department in TI's Semiconductor Group. "A device can simultaneously offer the low-power dissipation of CMOS together with bipolar's superior switching speed and current drive."

That combination is coming just in time for designers now working on the next generation of 32-bit microprocessor systems, which are requiring far more interface chips than ever before. Add to this the accelerating trend toward surface mounting, and it's easy to see that designers who want their boards to stay cool will need low-power, high-speed interface chips.

The SN74BCT interface family will include 8-, 9-, and 10-bit biCMOS bus drivers, memory drivers, latches, registers, and transceivers. Available this month will be four octal bus transceivers and four 8- or 9-bit-parity transceivers. By the end of the year, this family will number 37 devices, and by the end of next year it will grow to 98.

The advantages of biCMOS technology over pure bipolar go far beyond the relative performance of individual drivers or transceivers. A typical 32-bit microprocessor system may contain 10 or more interface devices. Just one bus driver is activated at a time, causing a typical driver to be in the disabled state as much as 90% of the time. When the interface units are pure bipolar, the

The interface ICs offer CMOS's low power and bipolar's switching speed, current drive

by Samuel Weber

disabled drivers are all burning up power, since they remain in the high-impedance state awaiting their turns to be activated.

The picture changes radically when the drivers are biCMOS. When the total current draw of all the disabled biCMOS drivers is compared with that of disabled bipolar drivers, the reduction in supply-current demand of biCMOS technology is overwhelming. In some cases, biCMOS devices can bring about a power savings of almost 100%.

Gate power consumption for the SN74BCT chips remains quite low, even as system operating frequencies increase. For example, power consumption of a biCMOS octal line driver is about one fourth that of the corresponding bipolar device, even across wide operating frequencies, for single-output switching up to 10 MHz. Studies indicate that traditional bus interfaces consume 30% of a system's total current.

System designers are fully aware of the trade-offs involved in using bipolar logic to drive buses. To get the needed drive currents of 48 to 64 mA, power consumption must be high, because bipolar drivers gobble up chunks of supply current even while idling.

BiCMOS technology eliminates this waste of energy by employing different three-state tactics. To reduce power consumption, TI designers added a pair of n-channel CMOS transistors and two gates—inverting and noninverting—to the basic gate to cut current flow to the bipolar transistors in the disabled state (see fig. 2). During normal operation, in the active state, a logic 1 is applied to the enable-control line to turn on CMOS

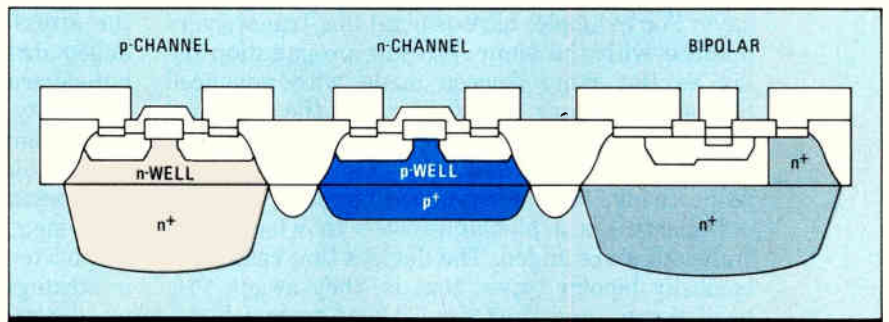

1. COMBINATION. TI's Impact-CS process combines the high speed, high output drive, and TTL I/O levels of bipolar with the lower power consumption of CMOS.

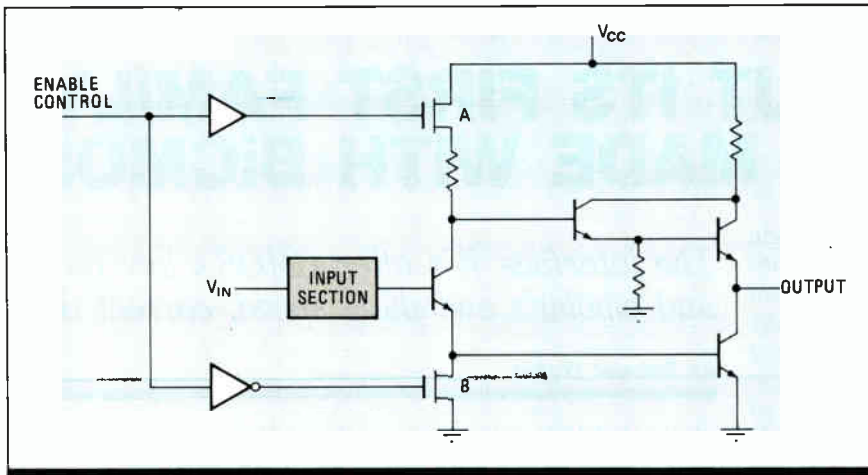

2. POWER SAVER. A pair of n-channel CMOS transistors and two gates—inverting and noninverting—cut current flow to the bipolar transistors in the disabled state.

transistor A and turn off CMOS transistor B.

Current flows from the supply through transistor A and into the base of the bipolar Darlington output stage. Current can also flow into the base of the saturating bipolar transistor, since transistor B is off. In the high-impedance state, the logic level on the enable line is reversed (logic 0). Transistor A is now off and transistor B is on. Neither the Darlington nor the saturating transistor can draw base current, putting the gate in its high-impedance state.

The result is a significant reduction in supply current flowing into the basic gate. A biCMOS driver that draws 30 mA when active draws just 10 mA when disabled. Furthermore, a biCMOS driver draws far less current than its advanced bipolar counterpart, which draws 150 mA whether active or disabled.

Although lowering system power is the primary motivation for making biCMOS interface chips, the devices must maintain high performance levels. TI's SN74BCT family offers speed and drive capabilities equivalent to advanced bipolar logic. Propagation delay times for a complete biCMOS gate function are comparable to those of advanced bipolar technology—3 to 5 ns.

"The major difference is that TI devices draw less than half the current of advanced bipolar drivers in the active mode and less than 10% of the current in the disabled mode," Thompson says. For example, biCMOS octal bus transceivers operate with the same 7-to-8-ns propagation delay as the same devices made with advanced bipolar processes. However, in the disabled (high-impedance) state, the biCMOS chips draw only 15 mA, compared with 115 and 170 mA, respectively, for the advanced bipolar types.

Impact-CS is a bipolar process to which CMOS transistors are added. The devices that result are basically bipolar types; that is, they accept TTL-level inputs, and they drive buses to which TTL devices are connected. But thanks to the CMOS transistors, these chips draw less power in both

the enabled and disabled states.

The bipolar process produces output transistors capable of supplying the 48-to-64-mA currents needed to drive the capacitive inputs of MOS memories and the low-impedance backplanes of high-speed bipolar systems. Another benefit of bipolar output transistors is their lower voltage swing compared with CMOS transistors (0.5 to 3.5 V, compared with ground to V_{cc}). A narrow voltage-swing range reduces the effect of transient-voltage noise on the ground pins.

With the Impact-CS process, bipolar devices can be fabricated with current gains of 100. The typical n-MOS transistor boasts a normalized current gain of $39 \mu\text{A}/\text{V}^2$, while the

figure for the typical p-MOS transistor is $12 \mu\text{A}/\text{V}^2$. Both n-MOS and p-MOS transistors have internal threshold voltages of 1.0 V.

The disable circuit provided by the CMOS transistors consumes considerably less current than a pure bipolar circuit; CMOS devices draw virtually no current in the standby or unlocked state.

Impact-CS is a combination 2.0- μm bipolar and 1.5- μm CMOS process that uses two metal levels for interconnections. The metal pitch on the first level is 4.0 μm , allowing for high-density packing of transistors. Also, reducing the metal pitch allows the transistors to switch faster, because it shortens the interconnections between devices.

The metal pitch can be as small as it is because Impact-CS incorporates a high degree of surface planarization, or smoothing, of its device surface. MOS devices usually contain greater topographical bumps and discontinuities on their surface. The smoother the surface, however, the better the step coverage, which in turn results in more reliable devices.

"Three additional processing steps are required to add CMOS transistors to what is inherently a bipolar process," Thompson says. "Since the bipolar process uses an n-type epitaxial layer, a masking level is needed to counter-dope selected regions to be p-type. The second masking step involves forming moats and isolation regions. In the third step, polysilicon gates for the CMOS transistors are formed." A lightly doped drain was also implemented to suppress hot-electron effects and to improve the future scalability of n-channel transistors.

The simplest implementation of a biCMOS device requires just two CMOS transistors to control the operation of the bipolar output stage. Future implementations of biCMOS technology may incorporate greater numbers of CMOS transistors in strategic locations, particularly as the Impact-CS process moves toward more-complex and more-advanced devices. □

For more information, circle 483 on the reader service card.

is an average of what's around it. Pixels cannot be turned on or off fully, because of crosstalk between them, and that's why the contrast ratio and brightness decrease as the number of lines increases.

Alphasil gets around the crosstalk problems of multiplexing by placing an amorphous-silicon thin-film transistor at every pixel on the screen so that each pixel is individually controlled (see fig. 2). This is a return to direct pixel addressing, but with an active switch right on the screen at each pixel to turn it on or off definitely. The ratio of current draw between on and off achieved by the Alphasil engineers with their thin-film transistor is a whopping 1 million to 1.

In the past, yield problems have frustrated the adoption of active-matrix LCDs. Building a reliable active matrix with a 100% yield over a wide area has proved to be a very difficult task. It is like fabricating a 5-inch wafer with 100,000 or more transistors without a single defect. It is equal to or more of a challenge than wafer-scale integrated circuits.

Building an active-matrix LCD requires the combination of two technologies: thin-film semiconductors and flat-panel liquid crystals. Display-industry research groups have tried many approaches to adding active-matrix diodes and transistors to their LCD displays. Alphasil's approach is the first from the semiconductor industry. "Our manufacturing process is 80% to 85% semiconductor and 15% display [technology], rather than the other way around," says Flasck. "When we set out to develop our manufacturing process, we laid down three rules for ourselves: standard materials, standard production equipment, and standard processing techniques—all so that we would get high yields, because yield is the name of the game," he adds.

Alphasil uses very thin amorphous silicon layers, which can be deposited on ordinary glass. Making the semiconductor part, the thin-film transistor, is very similar to standard wafer fabrication, but to approach 100% yield "we're using a 5-to-7- μm feature size so that we're not pushing the photolithographic state of the art," Flasck says.

"We also chose standard liquid-crystal technology in terms of the alignment layers, the polarizers, the choice of liquid-crystal material—we are using the type of material used in calculator and watch displays—and the sealing techniques, because these standard techniques do give you superb optical quality," says Flasck. Also, in Alphasil's LCD technology, neither the spacing between the plates nor the drive voltages are critical. Alphasil's conservative approach in both the semiconductor and liquid-crystal parts of the process add up to volume manufacturability with high yields.

The Alphasil displays are available in a reflective mode for low-cost, very low-pow-

er applications. In this mode the display uses 0.25 w. However, for those applications requiring high brightness and contrast, Alphasil has developed a backlighting module that can go to very high levels of brightness as more power is applied. Power consumption is just about linear with brightness.

Other manufacturers of backlit LCDs have used incandescent bulbs, fluorescent tubes, or electroluminescent panels. "What we're using is an old neon tube made by a guy who makes beer signs," says Flasck. The thin, 8-mm-diameter neon tube is bent into a serpentine pattern, and a translucent plexiglass plate between the tube and the LCD panel diffuses the light evenly over the display. The Alphasil engineers have developed a proprietary small, lightweight power supply for the neon tube.

And because neon tubes can be made to emit any color of light, Alphasil display users have a wide choice of character colors. Neon tubes are also very efficient—5 to 10 times more efficient than electroluminescent panels, for example. For a 50-fL display it draws 1 w. Flasck estimates that the current power supply can drive the tube to produce up to 200 fL of surface brightness on the display. To go higher, a different power supply will be needed.

Now the engineers are looking at five areas for future development of Alphasil's active-matrix LCD technology. They expect to offer full-color displays next year. In addition, they are working on gray-scale displays; panels measuring 1 ft or more; and resolution higher than the current 128 dots/in. They are also working on lowering the costs by increasing yields and by integrating drive circuits in thin-film silicon on the glass, instead of putting them on a printed circuit board. □

For more information, circle 484 on the reader service card.

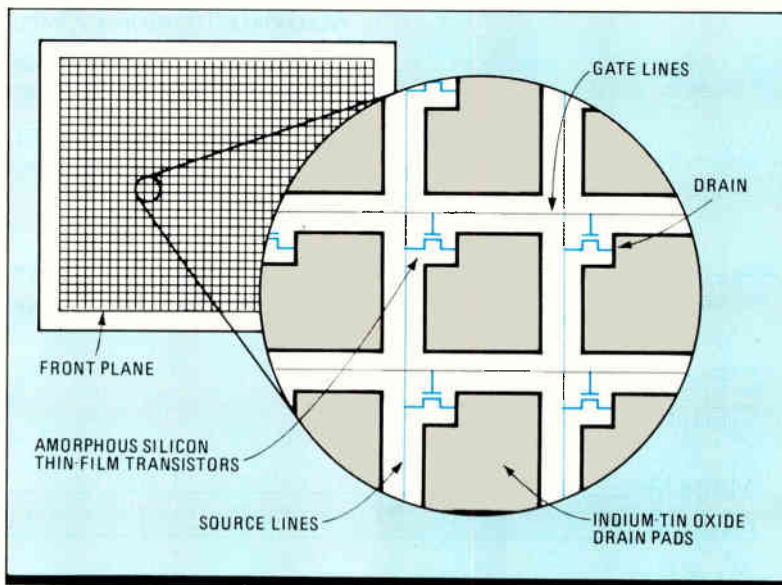

2. MANY TRANSISTORS. Thin-film transistors are fabricated in amorphous silicon at the corners of each pixel on one plate of an LCD panel.

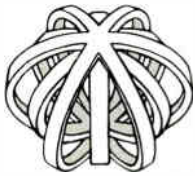

SALON INTERNATIONAL
COMPOSANTS ELECTRONIQUES 87
C O M P O N I C

COME AND DISCOVER THE RAW MATERIAL OF THE NINETIES!

TO DISCOVER THE NEW TECHNOLOGIES, THE NEW PRODUCTS,
THOSE THAT ARE SURE TO BE THE "RAW MATERIAL" OF TOMORROW'S INDUSTRY,
COME TO THE SALON INTERNATIONAL DES COMPOSANTS ÉLECTRONIQUES 87.

THE 5 DAYS OF THE EXHIBITION MEAN 5 DAYS OF MEETINGS,
INFORMATION AND DISCOVERY, 5 DAYS TO PLAN FOR NOW!

PARIS NOVEMBER 16 - 20, 1987

PARC DES EXPOSITIONS PARIS-NORD

ELECTRONIC COMPONENTS AND SUB-ASSEMBLIES:

SEMICONDUCTORS, MICROSYSTEMS, ELECTRONIC TUBES, PASSIVE COMPONENTS,
PRINTED CIRCUITS, HYPERFREQUENCY COMPONENTS, ETC...

ELECTRONIC TESTING AND MEASUREMENT:

ANALYZERS, RECORDERS, TESTS FOR ICs, CARDS AND PASSIVE COMPONENTS ETC...

INTERNATIONAL PANELS:

NEW TRENDS IN INTEGRATED CIRCUITS.

2ND INTERNATIONAL CONFERENCE ON PASSIVE COMPONENTS:

MATERIALS, TECHNOLOGY, IMPLEMENTATION.

PROFESSIONAL BADGES

AT THE SHOW ENTRANCE, REGULAR PRICE: 120 FF.

SPECIAL PRE-REGISTRATION PRICE

UNTIL SEPTEMBER 30, 1987, REDUCED PRICE: 60 FF.

ORGANIZATION S.D.S.A. - 20 RUE HAMELIN - F75116 PARIS - TEL. (33-1) 45.05.13.17 - Tx 630400F

PLEASE SEND ME

PRE-REGISTRATION CARD

EXHIBITION LEAFLET

PRE-CATALOGUE

PROGRAMMES OF PANELS AND CONFERENCES

MR OR MS _____

COMPANY _____

ADDRESS _____

Recent Ministry of International Trade and Industry guidelines and the rising value of the yen have created a \$124 billion market for U.S.-manufactured electronic products, a market the likes of which U.S. electronics manufacturers have never seen.

In fact, Japan's commitment to the development of supercomputers, 1-megabit DRAM (dynamic random access memory) chips, DAT (digital audio tape) recorders, and other advanced equipment, has the demand for electronic devices, computers, and measuring instruments at an all-time high.

And since the market embraces everything

A \$124,000,000,000 market in Japan for U.S.-manufactured electronics.

from consumer and industrial products to electronic components, now's the time for U.S. electronics manufacturers to cash in.

And the way to cash in.

All that takes is an ad that reaches its target audience. That's where **NIKKEI ELECTRONICS** comes in. Because 67% of all **NIKKEI ELECTRONICS** subscribers are high-level electronics engineers involved in research, development, and design, experts who consider **NIKKEI ELECTRONICS** their business information source.

Indeed, for a piece of Japan's \$124 billion electronics market, a piece in **NIKKEI ELECTRONICS** is all the U.S. electronics manufacturer requires. That and a good product is all it takes to cash in.

Exchange rate: US\$1 = ¥145

Media Outline

- Japanese-language publication
- Published biweekly
- Available by subscription only
- Circulation: 53,062 (Japan ABC)

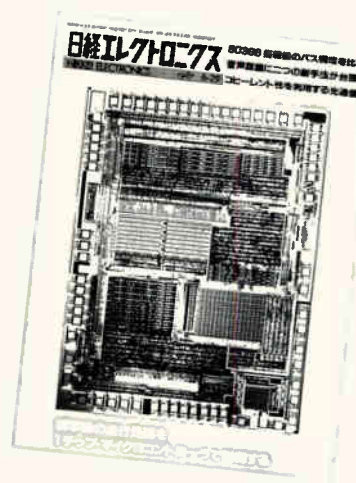

Affiliated Publications

Electronics, Data Communications and Aviation Week & Space Technology

NIKKEI ELECTRONICS

NIKKEI ELECTRONICS advertisements are handled by sales staff for **Electronics** magazine.

Western Sales Manager: Paul C. Mazzacano, McGraw-Hill/Electronics, 951 Mariner's Island Blvd., 3rd Floor, San Mateo, CA 94404, U.S.A. Tel: 415-349-4100

Costa Mesa Office: Fran Cowen, District Manager, McGraw-Hill/Electronics, 3001 Red Hill Blvd., Suite 222, Costa Mesa, CA 92626, U.S.A. Tel: 714-557-6292

Los Angeles Office: Chuck Crowe, District Manager, McGraw-Hill/Electronics, 3333 Wilshire Blvd., Los Angeles, CA 90010, U.S.A. Tel: 213-480-5210

Englewood Office: Harry Doyle, District Manager, McGraw-Hill/Electronics, 7400 S. Alton Court, Suite 111, Englewood, CO 80112, U.S.A. Tel: 303-740-4633

San Mateo Office: Jeff Hoopes/District Manager or Rich Bastas/Regional Sales Manager, McGraw-Hill/Electronics, 951 Mariner's Island Blvd., 3rd Floor, San Mateo, CA 94404, U.S.A. Tel: 415-349-4100

Stamford Office: Al Liedel, District Manager, McGraw-Hill/Electronics, 777 Long Ridge Road, Bldg. A, Stamford, CT 06902, U.S.A. Tel: 203-968-7115

Tokyo Office: Tatsuo Ito, International Advertising Sales Manager, 1-14-6, Uchikanda, Chiyoda-ku, Tokyo 101, Japan
Tel: (03) 233-8311 Telex: J29902 NKMCGRW

ing to be so much faster that the chances the bridge will encounter any kinds of collisions or congestion is much, much smaller," he says.

The 50-Mbit/s EN603 costs \$13,500 in single units, going up against lower-performance 10-Mbit/s bridges priced from about \$8,000 to \$11,500, says Gust. Network Systems is also offering a 10-Mbit/s bridge of its own, the EN601, which will use a 10-Mbit/s version of Hyperchannel as a backbone. It is priced at \$8,500. The third member of the family is the EN602, which for \$12,500 offers Ethernet linking via long-distance transmission media such as optical fiber, T1 telephone lines, microwave links, and satellite channels.

MIXED PROTOCOLS. Unlike the TCP/IP-based router product, the EN60X bridge family can handle a mixture of protocol traffic, including DECnet, XNS, and TCP/IP. The units employ a mix of TTL and CMOS chips, including three Motorola 6809 processors, all housed in a 5.5-by-16-by-17-in. cabinet. The bridges require no special software. The EN601 and EN602 are available now, and the EN603 is set for production delivery in the first quarter of 1988.

The introduction of router and bridge products compatible with networking standards other than Hyperchannel is a first for 13-year-old Network Systems [*Electronics*, Aug. 6, 1987, p. 22] and begins a commitment to support all widely used standards based on the Open Systems Interconnection model.

Hyperchannel products that tie in other standards will be introduced later, Gust says. "We're committed to providing the highest-performance work-station-to-mainframe interconnection in the industry, and doing that with industry standards."

—Wesley R. Iversen

Network Systems Corp., 7600 Boone Ave. North, Minneapolis, Minn. 55428.
Phone (612) 424-4888 [Circle 340]

SUPERMINI I/O RUNS 20 TIMES FASTER

Multiple input/output processors that are capable of handling up to 12 Mbytes/s boost performance twenty-fold in Floating Point Systems Inc.'s new P64/210 I/O subsystem. The predecessor subsystem was limiting the performance of the company's M64 Series of 64-bit minisupercomputers.

Because many of the Beaverton, Ore., company's minisupercomputers are used with Digital Equipment Corp. VAX superminis, the P64/210 is tailored to the VAX Unibus environment. It allows the M64 and VAX machines to share disk

Bio Medical Mfg
Electronics Personnel — Crossover to the exciting, stable environment of Medical Mfg. Design, Q.A./Q.C., Engineers, Prod-Supervisor — Etc. Forward your resume to Chuck Perry-Perry's Personnel, 4900 Bayou Blvd., #130, Pensacola, FL 32503 or call 904-479-1202.

POSITIONS WANTED

Electronic Engr, for hire. Microprocessor based designs, controls, telecom. Contract or per diem. Mr. Barry Masel. 718-476-1516.

SPECIAL SERVICES

Overseas — 75 Countries — Interviewing now. All Fields — for Conn. interview. Send resume: Global Services, (O) Clinton, CT 06413. Transportation not paid to Connecticut.

Confidential Design, prototype, short production run services. CAD PCB layout. Micro-P Control Systems, Interactive Video, Smart House, Telecom. Communications Systems Labs, 23 S. Kam Hwy, #206, Wahiawa, HI 96786 Telex 6502990026MCI or Toll-Free 800-521-1364.

Microcomputer Solutions — Systems Analysis, Database design, telecom, public access (VAN) Programming, expert system development. All microsystems. David Edwards (718) 768-0098.

Microcomputer System Design and Support for Intel based systems. Consulting in software and hardware, specializing in real time process control system designs. LJM Associates, Lee Mandell 818-347-2695.

Electronic Assembly & Production. Low South of the Border rates with U.S. production and quality control. Engineering assistance available. Contact Mr. G. Whelpley (602) 831-0575, Zephyr, Inc., 5225 S. McClintock, Suite B, Tempe, AZ 85283.

Electronic Designer that can convert your design problems into working solutions. Flexible fees. 916-721-3020.

INVENTIONS WANTED

Inventions, ideas, new products wanted! Industry presentation / national exposition. Call 1-800-288-IDEA. Canada, 1-800-528-6060. X831.

TO ANSWER BOX NUMBER ADS: Address separate envelopes (smaller than 11" x 5") for each reply to:

Box Number (As indicated)
Classified Advertising Department
Electronics
Post Office Box 900, NY 10108

COMPUTER MARKET PLACE

100Mhz Logic Analyzer Card

For PC/XT, PC/AT Monochrome & Color Card Systems

\$1199

- 24 Channels at 25KHz - 25 MHz
- 6 Channels at 100 MHz
- Internal Clock up to 100MHz
- External Clock up to 25MHz
- Threshold Voltage TTL, ECL, or variable from -10 to +10v
- Totally Software Controlled
- All Software Included



PAL/EPROM Programmer Card

For PC/XT/AT Systems



\$399

- Programs All 20 and 24 Pin MMI, NS, TI PALS
- Programs Eproms from 2716 to 27512 and 27512A
- Software Functions Include: Read, Write, Verify, Protect, Edit, Print, and File Save and Load of Program.
- All Software Included

CALL NOW FOR ORDERS AND TECHNICAL INFORMATION (201) 994-6669
Link Computer Graphics, Inc. 4 Sparrow Dr., Livingston, NJ 07039

SPICE up your PC

Z/SPICE professional circuit simulation Full version \$300 Student version \$79

ZTEC box 737, college place, wa 99324 (509)-529-7025

SPICE Circuit Simulation
8/16/32 bit PC's
PC too slow? Need > Maxmem?
Northern Valley Software
28327 Rothrock Dr. R.P.V., CA.
(213) 541-3677 90274

RELIABILITY PREDICTION SOFTWARE

ARE YOUR PRODUCTS RELIABLE?

RelCalc 2 automates MIL-HOBK-217D on your IBM PC!

Verv easy to use. Demo package \$25.

T-CUBED SYSTEMS
(818) 991-0057

31220 La Baya Drive, # 110
Westlake Village, CA 91362

HOT LINE

To place your
Computer Software Ad

Call Ilene Fader
212-512-2984

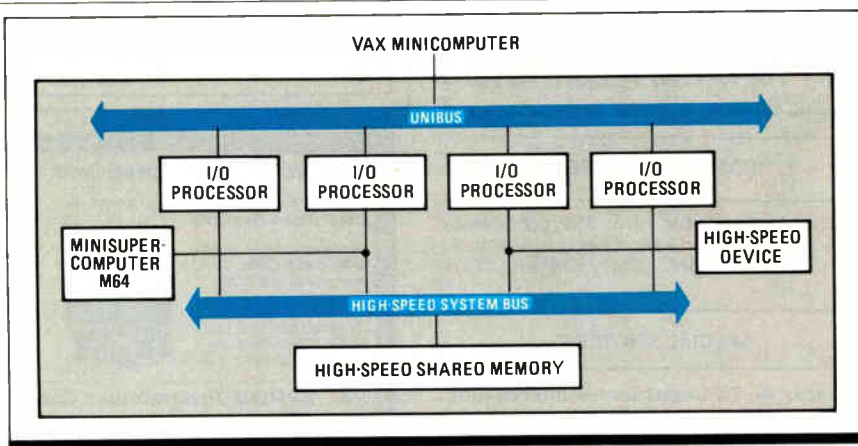

DUAL BUS. Parallel buses link VAX computers and M64 minisupercomputer environments.

files and other I/O peripherals. The P64/210's Unibus I/O processors handle data transfers at a 3-Mbyte/s rate over Unibus.

The P64/210 can also connect high-speed non-Unibus peripheral devices to minisupercomputer systems with its Openbus I/O processors, which run at a 12-Mbyte/s rate. This means system integrators can configure M64-series machines into powerful, complex systems using multiple M64s, array processors, VAXes, high-speed disks, high-density tapes, and high-speed analog-to-digital

converters. Flexibility of the I/O subsystem is further enhanced by up to 96 Mbytes of buffer memory. It can be accessed by the I/O processors at any speed up to the system bus's 24-Mbyte/s limit.

The P64/210 subsystem has three separate 32-bit buses to allow the system bus to handle concurrent transfers of 8-, 16-, or 32-bit data. The parallel I/O subsystem also has a built-in Unibus that links its multiple I/O processors together and to VAX machines.

The P64/210 offers full compatibility

with the VAX VMS operating-system software, providing support for the VAX Files-11 record-management protocol. This transparent coupling with the VMS operating environment means that a VAX and an M64 minisupercomputer can share files on the same high-performance disk drive.

The P64/210 targets real-time applications, such as aerospace and defense simulation, image and signal processing, seismic analysis, and graphics post-processing jobs.

Floating Point Systems will begin shipping the P64/210 in October, at a price starting under \$100,000.

—Tom Manuel

Floating Point Systems Inc., 3601 S.W. Murray Blvd., Beaverton, Ore. 97005. Phone (503) 641-3151 [Circle 341]

CARD FOR PC DRAWS 10 MILLION PIXELS/S

The Model 1104 graphics coprocessor from Metheus Corp. occupies only half a slot in an IBM Corp. Personal Computer or compatible, but it can draw 10 million pixels/s with 1,024-by-768-pixel resolution on up to four bit planes.

The card achieves performance double that of standard graphics cards by implementing 500 Kbytes of video random-

Color by

Watch Apple's new Macintosh II do for color computing what the original Macintosh did for black & white. Our RAMDAC enables Macintosh II to display some of the finest quality graphics available in a personal computer.

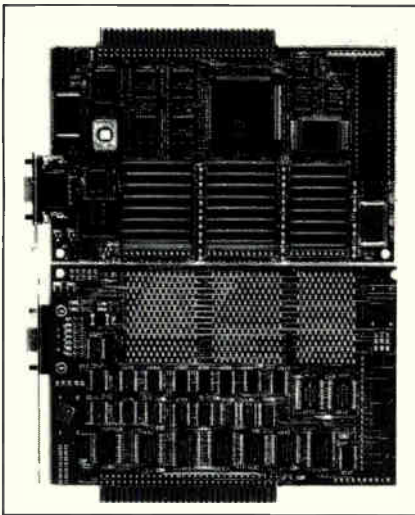

access memory and VLSI circuitry. The compact size of the 1104 represents a combination of high-level chip integration and surface-mount technology.

The 1104 is fully compatible with the company's 1100-series software drivers and supports a wide range of the most popular computer-aided design software packages. The card is available now for \$1,395.

Methus Corp., 5510 N.E. Elam Pkwy., Hillsboro, Ore. 97214.
Phone (503) 640-8000 [Circle 346]

MICROSOFT MOUSE HAS CAD SOFTWARE

The newest version of the Microsoft Mouse features enhanced mechanical design, three versions of high-quality graphics support—including a computer-aided-design version—and compatibility with IBM Corp.'s Personal Computer and Personal System/2.

A key design improvement moves the center of balance from the user's palm to his fingertips for improved control.

Three different software packages are offered. The first costs \$150 and is built around Microsoft Paintbrush, a color painting program developed by ZSoft of Marietta, Ga. The second, costing \$200, is bundled with PC Paintbrush for Microsoft Windows, the key difference being that it works within the Windows environment.

The third version, at \$175, targets the low-end CAD market with EasyCAD from Evolution Computing, Tempe,



Ariz. All three versions are available now.

Microsoft Corp., 16011 N.E. 36th Way, Redmond, Wash. 98073.

Phone (206) 882-8080 [Circle 347]

HP'S 80386 VECTRAS TRIPLE PERFORMANCE

Hewlett-Packard Co.'s Vectra RS/16 and RS/20 personal computers integrate Intel Corp.'s 80386 microprocessor to get three and four times the performance of the original Vectras. Both floor-standing units, the RS/16 runs at 16 MHz and the RS/20 at 20 MHz.

The RS/16 includes 16 Mbytes of main memory and comes with a 40-Mbyte hard-disk drive. The RS/20 offers 20 Mbytes of main memory and comes with either a 103-, 155-, or 310-Mbyte hard-disk drive. The drives have an industry-standard ESDI interface and feature an average access time of 17 ms.

The memory in both systems can be expanded by 16 Mbytes by adding modules to the processor board. Both computers will be available in the first quarter of 1988. The RS/16 costs \$6,495; the RS/20 ranges from \$7,495 to \$11,995.

Hewlett-Packard Co., 3000 Hanover St., Palo Alto, Calif. 94304.
Phone (415) 857-1501 [Circle 345]

Brooktree®



Macintosh II. 640x480 resolution, displays 256 colors simultaneously from a 16.8 million color palette. Bt453. Triple 8-bit 40 MHz RAMDAC with 256 color lookup table. Monolithic CMOS.

Brooktree Corporation, 9950 Barnes Canyon Road, San Diego, California 92121. 1-800-VIDEO IC or 1-800-422-9040, in California.



Apple® and Macintosh™ II are trademarks of Apple Computer Corporation.

New and Current
Products Presented
by the Manufacturer

Product Showcase

To advertise call Carol Helton, Advertising Manager (212) 512-2143

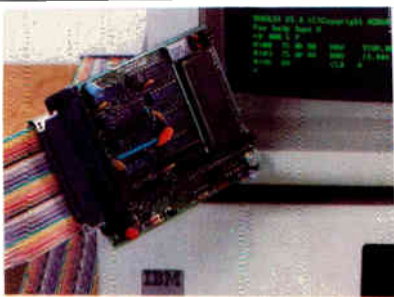

EMULATOR for 8051, 8052, 8752 8031, 8032, 80C452, 80C152

IBM PC plug in boards • 16MHz Real Time Emulation • 64K emulation memory • Advanced trace capabilities • Symbolic debugging Supports PL/M-51 and C51 • Price: 8031 Emulator \$1790, Trace \$1495. FREE DEMO DISK CALL NOHAU CORP. 408/866-1820 51 E. Campbell Ave. Campbell, CA 95008

NOHAU CORP.

CIRCLE 211



6800-FAMILY DEVELOPMENT SOFTWARE

Our C Compilers feature a complete implementation (excluding bit fields) of the language as described by Kernigan & Ritchie and yields 30-70% shorter code than other compilers. Our Motorola-compatible Assemblers feature macros and conditional assembly. Linker and Terminal Emulator are included. Wintek Corporation, 1801 South St., Lafayette, IN 47904. (800) 742-6809 or (317) 742-8428.

WINTEK CORP.

CIRCLE 260

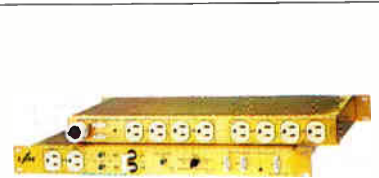

Z-LINE® POWER DISTRIBUTION & CONTROL SYSTEMS

A/C POWER DISTRIBUTION AND CONTROL SYSTEM MODEL TPC 115-10A MTD™, SPACE SAVER DESIGN FOR CLEAN POWER UP WITH MULTIPLE TIME DELAY™ PREVENTS HIGH CURRENT INRUSH BY SEQUENCING YOUR COMPUTERS POWER UP. FILTERS A/C LINE VOLTAGE AND PROTECTS YOUR SYSTEM FROM VOLTAGE SPIKES AND SURGES. PRICED FROM \$422 TO \$296. TO ORDER CALL (714) 540-4229 FAX (714) 641-9062 OR WRITE PULIZZI ENGINEERING, INC., 3260 S. SUSAN ST., SANTA ANA, CA 92704-6865

PULIZZI
ENGINEERING, INC.

CIRCLE 222



Glide Through PCB Design.

TangoPCB™ Create the toughest board designs with powerful layout software that's a snap to use. Function-rich Tango-PCB supports eight layers, 1 mil grid, OrCAD™ or Schema™ netlist input, print/plot/photoplot output, and more.

TangoRoute™ Get impressive completion rates and remarkable speed with Tango-Route, a four layer, eleven pass autorouter. **Just \$495 each.**

For IBM PC, XT/AT/PS2. Compare features and you'll buy Tango. Or try full-function Demo Package, just \$10. Order toll-free: 800 433-7801. VISA/MC. Thirty-day money back guarantee.

CIRCLE 243

ACCEL Technologies, 7358 Trade St., San Diego, CA 92121

YOUR AD HERE

PRODUCT SHOWCASE GETS RESULTS

Use this section to boost sales, introduce new products, test new markets, offer free samples, distribute catalogs and product information, and generate new leads. Get full color impact at now extra cost and a high response at a low cost per inquiry. *Electronics* readers turn to the Product Showcase in every issue to make quick decisions on what to buy. Your ad will be read by more than 131,900 key design engineers worldwide.

ELECTRONICS

CIRCLE 275



NEVER BEFORE AVAILABLE

- PIN-GRID-ARRAY TEST CLIPS
- LCC/PLCC TO DIP ADAPTERS
- DIP (LOW PROFILE) TEST CLIPS
- LCC/PLCC TEST CLIPS
- DIP TO PGA ADAPTERS
- PGA INSERT/EXTRACT TOOLS
- PGA BREADBOARD ADAPTERS

Emulation Technology Inc.
422 Ives Terrace, Sunnyvale, CA 94087
415/960-0652 Telex 184817 Attn #EMTEC

EMULATION TECHNOLOGY CIRCLE 249

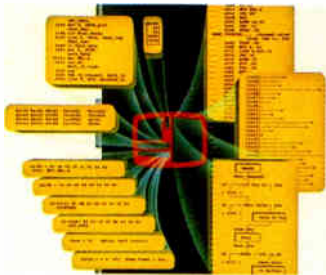

dICE-51: INCIRCUIT DEBUGGING FOR ONLY \$795

The CY-8051 in-circuit element replaces the 8051 and communicates with your IBM-PC over COM1. The powerful dynamic user interface provides source code and symbolic debugging with easy access to all 8051 spaces. Live keyboard, Global Symbol Monitor, 'C' support. Histogram generated during reduced speed execution. Lowest cost, most powerful 8051 design support. Mil spec and CMOS versions available.

Cybernetic Micro Systems
 Box 3000 • San Gregorio, CA 94074 • USA
 (415) 726-3000 • Telex: 910-350-5842

CIRCLE 226



GP-IB, HP-IB CONTROL FOR YOUR PC, PC/AT and IBM PERSONAL SYSTEM/2™

- Control instruments, plotters, and printers.
- Supports BASIC, C, FORTRAN and Pascal.
- Fast and easy to use. Thousands sold.
- Software library. Risk free guarantee.

cec Capital Equipment Corp.
 99 South Bedford St.
 Burlington, MA. 01803

FREE demo disk. Call (617) 273-1818

CIRCLE 241

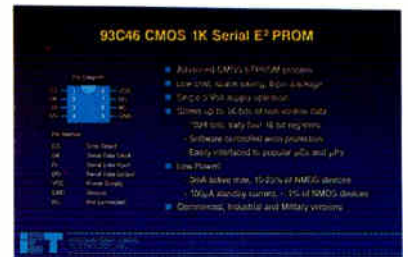

1024-BIT SERIAL CMOS EEPROM

The 93C46 is a CMOS EEPROM configured as a 1K bit serial access, 64x16, 5 volt only. The device draws only 3 milliamps max. active and 100 microamps in standby. For applications requiring up to 10,000 erase/wire cycles per register. The 93C46 is in stock at all Marshall Industries locations. Pricing is \$1.66 each for 100 pieces. International CMOS Technology, Inc., 2125 Lundy Av., San Jose, CA 408/434-0678.

INTERNATIONAL CMOS TECH.

CIRCLE 217

Analog Circuit Simulation

A full featured SPICE based simulator runs on the IBM PC with interactive input and output

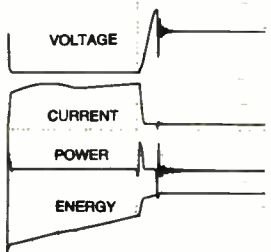

These waveforms show an IS_SPICE analysis of a power supply snubber. Intu_Scope was used for display and computation of power and energy. The output shown used an Intu_Scope plotter utility

PRE_SPICE, \$200.00: Interactive control, Monte Carlo Analysis, Optimization, libraries and parameter evaluation.
IS_SPICE, \$95.00: Performs AC, DC and Transient analysis.
Intu_Scope, \$250.00: Displays, manipulates and plots data.
 Programs are not copy protected, come with a 30 day money back guarantee and require PC with 640K RAM, fixed disk, coprocessor and CGA or EGA or Hercules graphics.



P.O. BOX 6607
 San Pedro, CA 90734-6607
 Tele: (213) 833-0710

INTUSOFT

CIRCLE 229

IEEE488

Technology that hits the mark

- For IBM PC/XT/AT/IC/RT6150 and all other compatible computers
- For PHILIPS PC-YES
- HP commands (enter, clear etc.) implemented
- SRQ/ASYST compatible
- 64 kByte memory capacity
- DMA and INTERRUPT can be activated by simple commands
- HELP functions, SYNTAX monitoring in clear text
- BASIC, BASIC(compiled), TURBO-BASIC, (TURBO-) PASCAL, MODULA-2, FORTRAN, C, ASSEMBLER

DEALER + OEM WELCOME

CIRCLE 235



Irwin GmbH
 Neuenburger Allee 43
 53000 Köln 41
 West Germany
 Phone: +49 221 4339059
 Telex: 78 37 223 42 37 gmbh
 FAX: 49 221 4918 11

YOUR AD HERE

PRODUCT SHOWCASE GETS RESULTS

Use this section to boost sales, introduce new products, test new markets, offer free samples, distribute catalogs and product information, and generate new leads. Get full color impact at now extra cost and a high response at a low cost per inquiry. *Electronics'* readers turn to the Product Showcase in every issue to make quick decisions on what to buy. Your ad will be read by more than 131,000 key design engineers worldwide.

ELECTRONICS

CIRCLE 275

Product Showcase Order Form

The best value for your advertising dollars. For a 1/9 page ad, here's all you have to do:

- 1) Send a 35mm color transparency of your product. (Black and white glossy photos are also accepted.)
- 2) Include 10 lines of typed copy, no more than 43 characters to a line. (Include spaces between words and punctuation in your character count.)
- 3) Write a headline of 32 characters or less.
- 4) We do all the rest. No production charges.
- 5) We also accept camera-ready art. Ad size: 2 1/4" wide x 3 1/8" deep.

1x	\$750	7x	\$715	18x	\$600
3x	\$735	12x	\$645	25x	\$570

Send this form with material to: Carol Helton, *Electronics* magazine, Product Showcase Advertising Manager, 1221 Avenue of the Americas, 42nd Floor, New York, NY 10020. (212) 512-2143

Name _____

Title _____

Company _____

Address _____

city _____

State _____ Zip _____

Phone _____

Electronics

Stop. Look. Listen.

Taking the time to assess your present position and future goals is important. If your position and goals are not moving in the same direction, it is even more important to consider a new environment.

In the Upper Mojave Desert town of Ridgecrest, California is Comarco's Weapons Support Division. Discover the rewards of living in an atmosphere of natural beauty while exploring a challenging new career. You'll become an integral part of our team, testing and evaluating sophisticated weapons systems in support of the U.S. Naval Weapons Center.

If you are a Degreed Engineer with 2-15 years experience in weapons systems or related fields, consider our openings. You'll find our environment offers stimulation for the senses, both intellectually and aesthetically.

RELIABILITY ENGINEERS	SENIOR DRAFTERS DESIGN
EXPLOSIVE ENGINEERS	ENGINEERING WRITER
PROPULSION SYSTEM ENGINEERS	(Specifications)
QUALITY ASSURANCE ENGINEERS	SOLDERING TECHNOLOGY INSTRUCTORS
	DRAFTING CHECKERS

You'll also enjoy an excellent climate, affordable housing, and an exciting variety of recreational activities, as we are only 150 miles northeast of Los Angeles and three hours from Mammoth Ski Resort.

We are inviting you to take the time to stop, look, and listen, because your senses and career both deserve the stimulation. Please submit your resume with salary history in confidence to: **Comarco Weapons Support Division, 1201 N. China Lake Blvd., Dept. EL-1087, Ridgecrest, CA 93555, Attention: Employee Relations Manager.**



U.S. Citizenship Required.
An Equal Opportunity Employer
M/F/H/V.



School of American Ballet student performance. Merrill Ashley. Copyright Martha Scope 1967

Thanks to the Library, American dance has taken great leaps forward.

American dance is more popular than ever, and one of the reasons is The New York Public Library's Dance Collection.

Choreographer Eliot Feld says the Library at Lincoln Center is "as vital a workroom as my studio." Agnes de Mille says, "the revival of any work is dependent on access to the Library's Dance Collection."

And they're not the only ones. For dancers and choreographers everywhere, over 37,000 volumes, 250,000 photographs, and an enormous film archive have been essential elements in the renaissance of American dance.

That's just one way The New York Public Library's resources serve us. The Library offers plays and puppet shows for children, programs for the elderly and disabled, extensive foreign language and ethnic collections, and scientific journals vital to the business community.

Again and again, the Library enriches our lives.



The New York Public Library
WHERE THE FUTURE IS
AN OPEN BOOK

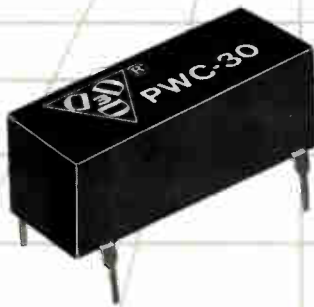
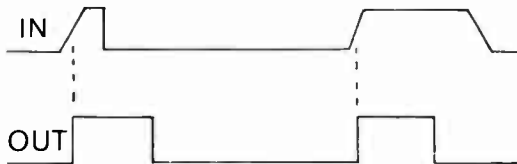

PULSE-WIDTH CONTROLLER

- Exact Pulse-width Control
- Fast & Clean Pulses
- Rising-edge Triggered
- Auto Insertable
- 5 NS to 500 NS Pulse-width Control



385 Lakeview Avenue • Clifton, New Jersey 07011 • (201) 772-1106

Circle 127 on reader service card

Advertisers Index

Accel Technology	101	‡	LTX Corporation	70, 71
Advanced Interconnections	75		Matrox Electronic Systems Ltd.	4th C
AMP Inc.	68, 69	‡	Measurement Systems Inc.	84
Analog Solutions	37		Mepco Centralab Inc.	87
Ando Electric Co. Ltd.	42	*	Micro Tek	50VV
AT&T Technology	28, 29		Mitel Corporation	2
Bayer AG	50L, 50M	*	Mitsubishi Electric Europe GmbH	50 O
Bertan Associates	44	*	Murata Mfg. Co. Ltd.	41
Brooktree Corporation	98, 99		National Semiconductor	2nd C, 1
Capital Equipment	102		Nicolet Test Instrument Division	30
Cherry Electrical Products	11		Nikkei Electronics	95
‡ Cinde Costa Rican Investment	19		Nohau Corporation	101
* Comadus SA	75		Noise Laboratory Co. Ltd.	23
Cybernetic Micro Systems	102	‡	P-Cad	49
* Cypress Semiconductor	50GG	*	Philips Elcoma	50RR, 50SS
■ Data Delay Devices	104		Philips T&M	49, 50 OO, 70, 71
Data Translation	24		Pulizzi Engineering Inc.	101
* DDC International	50TT	*	Rohde & Schwarz	50Y
* Dr. Joh. Heidenhain	50H, 50I	■	SDSA	92
Edge Computer Corp.	54	*	Siemens	50 II, 50JJ, 50KK, 50Q, 50D, 50E
Eltec Elektronik GmbH	50	‡	Siemens	42
Emulation Technology	101		Standard Telephone & Radio	52, 53
* Enertec Schlumberger	19		State of The Art	84
John Fluke Manufacturing Inc.	35, 45	■	Teledyne Relays	88
Force Computers Inc.	13, 14, 15	*	Teradyne Inc.	38, 39
Forth Inc.	9		Toshiba W. Germany	50CC, 50G
* Fujitsu Ltd.	50UU	*	UMC	3rd C
* Harting Elektronik GmbH	50U	*	Vaccumschmelze	50AA
Hewlett Packard Co.	16	*	Varta Batteries AG	50B
Hi Level Technology	20	*	Wandel & Goltermann	50K, 50EE
Ines GmbH	102		Wintek Corp.	101
Intel Corporation	6, 7		Zax Corporation	76
International CMOS Technology	102		Zehntel	41
Intusoft	102			
10 Tech	10			
* Iskra Commerce	50LL			
ITT Cannon	27			
* Krupp Widia	50Q			
* Leybold Heraeus	50S			

Classified and employment advertising

Link Computer Graphics Inc.	97
Northern Valley Software	97
Perry's Personnel	97
T-Cubed Systems	97
ZTEC	97
Career Opportunity	
Comarco	104
Emerson Electric	103

For more information of complete product line see advertisement in the latest Electronics Buyers Guide
 * Advertisers in Electronics International
 ‡ Advertisers in Electronics domestic edition

Advertising Sales Staff

Atlanta, Ga. 30319: Joseph Milroy
 4170 Ashford-Dunwoody Road N.E.
 [404] 252-0626

Boston, Mass. 02116:
 M. E. "Casey" McKibben, Jr.
 575 Boylston St.
 [617] 262-1160
 633-0155 Mobil Phone

Chicago, Ill. 60611: Alison Smith
 [312] 751-3738
 645 North Michigan Avenue

Cleveland, Ohio 44113:
 [216] 496-3800

Costa Mesa, Calif. 92626: Fran Cowen
 3001 Red Hill Ave. Bldg. #1 Suite 222
 [714] 557-6292

Dallas, Texas 75251: Harry B. Doyle, Jr.
 8111 LBJ Freeway, Suite 350
 [214] 644-1111

Englewood, Co. 80112: Harry B. Doyle, Jr.
 7400 South Alton Court Suite 111
 [303] 740-4633

Houston, Texas 77040: Harry B. Doyle, Jr.
 7600 West Tidwell, Suite 500
 [713] 462-0757

Los Angeles, Calif. 90010: Chuck Crowe
 3333 Wilshire Blvd.
 [213] 480-5210

New York, N.Y. 10020
 Matthew T. Reseska [212] 512-3617
 John Gallie [212] 512-4420
 Stan Tessler [212] 512-2788
 1221 Avenue of the Americas

Stamford, Ct. 06902
 Albert J. Liedel
 777 Long Ridge Road. Bldg. A
 [203] 968-7115

San Mateo, Ca 94404:
 Rich Bastas, Jeffrey C. Hoopes, Paul Mazzacano
 3rd Floor
 951 Mariner's Island Blvd.
 [415] 349-4100

Philadelphia, Pa. 19102: Joseph Milroy
 Three Parkway, [215] 496-3800

Pittsburgh, Pa. 15222: Joseph Milroy
 Suite 215, 6 Gateway Center, [215] 496-3800

Southfield, Michigan 48075:
 4000 Town Center, Suite 770, Tower 2
 [313] 352-9760

San Francisco, Calif. 94111:
 Rich Bastas, Jeffrey C. Hoopes, Paul Mazzacano
 425 Battery Street
 [415] 362-4600

Frankfurt/Main: Fritz Krusebecker, Dieter Rothenbach
 19 Liebigstrasse, Germany
 Tel: 72-01-81

Milan: Manuela Capuano
 1 via Baracchini, Italy
 Tel: 86-90-656

Paris: Jean - Christian Acis, Alain Faure
 128 Faubourg Saint Honore, 75008 Paris, France
 Tel: [1] 42-89-0381

Scandinavia: Andrew Karnig
 Finnbodavagen
 S-131 31 Nacka
 Sweden
 Tel. 46-8-440005
 Telex: 17951 AKA S

Tokyo: Hirokazu Morita
 McGraw-Hill Publications Overseas Corporation,
 Kasumigaseki Building 3-2-5, chome,
 Kasumigaseki, Chiyoda-Ku, Tokyo, 100 Japan
 [581] 9811

United Kingdom: Art Scheffer
 34 Dover Street, London W1
 Tel: 01-493-1451

Business Department

David M. Yake
 Business Manager
 [212] 512-2627

Daniel McLaughlin
 Director of Circulation
 [212] 512-6598

Roseann Lehmann
 Office Administrator
 [212] 512-3469

Frances M. Vallone
 Manager, Reader/Sales Services
 [212] 512-6058

Ann Strignano
 Billing Specialist
 [212] 512-2589

Thomas M. Egan
 Production Director
 [212] 512-3140

Carol Gallagher
 Production Manager
 [212] 512-2045

Evelyn Dillon
 Production Manager Related Products
 [212] 512-2044
 Postcards/Product Showcase
 [212] 512-2143

Classified Advertising

[212] 512-2556

Recruitment Advertising

Rosemarie Caruso
 [212] 512-2787
Subscription Sales
 [201] 988-3258

If the card below has already been used, you may obtain the needed information by writing directly to the manufacturer, or by sending your name and address,

plus the Reader Service card number and issue date, to Electronics Reader Service Department, P.O. Box 8565, Boulder, Colorado 80329-8565.

Electronics

October 1, 1987 This Reader Service Card expires January 1, 1988

Name _____ Title _____

Phone _____ Company _____

Street address (company | | or home | | check one) _____

City _____ State _____ Zip _____

Signature _____ Date _____

Was this magazine personally addressed to you? Yes No 5 Source of Inquiry Domestic

Industry classification (check one)

- | | | |
|---|--|---|
| <input type="checkbox"/> A. Computers Computer Systems and Equipment | <input type="checkbox"/> F. Test and Measurement Equipment | <input type="checkbox"/> J. Research & Development |
| <input type="checkbox"/> B. Communications Communications Systems and Equipment | <input type="checkbox"/> G. Consumer Products | <input type="checkbox"/> K. Educational 2-4 Year College University |
| <input type="checkbox"/> C. Military/Space Systems and Equipment | <input type="checkbox"/> H. Medical Systems and Equipment | <input type="checkbox"/> L. Other _____ |
| <input type="checkbox"/> D. Industrial Systems Controls and Equipment | <input type="checkbox"/> I. Software | Please specify |
| <input type="checkbox"/> E. Electronics Subassemblies Components and Materials | | |

Your principal job responsibility (check one)

- | | | |
|--|--|--|
| <input type="checkbox"/> A. Corporate Operating and General Management | <input type="checkbox"/> C. Engineering Services | <input type="checkbox"/> E. Manufacturing & Production |
| <input type="checkbox"/> B. Design & Development Engineering | <input type="checkbox"/> D. Basic Research | <input type="checkbox"/> F. Other _____ |

Estimate number of employees (at this location): 1. under 20 2. 20-99 3. 100-999 4. over 1000

1 16 31 46	61 76 91 106	121 136 151 166	181 196 211 226	241 256 271 348	363 378 393 408	423 438 453 468	483 498 703 718
2 17 32 47	62 77 92 107	122 137 152 167	182 197 212 227	242 257 272 349	364 379 394 409	424 439 454 469	484 499 704 719
3 18 33 48	63 78 93 108	123 138 153 168	183 198 213 228	243 258 273 350	365 380 395 410	425 440 455 470	485 500 705 720
4 19 34 49	64 79 94 109	124 139 154 169	184 199 214 229	244 259 274 351	366 381 396 411	426 441 456 471	486 501 706 900
5 20 35 50	65 80 95 110	125 140 155 170	185 200 215 230	245 260 275 352	367 382 397 412	427 442 457 472	487 502 707 901
6 21 36 51	66 81 96 111	126 141 156 171	186 201 216 231	246 261 338 353	368 383 398 413	428 443 458 473	488 503 708 902
7 22 37 52	67 82 97 112	127 142 157 172	187 202 217 232	247 262 339 354	369 384 399 414	429 444 459 474	489 504 709 951
8 23 38 53	68 83 98 113	128 143 158 173	188 203 218 233	248 263 340 355	370 385 400 415	430 445 460 475	490 505 710 952
9 24 39 54	69 84 99 114	129 144 159 174	189 204 219 234	249 264 341 356	371 386 401 416	431 446 461 476	491 506 711 953
10 25 40 55	70 85 100 115	130 145 160 175	190 205 220 235	250 265 342 357	372 387 402 417	432 447 462 477	492 507 712 954
11 26 41 56	71 86 101 116	131 146 161 176	191 206 221 236	251 266 343 358	373 388 403 418	433 448 463 478	493 508 713 956
12 27 42 57	72 87 102 117	132 147 162 177	192 207 222 237	252 267 344 359	374 389 404 419	434 449 464 479	494 509 714 957
13 28 43 58	73 88 103 118	133 148 163 178	193 208 223 238	253 268 345 360	375 390 405 420	435 450 465 480	495 510 715 958
14 29 44 59	74 89 104 119	134 149 164 179	194 209 224 239	254 269 346 361	376 391 406 421	436 451 466 481	496 701 716 959
15 30 45 60	75 90 105 120	135 150 165 180	195 210 225 240	255 270 347 362	377 392 407 422	437 452 467 482	497 702 717 960

Electronics

October 1, 1987 This Reader Service Card expires January 1, 1988

Name _____ Title _____

Phone _____ Company _____

Street address (company | | or home | | check one) _____

City _____ State _____ Zip _____

Signature _____ Date _____

Was this magazine personally addressed to you? Yes No 5 Source of Inquiry Domestic

Industry classification (check one)

- | | | |
|---|--|---|
| <input type="checkbox"/> A. Computers Computer Systems and Equipment | <input type="checkbox"/> F. Test and Measurement Equipment | <input type="checkbox"/> J. Research & Development |
| <input type="checkbox"/> B. Communications Communications Systems and Equipment | <input type="checkbox"/> G. Consumer Products | <input type="checkbox"/> K. Educational 2-4 Year College University |
| <input type="checkbox"/> C. Military/Space Systems and Equipment | <input type="checkbox"/> H. Medical Systems and Equipment | <input type="checkbox"/> L. Other _____ |
| <input type="checkbox"/> D. Industrial Systems Controls and Equipment | <input type="checkbox"/> I. Software | Please specify |
| <input type="checkbox"/> E. Electronics Subassemblies Components and Materials | | |

Your principal job responsibility (check one)

- | | | |
|--|--|--|
| <input type="checkbox"/> A. Corporate Operating and General Management | <input type="checkbox"/> C. Engineering Services | <input type="checkbox"/> E. Manufacturing & Production |
| <input type="checkbox"/> B. Design & Development Engineering | <input type="checkbox"/> D. Basic Research | <input type="checkbox"/> F. Other _____ |

Estimate number of employees (at this location): 1. under 20 2. 20-99 3. 100-999 4. over 1000

1 16 31 46	61 76 91 106	121 136 151 166	181 196 211 226	241 256 271 348	363 378 393 408	423 438 453 468	483 498 703 718
2 17 32 47	62 77 92 107	122 137 152 167	182 197 212 227	242 257 272 349	364 379 394 409	424 439 454 469	484 499 704 719
3 18 33 48	63 78 93 108	123 138 153 168	183 198 213 228	243 258 273 350	365 380 395 410	425 440 455 470	485 500 705 720
4 19 34 49	64 79 94 109	124 139 154 169	184 199 214 229	244 259 274 351	366 381 396 411	426 441 456 471	486 501 706 900
5 20 35 50	65 80 95 110	125 140 155 170	185 200 215 230	245 260 275 352	367 382 397 412	427 442 457 472	487 502 707 901
6 21 36 51	66 81 96 111	126 141 156 171	186 201 216 231	246 261 338 353	368 383 398 413	428 443 458 473	488 503 708 902
7 22 37 52	67 82 97 112	127 142 157 172	187 202 217 232	247 262 339 354	369 384 399 414	429 444 459 474	489 504 709 951
8 23 38 53	68 83 98 113	128 143 158 173	188 203 218 233	248 263 340 355	370 385 400 415	430 445 460 475	490 505 710 952
9 24 39 54	69 84 99 114	129 144 159 174	189 204 219 234	249 264 341 356	371 386 401 416	431 446 461 476	491 506 711 953
10 25 40 55	70 85 100 115	130 145 160 175	190 205 220 235	250 265 342 357	372 387 402 417	432 447 462 477	492 507 712 954
11 26 41 56	71 86 101 116	131 146 161 176	191 206 221 236	251 266 343 358	373 388 403 418	433 448 463 478	493 508 713 956
12 27 42 57	72 87 102 117	132 147 162 177	192 207 222 237	252 267 344 359	374 389 404 419	434 449 464 479	494 509 714 957
13 28 43 58	73 88 103 118	133 148 163 178	193 208 223 238	253 268 345 360	375 390 405 420	435 450 465 480	495 510 715 958
14 29 44 59	74 89 104 119	134 149 164 179	194 209 224 239	254 269 346 361	376 391 406 421	436 451 466 481	496 701 716 959
15 30 45 60	75 90 105 120	135 150 165 180	195 210 225 240	255 270 347 362	377 392 407 422	437 452 467 482	497 702 717 960

For additional information on products advertised, new products or new literature, use these business reply cards.

Complete entire card.
Please print or type.

Circle the number on the Reader Service postcard that corresponds to the number at the bottom of the advertisement, new product item, or new literature in which you are interested.

To aid the manufacturer in filling your request, please answer the three questions.

All inquiries from outside the U.S. that cannot reach Electronics before the expiration date noted on the Reader Service postcard must be mailed directly to the manufacturer. The manufacturer assumes all responsibilities for responding to inquiries.

Subscriptions & Renewals

Fill in the subscription card adjoining this card. Electronics will bill you at the address indicated on the card.

AFFIX
POSTAGE
STAMP
HERE

Electronics

**P.O. BOX NO. 8565
BOULDER, COLORADO 80329-8565**



AFFIX
POSTAGE
STAMP
HERE

Electronics

**P.O. BOX NO. 8565
BOULDER, COLORADO 80329-8565**



Win with UMC, Your Only Choice.

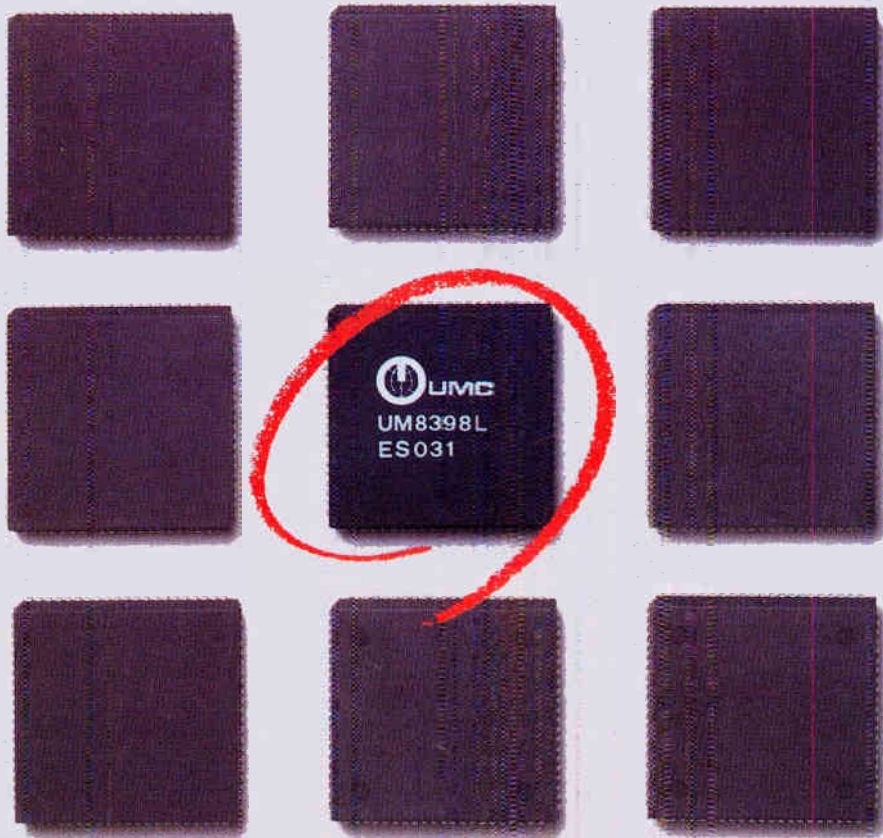

Faster + More Reliable + More Cost-effective

UMC is one of the leading advanced IC manufacturers for IBM PC compatible systems. We supply chips and integrated chip sets to meet the requirements in IBM PC and PC compatible systems. Our chips plus your design make your systems faster, more reliable, and more cost-effective.

Planning to conquer the PC system market? Win with UMC is your only choice.

We supply chips for PC/AT, PC/XT main board, display card, FDC card, HDC card, EGA card, and multi I/O card.



UMC

UNITED MICROELECTRONICS CORPORATION

For more information please contact:

U.S.A. HEADQUARTERS: NMC CORPORATION

3350 SCOTT, BLVD, BUILDING #57 SANTA CLARA, CA. 95054
TEL: 408-727-9239 TLX: 172730 NMC SNTA FAX: 408-9700548

Circle 901 on reader service card

Fast. Faster. Fastest.

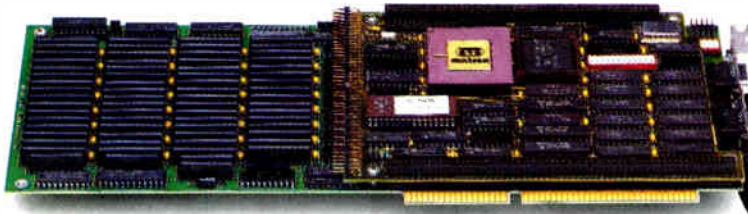

PG-1281 virtually redefines "high performance". With this new Matrox color display processor at the heart of an IBM PC AT, 386 PC, or compatible, a true professional workstation is born. Enhanced by four custom gate arrays, the PG-1281 is the fastest TMS34010-based board in the world today... and you have all the power of high-priced workstations at a fraction of the price!

- 1280 × 1024 resolution
- Full 64-bit bandwidth
- 65,000 vectors/second
- 100 million bits/second BITBLT
- Up to 1.5Mb on-board RAM
- Downloadable user code for easy application development
- Optimized drivers for major CAD packages
- Compatibility with all current graphics standards: Windows, X Windows, CGA, VDI, PGA, and more...
- Optional high-speed 3D coprocessor and EGA/VGA add-on modules.

If you need the best graphics performance available today, you need the PG-1281. For more details call us – fast!



1-800-361-4903

A LEADER IN VIDEO MICROTECHNOLOGY

matrox

In Canada, call (514) 685-2630. IBM and IBM AT are registered trademarks of International Business Machines Corporation. Windows is a trademark of Microsoft Corporation.

Circle 902 on reader service card

World Radio History

1281-ELEC