

AUGUST 25, 1981

**GETTING A PIECE OF THE VENTURE CAPITAL BOOM/94**

New concepts in local network architecture/119

Wescon: a sellout once more in its third decade/154

SIX DOLLARS

A Mc GRAW-HILL PUBLICATION

**International**

# Electronics<sup>®</sup>

**TRANSFORMER GOES PLANAR WITH THICK FILMS**

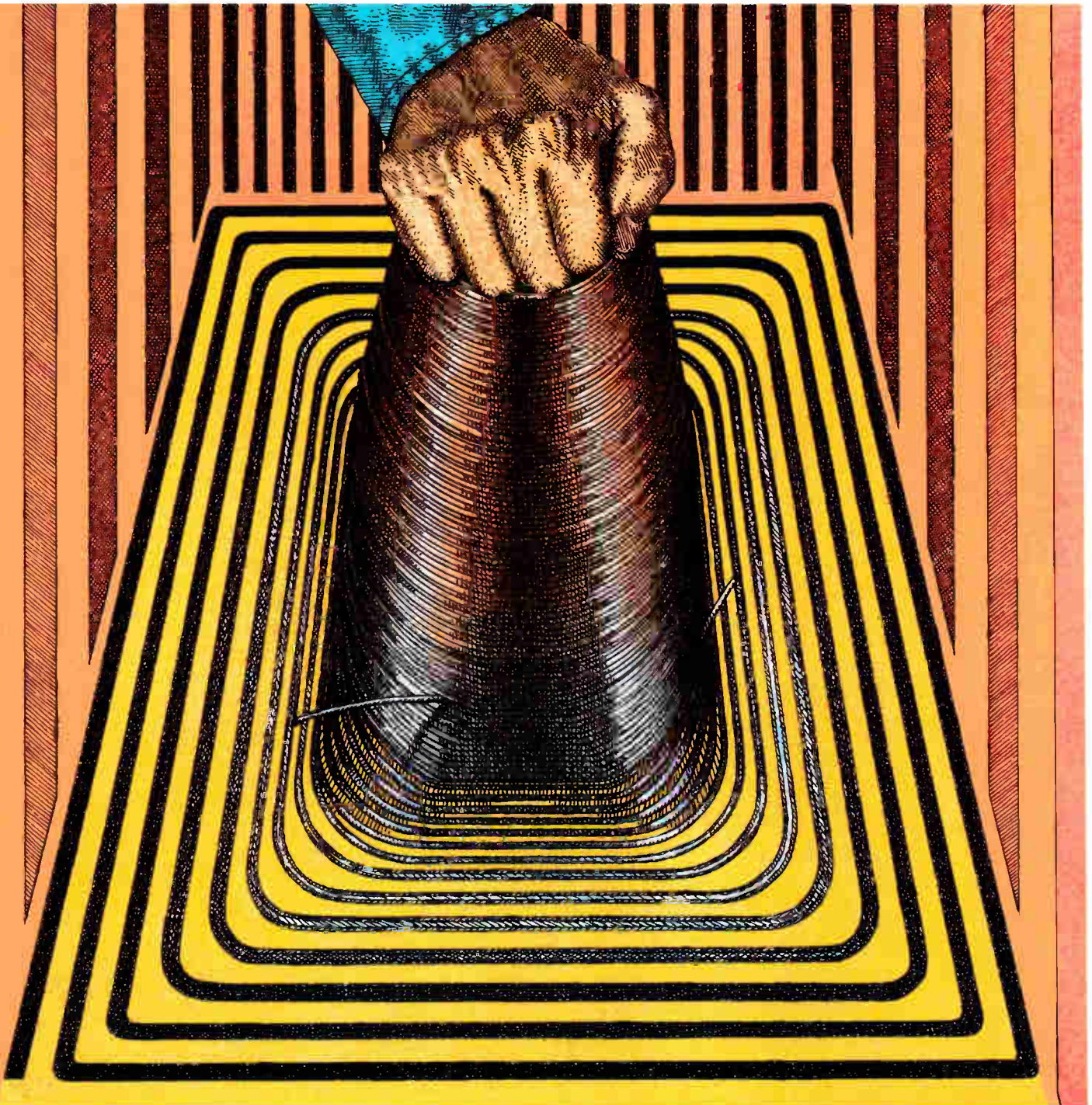

# OUR PHILOSOPHY:

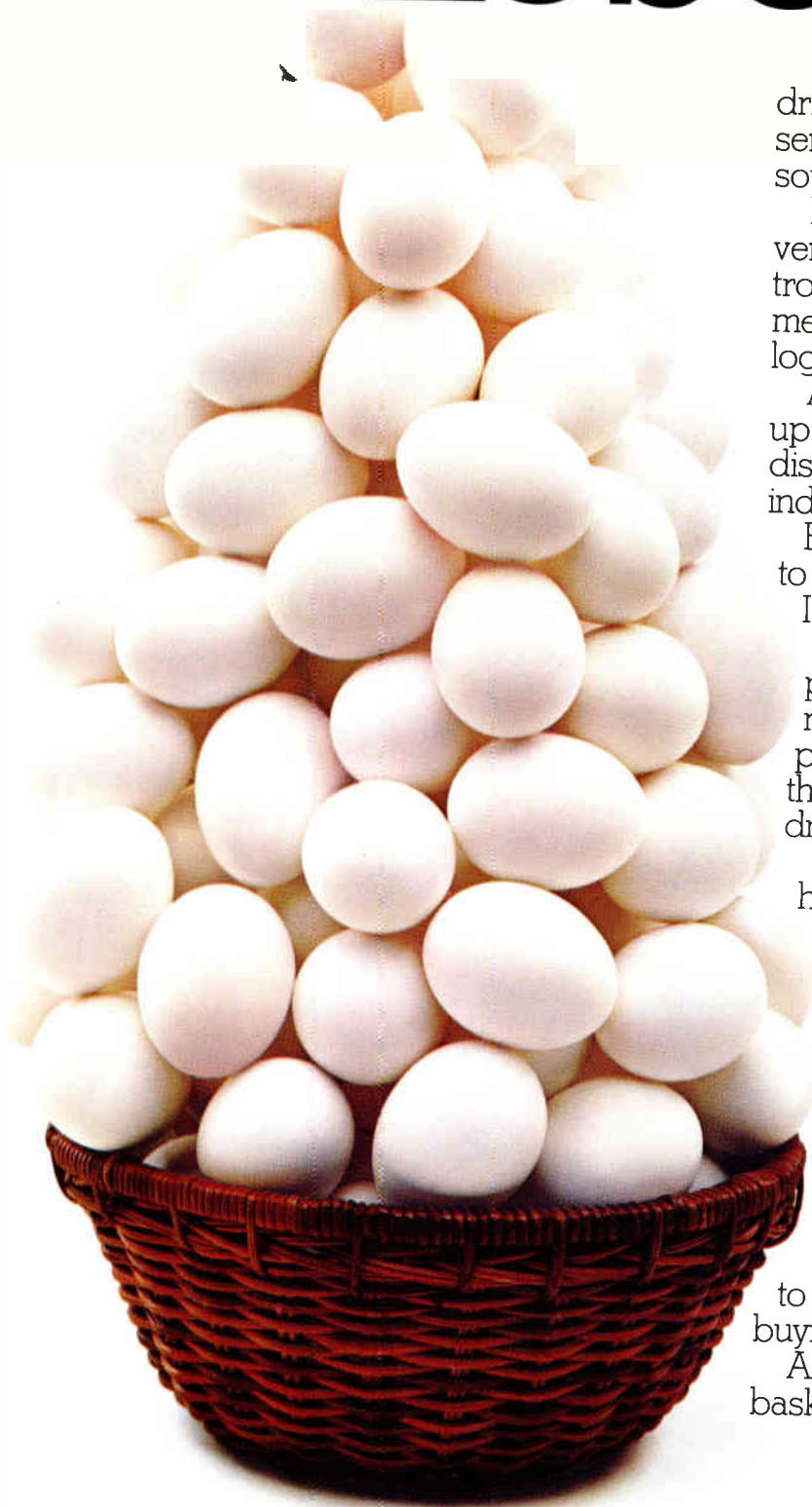

When it comes to choosing disk drives, we think it makes perfect sense to buy them all from one source.

Because dealing with several vendors means man-years of controller redesign, months for mechanical redesign and massive logistics for spare parts.

All of which costs money. In fact, up to \$500,000 for each additional disk drive vendor, according to industry estimates.

But that's money you don't have to spend.

If you specify Shugart.

We're the single source that can provide all the floppy and low-cost rigid disk drives you need for your present systems. And the source that will be able to provide the drives you need for future systems.

Thanks to our experience in high-volume manufacturing and our ongoing development of new drives.

At the same time, our application engineering team and worldwide field engineering force can minimize design time and maximize uptime. All of which saves you even more money.

Which is why you might want to rethink your philosophy about buying drives from several sources.

And put all your eggs in one basket. Ours.

**Shugart**

Right from the very start.

475 Oakmead Parkway, Sunnyvale, CA 94086 Telephone (408) 733-0100

Circle 900 on reader service card

World Radio History

# SURPRISE!



## Sample HP's New Crop of Bright Ideas.

HP now gives you the green light for any application. Our new high performance green indicators are two to three times brighter than existing green lamps, with excellent uniformity, consistent unit-to-unit color, and extremely low light output degradation.

HP green lamps are available in four distinct packages. T-1 $\frac{3}{4}$ 's come in both diffused and non-diffused, high and low profile packages. T-1 and rectangular lamps have wide angle diffused packages.

To see for yourself just how bright a green light can be, send the coupon in for a free sample.

For pricing and delivery information, call your nearby authorized Hewlett-Packard components distributor.

In the U.S., call Hall-Mark, Hamilton/Avnet, Marshall Electronics Group, Pioneer Standard, Schweber, and the Wyle Distribution Group. In Canada, contact Hamilton/Avnet or Zentronics, Ltd.

I'd like to sample your new crop of bright ideas.  
Please send me a free HP green indicator.

Name \_\_\_\_\_

Company \_\_\_\_\_

Address \_\_\_\_\_

City \_\_\_\_\_

State \_\_\_\_\_ Zip \_\_\_\_\_

In the U.S., mail coupon to:  
Hewlett-Packard Company  
640 Page Mill Road  
Palo Alto, CA 94304

In Europe:  
Hewlett-Packard, Nederland BV  
Central Mailing Department  
P.O. Box 529  
1180 AM Amstelveen  
The Netherlands



**HEWLETT  
PACKARD**

01106

# SURPRISE!



## Power MOS FET's are now available from HP

Look to HP for high quality, high performance and reliable Power MOS FET's. These FET's are ideal for off-line switching power supplies, inverter and converter circuits, motor drives and general industrial applications. HP MOS FET's are available now and feature: high breakdown voltage ( $V_{DSS}$ ), 450V minimum; low on resistance [ $R_{(ON)}$ ], 0.85 $\Omega$  maximum; and fast switching speed, 50 nanoseconds typical.

HP Power MOS FET's operate at high frequencies (200 kHz or more), with simple drive circuits. Switching losses are low and smaller components can be used, lowering system size and weight.

They're in stock right now at your local HP authorized distributor. In the U.S. contact Hall-Mark, Hamilton/Avnet, Marshall Electronics Group, Pioneer Standard, Schweber, or the Wyle Distribution Group. In Canada, call Hamilton/Avnet or Zentronics, Ltd.

 **HEWLETT  
PACKARD**

## 113 Technical Articles

### COMPONENTS

**Thick-film transformer advances hybrid isolation amplifier, 113**

### COMMUNICATIONS

**Local networks take to the factory and the office, 119**

**Local network architecture proposed for work stations, 120**

**Net for small computers minimizes their overhead, 125**

### SOLID STATE

**Memory management chip extends reach of 8-bit processors, 134**

### PACKAGING & PRODUCTION

**Leadless carriers, components increase board density by 6:1, 137**

### WESCON/81

**Quest for latest digital technology to draw crowds to San Francisco, 154**

DESIGNER'S CASEBOOK: 130

ENGINEER'S NOTEBOOK: 142

## 39 Electronics Review

SOLID STATE: High-frequency thin-film transistor operates at 300°C, 39

COMPUTERS: Lisp language gets special machine, 40

MICROWAVES: SAW device uses lithium niobate, 41

BUSINESS: Nippon Electric buy-in charged on Comsat earth stations, 42

PACKAGING: Chip makers line up behind leadless carrier types, 44

SOLID STATE: Silicon nitride helps shrink radiation-hardened memory, 44

DISPLAYS: 3-d graphics dazzles display conference, 46

Computer graphics industry set to climb, 48

PRODUCTION: Air Force to recruit robots for printed-circuit boards, 49

PERSONAL COMPUTERS: IBM Corp. elects to purchase software outside, 50

## 61 Electronics International

GREAT BRITAIN: Microprocessors in a ring take aim at mainframes, 73

SWITZERLAND: Two Josephson junctions in one device triple logic circuitry density, 74

GREAT BRITAIN: Cuts and soldered wire links customize multilayer board, 76

JAPAN: Gate-turn-off thyristors, microprocessors help shrink subway train, 78

NEW PRODUCTS INTERNATIONAL: 5E

## 89 Probing the News

BUSINESS: High-technology thieves peril nation, 89

## 93 Inside the News

VENTURE CAPITAL: For would-be entrepreneurs, the time is ripe, 93

## 169 Wescon / 81 New Product Review

Products bowing at the Sept. 15-17 show range widely; showgoers will note a visibly maturing relationship between instrumentation and microprocessors

## 193 New Products

IN THE SPOTLIGHT: Complementary-MOS PROM density hits 16-K, 193

INDUSTRIAL: Motor controller is programmable, 201

COMPONENTS: Operational amplifier aims at communications applications, 211

COMMUNICATIONS: Set tests telephone lines with pulses or tones, 224

MICROCOMPUTERS & SYSTEMS: C-MOS 8048 has extra features under register control, 237

MATERIALS: 247

## Departments

Highlights, 4

Publisher's letter, 6

Readers' comments, 8

News update, 12

People, 14

Editorial, 24

Meetings, 26

Electronics newsletter, 33

Washington newsletter, 57

Washington commentary, 58

International newsletter, 63

Engineer's newsletter, 146

New literature, 253

Products newsletter, 259

Career outlook, 261

## Services

Reader service card, 9E

Employment opportunities, 262

EDITOR-IN-CHIEF: Samuel Weber

SENIOR MANAGING EDITOR *News*:

Arthur Erikson

MANAGING EDITOR *Technical*:

Raymond P. Capece

ASSOCIATE MANAGING EDITORS:

Alfred Rosenblatt, Howard Wolff

ASSISTANT MANAGING EDITOR:

Margaret Eastman

SENIOR EDITORS: Ray Connolly, John G. Posa

ART DIRECTOR: Fred Sklenar

DEPARTMENT EDITORS

*Aerospace/Military*: Ray Connolly

*Circuit Design*: Vincent Biancomano

*Communications & Microwave*:

Harvey J. Hindin

*Components*: Roderic Berestford

*Computers & Peripherals*: Tom Manuel

*Industrial/Consumer*: Gil Bassak

*Microsystems & Software*: R. Colin Johnson

*New Products*: Jeremy Young, Steve Zollo

*Packaging & Production*: Jerry Lyman

*Solid State*: John G. Posa

*Test, Measurement & Control*:

Richard W. Comerford

CHIEF COPY EDITOR: Margaret Eastman

COPY EDITORS: David Kach, Erik L. Keller,

Benjamin A. Mason, Mike Robinson

ART: Charles D. Ciatto, *Associate Director*

EDITORIAL ASSISTANT: Penny Reitman

EDITORIAL SECRETARIES: Patricia Randall,

Janice Jung, Josephine Ortiz, Dawn Ramsay

REGIONAL EDITORS

*Boston*: James B. Brinton,

Linda Lowe (617) 262-1160

*Chicago*: Wesley R. Iversen (312) 751-3806

*Costa Mesa*: Terry Costlow (714) 557-6292

*Dallas*: J. Robert Lineback (214) 742-1747

*Los Angeles*: Larry Waller (213) 487-1160

*Palo Alto*: Martin Marshall (415) 968-2712

*Washington*: Ray Connolly (202) 624-7592

*Frankfurt*: John Gosch 72-5566

*London*: Kevin Smith 493-1451

*Paris*: Arthur Erikson, 723-4659

Robert T. Gallagher 723-4656

*Tokyo*: Charles Cohen,

Robert Neff 581-9816

McGRAW-HILL WORLD NEWS

Michael Johnson, *Editor*; James Smith, *Brussels*

Lois Bolton, *Milan*; Alex Beam, *Moscow*

Robert Skole, *Stockholm*

PUBLISHER: Paul W. Reiss

GENERAL MANAGER, DIRECT MARKETING

OPERATIONS: Horace T. Howland

DIRECTOR OF CIRCULATION: Frederick J. Kostbar

RESEARCH MANAGER: Margery D. Sholes

PROMOTION MANAGER: Jane De Court

MARKETING ADMINISTRATION MANAGER:

Frances M. Vallone

BOOKS & SPECIAL PROJECTS MANAGER:

Janet Eyler

SERVICE REVENUE ASSOCIATE:

June A. Noto

## Cover: Hybrid amplifier has thick-film transformer, 113

Thick-film technology has progressed to the point where it can produce flat-spiral windings for a compact, easily reproducible, low-cost transformer. The new circuit is the heart of a hybrid isolation amplifier, and its tight windings make for a wideband response.

The cover illustration is by Ron Chironna.

## Snaring venture capital: what the entrepreneur must know, 93

In the booming electronics industries, start-ups are legion, but would-be entrepreneurs must compete for backing from venture capitalists. The good news is that the money is there; the bad news is that a good product idea is only the beginning of the effort to secure backing. This Inside the News reports on what the financiers look for before deciding to back a new firm.

## Local networks extend their scope, 119

The use of local networks to tie together computing equipment is an idea whose time has come. Two related articles discuss a proposed six-layer local-net standard in which the first two layers are equivalent to the entire Ethernet scheme (p. 120) and introduce a low-cost network for personal computers in the office (p. 125).

## 8-bit microprocessors get memory management, 134

A memory management unit on a chip boosts the address limit of 8-bit microprocessors from 64-K bytes to 2 megabytes by widening the processor's 16-bit address to 21 bits. It also facilitates multitasking by providing separate register sets for the various users.

## Board density jumps six times with leadless parts, 137

Leadless passive components and chip-carriers can boost packing density six times on printed-circuit boards. The approach is a cost-effective alternative to large-scale integration and hybrid technology for low-volume systems—in avionics applications, for example.

## It's life on the fast track at this year's Wescon show, 154

The biggest San Francisco edition of Wescon yet will open its doors Sept. 15 with a full range of technical papers and a number of significant product announcements. This rundown on the technical sessions is followed by a report on product introductions, beginning on page 169.

## In the next issue . . .

An operating system on silicon . . . a controlled-impedance wiring technique . . . designing logic arrays remotely . . . an update on surface-acoustic-wave devices . . . motor-control chips.

August 25, 1981 Volume 54, Number 17  
105,067 copies of this issue printed

Electronics (ISSN 0013-5070). Published every other Tuesday except the issue of Monday, Nov. 30, by McGraw-Hill, Inc. Founder: James H. McGraw 1860-1948. Publication office 1221 Avenue of the Americas, New York, N.Y. 10020; second class postage paid at New York, N.Y. and additional mailing offices.

Executive, editorial, circulation and advertising addresses: Electronics, McGraw-Hill Building, 1221 Avenue of the Americas, New York, N.Y. 10020. Telephone (212) 557-1221. Teletype 12-7960 TWX 710-581-4879. Cable address: MCGRAW HILL NEW YORK.

Subscriptions limited to professional persons with active responsibility in electronics technology. No subscriptions accepted without complete identification of subscriber name, title or job function, company or organization, and product manufactured or services performed. Based on information supplied, the publisher reserves the right to reject non-qualified requests. Subscription rates: in the United States and possessions \$19 one year, \$32 two years, \$47 three years; company addressed and company libraries \$24 one year, \$42 two years, \$59 three years; Canada and Mexico \$20 one year, \$33 two years, \$48 three years; Europe \$50 one year, \$85 two years, \$115 three years; Japan, Israel and Brazil \$70 one year, \$115 two years, \$165 three years; Australia and New Zealand \$95 one year, \$170 two years, \$240 three years, including air freight; all other countries \$50 one year, \$85 two years, \$125 three years. Limited quota of subscriptions available at higher-than-basic rate for persons allied to field served. Check with publisher for these rates. Single copies: \$6.00. Please allow four to eight weeks for shipment.

Officers of McGraw-Hill Publications Company: Paul F. McPherson, President; Executive Vice Presidents: James E. Boddorf, Gene W. Simpson; Group Vice President: Daniel A. McMillan; Senior Vice President:

Editorial: Ralph R. Schultz. Vice Presidents: Kemp Anderson, Business Systems Development; Robert B. Doll, Circulation; James E. Hackett, Controller; Eric B. Herr, Planning and Development; H. John Sweger, Marketing.

Officers of the Corporation: Harold W. McGraw, Jr., President, Chief Executive Officer, and Chairman of the Board; Robert N. Landes, Senior Vice President and Secretary; Ralph J. Webb, Treasurer.

Title registered in U.S. Patent Office; Copyright© 1980 by McGraw-Hill, Inc. All rights reserved. The contents of this publication may not be reproduced in whole or in part without the consent of copyright owner.

Where necessary, permission is granted by the copyright owner for libraries and others registered with the Copyright Clearance Center (CCC), 21 Congress Street, Salem, MA 01970, to photocopy any article herein for the base fee of \$0.50 per copy of the article plus \$0.25 per page. Payment should be sent directly to the CCC. Copying done for other than personal or internal reference use without the express permission of McGraw-Hill is prohibited. Requests for special permission or bulk orders should be addressed to the publisher. ISSN 0013-5070/81\$0.50+\$0.25.

Subscribers: The publisher, upon written request to our New York office from any subscriber, agrees to refund that part of the subscription price applying to copies not yet mailed. Please send change-of-address notices or complaints to Fulfillment Manager; subscription orders to Circulation Manager, Electronics, at address below. Change-of-address notices should provide old as well as new address, including zip codes. Attach address label from recent issue. Allow one month for change to become effective. Subscriber Service: call (609) 448-8110, 9 a.m. to 4 p.m. EST.

Postmaster: Please send form 3579 to Fulfillment Manager, Electronics, P.O. Box 430, Hightstown, N.J. 08520.

# RF trans- formers

the world's widest selection of matching ratios  
**10KHz-800MHz...balanced, DC isolated, center-tapped**  
 46 off-the-shelf models from Mini-Circuits from \$2<sup>95</sup>

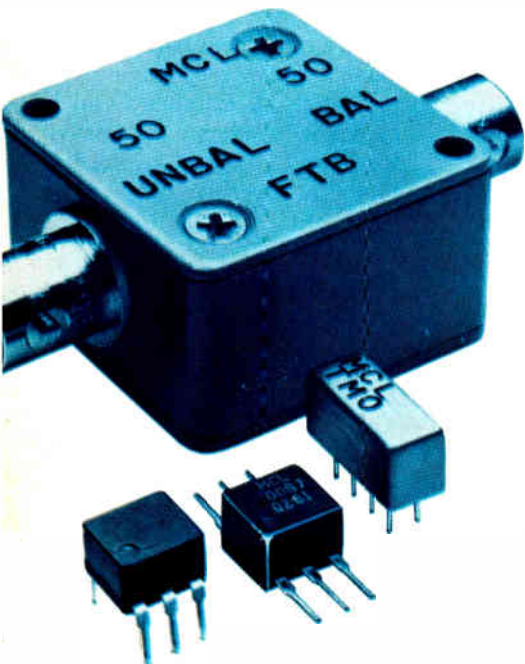

Bent Lead version,  
 please specify

Select from the economical, microminiature T-series (plastic case) or TMO series (hermetically-sealed metal case) covering 10 KHz to 800 MHz. These models operate from 12.5 to 800 ohms with insertion loss typically less than 0.5 dB.

For large dynamic range applications, specify the T-H series which can handle up to 100 mA primary current without saturation or distortion.

Need a connector version? Select from the FT or FTB series, available with unbalanced or balanced outputs. Connector choices are female (BNC, Isolated BNC, and Type N) and male (BNC and Type N). These units operate from 10 KHz to 500 MHz with impedances of 50 and 75 ohms.

Of course, Mini-Circuits' one-year guarantee is included.

#### DC ISOLATED PRIMARY & SECONDARY



	T1-1	T1-1H	T1.5-1	T2.5-6	T4-6	T9-1	T9-1H	T16-1	T16-1H
Model No.	TMO1-1		TMO1.5-1	TMO2.5-6	TMO4-6	TMO9-1		TMO16-1	
Imped. Ratio	1	1	1.5	2.5	4	9	9	16	16
Freq. (MHz)	15-400	8-300	.1-300	.01-100	02-200	.15-200	2-90	.3-120	7-85
T Model (10-49)	\$2.95	\$4.95	\$3.95	\$3.95	\$3.95	\$3.45	\$5.45	\$3.95	\$5.95
TMO model (10-49)	\$4.95		\$6.75	\$6.45	\$6.45	\$6.45		\$6.45	

#### CENTER-TAPPED DC ISOLATED PRIMARY & SECONDARY



	T1-1T	T2-1T	T2.5-6T	T3-1T	T4-1	T4-1H	T5-1T	T13-1T
Model No.	TMO1-1T	TMO2-1T	TMO2.5-6T	TMO3-1T	TMO4-1		TMO5-1T	TMO13-1T
Imped. Ratio	1	2	2.5	3	4	4	5	13
Freq. (MHz)	.05-200	.07-200	.01-100	.05-250	.2-350	8-350	.3-300	.3-120
T Model (10-49)	\$3.95	\$4.25	\$4.25	\$3.95	\$2.95	\$4.95	\$4.25	\$4.25
TMO model (10-49)	\$6.45	\$6.75	\$6.75	\$6.45	\$4.95		\$6.75	\$6.75

#### UNBALANCED PRIMARY & SECONDARY



	T2-1	T3-1	T4-2	T8-1	T14-1
Model No.	TMO2-1	TMO3-1	TMO4-2	TMO8-1	TMO14-1
Imped. Ratio	2	3	4	8	14
Freq. (MHz)	.025-600	5-800	2-600	.15-250	2-150
T model (10-49)	\$3.45	\$4.25	\$3.45	\$3.45	\$4.25
TMO Model (10-49)	\$5.95	\$6.95	\$5.95	\$5.95	\$6.75

#### FT FTB

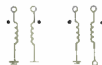

	FT1.5-1	FTB1-1	FTB1-6	FTB1-1-75
Model No.				
Imped. Ratio	1.5	1	1	1
Freq. (MHz)	1-400	.2-500	.01-200	.5-500
(1-4)	\$29.95	\$29.95	\$29.95	\$29.95

**Mini-Circuits**

A Division of Scientific Components Corp

World's largest manufacturer of Double Balanced Mixers

2625 East 14th Street, Brooklyn, New York 11235 (212)769-0200

Domestic and International Telex 125460 International Telex 620156

Never before...

200 watts  
of RF power with  
incredible  
versatility.

3200 L spans  
250 kHz to 150 MHz.



Now there's a completely solid state power amplifier that provides 200 watts of linear power over a frequency range from 250 kHz to 120 MHz. And at 175 watts, the range extends to 150 MHz.

Imagine the wide range of applications you can cover with this single Class A linear unit. All you need is any standard signal or sweep generator and you have the ultimate in linear power for RFI/EMI testing, NMR, RF Transmission, and general laboratory applications.

And, like all ENI power amplifiers, the 3200 L features unconditional stability, instantaneous failsafe provisions, and absolute protection from overloads and transients.

The 3200 L represents a breakthrough in RF power versatility and packaging. Never before has there been anything like it commercially available anywhere!

Contact us for a demonstration of the 3200 L and our complete catalog on the other amplifiers in our wide line. ENI, 3000 Winton Road South, Rochester, NY 14623.

Call 716/473-6900, or Telex 97-8283 ENI ROC.

**ENI**



The advanced  
design line of  
power amplifiers

## Publisher's letter

The Tax Reform Acts of 1969 and 1976 were prime examples of how misguided legislation can harm industry—particularly high-technology businesses like electronics where high risks and large quantities of start-up capital are required. When those acts doubled long-term capital gains taxes, restricted capital loss writeoffs, and eliminated treating stock options as capital gains, sources of venture capital practically dried up overnight. But when the capital gains tax was greatly reduced in 1978, venture capital suddenly resurged—more than \$1 billion now is available, according to those who add these things up.

That tide has launched a whole flotilla of startups in electronics and, being at the center of much of this activity, Martin Marshall of our Palo Alto bureau became fascinated by the forces behind it—the sometimes obsessive drive of the would-be entrepreneur and the sophisticated risk-taking of the professional venture capitalist.

"I wanted to provide a kind of guide for readers who dream about building their own business," says Marty. "And I'm also intrigued by the venture capital community. They're all dynamic, intelligent men—and not just out to make money, but determined to use their money to create something new and important and lasting." You'll find the start of the story on page 93.

At the very least, the development of the hybrid-compatible transformer for Analog Devices' new isolation amplifier that is featured in our cover story (p. 113) is noteworthy

in its bringing together of several exacting disciplines. Co-author Delip Bokil cites first the melding of his thin-film skills with co-author Bill Morong's expertise in magnetics.

"We knew we needed a different type of transformer," says Bokil. "The toroidal type is a neat package, but has problems with couplings between windings and is not well suited to production." So Bokil and Morong set out to build a prototype of their design, which required laying out the planar coils.

The next step in the project which began about a year and a half ago, required a ceramic laser-machining process that could later be adapted to tooling for mass production; for this he enlisted the services of Cermalloy Inc., West Conshohocken, Penn., whose Bruce Bertsch assisted in the preparation of substrates, including laying down the inks. "We never used copper before," notes Bokil.

He also wishes to acknowledge the help provided by Ron Overko of Mini-Systems in North Attleboro, Mass. in printing resistors over dielectric on the parent substrate. Finally behind every good engineer there's a good technician, and Bokil's case was no exception: Analog Devices' Jim Flaherty assembled the prototypes "superbly and with much enthusiasm," says Bokil.

### Wanted: a business trends editor

*Electronics* has a unique and important opportunity on its editorial staff for an editor to report and analyze business and market developments in the world's fourth largest industry.

The right person will combine communication skills with a broad familiarity with electronic technology and the electronic marketplace. Ideally, the candidate should have a technical degree and/or experience in marketing or market research, or a background in technical journalism. An MBA would be a distinct plus.

Send your resume and salary requirements to the Editor-in-Chief, *Electronics*, 1221 Avenue of the Americas, New York, N. Y. 10020.



# Catch the Bus for Completely Automatic Distortion Measurement

Designers and ATE people requested it — a NEW distortion analyzer with IEEE-488 bus compatibility. Now Krohn-Hite responds with the first *totally* automatic instrument for measuring low distortion, voltage, and frequency.

**Here's What "Completely Automatic" Means.** The 6880 self-tunes to the frequency of an external signal over the entire range of 1 Hz to 110 kHz, so manual frequency tuning is unnecessary. Distortion, AC voltage, and frequency measurements can be made with input levels from 0.1–130 V RMS. And by eliminating operator functions, the 6880 cuts time and costs.

**The 6880 Is Versatile.** It measures total harmonic distortion in percent or dB down to -90 dB (0.003%), with 0.1 dB resolution for

any input level. As an AC voltmeter, the 6880 measures RMS volts or deviation in percent or dB. As a frequency counter, it displays the fundamental input frequency from 1.000 Hz to 999 kHz. Built-in features include switch-selectable high and low pass filters, distortion output, analog output, and ultra-low distortion 1 kHz (0.003%) sinewave output.

Catch the IEEE-488 bus compatible, completely automatic 6880 distortion analyzer today at Krohn-Hite. Make Krohn-Hite your stop for a family of bus compatible instruments. Call for further information and look up our complete product listings in EEM and Gold Book.



**KROHN-HITE CORPORATION**

Avon Industrial Park, Avon, MA 02322  
(617) 580-1660 TWX 710 345 0831

**Krohn-Hite...Benchmark of Quality in Programmable Instruments**

OVERSEAS SALES OFFICE: ARAB REPUBLIC OF EGYPT, Cairo, E.P.I. Co; ARGENTINA, Buenos Aires, COASIN S/A; AUSTRIA, Wien, UNIVERSAL ELECTRONIK IMPORT; AUSTRALIA, Chatswood, South Melbourne, Fortitude Valley Q, Auburn, Kidman Park, Cloverdale, WARBURTON FRANKI LTD; BELGIUM, Brussels, C. N. ROOD s.a.; DENMARK, Naerum, SC METRIC A/S; ENGLAND, Reading Berks, KEITHLEY INSTRUMENTS, LTD; FINLAND, Helsinki, INTO/OY; FRANCE, Buc, M.B. ELECTRONIQUE; GERMANY, Munich, KEITHLEY INSTRUMENTS, GMBH; HOLLAND, Rijswijk, C.N. ROOD, b.v.; ISRAEL, Tel-Aviv, ARITMORE ENGINEERING CO. LTD; ITALY, Milan, Rome, VIANELLO S.P.A.; JAPAN, Tokyo, CHISHO CORP.; NEW ZEALAND, Lower Hutt, WARBURTON FRANKI LTD; NORWAY, Asker, TELEINSTRUMENT AB; PORTUGAL, Lisbon, MAGNETROM; SINGAPORE, Singapore, O'CONNOR'S (PTE), LTD; SOUTH AFRICA, Bramley, PROTEA P.N.I. (PTY), LTD; SPAIN, Barcelona, C.R. MARES, S.A.; SWEDEN, Vallingby, TELEINSTRUMENT AB; SWITZERLAND, Urdorf Zurich, MEGEX ELECTRONIC AG.

Circle 259 on reader service card

# High-volume PWB assemblies? Irvine Electronics is big on big numbers.

High-volume manufacturing is our specialty.

We've built over a million boards since 1974, with an enviable acceptance rate of 99.5%.

It's the kind of record that makes us an ideal primary or secondary source supplier. For commercial ANSI/IPC 600C. For military 454 as well.

We boast top-notch engineering. A highly experienced production staff. High-volume purchasing expertise. And we compete very effectively, especially on high-quality auto-insertable

Circle 8 on reader service card

PWBs requiring sophisticated functional test. And we back it all up with a 90-day warranty.

Like more information on our big number capability? Send for our free brochure. Call or write Sheridan H. Williford (714) 549-3533. Irvine Electronics, Rockwell International, 2901 W. MacArthur Blvd., Santa Ana, CA 92704.



**Rockwell  
International**

...where science gets down to business

## Readers' comments

### The old buddy network

To the Editor: A letter published in your June 30 issue ["Amateurs training amateurs," p. 8] criticized the Accreditation Board for Engineering and Technology as "an old buddy network" and implied that ABET and its accreditation processes were exclusively populated by faculty and administrators from engineering colleges.

Beginning in 1977, the Institute of Electrical and Electronics Engineers began a deliberate effort to involve members currently employed by industry in the accreditation process. The Institute's goal was to have one-half of the visitors evaluating programs, for which the IEEE was responsible, be individuals employed by industry or government.

The data for the past few years clearly indicates that the procedures now used by the IEEE are appropriate for encouraging industry involvement in the accreditation process. In 1977, of the 53 visits made to academic institutions, 21 were by industry or government visitors and 32 were by visitors with academic affiliations. In 1978, 27 of 57 visits were by nonacademic evaluators; in 1979, 16 of 32 had participants with industry or government affiliation; and in 1980, 22 of 45 came from outside the academic community.

A further indication of the IEEE's commitment to the involvement of those from industry in the accreditation of engineering programs is the list of individual *ad hoc* visitors from which those participating in visits are selected. For 1981-82, the IEEE list for electrical engineering programs includes 57 individuals whose current employment is with industry or government and 47 individuals whose current employment is with an academic institution. At the present time, most visitors make only one visit per year.

A recent increase in the size of the Engineering Accreditation Commission of ABET (this is the group responsible for the accreditation of engineering programs) allowed the number of IEEE representatives to be increased to four. Of the four, two persons are currently employed by

# Interested in higher performance software?

The Mark Williams Company announces **COHERENT**™, a state of the art, third generation operating system. **COHERENT** is a totally independent development of The Mark Williams Company. **COHERENT** contains a number of software innovations not available elsewhere, while maintaining compatibility with UNIX\*. The primary goal of **COHERENT** is to provide a friendly environment for program development. The intent is to provide the user with a wide range of software building blocks from which he can select programs and utilities to solve his problems in the most straightforward manner.

**COHERENT** and all of its associated software are written totally in the high-level programming language **C**. Using **C** as the primary implementation language yields a high degree of reliability, portability, and ease of modification with no noticeable performance penalty.

## Features

**COHERENT** provides **C** language source compatibility with programs written to run under Seventh Edition UNIX, enabling the large base of software written to run under UNIX (from numerous sources) to be available to the **COHERENT** user. The system design is based on a number of fundamental concepts. Central to this design is the unified structure of i/o with respect to ordinary files, external devices, and interprocess communication (pipes). At the same time, a great deal of attention has been paid to system performance so that the machine's resources are used in the most efficient way. The major features of **COHERENT** include:

- multiuser and multi-tasking facilities,
- running processes in foreground and background,
- compatible mechanisms for file, device, and interprocess i/o facilities,
- the shell command interpreter—modifiable for particular applications,
- distributed file system with tree-structured, hierarchical design,
- pipes and multiplexed channels for interprocess communication,
- asynchronous software interrupts,
- generalized segmentation (shared data, writable instruction spaces),
- ability to lock processes in memory for real-time applications,
- fast swapping with swap storage cache,
- minimal interrupt lockout time for real-

\*UNIX is a trademark of Bell Labs

- time applications,
- reliable power failure recovery facilities,
- fast disc accesses through disc buffer cache,
- loadable device drivers,
- process timing, profiling and debugging trace features.

## Software Tools

In addition to the standard commands for manipulating processes, files, and the like, in its initial release **COHERENT** will include the following major software components: **SHELL**, the command interpreter; **STDIO**, a portable, standard i/o library plus run-time support routines; **AS**, an assembler for the host machine; **CROSS**, a number of cross-assemblers for other machines with compatible object format with '**AS**' above; **DB**, a symbolic debugger for **C**, Pascal, Fortran, and assembler; **ED**, a context-oriented text editor with regular expression patterns; **SED**, a stream editor (used in filters) fashioned after '**ED**'; **GREP**, a pattern matching filter; **AWK**, a pattern scanning and processing language; **LEX**, a lexical analyzer generator; **YACC**, an advanced parser generator language; **NROFF**, an Nroff-compatible text formatter; **LEARN**, computer-aided instruction about computers; **DC**, a desk calculator; **QUOTA**, a package of accounting programs to control filespace and processor use; and **MAIL**, an electronic personal message system.

Of course, **COHERENT** will have an ever-expanding number of programming and language tools and basic commands in future releases.

## Language Support

The realm of language support is one of the major strengths of **COHERENT**. The following language processors will be supported initially:

- **C** a portable compiler for the language **C**, including stricter type enforcement in the manner of **LINT**.
- **FORTRAN** portable compiler supporting the full ANS Fortran 77 standard.
- **PASCAL** portable implementation of the complete ISO standard Pascal.

- **XYBASIC**™ a state of the art Basic compiler with the interactive features of an interpreter.

The unified design philosophy underlying the implementation of these languages has contributed significantly to the ease of their portability. In particular, the existence of a generalized code generator is such that with a minimal effort (about one man-month) all of the above language processors can be made to run on a new machine. The net result is that the compilers running under **COHERENT** produce extremely tight code very closely rivaling that produced by an experienced assembler programmer. Finally, the unified coder and conformable calling sequences permit the intermixture of these languages in a single program.

## Operating System

In part because of the language portability discussed above, and in part because of a substantial effort in achieving a greater degree of machine-independence in the design and implementation of the **COHERENT** operating system, only a small effort need be invested to port the whole system to a new machine. Because of this, an investment in **COHERENT** software is not tied to a single processor. Applications can move with the entire system to a new processor with about two man months of effort.

The initial version of **COHERENT** is available for the Digital Equipment Corporation PDP-11 computers with memory-mapping, such as the PDP 11/34. Machines which will be supported in the coming months are the Intel 8086, Zilog Z8000, and Motorola 68000. Machines for which ports are being considered are the DEC VAX 11/780 and the IBM 370, among others.

Because **COHERENT** has been developed independently, the pricing is exceptionally attractive. Of course **COHERENT** is completely supported by its developer. To get more information about **COHERENT** contact us today.



1430 W. Wrightwood Ave., Chicago, IL 60614  
TEL: 312-472-6659 TWX: 910-221-1182

# Program Measure and Display All Test Parameters of Radio and Audio Systems - Automatically!



**re** Instruments unique Dual Channel Audio Analyzer System simplifies radio/audio testing to a degree never previously available.

It automatically establishes, measures, evaluates and displays all significant parameters that define quality.

In essence this real time system - Forms the test set-up - Instructs the operator (if desired) - Controls signal sources - Measures and Displays the results on the CRT in practically any way you desire, including tabular, meter, graphical or symbolic formats.

Measured parameters can include:  
 Voltages - Frequencies - Power Levels - Swept Responses - All forms of Distortion (including THD, IM and TIM) - Signal to Noise Ratios - Optional Wow and Flutter and many more.

Contact us for more details on this exciting analyzer.

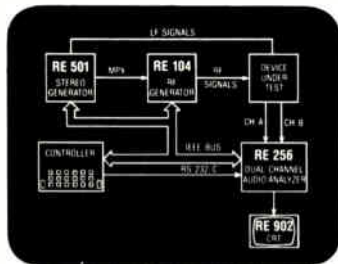

TEST SYSTEM DIAGRAMS

TEST PROCEDURE

- ADJUST TRIMMER R12 TO GIVE A MINIMUM READING ON THE METER.

IMPORTANT

BE SURE THAT THE SUPPLY VOLTAGE IS WITHIN LIMITS!

VIDEO PROMPTING

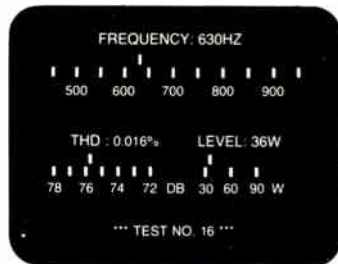

DYNAMIC METER READINGS (Analog and Digital)

\*\*\* RADIO UNDER TEST: 65327

DISTORTION

THD	1%
3RD HARMONIC	0.8%
7TH HARMONIC	0.1%
IM	0.7%
2 ORDER IM	0.6%
TIM	1.1%

DOCUMENTED TEST RESULTS

## Readers' comments

industry and two are employed by academic institutions. The other participating bodies of ABET have also committed themselves to increased participation by individuals currently employed by industry in the accreditation process and a conscious effort is being made to include representatives from industry as members of all visiting teams.

The facts concerning IEEE participation in the accreditation of engineering programs do not support the criticism by your readers.

E. W. Ernst,  
 vice president,  
 educational activities, IEEE,  
 Urbana, Ill.

## Substrate suppliers

**To the Editor:** The June 16 issue of *Electronics* ["Copper plus Invar suits chip-carriers, p. 46"] reported on Texas Instruments Inc.'s copper-clad Invar substrate material. However, the article seems to suggest that the Metallurgical Materials division is in the process of manufacturing printed wiring boards from this material and, therefore, in competition with the PCK Technology division of Kollmorgen Corp. and Bell Laboratories.

In truth, TI supplies only the clad metal. In fact, PCK Technology has evaluated the material and is now providing it, or Alloy 42, as the metal core in its Microwire development program at the customer's request. Bell Labs in Denver has also used Invar, in conjunction with a modified Lampac approach, and found the material to be acceptable for use with chip carriers.

Francis J. Dance,  
 program manager,  
 electronics materials,  
 Texas Instruments Inc.,  
 Attleboro, Mass.

## Correction

In Figure 2 of "Dual-function amplifier eases circuit design" (July 28, p. 137), the emitter resistor of transistor  $Q_3$  should have a value of 33 ohms, instead of 1 kilohm. Also, the LM329 zener diode shown at the lower left should be connected to the adjacent 3-k $\Omega$  resistor.

**re** RE INSTRUMENTS AS

Emdrupvej 26, 2100 Copenhagen Ø, Denmark  
 Phone 01-18 44 22 Telex 22211 re dk

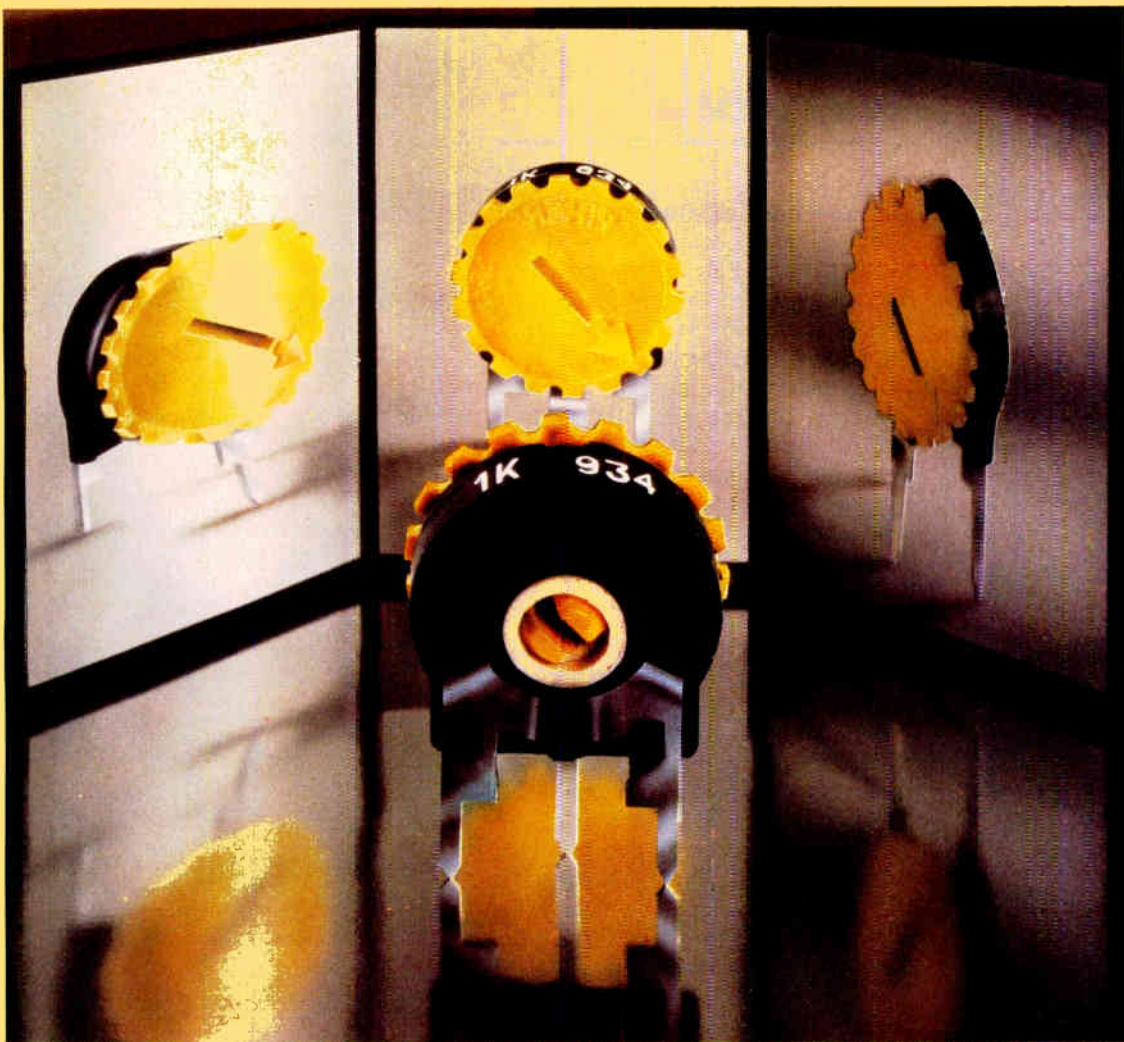

# STILL THE BEST. THE PIHER TRIMMER POTENTIOMETER.

Piher was the first to introduce enclosed trimmer potentiometers. Through constant improvements in design and engineering the original Piher potentiometer has remained the leader in the industry.

Our components are always as technically up-to-date as possible. Advanced automated production processes allow us to offer our 10mm and 15mm models at prices traditionally quoted for inferior open "skeleton" type trimmers.

Our basic potentiometers now incorporate a thru hole adjustment facility suitable for screwdriver or trimmer tool. Other features include arrowhead indicators giving wiping Circle 11 on reader service card

positions, dual contacts, resistance to cleaning solvents, even plug-in colored spindles and thumb wheels. And there's a lot more, including specials.

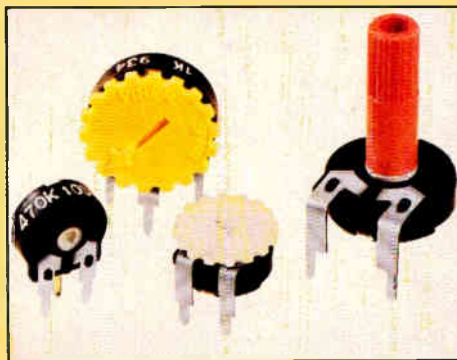

Call toll free **800-323-6693** today for more detailed cost and technical information on the Piher trimmer potentiometer. Why settle for second best when you can afford the original.

Piher International Corporation, 505 West Golf Road, Arlington Heights, Illinois 60005.



# PIHER

*"at the heart of today's technology"*

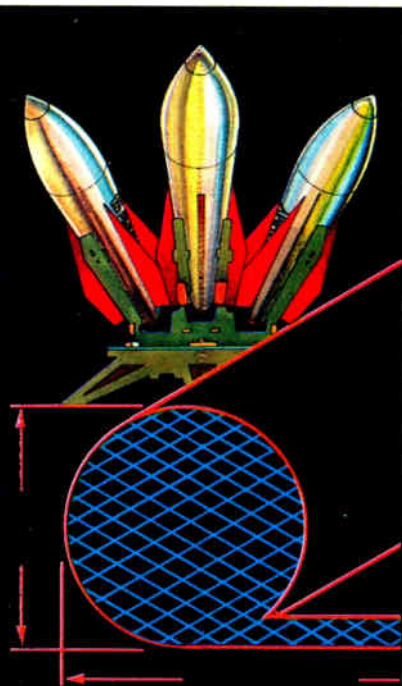

## Our EMC gasketing keeps the Hawk missile's secrets behind closed doors.

When the ground support equipment for the Hawk missile was experiencing electromagnetic interference (EMI), Spectrum Control, Inc. was called in. Spectrum is a full-service company that provides professional electromagnetic compatibility (EMC) testing, consulting, design and manufacturing. Our experts solved this EMI problem with custom-designed EMI gasketing\* around the computer cabinet doors and covers.

Spectrum also designs and manufactures EMI/RFI suppression filters, capacitors, shielded viewing windows and many other custom and standard EMC control devices. Our computer database contains over 57,000 product variations to help us solve any EMC problem you may have at any stage of your system's development. And our testing facilities include a completely equipped Anechoic Chamber and open field sites.\*\*

So contact us about your EMI problem. Write: Spectrum Control, Inc., 8061 Avonia Rd., Fairview, PA 16415. Or call: 814-474-1571.

\*See Engineering Bulletins 27-0027-26, 27-0027-28 and 27-0027-29. \*\*Spectrum's testing facilities meet all FCC, VDE, CISPR, CSA and MIL-STD 461 A/B requirements.

EMC gasketing is available locally through authorized Spectrum Control distributors.

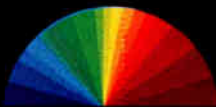

**SPECTRUM CONTROL INC.**

Making technology compatible with technology.

Circle 12 on reader service card

## News update

■ Toshiba Corp. has become pretty seriously involved with the T88000 16-bit microprocessor it unveiled last fall [*Electronics*, Oct. 9, 1980, p. 75]. The high-speed, complementary-MOS-on-sapphire part has already been designed into two medical-electronic products, and half a dozen more new products are in the works.

Moreover, Toshiba says it is designing silicon-on-sapphire chips for other applications and expects to sell them as components by next July. By then, the Japanese firm could also be producing the 4-K SOS static random-access memory for a mainframe cache memory it displayed last year [*Electronics*, Sept. 11, 1980, p. 80]. It has no plans to sell the T88000 separately.

Mixed calculations can be handled three to six times faster with the T88000 than with Intel's 8086 or Zilog's Z8000, according to Toshiba. The clock rate is 10 megahertz, with the SOS technology bringing the average propagation time of a gate down to only 0.7 nanosecond.

With microcode in off-chip read-only memory Toshiba tailors the SOS chip's architecture to suit the application. A floating-point binary architecture is used for scientific products, and a fixed-point binary-coded decimal architecture is employed for office computers and products designed for business arithmetic.

**Fast.** One of the two products already built around the T88000 is the Tosmac 500 Easy, a medical information terminal. It needs a high-speed processor because it must turn out billing statements rapidly while handling a large pharmaceutical and an even larger patient file. The other product is a computerized tomography system, where the chip handles fast Fourier transforms and instrument control.

The microprocessor will also soon turn up in a rack-mounted minicomputer, in which a single central-processing-unit board will replace five boards. Also coming is an office computer; three desktop systems, including a Japanese-language word processor and a scientific computer; and an English-language word processor.

-Charles Cohen

## SOFTWARE

# Tools

## SOFTOOL 80™

**A PROGRAMMING ENVIRONMENT AVAILABLE... OFF-THE-SHELF... TODAY. IT OFFERS:**

- Ease of use--interactives and tutorials
- Short-hand and structured languages
- Automatic code generation
- Automatic documenters
- Source code auditor
- Testing aids
- Optimization aids

ACTION: CALL US FOR DETAILS OR TO ARRANGE FOR A HANDS-ON DEMONSTRATION OF SOFTOOL 80™



**SOFTOOL CORPORATION**

340 South Kellogg Avenue  
Goleta, California 93117  
(805) 964-0560

Circle 261 on reader service card

## THIS WAFER IS JUST WAITING FOR YOUR MOS IMPRESSIONS.

Bring your tooling and test programs to one of the most spacious, state-of-the-art fabrication facilities in Silicon Valley. Call ZyMOS at (408) 730-8800.



**ZyMOS**

WHERE SILICON SOLUTIONS ARE CUSTOM MADE\*

477 N. Mathilda Ave.  
Sunnyvale, California 94088

Circle 262 on reader service card

# LINE-INTERRUPT switch meets latest specs... WORLDWIDE

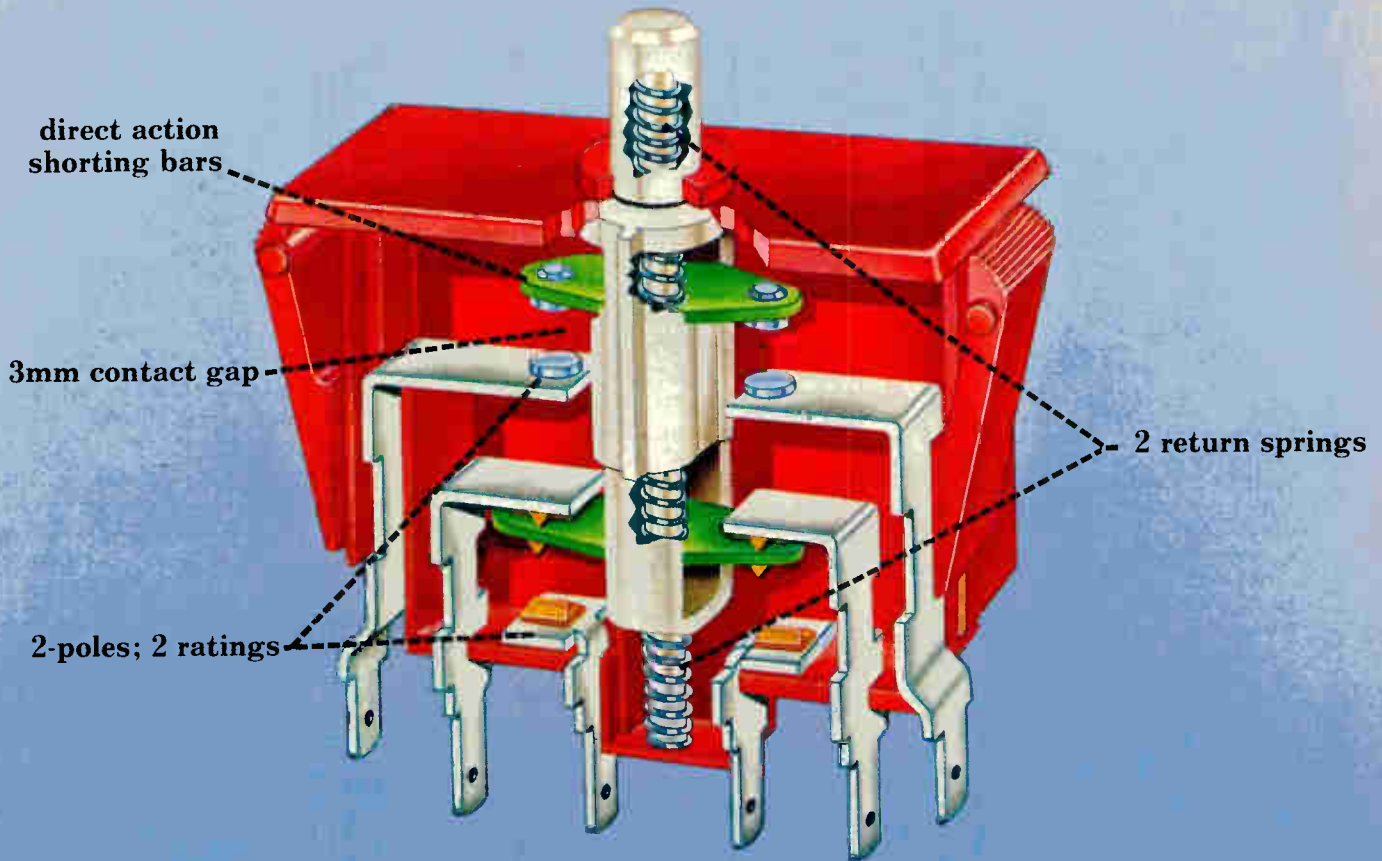

**This new safety interlock switch was designed to meet specs of such international agencies as VDE, BSI and others. U.L. listed and CSA approved.**

A redundant switch is a safe switch. Cherry builds double protection into this 3mm contact gap line interrupt switch.

Four contacts on each pole, parallel return springs and direct action shorting bars provide an extra margin of safety.

Many of today's products require two voltage levels; one for power and one for control functions. So Cherry offers two different electrical ratings in the same switch. Choose from 10 amp, 16 amp and 0.1 amp combinations. Also available in single pole versions.

**All this and Cherry dependability, too!**



*Available with housing that allows qualified servicemen to test "hot" circuit.*

See Us At WESCON/San Francisco-Sept. 15-17  
CHERRY BOOTHS:1532-1538

# CHERRY

## LINE-INTERRUPT SWITCHES

**CHERRY ELECTRICAL PRODUCTS CORP.** 3608 Sunset Avenue, Waukegan, IL 60085—312/689-7700—TWX 910/235-1572

Worldwide affiliates and phone numbers: Cherry Semiconductor Corp., East Greenwich, RI, U.S.A., 401-885-3600 • Cherry Mikroschalter GmbH, Auerbach, Germany, 09 643 181 • Cherry Electrical Products Ltd., Harpenden (Herts) England, (05827) 63100 • Chercra Brasil Industria E. Comercio Ltda., Sao Paulo, Brazil, 55 (011) 246-4343 • Hirose Cherry Precision Co., Ltd., Kawasaki, Japan, 044 933 3511

Electronics / August 25, 1981

Circle 13 on reader service card 13

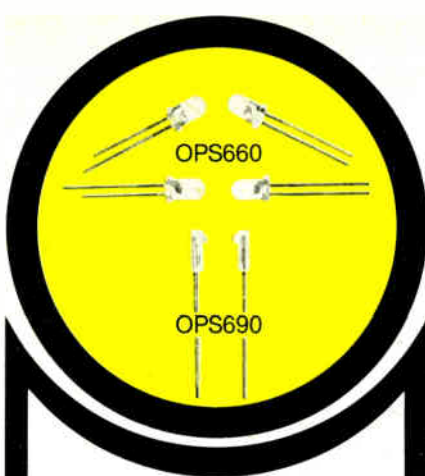

## INFRARED OPTOELECTRONIC MATCHED PAIRS ARE BETTER WHEN:

1. Your sub-assembly board space is limited and you would like to mold the discrete housing into the sub-assembly case.
2. You have low volume or multiple sensing requirements and you want to save the cost of tooling assembly housings.
3. You want to do pre-production breadboarding to determine optimum electrical specs and physical location, and then build your own assemblies. For these and other applications, matched pairs could be your lowest cost solution.

TRW Optron offers a series of matched pairs in two popular plastic package styles, the "end looking" OPS660 and the "side looking" OPS690. Each pair consists of a gallium arsenide infrared emitting diode and a silicon phototransistor, spectrally and electrically matched.

The OPS660 can be used in either a transmissive or reflective mode and will produce a minimum of .5 mA  $I_C(on)$  at an  $I_F$  of 20 mA with .25 inches separation between lens tips or .125 inches to reflective surface.

The OPS690, OPS691, OPS692, and OPS693 will produce minimum  $I_C(on)$ 's of 100  $\mu A$ , 500  $\mu A$ , 1 mA, and 2 mA, respectively, at an  $I_F$  of 20 mA with .125 inches separation between lens tips.

For detailed technical information on these and other TRW Optron optoelectronic components, contact your nearest TRW Optron sales office or the factory direct at 1201 Tappan Circle, Carrollton, Texas, 75006, USA TWX 910-860-5958 • Telephone 214/323-2200.

**TRW OPTRON**  
An Electronic Components  
Division of TRW Inc.

## People

Findex's Dashiell strives to do as well at home as abroad

The usual progression for a small microcomputer company in the U. S. is to build a strong domestic sales base, then move into overseas markets. But when George Dashiell took the reins of Findex early this summer, his overriding concern was to bolster domestic sales, until now dwarfed by the firm's 21-country international business.

Not surprisingly, the former vice president and general manager of Computer Automation's commercial division turned to a European product to help him make headway at home. His decision makes his Torrance, Calif., firm the first U. S. licensee of a popular European operating system developed by Holland Automation of Dordrecht. The HA software is used by—among others—the major Italian business-machine maker C. Olivetti & Cie., and by Zilog Inc. for a few systems it sells in Europe but not in the U. S.

Like other firms offering the Dutch software, Findex will sell it under its own brand name, calling its version the Findex Operating System. "We'll offer the operating system as an option. Users can buy either CP/M or the Holland package," the 56-year-old Dashiell says



**At home.** George Dashiell seeks to balance Findex's sales at home and abroad.

with a trace of a Virginia accent.

He turned to the HA system after seeing the advantages it brought when adapted to a Findex computer sold in the Netherlands—the HA Basic compiler operates at least 25% faster than the compiler based on CP/M, Dashiell notes. Also, HA offers small-business applications packages, thoroughly tested in Europe, written in Basic.

Although Findex has been building systems since 1979 in California, less than 10% of its sales have been in the U. S. Michael Wurmbrand, a Rumanian who started the firm and has since left it, found it easier to sell in foreign markets.

With the two operating systems and a wide range of applications packages to offer, Findex now plans to make its domestic sales equal overseas sales by entering vertical markets like accounting services and medical offices.

Findex sales were \$2 million last year, and Dashiell plans to double revenues during each of the next three years. Doing that won't be easy, but he feels confident. "Working a year in this industry is like working five in any other. I've got 150 years' experience," he quips.

TI's Rhines sees shorter design-in for 16-bit 9995

Texas Instruments Inc. is already changing some of its views when it comes to design-in cycles for 16-bit microcomputers, says Walden C. (Wally) Rhines, head of the recently created MOS Microcomputers division in Houston.

Until now, says the 34-year-old assistant vice president, the industry and TI have been anticipating lengthy design-in times. But the TMS9995—its speedy n-channel MOS microcomputer aimed at signal-processing applications [*Electronics*, Dec. 18, 1980, p. 90] has apparently shot down that notion at the Texas semiconductor firm.

"The 9995 has far exceeded our expectation—we didn't estimate that it would take off as fast as it did,"



# PDP-11/03<sup>®</sup> PDP-11/23<sup>®</sup>

## FIRSTMICRO<sup>™</sup>

### MICROCOMPUTER SYSTEMS



**FIRST COMPUTER CORPORATION NOW OFFERS MICROCOMPUTER DEVELOPMENT SYSTEMS IN BOTH 11/03 AND 11/23 CONFIGURATIONS.**

The Basic PDP-11/03 systems offer the designer a low cost compatible alternative to the larger members of the PDP-11 family. The larger faster PDP-11/23 systems offer the

power, expandability and operating systems of the larger members of the PDP-11 family while retaining the proven cost effective Q-Bus architecture. These systems save you money, improve programming efficiency, and boost productivity.

	11T03-L		11V03-L		11T23-L		11V23-L	
PART #	SRVXLLB		SRVXSSB		SRWXLLA		SRWXSSA	
	KD11-HA CPU 11/03		KD11-HA CPU 11/03		KDF11 CPU 11/23		KDF11 CPU 11/23	
	MSV11-DD 32KW Memory		MSV11-DD 32KW Memory		MSV11-DD 32KW Memory		MSV11-DD 32KW Memory	
	RL01 Controller		RX02 Controller		MSV11-DD 32KW Memory		MSV11-DD 32KW Memory	
	RL01 Controller		DLV11-J Serial (4)		RL01 Controller		RX02 Controller	
	DLV11-J Serial (4)		OPEN		RL01 Controller		DLV11-J Serial (4)	
BACKPLANE	OPEN		OPEN		DLV11-J Serial (4)		OPEN	
	OPEN		OPEN		OPEN		OPEN	
	OPEN		OPEN		OPEN		OPEN	
	BDV11-AA Bootstrap		BDV11-AA Bootstrap		BDV11-AA Bootstrap		BDV11-AA Bootstrap	

**FM1-1**

Serving the world with cost effective computer systems.

© Registered trademark of Digital Equipment Corporation  
 ™ Trademark First Computer Corporation



**First** <sup>TM</sup> **computer corporation**  
 645 BLACKHAWK DRIVE / WESTMONT, ILLINOIS 60559 (312) 920-1050

TX NUMBER 910-651-1916

**SOUTHERN REGION**  
 Houston, TX (713) 960-1050

**WESTERN REGION**  
 California (To be announced)

**NORTH CENTRAL REGION**  
 Chicago, IL (312) 920-1050

Electronics / August 25, 1981

Call us for sale prices

Circle 15 on reader service card

15

# THE EMULYZER™

## PROM EMULATOR/LOGIC STATE ANALYZER

### IN ONE COMPACT UNIT



Ideal for bit-slice designs and any high-speed microprogrammed processor/controller based on: 2901, 2903, 29116, 2910, 8X300, 8X02, 74S181, 3002, 8086, Z8000.

- 35ns PROM emulation
- Up to 16K by 128 Emulator Memory
- Emulates all types of PROM's
- 20 MHz Logic State Analyzer
- 4K by 80 Bits Trace
- Extensive Triggering Capabilities
- Multiple Break Points
- Single-Step
- Three RS232 Ports
- Printer Port
- Tape Cassette
- Software
- Compact
- Rugged
- Portable
- Ideal for Field Service

For full story on this proven, time-saving diagnostic tool, contact:

**HILEVEL**  
TECHNOLOGY, INC.

Park Irvine Business Center  
14661 Myford Road/Tustin, CA 92680  
(714) 731-9477

"SEE US AT WESCON/HILTON, BOOTH #H41"  
Circle 16 on reader service card

**Another increase  
in interest rates  
for U.S.  
Savings Bonds.**



**Ad Council** A public service of this publication  
and The Advertising Council.

**Growing Bigger...Faster.**

World Radio History

## People



**Achiever.** He's only 34, but Wally Rhines heads TI's MOS Microcomputers division.

notes the youngest vice president the company has ever had. "We have already won over 50 designs with it, and we are delivering production volumes less than six months after introduction." He thinks that the success came because the 9995's rapid mathematical computations hit a set of user needs that had not previously been addressed and can do so with a three-chip-per-system design at minimum.

He estimates that the microcomputer market, including 4-, 8- and 16-bit units, will grow at an annual rate of 40% during the next five years. To meet this growth, TI is putting all of its microcomputer resources under a single division. The move is part of an effort to "combine support and software development for all TI microcomputers," explains Rhines, who holds a Ph.D. in material sciences and engineering from Stanford University.

The consolidation also was created to facilitate upgrades of 4-bit device users to 8-bit users. But that does not mean the firm is turning its back on the highly successful TMS1000 family.

"We are continuing to introduce new 4-bit products," states the nine-year TI veteran, who first served in the company's Central Research Laboratories in Dallas. After other assignments, Rhines went to Lubbock, Texas, in 1976 to head component design and engineering for consumer products.

# Did you know that Mepco//Electra specializes in 11 different standard networks for data processing OEMs?

Networks for all reasons! A complete line of networks for all your data processing and digital equipment needs.

Yes, Mepco/Electra specializes in **11 standard networks**: 6, 8 and 10 pin standard S.I.P. resistor networks with line terminator, dual terminator, pull up/pull down circuits and 10K and 100K ECL terminator circuits.

**Check our specifications:** Resistance range  $47\Omega$  to  $1M\Omega$ ; Operating temperature range  $-55^\circ\text{C}$  to  $+125^\circ\text{C}$ ; Voltage rating 50 VDC, Tolerance  $\pm 1\%$ ,  $\pm 2\%$ ,  $\pm 5\%$  and  $\pm 10\%$ .

Power rating: as much as  $\frac{1}{4}W$  at  $25^\circ\text{C}$  per resistor.

Temperature coefficient  $\pm 200$  PPM/ $^\circ\text{C}$  standard,  $\pm 100$  PPM/ $^\circ\text{C}$

available; T.C. tracking between resistors  $\pm 50$  PPM/ $^\circ\text{C}$  and Voltage coefficient 150 PPM/V (Max), 25 PPM/V (Typical).

**And look at our performance:**

Environmental Characteristics Per Mil-R-83401		
Test	Mil-R-83401 Requirement (Max. $\Delta R$ )	Series 95 Test Results (Typical $\Delta R$ )
Thermal Shock	$\pm 0.5\%$	$\pm 0.2\%$
Power Conditioning	$\pm 0.5\%$	$\pm 0.1\%$
Low Temp. Operation	$\pm 0.5\%$	$\pm 0.5\%$
Short Time Overload	$\pm 0.5\%$	$\pm 0.6\%$
Terminal Strength	$\pm 0.25\%$	$\pm 0.5\%$
Moisture Resistance	$\pm 0.5\%$	$\pm 0.5\%$
Shock	$\pm 0.25\%$	$\pm 0.5\%$
Vibration	$\pm 0.25\%$	$\pm 0.5\%$
Load Life (1000 Hrs.)	$\pm 2.00\%$	$\pm 3\%$
High Temp. Exposure	$\pm 1.00\%$	$\pm 0.7\%$
Resistance To Soldering Heat	$\pm 0.25\%$	$\pm 0.6\%$

**All this and economical too!**  
The 2500 piece, standard 8 pin S.I.P. pull up/pull down resistor

network price is 33¢. And parts are **available from stock to 8 weeks.**

Try Mepco/Electra resistor networks in your data processing and digital equipment needs. For your resistor network needs call our Morristown facility at (201) 539-2000 or your local Mepco/Electra Distributor.

**Mepco/Electra: your resistor/capacitor company with tomorrow's technology today.**



Corporate Headquarters  
Columbia Road  
Morristown, New Jersey 07960  
(201) 539-2000  
TWX: 710/986/7437

Line Terminator

Pull Up/Pull Down

10K ECL Terminator

Dual Terminator

100K ECL Terminator

Photograph of 6, 8 & 10 pin Standard S.I.P. Dual Terminator Resistor Networks.

221/331GL M/E

331/391JL M/E

331/391GL M/E

© Copyright, 1981 Mepco/Electra, Inc.

## Now you do!

Circle 17 on reader service card



# When you're looking in memory design, there's

Back in 1969, when we introduced the world's first integrated 64-bit RAM, we literally started the whole revolution in memory design.

And we've stayed way out in front ever since. Because of all the companies in this business, we're the only one with the common sense to drive the design process in a full circle. From memory systems to microprocessors right on up to the next generation of memories, we just keep raising the level of technology higher and higher every step of the way.

It's that simple. Because we're the only company in the entire VLSI industry that designs a complete, state-of-the-art line of both memories *and* microprocessors.

What it amounts to is a definite feedback loop between our memory and microprocessor divisions. And you get all the benefits from it. Like easy upgrades. And faster design cycles.

You know the way it works: we

introduce a new memory, and it drives the technology forward. Our microprocessor people take advantage of this new technology. And use it to design new architecture. Which comes full cycle and drives our memory design group, who take the technology even farther forward.

Of course, it really amounts to momentum. And nobody else in the entire industry has the momentum we do.

Or the track record. We brought you the first MOS static RAM. The first integrated dynamic RAM. The first EPROM. The first 16K E<sup>2</sup>PROM. The first 1 megabit bubble. In fact, of the 31 breakthroughs in VLSI over the last decade, we delivered 24 of them first.

When you get right down to it, nobody else has the breadth we do, either. Our competitors might make memories for a few applications, but only Intel covers the entire scope of microprocessor-based products and gives you memories for every impor-

tant system application. Commercial and military. Complete with development tools and applications support.

And since we plan to keep coming around full circle this way for years, we've invested an enormous percentage of our profits right back into our design and production capability. So we can deliver all the memory product you need. Right when you need it.

That's the broad picture. Now we'd like to show you product by product, how we're right on the leading edge of memory development.

## **RAMs**

Ever since we introduced the first static and dynamic RAMs, we've gone on to develop just about every major breakthrough in this area to date. We're leading the way with redundancy techniques for high density 16K static and 64K dynamic RAMs. And with our new Series 800 family of RAMs, which we've designed to maximize effectiveness in specific microprocessor applications.

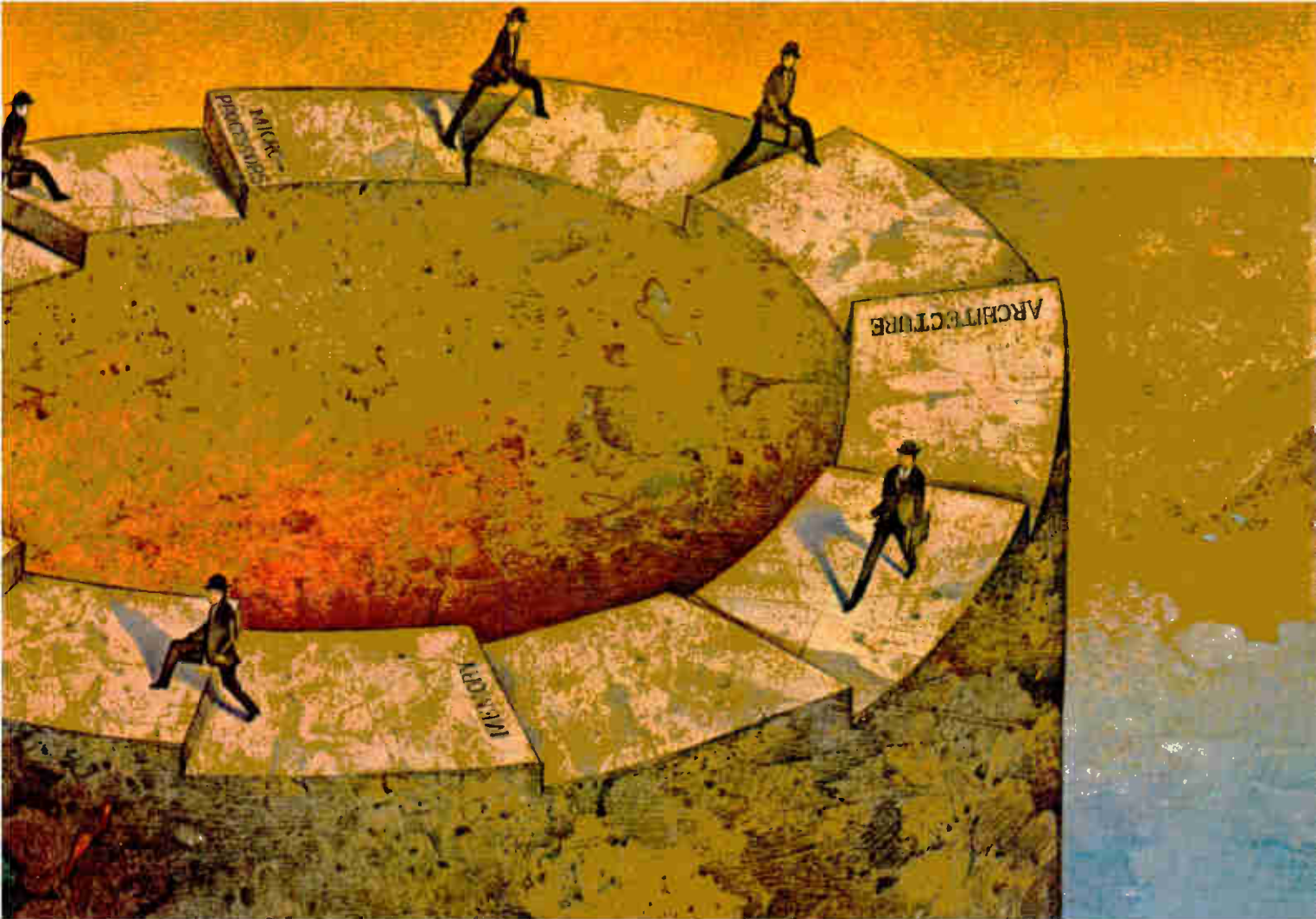

# for a real breakthrough only one sensible way to go.

## PROMs

Because of our process technology, we've always led the way in faster, denser PROMs, in MOS and bipolar.

In bipolar, we've developed a new process that gives our 16K PROM a 35ns access time. For its density, it's the fastest PROM available today. And with our new 32K, we'll take speed and density even further.

We're way out front with EPROMs, too. Because we invented them in the first place. And we've been upgrading them ever since. By giving you the first 5V only device. By establishing a complete byte-wide family.

And with our 16K E<sup>2</sup>PROM, we were the first to bring you in-circuit byte-erasability. And open whole new areas of design flexibility for you.

## BUBBLES

We were the first to recognize the need for a complete VLSI system approach to bubble storage memories, and made ourselves the key driving force behind

their acceptance, by producing the support circuitry which makes the total bubble solution easy to implement.

We're already producing bubbles in volume, with the yields supporting the long-term price guarantees we announced in 1980.

We've also introduced the Plug-a-Bubble™ System, which makes reprogramming in the field as easy as changing a cassette. And the iSBC™ bubble board, which gives you up to 512K bytes of memory and a Multibus™ interface on a single card. Of course, our bubble products are following the price guarantees we set last year, too.

## SYSTEMS

Our innovations show up just as often at the board level and system level. Where we're constantly improving the cost/performance per bit in add-in and add-on memory systems and off-the-shelf standard OEM memory systems.

Just as one example, our Series 90 standard memory system is now avail-

able with the iQX intelligent controller, which brings new levels of reliability and maintainability to memory systems.

## MEMORY SOLUTIONS

We've put together a new 64-page booklet that covers all our memories. It's called Memory Solutions. And we'd like you to have a copy. So get in touch with your local distributor or Intel sales office. Or write Intel Corporation, 3065 Bowers Avenue, Santa Clara, CA 95051. Or call us at (408) 987-8080.

It could be the most sensible thing you ever do.

Europe Intel International, Brussels, Belgium  
Japan Intel Japan, Tokyo United States and Canadian distributors Alliance, Almac/Strom, Arrow Electronics, Avnet Electronics, Component Specialties, Hamilton/Avnet, Hamilton/Electro Sales, Harvey, Industrial Components, Pioneer, L.A. Varah, Wyle Distribution Group, Zentronics

**intel** delivers solutions

TEK 2335/36/37 PORTABLE  
OSCILLOSCOPES

# Now there's a 100 MHz that's as tough as your field

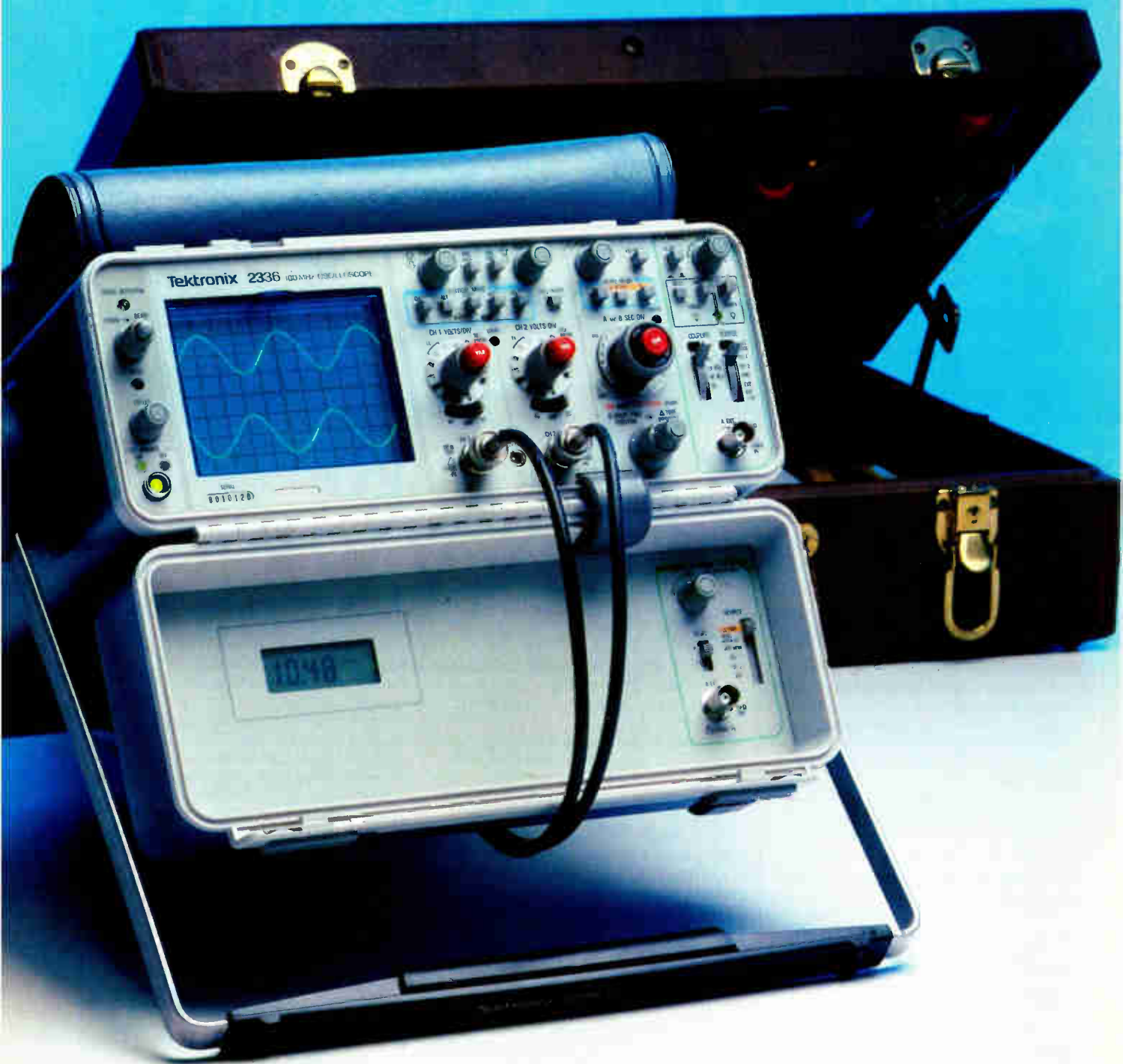

# scope service environment.

## A new concept in ultra-portables. Inside and out.

Service technicians have special needs. Their scopes must be small, powerful, versatile, and able to take the use and abuse of mobile field service.

Now, Tektronix offers three new, ultra-portable oscilloscopes for the field service environment.

Lightweight at about 17 lbs., these compact scopes are easy to carry, easy to use and rugged.

### Big scope performance.

With a 100 MHz bandwidth, these dual channel scopes are equipped for high speed logic and digital equipment testing. 5 ns horizontal sweep. 2 mV/div. vertical sensitivity. Dual channel and dual time-base measurements. Delayed sweep and more.

The easy viewing CRT displays the brightest, sharpest traces of any 100 MHz portable scope. Just as clear is the liquid crystal display for timing and the DMM in the flip top cover of the 2336 and 2337 models.

### Built to last in the field.

Built to last with unmatched performance in its size/weight class, the 2335 is Tektronix' solution to controlling your service oscilloscope life-cycle costs.

### You be the judge.

Call the Tektronix office nearest you. See for yourself how we can make your service people cost-effective and productive.

Model 2337 available September 1981

For further information, contact:

U.S.A., Asia, Australia, Central & South America, Japan  
Tektronix, Inc  
P.O. Box 4828  
Portland, OR 97208  
Phone: 800/547-6711  
Oregon only 800-452-6773  
Telex: 910-467-8708  
Cable: TEKTRONIX

Europe, Africa,  
Middle East  
Tektronix International Inc  
European Marketing Centre  
Postbox 327  
1180 AV Amstelveen  
The Netherlands  
Telex: 18312

Canada  
Tektronix Canada Inc  
P.O. Box 6500  
Barrie, Ontario L4M 4V3  
Phone: 705 737-2700

We're  
going  
places



**Tektronix**<sup>®</sup>  
COMMITTED TO EXCELLENCE

The International Standard of Quality guarantees these electrical AQLs on all parameters over the operating temperature range: 0.1% on MOS RAMs & ROMs; 0.2% on Bipolar Logic & Interface; 0.3% on Linear, LSI Logic & other memories.

**INT·STD·123**



If there's one thing this world doesn't need it's another rotten RAM. Another rejected ROM. One more paralyzed EPROM.

This is your chance to do something about it.

WE'RE ALREADY DOING OUR PARTS.

From now on, insist that all your MOS memories meet or exceed INT·STD·123, The

International Standard of Quality. We do.

Fact is, nobody's MOS RAMS and ROMS come with a guaranteed AQL better than 0.1%. Not here. Not in Japan.



# HELP STAMP OUT BAD MEMORIES.

---

Not anywhere.

And that's only one of the reasons we're among the industry's largest military and commercial memory suppliers. Here are a few others:

We put all our memories through the worst case test patterns we can come up with. We give every part MIL·STD·883 for free. And we've got the latest test equipment, the most complete line, the most

advanced products in the business.

Next time you buy MOS memories, don't take bad for an answer. Insist on INT·STD·123 from AMD.

**Advanced Micro Devices** 

901 Thompson Place, Sunnyvale, CA 94086 • (408) 732-2400

Circle 21 on reader service card

## The FAA's sins of omission

August, happily, is not a big month for industry conferences and conventions. But for those few meetings that were scheduled, registrants formed long lines at public telephones during coffee breaks in the attempt to book a seat on a departing flight. That has been one of the small but personally most irritating consequences of the strike of the Professional Air Traffic Controllers Organization.

More important to the nation at large will be the repercussions on U. S. airlines and the aircraft and avionics manufacturers that supply them. The carriers posted large losses in 1980 and in the first quarter of 1981, and their shaky economic position is being made still shakier by the Patco walkout. Reported revenue losses are running between \$20 million and \$30 million daily.

For the makers of commercial aircraft and their engines and avionic systems, the crunch has yet to come. But it will. These manufacturers expect that airlines will begin calling later this year either to defer delivery of new planes or to cancel some orders altogether.

It could be an example of ricochet economics at its worst. Some Reagan economic advisers fear the decline of this business could compound the problems of the general economic downturn that has already been forecast for the remainder of this year and so extend it further into 1982.

The pathetic part of all this is that the strike need not have happened at all if the Federal Aviation Administration had lived up to its repeated pledges to upgrade and automate the nation's air-traffic control system. That would have reduced the need for many of the controllers, for available electronic technology can perform at least as well and probably better many of the functions they now perform manually. Yet the FAA, like some of its other Federal counterparts, has been long on promises and short on performance.

The FAA, gripes one system planning staf-

fer, "does a great job when it comes to planning systems for use in the next decade, but it never gives much thought to today's problems or tomorrow's crisis. In the '60s we had great plans for the '70s. In the '70s we talked about the '80s. Today we are planning for the '90s."

Congress, too, has long been unhappy with FAA performance. As each new FAA administrator—backed up by the same old bureaucrats—has pleaded for funds to perform some technological magic on the air-traffic control system a decade hence, most Congressmen simply yawn. They have heard it all before.

The truly bad news is that the problem is unlikely to improve under the Reagan Administration as it continues to search for new ways to cut Federal spending and bring the budget into balance over four years. The FAA is a prime target in what is becoming a Catch-22 situation. For as the Patco strike reduces airline revenues, their taxable income will also decline, reducing Federal revenues even further and thus forcing even steeper cuts.

Laboring under that gloomy forecast, the outlook is discouraging at best for the FAA's automated en-route air traffic control system. Another 10-year effort with an estimated \$2.8 billion pricetag, AERA lumps together almost every conceivable subsystem imaginable, from a nationwide digital data net to doppler weather radars, microwave landing system and a collision avoidance system in every airplane cockpit [*Electronics*, Dec. 8, 1980, p. 48]. If those sound familiar it is only because they represent what the FAA has been studying and restudying for years.

If President Reagan and Secretary Lewis truly intend to rebuild the air-traffic control system as they say they are, then they must not stop at retraining a whole new crew of controllers. The whole FAA bureaucracy needs rebuilding, with emphasis on finding ways to move new technology into the system rapidly before problems become crises.



## We handle difficult personalities.

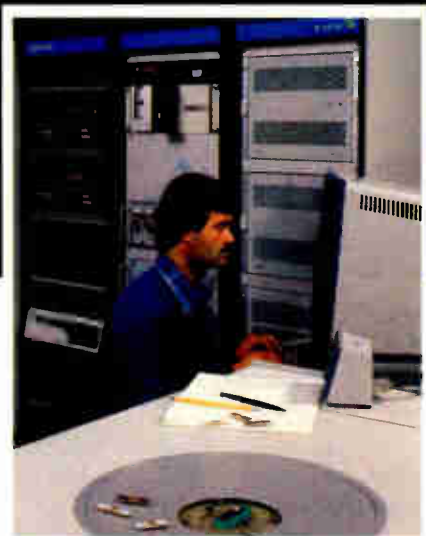

When it comes to characterization, many LSI/VLSI devices can be difficult little creatures. Normal evaluation procedures just won't work.

Like hybrids that present many simultaneous digital and analog operations. Or chips that require both algorithmic *and* random pattern testing. Plus the ability to change from one to the other on the fly.

There's only one test system that thrives on truly difficult personalities. The Tektronix S-3275. The more complex the device, the more you appreciate what the S-3275 can do.

Why? Because only the S-3275 combines all the right features into a single, powerful package. One that gives you the flexibility demanded by a growing versatility in device design and function.

### A system that optimizes design engineering productivity.

With 128 channels at 20 MHz, the S-3275's state-of-the-art pattern processor combines the functions of pattern processing and algorithmic pattern generation. The clock system provides 125 pS resolution on each of 16 phases. Plus the S-3275 has a waveform digitizer to provide FFT and THD analysis.

With the S-3275, you get more than just sophisticated hardware. You get TEKTEST III™, an operating system that allows up to four concurrent tasks.

So when you've got some difficult LSI/VLSI devices to handle, ask us. We know what to do with those kind of personalities.

For more information about the S-3275, contact your Tek Sales Engineer.

U.S.A., Asia, Australia, Central & South America, Japan  
Tektronix, Inc.  
PO Box 4828  
Portland, OR 97208  
Phone: 800/547-6711  
Oregon only 800/452-6773  
Telex: 910-467-8708  
Cable: TEKTRONIX

Canada  
Tektronix Canada Inc.  
PO Box 6500  
Barrie, Ontario L4M 4V3  
Phone: 705/737-2700

Europe, Africa, Middle East  
Tektronix International, Inc.  
European Marketing Centre  
Postbox 827  
1180 AV Amstelveen  
The Netherlands  
Telex 18312

**Tektronix®**  
COMMITTED TO EXCELLENCE

## CAMBION VERY-LOW-PROFILE (.093") IC SOCKETS

For dependable mounting of IC's on PC boards, choose from 2 different styles in 8 to 64-pin position sizes: *ROUND-PIN*, *SOLDER TAB* for mounting flush to boards, or *SQUARE-EDGE*, *WIRE-WRAPPABLE* version that grips both sides and edges of IC leads for increased reliability. Machined body provides rigidity for pin alignment and for IC insertion/extraction. Cambion delivers "where & when" at cost-efficient prices from its computerized off-the-shelf inventory. Get samples from over 100 Cambion Distributors, Cambridge Thermionic Corp., 445 Concord Ave., Cambridge, MA 02238, Tel: (617) 491-5400, Telex: 92-1480, TWX: (710) 320-6399.

Come on,  
make the  
connection!

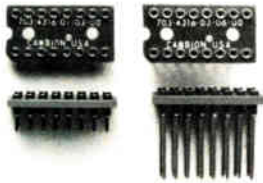

**CAMBION**  
The Right Connection.

Circle 26 on reader service card  
Visit us at WESCON, Booth 1312

## CAMBION CAGE JACKS...

convert costly minutes into profitable seconds! You're in volume production and need to PC board mount thousands of relays, fuses, switches, and other components that may require eventual replacement. Ree-lax! Specify Cambion plug-in CAGE JACKS and forget about unsoldering those faulty components and resoldering new ones. Instead, choose from over 70 different closed-entry mini CAGE JACKS that'll take pins/contacts from .014" to .093" dia. so your components can be replaced *fast!* Cambion ships "where & when" at great prices from its computerized off-the-shelf inventory. Get samples from over 100 Cambion Distributors, Cambridge Thermionic Corp., 445 Concord Ave., Cambridge, MA 02238, Tel: (617) 491-5400, Telex: 92-1480, TWX: (710) 320-6399. Come on, make the connection!



**CAMBION**  
The Right Connection.

Circle 116 on reader service card

## Meetings

**Comcon 81 Fall—22nd IEEE Computer Society International Conference**, IEEE (Victor Basili, Department of Computer Science, University of Maryland, College Park, Md. 20742), Capitol Hilton Hotel, Washington, D. C., Sept. 15-17.

**Wescon/81**, IEEE (Electronic Conventions Inc., Suite 410, 999 N. Sepulveda Blvd., El Segundo, Calif. 90245), Brooks Hall, Municipal Auditorium, and Hilton Hotel, San Francisco, Sept. 15-17.

**31st Annual Broadcast Symposium**, IEEE (R. A. O'Connor, CBS-TV Network, 51 W. 52nd St., New York, N. Y. 10019), The Washington Hotel, Washington, D. C., Sept. 16-18.

**ISS '81—International Switching Symposium**, IEEE (General Secretariat-ISS, Box 56, Station Ile des Soeurs, Verdun, P. Q. H3E 1J8, Canada), Hotel Bonaventure, Montreal, Canada, Sept. 21-25.

**Semicon/East '81**, Semiconductor Equipment and Materials Institute (625 Ellis St., Suite 212, Mountain View, Calif. 94043), Hynes Auditorium, Boston, Mass., Sept. 22-24.

**7th European Solid-State Circuits Conference**, IEEE, Convention of National Societies of Electrical Engineers of Western Europe (Bernd Hoefflinger, University of Dortmund, P. O. Box 500500, D-4600 Dortmund 50, West Germany), University of Freiburg, Freiburg, West Germany, Sept. 22-24.

**Electrical Overstress/Electrostatic Discharge Symposium**, IIT Research Institute (Nan Pfrimmer, Rome Air Development Center/RBRAC, Griffiss Air Force Base, N. Y. 13441), Aladdin Hotel, Las Vegas, Sept. 22-24.

**National Conference on Software**, Commission on Software Issues in the '80s (U. S. Professional Development Institute, 12611 Davan Dr., Silver Spring, Md. 20904), Shoreham Hotel, Washington, D. C., Oct. 5-6.

## HEWLETT PACKARD

DESKTOP &  
MINI COMPUTERS



### SAVINGS ALL MODELS

9845B ...  
9845C ... \$ CALL  
9835A ... OR  
9835B ... WRITE  
9826A ... FOR  
9825B ... PRICE  
9825T ... QUOTE  
HP85 ....

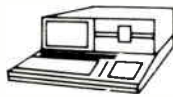

ALSO  
HP 1000L  
MINI COMPUTER  
SYSTEMS

#### CALL OR WRITE FOR FREE CATALOG

Call Now Toll Free—Ask For Opr. #554  
U.S.—800-824-7888  
Calif. only—800-852-7777  
Alaska/Hawaii—800-824-7919

## digital resources inc.

Box 23051, Portland, OR 97223 U.S.A.



503-246-0202  
NO SALES TAX  
International Sales  
Specialist—Telex 360-143

When you can't get action out west...

# COME EAST to CHERRY for CUSTOM ICs



## We'll treat you like a CUSTOMER!

We're the "action now" people who take your custom IC needs as seriously as you do. We know your business can't afford delays. So we give you the prompt attention you expect.

With full custom IC capabilities and some of the most advanced technology anywhere, we can meet your design, production and delivery schedules for digital and linear bipolar circuits. Need both on the same chip? We've done it with I<sup>2</sup>L... successfully!

And, if a full custom design isn't quite what you need, one of our circuits that has been processed up to the point where it is ready for your interconnect mask can be finished to your specifications, saving design time and cost.

Call us today for ACTION! Dial (401) 885-3600 and ask for Custom IC Engineering Sales. Or write for this 12-page, full color brochure describing production of custom ICs the Cherry way.

See Us At WESCON/San Francisco-Sept.15-17  
CHERRY BOOTHS: 1532-1538



# CHERRY SEMICONDUCTOR

**CHERRY SEMICONDUCTOR CORPORATION** 2000 South County Trail, East Greenwich, RI 02818/ 401/885-3600

A wholly owned subsidiary of Cherry Electrical Products Corp., Waukegan, IL, U.S.A., 312 689 7700 • Worldwide affiliates and phone numbers: Cherry Mikroschalter GmbH, Auerbach, Germany, 09 643 181 • Cherry Electrical Products Ltd., Harpenden (Herts) England, (05827) 63100 • Cerco Brasil Industria E Comercio Ltda., Sao Paulo 55 (011) 246-4343 • Hirose Cherry Precision Co., Ltd., Kawasaki, Japan, 044 933 3511

World Radio History

Circle 27 on reader service card

---

### LATEST NEFAX MACHINES HAVE NEW CAPABILITIES

---

**T**he NEFAX family of facsimile machines has grown with the addition of three new models.

The NEFAX-6500 meets both CCITT G3 and G2 standards for high and medium-speed transmission. And as an option, it can be provided with the low-speed mode to cover all speed ranges.

Through the use of LSI high-speed modem, the NEFAX-6500 can transmit a standard "A4" size page in 20 seconds—and through ultrahigh-speed mode in 10 seconds.

A switch on the NEFAX-6500 sets the number of scanning lines to either 7.7 lines/mm or 3.85 lines/mm in accordance with the resolution required. Its solid-state scanning system uses a CCD to enhance reliable operation.

The NEFAX-3700 is an addition to the NEFAX-3000 Series of medium-speed facsimile machines that meet CCITT G2 standards. It has a Super Express Mode that shortens transmission time by skipping over blank (white) portions of a document. Another new feature, Hi-Grey Scale Recording, reproduces half-tone nuances such as those found in photographs. And like the NEFAX-6500, the NEFAX-3700 can automatically send up to 30 pages in sequence.

Designed to fit on any office desk, the NEFAX-2000 is an economical medium-speed (G2) machine. It consumes little power—about 70VA—and is practically maintenance-free.

With these three new additions, the NEFAX line-up is now comprised of seven facsimile machines.



---

### LSI TRANSMULTIPLEXER INTRODUCED

---

**N**EC's new DTM-2400 transmultiplexer converts two 12-channel FDM group signals in the 60-108kHz band to a 24-channel digital carrier signal at 1.544Mb/s or vice versa.

Designed to satisfy all CCITT Recommendation G. 792 specifications by a large margin, the DTM-2400 incorporates state-of-the-art LSI and digital signal processing technology that reduces equipment size, cost, and power consumption. It is housed in a compact W19" x H7" x D14" subrack mountable in an EIA standard 19" rack.

The DTM-2400 has various options for signalling conversion, clock synchronization and signal interface conditions. For example, two replaceable modules are available for signalling conversion: a 3,825 (or 3,850) Hz out-of-band signalling module and a 2,600Hz SF signalling module.



A transmultiplexer with a larger capacity will become available later this year. This, the DTM-1200, will be able to perform a bilateral conversion between two 60-channel supergroup signals (2 x FDM BSG) in the 312-552 kHz band and five 24-channel PCM (5 x 1.544Mb/s) signals or four 30-channel PCM (4 x 2.048Mb/s) signals.

---

### FIP DISPLAYS FINE-PATTERN GRAPHICS

---

**B**ecause they are flat and provide easy-to-see displays without flickering or misregistration, graphic fluorescent indicator panels (FIP) are expected to replace cathode ray tubes in small display terminals.

The new FIP240A4XT from NEC is a large capacity 60 x 280 dot fluorescent indicator panel capable of displaying

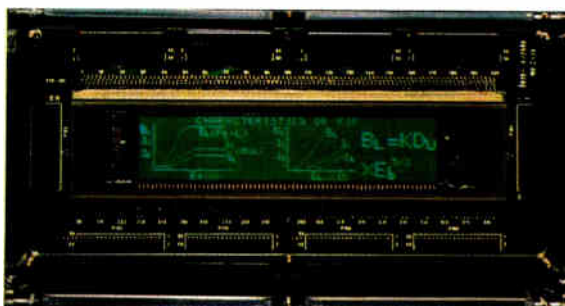

240 characters (40ch. x 6 lines). In addition, it can display fine-pattern graphics such as illustrations, tables and drawings with even brightness, and free from deformation.

These capabilities are due to the FIP240A4XT's 16,800 dot cells that are arranged at uniform 0.65 mm pitch intervals in an effective display area 38.80mm (vertical) x 181.80mm (horizontal). Each dot measures 0.45 x 0.45mm.

This large capacity graphic FIP is appropriate for a wide variety of hardware, including word processors, electronic typewriters, POS terminals and banking systems.

---

### MEXICO TO EXPAND MICROWAVE COMMUNICATIONS SYSTEM

---

**M**exico will have a fully solid-state 2700-channel microwave communications system installed by early 1982 along an existing link that extends about 2,200 kilometers from Guadalajara to Tijuana.

The new 45-station 2,200 kilometer microwave system was ordered from NEC by the Secretaría de Comunicaciones y Transportes, Dirección General de Telecomunicaciones (SCT), United States of Mexico. It will be equipped with NEC's latest 500 Series, including the TR-5G2700-500 microwave communications equipment.

The TR-5G2700-500 has a micro-

wave signal output power of 7 watts, uses no travelling wave tubes, and can handle 2,700 telephone channels on one RF carrier. The new Mexican system will be designed so that its channel capacity can be expanded up to 13,500 in the future.

Notably absent from the project is the construction of new station buildings. This is because the slim 500 Series equipment requires minimum floor space and can be installed in existing stations.

The major equipment will be manufactured locally by NEC de Mexico, S.A., de C.V., headquartered at Edo. de Morelos, near Mexico City.

# NEC

Nippon Electric Co., Ltd.  
P.O. Box 1, Takanawa, Tokyo, Japan.

# BIOMATION *K101-D*

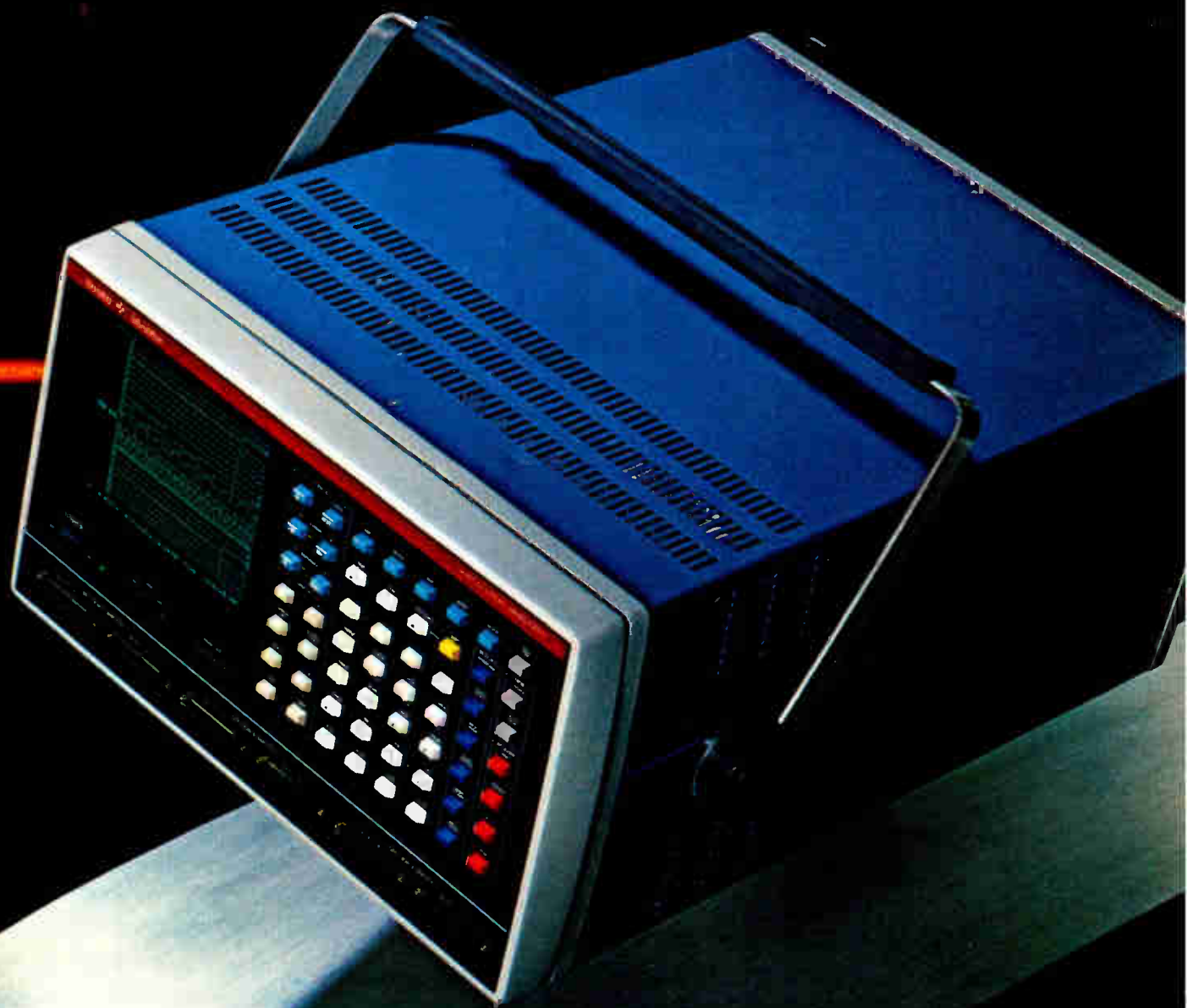



# BREAKTHROUGH

## The most powerful general purpose logic analyzer you can buy for the years ahead.

It's here. Biomation K101-D. The first logic analyzer to combine high-speed 50 MHz data and 100 MHz time domain capabilities with advanced 48-channel recording. With enough powerful extras to demolish your toughest hardware/software integration problems—even on the most complex multiplexed microprocessor.

### Fast, accurate software debugging.

With its 50 MHz clock rate, 48-channel recording and 16 triggering levels, the K101-D isolates software bugs faster and more precisely than ever before. Sophisticated disassembly firm-

ware generates precise mnemonics that cut analyzing time. And 12 external clocks (AND or OR) let you demultiplex 16-bit microprocessors, 16- and 32-bit minicomputers and bit-slice processors.

### 100 MHz high-speed hardware analysis.

The K101-D's advanced high-performance hybrid probes let you capture glitches as narrow as 5 ns. And, with 48-channel recording, 515-word memory and 16-level triggering, you'll trap the data you need. The convenient display formatting and expansion simplify analysis.

### Call now for a free demo.

See for yourself why the K101-D is a breakthrough in logic analyzers for the years ahead. For a demonstration or a copy of our detailed product brochure, write Gould Inc., Biomation Operation, 4600 Old Ironsides Drive, Santa Clara, CA 95050. For fastest response, call 408-988-6800.



**For powerful software debugging,** K101-D data domain capabilities include disassembly, 50 MHz clocking, 48-channel recording, 12 external clocks, 515-word memory, demultiplexing, 16-level trace control for triggering, 6 display code formats, and reference memory.



**For powerful hardware debugging,** K101-D time domain capabilities include 100 MHz clocking, 48-channel recording, 515-word memory, 5-ns glitch capture, 16-level triggering, channel labeling, new high-performance probe design, as well as horizontal and vertical display expansion for easy reading.

 **GOULD**  
An Electrical/Electronics Company

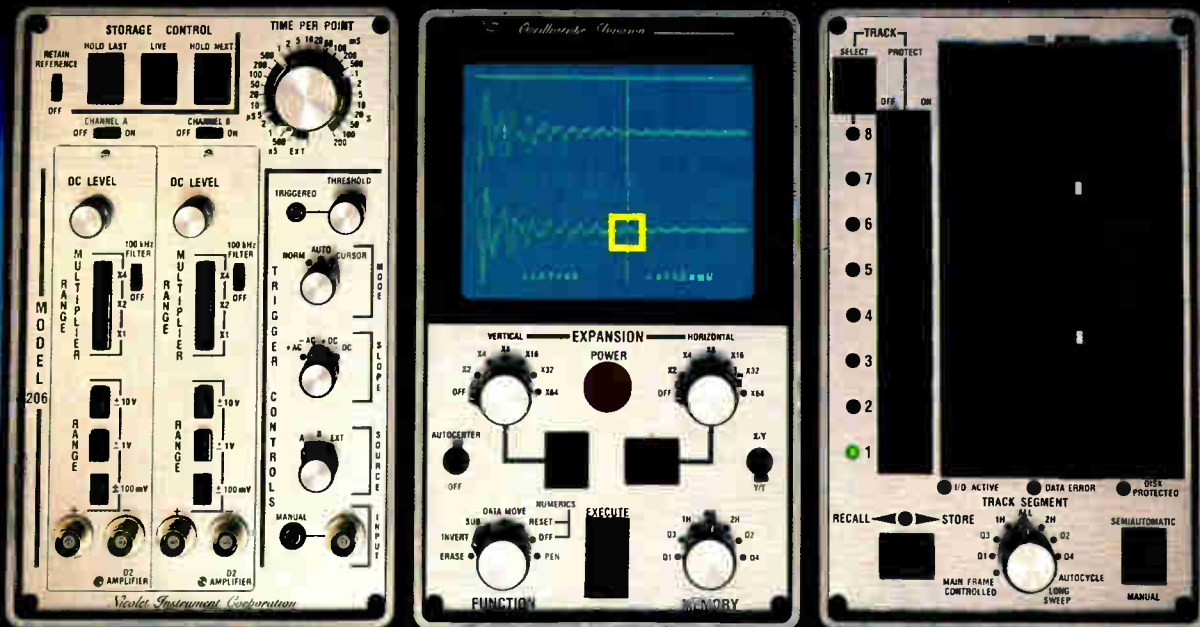

# See things you've never seen before.

Nicolet digital oscilloscopes offer you resolution, precision, dynamic range and transient capture capabilities unobtainable on analog oscilloscopes. *They are simple to operate and yet extremely versatile.*

Signals can be viewed live, continuously compared to a reference waveform or stored for detailed examination. Continuous, normal and pre-trigger operation are offered as standard and in all modes cursor-interactive time and voltage coordinates can be displayed concurrently with the signal. Stored waveforms can be displayed or plotted in XY or YT format, transferred to internal disk memory for permanent storage or output to other

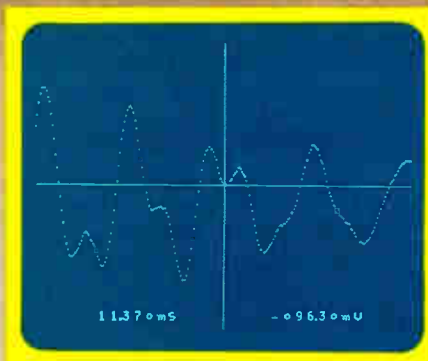

Expansion of selected area in above photo, for detailed analysis.



computing devices via industry standard interfaces.

In addition to offering you the performance you would expect from the industry leader, Nicolet digital oscilloscopes are extremely well proven with thousands in effective use throughout the world.

*Find out how Nicolet can help you solve problems and see things you've never seen before.*

For more information, simply circle the reader service card or call 608/271-3333. Or write: Nicolet Instrument Corporation, 5225 Verona Road, Madison, Wisconsin 53711.

**NICOLET INSTRUMENT CORPORATION**  
OSCILLOSCOPE DIVISION  
Sales and Service Offices Worldwide

# Digital Nicolet Oscilloscopes

Circle 32 on reader service card

## IBM poised to plug in 8087 number cruncher

Look for IBM Corp. to supercharge the number-crunching ability of its new personal computer (see p. 50) in early 1982. That's when it will be able to plug in Intel's 8087 arithmetic coprocessor, **which can be accommodated on the 8088 processor board.** The early 1982 date is when languages like PL/1-86, which can use the 8087, will become available. IBM will not discuss the matter.

## 1,000-V part among Motorola MOS FETs . . .

Backing up its strong commitment to power MOS field-effect transistors, Motorola Inc. expects to introduce about 180 new parts in the next six months. Scheduled from the Phoenix operation are 500-V p-channel FETs and soon to be announced 1,000-V devices—the highest voltage rating yet for a power MOS transistor. **Rated at up to 1 A with an on-resistance of 10  $\Omega$ , the kilovolt devices will sell for about \$12.** Although attractive for European markets because of the higher voltages there, the general appeal of such devices is uncertain—Motorola is testing the waters.

## . . . with high-voltage bipolars also listed

The expanded MOS effort does not mean bipolar devices are taking a back seat in the Power Products division at Motorola. Continued work on second- and third-generation Switchmode parts **will result in high-voltage bipolars, also.** Meanwhile, the Bipolar Integrated Circuit division is eagerly awaiting clearance to release semi-custom linear master-slice chips through Motorola's computer-aided design centers.

## New instrument combines data capture, analysis, display

A marriage of computer, data-acquisition system, and digital oscilloscope, the under-\$10,000 Data 600 from Data Precision Corp. in Danvers, Mass., is expected to bow within a month. Among its capabilities are acceptance of multichannel inputs at frequencies as high as 100 MHz and, using a 16-bit microprocessor, **performance of a variety of signal-processing and display tasks.** Many forms of sophisticated analysis are to be available with a single keystroke; among them is fast Fourier analysis.

## North Star adds multiuser, graphics capabilities to line

Keeping pace with the rapidly building market, personal computers' capabilities continue to mushroom. The latest step upward is from North Star Computers Inc.: a multiuser personal system and a desktop unit with full graphics capability. The San Leandro, Calif., firm is expanding its Horizon line to make it accessible to up to five users by **incorporating a 5¼-in., 5-megabyte Winchester drive for the TSS/5 model,** or a 14-in., 18-megabyte drive in the TSS/18 with an optional 13.4-megabyte tape backup. Cost will average \$2,508 per user, says North Star. The new machine with the graphics capability, called Advantage, will sell for \$3,999. That will buy a 12-in. display, two 5¼-in. high-density floppy disk drives, and graphics software packages.

## Redfield's new firm readies small computer

After a 16-month gestation period, the firm purchased in May 1980 by Peter Redfield, the man who founded and headed the ill-fated IteL Corp., is about to introduce **the first of a series of new products developed under his leadership.** The 13-year-old Digital Scientific Inc. of San Diego will unveil the Meta 4 2000, a Z80B-based small-business computer system

# Electronics newsletter

using the CP/M operating system with a disk capacity of up to 40 megabytes and a streaming tape drive backup for Winchester versions.

## **PDP-11, LSI-11 memories due from Cambex**

Two high-density, single-board memories for Digital Equipment Corp.'s PDP-11 and LSI-11 systems will accelerate Cambex Corp.'s drive into DEC-compatible markets this fall. **The Waltham, Mass., firm says its 512-K byte LSI-11 memory, priced at about \$2,400, is the densest yet and takes advantage of the LSI-11's new 22-bit addressing capability.** A second add-in, a 1-megabyte board for PDP-11 computers, will cost around \$6,300. Also in final development is a semiconductor replacement for DEC's RK05 disk memory; with 256-K bytes to 5 megabytes of capacity, the system will cost about \$11,000 per megabyte as a mainframe add-in.

## **Microcomputer boards to get silicone coat**

With the oil-exploration industry showing great interest in the finished product, Texas Instruments Inc. of Dallas plans to offer a new line of industrial-grade MOS microcomputer boards that will be conformally coated with a transparent silicone resin. A product of Owens-Corning Fiberglas Corp. of Toledo, Ohio, **the resin is designed to protect the board and its components against corrosion from acid, salt, moisture, dust, and abrasions.** Initially, TI will offer five members of the new TM990/C series of 16-bit-microprocessor-based boards. Each will be a complementary-MOS version of the standard TM990 microcomputer boards at present on the market. The coating, the C-MOS static memory devices, and special handling will add 25% to 30% to the price of the boards.

## **Ada gets first commercial compiler**

The rapidly maturing Ada programming language is about to take a giant step toward practical applications with the commercial release of the first Ada compiler. From Telesoft of San Diego, the compiler will sell for \$2,400 and is part of the company's Program Support Environment, **which includes Pascal and the ROS multitasking operating system.** Telesoft, which last spring merged with hardware maker Renaissance Systems Inc. [*Electronics*, May 5, p. 44], also is now offering its T68-KQ central-processing-unit board, which operates on the Digital Equipment Corp. Q-bus, and a work station that uses the board and includes an intelligent terminal with floppy-disk or Winchester storage and 256-K bytes of random-access memory.

## **Addenda**

Arco Solar Inc. has terminated the \$25 million contract under which it supported Energy Conversion Devices Inc.'s research on amorphous silicon photovoltaic cells. The Chatsworth, Calif., subsidiary of oil giant Atlantic Richfield Co. has told its former partner that **it has better options for research into thin-film amorphous materials,** ECD's specialty, but refuses to discuss the decision further. Industry speculation holds that a major reason is a multimillion-dollar investment Standard Oil of Ohio is reportedly making in the Troy, Mich.-based ECD. . . LSI Logic Corp., the Santa Clara, Calif., firm that is working with Toshiba Corp. on an advanced complementary-MOS logic array family (see p. 64), **is also bent on becoming a full second source of Motorola emitter-coupled-logic Macrocells.** The 600- and 1,200-gate devices provide delays of 900 ps.

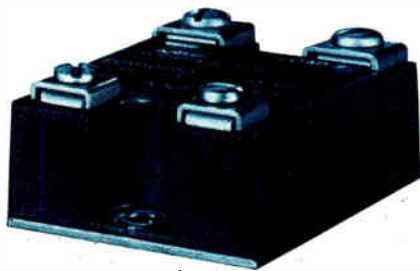

## Superior SSR Immunity to EMI. Under \$6.40\*.

Potter & Brumfield EOM series solid state relays do not false operate (half-cycle) even when subjected to EMI induced by transients greater than 10,000 Vpp (NEMA ICS 2-230 Electrical Noise Immunity Test). And they come in a low profile package at low, low prices.

Transients of less than 1500 Vpp can cause many SSRs to half-cycle, generating even more EMI which can upset sensitive logic circuits. Half-cycling can also lead to early relay failure and shortened load life.

EMI radiated or coupled into these SSRs through the baseplate, input terminals or plastic case can false operate the off-state triac/SCR gate firing circuit. This negates the zero-crossover function, so gating can occur at or near peak AC load voltage. Load current

\*OEM quantities

will then flow until the next zero-current point, and the load circuit becomes a potential source of harmful EMI.

The high noise immunity EOM can minimize these circuit problems. For complete specifications and results of our NEMA tests, write for product application note "False Operation of Solid State Relays."

The newest EOM in our SSR family measures only 0.875" high; and 10 amp, 120V AC models are available from leading distributors backed by P&B's sizable factory inventory. Consult our factory for other voltage and current ratings. Potter & Brumfield Division AMF Incorporated,

200 Richland Creek Drive,  
Princeton, IN 47671. 812/  
386-1000.



**We're demanding so  
you don't have to be.**

# Potter & Brumfield

*Meeting Japan's Challenge*

---

*First in a Series*

**IS JAPAN'S  
CHALLENGE TO  
AMERICAN  
INDUSTRY GOING  
UNANSWERED?**

*"What are you doing about Japan?" It's a question we are asked almost daily.*

*It may be the single most important question American business faces. The challenge to the U.S. economic position that Japan poses is serious.*

*Starting now and for months to come, we're going to be answering that question—in public.*

*Obviously, this is a subject on which many companies can speak out, and should. We are doing so because we believe it will be good for our country, good for Japan, and good for Motorola.*

*It will be good for America to correct the impression many Americans have that Japanese businesses are in some way inherently superior. That impression is false.*

*It will be good for Japan because Japan relies on a strong confident America as a trading partner and ally.*

*It will be good for us because by learning how Motorola is meeting the challenge, you will have a more balanced, accurate view of our ability to serve our customers best anywhere in the world.*

*Now, don't get us wrong. We respect Japanese businesses. They are our customers and suppliers, as well as our competitors. And they are very good.*

*But we also know there are many things American companies like Motorola do extraordinarily well today. And we have an exciting commitment to do things even better in the weeks and months to come.*

*At Motorola, these things take the specific form of the development of new technology, employee participation in management, quality standards, accomplishments in productivity, effective cooperation with our government in foreign trade, and many other programs, products and plans of a company that is succeeding now and committed to perfection.*

*These will be the subjects of ads to come.*

*Motorola understands the challenge from Japan.*

*You can be sure we're not leaving it unanswered.*



**MOTOROLA** A World Leader In Electronics

*Quality and productivity through employee participation in management.*

©1981 Motorola Inc. Motorola and  are registered trademarks of Motorola, Inc.

Circle 37 on reader service card

# Here's why we're Number One.

When it comes to logic probes, more people purchase Global Specialties! Because you can spend twice as much and not get the speed, precision, flexibility and accuracy offered by our four logically-priced probes—including our remarkable new 150 MHz ECL Probe. Not to mention the versatility, reliability and durability we've become famous for.

But we don't stop there. When it comes to logic testing, Global Specialties does the *complete* job. With our DP-1 auto-sensing digital signal injector—for fast, easy stimulus-response testing, at an economical \$83.00\*. Plus a line of multi-channel Logic Monitors that provide an inside picture of circuit activity at up to 40 nodes simultaneously. And each product has an idea-filled applications manual—as well as an unmatched line of highly-functional accessories, to extend its versatility still more.

With Global Specialties, there's no need to compromise on performance. Or *value*. Discover for yourself why we're the number-one logical choice!

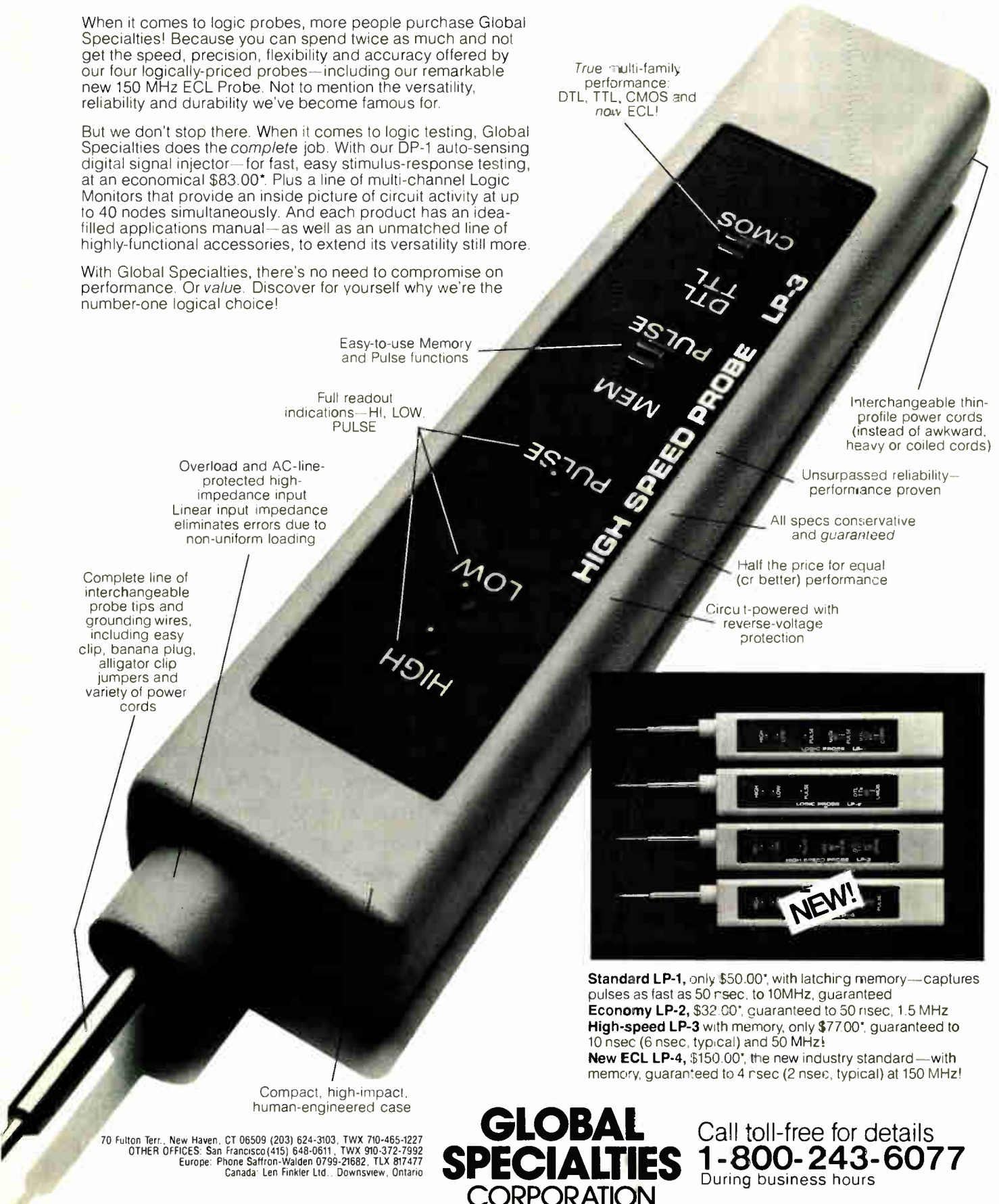

True multi-family performance: DTL, TTL, CMOS and now ECL!

Easy-to-use Memory and Pulse functions

Full readout indications—HI, LOW, PULSE

Overload and AC-line-protected high-impedance input  
Linear input impedance eliminates errors due to non-uniform loading

Complete line of interchangeable probe tips and grounding wires, including easy clip, banana plug, alligator clip jumpers and variety of power cords

Interchangeable thin-profile power cords (instead of awkward, heavy or coiled cords)

Unsurpassed reliability—performance proven

All specs conservative and *guaranteed*

Half the price for equal (or better) performance

Circuit-powered with reverse-voltage protection

Compact, high-impact, human-engineered case



**Standard LP-1**, only \$50.00\*, with latching memory—captures pulses as fast as 50 nsec. to 10MHz, guaranteed

**Economy LP-2**, \$32.00\*, guaranteed to 50 nsec, 1.5 MHz

**High-speed LP-3** with memory, only \$77.00\*, guaranteed to 10 nsec (6 nsec, typical) and 50 MHz!

**New ECL LP-4**, \$150.00\*, the new industry standard—with memory, guaranteed to 4 nsec (2 nsec, typical) at 150 MHz!

70 Fulton Terr., New Haven, CT 06509 (203) 624-3103, TWX 710-465-1227  
OTHER OFFICES: San Francisco (415) 648-0611, TWX 910-372-7992  
Europe: Phone Safron-Walden 0799-21682, TLX 817477  
Canada: Len Finkler Ltd., Downsview, Ontario

**GLOBAL SPECIALTIES CORPORATION**

Call toll-free for details  
**1-800-243-6077**  
During business hours

\*Suggested U.S. resale. Prices, specifications subject to change without notice. © Copyright 1981 Global Specialties Corporation

Circle 38 on reader service card

World Radio History



## High-frequency thin-film transistor operates at 200°C

by Roderic Beresford, Components Editor

Lithographic techniques adapted from IC fabrication form cadmium selenide devices on glass substrate

**Microelectronics Engineering Corp.**, a small custom hybrid-circuit house in the Deep South, has quietly developed an advanced process for the fabrication of thin-film transistors that any large semiconductor house would envy: the process yields cadmium-selenide small-signal transistors that can withstand temperatures up to 200°C.

The two-year project that led to the new transistor-making technique is part of an Army manufacturing-technology improvement program. "We are using advanced computer-aided processing to manufacture thin films," notes Samuel Hartin, vice president of business operations for the Auburn, Ala., firm. "Photolithography and automated control of deposition parameters give us reproducible, high-yield devices." Thin-film transistors (TFTs) in the past have given relatively poor electrical performance, in part because small, tightly controlled geometries are impossible with the relatively crude masked-evaporation methods ordinarily used to fabricate them.

**Heat beater.** Familiar integrated-circuit industry techniques for patterning and deposition benefit TFTs tremendously. "They've abandoned the old masked-evaporation process," comments Robert Brown, general engineer at the Redstone Arsenal in Huntsville, "and are adopting standard lithography to produce per-

fectly viable devices for demanding applications where silicon just won't work." The key to the high-temperature performance is the semiconductor CdSe, whose thermal properties lead to transistors with temperature coefficients about an order of magnitude lower than typical silicon devices, adds Brown.

The TFTs are built up on a glass substrate, which is not only inexpensive, but also can be virtually any size desired. A thin layer of aluminum oxide is first deposited over the entire substrate as a high-purity isolation layer.

As shown in the figure, the source and drain regions—made of a material MEC will not name—are topped by polycrystalline gate insulation and metal contacts. They are formed by deposition and patterning steps using standard 2.5-to-4-micrometer photolithography.

The accurate pattern control possible with photolithography keeps the gate-source and gate-drain overlap down to about 10% of the gate area, reducing the parasitic capaci-

tance that limits frequency response. These field-effect transistors can operate at frequencies of a few tens of megahertz and could reach several hundreds. Transconductance at present is high—about 0.1 mho.

Although the small-signal transistors are not intended for power handling, their heat dissipation can be boosted by using substrates with higher thermal conductivity, such as anodized aluminum or beryllia.

As for low temperatures, the devices have been tested down to -65°C and are expected to stand up to significantly lower temperatures.

Although MEC has emphasized the transistor's high-temperature capabilities, its thin-film technology is "essentially the same as that developed at Westinghouse Electric Corp. in the mid 1970s," maintains Peter Brody, who left Westinghouse to work at his own firm, PanelVision, also located in Pittsburgh, Pa. [*Electronics*, March 13, 1980, p. 127].

The possibility of fabricating decoders and drivers out of thin-film transistors at low cost makes this

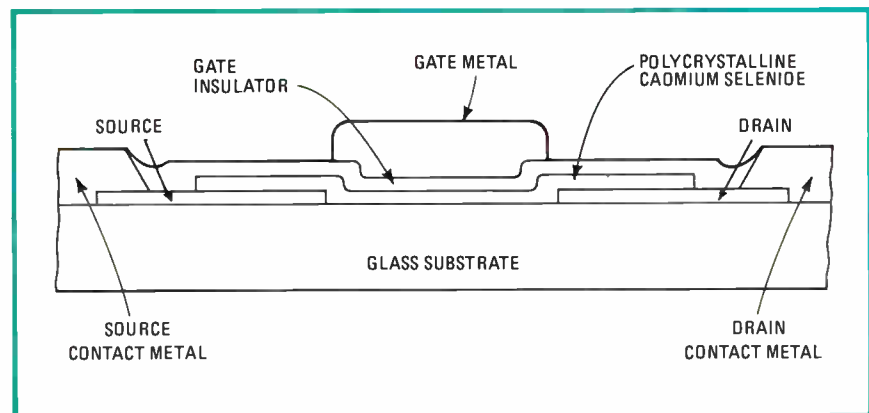

**Advance.** Cross section of thin-film transistor shows depletion-mode cadmium selenide channel formed by the photolithography of deposited polycrystalline material.

technology most promising for the eventual production of flat-panel electro-optical displays. Brody says the extensive work at Westinghouse is the source of most of the know-how behind current work in TFTs. "It's high time some others got into the act," he says.

MEC, which will use the TFTs in

high-temperature military and commercial circuits, also works with thick-film hybrids. It has developed a fine-line fabrication process that produces 2-mil-wide interconnects. These dense thick-film circuits will be used in new versions of the controls found on passengers' seats in the 747, DC10, and L1011 jets.

### Tailoring the 3600 to Lisp

The Lisp language was designed at the Massachusetts Institute of Technology in Cambridge primarily for investigations into how human intelligence could be modeled on computers. As it developed, the computer model grew to require a lot of main memory. Moreover, it executes relatively slowly on general-purpose computers, which is why Symbolics Inc. developed the 3600 computer hardware designed for the idiosyncracies of Lisp.

The language is highly symbolic and allows complex data structures—called objects—to be defined and manipulated by single instructions. An object could, for example, be a payroll record for John Doe. It would consist of different pieces of information, including Doe's address, social-security number, pay rate, and tax status.

Once the programmer defines the object, "John Doe," its individual parts (pay rate, for one), can be accessed by a relatively simple command like "Change John Doe's pay rate to \$20,000." Lisp will then automatically retrieve the information from the object and update and store it. A programmer need not write any of the routines for manipulating data that an ordinary language requires, which greatly speeds program development.

To accomplish the same functions in another language would require just about as much memory as Lisp requires. However, because it is so easy for the programmer to manage and manipulate data objects, the tendency is to create ever more complex one, and the memory needed balloons.

But not only are programs larger with Lisp; the run-time environment is larger too, boosting memory requirements still more. For instance, an interpreter and compiler are stored in memory, along with an on-line editor and other utilities.

So much more must be done at run time that a well-written Fortran program, for example, will always run faster on a general-purpose computer than will an equivalent Lisp program. Symbolics' 3600, has been built with special hardware and microcoded architecture to speed up the chores specific to the language. For example, Lisp needs extensive run-time error checking and the 3600 performs the checks in parallel with instruction decoding. It needs this checking to insure that modules that may have been separately compiled do indeed refer to the same type of objects.

The 3600 also has special data paths to identify the data type being implied by a generic instruction. For example, Lisp allows a single instruction, like add, to be used with many data types; separate instructions like floating-point add and integer add used with other languages are not needed. This single generic instruction is possible because the microcode that decodes instructions first determines the data types being used.

Another important design facet of the 3600 is its ability to track with small cache memories the temporary storage locations used for Lisp. The language makes extensive use of dynamic storage allocation—data objects are created and deleted from memory during program execution. Keeping track of these locations can add significantly to the run time of an ordinary computer. In fact, many of the Lisp implementations on general-purpose computers must periodically stop the program from running in order to do such "garbage collection"—the identification and reclaiming of storage no longer being used. The 3600 handles this chore while hardly slowing the processing at all.

—R. Colin Johnson

## Computers

### Lisp language gets special machine

A powerful new minicomputer whose architecture exploits the high-level Lisp programming language is about ready to go. The Symbolics 3600 targets the booming software development business and its computer-aided design and artificial-intelligence segments that eat up memory capacity and demand high speed. The computer, to be built by Symbolics, Inc., Woodland Hills, Calif., has 1.125 billion bytes of address space (256 million 36-bit words) and processes more than 1 million instructions per second.

Although performance at least beats more expensive minicomputers, this is not its prime feature, says marketing director Henry Baker Jr., "Total integration of the hardware with a large proven Lisp software base" takes the spotlight, he says.

Closely behind is price, about \$60,000 in quantity for a work station (\$75,000 for one), far cheaper than roughly equivalent minicomputers programmed for Lisp and Symbolics' own lower level LM-2 introduced for \$100,000 [*Electronics*, Aug. 11, p. 159].

Another view of the 3600's speed/price edge, according to Baker, is that it should operate twice as fast as a Digital Equipment Corp. VAX/780 computer selling for about \$200,000 and nearly as fast as a DEC 20/60, at around \$400,000, when both are running Lisp. These and other 3600 performance specifications are derived from simulations done on a Symbolics LM-2.

Although the 3600 shares with the LM-2 many basic operating traits common to Lisp, there are many differences. With any other computer, Lisp is just another program, but with the 3600, [Lisp's] features dominate the entire operating system and hardware architecture, Baker says. He sees the LM-2 as a transitional machine for Lisp experimen-

tation, with the 3600 taking over as a better and cheaper standard workstation.

One improvement that helps to boost speed to more than three times the LM-2 is data paths that permit parallel execution of the operations unique to Lisp. Other structural changes that push performance higher, according to Baker, include "an overlapped instruction fetch and an asymmetrical but dynamically more optimal instruction set."

Other upgraded features of the new Symbolics computer include packages that execute both Fortran-77 and Pascal, in addition to the primary Zetalisp in which all system programs are written. Also, a 68000-based front-end processor takes much of the load off the central processing unit during most operations by controlling low and medium-speed input/output devices and implementing error logging and recovery. It also debugs the 3600 when not running.

To simplify design and cut manufacturing costs, Symbolics chopped the board total to 6 from 14 in the LM-2. Chiefly, it did this by using more large-scale integration along with microcode to squeeze what

were formerly separate I/O controller boards (including those for disk, display, and local-network interfacing) onto the processor. Also, mass memory uses 64-K random-access memories, instead of the LM-2's 16-K RAMs.

The 3600's basic hardware consists of a free-standing cabinet containing the microcoded CPU, 1,125 megabytes of main memory, a fast-access 67-megabyte Winchester disk, and Ethernet II interface and two serial lines. A graphics console holds a keyboard, a landscape-format 1000-line black-and-white bit-mapped display, a "mouse" (pointing device), and includes audio output. An option is a color monitor. Extensive graphics software is built into Zetalisp itself, allowing multiple overlapping windows of information to be easily displayed.

Symbolics will unveil the 3600 this month at the Seventh International Joint Conference on Artificial Intelligence in Vancouver, B. C., Canada. Production will start soon for initial deliveries next March with rates to peak at 15 a month by the end of 1982. LM-2 manufacture will likely be all phased out by then, says Baker.

-Larry Waller

1980, p. 41]. Some of these devices have been fairly complex and costly to build, and some require large amounts of high-speed emitter-coupled logic to act as temporary memory for them.

Now, assistant group leader Richard W. Ralston, and staff member Daniel L. Smythe of the Massachusetts Institute of Technology's Lincoln Laboratory in Lexington, Mass., have developed what may be the simplest SAW correlator yet. Theoretically, it could be built monolithically and would not require costly outboard memory.

The unit consists of a lithium niobate piezoelectric SAW device resting on spacers about 350 nanometers above a silicon semiconductor sheet. On the silicon are 300 metal strips, or fingers, laid down at right angles to the direction of wave travel in the LiNbO<sub>3</sub>. Each finger is connected at one end to an MOS field-effect transistor and, through the transistor, to ground.

**Reference first.** During operation, all 300 transistor gates are momentarily biased on, grounding each finger for 4 to 5 microseconds as a reference wave propagates down the SAW device. The wave's electrical fields interact with free carriers in the silicon to leave a positive or negative charge on each finger. The charge pattern varies with the envelope of the reference wave, and its characteristic pattern is captured when the FETs are turned off at the end of their 4-to-5- $\mu$ s second sampling period. Turn-off takes about one nanosecond, more than fast

## Microwaves

### Surface-acoustic-wave signal processor reflects simplified correlator design

Military communications and radar systems are increasingly using pseudorandom-noise modulation or spread-spectrum multifrequency transmissions to make their signals harder to jam and detect. Receiving these more complex signals is not simple either.

The answer to date has been an ever more sophisticated series of analog correlators, convolvers, and filters, often built around surface-acoustic-wave (SAW) devices, that

**Finger wave.** Lincoln Lab correlator relies on SAW propagating along lithium niobate to create a charge pattern in metal fingers resting on a silicon sheet containing MOS FETs.

capture the signals in the midst of apparent noise [*Electronics*, July 31,

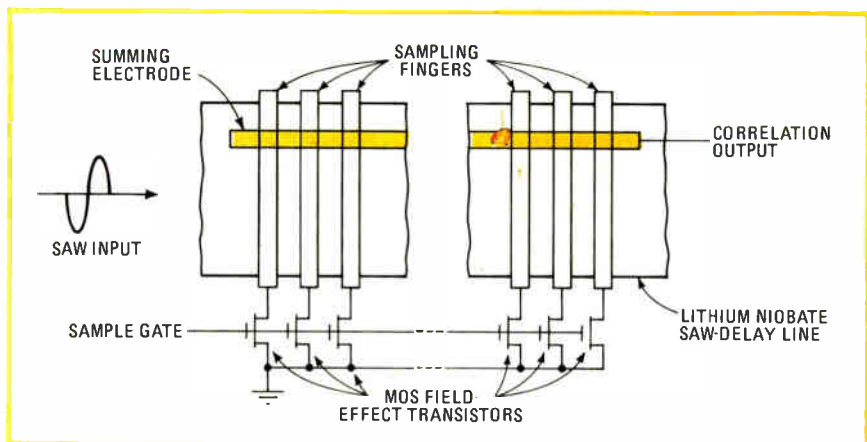

enough for the intended purpose.

Once the correlator has been programmed with the charge pattern, any unknown signal—typically riding a radar or communication system's intermediate frequency—can be injected into the same  $\text{LiNbO}_3$  SAW device. The unknown, sampled exactly like the reference, also charges the fingers, and if there is a strong correlation between the unknown and reference signals, these charges add together, producing a characteristic waveform at a summing electrode.

Compared with earlier, more complex devices, the new correlator has about 5 decibels less output, but it retains its memory of the reference and of the correlation for about the same time as more complex SAW devices do; it takes about 1 second for its output level to drop by 3 dB.

Earlier units with similar functions used arrays of diodes or charge-coupled devices as memory or to program the correlator. Thus, they needed separate inputs for reference and unknown signals. But the new unit does not, and its simple structure should be much easier to reduce to monolithic form.

The lab team suggests gallium arsenide as a good monolithic substrate material. Though it is more weakly piezoelectric than  $\text{LiNbO}_3$ , it is a semiconductor, and the team points out that a thin layer of zinc oxide could be laid down to improve piezoelectricity.

They also note that work in this direction is already under way at Motorola, Texas Instruments, and at United Technologies, and that both ZnO on silicon and on GaAs have been studied at these firms with the goal of producing devices similar to those unveiled by the Lincoln Lab.

A move to GaAs would make the present two-tiered structure unnecessary and possibly improve coupling between SAW waves and the finger structure. However, higher leakage currents with GaAs could cut memory time down from today's 1 second or so, to as little as 10 to 100  $\mu\text{s}$ . That is ample when only about 15  $\mu\text{s}$  is needed to completely reprogram the device.

**-James B. Brinton**

---

**Business**

---

## NEC buy-in charged on Comsat stations

Japan is again charged with dumping electronic products in the U.S.—this time in the burgeoning market for satellite earth stations. That is the claim of Aydin Corp., the Fort Washington, Pa., assembler of high-powered amplifiers using traveling-wave or klystron tubes for civilian and military earth stations.

The company is calling for a Federal investigation of two Communications Satellite Corp. January amplifier awards to Nippon Electric Co. The Aydin petition to the Federal government is being supported by the Communications division of the Electronic Industries Association.

NEC and its subsidiary, NEC of America, vigorously deny charges that they bought into contracts to crack the U.S. market, calling Aydin "a disgruntled bidder" whose petition "is flawed, inadequate and absurd," in its rebuttal.

The petition to the International Trade Commission and the Commerce Department's International Trade Administration to investigate the dumping is the first in the history of the U.S. telecommunications industry and should be the first test of the Reagan administration's high-technology trade policy. "These are important issues that need to be resolved quickly," says EIA vice president John Sodolski.

**Issues.** The two Comsat contracts that are cited by Aydin call for the design fabrication, and test of 29 high-powered amplifiers—nine using 3-kilowatt klystrons and 20 using TWTs. Both uplink transmission products, for civil and military satellites, operate in the C, X, and Ku bands.

NEC won both contracts with a unit-price bid of \$23,596 for the klystron parts, which Aydin asserts in its petition is 36.7% below fair value, and a unit-price bid of \$66,436 for the TWT amps without

the tube or related linearizing components. Of the latter award, Aydin says the three competing U.S. firms—itsself, Varian Associates of Santa Clara, Calif., and MCL Corp., La Grange, Ill.—bid between \$105,000 and \$125,000 per unit on the contract.

Comsat, however, says that both NEC proposals were technically superior and that the next lowest U.S. bid on the klystron amplifiers was only 2.9% higher—despite Aydin's claim. On the traveling-wave tube equipment, Comsat says, the U.S. bids were 39.5% and 40.5% higher than that of NEC.

The Japanese company raises the possibility of impropriety between Aydin and Varian on their bids for the 23 parts. Not only were the Aydin and Varian bids "within approximately 1% of each other," says the NEC filing, but both companies "claimed to have had the same or similar secret discussion concerning [the Nippon Electric bid] with Comsat's employees."

**Injury.** In its allegation of irreparable injury to domestic industry—a key point to be proven in any anti-dumping action—Aydin estimates that 40 to 50 TWT high-powered amplifiers are produced in the U.S. each year, with all but 10 going to the military market. Thus, says the company, the Comsat award forecloses the domestic commercial market to U.S. producers for two years, not counting the follow-on market for spare and replacement parts. Of the 100 to 120 klystron high-powered amplifiers built annually, all are for commercial use, according to the company.

The dumping damage, Aydin says, will force some of the companies still in the market to leave it—either itself, MCL, Varian, or Comtech Telecommunications Corp. of Smithtown, N. Y.

However, the NEC rebuttal in the dispute contends that Aydin is misleading the Commerce Department and the ITC by failing to note that Aydin "is merely an assembler" of high-powered amplifiers and does not manufacture any of the elements—the tubes, intermediate am-

# BE SMART ABOUT COSTS WHEN YOU WANT TO BE BRIGHT ABOUT DISPLAYS.

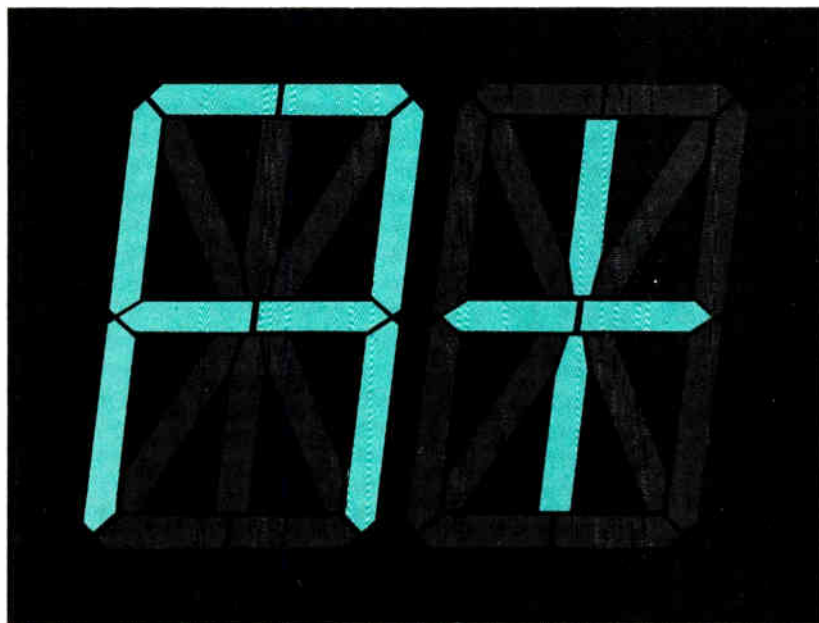

**Sprague Electric continues to be No. 1 for cost-effective volume production of BiMOS vacuum fluorescent display drivers.**



As the need for larger and brighter vacuum fluorescent displays has been increasing, Sprague Electric has been continually expanding its skills in the manufacture of complex array BiMOS drivers.

For nearly 10 years, Sprague has employed state-of-the-art processes to produce millions of display drivers. We have combined these

processes with MOS logic and bipolar buffers in a single unit, permitting a lowest-cost approach to integrated display circuitry. As a result, both the reliability and economy of Sprague drivers have been repeatedly proven in point-of-sale terminals, computer peripherals, avionics, instrumentation, electronic games, and similar applications.

**Sprague World Trade Corp.**—3, Chemin de Tavernay, 1218 Geneva, Switzerland. Tel. (022) 98 40 21  
**Sprague France S.A.R.L.**—2 ave. Aristide Briand, F-92220 Bagneux, France. Tel. 6 55 19 19  
**Sprague Electric (U.K.) Ltd.**—Salbrook Road, Salfords Redhill, Surrey RH1 5DZ, England. Tel. Horley 5666  
**Sprague Elektronik GmbH**—Darmstädter Landstr. 119-125, 6000 Frankfurt/Main 70, Germany. Tel. G611-6055-1  
**Sprague Benelux**—B.P. 104, B-9600 Ronse, Belgium. Tel. 055-21 53 02  
**Sprague Italiana S.p.A.**—Via G. de Castro 4, I-20144 Milano, Italy. Tel. (02) 498 78 91  
**Interelko AB**—Sandsborgsvägen 55, S-12233 Enskede, Sweden. Tel. 08-49 25 05  
**Semicaps**—Gammel Kongevej 148, 5 DK-1850 Copenhagen Denmark. Tel. 01-221510  
**Field Oy**—Veneentekijäntie 18, SF-00210 Helsinki, Finland. Tel. 90-69 22 577  
**Racom Electronics Co. Ltd.**—P.O. Box 21120, IL-Tel Aviv, Israel. Tel. 03-45 31 51  
**Bianchi S.A.**—Apartado 22C E-San-Sebastian, Spain. Tel. 943 36 20 45

455 1130R1 V2



a subsidiary of **GK Technologies**  
INCORPORATED

plifiers, or linearizers—"while NEC manufactures all three, as well as integrated circuits and other devices required. For an assembler to compare its cost structure with that of an integrated manufacturer and not explain the difference between the two is by itself misleading, says the Japanese company.

The ITC is expected to recommend by the end of September whether or not to hold a full-scale inquiry in the case.

-Ray Connolly

---

### Packaging

---

## Chip makers select leadless carriers

As 16-bit microprocessors quickly move into the age of ceramic leadless chip-carriers, three major U. S. manufacturers are lining up behind three different types of industry-standard packages.

Motorola Inc., which plans to unveil its strategy next month at Wescon/81, will soon be selling its MC68000 family in type C chip-carriers. This cavity-up package is suitable for sockets, clip-on leads, and direct soldering to substrates.

Also at Wescon, Zilog Inc. of Cupertino, Calif., will be showing its type B carriers. Like the C version, it has a cavity-up format but a different notch [sense] on the back for pin 1 identity.

Intel Corp. of Santa Clara, Calif., will be using type A carriers—a

three-layer cavity-down package with pads only on its top. This kind is limited to socket and clip-on-lead applications.

Intel based its choice on predictions that direct-soldering applications will not represent much of the chip-carrier business. "The applications for most of the new microprocessor products [packaged] in chip-carriers will be field replacement in sockets," says Fred Burris, manager of advance packaging development.

"That way it's a lot easier to go out and replace a chip-carrier on a board," he adds. Though type A's cavity-down configuration eliminates direct soldering applications, it also dissipates heat better.

The carrier's socket, jointly developed by Intel and Textool Products Inc. of Irving, Texas, has an aluminum cover that acts as a heatsink on the back side of the package. (Power dissipates through the back side of the die.)

Intel has already introduced its first 16-bit device in the type A carrier, the iAPX 8206 error-detection and -correction unit. Other devices will follow in October, including the iAPX 286 next-generation error-correction chip.

Meanwhile, Motorola's microprocessor operation in Austin, Texas, is betting on the more versatile type C package. Like Intel, Motorola believes more than 85% of microprocessor chip-carrier products will be initially used in sockets.

But as the market matures, the company predicts, the percentage of carriers soldered directly to substrates will grow. Motorola selected the type C package to address these future applications at no additional tooling and production cost.

The firm, which is developing direct-soldering techniques, has begun providing a few samples of a multilayer version in ceramic with a metal lid. With its sights set on production quantities in the fourth quarter, it plans to be the first to

---

**Package.** Type C leadless ceramic chip-carrier (above), suitable for socketing or direct soldering, will be used by Motorola for its 16-bit MC68000 family of devices.

offer a 16-bit family in carriers.

The multilayer carrier will cost the same as a ceramic dual in-line package. For example, the MC68000 8-megahertz version will cost \$124 each in quantities of 100.

Within nine months, Motorola also plans to begin supplying samples of the 68000 in two versions of a lower-cost single-layer type C chip-carrier. One will have a plastic lid bonded by epoxy. This version will essentially have the same mechanical characteristics as a plastic DIP.

The other will have a ceramic lid hermetically sealed to the carrier by a glass weld. These single-layer carriers will be available for delivery in the final quarter of 1982.

Meanwhile, Zilog is offering a few samples of both 8- and 16-bit microprocessors and peripherals in type B packages. The company plans to phase in the chip-carrier through 1982.

-J. Robert Lineback

---

### Solid state

---

## Nitride helps shrink rad-hard memory

Processing refinements are shrinking the size of radiation-hardened electronic devices, reports Harris Corp.'s Semiconductor Programs division. As proof, the Melbourne, Fla.-based division is ready to deliver a hardened version of its 4K-by-1-bit HM-6504 static complementary-MOS random-access memory. The memory occupies about the same area as a 1-K radiation-hardened RAM, says James E. Schroeder, principal engineer on the project.

Only about 10% larger than its commercial counterpart, the new HS-6504-RH equals the HM-6504's electrical performance, even when exposed to more than  $2 \times 10^5$  radiation-absorbed doses, or rads, maintains Schroeder. Despite its scaled-down geometries, he adds, the RAM retains both the total dose hardness and latch-up immunity that has been achieved using earlier hardening processes. Its performance suits it to many applications in deep-space and



# BE SMART ABOUT COSTS WHEN YOU WANT TO BE BRIGHT ABOUT DISPLAYS.

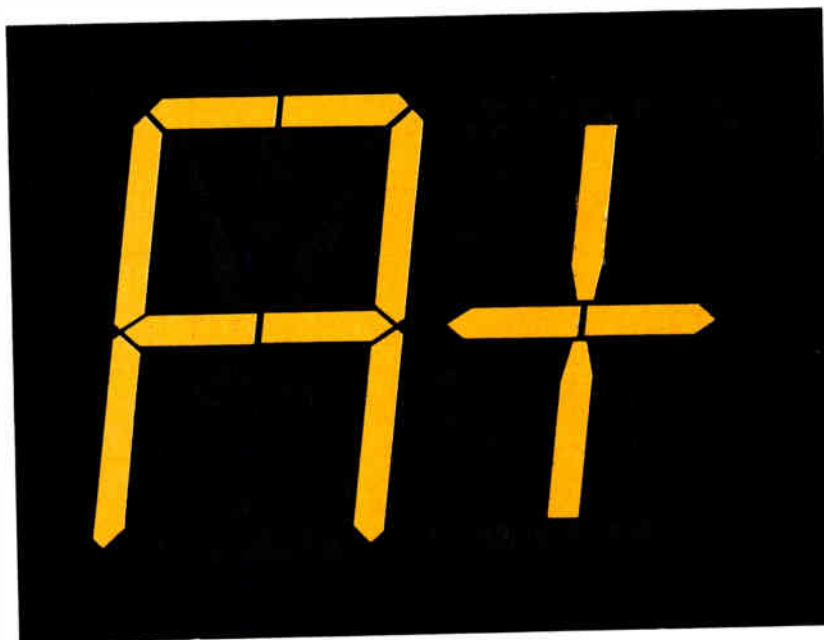

**Sprague Electric continues to be No. 1 for cost-effective volume production of bipolar gas-discharge display driver ICs.**



As the need for larger and brighter gas discharge displays has been increasing, Sprague Electric has been continually expanding its skills in the manufacture of bipolar high-voltage drivers.

For nearly 10 years, Sprague has employed state-of-the-art processes to produce millions of display drivers with voltage ratings well in excess of **100V**. We have combined these pro-

cesses with logic and buffers in a single unit, permitting a lowest-cost approach to integrated high-voltage circuitry. As a result, both the reliability and economy of Sprague drivers have been repeatedly proven in point-of-sale terminals, computer peripherals, avionics, instrumentation, electronic games, etc. Sprague is now developing **200V** monolithic integrated circuitry for release shortly.

**Sprague World Trade Corp.**—3, Chemin de Tavernay, 1218 Geneva, Switzerland. Tel. (022) 98 40 21  
**Sprague France S.A.R.L.**—2 ave. Aristide Briand, F-92220 Bagneux, France. Tel. 6 55 19 19  
**Sprague Electric (U.K.) Ltd.**—Salbrook Road, Salfords Redhill, Surrey RH1 5DZ, England. Tel. Horley 5666  
**Sprague Elektronik GmbH**—Darmstädter Landstr. 119-125, 6000 Frankfurt/Main 70, Germany. Tel. 0611-6055-1  
**Sprague Benelux**—B.P. 104, B-9600 Ronse, Belgium. Tel. 055-21 53 02  
**Sprague Italiana S.p.A.**—Via G. de Castro 4, I-20144 Milano, Italy. Tel. (02) 498 78 91  
**Interelko AB**—Sandsborgsvägen 55, S-12233 Enskede, Sweden. Tel. 08-49 25 05  
**Semicaps**—Gammel Kongevej 148, 5 DK-1850 Copenhagen, Denmark. Tel. 01-221510  
**Field Oy**—Veneentekijantie 18, SF-00210 Helsinki, Finland. Tel. 90-69 22 577  
**Racom Electronics Co. Ltd.**—P.O. Box 21120, IL-Tel Aviv, Israel. Tel. 03-45 31 51  
**Bianchi S.A.**—Apartado 220, E-San-Sebastian, Spain. Tel. 943 36 20 45



a subsidiary of **GK Technologies**  
Incorporated

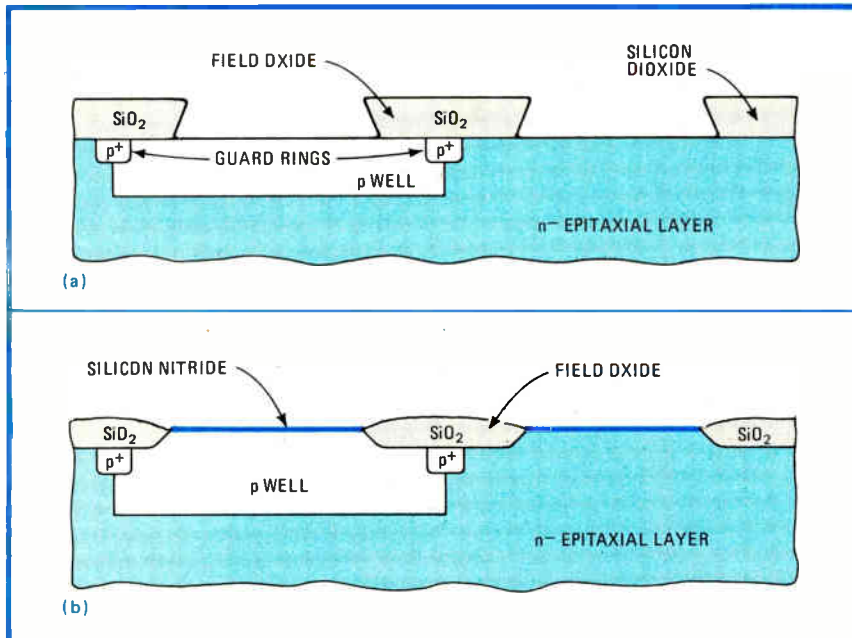

**Flatter.** The old method of oxidizing an entire wafer and etching (a) does not produce as flat a surface as using silicon nitride (b) to prevent oxidation of active regions.

weapons-radiation environments.

The Harris approach employs a special masking step and some additional processing to reduce chip size, although it preserves many chip characteristics of earlier techniques that were developed at Harris and Sandia National Laboratories in Albuquerque, N. M.

These features include an n<sup>-</sup>-on-n<sup>+</sup> epitaxial substrate that lends latch-up immunity, ion-implanted shallow source and drain junctions, and p<sup>+</sup> guard rings around n-channel devices that prevent radiation-induced surface inversion.

Both the old and new processes put a hardened silicon-dioxide layer between the epitaxial substrate and subsequent layers of polysilicon and aluminum. The oxide layer must be particularly thick (around 1 micrometer) in the so-called field areas between active device regions in order to minimize the parasitic capacitance between the substrate and overlying wiring levels.

In the old method, the entire wafer is uniformly oxidized to the required thickness, as shown in the figure. The oxide is then etched back in the regions where devices will be fabricated, exposing the silicon surface for gate oxidation.

The new method employs local oxidation instead, in which a thin silicon-nitride layer is deposited to prevent oxidation of the active regions while the thick field oxide is grown. Once the field oxide is completed, the nitride layer is stripped off the active regions. The result is a much flatter wafer surface—0.5- $\mu$ m steps instead of the 1.2- to 1.4- $\mu$ m height differences that existed between the gate and field oxide regions of the old technique. After the silicon nitride is removed, a thin silicon dioxide layer is grown.

Since the wafer surface is more planar, subsequent lithographic steps do not suffer from as much optical distortion as in the old method. This allows finer lines to be fabricated. The undercut profile of the etched field oxide in the old wafer-wide oxidation method is eliminated. Control of the active-region geometry is tighter, and these areas can be made smaller and closer together.

Besides the rad-hard HS-6504-RH, Harris has in final development a 1K-by-4-bit static C-MOS RAM, which is the hardened equivalent of the Harris HM-6514. Both the hardened RAMs have 4- $\mu$ m interconnect spacings, compared with the 7- $\mu$ m spacings in Harris's earlier 1-K rad-

hard RAM. Channel lengths in the new RAMs are 4  $\mu$ m for p- and 3  $\mu$ m for n-channel devices; metalization pitch, with contact, is 1  $\mu$ m.

Operating voltage for the 4-K RAMs is typically 5 V with an accuracy of  $\pm 10\%$ , compared with the 10-V operating levels of previous rad-hard memories, says Schroeder. Worst-case access time is 200 nanoseconds (150 ns is typical), and maximum cycle time is 450 ns. The RAMs draw a maximum of 7 milliamperes per megahertz when operating, and 100 microamperes in stand-by mode. Both parts, like their commercial twins, have TTL-compatible address inputs and output.

First deliveries of the rad-hard RAMs will be to sponsors of the Harris effort: Itek Corp.'s Advanced Technology division; the Jet Propulsion Laboratory; and the U. S. Naval Research Laboratory. Harris will begin offering samples this October, with pricing for both of the RAMs in the neighborhood of \$300 in 1,000-piece lots [*Electronics*, July 28, p. 34].

-Linda Lowe

## Displays

### 3-d graphics dazzles display conference

Three-dimensional computer graphics with powerful new processors for off-loading functions from host computers highlighted the Siggraph/81 conference in Dallas earlier this month. The hit of the equipment exposition, judging from the crowds it drew, was the SpaceGraph terminal, a 3-d display shown for the first time by Genisco Computers Corp., Costa Mesa, Calif.

The SpaceGraph [*Electronics*, July 28, p. 150] produces a true space-filling image—the object being displayed actually fills a volume of about 20 by 25 by 30 centimeters. This differs from the perspective projection of a 3-d image on a flat surface, which is what has been regarded as 3-d until now.

But perspective projection systems showed life as well. It was apparent that designers of computer graphics



# The Microprocessor's PAL.

## 8 bits in. 8 bits out.

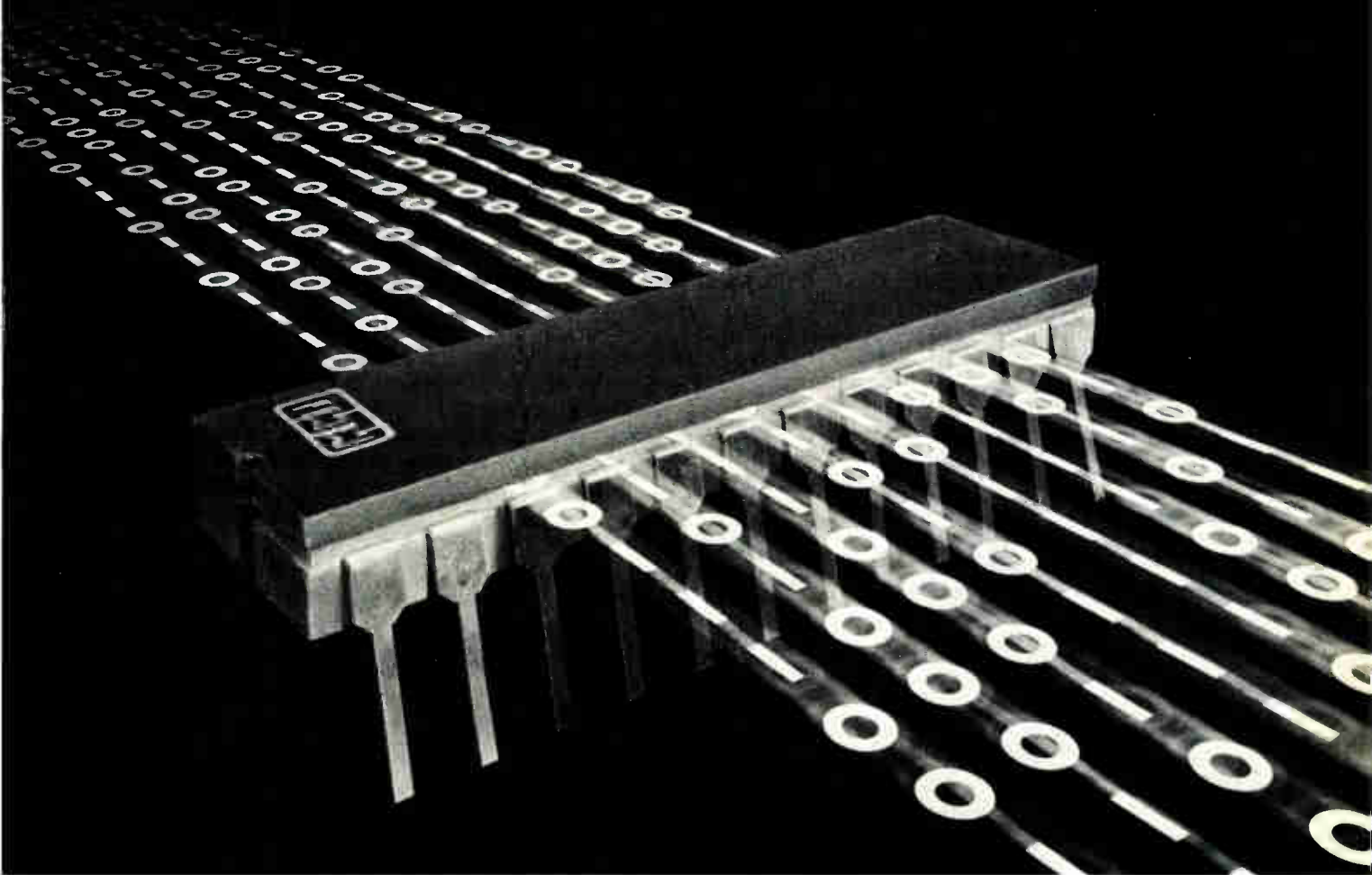

Introducing the first 4 units in Monolithic Memories' new PAL® Series 24, expressly designed for use in 8-bit systems.

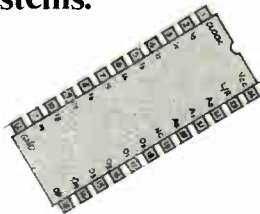

Now designers of microprocessor-based systems can implement logic functions easier than ever. Because our new PALs "speak octal," you can design more simply, reduce your parts count and speed your system's time-to-market dramatically.

### Choose your PAL today.

Four different 24-pin PALs, including 4-, 8- and 10-register versions, are available now in 300-mil-wide SKINNYDIP™ packages. They meet a range of octal interface and clocking requirements, including MPU interfacing, parallel in/out counters, parallel shift registers, shift register interface, etc.

Best of all, these PALs are on distributor shelves today. For more information about the 20X8, 20X10, 20L10, and 20X4, fill in this coupon and

mail to Monolithic Memories, Inc., 1165 E. Arques Ave., Sunnyvale, CA 94086. Offices in London, Paris, Munich and Tokyo.

ELEC 8/25/81 MM-15

I'm interested in PALs! Please send full product and application data to:

Name \_\_\_\_\_

Title \_\_\_\_\_

Company \_\_\_\_\_

Department \_\_\_\_\_

Address \_\_\_\_\_

City \_\_\_\_\_

State \_\_\_\_\_ Zip \_\_\_\_\_

©PAL is a registered trademark of Monolithic Memories, Inc. National Semiconductor Corp. is a licensed alternate source for PAL.

**Monolithic Memories** 

## Clamping Ideas from Weckesser

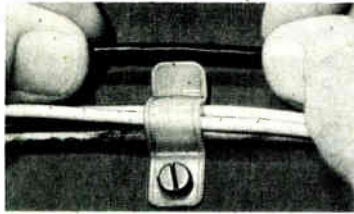

### Nylon FLEX-CLIP

Slip wires in or out for changes or removal. Contour of clip plus spring-back flexibility of nylon provides easy assembly, yet holds bundles securely.

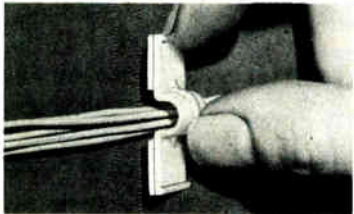

### Nylon PRESS CLIP

Peel off... press and it's on to stay. Adhesive-back provides fastest way yet to install clips. Four sizes for bundles from 1/8" to 1/2" dia.

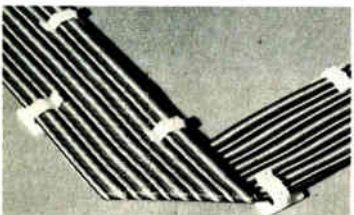

### PRESS CLIP for flat cable

One size nylon clip for any width flat or ribbon cable. Used along edges, provides unlimited flexibility in mounting arrangements. Adhesive-back or screw mounting hole.

Write for catalogs.

**Weckesser**  
**COMPANY, Inc.**

4444 W. Irving Park Road  
Chicago, Illinois 60641 (312) 282-8626

## Electronics review

### Computer graphics industry set to climb

Multibillion-dollar markets are just a few years away for the computer graphics industry with its array of terminals for computer-aided design and manufacturing and for the business office. So say industry officials attending the Siggraph/81 Computer Graphics Conference Aug. 3-7 in Dallas. Siggraph stands for the Special Interest Group on Computer Graphics of the Association for Computing Machinery.

Low-cost, higher-density memories, and a shortage of skilled labor are among a number of factors driving development of graphics hardware and software packages for CAD/CAM, points out Ken Anderson, publisher of The Anderson Report, an industry newsletter. "Before, it was driven by economics, and certainly the cost of labor was part of that," explains Anderson, a participant in the five-day conference. "But now the simple unavailability of people [to design] is even a more pressing issue. When the market is out there but you don't have the people to serve it, you very quickly reassess your priorities."

Anderson estimates that the total available computer graphics market could hit \$4.5 billion by 1984, with about half of that addressing CAD/CAM. The greatest percentage increase, however, will come from the office segment of the market. "There has been just a dramatic increase in the amount of software and systems dedicated to the creation of slides, viewgraphs, and charts of all kinds to help the manager run his company. It seems we have really underestimated the customer's acceptance of the technology," he notes. "I think it looks like \$300 million to \$400 million by the end of the year, with probably the [upward] knee in the curve occurring in the first part of 1982." And it was only in the beginning of 1981 that the business graphics systems really began to hit the market, he adds.

By 1984-85, Anderson predicts, business graphics sales will cross the \$1 billion mark. "It's not unreasonable to expect a growth rate of 80% to 90%" in the low-cost segment," he notes. Others see rapid growth in other segments as well.

Richard L. Davison, vice president and general manager of the Graphics Systems division of Applied Dynamics International, Ann Arbor, Mich., likes what he sees for computer-assisted instruction, which he believes "will have one of the most dramatic impacts on everyday life." He envisions graphics equipment being used in many places to assist the public, including museums, shopping centers, and malls.

Attendance at Siggraph also seems to reflect growth. This year's show attracted more than twice as many people—11,700—as did the 1980 show. That edition was in Seattle, not nearly as centrally located as Dallas; but then the Dallas show had to contend with the first week of the strike by U. S. air traffic controllers. Exhibit floor space increased 80%, as the number of exhibitors at the conference rose from 95 to 130. **-J. Robert Lineback**

systems have been quick to apply the newest large-scale integrated-circuit technologies in their domain.

High-speed 16-bit microprocessors, 64-K memory chips, and special-purpose graphics chip sets were being employed in the new products to produce very intelligent graphics terminals with reduced costs, more functions, or both. The increased processing power and larger memories in these products also mark a trend toward distributed computer graphics in which the terminals perform more of the purely graphics functions, freeing the host computer

to do more of the applications work.

Some of the more striking new product highlights of Siggraph came at the low-priced end of the spectrum. Here the target was the 3279 color display station from IBM Corp., which comes in two medium-resolution versions displaying either four or seven colors and selling for between \$4,500 and \$5,200. Two recently formed companies have taken on the 3279, with terminals that cost much less.

Integrated Terminals Inc., Addison, Texas, showed an eight-color terminal (model ITI 801) that sells



**Capable.** Twelve-inch-diagonal screen of Integrated Terminals' eight-color model 801 is set up to demonstrate several of the types of graphics displays it can present.

for \$3,000 in single quantities (down to \$2,200 each in 100-unit lots). Built around a Z80 microprocessor, the terminal has a 12-inch screen that displays twenty-four 80-character lines in a 640-by-240-dot matrix. A 48-line display will be introduced by the end of this quarter with two more models next year.

The other new terminal is the MVI-7 from Colorgraphic Communications Corp., Atlanta [*Electronics*, July 28, p. 14]. At \$3,500 each (\$2,800 in quantities of 100), this seven-color display uses a 720-by-280-dot matrix. It also has extra features, including horizontal scrolling and the ability to divide the screen into four areas that can be independently addressed and scrolled.

Both of the terminals emulate others already on the market, so they can be used immediately with existing software. Integrated Terminals' 801 is compatible with software from a leading terminal maker, Intelligent Systems Corp., and will soon be compatible with others as well. Colorgraphics' MVI-7 can emulate and bring color to any of six popular monochrome terminals, including Digital Equipment Corp.'s VT100 offering.

The presence of the 16-bit microprocessor was perhaps nowhere more felt than in several new stroke- and raster-refresh terminals. A trio of new designs have applied the Motorola MC68000, capitalizing on its high processing speed and large amount of memory that can be directly addressed.

Emphasizing the distributed computing possibilities inherent with the

68000 was Vector General Inc., Woodland Hills, Calif. The firm's VG33000-series terminals apply the microprocessor to such chores as servicing display interrupt requests, buffer management, editing, and changing views and perspectives.

The 16-bit 68000 is also at the core of the industry's highest-resolution flicker-free raster-refresh display, the System 3400 XV7 from Lexidata Corp., Billerica, Mass. Its display, with a 60-hertz noninterlaced refresh rate is made up of a 880-by-704-dot matrix.

Yet perhaps the record for handling vectors is held by the PS300 3-d perspective-projection terminal from Evans and Sutherland, Salt Lake City. This \$59,000 stroke-refresh unit can update an entire display of up to 95,000 line segments at 30 frames per second. -Tom Manuel

### Production

## Air Force to recruit robots for pc boards

The U.S. Air Force wants the productivity of defense contractors to rise sharply, so it has commissioned Westinghouse Electric Corp. to develop fully automated systems for the design, manufacture, and testing of printed-circuit boards.

Work on the three-year project at Westinghouse's Defense Electronics Systems Center at Baltimore, Md., started this month, and John A. Decaire, manager of manufacturing systems and technology, expects it

## SOMETIMES ROTARY SWITCHES ARE BETTER

Many switching possibilities in small volume, sealing for automatic soldering/cleaning, contact protection against any heat transfer from soldering.

This all adds up to a superior rotary switch, the FEME 5940-P type.

- 12 positions 30 degree detent angle
- dual-in-line 14 pin configuration, 2.54 mm pin spacing
- shorting and non-shortng contacts
- switching current: low level to 100 mA at 120 Vac/dc
- electrical life with low level 50,000 operations
- insulation resistance  $10^6$  MOhms
- climatic category as per IEC 68-1:40/085/21
- overall dimensions 10.8 x 17.8 x 21.3 mm.

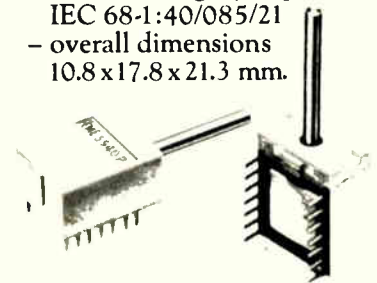

means reliability

F.E.M.E. - S.p.A.  
20149 Milano - ITALY  
Viale Certosa, 1  
Tel. 390.021 - Telex 331217



advertteam

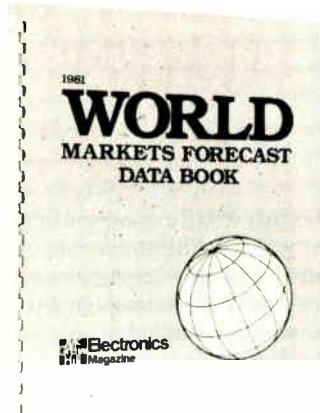

... that belongs in the hands of everyone serious about the technical, financial, and planning outlook for electronics.

*Electronics'* highly respected 23rd annual World Markets Forecast has been expanded to provide an in-depth look at current and future demand for some 200 component and equipment products in the USA, Western Europe, and Japan—including 23 additional pages of market-estimate and growth-rate tables.

**Includes information not published elsewhere ...**

- 1979-84 compound U.S. growth rates • U.S. report research methodology
- economic analyses for U.S., Western Europe, and Japan • Product-by-product markets for 11 Western Europe countries

Delivery is immediate (air shipment outside N.A.) for the *Electronics 1981 World Markets Forecast Data Book*. \$125 must accompany your order to:  
 Electronics Magazine Books  
 42nd Fl.  
 1221 Ave. of the Americas  
 New York, NY 10020 USA.

## Electronics review

will lead to an eightfold increase in productivity in pc-board assembly processes and a tenfold speedup of manufacturing cycle times.

**Shared benefits.** These dramatic benefits will not accrue to Westinghouse alone. "The Air Force is in this to increase productivity, quality, and cost savings on defense contracts generally, not just at one company," says Lt. Gen. James W. Stansberry, commander of the Electronic Systems Division at Hanscom Air Force Base, Mass.

So, along with \$7 million in seed money from the Electronic Systems division to get the project rolling, goes the requirement that Westinghouse must share its findings with over 100 other contractors through periodic seminars and briefings. All progress reports will be in the public domain, and Westinghouse will be obligated to license the know-how it develops, Stansberry points out.

An added industry-wide bonus, Decaire says, will be the establishment of standardized components for automated manufacturing systems as Westinghouse works with other firms engaged in the rapidly developing technology.

Along with the military grant money, Westinghouse plans on investing nearly \$200 million of its own to implement the results of its work for plant modernization, Decaire reports. The company will pursue three main themes: a work center for automatic storage, location, and kitting of pc-board components; a work station for fully automated assembly and quality testing of printed-circuit boards; and a work station integrating design, manufacturing, and testing of electronic cables and harnesses.

Robots with both touch and sight will work in the stations, paired with high-speed computers and advanced software, interactive-graphics-design systems, and computerized data bases. The robots will be central to Westinghouse's design effort. The firm is working in this area already with Japanese firms like Seiko, Fujitsu Ltd., and Hitachi Ltd., as well as with American robotics maker Automatrix, Inc., Burlington,

Mass., the Carnegie-Mellon Institute, Pittsburgh, Pa., and the University of Rhode Island, which is in Kingston.

**High return.** Stansberry predicts the project, the first of its kind in that it will affect production across several Air Force programs, should receive a 20- to 30-fold return on its investment over the next 10 years at Westinghouse alone. He adds that the Air Force plans other such contracts under its technology modernization program.

All of these programs will aim at developing widely-available automated-production technologies, and their award will be conditional on a company's willingness to invest its own resources in modernizing its production facilities. **-Linda Lowe**

## Personal computers

### IBM elects to buy software outside

The long-awaited personal computer from IBM Corp. came as no surprise when it was announced Aug. 12. But the startling fact was that the world's largest computer manufacturer had departed from its traditional software stance of doing everything itself.

Instead, IBM is relying on software expertise that is accumulating explosively in the microcomputer marketplace [*Electronics*, April 21, p. 163]. Software for the IBM Personal Computer is being supplied by outside software vendors. Moreover, IBM is forming a third-party publishing operation that will sign up application programs.

Built around a 16-bit microprocessor, the IBM machine should offer a significant challenge to the personal-computer market now dominated by Tandy Inc.'s Radio Shack and Apple Computer Inc. since it is competitively priced with their 8-bit offerings. In fact, Portia Isaacson of the market research firm, Future Computing Inc., Richardson, Texas, predicts \$1 billion in sales for the IBM computer by 1984, calling it

# Vero make the best available.

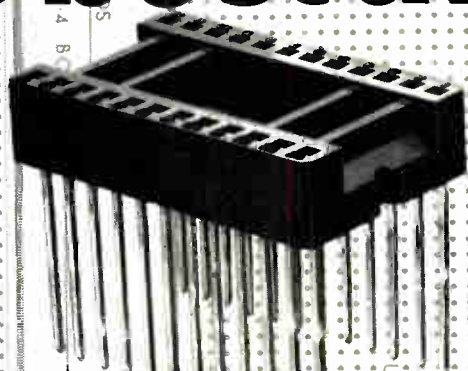

**High quality DIP Sockets and Pins at competitive prices – a vast range available immediately from Vero.**

**DIP Sockets Standard Profile** Solder and wire wrap termination. Gold and tin plated finish. Double face wipe contact for reliability.

**Low Profile** Tin plated solder termination. Double face wipe contact. Anti wicking insulating strip.

**Socket Pin DIPs** Tin plated solder and wire wrap termination with Beryllium copper 4 jaw gold plated inner contacts for ultra high reliability.

**Solder Pins and Terminals** for PCB applications – manufactured to close tolerances with a bright tin-lead finish for guaranteed solderability.

**Wire Wrap** Precision machined, gold plated types or low cost stamped tin plated styles.

**Probe** Interchangeable spring loaded tips in three configurations. Serrated, cup, cone/needle. Gold plated sleeves with rhodium plated probes for low contact resistance. Wire wrap and solder termination on receptacle.

What other company can offer such variety and quality immediately. Quality products from a quality British company.

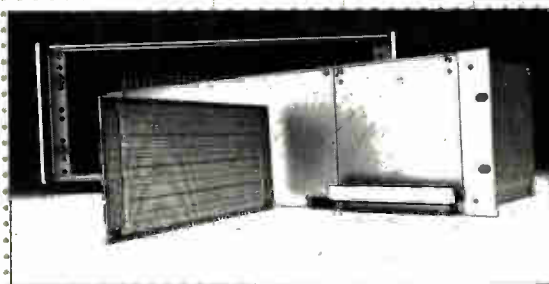

## BASICALLY YOU NEED VERO

Vero Electronics Ltd., Industrial Estate, Chandler's Ford, Hampshire. SO5 3ZR.

Tel: Chandler's Ford (04215) 60211

Please tick appropriate box.

- I would like further information about the Vero range of components.
- I would like further details about the whole Vero range of products.

Name \_\_\_\_\_ Position \_\_\_\_\_

Company \_\_\_\_\_

Address \_\_\_\_\_

Tel. No. \_\_\_\_\_

# SERIES SE3000

## Lightweight, instrumentation recorders

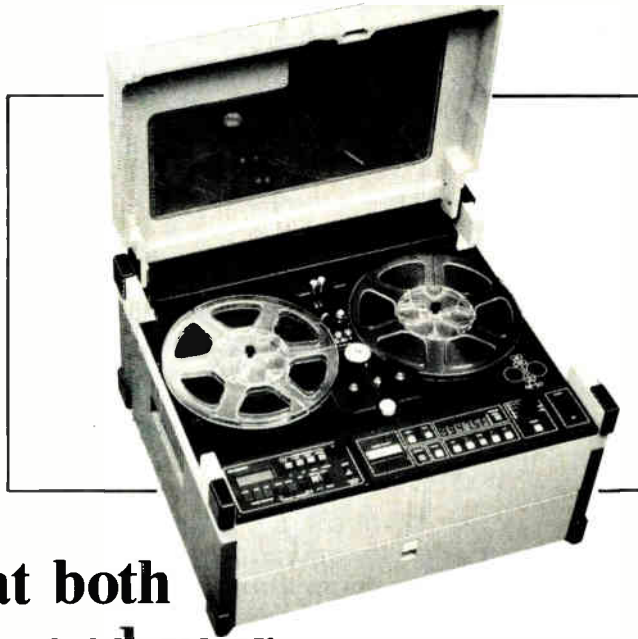

that both  
you and your  
budget can carry

These IRIG compatible ¼ and ½ inch portable instrumentation recorders are the first to offer the features and performance of 1 inch laboratory recorders that weigh and cost much more.

- 8 tachometer or tape servo controlled speeds, from 15/32 to 60 inches/second
- IRIG compatible recording up to 40 kHz FM, 300 kHz direct, and 0.5 Mbit/second HDDR
- 4, 7, 8, or 14 record/reproduce channels, plug in for any mix of FM, direct, and HDDR, fully aligned for 8 speed operation
- Built-in calibration, complete electronics-to-electronics checkout (FM and direct)
- Choice of interchangeable ac or dc power supplies

Call today. You'll be surprised how little a 55 lb, 14 channel portable instrumentation recorder can cost.  
Or write for our new 4 page brochure.



**EMI Technology Inc.**  
Instrumentation Division

6445 Powers Ferry Road Atlanta, GA 30339  
Telephone (404) 952-8502 TWX: 810-766-2267  
Toll Free Instrumentation Service: 800-243-2572

A Member of the THORN EMI Group

#### Sales Offices:

- Newport Beach, CA 92660 Telephone (714) 760-1955
- Reston, VA 22091 Telephone (703) 620-6056
- Sunnyvale, CA 94086 Telephone (408) 732-9027
- Framingham, MA 01701 Telephone (617) 875-5858

#### International:

SE Labs (EMI) Ltd.  
Spur Road, Feltham, Middlesex  
TW14 0TD, England  
Telephone 01-890-1477  
Telex: 23995

### Electronics review



**Little guy.** The components of IBM's Personal Computer include an 83-key keyboard, a 12-in. display, and a 16-bit microprocessor with dual 5.25-in. floppy disks.

"the most significant personal computer ever introduced."

Moreover, by designing around a 16-bit chip, IBM has ensured that its computer will have a long product life. Personal computers built around 8-bit processors do not have the processing speed necessary for things like the latest high-speed graphics and real-time interactive games.

In its basic configuration, it costs \$1,565, as compared with \$1,330 for an Apple II and \$870 for Radio Shack's TRS-80. The higher price appears not to be just a reflection of the IBM name, but seems to reside in the quality of construction: 80% American-made, the machine is housed in metal rather than plastic, uses a 12-inch green-phosphor cathode-ray tube and generally is more professional-looking than many of its counterparts. Also, it should help maintain U.S. market share, in the face of the Japanese import wave expected in 1982.

Based on Intel's 8088 microprocessor, the Personal Computer is enclosed in a chassis with a detachable 83-key keyboard and separate CRT. It comes with 40-K bytes of read-only memory holding Microsoft

# The talk of the town!

**General Instrument's new VSM2032 has made speech synthesis the talk of the town. In fact it speaks so well we named it Orator.™**

The VSM2032, a complete speech system, is immediately available. It needs only a power source and speaker to start talking...in less than an hour you can hear it speak, fluently, with a 32 word calculator/clock vocabulary that combines to form over one billion phrases.

You can use the Orator module as a stand alone voice system or interface it with industrial equipment, vending machines, instrumentation, arcade games, computers or warning devices.

#### **More than the spoken word.**

With Orator you get a lot more than talk. General Instrument's state-of-the-art technology utilizes Linear Predictive Coding (LPC) for speech data compression with minimum ROM support. And to obtain truly natural speech, a 12 pole cascade filter is used to implement a mathematical model of the human vocal tract so that Aunt Mary sounds exactly like Aunt Mary and not like Uncle Walter.

#### **Now. Talk's cheap.**

Simplified digital interfacing... immediate availability...high voice quality...low price...make Orator VSM2032 an attractive and feasible way to make your product speak. At a cost of \$99 (signifi-

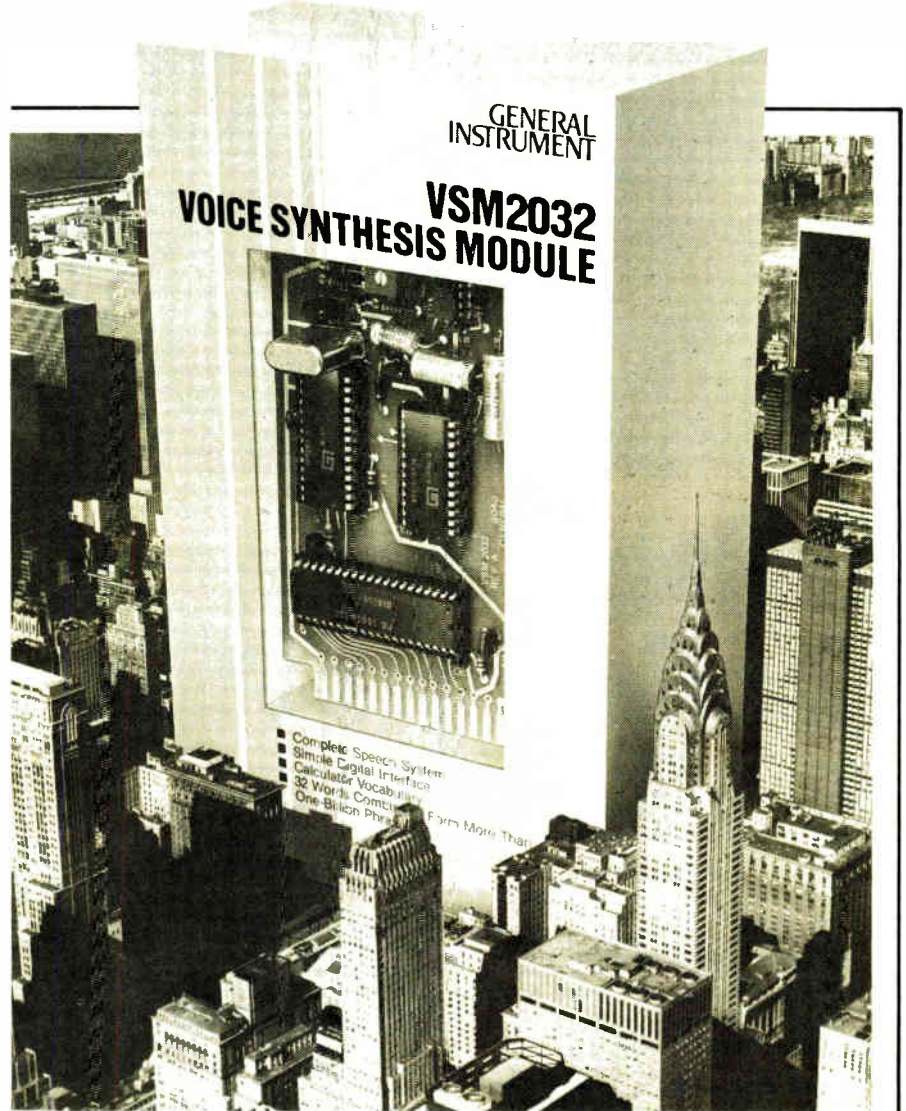

cantly less in production quantities), you can't afford not to hear Crator! And you can choose from standard vocabularies or your own vocabulary for orders of 250 or more modules.

The final word is up to you. For more information on VSM2032 contact General Instrument

Microelectronics Ltd., Regency House, 1-4 Warwick Street London W1R 5WB, England, or call 01-439-1891.

**We help you compete.®**

# GENERAL INSTRUMENT

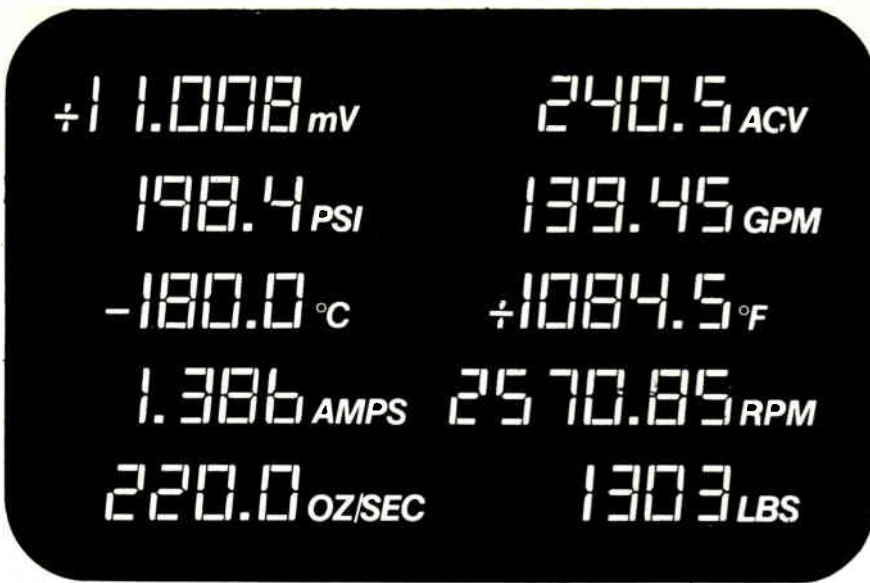

# United Systems' Indicators Will:

- MEASURE voltage and current; ac, true rms or dc.
- CONVERT the output of any transducer/transmitter to display in engineering units.
- DISPLAY temperature (C or F) directly from thermocouple, RTD, or thermistor sensors.
- INTERFACE readily into your system by optional "single line enable" parallel BCD output.
- INDICATE when a predetermined limit is exceeded, through relay closure or logic level output from optional internal comparator alarm.

And with United Systems' exclusive adaptors these indicators change, in the field, to perform any measurement listed above and more!

For additional information contact your United Systems Representative or call the factory (513) 254-6251.

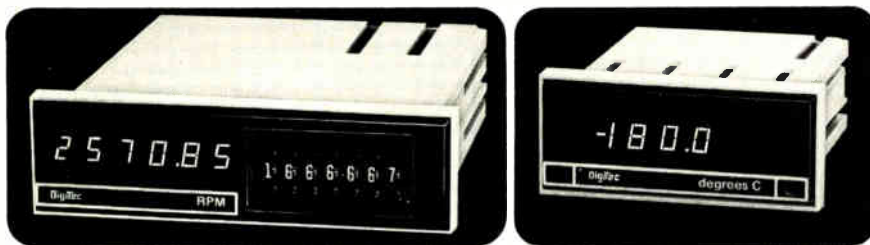

**DigiTec.** UNITED SYSTEMS CORPORATION

918 Woodley Road Dayton Ohio 45403  
(513) 254-6251 TWX (810) 459-1728

United Systems Corp: Precision measurements to count on

Basic and various system utilities. Its five-slot chassis is fully described by IBM so independent manufacturers may interface with it easily.

The computer employs 5.25-in. floppy disks holding 160-K bytes in IBM's own format, with 8-in. floppies on the way and hard disks further down the line. The display operates in three modes: twenty-four 80-character lines for text, and two color-graphics modes—320- and 640-by-200 picture elements. It also has all the standard home computer features including a speaker for music and inputs for game paddles and controllers.

**Vendors.** So far, two high-level languages, an operating system, and three applications packages have been written for the IBM computer by outside vendors. The languages use the Basic interpreter and Pascal compiler from Microsoft, which also has written a disk operating system. Personal Software Inc. has adapted VisiCalc, the popular program for handling lists of data. Peachtree Software Inc. has transferred its small-business management package, and Information Unlimited Software Inc., its EasyWriter word processor.

Other operating systems are being developed. Digital Research Inc. is adapting CP/M-86 and SofTech Microsystems Inc. to its UCSD p-system. In addition, IBM has established a software publishing department that will underwrite and market new application programs, paying royalties to authors.

It will, however, be the responsibility of the author to maintain the software. With IBM backing the 8088 architecture with software publishing operations, many more programs should become available.

In a configuration with 64-K bytes of user memory, dual disks and a CRT, the IBM Personal Computer will cost \$3,660. That makes it about \$450 more expensive than the Apple II, which has fewer features. The prices are almost equal if the Apple is expanded to include the interfaces for an 80-column display and upper- and lower-case characters, which are standard with IBM. **-R. Colin Johnson**



# RCA CMOS speaks your language.

These six languages have been tailored especially for the 1802 microprocessor and RCA CMOS Microboards. They will allow you to **write 100 percent of your code** in high-level language for most applications.

## **BASIC 1**

- Compiler/interpreter.
- Develop program using interpreter and compile for code compactness in target system.

## **BASIC 2**

- Extended BASIC interpreter with 1802 I/O control statements.
- Floating point math, string variables, multi-dimensional arrays.

\*Trademark of Enertec, Inc.

## **BASIC 3**

- ROM-BASIC interpreter runs on low-cost Microboard Development Systems.
- Run-time, auto-start interpreter ROM option available (also for BASIC 2).

## **PLM-1800**

- 1802 microprocessor dialect of PL-1.
- Structured language.
- Runs on RCA development systems.

## **MACROASSEMBLER**

- Nested macro capability lets you define your own instructions.
- Parameter substitution.

- Conditional and repetitive assembly.

## **Micro Concurrent PASCAL\***

- For real-time multi-tasking 1802 and Microboard applications.
- Cross-compilers available for most computers.
- ROM-able 1802 p-code interpreters, with and without floating point.

In plain English: whatever your 1802 application, we've made it easier than ever to program.

Contact any RCA Solid State sales office, representative or distributor.

**Or call (800) 526-3862.**

RCA Solid State headquarters in Somerville, N.J. Brussels. Sao Paulo. Hong Kong.

**Now RCA offers six programming languages  
for 1802 microprocessors.**

BASIC 1

BASIC 2

BASIC 3

PLM-1800

MACRO  
ASSEMBLER

Micro  
Concurrent  
PASCAL

1802

**Another reason to  
switch to CMOS.**

**RCA**

Circle 55 on reader service card

# NON-TDI NON-MOCA BASED

POLYURETHANE POTTING, ENCAPSULATING  
AND CASTING COMPOUNDS

FROM  
**CONAP**

CONATHANE® SYSTEMS combine unique advantages, easier handling and lower costs in urethanes that cure without voids. Series 2500 Systems are offered in a variety of filled and unfilled formulations to meet virtually any requirement for the potting or encapsulating of modules, strain-sensitive components, coils, transformers, and similar devices. The two liquid components of the Conathane Systems mix readily and change to solids with very low exotherm. Working life is excellent and vapor pressure low. Cure is at room or elevated temperatures. And the resulting solid polymers vary from soft elastomers with a Shore A hardness of 70 to tough and rigid plastics.

#### CHECK THESE OUTSTANDING PROPERTIES

- Non-MOCA\* curing systems
- Non-TDI prepolymers — for minimum health hazard to personnel
- Low stress buildup on sensitive embedded components
- Superior thermal shock resistance
- Excellent dielectric properties
- Reversion resistance
- Low water absorption
- Low shrinkage
- Excellent hydrolytic stability
- Dimensional and heat stability.

**FOR FLAME RESISTANCE** choose the Conathane EN-2540 Series, a new family of filled polyurethane resins specially formulated for general purpose electrical/electronic potting, casting and encapsulating. Provides flame resistance ratings of 94V-0 when tested in accordance with UL-94. Because of fast gelation and cure at low temperatures, is ideal for high volume production.

**GET MORE FACTS.** Write for Selector Bulletin P-133 on Conathane 2500 Series, or Bulletin P-137 on flame resistant Conathane EN-2540 Series.

\* DuPont Trademark

# CONAP

CONAP, INC. / OLEAN, N. Y. 14760 / 716-372-9650

## Washington newsletter

---

### **NSA center to rate secure computers . . .**

A new Computer Security Technical Evaluation Center is being set up by the National Security Agency for the Department of Defense and the intelligence community, says Adm. Bobby R. Inman, deputy director of central intelligence. Inman, former director of the NSA, the nation's chief cryptographic agency, told a National Bureau of Standards seminar on computer security that the new center will work with industry on developing secure computer systems and software for Government applications as well as in industry. **The center "will not make general endorsements,"** Inman emphasized, but as with the Pentagon's existing Qualified Product List, "the relative merit of a system in the hierarchy of evaluated products may be available publicly in order to provide incentive and encouragement for manufacturers to develop secure systems and for private-sector users to employ them."

### **. . . with budget set in \$25 million range**

The NSA Computer Security Evaluation Center will have separate facilities at Friendship, Md., in the industrial complex of the Baltimore-Washington International Airport, moving in "within a month or two," says NSA's George Cotter, the center's acting director. In an interview, Cotter estimated that the CSEC will have an annual budget of \$25 million to \$30 million, **"about two thirds of which—say, conservatively, \$10 million—will be spent on research, development, and procurement"** with industry. Starting small, the CSEC staff will build up to between 200 and 300 persons over the next five years, he adds.

### **NTT chief to lobby U. S. congressmen**

Nippon Telegraph & Telephone Public Corp.'s president, Hisahsi Shinto, is scheduled to spend Sept. 10 and 11 in Washington, D. C., promoting the opening of NTT's domestic telecommunications equipment market for U. S. suppliers in talks with Reagan Administration officials and members of Congress. **The visit is reportedly designed to assuage U. S. fears that Japan's next electronics export assault will come in the \$20 billion U. S. telecommunications equipment market.** The 1980 U. S. trade deficit in telephone and telegraph equipment alone totaled \$156.7 million last year, up 60% from the year before. The executive's schedule now includes meetings with Secretary of Commerce Malcolm Baldrige and members of the Federal Communications Commission and Congress, plus a reception sponsored by the Electronic Industries Association.

### **SBS proposes small-business digital network**

Satellite Business Systems Inc. wants to build 32 microwave digital termination systems in as many U. S. metropolitan areas to service medium-sized- and small-business communications users. In its filing with the Federal Communications Commission, **the McLean, Va., company says its new data exchange service, called DXS, complies with FCC rules** for digital message services [*Electronics*, Jan. 27, p. 61]. The SBS proposal, using its satellite network as a backbone, calls for installation of a 2-ft-diameter antenna and associated 10-GHz terminal equipment on a user's rooftop or window. The terminal—aimed at a central transeiving station with three antennas that each provide 120° coverage and four-mile range—would have data channels at speeds ranging from 2,400 b/s to 1,544 Mb/s. SBS wants to implement the DXS in mid-1983 between Chicago, Dallas, Los Angeles, New York, and Washington, D. C., with the 27 other systems in place by the end of 1986.

## Battling Japan for U. S. telecommunications

Washington's slow and soggy August is being enlivened with a new variation of the electronics trade war with Japan. It seems only yesterday that the conflict involved was the Japanese dumping of television receivers. Japan in effect won that battle, driving most American manufacturers either from the market or to offshore plants.

The new battle involves alleged Japanese dumping of telecommunications equipment, specifically high-powered amplifiers for domestic satellite earth stations (see p. 42). American manufacturers say that they have learned from the earlier bitter experience, and they are determined not to lose this one.

That determination was illustrated last month when the Electronic Industries Association's John Sodolski warned a House trade subcommittee that the \$20 billion domestic telecommunications equipment market—about half the world total—is being “specifically targeted for a concerted attack by foreign competitors” whose home markets remain closed to U. S. exports [*Electronics*, July 14, p. 58]. What distresses EIA members most, says communications division vice president Sodolski, is that equipment makers in Japan and Europe can “price and sell marginally, especially in the United States,” while supported by “assured long-term manufacturing contracts and [government]-subsidized research and development” at home.

Now the EIA division members are taking up the battle in earnest, building a war chest to support Aydin Corp. of Fort Washington, Pa., as it steps into the International Trade Commission arena. Aydin is charging that the Nippon Electric Co. of Tokyo is selling two types of earth station amplifiers to Communications Satellite Corp. at less than fair value—lower than the price set for the Japanese market—and thus threatening to damage U. S. industry. That is dumping.

### A difficult case

As the U. S. telecommunications equipment trade deficit with Japan continues to expand, the timing seems right for the EIA move. Yet there are indications in the initial Aydin petition and the NEC rebuttal that the EIA may be backing the wrong American warrior in the upcoming battle.

In what shapes up as a down-and-dirty fight—with Comsat saying only that NEC's

products were “technically superior”—Aydin will have a hard time proving not only that NEC's prices were below those in Japan, but also that Aydin has been or is likely to be damaged by the Comsat buy.

Aydin admits that Japan has few earth stations and that an accurate breakout of component prices is impossible because the stations are installed as complete turnkey packages. The company has therefore had to estimate and then reconstruct NEC's component costs for the amplifiers, using figures that NEC says represent “fanciful adjustments” to accurate prices and costs. NEC contends that its costs are lower because it is a vertically integrated manufacturer producing all the earth-station amplifier components for the uplink, while Aydin makes none of the components, buying them in the open market for assembly.

As to damage, NEC rejects Aydin's complaint by noting that the Pennsylvania company told the Securities and Exchange Commission and its stockholders in its April 27 first quarter earnings report that 1981 would be “another record year” for the company, even though NEC says the forecast came “after Aydin knew it had lost the Comsat contracts” in January and said nothing about it.

Equally troubling is the suggestion by NEC's lawyers that Aydin may have engaged in improprieties with Varian Associates, another losing competitor for the Comsat contracts. Price fixing is a serious charge and, of course, must be proven. As Japan knows well, it is not a practice peculiar to the U. S.

### The impact of politics

In sum, however, Aydin's initial petition and the rebuttal by NEC indicate that U. S. manufacturers need to make a stronger case for telecommunications equipment dumping by Japan or anyone else than is evidenced in this first effort, for U. S. industry is handicapped, so to speak, by a regulatory and judicial system in which the burden of proof is on the petitioner. If the ITC or the Department of Commerce decides that Aydin's charges are worth a full investigation—and they may do so—it will likely be more a product of international politics than anything else, a welcome result of the Reagan Administration's toughening stance on equal access to Japanese and other national markets for U. S. industry.

**-Ray Connolly**



# SPEECH TECHNOLOGY THAT PERFORMS

## SOUNDLY

After three years of fundamental research, an aggressive development effort, Votan introduces a bold, new speech technology that's changing the way people relate to computers. A technology already recognized as the most sophisticated and cost effective in the industry. A technology which, when incorporated into our V1000 Series Speech Recognition Systems, features

- 99+% Accuracy Under Difficult Industrial Conditions
- Excellent Noise Immunity
- Minimal (One Or Two) Training Trials
- Use With Inexpensive Microphones

## AND COMPLETELY

Votan is the complete speech company, with capabilities in every major speech area, including:

- **Speech Recognition**
  - Speaker Dependent
  - Continuous Speech Input
  - Speaker Independent
- **Speech Synthesis**
  - Preprogrammed
  - User Programmable
  - Voice Store and Forward
- **Speaker Verification and Identification**

Votan's exclusive digital signal processing technology is fundamental to all our products. It provides performance previously available only in expensive minicomputer-based industrial or research systems. Now, Votan offers this technology on chips, printed circuit boards, and OEM systems.

But don't take our word for it. Call us to train the V1000 System with your own voice and see it perform. Soundly.

*Or, try it at Wescon Booth H203 in the San Francisco Hilton.*



26046 Eden Landing Road, Suite 7  
Hayward, California 94545  
Telephone (415) 785-8060

Circle 59 on reader service card

# A FULL RANGE OF PRODUCTS... A NAME TO RELY ON!

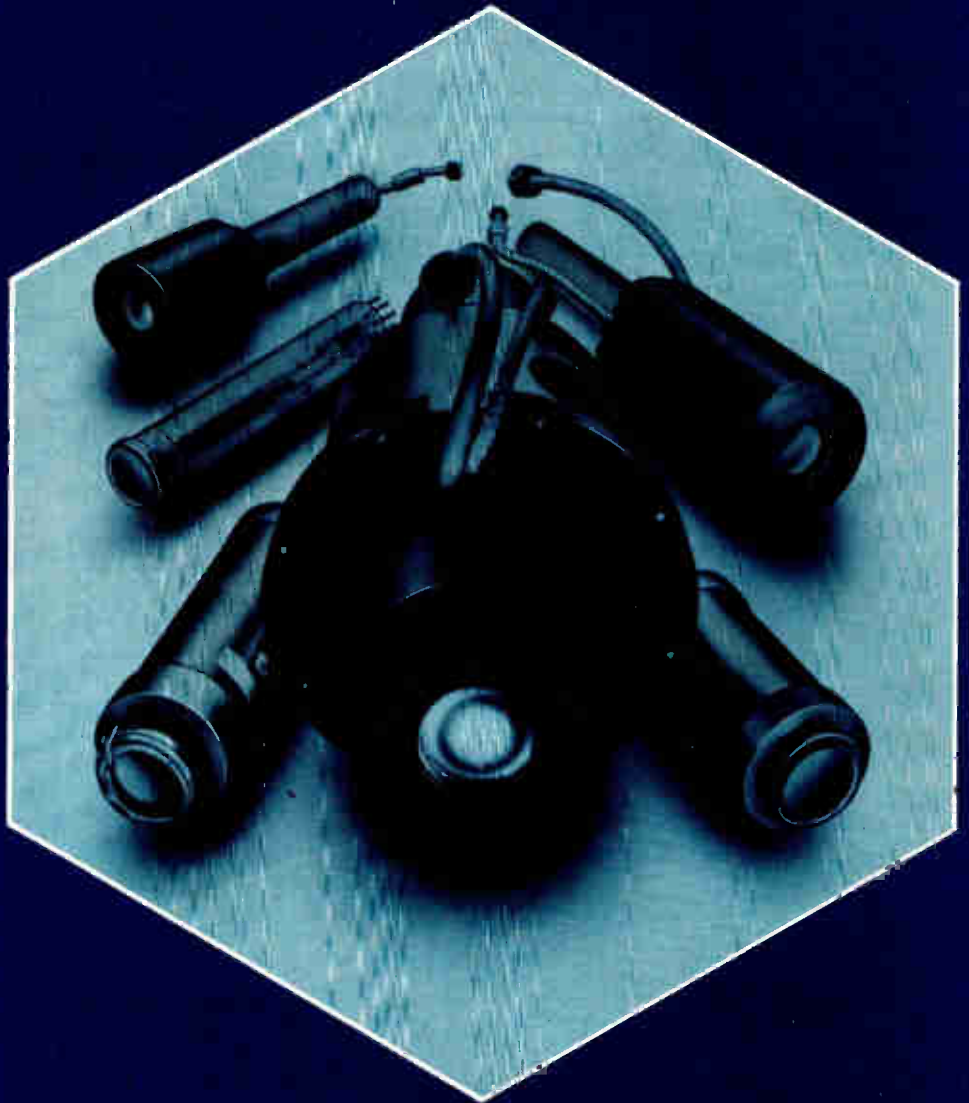

## Daytime - Night-time - Thermal imaging

- Vidicons • Silicon-target vidicons • Pyroelectric-target vidicons
  - Nocticon® L3 TV tubes • Supernocticon® L3 TV tubes.
- Potted, integral-coil, and ruggedized models available.



**THOMSON-CSF**  
COMPONENTS

**THOMSON-CSF** DIVISION TUBES ELECTRONIQUES  
38 RUE VAUTHIER / BP 305 / 92102 BOULOGNE-BILLANCOURT CEDEX / FRANCE / TEL. : (33.1) 604 81 75

**USA**  
THOMSON-CSF  
COMPONENTS CORPORATION  
CLIFTON NJ (201) 779.10.04

**BRAZIL**  
THOMSON-CSF  
COMPONENTES DO  
BRASIL Ltda  
SAO PAULO (11) 542.47.22

**GERMANY**  
THOMSON-CSF  
BAUELEMENTE GmbH  
MÜNCHEN (89) 75 10.84

**UNITED KINGDOM**  
THOMSON-CSF  
COMPONENTS AND  
MATERIALS Ltd  
BASINGSTOKE (250) 29.155

**ITALY**  
THOMSON-CSF  
COMPONENTI  
ROMA (6) 638.14.58

**SPAIN**  
THOMSON-CSF  
COMPONENTES  
Y TUBOS S.A.  
MADRID (1) 419.88.42

**SWEDEN**  
THOMSON-CSF  
KOMPONENTER  
& ELEKTRONRÖR AB  
STOCKHOLM (8) 22.58.15

**JAPAN**  
THOMSON-CSF  
JAPAN K.K.  
TOKYO (3) 264.63.46

Circle 60 on reader service card

August 25, 1981

# Electronics

## International®

Multimicroprocessor machine  
goes commercial: page 73

A large and a small Josephson junction below two control lines  
(across top) create compact three-dimensional AND gate: page 74

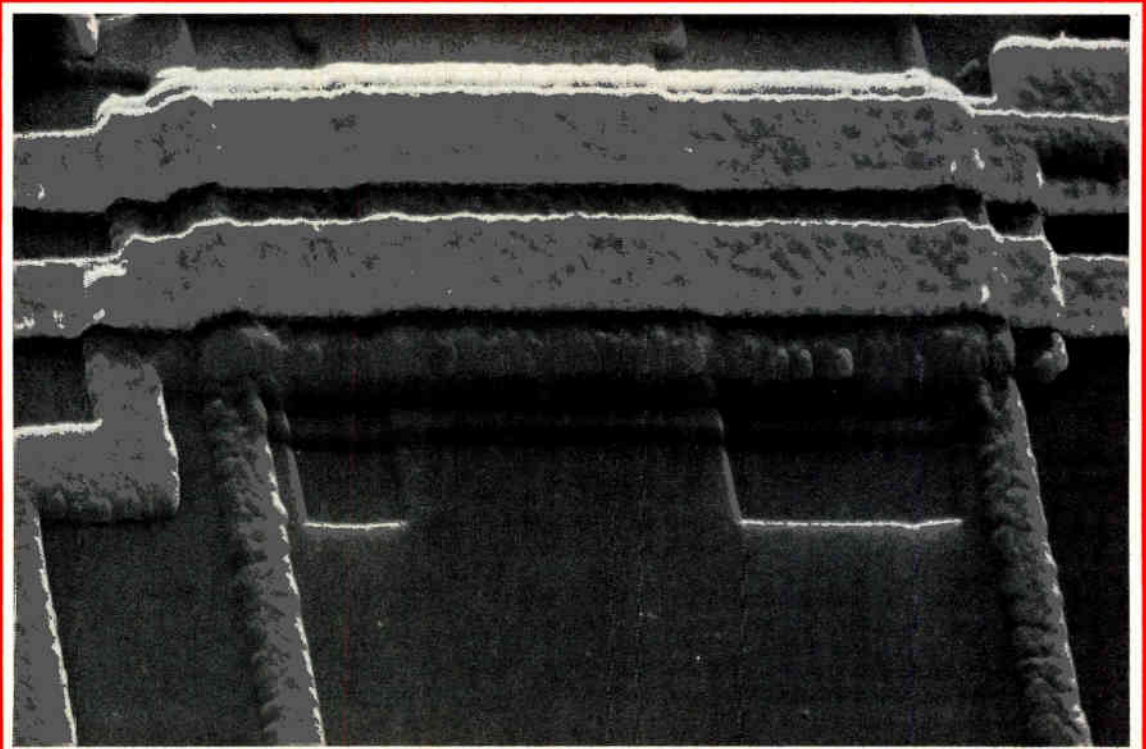

ONE OF OUR  
POWER LINE DISTURBANCE MONITOR'S  
BEST FEATURES STARTS  
RIGHT HERE.

Because that's where you start reading your data—at the top of the tape, instead of at the bottom (which is where you start with old-fashioned power analyzing equipment).



Franklin's Model 3600 tells you exactly what's going on in your power line in plain English—not in code. And it tells you when it happened so you can correlate power disturbances with errors on the computer log, in real time.

Circle 62 on reader service card

```

*** CALIBRATION ***
PHASE A      300Vac
PHASE B      300Vac
PHASE C      300Vac
PHASE A PULSE 592Vpk
PHASE B PULSE 595Vpk
PHASE C PULSE 604Vpk
DC           10.0Vdc
FREQUENCY    50.0 Hz
*****

```

```

TIME          10:46:33
DC HIGH      46:33
DC MAX 14.1V 46:47
DC HIGH      46:47
A UNDER     47:00
A MIN 92V    810 mS
A OVER       47:09
A MAX 135V   47:10
A PULSE -    47:20
A 101V      17 uS

```

```

ON BATTERY   10:49:57
POWER ON     10:50:03
A MIN 0V     50:03
DC MIN 0.0V  50:03
A UNDER     50:04
A MIN 105V   10 mS
FREQ MIN 56.8 50 mS

```

```

***** STATUS *****
DATE         07-29-81
TIME         10:50:17

```

INPUTS

```

PHASE A      115 Vac
PHASE B      115 Vac
PHASE C      115 Vac
3PH          112 Vac
DC           5.1 Vdc
FREQUENCY    60.0 Hz

```

THRESHOLD SETTINGS

```

UNDER        105 Vac
OVER         125 Vac
PULSE        100 Vpk

```

Franklin's Model 3600 has keyboard entry for precise setting of AC and DC under/over voltage, under/over frequency and high speed pulse threshold parameters, plus a digital display for monitoring signal levels, and verifying time and thresholds.

So write today for complete specifications and a demonstration of Franklin's Model 3600.



**Franklin Electric**  
Programmed Power Division

995 Benicia Avenue  
Sunnyvale, CA 94086  
(408) 245-8900 Telex 357-405

See us at WESCON, Booth H-46.



## European market gets own CCD TV camera

A miniature black and white camera weighing just 2.2 lb that conforms to Europe's 625-line standard—unlike the 525-line standard adopted by U. S. and Japanese manufacturers—will be available next month from Britain's English Electric Co., Chelmsford, Essex, which is part of the General Electric Co. Ltd. group [*Electronics*, Sept. 11, 1980, p. 78]. The 13-cm-long, 6.4-cm-wide and 20.4-cm-high camera **uses a charge-coupled-device imager from GEC's Hirst Research Centre that packs 220,000 imaging elements onto a 1-by-1.4-cm chip.** The resolution—about 67% that of TV studio broadcast cameras—is better than already marketed home video equipment, says the company, and suitable for closed-circuit TV and industrial applications. The price has yet to be fixed but may well be under \$4,000.

## VHD video-disk launch delayed

Unable as yet to mass-produce disks, the international consortium of four companies developing the Video High Density video-disk format has announced a six-month delay in its product launch. VHD thus stands to lose further ground to the two alternative and incompatible RCA and Philips formats already on sale in the U. S. At a recent meeting in Los Angeles, top officials of Victor Co. of Japan, Matsushita Electric Industrial Co., General Electric Co., and Thorn EMI PLC decided to postpone introduction of their system until at least April in Japan and June in the U. S. Also likely to suffer are the 11 Japanese companies that have bought production rights to VHD. Many have invested in plants, and some, according to industry experts, have already started making players, which are worthless without disks to play. Meanwhile, **Pioneer Electronic Corp. revealed plans to become the first video-disk marketer in Japan** by starting to sell 5,000 Philips-type players early next month.

## Netherlands charts three-way course for microelectronics

The Netherlands' Ministry of Science is currently drawing up a program for spending up to \$10 million a year on promoting the application of microelectronic devices by small and medium-sized Dutch firms. The program has three parts. The first is the establishment of three consulting centers by the end of this year to which the firms can turn for technical, managerial, and marketing advice on the microelectronic-based products they are designing. **The second will give financial help to small and medium-sized companies engaged in the design of chancy products** using new microelectronic technologies. If a product proves commercially successful, the company must repay up to 70% of the government's financial aid. The third portion will help universities expand their research and development facilities to accommodate more graduate students.

## Scrambling repels software pirates

Piracy of disk-based software for personal computer systems is a growing problem in the software industry, especially when software crosses national boundaries. But one British software publisher, London-based Little Genius Ltd., thinks it has the answer. It has developed a copy-proofing technique with which it plans to protect its own software—interactive teaching aids for Basic and Pascal programming—and which it is prepared to license. **The technique is to scramble the software before it goes on disk,** prefacing a program so stored with a preamble that configures the target machine to read it alone. Attempts to copy unscrambled programs trigger traps that erase them from user memory.

### **Israeli optical switch deflects fiber**

A small Israeli company, Arel Control Systems Ltd., has constructed a prototype 2-by-2 optical switch, the forerunner of a 16-by-16 switch, **for use in analog optical exchanges such as closed-circuit TV or fiber-optic digital data networks.** The device is electromechanical: vertical and horizontal deflectors—piezoelectric elements mounted end to end in one pliable component—position an optical fiber within the focal plane of a miniature lens whose output is a collimated beam 3 mm in diameter. The deflectors steer the beam between two photodiode detector/repeaters.

### **Three firms to submit proposals for Japan's Badge defense system**

The Japan Defense Agency has officially requested proposals by early next year for a new Badge (for base air-defense ground-environment) system from three of the five Japanese manufacturers preparing for the project [*Electronics*, July 14, p. 64]. Nippon Electric Co., Hitachi Ltd., and Fujitsu Ltd. were selected by the agency because only they among Japanese firms have both the computer and communications expertise required for the job, which includes **upgrading command installations at 27 sites throughout the archipelago and communications among them.**

NEC intends to bid as main contractor in a group that includes subcontractors Mitsubishi Electric, Toshiba, Oki Electric Industry, and Nippon Avionics (Nippon Avionics is a joint venture 51% owned by NEC and 49% owned by Hughes Aircraft). Hitachi is negotiating with System Development Corp., a U. S. firm, for the purchase of application software for use in this project.

### **Matilda tells it to the marines**

The talking computer that warns a crew of danger is no longer science fiction. Called Matilda, it has been developed for the smaller class of warship by MEL, a division of Philips Industries Ltd. located in Crawley, Sussex. **The synthesized voice also indicates from which direction the radar-detected threat may be expected,** and a visual display simultaneously provides the same information to a command position. The miniature rapid-reaction system, which automatically initiates countermeasures, is on display at the Royal Navy Equipment Exhibition in Portsmouth, Sept. 7-11, an export promotion for UK manufacturers of defense equipment.

### **Japanese-American team to make C-MOS gate arrays**

Complementary-MOS silicon-gate logic arrays customized by LSI Logic Corp. in Santa Clara, Calif., may be shipped to U. S. buyers next spring before wafer supplier Toshiba Corp. can ready chips for its Japanese customers. Toshiba will ship the wafers on a nonexclusive basis, complete except for two layers of aluminum interconnections, which LSI Logic will add with the aid of its LDS I development system before packaging the chips. A high-speed series will become available first, initially **in 880- and 2,000-gate devices, using 3- $\mu$ m rules and offering typical per-gate propagation delays of 2.5 ns.** Late next year, a very high-speed series, using 2- $\mu$ m rules and offering 1.5-ns delays, will become available, to begin with in 880-, 2,000-, and 6,000-gate densities.

### **Addendum**

Malta, as the last European country to do so, has begun color TV transmission using the West German-developed PAL system. For starters, the country has **put Grundig AG under contract to supply it with some 10,000 color sets.**

# Pro-Log M980 Programmer: Best in the field.

## Built rugged to keep working.

Weighing less than 22 pounds and compact enough to fit under an airplane seat, the Pro-Log M980 is still the most rugged PROM programmer for troubleshooting in the field.

Pro-Log programmers have been used on the Alaskan pipeline, in steel mills and in other hostile environments. One even survived a tornado that destroyed the building around it!

Look inside the M980 and you'll see there's little to go wrong. We designed it for reliability with a limited number of functional high-density parts and interconnects. A recent service study indicated that you can expect *10 years* of failure-free performance from the M980.

## Backed by the industry's longest warranties.

Based on the proven quality of 9,000 Pro-Log programmers and 20,000 personality modules performing reliably worldwide since 1973, Pro-Log gives you a two-year warranty on M980 control units and a one-year warranty on all personality modules.

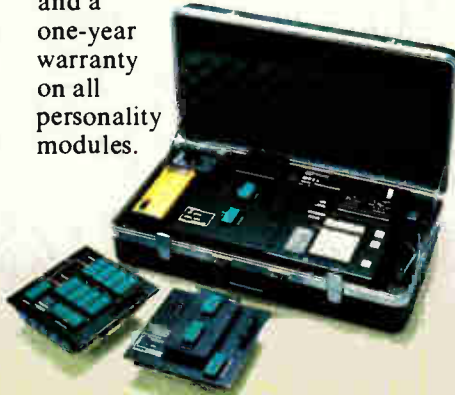

## Remote control for troubleshooting and updating.

For easy diagnosis and pattern updating in the field, connect the M980 to a computer, terminal or modem via the RS232C or parallel interface.

## Find out more.

For full details, send for our 32-page M980 brochure. Or better yet, ask for a free demonstration.

Write or call Pro-Log Corporation, 2411 Garden Road, Monterey, CA 93940, phone (408) 372-4593.



**PRO-LOG**  
CORPORATION





Copyright © 1981, Tektronix, Inc. All rights reserved. OEM quotations available on request. 973

## The practical 8-pen 4662 Option 31 Plotter by Tektronix

# As your plotting needs change, the 4662 keeps changing automatically!

**T**he new 8-pen turret option: one more reason why the Tektronix 4662 is one small plotter you won't outgrow. With the 4662, you automatically start off with more choices of plotting styles than on any other B-size (11" x 17"; 279mm x 432mm) plotter: Choose paper, Mylar® or overhead projector film. Select from nine colors and three pen types, including hard-nib, fiber-tip, and fine-line wet-ink pens for drawing multiple plots on a single page.

Add the new Option 31 turret, and you can preload all the pens you need for the most colorful or complex plot. The 4662 picks whatever you choose. Automatically.

**Present 4662 owners can keep their plotters and still keep current, because the 8-pen turret is easily retrofitted in the field.**

Adding just a few lines of code is all it takes to implement the convenience of automatic pen changes to existing programs!

That's typical of Tektronix, where equipment is designed to be dependably permanent. That's why both RS-232-C and GPIB interfaces are standard on the 4662 — so you can change processors without extra expense. And why we've already made additional memory available to 4662 owners.

**If you're in the market for a practical plotter, make it a permanent plotter.**

That makes it a Tektronix plotter, automatically! For more information on the 4662 Option 31, call 1-800-547-6711 (in Oregon, 1-800-452-6773), or contact your local Tektronix Sales Engineer.

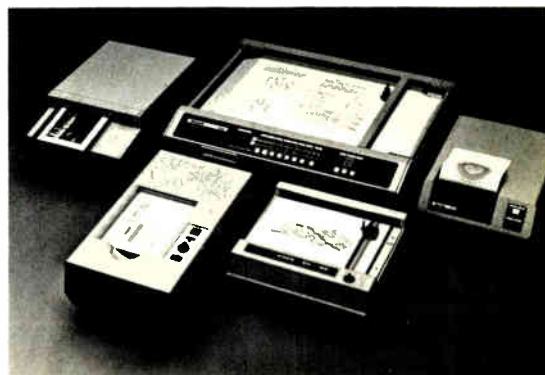

**Tektronix, Inc.**  
Information Display  
Division  
P.O. Box 4828  
Portland, OR 97208  
**Tektronix  
International, Inc.**  
European Marketing  
Centre  
Post Box 827  
1180 AV Amstelveen  
The Netherlands

**THE GRAPHICS  
STANDARD**

**Tektronix®**  
COMMITTED TO EXCELLENCE

Circle 67 on reader service card

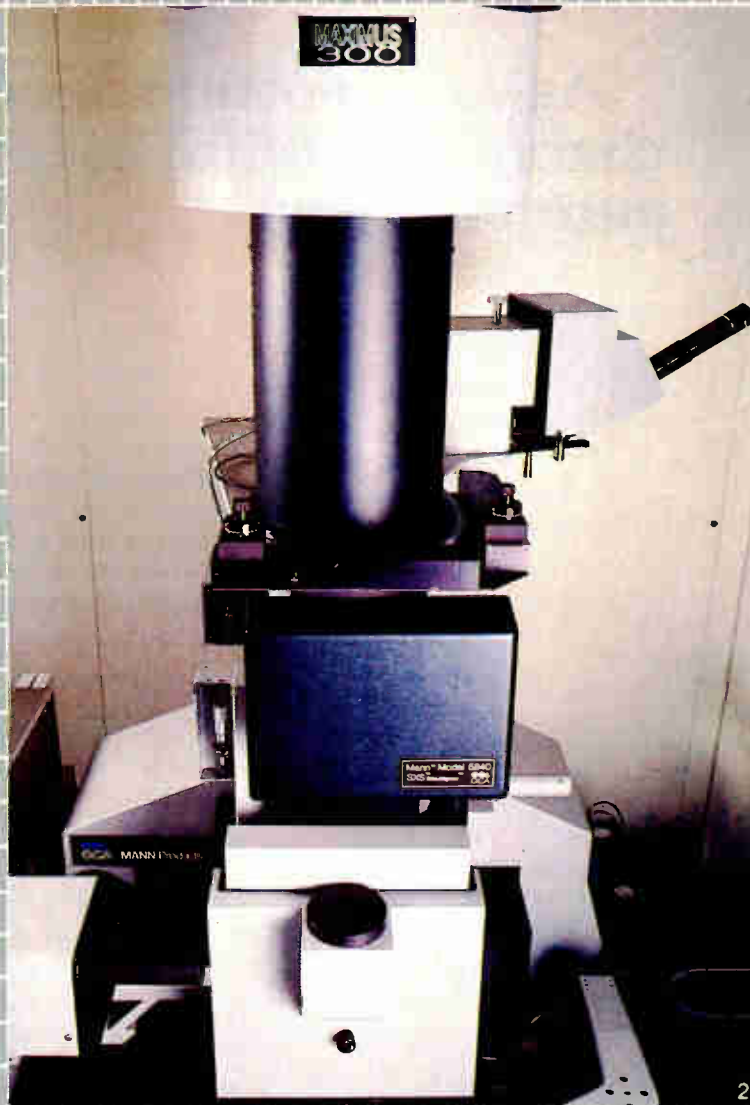
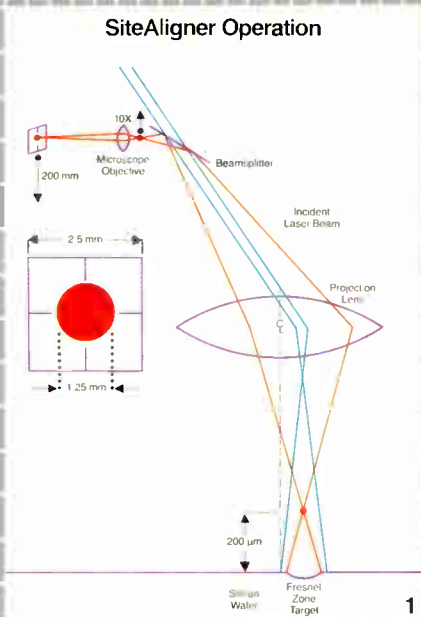

## INTRODUCING THE GCA SITEALIGNER.™ THE

Now you can blend the fine-line performance of the DSW® Wafer Stepper™ direct step on the wafer system into a mixed production line. And that includes anything from proximity and contact to projection systems.

The reason for this important development is the new Mann Model 5840 SXS™ SiteAligner.™

The SXS is an automatic, through-the-lens alignment system that aligns

each site on a wafer prior to exposure. And besides its ability to intermix with other types of printers, it brings individual DSW registration tolerance to  $\pm 0.25 \mu\text{m}$ , and the registration of matched DSW's all the way down to  $\pm 0.35 \mu\text{m} 3 \sigma$ .

The SiteAligner works on a unique Fresnel diffraction technique that allows alignment even when a target is damaged. The system uses a

wavelength of light that does not expose the photoresist coating.

Software flexibility lets you align over a wide variety of sequences, including once per row, once per quadrant, every nth site, or at every site. And batch characterization speeds throughput by examining the alignment corrections at each site on the first few wafers in a batch. If these corrections are within specified limits

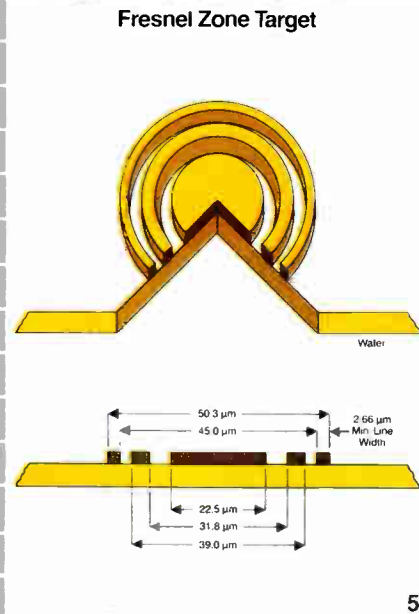
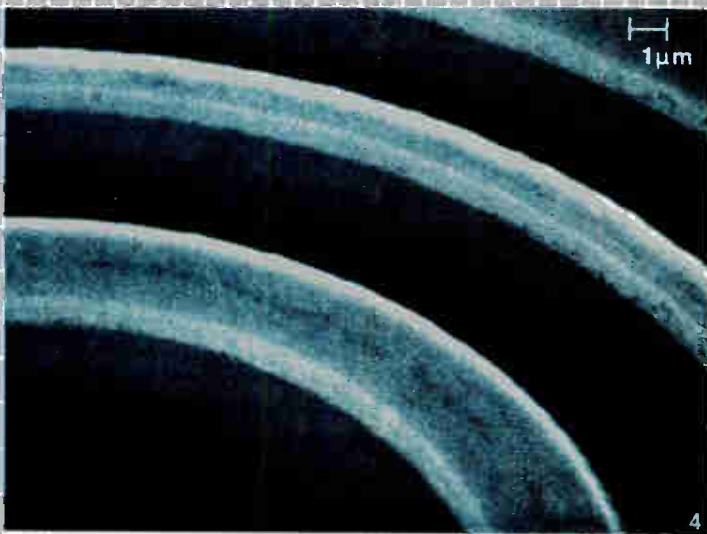
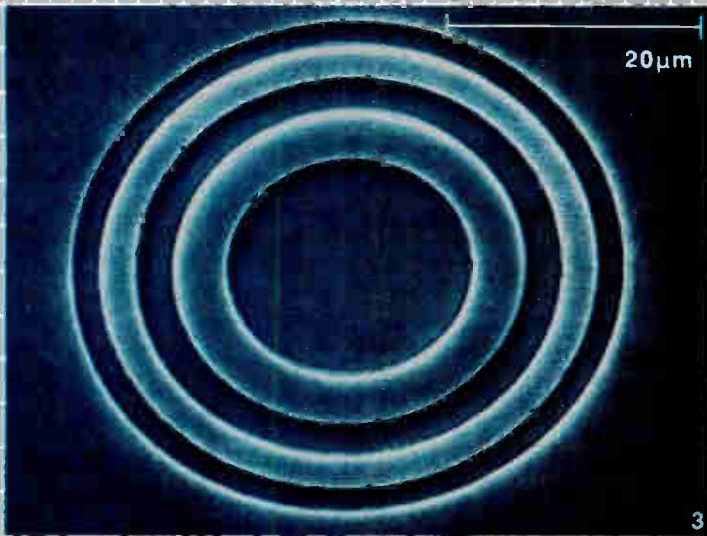

**A STEP  
AHEAD.**

## PERFECT MATCH IN A MIXED ENVIRONMENT.

the remainder of the batch can be exposed without individual alignments.

If you'd like to improve your production performance with a perfect match, call or write to us at one of these addresses: GCA/Burlington Division, 209 Burlington Road, Bedford, MA 01730, Tel: (617) 275-5400. Sumisho Electronic Systems, Inc., Landic Hirakawacho Building,

2-6-2 Hirakawa-Cho, Chiyoda-Ku, Tokyo, 102 Japan, Tel: 03-234-6211. GCA International, CH-8280 Kreulingen, Konstanzerstrasse 6, Switzerland, Tel: 41-072-71-1585.

1. Optical schematic of Mann Model 5840 SXS™ SiteAligner.™

2. SiteAligner mounted on the DSW® Wafer Stepper™ direct step on the wafer system.

3. Scanning Electron Microscope photo of Fresnel Zone Target on wafer (approx. 1600X).

4. Scanning Electron Microscope photo of Fresnel Zone Target on water (approx. 3000X).

5. Diagram of the Fresnel Zone Target. The Fresnel Zone Target allows alignment even if a target is damaged.



**GCA CORPORATION**  
**IC Systems Group**  
**Burlington Division**

209 Burlington Rd  
Bedford, Mass 01730  
(617) 275-5400  
Telex: 95-1257

RAMSEY, NJ 201-825-9623 • RICHARDSON, TX 214-644-3000 • SANFORD, ME 207-324-2677 • SUNNYVALE, CA 408-730-5200 • TEMPE, AZ 602-894-9831  
UNDERHILL, VT 802-899-3096 • 2950 VEDBAECK, DENMARK 2-890668 • WEYBRIDGE, SURREY ENGLAND 09322-27388

# Berg PC Board Modular as fast as they eliminate



What 300 million Berg Mod Jacks did to revolutionize the telephone industry can be done for many other products as well. Berg Mod Jacks can dramatically cut production costs and make field servicing easier with the quickest connect/disconnect system available today.



# Jacks plug and unplug hard wiring costs.

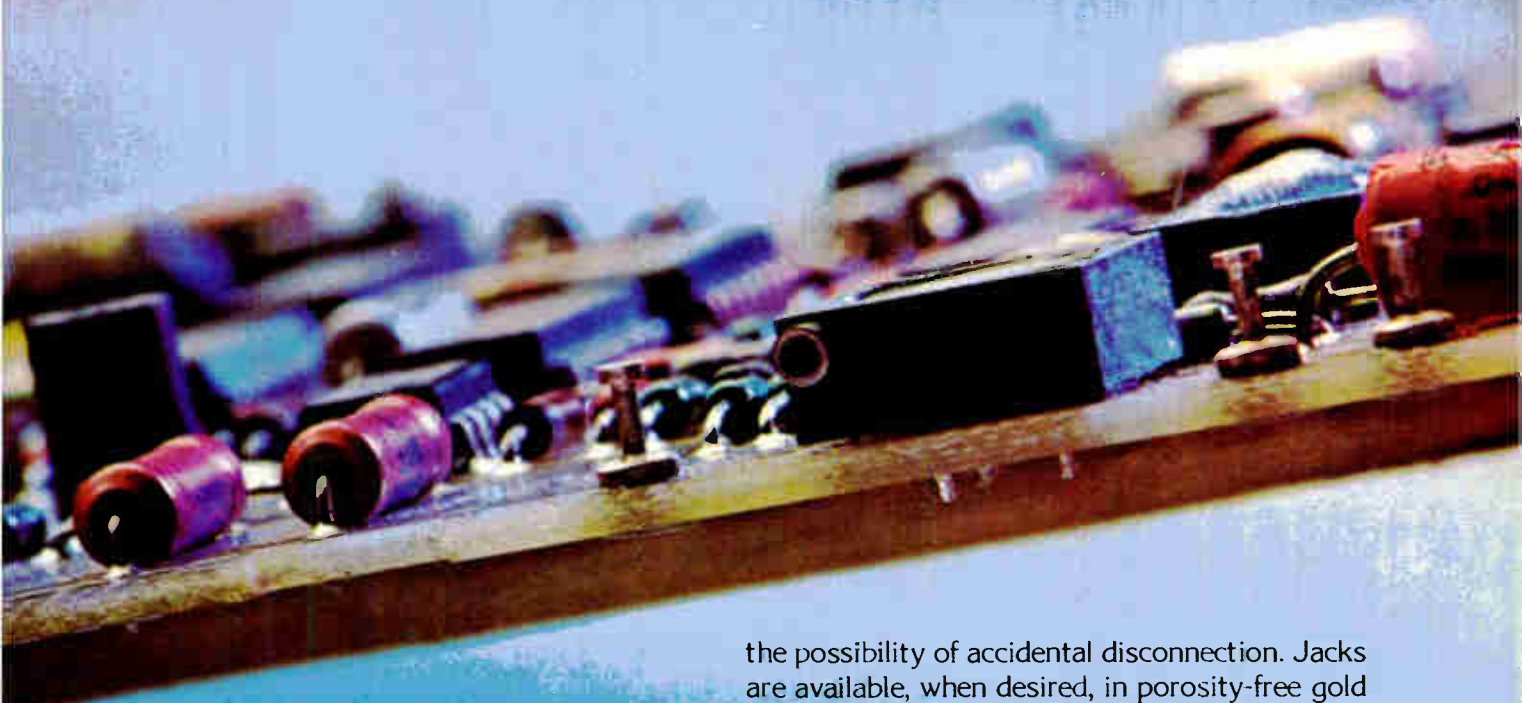

**Eliminate all wiring fabrication.** This highly reliable interconnection consists of four- and six-wire jacks which mate with male connectors on coiled or uncoiled cord of various lengths. An eight-wire jack with shorting bar and matching line cord is also available.

**Mount directly onto the pc board.** No investment in application machinery is necessary. Just snap the jacks into a pre-drilled pc board and wave solder them along with all your other components. Polarization assures proper mating of the jack and cord, and a self-locking feature virtually eliminates

the possibility of accidental disconnection. Jacks are available, when desired, in porosity-free gold plating to further match your reliability requirements. Berg quality remains high. Regardless of volume. Regardless of delivery requirements.

**Find out more about Berg PC Board Modular Jacks.** During our years of producing mod jacks we've developed the most reliable, totally automatic production and inspection system in the world. No one else is even close. Bulletin 1800 gives performance data and physical characteristics as well as information on our ability to meet your special needs. Write or call for your copy. The Du Pont Company, Berg Electronics, New Cumberland, PA 17070. Telephone (800) 233-7581. In Pennsylvania call (717) 938-6711.

**An electronics company.**



Circle 71 on reader service card

# A 50MHz scope with alternate time base and a low price tag...we just keep getting bigger and better.

At only \$1,895, this new dual channel scope may be the best bargain in town. Conservatively rated at 50MHz it will actually maintain a 3dB bandwidth at 65MHz and better than 9dB at 100MHz.

Rugged and portable, the KIK-5650 is comparable to Tek's 455 (at \$2,230) but offers a number of significant advantages including an alternate time base for viewing four waveforms simultaneously, an auto-dynamic focus circuit for clear, sharp pictures and a metal housing that minimizes RFI interference. And the 5650 is currently available from stock. Add these to the features called out below and you have a scope that is unequalled

by any other instrument in its price range.

But there's a lot more to your KIK-Scope than operating features and specifications. For one thing, your KIK-Scope is completely modular. All components are on plug-in boards. In the event of trouble, just send us the faulty board and we'll send you a replacement by return mail. This swap-out program assures fast maintenance turn around and minimum down-time. Then there's our 2-year warranty (CRT 1 year). That's twice as long as the warranty from most manufacturers and a reflection of the confidence we have in the quality components and workmanship that goes into all Kikusui products.

And, just to give you a little added assurance, your KIK-Scope comes with a 30-day "satisfaction-or-your-money-back" insurance policy.

The model 5650, along with the nine other KIK-Scopes in the line is described in our new catalog. Write for it. It's free.

Kikusui International Corporation  
17121 South Central Ave., Suite #2M  
Carson, California 90746  
(213) 638-6107 • TWX: 910-346-7648



A subsidiary of  
KIKUSUI ELECTRONICS CORP, JAPAN

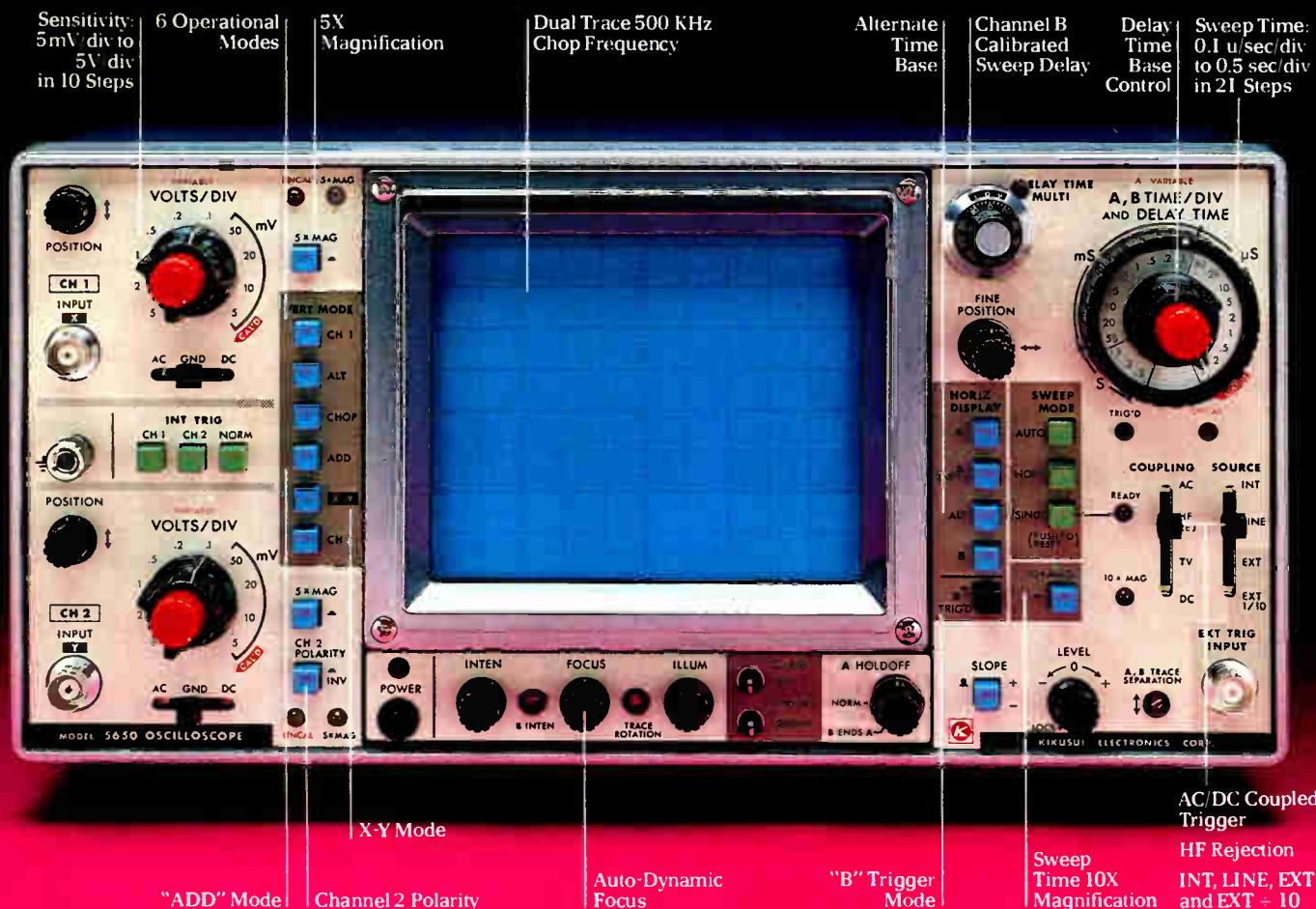

Circle 72 on reader service card

## Microprocessors in a ring take aim at mainframes

by Kevin Smith, London bureau manager

Commercial 16-chip unit is installed, even as research makes it possible to use 250 microprocessor chips

**Powerful computer systems** built from assemblies of inexpensive microprocessors may soon be ready to take on the conventional mainframe in industrial control, communications, data-base management, and other projects with a high degree of inherent parallelism. For example, the Demos design that began four years ago at Britain's National Physical Laboratory in Teddington, Middlesex, will shortly start earning its keep as an industrial controller, process monitor, and data-acquisition system.

The machine has been given commercial form by Scicon Consultancy International, a subsidiary of British Petroleum Ltd., which is currently installing its first Scidac system at a customer's site. For it, Scicon uses an adaptation of the laboratory's earlier ring to run just 16 microprocessors—actually 16-bit Intel 8086s—in parallel.

**Ring change.** But much more powerful multiprocessor arrays are already on the way. NPL engineers are now completing development of a high-speed local ring that will run 250 microprocessors in harness as a single virtual machine.

Apart from supporting tightly coupled microprocessor arrays, the Mark II ring has other potential applications, for which NPL is seeking backers. With a data rate of 60 megabits per second over a local 8-

bit bus, a worst-case response time of 4 milliseconds, and an ability to share capacity equally between users when fully loaded, it is suitable for use in office automation, private automatic branch exchanges, and other applications where voice and data must be combined.

The earlier Mark I ring proved too expensive for commercial realization, which was why Scicon adopted

a far simpler bus system. But in reengineering its ring, NPL has taken advantage of the latest programmable logic array concepts, and is now projecting a very competitive \$1,000 per ring node.

In Demos, the 8086 processors have their own individual stores and internal buses and communicate with each other over a unidirectional high-speed ring rather than through

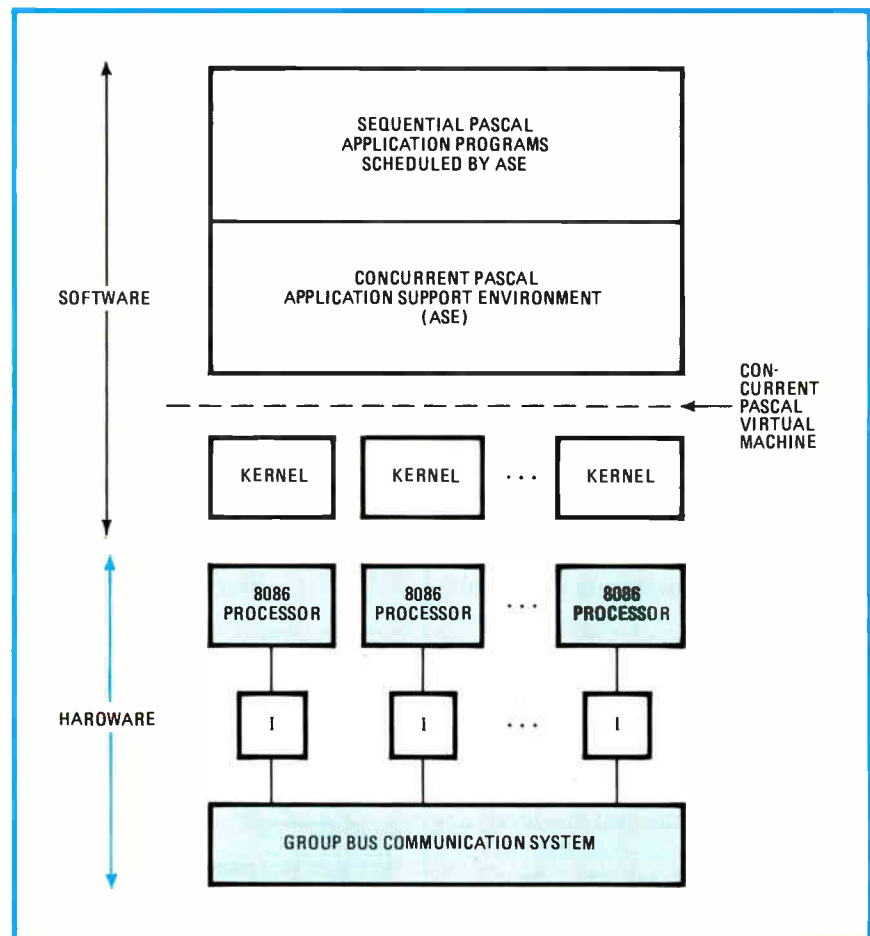

**Virtual machine.** Programmers can write modules in sequential Pascal for Scidac system unaware of its complexity—16 microprocessors linked to a bus by interface boards (I).

shared memory. High-speed kernels handle interprocessor messages as procedure calls. Such calls conventionally fetch the needed subroutines into main memory for sequential processing, but in a distributed processor each call is routed to the processor dedicated to that task, which returns its results.

This arrangement, argues Barrie Brinkman, who heads the Scidac project at Scicon, is simpler, cheaper, and more flexible than the shared-memory approach. Moreover, the communications interface does not have to map messages into the addressed processors, so that memory is relatively hardware-independent. Consequently new microprocessor products can readily be absorbed as they become available.

**Transparent.** Ideally, the user of a multiprocessor array should be unaware of the complexity of his system. In Demos, a user's application programs can be written as if for a single virtual machine, using a modular programming language like sequential Pascal. The component software modules are then allocated among processors during loading.

The operating system for Demos, however, is written in concurrent Pascal, which, says Peter T. Wilkinson, who heads the NPL project, lends itself to parallel processing with very clean interfaces between modules and allows fast high-quality programs to be written. Once a system has been developed for target configuration, its performance can be increased by the addition of more computer power without the need for software changes. This is achieved in a once-only operation with the aid of a system generator program, which reallocates the operating system modules among the available hardware, as the operator directs.

Fast interprocessor communication is essential for Demos to behave as a single virtual machine. The Mark II ring achieves this over a byte-wide data bus clocked at 8 megahertz. Messages are transmitted, a package at a time, by a token-passing system and can be up to 65 bytes long. The virtue of this organization is a fast response, as well as

shared capacity between users when the bus is fully loaded.

In the Mark I ring, interface logic per port amounted to some 28 small-scale integrated circuits, but the Mark II ring uses field-programmable logic sequencers to cut the chip count to 25 devices per port. These fit on a double Eurocard.

Potential users, like Britain's Central Electricity Board, have been impressed with the ring hardware, and now NPL is talking to several manufacturers interested in commercializing it. Work at NPL and at London-based Scicon meanwhile is going ahead to further develop the system's fault tolerance.

## Switzerland

### Two Josephson junctions in one device triple logic circuitry density

When it comes to Josephson junction technology, it's clearly International Business Machines Corp. that is leading the field, with hardly a year going by without experts at the company's research laboratories in Yorktown Heights, N. Y., edging toward a full-blown superconducting Josephson computer. [*Electronics*, Feb. 16, 1978, p. 43; Jan. 3, 1980, p. 41]. Now comes word of another major advance in the field from the IBM Zurich Research Laboratory of Rueschlikon, Switzerland.

There researcher Hansjörg Beha has designed and tested a new family of Josephson logic circuits termed magnetically coupled asymmetric interferometer logic—Mail, for short. To be discussed at the Seventh European Solid State Circuits Conference in Freiburg, West Germany, Sept. 22 to 24, the Mail device is an asymmetric two-Josephson-junction

interferometer— asymmetric because one junction is much larger than the other (see figure).

Beha's work at the Zurich labs draws upon the investigations he carried out at the University of Karlsruhe in West Germany, where in 1977 he first proposed such an interferometer as a logic gate. The key feature of the Mail device is that it combines galvanic isolation and logic operation in a single device, in contrast to other Josephson logic families. The single-device implementation, achieved essentially by the asymmetric junction areas, yields triple the density of other Josephson logic components.

**High gain.** Furthermore, the threshold characteristic of Mail circuits is so steep as to make them insensitive to control current variations. Also, they exhibit high gain compared with other Josephson de-

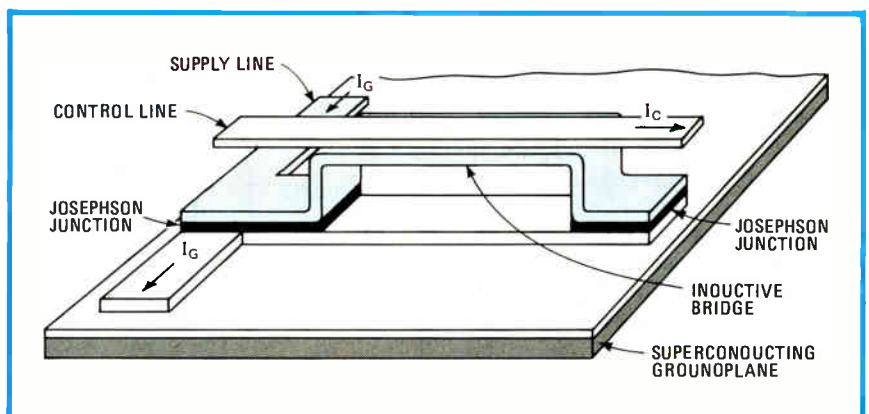

**Denser.** Compact Josephson design uses two differently sized junctions. An AND gate results if a second control line crosses inductive bridge, parallel to that shown.

TOP PERFORMANCE + DELIVERABILITY =



**BREECH-LOK® SERIES IV CONNECTORS.**



Shakespeare once said, "For want of a nail, the kingdom was lost." His point was that in any undertaking, the sum of the whole can never be better than the sum of all the parts. We are well aware of that, and when your company's reputation and product are on the line, we put our connectors on the line, every time.

At G&H Technology, we know that your requirements are being up-graded, and made more stringent every day. To meet that need, we offer you the **Breech-Lok® Series IV** . . . a series of MIL-C-38999 connectors designed to meet and surpass, by any standard, your requirements. What's more, we can deliver this technology to you, on time and on budget. **Breech-Lok Series IV** are deliverable within twenty weeks. Read that again. Twenty weeks. At the end of that time, you will have in your possession, the best performing connector around. We have the people, the facilities, the expertise and the desire to make that so.

Remember, our promise to you is this: Our connectors will stay coupled in any environment. No ifs, ands or buts. Any environment. Experts agree, **Breech-Lok Series IV** is the connector chosen for Missile "X." It is the quintessential performance-oriented connector.

**BREECH-LOK**  
CONNECTORS  
G&H TECHNOLOGY, INC.

1649 17th Street, Santa Monica, CA 90404 (213) 450-0561

World Radio History

Circle 75 on reader service card

vices. With the control current at its threshold value and with one junction area five times bigger than the other, the gain at the circuit's optimum gate current insertion point checks in at 9.8.

Computer calculations with OR and AND Mail device models based on 2.5-micrometer technology and lead electrodes point to a nominal gate delay of 25 picoseconds and a power dissipation of 5 microwatts per gate. That works out to a power-delay product of only 125 atto-joules—at least three orders of magnitude smaller than that for silicon or gallium arsenide devices.

In a single-device two-input AND Mail circuit, the gate current  $I_G$  is applied to the larger Josephson junction, and currents along two control lines (one for each junction) set up the magnetic field coupling the inductance to the interferometer portion. The output line ends in a load resistor that matches the line's characteristic impedance. Connecting several such resistors in series permits a large fanout.

A proper choice of the ratio of the junction areas, and thus of the Josephson current ratio results in an almost ideal threshold characteristic for performing the AND function. The device switches from the superconducting logic 0 state to the voltage or logic 1 state when both control signals are applied. To convert an AND circuit into a two-input OR circuit, a third control line carrying a bias circuit must be added to the other two.

The interest of IBM—and of other computer makers, notably the Japanese—in Josephson devices is understandable. Dissipating about 0.1% the power of silicon circuits and exhibiting switching speeds of around 10 ps, Josephson components are at present considered the best way to large computers with cycle times approaching 1 nanosecond. What's more, their low power consumption makes very dense, three-dimensional circuit packages possible to build.

A major barrier that must still be overcome, however, is high fabrication cost.

—John Gosch

---

## Great Britain

---

### Cuts and soldered wire links customize multilayer board in one or two weeks

One major bottleneck in the development of high-speed logic systems, the long 12-week turnaround times associated with multilayer boards, has been overcome by ICL Logic-layer Ltd., the Manchester-based printed-circuit-board manufacturing subsidiary of Britain's ICL Ltd. It has introduced a prototyping board, called Multiboard, for four-layer boards that can be customized with nothing more than a scalpel to remove unwanted track and soldered wire links to complete the desired pad connections.

With the kit, completed boards with component densities and electrical characteristics on a par with boards made from final artwork can be fabricated in one to two weeks, saving 10 weeks of development time and \$5,000. If further modifications are required, the savings multiply. The company is marketing the kit in Europe, where, according to product marketing manager Jim Betts, it has been well received, and will be launching it in the U. S. next year, when the firm will have readied supporting computer design aids.

**Difficult behavior.** Double- and single-sided board prototyping kits such as socket and wrapped-wire boards are well established, but they neither look like a finished multilayer board nor behave in the same way when system logic is ticking at 10 to 20 megahertz and more. In the multilayer printed-circuit board, signal paths appear as matched 50-ohm transmission lines, eliminating the problem.

A Multiboard is the size of a double Eurocard—233 by 160 millimeters—and by itself sells for around \$315. Its two inner layers carry a pair of interleaved power planes and a ground plane. X and Y logic tracks are carried on the two outer surfaces. The board is predrilled on a regular matrix with holes on an

accurate 0.1-inch pitch. It will accept most integrated-circuit packages with a lead spacing of 0.3 to 0.6 in. "We can get between 35 and 40 packages, or up to 650 pins, on a board," says Betts, who reckons that compares well with a fully custom board.

The board has plated through-holes located at strategic intervals to connect to the ground and supply planes. Supply pads, says marketing manager Jim Betts, will always be between one to one and a half pitches of an IC's supply pins, no matter where it is placed on the board. Single tracks are laid between rows of holes with regular connections to every third pad. Unwanted tracks can be sectioned with a scalpel nick and the redundant sections peeled off.

**Bridging the gaps.** Where necessary, links between pads or between an IC lead and a pad are formed from solid tinned-copper wire. When bridging surface tracks, the links are sleeved. The board's 50- $\Omega$  characteristic impedance is maintained regardless of customizing. A bridge link, for example, alters the characteristic impedance by less than 0.5  $\Omega$ .

Changes of direction from X tracks atop the surface to Y tracks beneath are accomplished through copper-filled vias and additional bridge links, if needed. The board's X-Y structure lends itself to the development of logical bus-structured layouts, with buses formed on one plane and connections to them made on the other plane.

Customizing a multilayer board is a relatively simple though somewhat painstaking task. The circuit layout is first worked out on a pad diagram, marking logic connections, links, and nicks in pencils of different colors. When the design has been finalized, it can be recorded as a cut-and-link program produced on a pad address

# If what you need is more of you...



## Pascal/MT+®

With our exclusive SpeedProgramming™ Package

Do you ever wish that you had more good people like yourself when you really have to produce? Pascal/MT+® and the SpeedProgramming™ Package makes you feel like you have an army of workers who know just what to do. With all of the tools we provide you for editing, checking, compiling, debugging and documenting your programs you are able to produce working programs in an amazingly short time. With Pascal/MT+® and SpeedProgramming™ you will never feel short-handed again!

Pascal/MT+® is a total programming system including our native machine code compiler, linker, Pascal-level debugger, disassembler, run-time subroutine library and the exclusive SpeedProgramming™ Package. Used by thousands of companies worldwide, our customers have told us that the Pascal/MT+® system, with its built-in mini-assembler and language extensions, all but eliminates the need for any assembly language programming. The efficient machine code produced by the ISO Standard Pascal/MT+® compiler combined with our extensions to the Pascal language for bit/byte manipulation, I/O port handling, business arithmetic, hardware floating point support along with our exclusive interrupt procedures allow construction of programs ranging from ROM based controllers and operating systems to extensive data base applications.

### The Pascal/MT+ System:

Compiler: Generates ROMable Native Code

- Complete ISO Standard (superset of Jensen & Wirth)
- Powerful Extensions Include:
  - Modular Compilation
  - Direct production of binary relocatable modules
  - Dynamic strings

- Chaining
- Powerful Overlay system
- Address and Size returning functions
- Bit manipulation (test, set, clear, shifts)
- Byte manipulation (high, low, swap)
- Imbedded assembly language
- Easy linkage to external assembly language
- Full NEW and DISPOSE procedures
- Direct access to I/O ports
- Fast floating point, both software and AMD 9511
- Accurate 18 digit BCD (fixed point, 14.4)
- Include files
- Hex literal numbers
- And more...

### Linker

- Combines relocatable modules into executable files
- Can generate Hex format for use with PROM programming

### Interactive Symbolic Debugger

- Variable display
- High-level breakpoints by procedure/function name
- Tracing/single step by Pascal statement
- Procedure/function entry and exit trace available

## FOR: 8080/8085/Z80/8086/68000

### Disassembler

- Combines a relocatable module with its listing file to produce interleaved Pascal and approximate assembly language code.

### The SpeedProgramming Package™

The SpeedProgramming Package is an integrated set of tools which allows you to create Pascal/MT+® programs, check them for correct syntax and undefined identifiers, format them to display flow of control, and do this all within the editing environment before you ever invoke the compiler. Programmers like SpeedProgramming because it frees them from the time consuming chore of repeated compilations to correct simple syntactic and typing errors. Managers find that SpeedProgramming improves productivity, thereby reducing development costs. SpeedProgramming combined with our field tested Pascal/MT+® package gives you a comfortable, powerful, interactive programming environment in which to create your professional quality software. Your products demand production quality tools. Order Pascal/MT+® with SpeedProgramming today!

### Screen Editor

- User configurable
- Standard random cursor movement, file access, search and replace, insert, delete, exchange, etc.
- Structured language editing features such as automatic indent, line adjustment, reading from and writing to a file, block text insertion and duplication.
- Requires: 24 X 80 CRT (or larger), ASCII Keyboard (7 bit data), random cursor addressing.

### Interactive Syntax Scanner

- Finds syntax errors in text being edited
- Enters SPEED, puts cursor at error, prints error text

### Variable Checker

- Catches undefined and mis-spelled variables before the compiler is invoked

### On-Line Reformatter

- Beautify programs in seconds
- Clearly show structure and program flow

### Source Code Management Tools

- Automatic Modification Log and Backup utility program

### Pricing

All systems include the SpeedProgramming Package™

Available now:

- 8080/8085/Z80 ..... Price \$475.00
- 56K Min CP/M-80
- Compiler requires 150K bytes disk storage
- SpeedProgramming Package™ requires 110K bytes disk storage

Coming soon:

- 8086/8088 ..... Price \$800.00
- CP/M-86 or 86-DOS or RMX-86
- 8086 cross compiler ..... Price \$650.00
- Hosted on CP/M-80
- 68000 ..... Price (to be announced)

Initially cross compiler  
Resident compiler to follow

Available on 8" (3740) single density. Contact distributors for other formats.

## MT Micro SYSTEMS

1562 Kings Cross Drive  
Cardiff, California 92007 (714) 755-1366

# ZYMOS IS THE LATEST WORD IN CUSTOM MOS TECHNOLOGY

For full design and fabrication service in a spacious, state-of-the-art Silicon Valley facility call ZyMOS at (408) 730-8800.

## ZyMOS

WHERE SILICON SOLUTIONS ARE CUSTOM MADE\*

477 N. Mathilda Avenue  
Sunnyvale, California 94088

Circle 78 on reader service card



## ADD A PRINTER

### The Canon P2010 and P2020 Provide Printed Augmentation For Instrumentation and Digital Computer Systems At Low Cost.

OEM's and wholesale distributors can now add the Canon P2010 and P2020 Dot Matrix Impact Printers to their product mix for greater sales and profits. With RS232 and IEEE 488 interface these are the ideal printers to interface with microcomputers, computer communications, and instrumentation.

For further information contact:  
Director of Marketing  
Canon Business Machines, Inc.  
3191 Red Hill Ave., Costa Mesa, CA 92626  
Phone (714) 556-4700 Telex 692451

# Canon

78 Circle 286 on reader service card

## Electronics international

form. This data can be used by a technician to produce prototype boards and, if satisfactory, provides fully sufficient information for the manufacture of a customized multi-layer board.

A natural next step is to commit

the design layout to a small personal computer. The resulting cut-and-link program can subsequently be used to generate the artwork for a fully customized multilayer circuit board automatically.

-Kevin Smith

## Japan

### Gate-turn-off thyristors, microprocessors help to shrink subway trains

A minisubway being developed for the Osaka Rapid Transit Authority may provide Japanese heavy electrical manufacturers with their first opportunity to combine variable-voltage variable-frequency inverters and alternating-current traction motors with regenerative braking in subway trains.

The fact that the inverter-induction motor drive is smaller than the present chopper-series motor drive makes it indispensable for the minisubway, and prototypes mounted in old coaches have been in operation on a 300-meter test track since July 22. But it also has other outstanding features that guarantee it will be the wave of the future.

**Variations.** A group of three manufacturers—Toshiba Corp. and Mitsubishi Electric Corp. led by Hitachi Ltd.—are developing the traction equipment. Yoshihiko Syoyama, manager of Hitachi's rolling stock and facility engineering department, says that they will develop standard

specifications for the equipment but that each firm's designs will reflect its own technology and so be slightly different.

For instance, each firm has developed gate-turn-off thyristors suitable for use in three-phase inverters operating from the 750-volt dc third rail of the proposed subway. GTOs simplify the design and eliminate the bulk and weight of the auxiliary thyristors and inductance-capacitance circuits needed to commutate inverters using silicon controlled rectifiers.

**Smart.** Each company also has developed microcomputer-based controls to provide the pulse-width modulation that enables the GTOs to invert the dc supply to alternating current varying between 3 and 125 hertz. The voltage maintained by the circuits must be constant over the higher part of the frequency range and proportional to frequency over the lower part.

Tests show that the lighter weight and improved traction of inverter

### Smaller is better in subways, too

Osaka's municipal transportation bureau is considering building a minisubway in outlying districts, where there are too few people to justify the expense of a full-size subway yet too many to be transported efficiently with buses. Such a service could start in 1990. Passenger coach floors will be lowered by 34 centimeters (13.4 inches) to provide more than half of the overall height reduction of 65 cm (25.6 in.), while width will also be decreased by 40 cm (15.8 in.) from that of the standard coach. Thus the trains will be able to travel in a tube with an inside diameter of only 4.1 meters (13 feet 5 inches) compared with the normal 5.7 (18 ft 8 in.).

Since most subways are now bored rather than dug by a cut and fill method, the minisubway pays off in a tremendous reduction of energy for boring and in the amount of dirt that needs to be removed and carried away. There is also a saving in cost of concrete to line the tunnels. The more efficient trains further contribute to energy savings during operation.



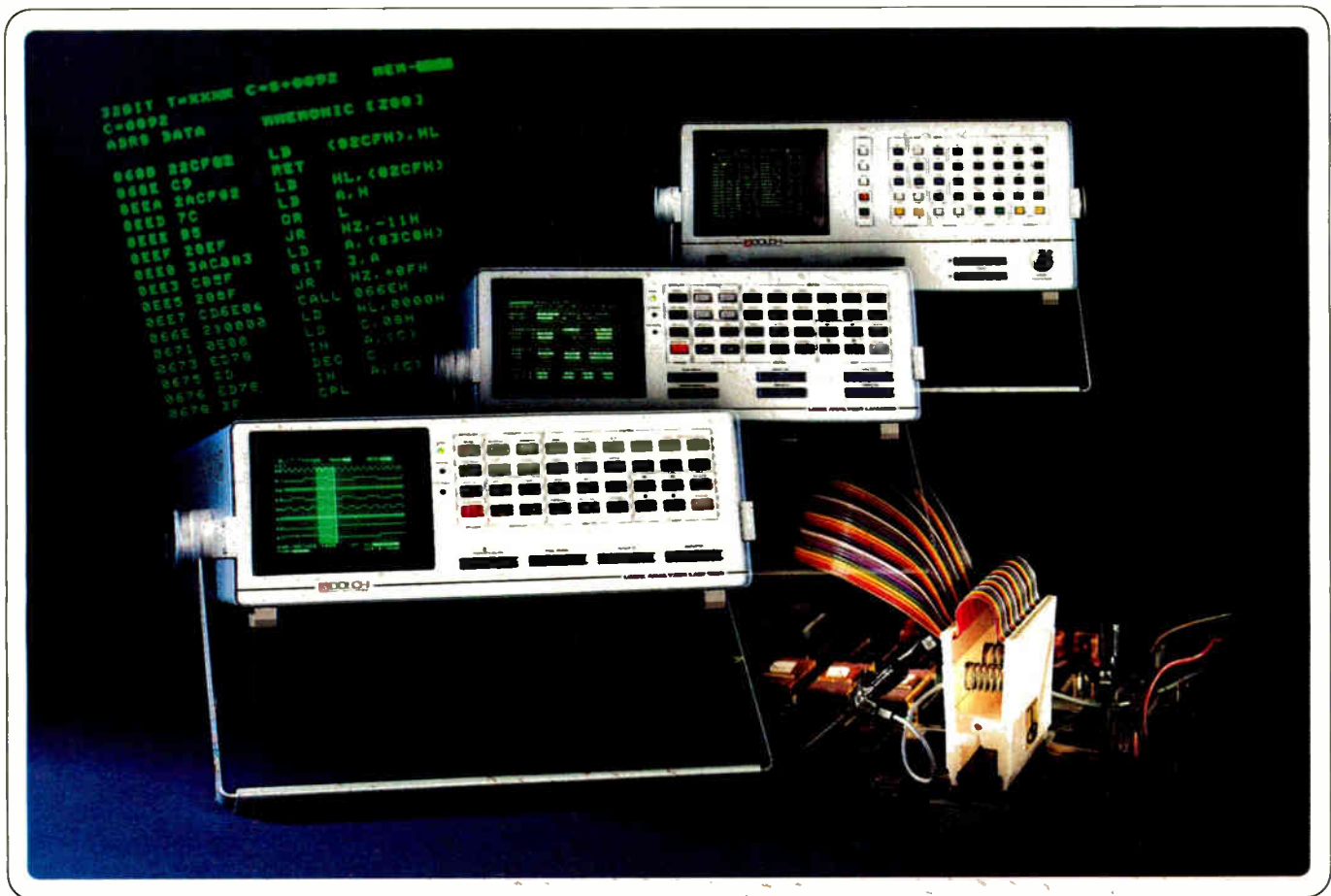

# 16 TO 96

## Channels, the most logical family

Dolch's family of third generation Logic Analyzers lets you meet your troubleshooting needs now, and expand to meet future needs.



With a new channel expansion probe, Dolch's line of 16, 32 and 48 channel Logic Analyzers can easily be extended by a factor of two.

**Disassembling bus activity** and displaying the state information in Mnemonic code is the most efficient method of tracing program execution. Dolch proudly provides the industry's widest selection of  $\mu$ P personality probes and disassembly firmware, for both 8 and 16 bit machines, as well as standard bus interfaces (GPIO & RS 232).

**Multilevel triggering**, as provided in all Dolch Logic Analyzers, proves extremely useful in the debugging of a program that contains multiple levels of nested sub-routines.

A **Battery-Backed Menu Memory** is one of Dolch's many unique contributions to the industry. It lets you store up to 6 separate files of display and menu parameters, for up to three months without power. This allows you to recall complete test setups with a single keystroke.

**Check these standard features and compare.** Dolch's incredible Logic Analyzers, with 16, 32, 48, 64 or 96 channels, offer you more.

- 1000 bits of recording and reference memory
- sampling rates up to 50 MHz
- 5 ns glitch capture
- binary, hex, octal, ASCII mnemonics, and timing display
- 4 level sequential triggering
- multilevel clocking for bus demultiplexing
- powerful compare and search features
- GPIB and RS 232 interfaces (standard)
- hard copy printout (via RS 232)

For more information contact:  
 Dolch Logic Instruments, Inc.  
 230 Devcon Drive  
 San Jose, CA 95112  
 Or call toll free (800) 538-7506  
 In California (408) 998-5730

For more information circle 79  
 For demonstration circle 159

**dli DOLCH**  
 LOGIC INSTRUMENTS

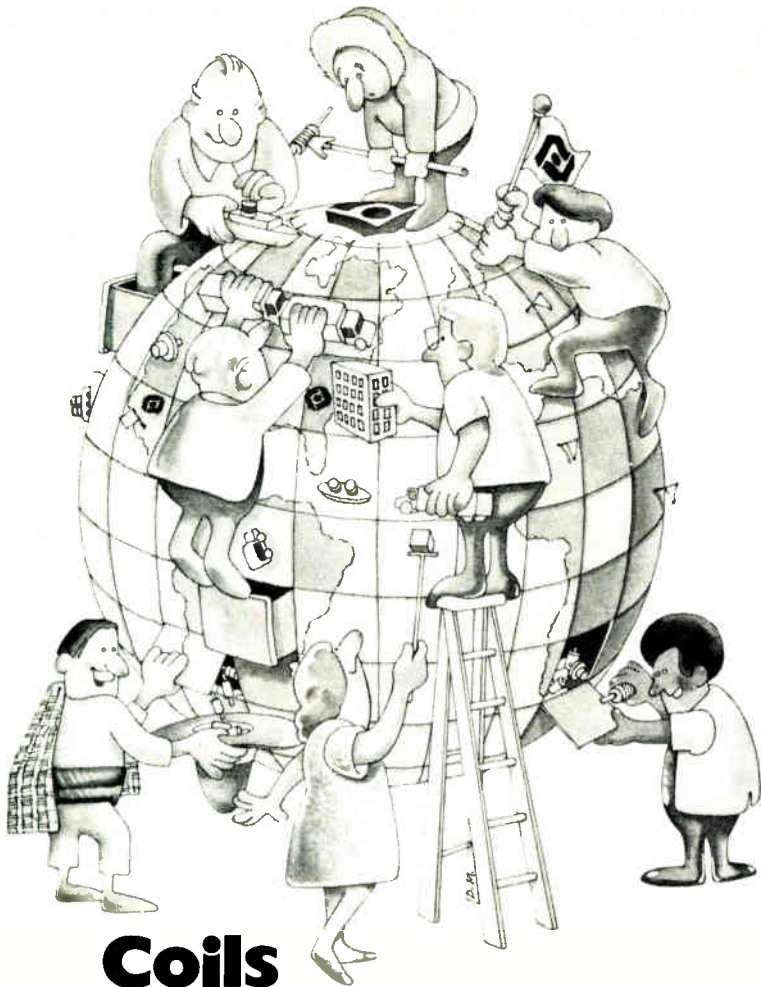

# Coils where you need them, when you need them.

Specify Delevan inductors and transformers and relax. Our coast-to-coast distribution network guarantees reliable, on-time delivery, no matter where you are. In Europe, too, our distributors have coils in stock for immediate, off-the-shelf service. Components are also available direct from the factory for OEM production or prototype design evaluation.

Our no-fault production record, plus sophisticated quality control and testing, have made Delevan components the standard of excellence throughout industry. In the long run, Delevan subassemblies can cost you less than "cheaper" ones. Delevan's proven dependability is your assurance of avoiding premature malfunction... a major cost to pay for a few cents' savings in parts.

Our lineup of RF inductors and transformers have been developed to keep pace with the growing needs of the electronics industry. So we're not going to let you down when you need them, wherever you need them. When your reputation is on the line, Delevan delivers.

**Delevan**  
Division  **AMERICAN  
PRECISION  
INDUSTRIES INC.**

270 QUAKER RO./EAST AURORA, N.Y. 14052  
TELEPHONE 716/652-3600 TELEX 91-293  
OTHER DIVISIONS INCLUDE BASCO, OUSTEX, AMERICAN  
PRECISION INDUSTRIES (U.K.) LTD., OUSTEX OF CANADA INC

drives enable them to operate with less energy consumption than chopper drives, even though the normal efficiency of the components is lower. Typically, dc motors have a 92% efficiency and ac motors one of only 90%, whereas chopper motors are 99% and inverters 97% efficient.

A full-size train operating at 32 kilometers per hour between stations 1.2 km apart regenerates 26% of its energy with chopper drive and 30% with inverter drives.

**Adding up the pluses.** Overall, the three-phase ac induction motor and its controls will be only about 80% as large and 90% as heavy as the series dc motor classically used in subway trains. Moreover, the induction generator can handle regenerative braking even at the highest speeds, but dc motors and chopper drives can control regenerative braking only at moderate to slow speeds.

During normal operation the rotor on an induction motor typically rotates several percent below synchronous speed, which is the speed of the rotating magnetic field set up by its stator. This mode of operation in effect raises the coefficient of friction between the train wheels and the track. Obviously motor torque falls toward zero as synchronous speed is approached. So if a motor spins the train wheels, speed increases only slightly, with rapid reduction in torque until the wheels again adhere to the track.

**Antiskid.** Also, an induction motor connected to an ac power line and driven mechanically several percent above its synchronous speed operates as a generator. If a train starts to skid during regenerative braking, the generator it is driving falls toward synchronous speed, and the greatly reduced torque reduces the braking force, ending the skid.

The higher coefficient of friction during both powering and braking make it possible to design a train with fewer powered coaches, cutting both its cost and weight and further reducing its gross energy input and expenditure.

This fall Osaka will decide on construction plans for one or more mini-subways.

**-Charles Cohen**



40Pin

24Pin

16Pin

8Pin

*All Design Engineers*

# Good news ... micropackaging to match microelectronics!

Looking for big space savings? Stop right here! These SO (Small Outline) ICs are shown actual size and yes, even that 40-pin device is less than stamp-size.

The new packages also come in 8-, 14-, 16-, 20-, 24- and 28-pin configurations and encapsulate most popular technologies... CMOS, LOCMOS, NMOS, bipolar analog and LP Schottky-TTL.

Their smaller-than-ever dimensions allow PC board sizes to be reduced dramatically, giving big savings in size and weight and a new competitive edge to your product. For applications where space is at a premium, SO-packaged devices can open up entirely new possibilities by allowing sophisticated electronics to be introduced for the first time.

They use the same chips as conventional DILs and power ratings apart, perform in exactly

the same way, including reliability. SO packages can therefore go into existing designs easily and quickly. And of course they're

ideal for your future designs employing automatic chip mounting techniques.

This topical, new type of packaging was pioneered by Philips\* and our SO ICs have been used extensively in watches, clocks and hybrid ICs. We therefore have unmatched experience in micropackaging and as a result can supply the widest range of analog and digital circuits. In fact, you need look no further than the box alongside to see clear proof of Philips' world leadership in this newest and smallest area of miniaturisation.

Send today for details on SO packaging and if possible mention your application.

Philips Industries  
Electronic Components and  
Materials Division  
Eindhoven, The Netherlands

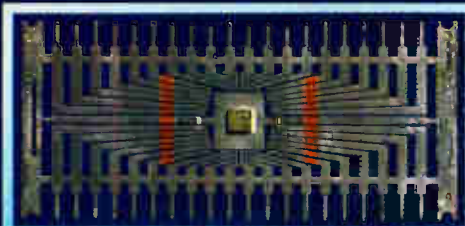

Conventional 40-pin DIL

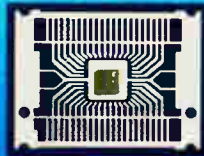

40-pin SO package

Both devices are shown actual size. Despite its fine leads, this SO package can be mounted using all soldering methods, including wave and reflow. SO packages reduce PC board real estate, and also give additional design freedom since tracks can be run under the devices.

\*Second-sourced in USA, Japan and Europe



Electronic  
Components  
and Materials

# PHILIPS

Circle 133 on reader service card

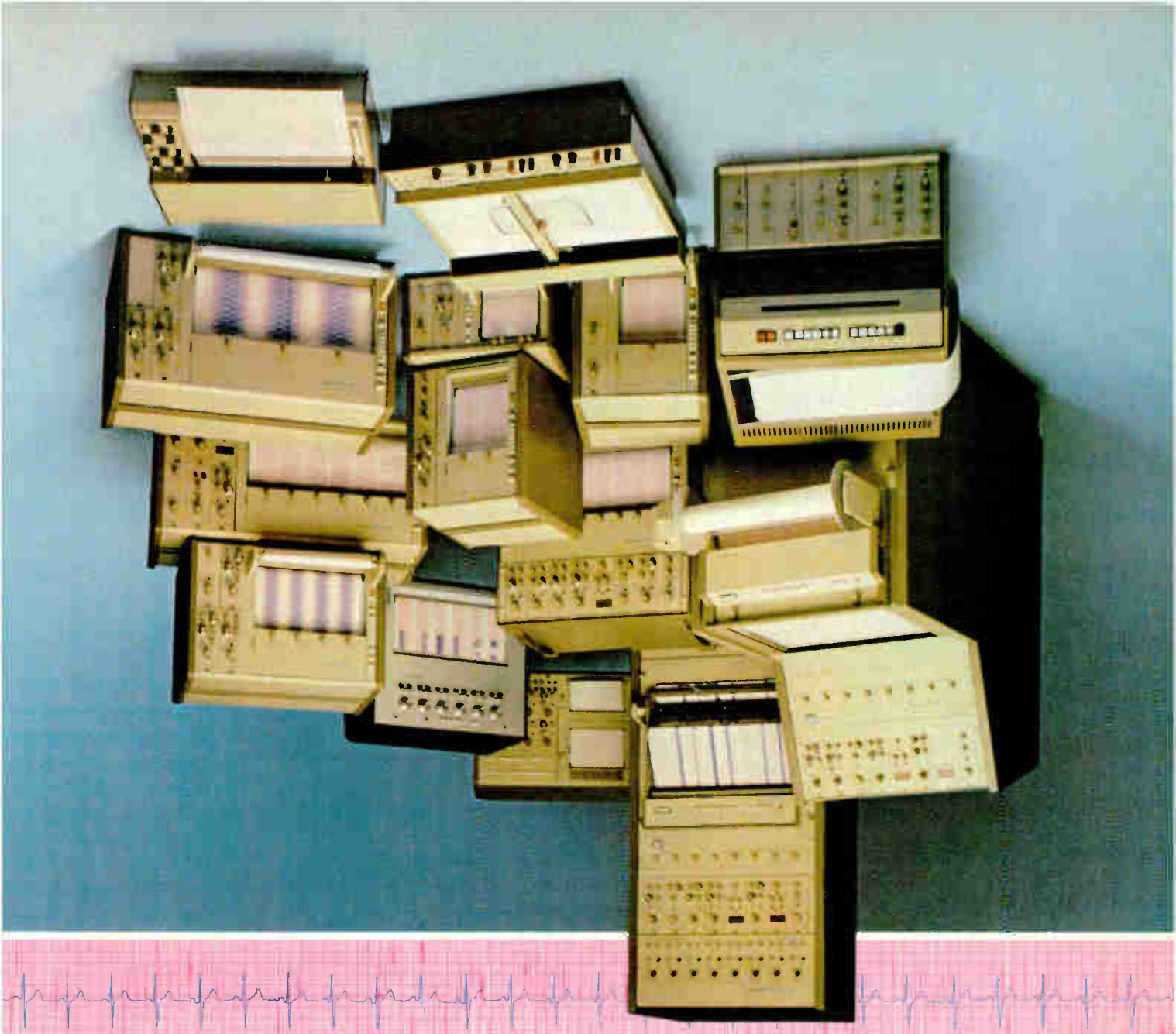

# From innovations in patient care

# to pulling energy out of the air.

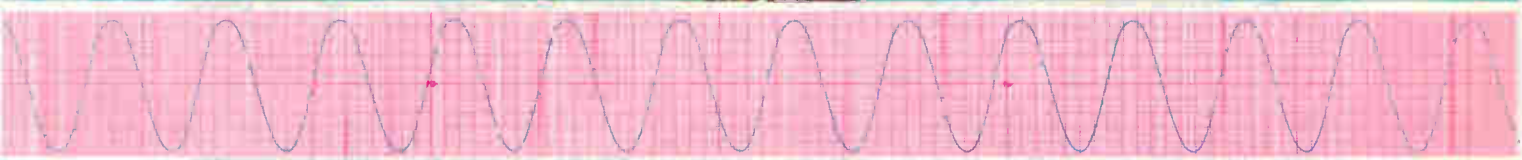

## More and more people trust Gould instrumentation.

Gould recorders are recognized worldwide for their accuracy and reliability in industrial, scientific and biophysical measurement applications. Those applications range from aiding research on serious injuries in hospital trauma units to collecting data on wind-turbine design that is helping solve our growing energy needs.

The Gould name has been synonymous with test and measurement instruments for more than four decades. We were there during development of the first electro-cardiograph in 1937—a major breakthrough in technology that was the forerunner of the advanced recorders which today wear the Gould name.



Gould recorders. Part of our rugged family of high quality, high performance instruments that measure, display, store or record data. A family that includes electrostatic and thermal array recorders. Logic analyzers. Oscilloscopes. X-Y and strip chart recorders. Biophysical recorders. And a full



range of signal conditioners. For more information, call or write Gould Inc., Instruments Division. Operations in Santa Clara, California; London, England; Paris, France; and Frankfurt, Germany. Headquarters at 3631 Perkins Avenue, Cleveland, OH 44114. 216/361-3315.

 **GOULD**

*An Electrical/Electronics Company*

Circle 134 on reader service card

**SIEMENS**

# At your fingertips

**Portable transmission test set 30 Hz to 20 kHz**

Ready for use at all times, the K1099 by Siemens is a compact, lightweight but complete test set for measuring level, gain, loss, noise, impedance and dc voltage on all VF transmission equipment.

The oscillator for the telephony range generates ten spot frequencies to CCITT recommendations or can be operated as a sweep generator compatible with our VF level tracers. The oscillator for the radio broadcasting range also supplies ten spot frequencies to CCITT and with a high harmonic margin. The versatile matching level meter covers both frequency ranges.

For measurements on data lines, a phase jitter meter is available with which weighted noise can also be measured. The level meter and oscillator are complemented by the B2099 answering equipment for communication via the test line. Portable transmission test set K1099 is battery-powered for operation in the field and particularly suitable for installation and maintenance work.

Further details of this portable test set and its component instruments can be obtained from the specialist advisers at Siemens branch offices, or write to: Siemens AG, Info-Service, E1 Postfach 156, D-8510 Fürth.



**Siemens communications test equipment**

## Data-communications analyzer has 20-min continuous tape loop

by Charles Cohen, Tokyo bureau manager

Software-controlled analyzer's tape drive gives operator time to react to unexpected trouble and halt recording

The MSO8A data-communications analyzer for systems using High-level Data-Link Control, bisync, and asynchronous protocols and operating at 50 to 9,600 b/s features an endless quad-density data cartridge that stores 20 minutes of data under full-duplex operation at the 9,600 b/s rate. Even though it represents about one third the cost of the \$6,500 instrument, the cartridge drive was included because users requested facilities for storage of data for at least 10 to 15 minutes of operation.

Although the analyzer is designed to trigger on two character strings of eight characters each, system malfunctions other than those expected can occur. Thus it is necessary to store data for a reasonable period to give operators time to become aware of the trouble and press the break key to stop the instrument before the recorded data is overwritten with new data. The analyzer includes time in hours, minutes, and seconds in the header of each 7-k-byte block of data on the tape to facilitate the search for the data being transmitted at the time of system trouble.

Data is displayed on a 7.5-in. cathode-ray tube as 20 rows of 40 characters each. In full-duplex operation, transmitted and received data are displayed on alternate rows with received data underlined.

underlined received data are displayed in sequence on the same lines.

Six different display codes are built into the analyzer: ASCII, EBCDIC, Baudot, hexadecimal, JIS7, and JIS8. (The Japanese Industrial Standard JIS7 code is similar to ASCII but includes a shift for characters of the Japanese katakana syllabary and is popular because it allows the use of the eighth bit for parity. The JIS8 code provides for the same characters without a shift but requires an external bit for parity.) Octal and binary displays are also implemented. Provision for shifting bits of display left or right makes it possible to shift a display that is garbled, because of the loss of one or more bits at an earlier time, until a reasonable message or control characters appear. This convenient feature is not commonly implemented.

Initial setup of the analyzer is facilitated by front-panel push-button selection of desired parameters from a menu offered on the CRT and two video printouts. Panel setup is stored near the start of the cartridge tape eliminating the need for battery-backed random-access memory for this function. Instrument test for initial checkout of the analyzer when first turned on is stored just before panel setup.

**Menu setup.** Trigger setting is done using a displayed menu that includes two eight-character strings, two timers, and two counters. Furthermore, the menu facilitates setting up a program directing the sequence of control to and from string-matching operations, time delays, and counts. Parity checks and block-check characters for cyclic and longitudinal redundancy checks





# FOR SALE worldwide

## inland international

Inland International is an exclusive worldwide distributor of computer components. We can deliver computer peripherals to your door anywhere in the world. We can do it fast, efficiently, and most important... at a lower cost than anyone else in the world. Most of the products we offer are available at the one-hundred unit price even in small quantities. We encourage your requests for proforma invoices, delivery information and a complete list of products we offer. Below is a partial list of manufacturers we represent.

- ADDS
- DEC
- Hazeltine
- Lear-Siegler
- Centronics
- Texas Instruments
- Teletype
- Dataroyal
- Motorola
- Beehive
- NEC
- Soroc

Inland International is the international marketing division of Inland Associates which has successfully served the computer industry since 1968.

For more information contact:  
**inland international**

Attn: Dennis A. Seager  
15021 W. 117th Street, Olathe, Kansas 66062  
913-764-7977 TWX 910-749-6408

Circle 136 on reader service card

### Leaders in Electronics

The only reference devoted solely to biographies of the most influential people in electronics

• corporate executives • technical managers • designers and developers • government and military officials • academics • editors/publishers • securities analysts • trade/professional group directors • consultants... plus an 80-page index of biographees by affiliation.

Prepared by the staff of **Electronics** magazine. 5,240 biographies. 651 pages, clothbound. \$39.50

Electronics Magazine Books  
P.O. Box 669, Hightstown, NJ 08520  
(609) 448-1700, ext. 5494

Send me \_\_\_\_\_ copies of *Leaders in Electronics* @ \$39.50 plus applicable sales tax. McGraw-Hill pays regular shipping and handling charges on pre-paid orders.

Payment enclosed     Bill firm     Bill me

Name \_\_\_\_\_

Company \_\_\_\_\_

Street \_\_\_\_\_

City \_\_\_\_\_ State \_\_\_\_\_ Zip \_\_\_\_\_

Signature \_\_\_\_\_

### New products International

can also actuate the trigger.

Both the IEEE-488 instrument interface and the RS-232-C serial interface are available as options. This makes it possible to install the analyzer at a user's premises and remotely control it to perform diagnosis from a control center to allow improved maintenance while reducing personnel and other costs. Software is available for a personal computer, offered by Anritsu, that both controls the analyzer and reproduces the analyzer display on the micro-computer display.

The analyzer is completely software-controlled. To achieve the required speed, the functions of the analyzer have been split among six separate microprocessors—five 4-MHz Z80s and one 8035. The Z80s were chosen for their high speed and ability to control dynamic RAM, which is used with three of the processors. The processors are coupled through common memory via 8-bit parallel buses.

**Multiprocessing.** The 8035 performs real-time clock control. One Z80 with 10-K bytes of read-only memory and 16-K bytes of RAM handles main control of the analyzer, including control of panel keys and display, and acts as the instrument's central processing unit, while a second with 3-K bytes of ROM and 16-K bytes of RAM handles data capture and simulation. These two processors, together with a third that controls the cartridge tape, perform functions that other manufacturers also control by microprocessor.

The last two microprocessors execute functions usually done by hardware. One Z80 with 1-K byte of ROM and 1-K byte of Hitachi static complementary-MOS RAM executes the data trigger program, including decisions, while the second with a similar configuration checks character string matches.

A 511-bit pseudorandom pattern generator is included for making measurements of the number of bit errors or block errors. A 1,500-character transmitting buffer memory is included for system simulation tests. Anritsu Electric Co., 5-10-27 Minami Azabu, Minato-ku, Tokyo 106, Japan [441]



# SIEMENS

## With these ICs you get all the strings in your hand



Your job as the designer of switched-mode power supplies will be simpler in the future. For with one single IC you already hold all the strings in your hand to control and monitor all kinds of high-performance, upward-compatible single-ended and push-pull converters. The names to remember are TDA 4700/TDA 4700 A and TDA 4718/TDA 4718 A – highly integrated devices featuring a whole series of very special properties, as for example

- precontrol (hum suppression)
- PLL circuit for external synchronization
- overload protection of the reference voltage source
- voltage and current control at input and output
- high noise immunity

The TDA 4718 is available as a particularly low-cost device. This type, housed in an 18 pin package, without regulating amplifier and without symmetry inputs, is especially suitable for use in SMPS's which are controlled on the primary side and where potential isolation is provided.

For detailed information, please write to us at Siemens AG, Components Group, Infoservice, Postfach 156, D-8510 Fürth, quoting "TDA 4700".

**For the best switched-mode power supplies possible:  
control devices TDA 4700 and TDA 4718**

World Radio History

Circle 137 on reader service card

# TEAC TOOK OUT BRUSHES TO BUILD IN RELIABILITY.

## Unique Long Life Brushless DC Motor

So reliable (lifetime 10,000 hours) that we let it run continuously. No motor start-up time. No electrical noise to bother CRT displays either.

## Controlled Frame Expansion

We matched the thermal expansion rate of the frame to that of the media. Head misalignment is greatly reduced.

## Choice of 2 Recording Methods: MFM/FM

Data capacity can be doubled using MFM. No write precompensation is necessary.

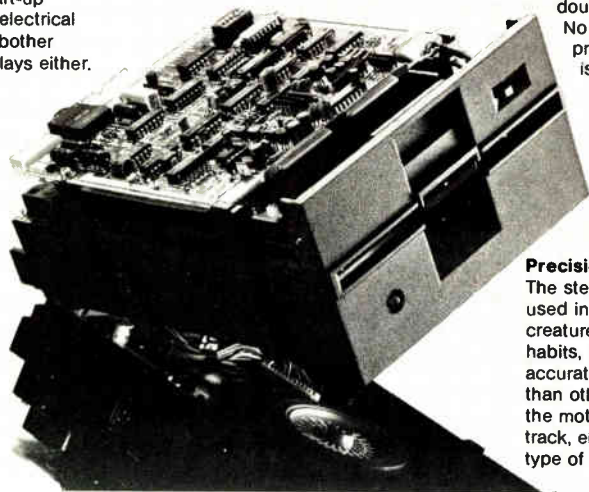

## Precision Head Seek

The stepping motors used in floppy disks are creatures of strange habits, stopping more accurately at some steps than others. TEAC steps the motor 4 times per track, eliminating this type of error.

**The super-reliable brushless DC motor used in our FD-50 series 5 1/4 Floppy Disk Drives lasts 10,000 hours.**

## 3 Models FD-50A/50C/50E, 3 Formats

The FD-50A is a single-density, 48 tpi, 40/35 track model. In 35-track mode it is fully compatible with the Shugart SA-400. The FD-50C is a double-track-density, 100 tpi, 77 track model, and compatible with the Micropolis 1015. The FD-50E is an industry-standard double-track-density 96 tpi, 80/70 track model.



## Electronics international

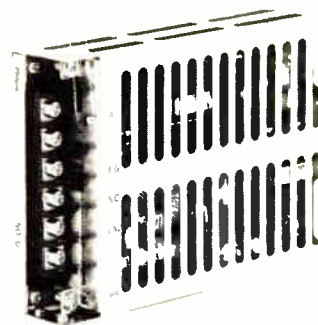

The VTM series of miniature switching power supplies deliver up to 15 W of power (1.04 W/in.<sup>3</sup>) with outputs up to 24 V at 0.62 A. They have an efficiency of 70% and a wide input range of 90 to 132 V ac. Intertek Inc., Naito Bldg. 7-2-8 Nishishinjuku, Shinjuku-ku, Tokyo 160, Japan [445]



The CE 160 graphic recorder digitally records waveforms of up to 10 kHz in real time onto aluminized recording paper using a built-in 1,800-word memory that automatically transforms data to hard copy. Computer Engineering Ltd., Wallace Way, Hitchin, Herts. SG4 0SE, England [446]

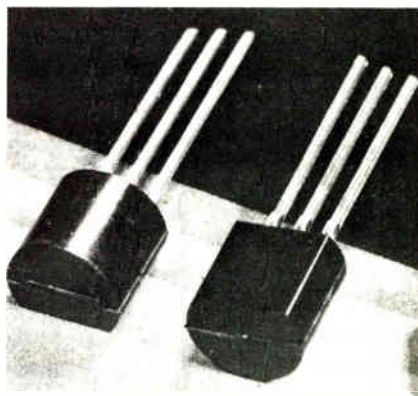

The U175M integrated circuit drives light-emitting diodes and glow lamps and causes them to blink at a frequency of 3 Hz. It has an output of about 30 mA and requires a supply voltage of 4.75 to 13.2 V. AEG-Telefunken, Theodor-Stern-Kai 1, D-6000 Frankfurt, West Germany [447]

TEAC CORPORATION: 3-7-3 Naka-cho, Musashino, Tokyo, Japan Tel. (0422) 53-1111 Tlx: 2822451, 2822551

• U.S.A. TEAC Corporation of America, Tel. (213) 726-0303 • Canada R H Nichols Co., Ltd., Tel. (416) 661-3190 • Hongkong Dah Chong Hong Ltd., Tel. 5-261111, 5-226258 • New Zealand W & K McLean Ltd., Tel. 587-037 • Australia Jacoby Mitchell Pty. Ltd., Tel. (02) 26 2675 • South Africa Mayfair Sales (Pty) Ltd., Tel. (011) 29-2921 • United Kingdom Tekdata Electronics Limited Tel. 0782 813631 • West Germany nbn Elektronik GmbH, Tel. 08152/390 • Holland Simac Electronics B V, Tel. 40-533725 • Belgium & Luxemburg Simac Electronics, Tel. 02-219.24.53 • France Tekelec Airtronic S A Tel. (1) 534-75-35 • Italy A.E.S.S.P.A., Tel. 54.64.741-2-3 • Spain Alao Ingenieros S.A., Tel. 733 0562, 733 3700 • Switzerland Wenger Datentechnik, Tel. 061/50 84 84 • Denmark Danbit, Tel. (03) 141515 • Sweden Scantete AB, Tel. 08-24 58 25

\* If no distributor is listed above in your area, please contact us directly for further details about our products.

Circle 138 on reader service card

# The magazine you're reading now could be your own.

Drop off the routing list. Get your own fresh, unclipped copy mailed to your home or office. Turn to the subscription card in the back of the magazine. If somebody has beat you to it, write: Electronics, P.O. Box 430, Hightstown, N.J. 08520.

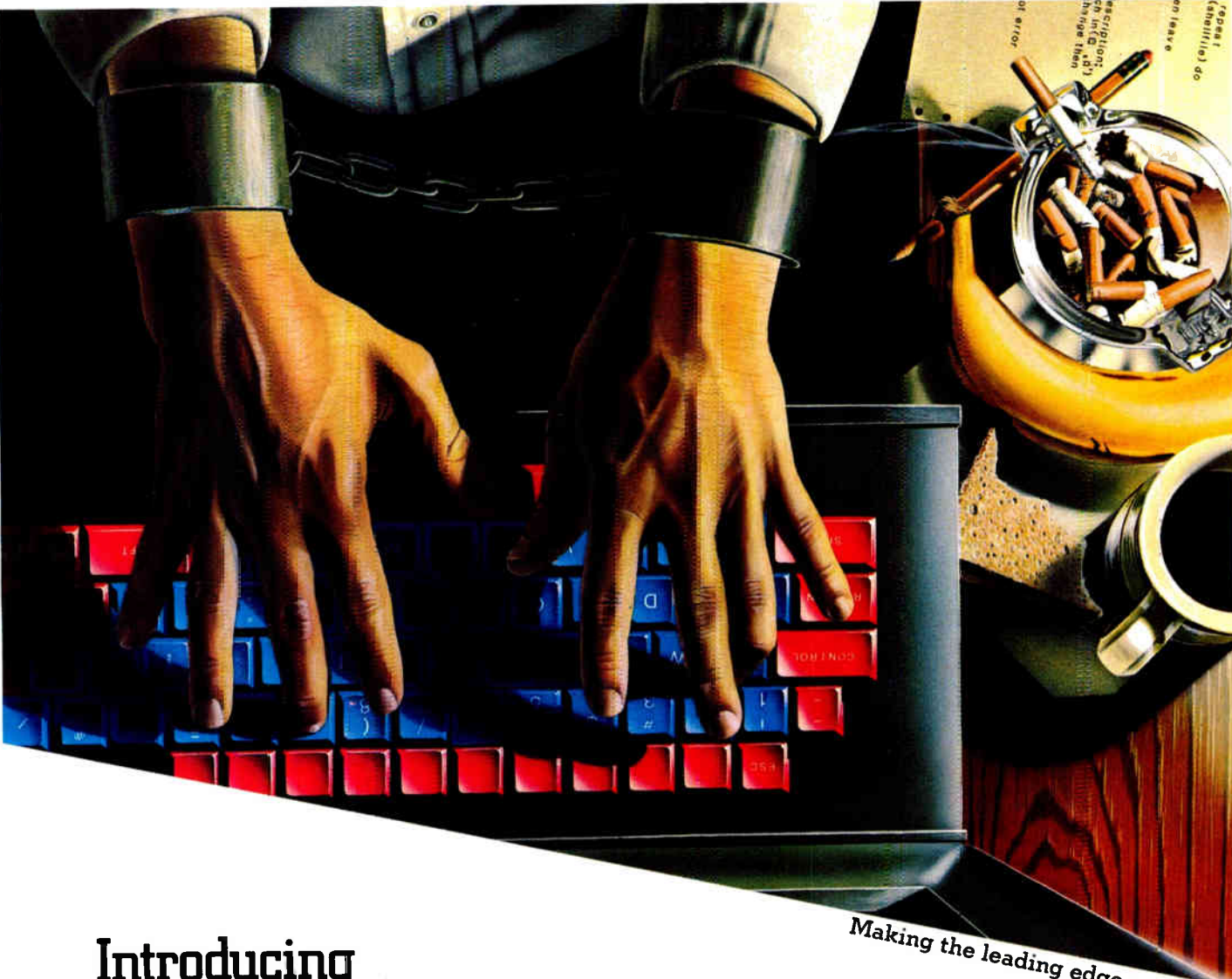

**Introducing  
an X.25 controller  
so powerful,  
it'll save you two years  
of hard labor.**

*Making the leading edge work for you.*



The evidence is overwhelming. Western Digital's remarkable new X.25 link level controller is the only sure way to avoid doing hard time. Like as much as two years of software development. And that can give your new product a healthy head-start to market.

But then, our new WD 2501/2511 is the world's most complete X.25 hardware/software solution. Because fully integrated, on a single device, is all the necessary X.25 Level II software. Plus bi-directional DMA to easily satisfy any and all buffer management requirements.

The savings are nothing short of astounding. In terms of software costs, board space and overall reliability.

What's more, our revolutionary WD 2501/2511 gives you unsurpassed control of all X.25 LAP/LAPB link-level procedures. And three integral self-tests.

So contact Western Digital for all the hard labor-saving details. Including the latest on our brand-new PacKit™ X.25 Development System.

It's the only way to avoid the shackles of a second-best solution.

**WESTERN DIGITAL**  
C O R P O R A T I O N

# TECHNOLOGY THAT REFLECTS THE



# FUTURE.

## **Microwave synthesizers are only the beginning.**

If you look closely into Systron Donner's model 1618 and 1626 microwave synthesizers, you can see the future. Because the advanced technology they incorporate exemplifies our commitment to leadership across a wide range of test and measurement instrumentation.

These synthesizers, essential to the test and measurement of microwave, communication, and electronic warfare applications, offer the widest range of performance available — from 50MHz to an astounding 26GHz. And we've produced the highest frequencies available without sacrificing precision: an indirect synthesis technique developed by Systron Donner avoids signal degradation with 1KHz resolution over the full frequency range. (1MHz with model 1626.)

But at Systron Donner we recognize that success in tomorrow's market depends on more than just technology; product packaging, reliability, ease of use, and a commitment to service and support will be more critical than ever before. Because as technology becomes more complex, product practicality assumes greater significance.

## **The acknowledged leader.**

We're the acknowledged leader in microwave synthesizers because of our attention to product practicality. Our synthesizers are fully debugged and field-proven. We offer the widest range of performance options, so users buy only what they need. And we're the only supplier to reduce microwave synthesizing to a single, compact product — with everything you need built right in.

## **Practical technology.**

Microwave synthesizers are an example of the Systron Donner commitment. A commitment we call "practical technology." Products designed to meet your real needs, not an application of technology for its own sake. Products that we can proudly call practical technology.

Even if you don't need a microwave synthesizer, chances are you do need frequency counters, power supplies, frequency response analyzers, pulse generators, time code generators, signal generators, digital multimeters, or any of a host of high quality, practical test and measurement instruments. Call us today on our information hot line at (415) 671-6637. Or write: Systron Donner, 2727 Systron Drive, Concord, California 94518 (TWX: 910-481-9479).

It's your practical move.

**Practical technology from**  
**SYSTRON INSTRUMENT**  
**DONNER DIVISION**

Member THORN EMI Group



Circle 83 on reader service card

*Cutting  
the high  
cost of  
micro-  
system  
service*

# Fluke simpli micro-system

"Our biggest headache with micro-systems was fault isolation. We tried every test instrument available. Nothing did the job until Fluke introduced their new Troubleshooters."

"I spent more than six months building fixtures and writing programs for our last micro-system tester. Even then it wasn't up and running right. That's frustrating ... and expensive!"

"People think you have to be a software wizard and an engineer to service micro-systems ... and with other test equipment, you do."

"The 9010A is fast, versatile and easy to use. And we won't have to trade it in on a new model next year."

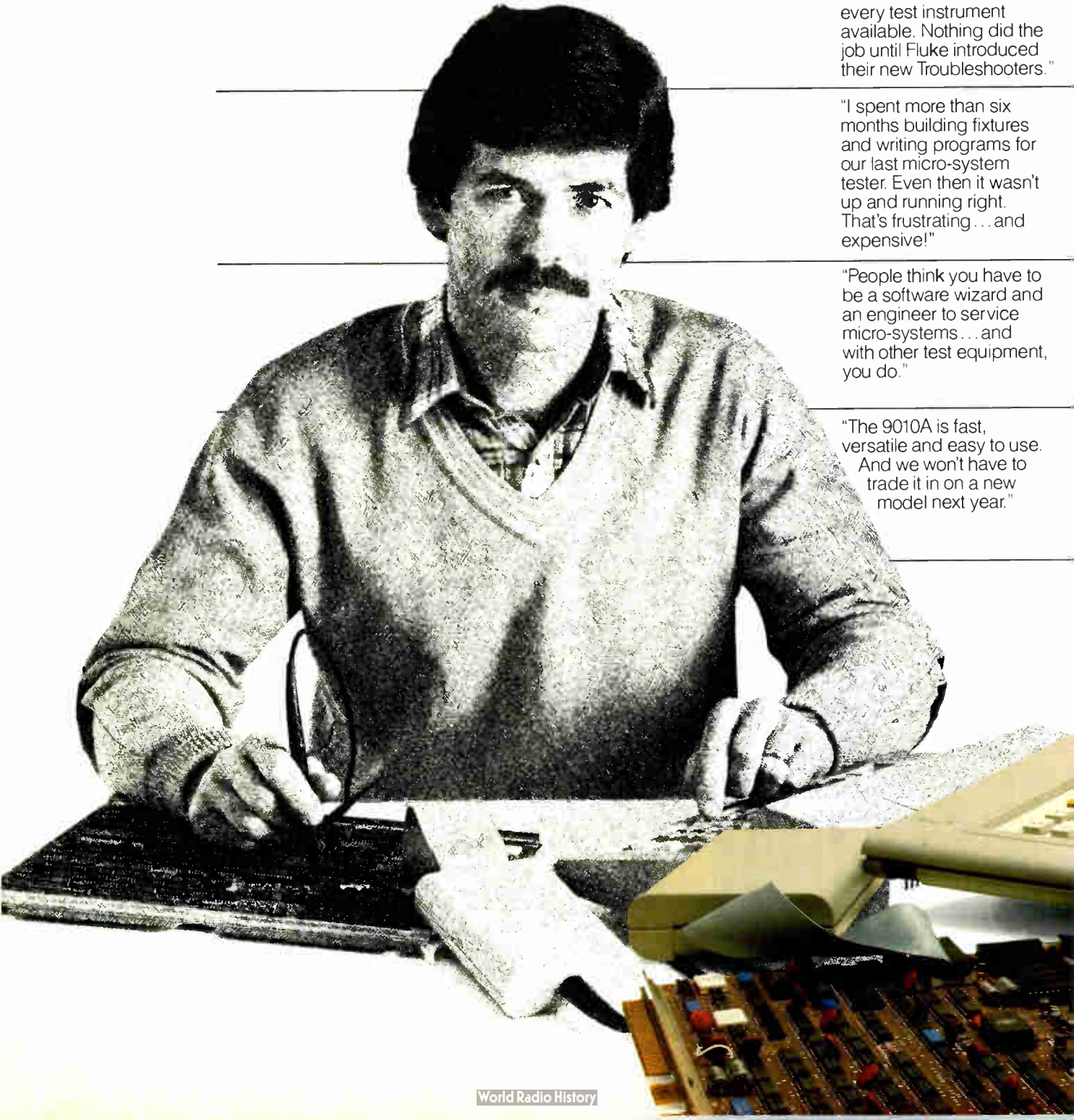

# fies service

At Fluke, we spent over two years talking to frustrated manufacturing and field service people around the world about this critical problem, and designed the 9000 Series Micro-System Troubleshooters in direct response to their concerns. The 9010A, the first in the series, is available today.

The real value, however, lies in what the 9010A doesn't cost. It frees you from front-end programming, software documentation, signature records and tedious wiring hookups. The 9010A represents a whole new class of service instruments. It lets you start testing today.

Fluke's solution is simple. The 9010A has the most practical interface you'll find: a self-contained pod for each microprocessor type. Just plug into the  $\mu$ P socket of a known good board, press the LEARN key and a revolutionary algorithm goes to work.

The 9010A automatically locates and identifies the RAM, ROM, and read/writable I/O on the bus of the unit under test and stores their characteristics in memory. No need for current software listings; this feature alone can literally save you months of front-end programming time. Operators without extensive training in digital logic can use the 9010A with confidence... and without delay.

Not with the 9010A. Automated tests for the entire kernel (RAM, ROM, I/O, power supply and clock) can be run with the push of a button. Also provided: automatic patterns to stimulate components like readouts, print heads, relays, interfaces and CRT's; a unique "loop-on-failure" control for isolating intermittent faults; and a

"smart" probe that can be synchronized to  $\mu$ P timing. These features give you a solid head start in developing special programs for off-the-bus testing as well. And the 9010A is fully interactive, so these programs can be generated and debugged directly on-line.

That's right. The 9010A is one of three Troubleshooters Fluke will introduce between now and January 1982. All of them will be fully compatible with 8-, 16-, and 32-bit  $\mu$ P's. All  $\mu$ P-dependent functions are located in the interface pods. Currently available pods include the **8080, 8085, Z80, 6502, 6800** and **9900**.

For details, and a schedule of future pod support, use the coupon below.

**FLUKE**<sup>®</sup>



## Fast Response Coupon

IN THE U.S. AND NON-  
EUROPEAN COUNTRIES  
John Fluke Mfg. Co., Inc.  
P O Box C9090, M/S 250C  
Everett, WA 98206  
(206) 356-5400 Tlx 152662

IN EUROPE E2 8/81  
Fluke (Holland) B.V.  
P.O. Box 5053, 5004 EB  
Tilburg, The Netherlands  
(013)673 973 Tlx 52237

Please send me 9000 Series information.  
 I'd like a demonstration. Please contact me.

We use the following microprocessor types in our products \_\_\_\_\_

Name \_\_\_\_\_

Title \_\_\_\_\_ Mail Stop \_\_\_\_\_

Company \_\_\_\_\_

Address \_\_\_\_\_

City \_\_\_\_\_ State \_\_\_\_\_ Zip \_\_\_\_\_

Telephone ( ) \_\_\_\_\_ Ext \_\_\_\_\_

© 1981 John Fluke Mfg. Co., Inc. All rights reserved.

For technical data circle no. 237

# To get the fastest in-circuit tester...





# get the tester with the fastest fault isolation.

With the increasing size and complexity of PCB designs, the real test for any in-circuit PCB test system is how fast it can accurately isolate and diagnose faults. While the Total Time for Fault Isolation (TTFI) is the cumulative time it takes to (1) load the program, (2) run the program, and (3) isolate and diagnose the fault, the key to greater PCB throughput is in the critical third step. And it's here, in fault isolation, that the new Fairchild 303S is in a class by itself.



Whether your boards are large or small, random logic based, micro-computer based, or high in analog component count, the Fairchild 303S will give you greater speed where it really counts.

## It's not only faster, it's easier.

The Fairchild 303S is built around a powerful new minicomputer with 256K bytes of MOS memory and resident operating software. Its advanced testing architecture is easily adaptable to virtually every test application, and allows even large PCBs to be quickly tested by executing complete programs entirely from memory. In addition, the new 303S offers a number of unique design enhancements that can dramatically cut PCB test time and significantly increase throughput.

**FAULTS™** is the industry's most powerful automatic program generator for complex PCBs. With **FAULTS**, approximately 90% or more of your program generation is done automatically, so you gain more efficiency in preproduction and faster throughput overall.

## The new Fairchild Series 30/ Model 303S. More speed where it counts most.



devices, the new Fairchild 303S will give you test results faster, easier and more accurately than ever before.

## And it's a lot more versatile, too.

The 303S isn't just built for speed, it's built for versatility. It comes with the largest number of uncompromised hybrid test points (927) in the industry, so it can be used to test either analog or digital points. By simply

**QA CHECK™** cross-checks and matches your final production data with your original program to ensure that nothing was omitted by the programmer. The result—more accurate fault isolation.

**PINCHECK™** ensures 100% interconnection integrity between the fixture and the board under test before each test program begins. **PINCHECK** assures diagnostic reliability by eliminating any fixturing faults. And it can check 1200 points in less than seven seconds, using three lines of simple code to implement.

**Automatic Wait Time™ (AWT)** prevents improper fault diagnostics caused by the interaction between components on the same node. Through software control, **AWT** dynamically samples the measured value of the component under test and automatically waits until it has stabilized before comparing the value to the programmed limits.

**HI-CURRENT** capability allows the 303S to test boards containing mixed logic and bus-oriented circuit designs. When multiple devices on a bus must be disabled, **HI-CURRENT** capability is required, and no other test system offers it.

From shorts and opens to LSI

adding another low-cost terminal, our Foreground/Background programming feature enables programming to be done without tying up the system. And our datalogging feature gives you hard copy documentation of faults—by shift, day, week, or any other time increment—to accurately pinpoint manufacturing problems as they occur.

Naturally, the 303S is compatible with all Fairchild Series 30 systems, so retraining is never a problem. And the 303S is backed by the largest service and support network in the industry.

If you're looking for a faster, easier and more accurate solution to in-circuit testing, take a closer look at the Fairchild 303S. It's got more speed, where speed counts most.

For more information on the Fairchild 303S, contact your nearest Fairchild Test Systems sales office, or write Fairchild Test Systems Group, 299 Old Niskayuna Rd., Latham, NY 12110; Tel. (518) 783-3600.

**FAIRCHILD**

A Schlumberger Company

**The First Family of ATE.**

Circle 87 on reader service card

# HOW TO COPE WITH THE PROBLEM OF CHANGE IN ANALOG LSI TESTING.

The constant change and complexity that marks analog LSI technology demands testing flexibility. Teradyne A300 software ensures exactly that.

Our key to dealing with change and developing new test requirements is PASCAL/STEPS<sup>™</sup>, a high-level language in a fully modular structure.

Unlike traditional job programming languages, PASCAL/STEPS separates the test

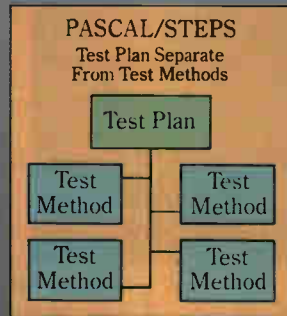

plan from the tests (see diagram). There's no interweaving of tests, limits, binning strategy and test sequence. There's no confusion when new programs or change is demanded. There's only flexibility.

The entire test plan is in one location so objectives are clear. Preparation and modification are easy. New tests are written individually and in any order. New programs can be prepared and on-line quickly to get new devices into production fast.

A300 software offers the flexibility to make job programming a snap. For all the facts write Teradyne at 183 Essex Street, Boston, MA 02111. Or call (617) 482-2700.

## TERADYNE

## High-technology thieves peril nation

Industry must form first line of defense against theft and illegal export of strategic technologies, U. S. agencies say

by Larry Waller, Los Angeles bureau

**Espionage, industrial theft,** and illegal export of U. S. high-technology secrets are once more in the headlines. In the past few months alone, an alleged spy who passed along secret radar data was uncovered at Hughes Aircraft Co., convictions were obtained in the case involving a foreign ring that stole chips from three Silicon Valley firms, and officials of a small California firm were convicted and sentenced for shipping laser mirrors to the USSR.

Whether such activities are on the upswing is really not the point, warns assistant U. S. attorney Theodore W. Wu, who handles high-technology cases in Southern California. "Because such threats are always there, companies and officials must protect themselves," he adds.

Wu has been speaking out strongly in recent weeks because of what he sees as a danger to national security by agents who are zeroing in on the acquisition state-of-the-art technology developments that give the U. S. a military and industrial edge over foreign competitors.

Wu's main concern is stopping the export of industrial equipment and data that are on the prohibited list of commodities and covered by the Munitions Act. Although existing regulations list these commodities in detail, Federal agencies charged with enforcing the law generally lack the necessary funds and manpower to do a comprehensive job, he says. "Therefore, citizens and industry itself are the first line of defense. It's an honor system that must work to make the export system work."

Companies must take the initiative in protecting themselves against violating Federal laws controlling

strategic exports. Not knowing the buyer is no excuse, so "somebody in a company better take it on himself to ask a few questions," says Wu.

Typical of the kind of commercial equipment covered by export control are big computers, communication and navigation gear, integrated-circuit production equipment, and advanced components. "Companies know their own business and customers better than anybody outside, and they have no excuse to be unaware of regulations," he adds.

**Indicator.** A dead giveaway that something might be up is an order that comes from an unfamiliar customer for a large system normally used only by big companies or government agencies. "This is often a tipoff that the nominal customer plans to resell it to a foreign power, so find out the end user," advises Wu.

Any company official tempted to "close one eye to make a sale" would do well to consider that he and his company could be held criminally liable. Wu has prosecuted a number of such cases and gained convictions.

His most recent trial success involved Spawr Optical Research Inc., a laser-component manufacturer in Corona, Calif. For knowingly selling precision mirrors required for high-powered lasers to the Soviet Union, two company officials received prison sentences and large fines.

Furthermore, a company such as Spawr that violates export laws "compromises itself with other customers so that its survival may be threatened." For example, Spawr's Government business was taken away.

Outright theft of secrets and small items such as ICs presents another problem that can be dealt with by better company security. While Wu does not directly state that U. S. internal plant security has become too lax, he maintains "companies should reassess it at once and modify as necessary to make it effective."

While it is tough to generalize about plant-security efficiency on an industry basis, and most sources do not attempt to, several common observations emerge. (Because of the subject's touchy nature, directors of

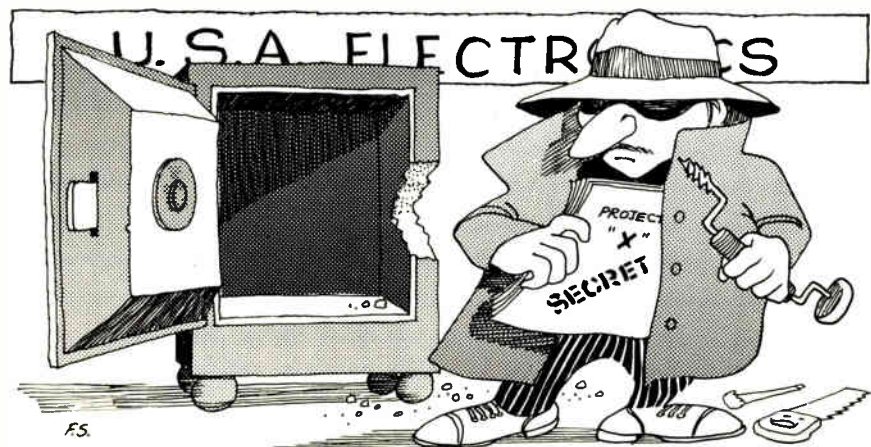

# Interface With Osborne



## Interfacing to S100 (IEEE 696) Microcomputers

by Sol Libes and Mark Garetz

This book assists S100 users in expanding the power and utility of their systems. It describes the S100 bus with unmatched precision and detail. Various chapters describe its mechanical and functional design, logical and electrical relationships, bus interconnections, and bussing techniques. Both parallel and serial interfacing are described as well as interfacing to RAM, ROM, and the real world. Additional chapters discuss D/A and A/D conversion, interrupts, timers, and direct memory access. #37-3 \$15 □

## Microprocessors For Measurement And Control

by D.M. Auslander and P. Sagues

Learn to design mechanical and process equipment which use microprocessor based "real time" computer systems. This book reveals the techniques, and, using case studies, builds and explores problems of increasing complexity. The book presents plans for prototype systems, allowing readers (even those unfamiliar with machine or assembly language) to initiate projects and carry them through to completion. #57-8 \$15.99 □

## PET and the IEEE 488 Bus (G.P.I.B.)

by Fisher and Jensen

At last, here's a book that describes the General Purpose Interface Bus (IEEE 488 Bus) comprehensively and in detail. PET and the IEEE 488 Bus provides chapters on all aspects of the G.P.I.B., including lines and signals, mechanical and electrical specifications, and execution and timing sequences. Other features include:

- Bus Structure • Handshaking Procedure
- Sample Bus Transactions • Timing Diagrams • How to use a Logic Analyzer for troubleshooting • Test Programs • IEEE 488 Bus-compatible products

#31-4 \$15.99 □

**Osborne/McGraw-Hill Dept. E28**  
630 Bancroft Way, Berkeley, CA 94710  
Call Toll Free: 800-227-2895  
in California (415) 548-2805

Name \_\_\_\_\_

Address \_\_\_\_\_

City/State/Zip \_\_\_\_\_

Plus:  75/Item 4th class  \$1.50/Item UPS

\$2.50/Item Air Mail  \$10.00/Item Overseas

(California residents add applicable tax.)

Please send me your free catalog.

Total amount enclosed \$ \_\_\_\_\_ or charge

my  Visa  Mastercharge

Card # \_\_\_\_\_ Exp. Date \_\_\_\_\_

## Probing the news

security at electronics and aerospace firms will discuss this topic only if they are not identified. Most of these officials generally share a Federal Bureau of Investigation background and keep in close touch.)

These sources agree that the threat of espionage is greatest at the highest technology levels, such as leading-edge microcircuits that have both commercial and military value. However, some managers and scientists, especially those who entered the industry after the late 1960s, do not take possible espionage as seriously as older hands who worked on classified or secret programs. This lack of seriousness is an attitude ingrained deeply at some Silicon Valley semiconductor firms, where information is exchanged freely outside official channels, and fast-moving technology advances often take precedence over security provisions.

In the opinion of many security officials, companies must start to forcefully bring home to younger engineers the need to keep important data from leaking out. "When his boss sits him down and explains what means in dollars and cents to his career, he starts to understand," says a veteran security director.

Also, many top managers and engineers do not realize the extent of surveillance that routinely occurs when they are involved in a secret program. Anyone with access to data about these programs can expect to be monitored, particularly when traveling. Many engineers with years of experience are still not aware they are watched during an overseas trip. Government agencies have learned

that information is often passed outside the U. S.

The most recent example of this pattern is the Hughes Aircraft case, where William H. Bell is accused of having made several trips to Europe beginning in 1979 to deliver rolls of film to Polish intelligence agents. This case illustrates another vulnerability: those who handle classified material getting into financial trouble and thus becoming prey to foreign agents. Bell has admitted selling secret documents for large cash payments and the promise of more.

Although chances are slim of stopping the rare bad apple from compromising an important program, sources agree, aggressive security can shut off many problems in advance before they become critical. It is up to managers to know their employees well and be aware of those who have problems that might cause security risks, security men insist. Top-secret projects in the past (the U-2 spy plane of the 1950s, for one) have been protected in this manner, with much success. Although informers are not an appealing source of information, a few well-placed ones are a big help to security officers.

Probably the best security tool is the knowledge that most spies get caught. "Knowing they can't get away with it for long will stop those who are motivated only by money," notes one security officer.

Companies who do not live up to security-clearance regulations are making a big mistake, say security officials. "They work, if people take them seriously and abide by them," says John C. Hagerman, corporate director of security of Litton Industries Inc. □

## Keeping police informed

"Since April of 1980 we have taken steps to better the security of our products," acknowledges the director of corporate security at Intel Corp. in Santa Clara, Calif. Besides beefed-up internal measures, says John O'Laughlin, a much higher level of cooperation now exists with law-enforcement agencies, particularly the Sheriff's office in Santa Clara County. "We need their help in investigations with search warrants and the like," he adds.

Intel and other Silicon Valley firms work hard in liaison with law agencies and have a security manager's group that meets monthly for this purpose. One aspect of the meeting is to help officers and prosecutors understand terms and technology better. "There's a jargon and mystique about the industry that often frightens them off," says O'Laughlin.

# Let us show how we can help you solve your problems



We develop, design, manufacture, supply, install and maintain

- Communication equipment and systems
- Computer and related equipment
- Automation of traffic, power generation/distribution and industrial processes
- Test and measuring equipment/instruments
- Active and passive electronic components
- Electromechanical devices, components and sub-assemblies
- Electrical and electronic equipment for motor vehicles
- Consumer products

Offered: licences, partnership, patents, joint venture, know how, co-production  
Make your choice of these lines to get complete information and offers

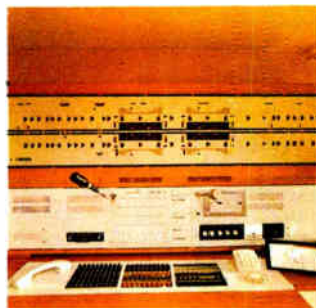
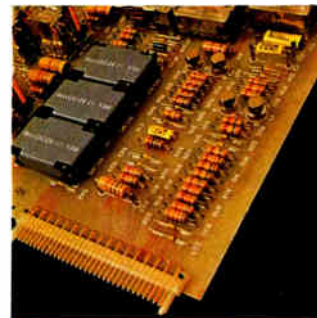

## Facts about Iskra

30,000 employees  
2000 research and development engineers  
90 factories, research, marketing and other organizations; turnover \$ 1.316 billion last year  
24 trading companies, representative offices and production plants in 18 countries  
all over the world  
In period 1976-1980, Iskra's export increased by 142% reaching \$ 145 million in 1980.  
In 1981, the export is expected to be \$ 200 million and in the period 1981-1985  
over \$ 1.5 billion.

Ask for a free copy of our brochure, Annual Report '80, catalogues, literature.  
See us at the International Fairs in Paris, London, Birmingham, Hannover, Basel,  
Leipzig, Munich, Köln, Milan, Moscow, Poznan, Budapest, Brno, Ljubljana, Zagreb,  
Belgrade, Bagdad



anniversary, celebrated on July 4th, 1981

# Iskra

For more information call or write  
Iskra Commerce, Trg revolucije 3, 61001 Ljubljana, Yugoslavia, Telephone-International: + 38 61 324 261.  
Telex: 31 356 yu iskexp or contact our subsidiaries in Brussels, Paris, Gonesse/Paris, Milan,  
Barcelona, Solothurn (Switzerland) Coulsdon/London, Syosset/N. Y., Stuttgart, Munich,  
Dusseldorf, Prague, Cairo, Tehran, Berlin, Warsaw, Bucaresti, Istanbul, Caracas, Moscow, Quito, Stockholm

## **ISO-CMOS™ A RANGE OF PRODUCTS FOR A RANGE OF APPLICATIONS.**

*The features that make Mitel Semiconductor's ISO-CMOS technology ideal for the telecom industry also make it ideal for a varied range of other applications.*

*Why?*

*Consider the stringent requirements of the telephone industry. Reliability is crucial. Power and space are limited in both telephone sets and PABXs. Battery back-up is important. A wide voltage range is needed.*

*ISO-CMOS technology meets these challenges and performs superbly. ISO-CMOS makes it possible for us to produce the best selling PABXs in the world.*

*Now, these very same features of ISO-CMOS products can be applied to any high speed, low power or portable applications in an electrically noisy world.*



*The Mitel Superswitch™ Family.  
Superb examples of  
ISO-CMOS™ application*

*Consider the following products for your application:*

*Digital:*

*MD21 SC14 1K x 4 static RAM  
MD235C 16 2K x 8 ROM  
MD4332 LCD Display Driver  
MD685C02 8 bit Microprocessor  
MD745Cxxx Octal Interface Circuits*

*Telecom:*

*ML8204/5 Telephone Set Tone Ringer  
MT4320/25 Telephone Set Pulse Dialer  
MT5087/89/91 Telephone Set DTMF Generators  
MT8804 8x4 Analog Switch Array  
MT8860/62/63 DTMF Digital Decoders  
MT8865 DTMF Filter  
MT8912 PCM Filter*

*Find out even more about Mitel Semiconductors by contacting your local Mitel sales office.*



# **MITEL SEMICONDUCTOR**

United States: 2321 Morena Blvd., Suite M, San Diego, California, U.S.A. 92110.  
Telephone (714) 276-3421. TWX: 910-335-1242.  
P.O. Box 17170, 600 West Service Road,  
Quiles International Airport, Washington, D.C., U.S.A. 20041.  
Telephone (703) 661-8600. TWX: 710-833-0865.

Canada: P.O. Box 13089, Kanata, Ottawa, Ontario, Canada K2K 1X3.  
Telephone (613) 592-5280. Telex: 053 3221. TWX: 610-562 8529.

Europe: 33/37 Queen St., Maidenhead, Berkshire, England SL6 1NB  
Telephone 0628 72821. Telex: 849-808.  
Bredgade 65A, 2nd Floor, 1260 Copenhagen K, Denmark  
Telephone (01) 134712. Telex: 19502.

Asia: TST P.O. Box 98577, Kowloon, Hong Kong.  
Telephone 3-318256. Telex: 34235.

TM Trademark of Mitel Corporation  
Copyright 1981 Mitel Corporation

## **BUILDING BETTER COMMUNICATIONS**

Circle 92 on reader service card

# Time is ripe for entrepreneurs

Venture capitalists are on the lookout for high-technology start-ups, as cut in capital gains tax helps increase available cash

by Martin Marshall, San Francisco regional bureau

Last month, a small group of ranking technical managers walked out of National Semiconductor Corp. to form what may become the next major semiconductor company in California's Silicon Valley. Their next step was a round of meetings with the venture capitalists of the electronics industry, the people who can turn an entrepreneur's dream into corporate reality.

As with so many other fledgling entrepreneurs, their dealings with the venture capitalists who can supply cash, counsel, and coddling are crucial. The annals of the electronics industries are studded with stunning successes that were started with venture capital.

Nor is the group of former National technologists the only one making the rounds of the money men. Silicon Valley and other parts of the country like Massachusetts's Route 128 have seen a flurry of start-ups in the last year or so, and many more firms will follow.

The money is there, but the competition for it is likely to be intense. To get an edge, the prospective entrepreneur needs to know what venture capitalists expect of him.

**Burning ambition.** Hidden in the heart of every talented and ambitious technologist is the desire to run his own show. As his career progresses, he may become a product line manager, an engineering manager, an operations manager, or even the general manager of a division.

For a particularly ambitious few, however, running part of somebody else's show is not enough, and realizing the desire means becoming an entrepreneur. It means coming up with a big idea, gathering a team,

seeking out sources of funding, and leaving the security of a salaried position at an established company to make a multiyear commitment to the unknown. For each of the heralded successes, such as Robert Noyce of Intel Corp., Jerry Sanders of Advanced Micro Devices Inc., Kenneth Oshman of Rolm Corp., Mike Markkula of Apple Computer Inc., or Jesse Aweida of Storage Technology Corp., there have been hundreds of obscure failures.

For those who are willing to take the plunge, there has never been a better time. "The 1980s will be the decade of the entrepreneur," asserts Stanley Pratt, editor of the *Venture Capital Journal*. "In 1979 and 1980, venture capitalists disbursed an estimated \$1 billion each year—more than double the average annual disbursements of the prior five years." What's more, he figures that there is another \$1 billion or so available in the pool of capital committed for investments in ventures, which

amounts to \$4.8 billion at present.

Although no one really knows how much of the money goes into electronics, Pratt notes that over 60% of venture activity is related to high technology. "Some of that is applied genetics, but most of it is computers and communications," he adds.

Geographically, the focus is in the San Francisco Bay Area. Western investors have their own explanation of the California start-up phenomenon. "The infrastructure exists on the West Coast, but I think it is more the risk-oriented mentality of the Westerner," declares Don Valentine, a managing general partner of the Sequoia Capital Fund and Capital Management Services Inc. of Menlo Park, Calif.

**Brimming pool.** The current pool of venture capital started to fill fast early in 1978, when the U. S. Congress passed the Steiger amendment to the tax code, which slashed the capital gains tax from 49% to 28%. The American Electronics Association lobbied heavily for its passage, as did the National Venture Capital Association under the direction of Reid Dennis. To document its case, the AEA surveyed 325 electronics companies to determine the effect of venture capital upon the electronics industries.

As reported to Congress by Edwin Zschau, chairman of System Industries Inc. and head of the AEA's capital formation task force: "We found that in one year alone—1976—each \$100 of equity invested produced \$70 in exports, \$33 spent on R&D, \$15 in Federal corporate taxes, \$5 in state and local taxes, and \$15 in personal income-tax revenues."

The brimming pool of venture

FLOW OF NEW MONEY INTO VENTURE CAPITAL (In \$ millions)		
Year	Into venture firms	Directly into businesses
1969	171	450
1970	97	350
1971	95	410
1972	62	425
1973	56	450
1974	57	350
1975	10	250
1976	50	300
1977	39	400
1978	570	550
1979	319	1,000
1980	900	1,000

SOURCE: VENTURE CAPITAL JOURNAL

## Inside the news

capital, of course, brought on a flood of entrepreneurs. "Compared with four or five years ago, there are more electronics entrepreneurs now, by an order of magnitude," observes W. Denman "Denny" Van Ness, vice president and partner in the venture capital fund of Hambrecht & Quist of San Francisco.

"The percentage of entrepreneurs funded, however, has remained about the same, or, if anything, it has increased," he says. "The reason is that more seasoned people are leaving their companies to become entrepreneurs." Historically, venture capitalists have funded only 1% to 2% of the proposals put to them. Once funded, however, an entrepreneur has a better than even chance to achieve some sort of success.

**Making contact.** With so many would-be entrepreneurs lined up around the edge of the investment pool, knowing how to approach an organization and understanding the way it sizes up candidates can provide a telling advantage for the applicant.

Notes George Quist, general partner of Hambrecht & Quist: "A critical factor for a guy getting started is sponsorship. If I get a cold call, the entrepreneur is not likely to get a strong reception. If that call is preceded by a call from someone I know who can tell me about him, then it helps considerably. If the entrepreneur has a track record in the industry, then he should know someone who can make that kind of connection."

John T. Neises, director of the National Venture Capital Association and general partner in the Charles River Partnership III in Boston, agrees that "an introduction from a known and successful businessman-entrepreneur is best. If you walk in with an introduction from Ken Olson [president of Digital Equipment Corp.], we will make time to listen to your proposal. The same is true of a recommendation from another respected venture capital house. Generally, the referral approach is the best approach.

"If you lack contacts, you have to engage in some G-2 work, selecting



**Go West.** Don Valentine, a California venture capitalist, believes most of the action is on the West Coast because, for one thing, people there have a risk-oriented mentality.

the venture houses most likely to be interested in and helpful to you. The venture capital guides in most business libraries are an aid. You need to know what kind of deal a firm is interested in, whether the firm is a lead or second-round house, and the size of the deal in which it can participate. You also need to know whether it has a conflicting venture in its portfolio."

Other money men are rather more casual. "We are available and far more approachable," observes Sequoia Capital Fund's Don Valentine. "We don't have fancy screening methods, because it is very rare that a team comes in that is overwhelmingly right."

"Direct contact with the venture capitalist, preferably by the entrepreneurial president, is best," says Burton J. McMurtry, a partner in Technology Venture Investors and Institutional Venture Associates, Menlo Park. A telephone call can get a preliminary reaction and suggestions, while a crisp summary letter can also be used—with a longer response time.

Above all, would-be entrepreneurs should never broadcast their deals to a long list of financiers. Venture capitalists declare this approach means certain death for a proposal. They

**People, not things.** In the view of Thomas J. Davis Jr. (below), in new ventures "people are everything. People make products, products don't make people."



recommend that applicants limit their approach to about three firms. The turnaround time on such proposals is currently about a month to six weeks, as against three to six months earlier this year, they note.

**Premium on talent.** Both people and a product idea are crucial to a start-up. "The principle of venture capital can be stated in four words: back the right people," asserts Thomas J. Davis Jr., who is a partner in the Mayfield Fund of Menlo Park. "People are everything. People make products, products don't make people."

Many of Davis's peers agree. "A new company seeks the level of its people, not its product," remarks Paul Wythes, general partner of Sutter Hill Investments in Palo Alto, Calif., a company that has helped some 80 electronics companies start up in its 19 years.

As John W. Poduska puts it, "Grade A people can take a Grade B idea and make a success of it. Conversely, Grade B people will run a Grade A idea into the ground." Poduska qualifies as a two-time winner in the venture capital stakes: he is the president of Apollo Computer Inc., a start-up in Chelmsford, Mass., and was one of the founders of Prime Computer Inc. of



# Smart enough to make ATE system control as easy as plugging in a cable.

Here's one instrument controller that gives you advanced system control and the smarts to make programming easier than you ever thought possible. How? Ingenious system interface capabilities and superior CPU intelligence. Together, they make the 1720A easy to program, easy to operate, and easy to integrate into your present system. Now that's smart.

## A better match for your interface needs.

Since there are three primary interfaces, shouldn't a smart instrument controller easily handle all three? You bet it should. That's why we equipped the 1720A with two IEEE-488 and RS-232 ports—both standard. And you won't find that anywhere else. Plus, we've added a new

bit-parallel interface capability.

So now, whether your instruments are old or new, hardware integration is about as easy as plugging in the cables. Which means flexible system design that has you up-and-running-fast.

## Minicomputer smarts give you easy programming and operating too.

Productivity isn't working harder. It's working smarter. The 1720A's minicomputer intelligence gives programmers smart tools—like enhanced BASIC and

Assembler software with special commands like RBYTE, WBYTE, RBIN and WBIN for faster, more efficient data bus manipulation.

For operators, our exclusive touch-sensitive display lets even unskilled operators perform complex test routines quickly and easily.

Does all this mean a big unwieldy package? Look again. The 1720A slides into a standard 19-inch rack.

## A shared commitment to better, easier in-house ATE.

We're working with you to make ATE less time-consuming and costly through the IEEE-488 standard interface. Proof is our 36 different IEEE-488 compatible products—with more on the way.

If you're ready for the best in ATE system control, let us show you how we can make it easy. Write, or call toll free 1-800-426-0361 for a demonstration. Or send for our Instrument Controller Comparison Guide.



For technical data circle no. 95

---(fast response coupon)---

E2 8/81

IN THE U.S. AND NON-EUROPEAN COUNTRIES:

John Fluke Mfg. Co., Inc.  
P.O. Box C9090, M/S 250C  
Everett, WA 98206  
(206) 356-5100. Tlx: 152662

IN EUROPE:

Fluke (Holland) B.V.  
P.O. Box 5053, 5004 EB  
Tilburg, The Netherlands  
(013) 673973. Tlx: 52237

- Send 1720A Instrument Controller Comparison Guide
- Have sales representative call for demo

Name \_\_\_\_\_

Title \_\_\_\_\_ Mail Stop \_\_\_\_\_

Company \_\_\_\_\_

Address \_\_\_\_\_

City \_\_\_\_\_ State \_\_\_\_\_ Zip \_\_\_\_\_

Telephone ( \_\_\_\_\_ ) \_\_\_\_\_ Ext. \_\_\_\_\_

## Inside the news

nearby Wellesley Hills, Mass.

Other investors, however, choose to focus upon a product idea first. "Under our charter, the first criterion is advanced technology," says T. F. "Ted" Walkowicz, who is a general partner in Advanced Technology Ventures in New York. "After that screening, then the key factor becomes people."

Every venture capitalist has his particular yardstick for sizing up people who want backing for a start-up. "An entrepreneur who approaches me should have some experience in running a profit-and-loss center," says Arthur Rock of Arthur Rock & Co. in San Francisco, one of the best known of the venture breed.

When technologists with profit-and-loss experience are not available, some money men adjust their requirements accordingly. "I want to see an entrepreneur who is bright and who has a strong ego, integrity, knowledge of products in his marketplace, an empathy for people, creative thinking, and a good numbers sense," says Jack Melchor of Melchor Venture Management and the Portola Venture Fund in Los Altos, Calif.

As Fred Adler, general partner of Adler & Co. in New York, puts it: "We prefer a guy who has been a business unit manager, but we can also look at an engineering manager. He might be a guy who has identified a \$200 million or \$500 million market, but who has been impeded in realizing it by the company in which he works."

**Teamed up.** A few individuals like Gene Amdahl or Seymour Cray could command venture capital alone when they launched successful computer companies. But most financiers prefer to see an entrepreneurial team, however incomplete. "We prefer to have a management team in place when we start to fund a company," explains Eugene Kleiner of Kleiner, Perkins, Caufield, & Byers in San Francisco.

**Ready and willing.** "We prefer to have a management team in place when we start to fund a company," says San Francisco venture capitalist Eugene Kleiner.

One of the founders of what was then called Fairchild Semiconductor, Kleiner notes that such a leader need not necessarily have been a company president before. "The good people then attract the rest of the management team, and we will help the company to find one or two people," he observes.

"Ideally, the entrepreneurs will be a group of people who worked together at a large company," declares Kenneth W. Rind of the Oxford Group in Greenwich, Conn. "The top guy will have had division or product line profit-and-loss responsibility, and he will be joined by a marketing manager, an engineer,

and a controller. The classic instance would be a group out of IBM, but we would still be wary unless one of them had profit-and-loss experience." The group that recently left National Semiconductor [*Electronics*, Aug. 11, p. 46] thus rates as a dream team.

Spotty teams must be avoided at all costs, says Russell E. Planitzer, a partner of J. H. Whitney & Co. in New York. "Often guys get together, issue the stock among themselves, and because of a 'hire your friends' phenomenon, have a number of weak people holding amounts of stock they can't support within the firm," he says. "This not only makes the idea

**Qualities.** Jack Melchor wants the entrepreneurs that he backs to have "a strong ego, integrity, knowledge of his market, an empathy for people, and a good numbers sense."



# "We asked for a high frequency counter that measures accurately in tough RF environments. We weren't disappointed."

"Measuring frequencies on-site can be a difficult job. Signals from nearby transmitters can interfere with the frequency we're monitoring. But Fluke has packed all the features we need for high frequency

measurements into their new 7220A Frequency Counter, and then some."

"A full 10 Hz to 1300 MHz bandwidth through 2 input channels, and 5 mV rms basic sensitivity give us the full frequency coverage we

need. The 7220A's X1 to X100 variable attenuator, effective overload protection, and 100 kHz low-pass filter on the Channel A input help us take clean, stable readings of audio signals with RF contamination. And an integral stainless steel RF shield surrounds this counter."

## "We take accuracy with us."

"An optional battery pack combines with a choice of ovenized oscillators for high-accuracy, no-warm-up readings - even in the field."

"And because the 7220A is a member of Fluke's Portable Test Instrument (PTI) family, this counter quickly stacks-and-latches to any PTI Instrument. With the Fluke 1120A Translator, we can even assemble an inexpensive, transportable IEEE-488 system."

## Convincing Evidence.

Communications specialists everywhere are finding that the new Fluke 7220A makes their tough frequency measurements on the bench or in the field. For more information on Fluke Counters, call toll free 800-426-0361, use the coupon below, or contact your Fluke Sales Office or Representative.



### Fast-Response Coupon

E2 8/81

IN THE U.S. AND NON-EUROPEAN COUNTRIES:  
John Fluke Mfg. Co., Inc.  
P.O. Box 13996, M/S 250C  
Everett, WA 98206  
(206) 356-5400  
Telex 152662

IN EUROPE:  
Fluke (Holland) B.V.  
P.O. Box 5053, 5004 EB  
Tilburg, The Netherlands  
(013) 673 973  
Telex 52237

- Please send me the 7220A Brochure.  
 Please have a Sales Engineer contact me.

Name \_\_\_\_\_  
Title \_\_\_\_\_ Mail Stop \_\_\_\_\_  
Company \_\_\_\_\_  
Address \_\_\_\_\_  
City \_\_\_\_\_ State \_\_\_\_\_ Zip \_\_\_\_\_  
Telephone ( ) \_\_\_\_\_ Ext. \_\_\_\_\_

For technical data circle no. 6

---

## Inside the news

---

unattractive to the venture capitalist, but also can make it tough to put a good second tier of managers together. You need stock as a lever."

Another caution is that applicants should not try to gloss over their own weaknesses. "We funded one entrepreneur who had been fired from his previous job," recalls Adler & Co.'s Adler, "because we looked into the reasons for it and decided it had nothing to do with how he would perform in the new company."

Adds Frank Caufield of Kleiner, Perkins, Caufield, & Byers, "One of the screens we apply is to ask ourselves if the entrepreneur will tell us the bad news as well as the good immediately. We want to know, when things get tough, if this is the kind of guy that we can get down in the trenches and work with."

**Portrait.** Venture capitalists have personal preferences for traits among entrepreneurs, but a rough composite can be pieced together. "A guy who just wants to be a millionaire is not very interesting to me," observes Sequoia's Valentine. "I'm looking for the guy who wants to build a \$500-million-a-year company with perhaps \$50 million in

personal net worth."

He notes that the ideal entrepreneur can be a "narrowly focused, driven, often boring individual. He might be the kind of guy that I would be reluctant to spend my weekend off with."

Jim Riley, cofounder of Dataquest Inc., former president of Signetics Corp., cofounder of Intersil Inc., and part-time venture capitalist, agrees with Valentine. "The lead entrepreneur must have tunnel vision," he says. "He is willing to subordinate everything else to his venture, even including commitments in his personal life."

The key is how the individual operates under stress, avers John Woodman, vice president for research at the San Francisco office of Dean Witter Reynolds Inc. In preparation for his firm's entry into the venture field this summer as a general partner of U. S. Venture Partners, Palo Alto, he compiled a psychological profile of the entrepreneur.

"They are all rational-emotive, a normal state, when they come in through the door," he says. They "tend to move toward aggressive-directive behavior, and it is the function of the venture capitalist to help them redirect that energy in a fashion that nurtures the company."

Although most venture capitalists like an entrepreneur to have confidence bordering on arrogance, Mayfield Fund's Davis notes that such an attitude should not apply to the technologist's concept of marketing. The entrepreneur should not believe for a second in the old advice that if he builds a better mousetrap, the world is bound to beat a pathway to his door, he argues.

"He knows that everything has to be sold, and he does not react to every slump in sales by running back to the lab to try to invent something that will sell itself," he says. Davis wants the type of entrepreneur "who gets right up, belly button to belly button, with his customers, both to find out what they need and want and because he loves the action of making sales himself."

**Double scrutiny.** While the entrepreneur may come in for the heavier scrutiny, most venture capitalists caution that the selection process is two-way. "The entrepreneur should do his homework on the venture capitalist, because the corporate marriage lasts a long time," cautions Sutter Hill's Wythes. "He will want the venture capitalist to be there for the second and third round of financing, and he will need the venture capitalist's help to raise financing beyond that."

It is essential that the entrepreneur check to see how the financier has dealt with previous entrepreneurs. Fred Adler advises technologists to find out what successful companies potential backers have funded and then ask the company presidents what the investors did for them and what kind of board members they turned out to be.

The entrepreneur can be sure that, before funding, the venture capitalist will conduct an extensive checking process. "The reference check of the entrepreneur is the most important part," asserts James Bochnowski, a partner in Technology Venture Investors and a former president of Shugart Associates. "We talk to all the people that the entrepreneurs have dealt with in the past. Then, in the interview process, we try to be candid with them. We tell them where our discomfort lies, whether we would rather they had a different chief executive officer, and any

---

## Small investors supply seed money

Rather than just an idea for a product and a plan for getting it to market, some entrepreneurs prefer to have a working prototype in hand before negotiating for a significant amount of venture capital money. A prototype can be more convincing to a venture capitalist, and so the entrepreneurs can retain more equity for themselves.

When seed money, as distinct from venture money, is needed, another class of capitalists comes into play. Venture organizations usually prefer to invest at least \$250,000 and sometimes a minimum of \$500,000, compared to the \$10,000 to \$100,000 that could be described as seed money. The reason for the minimum is that each principal venture investor can actively participate in only six to eight companies at a time. Since the fund is usually investing other people's money and only retains a small percentage, the minimum figure is calculated as the one that will make the venture capitalist's time spent worthwhile.

"Deals are getting bigger, and there is a propensity for venture capitalists to go for the big deals," observes Dataquest's James Riley, a part-time investor. "It's hard for them nowadays to do deals under \$500,000. This has created a market for individuals to do smaller deals using their own money." Riley is one such seed sower and points out that "working with my own money, I can do deals with several zeroes less than the big funds."

Some venture capitalists are capable of investing both fund money and personal money, thus providing a natural follow-on to a seed investment. Among others, these include Jack Melchor, Pitch Johnson, Fred Adler, and Peter Wolken.

-M.M.

**Manager wanted.** New Yorker Fred Adler wants "a guy who has been a business unit manager, but we can also look at an engineering manager" to head a start-up.



**Top spot.** Kenneth W. Rind of the Oxford Group in Connecticut, at left with partner Neil Ryan, says the top person in a start-up should have had division or product line responsibility.

weaknesses we see."

The astute venture capitalist also does not rely solely upon his own judgment. "We call the potential customers of a prospective company and ask them if they truly need such a product," notes Jack Melchor of the Melchor and Portola venture funds. "The two extremes that we have seen in that category are Triad Systems, which had clearly identified its customers, and Rolm, which had not immediately identified its customers. Both made it big" in the small-computer business.

**A proper plan.** A team's business plan comes in for hard scrutiny as well. The plan's initial degree of formality varies, but the applicant must convince the investor that he has put some serious thought into it.

"Sometimes the business plan is just a phone call and sometimes it is a rough plan," says Melchor. "I don't like a lengthy business plan; about 15 to 20 pages should be enough . . . especially, I hate to see a guy with a business plan that's been written by a consultant. If he doesn't know it himself, he can't be committed to it."

"The writing of a business plan is essential," adds Technology Venture's Bochnowski. "It should include the background of the key people, a description of the market the entrepreneurs wish to enter, their product development strategy, their

manufacturing and service strategy, their projected balance sheets for three to five years, their proposed sources of capital, and the risks and potential problems they see."

There is a clear progression in writing of a business plan, observes Franklin "Pitch" Johnson, owner of Asset Management Co., Palo Alto. "It begins with a hypothesis, or 'genius leap,' but what separates it out is the entrepreneur's ability to think in concrete terms," he cautions.

"The whole reason to write a business plan is not to raise money; it is an exercise to see if the idea holds water and to get it squared away in the entrepreneur's head. If the business plan is written strictly as a selling tool to the venture capitalist, then it is unlikely he will fund it."

Apollo Computer's Poduska has this advice: "A business plan should run 10 pages plus a summary page, and it should address these issues in this order: the nature of the business; a description of the market with projections of growth and share of market; description of the product or service; and capital requirements."

Ezra Mintz, president of Minerva Ventures Inc. and of Colorgraphic Communications Corp., both in Atlanta, says that "most venture capital houses will tell you that they want a business plan, market projections, team description, competitive analysis, and so on. But most impor-

tant may be a quantitative analysis of the competitive situation."

As for the rosy projections that sometimes color business plans, venture capitalists examine them carefully. "When I check out a business plan, I go backwards from the numbers to what it means in terms of the company and the marketplace," observes Johnson.

"Tandem [Computers], for example, had some very specific ideas. Some venture capitalists were skeptical that something could accelerate that much, but we had confidence in the management team and they did just about what they said they would do." In the end, Johnson notes, "it boils down to how closely the business plan's sense of reality matches my own."

Evaluations of business plans range from a minute analysis of an entry into an existing field to a gut-level reaction to a new field. In backing the Apple Computer venture along with VenRock Associates, the venture capital arm of the Rockefeller family interests, Arthur Rock declares, "We just thought that personal computers were a good idea."

When his group looks at a business plan, says Fred Adler, "We don't make judgments like whether C-MOS is better than SOS. We ask ourselves: if the supposition is true, what are the commercial implications? We can't second-guess on the

## Inside the news

bits and bytes."

Adds George Quist: "I don't want to hear simply that someone wants a 5% share of a \$200 million market. I want to see him pinpoint his markets. If it's a chip design, for example, then I want him to tell me 'Intel said they would produce this amount and National will produce this amount.' Then we contact the potential customers. That's one of the good things about technology, it's measurable."

**Negotiating the deal.** Once the entrepreneurial team has sustained the interest of a venture capitalist, the crucial stage of negotiating a deal follows. The profit expectations and stock demands of the money men can come as a shock. "The technologist generally thinks in terms of percentage, while the venture capitalist is interested in multiples," notes Peter Wolken of Associated Venture Investors of Menlo Park.

"We want to see a company that will increase the value of our investment by tenfold to a thousandfold over a 5-to-10-year period," he says. "The tenfold figure is not an objective; it is a minimum. The entrepreneur must raise his sights from the growth level of his present company to much higher rates."

While cautioning that each deal is unique, H. Dubose Montgomery of Menlo Venture Corp., Menlo Park, offers this description of a typical slicing of the corporate pie in a start-up: "For two guys and an idea requiring an investment of \$2 million to \$4 million over the course of 18 months to two years, it would be appropriate to ask for about two thirds of the company."

Advanced Technology Venture's Walkowicz agrees, noting, "A new venture is like a three-legged stool. One third of it is the entrepreneurs, and the other two thirds are two financial groups that are genuinely independent. That way no one is in the position to push anybody else around."

Technology Venture Investor's Bochnowski gives some idea of variability in this hypothetical case by adding, "I can make a case for asking 60% to 70% for a \$2 million

investment. If it's a better team, then 50% might be appropriate."

To get the number, Bochnowski determines the market risk and the dollar risk and comes up with a reasonable economic risk. "Then I would project a price/earnings ratio, risk-adjust it, and feed it back to the present. I would also check the numbers on similar deals," he explains.

Apollo Computer president Poduska says, "At the end of the first milestone, whether it's the first million dollars, the first year, or whatever, the fully diluted split generally runs about 60:40 in favor of the venture capitalist, though occasionally it is 70:30. But it is not the figure that precedes the percent symbol that's important; it is the one after the dollar sign."

Entrepreneurs should make every effort to bring their proposed company into the negotiation session free of ties. "Previous agreements with finders are a ball and chain to negotiations—and you simply don't need them in Silicon Valley," states Eugene Kleiner of Kleiner, Perkins, Caufield, & Byers. "I would also recommend to an entrepreneur that he leave his previous employer in a clean fashion and not take anything with him."

While the venture capitalist needs enough percentage to make his investment worthwhile, he must leave enough to keep the entrepreneurs interested. "We like to see the

founders having 25% to 50% of the company," declares Kleiner.

For the same reason, Ted Walkowicz asserts that "we try not to dilute the management founders below 20% to 25%, so that they will keep their motivation. We also do more option plans to keep from diluting the entrepreneurs." Observes Fred Adler, "We also reserve a pool of stock that is earmarked to attract new people to the company."

**Who's in charge?** A psychological factor that sometimes enters the negotiations is the entrepreneur's fear of losing control of his company to the venture capitalist. This, the investors claim, comes from the failure to distinguish operational control from the amount of stock needed for return on investment.

"If control is an issue, I'm not interested in the deal," flatly states Arthur Rock. Adler agrees, warning, "If I detect paranoia, I run from the deal. Theoretical control is nonsense, because if the technical people walk away from the company, the investor is left holding a bag of air."

Rather than worry about a venture capitalist's nominal control and participation in a company, most entrepreneurs welcome it. A surprising number of electronics financiers are former entrepreneurs, company presidents, and operating officers of electronics companies. They can tender advice, as well as money, and can help out in the financial areas



**Check.** Reference check of entrepreneur is most important, says James Bochnowski, center. His partners at Technology Venture Investors are David Marquardt, left, and Burt McMurtry.

# Announcing a NEW GENERATION of Airborne Yokes from THE GREAT AMERICAN YOKE COMPANY.



CELCO Airborne Yokes are designed for aircraft information displays, orbiting satellite, hand-carried and helmet displays, or wherever airborne and portable yoke applications require extremely small size and light weight without sacrificing high performance.

The highly efficient design of CELCO Airborne Yokes translates into space and power savings so critical to the airborne environment.

For three decades CELCO has met the demands of research in all fields of science and industry where high resolution CRT deflection components are required. CELCO YOKES are well known and respected throughout the Free world where they are the choice for military, medical, environmental, space, nuclear, earth resources and commercial applications.

Designing a high resolution Airborne CRT Display? CELCO engineers will help you select the correct combination of deflection components from among our standard catalog units. Or, we'll design custom production yokes to meet your most precise display requirements. Call or write CELCO today for your FREE CRT Display Computer and your complete CELCO Display Engineering Catalog.

CONSTANTINE ENGINEERING LABORATORIES CO.  
70 Constantine Drive Mahwah, NJ 07430  
1150 E. Eighth Street Upland, CA 91786

**Celco**

ED 8/6

Circle 101 on reader service card



## Inside the news

on a winner. As selective as the investors may be, they know that some of their ventures will not meet expectations. "You haven't been in venture capital until you've had to write off one or two," says Wythes.

Pitch Johnson sees four kinds of companies resulting from venture deals. "Typically about 10% of the companies will fail. Some 30% to 40% of the companies will do well, which means that they will have a 40% to 50% compound annual return," he says.

"Then, about 20% will do very well, significantly surpassing the 10-times multiple over five years." The other 30% to 40%, says Johnson, constitute the "living dead": companies that do not go broke, but also do not return much on their investment.

Whatever the performance of the company, the venture capitalist cannot realize a profit on his investment until the company becomes liquid. That means that it must either be acquired, merge with a publicly held company, or make a public offering of its shares. Only then can the venture capitalist reinvest his money in other start-ups.

**Go do it.** When that money is reinvested, some believe that it will not gain the same returns as earlier deals. "Between 1974 and 1981, ven-

## For more information

**"Guide to Venture Capital Sources,"** edited by Stanley Pratt, provides a complete list of venture capital sources as well as several practical articles on the subject. Contact Capital Publishing Corp., Wellesley Hills, Mass., (617) 235-5405.

**Membership Directory, National Venture Capital Association,** lists names, phone numbers, and addresses of members. Contact 1225 19th St. NW, Suite 750, Washington D. C. 20036; (202) 650-5756.

**Membership Directory, Western Association of Venture Capitalists,** in addition to names and addresses, gives areas preferred and avoided for investment, minimum and maximum investments desired, and types of financing and special help provided. Contact 3000 Sand Hill Rd., Bldg. 2, Suite 260, Menlo Park, Calif. 94025, (415) 854-1322.

ture capitalists had a stellar record of investments," Jim Bochnowski says. "In 1974, in particular, only the very best deals got funded. I believe that in the next six years the percentage of winners cannot help but go down."

Even so, most venture capitalists are highly optimistic about the rash of start-ups. "The best time to start a new company is tomorrow morning," Melchor says. "There has never been a better time."

Others see a change in the nature of start-ups, particularly in Silicon Valley. "All ventures will upgrade from high technology to very high technology because the return per employee will have to be significantly higher," believes Associated Venture Investor's Wolken.

He regards the thrust into venture

capital an American ace-in-the-hole in world economics. "The Japanese have the unfair advantage of low-interest loans and the restriction of competition from abroad," he asserts. "Our unfair advantage is venture capital."

Tommy Davis sees the whole venture-entrepreneur combination as a product of the American tradition, observing that "the dynamics of our economy and our social structure are such that no matter how hard the large companies try to hold their employees, a rather steady stream of them will leave in order to form teams to start new enterprises."

As Eugene Kleiner puts it, "Don't be afraid. Do it." □

Reporting for this article was also provided by James B. Brinton and Linda Lowe in Boston and Ray Connolly in Washington, D. C.

**Growth.** Peter Wolken wants tenfold growth—not an objective, but a minimum—in 5 to 10 years. He is at left with Associated Venture Investors partner Jack Loustaunou.



**Money counts.** Apollo Computer president John W. Poduska advises entrepreneurs not to concern themselves with ownership percentages, but with the dollars.





# BAUSCH & LOMB INNOVATION!

For fast, accurate inspections of wafers, hybrids, and multi-layered chips, specify Bausch & Lomb MicroZoom™ Microscopes... the *only* microscopes with both the high magnifications and long working distances demanded by these semiconductor applications.

No more pieced-together compromises! Bausch & Lomb innovation has produced a unique long working distance microscope with magnifications to 1000X and working distances from .5" to 1.2".

And, MicroZoom Microscopes also include these innovations:

- Continuously in-focus 1X to 2X zoom range. Focus once, then zoom to optimum magnification with no lost time refocusing.
- New 50X LWD objective to give you the optimum (up to 1000X) for pre-etch and post-etch inspections.
- Wide field images let you see a full ¼" chip, crisp and erect, for fast, accurate interpretation.
- Advanced tungsten-halogen vertical illumination system provides contrast control and true color rendition. A must for accurate

photomicrographs!

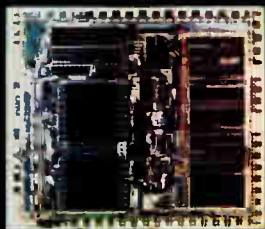

A full ¼" square chip can be viewed at the lowest magnification, 22.5X.

- Special MicroZoom Prober Models, designed for mounting on your probe station, add greatly to the safety, speed, and accuracy required for critical autopsy probing applications.



When faster assembly and inspection are required, choose Bausch & Lomb StereoZoom® Microscopes. Large working distances to 10.5".

Zoom ranges from 1X to 7X. Magnifications to 280X.

For critical work in wafer fabrication inspections, select Bausch & Lomb BALPLAN® Incident Light

Microscopes with magnifications up to 1500X and the clarity of six versatile illumination modes.

All three of these line microscopes accept a full range of high performance photomicrographic

equipment and versatile accessories.

Write or call today for complete information, applications assistance or a demonstration.

**For inspection reliability, performance and innovation, THINK BAUSCH & LOMB.**

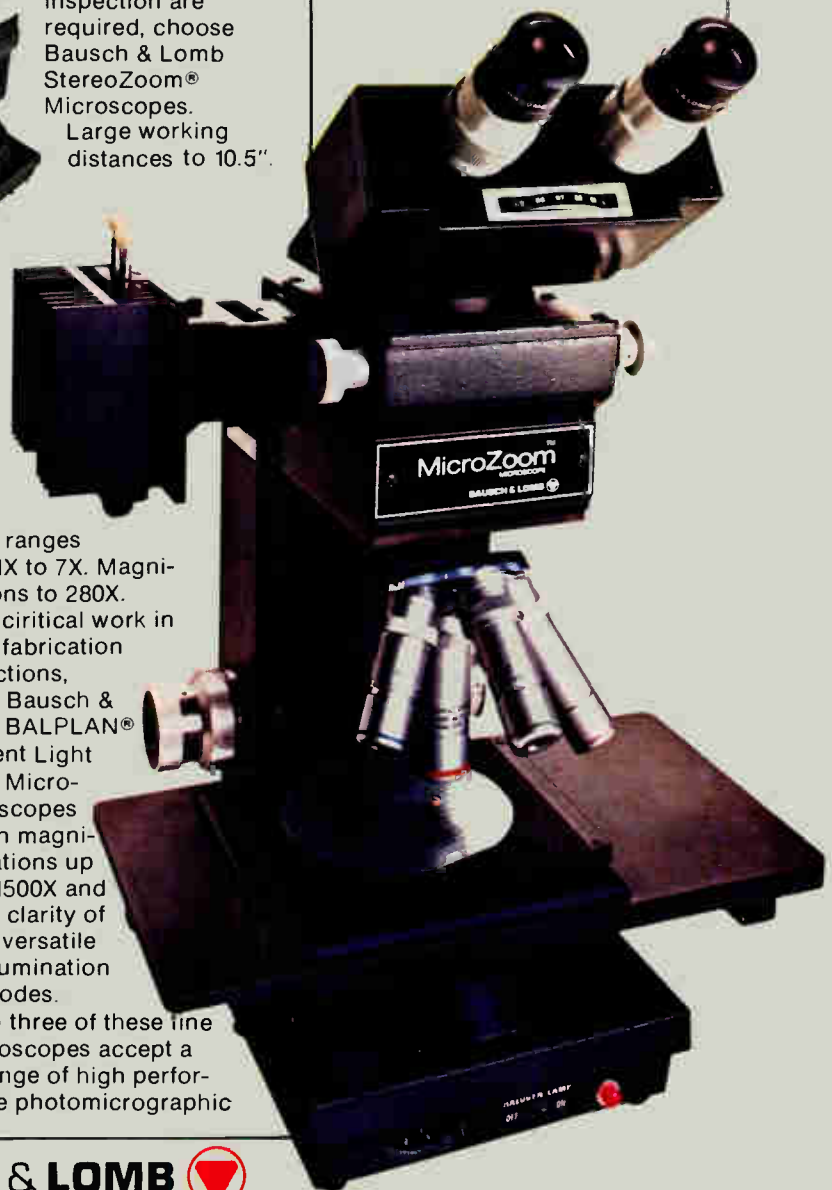

**BAUSCH & LOMB** 

Rochester, New York 14602 USA 716-338-6000, TWX 510-253-6189 TELEX 97-8231, CABLE Bausch & Lomb  
Regional Offices SOPD International CANADA Bausch & Lomb Canada Ltd., Don Mills, Ontario EUROPE Bausch & Lomb GmbH, Muenchen, Germany, Bausch & Lomb France  
S.A., Versailles France, Bausch & Lomb U.K. Ltd., Epworth Downs, Surrey, Bausch & Lomb Italiana S.p.A. 00198 Rome, Italy FAR EAST Bausch & Lomb (Hong Kong) Ltd.,  
Shaukeiwan and Singapore, BLJ Co. Ltd. Tokyo.

Circle 105 on reader service card

# THERE IS NO EQUIVALENT LINE.

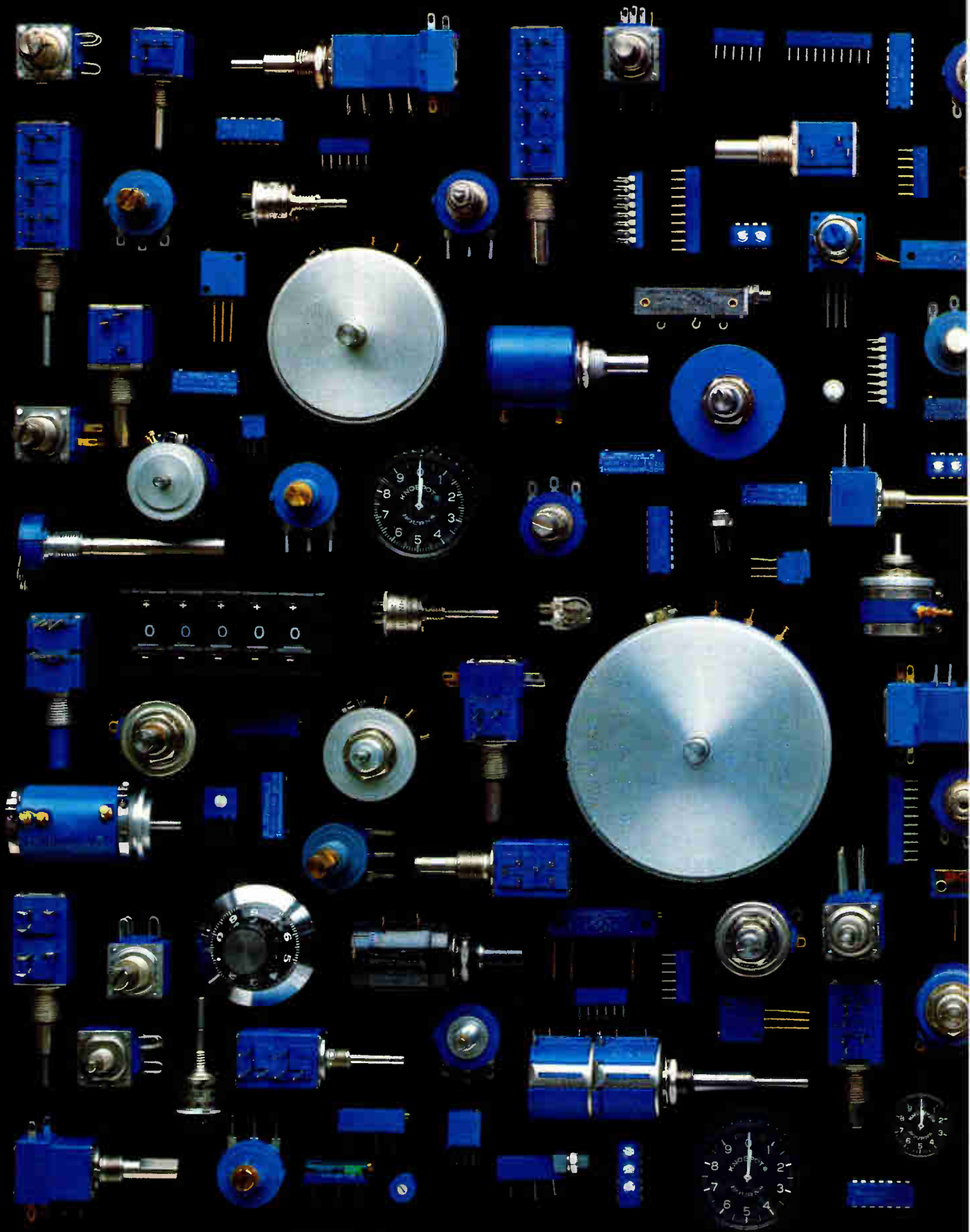

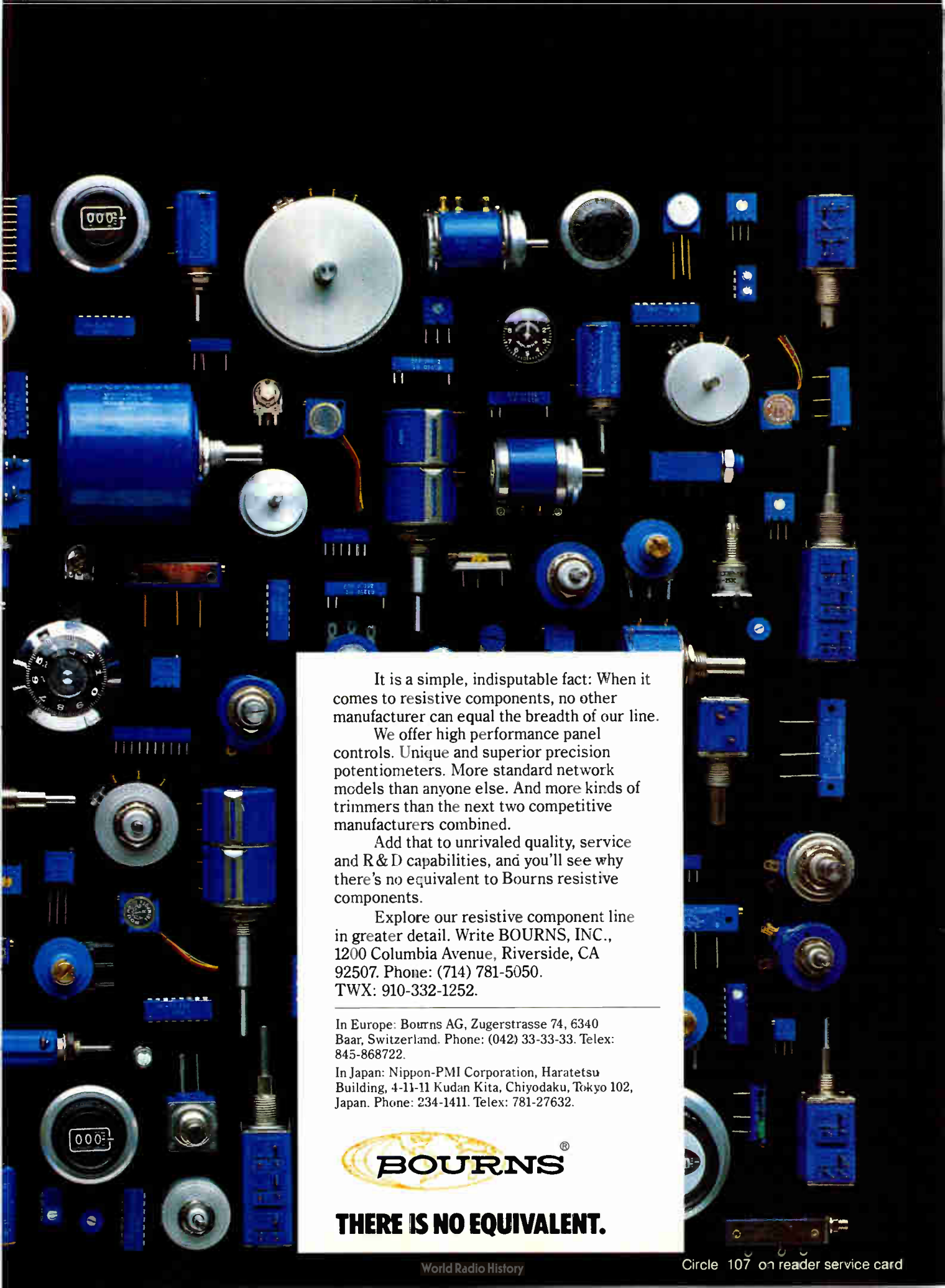

It is a simple, indisputable fact: When it comes to resistive components, no other manufacturer can equal the breadth of our line.

We offer high performance panel controls. Unique and superior precision potentiometers. More standard network models than anyone else. And more kinds of trimmers than the next two competitive manufacturers combined.

Add that to unrivaled quality, service and R & D capabilities, and you'll see why there's no equivalent to Bourns resistive components.

Explore our resistive component line in greater detail. Write BOURNS, INC., 1200 Columbia Avenue, Riverside, CA 92507. Phone: (714) 781-5050. TWX: 910-332-1252.

In Europe: Bourns AG, Zugerstrasse 74, 6340 Baar, Switzerland. Phone: (042) 33-33-33. Telex: 845-868722.

In Japan: Nippon-PMI Corporation, Haratetsu Building, 4-11-11 Kudan Kita, Chiyodaku, Tokyo 102, Japan. Phone: 234-1411. Telex: 781-27632.

**BOURNS**<sup>®</sup>

**THERE IS NO EQUIVALENT.**

# Nothing succeeds like



# cost-effectiveness.

Your most cost-effective product solution is the one that delivers most for the least. And the most cost-effective solutions in integrated circuits are usually custom.

Because compared to standard logic, custom solutions offer superior performance. Reduced component count. Less power consumption. Proprietary protection. And lower costs in production. And AMI makes custom cost-effective for you at almost any volume level.

**Cost-effective at almost any volume level.** The same custom solution that's right for very large volume runs may not be right for small ones.

That's why AMI offers a full-spectrum of custom solutions. Semicustom logic arrays. Full custom—including computer-drawn standard cells, computer-aided designs and hand-drawn designs. We can even teach you to design your own circuits. And provide custom fabrication of circuits from your own tooling.

And no one has greater experience than AMI in helping you pick the right solution. The one that gets you to market at the lowest possible cost, in the shortest possible time.

**The economy of custom production.** Once you have the right approach, we use the industry's most sophisticated design systems to further reduce costs and get you into production quickly.

AMI also adds cost-effectiveness to production with a large selection of processes. In fact, AMI fabricates in 25 variations of NMOS, CMOS, PMOS—including those for digital and analog on the same chip. This unique degree of flexibility assures you get the most cost-effective process for your circuit requirements.

We can deliver product any way you like, too. Prototypes, wafers, untested or fully tested assemblies. And we can do it quickly.

**Custom solutions. Not just custom circuits.** AMI has delivered more custom solutions than any other company. And no one offers more capability all in one place.

If you'd like to know more about how we can put all this experience to work making cost-effective solutions for you, visit or call the AMI Sales Office nearest you.

Because in this business, a little cost-effectiveness goes a long way.



**AMI**  
Microsystems, Ltd.

## The most natural solutions in MOS.

Princes House, Princes Street, Swindon, England  
SN1 2HU, Phone (0793) 37852;

124 Avenue de Paris, 94300 Vincennes, Paris, France,  
Phone (01) 374 00 90;

Suite 237, Rosenheimer Strasse 30-32, 8000 Munich 80,  
West Germany, Phone (089) 483081;

Piazza Gobetti 12, Milano 20131, Italy,  
Phone (02) 293745.

©1981 AMI Microsystems, Ltd.

---

**FAIRCHILD**

---

A Schlumberger Company

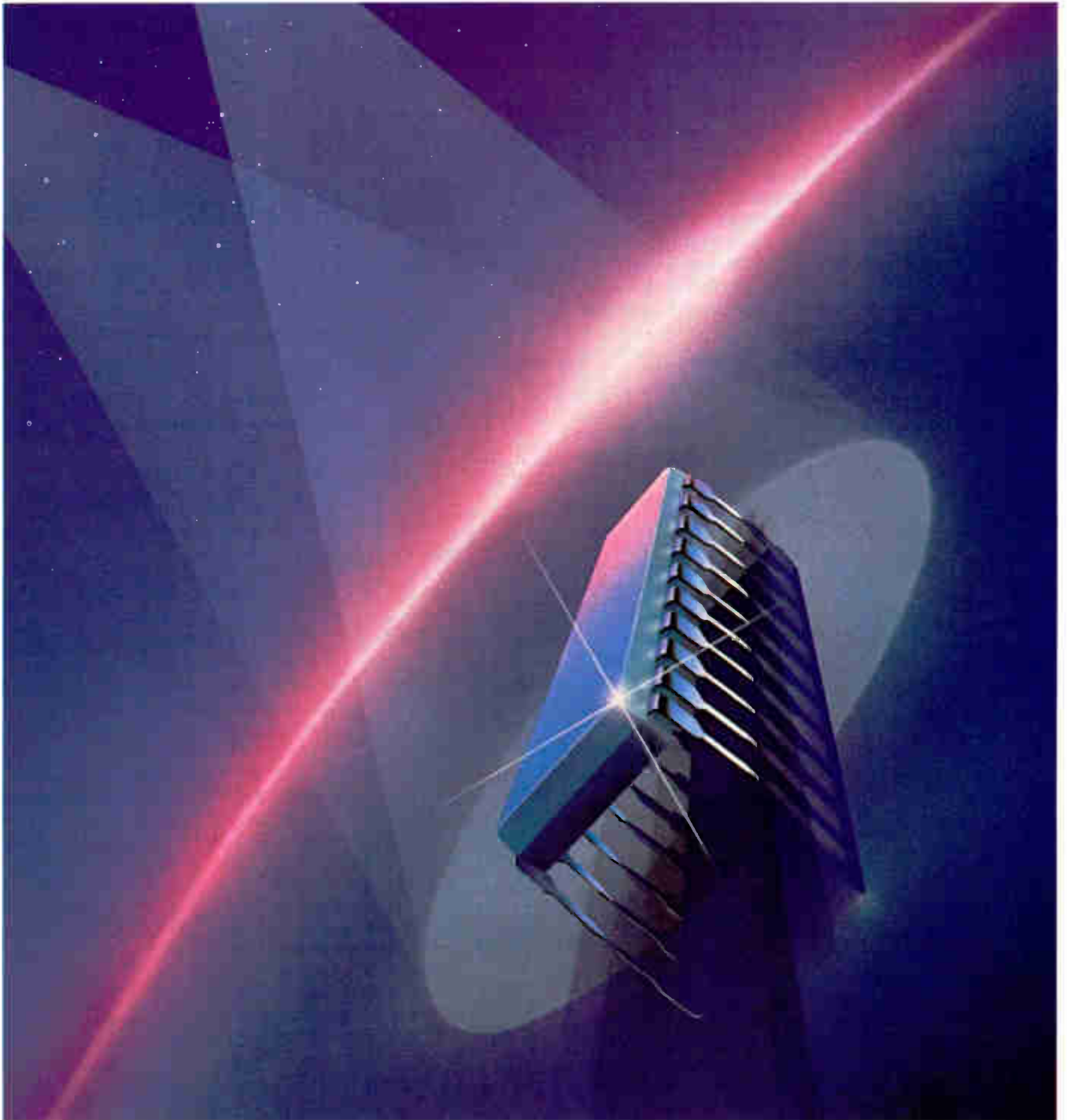

---

**FAST Success.**

## Fairchild Advanced Schottky TTL.

It's been a FAST two years.

When we introduced the FAST family of high-speed, low-power latches, buffers, flip-flops, counters, registers, multiplexers and LSI functions, we knew it would be a success. Because you just can't lose with the kind of performance FAST demonstrates.

Our endeavor paid off, and now we're producing over 40 different FAST devices, millions of units a month, with an additional 71

products defined!

Major customers in aerospace, defense, computers, telecommunications and instrumentation are FAST converting. And to make things move even FASTER, we have an alternate source with a major semiconductor manufacturer.

You can check into upgrading your TTL system the FAST way by ordering a FAST Evaluation Kit from any Fairchild distributor.

Discover the logic family of the '80s, and see how FAST your system can run.

For more information, call or write FAST, Fairchild LSI Products Group, P.O. Box 7880LSI, Mountain View, California 94042. Telephone: (415) 962-FAST. TWX: 910-379-6435.

**France:** Fairchild Camera & Instrument S.A., 121 Ave. d'Italie, 75013 Paris. Tel: 331 584 55 66. Telex: 0042 200614.

**Italy:** Fairchild Semiconduttori S.P.A., Viale Corsica 7, 20133 Milano. Tel: 02 296001-5. Telex: 843-330522.

**Germany:** Fairchild Camera & Instrument (Deutschland) GmbH, 8046 Garching Hochbruck, Daimlerstr. 15, Munchen. Tel: 089 320031. Telex: 52 4831 fair d.

**England:** Fairchild Camera & Instrument (UK) Ltd., 230 High St., Potters Bar, Hertfordshire EN6 5BU. Tel: 0707 51111. Telex: 262835.

**Sweden:** Fairchild Semiconductor AB, Svartengsgatan 6, S-11620 Stockholm. Tel: 8-449255. Telex: 17759.

**Japan:** Fairchild Japan Corporation, Pola Bldg., 1-15-21 Shibuya, Shibuya-Ku, Tokyo 150. Tel: 03 400 8351. Telex: 2424173 (TFCTYOJ).

**Hong Kong:** Fairchild Semiconductor (HK) Ltd., 135 Hoi Bun Road, Kwun Tong, Kowloon. Tel: 3-440233. Telex: HX73531.

Fairchild Camera and Instrument Corp



# Our new 208 A/B is adaptable to either dial-up or dedicated use. What's your line?

- Converts from dial-up to dedicated lines with only three straps
- Bell-compatible
- Smallest, lightest 4800 bps modem anywhere
- 10W max power requirement
- Adaptable to two- or four-wire private circuits
- Front panel control permits switched network voice communication via standard telephone
- Built entirely from standard, commercially available parts
- Compatible dialer available now
- Modular back panel accepts standard telephone jacks.

For full technical details, contact Universal Data Systems, 5000 Bradford Drive, Huntsville, AL 35805. Phone: 205/837-8100. Telex: 810-726-2100.

"Confidence in Communications"

## Universal Data Systems



Member  
IDCMA

DISTRICT OFFICES: Summit, NJ, 201/522-0025 • Blue Bell, PA, 215/643-2336 • Atlanta, 404/998-2715 • Chicago, 312/441-7450  
• Columbus, OH, 614/846-7478 • Dallas, 214/385-0426 • Santa Ana, 714/972-4619 • Sunnyvale, 408/738-0433 • Boston, 617/875-8868.

Circle 112 on reader service card

Created by Dayner/Hall, Inc., Winter Park, Florida





# Thick-film transformer advances hybrid isolation amplifier

Metal-ceramic sandwich forms low-cost flat-spiral coils that yield wideband coupling and high common-mode rejection

by Delip Bokil and William Morong,\* *Analog Devices Inc., Norwood, Mass.*

□ A transformer that uses thick-film technology for the task of producing a planar coil achieves tight windings and consequently a wideband response. The component's development was spurred by interest in a small, economical isolation amplifier for medical electronics and process control applications, but its potential uses extend far beyond these fields.

The transformer is the heart of the AD293/4, a hybrid flyback isolator design that offers superb electrical isolation, precise transfer characteristics, and low power consumption. Thick-film processing makes the new parts small, reliable, and inexpensive to produce and use.

Isolators have long suffered from the cost and inconvenience of bulky wirewound transformers. Even optical isolators usually need transformers for coupling power supplies across the barrier—only transformer coupling holds the promise of the transmission of both signals and power through a single isolation element.

### Flyback is the choice

A single-transformer flyback isolator is the most reliable because it has only one critical insulation system, and it has proven adequate for low-accuracy amplifiers [*Electronics*, July 20, 1978, p. 105]. Such a part (Fig. 1) incorporates a power oscillator to produce an asymmetrical square wave that periodically energizes the transformer. When the oscillator switches off, the coil voltages reverse because the current cannot change discontinuously.

This flyback pulse is amplitude-modulated under control of input amplifier  $A_{in}$  and is demodulated by identical circuits in the input and output sections. The output of the first demodulator feeds back to  $A_{in}$ , which adjusts the modulator so that this signal—as well as the output of the second demodulator—follows the input voltage.

Past attempts to improve this technique have been beset with difficulties that are overcome by the flat-spiral coil in the AD293/4. Many of the earlier flyback isolators exhibit a bewildering vari-

ety of flaws, most of which trace back to the transformer (see "Flyback isolators pose problems," p. 114).

Conventional transformer and printed-circuit-board construction techniques have provided adequate modular and board-level isolation amplifiers in the past, but they could not meet the design goals for the AD293/4. Thick-film hybrid construction techniques promise fulfillment of the elusive goals of a small, hermetically sealed part that is economical to produce. Furthermore, recently perfected techniques for the deposition and trimming of thick-film resistors on dielectric substrates assure that dense hybrid amplifiers will have superior electrical performance.

The cost of these benefits is the challenge of fabricating the transformer as a thick-film component. Conventional transformers are large, mechanically nonuniform components, generally

**Hybrid isolator.** Thick-film fabrication techniques applied to the transformer coils can shrink the cost and size of isolation amplifiers. The ferrite core set is attached to the hybrid substrate and supports the thick-film windings.

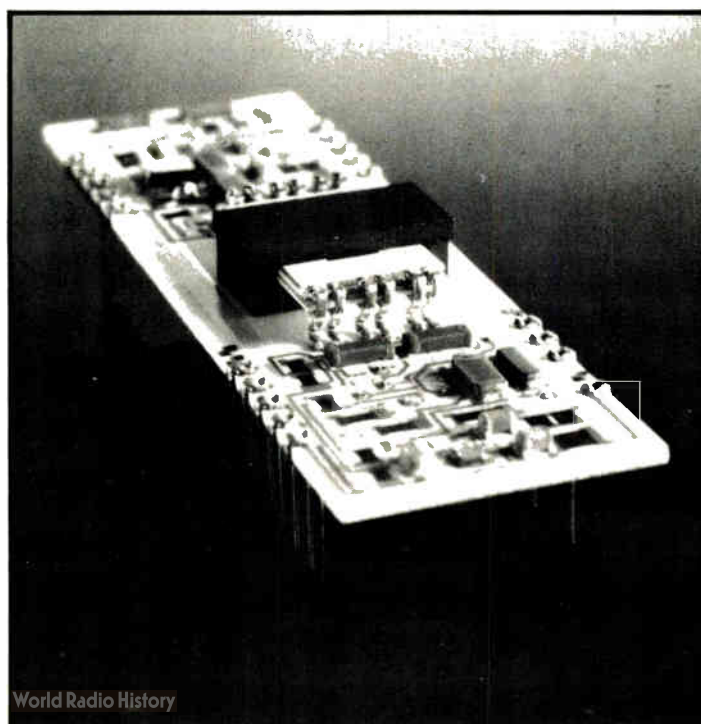

\*Now with Intronic



handmade out of low-temperature materials and thus, on all counts, incompatible with thick-film fabrication techniques.

Isolator designers traditionally have sought small, economical transformers with superior coupling, high voltage insulation, and low interwinding capacitance. The designer of a hybrid isolator needs a device that, in addition, is easily secured by

epoxy, has an ordered termination system compatible with standard thick-film techniques, and is completely testable before attachment to the hybrid substrate.

The transformer configuration (patent pending) shown in the opening photograph boasts several outstanding characteristics. The flat spiral windings can be mass-produced by thick-film deposition

**1. Across the barrier.** Flyback isolators use a single-transformer to transmit signals and power between the input and output. A power oscillator generates the flyback pulse that is modulated by input signals and demodulated in the output section.

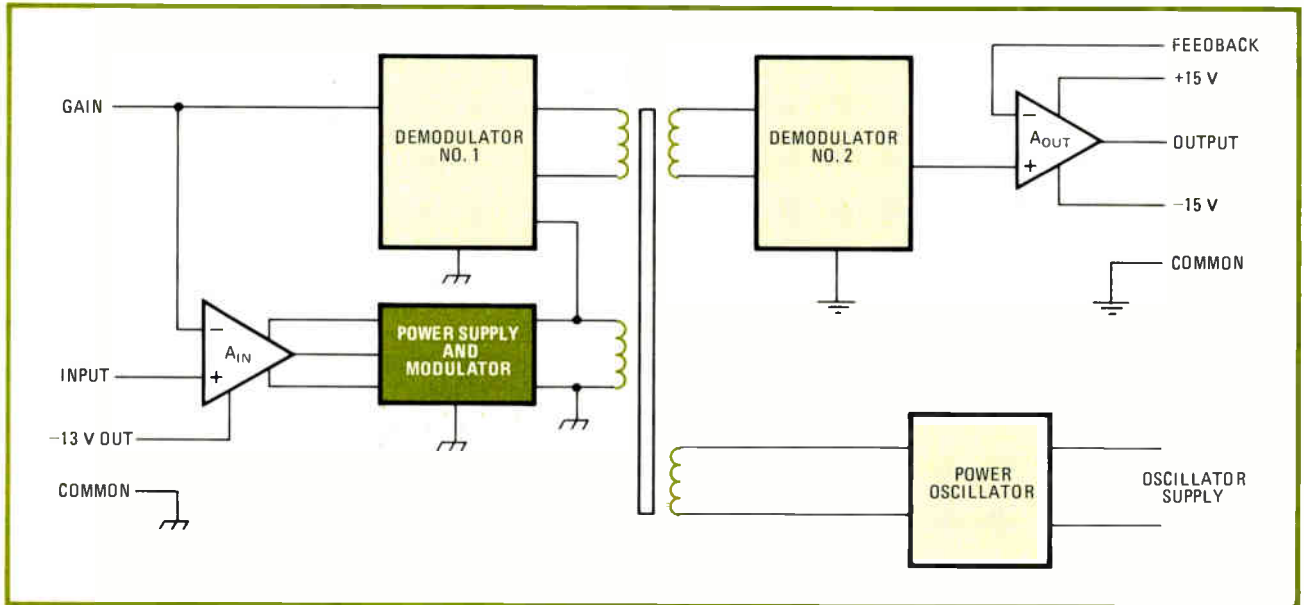

## Flyback isolators pose problems

A significant portion of the energy in a flyback pulse is at a much higher frequency than that of the isolator carrier. The ferrite core of the transformer is not the proper conduit for these signals, because the high-frequency properties of ferrites vary widely with temperature and applied and remanent magnetic fields, as well as from lot to lot. So, good transformer action at high frequencies must be obtained from the windings of the coils rather than from the core, which should be used merely to extend the low-frequency response.

Ideally, the primary and secondary windings of a transformer occupy the same space so that the flux lines of each one will envelop the other, giving excellent coupling over a wide bandwidth. In such a transformer, it is difficult to electrically insulate the primary from the secondary—the crucial step in constructing an isolation amplifier. There are at least four alternative winding methods that have been tried.

Multifilar windings couple well because the conductors of the different coils are wound together. But the conductors must be insulated to withstand, at any point along their length, the full potential across the isolation barrier. For high-voltage isolation, the large volume of insulation required makes such transformers unwieldy. Also, the close spacing of the conductors often makes the interwinding capacitance relatively high, thereby providing a

leakage path for ac signals across the isolation barrier.

Sector windings group many turns of each coil in sequence, allowing thicker insulation that reduces capacitance and enhances high voltage endurance. However, the turns of a sector winding act in concert to produce a toroidal flux that tends to close upon that sector more easily than upon others. This unfavorable property causes inferior coupling, as evidenced by the relatively large leakage reactance of sector-wound transformers.

Interleaved windings in which portions of different coils are alternately stacked maximize the ratio of mutual to leakage inductance. This compromise method provides reasonably low capacitance and high breakdown voltage—if care is taken to avoid mechanical stress at the jumpers between the winding segments. High cost detracts from this relatively complex solution.

Flat spirals—seldom found in small transformers—are often seen as tape windings in high-power applications. The coil pitch limits the number of turns per layer, which in turn limits the inductance attainable without complex interleaving. Although low-frequency response is poor in spiral-wound transformers, bandwidth is excellent. In this respect, in fact, stacked spirals are similar to wound multiple transmission lines. The AD293/4 capitalizes on fabrication advances that make it possible to lay down finely pitched flat spirals in a thick film.

to give a stable, highly reproducible structure. Their low profile keeps the height of the finished hybrid package to a maximum of 0.375 inch, consistent with the standard 0.4-in. clearance between printed-circuit boards and test equipment. A durable ceramic substrate supports the transformer and insulates it from other circuit components. The ferrite E-I core set extends the transformer's low-frequency response. What is more, it gives a smooth flat surface for attaching the transformer to the main isolator substrate.

The wide transformer bandwidth so important for flyback isolators demands closely spaced coils that are often difficult to insulate. Careful design of the AD293/4's critical insulation system ensures that the planar windings perform reliably at high voltages. The spirals' flat profiles allow exposed conductors to be separated by up to 0.5 in. (12.7 millimeters), reducing the risk of breakdown along the outside edges of the insulating material. These regions are most vulnerable because they may be exposed to contaminants.

Each group of three windings that makes up the input and output sections is sandwiched between ceramic layers that are bonded together with a dielectric. Excluding air from this assembly prevents corona breakdown that can easily occur in voids between the insulating layers and lead to catastrophic failure. Thick-film processing itself promotes high-voltage endurance, because it does not produce sharp points or irregularities in the conductor or insulator patterns that could localize destructively large electric fields.

A significant layout challenge is attaining a large value of inductance in the limited space available. As a result, the winding's spiral must have a fine pitch, increasing the chances of short-circuited coils. A line width of 5 mils (127 micrometers) and a line spacing of 7 mils (178  $\mu\text{m}$ ) make a fair compromise between inductance and yield, and so these dimensions were selected for the AD293/4.

Gold is the traditional thick-film material of choice for reliable, low-resistance conductors, but recent price escalations dictate its elimination except where absolutely necessary. Thick-film copper conductors in the recent past were plagued by interdiffusion, delamination, and blistering, but newer compositions overcome these problems. Their surface conductivity of 2.4 milliohms per square (corresponding to a bulk conductivity of  $2.9 \times 10^{-6}$  ohm-centimeter) is low enough so that only a single layer is needed for each winding. Since copper can be deposited with fine resolution, the yield is not degraded.

### Material progress

In this novel winding construction (Fig. 2), metal and dielectric layers are sequentially printed, dried, and fired using conventional thick-film techniques. Layers  $M_1$ ,  $M_2$ , and  $M_3$  are three separate input coils of eight turns each. Layer  $M_4$  returns the inner end of each coil to a corresponding pad on the outer edge of the substrate.

Two identical substrates arranged back to back constitute the input and output winding sections of the transformer. The alumina ceramic substrates



**2. Flat out.** Conventional thick-film processing gives the spiral windings shown from above (a) and in cross section (b). To make room for eight turns the coil pitch is squeezed down to 12 mils. Sequential printing and firing builds up the conductor layers.

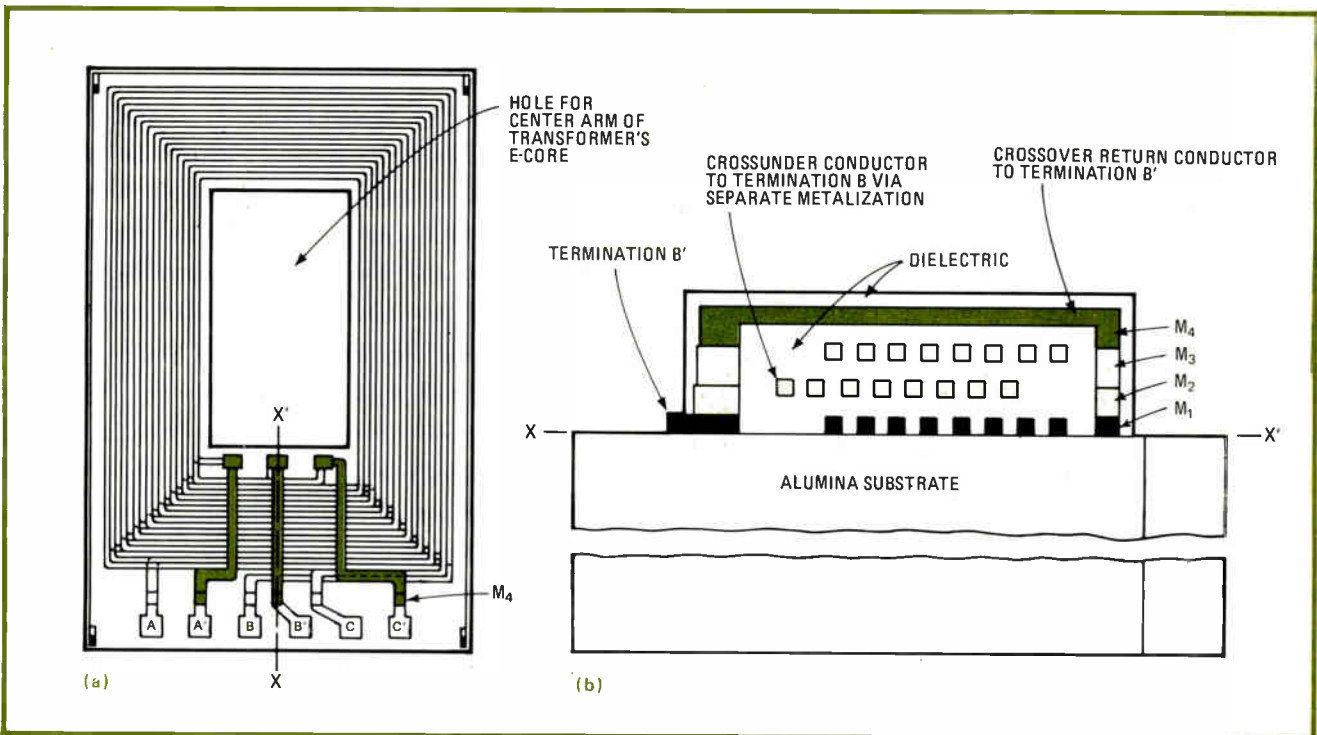



provide dimensional separation on top of a high-temperature dielectric so that the transformer exceeds its voltage-breakdown requirements and is compatible with high-temperature processing.

The number and correct placement of turns can significantly affect the electrical properties of a transformer. The inherent variability of these two factors in conventionally wound transformers often degrades their transfer characteristics and high-voltage endurance. The thick-film deposition process increases the uniformity of the turns, as well as allowing mass production of the transformer.

### Transformer production

The uniformity of the coil fabrication process eliminates the need for traditional turns testing during and after manufacture—a simple functional check suffices as the final test. A “printing-press”

approach that processes eight transformer segments on one substrate dramatically raises fabrication throughput by increasing the printing rate and reducing handling through the drying and firing cycles. Following visual inspection and electrical testing, the individual segments are separated along score lines.

To connect the completed transformer in the amplifier circuit requires a bonding method as reliable as the component itself, as opposed to traditional termination schemes that utilize staking, pin-swaging, or soldering. A hard look at those techniques uncovers many pitfalls. For example, insulation stripping typically involves dipping the wire ends in a solder pot at 260° to 370°C. The ends of fine wires often become brittle or disappear in the molten solder. Even worse, carbonized deposits remain and jeopardize high-voltage performance.

**3. Broadband.** The tight coil geometry of the thick-film windings leads naturally to extended high-frequency response. The amplifier bandwidth is limited by the oscillator carrier frequency, which must fall within the transformer's passband.

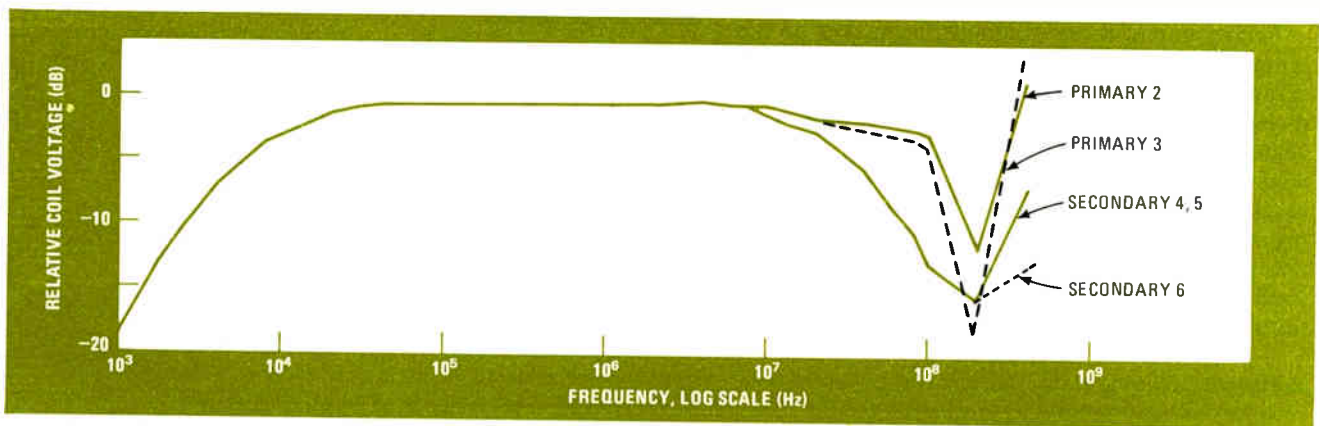

## Magnetic isolators still better for analog signals

Isolation amplifiers, which provide no electrical connection between their input and output circuits, have exceptionally high common-mode rejection and typically can withstand thousands of volts across their insulating barriers. Industrial process controllers, precision data-acquisition systems, and cardiac monitors are their principal applications.

Both optical and magnetic couplings are commonly used in these units to transmit the signals across the barrier. In optical isolators, the input signal modulates the output intensity of one or more light-emitting diodes, whose outputs are directed at photodiodes across the barrier. Because of the relatively poor aging characteristics of the optical components and the unpredictable propagation delay across the barrier, these isolators are better suited to digital applications where gain stability and amplifier accuracy are not critical.

The simplest magnetically coupled isolators use a single transformer to transmit signals and power between the input and output circuits. Sharing of the transformer is accomplished by periodically charging it with a brief current pulse and then using feedback control in the input section to force the flyback voltage to track the input. The stability and reproducibility of the magnetic components

are generally better than those of optical parts, leading to better dc performance. The cost of magnetic components is not necessarily a disadvantage, since optical isolators almost always require magnetic couplings in order to transmit power to the input circuits.

In two-transformer isolators, an amplitude-modulated carrier couples signals through one transformer. The same carrier, unmodulated, is applied to the second transformer to power the input section. Separating these two functions gives the designer the flexibility to optimize the signal path for accurate dc performance, but it does increase the cost of the amplifier [*Electronics*, July 3, 1980, p. 151].

Since all types of magnetic isolators have an output ripple at the carrier frequency that must be filtered, their bandwidth is limited to well under the carrier frequency, which itself must fall within the transformer's passband—amplifier bandwidth is usually around 20 kilohertz at most. Optical isolators have comparable limitations, due to the response time of the photodiodes and the need for an optical feedback path to maintain gain stability. For the present, then, magnetic isolators are preferred in demanding analog applications because they give better dc performance at comparable cost.

**-Roderic Beresford**

Alternatively, transformers are fitted with expensive preformed headers containing terminals in order to facilitate system assembly. A skilled operator is required to place strain-relief loops in each wire, attach them to a post, and solder the joint. Dangers abound in this process—the hot soldering iron often touches neighboring wires, destroying their insulation. Solder balls, carbonized flux, and cold solder joints impair long-term reliability. Fine wires often are unable to handle the stress imposed by the final encapsulation that may be added to improve the voltage rating of the transformer.

### A different approach

The termination method in the AD293/4's transformer is a radical departure from the traditional and avoids all of the problems of the conventional approaches. Soldered-on edge clips or connectors with a 50-mil spacing for a dual in-line package are used for joining the transformer input/output pads to the device substrate.

The lead frame is first attached to the transformer substrate using solder paste and a vapor-phase reflow machine. This technique is a precisely controlled and well-ordered mass-termination process occurring in an inert atmosphere that prevents flux charring. A simple cleaning step removes all contaminants after soldering. The free ends of the transformer leads can then be attached to the parent substrate with a conductive epoxy, or they can be soldered to the metalized pads.

The thick-film spiral with its mechanically ordered termination system is a rugged, reproducible component. Since completion of the transformer is independent of parent substrate fabrication, testing before final assembly of the hybrid is simple—and salvage of the transformer or the parent substrate is possible, significantly improving the yield. The structure is amenable to encapsulation that enhances its mechanical and high-voltage endurance and also allows its use as a discrete component in other devices needing its excellent wideband characteristics.

### Broadband response

The superior frequency response of the hybrid transformer is evident in Fig. 3, which shows the transfer characteristics for the various windings from 1 kilohertz to 400 megahertz. In this test, a signal is applied to one of the transformer's primary windings, and the other five coils are shunted by 300- $\Omega$  load resistors. The coupling is nearly ideal up to 20 MHz and the low-frequency response extends to around 10 kHz.

The excellent performance of the transformer in the flyback isolator is apparent in the oscilloscope trace of Fig. 4, which shows two periods of the isolator carrier's waveform. The power oscillator provides the high-frequency square wave at the beginning of the period, and the input voltage controls the level of the flyback pulse that follows.

Although the carrier's fundamental frequency is 200 kHz, much of the energy in the power pulses is at several megahertz and above, so that the hybrid transformer's wide bandwidth is necessary.

Not only does the transformer meet its design specifications, but prototype isolators incorporating it exceed their most important design goals (see table). Superior isolation is evidenced by the maximum common-mode voltage rating of greater than 2.5 kilovolts and the common-mode rejection ratio of nearly 120 decibels. The AD294 has a slightly thicker transformer substrate than the 293, allowing it to withstand 8 kv of common-mode voltage. The amplifier's excellent dc characteristics—low nonlinearity and temperature drift of the gain and offset voltage—will satisfy demanding data-acquisition system applications. □

**4. On the job.** The thick-film transformer is put to the test in the AD293/4 amplifier. Coils are energized briefly by the power oscillator (square wave), which is then switched off. The isolator's input controls the level of the flyback pulse that follows and is coupled to the output section.

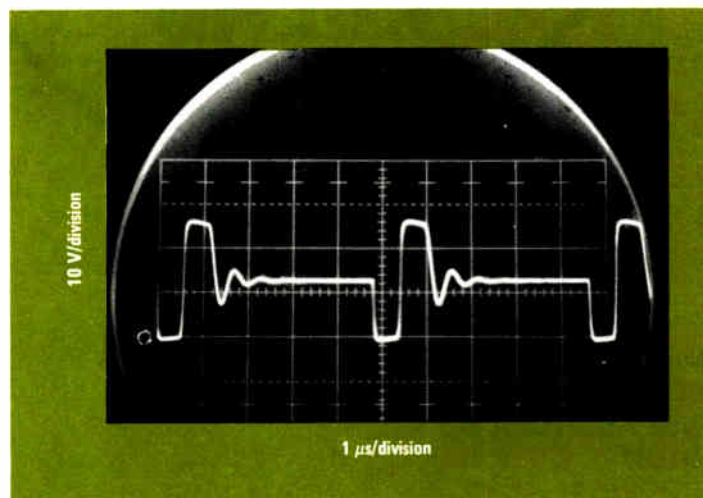

PERFORMANCE DATA FOR THE AD293 HYBRID ISOLATION AMPLIFIER

	Design goal	Prototype result
Gain range, G	1 – 100	1 – 1,000
Minimum rated output voltage	±10 V	±10 V
Small-signal frequency response G = 1 G = 1,000	2.5 kHz —	3.3 kHz 2.2 kHz
Output nonlinearity, G = 1, +5-V input	±0.035%	±0.006%
Maximum peak common-mode voltage, 1-min duration	2,500 V	> 2,500 V
Common-mode rejection ratio, G = 100, 1-k $\Omega$ balanced source resistance	115 dB	119 dB
Input offset voltage at +25°C	—	±0.4 ±7/G mV
Offset voltage temperature coefficient, –25° to +85°C	150 $\mu$ V/°C	75 $\mu$ V/°C
Gain temperature coefficient, G = 1, –25° to +85°C	±50 ppm/°C	±7 ppm/°C



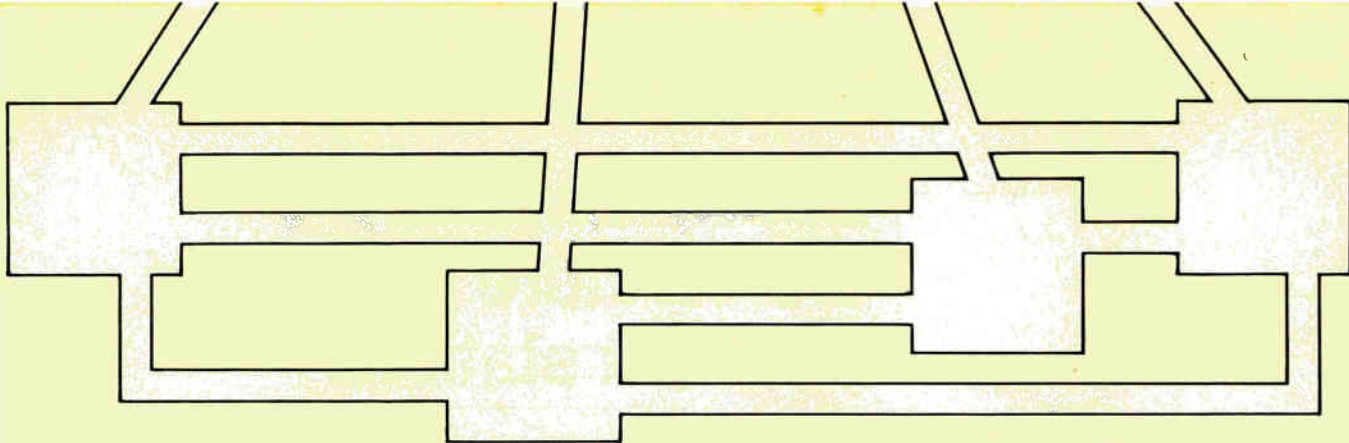

# LOCAL NETWORKS TAKE TO THE FACTORY AND THE OFFICE

Diverse network schemes link personal computers, mainframes, mass storage, and many types of equipment

by Harvey J. Hindin, *Communications & Microwave Editor*  
and Tom Manuel, *Computers & Peripherals Editor*

□ Local networks have been part and parcel of distributed data-processing systems for some years. Lately, however, they have attracted a lot more attention because of the important role they are playing in integrating the many new computer-based tools intended for factory and office automation.

In the past year alone, many have entered the marketplace. Not bound by any one architecture, they range from low-cost networks for personal computers to very fast, high-volume links for mainframe units.

Some networks are proprietary and interconnect products from only one vendor. These include IBM Corp.'s Systems Network Architecture and the Series/1 Local Communications Controller, Datapoint Corp.'s ARC network, Prime Computer Corp.'s Primenet, and Digital Equipment Corp.'s DECnet.

Other local networks promise to be more flexible and, to varying degrees, can accommodate products from a variety of vendors. Some of these have been described in *Electronics*, including the Net/One from Ungermann-Bass Inc., the Z-Net from Zilog Inc., the Cluster/One Model A network from Nestar Systems Inc., and a network design from Motorola (see the issues of Sept. 25, 1980, p. 114; Feb. 10, 1981, p. 149; June 16, 1981, pp. 171 and 176). In the following articles, Corvus Systems Inc. introduces its Omninet, and Intel Corp. proposes a six-layer local network standard in which the first two layers equal the entire Ethernet scheme.

Perhaps the key area of application for these networks will be the office. In its report, "Advanced Local Networks," the Yankee Group, a Cambridge, Mass., consulting firm states, "It is clear that the local network will be a market imperative for office automation vendors within the next two years" since their ability to commu-

nicate will be the most important new feature of future office systems.

Yet there is an alternative to the local network that could win out, says Ken Bosomworth, president of the well-known data-communications consulting firm, International Resources Development of Norwalk, Conn. Private branch exchanges capable of handling both data and voice were introduced at a rapid rate throughout last year [*Electronics* April 7, p. 139], and existing voice PBXs can easily be updated with data add-ons. So it is this equipment, with its already installed networks, that will shape the office of the future, argues Bosomworth.

Industry experts do agree, however, that local networks will take as many forms as users require. Probably no single product can hope to dominate the market because of the diversity of user needs; but an astute vendor may win a profitable market share.

To achieve this, manufacturers will have to produce a low-cost local network capable of handling high-level languages and equipped with sophisticated operating systems, inexpensive mass storage, and the kind of high-performance communication facilities that allow data and expensive peripherals to be shared among many inexpensive terminals. Such a setup should have large-bandwidth communication to serve workstations separated by thousands of feet, should be easy to expand, and should be able to incorporate many different machine types. The failure of one component should not affect the operation of others, and finally, the system should be easily hooked up to remote local networks.

All this has not yet happened, of course. But the articles following indicate that vendors are attempting to meet these criteria in order to market local networks that can serve a broad spectrum of users.



# Local network architecture proposed for work stations

---

General-purpose standard compatible with Ethernet will serve many applications at a wide range of performance levels

---

by Robert Ryan, George Marshall, Robert Beach,  
and Steve Kerman, *Intel Corp., Santa Clara, Calif.*

□ Computer-based communicating work stations and microprocessor development systems, which promise to usher in an era of electronic offices and workplaces, will need to be attached to local networks through a standardized architecture in order to be cost-effective. In response to the lack of such a standard, Intel has come up with a local network architecture that is currently geared to work stations and development systems based on Intel microprocessors. Called iLNA, the proposed network takes advantage of the work already done in association with Digital Equipment Corp. and Xerox Corp. by using the Ethernet local network design as the basis for its own data-carrying scheme.

What has been proposed is a six-layer architecture combining software and hardware that will expedite all local network functions. Its goal is simply efficient, flexible communication between users and application programs, application programs and resources, and any other combination of users, programs, and resources within the local network.

The concept of a layered architecture is not new. Indeed, IBM's well-known Systems Network Architecture is layered, as is the forthcoming International Standards Organization and American National Institute Reference Model of Open Systems Interconnection. What is new is the fact that a network architecture has been specifically designed for Intel- and Ethernet-based equipment (see "Specifying the network," p. 122). If eventually accepted as an industry standard, the proposal will become the basis for future network architectures, and manufacturers of equipment that hooks up to local networks will want their equipment to be compatible.

In developing a local network architecture, the primary goal has to be achieving cost-competitiveness with any general-purpose network design, while at the same time equaling the efficiency and performance of a network designed for a specific application. Likewise, the network has to facilitate communication through commonly used interfaces but not be bound by any one topology or internal communication mechanism. In addition, it has to function independently of any particular computer's operating system or hardware.

The network also has to act as an error-free message-

delivery medium between communication processes (programs resident in equipment attached to the network) and permit an operator or program to monitor, maintain, and modify network operations. While performing all these chores, the network must also be able to serve low-cost, low-performance equipment and incorporate future technology. In addition, the failure of any device at a work station should have minimal effect on the operation of other work stations.

To perform all these tasks, the Intel network architecture defines a set of interfaces, algorithms, and protocols by which application programs on various kinds of Intel microprocessor-based work stations can communicate. It also establishes a process-to-process communication mechanism whereby a process (any application, function, or peripheral using the network) is defined as the active element in a communicating node and the ultimate source or destination for data. Thus, for example, terminals, files, and input/output devices can communicate with one another through the use of processes. Messages are sent and received by the designated processes through what is termed a communications socket, which is a hierarchical address composed of three unique identifiers—one each for the local network, the host, and the port to a process.

Each node in the network, which may consist of one or more pieces of equipment, has a unique host identifier that distinguishes it from all other nodes installed anywhere, to ensure eventual communications between equipment on various local networks. Within each node, each process is given a local address, or port identifier. The binding of ports to processes is the responsibility of the node, and the ports remain unique within each node. Certain ports, however, may be assigned numbers in accordance with a globally consistent scheme.

Each installed local network will be given a unique identifier, its network identifier, that identifies it in multiple-network applications. In a single-network application, the network identifier is not used, but its assignment assures that an orderly progression to an internetworking environment is possible.

In designing its architecture, Intel examined applications needs of its users and chose a suitable set of



interconnect functions to serve them. These functions were then defined in a series of layers that permit the network to achieve high performance across a wide applications base. The architecture is divided into six layers (Fig. 1). The ones of interest here are the physical-link, data-link, transport, session, and network-management layers. The network layer is used when one local network must be connected to another.

The lowest-level means of sending data from one node to another, the physical-link layer, is responsible for delivering the smallest unit of data (the bit) the network handles. This layer is the one directly concerned with the transmission medium, signal type, data rate, and mechanical interconnect specifications of the network. It can be implemented using two modems, two telephone sets, and a telephone line or using coaxial cable, a baseband line driver, receiver chips, and a universal synchronous-asynchronous receiver-transmitter (Usart).

### Moving from node to node

While the physical link moves data bits from one node to another, it cannot guarantee successful transmission. Electrical noise in the environment causes errors, although some transmission media are less susceptible than others. For example, the error rates generally run between 1 bit-error per 10,000 bits and 1 bit-error per 100,000 bits for transmissions over a modem-telephone network, but can be less than 1 bit in 10 million for local coaxial-cable-based networks.

Error rates can be kept quite low at the physical link level if the network designer is willing to properly locate and shield the network cabling from rf interference by other electrical utilities in, say, a building. However, the higher-level layers are a better place to reduce errors because they can exploit such multiple-bit schemes as redundancy codes and automatic repeat requests that are not available at the physical link level.

In the Ethernet physical link, data is transmitted on a 50-ohm coaxial cable that is up to 500 meters long per segment. The Manchester-encoded, baseband signal carries data at a rate of 10 megabits per second. At the start of a transmission, a 64-bit preamble is used to stabilize and synchronize the communication channel circuitry. After reception, the preamble is removed and only the Ethernet header and data are passed on.

### Packet-delivery service

The data-link layer makes possible a node-to-node packet delivery service. As such, it is the first step toward a process-to-process packet delivery system. The data link supplies some of the services missing from the physical link. Among others, it is responsible for framing, or the determination of where a message begins and ends; addressing, or the determination of which station should receive a message; error detection, or the determination of bit errors in the packet; and link management, which controls the access of multiple transmitters and receivers to the physical link.

A data link may deliver all the packets error-free by using various error-correcting protocols. Or it may provide, as the Ethernet data-link architecture does, a best-effort delivery service in which not all packets are deliv-

ered, but all those that are, arrive unmodified. With error-free packet delivery all packets are delivered (no lost packets), all packets are delivered just once (no duplicate packets), and all packets are received in the order sent (no nonsequential packets). However, when error-free packet delivery is required, data-link error control is necessary to perform packet sequencing and retransmission. In addition, besides having the higher-level error-coding alternatives previously noted, data-link error control also is expensive and, given the physical-link error rates, not cost-effective.

Data-link error control might provide a reliable node-

**1. Layers.** In the Intel local-network architecture, there are six levels of hardware and software, with the network layer omitted in strictly local (non-store-and-forward) configurations. The physical link and data link contain hardware; the others only software.

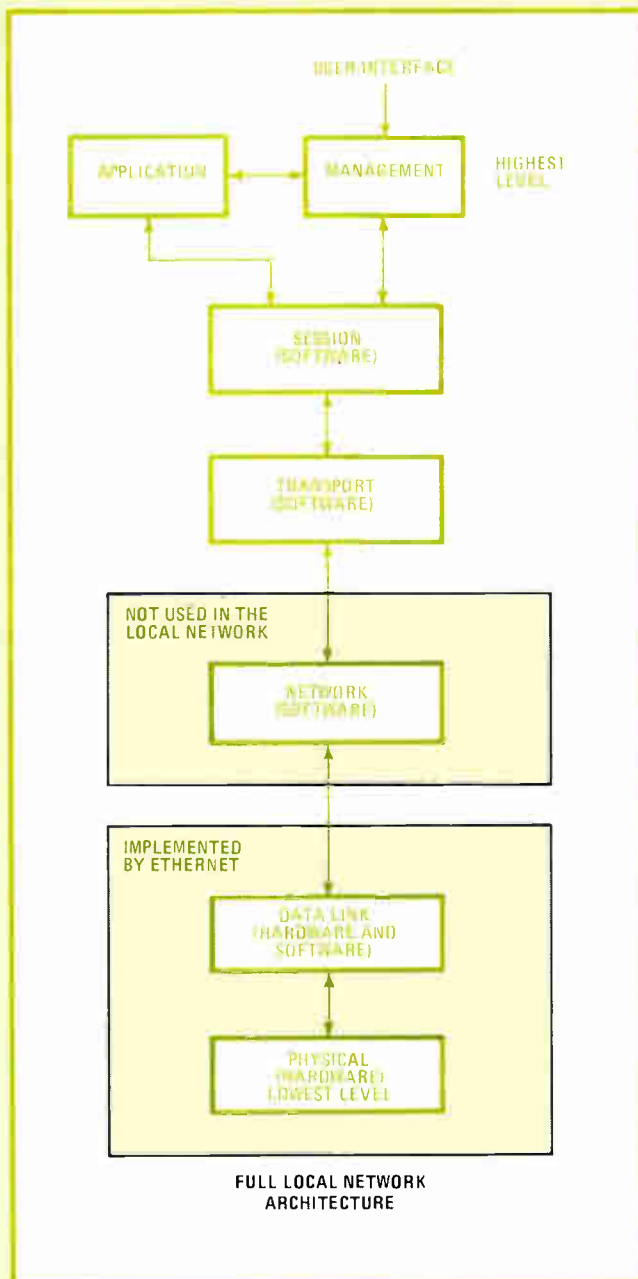

---

## Specifying the network

The Digital Equipment-Intel-Xerox specification for the Ethernet network is the first portion of Intel's forthcoming local network architecture, and the first hardware produced for this architecture will be the Ethernet intelligent controller. The two-board set, which plugs into an Intel Multibus chassis, supplies many of the functions of the physical- and data-link layers of the network architecture.

The data-link functions performed are framing (including packet-boundary delineation and address recognition), link management (including transmission scheduling and retries in case of a collision between packets), and error detection. The physical-link functions performed are preamble generation and removal and bit encoding and decoding. The set also handles a number of system-oriented functions, such as interfacing with the system parallel bus, communicating with the central processing unit, handling data movement to and from the buffers, and

interfacing with the transmitter-receiver units.

The board hardware consists of an Intel 8086 5-megahertz microprocessor with local random-access and read-only memory, direct-memory-access channels for sending and receiving data at the required 10 megabits per second, bit-serial send-and-receive logic, packet address-recognition logic, error detection logic, and interval timers. One board contains the microprocessor, memory, timers and DMA control; the other contains the serial send-and-receive and error-detection logic.

The boards implement part of the data-link layer and also contain seven major software functions. These include the executive (or scheduler), the rest of the data-link software, transport control, session control, network management, the bootstrap, and diagnostics. Typically these software functions are implemented with programs that occupy small amounts of memory space.

---

to-node delivery service, but it does not ensure a reliable end-process-to-end-process delivery service. That is particularly true in any internetworking environment where two or more local networks are connected and there are multiple gateways (the physical and software connections) acting as packet forwarders. The risk of packet nondelivery then is moderate to high. In addition, end-to-end delivery retransmission (error control) would still have to be performed at the transport layer, making error control at the data-link layer redundant.

### Collision insurance

The data-link software supports a large address space—up to a 48-bit destination identifier and a 48-bit source identifier—to permit flexibility in managing internetwork gateways. In operation, data-link users must supply both transmit requests and standby receive-buffers to the network. The transmit requests contain the address of the destination nodes and the data to be sent. The data link combines both into a packet that is transmitted when the line becomes idle.

Should multiple nodes transmit concurrently, they all abort their transmissions, generate a jam signal that reinforces the initial collision signal, wait a random interval before retransmission to avoid repeated collisions, and then try again. The average retransmission interval increases as a function of channel load in order to achieve channel stability under overload conditions.

On the receiving side, the intended packets are recognized by the data link, which performs a 32-bit cyclic redundancy check. If the packet is good, it is placed in an empty receive buffer. A packet that has collided is recognized as such and dropped.

As noted earlier, the data link supports framing, addressing, error detection, and link management. In the Intel Ethernet approach to framing, a carrier-sense function determines the end of a packet. When the carrier is lost, the packet is finished. The two-bit beginning-of-packet indicator at the end of the preamble actuates carrier sensing.

The address scheme permits a received packet to be accepted by any number of nodes. The data link recog-

nizes single-host, broadcast, and multicast addresses. The first bit within the destination address distinguishes between single-host and multicast delivery, and the next 47 bits determine the multicast group identifier. Broadcast addressing is simply a special case of multicast in which the next 47 bits are all logical 1s.

The link management function controls line access when two or more nodes attempt to transmit data simultaneously through an arbitration policy called carrier-sense multiple access with collision detection. With this system, when a packet is to be sent, the link management facility determines if another carrier is present. If this is so, or if the interpacket gap time has not expired, the waiting packet is not released onto the line. When the data packet is finally transmitted, the link management function monitors the line to determine whether a collision has occurred. If a collision is detected, the random waiting period for retransmitting the packet is chosen by executing what is known as a truncated binary exponential back-off algorithm.

### Reliable transport

The transport layer software (there is no hardware in this layer) makes possible location-independent, reliable packet transmission. Users of this layer can establish, maintain, and terminate virtual circuits, which represent full-duplex data paths between sockets.

A virtual circuit is defined by its basic properties. First, it permits multiple virtual connections to exist between processes. Second, it can be dynamically managed by the communicating processes. Third, it can accommodate message lengths that are independent of transport communication. Finally, it transmits data in a full-duplex error-controlled and flow-controlled format.

While the data-link layer makes a best-effort attempt to move individual packets from one physical node to another, the transport layer is responsible for reliably moving a user's variable-length message, such as a file transfer, from one process to another, even though the underlying packet delivery service will occasionally drop packets, duplicate packets, or deliver them out of order. A secondary responsibility of the transport layer is to

**2. Extensions.** The six-layer local network architecture can be extended to include remote network configurations by simply adding the network layer and the new data links. These new configurations can be co-located or geographically dispersed.

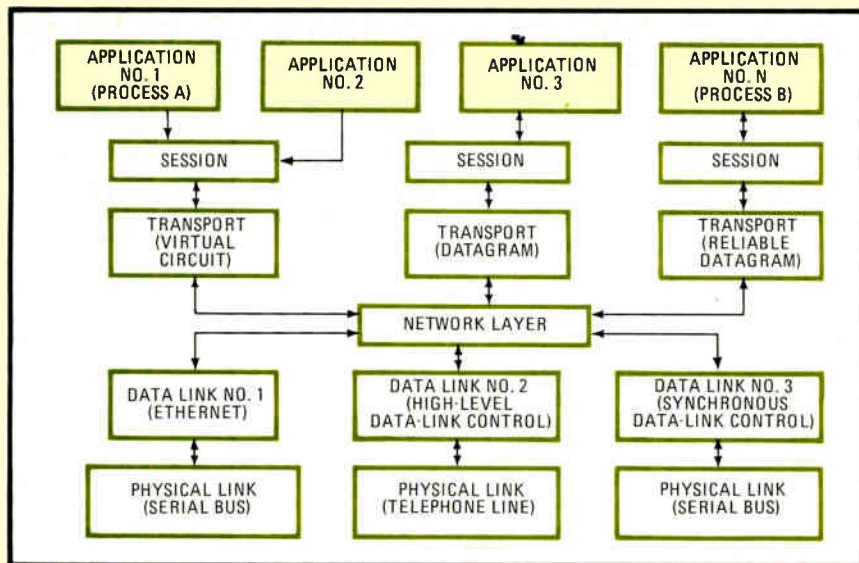

prevent fast transmitters from swamping slow receivers. It also must ensure that the network's communication subsystem resources (primarily media bandwidth, communications processor usage, and communications buffer memory) not be wasted in frequently retransmitting packets when there is a speed mismatch. Both are accomplished by a flow control function that throttles fast transmitters when the receiver cannot keep pace.

The transport software serves several other functions as well. Since the transport layer should insulate user software from the limiting characteristics of the underlying physical network, it performs fragmentation and reassembly services that let the user software send arbitrarily long messages over the network. To accomplish this, the transmitting transport software breaks messages into packet-sized chunks and the receiving software then reassembles them.

### Acknowledge and over

In order to provide its services, the transport software carefully manages the user's service requests and the packets exchanged on the data link. For example, the transport software associates a unique sequence number with every packet it sends. Likewise, the receiving transport software sends back acknowledgment packets, indicating with the sequence number which packets have been correctly received and accepted. Packets not acknowledged within a specified time are automatically retransmitted by the sender.

The transport software controls the data flow by exchanging information on the amount of receive-buffer memory that each claims to have available. The amount of buffer memory available is called a window, and a receiver that has indicated it has a large amount of receive buffer space is said to have its window wide open.

### Open window

If the transmitter has several data packets, they will be delivered much faster if the receiver has sufficient buffer space and has opened its window than if the window is small and requires an exchange of window information after each packet is sent. To expedite the

information exchange, the transport software uses a combined error- and flow-control algorithm that permits both functions to work at the same time. For process-to-process addressing, the transport software adheres to the standard network-address structure, which consists of the network, host, and port identifiers.

The session control software layer identifies and locates process names within the network. In order to communicate, a process using the transport layer in one node must know the socket of other processes. Since, it is unlikely that the naming convention for processes under a given computer's operating system conforms with that used in another, the session layer resolves this problem through a location-independent scheme known as a binding function, which provides users with standard-format, location-independent names for remote processes they must access.

### Ties that bind

The binding function is composed of two operations—mapping and updating. Mapping is the function that, on demand from the user software, translates between process names and sockets. Updating distributes the mapping information throughout the network so that it is available when needed at each node.

The session software also supplies network status information to the application software. In turn, the transport software gives the session layer status information on its best estimate of the quality of the underlying network layers. However, the decision to abort a connection is left to the user for all but the most extreme cases, such as evidence of total equipment failure.

### Network management

The network-management software layer provides the user with all those functions not required for normal operation. In addition, it includes diagnostic utilities for accessing the network components when any portion of the network fails. It also has maintenance tools that gauge the performance of various network components so users can plan for changing network demand.

Network management functions fall into one of three

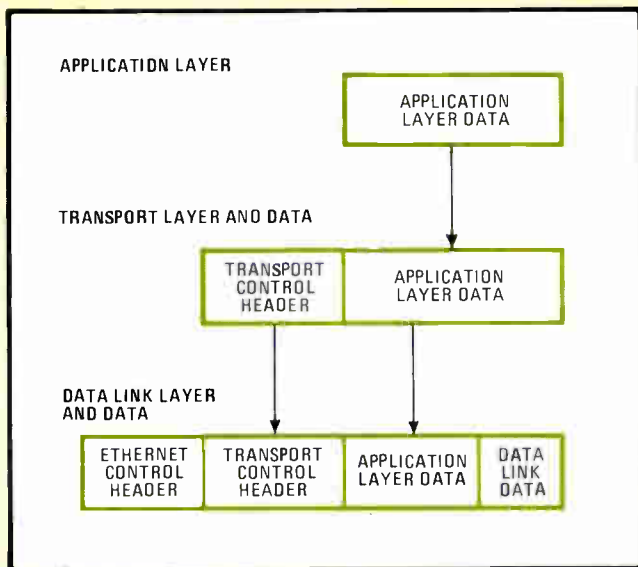

categories: operation, maintenance, or planning. The operation category includes all functions that are performed on a day-to-day basis as part of normal network operation. A major goal of the Intel network architecture has been eliminating the full-time network operator, and thus only the network bootstrap and the manual operations needed to add a new node to the network are included in the management layer.

The network bootstrap is the operational function used by a booting node to load its operating system from another network node. The bootstrap sequence begins when the booting node transmits a multicast packet addressed to any node that has a copy of the operating system and is willing to send it. If such a node exists on the local Ethernet data link, it will respond.

Should more than one node reply, the booting node will accept the first reply and ignore all others. If no reply is received, as would happen if either the request or reply is lost in the network because of line noise, the booting node will retransmit the request. If a reply still is not received after several retries, the bootstrap attempt will be aborted.

### Preventive maintenance

The maintenance category detects failures in the network, even though it may be uncertain of exactly what the problem may be. Problem detection proceeds through three mechanisms. The first is a set of error counters made possible by the management layer; the second is an error-reporting and -logging mechanism; and the third is user observation.

The first problem detection mechanisms, the error counters, are maintained by the individual layers and record occurrences of recoverable errors. The presence of errors does not necessarily indicate a failure in that the layers are designed to operate normally in the face of a large number of errors. An excessive number of errors, however, may indicate that a problem is developing.

Since this set of counters is maintained at each node in the network, and since the nodes can be spread over a large area, the network management layer includes a remote examination function for interrogating nodes

**3. Headers.** If two processes on two different local network nodes want to communicate, the session layer software establishes a virtual circuit between them. The transport- and data-link layers add headers for identification, addressing, and control.

without interfering with network operations. The network management layer in a node desiring information from a remote node first sends a request to the network management layer in the remote node. The management layer in that remote node then performs the desired function and transmits a response to the requesting node.

### Isolating errors

The error-counting mechanism is supplemented by an error-reporting mechanism that logs problems detected by the communication system to an error-logging file. Once a problem has been detected, it is isolated to some serviceable component through two mechanisms. First, the same error counters are used to isolate the error. Second, the management layer generates test traffic, including a loopback function within each layer, and observes the behavior of the system.

Generally, correcting the problem involves repairing or replacing hardware. Some problems, however, can be corrected simply by reinitializing a system component. In that case, the management layer can stop and reinitialize each layer.

In its planning function, the management layer supplies the network administrator with statistical information about the use of the network to help in planning network growth.

### By way of example

To illustrate the operation of the software and hardware layers with a practical example, consider a case in which there are two processes, A and B, that reside on two different nodes (Fig 2). Application process A's request to communicate with process B on some remote node requires the cooperation of the communication layers of each node.

The source node's session layer first determines that process B resides at socket n, thus pinpointing process B to a specific port residing in a specific node on a specific network through the port identifier. By means of the transport interface, the session layer then attempts to create a virtual circuit between the source port and the destination port. Assuming there are no conflicts on the network, the virtual circuit is established after the two transport-layer sites exchange connection information.

The two processes can now send or receive over the virtual circuit so that data can be delivered in order, unmodified, and without duplication. The transport layer adds a transport header that includes the virtual circuit identifier and a sequence number to each piece of data it handles. It then passes the data, transport header, and application data to the Ethernet data link.

The data link adds its header (Fig. 3), consisting of the address (destination and source identifiers), framing, and error-detection bits, and it then attempts to transmit the packet. Once the data-link has established the carrier signal, the physical link is responsible for the transmission of the bits over the serial link. □

# Network minimizes overhead of small computers

A two-wire cable and a microprocessor-based interface board direct all the traffic in a low-cost 1-Mb/s local network

by Mark Hahn and Phil Belanger, *Corvus Systems Inc., San Jose, Calif.*

□ Personal computers can approach their full potential in business applications only when they are tied into a local network. Such a network satisfies the need for efficient communications by enabling a collection of inexpensive computers to share not only data but also expensive peripheral equipment.

The Omninet local network from Corvus Systems connects many popular personal computers and mini-computers, from the Apple II to the LSI-11, using simple twisted-pair cable and a correspondingly simple network interface board (Fig. 1). The intelligent network interface, called a transporter, contains processors and software that eliminate the need for a complex cable and sophisticated network software in the host computer. The result of all this is a low-cost, durable, heavy-duty network operating in the medium-speed area of 1 megabit per second.

As many as 64 computers or peripheral devices, each

with a transporter installed, can be supported on a network of up to 4,000 feet (1.2 kilometers) of twisted-pair cable meeting the RS-422 standard. No repeaters are required on networks of up to 2,000 feet of unshielded cable or 1,000 feet of shielded cable.

The transporter in each node manages the network for that node, thus serving as the common network interface for all nodes. Every transporter is the same except for a small part of its circuitry for interfacing with a particular host. No master network controller is required, as the individual transporters supply all the control needed for the chosen distributed network control scheme, known as carrier-sense multiple access (CSMA).

In addition, to reduce the burden on the host, the transporter performs many high-level network tasks that are often the responsibility of the host computer in other networks. Generating and receiving acknowledgments, retransmitting messages, and detecting duplicate mes-

**1. All hooked together.** A typical Omninet network may contain several personal computers and a disk drive or two, and in the future it will be able to add printers and modems for dial-up access by terminals and interconnection with other networks.

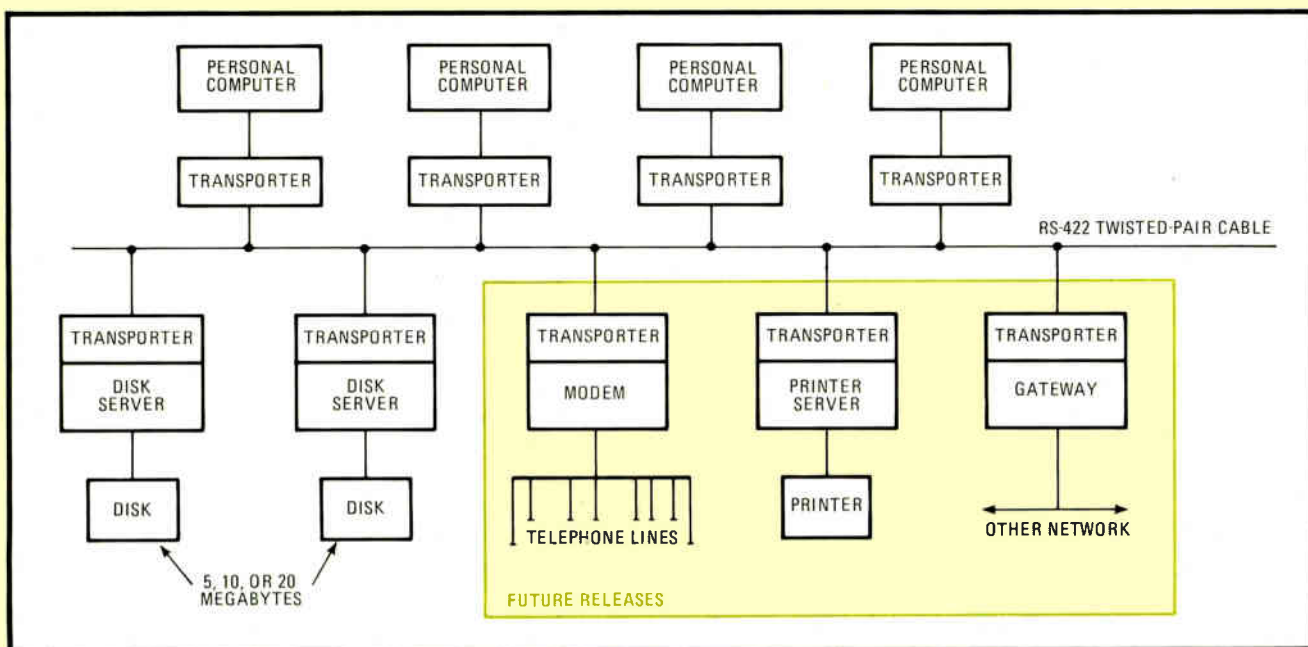

sages all are performed automatically by the transporter. A host computer sends messages by issuing a simple command and is not disturbed by the network transporter until a valid message arrives.

### Heart of the net

The transporter implements the network protocol for the first four layers, or levels, of the International Standards Organization and American National Standards Institute's Reference Model of Open Systems Interconnection—that is, through the transport layer (Fig. 2). Hence the name, "transporter."

The transporter fundamentally consists of nine integrated circuits (Fig. 3). The basic design uses an interface for directly accessing the memory of a host computer (DMA) that can be adapted for almost any processor bus with a minimal amount of additional hardware. For example, the Apple II computer can be accommodated by adding only five ICs to the basic transporter.

A gate array customized for the Omninet transporter—one of three main chips—controls the interface between the transporter and the host computer's bus or a peripheral device. This control logic requires no buffering of data in the transporter—it can access the host computer's memory directly with a 24-bit address. It also controls the RS-422 driver and receiver circuits—the network transceiver.

Secondly, a Motorola MC6854 Advanced Data-Link Controller (ADLC) is the low-level network interface with the cable. The chip performs many of the functions of the data-link layer, including bit serialization; cyclic-redundancy-code generation and checking; packet framing; 3-byte first-in, first-out buffering; and implementation of the bit-level protocol, which uses nonreturn-to-zero inverted encoding. Zero insertion is also performed whenever the bit stream contains more than five 1s together.

A Motorola MC6801 single-chip microcomputer oversees the two interfaces and manages the conversion and transfer of data and control information between the host computer or peripheral device and the network. The 6801 is a 6800 microcomputer with expanded instructions, 2-K bytes of read-only memory, 128 bytes of random-access memory, 27 input/output pins, and a timer and counter, plus other features.

### Complete control

The DMA interface is unusual in that each cycle is explicitly invoked by a 6801 instruction. When instructed, the gate array stops the 6801 processor's clock until a memory access of the host is completed. Through this feature, the transporter's software has complete control of the transfer of data between the transporter and the host computer.

With this kind of control, two DMA cycles, one right after the other, can be completely unrelated with respect to their location in the host memory. This capability, in

**2. Seven-layer cake.** The layered reference model of the International Standards Organization and the American National Standards Institute divides local network functions into seven hierarchical layers, or modules. Omninet implements the four lowest layers.

turn, makes possible the implementation of packet splitting and demultiplexing. An example of the 6801 software code for DMA reading and writing between the transporter and the host is shown on page 128.

The RS-422, or physical-layer, protocol, governed by the gate array, uses no carrier signal. However, a function in the Advanced Data-Link Controller, operated at the data-link layer, can tell if there has been a transition on the cable, or in other words, activity on the net. Omninet defines activity on the net as its carrier signal.

Carrier sensing takes place twice. When the ADLC senses that there has been no activity for 15 microseconds, it tells the software in the microcomputer that it may proceed with a transmission. The software then instructs the interface control logic to start a transmission. Because considerable time elapses during the execution of the software instructions—about 35  $\mu$ s since the ADLC has reported no activity—a second level of carrier sensing is invoked. Special high-speed logic designed into the gate array makes a last-nanosecond decision by checking the network activity again before sending data out on the cable. If there has been no activity since the previous check, it proceeds with the transfer; if there has been activity, it aborts the transfer and tells the software that it must wait and try again.

### Stopping collisions

With the two levels of carrier-sensing hardware and the collision-avoidance software, collisions—two or more stations trying to transmit at the same time—are almost always avoided. Consequently, Omninet operates efficiently without collision-detection circuitry, which would make the system more complex and more expensive.

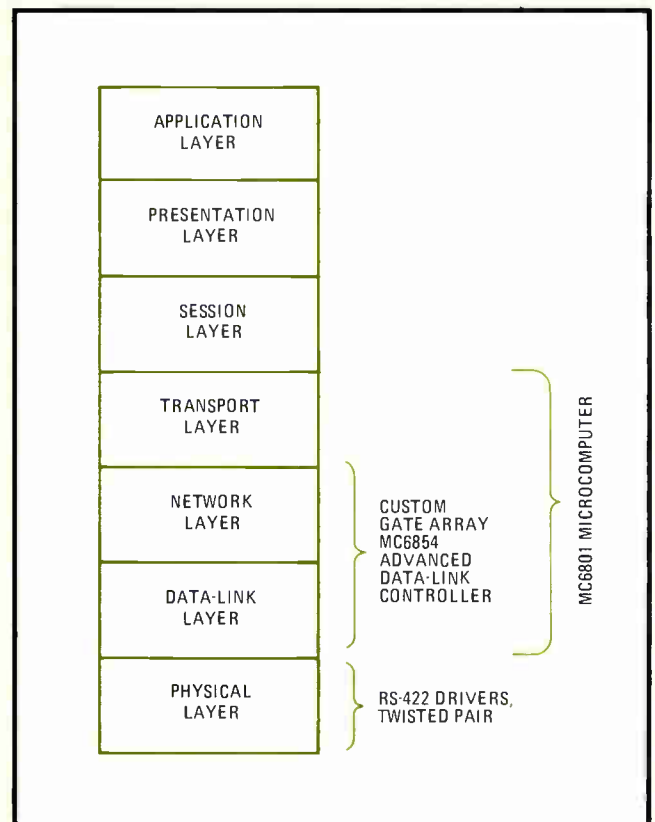

The interface control logic also extends addresses, when necessary, for the DMA transfers between the transporter and the host computer. This address extension allows the 6801 to address host computer memories having up to 24 bits of address space, even though it itself has only 16 address bits.

Another cost savings results from the simple transceiver design. The complete transceiver is implemented with just two ICs, a Texas Instruments SN75174 differential line driver and an SN75175 differential line receiver. These interface circuits go beyond the RS-422 protocol by allowing any two interfaces to be active at once without damaging the circuits. They have a high level of noise rejection through hysteresis. Since the balance differential signals can have up to 24 volts of difference in their common-mode voltage, no isolation transformers or optical isolators are required, as would be the case with coaxial cable.

### Twisted-pair rationale

There are several reasons why twisted-pair cable was selected. The first is its low cost. The second is that anyone can install a network—lay the cable and connect the Omninet transporters to it—using only pliers and a screwdriver (the task is similar to hooking up hi-fi speakers). On the other hand, shielded twisted-pair cable is no more susceptible to radio-frequency interference than coaxial cable.

The performance of the network is enhanced by its efficient low-level acknowledgment scheme. Omninet uses what is called a positive acknowledgment protocol; that is, every message, if received correctly, is acknowledged by the receiving station. If a message is not

positively acknowledged within 15 to 20  $\mu$ s, the sending station will retransmit it after waiting a random time interval. A message is retransmitted until it is acknowledged or until it has been retransmitted a maximum number of times specified by the user.

The transporter receiving a message sends the acknowledgment as soon as the message has been validated. The receiving station does not wait or check the line for activity before sending the acknowledgment, but all other stations wanting to transmit are waiting because they will have detected that the line is busy. Therefore, acknowledgments are sent immediately and never lost. As noted, all the acknowledgments and retransmission processing is done by the transporters, without any involvement on the part of the host computers at each station.

Many factors determine how long the transporter software will wait before retransmitting a message after not getting an acknowledgment or after being told by the hardware that the line is busy. With the transporter's retransmission algorithm, the wait clock that measures the random time interval between transmissions ticks only when the network is idle. The busier the network, the longer it takes for this random time interval to elapse. Thus the transmission or retransmission rate is adjusted automatically according to the level of traffic on the network.

The algorithm also eliminates the queuing phenome-

**3. Smart transportation.** The Omninet transporter is really a small computer with its complement of intelligent digital hardware and software, including a custom gate array for interface control. The transporters perform distributed control of a 1-Mb/s local net.

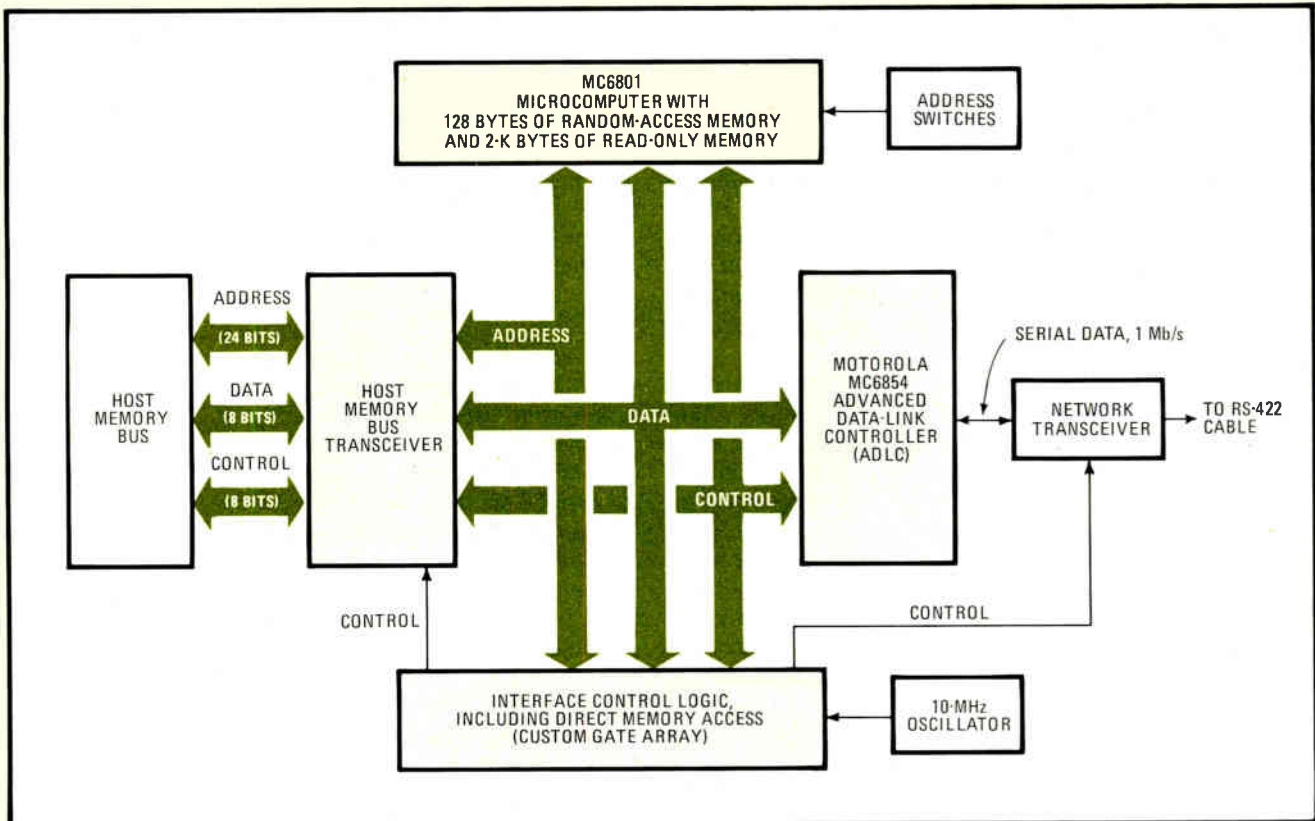

6801 INSTRUCTIONS FOR TRANSFERRING ONE PACKET	
PROGRAM	COMMENTS
LDS ADDR	Load address of data buffer.
LDD LENGTH	Get length from Omninet header.
DMALoop: INS	Increment stack pointer, causing hardware to stop 6801 clock, read byte from advanced data-link controller, and directly access the host's memory and store the data at the address in stack pointer.
SUBD #1 BNE DMALoop	Decrement loop counter.

non that is often a problem with the usual CSMA protocols. Queuing occurs in CSMA networks when two or more stations are ready to transmit a packet while another is being sent. Every station must defer its transmission until the network becomes idle again. Since each station with a message to transmit will try to send as soon as the current transmission is completed, another collision will usually result, and that would necessitate further waiting. When the retransmission interval is shorter than the time it takes to transmit a packet, queuing occurs and the randomness of the wait time is canceled. In the Omninet local network, the wait-time between transmissions does not elapse when the network is busy so several transporters will not queue up during the transmission of long packets.

### Two types of services

The transport layer in network systems usually provides one of two types of services to the higher-level protocols: either datagrams or virtual circuits. A datagram is a single, short, one-way message that is not guaranteed to reach its destination. Datagrams are fast, efficient, and well-suited for transaction-based systems. They can take full advantage of the broadcast nature of the network. However, they are severely limited by their length and the fact that they are one-way.

A virtual circuit, in contrast, is a sequenced and synchronized two-way conversation that usually involves the exchange of several messages. Virtual circuits minimize the probability that messages will be lost, duplicated, or received out of order. They can be made up of datagrams, but that implies that each high-level protocol requiring reliable data transfer must implement its own dependable delivery mechanism.

Providing virtual-circuit service in the Omninet transporter would have required much more memory than that available in the 6801, and adding the necessary external memory and software would have increased the cost of the transporter to an unacceptable level. On the

**4. In the packet.** The format of the Omninet packet has two header fields. The user header is optional and may be employed to split a packet. The network transporter software can put data from the user header in a different place in the host memory from the user data.

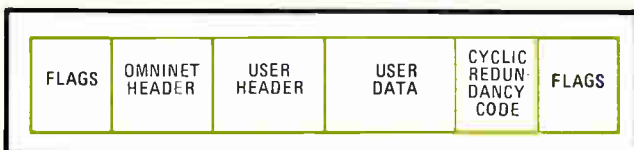

other hand, many of the hosts that will be used on Omninet will be 8-bit microcomputers with limited memory space and unsophisticated operating systems, and stealing memory from them is a bad idea. These systems can neither hold enough software nor spare enough processing time to perform reliable communications using just a simple datagram service.

In other words, datagram service was considered not good enough for personal computers, whereas complete virtual circuits are too expensive.

### Toward a virtual circuit

The compromise decided on for Omninet's transporter is more reliable than datagrams but not as secure as virtual circuits. It is called a micro virtual circuit—because state information about message transfers is maintained for only microseconds and because it provides many of the same features as a virtual circuit. Micro virtual circuits guarantee that a message sent through the network will be received correctly by the appropriate host. If not, the sender will be notified that the message was not delivered. Furthermore, duplicate messages will be discarded and messages will arrive in the same order in which they were transmitted.

The network's responsibility for routing data does not end when the packet arrives. The transporter then transfers the data into the host computer's memory at the location specified in special memory-address sockets. Each transporter contains four sockets, any number of which may be activated at one time. The socket number is specified in a separate file in the packet header, and the transporter automatically loads the incoming packets into the correct places in host memory.

Packet splitting is another network function that uses the socket structure. As shown in the Omninet packet format (Fig. 4), a packet may include a user header. If a user header is specified, the transporter will transfer it into a different memory location from the one used for the data portion of the packet—for example, the former into the system memory and the latter into the user space. This technique eliminates the need for the host computer to move the data from one memory location to another each time a new packet is received.

### Low-cost servers

Corvus Winchester disk systems can be installed on an Omninet network with the disk-server transporter. This stand-alone device is a standard transporter with extended 6801 code and a Corvus disk system interface; it costs little more than a standard transporter. All host computers on the network can share the disk storage. The disk server eliminates the need for a computer to interface the disks with the network, thereby contributing to low cost and high performance because no time is lost transferring the disk data into and out of a dedicated computer. Currently, one server can support up to four disk drives of 6, 11, or 20 megabytes, for a total of up to 80 megabytes of shared storage. Another device, similar to a server, is the Omninet gateway computer for interconnecting Omninet or linking them to other networks such as Ethernet, IBM's System Network Architecture, and public packet switched networks. □



# Exclusive new Zenith CRT Display with L-Power for logic circuits means lower system cost.

This is no ordinary CRT Display. It also provides the power for your terminal logic circuits. This unique, scan-derived system replaces conventional power supplies, and results in CRT Display systems that are compact, uncomplicated, and have fewer parts. You get optimum reliability, a cooler-running terminal and lower system cost.

The Zenith CRT Display testing program subjects test units to

thousands of hours, under extreme humidity, vibration, altitude, and temperature conditions. And exhaustive analyses of components and subassemblies, including electron microscope and thermograph scans in the Zenith Reliability Lab.

All Zenith CRT Displays: 5", 9", 12", and 15" are available with this innovative new L-Power system. For further information write: CRT Display Engineering Division, Zenith Radio Corporation, 1000 Milwaukee Avenue, Glenview, Illinois 60025, or call (312) 773-0074.

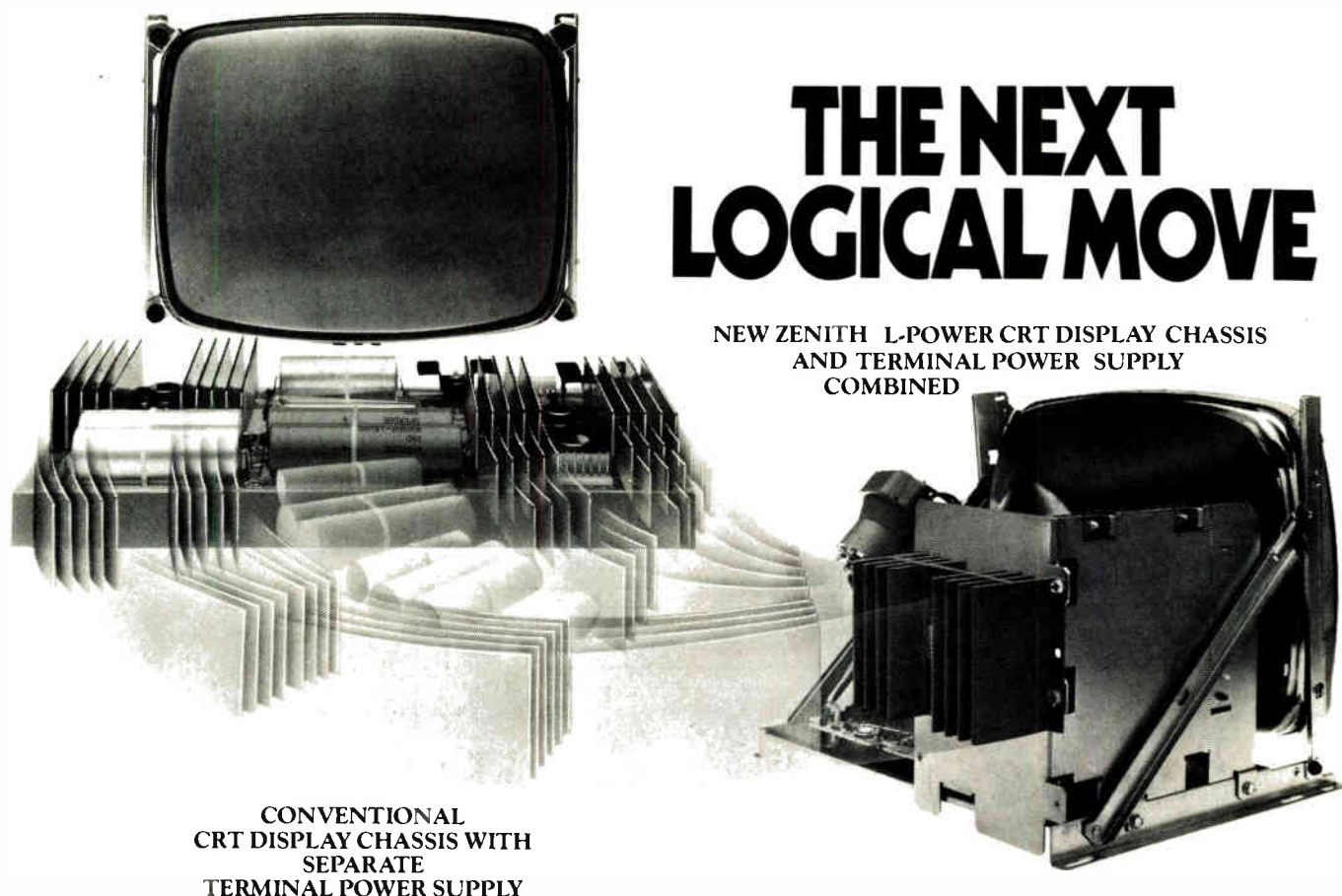

CONVENTIONAL  
CRT DISPLAY CHASSIS WITH  
SEPARATE  
TERMINAL POWER SUPPLY

## THE NEXT LOGICAL MOVE

NEW ZENITH L-POWER CRT DISPLAY CHASSIS  
AND TERMINAL POWER SUPPLY  
COMBINED

**ZENITH**  
®

The quality goes in before the name goes on.

## Low-cost generator delivers all standard bit rates

by Robert E. Turner  
Martian Technologies, Spring Valley, Calif.

Costing only \$2, this generator can drive universal asynchronous receiver-transmitters and other RS-232 serial interface chips at any standard bit rate selected by the user. It is especially suitable for systems based on the Z80 microprocessor from which the generator can derive its 4-megahertz quartz-crystal time base.

As the figure shows, a 4-MHz input clock is divided by 13 by the 74LS393 counter (A<sub>1</sub>) and a 74LS11 AND gate, thereby providing a 3.25-microsecond signal that is suitable for driving the CD4024 seven-stage counter, A<sub>2</sub>. This signal is close to 16 times the maximum 19.2-kilobit/s output frequency. Smaller divisions are handled by the counter, which supplies 9,600-, 4,800-, 2,400-, 1,200-, 600-, 300-, 150-, and 110-b/s outputs.

The counter outputs are wired so that a bit rate may be selected for both channels of a Z80A serial input/output module or dual asynchronous receiver-transmitter serial interface chip. The output frequency of the generator is 16 times greater than the bit rate, so each serial data bit is sampled 16 times per bit period.

The bit-rate clock frequency is selected with either

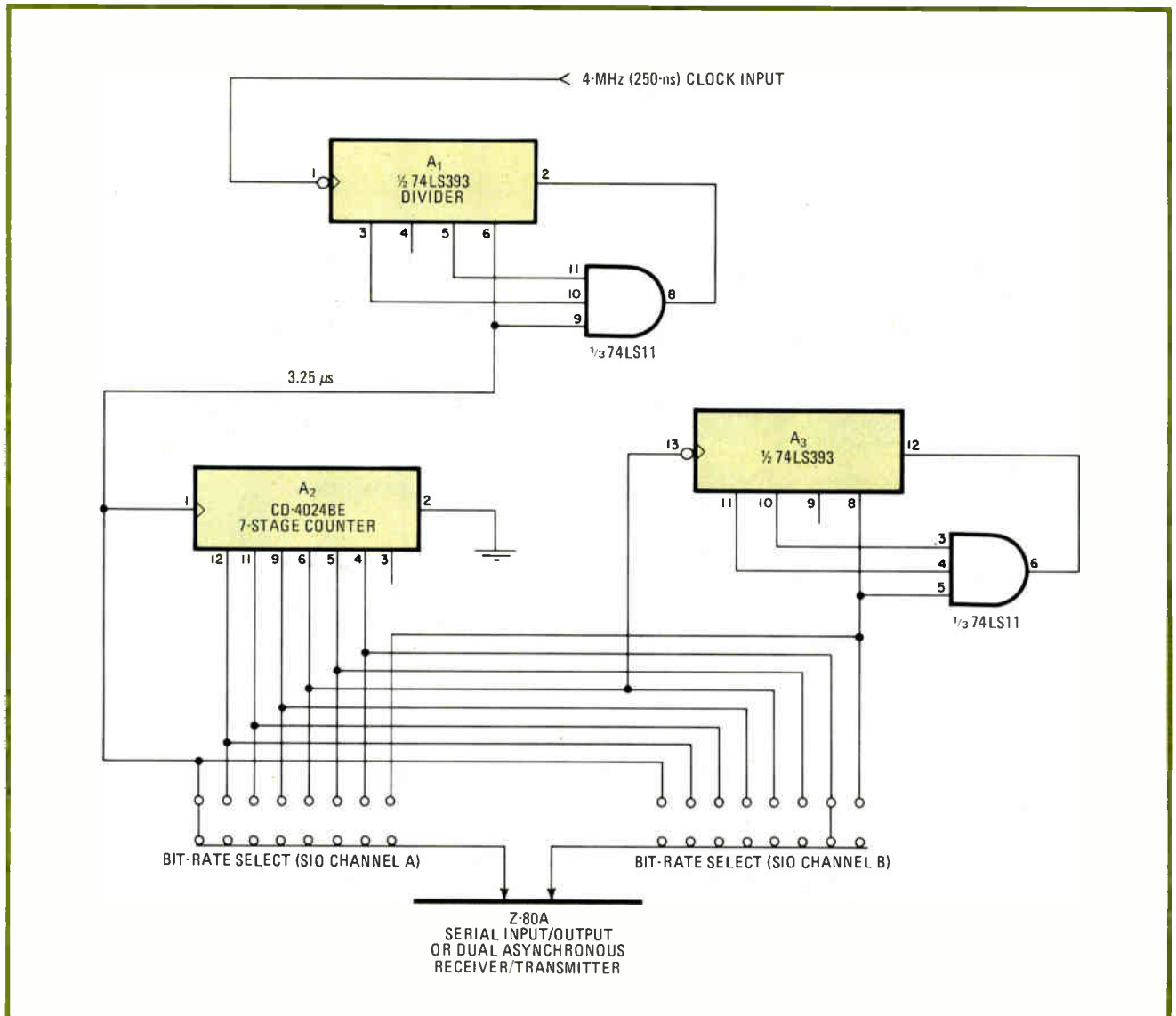

**Trimmed taps.** With a Z80 system clock trimming costs to \$2, the four-chip generator delivers all standard bit rates for RS-232-based systems. The generated rate accuracy is high (see table). The system can be easily modified for older interfaces.

GENERATOR RESPONSE

Period	Actual output (b/s)	Ideal output (b/s)	Error
52 $\mu$ s	19,230.76	19,200	+0.16%
104 $\mu$ s	9,615.38	9,600	+0.16%
208 $\mu$ s	4,807.69	4,800	+0.16%
416 $\mu$ s	2,403.84	2,400	+0.16%
832 $\mu$ s	1,201.92	1,200	+0.16%
1.66 ms	600.96	600	+0.16%
3.33 ms	300.48	300	+0.16%
6.65 ms	150.24*	150	+0.16%
9.15 ms	109.26	110	-0.68%

\*OUTPUT AVAILABLE, BUT NOT CONNECTED IN CIRCUIT SHOWN

printed-circuit-board jumpers or by small dual-in-line-packaged switches. The entire circuit is small enough to be mounted next to the Z80's DB-25 connectors that are mounted on its rear panel, making it easy for the end user of the RS-232 interface to select a bit rate. The dual-channel version of the circuit requires only five interface lines: the 4-MHz clock input, bit-rate clock A and B outputs, the 5-volt line, and logic ground.

As for the accuracy of the rates generated, they are well within the 1% timing variation standard required by the RS-232 interface (see table). The generator has been

used with many different terminals and printers, and no operating difficulties have been encountered.

The circuit may also be used with most of the older serial interface chips like the 8251 and the 6850, if the user is willing to sacrifice the 19.2-kb/s output. In this case, the divide-by-11 counter would be driven by a 2-MHz clock, with the highest bit rate available becoming 9.6-kb/s. This signal drives the counter. The output of the counter that divides the 110-b/s signal by 11 (counter A<sub>3</sub>) would then be connected to the new 1,200-b/s output of the seven-stage counter. □

## Improving the LM395 for low-level switching

by Yehuda Gabay  
Israel Atomic Energy Commission, Beersheba, Israel

The most significant drawback of a power transistor like National Semiconductor's LM395 is its relatively high quiescent current (10 milliamperes or so), which makes it impossible to use as a reliable switching device for small loads or loads that require dynamic currents ranging from zero to some high value. Adding a transistor-

diode network and an optocoupler to the circuit, however, adapts the LM395 as a low-level (down to 0-mA) switch without sacrificing the current-handling capabilities of the power transistor and provides input-to-output isolation as well.

This circuit is configured as a normally-off switch whose quiescent load voltage is a maximum of 0.6 volt. Placing a logic 1 at the input of optocoupler U<sub>1</sub> causes transistor Q<sub>1</sub> to turn off. Thus the power transistor, Q<sub>2</sub>, conducts and the desired current flows through the load, R<sub>L</sub>.

If the input to the optocoupler goes to a logic 0, Q<sub>2</sub> cuts off and no current flows through the load. In this state, Q<sub>1</sub> conducts and the quiescent current of Q<sub>2</sub> that must flow is shunted through diode D<sub>1</sub> and through Q<sub>1</sub> to

**Bypass.** A floating switch in the form of an optocoupler adapts power transistor Q<sub>2</sub> for handling small load currents, directing transistor Q<sub>1</sub> to bypass Q<sub>2</sub>'s high quiescent current (10 mA) when a logic 0 is applied to the circuit input. If a normally on switch is desired, Q<sub>1</sub> and its associated circuitry need only be removed. U<sub>1</sub>'s output transistor then will take Q<sub>2</sub>'s quiescent current to ground.

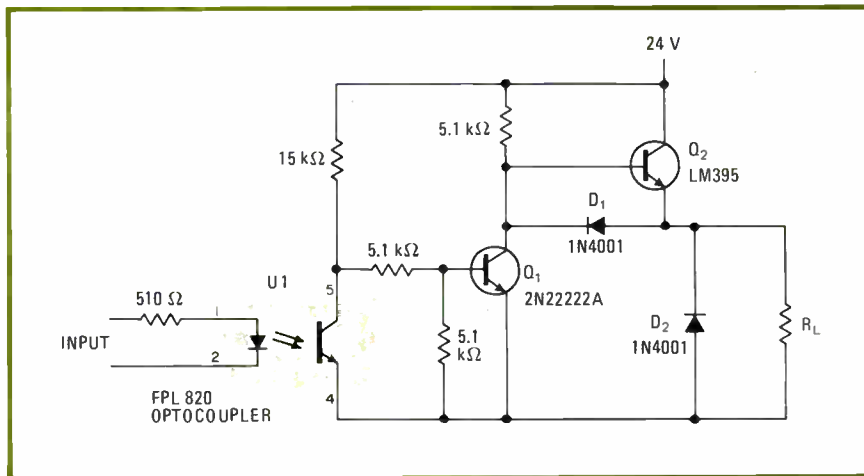



# HERMETICS. AN ALMOST COUNTLESS SELECTION YOU CAN COUNT ON.

From intense radiation to the arctic cold. The ocean floor to the surface of the moon. Military applications to recreational vehicles.

Wherever there's a severe environment, chances are you'll find an ITT Cannon hermetic connector.

Why Cannon?

Simple. We have the broadest line of hermetically sealed connectors in the industry. (Everything from rectangular to circular, subminiature to miniature.) We're known for connectors that are reliable. And we have what is probably the best delivery time around.

Not only that. If by some chance we haven't got the right connector for that special application, we have the capability to develop and manufacture it for you on a custom basis.

So whether your needs dictate an off the shelf or custom hermetic connector, you can count on Cannon. Write us for our catalog and further information. Or give us a call.

ITT Cannon Electric, Phoenix, a Division of International Telephone and Telegraph Corporation, 2801 Air Lane, Phoenix, AZ 85034. Telephone: (602) 275-4792. In Europe, contact ITT Cannon Electric, Avenue Louise 250, B-1050 Brussels, Belgium. Telephone: 02/640.36.00.

## CANNON ITT

You can always connect with Cannon.

Circle 132 on reader service card

World Radio History

ground. It should be noted that  $D_2$  bypasses transients to ground that are caused by an inductive load.

In the case where the user desires to implement a normally closed switch, it is only necessary to remove the circuitry centered around  $Q_1$ . Then,  $U_1$ 's output transis-

tor will serve to bypass  $Q_2$ 's quiescent current to ground when necessary. □

Designer's casebook is a regular feature in *Electronics*. We invite readers to submit original and unpublished circuit ideas and solutions to design problems. Explain briefly but thoroughly the circuit's operating principle and purpose. We'll pay \$75 for each item published.

## Low-cost controller stabilizes heater-type cryostats

by S. K. Paghdar, K. J. Menon, R. Nagarajan, and J. Srivastava, *Tata Institute of Fundamental Research, Bombay, India*

Controllers for maintaining small objects at a low temperature use either complicated gas-flow techniques, that regulate gas pressure or costly commercial units that are built for general applications and must be modified to suit a particular need. Finger-type cryostats, in contrast, which control a heater on the principle of error-sensing and feedback techniques, are extremely simple, easy to implement, and inexpensive. As for stability, this circuit holds the temperature to  $\pm 0.2^\circ\text{K}$  over 24 hours (short-term variation is  $\pm 0.01^\circ\text{K}$ ) in the range of 80 to 200 K.

As shown in the figure, the circuit may be built around an OC23 or other power transistor, that has a fairly linear base-current-to-collector-current characteristic, eliminating the need for the additional amplification usual in circuits of this type. Error signals from a Wheatstone bridge are applied to the 741 operational amplifier act as the temperature control. The signal is then amplified by transistor  $Q_1$ , and passes to  $Q_2$ , which

drives a resistive load and associated container that, placed inside the liquid-nitrogen-filled cryostat, heats the environment.

Thermal changes are sensed by a copper resistance thermometer, also located inside the cryostat. This element, placed in one arm of the Wheatstone bridge, reflects changes in the equilibrium temperature between the container and environment and in effect acts to cancel the original error signal applied to the op amp.

This part of the circuit serves only to correct temperature variations and does not set the temperature of the cryostat. Potentiometer  $R_1$  fulfills this task by setting the bias current at the output without affecting the base-driving circuit of the power transistor.

To calibrate the system, switch  $S_1$  is placed in the manual position and  $R_1$  adjusted to obtain the desired cryostat temperature. Next, the Wheatstone bridge should be balanced by adjusting the standard resistor, whose value will be determined by the center value of the circuit's copper resistance thermometer.

The gain of the amplifier stage,  $R_3/R_2$ , should be matched to the response of the cryostat. A nominal value might be 1,200, as in this circuit.

The system can handle heater currents of up to 850 milliamperes. Above this value, however, the current gain of the power transistor begins to fall, so that the circuit will not function effectively in the specified temperature range. □

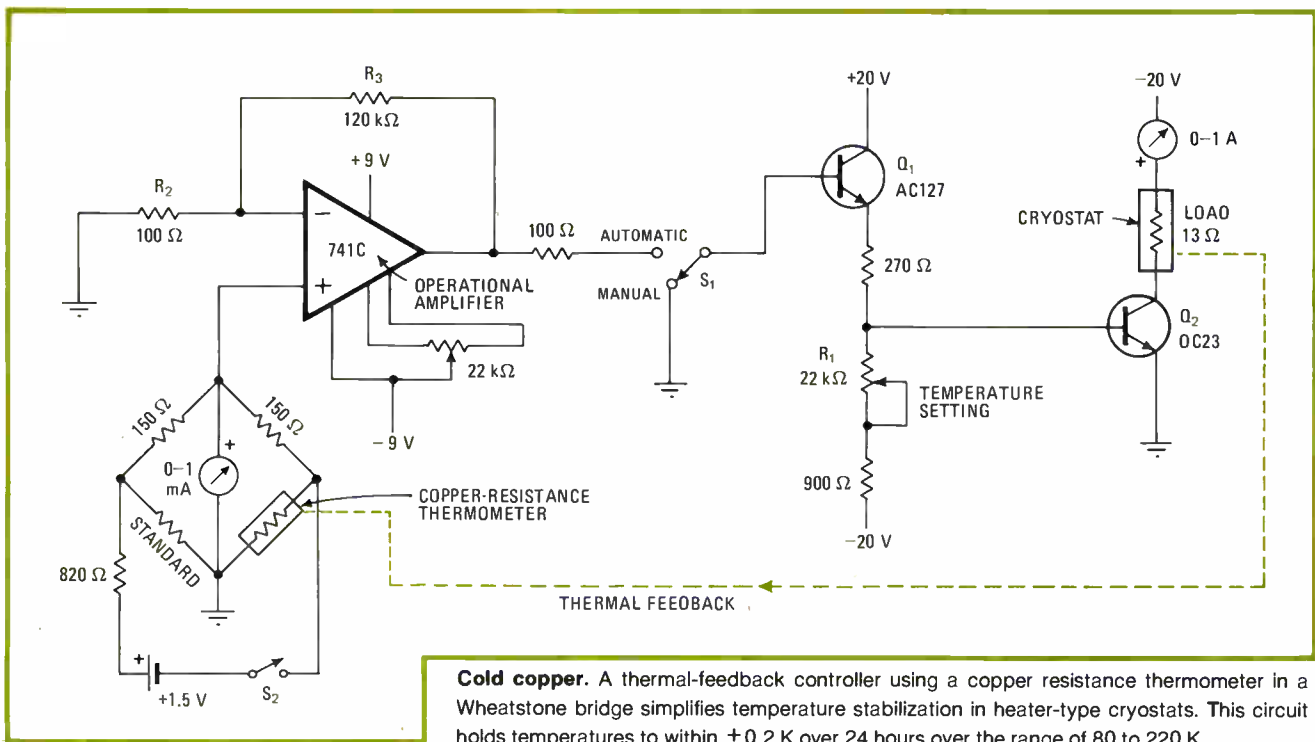

**Cold copper.** A thermal-feedback controller using a copper resistance thermometer in a Wheatstone bridge simplifies temperature stabilization in heater-type cryostats. This circuit holds temperatures to within  $\pm 0.2^\circ\text{K}$  over 24 hours over the range of 80 to 220 K.

# Memory management chip extends reach of 8-bit processors

As well as boosting address limits to 2 megabytes, the MC6829 eases the handling of multiple tasks by providing separate register sets for users

by Edward J. Rupp, *Motorola Inc., Austin, Texas*

□ Memory management is making its way into the 8-bit microprocessor world—and small wonder, for its benefits are as attractive here as in the realms of bigger processors. By allowing a larger memory to be divided into many fixed-size pages, a memory management unit can extend an 8-bit system's address limits beyond the bounds of 64-K bytes. The MMU—a subsystem in itself—can also promote the design of multitasking systems by easing control of swapping—the movement of tasks into and out of physical memory.

An MMU allows programs to be moved among the system's various types of memory with no need for code changes or even for program fragments to be in contiguous locations. Different tasks running on the system may all use the same logical addresses in their code, because the part handles the relocation necessary to prevent collisions.

Because it can translate different addresses to the same location, the unit eases sharing expensive peripherals and memory among processors. A shared memory makes economical use of read-only programs like language compilers and helps implement intertask communication via semaphores—flags residing in shared memory that synchronize the message passing.

On the microsystem level, however, a memory management unit built from TTL can become complex beyond the point of diminishing return. So a large-scale integrated-circuit implementation introduces reliability and is a cost-effective companion for a microprocessor. To expand the memory space of 8-bit microprocessors, Motorola has developed an MMU on a chip.

The MC6829 memory management unit is designed to be directly compatible with the MC6809 microprocessor.

However, it will work with other 8-bit processors, too. It extends the addressing range of the 6809 to 2 megabytes and allows rapid switching between as many as thirty-two 64-K-byte memory maps.

The 6829 uses a simple paged mapping scheme converting 16-bit logical addresses from the processor into the 21-bit physical addresses delivered to memory (Fig. 1). Of the 16 processor address lines, five are fed directly into the MMU. They are applied to a 32-word mapping

random-access memory, and the data outputs of the RAM become the upper bits of the physical address.

Four groups of 32 mapping registers each are resident on chip, although only one set is active at any one time, as controlled by the operating-key register. Each set is arranged as 32 words of 10 bits each, so that 10 mapped address lines leave the chip.

The 11 unmapped processor lines determine the page size of 2-K bytes. Combining the 6829's 10 output bits with the 11 unmapped bits gives a total of 21 address lines for the address range of 2 megabytes. It takes 110 nanoseconds to translate a logical address into a physical one.

The chip's resources are devoted to handling large

memories in multitask environments—there is no provision for page protection, such as flagging read-only pages and generating traps when a write is attempted. Read-only areas could be created, however, by dedicating one of the upper address bits, like bit 20, to write protection. Also, the 6829 is not designed for transparent page swapping—the programmer must include instructions for loading mapping registers before page access.

The chip does provide a convenient means of setting up and changing the contents of its mapping RAM. In

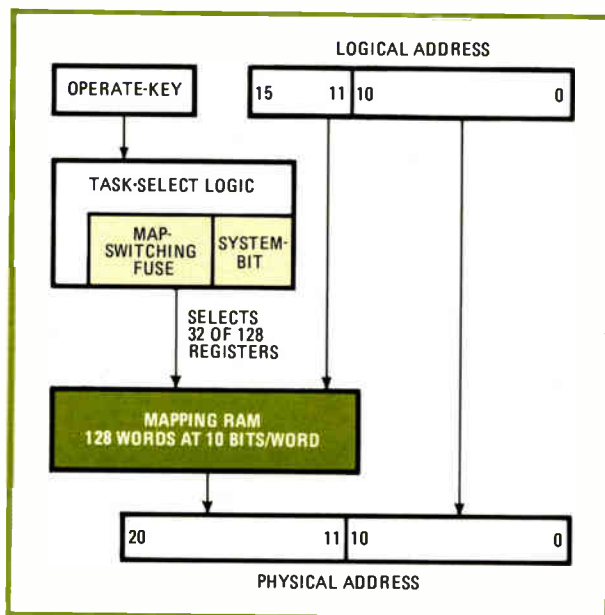

1. The physical translation. A 16-bit logical address is translated into a 21-bit physical address that gives 8-bit microprocessors access to 2 megabytes of memory. One MMU can handle four 64-K-byte tasks organized into thirty-two 2-K-byte pages.

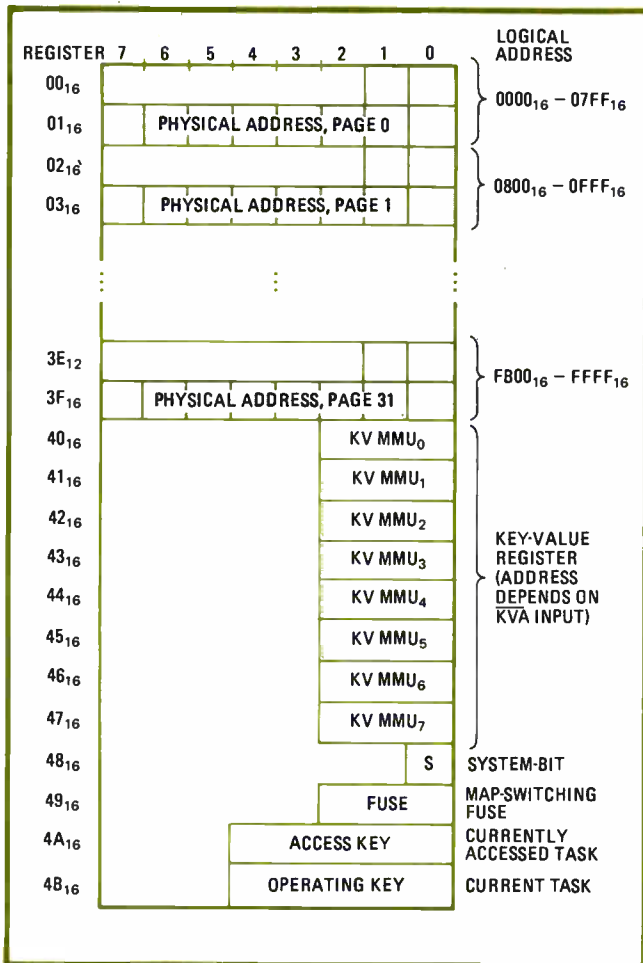

**2. Register access.** All the registers on the 6829 memory management unit are mapped into the host microprocessor's address space. The key-value registers differentiate MMUs that are wired in parallel, and the access-key register selects one of four tasks.

effect, it appears as a peripheral to the processor during such operations, specifically as 32 double-byte registers. Each of these registers controls the logical to physical mapping for one 2-K-byte page.

### Multiple tasks

For multitasking, each 6829 contains enough mapping RAM to hold the addresses for four complete tasks, each of which may have direct access to up to 64-K bytes of memory on thirty-two 2-K-byte pages. If a task is larger, it can simply revise its memory map periodically, giving indirect access to the entire 2 megabytes. Eight of the chips may be present in any one system, which allows thirty-two 64-K-byte tasks to be maintained in hardware registers. Also, the chips may be wired in parallel, easing the design of a multiple-MMU system (Fig. 2).

If a system needs access only to large amounts of memory, a single chip can handle all accesses, though its mapping registers will need to be reloaded. If the goal is fast switching between many tasks, each of them can be assigned to a separate set of MMU registers in a multiple parallel configuration.

Task switching is accomplished by writing the task number in a special register (the operating-key). If that

register's contents match those of the key-value register, then that MMU provides a mapped address; otherwise it stays off the memory address bus. During the power-up sequence, the processor initializes the key-value register for each part with a different value. With the exception of the key-value access pin, then, multiple MMUs may be wired in parallel (Fig. 3).

Task selection is controlled by the operating-key and the system-bit registers working with the bus-available and bus-state inputs. The 6809 generates the BA and BS signals directly, though other microprocessors may be adapted to the 6829 by generating these signals with external logic. The scheme for task switching may also change when using other processors.

Task 0 (usually assigned to implement the operating system) is the only one that has access to the registers on the MMU. This provision ensures that a register like the operating-key cannot be changed while its value is being used by a current task. In most multitasking environments, task 0 will contain the program that controls the mapping for all other tasks and will manage the hardware interrupts as well.

### Mapping access

The operating system also must have access to the mapping RAM. To do this it uses the access-key register of the 6829. Writing a task number into the access key causes the contents of the mapping RAM for that task to appear in the first 64 bytes of the 6829's registers. The map may then be examined or changed as needed.

A typical operating system function (system call) is to transfer bytes between tasks, usually between the operating system task and a user task. A subroutine can do this easily by mapping a page of the task 0 map onto the appropriate user task page, with no physical movement of the data. The overhead for large memory transfers is only slightly greater than that of a nonmapped system (about two extra instructions per byte moved).

Software interrupts are an ideal way to handle such system calls because they cause automatic switching to the operating system, which can then perform the requested function and subsequently resume execution of the user task. The return to a task is accomplished by setting the operating-key register to the task number, clearing the system-bit (S-bit) and executing a return-from-interrupt (RTI) instruction (see table).

The S-bit controls the precise moment that the set of 32 mapping registers for a new task is activated. It must be cleared after execution of RTI, which is in task 0's memory and therefore is inaccessible to the new task. Since the instruction to clear the S-bit occurs before RTI, the clearing must be delayed a few cycles so that the processor can have the time to execute that instruction. The 6829 provides this delay with a 3-bit down counter called the fuse register. A value of n written to the fuse will cause an n-cycle delay in clearing the S-bit.

Direct memory access may also use the MMU. This is accomplished when the BA input is high, which temporarily overrides the value in the operating-key register and permits task 1 to be selected for mapping the DMA transfer address. BA = 1 implies that the processor has relinquished the bus to some other controller. By

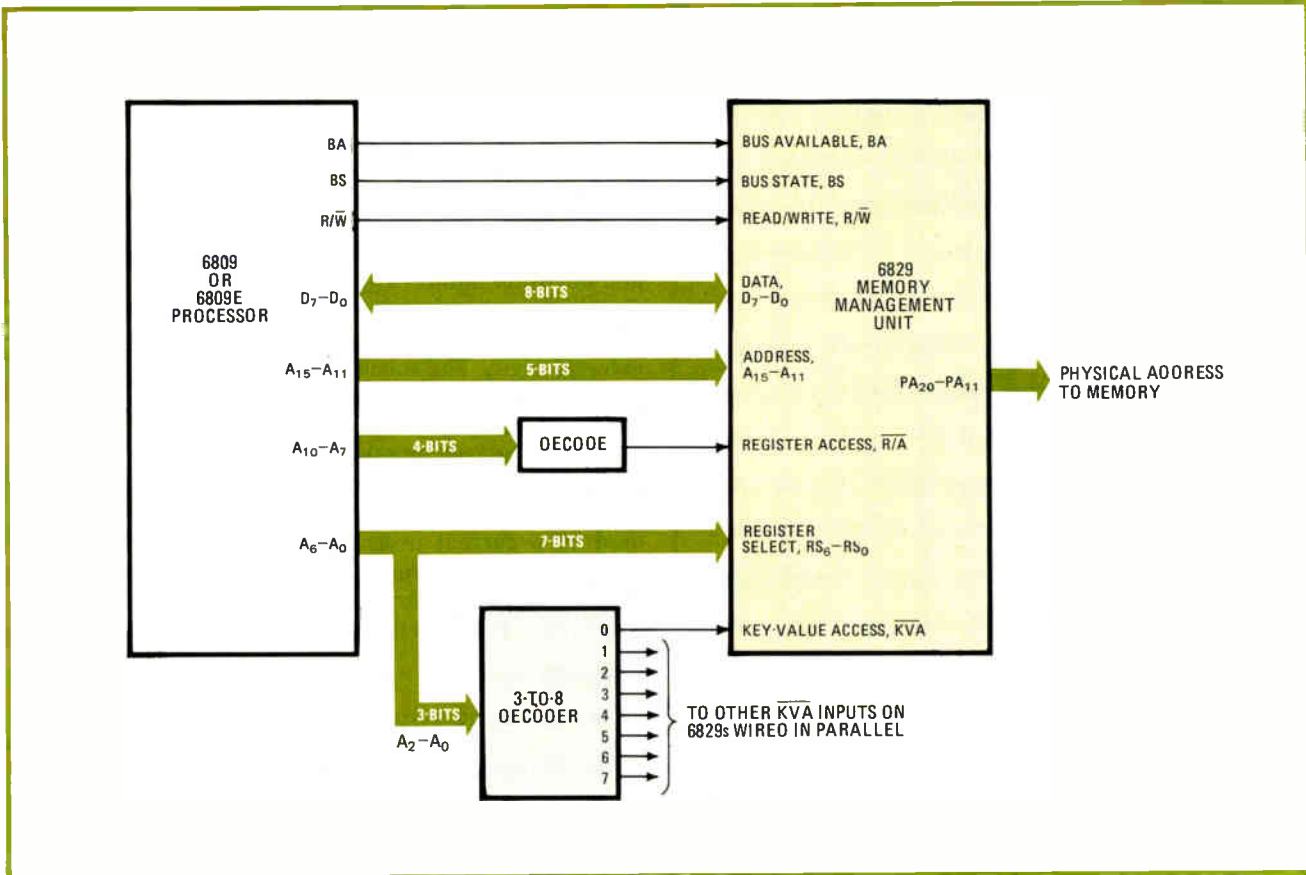

**3. Memory marriage.** The processor is married to the memory system by the MMUs. Eight can reside in a single system with all pins (except KVA) wired in parallel. The KVA pin allows a unique value to be written into the key-value register on each chip separately.

switching to task 1 during these operations, the new bus controller has a completely separate 64-K-byte map with which to work.

Thus a DMA controller could transfer up to 64-K bytes without interfering with any other processor operations. Alternatively, parts of task 1 and other user tasks could be mapped together, allowing direct memory access into any task. The fuse register ignores DMA cycles in order to maintain synchronization with the processor.

The mapping delay, called latency, introduced by the MMU adds directly to the cycle time of the processor. The effect of this delay is to reduce the available setup time for the system peripherals and memory. The current design of the 6829 requires 110 ns to complete the mapping function and arbitrate among multiple MMUs.

The mapping starts at the very beginning of each cycle, but arbitration among multiple units cannot occur

until one quarter cycle later, since each of them must determine the state of the BA and BS inputs for the cycle. At this point, one of the parts will determine that it must supply a mapped address to the physical address bus and turn on its address lines, with all other MMU output lines remaining disabled.

### Design choices

When building a system with the 6829, a number of choices are possible. One option is to build the system so that each task has its own set of MMU registers. This is probably the fastest and easiest approach, but it does limit the number of tasks that may be running on the system to a maximum of 32.

Another approach is to use a single 6829 and reload its registers at each task switch. This scheme uses task 0 as the operating system task, task 1 as the DMA map (if needed), and tasks 2 and 3 as the sites of the maps for the user task. The maps for the remaining tasks would be kept in memory and loaded as needed. Any number of tasks may be supported with this method. However, the overhead of reloading registers makes this approach relatively slow.

Alternatively, the designer could use multiple 6829s, treating their registers as a resource to be allocated among the tasks. When a task is ready to run, a free set of MMU registers is allocated and initialized for it. High-priority tasks could then remain in the registers, with little used tasks in external memory. □

SUBROUTINE TO SWITCH TASKS		
PROGRAM		COMMENTS
RETURN	ORCC #1 + F	disable interrupts (enter critical section)
	STS OSSP	save current operating-system stack
	LDS SAVESP	restore user's stack
	LDA #1	cause map switch one cycle after write
	STA FUSE	write 1 to fuse register
	RTI	return to user task



# Leadless carriers, components increase board density by 6:1

Vapor-phase-soldered components withstand military environments, decrease assembly costs

by P. R. Jones, *Rockwell International Corp., Collins Telecommunications Products Division, Cedar Rapids, Iowa*

□ Possibly nowhere is the need for high packaging density felt so keenly as in the design of avionics equipment. Yet the seemingly obvious routes—large-scale integration or hybrid circuitry—are not always practical for this application. LSI is not cost-effective for systems whose yearly production volumes rarely exceed 1,000 and can fall as low as 50, while ceramic substrates are often unsuitable at the very high and ultrahigh frequencies and the analog power levels that are characteristic of communications equipment.

Printed-circuit boards, however, can be made to achieve six times their usual packaging density if leadless chip-carriers and leadless passive components replace the dual in-line packages and leaded resistors and capacitors in widespread use today. Figure 1 shows just such a pc board using surface-mounted leadless components.

This board far exceeds the original goal—a four-to-one increase in density—set before the advanced technology and engineering department of Collins Telecommunications Products division when it was assigned the task of developing a more cost-effective method of manufacturing more reliable and more complex systems. Other significant advantages of this chip-carrier approach are, in fact:

- Reduced assembly costs, because the circuit boards used are fewer in number and less complex.
- Greater reliability, because each board has only one or two layers and few plated through-holes.
- More compact assemblies, and hence shorter circuit paths, because component height is reduced to as little as 0.08 inch above the board.
- Twice the resistance to vibration of conventional circuit boards.
- Greater ability to dissipate heat, because the boards can be constructed with a very smooth back side that it is easy to laminate to a metal plate.

## In the beginning

As its first step in increasing the packaging density of pc boards, the high-density project team at the Collins department focused on the use of leadless passive components. It began by adapting selected circuit boards to use with leadless components, wherever possible using commercially available chip resistors and capacitors.

One of the keys to the high-density project's success

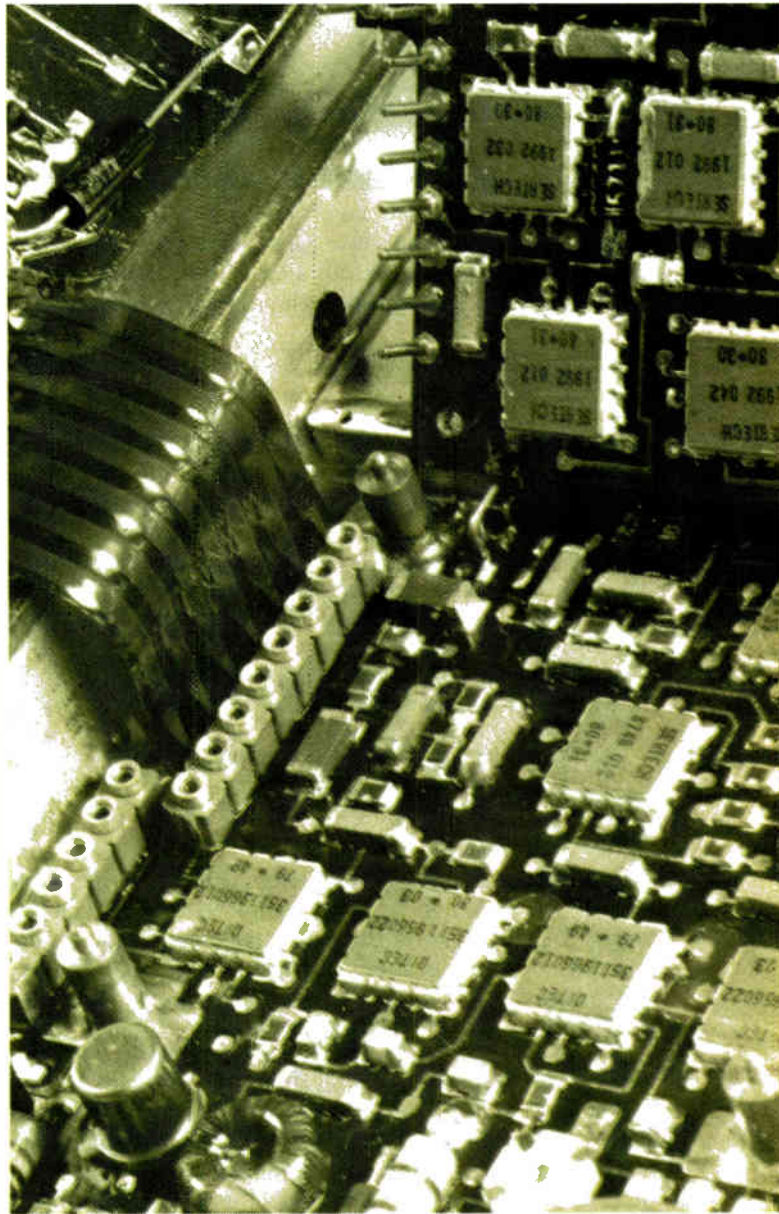

**1. Carriers to boards.** This is part of the ARC-182 multimode military aircraft transceiver frequency synthesizer showing leadless chip-carriers applied to a polyimide-glass board. Conventional and leadless components form an optimum cost-versus-density solution.



**2. Vapor-phase soldering.** One of the keys to successful mounting of leadless chip-carriers and other leadless components on standard pc-board surfaces is vapor-phase soldering. In this operation, all solder joints are fused simultaneously in an oxygen-free environment.

was vapor-phase reflow soldering. This process involves heating the entire circuit board, with the components in place, in a vented container. The heat-transfer medium is the dense saturated vapor created by a fluorochemical liquid heated to its boiling point—215°C, in the case of Fluoronert Liquid FC-70, the vapor-phase soldering fluid with which 3M Co. pioneered the method. No complex temperature-control systems are needed, and an air-free environment eliminates the development of oxides (Fig. 2). The procedure heats all board elements to precisely the same temperature, can be carried out either manually or automatically, and uses either preformed solder elements or a paste alloy that is screened onto pc-board traces. The Collins team opted for a paste formulated to have a tacky surface that grips and holds components prior to soldering.

### Heat-resistant

During the research and development phase, the team found that about 85% of all military-standard components could withstand the heat and duration of vapor-phase soldering. Sensitive items and those that contain thermoplastic materials had to be assembled with soft solder after the vapor-phase process.

The project's first phase covered constructing and testing 150 boards employing standard DIPs and leadless ceramic resistors and capacitors. A control group of boards had identical circuitry and pin-outs but used leaded components and conventional assembly methods. All the boards held early designs of circuits intended for the ARC-182 multimode military aircraft transmitter-receiver, which was then under development at the division for the Naval Air Systems Command.

To check out the leadless approach as thoroughly as

possible, groups of boards were subjected to a series of tests designed to represent the worst possible combination of environments and conditions. These were decidedly more extreme than the circumstances specified in normal military standards.

The humidity test portion was adapted from MIL STD 810C, method 507.1, with values and calibration in accordance with MIL-C-4566A. Temperature-cycling tests were chosen from those for class 2 equipment in MIL-E-5400R. The vibration procedure followed the reliability development test specified in test level F, MIL STD B (with random in lieu of sinusoidal vibration) for the multimode transceiver project.

In every test procedure the boards carrying the leadless passive components performed as well as or better than standard boards. None of their solder joints broke. They withstood vibration tests with an input of 20 gravities, root mean square, a force that shook the leaded components loose from the conventional pc boards. Moreover, the leadless terminations successfully resisted thermal cycling and humidity exposure well beyond the expected levels.

In sum, then, the first phase of the high-density project proved the concept was viable. However, the use of standard DIPs and some components unavailable in other than a leaded form meant that density had so far been improved only 100%.

A second phase of circuit compression was then attempted in which the DIPs were replaced by the much smaller leadless ceramic chip-carrier. Preliminary design work indicated the latter had three-to-one space advantage over the DIP.

### Next phase

During the first phase of the project, there had been no economical and ready source of chip-carriers containing the required ICs (although chip-carriers as such were available). Further, there had been no dependable method of mounting ceramic chip-carriers directly on conventional pc-board pads. But these lacks had been remedied by the start of the second phase of the high-density project, and today a broad range of ICs packaged in ceramic chip-carriers is available from semiconductor manufacturers and custom-packaging firms such as Texas Instruments, Motorola, Harris Semiconductor, Mostek, and Fairchild.

The leadless chip-carriers were mounted on patterns of copper pads, or footprints, on standard polyimide- and epoxy-glass substrates. To attach the carriers to the boards, Alpha Metals Inc.'s 63/37 RMA20 screen-printable solder paste proved to have the thixotropic characteristics, consistency of viscosity over time, drying time, and other properties desired. Thermal-cycling tests revealed that solder-paste formulation and alloy is especially critical in chip-carrier attachment.

The tests deployed in the second phase included the same kind of demanding procedures as the tests in the earlier phase. Four rows of chip-carriers were mounted on a pc board. In the first and third rows they were wired in daisy-chain fashion. To reveal open joints or any build-up in resistance, a 60-milliampere dc test current was applied to the loops and monitored during thermal

cycling. The second and fourth rows were simply checked for mechanical failures—that is, broken joints.

The initial tests used a temperature range of  $-55^{\circ}\text{C}$  to  $+120^{\circ}\text{C}$  in half-hour cycles on 60 epoxy-glass and polyimide-glass boards, bearing various sizes of chip-carriers having anywhere from 16 to 48 input/output pads, as well as copper traces oriented in both axes of the glass substrate weave.

### Test results

After 1,000 cycles on 20 boards (10 epoxy-glass plus 10 polyimide-glass) there were no fractures in the chip-carrier-to-solder-pad interfaces. However, one failure was caused by the separation of a gold-wire bond inside the carrier.

Also, there were no detectable differences in the test results between the epoxy-glass and polyimide-glass boards regardless of the fiber orientation of the boards. The difference in the thermal coefficients of expansion of the substrates and the ceramic leadless components did not affect the performance and reliability of circuits. (Thermal-shock tests are now a part of the production post-assembly inspection, and indications are that this procedure may be more indicative of future reliability than the conventional time-consuming burn-in method.)

A pilot run of 150 boards showed that the vapor-phase soldering process worked well on epoxy-glass substrates as well as polyimide-glass boards. Polyimide was selected for the ARC-182 multimode military transceiver project, however, because its higher temperature resistance provides a larger margin of safety, or forgiveness, during repair. Also, pads adhere rather better to the polyimide substrate than to an epoxy one.

One side benefit of leadless assemblies is the elimination of lead protrusions on the back of finished pc boards. This smooth surface makes it possible to bond the aircraft transceiver boards to a metal backing for efficient heat transfer.

In such cases, an aluminum backing plate is coated with insulating epoxy and then fastened to the smooth board with a visco-elastic adhesive that improves heat transfer while allowing for differences in thermal expansion and that also damps vibration by as much as 50%. This assembly method makes it possible to maintain a heat differential of approximately  $1^{\circ}\text{C}$  per watt between the component and the external heat sink, even on high-power-dissipation analog circuits.

### Circuit layout

Though the use of leadless devices on pc boards has many packaging and circuit-performance advantages, it also introduces new considerations in design and manufacturing that must be recognized and accommodated.

Circuit-layout procedures and details of the new method turn out to be easier than conventional methods when complex circuitry is involved. Also, the reduction in the number of circuit layers and in the distances between components simplifies circuit drafting.

The Collins division has developed digitized parameters for the footprint of each of the leadless chip-carriers and chip components. Each set of pad patterns is grouped around an X-Y coordinate grid with a specified

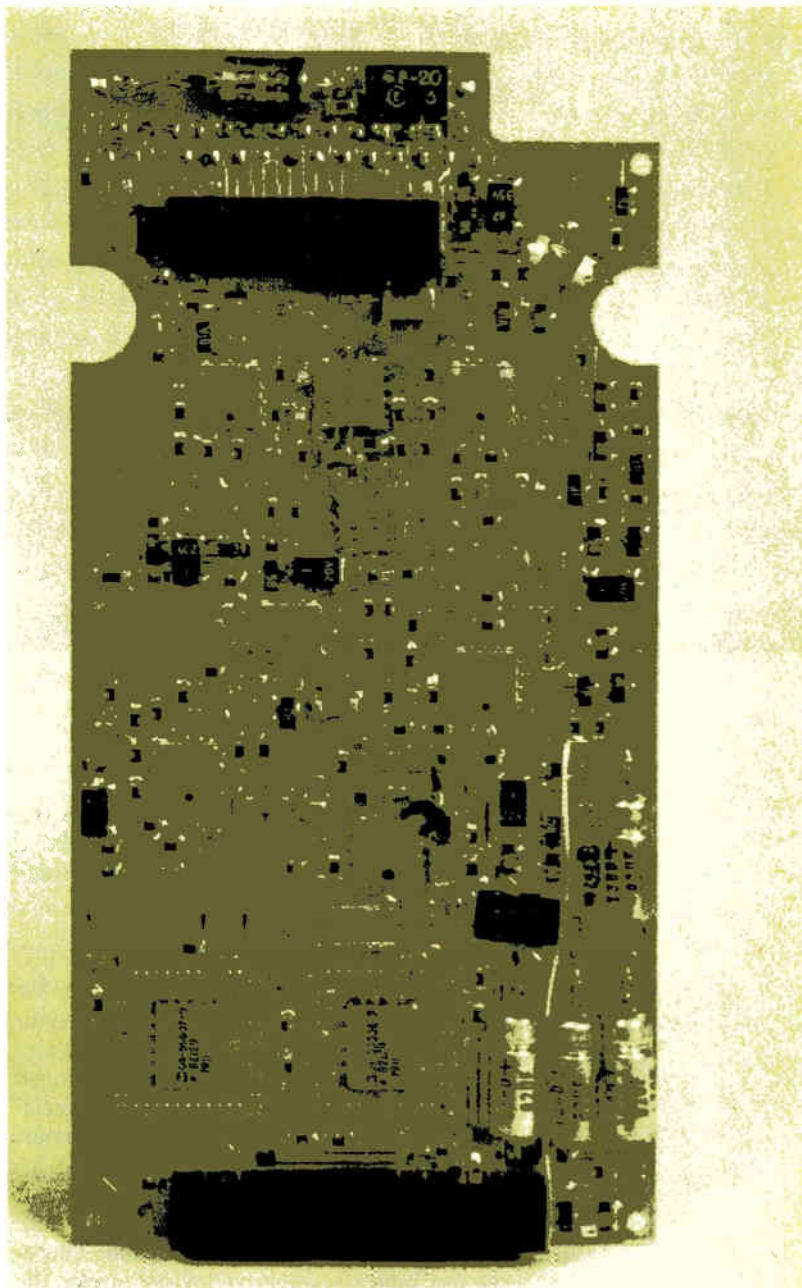

**3. Nested footprints.** Nested footprints accommodate the size differences of the various leadless ceramic chip-carriers available from multiple vendors. The unused footprint is selectively masked out with a solder resist in order to keep it free of solder.

orientation that is compatible with automatic-assembly and testing equipment. In addition, the digital-parameter program can accommodate changes in industry standards and the emergence of new devices.

The minimum allowance for circuit spacing is 10-mil lines and 10-mil spaces. This layout rule combined with minimum solder-fillet requirements (for inspection purposes) permits the chip-carriers and components to be located within 0.03 in. of one another.

One design element in particular gives the layout designer an extra degree of flexibility. Two different-sized chip-carrier footprints may be centered over the same location as shown in Fig. 3, so that either of two

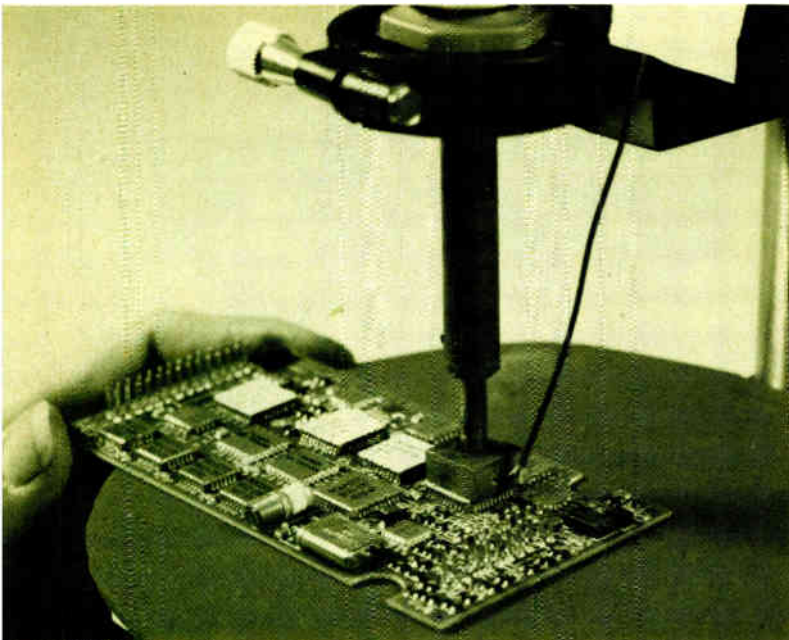

**4. Repairability.** A manual soldering device for applying or removing individual chip-carriers has thermocouple wires buried in its tip to monitor its temperature and therefore prevents it from overheating either the lid bond or die attach inside the carrier's case.

sizes of carrier may be assembled, depending on the exact circuit function or part availability. Selective masking of the solder-paste screen over the unused footprint keeps it free of paste and solder buildup.

A solder mask is recommended for most board designs. This mask, whatever the type, should be applied over bare copper only and not over tin-lead plating, for two reasons: the copper prevents the solder paste provided for each chip-carrier contact from being drawn away by the molten tin-lead plating under the solder mask during reflow, and it also prevents the mask material from wrinkling and possibly lifting the chip-carrier, causing open or, at best, poor solder joints.

The standard bed-of-nails board-level test equipment will not work with most of these new boards since there are few, if any, nodal points on a board's bottom. Therefore, alternative test methods must be devised or else the designs modified so as to provide test points. While this is a definite initial barrier to the adoption of this packaging method, the other benefits make the obstacle well worth overcoming.

#### Other considerations

Another advantage of the approach is the relative ease of chip replacement. With the proper tools, it is possible to remove and replace a leadless chip-carrier much faster than a comparable DIP and with less potential damage to the board. The Collins division has developed a simple and low-cost solder tool with a flat area that contacts the top of a chip-carrier (Fig. 4). The small drill-press-like stand in which it is mounted allows the operator to pull the carrier away evenly without exerting any side force on the ceramic housing. Alternatively, a carrier may be removed by heating its top until the solder melts, and then picking it off the board.

Conversely, the device may be manually attached by placing solder paste on the pads on the board, setting the chip-carrier in place and heating it until the solder flows. When the iron is removed, the chip-carrier automatically centers itself over the pads. This device must be temperature-controlled in order to avoid damage to the chip or chip-carrier.

The purchase prices for leadless components are currently higher than for conventional leaded items (except for chip capacitors, which cost about the same in either form). But this situation is likely to change as the demand for these leadless devices increases.

However, parts-placement labor costs for these new boards are consistently two thirds less than for a standard pc board that is manually assembled. This cost reduction is attributable to the absence of hand soldering steps, lead forming and cutting, and parts insertion. Automated pick and place rates are approximately equal to automatic insertion rates.

This design approach results in yet another important cost reduction—the simplification of pc-board design. Because these boards reduce or eliminate leaded components, there are far fewer plated through-holes to take up space on and complicate pc-board design and construction. Consequently, it is generally possible to reduce the number of board layers and hence board cost.

Reducing the number of plated through-holes improves reliability, and the elimination of board drilling creates additional savings. Where designs must change, it is cheaper to scrap a quantity of single- or double-sided boards than a multilayer inventory. Experience to date shows that the overall pc-board design and production costs for the leadless approach may be as much as 30% lower than for the standard DIP approach. Naturally, the quantity and availability of leadless components affect the resulting costs.

#### Unshakable attachment

Project testing is an ongoing process and the Collins division has currently completed 4,000 hours of a 10,000-hour temperature- and vibration-test sequence on the ARC-182 multimode military aircraft transceiver to force typical radio-failure modes. These tests reveal workmanship problems, bad joints, and poor workmanship and generally speed the learning curve in manufacturing refinement for a new process.

Currently, the performance of leadless circuits exceeds that of conventional circuitry. For example, the military-aircraft-radio contract calls for a 1,000-hour mean-time-between-failure rating, and the new circuits indicate a calculated rating of 1,900 hours.

The approach has also been shown to work on a commercial system—a compact radio needing the addition of special circuits within an existing housing that was already essentially full. Being nonmilitary, the system had to meet fewer demands in the way of preproduction testing and seemed an ideal candidate for the application of the high-density leadless-package construction method. To hold costs down, standard epoxy-glass boards were used, and tests demonstrated that chip-carriers could be replaced up to 15 times without damage to the copper traces on the board. □

# The price of high performance, dual-channel analysis just dropped a few thousand

Dual presentation raster-scan video display. Fully annotated and flicker-free.

400-line resolution for signals up to 100 KHz.

Digital zoom option available.

Small, lightweight, single-unit configuration.

Touch-panel controls. Dust- and moisture-sealed for increased reliability.

IEEE 488 and R232C combined plug-in option available.

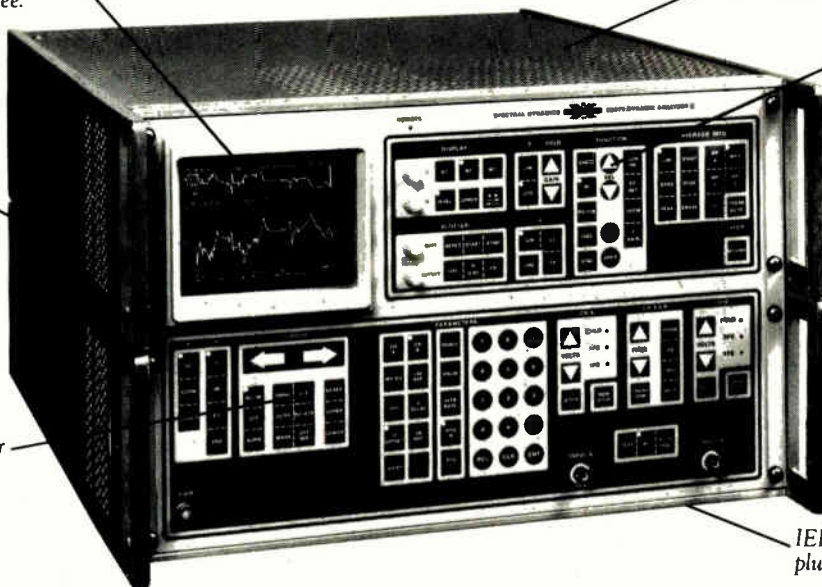

The Scientific-Atlanta SD375 is not just another new analyzer. It represents a whole new generation in spectrum analysis instrumentation.

No other analyzer (not even the highest priced models on the market) can give you comparable capabilities and application flexibility.

In fact, you'd pay *thousands more* to do what our remarkable model does.

Dual microprocessor architecture is the key. It gives the SD375 unmatched flexibility in computing mechanical, structural (including modal), acoustical and electrical/electronic phenomena.

Operating in both frequency and time domains, it processes signals up to 100 KHz. Spectrum analysis is accomplished with 400-line resolution and at eight times the rate of bargain-priced, limited feature analyzers.

## QUICK, EASY TEST RESULTS

The SD375 is a "smart" analyzer with flexible, systems-compatible software that helps simplify even the most complex signal-processing problems.

Any of 29 different display modes can be selected through easy-to-read "menus." And up to seven front panel set-ups can be stored and instantly re-

called for repeating test sequences.

Test results are shown on the SD375's fully annotated raster-scan video display either in absolute terms (volts, dB, etc.) or in direct-reading engineering units. You save time and effort by avoiding tedious conversions or interpretations.

## MORE INTERFACING OPTIONS

The IEEE 488 and RS232C combined interface option provides direct digital compatibility with peripheral test equipment used in larger test systems.

In seconds, its I/O interface parameters can be reprogrammed through a unique I/O menu (on video display), permitting instant bi-directional communication with a wide variety of computers, plotters, calculators and terminals.

Other SD375 options include digital zoom and a noise source, as well as mass data storage, text entry and fully-annotated hard-copy printout.

## MORE IS LESS

The SD375 out-performs those slower, 25 KHz analyzers with only 125-line resolution. And it offers sophisticated analysis capabilities that the highest-priced units can't match.

We'd like a chance to prove the

SD375's cost effectiveness and capabilities with a short demonstration, or a side-by-side comparison with any other dual-channel analyzer on the market today.

Clip the coupon below for more information and a demonstration. Or call Roger Koch at (714) 268-7129.

## Scientific Atlanta Spectral Dynamics

P.O. Box 671  
San Diego, CA 92112

- Please send me more information on the SD375 Dual-Channel Analyzer.  
 Please call me to arrange for a demonstration.

ELC-8-25-81

NAME \_\_\_\_\_

TITLE \_\_\_\_\_

COMPANY \_\_\_\_\_

ADDRESS \_\_\_\_\_

CITY \_\_\_\_\_

STATE \_\_\_\_\_ ZIP \_\_\_\_\_

BUSINESS TELEPHONE ( ) \_\_\_\_\_

## Audio-visual controller synchronizes museum display

by William S. Wagner  
Northern Kentucky University, Highland Heights, Ky.

A synchronized sound-and-transparency show that may be placed in any convenient area of a museum or science building can be created with this interface. Built entirely with off-the-shelf components, the cost of the circuit is below \$20.

The interface controls a cassette player and a display having several illuminated panels. Each panel contains a color transparency and a source of light (in this case, a light bulb). The circuit causes these transparencies to light in sequence, while advancing the cassette tape, which contains a recorded message for each panel. Pairs of recorded audio tones control panel sequencing and

thus synchronize the audio-visual display.

When the show ends, a second pair of audio tones shuts the entire display off. Because a continuous tape loop is used, the show may be restarted by pressing a start button. A pause button is included to extend the viewing period of any panel.

As for circuit operation, when the start button is pressed, the 4043 reset-set flip-flop sets, turning on the 2N2222 transistor and pulling in the double-pole, double-throw relay. Its normally open contact closes, turning on the cassette player's motor. At the same time, the relay's normally closed contact opens, allowing the audio signal to reach the LM324 amplifier. A 667- and a 1,200-hertz tone combine to form the initial sound heard and to activate their respective 567 phase-locked loops. This causes pin 3 of the first 4001 NOR gate to go high and advance the 4017 ring counter.

When pin 2 of the counter goes high, the 2N3904 and 2N3906 transistors turn on and the triac fires, causing the first light bulb to illuminate the first transparency. Then the recorded message corresponding to that trans-

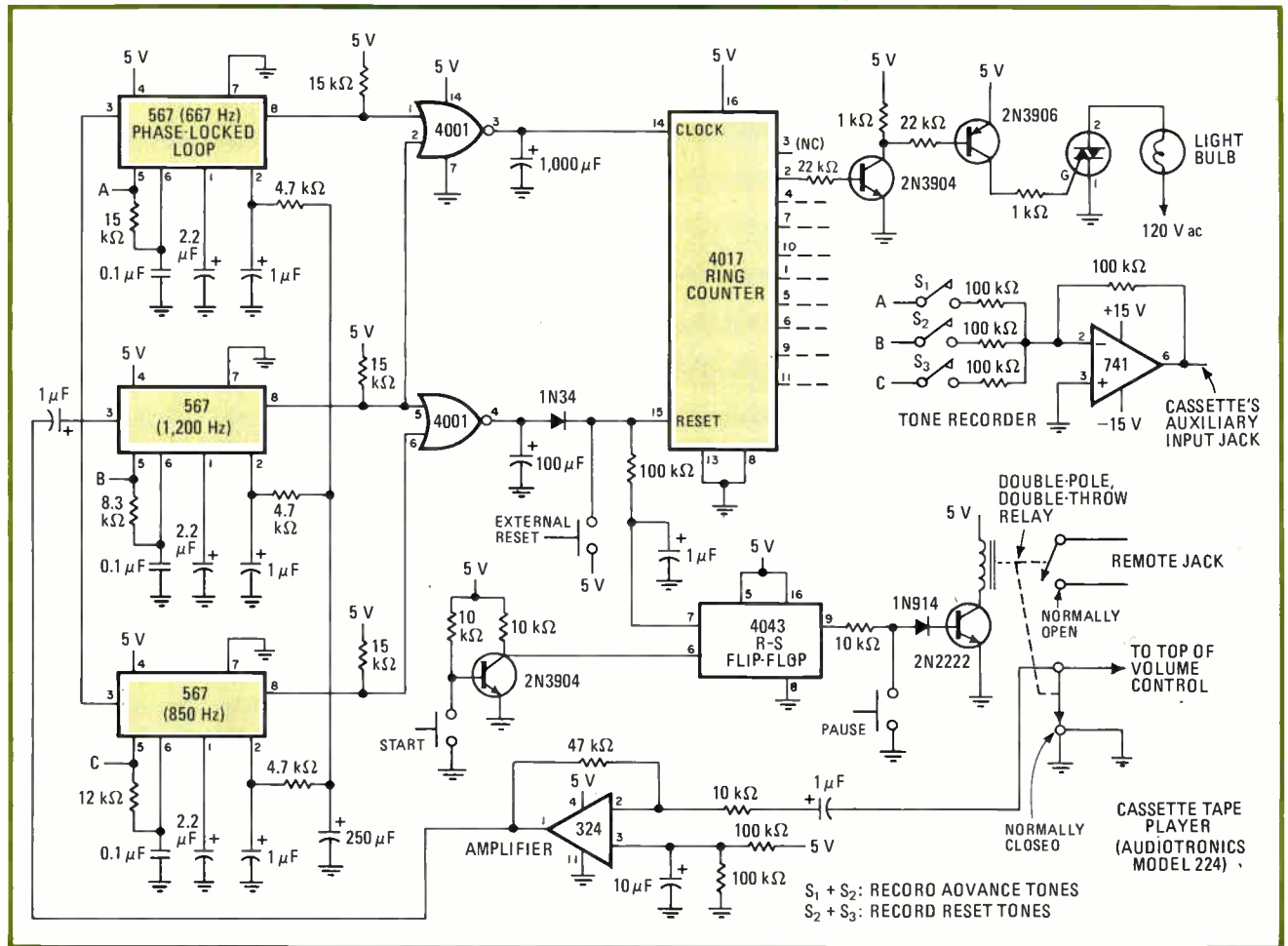

**Show and tell.** This interface synchronizes sound with illuminated panels and can be used in museum or science building displays. Cassette tapes hold recorded segments corresponding to information seen on illuminated display panels. When the circuit detects a chord preceding a given segment of text, the following panel is illuminated. Also, the interface has an automatic shut-down feature.

parency is played. At the end of the message a second pair of recorded tones (667 and 1,200 Hz) causes the 4017 counter to advance to pin 4, turning off the first light and turning on the second with its appropriate interfacing transistors and triac.

This process is repeated until all transparencies have

been displayed and described. At the end of the show, recorded tones at 850 and 1,200 Hz activate their respective PLLs and the 4017 is reset so that all lights are turned off. The 4043 R-S flip-flop is also reset and turns off the 2N2222, which deactivates the relay and turns off the cassette player. □

## Making a clock chip keep better time

by M. F. Smith

Department of Computer Science, University of Reading, England

Maintaining both the time and date functions in microprocessor applications became much easier when National's MM58167 and MM58174 microprocessor-compatible real-time clocks were introduced. The software approach that was used before their introduction simplified software and memory requirements, allowed increased flexibility of clock rates and selection of time, resolution, and easily accommodated scheduling protocols. However, keeping time during a brown-out was still disastrous to system operation as was attempting to maintain the correct time despite the occasional timing difficulties that occur under software control.

Yet, occasional read errors and problems with spurious writing to the MM58174 when power is going

down creates difficulties with the hardware-based system. These difficulties can be overcome with the software and hardware fixes prescribed here, which are intended for the MC6800 microcomputer system.

The problem with occasional read errors may be easily overcome by modifying software control to ensure that a valid binary-coded decimal number is read before the program continues and by ordering a rereading of the data if it has not been captured the first time (see printout of the partial listing, line 84). The cause of the read errors has never been definitely ascertained, although the problem has been encountered when other microprocessors have been used, such as National's 1NS8073. Thus, there may be a rare timing problem within the MM58174 itself, or the difficulty may occur between the microprocessor and the clock chip.

Trying to write to the clock chip when the power is going down will ordinarily cause a loss of timing information. A number of methods of preventing the loss were tried, and the one in the figure was the simplest and most successful.

Here, the CD4066 electronic switch will allow the chip to be selected only when the MC6800 clock enables

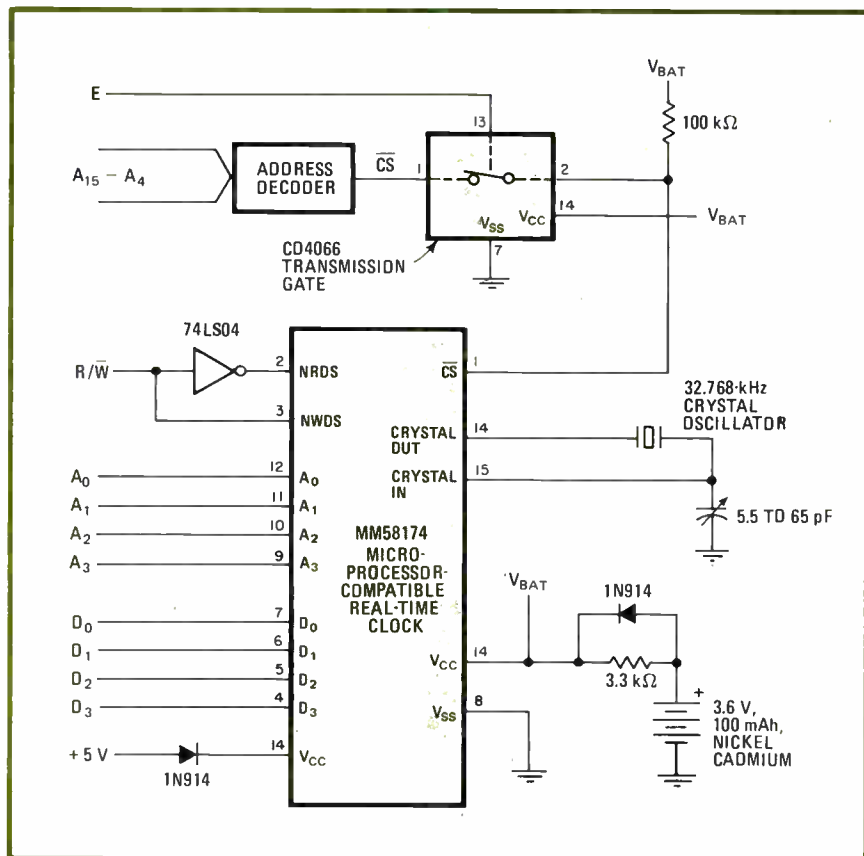

**Glitch-free.** The CD4066 transmission gate prevents loss of time-date information that is associated with an MM58174 hardware clock during a power-down condition. Read errors in time-date information may be eliminated in the software of a microprocessor system by writing a loop to ensure the program does not advance until the data has definitely been read correctly.

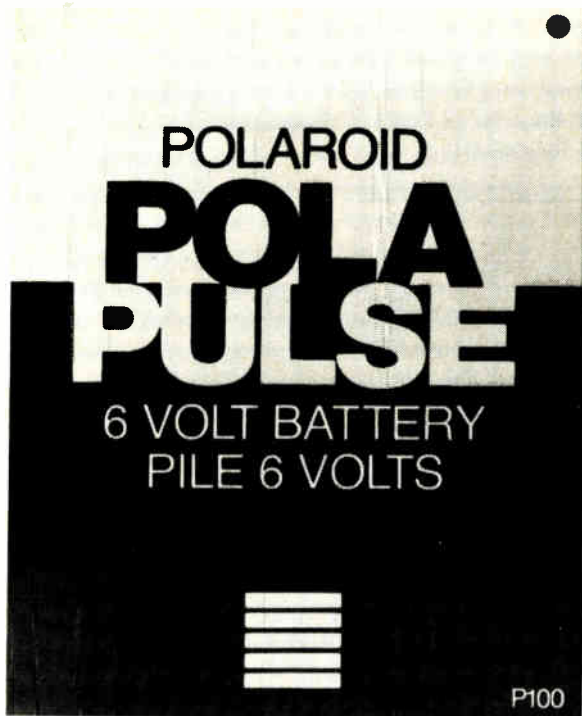

ACTUAL SIZE

P100



SIDE VIEW

The 6-volt wafer-thin battery that can change the shape of things to come.

We've developed a battery at Polaroid called the Polapulse P100. It's thinner and lighter than any conventional battery we've ever seen.

It can make products thinner, lighter and more compact than if they used conventional batteries. In some cases it can make a product easier to use. It can even help, in some instances, to increase profits.

**Less cost, more profit.**

For example, take the prototype for a printing calculator.



The Polapulse battery's unique card-in-slot replacement feature requires a one-piece, rather than a three-piece mold, saving 33% of a

manufacturer's plastic costs.

With less plastic the calculator is a sleek 6½ x 3¾ x 1½", weighs only 11.2 ounces, and saves 38% of packaging and shipping costs.

And since Polapulse needs fewer contacts, a manufacturer saves 70% of contact costs.

Equally notable is the particular ability of the Polapulse battery to power a printing calculator's motor with a surge of high current at the beginning of each print. It can then satisfy the high surge

demand with low internal resistance and fast voltage recovery.

**Heavy duty lightweight.**

Design engineers at D.E.I. Teleproducts, a West Coast manufacturer of line drivers, developed test equipment with the Polapulse P100 battery. D.E.I.'s new interface monitor and tester is less bulky and more portable because Polapulse is four times lighter than the conventional power source.



Polapulse has 6 volts of power packed into a one-ounce 3.73 x 3.04" parcel only .18" thick and offers high surge at short pulse. This provides D.E.I.'s new equipment with brighter, easier-to-see LED's.

The interface monitor and tester, only 5¾ x 4¾ x 1", has a larger face than comparable testers which permits bigger turrets spaced farther apart for easier connections.

**Thin battery, wide appeal.**

A new slide bolt, door-mounted burglar alarm owes its streamlined 4 x 3¼ x 1½", 8-ounce design to the Polapulse battery.

Again, the card-in-slot replacement feature makes an important contribution. The

burglar alarm can remain in place at all times. Even when changing batteries.

It is also virtually impossible to short out the battery by accidentally reversing polarity of the contacts.

The user does not experience perceived product failure. And, therefore, does not send the product back to the manufacturer for a repair that simply entails proper battery replacement.

**Security is a Polapulse battery.**

Every Polapulse receives 100% inspection, the sort of inspection reserved for major manufacturers' top-of-the-line power cells. Each Polapulse receives electrical and visual inspection at assembly and again after 60 days of controlled aging.

It also features a unique seal modeled on the Polapulse SX-70 film pack battery which boasts an infallible leakage record—no known leak damage in over 400 million SX-70 film packs.

**Your chance to wield power.**

Experiment with our Designer's Kit. It contains five Polapulse P100 batteries and a molded battery holder.

Send check or money order for \$16.75\* (plus applicable taxes) to Polaroid Corp., Commercial Battery Division, Dept. A494, 784 Memorial Drive, Cambridge, Mass. 02139.

For more information about the battery that can change the shape of things to come, call us at (617) 577-4228, or write to the above address.

**Polaroid**

Our inventions can be your components.





PARTIAL PROGRAM LISTING FOR CONTROL OF MM58167 MICROPROCESSOR -COMPATIBLE REAL-TIME CLOCK

Hexadecimal code	Location and label	Mnemonic	Operand	Comments
004E 004E B67807 0051 8D30 0053 25F9 0055 B67806 0058 8D29 005A 25F9	82 HR_MIN_DISPLAY: 83 H_T 84 85 86 H_U 87 88 89	LDA BSR BCS LDA BSR BCS	HOURS_TENS,E DIGIT_DISPLAY H_T HOURS_UNITS,E DIGIT_DISPLAY H_U	;GET HOURS FROM CLOCK CHIP ;AND PUT IN BUFFER ;RETRY IF CLOCK CHIP ;DOES NOT READ PROPERLY ;RETRY IF ERROR
005C 863A 005E BD0000	90 91 92	LDA JSR	#: " DISPLAY	DISPLAY COLON
0061 B67805 0064 8D1D 0066 25F9 0068 B67804 006B 8D16 006D 25F9	93 M_T 94 95 96 M_U 97 98 99	LDA BSR BCS LDA BSR BCS	MINUTES_TENS,E DIGIT_DISPLAY M_T MINUTES_UNITS,E DIGIT_DISPLAY M_U	;DISPLAY MINUTES ;RETRY IF ERROR
006F 863A 0071 BD0000	100 101 102	LDA JSR	#: " DISPLAY	;DISPLAY COLON
0074 B67803 0077 8D0A 0079 25F9 007B B67802 007E 8D03 0080 25F9 0082 39	103 S_T 104 105 106 S_U 107 108 109 110 ;	LDA BSR BCS LDA BSR BCS RTS	SECONDS_TENS,E DIGIT_DISPLAY S_T SECONDS_UNITS,E DIGIT_DISPLAY S_U	;DISPLAY SECONDS ;RETRY IF ERROR ;RETRY IF ERROR
0083 0083 840F 0085 8109 0087 2207 0089 8B30 008B BD0000 008E 0C 008F 39 0090 0D 0091 39	111 DIGIT_DISPLAY: 112 113 114 115 116 117 118 119 A_S_ERROR 120 121 ; 122 ;	ANDA CMPA BHI ADDA JSR CLC RTS SEC RTS	#0FH #9 A_S_ERROR #30H DISPLAY	;MASK OFF TOP PART ;MUST BE A NUMBER ;MAKE ASCII ;AND OUTPUT TO DISPLAY ;FLAG SUCCESSFUL ;FLAG ERROR
0092 0092 B67809 0095 8DEC 0097 25F9 0099 B67808 009C 8DE5	123 MO_DISPLAY: 124 D_T 125 126 127 128 129	LDA BSR BCS LDA BSR	DAYS_TENS,E DIGIT_DISPLAY D_T DAYS_UNITS,E DIGIT_DISPLAY	;DISPLAY DAYS ;RETRY IF CLOCK CHIP ;READ ERROR
009E BD0000	130 131	JSR	DISPLAY_SPACE	;SEPARATE
00A1 F6780C 00A4 C40F 00A6 C109 00AB 22F7	132 MO_T 133 134 135 136	LDAB ANDB CMPB BHI	MONTHS_TENS #0FH #9 MO_T	;SHOW MONTHS ;MASK OFF TOP PART ;MUST BE A NUMBER ;RETRY IF ERROR
00AA 4F 00AB 5D 00AC 2705 00AE 5A 00AF 8B0A 00B1 20F8	137 138 QUICK_CNV 139 140 141 142 143	CLRA TSTB BEQ DECB ADDA BRA	MO_U #10 QUICK_CNV	;CONVERT B INTO ;BINARY OF DECIMAL ;VALUE
00B3 F6780E 00B6 C40F 00B8 C109 00BA 22F7	144 MO_U 145 146 147 148	LDAB ANDB CMPB BHI	MONTHS_UNITS #0FH #9 MO_U	;MASK OFF TOP PART ;MUST BE A NUMBER ;RETRY IF ERROR

it. Once power to the microprocessor begins to fail, the signals from the E line cease and the MM58174 can no longer be selected. The 100-kilohm resistor is required to hold the chip-select line high when the electronic switch is open.

The software for using the hardware clock with the MC6800 is fairly straightforward. However, the pro-

gram requires a few external routines for accessing the output port and a look-up routine for accessing the month, so that program size will be about the same as for a totally software-based clock.

Engineer's notebook is a regular feature in *Electronics*. We invite readers to submit original design shortcuts, calculation aids, measurement and test techniques, and other ideas for saving engineering time or cost. We'll pay \$75 for each item published.

## **Chemical analysis made easy for EEs**

At times every electronics engineer needs to know the composition of an ink resin, plastic, adhesive, sealants, or other commercial organic material. But his rudimentary chemistry background rarely equips him for the task. A new series of analytical kits that should ease this situation are now being supplied by Novitex Inc., P. O. Box 6777, San Buenaventura Research Center, Ventura, Calif. 93006.

The kits provide more information than do conventional infrared spectroscopy and complement quantitative methods. The user simply heats a very tiny sample of the test material in a test tube with one or more special reagents and holds a strip of filter paper moistened with other reagents over the mouth of the tube. **Then if a particular color of stain results, a certain chemical monomer or polymer is present.** Among the materials that can be identified are vinyl chloride, acrylonitrile, styrene, epoxies, urethanes, and silicones. Kit prices vary from about \$60 to \$180, depending on the series of polymers selected.

## **Elastomeric film keeps chips in their place**

In hybrid manufacturing, assembly positions normally have cavity trays (sometimes called waffle packs) or flat glass plates carrying arrays of chips that will eventually be attached to hybrid substrates. A different cavity tray is required for each chip size. Because of the clearance required for picking chips out of the cavities, chips can rattle and bounce. In addition, chips can become misoriented, causing problems in automatic assembly. The same sort of problem occurs with the glass trays.

A novel carrier designed by Gel-Pak Chip Carrier Systems, a division of Vichem Corp. in Stanford, Calif., uses a thin film of a Dow Corning silicone rubber to immobilize the delicate electronic chips. In the carrier, a 15-mil-thick film of clear silicone is applied to a flat glass or plastic tray or to the bottom of a snap-lid plastic box. Once a chip is placed on the rubbery surface, **friction between the two surfaces holds it so firmly it will not slip or bounce**, even if the carrier is tilted or jarred. Chips can be removed easily with either tweezers or vacuum collets. Only two film types are needed to handle virtually every device size: one with a smooth silicone surface for small chips and beam-lead devices and the other with a specially treated silicone for large devices. A silicone elastomer was selected for this application because of its durability, transparency, and high temperature resistance.

## **Where to read up on the reliability of nonelectronic parts**

The reliability of electronic equipment is certainly one of the most pressing problems of the 1980s, and of course most of the attention has been focused on semiconductor and passive component reliability. But what about the hundreds of nonelectronic parts in use, such as switches, relays, connectors, integrated-circuit sockets, motors, and so on? The second edition of the Reliability Analysis Center's compilation of analyzed reliability data on nonelectronic parts will soon be issued. This 280-page volume contains the failure rates and failure modes of a wide variety of mechanical, electrical, pneumatic, hydraulic, and rotating parts. It combines a presentation of failure rates at the generic-part level with **detailed line entries representing experience at the equipment level of parts operated in many different field environments.** A copy of NPRD-2 costs \$60. It may be ordered directly from Reliability Analysis Center, Griffiss Air Force Base, N. Y. 13441, or by calling (315) 330-4151. -Jerry Lyman



# AT BUSSMANN, ALL FUSES ARE CREATED EQUAL.

THE FIRST FUSE WAS 99  $\frac{44}{100}$ ° PERFECT. WE MAKE THE REST JUST LIKE IT.

Reliability of a Buss fuse is designed in and built in. We spend a lot to make certain that each one is as good as its near-perfect prototype. It's one of the reasons why Buss is the best-known name on fuses. But there are other reasons.

Like the Buss MDL dual-element fuse (above). It's designed to absorb starting currents up to five times normal for ten seconds without nuisance tripping, yet protect equipment by clearing safely in one-half a wavelength on shorts. And when we manufacture them, we make certain they will do exactly that. By testing each fuse, individually. Random checking is not good enough where circuit protection is concerned.

Bussmann reliability also comes from other things we do: like sophisticated new fuse designs; like our extensive technical literature program; like our traveling

fuse seminars, like the industry's largest corps of technical people to help you with applications.

If you are looking for simple, reliable, no-nonsense circuit protection, get Buss and everything that goes with it.

See your Buss distributor for any of our 3,000 electronic fuses, clips, blocks and accessories. See your Buss sales representative for applications assistance. Bussmann Division, McGraw-Edison Company, P.O. Box 14460, St. Louis, Missouri 63178. (314-394-2877)

**McGraw-Edison**

**Bussmann**

ELECTRONICS PROTECTOR NUMBER ONE.

Circle 147 on reader service card

# THE DIP.

The new contact is designed so it won't pull out on you. We've offset the contacts in the connector body for improved support.

The tail's right on spec, too: MIL-C-83503/6. The result: assured quality and reliability.



Choose your contacts: selectively plated with 30u" of gold. Or tin-plated, for lower costs on the right applications.

Either way, you get outstanding electrical and mechanical performance. (And Scotchflex products have successfully passed 40-year life-cycling testing)

The secret behind the new Scotchflex® brand connector is riveting: the cover is locked onto the connector body so it won't come loose.

So we call it "Rivet Top." When assembled, the plastic posts are forced down and locked in place.

# THIS NEW 3M CONNECTOR IS ONLY THE DIP OF THE ICEBERG.

# THE ICEBERG.

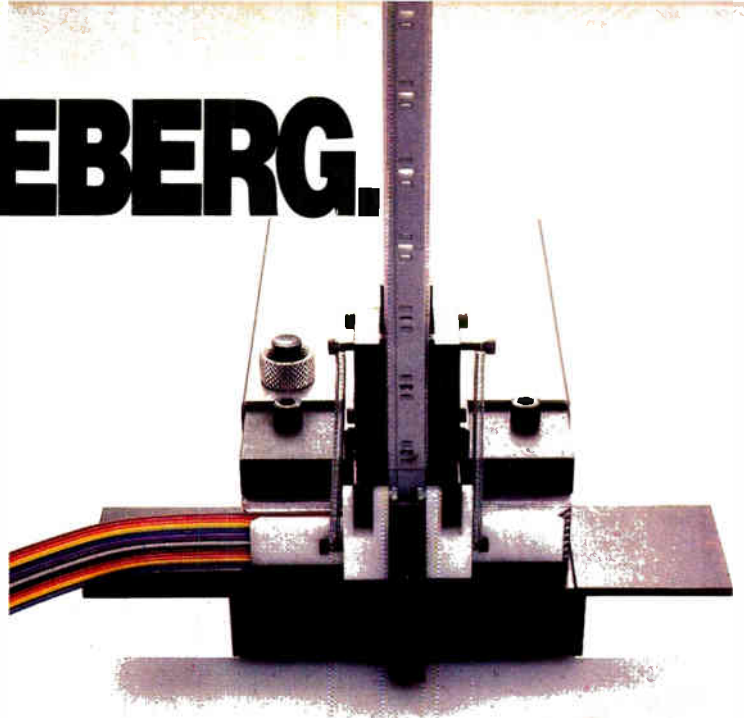

Now 3M takes you a step beyond pre-assembly, for what we think is the fastest jumper assembly system on record. It all starts with the special magazine for 14-pin and 16-pin connectors. It comes pre-loaded. Just position the magazine in the new automatic DIP terminator.

Next, cut your cable to length. Insert it into the terminator. Activate the switch. In less time than it takes to tell, your jumper assembly is ready to go.

The system slashes production time by up to 66%; cuts reject rates; delivers every ounce of reliability you demand.

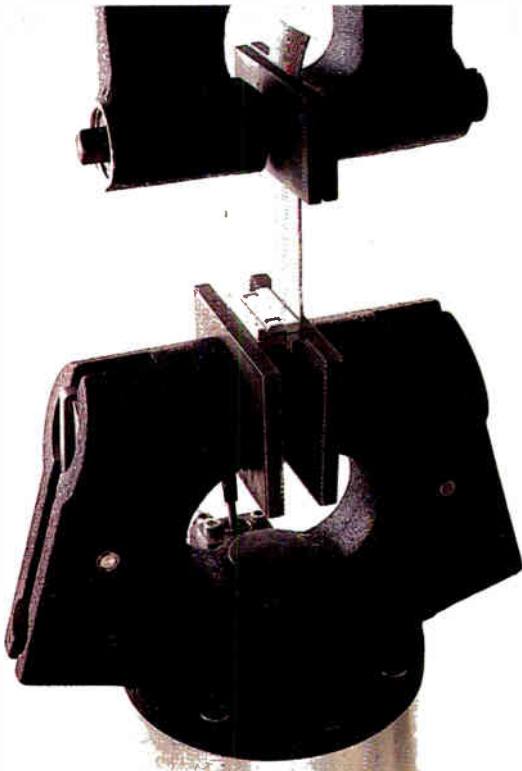

The bottom line: a connector-cable assembly with 16 pounds of retention strength—one of the industry's highest for 14-pin and 16-pin connectors.

Add the reliability of 3M's proven U-contacts; the high performance of Scotchflex cable: you get a system that's a lot more than the sum of its parts.

And for a change, more costs less, two ways. The DIP has a new, lower price—you get economy from the very first order. And the new terminator lets you boost productivity and cut assembly costs.

So call your 3M distributor for the details, or write Electronic Products Division/3M, 225-4S, 3M Center, St. Paul, MN 55144. You'll see why it pays to Specify the Source.

3M Hears You...

# 3M

Circle 149 on reader service card

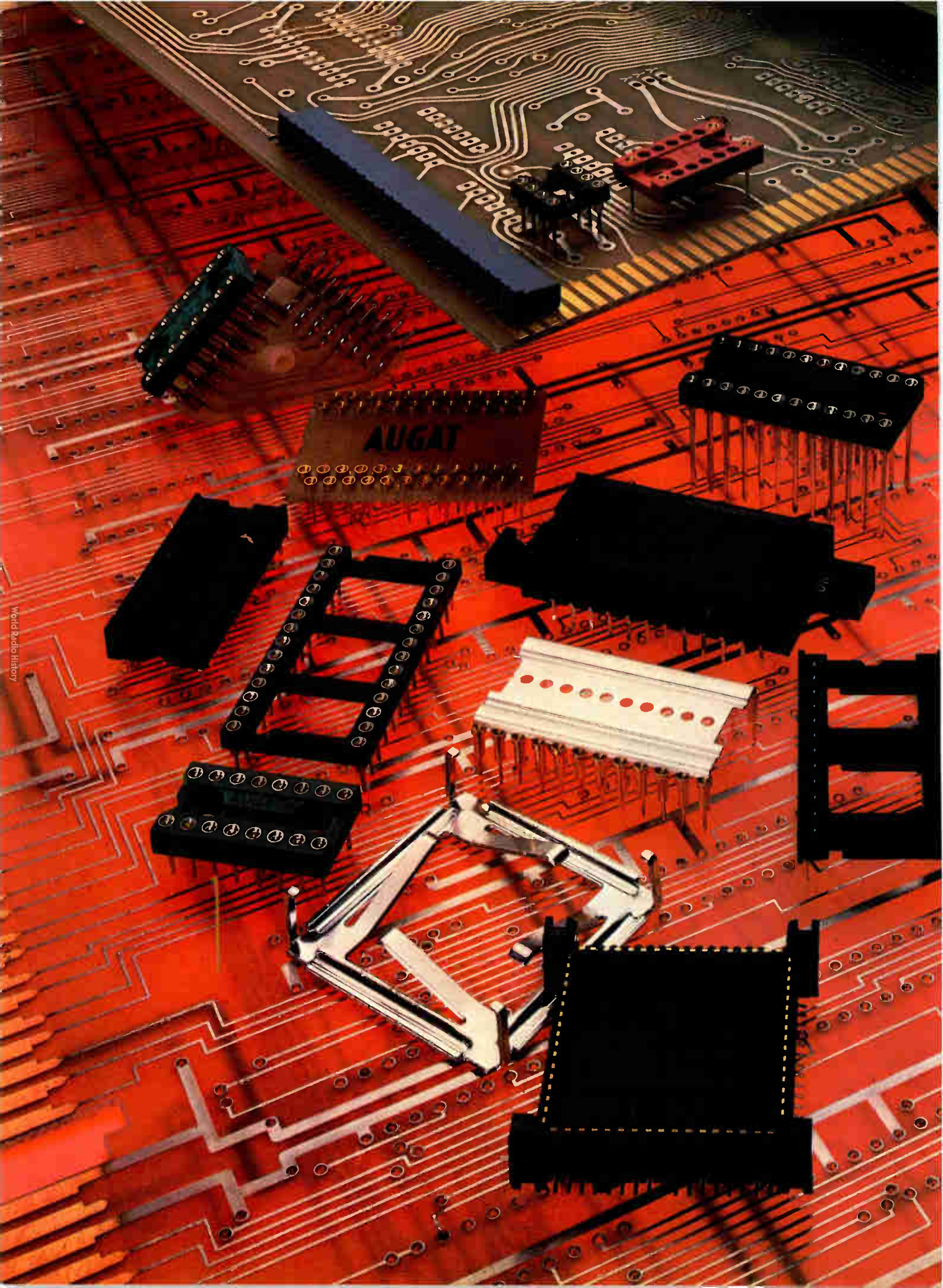



# Augat applies for your job.

Name:

Augat, Inc.

Experience:

Over 30 years designing and manufacturing the broadest selection of sockets in the industry. With sizes, specifications and prices to fit every application.

Professional Qualifications:

**HIGH-RELIABILITY DIP SOCKETS.** Versatile precision 4-finger machined contacts. All popular DIL and SIL packages. 100% anti-flux and solder wicking. Choice of solid, open or no insulators.

**LOW-COST SOCKETS.** For superior performance with economy. A broad line of single and dual contacts in a wide selection of materials and platings.

**HIGH-TECHNOLOGY SOCKETS.** The finest quality leadless chip carriers, planar array pin packs, LIF DIP sockets and many others.

**SPECIALTY SOCKETS.** IC connectors for high temperature burn in, Quad-in line packaging, numerical display, special LSI or hybrid packaging and other sophisticated applications.

References:

More than 2000 customers. (Names furnished on request.)

Availability:

Ready to go to work for you today. Just call your Augat distributor, or contact Augat, Inc., 33 Perry Avenue, P.O. Box 779, Attleboro, MA 02703. Tel: (617) 222-2202. TWX: 710.391.0644.

**AUGAT**<sup>®</sup>

Augat interconnection products,  
Isotronics microcircuit packaging,  
and Alco subminiature switches.

"See us at Wescon, Booth #422"

Circle 151 on reader service card

# Can your application use





# a \$653\* 16-bit micro?

If your system design is stretching the capabilities of 8-bit performance, take the step into 16-bit micros without sacrificing cost efficiency.

And at the same time, get all the advantages of a more powerful and proven instruction set. Faster processing. Larger addressing capability. Expandability which allows your system to grow as your needs grow, without changing system architecture. And without appreciably changing your software requirements.

Chances are, you *can* use Digital's \$653 16-bit micro in your application.

For full information, fill out the coupon or call toll free (800) 225-9220. In MA, HI, AK and Canada call (617) 467-7000. Or simply contact the Hamilton/Avnet or Harvey Electronics office near you.

\*In quantities of 50. Single unit price is \$990. Domestic U.S. prices only.

Please rush your 16-bit Micros Application Information Package to me at once. My application is:

- Laboratory/Scientific
- Data Communications
- Industrial Controls (please specify) \_\_\_\_\_
- Other (please specify) \_\_\_\_\_

Name \_\_\_\_\_

Title \_\_\_\_\_

Company \_\_\_\_\_

Street \_\_\_\_\_

City \_\_\_\_\_

State \_\_\_\_\_ Zip \_\_\_\_\_ Tel. (    ) \_\_\_\_\_

**Digital Equipment Corporation**  
Microcomputer Products Group, MR2-2/M65,  
One Iron Way, Marlboro, MA 01752

DEC-C-169

N-8-25-1

**digital**

**We change the way  
the world thinks.**



## Quest for latest digital technology to draw huge crowd to San Francisco

by Howard Wolff, *Associate Managing Editor*

□ When Wescon/81 opens its doors in San Francisco's Civic Auditorium and Brooks Hall on Sept. 15, the show that has become the largest electronics exhibition in the U.S. will also be closing out its third decade. And, as has become the custom in recent years, it will be a sellout. Exhibits will overflow the 819 booths those two halls can accommodate into 138 booths at the San Francisco Hilton Hotel—the first time the hotel has been used for Wescon exhibits.

During its three-day stand in the city that likes to call itself America's favorite, Wescon's professional program at the hotel will include 36 sessions. Some 55,000 persons are expected to register, topping the record 53,103 who turned out last year at Anaheim, Calif. (the show alternates between San Francisco and the Los Angeles

area). And there will be a "last" at this year's edition—the final Wescon at the Civic Auditorium and Brooks Hall. When it returns to San Francisco in 1983, the show will be housed at the new Moscone Convention Center.

As for the program itself, among the highlights will be sessions on integrated circuits—in general, microprocessors and, in particular, communications. Heavy emphasis will again be placed on digital technology.

### Quick work on fast LSI

For session 14, on very high-speed large-scale integration, Rob Walker, engineering vice president for the recent start-up company LSI Logic Corp. of Santa Clara, Calif., will bring together speakers from IBM, Motorola, Honeywell, and his own firm to discuss their bipolar

circuit technologies. IBM Corp.'s Hopewell Junction, N. Y., facility will disclose a circuit technique that features the high performance of emitter-coupled logic but with less than TTL power consumption. Motorola Inc. of Mesa, Ariz., and Honeywell Inc.'s Plymouth, Minn., Solid State Electronics division will outline the plans for their ECL and current-mode-logic processes, respectively.

LSI Logic will give a paper entitled "Future Trends in High-Speed LSI and VLSI." The presentation will provide an overview of trends in process, device, and circuit technology, design techniques, and the testing and assembly of semiconductor chips. In addition, LSI Logic will allude to its first product: a gate-array design system called the LDS I (Fig. 1).

The compact LDS I computer-aided design system will automate every step between a customer's logic diagram and mask generation. The system provides for logic checking, circuit simulation, macrocell placement, path timing, and test-program generation. The idea is to allow a system engineer, unfamiliar with gate-array layout and design, to complete a design—regardless of chip technology.

In session 25, on electrically erasable programmable read-only memories, speakers from Intel, Xicor, General Instruments, and Hughes Aircraft will discuss their offerings. There will be some new product introductions. For instance, Intel Corp., in Santa Clara, Calif., is coming out with a slightly different version of its 2-K-by-8-bit EE-PROM that will emphasize block erasure (as opposed to byte and block erasure in its 2816) for a lower cost per bit. In addition, the Hicksville, N. Y.-based General Instrument Corp. may soon supply a metal-nitride-oxide-semiconductor 2-K-by-8 bit EE-PROM intended as a replacement part for Hitachi's 16-K MNOS EE-PROM. Xicor Inc. of Sunnyvale, Calif., will discuss its so-called shadow random-access memories, a device type Hughes Semiconductor in Newport Beach, Calif., is developing in complementary-MOS.

### PALs and PROMs

Programmable-array logic, or PAL chips, plus some of the latest programmable ROMs, will be the subject of session 33, on user-programmable circuits. John Birkner of Monolithic Memories Inc. in Sunnyvale has come up with a development system and a high-level language specifically for PAL devices. Written in Basic and Fortran, the designer enters a logic description and the system verifies the circuit and ultimately programs the PAL chip.

By scaling down geometries, Intel has taken its bipolar fusible-link PROMs to the 32-K density level with an access time of 40 nanoseconds. In Melbourne, Fla., Harris Semiconductor, too, has shrunken its pioneering 4-K C-MOS fusible-link PROMs for two new 16-K parts, organized by 4 and by 8 bits. Interestingly, Intel and now Harris both use polysilicon fuses.

Advanced Micro Devices Inc. of Sunnyvale has engi-

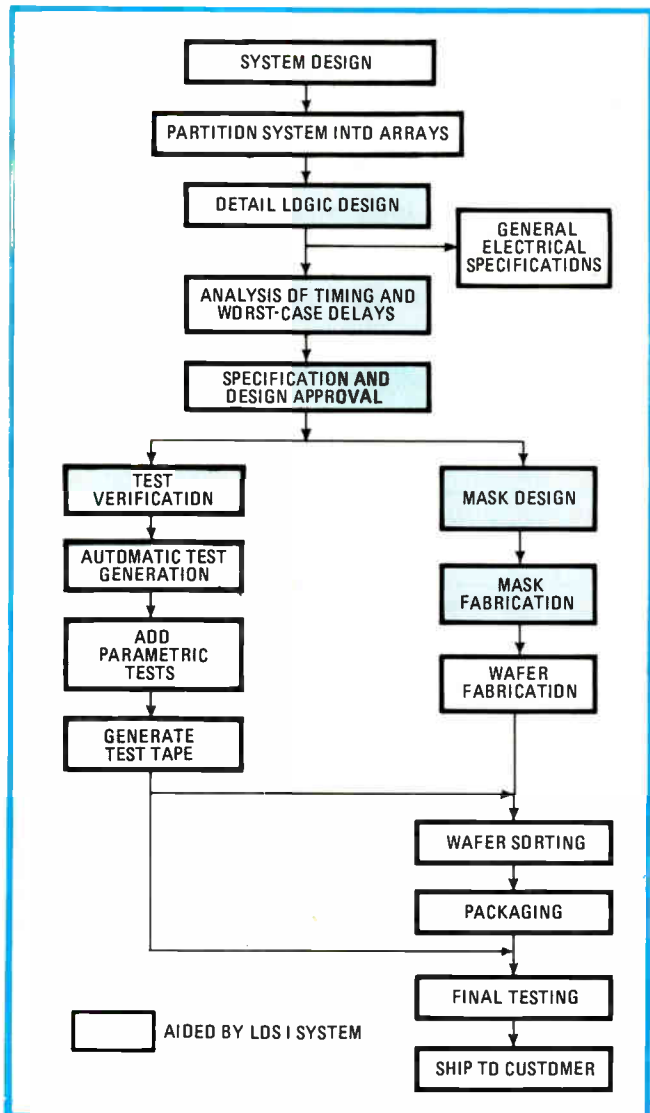

1. CAD takeover. In session 14, "Very High-Speed Digital Large-Scale Integration," LSI Logic will show how its first product, the LDS I gate-array design system, will assist users in the phases of gate-array design and production highlighted in color above.

needed a bipolar PROM called a registered PROM that incorporates an output latch for pipelining operations. The latch holds the data referenced during the previous cycles so that subsequent accessing can occur in parallel.

The highlight of the microprocessor sessions will be the ninth—"Virtual Memory Concepts for 16-bit Microprocessors." Details of three new memory management units for the leading 16-bit microprocessors will be revealed for the first time—the iAPX-286 from Intel, the MC68451 from Motorola Inc. in Austin, Texas, and the Z8015 from Zilog Inc. in Cupertino, Calif. Also, National Semiconductor and Texas Instruments will present papers on their approaches.

The 286, due to see silicon early next year, is the only

16-bit microprocessor to employ an on-chip memory management unit. It maintains software compatibility with the 8086 by making the additional circuitry transparent to the user. Its memory-mapping registers are actually widened versions of the segment registers already present on the 8086.

Motorola's 68451 is a companion to its 68000 microprocessor, the 16-bit machine that gets the prize for having the most second sources (six, of which four were announced since last year). This part uses some novel masking techniques to provide user protection and page

relocation. It also includes an instruction-abort output for missing page faults. However, this output will not be very useful until the new version of the 68000 that allows instruction restarting comes out next year.

Zilog will discuss its second memory management unit at a time when everyone else is still coming up to speed on a first. Nor is the new one, the Z8015, just a remake of its present Z8010. It is a new design that divides the 8-megabyte address space of the Z8001 microprocessor into 4,096 pages of 2-K bytes each. Thus, users of the Z8001 will be able to choose between a variably-

**WESCON/81 TECHNICAL SESSION SCHEDULE**

	TUESDAY			WEDNESDAY		
	9:00 – 11:00 a.m.	12:30 – 2:30 p.m.	3:30 – 5:30 p.m.	9:00 – 11:00 a.m.	12:30 – 2:30 p.m.	3:30 – 5:30 p.m.
<b>Signal Processing</b>	Trends in digital signal/array processing	Trends in digitizing signal analyzers				
<b>Design</b>				Very high-speed digital large-scale integration	The outlook for linear ICs in the '80s Transporting high-speed digital signals point-to-point on circuit-board assemblies	
<b>Instrumentation and Test</b>			User friendliness in advanced instrumentation	IC sensors markets, applications, and technologies		Analog-to-digital interface systems
<b>Memories</b>			Virtual memory concepts for 16-bit microprocessors and computers			
<b>Microcomputers</b>	16-bit microcomputer architectures				Single-chip microcomputers, part 1	Single-chip microcomputers, part 2
<b>Microprocessors</b>		Advanced 16-bit peripherals – the family concept		Trends in complementary-MOS microprocessors		
<b>Packaging and Production</b>					Flux residue removal and its impact on quality control and reliability	Advances in leadless chip-carrier packaging and attachment
<b>Telecommunications</b>				Fiber optics today		Mixers for high-performance radio
<b>Speech</b>	Speech technology in the 1980s	Voice processing	Computer-controlled voice message systems and the office of the future			

sized-segment approach to memory management and a fixed-size-paged approach.

For microcomputers, sessions 17 and 21 form a two-part series that focuses on single-chip models. In the first part, the cost-effective use of such devices for system design is the primary concern.

Perhaps the best example of this is seen in the paper in which Peter Brown, an applications engineer at Zilog, describes the design of a general-purpose microcomputer board fabricated with only seven chips, as shown in Fig. 2. Key to this compact configuration is a special micro-

computer, the Z8671, which has a Basic interpreter and debugging routines in its 2-K bytes of on-board ROM. In addition, the chip is configured to serially input and output information to a terminal and external memory.

### High-speed logic on boards

In past years, circuit designers rarely had to contend with routing high-speed digital signals on circuit-board assemblies. Now there is a host of families available. The purpose of session 18 is to give the circuit designer background when digital signals must be transported at high speed through double-sided and multilayer printed-circuit boards or through boards that have been wired by the Wire-Wrap or Multiwire processes. The challenge to the engineer is to preserve signal fidelity while holding down crosstalk.

All the papers in this session treat signal lines as transmission lines. In the first and most basic paper, Thomas Balph, manager of systems engineering at Motorola Semiconductor Sector's strategic industrial marketing branch in Phoenix, Ariz., discusses the characteristics of microstrip, stripline, and wire over ground in relation to pc boards and discretely wired circuits. The causes and cures of ringing and crosstalk are also covered, as they apply to the various logic families shown in Balph's table (see p. 159). One of the more interesting papers is by N. C. Arvanitakis and J. J. Zara of IBM Corp.'s System Products division in Endicott, N. Y. They go into the design and measurement results for the electrical parameters for the card-on-board packages used in the IBM 4300 series processors.

One of the nagging problems facing packaging engineers today—how to reliably attach leadless chip-carriers to pc boards—will be attacked in session 22. Specific experiences as well as directions in packaging will be discussed. Perhaps the session's most useful paper is one by Charles Lassen of the PCK Technology division of Kollmorgen Corp. in Melville, N. Y. Called "Discrete Wired Metal-Core Substrates for Leadless Chip-Carriers," it reviews the options available to the designer interested in attaching carriers to pc boards—a leaded conversion as in the use of clips or sockets; the use of a low-expansivity substrate like epoxy/Kevlar; and the use of supported thin substrates on a metal core, such as Lampac and thin discrete wiring.

### Outlook for instruments

With a multitude of new varieties of instruments on the floor of Wescon this year, two technical sessions will help give potential users a perspective on what is happening in instrument design. Session 7, chaired by Arthur Crooke of Data Precision Inc. of Danvers, Mass., will examine some recent trends toward what Crooke describes as "a new class of generalized sampled-data measuring instruments."

What Crooke has noted in the industry today is that advances in analog-to-digital conversion speeds and the

THURSDAY		
9:00 – 11:00 a.m.	12:30 – 2:30 p.m.	3:30 – 5:30 p.m.
Technology to help the handicapped		
Electrically erasable memories provide new system flexibility	Battery backup techniques for memory preservation	
Microcomputer bus structures	Computers for engineering applications	User-programmable circuits
Multitasking operating systems	The expanding spectrum of microprocessor peripherals	Standard software for standard microcomputer modules
		Microprocessors in industrial control

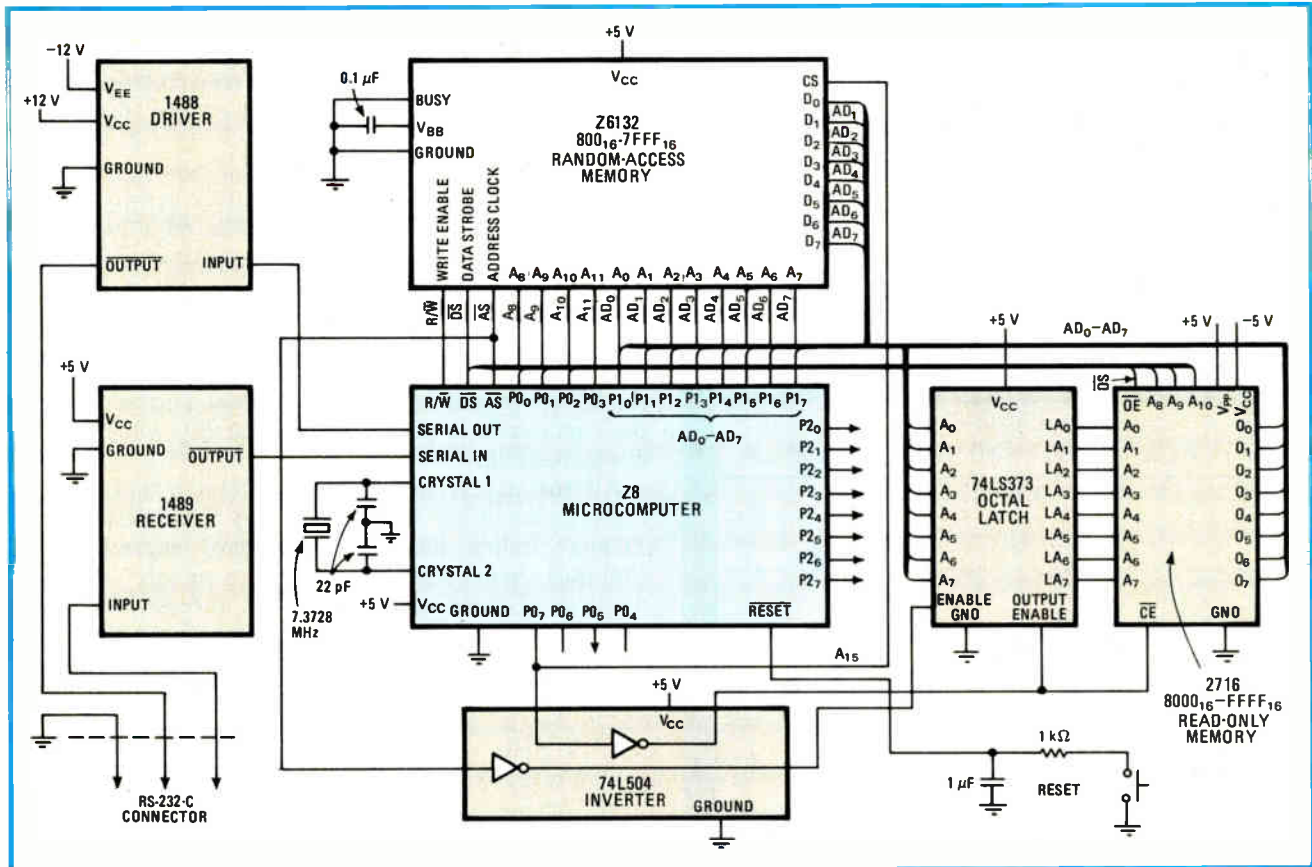

**2. Magnificent seven.** A full microcomputer board, with an RS-232-C port linking with a terminal and having Basic burned into the on-board microcomputer ROM, consists of only seven chips. It is described in session 17 in the talk on a compact Z8 board.

availability of inexpensive memory and computing power is making the architectures of various sampled-data instruments—digital oscilloscopes and spectrum analyzers, for example—roughly comparable. Extrapolating from these observations, the session's participants will consider the factors that influence the degree of specialization evident in today's processor-based instruments and will attempt to define a general-purpose instrument such as the one shown in Fig. 3.

The fact that sophisticated computing power is becoming readily available in instrumentation today creates a problem that will be examined in session 11. Instrument designers now have to take into account the fact that the user of a measurement tool should not need a computer science degree to operate it, and so the session will examine the question of user friendliness in advanced instrumentation. The session chairman is Bob Anundson of Tektronix Inc., who was largely responsible for the creation of the Beaverton, Ore., firm's 4041 IEEE-488 controller [*Electronics*, Aug. 11, 1981, p. 129].

To judge by the contents of session 15 on IC-sensor technology, the cost-sensitive consumer markets are still a long way from having the broad range of microprocessor-compatible sensors that they could use. A market

overview from S. E. Craft and R. S. Whiskin of Mackintosh Consultants Co. in San Jose, Calif., projects that the U. S. automotive industry will consume about 110 million sensors in 1986, representing a market worth around \$225 million—the estimated world market for all sensors being around \$600 million. But the session papers are limited to high-performance strain gage and pressure transducer technology and do not address the tough task of low-cost data acquisition.

### Analog-digital interfaces

Data-conversion and -acquisition systems will be subjected to several reviews and error analyses in session 23, which will be chaired by John Sullivan of Harris Semiconductor. To keep pace with the rapid development in microprocessors, data converters are being pushed to higher levels of integration—the pace of their advance being limited mainly by the difficulty of combining digital and analog functions in any one technology. Gerard McGlinchey and Edgar Macachor of Advanced Micro Devices will describe a high-frequency linear bipolar process that can support fast, dense, low-power logic gates. By using a 1-ohm-centimeter epitaxial layer thinned down to 4 micrometers, npn transistors were

able to achieve a cutoff frequency of 1.5 gigahertz.

These devices make a linear differential logic (LDL) gate as fast as ECL, but at one fourth the power consumption and in one third the area. The tradeoff is a much reduced logic swing that cuts the error budget by almost an order of magnitude. LDL is put to use in the Am6108, an 8-bit successive-approximation analog-to-digital converter, that converts in under a microsecond and can be interfaced with different processors using a minimum number of logic gates.

In session 19—"The Outlook for Linear ICs in the '80s"—Analog Devices, Norwood, Mass., will be represented with a fast, systems-level digital-to-analog converter. The AD567 incorporates a voltage reference, scale-setting resistors, and interface logic on chip and settles in 250 ns. Its interface logic includes two ranks of latches arranged to accept data from a 4-, 8-, 12-, or 16-bit data bus. They can be enabled with pulses as short as 100 ns.

Precision Monolithics Inc. of Santa Clara will present details of the OP-27/37, a "triple threat" operational amplifier that sets records for low-noise voltage without sacrificing the dc precision of its high-speed performance. By running the input stage at a relatively high current, the amplifier gives a mere 80 nanovolts of peak-to-peak noise in the 0.1-to-10-hertz band and 3 nV/Hz<sup>1/2</sup> at audio frequencies. On-chip offset trimming keeps other error sources down near the "noise floor."

### Discussions of speech

In session 2, "Speech Technology in the '80s," attendees will explore some of the near- and long-term milestones for the growing technology of electronic speech synthesis. In her paper, chairwoman Sharon B. Crook of Texas Instruments Inc., Midland, Texas, describes "the technology innovations necessary to accommodate the market need" for speech products.

The subject of speech is broached again in session 6, which assesses the prospects of voice-processing technology for the 1980s. Emphasized here is the voice input/output's capacity to save time and free the hands and eyes. Higher productivity is the reason to go with electronic speech synthesis and recognition. Alexander Nahow and Alan Strass of the General Electric Co. in Bridgeport, Conn., give an industrial user's perspective of the field, based on extensive experience with in-house testing at GE.

Still another area into which electronic speech spills is covered in session 28, on technology to help the handicapped. Electronics can be used in "talking signs" to aid the blind. For example, infrared transmission would silently duplicate the written messages on street signs, house numbers, and bus stops, and the results would be read by handheld "readers" carried by a sightless person. Many instruments can be modified for use by the blind, and even the display of such complex instruments as an oscilloscope can be made accessible to the blind by

TYPICAL CHARACTERISTICS OF MAJOR HIGH-SPEED LOGIC FAMILIES							
	Logic family						
	F100K	MECLIII	10KH	10K	FAST	74AS	74S
Propagation delay (ns)	0.95	1.0	1.0	2.0	3.5	2.8	5.0
Power (mW)	46	60	25	25	4	20	20
Power-speed product (ps)	44	60	25	50	14	56	100
Rise and fall times (ns)	0.8	0.6	1.5	2.0	1.5	1.0	1.5
Technology	ECL	ECL	ECL	ECL	TTL	TTL	TTL

SOURCE: MOTOROLA

recently developed means, explains John Brabyn of the Smith-Kettleweil Institute of Visual Sciences in San Francisco. In his paper, he introduces the concept of rehabilitation engineering and says that "putting handicapped people to work should be one of the most urgent priorities in the utilization of the latest electronic technology."

### CAD from the desk of . . .

The desktop computer gets attention as a tool for computer-aided engineering and design in session 30, computers for engineering applications. According to chairman Bruce Hamilton of Tektronix Inc., Beaverton, Ore., the central message will be "that desktop computer-aided design is here—it's real, it's technically possible, it's affordable, and here are some examples."

"There are a lot more opportunities for desktop computers than many people realize. You don't necessarily need a VAX, a DEC system 20, an IBM 370, or a CDC 6600," he says.

The four papers to be presented show several examples of applying desktop computers to both CAD and computer-assisted engineering, CAE.

The first paper, on two-dimensional drafting, will be given by John Tangey of Tektronix. He will show how a desktop computer can be used to solve many generalized drafting problems. Demonstrating that such computers can, in fact, function as tools for CAE, William Cummings of Hewlett-Packard Co., Fort Collins, Colo., discusses in the second paper all aspects of design from the concept through to the final product. His paper is entitled, "CAE—Productivity Improvements Using Desktop Computers."

While the first two papers present a look at a horizontal slice of the use of small computers in a variety of engineering tasks, the next one shows a vertical slice. In "A Desktop Graphics Work Station for VLSI CAD," Larry Dorrie and Michael Dickens of Avera Corp., Scotts Valley, Calif., tell what they did and why they did it in developing a work station specifically for the computer-aided design of VLSI. Looking beyond what is now

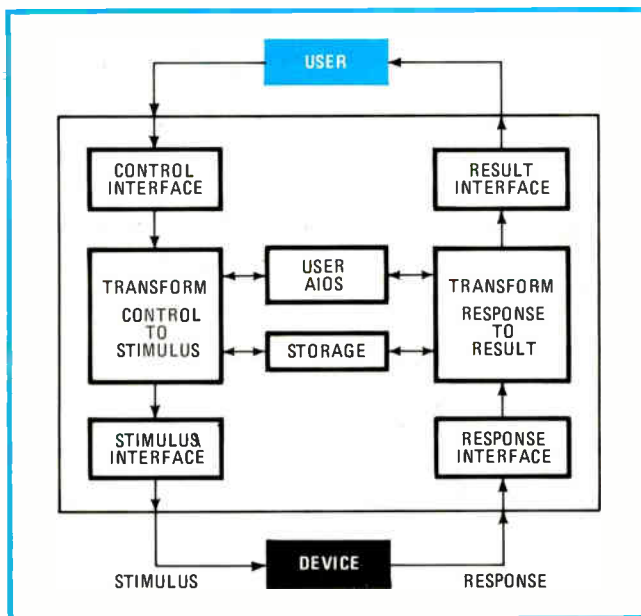

**3. Toward a new definition.** In "Future Trends in Digitizing Signal Analyzers," Arthur W. Crooke proposes this functional model for general-purpose instruments. A microcomputer, a-d and d-a interfaces, a display, and a control panel make up the hardware.

available, James D. Howard of Intel Corp., Aloha, Ore., in the last paper of session 30, discusses what is desirable in a graphics-based engineering work station for VLSI design.

A new subject for Wescon this year is office automation—in particular, telephone message systems using digitized voice [*Electronics*, April 21, 1981, p. 99; July 14, p. 34]. Howard I. Cohen of General Telephone & Electronics in Needham, Mass., says that "voice messaging is going to be very important in office automation—some people believe that electronics text mail systems alone will not be enough. For example, they ask how are you going to get all those people to type?" He is organizer and chairman of session 10 on computer-controlled voice message systems.

### The direction of digital signal processing

For Lyle F. Pittroff, chairman of session 3, "Future Trends in Digital Signal/Array Processing," the five papers he has gotten together "provide a broad spectrum of the participants in the signal-processing business." Pittroff's firm, Advanced Micro Devices, where he is manager of bipolar product planning, is sponsoring one of the three papers about chips designed for signal processing. Its author, Bernard J. New, will present preliminary information about the Am29540 fast-Fourier-transform address sequencer.

Another chip paper by John Eldon, senior systems engineer of TRW Inc.'s LSI Products division in La Jolla, Calif., will discuss that company's new 64-bit digital correlator [*Electronics*, July 14, 1981, p. 118]. Also, a

paper by a team of authors from Monolithic Memories Inc. will discuss a bipolar number-cruncher that they say "provides a cost-effective alternative to MOS devices in microprocessor systems."

Not only will chips be discussed, but systems and applications will also be covered. For example, Dave Birkner, engineering vice president of Computer Design & Applications in Newton, Mass., will present a paper on "Advances in Array Processor Programming Techniques" and Alan Peterson of Stanford University in Palo Alto, Calif., will discuss the "Application of the Fast-Fourier Transform in Fast Convolution and Digital Filtering."

While signal processing helps the system user get the most information out of his equipment, it is important to get the information into the systems in the first place. Often, this requires a first-class radio receiver.

The technologies that add glamour to receiver design these days are microprocessor control, light-emitting-diode displays, and digitally synthesized local oscillators. "But," comes the reminder from James M. Bryant, special projects manager of Voxson Audio Ltd., of Abingdon, England, "the mixer is the most critical part of a high-performance superheterodyne receiver. Only this device determines a receiver's ability to receive a microvolt signal in the middle of a band full of 100-millivolt signals or worse."

To ensure that attendees at his session 24 come away aware of the problems of mixer design, Bryant has put together four papers. Three are on the design and performance of various types of discrete-component and integrated mixers and the fourth is on mixer problems as seen by their receiver designer. The fact that four of the five authors of the mixer papers are radio amateurs should come as no surprise since the amateur bands are often shared with high-power broadcast services. The mixer determines the amateur's success in differentiating his microvolt signal from the 100-mV signals that are but tens of kilohertz away.

### How to do it with fiber

No major technical meeting would lack status without a session on fiber-optic technology. Wescon has a four-paper tutorial session 16, put together by Ronald L. Ohlhaber, product development manager at Belden Corp. of Geneva, Ill. Ohlhaber will present one of the papers on relating the properties of fiber cable to its applications. But cables have to be hooked together, and that will be the subject of James Leidy's paper on "Advances in Fiber Optic Connectors." Leidy's connectors also hook up to emitters and detectors, which is where Motorola's paper on low-cost fiber-optic components for industrial applications comes in. Finally, for do-it-yourself types, H. A. Carnes and E. E. Basch of GTE Laboratories Inc. in Waltham, Mass., have prepared "Fiber-Optic Transmission Links." Their paper features a link power-budget calculation. □



# We know how



**to make mobile dialling easy**

Italtel's radio mobile telephony system RTMS 101: it can provide mobile subscribers with a service of the same quality of that enjoyed by every other subscriber of the telephone network.



# ITALTEL

Telecommunications is our business

20149 Milan (Italy) - 12, Piazzale Zavattari - phone (+ 392) 4386.1

Circle 160 on reader service card

World Radio History

# This new programmable sweep generator uses distributed microprocessor architecture.

CW accuracy can be held to  $\pm 10$  Hz or better by phase locking to external frequency counter or lock box.

Both F1 (start) and F2 (stop) sweep frequencies, or M1, M2 marker frequencies or any combination can be displayed simultaneously.

GPIB (IEEE-488) bus messages include serial and parallel poll, group execute trigger and SRQ.

Five sweep modes provide broad or narrow band control for unprecedented measurement flexibility.

Self-test and automatic fault diagnosis occur every time the instrument is turned on; a diagnostic code is displayed on the front panel.

SAV and RCL commands can be used to store test setups. Non-volatile memory holds controls and readings at previous setting for 20 days or more.

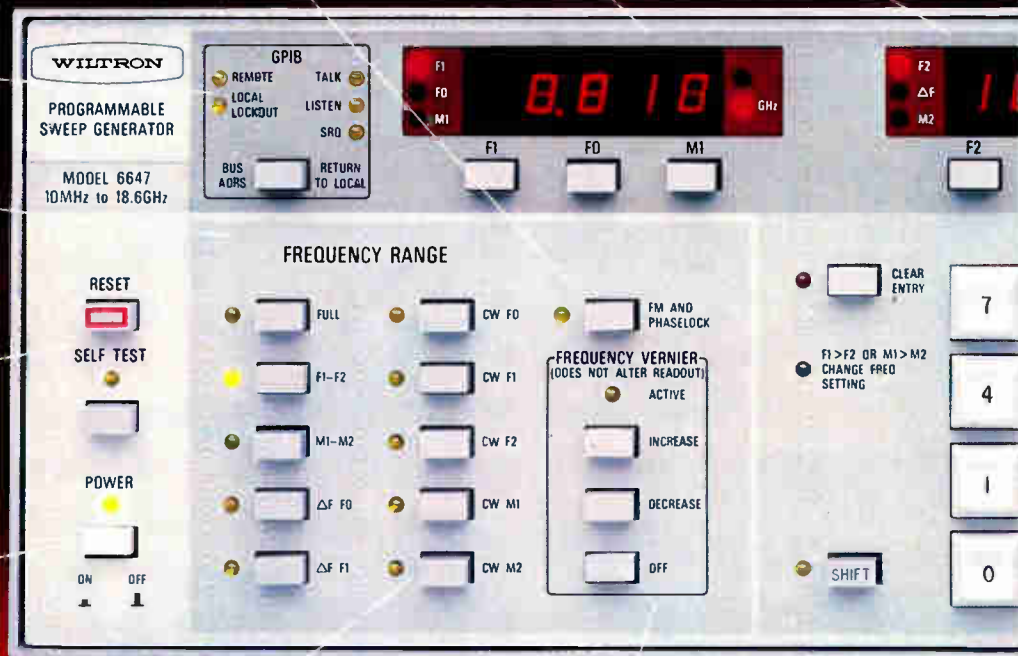

Remarkably clean and stable CW signals are available with 1 MHz resolution at five pushbutton-selected frequencies or program-selected values.

Frequency Vernier with 100 kHz resolution allows precise adjustment of CW or center of  $\Delta F$  sweep frequency.

Digital convenience and accuracy are part and parcel of the new Wiltron 6600, an eminently easy-to-use family of instruments which combines new RF technology with microprocessor control. With 10 MHz to 40 GHz coverage, the 6600 group is expressly designed to meet your ATE needs too. There are, quite simply, no more advanced sweeper/signal sources at any price.

## A look at the features

Here in one compact 33 pound unit we give you a virtually self-explanatory pushbutton controlled front panel. All pushbutton controls can be programmed via the IEEE-488 interface bus. We give you a sweeper using fundamental oscillators avoiding the substantial errors generated by the harmonic products of multiplier type oscillators. We give you modular construction without the disadvantages of RF plug-ins. We give you a fast unit using distributed microprocessors and a display preprocessor to reduce bus loading and measurement times.

The result, broadband coverage with the lowest harmonic content ( $>40$  dBc, 2-20 GHz), lowest residual FM and greatest stability on the market today. We give you a unit with the best frequency accuracy ( $\pm 10$  MHz up to 20 GHz) because it uses a ROM to correct non-linear residual frequency characteristics of YIG oscillators.

Programmable parameters include stepped sweep with selectable step size, start and stop frequencies, sweep width, marker frequencies, sweep time, output power level and optional attenuation.

Other features of note include high spectral purity, modular construction, self-test, 82 dB power control range with 0.1 dB resolution and power sweep.

## So easy to operate

Multiple microprocessor design and human engineered panel controls make it easy for even the least experienced to use—on or off the bus.

# It's a Wiltron.

Optional attenuator provides bus or front panel control of power level over 82 db range.

All frequencies, sweep times, power levels and their units are displayed when selected on the corresponding pushbutton or commanded over the bus.



Three markers provide easy identification of swept frequencies, center frequency of  $\Delta F$  sweep and M1-M2 sweep limits.

Slope control compensates for losses that vary with frequency to provide flat output at test point.

Excellent source match (<1.4 up to 20 GHz) reduces measurement errors.

Wiltron super-flat leveling components hold variations in output power to  $\pm 0.6$  dB from 10 MHz to 20 GHz.

External directional detector or power meter can be used to level output power at remote test position.

Keypad provides fast, precise data entry.

Convenient electronic control lever obsoletes tedious and inaccurate twiddling of mechanical control knobs.

Eight models cover the frequency range of 10 MHz to 40 GHz.

Model	Range	Power
6609	10 MHz to 2 GHz	>20 mW (+13 dBm)
6617	10 MHz to 8 GHz	>10 mW (+10 dBm)
6637	2 GHz to 18.6 GHz	>10 mW (+10 dBm)
6638	2 GHz to 20 GHz	>10 mW (+10 dBm) at $\leq 18.5$ GHz >5 mW (+7 dBm) at >18.5 GHz
6647	10 MHz to 18.6 GHz	>10 mW (+10 dBm)
6648	10 MHz to 20 GHz	>10 mW (10 dBm) at $\leq 18.5$ GHz >5 mW (+7 dBm) at >18.5 GHz
6636	18 GHz to 26.5 GHz	>3.1 mW (+5 dBm)
6640	26.5 GHz to 40 GHz	> 1 mW (0 dBm)

Compare the Wiltron 6600 with any other sweeper

For a demonstration and/or our new brochure, phone Walt Baxter, (415) 969-6500, or write Wiltron, 805 E. Middlefield Road, Mountain View, CA 94043.

**WILTRON**

See us at WESCON Booth No. 1856-1858.

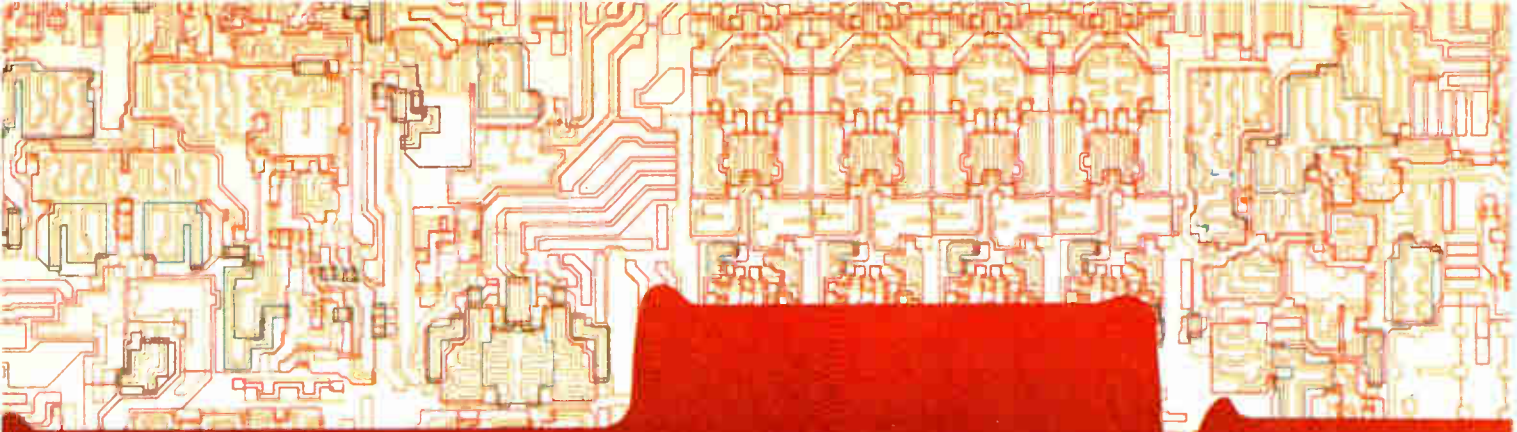

$\overline{\text{RAS}}$

$\overline{\text{CAS}}$

60 mA

40 mA

20 mA

0 mA



*TI's 64K dynamic RAM.  
More memory. More performance.*

# TMS4164

## The performance leader. From Texas Instruments.

When we began designing the 64K RAM, we decided to make it better than the 16K. Not just four times bigger.

What's better? In a word, performance. Add up high speed, reliability, low power and improved system operating margins, and you'll see why our superior performance puts the TMS4164 in a class all by itself.

**Faster access times**  
The wide range of TMS4164 functionality and speed potential is demonstrated in the graph to the right. This illustrates the wide

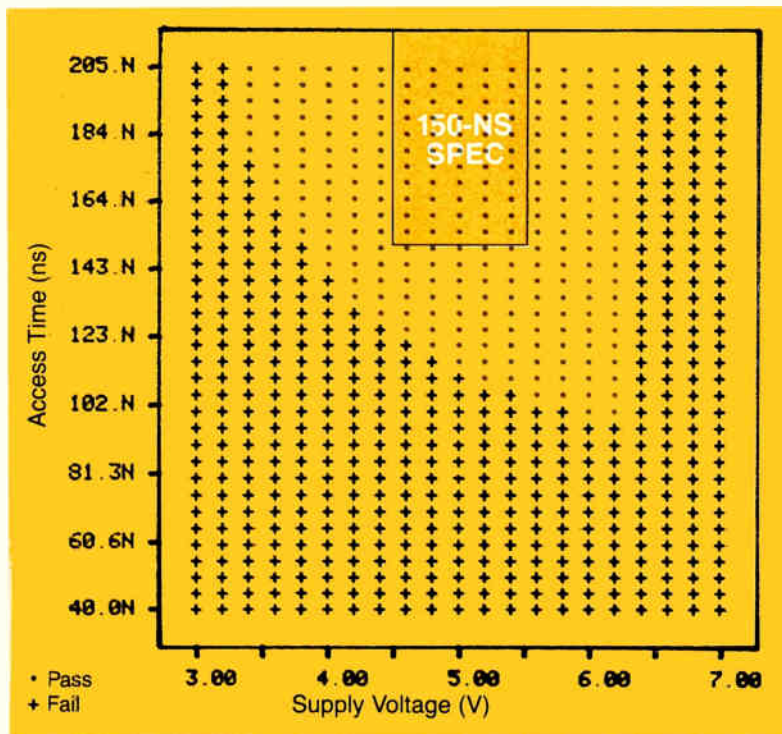

operating margins designed into the high-performance 150-ns TMS4164. And, even faster devices are on the way.

**Power dissipation**  
At 125-mW typical, the TMS4164 is unequalled in the industry for low power dissipation. Power design features like interlocked clocks mean you use only as much power as you need. Only when you need it. Our optimum architecture, requiring only 256 sense amplifiers, assures you of minimum power dissipation and enhanced reliability.

### Ease of use

Two separate 8-bit internal buffers simplify use — one is for row address, one is for column address. TTL-compatible, one-clock operation greatly expands input timing flexibility and assures fast throughput.

TMS4164 64K Dynamic RAM			
	4164-15	4164-20	4164-25
Access Time Row Address (Max)	150 ns	200 ns	250 ns
Cycle Time Read or Write (Min)	280 ns	350 ns	416 ns
Cycle Time Read Write (Min)	280 ns	350 ns	416 ns
Power Dissipation Operating (Typ)	140 mW	125 mW	105 mW

**Lowest power surge**  
Our 256 cycle refresh architecture has significantly reduced the current surge problem of designing with other dynamic RAMs. The resultant lower current spikes ( $\approx 60\text{mA}$ ), less than on one 16K dynamic RAM, facilitate system power distribution, increase noise immunity and improve board layout.

**And there's more**  
The TMS4164 is the smallest 64K chip (35K mil<sup>2</sup>) in production. Perfectly suited for use in main-frame computers and large minicomputers, the TMS4164 also finds

ideal application in microprocessor-based systems which demand small size, low cost, and improved performance.

### Available now

The high-performance TMS4164 is now stocked for immediate delivery. Order today from your nearest authorized TI distributor. Or, for more information, write Texas Instruments Incorporated, P.O. Box 202129, Dallas, Texas 75220.



*Texas Instruments invented the integrated circuit, microprocessor and microcomputer. Being first is our tradition.*

© 1981 Texas Instruments Incorporated

## TEXAS INSTRUMENTS

85011

ARGENTINA 748-1141 • AUSTRALIA (02) 887-1122 • BELGIE/BELGIQUE (02) 720.80.00 • BRASIL 518423 • DEUTSCHLAND 08161/801 • FRANCE (3) 946 97 12 • ITALIA (0746) 69034  
JAPAN 03-498-2111 • MEXICO 567-9200 • NEDERLAND 020-473391 • SCHWEIZ/SUISSE 01 740 22 20 • SVERIGE (08) 23.54.80 • UNITED KINGDOM (0234) 67466

Electronics / August 25, 1981

Circle 164 on reader service card 165



# BUMPER CROP

**8-inch Winchester Multi-User Systems. Now In Volume-\$8,500.**

Altos is delivering the cream of the crop with their new 8-inch multi-user Winchester disk systems. They're freshly packed with the quality features you expect from Altos, and at a price you expect from Altos, too—just \$8,500.

Pick from two fully integrated systems, each packaged in our new compact, stylish cabinet suitable for either rack mount or table top applications. You get 10 MBytes of reliable on-line storage in our 8-inch Winchester drives. Then for system back-up storage, you can select from

either 8-inch, single or double-sided floppy drives (ACS8000-10 and -10D) or a 1/4-inch magnetic tape drive (ACS8000-10/MTU). And for powerful performance, all of these Z80A\*based systems come complete with 208K of RAM and 6 programmable serial ports, ready to support four users.

Here's the most bountiful selection of systems and capacities in the field from the company that knows how to deliver quality systems in the volumes that OEMs need to stay competitive.

And Altos supports these systems with a broad software selection including the three industry standard operating systems—CP/M, multi-user MP/M\*\* and OASIS†. These operating systems support seven high level programming languages: BASIC, FORTRAN, COBOL, PASCAL, APL, PL/1 and C. Also available are comprehensive communications packages: ASYNC—Altos-to-Altos, BISYNC—Altos-to-mainframe and full networking with CP/NET. All are designed to run on a high speed 800 Kilobaud networking channel—standard with every system.

The ACS8000-10 Winchester systems join our growing family of field-proven products. In just three years, more than 8,000 systems have been shipped to an OEM customer-base.

Get to market fast. Harvest your 8-inch Winchester system direct from the heart of Silicon Valley. Call or write today for specific product information and OEM pricing. Altos Computer Systems, 2360 Bering Drive, San Jose, CA 95131, (408) 946-6700, Telex 171562 ALTOS SNJ.

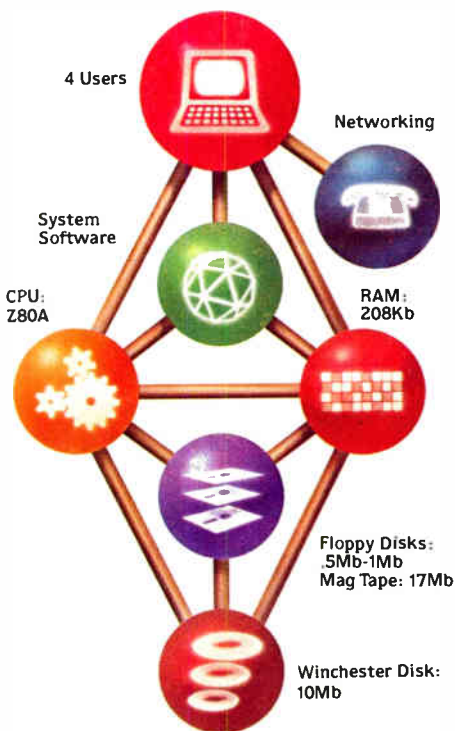

SYSTEMS PICTURED:  
 ACS8000-10 (10Mb HD + 1 floppy) \$ 8,500  
 ACS8000-10/MTU (10Mb HD + DEI Mag Tape) \$10,990



**Packed with Fresh Ideas**



\*Z80A is a registered trademark of Zilog, Inc.  
 \*\*CP/M and MP/M are registered trademarks of Digital Research, Inc.  
 †OASIS is a registered trademark of Phase One Systems, Inc.  
 ‡datapro is a registered trademark of Datapro Research Corp.  
 © 1981 Altos Computer Systems

Circle 269 on reader service card

# The enemy without.

Lightning and other unusual electrical overloads are a constant danger to electronic equipment.

Not only do they cause severe damage to costly installations, they result in fires and explosions that do even more damage as well as being a danger to life and limb.

The problem is acute with many modern forms of business systems, computers, semi-conductors, burglar and fire alarms, etc. as well as other vulnerable equipment like traffic signals where being "off line" is a very expensive business.

The answer is as ingenious as it is effective. M-OV protection stops surges of electricity in their tracks before they reach your equipment. An M-OV protection "package" consists of a surge arrester (or gas-discharge tube) and back-up mounts.

They work *very* fast.

## AT RISK:

Mainframe Computers  
Microprocessors  
Semi Conductor Units  
Transport Signalling  
etc, etc.

They work *every* time. They save money and keep you "on line."

They are effective not solely because M-OV

technology is first class. (A technology that measures in Picoseconds and Picofarads!) We also place great emphasis on testing each unit. They are subjected to 11 different tests to make sure they give you the protection you need. (Dozens of Telecommunication Authorities around the world will vouch for that). What's more, M-OV protection is available "off the shelf." Get in touch with us about price and delivery today.

Remember, to combat the enemy without, you must install the friend within. From M-OV.

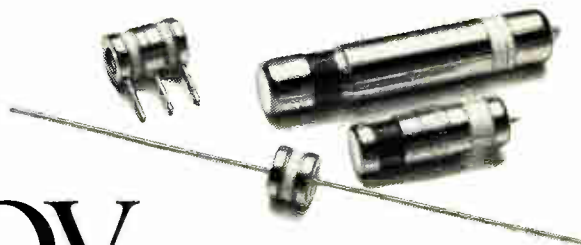

# M-OV

A MEMBER OF THE GEC GROUP

**S&C**

S740

THE M-O VALVE CO LTD, HAMMERSMITH, LONDON W6 7PE, ENGLAND. TEL 01-603 3431. TELEX 23435. GRAMS THERMIONIC LONDON

168 Circle 169 on reader service card

Electronics / August 25, 1981



## New products

Highlights of the product introductions at Wescon '81 include instruments that exhibit maturing microprocessor-based design

### Modular digital analysis system generates patterns, captures responses at up to 330 MHz

When Wescon's gates swing open next month, visitors will enter a new era of instrumentation. Increased sophistication in the use of microprocessors is the cause of that new era, and one of its best exemplars will be a tool that changes the meaning of logic analysis.

Called the DAS 9100 digital analysis system, it combines logic response gathering with its logical counterpart—digital pattern generation. Configurable from printed-circuit cards, it can team a 25-MHz pattern generator for exercising the circuit under test with a wide variety of data-acquisition cards for monitoring the circuit's response.

The object of merging these two sides of the digital test function in one benchtop unit, according to Tektronix designer Steve Palmquist, is to streamline engineering effort. Palmquist has talked to many product designers who "spend 50% of their design time building test fixtures." Thus he and software maven Gerd Hoeren set out to build an extremely flexible expandable system with which the user could, in effect, converse easily with the circuit he or she was designing.

The heart of the resultant system is a

Z80 controller card that runs Pascal software to orchestrate the functions of the other system cards, or modules. It and the trigger-time-base card take up two slots in the DAS mainframe, leaving six for the user to fill with combinations of generation and acquisition cards.

The primary pattern generation card, the 91P16 which has 16 data output ports, can be expanded with up to two 32-channel 91P3Z slave cards, so that a total of eighty 25-MHz channels can be used to deliver test vectors. Two strobe channels on the primary card and four on each slave make it possible for the pattern generator to simulate various system bus structures.

For capturing responses from a

circuit under test, two kinds of cards are provided: one type for watching software flow and another for checking hardware operation. The card aimed at software debugging—the 25-MHz 91A32—offers a broad 32 channels, while the speed needed for catching glitches is provided by the cards for hardware—the 8-channel, 100-MHz 91A08 and the 4-channel, 330-MHz 91A04, and the latter's 4-channel expansion card, the 91AE04. Both acquisition-card types may be used simultaneously, with the software cards arming hardware ones so that program events can automatically be correlated with hardware operations.

The actual operation of the instrument could have turned out to be a nightmare, had not the software been designed to provide an extremely efficient set of menus. A total of seven different menus can be called to the DAS screen, letting users define output patterns, strobe timing, system mnemonics, logic state and timing displays, and so on by moving a cursor to the appropriate field. Setting up the test conditions thus becomes a quick job, particularly since the DAS itself automatically adjusts the menus to reflect the cards

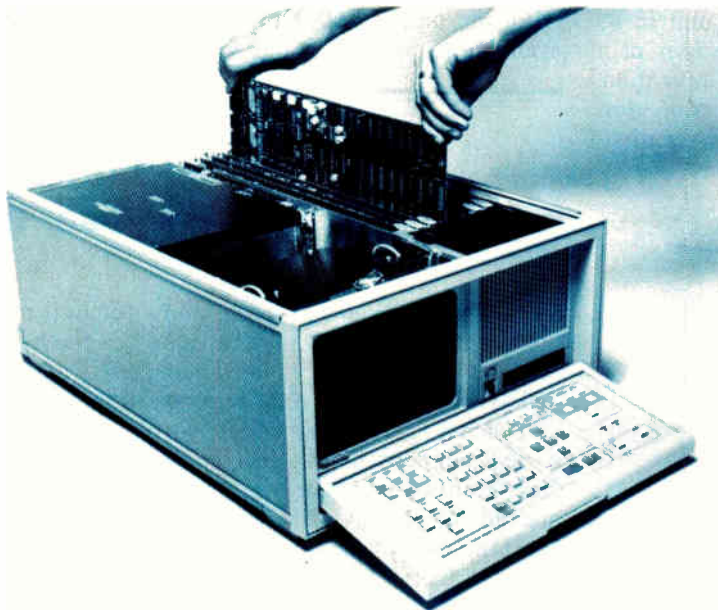

it contains. Further, set-ups and pattern programs can be stored using an optional DC-100 tape drive or RS-232-C port.

Prices for the cards vary from \$3,700 for the basic pattern generator card to \$7,950 for the 4-channel, 330-MHz data-acquisition module,

and the mainframe is priced at \$4,950. A typical system—one with 32 channels of 25-MHz data acquisition, 8 channels of 100-MHz acquisition, and 16 channels of pattern generation—is priced at \$16,900.

Tektronix Inc., P. O. Box 1700, Beaverton, Ore. 97075. Phone (800) 547-6711 [351]

## 1.8- $\mu$ s 10-bit a-d converter dissipates only 775 mW

Fast 10-bit analog-to-digital converters tend to run hot. This is less true of Analog Devices Inc.'s new AD579, however, which is claimed to have the lowest power dissipation in its market at a typical 775 mW. A hybrid design, complete with internal clock, voltage reference, and comparator, the unit from Analog's Semiconductor division converts in 1.8  $\mu$ s maximum and also is said to offer initial accuracy, linearity, and temperature coefficients comparable with those of modules.

Though there are hybrid a-d converters with faster conversion times, their power dissipation—as much as three times the AD579's worst-case 1.2 W—makes them unattractive in some applications. In addition, the AD579 may be the only unit in its market niche to offer the user of a choice of  $\pm 15$ - or  $\pm 12$ -v operation. In the case of the 12-v version, designated with a Z suffix, power dissi-

pation for rated accuracy is said to be about 20% less than that of the 15-v model, though Analog Semiconductor does not specify an exact figure for it.

The AD579 sells for \$138.50 to \$251 each, depending on packaging and environmental characteristics; for 100-unit lots, prices fall to \$103.50 to \$178.50. Thus, it competes well with modules on a price-performance basis, according to the company; its specifications are comparable with modules', and in its 32-lead double-width dual in-line package, the AD579 requires less board space and power.

The internal scaling resistors let the part serve analog input ranges of  $\pm 5$ ,  $\pm 10$ , 0 to 10, and 0 to 20 v. Also, the unit's +10-v reference is available at pin 24. The buried-zener

reference is laser-trimmed to within  $\pm 0.1\%$  accuracy and offers up to 1 mA for external use; its temperature coefficient is  $\pm 15$  ppm/ $^{\circ}$ C.

**Accuracy.** Gain error for the AD579, as well as its bipolar and unipolar offset error, measure 0.25% of full-scale range, maximum. Linearity error is a maximum of 0.048% of full-scale range. Differential-linearity error is specified as  $\frac{1}{2}$  least significant bit, maximum.

Gain drift is independent of specified temperature range, measuring 30 ppm/ $^{\circ}$ C maximum whether the unit in question is rated for operation for 0 $^{\circ}$  to 70 $^{\circ}$  or -55 $^{\circ}$  to +125 $^{\circ}$ C. Unipolar offset is 5 ppm/ $^{\circ}$ C maximum; maximum bipolar offset is 15 ppm/ $^{\circ}$ C.

Power requirements for the AD579 are relatively relaxed. Logic input voltage range can be as wide as 4.25 to 5.75 v for rated accuracy. Power supply voltage ranges for rated accuracy also are broad, with the 15-v models capable of handling 13.5- to 16.5-v inputs and the 12-v versions operating with anything between 11.4 and 16.5 v.

The AD579 is available in hermetic ceramic packages. Units made in accord with MIL-STD-883B are available. Delivery is from stock to two weeks.

Analog Devices Inc., Semiconductor Division, 829 Woburn St., Wilmington, Mass. 01867. Phone (617) 935-5565 [358]

## 48-channel logic analyzer has high-level user interface

Setting a new record in speed, number of channels, and storage capacity may be a good way of advancing logic-analyzer design. But the people at Dolch Logic Instruments GmbH, parent company of DLI Inc. in San Jose, Calif., think there is a better one to more analyzer efficiency: combine high performance with analysis tools that easily interface with the system under test as well as

with the instrument's operator.

Such interfacing, in conjunction with intelligent probing and advanced trigger and analysis features, is the hallmark of DLI's 48-channel, 50-MHz logic analyzer, the LAM 4850A. The successor to the world's first 48-channel analyzer, the LAM 4850 [*Electronics*, May 24, 1979, p. 217], the A version will go to market in September in both Europe and

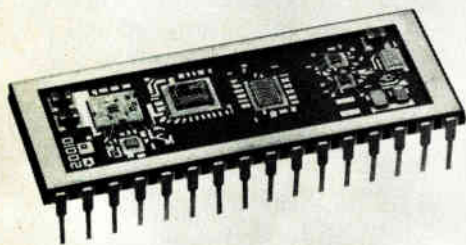

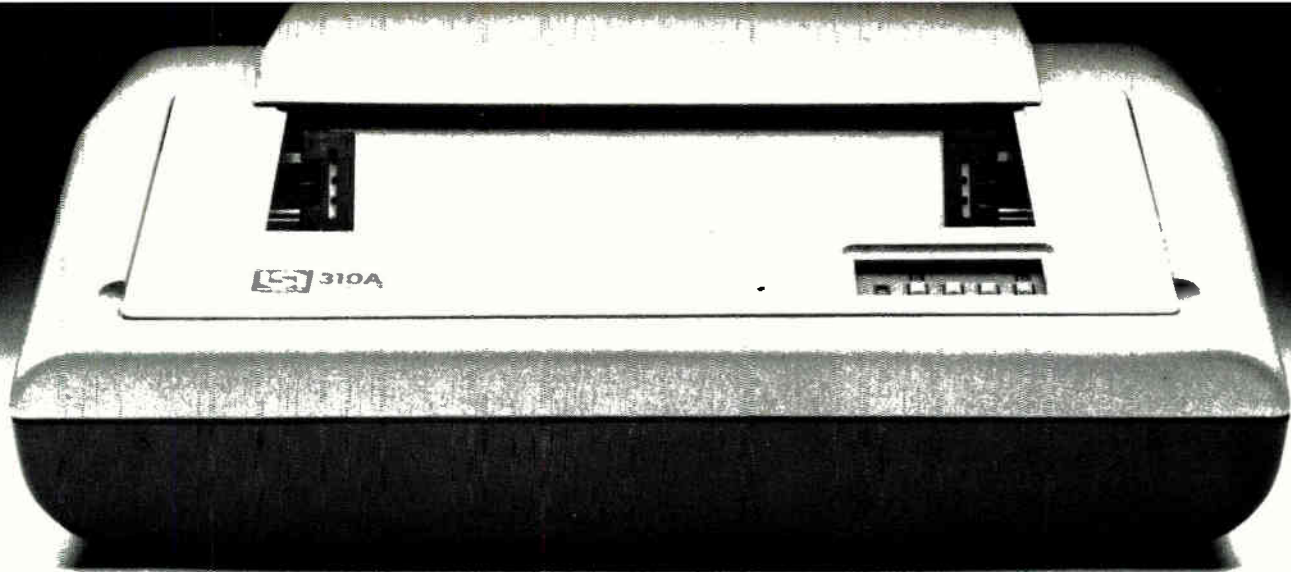

# LSI quietly presents the Hummm Terminal.

From those wonderful folks who brought you the Dumb Terminal® video display, now there's the Hummm Terminal™ Printer.

Featuring quiet operation that's almost unheard of, outstanding reliability and print quality, impressive throughput and a long list of sensible features.

All at a hard-to-believe low price. So low, in fact, that you'll immediately know why we call it Hummm Economics.

## A LOT OF IMPACT PRINTER WITHOUT A LOT OF NOISE.

Quite simply, the 310A Hummm Terminal is one of the quietest impact printers in its class. In fact, with its Acoustic Quieter it checks in at a soothing 56dBA. That's quieter than most typewriters. And than most copy machines.

Fine engineering is the quiet secret. The Hummm Terminal hums along bidirectionally at 180 cps.

## BELLS AND WHISTLES STANDARD.

You won't find many options on the Hummm Terminal. Because we made most of them standard.

Its logic seeking capability finds the shortest path to the next character on a new line—thanks to space and blank character compression. And with an optionally expanded buffer of 2048 characters, a full terminal screen can be dumped instantly.

You get superior printing capability, including true lower case descenders and underlining—good for an original and five crisp copies on multipart forms. A 9x7 character field. Complete horizontal and vertical forms control. 14 switch selectable form lengths, and 14 perforation skip-over formats. And a 100% duty cycle.

## HUMMMAN ENGINEERED.

The Hummm Terminal brings to computer printers the same high standards that made our Dumb Terminal video display the standard for an entire product category. It's rugged, durable, and stylish so it fits right into any office decor.

So call your nearest LSI Autho-

rized Distributor and ask him for some Hummm Terminal information. And when you do, fill out the coupon completely and send it to us. We'll send you a free Hum<sup>3</sup> with over 3 billion combinations—and only one right one.

It'll give you something to do during those quiet moments when the Hummm Terminal is humming along.

Lear Siegler Data Products LTD  
Orchard House, Connaught  
Road, Brookwood, Surrey GU24  
Oat, United Kingdom Tel: Brook-  
wood (048 67) 80666 Telex: 859415

## THE 310A HUMMM TERMINAL.



LEAR SIEGLER, INC.  
DATA PRODUCTS LIMITED

"Hummmm."

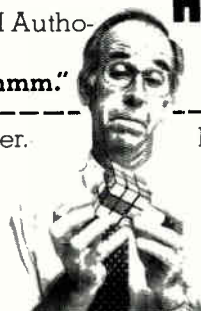

Hummm, Lear Siegler. You've certainly given me something to think about. I asked my distributor about the Hummm Terminal.

Here's his name along with my business card.

(I realize that I can't get a Hum<sup>3</sup> if I don't include my card.)

Name \_\_\_\_\_  
Distributor \_\_\_\_\_  
Distributor Sales Rep. \_\_\_\_\_  
Distributor Location \_\_\_\_\_  
Distributor Telephone \_\_\_\_\_

Lear Siegler Data Products LTD, Orchard House, Connaught Road, Brookwood, Surrey GU24 Oat, United Kingdom

H

Circle 170 on reader service card

Lear Siegler Authorized Distributors: AUSTRIA Micro Automatica Vienna Tel 222 835634, BAHRAIN Martech Computer Services Tel 252600, BENELUX Computec Waalre Tel 4904 5865, CYPRUS Logimetrics Nicosia Tel 44400, DENMARK Iversen & Martens Holte Te. 452 424711, FINLAND Jertec Helsinki Te. 585133, FRANCE Technology Resources Neuilly Tel 747 7051, GERMANY Deutsche Eurotech GmbH Meerbusch 1 Tel 2105 73073, GERMANY Teleprint/TDC Frankfurt Tel 6196 46064, GREAT BRITAIN IT Microprocessors Harlow Tel 0279 26777, Penny & Giles Christchurch Tel 04252 71511, Peripheral Hardware West Molesey Tel 01 941 4806, Riva Terminals Ascot Tel 03447 5193, GREECE Infodata Athens Tel 642 1368, ICELAND Ortlofu Tækr: Reykjavik Tel 11218, ISRAEL Information Systems Tel-Aviv Tel 483261, ITALY Stelit Rome Tel 501 2996, Teleprint Milan Tel 2155724, NORWAY Kjell Bakke Nygata Tel 711872, PORTUGAL Datamatic Braga Codex Tel 27327, REPUBLIC OF IRELAND Cara Data Processing Dublin Tel 632366, SOUTH AFRICA Data Corporation of S.A. Johannesburg Tel 287911, SPAIN Specific Dynamics Iberia Madrid Tel 403 0362, SWEDEN Dataatrix AB Sigtuna Tel 760 51655, SWITZERLAND Rotronic Zurich Tel 523211, Technology Resources Bern Tel 22 39 73, Teleprint TDC Zurich Tel 056 26 30 63, LEBANON, SAUDI ARABIA, SYRIA Orcent Computer Division Damascus Tel 456000, Microelectro Developments Tel 0582 421793

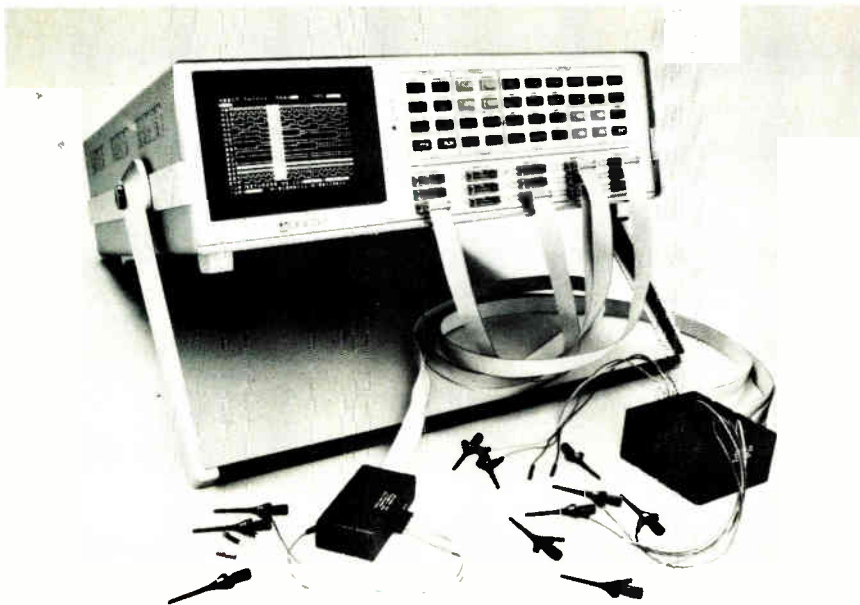

the U. S. Its U. S. price is \$11,750.

Featuring what Volker Dolch, head of DLI, calls "an advanced level of user communications," the microprocessor-controlled 4850A has a monitoring function that presents status information and comments on the menu setups on a separate display. Whenever a parameter is entered into the menu formats, the monitor can be called up any time to interpret it, its range, or its interaction with the present setup. Not only does the instrument signal erroneous entries by flashing messages, but it also spells out why a particular entry was in error.

As Dolch points out, it is a tricky task, even for the experienced operator, to collect meaningful data across 48 channels using three simultaneous external clocks, an internal one, and nine clock qualifiers, and to trigger at the same time on nested subroutines. The 4850A's monitor, however, makes that task a relatively simple one since it interprets the setup and keeps track of clock and trigger events at the inputs.

A battery-backed complementary-MOS memory stores up to six files of menu parameters and display configurations. Even after three months without power, the 4850A can recall previously entered setups. Storage

and recall are handled by a scratch table display, so that the user can keep a log of various test conditions.

A number of high-performance general-purpose probe pods, each handling four channels, facilitate operation. Designed around a custom thick-film hybrid circuit, the quad-channel pods minimize loading and distortion of the signal being investigated because of their high impedance—1 MΩ. The pods can be stacked together to form application-oriented input blocks. The hybrid circuit in each pod helps catch glitches as short as 5 ns in duration.

The 4850A can be turned into a dedicated tool with Dolch's personality probes and disassembly software. Probes supported by mnemonic disassemblers are available for the 8080, 8085, 8086, 6800, 6802, 6805, 6809, Z80 and 1802 microproces-

sors. The unit has RS-232-C and IEEE-488 interfaces.

Also interfacing with the 4850A are a signature-analysis probe and a channel-expansion probe. With the latter, up to 96 channels can be traced by doubling the basic 48 channels. Available later this year will be the 68000 and Z8002 trace modules and disassemblers.

The 4850A consists of three independent 16-channel analyzer modules with a maximum sampling rate of 50 MHz, a 1,000-bit-per-channel resolution, four-level sequential triggering, and three levels of clocking. One or more modules may be switched on or off, depending on the task at hand. Available from the firm shortly will be a 16-channel 4-K recording block with a maximum sampling rate of 10 MHz.

There are two levels of complexity of trigger performance. The standard one has four trigger levels with pass counting on each level and with range triggering and trigger delay capabilities. The advanced version has 12 trigger levels with an interaction capability for selective tracing. Boolean combinations of three trigger words, each 48 bits wide, are possible on every sequential step. Conditional advance, jump, and restart capabilities are also provided.

A search feature simplifies locating specific occurrences in the memory. It can search for strings of up to 12 words, making it possible to identify and address, not only single events on the 48 channels but also sequential occurrences of specific program conditions.

DLI Inc., 230 Devcon Dr., San Jose, Calif. 95112 [353]

## Hybrid sample-and-hold amp settles to $\pm 0.01\%$ in 200 ns

Teledyne Philbrick's 4860—a thin-film hybrid sample-and-hold amplifier—sets a tough performance standard for high-speed data acquisition:

it typically settles to  $\pm 0.01\%$  accuracy in only 160 ns and is guaranteed to do so at 200 ns maximum.

Even with this speed, the hold

International Automation Exhibitions  
 ... 1979 Paris "MESUCORA" ... 1980 Düsseldorf "INTERKAMA"  
**1981 MILAN - B.I.A.S.**

In 1981 the BIAS only presents Automation and Microelectronics in Europe



Milan Trade Fair Premises 6th - 10th October 1981

17th International Automation Instrumentation and  
 Microelectronics Conference and Exhibition

- Systems and devices for Automation, process-control and regulation, detectors
- Laboratory Devices and Instrumentation
- Components, sub-systems, peripherals and processing units

Exhibition Secretariat  
 Viale Premuda, 2  
 20129 Milano  
 tel. 796096/421/635

Contemporaneously with the 7th RICH and MAC 1981

Circle 172 on reader service card

# M243 by SORD

For all the micropower  
 you'll ever need



● **Multiprocessing**

SORD's experts have done it again. Just add the right terminals and the M243 will process several jobs simultaneously, taking full advantage of the power and speed of the Z80A CPU.

● **You're not the programmer**

PIPS is the programmer. You input a 2-character command, PIPS outputs a graph. You input another 2-character command and PIPS outputs an alphabetical list. PIPS takes over all those tedious time-consuming jobs around the office.

● **Telecomm hookup**

In the age of distributed data processing, no system is complete without telecommunications capabilities. The M243 has those capabilities.

The computer has now become your personal tool.



**SORD COMPUTER SYSTEMS, INC.**  
 Isoma No. 2 Bldg., 42-12 Nishi-Shinkoiwa 4-chome,  
 Katsushika-ku, Tokyo, Japan 124 Phone: (03)696-6611  
 Telex: 2622393(SORD J) Cable: SORDCOMPSYS TOKYO

**SOFTWARE**

Extended BASIC  
 BASIC Compiler  
 (APU Version)  
 Assembler

FORTRAN-IV  
 COBOL  
 PASCAL

**PIPS Electronic Language**  
 Data entry  
 English word processor  
 Comm package  
 Accounting packages

**HARDWARE**

Z80A (4 MHz) CPU  
 64 Kbit dynamic RAM chips  
 192 Kbyte standard memory  
 (addressable to 1 Mbyte)  
 Full ASCII keyboard  
 10-key pad and special keys  
 (German, French, Azerty,  
 Danish, Swedish, etc.)  
 Broad expandability  
 The M243 is fully upward  
 compatible, allowing disk  
 systems to be mixed.

**The M243 Family**  
 M243mark IV  
 Dual-sided double-density,  
 double track minifloppies:  
 Standard capacity:  
 720 Kbyte X 2  
 Maximum capacity:  
 approx. 2.8 Mbyte  
 M243mark V  
 Dual-sided double-density  
 full-size floppies:

Standard capacity:  
 1 Mbyte X 2  
 Maximum capacity:  
 approx. 4 Mbytes  
 M243mark VI  
 Winchester-type hard disk:  
 Standard capacity:  
 10 Mbytes X 1  
 Maximum capacity:  
 approx. 40 Mbytes  
 (a 20 Mbyte hard disk is  
 forthcoming)

*Distributors in Europe:*  
 CHRISTOS AXARLIS S.A. Athens (141), Greece Phone: 36.15.483 Telex: 214108 (AXAR GR) COMPTRONIX AG Horgen 1, Switzerland Phone: 01/725 04 10 Telex: 58799 (CPTX CH) N.V. EGEMIN S.A. (BENELUX) Schoten, (Prov. Antwerp), Belgium Phone: (031) 452790 Telex: 32525 (EGEMIN B) GEPSI Paris, France Phone: 554.97 42 Telex: 204871 (GEPSI F) IMPORMAPEL, LDA Lisbon, Portugal Phone: 32 12 25 MITSUI & CO. EUROPE (ESPANA) S.A. Madrid-20, Spain Phone: 455-1500 Telex: 27201 (MITSUI E) MITSUI & CO. EUROPE G.m.b.H. 4000 Düsseldorf 1, Königswall 92a, West Germany Phone: 211-87981 Telex: 8582081 (MIT D) MULTIPLEX COMPUTER APS Lille Skensved, Denmark Phone: (03) 66 9511 Telex: 43574 (AWILCO DK) SCANDINAVIAN MICRO COMPUTER AB Gothenburg, Sweden Phone: 031-17 22 60 Telex: 27870 (SCAMIC S)

Circle 270 on reader service card

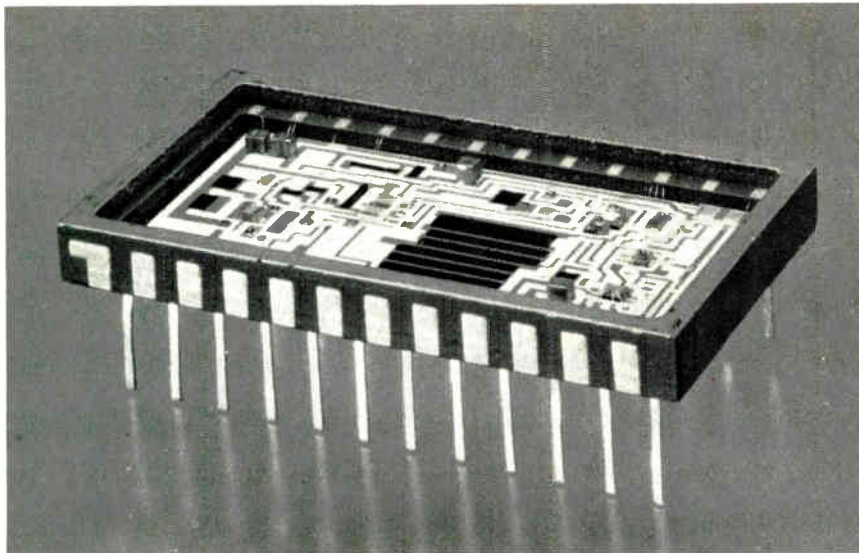

capacitor is large enough to keep the pedestal error to at most  $\pm 20$  mV and the droop rate to at most  $\pm 5$   $\mu\text{V}/\mu\text{s}$ . The secret of this high performance is a proprietary operational amplifier using a discrete field-effect transistor at its input—an op amp that drives up to  $\pm 40$  mA and gives the 4860 a 16-MHz bandwidth and 300-V/ $\mu\text{s}$  slew rate. What's more, the FET input matching is so good that the maximum offset drift is only  $\pm 15$  ppm of the +10-V full-scale range per °C. Using a high-speed double-diffused MOS FET switch at the input, the device maintains a high feedthrough attenuation of 74 dB at 2.5 MHz.

The sample-to-hold transient settles to  $\pm 0.01\%$  of full scale ( $\pm 1$

mV) in 60 ns typically. Other key specifications are a low maximum offset error of  $\pm 5$  mV, an aperture delay time of 6 ns, and an aperture jitter of only  $\pm 50$  ps.

The push for higher speeds in sample-and-hold amplifiers has led to higher power consumption and reduced operating temperature ranges. But the 4860 employs TTL—not emitter-coupled logic—and as a result, consumes a low 875 mW, enabling it to operate reliably over the full  $-55^\circ$  to  $+125^\circ\text{C}$  range. Fully screened versions meeting MIL-STD-883 are available. Prices start at \$164 in lots of 100, and prototype quantities are now in stock.

Teledyne Philbrick, Allied Drive at Rte. 128, Dedham, Mass. 02026 [354]

generator [*Electronics*, May 22, 1980, p. 199]. The 5910 consigns generation of arbitrary waveforms to hardware rather than software, which speeds waveform production, reports Gary R. Ware, project engineer at the firm.

The microprocessor-based 5910 stores arbitrary waveforms in a 1-K-by-12-bit MOS memory bank. After defining a particular wave shape, the user can enter the points by hand as a series of voltage levels at up to 1,024 intervals of equal length. The 5910 automatically scales the entered voltage inputs along a 4,096-level resolution range to reproduce the waveform. Data points are put out by the generator in a minimum of 200 ns.

**Download.** The generator's IEEE-488 bus interface makes it possible to download digitized waveforms into its memory. A computer on the bus may be used to feed the 5910 data for complex algorithm-based waveforms, or other digitization methods may be employed to reproduce hand-drawn or existing analog wave shapes.

Originally designed for the 5900, an autoprogrammer unit continues to operate in the 5910's production of log and nonlinear waveforms. Featuring arithmetic and automatic increment or decrement functions, the autoprogrammer performs digital linear sweeps over a 10,000-to-1 range, log sweeps over the 5910's frequency range of 0.0001 Hz to 5 MHz, and nested loops that intermix log and linear sweeps.

The unit has nine storage registers, each storing parameters for an entire instrument setup. Other features include fixed or variable dc offset to  $\pm 15$  V; 20-, 40-, and 60-dB

## Arbitrary-waveform/function generator puts out waves digitized to 12-bit resolution

The 5910 generator of arbitrary waveforms or other functions produces repetitive waveforms of any desired shape in addition to the sine, triangular, square-wave, and other standard waveforms used in bench-top and automatic-test applications. Unlike Krohn-Hite Corp.'s earlier model 5900 programmable function

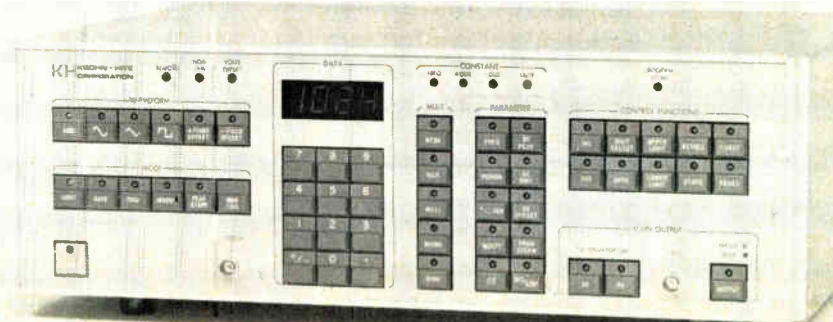

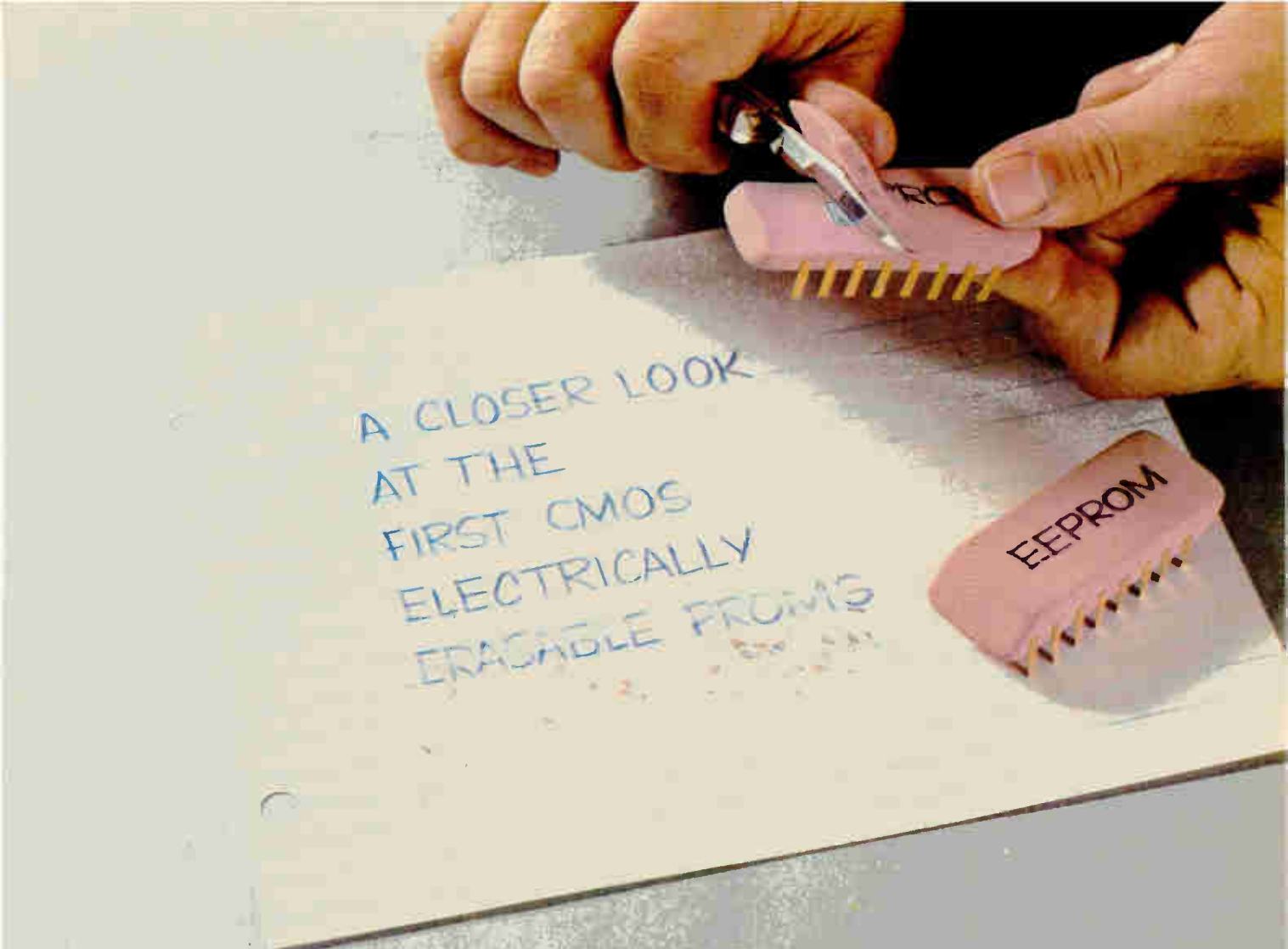

## HUGHES EEPROMS NOW IN VOLUME PRODUCTION!

**HUGHES**

HUGHES AIRCRAFT COMPANY

### Solid State Products

500 Superior Avenue  
Newport Beach, CA 92663  
(714) 759-2942  
TWX: 910-596-1374

In Europe

### Hughes Microelectronics Ltd.

Clive House  
12-18 Queens Road  
Weybridge, Surrey KT 139XD  
England  
Telephone: 932-47262  
Telex: 929727

Hughes EEPROMs, introduced in 1980, are gaining wide market acceptance in applications requiring electrically erasable non-volatile memory and low power operation. Production quantities are now being delivered for both the 4K and 8K bit versions.

Applications are divided into two general categories:

- convenient alternative to EPROMs
- in-circuit programming which offers new dimensions in innovative design techniques.

For example; Hughes has developed a digitally compensated crystal oscillator (DCXO) with temperature compensation using our HNVM 3008. The ROM code is not written until after the product is completely assembled, providing more accurate compensation, ease of manufacture, and subsequent recalibrations in the field. Other applications are emerging for postage meters, portable terminals, adaptive processors and many more.

The HNVM 3004 (512 x 8) and the HNVM 3008 (1024 x 8) EEPROMs can be written 10,000 times and retain information for 10 years at 125°C or 20 years at 70°C. Naturally, the Hughes HNVM 3000 series are compatible with all major logic families.

To respond to the EPROM market, Hughes is introducing the HNVM 3704 (512 x 8), our first product to provide a cost effective alternative to EPROMs with CMOS characteristics. This device can be programmed electrically in 1 millisecond and erased electrically in 100 microseconds.

It is time for you to consider Hughes EEPROMs. Programming is easy to accomplish either in-circuit or out-of-circuit. Parts are available now from Hughes distributors. For more information and your copy of our new EEPROM application notes contact your local Hughes Representative or Hughes—Solid State Products.

**Hughes... A Leader in CMOS Technology.**

REPRESENTATIVES: Austria — Burisch (0222) 38 76 38-0; England — Peico (0273) 722 155; France — Alfatronic (1) 791.44.44; Sweden — Allhabo 08-224500; Switzerland — Kontron 01 628282; West Germany — Astronic 089/304011 & Microscan 40/6 30 50 67; Hong Kong Tektron 3-856199; Japan — Nihon Teksel (03) 461-5121

attenuation; waveform inversion; zero-or-peak and start-or-stop levels for gated, triggered, and triggered-burst modes; and user-selectable upper and lower parameter limits.

The unit's maximum output is 30 V peak to peak (open circuit) or 15-V p-p into 50  $\Omega$ , and its duty cycle is variable from 1% to 99%. Amplitude accuracy typically is to within  $\pm 2\%$  of reading; slew rate is 20 V/ $\mu$ s max-

imum, and sine-wave distortion at maximum output is less than 0.5% ( $-46$  dB) to 100 kHz, and 3% ( $-30$  dB) at 5 MHz.

The 5910 weighs in at 26 lb and typically consumes 60 w, 25 w in standby mode. The instrument operates from 0° to 50°C, costs \$4,500, and can be delivered in 60 days.

Krohn-Hite Corp., Avon Industrial Park, Bodwell Street, Avon, Mass. 02322 [357]

## Multichannel thermal recorders have fast-heating thin-film print heads

Though thermal recorders are much neater than ink recorders, the slow heating that makes them fail when operating at high speeds has discouraged their use. But the Linearcorder

Mark VII print head heats and cools so quickly that it prints under all circumstances. The head, which weighs only 0.3 g, will even print dot-matrix characters.

Watanabe Corp. of America, a subsidiary of Watanabe Instruments Corp. of Tokyo, uses the patented ceramic head on the WR 31001 family of recorders. The device uses thin-film technology, with components other than the ceramic consisting of an insulating material, heating element and a wear-resistant layer that touches the heat-sensitive paper. The low-wear layer gives the head a life of about 500 km, or about one year's writing time, says Edward P. Brooks, president.

The head's ceramic portion contains diamond dust and hydrogen, the latter being mixed in to increase conductivity and lower the weight, Brooks says. Its small mass permits the new material to dissipate heat quickly: rise time is 3 ms and fall time is 5 ms. The recorder will print at a high signal velocity even at high chart speeds, as is necessary when recording square waves. Because of rapid cooling, the recorder can print a solid block without burning through the paper.

**Dot-matrix printing.** The model 3101 prints the time, date, speed and elapsed time along the edge of the chart, using five-by-seven-dot-matrix characters. Additional information may also be printed by interfacing a computer with the recorder. A stepper motor gives a wide range of paper-drive speeds with a greater accuracy than competitive units, says Brooks. Speeds range from 0.05 to 500 mm/s, with an accuracy within 0.2%.

The pen motors are accurate to within 0.5%, with a frequency response from dc to 60 Hz at 4-cm amplitude, 120 Hz at 1-cm amplitude. The recorders have pen mechanisms with either  $\pm 20$ - or  $\pm 40$ -mm travel.

The WR 3101 family includes 2-, 4-, 6-, 8-, and 12-channel units. Each channel operates separately, with one signal input cable for each. The recorders may be rack-mounted either horizontally or vertically or placed on a table.

Recorders in the line range in size from a 12-lb unit measuring 430 by

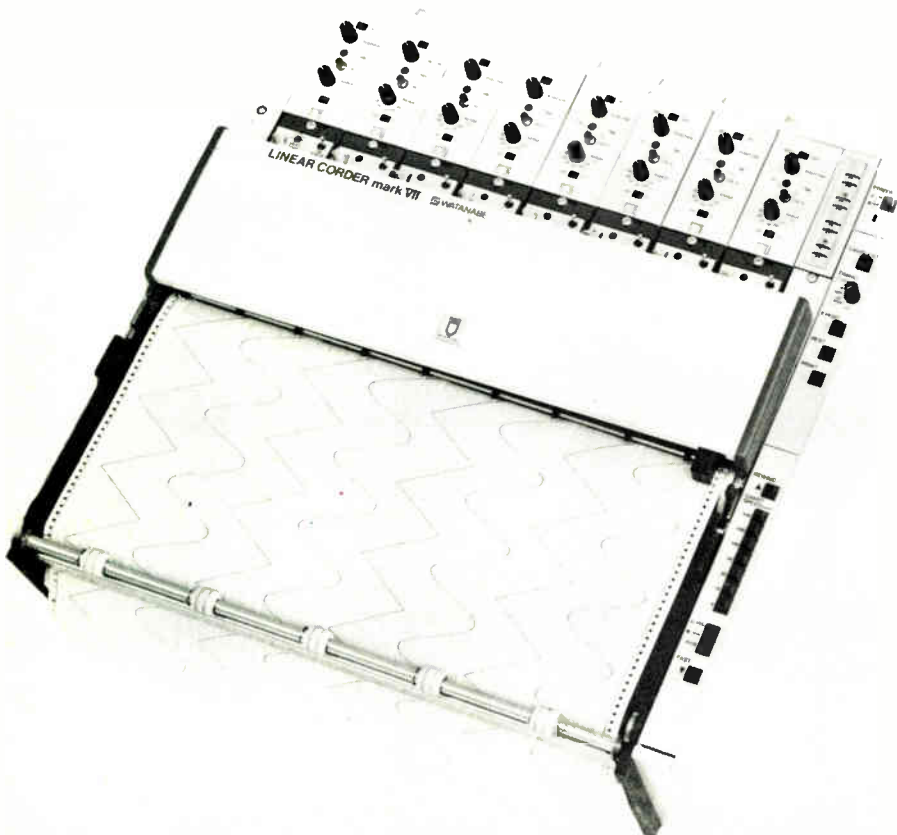



# At your fingertips... 268 proved-in-action circuits for instant, versatile use in your own design solutions!

## Electronic Circuits Notebook 344 pp., illus.

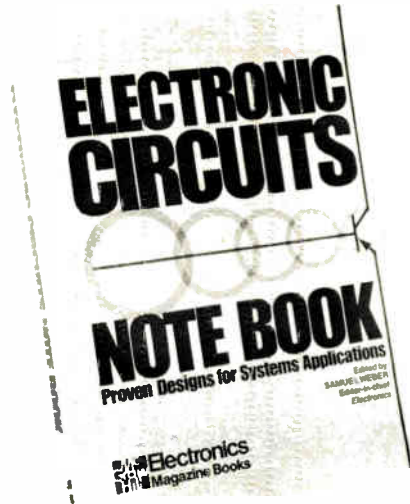

This companion volume to the highly respected "Circuits for Electronics Engineers" continues to meet the toughest standards of performance, cost reduction, and reliability.

Circuits presented in *Electronics'* renowned "Designer's Casebook" section from late-1977 to mid-1980 are gathered here for the first time in a single, easy-access resource.

### Conveniently arranged by 39 vital functions.

Intended to provide ready solutions to recurrent engineering problems, ELECTRONIC CIRCUITS NOTEBOOK presents stimulating approaches that speed innovative, creative design concepts.

You'll find the most needed, most reliable information on a vast range of circuit designs, including...

- one-chip gyrator that simplifies an active filter
- automatic gain control with 60 decibel range
- high-accuracy calibrator that uses no precision components
- power supply modification to add programmability
- shift registers that act as control interface for microprocessor
- RAM and d-a converter that form a complex-waveform generator
- standard ICs to provide raster scan interface
- voltage-to-current converter that handles bilateral signals
- hybrid servo system that minimizes hunting
- peak detector that recovers narrow pulses accurately
- EPROM that achieves nonuniform data-channel sampling
- optoisolator that initializes signal-averaging circuits

- three-chip logic analyzer that maps four-input truth table
- digital phase shifter that covers 0° to 360° range
- audio blanker that suppresses radar-pulse and ignition noise
- power-up relays that prevent meters from pinning
- up/down latching sequencer that keeps order
- low-cost fiber-optic link that handles 20-megabit/s data rates
- and much more!

### New ideas and approaches keep you up to date fast.

Focused strictly on the problems facing today's practicing design engineers, ELECTRONIC CIRCUITS NOTEBOOK delivers top-competency, professional answers to your most demanding projects.

Hundreds of complete schematics, block diagrams, waveforms, and other illustrations help provide immediate understanding of the latest breakthroughs and advances. Use this absolutely essential volume to...

- design appropriate circuitry to meet the most challenging specifications
- cut design time by adapting proven circuits to a wide range of applications
- save money and increase productivity by avoiding costly design errors

Why take the chance of being less than on top of the latest circuitry developments? Before you tackle your next project, order this essential resource *today!*

### Don't forget the other valuable Electronics Magazine Books on the coupon below.

Electronics Magazine Books  
P.O. Box 669, Hightstown, NJ 08520  
(609) 448-1700, ext. 5494

No. of Copies	Title	Price
_____	Electronic Circuits Notebook	\$14.95
_____	Circuits for Electronics Engineers	\$15.95
_____	Design Techniques for Electronics Engineers	\$15.95
_____	Microprocessors	\$ 8.95
_____	Applying Microprocessors	\$ 9.95
_____	Large Scale Integration	\$ 9.95
_____	Basics of Data Communications	\$12.95
_____	Memory Design: Microcomputers to Mainframes	\$12.95
_____	Personal Computing: Hardware and Software Basics	\$11.95
_____	Microelectronics Interconnection and Packaging	\$12.95
_____	Practical Applications of Data Communications: A User's Guide	\$13.95
_____	Microprocessors and Microcomputers: One-chip Controllers to High-end Systems	\$13.95

Discounts of 10% on orders of more than 10 books.

If after my 10-day free-trial examination I am not fully satisfied I understand that my payment will be refunded. Payment must accompany orders under \$25.

Payment enclosed     Bill firm     Bill me

Charge to my credit card:

American Express     Diners Club  
 Visa     MasterCard\*

Acct. No. \_\_\_\_\_ Date Exp. \_\_\_\_\_

\*On MasterCard only, first numbers above name \_\_\_\_\_

Name \_\_\_\_\_ Title \_\_\_\_\_

Company \_\_\_\_\_

Street \_\_\_\_\_

City \_\_\_\_\_ State \_\_\_\_\_ Zip \_\_\_\_\_

Signature \_\_\_\_\_ EL1

187 by 199 mm to a 41-lb, 430-by-187-by-649-mm unit. Prices range from \$11,000 to \$15,000 in single quantities and delivery is with-

in 30 days of receipt of order.

Watanabe Corp. of America, 3188-D Airway Ave., Costa Mesa, Calif. 92626. Phone (714) 546-5344 [356]

## Signature analyzer performs single-channel logic analysis

The LA-1000 system analyzer from the B&K Precision product group of Dynascan Corp. is a signature analyzer with a built-in volt-ohm-frequency meter and a single-channel logic-analysis feature. With its low price of about \$1,750, the unit is designed for easy use by field technicians inexperienced in digital test techniques.

Its single channel of logic analysis is obviously not intended for software debugging or timing analysis in large systems, as are multichannel logic analyzers made by B&K and other firms. But B&K engineers feel that the single-channel capability will be useful in many applications. Teletypewriter gear and other systems employing serial digital communications over single lines or twisted pairs are examples. Probing a single node in a digital circuit is often valuable in troubleshooting.

Compared with multichannel analyzers, the logic analysis function of the LA-1000 is very easy to use. Once the mode switch is set, a total of six buttons—three on the LA-1000 itself and three on the attached

probe control pod—are all that are required for logic analysis operation.

Capable of 20-MHz synchronous operation, the LA-1000 can handle both TTL or complementary-MOS logic in its logic analysis mode. A 256-bit memory permits storage of 16 pages of 16 bits each. State data formatted in hexadecimal code can be shown on an integral four-digit light-emitting-diode display, and an oscilloscope output is also provided for display of a 16-bit single-channel timing diagram.

In its signature-analysis mode, the LA-1000 displays signatures in stan-

dard hexadecimal coding. Features include an unstable-signal indicator for diagnosing intermittent failures and a self-test capability. Input signals need only be valid for 10 ns before the selected clock edge (setup time), permitting operation at higher clock rates than is possible with signature analyzers requiring longer setup times.

Also in the LA-1000 are an auto-ranging 30-MHz frequency counter and a digital voltmeter and ohmmeter. The autoranging meter is independent of other instrument functions and is controlled by a Rockwell PPS-4 4-bit microprocessor, displaying dc and ac voltage and resistance on a separate 3½-digit display. Dc and ac voltage can be measured to within 0.1% and 0.5% accuracy, respectively, while resistance is measured to ±0.3%. The frequency counter makes use of a custom MOS chip used in earlier B&K products. The analyzer is available now.

B&K Precision, Dynascan Corp., 6460 West Cortland St., Chicago, Ill. 60635 [355]

## STD-bus system chassis offered by Mostek

Mostek Corp. is unveiling the first members in a User Configurable series of general-purpose computer systems designed around STD-bus cards and housed in a low-profile, industrial-grade chassis. The series marks a new thrust by Mostek into the systems business and is intended to reduce development cycles by 9 to 18 months for STD-bus customers who would otherwise design and build their own computer enclosures.

Targeted at original-equipment manufacturers and system integrators, the Matrix series of user-configurable products is a Z80-based board system using STD bus architecture and 4½-by-6½-in. cards. The series operates on M/OS-80, an operating system developed by Mostek for the Z80, which it second-sources.

M/OS-80 will allow Matrix customers to use any CP/M-compatible application program.

The goal of the Matrix series is to enable system designers to develop less expensive customized machines by giving them a selection of a wide range of standard hardware (such as STD-bus boards and disk memories) and software. The use of an integrated switching power supply reduces the size of the cabinet.

Initially, Mostek will offer two models. The 010 will come with power supply, 10 card slots, and a chassis with a space for a floppy-disk drive. The 100 will have the same features as the 010, plus a single-sided double-density 8-in. floppy-disk drive. Both models are available in either low-profile rack-mountable or table-



# SLASH INSTALLED CONNECTOR COSTS 50% with **PANDUIT® MAS-CON™** Mass Terminated System

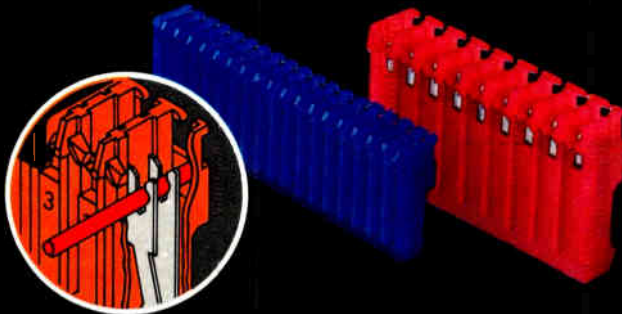
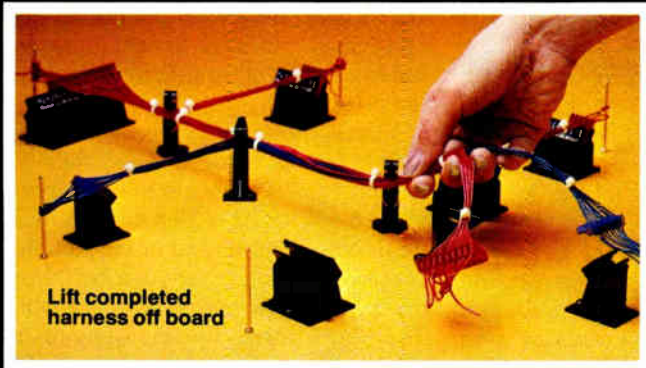
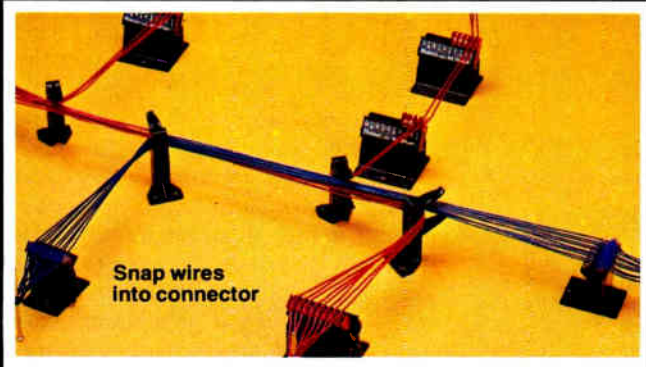

**Pre-loaded insulation displacement contacts eliminate wire stripping, crimping and hand loading contacts.**

Savings as much as 50% in total installed costs can be yours when you switch from your crimp-type connector system to the MAS-CON Mass Terminated System. Panduit MAS-CON connectors eliminate stripping, crimping and hand loading of contacts... and eliminate the need for expensive crimping equipment.

What you get instead is a ready-to-wire IDC system that is simple, consistent, reliable and provides you with all these advantages:

- .100" centerline (2-28 circuit) and .156" centerline (2-24 circuit) end and through style connectors.

- Pre-loaded IDC's and a unique wire retention system which allows a *complete* harness to be removed from the board for termination.
- All connectors accept discrete wire, pre-notched flat cable or pre-split ribbon cable.
- Complete selection of flat, locking and polarizing header assemblies with straight or angled posts.
- Full line of economical termination tools, including manual and pneumatic hand tools and bench presses with interchangeable unit die sets.
- Shipment from stock... Ask for FREE demonstration and literature.

### NEW PAN-FLEX™

.100" and .156" Flat Cable available in standard or pre-notched versions. UL style 2651.

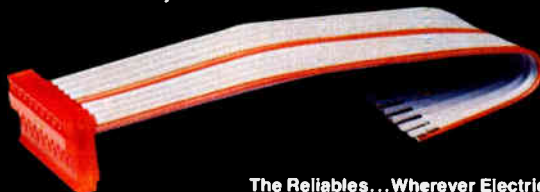

The Reliable... Wherever Electricity is Used

**FREE  
SAMPLES**



ELECTRONIC PRODUCTS GROUP

Tinley Park, IL 60477 • Phone: (312) 532-1800  
In Canada: Panduit (Canada) Limited

Visit PANDUIT at WESCON Booth 1715-1717

Circle 179 on reader service card

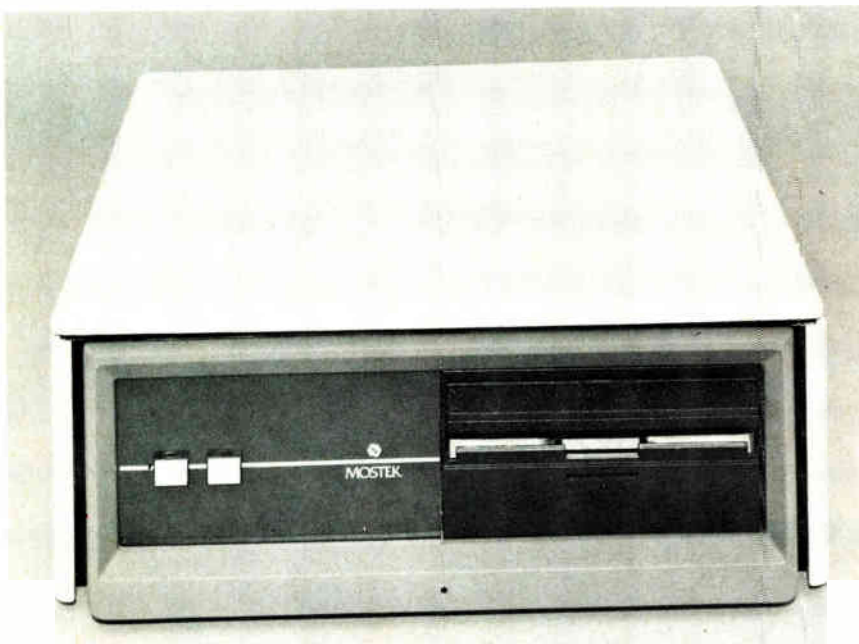

top versions, measuring 19 in. wide by a 0.75 in. high by 22.5 in. deep and 21 by 8¼ by 22.5 in., respectively. The system provides +5 v at 15 A, +12 v at 0.5 A, -12 at 0.25 A and +24 v at 3.4 A for internal components. Standard 115- or 230-v ac is required at either 50 or 60 Hz.

In quantities of one to nine, the 010 will cost \$1,250 each, and the 100 will go for \$1,750 each. The 100 is available now and the 010 will be

ready for delivery in the final quarter. Future members of the Matrix family will include such features as: STD-bus boards (such as serial input/output, central processing unit, and memory cards); software; combinations of Winchester and floppy-disk drives; and networking capabilities.

Mostek Corp., Micro Systems Division, 1215 West Crosby Rd., Carrollton, Texas 75006. Phone (214) 323-6000 [352]

## 35-MHz programmable scope aims at production, inspection

Kikusui International Corp. is targeting U.S. production and inspection lines with a dual-channel programmable instrument. The 35-MHz bandwidth and 5-mV sensitivity of the model COS 5030PG is admittedly at the low end of scope performance for engineering and development. But the oscilloscope's combination of low price and numerous programmable features, as well as the resulting simplicity of operation, should make it an attractive workhorse production or inspection unit,

the company believes.

Although pricing is not final, the basic scope is in the \$3,600 range, and a configuration with all options boosts it to about \$6,000. The options include remote and step controllers, probe selectors, memory, and interface and make it possible to operate the instrument with any combination of computer or manual control, says William White, a marketing executive for the firm.

The Kikusui scope's programmability covers about 95% of its

switches and controls for waveform display. Since it can be controlled either manually, with a step controller, or with a computer, the result "is an effective labor-saving instrument for production-line inspection," says White. An interface option sets the scope up for connection to the IEEE-488 instrumentation bus for computer control.

Among its programmable vertical functions are sensitivity, input coupling, mode, and position. Horizontal A and B sweep are programmable; continuous adjustment of the variable A sweep is possible. Six levels of trigger control are also programmable on the COS 5030 PG, as are trigger source, coupling, slope, and level. Other programmable functions offered are delay time and intensity.

When the oscilloscope is linked with a remote controller and memory unit, up to 96 steps may be performed. With the step-control option, these steps stored in the remote controller and memory can be automatically incremented up or down. The time interval for this stepping is adjustable for approximately 3- to 30-second periods. For manual operation, control knobs are located on both the main instrument and the remote unit. In this mode, delay-time positioning can be set at 5% to 95% of the main sweep.

**Option combinations.** The portable instrument may also be rack-mounted; it is designed for simple installation with a minimum of connections between units. The cathode-ray tube has a 5.5-in.-square screen of the dome-mesh, post-acceleration type, with a parallax-free internal graticule. The principal option combinations with the programmable instrument would be a remote and step controller, a memory unit and step controller, or an interface and a personal computer.

Much of the final design thinking for the U.S. unit comes from suggestions offered by Japanese manufacturers of video-tape and video-disk equipment who use similar oscilloscope systems for inspection

# It's fast. It's programmable. Meet HP's new 8161A Pulse Generator. 1.3 ns variable transition times, 100 MHz.

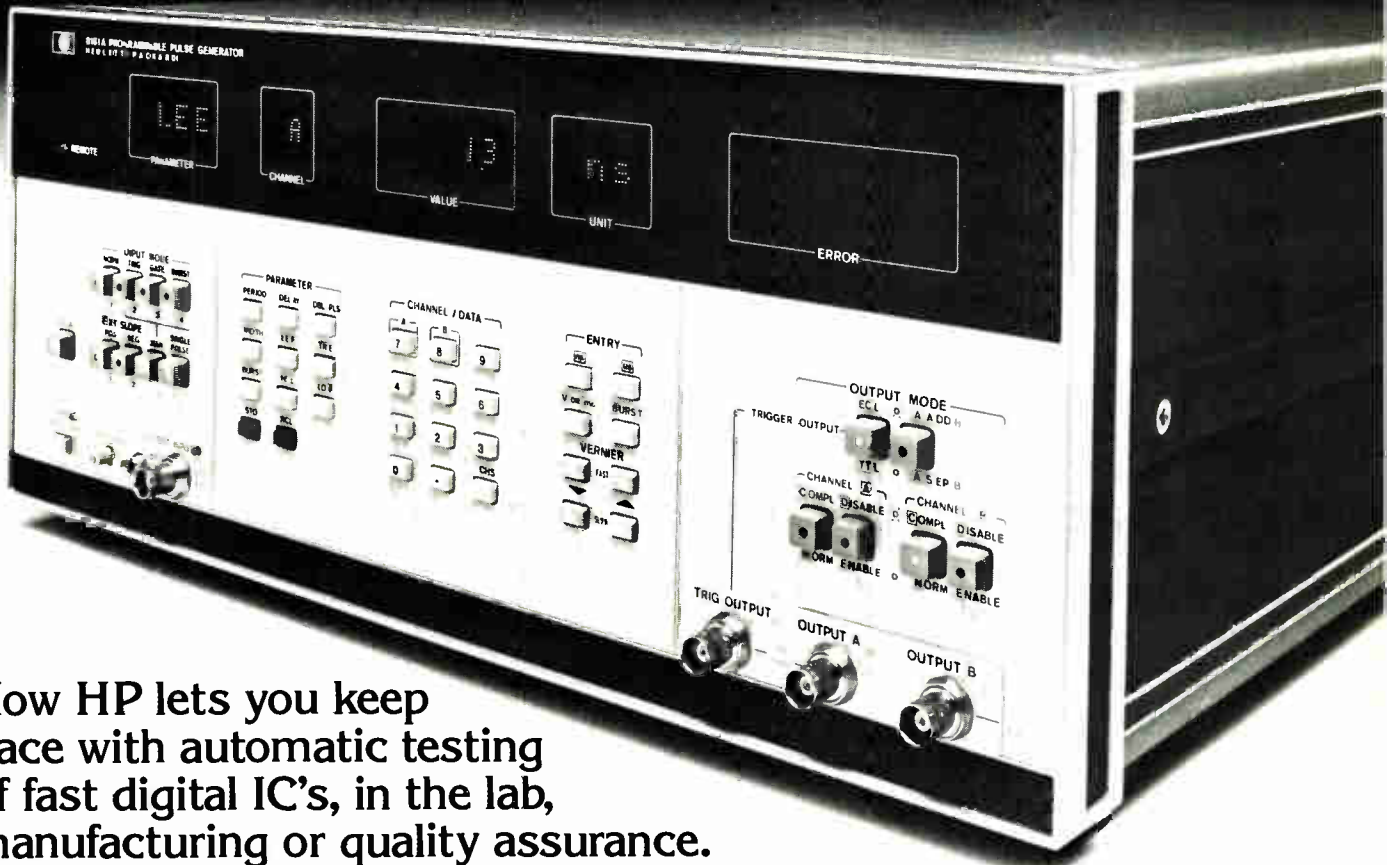

Now HP lets you keep pace with automatic testing of fast digital IC's, in the lab, manufacturing or quality assurance.

The new Hewlett-Packard 8161A offers a flexible, easy-to-use solution to the problem of testing fast high-technology circuits such as 10K ECL logic and advanced Schottky devices. And, it's the first HP-IB programmable pulse generator with variable transition times down to 1.3 ns, allowing you to evaluate high-speed logic circuits thoroughly.

**Features you'll appreciate — now, and in the future.** Fast, clean 100 MHz, 5V pulses are just part of the 8161A's story. With 1-2% basic timing accuracy over a wide temperature range plus a one-year recalibration period, the 8161A gives you quality measurements while it saves on maintenance time and expense. Two complementary outputs are standard. And, you can get an optional, fully independent, second output channel that lets you generate complex waveforms in A + B mode. External operating modes and counted burst further enhance the 8161A's flexibility.

**A real time saver on the bench.** When used as a bench instrument, this new HP Pulse Generator's easy, microprocessor-controlled operation will simplify most test setups. With its high accuracy, no time-consuming 'tweaking-in' is required. Storage of nine complete parameter setups for quick recall simplifies operation. And outstanding repeatability means reliable measurement results.

**Ideal for fully automated testing.** In an R&D or production system, the versatile new HP 8161A is easily integrated using HP-IB, which allows automated testing of advanced semiconductor devices and system modules. Besides saving time and increasing throughput, the 8161A will eliminate errors associated with manual measurements. You'll get reproducible results over long periods of time without the necessity of constant system monitoring or correction loops.

**Fully detailed information — yours for the asking.** For comprehensive technical data and application note, write: Hewlett-Packard, 1820 Embarcadero Road, Palo Alto, CA 94303. Or call the HP regional office nearest you: East (201) 265-5000, West (213) 970-7500, Midwest (312) 255-9800, South (404) 955-1500, Canada (416) 678-9430.



HP-IB: Not just IEEE-488, but the hardware, documentation and support that delivers the shortest path to a measurement system.



Circle 181 on reader service card

**Check**

- Transistors
- Capacitors
- Diodes
- IC's

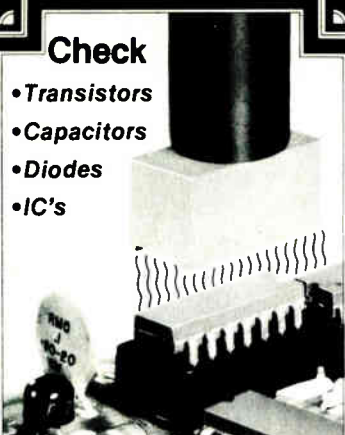

**CONTROLLED HEATING**  
... where it counts

**THERMO-PROBE**

Heat any integrated circuit or electronic component to its rated temperature with a heat probe. Accuracy  $\pm 3^{\circ}\text{C}$  or better. Or check the component's temperature with a thermo-couple probe. Model 810 Thermo-Probe does both. Reads out directly in  $^{\circ}\text{C}$  and  $^{\circ}\text{F}$  on a large  $4\frac{1}{2}$ -inch meter.

**MTI MICRO-TECHNICAL INDUSTRIES**  
23112 "C" Alcalde  
Laguna Hills, Calif. 92653  
(714) 855-4326  
TWX (910) 595-1745

Circle 182 on reader service card

## Another increase in interest rates for U.S. Savings Bonds.



*Growing Bigger...Faster.*

**Take  
stock  
in America.**

UNITED STATES  
SAVINGS BONDS

AG Council A public service of this publication and The Advertising Council.

## Wescon/81



tasks. After the programmable system has been set up by a test engineer, "it can be operated by pushing one button," White claims. Small quantities of production units will be ready in 60 to 90 days.

Kikusui International Corp., 17819 S. Figueroa St., Gardena, Calif., 90248. Phone (213) 515-6432 [359]

## Dry-type metalized-film capacitors lower cost of self-protection

The SF dry-film capacitor series from the Electronic Components division of Panasonic has a self-protection feature built into the rolled metalized film and dielectric. The 0.5-to-60- $\mu\text{F}$ , 360- and 400-v capacitors thus increase reliability in motor circuits, ballasts, and other ac applications. They also reduce weight and size in comparison to other self-protecting capacitors, says the manufacturer.

The metalized-film electrodes are separated into many small segments connected in parallel. If breakdown of the dielectric occurs, the affected segment is electrically disconnected from the rest—a fuse link in the metal film is blown—and the unit continues to function at a slightly reduced capacitance. Because the paralleled elements are very small relative to the total capacitance, the drop in value is unlikely to affect the unit's performance.

The self-protection feature lends itself to conventional mass-production techniques, allowing the firm to offer added reliability at prices very near those of standard unprotected dry-type metalized-film capacitors. The Panasonic parts range from \$1 to \$5 apiece in quantity. The expense and the bulk of the added internal-protection devices of conventional self-protected capacitors is avoided; size and weight are reduced by 30% to 50%.

The operating temperature range of capacitors in the SF series is  $-55^{\circ}$

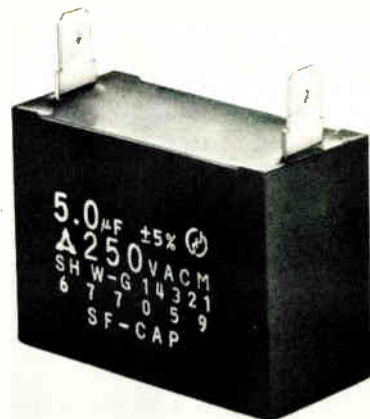

to  $+85^{\circ}\text{C}$ . Delivery takes 14 to 16 weeks.

Panasonic, One Panasonic Way, Secaucus, N. J. 07094. Phone (201) 348-5206 [363]

## 500-W switchers near \$1 per watt

ACDC Electronics is using its sub-modular architecture in a new line of 500-w switching power supplies to speed deliveries and to lower prices.

The architecture breaks a power supply into three segments, and the division of Emerson Electric Co. has already used it for two years in switchers with outputs below 300 w and above 1,000 w. The RSF series is

# Just published... your headstart on electronics demand worldwide!

Focus on the outlook for almost 200 electronics products! In 13 countries including the U.S., Japan, and all of Western Europe! Results of an authoritative, worldwide research effort! Packed into easy-to-use tables and on-target analyses!

*Electronics'* highly respected 23rd annual market forecast has now been expanded to provide an in-depth look at the current and future demand for electronics products in the United States, Western Europe, and Japan—including 23 additional pages of market-estimate and growth-rate tables.

More helpful and reliable than ever before, the 55-page report offers invaluable guidance on the outlook for some 200 electronic products by such categories as...

components • communications equipment • industrial electronics • test and measuring equipment • semiconductors • data-processing systems, peripherals, and office equipment • and consumer electronics

## Far-ranging research findings not available elsewhere are brought together here for immediate access to...

- compound annual U.S. growth rates for 1979-1984
- U.S. report research methodology and response ranges • economic analyses and outlook for the U.S., Western Europe, and Japan
- Product-by-product, country-by-country market

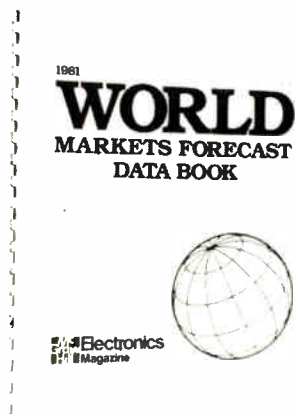

## Electronics' 1981 World Markets Forecast Data Book

by the Editors of *Electronics*

estimates for Belgium, Denmark, France, Italy, Netherlands, Norway, Spain, Sweden, Switzerland, United Kingdom, and West Germany

Emphasis throughout is on the key factors influencing product price and consumption volume in the coming years, including: rapid technological change, intense competition, high costs of research and development, high and rising costs of production and distribution, and changes in the volume of sales.

Some 40 *Electronics* editors stationed worldwide worked together to analyze hundreds of questionnaires and conduct follow-up interviews.

**The results belong in the hands of everyone serious about the emerging technical, financial, and planning outlook for the electronics market.**

## Among the vast range of most-needed information found here are

U.S. market estimates and growth rates for...

- semiconductors and 15 other categories of components
- consumer electronics • 10 sections of industrial and commercial equipment... plus Federal procurement projections!

Western Europe 1979-1981 consumption of...

- 66 components • 100 types of electronic equipment... all spelled out product by product, country by country!

Japan/Western Europe demand for...

- 86 equipment products • 54 separate components... all in one easy-to-compare table!

Order today for immediate delivery!

Electronics Magazine Books  
1221 Ave. of the Americas, 42nd Fl.  
New York, NY 10020 USA



Send me \_\_\_\_\_ copy (copies) of *Electronics'* 1981 World Markets Forecast Data Book (606724-6) at \$125 each, plus local sales tax in U.S. (Price includes first-class mail in North America, air shipment elsewhere.) I understand that full payment must accompany this order.

Name \_\_\_\_\_ Title \_\_\_\_\_

Company \_\_\_\_\_

Address \_\_\_\_\_

City \_\_\_\_\_

State/Country \_\_\_\_\_ Zip (U.S.) \_\_\_\_\_

ELI

# If you specify axial leaded resistors

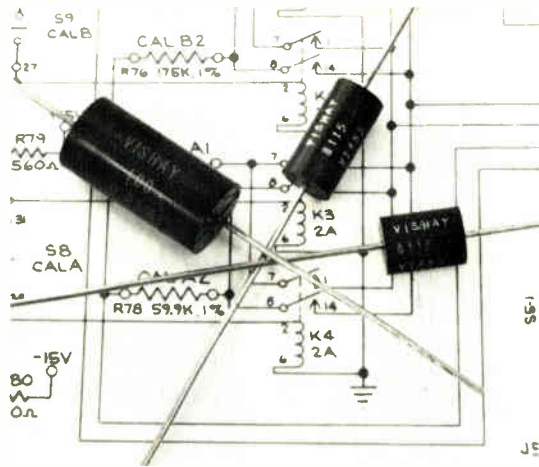

## you should consider **VISHAY**

Now, the same Bulk Metal® Foil technology which has made Vishay's precision resistive components synonymous with quality is available in an axial leaded, tubular, precision resistor. Vishay's VTA series is designed to be interchangeable with conventional axial leaded configurations but exhibits these superior specifications:

- Load life stability: 500ppm maximum  $\Delta R$  at 2000 hrs. under full rated power at 125°C
- Shelf life stability: 25ppm maximum  $\Delta R$  after 1 year
- Rise time: 1.0 nanosecond typical
- Temperature coefficient of resistance: 10ppm/°C standard (-55°C to +125°C) 2ppm/°C available

### VISHAY QUALITY AT A COMPETITIVE PRICE

To learn how Vishay put superior resistor performance in an axial leaded package, write

**Vishay Resistive Systems Group**  
of Vishay Intertechnology, Inc.

USA and CANADA  
63 Lincoln Highway, Malvern, PA 19355  
or call—(215) 644-1300

INTERNATIONAL  
Headlands Grove  
Swindon, Wilts SN2 6JQ, England  
or call—0793-33577

# VISHAY

**...to be precise**

Wescon/81

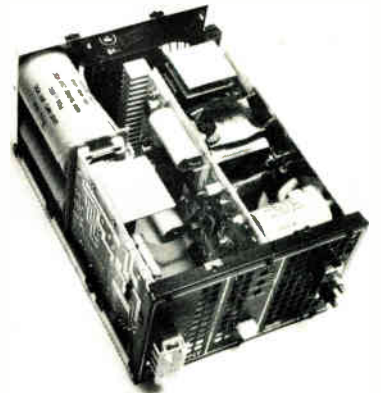

designed to fill part of that gap.

The new switcher family, which offers one to four outputs, uses recently developed large-scale integrated inverter-control circuitry, power semiconductors, and fault- and error-detection chips to reduce the number of components by 20%.

By using revised versions of the existing input, converter, and output modules, ACDC is aiming to provide supplies with a short lead time, high reliability, and low development costs. Small-quantity shipments will begin in this month, and production deliveries will start during the first quarter of next year, with deliveries taking six to eight weeks. Single-output units start at \$595, with quad units listing for \$745, each in single quantities. In large volumes, pricing is near \$1 per watt.

The RSF single-output models have current ratings of 18 to 100 A at 2 to 28 v dc. Additional outputs range from 5 to 28 v at 2 to 20 A. The RSF 100 series of dual-output switchers combines any two voltages from 2 to 28 v at 14 to 80 A with a total power output of 500 w.

Ripple output is a maximum of 10 mV peak to peak. Regulation is to within 10 mV. Input can be 90 to 132 or 180 to 246 v ac, or optionally 165 to 250 v ac. The units are 60% to 80% efficient, depending on the model. Full output is achieved at 50° C, derating to 70% at 71° C.

Overvoltage protection for all outputs, short-circuit protection, and soft starting and overheating protection with automatic reset when nor-



# The Task Master.

## 783 KSR

### Keyboard Send-Receive Data Terminal

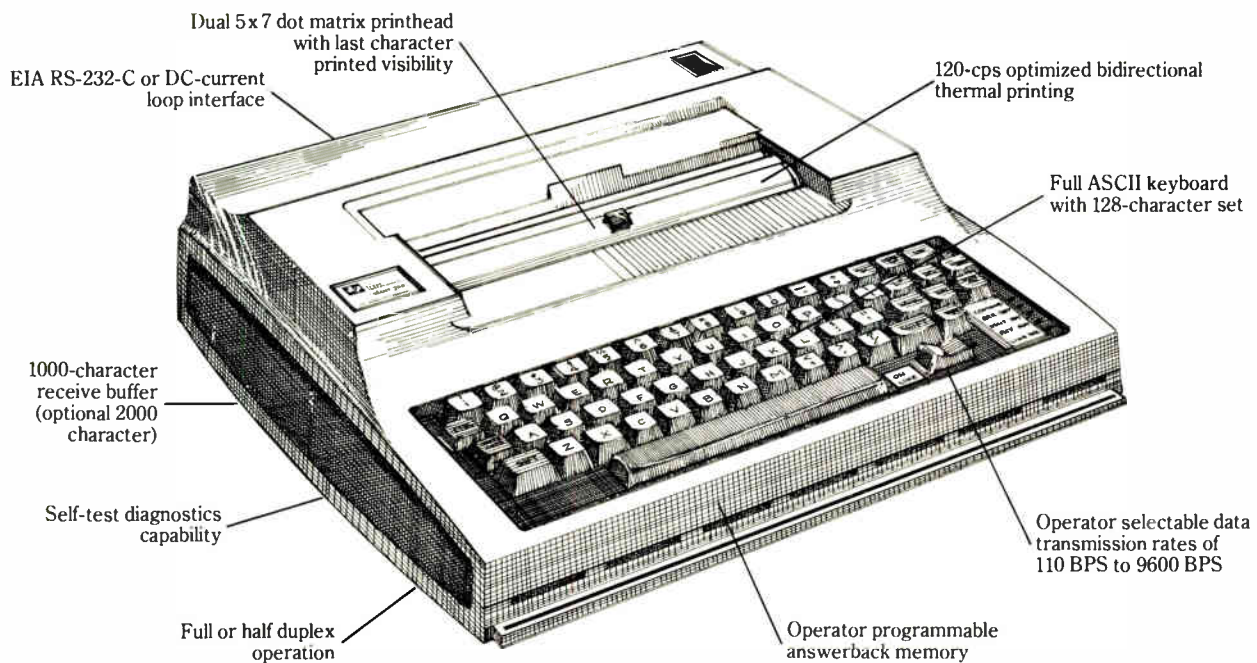

Ideal for commercial applications, TI's *Silent 700*\* Model 783 KSR Data Terminal can master your workload with high-quality, efficient thermal printing. Offering a variety of user-oriented standard features and options, the virtually silent 783 KSR takes less work space while it maximizes printing throughput. That's why the versatile 783 KSR was designed to handle your most demanding printing tasks.

TI is dedicated to producing

quality, innovative products like the 783 KSR Data Terminal. TI's hundreds of thousands of data terminals shipped worldwide are backed by the technology and reliability that come from 50 years of experience, and are supported by our worldwide organization of factory-trained sales and service representatives.

For more information on the 783 KSR, contact the TI sales office nearest you, or write Texas Instruments

Incorporated, P.O. Box 1444, M/S 7884, Houston, Texas 77001, or phone (713) 373-1050. In Canada, write Texas Instruments Incorporated, 41 Shelley Rd., Richmond Hill, Ontario L4C 5G4, or phone (416) 884-9181.



*We put computing within everyone's reach.*

\*Trademark of Texas Instruments Copyright © 1981, Texas Instruments Incorporated

## TEXAS INSTRUMENTS

INCORPORATED

# U.L. requirement called for high strength.

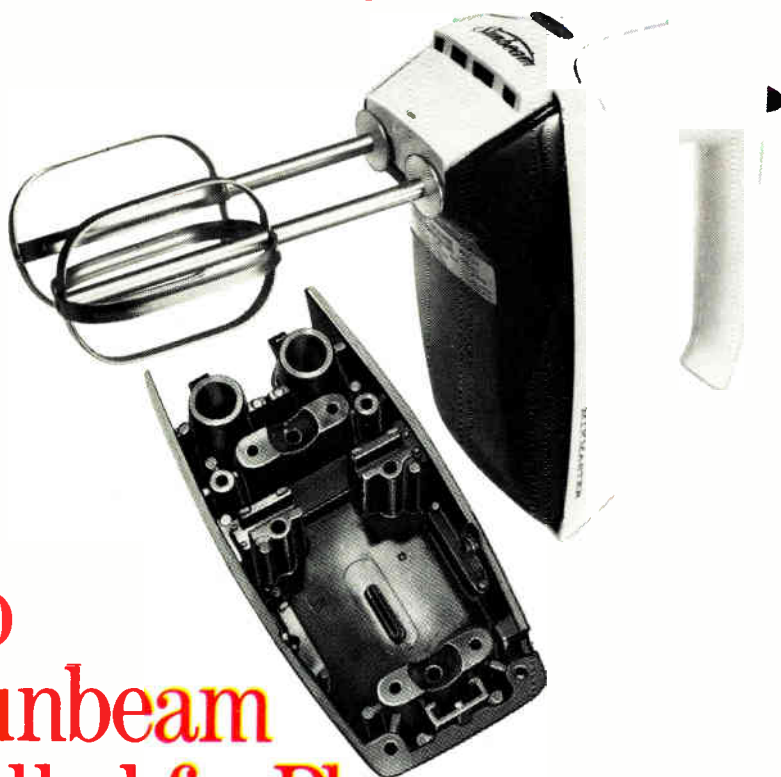

## So Sunbeam called for Plenco.

Sunbeam Appliance Company, Chicago, a division of Sunbeam Corporation, manufactures a complete line of appliances whose name and reputation are known the world over.

At Plastics Engineering we take a certain pride in having had a small part in the building of that reputation. Please note, for example, the molded housing featured on this Sunbeam Mixmaster Mixer.\* Attractive, extra-rugged, the housing is Sunbeam's answer to the new U.L. Drop and Ball impact tests calling for a tougher molding material. Again Plenco was able to help.

Reports the manufacturer: "Your Plenco 524 Brown Impact phenolic thermosetting compound with a special rein-

forcement to provide high strength at low cost was selected. Although thermoplastic was an option, with this thermoset traditional or regular phenolic molds can be used and the expense of new molds saved. Dimensional stability, too, remains the same—an added advantage the thermoset offers."

Consider your own application and what benefits a quality thermoset compound can bring you. Call Plenco at (414) 458-2121.



PLASTICS ENGINEERING COMPANY  
Sheboygan, WI 53081

Through Plenco research... a wide range of ready-made or custom-formulated phenolic, melamine-phenolic, alkyd and polyester thermoset molding compounds, and industrial resins.

\*Sunbeam and Mixmaster are registered trademarks of Sunbeam Corporation.

Wescon/81

mal temperatures are regained are standard. Options include outputs indicating ac power failure and outputs out of tolerance and a remote-inhibit input.

ACDC Electronics, Products Marketing Department, 401 Jones Rd., Oceanside, Calif. 92054. Phone (714) 757-1880 [360]

## Saddle joint extends edge connectors

Responding to a special request for an extremely long printed-circuit connector, Viking Connectors is using a new concept throughout its line of printed-circuit-board edge connectors. Called a saddle connector, it can double the 50 or so maximum positions previously possible by using a bonded U-shaped support member that joins two connector bodies. The result is a rigid double-length edge connector.

Interest in longer printed-circuit connectors is not rare, maintains Viking—demand for them is growing as an efficient solution for connecting computer cards to a backplane or motherboard. In the past, extending connectors to gain positions has caused either the board or the connectors themselves to warp. Another way to get extremely long connections is by assembling modular types end to end. However, manufacturing costs tend to be higher with this method. With the new bonded support, warpage does not occur, Viking says. The saddle joint is strong enough to withstand a force of 150 lb.

Since the saddle concept will be applied with all standard Viking edge connector types, all varieties of contacts will also be available. Viking has already produced saddle units with 79 and 80 positions and can build them with up to 100 dual positions on 0.125-in. centers.

The price of the saddle assembly adds \$1 to the cost of a pair of connectors, in quantities of 1,000 to



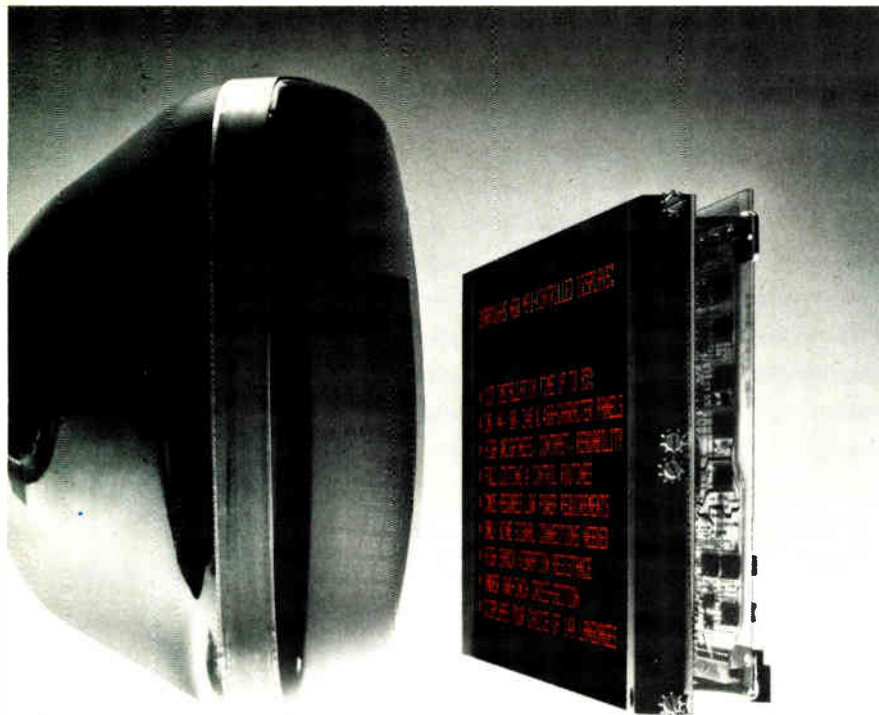

**12 inches fat...1½ inches thin.**

You could fit nine Burroughs 240 or 480 character display panels in the space of one CRT. Imagine the bulk and weight you'll save in your product's design.

What's more, they're available with built-in microprocessor control and memory. All you do is feed in 8-bit signals and you've got one of the brightest, easiest-to-read displays yet. Plus savings of 50% or more in size and weight. Get the full story. Call or write for the name of your nearest representative.



Burroughs OEM Marketing, Burroughs Place, Detroit, MI 48232. (313) 972-8031. East Coast: (201) 757-5000. Central U.S.: (612) 932-3800. West Coast: (714) 835-7335. In Europe, Langwood House, High Street, Rickmansworth, Hertfordshire, England. Telephone Rickmansworth (09237) 70545.

# Burroughs

Circle 188 on reader service card

## NEW 1981 Electronics Buyers' Guide

The only book of its kind in the field. If you haven't got it, you're not in the market.

**To insure prompt delivery enclose your check with this coupon.**

Yes, please send me \_\_\_\_\_ copies of 1981 EBG.

I've enclosed \$30 per copy delivered in USA or Canada. Address: EBG, 1221 Avenue of the Americas, New York, N.Y. 10020.

I've enclosed \$52 for air delivery elsewhere. Address: EBG, Shoppenhangers Road, Maidenhead, Berkshire S16, 2Q1 England.

Name \_\_\_\_\_

Company \_\_\_\_\_

Street \_\_\_\_\_

City \_\_\_\_\_

State \_\_\_\_\_ Zip \_\_\_\_\_ Country \_\_\_\_\_

2,499. Delivery takes 8 to 10 weeks. Viking Connectors Inc., 21001 Nordhoff St., Chatsworth, Calif. 91311. Phone (213) 341-4330 [362]

## Software configures PROM programmer

The Z-800 is a small portable programmer for erasable programmable read-only memories that handles, without the need for personality modules, 2508, 2528, 2532, 2564, 2556, 2716, 2732, 2732A, 2764, and 2728 n-channel MOS E-PROMs. The software-configurable unit will accommodate future E-PROMs through software updates.

The programmer has an RS-232-C interface that allows data to be downloaded from a computer or development system; it adjusts automatically to transmission rates from 110 to 1,200 b/s. Alternatively, it can copy a master E-PROM mounted in one of its two zero-insertion-force sockets. The generic number of the E-PROM is keyed in on a hexadecimal keyboard; the master and the copy can be of different types.

The user may define portions of the master that are to be copied; he may change the locations of those blocks in the copy, thus inserting or deleting data. Changes may be specified in data at up to 16 locations during the duplication process.

An E-PROM may also be programmed without a master copy, one location at a time, using the keyboard. An address and the data at that address appear on a hexadecimal display. The unit lets the user step through the program listing on the copy.

The \$1,500 Z-800 E-PROM programmer measures 9.6 by 4.4 by 1.6 in. and draws 600 mA at 8 to 12 V; a 115-v ac power pack is included. Deliveries take up to four weeks.

Quantec Systems Inc., P. O. Box 832, Station A, Scarborough, Ont. M1K 5C8, Canada. Phone (416) 291-8761 [361]

# RACAL-VADIC'S FULL V.22 COMPLIANT MODEM MAKES COMMUNICATING AS SIMPLE AS...



## V.22 Means Four Times the Speed!

Racal-Vadic, world leader in low and medium speed modems, is in full production on Model 1222, a V.22 compliant modem which operates full duplex at 1200 bits/second over 2-wire dial-up or leased lines. Furthermore, it offers all three V.22 alternatives... A, B, and C.

The 1222 makes it possible for terminal users to transmit and receive data four times faster, with no change in protocol, by merely replacing a V.21 300 bps modem with the new Racal-Vadic 1200 bps full duplex unit. No longer will data terminals with 1200 bps capability have to settle for 300 bps operation!

## Racal-Vadic, World Leader in 1200 bps Full Duplex Technology

Racal-Vadic is by far the world's leading manufacturer of 1200 bps full duplex modems. No wonder! Racal-Vadic invented 1200 bps 2-wire full duplex

transmission in 1973, and has a worldwide installed base of over 125,000 of these modems.

There are a number of reasons why the Racal-Vadic 1222 is the most versatile V.22 compliant modem you can buy. First, it offers all three alternatives... A, B, and C. The inclusion of alternative C means that the 1222 will operate with any terminal at ALL standard asynchronous speeds to 1200 bps, plus split speed (300 bps in one direction, 1200 bps in the other), and overspeed as well.

Also, displays and built-in diagnostics are second to none for pinpointing faults in the entire data network. Packaging is versatile, too. The 1222 is available in a compact desk top cabinet for remote use, or for central computer sites. Up to seven 1222 modems can be housed in a 8<sup>3</sup>/<sub>4</sub>-inch high rack-mounted card nest including power module.



Further, the 1222 is backed by Racal, worldwide leader in data communications.

# Racal-Vadic

Member IDCMA

222 Caspian Drive • Sunnyvale, California 94086 U.S.A.  
Telephone: (408) 744-0810 • TWX: 910-339-9297

**RACAL**  
The Electronics Group

Europe, Middle East, and Africa, Contact:  
Racal-Milgo Limited

Richmond Court • 309 Fleet Road, Fleet, Hampshire, England GU13 8BU  
Telephone: Fleet (02514) 22144 • Telex: 858294

Australasia and Latin America, Contact:  
Racal-Vadic Inc.

222 Caspian Drive • Sunnyvale, California 94086 U.S.A.  
Telephone: (408) 744-0810 • Telex: 910-339-9297

# Our lowest profile DIP sockets even have MIL-S-83734 approval.

That's one advantage of our DIPLOMATE sockets. There are more.

They have an anti-overstress design to prevent socket damage. Their contacts are anti-wicking and anti-bridging. Their optional leg retaining detents help increase your productivity. And the ladder



housing version eases cleaning and viewing of circuit traces after insertion.

You can't find a higher qualified low profile DIP socket.

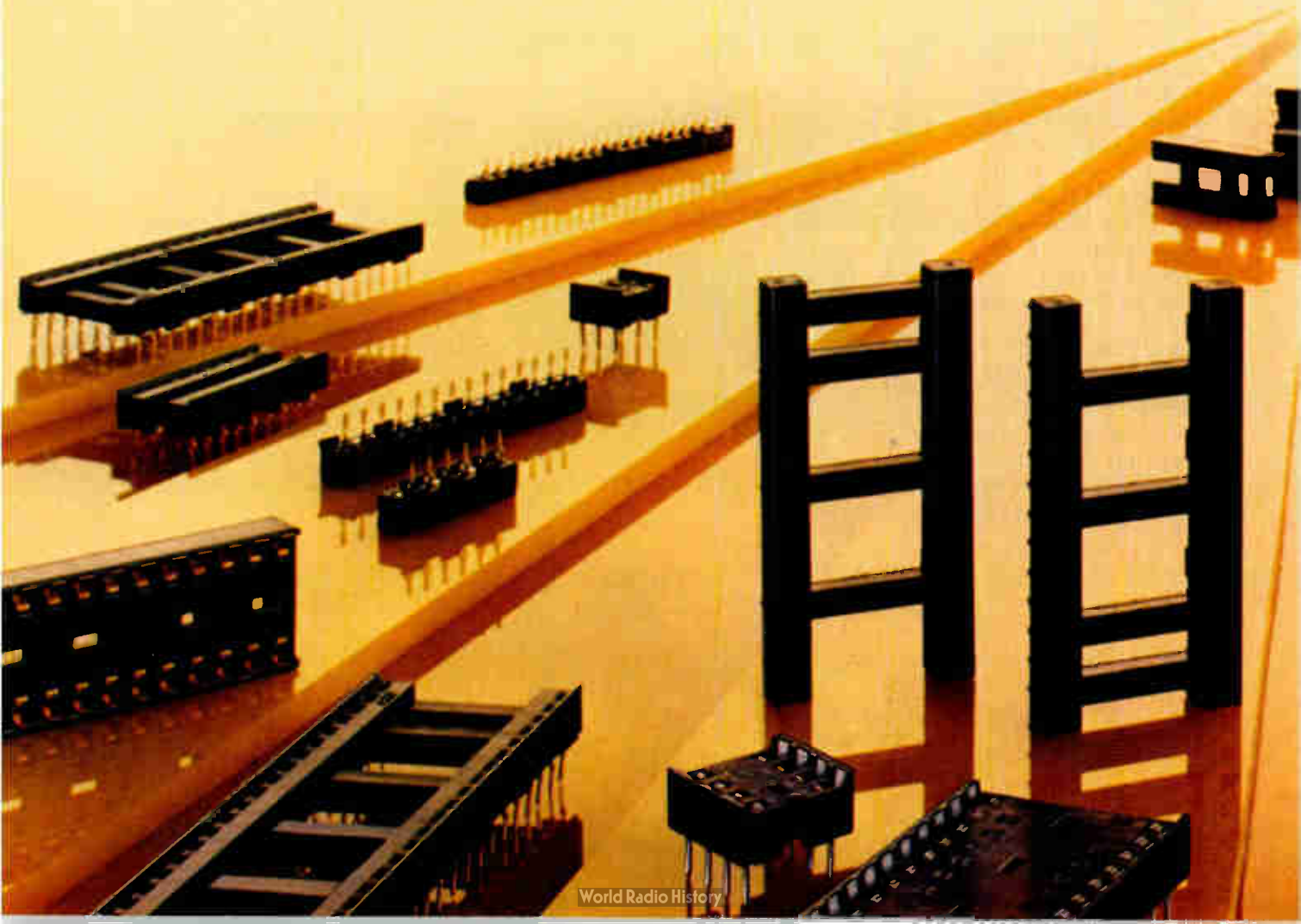

# AMP Facts

## DIPLOMATE SL Sockets

Sizes: 8 through 40 positions  
Profile: .160"  
Engaging force: 340 grams max.  
Separating force: 25.5 grams min.

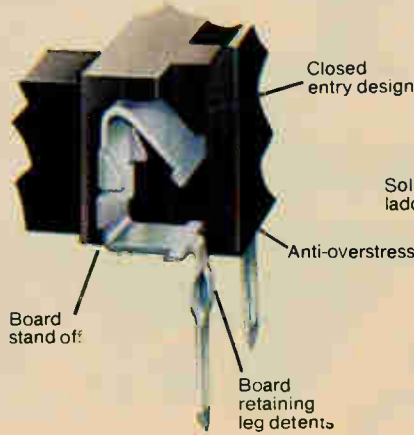

## DIPLOMATE DL Sockets

Sizes: 6 through 40 positions  
Profile: .175"  
Engaging force: 340 grams max.  
Separating force: 14 grams min.

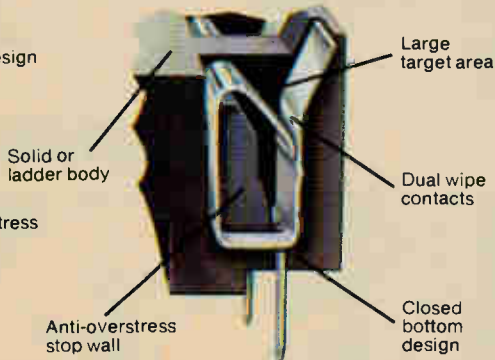

For a free sample, call the AMP DIP Socket Information Desk at (717) 780-8400.

AMP Incorporated, Harrisburg, PA 17105.

AMP and DIPLOMATE are trademarks of AMP Incorporated.

# AMP means productivity.

CIRCLE  
NUMBER  
125

# THIS NEW DATA I/O 6800 FAMILY TESTER CAN SAVE YOU A LOT MORE THAN IT COSTS.



## Reject bad devices before they get into your production line.

Everytime a faulty microprocessor or peripheral chip slips into one of your products it costs you profit in troubleshooting and replacement.

With the new Data I/O Model 1500A, you can set up a low-cost incoming inspection program to detect faulty 6800 family devices before they get loaded into boards.

## Comprehensive testing detects problems in 6800, 68A00, 68B00, 6802, 6808, 6810, 6821 and 6850 devices.

The Data I/O 6800 family tester performs a full-functional test on devices under worst case load and supply voltages at real time speed in less than one second.

The test may reveal, for example, that the clock is inactive, or a line on the address bus is not working, or the internal RAM is defective.



## Easy set-up and operation.

Simply plug the correct test adapter into the tester and you're ready to begin. No need to hire skilled personnel to write test programs, specify test vectors or parameters. It's all contained in a pre-written test sequence.

To operate, simply place the device in the socket and press the button. A green light identifies a functional part. A bad part triggers a three-digit code, which identifies the specific problem.

## Reduce parts shortages and ease device returns.

You don't have to reject an entire lot because of a few bad components.

With the 6800 family tester you can quickly and efficiently screen all devices to make the best use of the components you have.

Most device vendors require proof of failure before they will accept rejects. The failure code provided by the 6800 family tester identifies the problem and will speed up the process of returning faulty parts.

## Backed by Data I/O's commitment to quality and performance.

We've put the same care and engineering skill into the Model 1500A that we put into our entire range of PROM and logic device programmer products. The Model 1500A has been evaluated by device manufacturers and recognized as a viable test method. Each unit is backed by Data I/O's worldwide network of sales and service personnel.

Find out more about this remarkable new approach to testing by circling the reader service number or contacting Data I/O, P.O. Box 308, Issaquah, WA 98027. Phone 206/455-3990 or TOLL FREE 800/426-9016.

**DATA I/O**  
**6800**  
**FAMILY**  
**TESTER**

**DATA I/O**



# C-MOS PROM density hits 16-K

Polysilicon-fuse programmable read-only memories  
operate on 25 mW/MHz, typically, and stand by on 500 $\mu$ W

by James B. Brinton, Boston bureau manager

The first 16-K complementary-MOS programmable read-only memories are now available from the Semiconductor Products division of Harris Corp. Harris is alone in this market, having already introduced 1-K and 4-K PROMs using low-power C-MOS and polysilicon-fuse technology [*Electronics*, Aug. 14, 1980, p. 36].

Although there are no other C-MOS PROMs on the market, both 4-K and 16-K C-MOS erasable PROMs are available. According to Bruce G. Grieshaber, Harris's C-MOS product marketing manager, even though the Harris part's cell is about 20% larger in area than E-PROM cells, Harris PROMs are competitive in price.

But for now, it appears that for low-power applications where PROM rewrite is not necessary, Harris' new units are king. The HA-6616 is organized as a 2-K-by-8-bit part with a byte-wide pinout, uses a single +5-v supply, is compatible with standard TTL inputs, and has enough drive capability to fan out to eight low-power Schottky TTL inputs. Access time is not as short as that of bipolar PROMs, but it is a respectable 125 ns typically and 200 ns at most. The HA-6646 is similar, but it is a 4-K-by-4-bit part.

Grieshaber says that C-MOS PROMs will be one of Harris' major thrusts for the near future, and that the 16-K device is to be followed with 32- and 64-K PROMs within about a year [*Electronics*, July 14, p. 33].

A major advantage of the new PROMs is their low power consumption. Standby drain is typically 50 to 100  $\mu$ W and the units are rated at 500  $\mu$ W maximum. Operating power drain is typically 25 mW/MHz with the maximum rating 50 mW/MHz. Harris recommends the low-power parts for applications like hand-held instrumentation and communications systems, remote data-acquisition and data-processing systems, processor-control storage, and sometimes as a replacement for synchronous logic.

**Address latches.** The synchronous PROMs also are designed to interface gracefully with microprocessors,

notes Grieshaber, thanks to the provision of on-chip address latches and a separate output-enable pin. This feature should especially simplify any implementation using a bus structure with multiplexed addresses and data. The synchronous design approach also pays off in reduced power consumption when compared with asynchronous units.

Although C-MOS is a recognized low-power technology, it is possible to sink a good deal of current if a C-MOS IC is poorly designed. It was partly to keep power requirements down that Harris decided on a synchronous design. Grieshaber says it also improves speed.

In a synchronous PROM, the latched address register stores address information temporarily. Simultaneously, fuse-read current is turned off. Thus, not only is the read current almost independent of the number of fuses blown in the PROM, but it flows only when the PROMs' output enable pins are activated. If the design were asynchronous, current would be continually running through all intact fuses, raising standby dissipation to as much as 10 mA, says Grieshaber.

In layout, the new PROMs are much like their 4-K predecessors. The major change is in a move from a 3.5- to 2.5- $\mu$ m geometry and a generally tighter layout. As a result, says Grieshaber, the Harris division was able to reduce cell size from 2.25 square mils on the 4-K

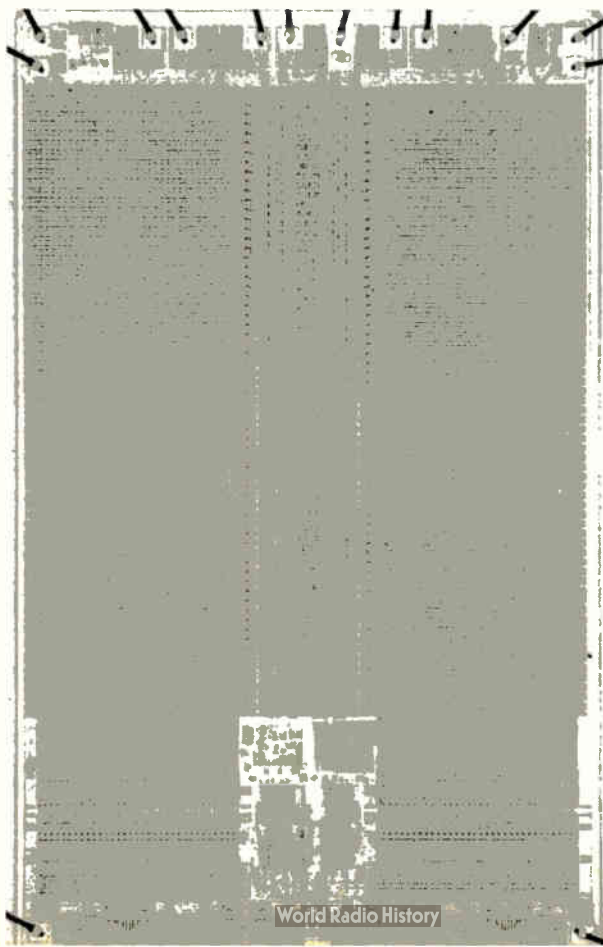

# NOTHING OFF THE SHELF!

But we've built Custom Transformers from Frame to CRT . . . in volume. With your specs/ requirements our 4 Plants can build the transformers you need . . . UL and CSA listed . . . and conforming to international specs IEC, CEE, VDE, BSI, SIMCO, NIMCO.

## What's Your Configuration?

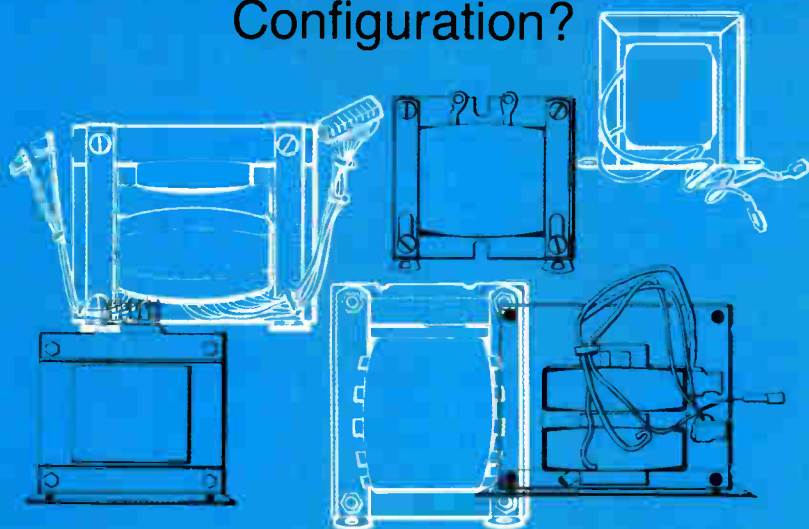

Reps Worldwide  
Just give us a call — 618/654-2341

**B** Basler Electric  
Highland, Illinois

BOX 269 • ZIP 62249 • TWX 910/996-2522

Circle 194 on reader service card

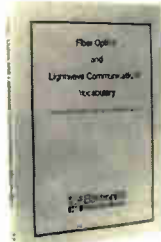

## FIBER OPTICS VOCABULARY

The basic reference document on fiber optic and lightwave communications for those who design, develop, operate, use, manage, or manufacture communications or data processing equipment and components.

- 1400 entries, with
- index of terms
- inversions and cross-references

Order your copies today!

\$12.95 each, discounts of 10% on orders of more than 10.



Electronics Magazine Books  
P.O. Box 669  
Hightstown, NJ 08520  
Tel. 609/448-1700, ext. 5494

## New products

PROM to only 0.795 mils<sup>2</sup> on the new 16-K devices.

With the smaller cell size, the company was able to keep die size very close to that of the 4-K device. The older unit was 137 by 197 mils for an area of 26,989 mil<sup>2</sup> and the 16-K devices are only 139.8 by 232 mils for an area of 32,434 mil<sup>2</sup>, an increase of only about 17%. The raised packing density is due in part to a vertical npn-transistor design pioneered in the firm's 1-K C-MOS PROMS. This helps control the size of the C-MOS transistors that must carry the fusing current, one of the key factors limiting density. In Harris's C-MOS PROMS, the npn transistor operates in an emitter-follower configuration, amplifying the fusing current. A direct contact from the polysilicon fusible links to the n<sup>+</sup> emitter is made in Harris' process. The contact helps reduce cell size by letting the fuse be placed directly over the cell transistor.

To keep programming current and voltage requirements low, Harris has left an opening in the silicon dioxide passivation layer above each fuse. As a result, less heat is lost in surrounding materials as a fuse is blown, and, adds Grieshaber, the oxide that forms as the fuse material vaporizes helps maintain high resistance at the site of the blown fuse.

As do some other makers, Harris includes test fuses to be blown and checked during processing, and as a final test at outgoing inspection, Harris also includes circuitry for testing row and column decoders. Thus, a user is warranted in a fair degree of faith that the PROMS will program and read out properly.

The units are available operable over the -40° to +85°C industrial temperature range and the military -55° to +125°C range. The package is a standard 24-pin dual in-line ceramic package.

Introductory price in 100-unit lots is \$65 for the HA-6616 and -6646. Samples should be available by October or November with pre-production quantities due in January.

Harris Corp., Semiconductor Products Division, P. O. Box 883, Melbourne, Fla. 32901. Phone (305) 724-7000 [338]

Electronics/August 25, 1981

# WITH TRILOG PRINTERS: THE EXTRAS ARE FREE!

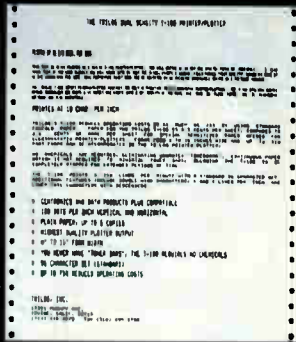

NORMAL AND COMPRESSED PRINTING

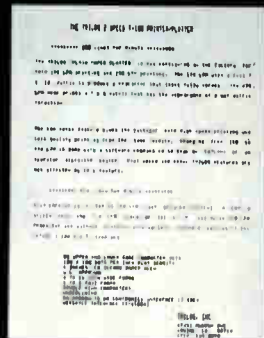

150 LPM AND 250 LPM

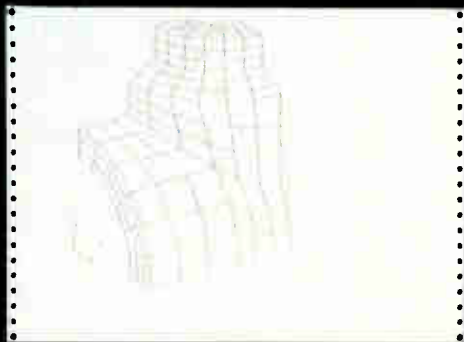

HI RES. STRESS ANALYSIS (PDA Eng.)

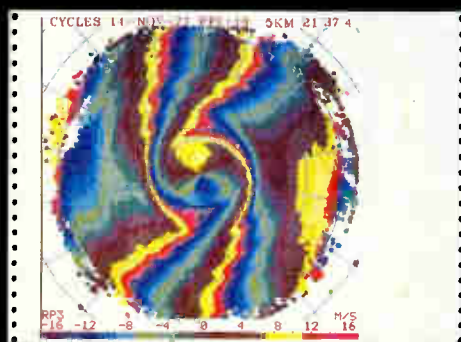

RADAR WEATHER MAPPING



SCIENTIFIC: MOLECULAR STRUCTURE (MIT)

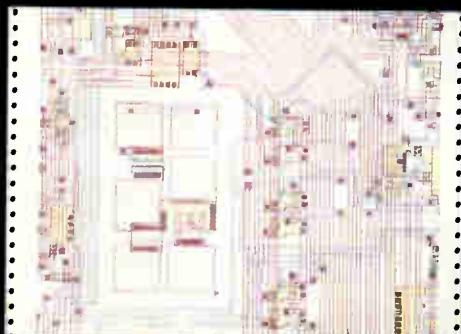

CAD/CAM: IC CHIP LAYOUT (Silicon Systems Inc.)

ONLY the TRILOG COLORPLOT™ line printer has all the EXTRAS — at no additional cost!!! EXTRAS such as near letter quality printing at 150 LPM, and either matrix quality printing at 250 LPM, or text quality 150 LPM compressed print at 16 2/3 CPI for printing full 132 character lines on 8 1/2 inch paper. PLUS, high resolution black and white graphics plot-

ted on plain paper at only 1/2 cent per copy. But, that's not all...the most exciting and unique EXTRA of them all is the ability to plot high resolution FULL COLOR graphics for applications such as: CAD/CAM, Scientific, 3-d Cartography, Computer Art, and Business Charts.

COLORPLOT™ is sold and serviced through the worldwide network of TRILOG distributors. For further information contact your local TRILOG distributor, or request the "COLORPLOT Packet" by writing or calling: TRILOG, Inc., 17391 Murphy Avenue, Irvine, CA 92714 -- (714)549-4079. TWX(910)595-2798.



# TRILOG

# molex

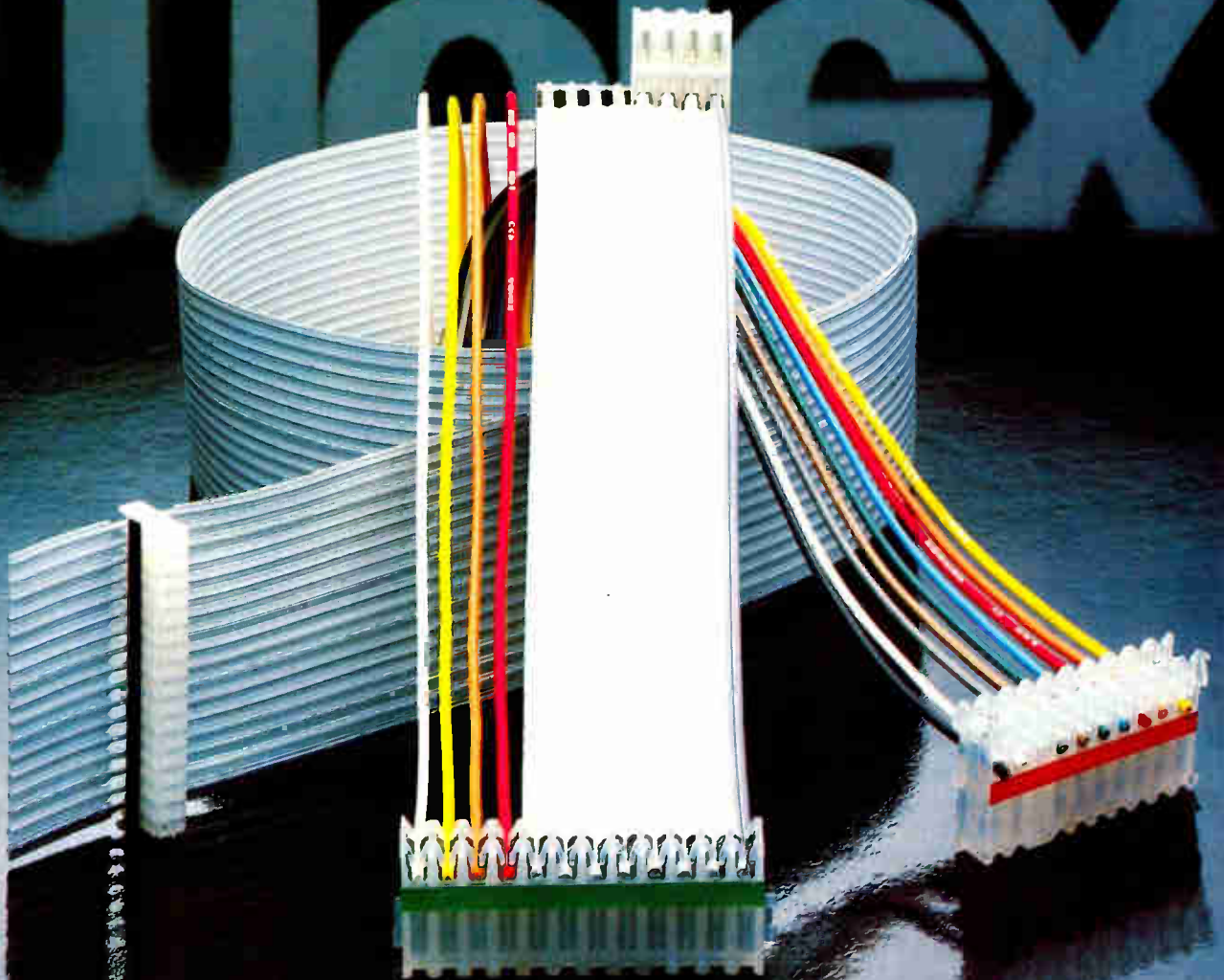

# For mass termination component cost savings and applied labor reductions: Molex has the answer.

## Molex is the only manufacturer that offers cable systems on five center lines.

If your application calls for ribbon cable, discrete wire, or a combination of both in the same connector, Molex\* Jet-Flecs\* insulation displacement connectors can provide a complete system to meet your requirements on .050" (1.27mm), .098" (2.5mm), .100" (2.54mm), .156" (3.96mm) and .200" (5.08mm) center applications.

The photo depicts harness and non-harness board .156" and .100" center connector versatility. What the photo cannot show is the vast selection within the Molex system including 3 reliable contact designs.

Jet-Flecs .156" connectors accept wire gauge sizes from 18-28 AWG and Jet-Flecs .100" connectors accept 22-28 AWG. The Jet-Flecs connectors are drop-in replacements for standard KK\* crimp products. There is no need to redesign your present product or application to utilize the advantages of the Jet-Flecs system since the connectors will mate with Molex KK headers accepting round or square pins.

## Cost savings up to 40%

When using insulation dis-

placement, your applied costs are lowered by 30 to 40%. This is accomplished by replacing the strip, crimp, and insertion steps with one simultaneous mass termination operation.

The components and cable are only half the system. The big advantage Molex offers is the complete range of application tooling. This equipment ranges from single wire hand tools to fully automatic assembly machines.

Molex's application equipment is in two

main categories, cable assembly and discrete wire assembly.

For cable termination, an arbor-type press is available and a semi-automatic terminator for higher production rates.

Discrete wire termination can be accomplished with the use of an arbor-type

press, a semi-automatic single wire terminating machine, a harness board assembly tool (which is compatible with your present harness board), or a fully auto-

matic multi-wire assembly press.

Many of these unique application tools are available for demonstration in your manufacturing facility. Or, if you choose, one of the Molex equipment demonstration vans can visit your facility and show the complete array of tooling which is available to help lower your costs.

## Molex and distributors now offer cable system assemblies!

Molex franchised distributors

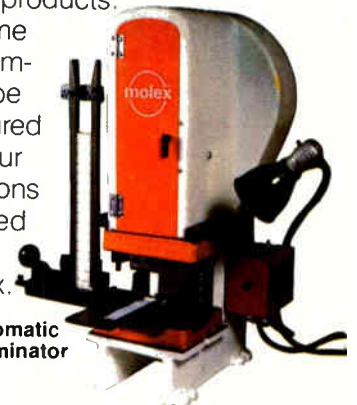
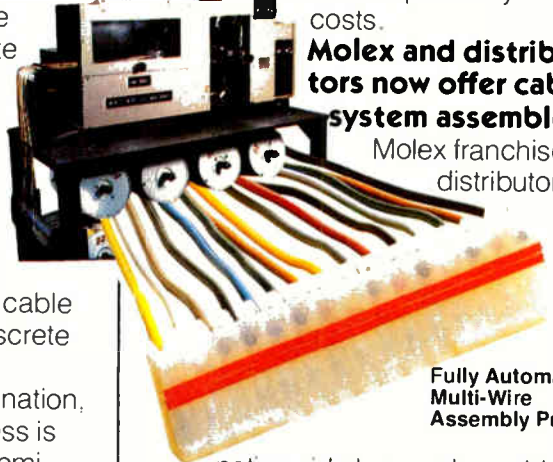
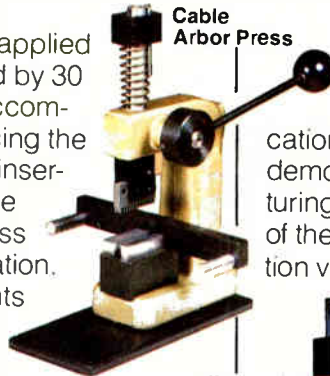

\*Molex, Jet-Flecs and KK are registered trademarks of Molex, Incorporated.

**molex**® . . . Affordable Technology

For complete details and catalogs, contact:  
**Molex Incorporated**, 2222 Wellington Court,  
Lisle, Illinois 60532 (312) 969-4550

Circle 197 on reader service card

# NO.1 AGAIN

## This time in Switchers

Long the recognized leader in quality open-frame linears, Power-One is now setting the pace in switching power supplies.

Our fast growing line of efficient high-performance switchers offer a combination of features not found in others at these low prices. Features such as fully regulated outputs, 115/230 VAC input capabilities, superior hold-up time, and totally enclosed packaging for enhanced safety. Additionally, these models incorporate many other innovative ideas that set our switchers apart... while reflecting the same simplicity of design that has kept our open-frame linears the most cost-effective in the industry.

Best of all, Power-One switchers are 100% American built by Power-One personnel, at

Power-One facilities, and under tough Power-One quality control standards. Adding up to total dependability at typical Power-One low prices.

So check us out. See why we're leading the way again. This time in switchers.

Send for our new '81 Catalog. Better yet, contact your local Power-One representative for immediate action.

VOLTS	AMPS	MODEL
5V	40A	SK5-40
12V	16.8A	SK12-16.8
15V	13.4A	SK15-13.4
24V	8.4A	SK24-8.4
28V	7.2A	SK28-7.2

SIZE: 2"H X 4.88" W X 13"L

**\$250**  
200 WATTS



**\$115**  
50 WATTS

VOLTS	AMPS	MODEL
5V	10A	SD5-10
12V	4.2A	SD12-4.2
15V	3.4A	SD15-3.4
24V	2.1A	SD24-2.1
28V	1.8A	SD28-1.8

SIZE: 2"H X 4.88"W X 6.25"L



OUTPUT	VOLTS	AMPS
#1	5V	20A
#2	12V	5A
#3	-12V	3A
#4	5V, 12V, 15V, or 24V. USER SELECTABLE	3.5A

SIZE: 2"H X 4.88"W X 14"L

MAX OUTPUT POWER: 150 WATTS  
CONTINUOUS, SUM OF ALL OUTPUTS

150 WATTS - 4 OUTPUTS  
THE UNIVERSAL SHQ-150W

**\$295**

**NEW**

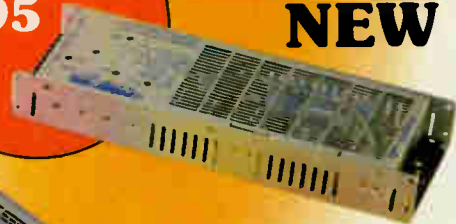

**\$170**  
100 WATTS

VOLTS	AMPS	MODEL
5V	20A	SF5-20
12V	8.4A	SF12-8.4
15V	6.7A	SF15-6.7
24V	4.2A	SF24-4.2
28V	3.6A	SF28-3.6

SIZE: 2"H X 4.88"W X 10"L

**FREE! NEW 1981 CATALOG AND POWER-ONE TOUR GUIDE**

SEE EEM OR GOLDBOOK FOR OUR COMPLETE PRODUCT LISTING AND LOCATION OF YOUR NEAREST POWER-ONE REPRESENTATIVE.



**POWER-ONE** D.C. POWER SUPPLIES

POWER-ONE INC. • POWER ONE DRIVE • CAMARILLO, CA 93010  
PHONE: (805) 484-2806 • (805) 987-3891 • TWX: 910-336-1297

World Radio History

Circle 200 on reader service card

Industrial

## Motor controller is programmable

8088-based unit allows manufacturing line to handle several different workpieces

Taking aim at the wear-prone cams, clutches, and limit switches that define and control a fixed sequence of motion at a factory work station is the 2184 digital servo controller from the Modicon division of Gould Inc. Because it is programmable and can be digitally linked to other factory controllers, its makers claim that the new servo controllers will increase throughput and add flexibility along a manufacturing line. With it, operations can be changed instantaneously, under computer control, instead of taking the hours or even days typically needed to reconfigure a conventional transfer line. In addition, the 2184 keeps track of malfunctions along the line and responds by taking corrective action or shutting the equipment down, if necessary.

Without a programmable controller, a transfer line typically carries one type of workpiece, which arrives at a work station for one specific operation. With a controller, a more efficient scheme is possible: several types of workpieces can be placed on one transfer line, their sequence known by the controller, and the operation at each station can be modified for the individual workpiece. A separate programmable digital controller at each work station can store a different program for each part, calling it up as needed. The 2184, for example, can at present store 12 such programs, and Modicon says it will expand this capacity to 50.

The package contains an 8088 high speed central-processing unit, battery-backed memory, power supply and 0-to-10-v standard servo-drive interface. Designed to control



electric and hydraulic drives, it has eight inputs and eight outputs for gages and switches.

In designing the 2184, Modicon departed from practice followed in its standard factory-programmable controllers. "The technology had to take a totally different approach. You need an order of magnitude faster response," points out Robert Goelz, sales manager for motion controls.

Unlike a standard programmable controller, the 2184 is an event-driven machine. It does not scan input and output lines. Rather, "it is dedicated to servo control," states Stephen P. Mader, Modicon's national sales manager for motion-control and communications products.

The power of the 2184 rests in its ability to outline a complete motion scheme, or profile. The user defines the position and velocity a servo should have, and the 2184 calculates the line connecting to that position and the acceleration and deceleration needed for the motor to move it there. A single motion between two nearby points is called a chord, and a series of chords constitutes a profile. The unit can position motors to within  $\pm 0.001$  in.

The 2184 is programmed in the English language on a standard \$5,995 programmer that Modicon already offers for its line of programmable controllers, the P-190. Thus, any user already equipped with a P-190 can use it for the 2184. Set up to program a profile on the 2184, the interactive P-190 asks the operator first whether metric or

English units are to be used; it then asks him to specify the maximum velocity, and so on.

Modicon says it will begin shipping the 2184 programmable servo controller in October. It will carry a list price of about \$4,500.

For factories that have analog and digital controls, Modicon states that this is a missing link in the evolution of the fully automated factory. "In the factory you have analog and digital stuff and then you have motor controls," Mader says. "Once you can control motors, and you've got control of the analog and digital quantities, then you've got the automated factory."

Gould Inc., Modicon Division, P. O. Box 83-S. V. S., Andover, Mass. 01810. Phone (617) 475-4700 [391].

## Terminal captures data for NCR Data Pathing system

The 2.6-lb portable 2860 PDCU data-capture unit is for use with NCR's Data Pathing shop-floor data-collection systems. The programmable terminal is designed to extend industrial source-data management into environments that could not previously be reached with stationary data-collection terminals, and it eliminates much handwritten data collection.

To operate the 2860, a user loads one to four application programs into its memory by connecting it to an NCR 2820 multifunction terminal or 2830 industrial display station communication cable. During use, terminal programming guides the



# Looking for a faster processor-to-processor communications link?

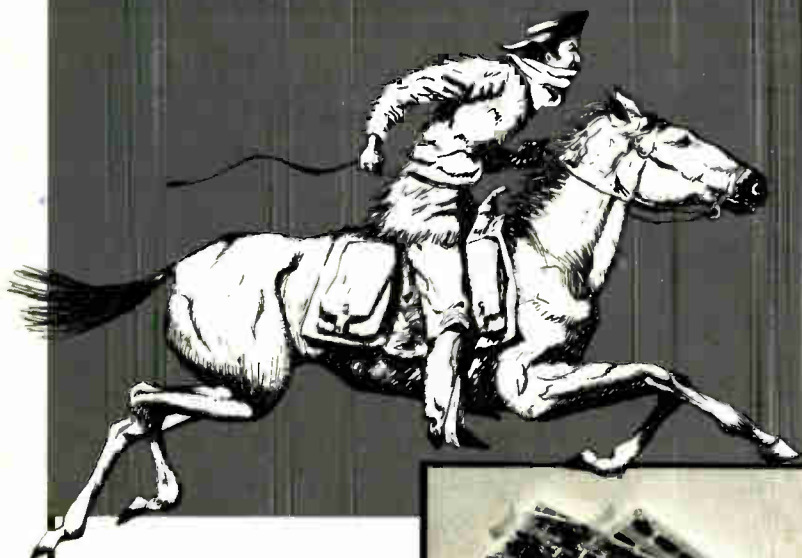

Use Megalink™ for 1 Megabit/sec DMA transfer between as many as 255 DEC and Intel processors on local networks up to 32,000 feet long.

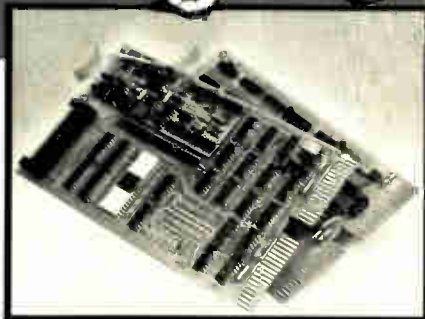

- Q bus, Unibus, and Multibus compatible units plug directly into DEC and Intel backplanes.\*
- Multidrop operation of different processors on single coaxial cable for distributed networks.
- Integral 1 Megabit/sec FSK modem is immune to baseband noise.
- Software compatible drivers available.
- HDLC protocol implemented in hardware.
- Polled, token pass, or CSMA contention networks possible.

Call Garry Stephens today at (203) 544-9371, or write now for specifications of Megalink DMA Interface Units

## computrol

15 Ethan Allen Highway  
Ridgefield, CT 06877  
(203) 544-9371

\*DEC, Q bus, and Unibus are trademarks of the Digital Equipment Corporation. Intel and Multibus are trademarks of the Intel Corporation.

## New products

operator through each data-entry step, with prompting messages appearing on a 16-character light-emitting-diode display and predefined LED indicators. Operators enter data through a 48-key sealed keyboard or an optional bar-code reader. Entered data appears on the display for verification. Up to 8,000 characters of alphanumeric or 16,000 characters of numeric information can be stored in its memory. Data is then unloaded by connecting the 2860 to an NCR multifunction terminal that is on line to the central factory data collection system. Available during the first quarter of 1982, the unit will sell for \$2,500.

NCR Corp., Dayton, Ohio 45479. Phone (513) 445-2075 [393]

### Programmable mini controller can handle 46 I/O channels

The SYSMAC-M0 three-model series of small programmable controllers offers its own power supply unit, as well as input/output expandable



to 46 channels. The \$495 W model has a keyboard, 256 words of random-access memory, four banks of 256 words in erasable programmable read-only memory, an up-down program loader, program display, and 32 I/O channels. The down-scaled A model at \$450 has the features of the W except the erasable PROM and up-down program loader. The original-equipment manufacturer version, model S for \$350, contains only the E-PROM and the I/O channels.

The compact 6-by-3-by-4-in. controllers have industrial machine and small system control applications. Also available is the SYSMAC-P0 sequence controller for independent



# The Professional Alternatives: The HP-41C And The NEW HP-41CV.



Now Hewlett-Packard offers you a choice in full performance alphanumeric calculators. The new HP-41CV has five times more built-in memory than the HP-41C. Both calculators are powerful yet easy to use. You can communicate with words as well as numbers. For example, label and call up programs by name and receive meaningful prompts while executing programs. Continuous Memory retains programs and data even while the machines are off. Need lots of memory? Choose the HP-41CV. If your needs are more modest, select the HP-41C. The HP-41C can grow with you by adding memory modules.

## BOTH OFFER CONTINUAL GROWTH POTENTIAL

By themselves the HP-41C and HP-41CV may be all the calculator you'll ever need. But if you need more capability, you can expand your calculator into a complete computational system. Each calculator has four ports which allow you to plug in a Printer/Plotter, an "Extra Smart" Card Reader or an Optical Wand for reading bar codes. Application Packs and Solution Books offering complete solutions are also available. And now, HP offers a new service: Custom Modules (ROM's) from your software for high volume, unique problem-solving needs. Costs are reasonable. Call us.

## ONLY FROM HEWLETT-PACKARD

Powerful yet easy to use calculators. A full line of peripherals and software. A time-proven logic system-RPN. No equals key. Less keystrokes. Computation is displayed as you proceed. The new HP-41CV and the HP-41C are available now, with new low prices. For details and address of nearest dealer, CALL TOLL-FREE 800-547-3400, Dept. 214L; except Hawaii/Alaska. In Oregon, 758-1010. Or write Hewlett-Packard, Corvallis, OR 97330, Dept. 214L.

611/07

HP-41C, \$250; HP-41CV, \$325; Optical Wand, \$125; Printer/Plotter, \$385; Plug-in Card Reader, \$215; Quad Memory Module (brings HP-41C to HP-41CV memory capacity), \$95; Memory Module, \$30; Application Packs, most are \$30; Solution Books, \$12.50.

Prices are suggested retail excluding applicable state and local taxes—Continental U.S.A., Alaska and Hawaii.



**HEWLETT  
PACKARD**

Circle 203 on reader service card

# Yes! There is a Stator Yoke for 110° CRT's!

The Syntronic Data 110 Stator Core Yoke will produce clear, clear dot/matrix or stroke-written characters anywhere on a 110° CRT . . . over 6000 of them on a 15" diag. screen.

This is achieved using a precision-tooled ferrite stator core, built-in geometry correction, complementary coil turns distribution, and interlocking components for repeatability in volume production.

If a saddle yoke doesn't do the job . . . evaluate the Data 110 Yoke.  
Ask for Bulletin #033.



Data 110 Stator Yoke



**syntronic**

Syntronic Instruments, Inc.  
100 Industrial Road  
Addison, IL 60101  
Phone: (312) 543-6444

## New products

use or as an add-on.

Omron Electronics Inc., 650 Woodfield Rd.,  
Schaumburg, Ill. 60195. Phone (312) 843-  
7900 [394]

Encoder puts out 3 channels  
of square, amplified sine wave

Datametrics' K3 series kit encoder is a modular optical encoder designed to be integrally mounted on a servo motor. The kit consists of an optically encoded disk on a precision-bored hub mounted on a motor shaft, plus a light-emitting-diode light source and photocell detector assembly that mounts directly on the motor back-end. Up to three channels of square wave or amplified sine wave output are available in a case 2.1 in. in diameter. Line counts of up to 1,200 pulses per revolution can be specified. Metal deposition on glass, photoemulsion on plastic, and etched metal versions are available.

The self-aligning encoders are immune to the effects of power supply variation and component aging because they use a single LED light source and a monolithic sensor array. Prices range from \$99 for a square-wave single channel unit with no markers to \$145 for a sine-wave dual-channel model with markers. Discount pricing for original-equipment manufacturers is available, and delivery takes six to eight weeks.

Datametrics Inc., 340 Fordham Rd., Wilming-  
ton, Mass. 01887. Phone (617) 658-5410  
[398]

Analog bar-graph indicator  
responds in under 1 ms

The solid-state analog bar-graph indicators in the APM 20 series employ a 3-in. 20-element bar graph and are available in voltmeter and ammeter ranges of 0 to 50 mV, 0 to 1 V, 0 to 10 V, 0 to 1 mA, and 4 to 20 mA, all dc. Options include offset span, differential input, a response time of less than 1 ms, and either single or dual set-point controls. The standard bar graph is red, but green

# The quiet performer.

**The New Gould 2200S.** Our new 2200S oscillographic recorder with incremental chart drive performs so quietly you'll barely know it's running. Plus, you get unmatched versatility from the following innovative features:

- **Quiet drive, smooth trace**—A microprocessor-controlled stepper motor greatly reduces noise by eliminating mechanical transmission used in most recorders. Increments of 0.0125 mm/step create smooth, accurate traces.

- **Versatile chart speed control**—Twelve standard chart speeds from 0.05 mm/s to 200 mm/s are selected by front panel pushbuttons or by TTL remote control. Plus, there is a continuously variable front panel speed control

- **Added recording dimension**—Since chart speed is controllable by an external pulse input, the 2200S can display a signal as a function of any variable that can be transformed into a pulse train. Thus, the 2200S can function as a Y-Xt recorder.

- **Use it anywhere in the world**—The Gould 2200S operates on line voltages of 100, 115, 200, or 230 Vac from 50 Hz to 400 Hz.

- **Synch output**—Recorders can be slaved together by synchronizing chart speeds using this TTL pulse output.

- **High accuracy**—Crystal-controlled clock provides a chart speed accurate to  $\pm 0.25\%$ .

- **One or two channels**—One 100mm or two 50mm channel models are available with exceptional frequency response up to 125 Hz. 99.65% linearity full scale, square wave recording with less than 1% overshoot and rectilinear trace representation. Exclusive pressurized ink or fine-line thermal writing is available.

- **Application flexibility**—The 2200S accepts the Gould 4600 Series of plug-in amplifiers for a broad range of industrial, scientific and biophysical measurement applications.

For more information, contact Gould Inc., Instruments Division, 3631 Perkins Ave., Cleveland, Ohio 44114.

In Europe, contact Gould Instruments S.A.F., 57 rue St. Sauveur, 91160 Ballainvilliers, France.

**For brochure call toll-free: 800-331-1000 (in Oklahoma, call collect: 918-564-8300).**

Circle 205 for Literature  
Circle 232 for Demonstration

 **GOULD**  
An Electrical/Electronics Company

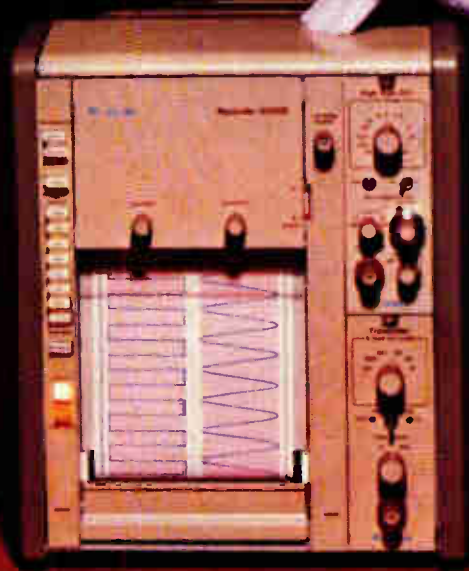

# CODELINK™ OPTICAL DATA LINKS

10Mbps – 20Mbps – 50Mbps – 100Mbps

- High-Reliability Integrated Construction
- Optical Fiber Lengths To Greater Than 1000m
- TTL Or ECL Signal Input & Output
- Single 5Volt Power Supply
- Built-In Codedata™ Encoding With Clock Output Or Free Format Data
- Codenoll Also Offers Analog Data Links

#### COMING SOON:

#### CODESCAN™-1

Semiconductor Laser Scanner

#### CODEHEAD™-1

Semiconductor Laser Head  
For Video & Computer  
Disc Systems

#### ENGINEERING POSITIONS AVAILABLE

**Electro-Optic** – Design and develop advanced concept laser scanning and optical disc storage subsystems. One position will require some lens design. BS/MS/PhD.

**Electronics** – Design high speed digital and analog circuits for use in fiber-optic receivers and transmitters as well as laser scanning and video disc subsystems. BS/MS/PhD.

**Technicians** – Develop, breadboard, and evaluate laser diode scanning and optical disc subsystems. AS/or equivalent.



## CODENOLL TECHNOLOGY CORPORATION

1086 North Broadway, Yonkers, NY 10701 / (914) 965-6300

See us at WESCON Hilton Hotel Booth H-64

Circle 206 on reader service card

### Keeping you ahead of the pack...

You (and we) are in a quick-moving business. News breaks frequently. Change is the name of the game. Awareness is the way to win.

Give us one hour of your time every two weeks and we will keep you aware of what's going on around you and around the changing world of electronics technology.

Keep ahead of the pack. Send in one of the subscription cards in this issue.

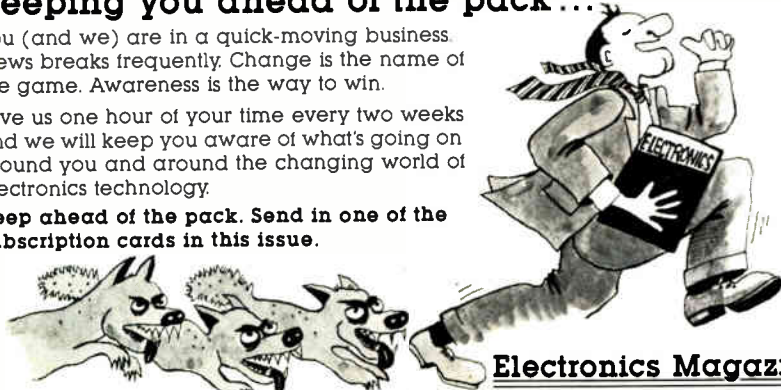

Electronics Magazine

### New products

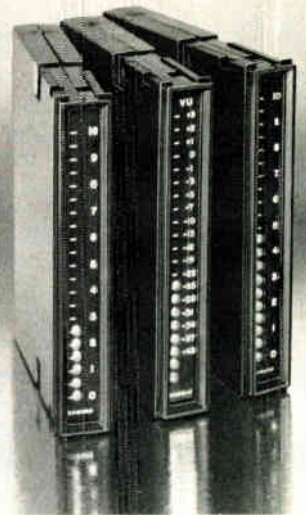

or yellow are available to meet special requirements. The meters meet ANSI 39.1 shock, temperature, and humidity requirements.

In quantities of 1 to 9, the meters cost \$60, \$50 in quantities over 50. Delivery is from stock.

Bowmar/ALI Inc., 531 Main St., Acton, Mass. 01720. Phone (617) 263-8365 [396]

18-mm photoelectric sensor  
sees as far as 78 in.

The type E58 photoelectric sensors detect virtually any material and measure only 18 mm in diameter. A one-piece three-wire design, the tubular units provide diffuse- or retro-reflective sensing and are offered in ac, dc (pnp), and dc (npn) configurations. Equipped with pulsed light-emitting diodes, they operate in the infrared spectrum and are unaffected by ambient light.

The units have sensing distances of 80 mm (3.15 in.) for the diffuse-reflective models and 2 m (78.7 in.) for the retroreflective models. The ac devices are rated at 120 v, the dc units at 10 to 30 v. In addition they have LED state indication, US and DIN mounting dimensions, and short-circuit protection on dc devices. In lots of 100, the ac models are about \$120 and the dc versions \$100. Delivery is from stock.

Eaton Corp., Cutler-Hammer Products, 4201 N. 27th St., Milwaukee, Wis. 53216. [397]

# High-clarity. One way itron fluorescents will brighten your displays' future.

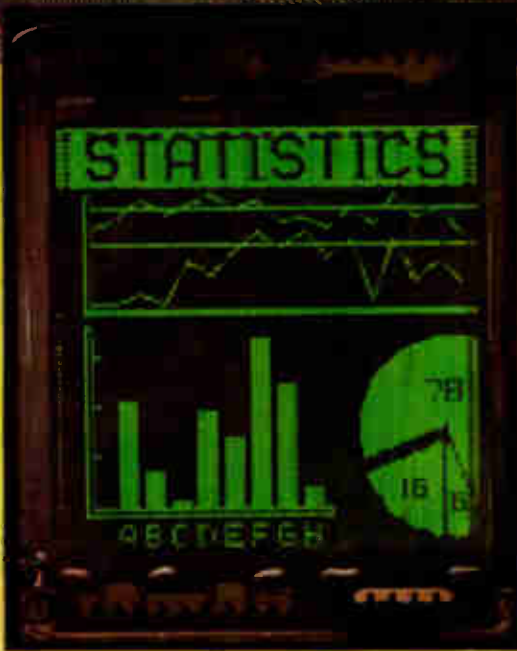

The brilliance and conciseness of our new high density 128 x 128 and 256 x 64 dot matrix display panels—made possible by our advanced double-matrix structure—exemplify the wealth of benefits afforded by "itron" fluorescent units. Let's enumerate some of the other reasons they'll enhance your designs' future.

Take alphanumeric. As the inventors of fluorescent technology, we naturally offer the widest selection of 14-segment and dot matrix arrays—from 5mm to 15mm in character heights, and packages ranging from 14-segment 8-character mini-units to complete 240 character 5x7 dot matrix plug-in panels, and everywhere in-between.

Their proven performance record, combine with cost-conscious pricing and ease of installation to make for time and money savings. And, their easy readability—even under high ambient light conditions and at extreme viewing angles—as well as low power requirements, are other good reasons why "itron" fluorescent displays will embellish your equipments' capabilities. As there're many more things to be said for "itron" fluorescent displays, contact us for particulars.

**itron**<sup>®</sup>  
FLUORESCENT DISPLAYS  
Patented and Manufactured by  
ISE ELECTRONICS CORP

#### INTERNATIONAL REPRESENTATIVES

WEST GERMANY: Neumüller GmbH, Eschonstr. 2, 4021, Taufkirchen, Munich. Phone: 089/6118-245 Telex: 522106

FRANCE: Europavia France, 5 Avenue Leon Harmel 92167 Antony Cedex. Phone: 666-21-111 Telex: 422043H1

UNITED KINGDOM: ITT Meridian, West Road, Harlow, Essex CM20 2BP. Phone: 0279-35351. Telex: 817202

SWEDEN: AB Nordqvist & Berg, Box 9145 S-10272 Stockholm. Phone 08-650400 Telex: 10407

DENMARK: E. V. Johansen Elektronik A-S, Tårnvej 15-2200, Copenhagen. Phone: 01/839022 Telex: 16522

HONG KONG: Phone: 5-232420. TAIPEI: Phone: 351 0293.

#### NORITAKE ELECTRONICS, INC.

EASTERN OFFICE: 41 Madison Avenue, New York, NY 10010 • (212) 481-3440 • Telex: 12-5469

CENTRAL OFFICE: 1822 Brummel Drive, Elk Grove Village, IL 60007 • (312) 439-9020

WESTERN OFFICE: 22410 Hawthorne Blvd., Torrance, CA 90505 • (213) 373-6704 • Telex: 67-4910

#### NORITAKE COMPANY, LIMITED

JAPAN: 1 - 1, Noritake-Shinmachi, Nishiku, Nagoya-Shi • (052) 562-0336 • Telex: J59738

EUROPE: Burotel/Belgium SA, Rue de la Presse 3-5, 1000 Bruxelles • (02)217-83-60 • Telex: 4626962

# Crystal Clock Oscillators by



**MOTOROLA**

**NEW!**

**NEW!**

**CMOS!**

**NEW!**

**NEW FREQ!**

**NEW!**

see us at WESCON  
Booth 1721

## ... more timing standards for the computer industry

Our broad selection of crystal clock oscillators has been made even broader with the introduction of:

An **extended-temperature** ( $-40$  to  $+85^{\circ}\text{C}$ ) clock in an all-metal welded package; two new **MOS drivers for Zilog** (or equivalent) 4 and 6 MHz microprocessors with system timing TTL outputs at twice the processor frequency; a baud rate generator with **zero error** at 19,200 baud; a **fourth frequency** available in the LOCO II low cost oscillator family; a **tight symmetry** clock; a **dual complementary** output clock; and a 10 to 15 MHz clock with a  $\pm 2$  output.

Complete in-house control, from quartz growing through thick-film processing enhances reliability.

High volume production capability plus fast prototype delivery helps you meet your own delivery requirements.

DIP packaging saves board space, cuts assembly time over discrete component equivalent. Simply plug a Motorola Clock into your circuit to satisfy all your system timing requirements.

Send today for more information on the clock oscillator to fit your application.



**MOTOROLA INC.**

Component Products / 2553 N. Edgington Street / Franklin Park, IL 60131 / 312/451-1000 TWX: 910-227-0799 Telex: 4330067

Circle 208 on reader service card

World Radio History

# KEYBOARDS THAT LAST AND LAST

Awesome things are happening at Key Tronic Corporation. The introduction of touch feel capacitive keyboards is just one. How can one keyboard supplier offer so many different technologies? As we've said before, only one can build just one. But, what about manufacturing hundreds of thousands of different keyboards with the same product? Supplier experience and technology are the keys to being as innovative as the finished product.

Key Tronic has shipped over two million finished keyboards. Complete in-house design, engineering and production of switches, keytops, printed circuit boards, and assembly give Key Tronic the price and quality advantages for you.

Whether your requirements are tactile or linear feel, we have both. We also have reedswitch or solid state capacitive keyboards, with microcomputer, LSI, TTL, or minimum interfaces.

Some of you might say, "But they don't make membranes." Key Tronic would just like to say, "Soon, very soon."

 **key tronic**  
INTERNATIONAL KEYBOARDS

P.O. BOX 14687 — SPOKANE, WASHINGTON 99214 U.S.A. PHONE (509) 926-8000 — TWX 510-772-1985

# We're making light work out of fiber optics.

If you've been thinking about fiber optics, you'd be wise to think Fairchild.

The fact is, we give 10 Mb/s performance in a module that's more than just a kit. No soldering. No assembly. No lab work. No fiber polishing.

That's right. A module that's ready when you are. That comes complete with a circuit board, transmitter, receiver and five meters of glasscore fiber.

We also include a 12-page brochure on fiber optics theory. Construction. Propagation modes. Etc. Etc.

If that's not enough, you get the entire package for only \$50.00. Just call or write your Fairchild distributor and ask for



the GR 1 Fiber Optics Module.

And get ready for a brighter future.

For complete product information, call (415)

962-5011. Fairchild

Optoelectronics Division, MS 4-307,

464 Ellis Street,

Mountain View,

California 94042.

France: Fairchild Camera & Instrument S.A., 121 Ave. d'Italie, 75013 Paris. Tel: 331 584 55 66. Telex: 0042200614. Italy: Fairchild Semiconductor S.P.A., Viale Corsica 7, 20133 Milano. Tel: 02 296001-5. Telex: 843-330522. Germany: Fairchild Camera & Instrument (Deutschland) GmbH, 8046 Garching Hochbruck, Daimlerstr. 15, Munchen. Tel: 089 320031. Telex: 52 4831 fair d. England: Fairchild Camera & Instrument (UK) Ltd., 230 High St., Potters Bar, Hertfordshire EN6 5BU. Tel: 0707 51111. Telex: 262835. Sweden: Fairchild Semiconductor AB, Svartengsgatan 6, S-11620 Stockholm. Tel: 8-449255. Telex: 17759. Japan: Fairchild Japan Corporation, Pola Bldg., 1-15-21 Shibuya, Shibuya-Ku, Tokyo 150. Tel: 03 400 8351. Telex: 2424173 (TFCTYO J). Hong Kong: Fairchild Semiconductor (HK) Ltd., 135 Hoi Bun Road, Kwun Tong, Kowloon. Tel: 3-440233. Telex: HX73531.

**FAIRCHILD**

A Schlumberger Company

## The Light Source

Fairchild Camera and Instrument Corp.

Circle 210 on reader service card



## New products

### Components

# Op amp aims at communications

741-like monolithic amplifier is faster with 10-kHz maximum undistorted output frequency

The versatility that has made the 741-type operational amplifier so popular has its limits—the device's maximum undistorted output frequency of 5 kHz does not quite stretch far enough for a large number of telecommunications applications. As a result, telecommunications systems designers usually have specified premium 741 types—those exceptional chips in a batch that could give full power up to the 7-kHz frequencies needed for such applications. Now, however, this need is being addressed by a standard product, the pin-compatible OP-19 from Precision Monolithics Inc. The OP-19 has a slew rate of 1.0 V/ $\mu$ s, which allows it to stretch its maximum undistorted output frequency to 10 kHz.

The OP-19 is fabricated with the same triple-nitride passivation scheme as previous PMI 741-type op amps, but this one offers a number of improvements in specifications. One such improvement is the slew rate, which compares to a 0.8-V/ $\mu$ s rate on the firm's 741 op amps. The input offset voltage on the best version, the OP-19A, is typically 0.3 mV with a maximum of 0.5 mV. This compares with a typical 0.5-mV specification on PMI's 741. This capability is made more attractive by the fact that the A version holds these specifications over a full military range of  $-55^{\circ}$  to  $+125^{\circ}$ C.

"We use some input bias cancellation schemes to allow the  $h_{re}$  gains to hold up in the nanoampere and picoampere regions," says product manager Tom Schwartz. "What we've produced is a 741 with better dc characteristics and higher speed."

Also among the improved speci-

fications is the OP-19's common-mode rejection ratio. The A version is specified at 100 dB typical and 85 dB minimum over a  $\pm 10$ -V range with source resistance at less than 20 k $\Omega$ . This compares with a 70-dB minimum specification for the 741. Input offset current for the OP-19 is 0.5 nA, while its input bias current is 18 nA. Its average input offset voltage drift is a very low 2.0  $\mu$ V/ $^{\circ}$ C at a substrate resistance of 500  $\Omega$ .

In some applications, the OP-19 can also be compared with PMI's high-speed operational amplifier, the OP-02. Its slew rate beats the 0.5 V/ $\mu$ s rate of the OP-02, and its large-signal bandwidth of 20 kHz (typical) compares with 8 kHz (typical) for the OP-02.

**Certified.** The OP-19 is screened into three quality versions, A, B, and C, over the full military temperature range, and three versions, E, F, and G, over the commercial range of  $0^{\circ}$  to  $70^{\circ}$ C. It is packaged in either a Z version, which is an eight-pin miniature dual in-line package as well as a J version in a TO-99 package. Still other versions have undergone the full military 883B processing certification. The prices range in quantities of 100 from \$2.75 each for the OP-19GZ to \$14.40 each for the OP-19AZ/883.

Precision Monolithics Inc., 1500 Space Park Dr., Santa Clara, Calif. 95050. Phone (408) 727-9222 [341]

## Isolation amplifiers use hybrid transformers

Analog Devices' new hybrid transformer technology (see p. 113) is being put to use in the AD293/4 isolation amplifiers—four units aimed at industrial, medical, and military applications. The 0.8-by-0.4-in. transformer employed is only 0.21 in. high, including a small E core. The AD293A and -B amplifiers offer  $\pm 0.1\%$  and  $\pm 0.05\%$  maximum nonlinearity, respectively; the AD293S/883B, as the name implies, is manufactured in accordance with MIL-STD-883B.

The fourth version, designated

12 Weeks  
From This

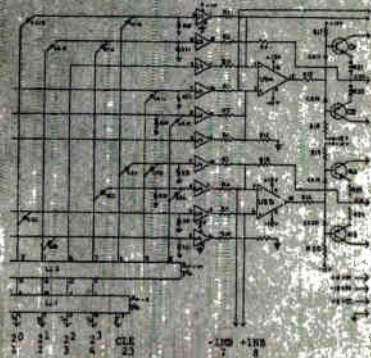

To This



# Custom Hybrids Aerospace Military Medical

Crystalonics can deliver prototype quantities of custom hybrid circuits in less than 12 weeks from the time you present your debugged design. Our people have been designing and building devices and circuits exclusively for high reliability applications for twenty years. Our engineers have sharpened their skills in teamwork with designers of aerospace, military and medical projects, such as F15, Hawk, Viking Mars, Intelsat and implantable pacemakers. We can ease you quickly and confidently through the transition from schematic to finished hybrid package. Utilize the hybrid's advantages of space, weight, reliability and cost by calling on our experience: (617) 491-1670.

 **TELEDYNE  
CRYSTALONICS**

147 Sherman Street  
Cambridge, MA 02140  
Tel: (617) 491-1670  
TWX 710-320-1196

Microprocessor Designers...



# World-Concept Low Power Switchers and UPS

## Operate almost anywhere with one power supply

Compare Converter Concepts' switchers and uninterruptible power supplies and you'll know why they're becoming a world standard for design and quality.

**WIDE INPUT VOLTAGES** Only Converter Concepts produces 15 to 150 watt switchers that operate on any voltage from 90 to 250 VAC or 10 to 40 20 to 60VDC — WITHOUT CHANGING SWITCHES, JUMPERS, TAPS OR OTHER MODIFICATIONS

**LATEST SWITCHER CONCEPTS** Wide input ranges are possible through the use of a simple single transistor, single transformer flyback design with soft turn-on and short-circuit protection. Means higher reliability and efficiency at a competitive price.

**MANY SWITCHER OPTIONS** Single, dual or triple output options in four input power ranges.

printed circuit, open frame or RFI-resistant enclosed packages; integral UPS options

**UNINTERRUPTIBLE POWER** Automatic, instant transition from AC line to backup battery operation is available either as a separate unit for use with CCI's multiple output DC to DC converters and battery, or as the integral 04 switcher option which features integral battery charger

**NATIONWIDE REPRESENTATIVES** Call us today for engineering assistance, our latest catalog, prices and your nearest CCI representative.



**CONVERTER  
CONCEPTS** INC.

435 S. Main St. Pardeeville, WI 53954 (608) 429-2144  
4081

Circle 212 on reader service card

## ESPECIALLY FOR SOLAR CELLS—TFS THICK FILM CONDUCTOR PASTES

### FOR FRONT COLLECTOR GRID METALLIZATION:



#### CONDUCTROX® 3347 SILVER

- Low resistance
- Excellent adhesion
- Good ohmic contact

### AND BACK SURFACE GROUND PLANE:

#### CONDUCTROX® 5540 ALUMINUM

- Small particle size for rapid diffusion
- Efficient back surface field formation
- Inexpensive
- Excellent ohmic contact

#### CONDUCTROX® 3398 ALUMINUM-DOPED SILVER

- Very low resistance
- Rapid back surface field formation
- Solderable using conventional techniques

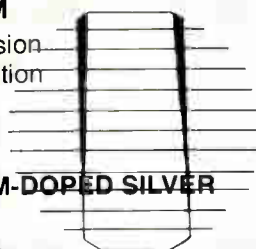

- Fine lines—an important feature in solar cells—are assured by TFS exclusive PARTILOK® vehicle.
- All pastes can be fired with conventional or infrared-firing techniques.



THICK FILM SYSTEMS  
DIVISION OF FERRO CORPORATION  
324 PALM AVENUE, SANTA BARBARA, CA 93101  
(805) 963-7757 TELEX 98-0165 or 241134



212 Circle 115 on reader service card

World Radio History

## New products

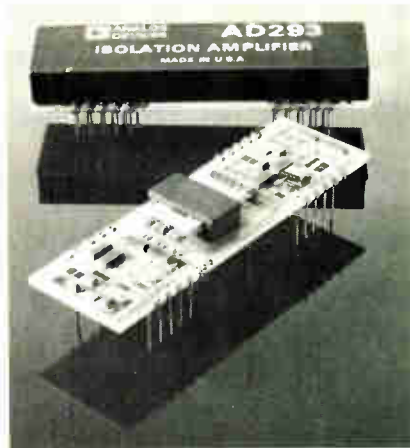

AD294, has the high common-mode voltage rating required for medical applications. It is capable of withstanding  $\pm 8$ -kv pulses 10 ms long every 10 seconds, as needed by equipment used in the presence of defibrillators. Medical use also calls for low leakage; a low  $2\text{-}\mu\text{A}$  root mean square leakage specification is shared by all four versions.

The 293/4 is designed with monolithic amplifiers at input and output. Both amps are adjustable in gain, to a maximum gain of 100 at the input and 10 at the output. Gain variation with temperature for the entire unit is  $\pm 50$  ppm/ $^{\circ}\text{C}$ , maximum.

Maximum safe input voltage is 120 v rms continuous or 240 v rms for 1 minute. The common-mode voltage rating of the 293 is  $\pm 2,500$  v continuous; the 293 will also handle 2,500 v of 60-Hz ac for 1 minute. The common-mode rejection ratio ranges from 100 to 115 dB, minimum, depending upon whether the source impedance is unbalanced or balanced, respectively. Differential input impedance is  $10^8 \Omega$  shunted by 150 pF; common-mode input impedance is  $5 \times 10^{10} \Omega$  shunted by 50 pF.

Input noise is weighted toward low frequencies, with a rating of 10  $\mu\text{V}$  peak to peak between 0.05 and 100 Hz, compared with half that, 5  $\mu\text{V}$ , between 10 and 1,000 Hz. The 3-dB bandwidth is 2.5 kHz; full-power-output frequency depends on the overall gain selected and ranges from 250 Hz to 2.5 kHz; rated full-power output is  $\pm 10$  v minimum into a 5- $\Omega$  load; output impedance is less than 1  $\Omega$  and the unit slews at

Electronics / August 25, 1981



# We don't claim leadership in microcomputer software. We earn it.

**Every day.** We think that supporting software is as important as developing it. Six years ago, we put BASIC on the first microprocessor based computer. Today, Microsoft BASIC is running on over 700,000 systems. Worldwide. Because we never stopped improving it. It's an everyday job at Microsoft.

**Languages.** BASIC for 8-bit microcomputers was our first language. Today we offer a full range of languages: BASIC, COBOL, FORTRAN and Pascal for both 8-bit and 16-bit microcomputers. Fully supported languages that meet industry standards. Plus enhancements we add to increase their utility. Languages that provide transportable applications software between microprocessors. Synergistic languages that provide feature-for-feature compatibility between 8-bit and 16-bit machines.

**More than languages.** In addition to languages, Microsoft has utility programs and end-user system software. Microsoft developed XENIX™, our implementation of UNIX® for 16-bit microcomputers. It isn't "UNIX-like." It's fully supported UNIX for the 16-bit world.

**Partnership.** When you put Microsoft products on your system, you enter an on-going partnership with some of the industry's foremost experts. We continually research hardware and software technology in an effort to develop new products, and, to improve our present products. And when those improvements are made, the updated products are

made available to our customers. That's a nice thing to know when you're developing systems.

**Easy to OEM.** Our royalty plan for licensing software allows you to add Microsoft software to your system with a very low initial investment, paying royalties on a when-sold basis. And if you're on a sensitive schedule, remember most of our products are available off the shelf. No waiting.

**Questions?** Call our OEM Accounts Manager. We'd like to show you why buying leading edge software is a lot less expensive than writing it. And remember, Microsoft is "One-stop Shopping" for your system software needs.

**Microsystem specialists.** Microsoft led the industry into the 8-bit world. Now, we're leading it into the 16-bit world. With fully supported and maintained software. The kind of software that gives our customers a lead on the competition. Today, people say we're the leading microcomputer software source. It's the kind of reputation people give you only when you earn it.

## MICROSOFT

10800 N.E. 8th St., Suite 819  
Bellevue, Washington 98004  
(206) 455-8080 • TLX: 328945

A CLEAR FACT FROM ITT JENNINGS:

# 38 YEARS OF VACUUM CAPACITOR EXPERIENCE MEANS THERE'S NOBODY BETTER

Back in 1942, ITT Jennings was one of a handful of companies supplying "fixed" vacuum capacitors to the Army Signal Corp. Because they were fixed capacitors, large capacitor banks were needed to handle the wide range of frequencies. To reduce the number of capacitors required for this type of tuning, ITT Jennings developed and patented the "variable" capacitor. This pioneered the way for compact communications gear.

Today, some 38 years later, ITT Jennings is still the pioneer in vacuum capacitor technology. We supply more specialized variable and fixed vacuum capacitors to the vast RF communications universe than anyone.

You will find our vacuum capacitors available in both glass and ceramic envelopes, with working voltages to 36 KV, capacitance values up to 5000 pF, and current ratings to 420 A RMS (air-cooled), or 840 A RMS (water-cooled).

It's no wonder that we know more about vacuum capacitors than anyone. If you would like to know a little more, we have a 56-page catalog that will tell you the whole story. Write us at: 970 McLaughlin Ave., San Jose, CA 95122, or call us direct at (408) 292-4025. When it comes to vacuum capacitors, remember there's nobody better.



## JENNINGS ITT

DIVISION OF INTERNATIONAL TELEPHONE AND TELEGRAPH CORPORATION

Circle 214 on reader service card

## NEW 1981 Electronics Buyers' Guide

The only book of its kind in the field. If you haven't got it, you're not in the market.

To insure prompt delivery  
enclose your check with  
this coupon.

Yes, please send me \_\_\_\_\_ copies of 1981 EBG.

I've enclosed \$30 per copy delivered in USA or Canada. Address: EBG, 1221 Avenue of the Americas, New York, N.Y. 10020.

I've enclosed \$52 for air delivery elsewhere. Address: EBG, Shoppenhangers Road, Maidenhead, Berkshire S16, 2Q1 England.

Name \_\_\_\_\_

Company \_\_\_\_\_

Street \_\_\_\_\_

City \_\_\_\_\_

State \_\_\_\_\_

Zip \_\_\_\_\_

Country \_\_\_\_\_

### New products

9.1 v/ms. The parts require  $\pm 15$  v  $\pm 5\%$  for operation at rated specifications. Prices in quantities of 1 to 24 are \$69 for the AD293A and \$79 for the 293B and 294; delivery for these is 4 to 6 weeks. Six-week deliveries of the AD293S/883B are due to start in November; its price is not yet set.

Analog Devices Inc., Route One Industrial Park, Norwood, Mass. 02062. Phone (617) 329-4700 [342]

### GaAs amp operates over bandwidths of 1 GHz

The CGY 21 monolithic GaAs wide-band amplifier has frequency ranges of 40 MHz to 1 GHz. It offers a noise figure of 4.5 dB, and its output voltage is 320 mV into 50  $\Omega$  or 400 mV into 75  $\Omega$  with a gain of 20 dB minimum. The basic GaAs material for the CGY 21 is manufactured by Siemens in Munich, where 2-in. wafers are already being processed. The active layer is achieved by direct ion implantation, which saves on time and cost and produces layers of high uniformity.

The amplifier is designed to replace hybrid and discrete amplifiers in wideband communication applications, such as TV satellite downlink receivers, cable-television line amplifiers, instrument preamplifiers, and broadband tactical receivers. In small quantities, the TO-5 or SIL-9 packaged amplifier costs \$150. Full production is expected in spring of 1982, and in 1,000-piece lots, it will be about \$25. Microwave Semiconductor Corp., 100 School House Rd., Somerset, N. J. 08873. Phone (201) 469-3311 [343]

### Molded rubber key pad snaps when contact is made

The KEA4A901 keyboard is a single piece of molded silicone rubber that functions as both spring and contact for all the keys. Contact is made through carbonized portions of the rubber that are pressed against



# DYNAMIC RAM TIMING MODULES

The increasing size and density of dynamic RAM memories require that timing signals be accurate and repeatable. Precise signals allow more events to be timed in a given time period.

Catalog 812 for standard digital delay modules now includes a new series of:

## HIGH PERFORMANCE DIGITAL TIMING MODULES

- Providing ten precision timing edges derived from one input pulse
- With total delays from 25ns to 500ns
- TTL compatible, D.I.L. package.

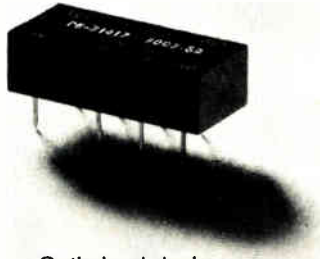

Optimized designs, continuous improvement in processes and statistical analysis of performance data have contributed to this outstanding component.

## PULSE ENGINEERING'S TIMING MODULES — THEY MEAN A LOT TO YOU:

Precision — reliability  
Performance — quality  
Availability

# PULSE ENGINEERING

P.O. Box 12235, San Diego, CA 92112 • (714) 279-5900

Circle 216 on reader service card

## New products

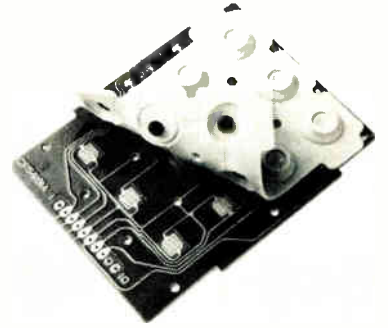

intertwined leads on a printed-circuit board. A tactilely distinct though inaudible snap made when the key is pressed indicates to the user that contact has been made. The conductive element in the contacts is carbon, not precious metal, immunizing it against the price changes of gold and silver. The molded rubber covers the printed-circuit board tightly enough to exclude dust from the contact area, and the carbon contacts are not affected by oxygen and sulphur. In addition, the keys are double-shot-molded, which means the graphics are injected into, rather than painted on, the plastic and are as deep as the keys. In 10,000-unit quantity orders the key pad sells for \$2.90; sample price is \$5.30. Delivery is 30 to 90 days after receipt of order.

Alps Electric Inc., 100 North Centre Ave., Rockville Centre, N. Y. 11570. Phone (516) 766-3636 [344]

## Magnet withstands 250°C without flux degradation

The Raeco-23 samarium-cobalt magnet has a 23-megagauss-oersted energy product and an intrinsic coercive force of 14 kOe. In addition to the Raeco-23, Raytheon has three other types with energy products of 10, 16, and 20 MG-Oe and intrinsic coercive forces of 22, 18, and 16 kOe, respectively. When stabilized, all magnets can operate at up to 250°C for extended periods of time with little or no degradation in the flux. They are also small and stable over a wide temperature range.

The Raeco-23 can be used where

## McGraw-Hill's Electronic Bookshelf™ is on the Air!

Ask your computer to call (212) 997-2488 for the latest info on our computer and electronics books. The system is up daily from 6 pm to 8 am and 24 hours on weekends.





# Methode's offers more tooling options & lowest total cost!



JAGUAR I.D.C. CONNECTORS



TERMINATOR JT-10 FULLY AUTOMATIC  
DUAL END ... RANDOM LENGTH



TERMINATOR  
HAND TOOLS



TERMINATOR JT-1  
HARNESS MAKER



TERMINATOR JT-5  
FULLY AUTOMATIC



TERMINATOR JT-3  
SEMI-AUTOMATIC

Our Jaguar **MULTIPLE TERMINATION SYSTEM** is a complete wire-to-post interconnect system on .100" and .156" centers that accommodates discrete wire or ribbon cable with solid, stranded or fused-stranded conductors. This reliable insulation displacement system eliminates wire stripping, crimping and stuffing ... and, features buy or lease application tooling for very small or very large runs up to 24,000 connections per hour. We'll even customize tooling to meet your exact needs. Just circle the reader service number to receive our fully illustrated Jaguar system catalog.



**Methode Electronics, Inc.**  
INTERCONNECT PRODUCTS DIVISION  
1700 Hicks Road  
Rolling Meadows, IL 60008  
(312) 392-3500 TWX: 910-687-0760

Circle 217 on reader service card

The only DZ11 Compatible Multiplexor for LSI-11.  
And it has RS-422 plus RS-232 and current loop capability-

# MDB makes the difference!

Now you can have it all for your LSI-11 or PDP<sup>®</sup> 11 system! Full DZ11 multiplexor performance with the added benefit of EIA-RS-422 long line capability—communicates at distances to 3000 feet (914.4m) at rates to 19.2K baud. What's more, MDB's DZ11 multiplexors let you combine RS-422 with EIA-RS-232 in any combination up to a total of eight lines on a single board. Or combine RS-232 with current loop in the same way. Eight and sixteen channel RS-232 DZ11 multiplexors are also available. No more doubling up on boards, distribution boxes, rack space or price. You see the results in your system's performance and cost.

And that's not the only difference we can make to you. MDB has line printer controllers that are completely self-testing and we make more controllers for more computer/printer combinations than any company in the world. MDB offers PROM modules with window mapping, communications interfaces that support X.25 and a unique LSI-11/23 system with 22 bit addressing and up to 4 Mbytes of memory. From purely compatible to purely incredible all MDB products are built with exceptional quality and responsiveness to customer requirements. Our boards are warranted for a full year, many are available off the shelf and they can be purchased under GSA contract #GS-OOC-02423.

Call or write for all our specifications—the MDB differences that make a difference.

\*Trademark Digital Equipment Corp.

**MDB** 1995 N. Batavia Street  
Orange, California 92665  
714-998-6900  
SYSTEMS INC. TWX: 910-593-1339

See us at Wescon booth #1826

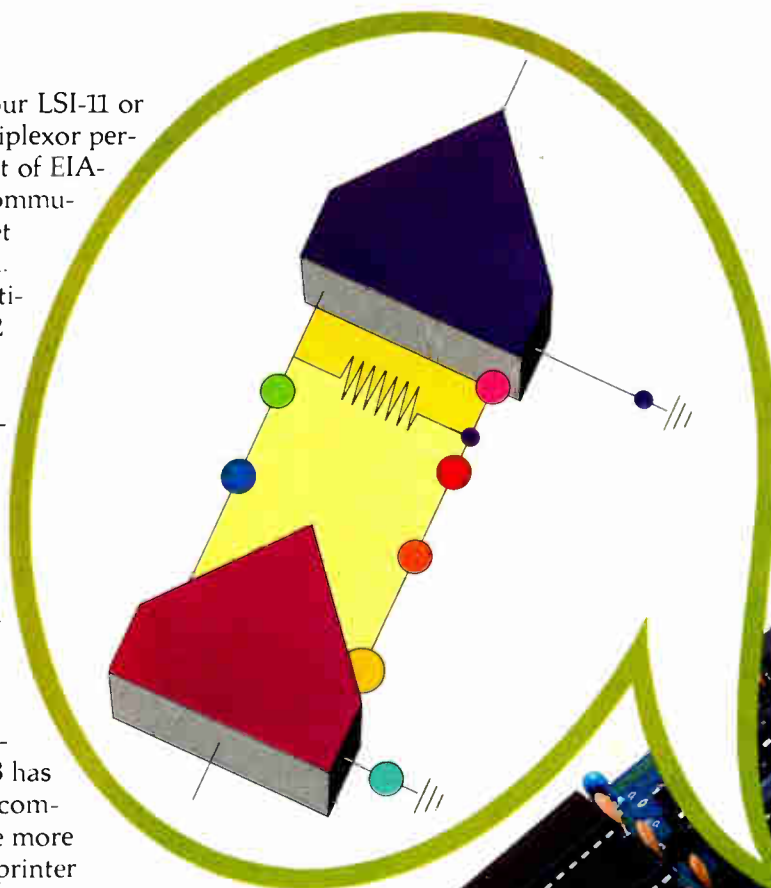

Circle 155 for  
featured product data.  
Circle 156 for  
general info.

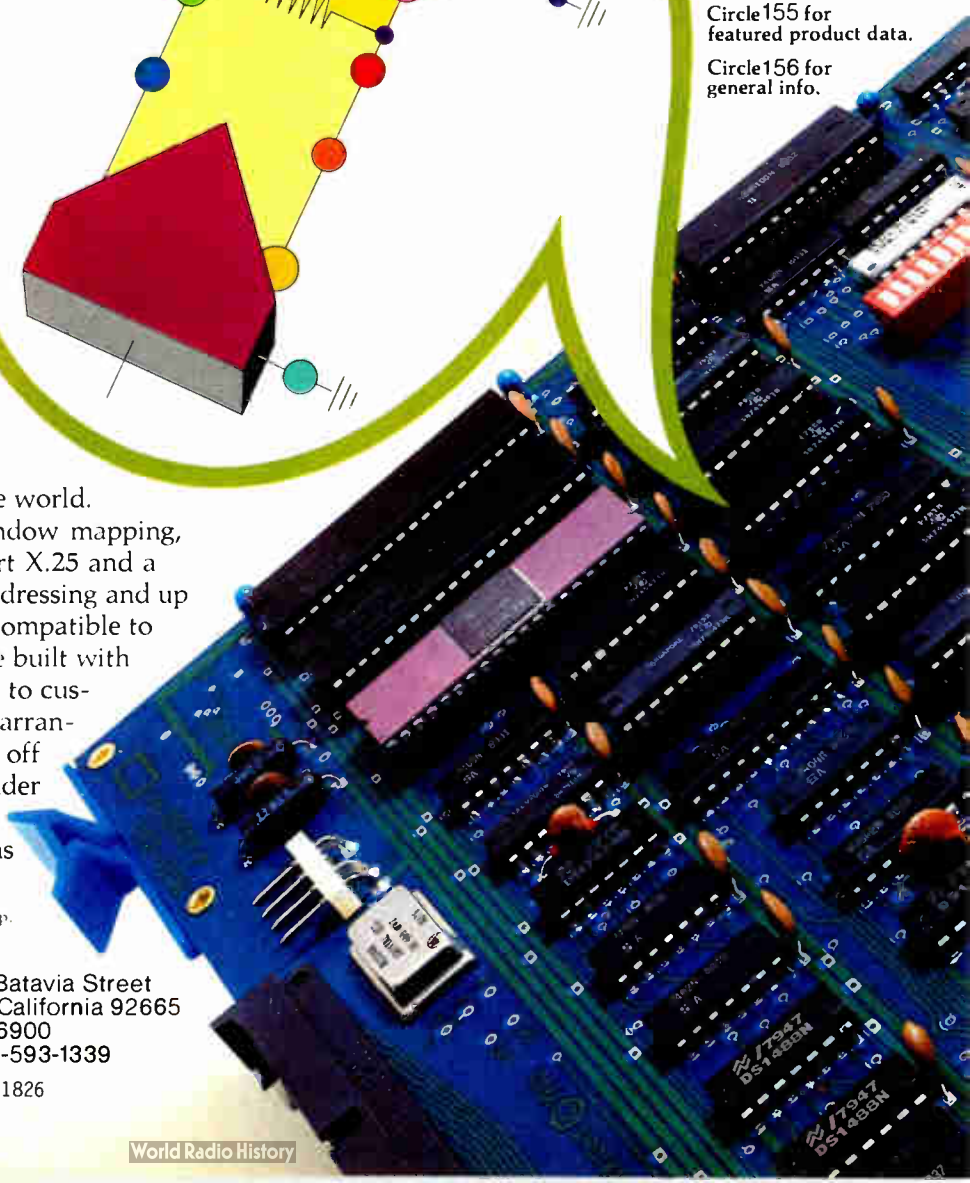



## New products

high strength is required or in the demagnetizing ambiances of electronic components, magnetic couplings, bearings and motors, generators, gyroscopes, meters, and relays. Prices for the custom-made magnet depend on such features as size, shape, ground, and whether the magnet is treated or untreated, plated or not. Delivery is 12 weeks after receipt of order.

Raytheon Co., 190 Willow St., Waltham, Mass. 02254. Phone (617) 899-8400 [345]

60-Hz relay features  
time delays of 50 ms to 24 h

Syracuse Electronics' digital circuitry time-delay relay is available with standard input voltages in six ac values of 12 to 230 V and six dc values

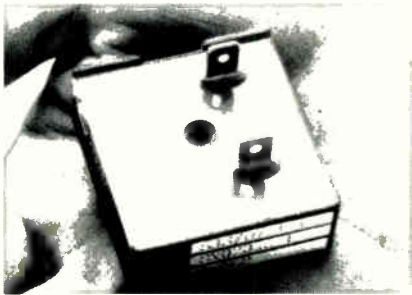

of 12 to 240 v. It operates at a frequency of 50 or 60 Hz maximum, consumes 3 W, and is available in time delay ranges of 50 ms to 24 h. The solid-state relay output is single-pole, single-throw, and normally open, and its contact rating for ac and dc values is 1 A at 25° and 40°C. It has a useful life of over 10<sup>8</sup> operations, with a typical repeat accuracy of ±0.5%.

Options include: redundant diodes to protect the output circuit from half-waving; low on-stage voltage for a lower on-stage output voltage than is usual for ac and dc models; and polarization in dc units to provide a lower on-stage voltage than is usually standard to drive dc loads that are unstable with low input voltage tolerance. Prices vary with quantity, and delivery takes two weeks.

Syracuse Electronics Corp., P. O. Box 566, Syracuse, N. Y. 13201. [348]

# TOUGH LITTLE TAPE SYSTEM

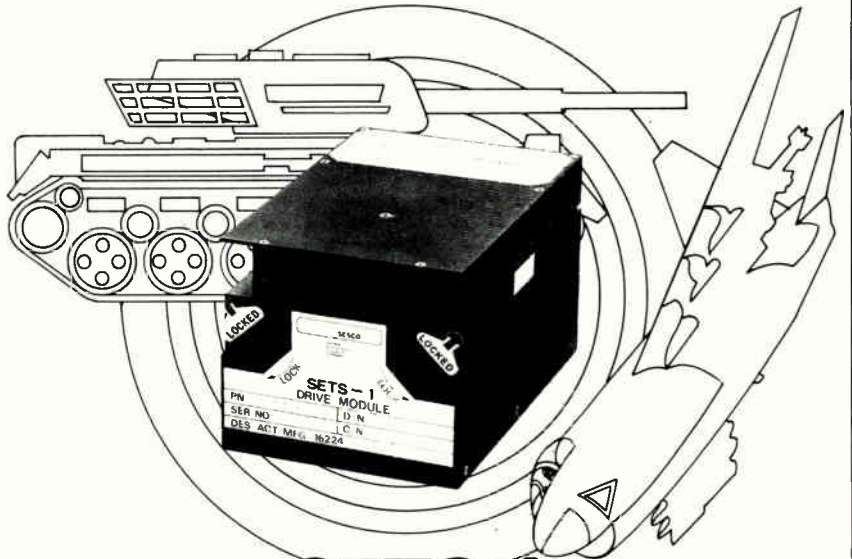

## SETS-1

A 23-megabit digital tape system for airborne and other severe environments

Meeting MIL-E-16400, 5400 and 4158, SETS-1 is a compact digital tape system which stores 23 megabits of data at 1600 bits per inch on 300 feet of 1/4-inch magnetic tape. It has bidirectional read/write on 4 tracks with a 192K bit-per-second transfer rate.

SETS-1 consists of a compact drive module coupled to a removable, hermetically sealed tape module. It's being used right now by the Army and Air Force for bulk storage and data gathering from tanks, aircraft and remote sites. Also as a data entry device for mission loaders, communications and fire control systems.

Phone or write for details today.



**Severe Environment Systems Company**

A Subsidiary of Electronic Memories & Magnetic Corporation

P.O. Box 668 • Chatsworth, CA 91311 • Telephone: (213) 998-9090 • TELEX 69-1404



Circle 219 on reader service card

## FIBER OPTICS VOCABULARY

The basic reference document on fiber optic and lightwave communications for those who design, develop, operate, use, manage, or manufacture communications or data processing equipment and components.

- 1400 entries, with
- index of terms
- inversions and cross-references

Order your copies today!

\$12.95 each, discounts of 10% on orders of more than 10.



Electronics Magazine Books  
P.O. Box 669  
Hightstown, NJ 08520  
Tel. 609/448-1700, ext. 5494

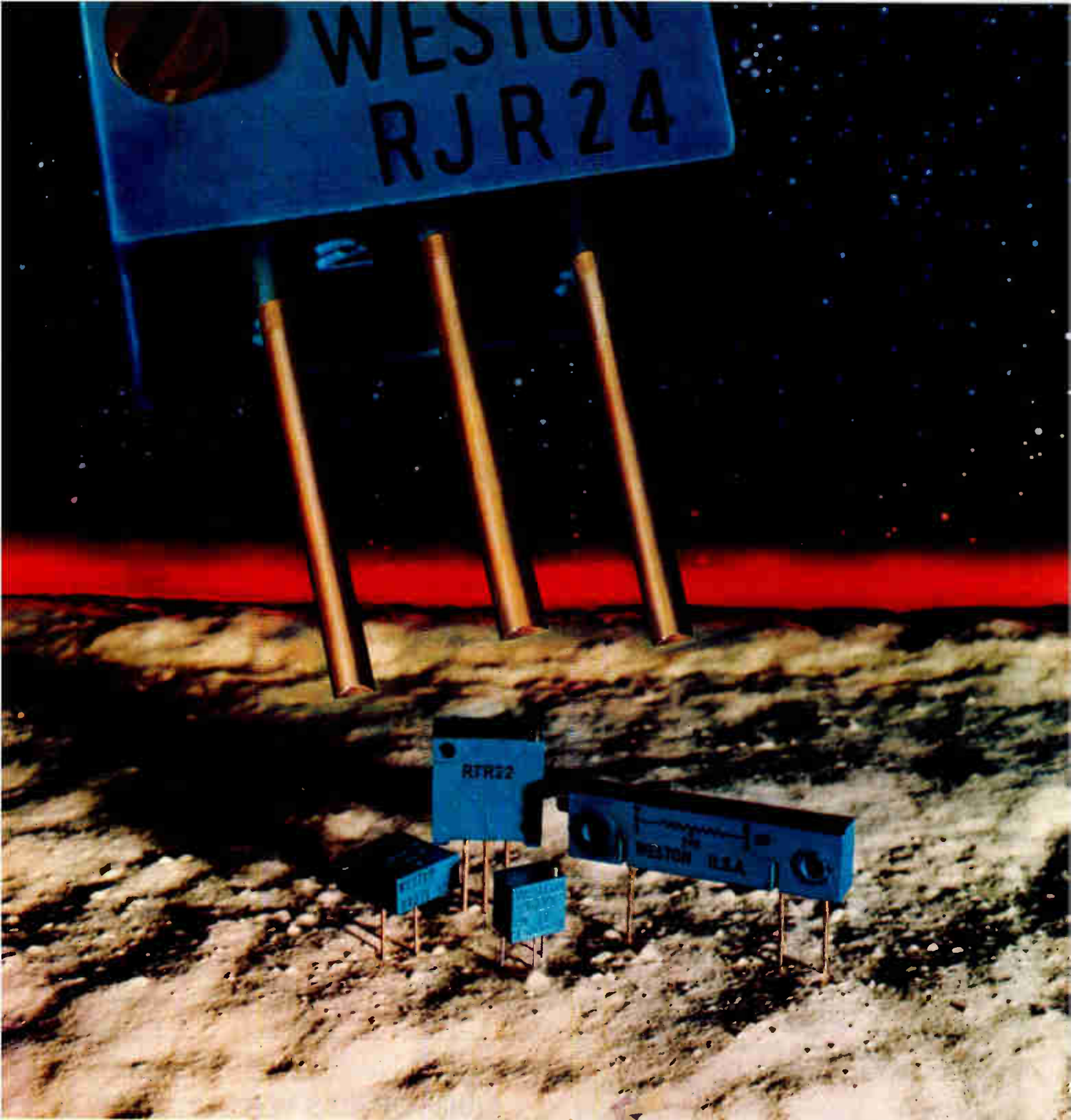

## TAKING YOU INTO THE FUTURE.

Weston's Established Reliability line of mil-qualified trimming potentiometers has the quality and design excellence to take you into the future with consistently high performance. In both wirewound and cermet, Weston technology comes through in a wide variety of models and terminal configurations to fit your most demanding applications. Choose from our RTR12, RTR22, RTR24, RJR24 and RJR26 models.

Weston has a proven track record as an acknowledged leader in the manufacture of military approved devices to Circle 220 on reader service card

military specifications both Mil-R-39015 and Mil-R-39035. In fact, most of our established reliability trimmers are available from either factory or distributor stock. Call or write today for complete specifications, pricing and evaluation samples for any of Weston's complete line of established reliability or standard military QPL trimmers.

**FAIRCHILD WESTON**

**Schlumberger**

WESTON CONTROLS  
Archbald, Pennsylvania 18403  
Telephone: (717) 876-1500  
Telex: 83-1873  
TWX: 510-656-2902



# SUWA SEIKOSHA

## A Specialist in CMOS LSI

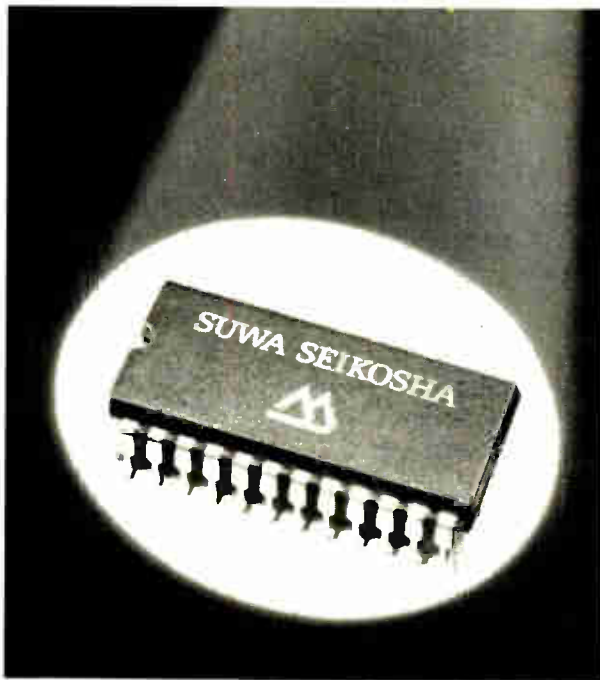

Suwa Seikosha, a major manufacturer of the famous SEIKO watches, was the originator of the quartz watch. As the pioneer of quartz watch technology, the company has consistently developed and manufactured its own miniature electronic parts and ICs. Today this accumulated "Mechatronics" technology is being applied to the development of a variety of new products in addition to watches.

A new Suwa Seikosha plant at Fujimi was set up in April 1980 to concentrate on the manufacture of CMOS LSI and other semiconductor parts. These units include: "Melody ICs," microcomputers, memories, speech synthesizers, and others. Suwa Seikosha, as a leading CMOS LSI maker, is aggressively exploring many future possibilities that will employ the company's most advanced technology.

### CMOS LSI FOR USE IN LOW POWER SYSTEMS

- **MELODY IC**  
7910 Series  
7920 Series  
7930 Series  
SVM7940 Series  
SVM7950 Series  
SVM7990 Series
- **TIME STANDARD IC**  
(Standard Pulse Generator)  
8640  
8650  
8651
- **MEMORIES**  
SRM2114 (1K × 4-bit Static RAM)  
SRM6504 (4K × 1-bit Static RAM)  
SRM6514 (1K × 4-bit Static RAM)  
SMM2364 (8K × 8-bit Mask ROM)  
SMM2365 (8K × 8-bit Mask ROM)
- **MICROCOMPUTER**  
SMC1102 (One chip 4-bit Micro Computer, built-in LCD Driver)  
SMC1112 (Low power version of SMC1102)
- **HIGH COMPACT MELODY MODULE**  
SEK7 Series
- **LCD DRIVER**
- **CUSTOM LSI**
- **CMOS LSI for Watch and Clock**
- **SPEECH SYNTHESIZER**  
SVM9300

Semiconductor Operation Division (Fujimi Plant)  
281, Fujimi, Fujimi-macta, Suwa-gun, Nagano-ken,  
399-02 JAPAN  
Phone: (02666) 2-4112 Telex: 3362-432 S SEIKF J  
Fax: UF520 III (02666)2-5393

## SUWA SEIKOSHA CO., LTD.

#### SUBSIDIARIES

**Epson America, Inc.**  
3415 Kashiwa St.  
Torrance, CA 90505 U.S.A.  
Phone (213) 539-9140  
Telex (230) 182412

**Epson U.K. Ltd.**  
Sherwood House  
176 Northolt Road  
South Harrow, HA2 OEB, U.K.  
Phone 01-422-5612 Telex (51)8814169

**Epson Electronics Trading Ltd.**  
Tsim Sha Tsui Centre, Room 411  
East Wing No. 6  
Ching Yee Road, Tsim Sha Tsui,  
Kowloon, Hong Kong  
Phone 3-694343/4 Telex (802)64714

#### AUTHORIZED AGENTS

**W. Moor AG**  
3105 Regensdorf-Zurich  
Bahnstrasse 58, Switzerland  
Phone 01-840-6644 Telex (45)52042

**W. Moor GmbH**  
1150 Wein XV  
Stochengasse 1/1/1, Austria  
Phone 0222-858646  
Telex 135701

**Technoprojekt GmbH**  
Heinrich-Baumann-STR 30  
7000 Stuttgart  
West Germany  
Phone 0711-561712 Telex 721437

**Charming Industrial Co., Ltd.**  
51-5 Sec. 2, Chang Ar Road, East  
Taipei 104, Taiwan, R.O.C.  
Phone 02-522-1566  
Telex 22279

# Bare and loaded board testing takes a quantum leap forward!

## with the introduction of Trace's new Series TA-9 Test Analyzer System.

From this moment on, you will have an entirely new concept of high speed board testing. You are about to discover an analytical system so advanced that its capabilities will dwarf and obsolete any you have used or known.

### □ The Trace Series TA-9.

Conceived and developed by the same people who revolutionized board testing procedures with their TA-4 and TA-5 Systems, the Series TA-9 virtually eliminates the division between tester and computer.

Through a dramatic, new design principle, the tester, itself, has been transformed into a true computer, containing both program and data memory. This significant change opens the door to a vastly broadened range in the selection and control of test algorithms. A range never possible before. And, for the first time, both bare and loaded boards may be tested at high speeds, with a system that pinpoints even the minutest areas of error.

The network program may be put into the data memory either from a known good board, uploaded from a floppy disk, or transferred in from a data processing computer. A new system of Crosspoint™ switching, originated by Trace, allows infinite variation of the matrix configuration. Instructions, based on high level, macro-

instruction machine language are carried out in 2 clock cycles. The Series TA-9 requires fewer instructions to function at speed advantages of 100 to 1 and more over microprocessor controlled units.

The Series TA-9 is always at the command of the operator. Programs may be created, edited and revised quickly and easily and existing programs may be saved or incorporated into the new mode.

### □ A new era of testing evolution.

The Series TA-9 is designed to stand alone. But the use of a data processing computer, in conjunction with it, can increase its versatility even more. It will never become obsolete. Because it has been designed to become the basic system for a series of modular units, now under Trace development and testing, that will continue Trace's leadership in technological advances in the testing industry. The Series TA-9 will grow in its capabilities to meet your expanding needs.

### □ Before you invest - investigate Trace

If you are considering a new testing system, it will pay you to look into Trace and the new Series TA-9. Because Trace is the acknowledged leader and innovator in the field.

After all, you'll have to work with the system you choose, for a long, long time!



**Write, wire or phone for the complete TA-9 story!**

# TRACE

## INSTRUMENTS

A  Methode Company

9030 Eton Avenue • Canoga Park, California 91304 • Telephone (213) 341-5593 • TWX 910-494-5989

Austin: (512) 258-8917 • Bellevue: (206) 454-0900 • Boston: (617) 890-2252 • Burtonsville: (301) 384-8500 • Dallas: (214) 231-8106 • Dayton: (513) 433-8171  
Des Plaines: (312) 298-2330 • Englewood: (201) 871-3916 • Hartford: (203) 248-9361 • Houston: (713) 864-1711 • Huntsville: (205) 533-5896 • Indianapolis: (317) 255-4147 • Minneapolis: (612) 888-7489 • Philadelphia: (215) 825-9515 • Portland: (503) 292-6934 • Raleigh: (919) 787-5818 • Salt Lake City: (801) 942-3269 • San Antonio: (512) 736-3164 • Scottsdale: (602) 948-8888 • St. Louis: (314) 291-0001 • Sunnyvale: (408) 739-8011 • Rochester: (716) 334-2445 • Tustin: (714) 544-1662 • Winter Haven: (813) 294-5815 • Canada: (416) 676-1042 • Europe/South America/Mid and Far East: (714) 641-8736 • France: (212) 248-9700

# Oak puts E<sup>3</sup> up against the world's fastest typists.

In a keyboard market clogged with claims and confusion about "N-key-rollover," look to Oak's FTM® keyboard for the practical answer. It provides E<sup>3</sup>-Entry Error Elimination. And that means precisely what it says. We challenge the fastest typists in the world to make it error. They can't.

Yet E<sup>3</sup> makes its real contribution to Oak's Full Travel Membrane (FTM) keyboard—and to you—in the cost column. You get the Entry Error Elimination and 100-million-cycle-plus performance you've got to have in a keyboard at prices far below those of keyboards with comparable performance. That's practical. Entry Error Elimination is a remarkably sensible micro-

processor based N-key-rollover and phantom key lockout system developed by Oak engineers. Without the cost and complexity of Hall Effect and capacitive technologies.

And that's not all. Beneath the FTM keyboard is Oak's proven, industry-leading membrane switch technology. So you get all the good things of membrane switching—reliability, durability,

RFI and EMI resistance, design flexibility, and—of course—low cost. All without sacrificing the qualities you demand in a keyboard, right down to human engineered industry standard feel and touch.

Call or write us today for the data and details to prove it. You can't afford not to call Oak.

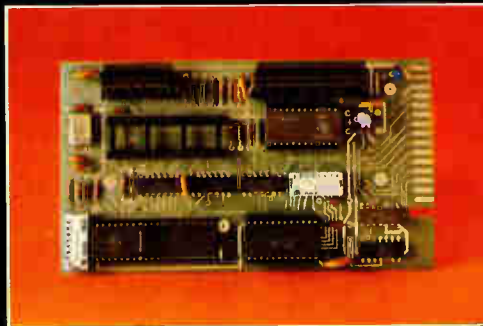

**OAK** Switch Systems Inc.

An Oak Technology Inc. Company

P.O. Box 517 • Crystal Lake, Illinois 60014  
Phone 815 459-5000 • TWX 910 634-3353 • TELEX 72-2447

Circle #223 for further information

Circle #117 to have a sales call

---

## New products

---

Communications

# Set tests line with pulses or tones

---

Telephone-line tester operates using line power and works despite reversed connections

---

The MT-911G test set for telephone lines using either rotary-pulse or Touch-Tone dialing now runs from phone-line power, satisfying phone company specifications for doing so. Previous test sets from Metro Tel Corp.'s product line required a battery to power the reverse-polarity indicator. Battery power is also used in the firm's sets to operate an optional last-number-recall feature; the 6-v battery is still required for this option. Space is left inside the



portable instrument for the battery.

The MT-911G operates even if the tip and ring circuits are connected in reverse during a phone-line check, merely indicating the condition with a light-emitting diode. Previous sets did not have this time-saving bipolar-operation feature. Another update involves the asterisk button, which on earlier members of the line served only as an on-off switch. The set now emits a tone when this button is pushed, serving a command function.

It also offers transmitter muting to permit its use in noisy locations. By pressing the mute button, the operator can momentarily cut off the set's transmitter so that loud ambient noises during communication with the test board are not received back in his ear.

The capability to test a 2,000- $\Omega$  loop is standard on the MT-911G. Interface impedance in the talk mode is  $1,200 \pm 150 \Omega$  from 450 to 3,200 Hz; in the monitor mode, impedance is a minimum of 600  $\Omega$  from 500 Hz to 100 kHz. Operating in the rotary mode, dialing rate is 10 pulses/s  $\pm 2\%$ , break percentage is  $61 \pm 1\%$ , and interdigit time is  $800 \pm 10$  ms. Frequency accuracy in the tone mode is within  $\pm 1.5\%$ .

Many telephone systems are in the process of moving from rotary to tone dialing, and for the time being use both types. The MT-911G's multimode capability suits the unit to use during the transition. It offers a variety of interchangeable cords, all of which plug into its standard modular connector.

The test set measures 8.75 by 2.5 by 2.5 in. and weighs only 10 oz. Without cords, its price is \$147.30; delivery is from distributor stock.

Metro Tel Corp., 15 Burke Lane, Syosset, N. Y. 11791. Phone (516) 364-3377 [401]

---

## Transmitter sends analog signals as low as 10-mV

The 3714T fiber-optic transmitter accepts analog signals, amplifies them (the user selects adjustable gains of 1 to 1,000 v/v), converts



them into a frequency-formatted digital pulse train, and changes that into a light output. When used with fiber-optic cable and either the 3712R or 3713R receivers, the 3714T forms a data link that will transmit analog signals as low as 10 mV full scale over distances of up to 1.7 km. The link output is a TTL digital pulse train that may be interfaced with a counter for analog-to-digital conversion or converted back into analog form with a frequency-to-voltage converter.

It has an input impedance of  $10^{10} \Omega$ , a gain drift of 175 ppm/ $^{\circ}\text{C}$  maximum, and a linearity of  $\pm 0.01\%$  maximum full scale (for voltage-to-frequency converter output of 0.01 Hz to 10 kHz). Its input voltages are 0 to +10 or -10 v unipolar and -5 to +5 v bipolar, with a maximum output frequency of 50 kHz. Delivery is from stock on the 3714T, which sells for \$93.75 in lots of 100.

Burr-Brown, Box 11400, Tucson, Ariz. 85734. Phone (602) 746-1111 [403]

---

## 8103 smart controller has dual-ported RAM

The 8103 smart communications controller uses a dedicated 8085 microprocessor to meet serial RS-232-C and Bell 202 requirements. It is partitioned into three sections: the central processing unit, a serial communications interface, and a dual-ported random-access memory. All the communication channels are controlled by the 8085.

The CPU is equipped with 16-K bytes of RAM, read-only memory, and erasable programmable ROM

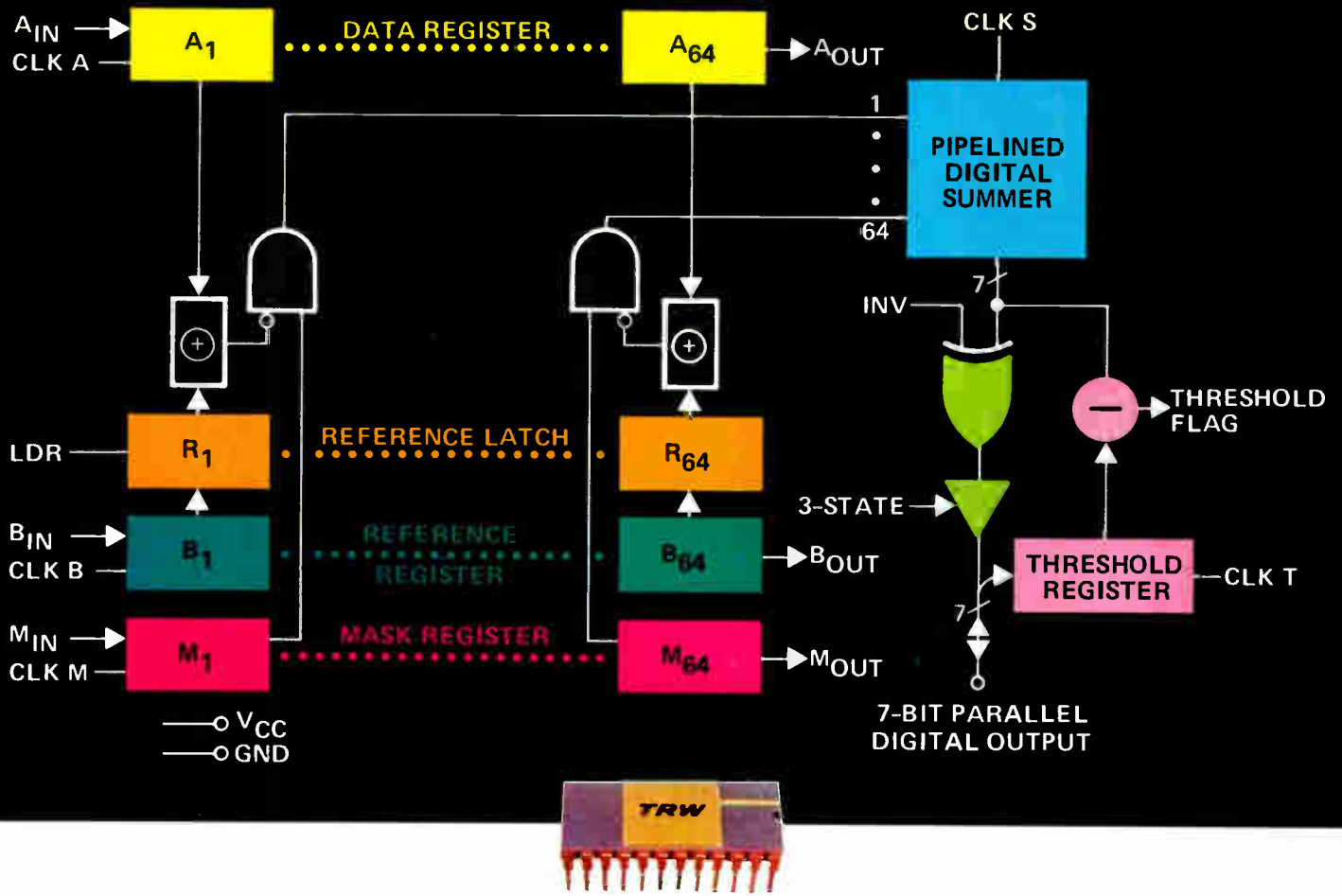

# Now! A 64-bit, 20 MHz All Digital Correlator.

(On a single chip.)

Our TDC1023J correlator chip gives you the ability to detect a desired signal in the presence of other signals or noise. It can recognize and compare signal patterns. It may be used to measure time delays through various mediums such as materials, the body, RF paths, electronic circuits. It's ideal for the digital design engineer working in these areas:

- Convolution
- Error detection and correction
- Noise reduction in communications
- Pattern and image recognition
- Signal synchronization
- Signature analysis

And just take a look at these key features:

- Separate buffer registers—speeds processing, reduces external components
- Threshold register—enables flag at preset correlation level
- Mask register—permits adjustable compare lengths
- 20 MHz correlation rate

- +5V supply: TTL compatible
- 24 pin ceramic DIP package
- Only \$85 in 100's

Prices quoted are U.S. prices.

**For complete information on our all new digital correlator, call your nearest TRW International Sales office and ask for our new 32 page brochure, "Correlation — a powerful technique for digital signal processing!"**

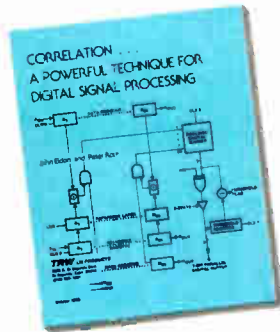

- ARGENTINA, Buenos Aires 304132
- AUSTRALIA, Moorabbin 5559566
- AUSTRIA, See Germany
- BELGIUM, See France
- BRAZIL, Sao Paulo 2409211
- DENMARK, Herlev 842000
- FINLAND, Helsinki 6926022
- FRANCE, Paris 7581111
- GERMANY, Munich 7146065
- HONG KONG, Kowloon 3856199
- ISRAEL, Tel Aviv 444572
- ITALY, Monza 360021
- JAPAN, Tokyo 4615121
- NETHERLANDS, Den Haag 210101
- NEW ZEALAND, Wellington 851279
- NORWAY, Oslo 786210
- SOUTH AFRICA, Capetown 21-215350
- SPAIN, Madrid 2425204
- SWEDEN, Vallingby, Stockholm 8635040
- SWITZERLAND, Zurich 429900
- TAIWAN, Taipei 7512062
- UNITED KINGDOM, London 9025941

TRW keeps you ahead in digital signal processing

**TRW LSI PRODUCTS**

An Electronic Components Division of TRW Inc.

Circle 224 on reader service card

## OSCILLATORS WITH A FREQUENCY RANGE FROM KHz TO MHz

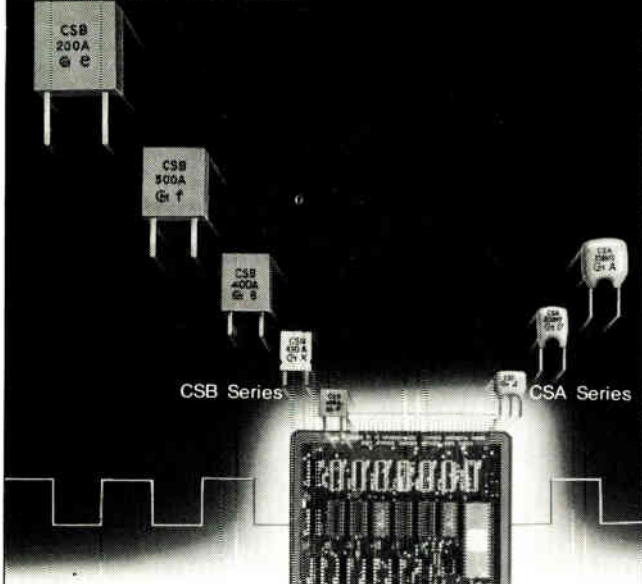

Ceramic Capacitors for CSA are also available

# Ceramic Resonator **CERALOCK**<sup>®</sup>

A Series of Microprocessor Clock Base

The use of microcomputers daily expands into a wide variety of fields. MURATA's newest contribution to this trend is the commercial development of CERALOCK<sup>®</sup>, the small ceramic oscillator. CERALOCK<sup>®</sup> is designed to function as a clock signal oscillator, an integral part of oscillator circuits, the heart of a microcomputer. MURATA offers an entire series of these oscillators with frequencies ranging from 190 KHz to 30 MHz.

#### ■ Applications

Square-wave and Sine-wave oscillator/Clock generator for microprocessors/Tone Dialer and Pulse Dialer for telephone/Remote control system/Car electronics (Engine control, digital speed meter and so on)

#### ■ Specifications

Item	Type	CSA Series	CSB Series
Frequency Range		2.5 to 30MHz	190 to 800KHz
Vibration Mode		Thickness Vibration Fundamental	Area Vibration Fundamental
Frequency Tolerance		±0.3%max.	±0.3%max. (±1KHz:190-375KHz) ±0.2%max. (±2KHz:375-800KHz)
Oscillating Frequency Temperature Stability		±0.3%max. (-20°C to +80°C)	±0.3%max. (-20°C to +80°C)
Aging (for 10 years)		±0.5%max. (at room temp.)	±0.5%max. (at room temp.)



MURATA MFG. CO., LTD.

HEADQUARTERS Nagasaki-kyo-shi, Kyoto 617, Japan Phone 075 929 9111 Telex 64270 MURATA J  
 MURATA CORPORATION OF AMERICA Phone 404 552 9777 Telex 0542329 MURATA ATL  
 MURATA ERIE ELECTRONIK GMBH (West Germany) Phone 0911 68065 Telex 623763 MEGND  
 MURATA ERIE ELECTRONIQUE S.A. (France) Phone 559 69D1 Telex 204520 ERITRON PARIS  
 MURATA ERIE ELETTRONICA S.R.L. (Italy) Phone 66B 4633/4835 Telex 330385 ERIE MIL  
 MURATA ELECTRONICS SINGAPORE (PTE.) LTD. Phone 25542-3, 2554023 Telex 21127 MURASIN  
 MURATA COMPANY, LIMITED (Hong Kong) Phone K306291-2 Telex 86208 HKMRT HK  
 TAIWAN MURATA ELECTRONICS CO., LTD. Phone 042-31 4151-2 Telex 51249  
 MURATA MFG. CO., LTD. Seoul Branch (Korea) Phone 778 2783 Telex K26858 MURASUL

## New products

points while optimizing the bandwidth of the telephone circuits.

Multiplex.25 can be used as a terminal concentrator for mainframes and minicomputers that employ the X.25 synchronous interface. It can also exchange data with hosts of dissimilar speeds, and concentrate terminal traffic on single trunks to a data network, eliminating dial-out and dial-in modems and the monthly message-unit telephone company charges.

The four- or eight-port multiplexer is compatible with the GTE Tele-net and the Tymnet networks in the U.S., Datapac in Canada, PSS and IPSS in the UK, Transpac and NTI in France, DN-1 in the Netherlands, CTNE and RETD in Spain, as well as the Euronet network and the offerings of the international record carriers such as Western Union International, ITT Worldcomm, and RCA Globecom. The four-port version sells for \$995, the eight-port version for \$1,700. Delivery takes 30 days.

Dynatech Packet Technology Inc., 7664-A Fullerton Rd., Springfield, Va. 22153. Phone (703) 569-8531 [405]

## Receiver gets quality TV signals from satellites

The 7500 receiver of television video and sound from satellite transmissions exceeds the requirements of RS-250B/NTC-7. It is modular in construction: all its circuits plug in from the top except for the down converter, which is removable from the front panel. Using the keyboard and display, the user can enter a frequency and transponder number directly and step either of them up or down from its present value or else select one of six memory channels that are preprogrammed by the user.

Frequency control of the model 7500 is gained with a phase-locked frequency synthesizer. Two versions of the synthesizer are available—one with 20-MHz channel spacing for conventional full transponder video and the other with 250-kHz channel spacing for half-transponder and other special applications. The unit



# To buy or not to buy, That is the question.

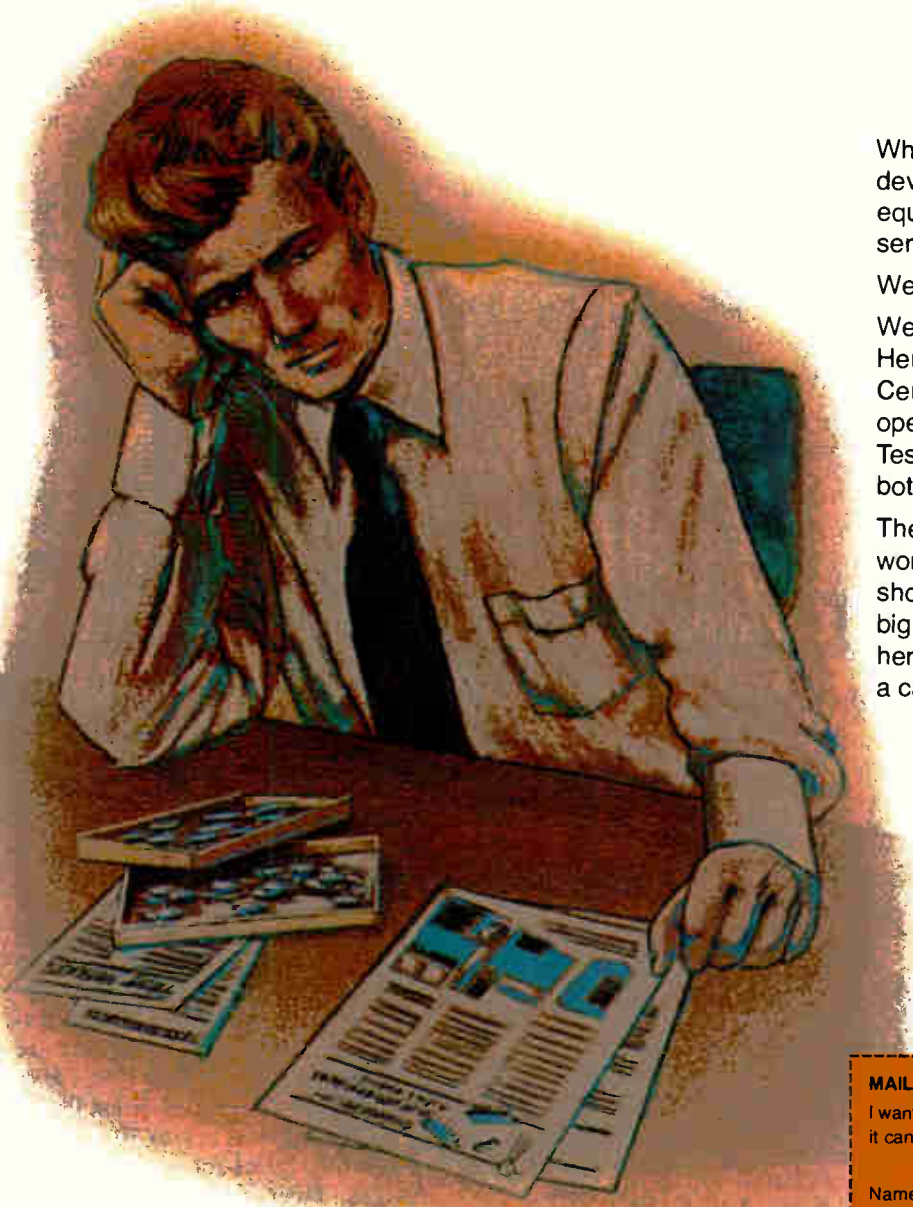

When it comes to a decision about device environmental testing . . . buying equipment versus buying testing services . . . Trio-Tech has the answer.

We can supply both.

We'll provide Burn-In Systems, Hermeticity Testing Equipment and Centrifuges, and teach you how to operate them . . . or, use our complete Test Lab Screening Services . . . or use both.

The testing expertise we've developed worldwide since 1959 is available to show you how a little testing can make a big difference in device reliability. We're here to answer your questions. Give us a call.



**Environmental Test Equipment and Screening Services since 1959.**

2040 N. Lincoln St., Burbank, CA 91504, (213) 846-9200

TLX 194811 (TTI INTL BUBK), Cable: TRIOCAL

Mountain View • Singapore • London • Manila

#### MAIL ME YOUR FREE BROCHURE

I want to know more about component testing and what it can do for me.

Name \_\_\_\_\_

Title \_\_\_\_\_

Company \_\_\_\_\_

Address \_\_\_\_\_

City \_\_\_\_\_

State \_\_\_\_\_ Zip \_\_\_\_\_

Phone ( ) \_\_\_\_\_

**TRIO-TECH INTERNATIONAL**

2040 N. Lincoln St., Burbank, CA 91504

## C&K INTRODUCES ITS NEW SOLID STATE PUSHBUTTON SWITCH SS01

This NEW low profile, P.C. mounted switch module provides logic-compatible, bounce-free complementary outputs and user selectable mode of operation (momentary or alternate action).

The SS01 switch features a custom design integrated circuit for extreme reliability and life, and internally connected L.E.D. for indication of state.

For further information, call or write, (617) 964-6400

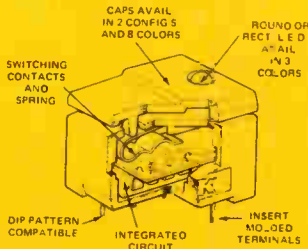

**C&K Components, Inc.**  
15 Riverdale Avenue, Newton, MA 02158

The Primary Source Worldwide...

"Visit us at Wescon, Booth No. 1330-1332."  
Circle 230 on reader service card

## A Temperature Controller For Every Application



### CHOOSE FROM:

- Control: 1, 2, or 3 Mode, On/Off, Limit
- Setpoint: Analog, Digital
- Indication: Full Range, Deviation
- Outputs: Current, Voltage, EM Relay, SS Relay, Power Pack

### PLUS:

- Solid State Reliability
- Computer Tested
- Modular Construction
- Space Saving Size
- Optional Alarms
- Plug-in Electronics AND LOW COST



For additional information, circle the Reader Service Number or contact:

Process Control Division, 1601 Trapelo Road,  
Waltham, MA 02154, 617-890-2000.

In Canada: Lisle-Metrix Ltd., Toronto

See LFE at Wescon, Booth 1851

Circle 120 on reader service card

## New products

costs \$4,500 and is available 30 days after receipt of order.

Scientific Atlanta Inc., 1 Technology Parkway, Box 105600, Atlanta, Ga. 30348. Phone (404) 441-4000 [406]

### Infrared system transmits voice, computer data

Light Comm I infrared transmission system transmits computer data or voice on an invisible beam. By placing computer data directly onto an incoherent infrared light beam, it makes short-range data communications less expensive than if it used microwaves, fiber optics, or metallic wire, all of which entail trenching charges. A reliable and secure transmission system with no Federal Communications Commission restrictions, Light Comm I runs at standard data rates of 2,400, 4,800, and 9,600 b/s and 19.2, 38.4, and 76.8 kb/s. The system includes two optical transceivers, associated cabling, and digital controller with RS-232-C interface. The system sells for \$12,000, with delivery in 30 days.

Light Communications Corp., 25 Van Zant St., Norwalk, Conn. 06855. [407]

### Couplers allow transmission of 1,500-nm wavelengths

Phalo's digital and analog three- and four-port optical directional couplers are for use as taps or feeds in multi-terminal networks, multiplexing, and other applications. The couplers permit full-duplex operation over a single fiber. The standard products are available using Corning SDF fiber and a variety of graded-index fibers. They also have a 1:1-to-20:1 range of splitting ratios for use in network designs. Their passivity permits operation at all standard transmission wavelengths from 600 to 1,500 nm. In quantity the couplers sell for less than \$200 each, with delivery from stock in two to four weeks.

Phalo, Optical Systems Division, 9240 Deer-ing Ave., Chatsworth, Calif. 91311. Phone (213) 998-3177 [408]

# THE COMPANY THAT STARTED AHEAD IN THICK-FILM NETWORKS STAYS AHEAD

Ever since thick-film resistor networks were first made, Sprague Electric has led the way. By doing much of the pioneering. By being first to put a network of resistors in a standard dual in-line package. By making more thick-film circuits than anyone else...year after year.

Last year, Sprague made well over 100 million networks. In United States and Europe. For applications in automotive engine con-

trol, data processing, telecommunications, etc. Today, the broad Sprague product line includes resistor networks, resistor-capacitor networks, resistor-diode networks, and active hybrid microcircuits.

Although the electronics industry constantly changes, the world's leading maker of thick-film networks continues to be Sprague Electric Co., North Adams, Mass. 01247.

4SD 112C

**SPRAGUE**<sup>®</sup>

THE MARK OF RELIABILITY

**THE BROAD-LINE PRODUCER OF ELECTRONIC PARTS**

a subsidiary of **GK Technologies**  
Incorporated

**Memodyne Corporation,  
the data logging people, proudly introduce  
a brand new 20 column  
ALPHANUMERIC THERMAL PRINTER  
Model MAP-20S. **IN STOCK!****

- Simple 2 wire data input
- Isolated 20 mA current loop and RS232C interface
- Baud rates from 75 to 9600
- Internal/External Baud Clock
- 96 Character print set
- Print rate of 2 lines per second
- Internal self test program of all characters
- Programmable controls for:  
Text or lister printing  
Character size — normal or extended  
Baud rate
- Complete with microprocessor electronics and AC power supply
- Small size measures 4.4" W x 2.75" H
- Fits in panel 4.5" W x 2.78" H
- Weighs 4.2 lbs.

Price \$725.00 each in single quantities.  
Write for our complete 8 page color brochure.



Extended Size  
THE WORLD'S SMALLEST  
ALPHANUMERIC THERMAL  
PRINTER.

**Memodyne**  
CORPORATION

220 Reservoir Street Needham Heights, MA 02194  
(617) 444-7000 Telex: 92-2537

Circle 232 on reader service card

# What are you doing in October?

You could be learning VLSI design from September 28 — October 23. VLSI Technology, Inc. is offering an intensive 4 week course in user-designed VLSI systems. Following Mead/Conway

design principles, students will design an actual nMOS chip that will be fabricated and returned for testing after the course. This is the first such course offered by a semiconductor company. We are ready to support your follow-on needs for future training, CAD tools and fast-turnaround chip fabrication.

**For further information, contact Andy Haines,  
VLSI Marketing at (408) 727-3108.**



**VLSI Technology, Inc.**  
3101 Scott Blvd.  
Santa Clara, CA 95051  
(408) 727-3108

# PQ FOR POWER AND QUALITY

PQ\*cores, an original product from TDK, stand for Power and Quality.

They have been designed so as to pack more power into a more compact frame. In short, they stand out for their efficiency to occupied space ratio. For example, they occupy 60% less space than EC Cores.

This has been made possible through the use of advanced ferrite technology and high power materials such as H7c1.

The PQ Core is ideally suited for the manufacture of High Frequency converter Transformers.

The PQ core: A highly efficient shape ideal for your new switching power supply. \*PAT. PENDING

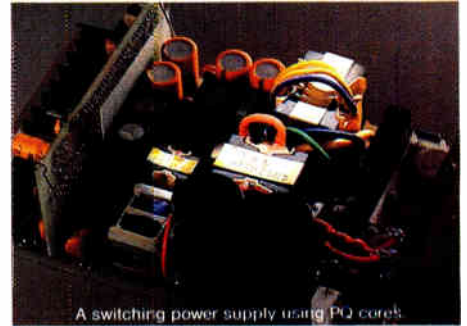

A switching power supply using PQ cores

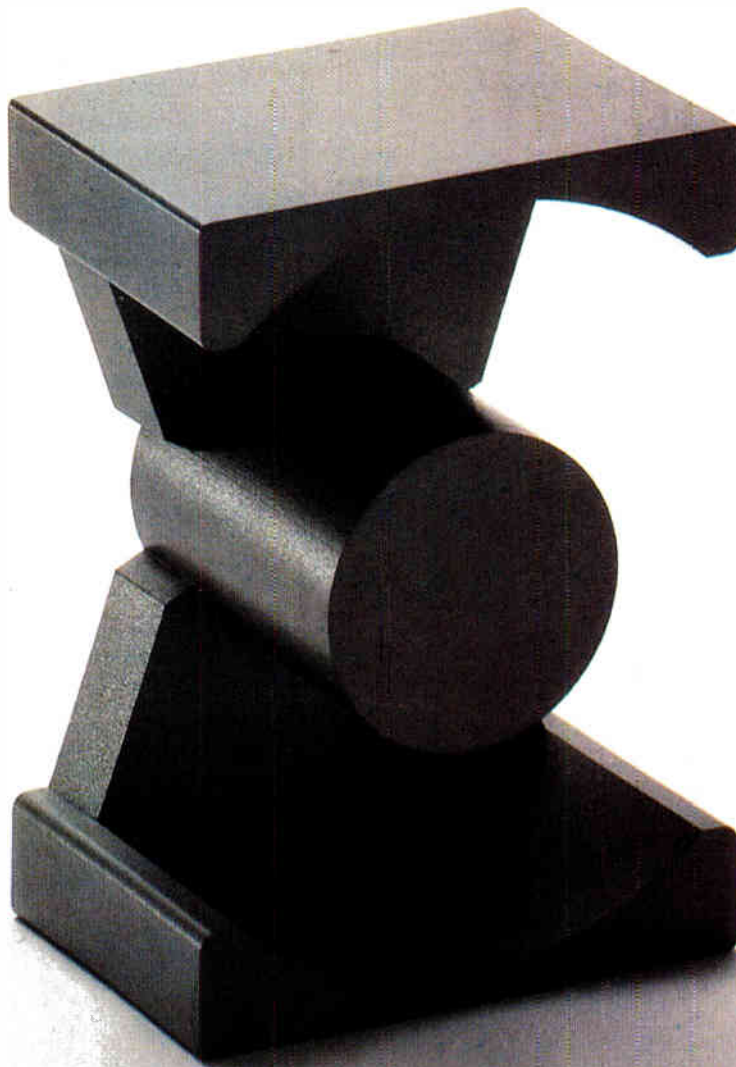

**TDK ELECTRONICS CO., LTD.** 13-1, Nihonbashi 1-chome, Chuo-ku, Tokyo 103 Japan Phone: Tokyo (03) 278-5111 Telex: J24270, J26937 (TODENKA)  
**TDK CORPORATION OF AMERICA** 4709 Golf Road, Suite 300, Skokie, Illinois 60076 U.S.A. Phone: (312) 679-8200 Telex: 9102230220 (TDK SKO)  
**LOS ANGELES BRANCH** 2041 Rosecrans Avenue, Suite 365, El Segundo, California 90245 U.S.A. Phone: (213) 644-8625, Telex: 9103487134 (TODENKA ELSD)  
**NEW YORK BRANCH** 755 Eastgate Blvd., Garden City, N.Y. 11530 U.S.A. Phone: (516) 248-5230 Telex: 144535 (TDK ELECT GRCY)  
**INDIANAPOLIS BRANCH** 5377 West, 86th Street, Indianapolis, Indiana 46268 U.S.A. Phone: (317) 872-0370 Telex: 272393 (TDKCORP IND)  
**TDK ELECTRONICS EUROPE GmbH** Christinenstrasse 25, 4030 Ratingen, F.R. Germany Phone: (02102) 4870 Telex: 8585013 (TDKD)

**MH&W INTERNATIONAL CORP.** 14 Leighton Place, Mahwah, New Jersey 07430 U.S.A. Phone: (201) 891-8800 Telex: 642421, 642422  
**MH&W INTERNATIONAL (CANADA) LTD.** 7520 Bath Road, Mississauga, Ontario L4T 1L2, CANADA Phone: (416) 676-9041 Telex: 06-983683 RFM MSGA  
**MONTREAL** 7575 Trans-Canada Highway, Suite 305, St. Laurent, Quebec H4T 1V6, CANADA Phone: (514) 331-2827 Telex: 05825732 MTL

FERRITE CORES FOR SWITCHERS  
**PQ**  
Power & Quality

# LIQUID CRYSTAL DISPLAYS

(Unit : mm)

■ For watches  
SP-04D



SP-12

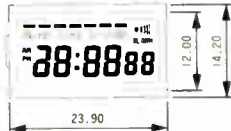

■ For calculators  
SP-203



■ For clocks and measuring instruments  
SP-201



■ For games and large instruments  
SP-101

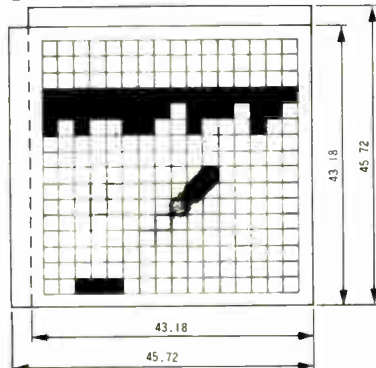

## [Characteristics]

- (1) High contrast and wide viewing angle.  
Special organic panel construction provides excellent contrast and wide viewing angle.
- (2) Color display.  
Color polarizer type and guest-host type.
- (3) Excellent multiplexing characteristics.
- (4) Wide variety of glass thickness.
- (5) Various reflector.  
Color, transfective, patterned, etc.

**DAINI SEIKOSHA CO., LTD.**

Sales Division: 31-1, 6-chome, Kameido, Koto-ku, Tokyo, 136, Japan.  
Phone: Tokyo 684-2010 Telex: 2622410 DSEIKO J  
Frankfurt Representative Office: Arabella Center 13 OG Lyoner Strasse 44-48, 6000 Frankfurt/Main 71 W. Germany. Phone: 0611-666971 -2, Telex: 413045 DSFM D  
Seiko Instruments U.S.A. Inc. 2990W. Lomita Blvd., Torrance Calif., 90505  
Phone: 213-530-3400 Telex: 9103477307

Circle 234 on reader service card

## IN THE MARKET FOR FERRITES?

✓ Check out **PERMAG** your one-stop shopping mart for sophisticated magnetic materials

"In the Magnetic Field, PERMAG is No. 1"

ALL ACROSS THE COUNTRY



ATLANTA • BOSTON  
CHICAGO • DALLAS  
LOS ANGELES  
MINNEAPOLIS/ST. PAUL  
NEW YORK • SAN FRANCISCO  
TOLEDO

Consult Yellow Pages for the PERMAG near you.

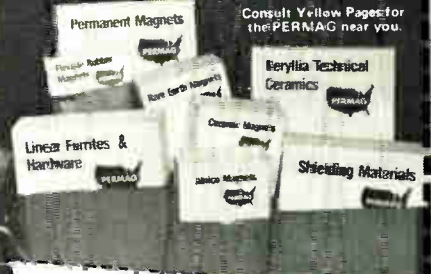

PERMAG CORP., 400 Karin Lane, Hicksville, N.Y. 11801  
Send me your catalog.

Name \_\_\_\_\_  
Address \_\_\_\_\_  
City \_\_\_\_\_  
State \_\_\_\_\_ Zip \_\_\_\_\_

## Tool kit or tool case, isn't it time you owned a Jensen?

A Jensen tool kit's combination of functional case, exclusive pallet design, and proven selection of professional-quality tools gets work done faster, more efficiently. Its executive appearance gives you pride in your work; gives customers confidence in your service. Assures you of front-door access to the equipment you are charged to maintain. Choose from more than 50 standard models or let us custom-design a kit to match your needs. Write or call for more information or a free catalog.



**JENSEN TOOLS INC.**

1230 SOUTH PRIEST DRIVE TEMPE, ARIZONA 85281  
(602) 968-6231

Circle 121 on reader service card

# The perfect system for finding fault.

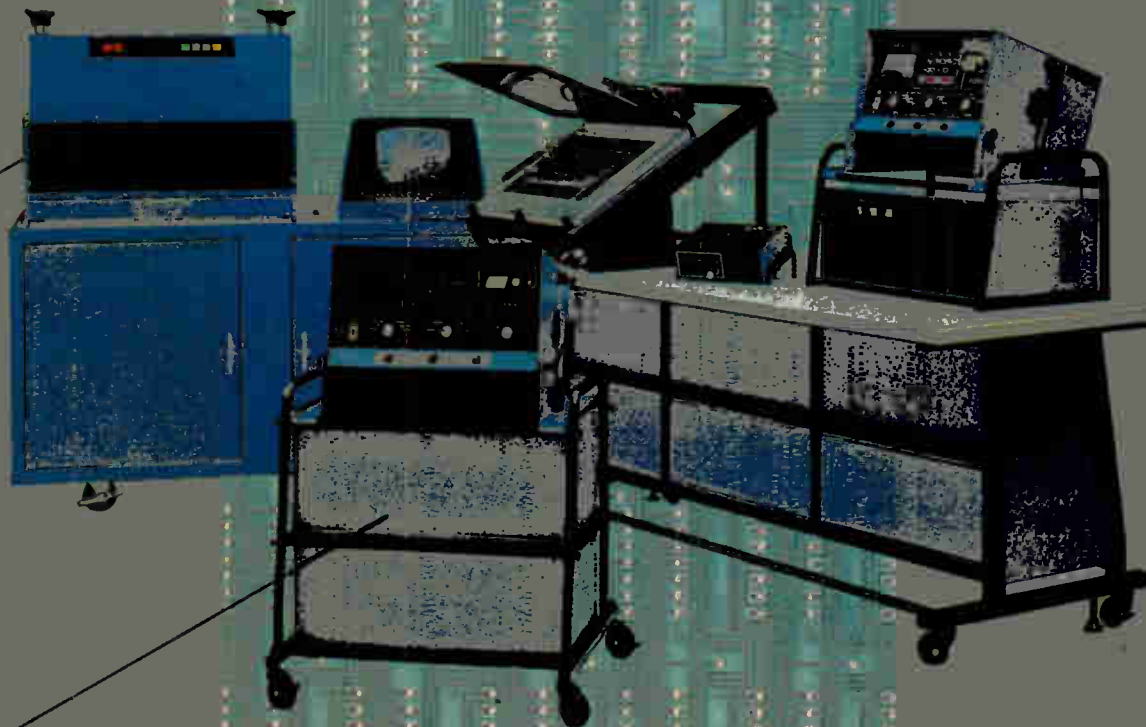

When you use an Everett/Charles Series 50 bare board tester with Everett/Charles test fixturing, you can be sure only 100% good boards get into your production line. That's because we make everything from the electronics to the mechanics to produce equipment that is fully modular and totally adaptable.

**Test up to 8,000 points.**  
Simple, reliable test fixturing, the Series 32 is

ideally suited for use with the Series 50. Vacuum-actuated and flexible, the Series 50/32 Test System is easily justifiable for the majority of bare board applications.

**Test up to 24,576 points.**  
A combination of the field-proven Series 50 and the Series 10 pneumatically-actuated fixture, the

50/10 Test System is capable of testing up to 24,576 points in less than 12 seconds. And, it can do it with test programs learned from a known good board.

If you're looking for a way to find shorts and opens in bare printed circuit boards we have a system no one can fault. The Everett/Charles Series 50 Test System.

Everett/Charles Test Equipment Inc. 2887 N. Towne Avenue, Pomona, CA 91767 (714) 621-9311  
TWX 910-581-3838  
Everett/Charles International, Inc.  
USA (714) 625-1596, TWX 910-5811462.  
United Kingdom, Tel. (0462) 31341, Tlx 626055.  
Germany, Tel. (06821) 21067, Tlx 4188731.  
Japan Tel. (045) 242-2556, Tlx 03823155

**EC**<sup>TM</sup>  
Everett/Charles  
Test Equipment, Inc.

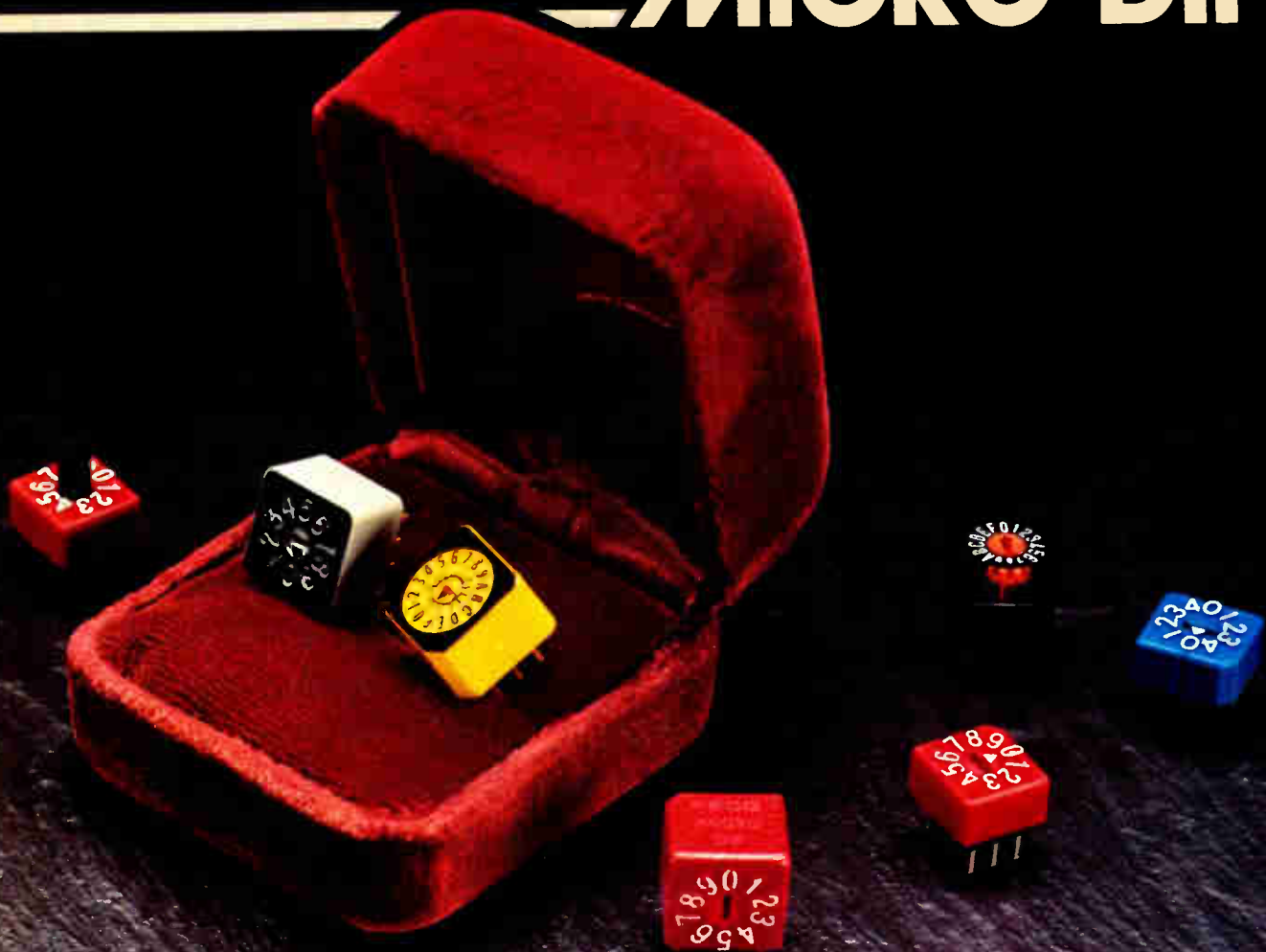

## GREAT THINGS COME IN SMALL PACKAGES

Save space in your design with MICRO-DIP® 16 and 10 position pre-coded DIP switches. In one neat little package, EECO's MICRO-DIP can meet all your design parameters. Used for setting limits or addressing, MICRO-DIP is micro-sized to save valuable P.C. board space. A coded output from a digital setting simplifies user interface.

### EECO RELIABILITY IN A SWITCH AS SMALL AS .396" x .376"

Reliability that's achieved by EECO's exclusive gold contact system, which assures low contact resistance, and a bottom seal on some models, to protect against flux migration. Compact switching that's available in one- or two-pole, 10- or 16-position models, each versatile enough to meet your design needs.

And MICRO-DIP offers a wide variety of switching combinations. For example, two 16-position (hexadecimal) MICRO-DIP switches mounted side-by-side in a 16-pin socket offer 256 bits of information, or enough for an 8-bit word.

### MICRO-DIP MAKES IT SIMPLE

Coordinating with microprocessor technology, MICRO-DIPs are simple to design in, and simple to adjust in the field, even by non-technical users. To make adjustments even easier, EECO's BCD right-angle model allows mounting on the card edge to provide access without pulling the card.

MICRO-DIP can be mounted directly to P.C. boards or inserted into standard DIP sockets, and its small size and low profile make it ideal for high density packaging requirements. Available in screwdriver or extended shaft adjustable models, this neat little switch can be actuated in either direction.

To make designing maximum function in minimum area simple, choose EECO's MICRO-DIP switch. For detailed information, write EECO Incorporated, P.O. Box 659, 1601 E. Chestnut Ave., Santa Ana, CA 92701, or call 714/835-6000.

**EECO**  
Incorporated



Microcomputers &amp; systems

## C-MOS 8048 has extras

---

Microcomputer powers up  
as standard 8048; register  
controls optional features

---

The ranks of complementary-MOS versions of popular microprocessors and microcomputers using n-channel MOS are growing steadily. The newest circuit is National Semiconductor Corp.'s C-MOS version of the 8048. This 8-bit microprocessor, originated by Intel in n-MOS, uses National's 5-v-only double-level polysilicon C-MOS process—the same as in its NSC800 microprocessor that combines the Z80 instruction set with the 8080 multiplexed bus structure.

The chip is offered in two versions: the 80C48 is identical to the n-MOS

version but is cast in C-MOS. The 6-MHz 80CX48, however, goes beyond its n-MOS counterpart by having a special idle mode that lets it stand by in a low-power state and retain data in its 64-byte internal random-access memory.

**Option activation.** The characteristics that differentiate it from the 80C48, besides the pin-activated low-power idle state, are each activated by a bit in the special feature-control register (FCR). Upon powering up, the device configures itself as a standard 8048. However, when one of the previously undefined bits in the FCR is toggled, the 80CX48's special attributes become available until it is reset.

The part is put to sleep when a pin—the power-supply pin on the original 8048—is brought low. When shut down, the 80CX48's supply current is lowered from 5 mA to 20  $\mu$ A. This lowering compares with a reduction of 10 mA to 1 mA for a Nippon Electric Co. version of the chip [*Electronics*, July 14, p. 179]. The 80CX48 cannot, however, be

put to sleep by a software instruction as NEC's version can.

Other features in the device involve the timer-counter built into the 8048. The CX version adds a programmable (for eight different decimal-oriented values) prescaling of the clock signal that is supplied to the timer-counter, in contrast to the constant divide-by-32 prescaler of the 8048. Also, the output of the prescaler may be gated, under control of an FCR bit, with an external signal supplied to a special pin. In addition, a new register has been added that will automatically load the timer-counter when it overflows, permitting true *modulo-n* counting in hardware.

National's continue option allows the 80CX48 to ignore the logic level on the idle input. When set, another bit in the FCR keeps the levels of the input/output lines constant during the idle mode, rather than allowing them to enter the high-impedance mode.

The part is also designed to work with National's other P<sup>2</sup>C-MOS support chips like the NSC810 RAM, I/O, and timer chip, and the NSC830 read-only memory and I/O chip. Intel also is said to be working on a C-MOS version of the 8048 as one of the initial offerings in its drive to develop this low-power process.

The 80C48 will be available for volume deliveries in October at a price of \$15. The 80CX48 will arrive in November for \$16. Both prices are for 1,000-piece quantities.

National Semiconductor, 2900 Semiconductor Dr., Santa Clara, Calif. 05051 [371]

---

### Multimodule board connects to IEEE-488 instruments

The iSBX 488 General-Purpose Interface Bus multimodule board provides a standard interface from any Intel iSBC Multibus board equipped with an iSBX connector to over 600 instruments and computer peripherals that use the IEEE-488 GPIB standard. The module may be configured as a talker, talker and listener, or bus controller. It employs Intel's very

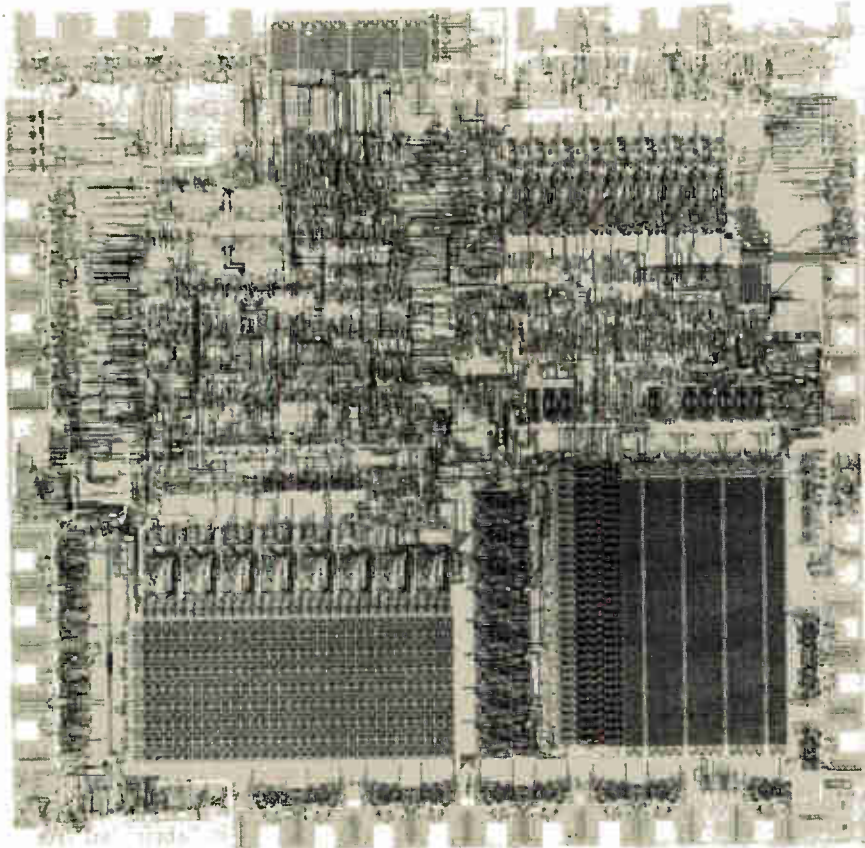

## Stepper Motors can be smarter than ever!

Because the new CY512 Intelligent Positioning Stepper Motor Controller, the only second generation stepper controller, is now available. Based on our popular CY500, the new CY512 provides:

- Faster stepping (8K steps/second at 11 MHz).
- Increased program storage capability.
- Improved ramping and rate resolution.
- Position and status readout.
- Automatic direction determination, just specify the target location (absolute mode).
- Absolute and relative position commands.
- ASCII or binary operation (including readout).
- 25 Powerful commands (all-new Jump, Loop and Delay).

Plus all the standard CY500 features. The CY512 is off-the-shelf at only \$145/single (\$75/100's). For full details contact:



**Cybernetic  
Micro  
Systems**

445-203 So. San  
Antonio Road, Los Altos,  
CA 94022, (415) 949-0666

Circle 238 on reader service card

## Say It In Sign Language There's No Better Way

**Ferranti-Packard alphanumeric display modules are ideal for visual communications. They're silent, easy-to-read modules you can count on for fast accurate information.**

And, there are good reasons for using Ferranti-Packard. These versatile electromagnetic modules are economical to apply and operate. Power consumption is negligible. Remanent magnetism provides inherent memory so power is only required to change the display - not retain it.

The rotating fluorescent discs are the only moving parts - and are rated for over 100 million operations. Viewing is by reflecting light - so the visibility increases with the ambient light level. This makes them ideal in brightly lit conditions, indoors or out.

Modules are available in a range of colors and character sizes, from 3 inches (70 mm) to 18 inches (450 mm). They are ideal for industrial displays, digital readouts, advertising displays, score boards, bulletin boards, paging systems and traffic control signs.

**When clear displays count, specify Ferranti-Packard.**



**Ferranti-Packard Electronics Ltd.**



6030 Ambler Drive, Mississauga  
Ontario, Canada L4W 2P1  
Telephone: (416) 624-3020  
Telex: 06-961437

## New products

large-scale integrated-circuit technology to incorporate the 8291A GPIB talker/listener, 8292 GPIB controller, and two 8293 GPIB transceiver devices on a 3.7-by-2.85-in. printed-circuit board.

With the board configured as a controller, users of single-board computers can program and control up to 15 instruments over a standard parallel bus. The multimodule board can be used on such Intel 8-bit processor boards as the iSBC 80/10B board (8080), 80/24 board (8085), and 88/40 measurement and control computer (8088); and on 16-bit processors such as the 86/05 board (8-MHz 8086).

The iSBX 488 module operates at programmable data rates of up to 50 kilobytes/s and implements complete sets of GPIB functions instead of only subsets. It supports direct-memory-access data transfers of up to 300 kilobytes. It requires 600 mA from a +5-v power supply.

Available immediately, the iSBX 488 multimodule board sells for \$650 in single-unit quantities and \$598 in quantities of 10. The iSBC 988 0.5-meter companion cable that supports the IEEE-488 standard is available for \$75.

Intel Corp., 5200 N. E. Elam Young Parkway, Hillsboro, Ore. 97123. Phone (503) 640-7147 [373]

## IC gives 68000 processors memory management

The MC68451 single-chip memory management unit allows MC68000 16-bit microprocessor users to segment 16 megabytes of memory 32 ways. Each of the unit's 32 segments can cover a range from a minimum of 256 bytes to the full 16-megabyte addressing space of the 68000. The device uses bit-replacement techniques, as opposed to adders, for translation of the microprocessor's logical addresses into physical addresses. Direct address translation keeps the chip size to a minimum and enhances the memory management unit's speed.

The MC68451 is fabricated from

# MORROW DESIGNS

NOW, 26 Mbytes  
\$4,495

## Leading edge technology in hard disk systems.

Complete systems. Morrow Designs hard disk subsystems are delivered complete with hard disk, controller, cabinet, power supply, fan, cables and CP/M<sup>\*</sup> 2.2 operating system.

**Widest range.** Morrow Designs offers the widest range of hard disk systems available from a single supplier. 5¼," 8," 14." Five to over 100 megabytes of formatted hard disk storage. \$2,995 to \$17,980. Cost effective systems that work. And keep working.

**S-100 and more.** Morrow Designs hard disk systems are designed for use with the CP/M operating system. Available software packages allow our systems to run on any IEEE696/S-100 Standard system with no hardware modification. Plus, Cromemco<sup>\*\*\*</sup>, North Star<sup>\*\*</sup>, Vector Graphics, Godbout, Dynabyte, Exidy<sup>\*\*\*\*</sup>, IMSAI, Micro-mation, Processor Technology and California Computer Systems.

**Reliable systems.** Morrow Designs is committed to hard disk system reliability. Not simply with a 90-day warranty, but with a money back guarantee. If our system fails to perform to specification, send it back. We'll send back your money.

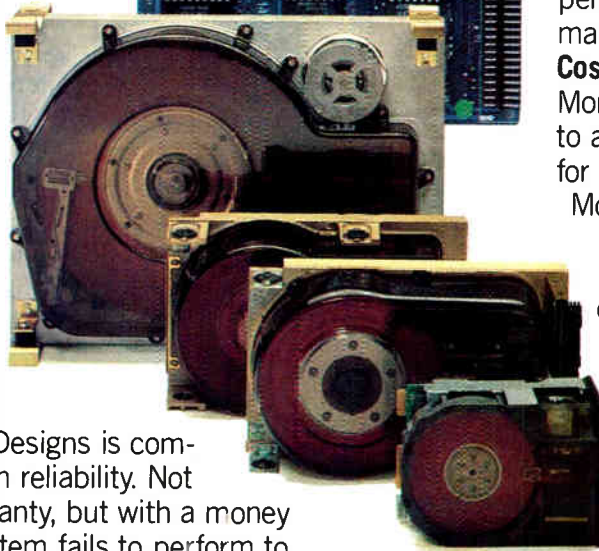
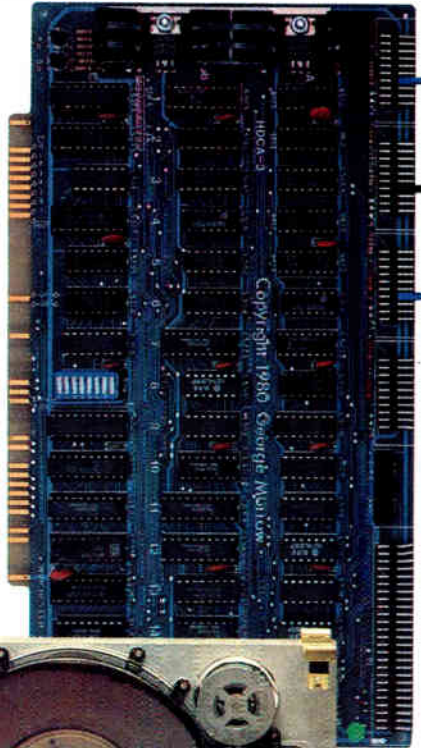

**Experience.** As of April, 1981, there were over fifteen hundred Morrow Designs hard disk systems successfully installed. In fact, over 200 independent systems integrators now use our hard disks to solve their mass storage problems.

**Performance answers.** Morrow Designs hard disk systems have been benchmarked against all other systems. None is faster under CP/M. Morrow Designs hard disks operate at 10 times the speed of a floppy disk drive. Transfer rates range from 590,000 bytes to 900,000 bytes per second. That kind of performance can become addictive.

**Cost effective answers.** Compare Morrow prices and performance to anything presently available for S-100 systems. You'll find Morrow's price/megabyte/performance ratio to be unmatched. Leadership in disk systems technology earned us leadership in price/performance. And that may have earned us a call from you. Circle the Reader Service Number for our full line data sheets. Can't wait? Call us at (415)

524-2101. And yes, OEM quantity prices are available. **LOOK TO MORROW FOR ANSWERS.**

## MORROW DESIGNS

5221 Central Avenue, Richmond, CA 94804  
(415) 524-2101



\*CP/M is a trademark of Digital Research.

\*\*Northstar is a trademark of North Star Computers, Inc.

\*\*\*Cromemco is a trademark of Cromemco, Inc.

\*\*\*\*Exidy is a trademark of Exidy Corporation.

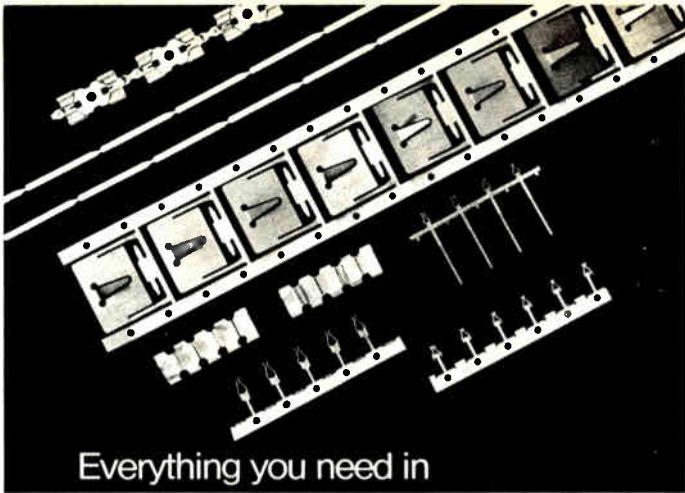

## Everything you need in Circuit Board Terminals

- Stamped pins and receptacles in quantity in strips, on reels or loose.
- Your designs, competitive types, or our more cost-effective designs.
- In-house high-speed presses assure quality and reliable delivery at lowest possible cost.

### PLUS

- Universal's automatic pin and terminal insertion machines and systems custom tooled to install them in your boards at rates up to 10,000/hour.

Call or write:



Universal Instruments Corporation  
Box 825, Binghamton, New York 13902  
Tel. 607/772/7522 TWX: 510/252/1990

Subsidiary of **DOVER CORPORATION**

Circle 240 on reader service card

## WATERPROOF BOOT SEALS MULTIPLE POSITION STRIP SWITCH ...plus complete Interlock Protection



### Specify CAPITOL S-Switches with Waterproof Boot Seals.

- Rugged • Long Life
- Millions of cycles
- Custom designed contact assembly includes Form A, B, C, D in combination or alone
- Positive mechanical Lock Out—only one button can be engaged

- at any time
- From 2 to 20 button/strip
- Lightweight anodized aluminum frame

Write or phone  
**CAPITOL today.**  
Switching Quality  
from Quality  
Switching from  
**CAPITOL...**

The Capitol Machine  
and Switch Company  
87 Newtown Road  
Danbury, CT 06810  
203/744-3300

**Capitol**  
SWITCH

See us at Wescon Booth #414

240 Circle 123 on reader service card

## New products



Motorola's H-MOS Level I technology and has 3.5- $\mu$ m line widths. It has a speed of 125 ns. The unit goes for \$215 in single quantities, \$150 in lots of 100, and \$120 in orders of 500. Production volumes will be available later in 1981.

Motorola Inc., 3501 Ed Bluestein Blvd., Austin, Texas 78721. Phone (512) 928-6369 [374]

## Multibus debugger gives users real-time displays of addresses

The 1506 Multibus display computer board is a debugging tool for Multibus users and provides both static and dynamic displays of program execution. Used to monitor addresses, data interrupts, and control signals, it automatically holds and displays the last bus cycle executed. Prior selection of memory read, write or input/output read or write results in an indication of the address, interrupt, or last data value for the last cycle executed by the bus selected.

The 1506 gives the Multibus user real-time memory and I/O mapping capability. Connecting the low- and high-address connectors to the X-Y inputs of a standard oscilloscope provides a real-time display of the upper and lower I/O addresses.

In addition, the 1506 includes leading- or trailing-edge selection, 16-bit data display, 16- or 20-bit address display, power-up indication for bus voltages, and a transfer-acknowledge switch for generating an artificial transfer-and-acknowledge signal.

The 1506 costs \$495 each, with large-quantity discounts available. Delivery is from stock.

LeCroy Research Systems Corp., 700 So. Main St., Spring Valley, N.Y. 10977. Phone (914) 425-2000 [375]

Electronics/August 25, 1981

# WESTERN DIGITAL CORPORATION

## Look whos turning the disk controller market upside down.



It's no secret. Western Digital has been building a reputation for innovative disk controllers for years. It started back in 1977 with the world's first LSI floppy disk controller. And now includes the first Winchester disk controller, too.

What's more, today, Western Digital's 7-member family of floppy disk controllers is *the* industry standard. Giving you nothing short of the broadest selection of controllers in the business.

And only Western Digital offers the vital support chips for both data separation and DMA control. Of course, our pioneering Winchester controller effort is equally impressive. Either as a fully-assembled board or money-saving chip set. And our extensive on-line design support services are yet another plus.

Better still, more breakthroughs are on the way. So contact the only disk controller maker holding all the chips.

Western Digital.

We'll stand on our head to give you better solutions.

Making the leading edge work for you.

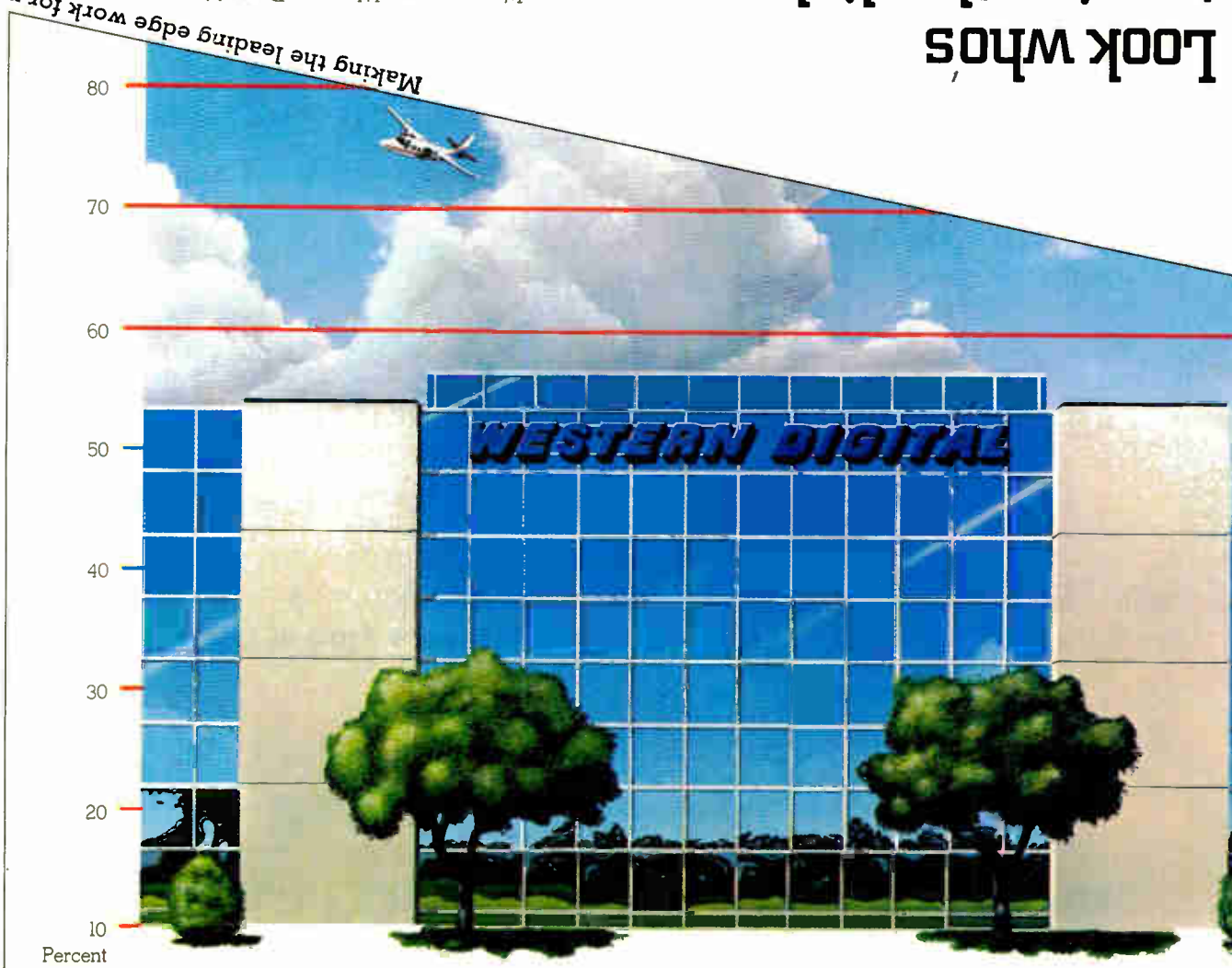

Legend: Western Digital's share of market for floppy/Winchester controllers just keeps building.

# The NEW Electronics Buyers' Guide is now available!

**The 1981 EBG is only a postage stamp away!** Completely new listings of catalogs, new phone numbers, new addresses, new manufacturers, sales reps, and distributors! The total market in a book—four directories in one!

**1.**

Directory of products. Over 4,000 products, over 5,000 manufacturers.

**2.**

Directory of catalogs. Includes six post-paid catalog inquiry cards for 10-second ordering.

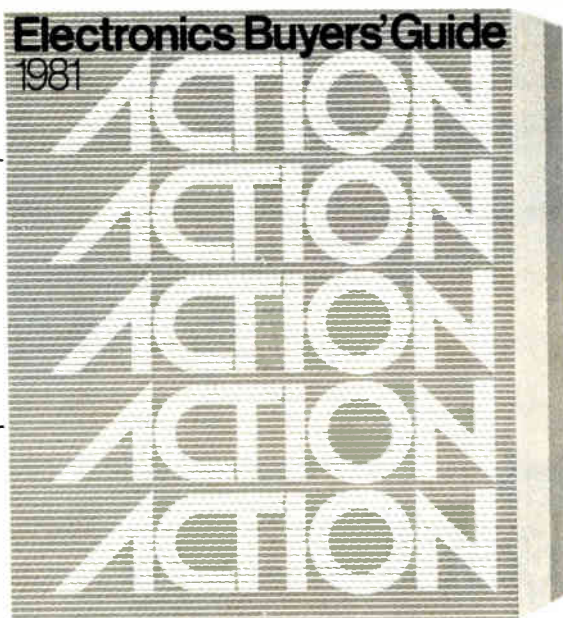

**3.**

Directory of manufacturers. Local sales offices, reps, and distributors, with phone numbers. Number of employees and engineers, dollar volume, name of company contact.

**4.**

Directory of trade names of products and their manufacturers. You can trace a product by its trade name only.

**The only book of its  
kind in the field.**

**If you haven't got it,  
you're not in the market.**

**To insure prompt delivery  
enclose your check with the  
coupon now.**

Yes, please send me \_\_\_\_\_ copies of 1980 EBG.

I've enclosed \$30 per copy delivered in USA or Canada. Address: EBG, 1221 Avenue of the Americas, New York, N.Y. 10020.

I've enclosed \$52 for air delivery elsewhere. Address: EBG, Shoppenhangers Road, Maidenhead, Berkshire S16, 2Q1 England.

Name \_\_\_\_\_

Company \_\_\_\_\_

Street \_\_\_\_\_

City \_\_\_\_\_

State \_\_\_\_\_ Zip \_\_\_\_\_ Country \_\_\_\_\_



**Socket Connectors**  
IDS Series—Optional strain relief.



**Low Profile Headers**  
IDH/LP Series—Low profile for high density packaging.



**Edge Card Connectors**  
IDE Series—Three mounting options available.



**Transition Connectors**  
IDT Series—Cover latch swivels for easy cable insertion.



**NEW "K" series Sockets and Headers**  
MIL-C-83503 compatible, plus positive mating/keying options that can't go wrong.



**"D" Connectors**  
IDD Series—9, 15, 25 and 37 pin and socket.



**Standard Headers**  
IDH Series—Straight or right angle, ejector/latches available.



**Cable plugs**  
IDP Series—Tapered pins for easy insertion.

# 90% ain't bad

**Yes, the 10% that most people don't use is missing. But everything else you need in IDC Flat Cable Connectors is available from RN, off-the-shelf.**

When we say RN has a full line of IDC Flat Cable interconnection components, we want to tell it like it is. We are delivering 90% of everything available in IDC connectors today. And, chances are, you'll never have need for the 10% that's missing. Most people don't.

**Check into the many advantages of the complete RN flat cable system:**

- Fewer pieces for faster assembly, reduced inventory.
- Highly competitive pricing—in all quantities.
- Assured reliability and compatibility of cable and connectors—RN supplies both.

## 100% gas-tight reliability

is assured by the proven RN "tight-grip" contacts. Total normal force is applied directly against cable. No chance for gas penetration or corrosive build-up even in hostile environments.

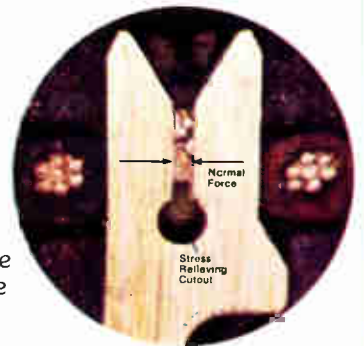

Microphoto



**WRITE TODAY** for the new catalog featuring the full line of RN IDC flat cable connectors

Circle 155 on reader service card

# **RN** EUROPE, S.A.

ROBINSON-NUGENT EUROPE, S.A./Rue Paul Lanters, 38A - B 1050 Bruxelles, Belgium/Phone: (02) 640-79-40/Telex: 62432 RN-EUR

World Radio History

In celebration of the 50th anniversary of *Electronics Magazine* . . .

you are invited on an extraordinary journey exploring where electronics has been and where we are going . . .

# AN AGE OF INNOVATION

## The World of Electronics 1930-2000

by the Editors of *Electronics*

274 pages, 300 illustrations including many in full color, hardcover, \$18.50

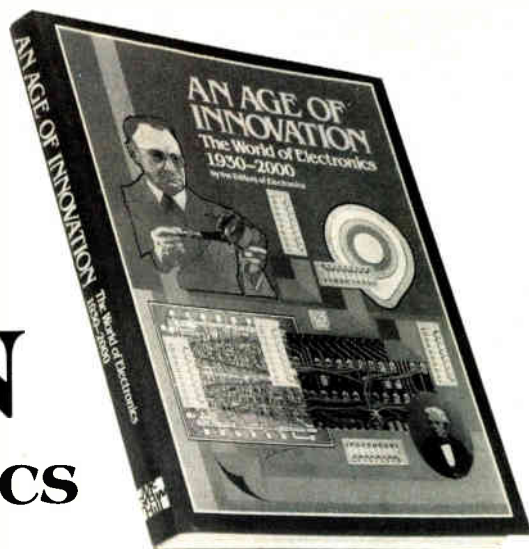

Never before has the history of electronics been brought together in such an exhilarating, comprehensible look at the advances that have shaped our world.

Painstakingly researched and written, AN AGE OF INNOVATION brings you up close to the discoverers who set the pace for an age . . . the classic circuits that marked turning points in the development of electronic systems . . . and the major breakthroughs that brought us to where we stand today.

### Discover our legacy of achievement as you . . .

- witness the 1930s' great advances in fm and television . . . the invention of negative feedback . . . and the patenting of the semiconductor for amplification
- watch the tide of progress as World War II leads to outstanding advances, including radar, loran, computers, and guided missiles. See how at the war's close commercial television, stereo and tape recording mark the beginning of the all-pervasive impact of electronics
- share the 1960s' excitement of men landing on the moon, thanks in part to semiconductors and the expansion of computer power to an unprecedented degree
- acquire new perspective on the 1970s' two major events that will forever change the way we live—the end of cheap energy and the birth of the microcomputer

### Then look ahead to . . .

- future electronics systems that will transform everyday life
- the transcending of present technology limits—and the path circuit development will take into the new century
- the electronics needs—and careers—that will be the hallmark of our changing environment
- and much more!

AN AGE OF INNOVATION gives you an unforgettable overview of both the development and future of electronics. Everything from the individuals whose foresight and daring led to great advances . . . to the origin of specific technological breakthroughs you use in your own work and home . . . to the challenges and discoveries we will face tomorrow.

AN AGE OF INNOVATION is *Electronics'* celebration not only of our own fifty years of publishing excellence, but also of a half-century of electronics achievement. Let us share it with you!

Available only through *Electronics*. Not sold in any bookstore or through the McGraw-Hill Book Company. To secure your copy now, use the convenient coupon below.

Electronics Magazine Books  
P.O. Box 669, Hightstown, NJ 08520  
Tel. 609/448-1700, ext. 5494



Send me \_\_\_\_\_ copies of *An Age of Innovation* @ \$18.50 plus applicable sales tax. McGraw-Hill pays regular shipping and handling charges on pre-paid orders.

Quantity discounts available. Ten-day money-back guarantee applies on all books.

Payment enclosed     Bill firm     Bill me  
Charge to my credit card:     American Express  
 Diners Club     Visa     MasterCard

Acct. No. \_\_\_\_\_ Date Exp. \_\_\_\_\_

On MasterCard only,  
first numbers above name \_\_\_\_\_

Name \_\_\_\_\_

Company \_\_\_\_\_

Street \_\_\_\_\_

City \_\_\_\_\_ State \_\_\_\_\_ Zip \_\_\_\_\_

Signature \_\_\_\_\_

EL 1



Stanley has a colorful and super-bright liquid crystal display with your name on it.



Based on technology derived from Guest-Host type LCDs, Stanley's new displays outshine all existing types. The colors have to be seen to be believed: clear blue, vivid green, bright yellow, vibrant red, and black and white combinations. Or, for even more variety in color, black and white elements with color filter patterns.

The Stanley LCD is neither influenced by variation in temperature nor fluctuation in voltage.

The brilliant color, high contrast and wide angle of view are all engineered-in to stay.

You specify the design and the function, we deliver. . . .

transmissive, reflective or transreflective type. . . and meet your need to the letter.

For more information, write to Stanley Electric Co. at the address below:

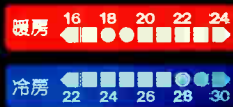

Color LCD Samples

# Stanley shines.

## In bold bright colors, wide angles, eye-easy contrast and any pattern you want.



**Stanley now for shine and rich variety in equipment applications:**

Automobile equipment, aircraft equipment, consumer electric appliances, audio equipment, digital clocks, multi-testers, optical

instruments, calculators, computer terminals, automatic control machinery, emergency equipment and other uses.



**STANLEY  
ELECTRIC CO., LTD.**

LCD Sales Section:  
2-9-13, Nakameguro, Meguro-ku, Tokyo 153, Japan  
Tel. Tokyo 03-710-2531 Telex. 2466623



# UNIVERSAL



## Bendix Tri-Start

For all your applications,  
from general-duty to  
high-performance

Bendix-designed and DOD-preferred, our Series III Tri-Start Connectors meet higher performance levels than all other series in MIL-C-38999, including Series IV. This performance leader meets the challenge of new technology through its ability to:

- withstand vibration (60G peak at temperatures up to 200°C)
- withstand humidity after temperature life
- suppress electrolytic erosion
- provide superior EMI shielding
- resist corrosion (by withstanding 500-hour salt spray)

A new breed of connector capability, Tri-Start eliminates lock-wiring, couples in a 360° turn of the coupling nut, and intermounts with standard MS connectors.

Rugged yet precise, Bendix Tri-Start is available in a variety of shell styles and service classes, including class K firewall.

Insert arrangements cover contact sizes 12 through 22D, in a variety of types.

For general-duty to high-performance applications, call 607-563-5323 or write The Bendix Corporation, Electrical Components Division, Sidney, NY 13838

**We speak connectors.**



## New products/materials

**Xersin flux materials** are based on definably pure chemicals rather than natural rosin. The residues of Xersin are less corrosive than rosin fluxes and in most cases need not be removed from a printed-circuit board after the soldering operation. Also, the fumes given off during soldering are reduced and contain none of the aldehydes found in rosin. Multicore has developed a range of products using the Xersin technology, among them wire-cored solders, foaming fluxes, a combination preservative and flux, protection coatings, solder creams, solder wick, and a material that combines the functions of an etch resist, flux, and preservative. Xersin is priced comparably with standard rosin material, with delivery from stock.

Multicore Solders, Cantiague Rock Road, Westbury, N. Y. 11590. Phone (516) 334-7997 [476]

**The Vynastat antistatic and antifatigue mat** has a grid construction formed by heat-welding extruded strips of conductive polyvinyl chloride and has an embossed tread on top and bottom to prevent slipping. The resistivity from the mat to the end of the grounding tape is  $1.9 \times 10^6 \Omega$ . The mat is  $\frac{3}{8}$  in. thick and 2 or 3 ft wide by 33 ft long, or mats may be cut to size. The 2-ft-wide roll sells for \$4.82; delivery is from stock.

Tepromark International Inc., 206 Mosher Ave., Woodmere, N. Y. 11598. Phone (516) 569-4533 [477]

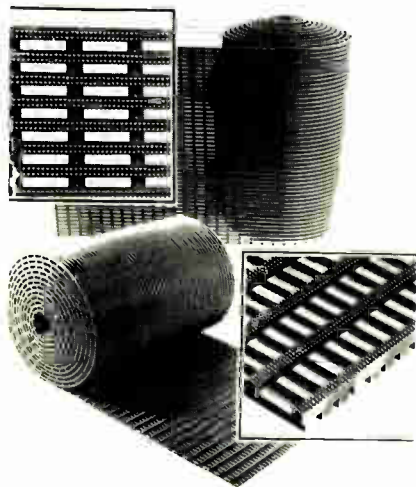

**Rubalit substrates**, an alumina compound developed by Rosenthal Technik, are currently offered in four compositions. All are suitable for die-stamping and for pressing or laser cutting. Rubalit 708 contains 96% alumina and is intended for thick-film substances and potentiometers. Rubalit 710, which contains 99.6% alumina, was developed for substances in thin-film and microwave applications, with precisely defined, smooth surfaces and with a closely controlled dielectric constant. Rubalit 711 is an opaque ceramic that contains 92% alumina and is of use in lids and special substrate applications. And Rubalit 717 with 99.5% alumina is offered as metalized substrates in thicknesses of 0.27 to 0.635 mm. Pricing averages \$0.03/in.<sup>2</sup>, with delivery from stock.

Rosenthal Technik North America Inc., 100 Niantic Ave., Providence, R. I. 02907. Phone (401) 943-2200 [478]

**Tra-Bond F 120** is a two-part medium-viscosity epoxy adhesive and cures quickly at room temperature. Fully cured, it is nearly transparent, shrinks minimally, has mechanical and electrical insulation properties, and develops strong bonds to many materials used in optic and fiber-optic products. Tra-Bond may be bonded to Pifax and other glass- or plastic-core cables and to various types of single- or multi-channel plastic or metal terminations and connectors. It is available for immediate delivery in a range of premeasured two-component Bipax packages. In quantities of 1 to 24, a 2-g packet sells for \$1.70 and a 24-g package for \$3.30.

Tra-Con Inc., Resin Systems Division, 55 North Street, Medford, Mass. 02155. Phone (617) 391-5550 [479]

**Dow Corning 1-2577** elastoplastic silicone conformal coating is a clear, tough, glossy resin for protecting circuitry where maximum reliability is required, as in automotive electronics, fire alarms, process controls, energy control modules, instruments, and computer modules. It can be cured at room temperature, but the cure rates can be accelerated. The

coating has good dielectric properties at both high and low frequencies and better thermal and mechanical shock resistance than previous silicone resins. It is serviceable from  $-65^\circ$  to  $+200^\circ\text{C}$ . In 440-lb drums, the resin costs \$9/lb; delivery is from stock.

Dow Corning, Midland, Mich. 48640. Phone (517) 496-4510 [480]

**A proprietary copper** conductive transfer film is useful in low-voltage switch and circuitry applications. The metalized polyester film is available in roll form and suitable for graphic, thermoplastic, and thermoset materials. It meets the demand for low-cost touch-switch technology in the microelectronics used to operate computers, consumer appliances, and elevators. It replaces the slower, more costly methods of silk-screening a conductive ink onto a film surface or chemically etching a copper foil laminate. The film is hot-stamped just as a conventional foil would be on existing equipment with a rubber or metal die. Formulations are available for adhesion to a range of thermoset materials. Prices average \$0.30/ft<sup>2</sup>, with delivery taking up to four weeks on stock items. Custom orders take longer, depending on requirements.

Web Technologies Inc., 27 Main St., Oakville, Conn. 06779. Phone (203) 274-0388 [411]

**Broadband infrared AR coatings** come in thicknesses of 8 to 11.5  $\mu\text{m}$  on materials of germanium or zinc selenide, 3 to 5  $\mu\text{m}$  on germanium or silicon, and 3.5 to 12  $\mu\text{m}$  on germanium. Transmission exceeds 98% average with a minimum of 96% when coated on two sides of a 1-mm-thick substrate. The coatings can operate over a temperature range of  $-150^\circ$  to  $+350^\circ\text{C}$  while being virtually insoluble in water, acetone, alcohol, and mild detergents. Their average reflectance is less than 0.5% per surface. Pricing is based on length and thickness with original-equipment manufacturer discounts available. Delivery takes four to six weeks.

Broomer Research Corp., 23 Sheer Plaza, Plainview, N. Y. 11803. Phone (516) 249-1544 [412]

RANDOM ACCESS AUDIO . . .



THE SEARCH 400 FROM TRIPLE I

A compact, self-contained system providing fast random access to as many as 400 locations from a single C-120 cassette. The Phi-Deck cassette transport allows access speeds to average 200 ips. Available in either mono or stereo formats. Excellent accuracy and repeatability. Manual or Microprocessor controllable. Ideal for:

- Computer Aided Instruction
- Multi-Language Presentations
- Emergency Announcements
- Information Centers
- Spot Commericals
- Advertising Displays



**Triple I**  
Incorporated

4605 North Stiles  
P.O. Box 18209  
Oklahoma City, OK 73154  
(405) 521-9000 TWX: 910-831-3286

**HIGH-SPEED CASSETTE DUPLICATOR FOR USE WITH SEARCH 400**

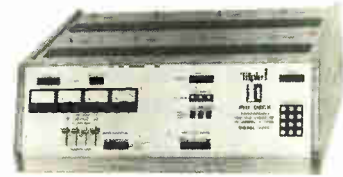

The model 8000 duplicator is designed to produce multiple cassette copies for use in the Search 400 system. The unit contains a master cassette unit and seven slaves. The unit can also make cassette copies from a reel-to-reel master.

Circle 248 on reader service card



**SKAN-A-MATIC SELLS SEXY SKANNERS**

Coaxial fiber optic design puts the phototransistor in the tip away from lamp or LED heat for negligible drift.

Response time from skanner to amplifier output in 5 microseconds.

Our S 35203 coaxial fiber optic skanner detects a wide range of colors including red, blue, green, yellow and orange. Uses optical filters.

And there's more. Widest selection of subminiature photoelectric sensors ever offered. Controls and automation systems to match. 3 day shipments.



SEND FOR MORE INFORMATION

**SKAN-A-MATIC**  
CORP.

P.O. BOX 5, ELBRIDGE, N.Y. 13060 / PHONE (315) 689-3961

See us at Booth 1410, WESCON/81

7119-R4 SHOW

Circle 126 on reader service card

**"SURGE FREE"**

**SURGE ABSORBABLE DISCHARGE TUBE (FOR CIRCUIT PROTECTION)**

● POINT

- (1) Usable at wider ambient condition, especially good under high humidity
- (2) Visibility for operation
- (3) Compact and easy assembly
- (4) Stable characteristics

● APPLICATION

- Computer circuit
- Communication equipment
- Home Appliance
- Aircraft and Automobiles

● TYPE

Type	Breakdown Voltage (V) dc	Insulation Resistance (Ω)	Maximum Surge Current (8 × 20μs) KA	Life Times at 500A
SA-80SS	80 ± 10%	10 <sup>7</sup> min	0.7	3000
SA-200SS	200 ± 10%	10 <sup>7</sup> min	0.7	3000
SA-80	80 ± 10%	10 <sup>10</sup> min	1.5	3000
SA-140	140 ± 10%	10 <sup>10</sup> min	1.5	3000
SA-200	200 ± 10%	10 <sup>10</sup> min	1.5	3000
SA-250	250 ± 10%	10 <sup>10</sup> min	1.5	3000
SA-300	300 ± 10%	10 <sup>10</sup> min	1.5	3000
SA-7K	7000 ± 1000V	10 <sup>10</sup> min	—	5000
SA-10K	10000 ± 1000V	10 <sup>10</sup> min	—	5000

Change of Ez by cycling discharge

(Model) SA-80

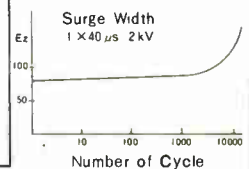

● MAIN PRODUCT

NEON GLOW LAMP, XENON FLASH LAMP, RARE GAS, DISCHARGE LAMP. MINIATURE: BLACK-LIGHT, UV-LIGHT, FLUORESCENT COLOR-LIGHT.

**ELEVAM ELECTRONIC TUBE CO., LTD.**

NO. 17-BCHOU 2-CHOME OTA-KU, TOKYO JAPAN  
TELEPHONE: 03(774) 1231~5 TELEX: 246-8855 ELEVAM



## Sudden Service

**Samtec ships your order before you finish your morning coffee.**

There's no reason to be concerned about whether your electronic hardware suppliers are going to deliver your order when you need it. Not when you can count on Samtec's "Sudden Service".

Samtec cares about your order as much as you do. That's why we stock a full line of the products you need, including the industry's largest selection of instant break-away socket and terminal strips. These versatile strips speed assembly, fit where sockets won't, interconnect PCB's, and mount any standard or odd-sized components.

So sit back, relax and enjoy your morning coffee. With Samtec's variety of components, huge inventories and dedication to providing the best service possible, you can rest assured your order is on its way.



Call or send the coupon below for our new catalog with complete specs and ordering data.



### ELECTRONIC HARDWARE

P.O. Box 1147 • 810 Progress Boulevard  
New Albany, IN 47150 • (812) 944-6733

Name \_\_\_\_\_

Company \_\_\_\_\_

Address \_\_\_\_\_

City \_\_\_\_\_ State \_\_\_\_\_ Zip \_\_\_\_\_

© 1981 Samtec Inc

World Radio History

Circle 249 on reader service card

# One tool does it all.

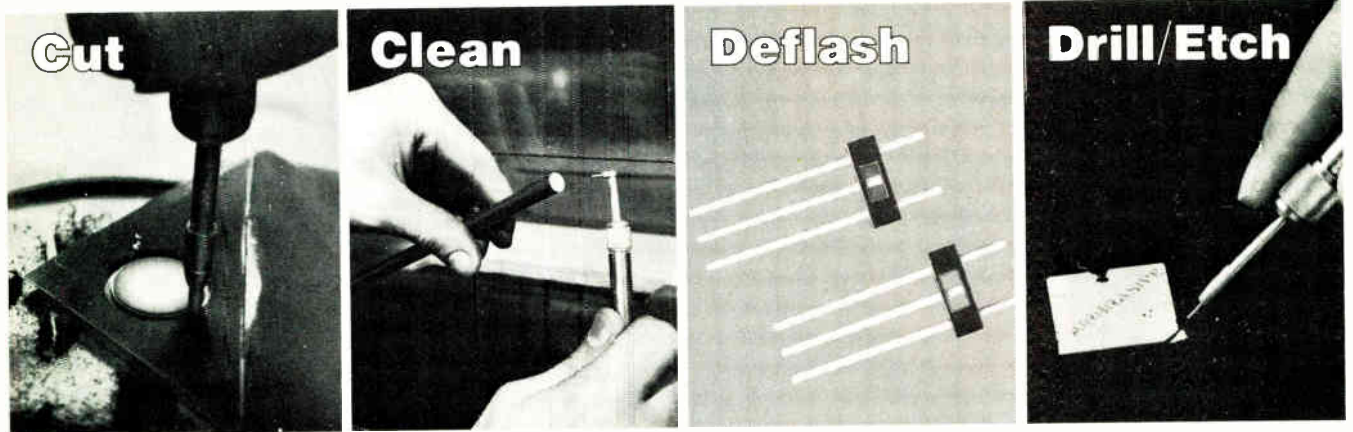

## Airbrasive®

Why buy 12 high-tolerance production tools when one inexpensive Airbrasive unit will do? This "Wonder Tool" abrades/cleans/cuts/deburrs/deflashes/drills/etches/laps/peens/shapes/strips and/trimms to critical tolerances using a cool, shockless stream of micro-abrasive particles. It's perfect for boosting production in many electronic component manufacturing operations: cleaning potted leads; removing brazing spatter and excess solder; labeling custom components; coding parts; roughening contacts for maximum conductivity; angle-cutting silicon wafers; trimming resistors and capacitors; and more.

Circle 128 on reader service card



There is a right Airbrasive unit for the particular job you need done. Model K—for lab and light production; Model H—production work-horse; Model HME—high capacity, heavy duty.

For a brochure and price list or demonstration at your place of business call 201-752-8300. Or write S.S. White Industrial Products, Pennwalt Corporation, 151 Old New Brunswick Road, Piscataway, NJ 08854.

**S.S. WHITE INDUSTRIAL PRODUCTS**

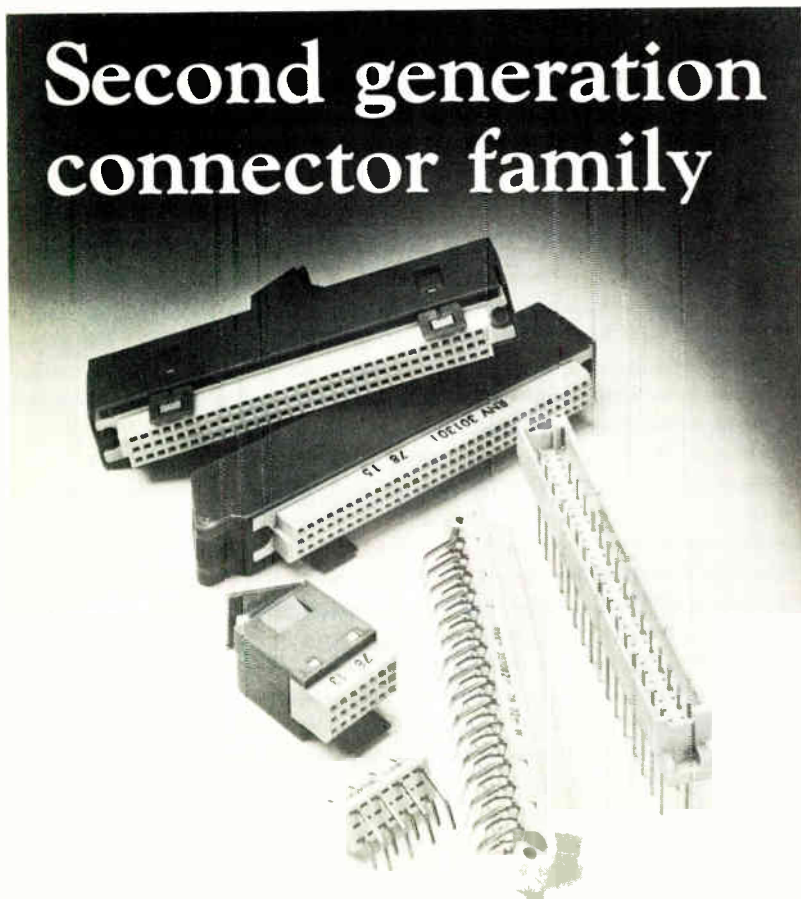

## Second generation connector family

Now! Introducing a second generation of the full range of inversed and standards European connectors. The locking spring is now on the covers, rather than on the connectors. This simplifies installation and improves performance. The 8—96 point male and female connectors feature selective gold plating on contact surfaces. Connection on back plane, rear or front edge to PCBs. Connector forks are extra long, for greater reliability and reduced plug-in error. We offer a complete line of 2-pole power supply connectors, locking devices, covers and other accessories. Ericsson's big series production means that the component users will take advantage of the experience we have gained from using and installing our own communication systems.

**LM ERICSSON**  
**TELEMATERIEL AB**

Components Department  
Box 401, S-135 24 Tyresö, Sweden  
Telex 109 20 LMSBO S

*We are a major supplier of components for the industrial market. We belong to the Ericsson Group, one of the world's leading telecommunications manufacturers.*

# ASTRO-MED



*New! AC-DC*

## DASH II RECORDER

- Take *anywhere* rugged design
- Rechargeable battery or line operate
- Position feed-back galvos . . . 99.5% accuracy
- DC — 125 Hz.
- Crisp, clear traces . . . low cost thermal paper
- Simple to operate . . . years of trouble free operation

This new Dash II may very well be the final word in portable/lab high speed recorders. With rechargeable batteries and built in charger, you can take it anywhere — land, sea or air, and use it for 4 to 5 hours. Then, you can continue to operate *while recharging* the batteries. Accuracy? The patented (U.S. #4,134,062) Pathfinder™ galvo is *position feedback* with better than 99.5% accuracy. High stylus pressure delivers crisp, clear traces on low cost thermal paper.



ASTRO-MED DIVISION  
ATLAN-TOL INDUST  
Atlan-tol Industrial Park/West V  
401-828-401

Circle 251 on

Get all the facts. Call or write

Engineers and other Aerospace Professionals

# Your great ideas today could become a great advance tomorrow at Martin Marietta

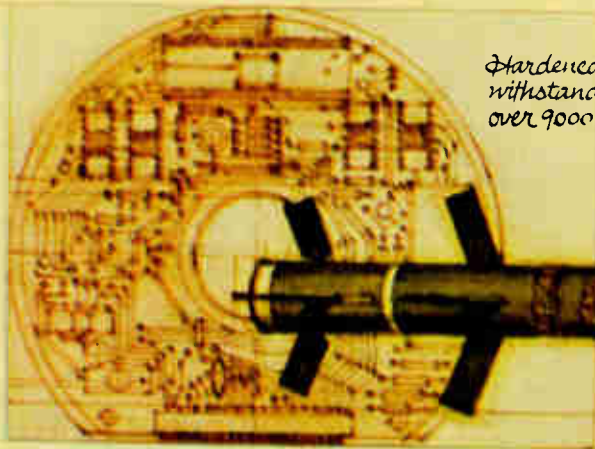

*Hardened electronics  
withstand firing forces  
over 9000 G.*

Copperhead Guided Projectile

Great advances are built on solid experiences. At Martin Marietta Aerospace, we're playing a bigger role than ever in the extraordinary evolution in defense and space technology. We know that tomorrow's great ideas are going to come from those people working in a challenging and sophisticated environment with today's great technologies. In Orlando we're working on a broad range of projects including the Millimeter-wave Contrast Seeker used in the Copperhead Guided Projectile. Our success has led to many on-going projects including Pershing II, a tactical interdiction system, and TADS/PNVIS, a helicopter fire control system.

When you join Martin Marietta, you'll find the excellent salary and complete benefits coverage you'd expect from an industry leader. Learn about career opportunities in Orlando, or our other locations by sending your resume or a letter to the facility of your choice.

**In Orlando:** P.O. Box 5837-MP#9, Orlando, FL 32855; **In Denver:** P.O. Box 179, Mail #D-1311, Denver, CO 80201; **At Vandenberg AFB:** Box 1681, Vandenberg AFB, CA 93437; **In New Orleans:** Michoud Assembly Facility, Box 29304, New Orleans, LA 70189.

We are an equal opportunity employer, m/f/h.

Millimeter-Wave  
Contrast Seeker

*Printed  
circuit  
boards*

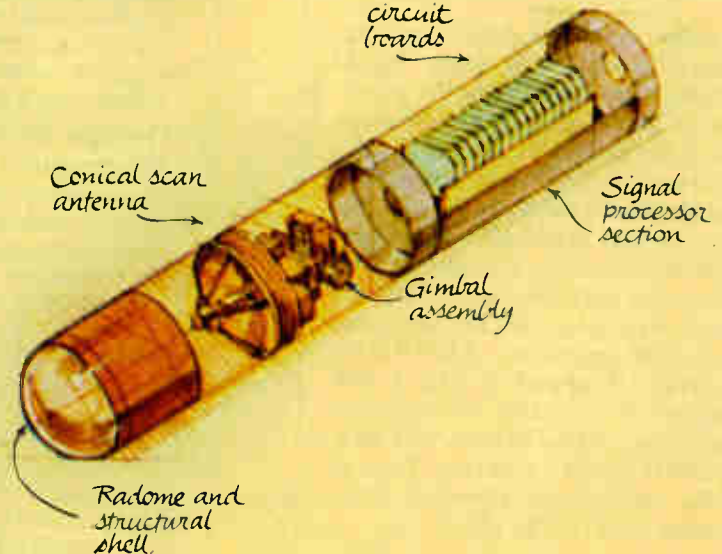

**MARTIN MARIETTA**



Engineers and other  
Aerospace Professionals

# Bring your great ideas to Martin Marietta

## ORLANDO, FLORIDA

Orlando is situated in the center of Florida's year-round outdoor living and cultural activities. Orlando also boasts an exceptional education system and no state income tax.

- Guidance/Control Systems Analysis
- System Requirements Analysis/Definition Integration
- Radar System Design
- ATE Electronic or Software Design
- Structural Dynamics Analysis
- Facilities Design: EE, ME, HVAC
- Tool Design
- Industrial Engineering
- NC Programming

## DENVER, COLORADO

Located on the foothills of the Rocky Mountains, Denver offers year-round recreational and cultural opportunities including theater, symphonies and museums.

- Electronics Engineers
- Systems & Test Engineers
- Manufacturing Engineers
- Mechanical Engineers
- Quality Engineers
- Software Engineers
- Materiel
- Finance

## New literature

surements, and Automated Parametric Test Systems divisions. The catalog lists product descriptions, capabilities, features, specifications, and application information. In addition, each major section is prefaced with technical data, theory of operation, and design considerations relative to the instruments described. For a copy, contact Keithley Instruments Inc., 28775 Aurora Rd., Cleveland, Ohio 44139. Phone (216) 248-0400 [428]

**Microwave product information.** The complete line of MIC microwave and intermediate- and radio-frequency products is described in the RHG Electronics Laboratory catalog. The 112-page catalog contains three sections of detailed technical data on i-f and rf products, MIC mixers and mixer preamplifiers, and microwave relay links. Another section describes custom devices and subsystems. Technical information is included on the relationship of log amps to other components, linearity measurement, phase and gain matching, and mixer specifications, as well as standard specification test methods. Copies of catalog No. 200 are available from the Sales Department, RHG Electronics Laboratory Inc., 161 East Industry Court, Deer Park, N. Y. 11729. Phone (516) 242-1100 [423]

**Integrated circuits for industry.** A 12-page brochure covering Siemens Corp.'s integrated circuits for industrial applications lists the various IC types, packages, package dimensions, descriptions, and electrical characteristics as well as general product information. The ICs include linear and digital circuits in bipolar, MOS, and mixed technologies for use in a broad range of applications including industrial applications. Copies of the brochure are available from the Components Division, Siemens Corp., 186 Wood Ave. South, Iselin, N. J. 08830 [424]

**Instruments for rent.** Genstar Rental Electronics' catalog lists over \$45 million worth of electronic instruments for rent throughout North



America. All items listed include a description plus the 30-day rental price. Items are catalogued alphabetically by product type and are divided into 47 categories, which range from amplifiers to test chambers. There are analyzers, generators, and meters as well as sophisticated instruments such as desktop computers, microprocessor instrumentation, programmable read-only memories, programmers, oscilloscopes, magnetic-tape recorders, and data terminals. Copies of the catalog are free and may be obtained by contacting Genstar Rental Electronics Inc., 19527 Business Center Dr., Northridge, Calif. 91324. Phone (213) 993-7368 [425]

**Software directory.** Datapro's Directory of Microcomputer Software helps to identify, evaluate, and select microcomputer software. Detailed descriptions of over 2,000 software products are arranged in an easy-to-compare format. More than 1,000 vendor profiles, including hard-to-locate suppliers, provide information on product lines, application emphasis, and sales volume. The directory is divided into four major indexes: applications area, product name vendor or product name, and computer system. The two loose-leaf volumes, 12 monthly supplement monthly newsletter, and teletype inquire services cost \$290. Data Research, 1805 Underwood Delran, N. J. 08075 [426]

# “When are you going to get yours?”

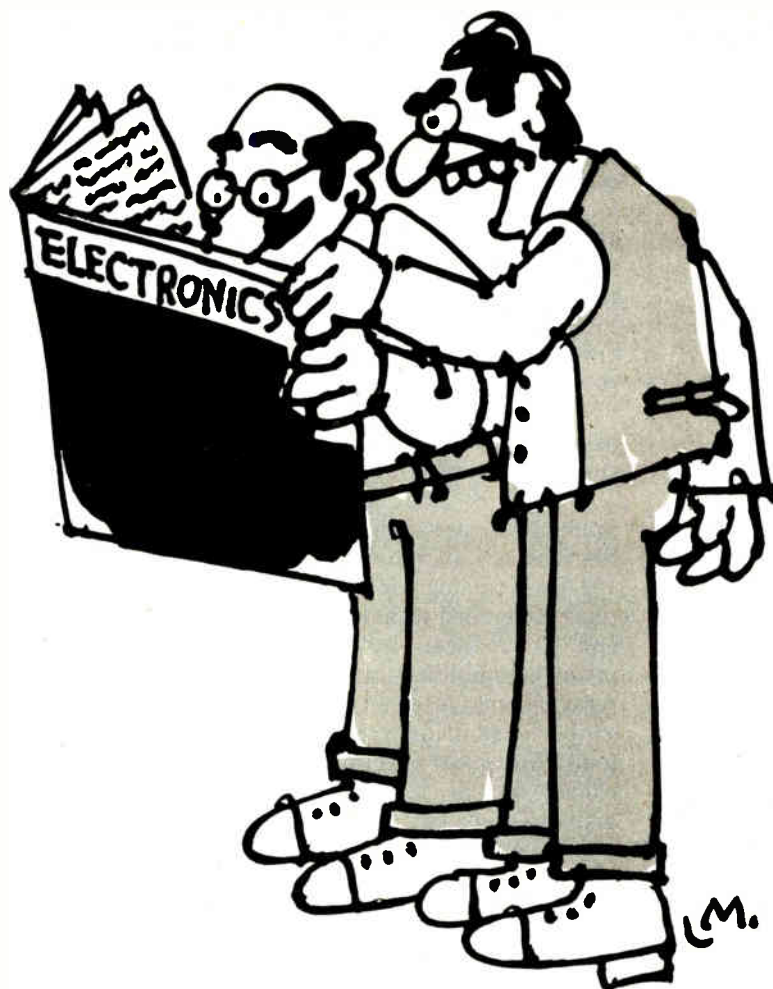

When are you going to get your very own, personal subscription to Electronics?

It could be very important to you. And we're not just referring to your status in the office hierarchy.

You (and we) are in a quick-moving business. News breaks frequently. Change is the name of the game. Awareness is the way to win.

You've got to follow what's going on beyond your specialty. Your career may have to last longer than your specialty.

If change is the game, obsolescence is the penalty for losing. Obsolescence of products, of technology and, unfortunately, of people. We can't change this fact. But we can help you cope with it.

Give us one hour of reading time every two weeks and we will keep you aware of what's going on around you and around the changing world of electronics technology.

Move up. Fill out one of the subscription postcards in this issue.

## **Electronics Magazine. The one worth paying for.**

**New, from Three Phoenix**

# High Speed Functional Logic Testing: A Technical Innovation.

Until now, the "Hot Bed", "Test Bed" or "Hot Mock-Up" has been the only means of performing vital high speed functional PC board testing. The major draw back of this capital and labor intensive procedure is that fault isolation frequently requires a complete multi-station low speed diagnostic retest.

Now, Three Phoenix Company introduces its 3PX680 20MHZ high speed functional logic test system. A state-of-the-art system designed to board-test microprocessors, memories and hybrid assemblies at their operating speeds.

The 680 performs high speed board level testing such as testing of logic circuitry with embedded memory at memory operating speeds, emulating the hot bed procedure. And, at the same single test station, the 680 will perform traditional low speed diagnostic testing, eliminating a lot of



the waste of hot bed/multiple test station systems.

Three Phoenix has developed new hardware technologies and software systems to achieve the 680's effective and economical approach to high speed testing. And, a decision tree method of fault isolation was developed, overcoming the costs of pure guided probe, to accomodate diagnostic testing at board speeds.

And there's more. Find out what the 3PX680 high speed functional testing system can do for you. Call Three Phoenix today for more information.



## THREE PHOENIX COMPANY

21639 North 14th Avenue, Phoenix, Arizona 85027  
Telephone: (602) 242-6300, Telex: 667455

**We put technology to the test**

Circle 257 on reader service card

# this publication is available in microform

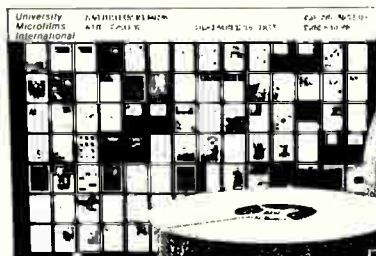

Please send me additional information.

Name \_\_\_\_\_  
Institution \_\_\_\_\_  
Street \_\_\_\_\_  
City \_\_\_\_\_  
State \_\_\_\_\_ Zip \_\_\_\_\_

## University Microfilms International

300 North Zeeb Road  
Dept. P.R.  
Ann Arbor, MI 48106  
U.S.A.

18 Bedford Row  
Dept. P.R.  
London, WC1R 4EJ  
England

# Dialight sells only used rockers and toggles.

**That's because all are 100% tested.** At Dialight we don't use hit-or-miss sampling to test our miniature rockers and toggles. All are 100% tested electrically and mechanically before you get them. And all are made in the U.S.A.

You can choose from thousands of different designs. Our rocker and toggle line contains

countless combinations of standard colors, sizes, mountings and contact ratings. Included are dozens of front-panel and sub-panel types, plus many styles for snap-in and printed circuit board applications.

If our catalog doesn't show exactly the switch you need, we'll design and build it to order.

Next time specify only used switches — 100% tested rockers and toggles from Dialight, 203 Harrison Place, Brooklyn, N.Y. 11237 (212) 497-7600.

***DIALIGHT***  
**meets your needs.**

A North American Philips Company



Visit us at Wescon, Booth #1513,1515,1517

Circle 258 on reader service card

## **Smart Interface unit could replace diskette in printer applications**

A programmable buffered interface unit from Microcompatible Inc., Atlanta, Ga., may eliminate the need for a disk drive in some small-computer applications. **The Microcue stores either 16- or 32-k bytes of data in MOS random-access memory, and interfaces almost any small computer** with a parallel or RS-232-C serial interface output port with almost any printer. Useful in memory-limited applications, it can store up to 16 pages of text, manage printer functions without incurring central-processing-unit or controller overhead, and free a disk drive that would have been needed for printing. The Microcue accommodates bit rates of 110 to 9,600 b/s. Units are available with up to four inputs and outputs at prices from \$299 to \$699.

## **Small chip stores, speaks four words**

A Chicago start-up firm known as Data Voice Corp. is paying no heed to speech synthesis techniques that allow large vocabularies by minimizing memory requirements. The company's first product, called Cheaptalk, is a 3-by-3-in. voice-synthesis circuit board that is a memory hog; but by using data rates of 12,000 to 20,000 b/s, the firm says that **extremely high voice quality can be achieved at a low price for applications that need only a 1 to-4-word vocabulary**. Cheaptalk uses a 32-K erasable programmable read-only memory for storing a maximum of **2.5 s of waveform-encoded speech**. The board will sell for \$54 in 100-unit quantities and for \$30 in quantities of 2,500 or more. Twenty-five standard words or phrases are available, but custom vocabulary encoding is also available for \$100.

## **High-speed network gets satellite capability**

Network Systems Corp., Brooklyn Park, Minn., is adding satellite communications capability to its Hyperchannel line of high speed network products. Developed under funding from Satellite Business Systems, the model S720 satellite link subsystem will employ an RS-449 interface, allowing **full-duplex data transfers at rates up to 44.7 Mb/s** between geographically separate Hyperchannel networks. Priced at about \$85,000, the S720 will be available in early 1982.

## **PROM burner is software controlled**

Programming most families of erasable programmable read-only memories, the Ackerman Digital Systems Prom Blaster is controlled by software running under either Digital Research's CP/M or the Elmhurst, Ill., firm's 6809 single-board computer monitor, Adsmon. **The Prom Blaster uses a single 28-pin zero-insertion-force socket and programs 1-, 2-, 4-, or 8-K erasable PROMs**, including three-supply parts. With the high-voltage supply on card, it works with the S-100 bus as an input/output device, has phantom slave and extended device options, and includes wait states. The cost of the kit is \$199 and includes PromWriter software.

## **S-100 computers use streaming drive for back-up**

Measurement and Controls of Orange, Calif. is introducing versions of its 2800 family of S-100-bus microcomputers next month, both using Archive Corporation's 20-megabyte streaming tape drive. **The new systems use existing 2800 configurations**, but replace an 8-in. floppy with the 90 in./s streamer, backing up a 10-megabyte Memorex Winchester. The single user CP/M system sells for \$11,430, while the multiuser MP/M model lists for \$12,500 in single units.

**GREAT** working at Lawrence Livermore  
National Laboratory  
**GREAT** living in Northern California

**Electronics Engineers**

**Engineering Development in  
Energy and National Defense R&D**

**Technically Challenging Work in  
Multi-Disciplinary Teams**

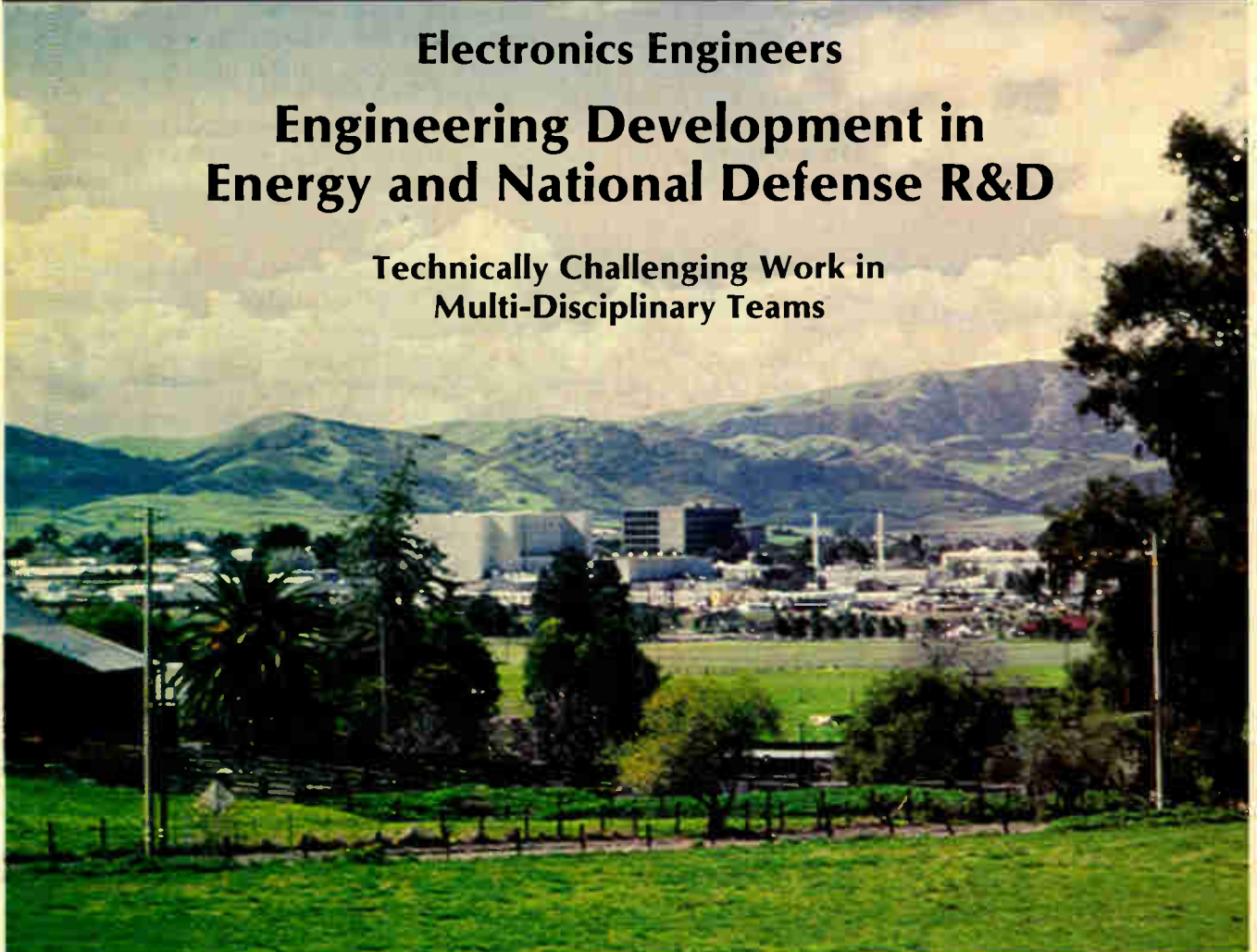

- Fusion Engineering
  - High Energy Pulse Power Systems
  - Software Engineering
  - Nuclear Systems Safety Research
- . . . Extensive equipment, technical personnel and facilities support
- . . . On-site advanced degree programs

- Mini/Micro Computer Control and Data Acquisition
  - Instrumentation, Control Systems, and Electro Optics
- . . . Three weeks' vacation
- . . . Quick access to San Francisco Bay Area, ocean, mountains

University of California  
**Lawrence Livermore  
National Laboratory**

Resumes may be sent in strict confidence to George Kumparak, Professional Employment Division, LAWRENCE LIVERMORE NATIONAL LABORATORY, P.O. Box 808, Dept. KET-081, Livermore, CA 94550. Or call Ed Latranchi, Department Head, collect at (415) 422-8373, for more information. U.S. CITIZENSHIP IS REQUIRED. We are an equal opportunity employer M/F.

## Career outlook

### Academia doesn't pay

Many undergraduate engineering students sign up for their first industry job with the expectation of getting two or three years of experience—and some money in the bank—before returning to school for a graduate degree.

Anyone doing so, believing it will eventually mean more money in the long run, may be making a mistake. "There's no great economic inducement for going to graduate school," says William S. C. Chang, head of the microelectronics program at the University of California at San Diego. "Graduate students are poorly paid. BSEE holders entering industry will make a salary of around \$22,000 to \$25,000" and in four years will be making as much as those who are fresh out of school with a Ph. D.

For those who stay in school long enough to attain a Ph. D., the economic inducement to stay on and teach is lacking. Says Chang, "A beginning Ph. D. in industry gets about \$35,000 a year—at a university only \$25,000."

**Attractions.** Moreover, Chang points out, industry can attract bright and highly schooled engineers because high-technology firms can, and do, spend heavily for research and development in well-equipped laboratories. Most universities, on the other hand, are having a hard time keeping their laboratory equipment up to date. Even a school like the University of Illinois, Urbana-Champaign, has laboratories that are still working with hardware based on vacuum-tube technology, says G. W. Swenson, head of the department of electrical engineering.

However, the greatest need in academia is for engineers with advanced degrees. Says one EE department head, "Our labs aren't quite up to snuff, but we could live with that if we could find qualified people. If they were out there we could hire them. But they're not going on to grad school and thinking, 'I'm going to get a Ph. D. and teach.'"

So the nation's universities and colleges are looking for ways to

attract experienced engineers with high-level training back into the classroom—at least part time. "I advocate strong university-industry-governmental interrelationships," says Lester Gerhardt, director of electrical, computer, and systems engineering at Rensselaer Polytechnic Institute, Troy, N. Y. "I would encourage more Ph. D.s and higher degrees and regular leaves of absence—not only for training, but for adjunct professorships."

**Funding.** Faced with Federal funding cuts just when they need more money to pay competitive salaries to engineering professors and give them up-to-date laboratory equipment, engineering schools are now counting on industry for money.

More industrial funding is an obvious solution in meeting the rising cost of educating EEs, maintains Irene Miller, assistant chairman of the electrical engineering department at Stanford University, Palo Alto, Calif. Miller cites the example of the Stanford Center for Integrated Systems, which begin with the help of a dozen industrial sponsors such as IBM, General Electric Co., and Xerox Corp. Member companies can send staff members to the center to design integrated circuits with a fast turnaround.

**Ten grand a head.** According to Swenson of the University of Illinois, "Industry is going to have to start training engineers and contributing more to universities. A \$10,000 donation per student hired wouldn't be unreasonable. Society is going to need more engineers, but if you haven't the money to hire faculty or teaching assistants or to upgrade labs, then you have to cut back."

"Numerically," Swenson continues, "industry gives us a substantial amount; ideally, not enough. The trouble is the gifts don't necessarily address our most urgent needs."

With engineering enrollments at record levels because of the current shortage of engineers, the schools find it hard to compete with industry for the brainpower they desperately need. Paradoxically, whether they will be able to do that depends a lot on industry. —Andrew McCann

## POSITIONS VACANT

**Communications Specialist** — Local Network. The University of Arizona, Tucson, is seeking senior level professional for local area network design, development and operations. Responsibilities include design, specification, selection of all elements of local data communications network including wide-band links, switching, monitoring, and control facilities. Position requires advanced knowledge of digital analog communications systems. Person filling position will lead development of University-wide network. Master's degree in appropriate field or equivalent plus a minimum of 4 years experience in design of complex digital and analog communications networks are required. Open until filled. Send resume to: Robert A. Leach, University Computer Center, University of Arizona, Tucson, AZ 85721. Equal opportunity/affirmative action employer.

**Electronic Engineers—Sunbelt/Southwest.** Opportunities in Design Software, Digital/Analog, Microprocessing, Personalized representation. Employer fee paid. J. Gifford Inc., 5310 East 31st Street, #225 Tulsa, Oklahoma 74135. (918) 665-2626.

**Murkett Associates Qualified Reputable Management** placement with national affiliates—fee paid. Box 527 Montgomery, AL 36101.

## POSITIONS WANTED

**Seek responsible challenging position in Europe.** 18 years experience in micro computer / computer hardware/firmware/software / training / management. Fluent German. PW-4252, Electronics. Telephone 316 / 775-3348.

TO ANSWER BOX NUMBER ADS Address separate envelopes (smaller than 11" x 5" for each reply to:

Box Number  
(As indicated)  
Electronics  
Box 900, NY 10020

# MEDICAL PRODUCT ADVANCEMENTS CAN'T WAIT UNTIL TOMORROW!

When it comes to the design and manufacture of greatly needed medical supplies and devices — time and quality are essential. And we're meeting the challenge. We're Ohio Medical, a leading medical products manufacturer, committed to staying ahead of market demands for our highly sophisticated products: incubators, disposables,

anesthetics, anesthesia and pulmonary function equipment, monitors, ventilators, and others. Right now our NEW PRODUCT DEVELOPMENT efforts provide exceptional opportunities for qualified professionals to help us launch a new generation in medical technology.

**PRODUCT ENGINEER/MECHANICAL:** Positions require a minimum of 2 years industrial product design/development experience, preferably in electromechanical equipment, plus a BSME or related degree. An MS will be considered in lieu of experience. Electronic instrumentation or Electronic/Mechanical packaging design expertise is an asset.

**PRODUCT ENGINEER/ELECTRICAL/ELECTRONIC:** Requires a minimum of 1-4 years

experience, proven design background using microprocessors and exposure to hardware and software areas.

**STAFF ENGINEER BSEE OR ME:** Requires a minimum of 5 years product development experience, including microprocessor applications development and effective communication skills. MS, exposure to a medical or related environment and 2 years managerial experience desirable.

In addition to exceptional challenges, rewards and recognition, the professionals at Ohio Medical enjoy the excitement of participating in high impact, development groups, where the results of individual efforts are immediately visible. We also offer excellent relocation package, benefits and compensation programs as well as the attractive lifestyle possibilities of our beautiful Madison, WI location. For further information, contact: Manager, Industrial Relations Department E8/25

(608) 221-1551

## Ohio Medical Products

a division of  
**IACO**

P.O. Box 7550 / Madison, WI 53707

An Equal Opportunity Employer M/F

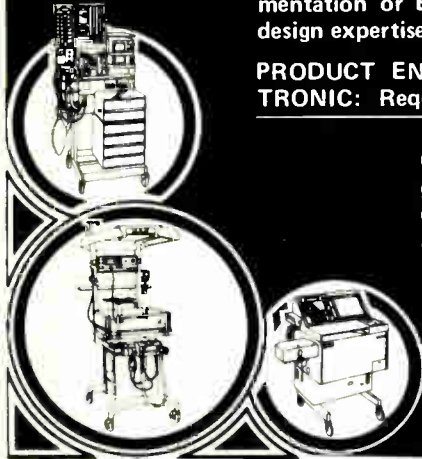

## We're looking for a whole new breed of CAD.

At United Technologies Microelectronics Center (UTMC), we offer you something very few companies can — a small company atmosphere, backed by a multi-billion dollar corporation. At our new design center in Colorado Springs, you'll work in a total state-of-the-art R&D environment on CAD and CMOS gate array designs.

We're looking for top-notch computer-aided design engineers who feel their only limitations are budgets, resources and the equipment they're using.

So if you're a degreed CAD programmer/engineer who is looking for an unsurpassed work environment, and an excellent compensation/benefit package, let us tell you more about UTMC. Contact Les Gaskins collect at (303) 594-8000 or send a resume in confidence to UTMC, 4525 Northpark Drive, Colorado Springs, CO 80907.



UTMC is an equal opportunity employer m/f/h/v \*1981 United Technologies Microelectronics Center

### CONNECTOR PROJECT ENGINEERS

We have client companies who are in need of people with experience in designing electrical and electronic connectors for consumer, industrial, data processing, and aerospace applications. Salary — \$32,000-\$37,000. Client companies assume all fees. For details send resume in strictest confidence to: P-4799 Electronics.

### S.W. & SUNBELT

- Circuits EE's · Microsystems
- Systems EE's · Software Design
- Product EE's · Hardware Design

**\$20,000 to \$45,000**

100% Fee Paid

Specializing in placing EE's with data acquisition, peripheral and instrument manufacturers across Southern U.S. Send resume, geographic preference, salary and salary requirements to:

J. Robert Thompson Companies, Inc.  
Management & Employment  
Consultants  
2200 West Loop South, Suite 800  
Houston, Texas 77027  
(713) 627-1940

CALL IN  
YOUR  
CLASSIFIED ADS  
212/997-2556



A  
LOOK...

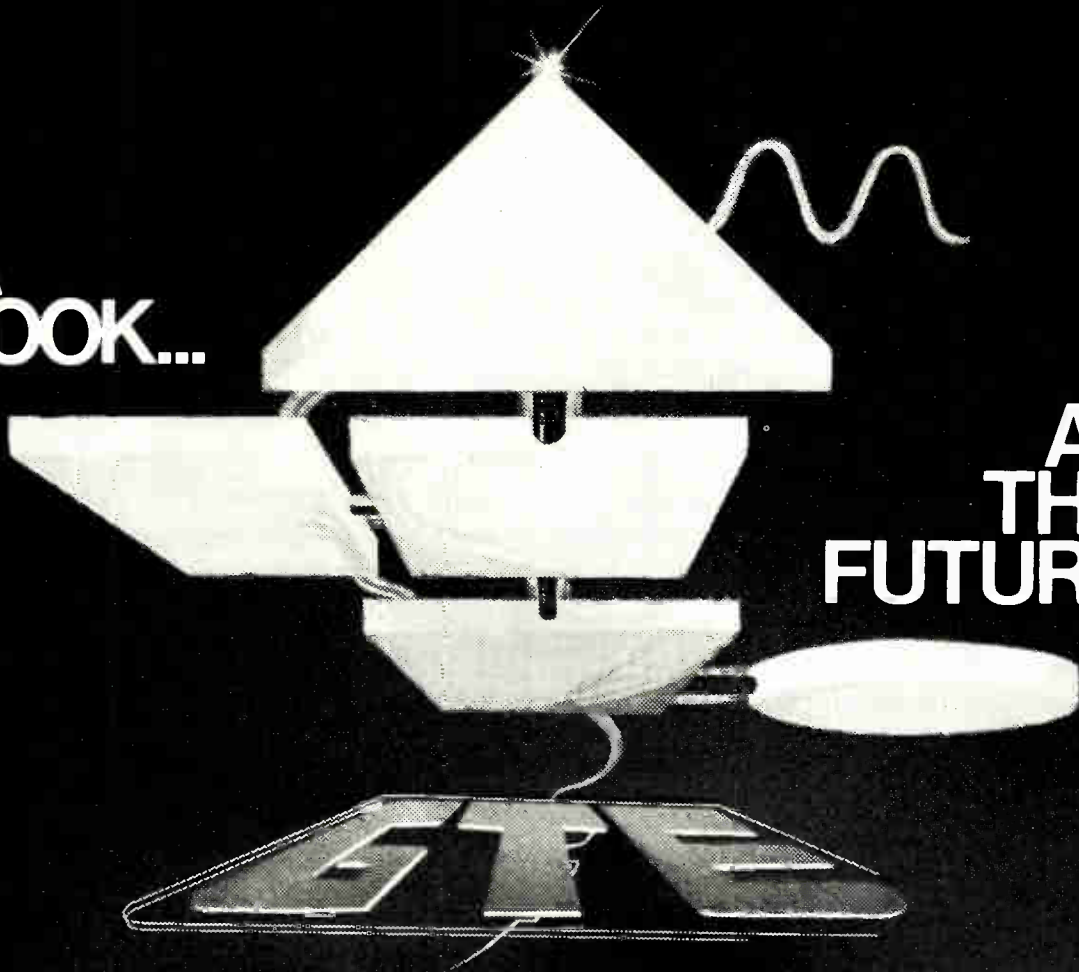

AT  
THE  
FUTURE

At GTE Automatic Electric Laboratories, talented professionals are designing and developing the next generation of high speed digital telecommunication systems. As energy costs spiral, travel will be replaced by new systems of high speed communication...the challenge is yours to meet!

Join us at our new multi-million dollar R & D facility in a growing high tech center, Phoenix, AZ. In addition to our application of the latest design methodology techniques, our staff is involved in the development of on-line and support software, system planning, and the test/evaluation of prototype systems.

If you are degreed and have experience in Electrical Engineering, Computer Science, Computer Engineering or a related field, the following positions are currently available.

OPERATING SYSTEM  
SOFTWARE  
ON-LINE RECOVERY AND  
DIAGNOSTIC SOFTWARE  
DEVELOPMENT SUPPORT  
SOFTWARE

TEST UTILITY SOFTWARE  
CALL PROCESSING AND  
ADMINISTRATIVE  
SOFTWARE  
DATA BASE DEVELOPMENT  
SYSTEM TEST AND CONTROL

Take a look at the future...with GTE in Phoenix. For immediate consideration, send your resume or letter of interest to: GTE Automatic Electric Laboratories, Manager of Manpower, Dept. T825, 2500 W. Utopia Road, Phoenix, AZ 85027.

## GTE AUTOMATIC ELECTRIC LABORATORIES



Research and  
Development

An Equal Opportunity Employer M/F/H

## TEACH IN JAPAN

Persons with a degree in electrical, mechanical or civil engineering or allied fields wishing to teach adults for one or two years in Tokyo should write to:

Personnel Director  
International Education Services  
Shin Taizo Building  
10-7, Dogenzaka 2-chome  
Shibuya-ku, Tokyo 150  
Japan

Instructors employed by I.E.S. will teach Japanese businessmen and engineers English as a second language and the terminology in their own field of study or job-experience.

No Japanese-language is required for classroom instruction. Teaching experience is not required. An orientation and training are given in Tokyo.

Information on salary, transportation and housing can be obtained by providing International Education Services with a detailed resume and a letter indicating an interest in the position.

Personal interviews will be held in San Francisco, Seattle, Los Angeles, Detroit, New York and Washington (D.C.) in September, 1981.

Selected applicants would be expected to arrive in Tokyo from January to May, 1982.

## TEXAS, SOUTH & SOUTHWEST POSITIONS

Engineering & Management positions throughout Texas, the South and Southwest. Employers pay all fees. Send resume or call Bob Hogue, Sr. Mbr. IEEE (512) 658-3525.

Invest in your career—call our 24 hour/day

**HOT LINE 1 + 512-658-8133**

for 3 minute recording of latest openings.

*SouthWest Technical*  
personnel consultants

P.O. Box 33070  
San Antonio  
TX 78233

## HIRE 1983 & 1984 GRADUATING ENGINEERS —THIS SUMMER!—

First, it's in our industry's best interest to provide career-conscious undergraduate engineering students with meaningful summer job experience in their future profession.

Second, since there'll always be more anxious applicants than openings, you'll be able to select the cream of the crop, then evaluate them under "game-conditions" with an eye towards hiring them, when as coveted graduates, the job market may well be in their favor.

By filing out and returning the coupon below, your organization will be included in summer job listings to be featured in the January 1982 issue of McGraw-Hill's GRADUATING ENGINEER.

This edition will be distributed on over 500 campuses by engineering department heads, placement officers, and minority advisors. Students will then contact you directly.

## Free summer job listing

MAIL TO: ELECTRONICS/POST OFFICE BOX 900/NEW YORK/NY 10020

NAME/TITLE (of individual to be contacted)

ADDRESS: (Mailing address of your personnel office)

ORGANIZATION: (Firm, Company, Government Agency or Institution)

TYPE AND NUMBER OF STUDENTS SOUGHT: Electronics Avionics

Technician Computer Science Other: (Draftsperson, etc.)



Note: Last date coupons can be accepted for this year's summer job listings is 11/15/81

# NOTICE TO EMPLOYERS:

## Why we can recommend our readers for the top jobs

The subscribers to this magazine have qualified professionally to receive it. They are also paid subscribers—interested enough in the technological content to have paid a minimum of \$19 for a subscription.

As subscribers to ELECTRONICS, our readers have told you several things about themselves. They are ambitious. They are interested in expanding their knowledge in specific areas of the technology. And they are sophisticated in their need for and use of business and technology information.

Our readers are now in senior engineering or engineering management, or they are on the road toward those levels. In either case, they are prime applicants for the top jobs in almost any area.

If you are interested in recruiting the best people in electronics, these pages are open to you for your recruitment advertising.

Our readers are not "job-hoppers". To interest them you will have to combine present reward with challenge and opportunity for future career advancement.

The cost of recruitment advertising on these pages is \$87 per advertising inch. For information call or write:

# Electronics

Post Office Box 900, New York, NY 10020  
Phone 212/997-2556

RESEARCH AND  
DEVELOPMENT ENGINEERS

# THE FUTURE OF TELECOMMUNICATIONS IS STARTING TODAY IN THE TAMPA BAY AREA

The time: Now. The place: GTE's new state-of-the-art telecommunications facility in St. Petersburg, Florida. The focus: Tomorrow. Our facility represents a new plateau in the progress GTE has made in developing computer based telecommunications systems with expanded capabilities. In merging advanced communications and electronics technologies we've introduced new systems with remarkable voice and data services that meet the needs of an increasingly sophisticated market.

We're looking for a start-up team of creative hardware design professionals who will enjoy working in an environment without precedent. We have the following positions available to ambitious candidates:

## MICROPROCESSOR SYSTEM DESIGN ENGINEER

Approximately 15 years experience in microprocessors, memory and peripheral components required. Responsibilities include evaluating, selecting and recommending state-of-the-art components for telecommunications products.

## TRANSMISSION AND PROTECTION ENGINEER

Specify transmission requirements for PABX and key systems.

## TRANSMISSION ENGINEER

Responsibilities include evaluating and advising product design for meeting transmission and interference requirements.

## LINE AND TRUNK CIRCUIT DESIGN

Approximately 15 years of design experience in line/trunk circuit design. Responsibilities include designing the line circuits and trunk circuits for the key system and next generation voice/data switches.

## POWER SUPPLY DESIGN ENGINEER

Design and develop power supplies and distribution techniques for use in terminals and small switch units. Requires 10 or more years of experience.

## LOGIC CIRCUIT DESIGNER

Approximately 12 years relevant experience in the design of computers, digital systems, logic circuits and LSI circuit development for computers and communication systems.

## COMPONENT ENGINEERS

Assist in the evaluation and qualification of new technology components for use in advanced telecommunications products. Requires 4 or more years of experience.

You'll find yourself in surroundings that promote accomplishment. In addition to our new building, the growing Tampa Bay area offers its own special advantages. Housing is affordable. Assumable mortgages are available. The Gulf Coast beaches provide enjoyable recreation. There is a diverse spectrum of cultural and educational activities. And our "flex-time" working schedules allow you the time you want to participate. We're offering attractive salaries, a comprehensive benefits package and excellent opportunity for advancement. If your abilities have exceeded the potential and challenge of your present position, send your resume with salary history to:

Manager, Employment  
Dept. E825

**GTE SUBSCRIBER NETWORK PRODUCTS**  
11601 Roosevelt Blvd. N.  
St. Petersburg, Florida 33702

An Equal Opportunity Employer M/F



**SUBSCRIBER  
NETWORK PRODUCTS**

ADAC	198	‡ Fujitsu America, Inc.	61	■ Panduit Corporation	179
‡ Advanced Micro Devices	22, 23, 91	• Fujitsu Limited	103	■ Permag Corporation	234
‡ Allen Bradley	104A, 104B	GCA Corporation	68, 69	• Philips Elcoma Market Promotion	1E
• Altos Computer Systems	166, 167	• GEC M-O Valve	168	■ Piher International	11
American Microsystems, Inc.	108, 109	General Instrument Microelectronics	53	Plastics Engineering Company	186
AMF/Potter & Brumfield	35	G&H Technology	75	‡ Plessey Semiconductors	168
■ AMP, Inc.	190, 191	■ Global Specialties Corporation	38	Polaroid/Industrial	144
Astro Med	251	• Gould Inc., Instruments Division	2E, 3E, 205	Pomona Electronics	242
Augat, Inc.	150, 151	Gould Inc., SC Operations	30, 31	Power One, Inc.	200
‡ AVX	161	Hamilton/Avnet Electronics	4C	■ Pro-Log	65
■ Basler Electric Company	194	■ Hewlett Packard	1, 2, 181, 203	■ Pulse Engineering	216
Bausch & Lomb Scientific Optical Products	105	Hilevel Technology, Inc.	16	Racal-Vadic	189
■ Bendix Electrical Components	246	‡ Hitachi America, Ltd.	166, 167	Radiometer Electronics, U.S., Inc.	10
Berg Electronics	70, 71	Honeywell Optoelectronics Division	48A, 48F	RCA/OEM	226
• Bias Microelectronics	173	‡ Hughes Aircraft Company	244	RCA Solid State	59, 199
Bourns, Inc.	106, 107	Hughes Aircraft, Solid State Products	175	■ Robinson Nugent, Inc.	243
Burroughs	188	• Inland International, Inc.	6E	Rockwell International	8
■ Bussmann Division McGraw Edison	147	Intel MSO	18, 19	Samtec, Inc.	249
Cambion	26	• Iskra Commerce Marketing	91	Scientific-Atlanta	141
Canon Business Machines	78	• Italtel/SIT	161	Semiconductor Equipment & Materials Institute	118
The Capitol Machine & Switch Company	240	■ ITT Cannon Electric	132	‡ SGS	50, 51
■ CELCO	101	ITT Jennings	214	Shugart Associates	2C
■ Cherry Electrical Products	13, 27	‡ ITT Schadow, Inc.	177, 187	• Siemens AG	4E, 7E
■ C & K Components	230	■ Jensen Tools & Alloys	234	Skan-A-Matic Corporation	248
Codenoll Technology Corporation	206	Kadak Products, Ltd.	226	Softool Corporation	12
Computrol Corporation	202	Key Tronic Corporation	209	• Sord Computer Systems, Inc.	173
■ Conap, Inc.	56	Kikusui International	72	Spectrum Control	12
■ Converter Concepts	212	Krohn-Hite Corporation	7	Sprague Electric	43, 45, 231
‡ Cortron	171	Lawrence Livermore Labs	260	Stanley Electric Company	245
‡ CTS Corporation	183	■ Lear Siegler, Inc.	171	Suwaseikosha	221
Cybernetic Micro Systems	238	■ LFE Corporation	230	■ Syntronic Instruments, Inc.	204
Daini Seikosha Company, Ltd.	234	Martin Marietta	254, 255	Systron Donner	82, 83
Data I/O Corporation	192	MDB Systems, Inc.	218	TDK Electronics Company, Ltd.	233
■ Delevan Division American Precision	80	■ Memodyne Corporation	232	• TEAC Corporation	8E
‡ Deltron, Inc.	253	■ Mepco/Electra	17	Tektronix	20, 21, 25, 66, 67
Dialight	258	Method Electronics	217	Teledyne Crystalonics	211
Digital Equipment, Microcomputer	152, 153	Microsoft	213	Taradyne, Inc.	88
Digital Resources, Inc.	26	■ Micro Technical Industries	182	Texas Instruments Semiconductor	164, 165, 185
Dolch Logic Instruments	79	■ Mini-Circuits Laboratory	5	Thick Film Systems	212
‡ Eaton Corporation, Cutler Hammer	103	3M Company Scotchflex	148, 149	• Thomson CSF Div. DTE	60
■ EECO, Inc.	236	Mitel Corporation	92	Three Phoenix Company	257
■ Electronic Navigation Industries	3C, 6	Molex, Inc.	196, 197	Trace Instruments	222
Elevam Electronic Tube Company, Ltd.	248	Monolithics Memories	47	Trilog, Inc.	195
■ EMI Technology	52	Morrow Design	239	Trio-Tech International	229
EMM SEECO	219	Motorola Corporate	36, 37	Triple I, Inc.	248
LM Ericsson Telematerial AB	250	■ Motorola, Inc., Component Products	208	TRW LSI Products	225
Everett/Charles Test Equipment, Inc.	235	MT Micro Systems	77	TRW Optron	14
Fairchild Analog & Components	210	• Murata Manufacturing Company, Ltd.	228	‡ US Instrument Rentals	228
Fairchild Semiconductor	110, 111	Nicolet Instrument Corporation	32	United Systems Corporation	54
Fairchild Test Systems	86, 87	Nippon Electric Company, Ltd.	28, 29	Universal Data Systems	112
FEME S.p.A.	49	Noritake Electronics, Inc.	207	Universal Instruments	240
■ Ferranti Packard, Ltd.	238	Oak Industries	223	• Vero Electronics, Ltd.	51
■ First Computer Corporation	15	OKI Semiconductor	215	Viahay Resistive Systems Group	184
John Fluke Manufacturing Company	84, 85, 95, 97	Osborne & Associates, Inc.	90	VLSI Technology	232
■ Franklin Electric	62	Panasonic	252		

Votan	55
Weckesser Company, Inc.	48
Western Digital	81, 241
Weston Controls	220
White, SS Industrial Products	250
Mark Williams Company	9
Wiltron	162, 163
‡ Woven Electronics	173
Zenith Corporation	129
■ ZyMos	12, 78

<b>Classified and employment advertising</b>	
GTE Subscriber Network Products	263, 265
International Education Services	264
Ohio Medical Products	262
Southwest Technical	264
J. Robert Thompson Companies Inc.	262
United Technologies Microelectronics Center	262

- For more information of complete product line see advertisement in the latest Electronics Buyers Guide
- \* Advertisers in Electronics International
- ‡ Advertisers in Electronics domestic edition
- Advertisers in regional issue

## FIBER OPTICS VOCABULARY



The basic reference document on fiber optic and lightwave communications for those who design, develop, operate, use, manage, or manufacture communications or data processing equipment and components.

- 1400 entries, with
- inversions and cross-references
- index of terms

### Order your copies today!

\$12.95 each, discounts of 10% on orders of more than 10.



Electronics Magazine Books  
P.O. Box 669  
Hightstown, NJ 08520  
Tel. 609/448-1700, ext. 5494

# The biographies of 5,240 of your colleagues...

## Profiles the Top Management of Major Electronics Firms throughout the World —and more

This is the only reference devoted solely to biographies of the most influential people in electronics: corporate executives... technical managers... designers and developers of important products and processes... government and military officials... academics... editors and publishers... securities analysts... directors of trade and professional groups... and consultants.

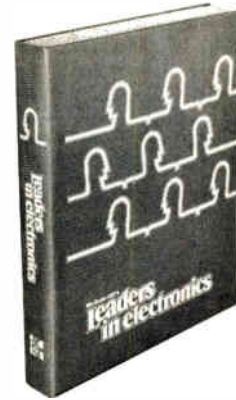

## McGraw-Hill's Leaders in Electronics

Prepared by the Staff of Electronics

651 pages

### As easy to read as any professional publication in electronics

With LEADERS IN ELECTRONICS on your bookshelf, you no longer have to search through many different sources for biographical data on your colleagues. What's more, you don't have to strain your eyes reading minuscule type, nor do you have to waste valuable time trying to decipher seemingly endless paragraphs of abbreviations. Boldface type spotlights the various information categories so that you can scan entries rapidly to pinpoint what you need.

### Unique convenience feature... Index of biographees by affiliation

A special 80-page index lists individual organizations alphabetically, complete with the names and titles of top employees. By looking up the names in the general biography listing, you can get a complete profile of the organization's top management in a matter of minutes. Plus an easy-access listing of independent consultants in every electronics specialty.

#### Electronics Magazine Books

P.O. Box 669, Hightstown, NJ 08520

Send me \_\_\_\_\_ copies of *Leaders in Electronics* @ \$39.50 plus applicable sales tax. McGraw-Hill pays regular shipping and handling charges on pre-paid orders.

I must be fully satisfied or you will refund full payment if the book is returned after ten-day trial examination.

- Payment enclosed
- Bill firm
- Bill me
- Charge to my credit card:  American Express
- Diners Club
- Visa
- Master Charge

Acct. No. \_\_\_\_\_ Date Exp. \_\_\_\_\_

On Master Charge only, first numbers above name \_\_\_\_\_

Name \_\_\_\_\_

Company \_\_\_\_\_

Street \_\_\_\_\_

City \_\_\_\_\_ State \_\_\_\_\_ Zip \_\_\_\_\_

Signature \_\_\_\_\_

# Books of special interest to our readers

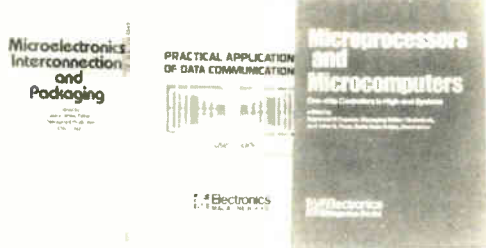

## Basics of Data Communications

This compilation of essential articles from *Data Communications* magazine includes chapters on terminals, acoustic couplers and modems, communications processors, networking, channel performance, data link controls, network diagnostics, interfaces, and regulations and policy. Pub. 1976. 303 pp

Order #R-6G3, \$12.95

## Circuits for Electronics Engineers

Almost 350 circuits arranged by 51 of the most useful functions for designers. Taken from the popular "Designer's Casebook" of *Electronics*, these circuits have been designed by engineers for the achievement of specific engineering objectives. Pub. 1977. 396 pp.

Order #R-711, \$15.95

## Design Techniques for Electronics Engineers

Expert guidance at every point in the development of an engineering project—making measurements, interpreting data, making calculations, choosing materials, controlling environment, laying out and purchasing components, and interconnecting them swiftly and accurately. Nearly 300 articles from *Electronics*' "Engineer's Notebook." Pub. 1977. 370 pp.

Order #R-726, \$15.95

## Microelectronics Interconnection and Packaging

Up-to-date articles from *Electronics* include sections on lithography and processing for integrated circuits, thick- and thin-film hybrids, printed-circuit-board technology, automatic wiring technology, IC packages and connectors, environmental factors affecting interconnections and packages, computer-aided design, and automatic testing. Pub. 1980. 320 pp.

Order #R-927, \$12.95

## Electronic Circuits Notebook

Contains 268 completely illustrated electronic circuits conveniently arranged by 39 vital functions, including amplifiers, audio circuits, control circuits, detectors, converters, display circuits, power supplies & voltage regulators, function generators, memory circuits, microprocessors, and many others. Pub. 1981. 344 pp. Order #R-026, \$14.95

## Memory Design: Microcomputers to Mainframes

The technology, devices, and applications that link memory components and system design. How to apply the new technology to meet specific design goals. Edited from the pages of *Electronics*. Pub. 1978. 180 pp. Order #R-732, \$12.95

## Microprocessors

The basic book on microprocessor technology for the design engineer. Published in 1975, articles are drawn from *Electronics*. 150 pp. Order #R-520, \$8.95

## Personal Computing: Hardware and Software Basics

More than 50 articles from leading publications give you up-to-date information on personal computing hardware, software, theory, and applications. Pub. 1979. 266 pp. Order #R-903, \$11.95

## Practical Applications of Data Communications: A User's Guide

Articles from *Data Communications* magazine cover architecture and protocols, data-link performance, distributed data processing, software, data security, testing and diagnostics, communications processors, and digitized-voice and data-plus-voice. Pub. 1980. 424 pp. Order #R-005, \$13.95

## Microprocessors and Microcomputers: One-chip Controllers to High-end Systems

Practical orientation to second- and third-generation 8-bit devices, the latest 16-bit devices, one-chip microcomputers, and software for microprocessors in 95 articles from *Electronics*. Pub. 1980. 482 pp. Order #R-011, \$13.95

## Advertising Sales Staff

**Advertising sales manager:** Norman Rosen  
3200 Wilshire Blvd., South Tower  
Los Angeles Calif. 90010 [213] 487-1160

## Market managers:

*Components:* William Boyle, Rochester, N.Y.  
*Computers & Peripherals:* Frank Mitchell, Boston  
*Test & Measurement:* Don Farris, San Francisco  
*Semiconductors:* Norman Rosen, Los Angeles

**Atlanta, Ga. 30309:** Peter Stien  
100 Colony Square, 1175 Peachtree St., N.E.  
[404] 892-2868

**Boston, Mass. 02118:** Frank Mitchell  
Paul F. McPherson, Jr.  
607 Boylston St., [617] 262-1160

**Cleveland, Ohio 44113:** William J. Boyle  
[716] 248-5620

**Fort Lauderdale, Fla. 33306:** Peter Stien  
3000 N.E. 30th Place, Suite #400  
[305] 563-9111

**New York, N.Y. 10020**  
1221 Avenue of the Americas  
John Gallie [212] 997-3616

Matthew T. Reseska [212] 997-3617  
**Philadelphia, Pa. 19102:** Matthew T. Reseska  
Three Parkway, [212] 997-3617

**Pittsburgh, Pa. 15222:** Matthew T. Reseska  
4 Gateway Center, [212] 997-3617

**Rochester, N.Y. 14534:** William J. Boyle  
Powder Mill Office Park, 1163 Pittsford-Victor Rd.,  
Pittsford, N.Y. 14534 [716] 248-5620

**Chicago, Ill. 60611**  
645 North Michigan Avenue  
Jack Anderson [312] 751-3739  
Robert M. Denmead [312] 751-3738

**Southfield, Michigan 48075:** Jack Anderson  
4000 Town Center, Suite 770, Tower 2  
[313] 352-9760

**Dallas, Texas 75201:** John J. Uphues  
2001 Bryan Tower, Suite 1070  
[214] 742-1747

**Denver, Colo. 80203:** Harry B. Doyle, Jr.  
655 Broadway, Suite 325  
[303] 825-6731

**Houston, Texas 77040:** John J. Uphues  
7600 West Tidwell, Suite 500  
[713] 462-0757

**Los Angeles, Calif. 90010:** Chuck Crowe  
3200 Wilshire Blvd., South Tower  
[213] 487-1160

**Costa Mesa, Calif. 92626:** Edward E. Callahan  
3001 Red Hill Ave. Bldg. #1 Suite 222  
[714] 557-6292

**Palo Alto, Calif. 94303:** Don Farris,  
Larry Goldstein, Lauren Scott  
1000 Elwell Court, [415] 968-0280

**Paris:** Michael Sales  
17 Rue-Georges Bizet, 75116 Paris, France  
Tel: 720-16-80

**United Kingdom:** Simon Smith  
34 Dover Street, London W1  
Tel: 01-493-1451

**Scandinavia:** Andrew Karnig and Assoc.  
and Simon Smith  
Kungsholmsgatan 10  
112 27 Stockholm, Sweden

Tel: 08-51-68-70 Telex: 179-51  
**Milan:** Ferruccio Silvera and A. Fabio Guarnieri  
1 via Baracchini, Italy  
Tel: 86-90-656

**Brussels:**  
23 Chaussee de Wavre  
Brussels 1040, Belgium  
Tel: 513-73-95

**Frankfurt/Main:** Fritz Krusebecker  
Liebigstrasse 27c, Germany  
Tel: 72-01-81

**Tokyo:** Akio Saijo and Hirokazu Nakamura  
McGraw-Hill Publications Overseas Corporation,  
Kasumigaseki Building 2-5, 3-chome,  
Kasumigaseki, Chiyoda-Ku, Tokyo, Japan  
[581] 9811

## Business Department

**Thomas M. Egan**  
Production Director  
[212] 997-3140

**Carol Gallagher**  
Production Manager  
[212] 997-2045

**Betty Preis**  
Production Manager Domestic  
[212] 997-2908

**Thomas Kazich**  
Production Manager Related Products  
[212] 997-2044

**Karen Walpole**  
Production Assistant  
[212] 997-2843

**Frances Vallone**  
Reader Service Manager  
[212] 997-6058

## Electronics Buyers' Guide

**H.T. Howland**, General Manager  
[212] 997-6642

**Regina Hera**, Directory Manager  
[212] 997-2544

## Classified and Employment Advertising

**Gerry F. Moss**, Manager  
[212] 997-2897

## Order today using this coupon!

Electronics Magazine Books  
P.O. Box 669  
Hightstown, NJ 08520  
Tel. (609) 448-1700, ext. 5494



Order #	Qty.	Price
R- _____	_____	\$ _____
R- _____	_____	\$ _____
R- _____	_____	\$ _____
R- _____	_____	\$ _____
R- _____	_____	\$ _____
Total		\$ _____

Name \_\_\_\_\_

Title \_\_\_\_\_

Company \_\_\_\_\_

Street/PO address \_\_\_\_\_

City/state/zip \_\_\_\_\_

Payment enclosed (payment must accompany orders under \$25)

Bill my company (or attach company Purchase Order)

Bill me

Ten-day money-back guarantee applies on all books.

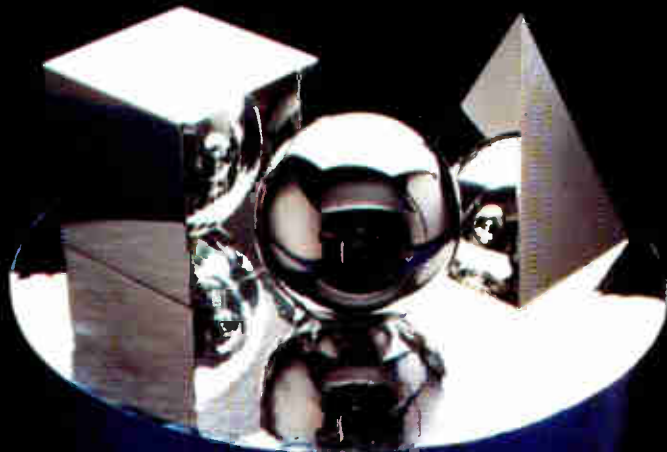

Wherever you need  
100 Watts of RF power  
from 10kHz to 400MHz...



# ENI has it covered.

Imagine the tremendous versatility you could enjoy with the extremely wide coverage of just these two broadband power amplifiers.

The **ENI 5100L** spans the frequency range of 1.5 to 400 MHz with a Class A linear output rating of 100 Watts and a flat 50 dB gain. And it will deliver 200 Watts from 1.5 to 200 MHz.

The **ENI 2100L** covers the range from 10 kHz to 12 MHz with a Class A linear output of more than 100 Watts. And it, too, can deliver 200 Watts over much of its useful frequency range.



Both units are solid state. Both units are unbelievably rugged. Unconditionally stable. Will not oscillate for any conditions of load or source imped-

ance. And will withstand all mismatched loads including short and open circuits.

Now there's no need to buy a whole expensive spread of individual units. With just these two portable amplifiers, you can work on an almost infinite range of applications. If it's 100 Watts... ENI has it covered!

For more information, a demonstration, or a full line catalog, please contact us at ENI, 3000 Winton Road South, Rochester, NY 14623. Call 716/473-6900, or telex 97-8283 ENI ROC.

# ENI

The advanced design line of RF power amplifiers

ENI products available through ENI Power Systems, Ltd., 23 Old Park Road, Hitchin, Hertfordshire, England SG52JS, Tel: Hitchin 51711, TELEX 825153 ENI UK G. And: **AUSTRALIA:** Elmeasco Instruments Pty. Ltd., Concord N.S.W. Australia, Tel: 939-7944 **BELGIUM:** Regulation-Mesure S.P.R.L., 1150 Brussels, Belgium, Tel: 771.20.20 **DENMARK:** Instrutek, 8700 Horsens, Tel: 05-611100 **EGYPT:** Electronic Precision Instrument Co., P.O. Box 1262, Cairo, Arab Republic of Egypt, Tel: 860819 **FRANCE:** Comsatec, 92300 Levallois-Perret, France, Tel: 758.59.10 **GERMANY, AUSTRIA:** Kontron Elektronik GmbH, 8057 Eching/Munich 1, Germany, Tel: 89-3188-1 **ISRAEL:** RDT Electronics Engineering Ltd., Tel Aviv 61210, Israel, Tel: 483211-5 **ITALY:** Vianello S.p.A., I-20121 Milano, Italy, Tel: 34.52.071 **JAPAN:** Astech Corporation, Shinjuku-ku, Tokyo 160, Japan, Tel: Tokyo 343-0601 **NETHERLANDS:** Koning en Hartman Elektrotechniek B.V., The Hague 2040, Netherlands, Tel: 70-678380 **SOUTH AFRICA:** Associated Electronics (Pty.), Ltd., Johannesburg, South Africa, Tel: 724-5396 **SWEDEN:** Saven AB, S-18500 Vaxholm, Sweden, Tel: 0764/31580 **SWITZERLAND:** Kontron Electronic AG, 8048 Zurich, Switzerland, Tel: 01 62 82 82 **UNITED KINGDOM:** Dale Electronics, Ltd., Fnmley Green, Camberley, Surrey, England, Tel: Deepcut (02516) 5094

Circle 250 on reader service card

World's largest  
local distributor  
with 44 locations  
stocking the finest  
lines of electronic  
components and  
computer products

**ALABAMA**

Huntsville (205) 837-7210

**ARIZONA**

Phoenix (602) 231-5100

**CALIFORNIA**

Avnet, L.A. (213) 558-2345

Avnet, O.C. (714) 754-6111

Hamilton, L.A. (213) 558-2121

Hamilton, O.C. (714) 641-4100

San Diego (714) 571-7510

San Francisco (408) 743-3355

**COLORADO**

Denver (303) 779-9998

**CONNECTICUT**

Danbury (203) 797-2800

**FLORIDA**

St. Petersburg (813) 576-3930

Miami (305) 971-2900

**GEORGIA**

Atlanta (404) 447-7507

**ILLINOIS**

Chicago (312) 860-7700

**INDIANA**

Indianapolis (317) 844-9333

**KANSAS**

Kansas City (913) 888-8900

**MARYLAND**

Baltimore (301) 995-3500

**MASSACHUSETTS**

Boston (617) 273-7500

**MICHIGAN**

Detroit (313) 522-4700

Grand Rapids (616) 243-8805

**MINNESOTA**

Minneapolis (612) 932-0600

**MISSOURI**

St. Louis (314) 344-1200

**NEW JERSEY**

Fairfield (201) 575-3390

Cherry Hill (609) 424-0100

**NEW MEXICO**

Albuquerque (505) 765-1500

**NEW YORK**

Long Island (516) 454-6060

Syracuse (315) 437-2641

Rochester (716) 475-9130

**NORTH CAROLINA**

Raleigh (919) 829-8030

**OHIO**

Cleveland (216) 831-3500

Dayton (513) 433-0610

**OREGON**

Portland (503) 635-8831

**TEXAS**

Dallas (214) 659-4111

Houston (713) 780-1771

Austin (512) 837-8911

**UTAH**

Salt Lake City (801) 972-2800

**WASHINGTON**

Seattle (206) 453-5844

**WISCONSIN**

Milwaukee (414) 784-4510

**INTERNATIONAL**

Telex 66-4329

Telephone (213) 558-2441

**CANADA**

Toronto (416) 677-7432

Montreal (514) 331-6443

Ottawa (613) 226-1700

Calgary (403) 230-3586

**JAPAN**

Tokyo (03) 662-9911

Osaka (06) 533-5855

# WE STOCK FAIRCHILD FROM A TO ZENER.

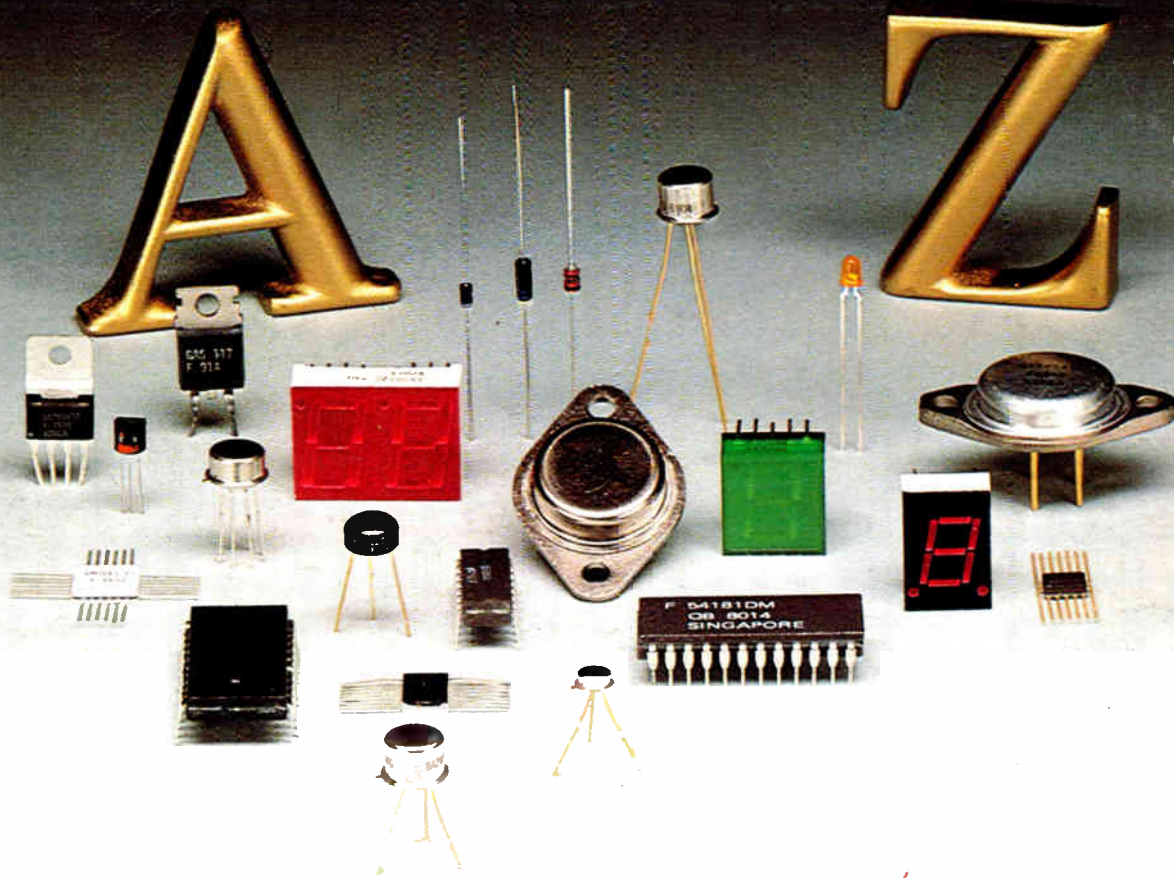

## FAIRCHILD from HAMILTON/AVNET

Call your nearby Hamilton/Avnet  
location for immediate off-the-shelf  
delivery of the entire line of  
Fairchild semiconductor products.



**Hamilton Avnet**  
ELECTRONICS A DIV. OF AVNET, INC.

"We're large enough to be local."

Circle 902 on reader service card