

MARCH 13, 1980

**HOW COMPANIES AND NATIONS MANAGE R&D/81**

Special report: the many faces of alphanumeric displays/ 127

Semiconductor reliability, Japanese style/ 140



FOUR DOLLARS A MCGRAW-HILL PUBLICATION

# Electronics®

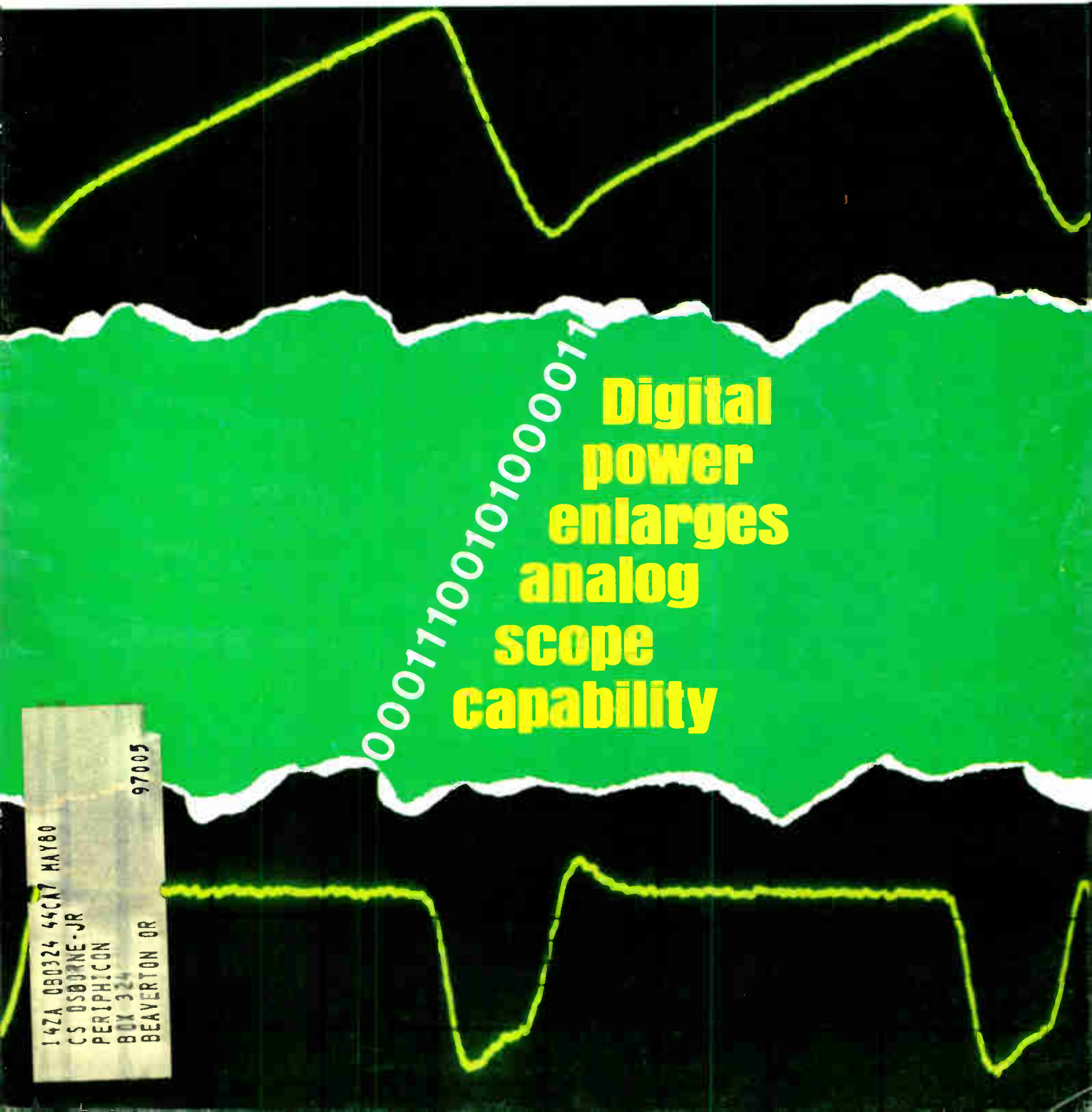

0001100101000011

**Digital  
power  
enlarges  
analog  
scope  
capability**

14ZA 080324 44CA7 MAY80  
CS OSBORNE - JR  
PERIPHICON  
BOX 324  
BEAVERTON OR 97005

# New Hybrid Modular Pot...



**For long life,  
infinite resolution,  
low TC and tight linearity.**

Now there's a new element in the Bourns Model 80 family of modular pots. It's the Model 83/84 10-turn modular pot with the exclusive Bourns Hybritron® resistance element combining the best of both

worlds . . . wirewound and conductive plastic.

The Hybritron element displays the long operational life (4,000,000 shaft revolutions), essentially

infinite resolution and low noise characteristics of a pure conductive plastic element. It also exhibits the low tempco (+100 ppm/°C), tight linearity ( $\pm 0.25\%$  max) and resistance stability approaching that of a pure wirewound element.

There's more. The Model 83/84 Hybritron pot is available with either PC pins or solder lugs. As with all of the

Model 80's, it requires only one mounting hole and occupies just a  $\frac{5}{8}$ " square area on the panel. It can be ganged up to two modules and is fully compatible with all other members of the Model 80 family, including combinations of 10-turn, single turn or switch modules. Priced just slightly higher than the Model 83/84 wirewound style, it's available in standard resistance values from 1K to 100K with various options.

For the best of both worlds, contact your local Bourns representative or send today for your new PC-1 Panel Controls catalog. See the 1979-80 EEM directory, Volume 2, pages 3754, 3755.

CONTROLS DIVISION, BOURNS, INC.,  
1200 Columbia Avenue, Riverside, CA 92507  
Phone: 714 781-5305 TWX: 910 332-1252

European Headquarters: Bourns AG, Zugerstrasse 74 6340 Baar, Switzerland. Phone: 042 33 33 33. Telex: 78722.

CONDUCTIVE PLASTIC  
COATING OVER  
WIREWOUND ELEMENT

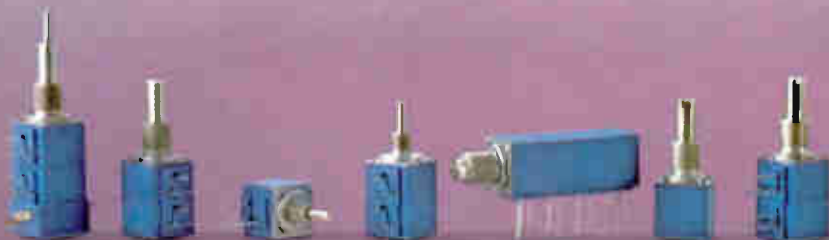

*The last word in resistive components*

# BOURNS®

Facts from Fluke on low-cost DMM's

# Conductance: What it is, and what it can do for you.

We've often referred to conductance as the "missing function" in DMM's — the capability so many of you have wanted in a DMM but couldn't find until we introduced the 8020A Analyst.

Since its introduction, the Fluke 8020A has become the world's best-selling DMM. And four more low-cost models with conductance ranges have been added to our line. But you'll still find this function only on Fluke DMM's.

Simply stated, conductance lets you make resistance measurements far beyond the capacity of ordinary multimeters. Until the 8020A, there was no way to make fast, accurate readings from 20 M $\Omega$  to 10,000 M $\Omega$  — ranges typically plagued by noise

pickup. Yet, measurements at these levels are vital in verifying resistance values in high-voltage dividers, cables and insulators.

With conductance, the inverse of ohms, which is expressed in Siemens — Fluke DMM's can measure extreme resistances. Simple conversion of direct-reading conductance values, then, yields resistance measurements to 10,000 M $\Omega$  (and 100,000 M $\Omega$  with the 8050A), without

special shielding and using standard test leads.

Here the 8020A is being used to check leakage in a teflon pcb. With a basic dc accuracy of 0.1% and an exclusive two-year warranty, this seven-function handheld DMM has made hundreds of new troubleshooting techniques such as this possible, and more are being discovered every day.

For more details, call toll free 800-426-0361; use the coupon below; or contact your Fluke stocking distributor, sales office or representative.



8020A  
Multimeter

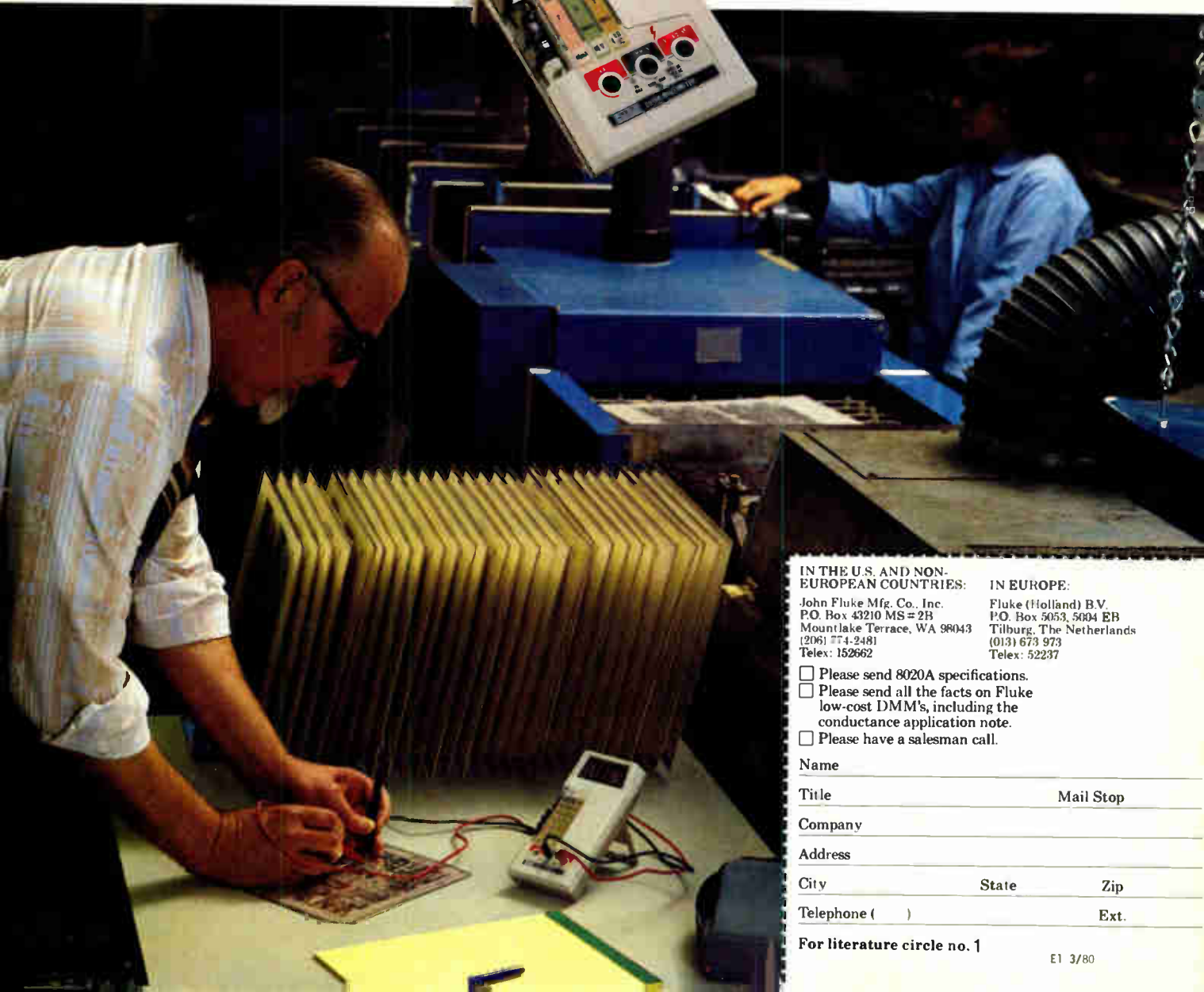

IN THE U.S. AND NON-EUROPEAN COUNTRIES:

John Fluke Mfg. Co., Inc.  
P.O. Box 43210 MS = 2B  
Mountlake Terrace, WA 98043  
(206) 774-2481  
Telex: 152662

IN EUROPE:

Fluke (Holland) B.V.  
P.O. Box 5053, 5004 EB  
Tilburg, The Netherlands  
(013) 673 973  
Telex: 52237

- Please send 8020A specifications.
- Please send all the facts on Fluke low-cost DMM's, including the conductance application note.
- Please have a salesman call.

Name \_\_\_\_\_

Title \_\_\_\_\_

Mail Stop \_\_\_\_\_

Company \_\_\_\_\_

Address \_\_\_\_\_

City \_\_\_\_\_

State \_\_\_\_\_

Zip \_\_\_\_\_

Telephone ( ) \_\_\_\_\_

Ext. \_\_\_\_\_

For literature circle no. 1

E1 3/80

# Z-2H Computer System

A B

C Cromemco

## Low-cost hard disk computers are here and field proven

11 megabytes of hard disk and 64 kilobytes of fast RAM in a Z80A computer for under \$10K. Two floppy drives, too. Naturally, it's from Cromemco.

It's a reality. In Cromemco's new Model Z-2H you get all of the above and even more. With Cromemco you get it all.

In this new Model Z-2H you get not only a large-storage Winchester hard disk drive but also two floppy disk drives. In the hard disk drive you get unprecedented storage capacity at this price—11 megabytes unformatted.

You get speed—both in the 4 MHz Z80A microprocessor and in the fast 64K RAM which has a chip access time of only 150 nanoseconds. You get speed in the computer minimum instruction execution time of 1 microsecond. You get speed in the hard disk transfer rate of 5.6 megabits/sec.

### EXPANDABILITY

You get expandability, too. The high-speed RAM can be expanded to 512 kilobytes if you wish.

And the computer has a full 12-slot card cage you can use for additional RAM and interface cards.

### BROADEST SOFTWARE SUPPORT

With the Z-2H you also get the broadest software support in the

microcomputer field. Software Cromemco is known for. Software like this:

- Extended BASIC
- FORTRAN IV
- RATFOR (RATional FORtran)
- COBOL
- Z80 Macro Assembler
- Word Processing System
- Data Base Management

with more coming all the time.

### SMALL, RUGGED, RELIABLE

With all its features the new Z-2H, including its hard disk drive, is still housed in just one compact cabinet.



Hard disk drive at lower left can be interchanged just by sliding out and disconnecting plug. Seven free card slots are available. Z-2H includes printer interface card.

Included in that cabinet, too, is Cromemco ruggedness and reliability. Cromemco is time-proved. Our equipment is a survey winner for reliability. Of course, there's Cromemco's all-metal cabinet. Rugged, solid. And, there's the heavy-duty power supply (30A @ 8V, 15A @ +18 V, and 15A @ -18V) for circuitry you'll sooner or later want to plug into those free card slots.

### SEE IT NOW

Last summer we told you this new Z-2H would be a smash. And it is. So see it at your dealer's now. Have him put you in touch with a user—there are lots of them because Cromemco has been delivering for months. See for yourself how pleased our users are.

### PRESENT CROMEMCO USERS

We've kept you in mind, too. Ask about the new Model HDD Disk Drive which can combine with your present Cromemco computer to give you up to 22 megabytes of disk storage.

 **Cromemco**  
Incorporated  
280 BERNARDO AVE., MOUNTAIN VIEW, CA 94040 • (415) 964-7400  
Tomorrow's computers today

## 105 Technical Articles

### INSTRUMENTS

**On-board digital processing refines scope measurements, 105**

### MEMORIES

**Good bits swapped for bad in 64-K E-PROM, 115**

### SPECIAL REPORT

**Display technologies offer rich lode for designers, 127**

### COMPONENTS

**How Japanese manufacturers achieve high IC reliability, 140**

DESIGNER'S CASEBOOK: 122

ENGINEER'S NOTEBOOK: 148

---

## 39 Electronics Review

COMMUNICATIONS: Fiber optics going underwater, 39  
PRODUCTION: Manufacturers design out gold, 40  
COMPONENTS: Data compression cuts driver lines, 41  
MEMORIES: Bubble offerings start to balloon, 41  
SOLID STATE: Japanese RAMs hit 512 K, 42  
INSTRUMENTS: Intel, TI upgrade GPIB chips, 44  
PERIPHERALS: LSI is rampant in tape subsystem, 46  
MEMORIES: TI to push its E-PROM pinout, 46  
CONSUMER: Add-on + TV game = home computer, 46  
Other makers eye RCA video disk, 48  
NEWS BRIEFS: 48

## 63 Electronics International

BRITAIN: Twin-E-beam unit positions accurately, 67  
JAPAN: Augmented raster scans speeds up  
electron-beam machine, 68  
FRANCE: Loose fit cuts optic-cable loss, 70  
WEST GERMANY: Laser computer link transmits  
more than 1 Mb/s, 70  
AROUND THE WORLD: 72

## 81 Inside the News

U. S. is losing ground in the lab, 81

## 88 Probing the News

COMPONENTS: April in Paris has a familiar air, 88  
SEMICONDUCTORS: Foundry plan is called answer to  
bigness, 90  
ABROAD: Siemens has big plans for Sipmos, 92  
UK calls for engineering elite, 94

## 157 New Products

IN THE SPOTLIGHT: Smart multimeter measures and  
calculates, 157  
Disk drive drops development cost, 166  
MICROCOMPUTERS & SYSTEMS: Compact emulator  
simulates I/O, 168  
DATA ACQUISITION: Accurate d-a unit spans 70°C, 174  
POWER SUPPLIES: 4.5-W supply is only 0.4 in. high, 184  
COMPONENTS: LED display is interactive, 194  
COMMUNICATIONS: Unit tests PCM channels, 204

## Departments

Highlights, 4  
Publisher's letter, 6  
Readers' comments, 8  
News update, 12  
People, 14  
Editorial, 22  
Meetings, 26  
Electronics newsletter, 33  
Washington newsletter, 55  
Washington commentary, 56  
International newsletter, 63  
Engineer's newsletter, 152  
Products newsletter, 217  
New literature, 220

## Services

Reprints available, 188  
Employment opportunities, 229  
Reader service card, 237

EDITOR-IN-CHIEF: Samuel Weber

MANAGING EDITORS  
*Technical:* Raymond P. Capece,  
Alfred Rosenblatt  
*News:* Gerald M. Walker  
*International:* Arthur Erikson

ASSISTANT MANAGING EDITORS: Howard Wolff,  
Margaret Eastman

SENIOR EDITOR: Ray Connolly

ART DIRECTOR: Fred Sklenar

ASSOCIATE EDITOR: Benjamin A. Mason

DEPARTMENT EDITORS  
*Aerospace/Military:* Ray Connolly  
*Circuit Design:* Vincent Biancomano  
*Communications & Microwave:*  
Harvey J. Hindin  
*Components:* Roger Allan  
*Computers & Peripherals:* Anthony Durniak  
*Industrial/Consumer:* Gil Bassak  
*Test, Measurement & Control:*  
Richard W. Comerford  
*New Products:* Ana Bishop  
*Packaging & Production:* Jerry Lyman  
*Solid State:* John G. Posa

CHIEF COPY EDITOR: Margaret Eastman

COPY EDITORS: Mike Robinson,  
Charlotte Wiggers, Jeremy Young

ART: Charles D. Ciatto, *Associate Director*  
Paula Piazza, *Assistant Director*

EDITORIAL SECRETARIES: Maryann Tusa,  
Penny Reitman, Gail Walker

EDITORIAL ASSISTANT: Marilyn B. Steinberg

REGIONAL EDITORS  
*New York:* Pamela Hamilton (212) 997-2306  
*Boston:* James B. Brinton,  
Linda Lowe (617) 262-1160  
*Chicago:* Larry Marion (312) 751-3805  
*Dallas:* Wesley R. Iversen (214) 742-1747  
*Los Angeles:* Larry Waller (213) 487-1160  
*Palo Alto:* Bruce Le Boss, *Manager*  
Martin Marshall, *Computers & Instruments*  
(415) 968-2712  
*Washington:* Ray Connolly (202) 624-7592  
*Frankfurt:* John Gosch 72-5566  
*London:* Kevin Smith 493-1451  
*Paris:* Arthur Erikson,  
Kenneth Dreyfack 720-20-70  
*Tokyo:* Charles Cohen 581-9816

McGRAW-HILL WORLD NEWS  
*Editor:* Michael Johnson  
*Brussels:* James Smith  
*Milan:* Jeff Ryser  
*Moscow:* Peter Hann  
*Stockholm:* Robert Skole  
*Tokyo:* Robert Neff

PUBLISHER: Paul W. Reiss

GENERAL MANAGER, DIRECT MARKETING  
OPERATIONS: Horace T. Howland  
CIRCULATION MANAGER: Herbert A. Hunter  
RESEARCH MANAGER: Margery D. Sholes  
MARKETING ADMINISTRATION MANAGER:  
Frances M. Vallone  
BOOKS & SPECIAL PROJECTS MANAGER:  
Janet Eyer

## Cover: 16-bit brain adds to scope's capability, convenience, 105

Waveform digitizers working alongside oscilloscopes have been feeding data to computers for some time, but now Tektronix has built considerable microcomputer power right into a 400-MHz digitizing scope. Measurements that had to be eyeballed before can now be performed with increased accuracy at the touch of a button, as can a number of common but complex types of waveform analysis. The instrument can be programmed by anyone familiar with scientific calculators and is as much at home in automatic testing environments as it is in the lab.

## Europeans, Japanese push ahead in R&D, 81

In the second in a series on the international status of research and development, France, West Germany, and Japan share the spotlight as leaders in R&D spending as a portion of gross national product. The Common Market is a strong force behind the European efforts.

## Dealing with defects in a high-density E-PROM, 115

At the 64-K level, Mostek is bending over backwards to increase yields. Going beyond the addition of a few redundant rows and columns, the company has designed its MK2764 with entire blocks of redundant bit cells representing a 20% overhead in storage area. The chip also has features that allow testing for programming stress problems that have been escaping manufacturers' notice.

## Display field blooms with many-colored choices, 127

Proliferating display technologies are confronting the designer with a baffling array of alternatives. A special report sorts through them, pointing out trends to increased brightness, efficiency, color and size choices, and microprocessor-based intelligence in display systems. The CRT's shortcomings leave opportunities open for other technologies.

## Japanese IC makers know that neatness counts, 140

So utterly have they turned the problem around, it's easy to forget that Japanese electronics manufacturers ever had a reputation for poor quality. Claiming the lowest part-failure rates in the industry, they say that screening for bad parts is the method they rely on least: their approach involves a company's entire design, managing, and production staff.

## . . . and in the next issue

A special report on the Japanese computer industry . . . ion-beam IC fabrication techniques, one writing with a focused beam and the other using masks, look promising for submicrometer line widths . . . a simple and dense new stacked-fuse PROM technology.

March 13, 1980 Volume 53, Number 6 100,292 copies of this issue printed

Electronics (ISSN 0013-5070) Published every other Thursday with an additional issue this April by McGraw-Hill, Inc. Founder James H. McGraw, 1860-1948. Publication office 1221 Avenue of the Americas, N.Y., N.Y. 10020, second class postage paid at New York, N.Y. and additional mailing offices.

Executive, editorial, circulation and advertising addresses: Electronics, McGraw-Hill Building, 1221 Avenue of the Americas, New York, N.Y. 10020 Telephone (212) 597-1221 Teletype 12-7950 TWX 710-581-4879 Cable address MCGRAW HILL NEWS YORK

Subscriptions limited to professional persons with active responsibility in electronics technology. No subscriptions accepted without complete identification of subscriber name, title or job function, company or organization, and product manufactured or services performed. Based on information supplied, the publisher reserves the right to reject non-qualified requests. Subscription rates in the United States and possessions \$17 one year, \$29 two years, \$43 three years, company addressed and company libraries \$23 one year, \$41 two years, \$58 three years, APO/FPO addressed \$35 one year only. Canada and Mexico \$19 one year, \$32 two years, \$47 three years, Europe \$46 one year, \$78 two years, \$110 three years; Japan, Israel and Brazil \$70 one year, \$115 two years, \$165 three years; Australia and New Zealand \$95 one year, \$170 two years, \$240 three years, including air freight, all other countries \$50 one year, \$85 two years, \$125 three years. Limited quota of subscriptions available at higher-than-basic rate for persons allied to field served. Check with publisher for these rates. Single copies \$4.00, special issue \$9.00. Please allow four to eight weeks for shipment.

Officers of McGraw-Hill Publications Company Paul F. McPherson, President; Executive Vice Presidents James E. Boddorf, Gene W. Simpson, Group Vice President Daniel A. McMillan, Senior Vice President Editorial Ralph R. Schütz, Vice Presidents Kemp Anderson, Business

Systems Development, Stephen C. Croft, Manufacturing; Robert B. Doll, Circulation; James E. Hackett, Controller; William H. Hammond, Communications; Eric B. Heir, Planning and Development; John W. Patten, Sales; Edward E. Schirmer, International.

Officers of the Corporation Harold W. McGraw, Jr., President, Chief Executive Officer, and Chairman of the Board, Robert N. Landes, Senior Vice President and Secretary, Ralph J. Webb, Treasurer.

Title registered in U.S. Patent Office, Copyright © 1980 by McGraw-Hill, Inc. All rights reserved. The contents of this publication may not be reproduced in whole or in part without the consent of copyright owner.

Where necessary, permission is granted by the copyright owner for libraries and others registered with the Copyright Clearance Center (CCC), P.O. Box 8991, Boston, MA 02114, to photocopy any article herein for the base fee of \$0.50 per copy of the article plus \$0.25 per page. Payment should be sent directly to the CCC. Copying done for other than personal or internal reference use without the express permission of McGraw-Hill is prohibited. Requests for special permission or bulk orders should be addressed to the publisher. ISSN 0013-5070/80\$0.50+25.

Subscribers: The publisher, upon written request to our New York office from any subscriber, agrees to refund that part of the subscription price applying to copies not yet mailed. Please send change-of-address notices or complaints to Fulfillment Manager, subscription orders to Circulation Manager, Electronics, at address below. Change-of-address notices should provide old as well as new address, including zip codes. Attach address label from recent issue. Allow one month for change to become effective. Subscriber Service call (609) 448-8110, 9 a.m. to 4 p.m. EST.

Postmaster: Please send form 3579 to Fulfillment Manager, Electronics, P.O. Box 430, Hightstown, N.J. 08520.

# smart power for ATE!

PROGRAMMABLE POWER FOR YOUR AUTOMATIC TEST EQUIPMENT

## KEPCO series **ATE** power supplies

- programmable from IEEE-488 bus with Kepco digital interfaces
- automatic crossover voltage and current stabilization
- 0.001% stabilization (load effect)
- 0.0005% stabilization (source effect)
- programmable over-voltage crowbar with flag
- fast programming capability
- five groups, 50 Watts to 1000 Watts



50 & 100 WATT MODELS

250 WATT MODEL

**KEPCO**® For complete specifications, write Dept. COF-14

KEPCO, INC. • 131-38 SANFORD AVENUE • FLUSHING, N.Y. 11352 U.S.A. • (212) 461-7000 • TWX #710-582-2631 • Cable: KEPCOPOWER NEWYORK

Circle 5 on reader service card

# Now... the only RF power amplifier you may ever need.

The new ENI 550L  
delivers 50W, 1.5-400 MHz.



This single unit is so incredibly versatile it can replace several you may be using now. And you may never need another. It's an extremely broadband high power, solid state, Class A linear amplifier. It's rated at 50W from 1.5-400 MHz. But it can provide 100 Watts from 1.5-220 MHz. All you need with the 550L is any standard signal or sweep generator and you've got the ultimate in linear power for such applications as RFI/EMI testing, NMR, RF Transmission, ultrasonics and more.

And, like all ENI power amplifiers, the 550L features unconditional stability, instantaneous failsafe provisions, and absolute protection from overloads and transients.

The 550L represents the pinnacle in RF power versatility. There's nothing like it commercially available anywhere! And it may be the only RF power amplifier you ever need.

For more information, a demonstration, or a full line catalog, please contact us at ENI, 3000 Winton Road South, Rochester, NY 14623. Call 716/473-6900, or telex 97-8283 ENI ROC.

## ENI



The advanced  
design line of  
power amplifiers

## Publisher's letter

As components editor Roger Allan began work four months ago on the special report on display technology that appears on page 127, he was impressed by the conviction and zeal with which various researchers in flat-panel displays viewed developments in the marketplace. The recurring theme went more or less like this: "Ours is without a doubt the flat-screen, thin-panel display of the future. All those other display efforts are heading down the wrong road." Needless to say, it was difficult to get many unbiased views, a state of affairs that makes this technology unusual.

But Roger did manage to find some display experts willing to step back and take the long view of the various technologies and their worth. They generally believe that different approaches will find different niches in the marketplace. A refreshing outlook is that of Elliot Schlam. In his work at the Army's Electronic Research and Development Command—called Eradcom—at Fort Monmouth, N. J., Schlam was seeking a rugged and versatile flat-panel display for the military. While pointing to ac electroluminescent technology as one with the best potential for military flat panels, he is careful to point out that for other applications, particularly those outside the military, all of the leading flat-panel approaches now being taken are good candidates.

Speaking of research and development, it is again the subject of the Inside the News in this issue (p. 81), and for some pretty good reasons. "It's a big subject in more ways than one," says Jim Brinton, our Boston bureau chief. "Not only does the

R&D story have more facets than a good diamond, but further, there seems to be a lot of confusion in business and industry about what it all means."

Having become more of an authority in the course of covering the R&D story than he would like, Jim is now venturing some opinions of his own. "First," he says, "neither government nor industry is spending enough, and what they do allocate gets eaten up by rising costs, inflation, and some costly government requirements—often well-intentioned but absurd. Second, there seems to be a tendency in the U. S. to try to penalize success; profit is a dirty word, but you don't make money—or create industries and jobs—without taking risks, and R&D is inherently risky. We ought to encourage it, but instead seem to be strangling it.

"And third, other nations seem to be more pragmatic about R&D. They often spend more on basic research than we do, and that's where the next decade's new technologies, industries, and jobs are coming from."

This part of the R&D story came from our bureaus in Frankfurt, London, Paris, and Tokyo.

The annual index of *Electronics* articles, a complete and handy compilation that will direct you to everything we printed last year, will be available soon. For a free copy, circle 370 on the reader service card.

### Why not an editorial career?

*Electronics* has available challenging editorial positions for electronics engineers with a bent for journalism. Our editors keep abreast of and write or edit articles on the latest trends in electronic technology. Right now, we're looking for editors to cover microcomputer systems and software and with general expertise. A bachelor's degree and design experience are desirable. Salary and benefits are excellent. Write a letter telling us about yourself to the Managing Editor (Technical) at *Electronics*, 1221 Avenue of the Americas, New York, N. Y. 10020.



# The scope that never forgets.

Gould's digital OS4000 stores event data for the life of the scope. Solid state memory lets the Gould OS4000 give you instant replay of stored event data for as long as you need it (while the unit is getting power). In addition to the event itself, the OS4000 uniquely stores and displays what happened before the event and after it. The OS4000 can then expand the event display so you can study it in slow motion detail. Plus, it also allows you to compare delayed and original sweeps. And, when needed, the OS4000 can perform as a real-time scope with



a bright, stable, flicker-free display.

The Gould OS4000 is easy to operate whether it's being used as a digital storage or conventional oscilloscope, waveform recorder, transient recorder, comparator or signal generator. Interfaced with a recorder, the OS4000 can generate hard copy data from both ongoing events or 'replayed' displays.

For more information on the scope that out-remembers any tube storage scope on the market, contact Gould Inc., Instruments Division, 3631 Perkins Ave., Cleveland, Ohio 44114.

**For brochure call toll-free: 800-331-1000 (in Oklahoma, call collect 918-664-8300).**

 **GOULD**

An Electrical/Electronics Company

Circle 7 on reader service card



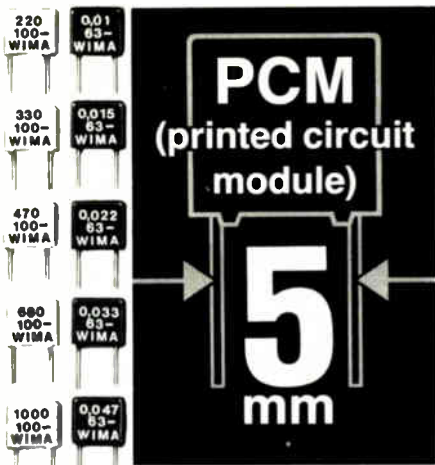

## Complete ranges from 220 pF to 1.0 $\mu$ F

WIMA were first with 5 mm pcm plastic film capacitors – miniature components designed for semiconductor technology.

WIMA plastic film capacitors show greater reliability and should be preferred to other types.

The uniform lead spacing of 5 mm for the complete capacitance range is ideal for automatic component insertion.

WIMA have always been in the forefront of plastic film capacitor technology.



FKP 2: 220 pF to 0.01  $\mu$ F: D.F.  $2.4 \times 10^{-4}$   
 FKZ 2: 220 pF to 0.01  $\mu$ F: D.F.  $1.2 \times 10^{-3}$   
 FKS 2: 1000 pF to 0.015  $\mu$ F: D.F.  $5.6 \times 10^{-3}$   
 MKS 2: 0.01  $\mu$ F to 1.0  $\mu$ F: D.F.  $5.8 \times 10^{-3}$   
 (Typical values at 1000 Hz)

### WILHELM WESTERMANN

Spezialvertrieb elektronischer Bauelemente  
 P.O. Box 2345 · D-6800 Mannheim 1  
 Fed. Rep. of Germany

U. S. Sales Offices:  
 THE INTERNATIONAL GROUP INC.  
 North Dearman Street · P.O. Box 23  
 Irvington · New York 10533 · (914) 591-8822

TAW ELECTRONICS CO.  
 4215 W. Burbank Blvd., Burbank  
 California 91505 · (213) 846-3911

8 Circle 8 on reader service card

## Readers' comments

### Flexible standard

**To the Editor:** The review of the impact of the proposed standard for instruction-naming and assembly-language conventions [Jan. 17, p. 98] does not reflect the scope of the standard, namely, "... to name a common set of instructions used by most microprocessors, provide rules for the naming of new instructions and the derivation of new mnemonics, and establish assembly language conventions." Limitations to the scope spelled out in the standard are that the standard does not define or restrict programming style, number of instructions, architectures, or media file format.

In light of this, the statement that the standard will limit manufacturers' freedom in determining their microprocessors' instruction sets is incorrect. Actually, appendixes published with the standard include standard mnemonics for the 8080, 8085, 8086, Z80, Z8000, 6800, 68000, and LSI-11, demonstrating its flexibility.

Furthermore, statements to the effect that the standard is too late are suspect, coming as they do from manufacturers who themselves estimate that 60% to 70% of software development for microprocessors is done with assembly language and who have just gone through the exercise of developing translators to convert their 8-bit assembly-language code to 16-bit code—a task that would have been unnecessary had the standard been in use.

### Corrections

*Two instructions were inadvertently omitted in the calculator note "TI-59 solves fifth-order differential equations" (Jan. 31, p. 109). The number 03 should appear in location 181. Instruction INV should be in location 204.*

*Because of a printer's error, mistaken information appeared in the Addenda to the Feb. 28 International Newsletter (p. 64). Hitachi Ltd. has not announced a 64-k electrically erasable programmable read-only memory, though the company is in fact currently working on one.*

Finally, I must take issue with the suggestion that the standard was developed from a higher-level, data-processing point of view. As the scope makes clear, the objective was to encompass a common set of microprocessor instructions and to provide clear, easily learned names and mnemonics, a task that we quickly concluded was not possible with a two- or even with a three-character limitation.

The richness of present microprocessor architectures, let alone that of future developments, calls for clarity rather than extreme conciseness.

Andrew Allison  
 Los Altos, Calif.,

### The IEEE's umbrella

**To the Editor:** The interview with me (Jan. 31, p. 14) credited me with an accomplishment which, alas, was not mine. I did not take the Institute of Electrical and Electronics Engineers into the American Association of Engineering Societies (AAES)—that process took three years of delicate negotiations, 1976 to 1979. From most of that time I was not on the board. The IEEE joined the AAES last year—before I became president.

I must reserve judgment on the new umbrella organization, but it is a noble experiment, and I shall make every effort to help it succeed, in the interests of members of the IEEE and of all engineers.

We must give AAES a reasonable period of time to prove itself—perhaps two years. Then the IEEE should re-evaluate its participation in a pragmatic, nonsentimental way.

The potential advantages to the IEEE of cooperation with its sister engineering societies in AAES are tremendous, but my continued support will depend upon its performance, which hangs in part on the IEEE's own representatives on the AAES Councils. It is therefore extremely important for the IEEE to nominate member-oriented people to the AAES Councils.

Leo Young  
 President  
 IEEE  
 New York, N. Y.

# Quality impressions are made easily with OEM band printers from CDC

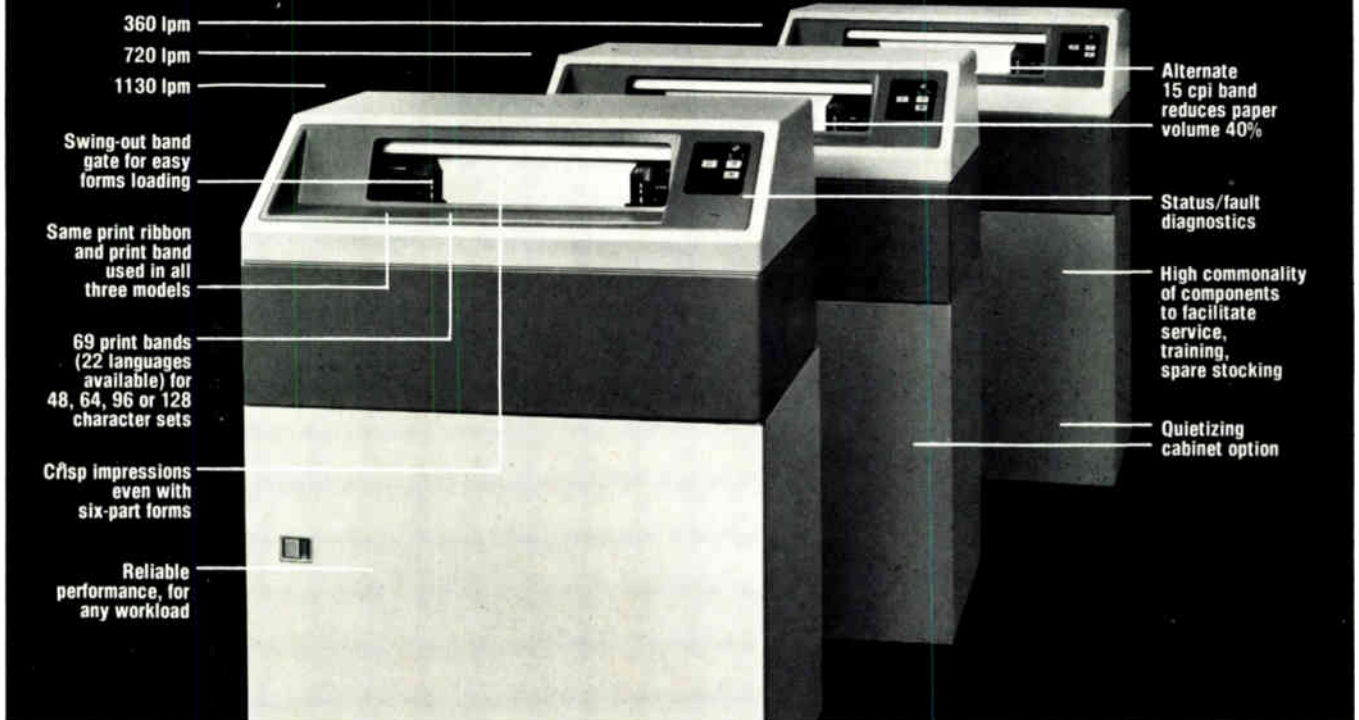

360 lpm  
720 lpm  
1130 lpm

Swing-out band gate for easy forms loading

Same print ribbon and print band used in all three models

69 print bands (22 languages available) for 48, 64, 96 or 128 character sets

Crisp impressions even with six-part forms

Reliable performance, for any workload

Alternate 15 cpi band reduces paper volume 40%

Status/fault diagnostics

High commonality of components to facilitate service, training, spare stocking

Quietizing cabinet option

If you're an OEM, you already know what Control Data has done for disk technology. Now we're determined to earn the same reputation for excellence in band printer technology. By giving *you* versatility and maintainability. By giving *your customer* reliability, superior print quality and economical operation.

### Engineered for component commonality

All three members of our 9380 family of band printers look pretty much alike. Inside and outside. So your servicing, training and inventory requirements are simplified. Yet you can choose from three print speeds, 69 print bands and lots of other options.

### Built with the features and economy to attract end-users

Our 360/720 lpm models offer a compressed pitch option. That saves your customer money in paper expense. And gives him the capability to print 132 columns on standard 8½ by 11 inch paper. Bands switch in seconds. Paper loading is easier. Operator controls and adjustments are minimal. And your customer will like the clean, crisp impressions delivered by our proven hammer technology.

Put quality behind your nameplate. Let us send you data sheets and print samples. Call us at 313/651-8810 or if in Europe, contact one of our European representatives. Or return coupon to:

Product Sales Manager E30  
Control Data Corporation  
1480 N. Rochester Road, Rochester, MI 48063

Please send literature and sample printouts on your band printers.

Name \_\_\_\_\_ Title \_\_\_\_\_

Company \_\_\_\_\_ Phone \_\_\_\_\_

Address \_\_\_\_\_

City \_\_\_\_\_ State \_\_\_\_\_ Zip \_\_\_\_\_



**Addressing society's major needs**

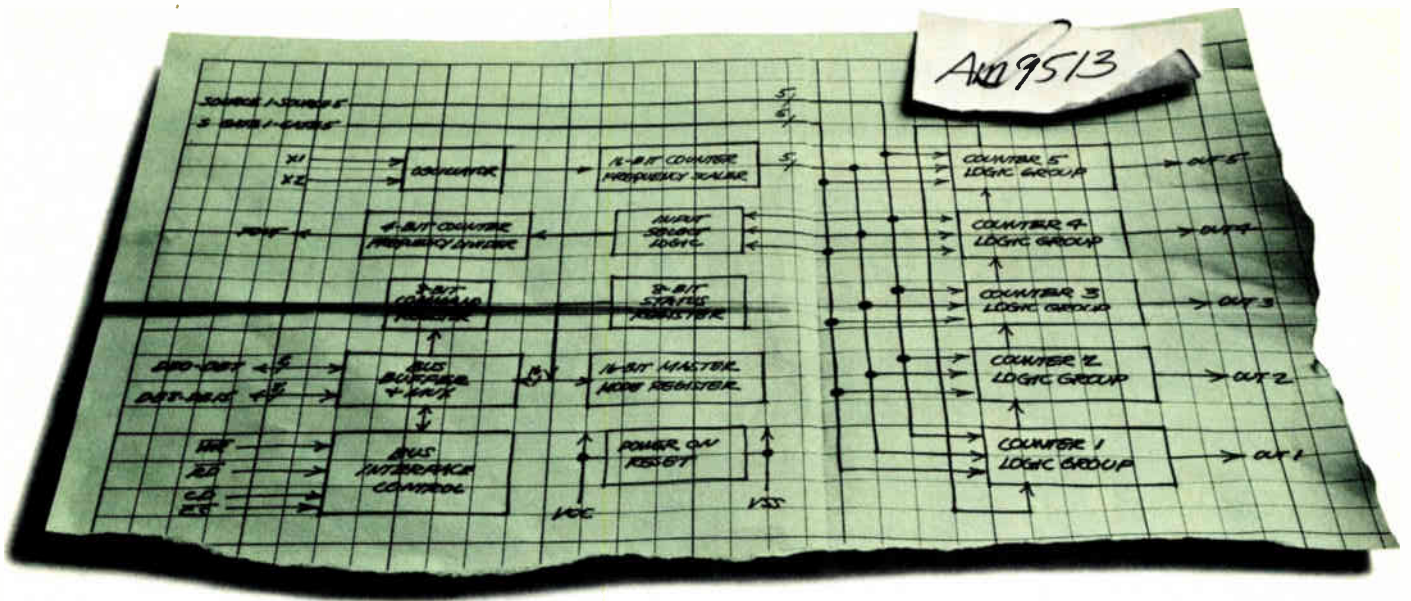

# And now, The Time Machine.™

The Time Machine is a trademark of Advanced Micro Devices

Advanced Micro Devices announces the Am9513 — an 8-bit and 16-bit programmable System Timing Controller.

It's the most flexible, most versatile, most powerful timing device ever created.

The Time Machine replaces all the timing and counting elements in typical MPU-based systems.

You get an internal oscillator and five programmable, general-

purpose, 16-bit counters on one +5V chip. The counters can count up, down, in binary or BCD. And The Time Machine doesn't waste any time. It can achieve speeds up to 7MHz!

Most old-time timers are lucky to have six distinct operating modes. The Time Machine gives you twenty-two.

Why buy another timer when you can own The Time Machine?

**Advanced Micro Devices** 

901 Thompson Place, Sunnyvale, CA 94086 · (408) 732-2400

## News update

■ The Electronic Systems division of the U. S. Air Force Systems Command has completed the first phase of the installation of the North Atlantic Treaty Organization's digital communications system. The initial portion of DEB, for digital European backbone [*Electronics*, Oct. 26, 1978, p. 179], includes installation of digital microwave equipment, antennas, and towers at 13 locations in Italy and southern West Germany.

A second phase will equip 12 sites in the western portions of West Germany. More than 100 military sites will be linked to provide multiple high-security facilities for high-priority, high-volume users.

When completed in 1986, DEB will supply twice as many communication channels as do the existing analog systems for the U. S. and NATO forces in Europe and for other tactical users. Making this possible are the narrower bandwidths required by newly developed radios, which will allow users to operate with less interference on a new set of frequencies. **-Harvey J. Hindin**

■ American Telephone & Telegraph Co.'s trial service of video conferences via telephone links has picked up another customer with its own teleconferencing center identical to AT&T's Picturephone Meeting Service. Ford Aerospace and Communications Corp., a subsidiary of Ford Motor Co., has put the center in its Detroit headquarters.

Bell's PMS [*Electronics*, Nov. 13, 1975, p. 8] now has 12 centers in the United States—of which the nationwide accounting firm Arthur Andersen & Co. has three. The Ford center has a fiber-optic link with an AT&T switching center in Detroit.

The centers use voice-actuated switching between four primary cameras. Three are focused on key seats around a conference table, and the fourth shows a wide-angle view of the table when conferees at the other center are talking. Three auxiliary cameras provide closeups during demonstrations and transmission of slides and graphics. Each center has two monitors. **-Martin Marshall**

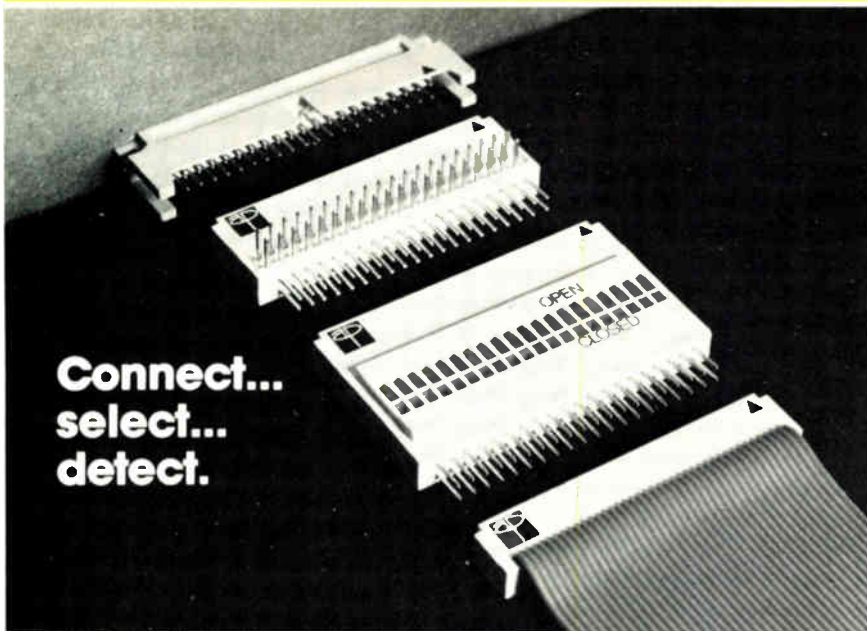

**Connect...  
select...  
detect.**

### Save valuable time when testing.

**CONNECTION MADE SIMPLE.** Intra-Connector allows immediate access to those lines previously inaccessible. External pin contacts can be probed individually or connected to another cable assembly.

**SELECTION MADE SIMPLE.** Intra-Switch permits opening and closing of lines individually or in any grouping required for diagnostic or quality

testing. Easy operation with just a nudge of a pencil or probe

Both the Intra-Connector and Intra-Switch mate with standard .10" x .10" dual-row connectors. They are available in 20, 26, 34, 40 and 50 contact models. Call (TOLL FREE) 800-321-9668 for the name of your local AP Distributor, he'll be glad to introduce you to these two products.



**AP PRODUCTS INCORPORATED**

1359 W. Jackson St., Painesville, Ohio 44077 Tel. 216/354-2101 TWX: 810-425-2250

Circle 12 on reader service card

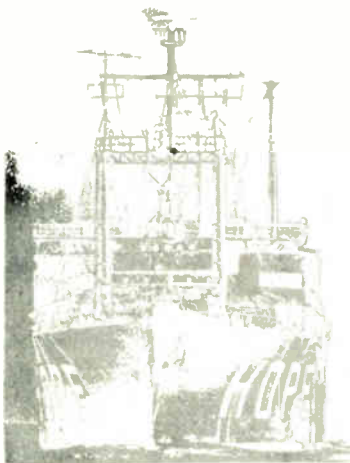

## HOPE The project a ship launched.

First there was the hospital ship S.S. HOPE, now retired. Today HOPE is an established project which has carried its goal of improving health through education to 24 developing countries of the world and the United States.

Give to:

**PROJECT  
HOPE**

Department A  
Washington, D.C. 20007

# For a product as critical as custom I<sup>2</sup>L circuits...

## you need a company as reliable as CHERRY

Cherry has been combining both digital and linear functions on the same chip since the infancy of I<sup>2</sup>L logic. Long experience, integrity of design, technological innovation and manufacturing excellence are only the beginning. You'll never meet a group of engineers more eager to work with you to solve **YOUR** problems. Engineers ready for the challenge of new design concepts. Eager for your business.

It really doesn't matter what your IC problem is. Whether the solution is one of our standard digital or linear bipolar ICs—or the most sophisticated custom design—Cherry has or can provide the right solution. At the right price. With the right delivery date.

All this from the folks at Cherry: A trusted name in industry for more than 25 years.

**SEND FOR OUR FREE 36 page catalog of digital and linear ICs.** Includes low level amplifiers—differential amplifiers—level detectors—DC to DC converters—timing circuits—motor speed controls—optical detector systems—camera controls—flip chips.



# CHERRY SEMICONDUCTOR

**CHERRY SEMICONDUCTOR CORPORATION**

99 Bald Hill Rd., Cranston, Rhode Island 02920 / (401)463-6000 / TWX 710-381-1757



## EXPANDED ZIP DIP® II Socket/Receptacle Series

**New Textool models test up to 64 pin 900 mil devices**

Textool's expanded ZIP DIP II socket/receptacle series (12 different sizes) now offers new models capable of testing 64 pin 900 mil, 48 pin 600 mil, 42 pin 600 mil, and 28 pin 400 mil devices.

Versatile ZIP DIP II sockets feature an enlarged entry for use with an even wider range of devices and a flat top plate for easier entry and extraction. Contacts are on even 100 mil spacing (300, 400, 600, and 900 mil) for more convenient mounting on standard hardware.

A built-in "stop" insures that the ZIP DIP II handle can't be easily overstressed. Top mounted assembly screws facilitate the replacement of damaged or worn internal parts. Textool has strengthened both hardware and plastic for increased reliability

and screw mounting of the socket to the ZIP DIP II receptacle makes possible a more positive locking system.



The ZIP DIP II receptacle (shown with socket mounted) has all the features of previous ZIP DIP receptacles, yet at a lower price. It virtually eliminates mechanical rejects, is a disposable plug-in unit requiring no soldering and has a typical life of 25,000-50,000 insertions. The receptacle is ideal for high volume hand testing and, since replacement time is eliminated, a test station can process literally millions of devices before it must be replaced.

**Detailed information on these and other products from Textool . . . IC, MSI and LSI sockets and carriers, power semiconductor test sockets, and custom versions . . . is available from your nearest Textool sales representative or the factory direct.**

**Textool Products Department  
Electronic Products Division 3M**

1410 W. Pioneer, Irving, Tex. 75061  
214-259-2676



## People

### Roberts to take 'em all on with Zenith Data Systems

Edward J. Roberts' credentials are not those of a brash upstart. A recipient in 1958 of a BSEE and a BS in accounting from the University of Colorado, he has spent nine years as director of Zenith Radio Corp.'s internal information systems and as corporate treasurer. But as the new general manager of Zenith's Data Systems Corp. subsidiary, Roberts, 49 years old, who has a staff of 30 people, talks confidently of competing head on with the likes of IBM Corp. "The computer industry has not done extensive cost reductions, but Zenith is an expert in cost reduction," he says.

Zenith plans to take the cost-consciousness and marketing savvy of color television and apply it to the manufacturing and distribution of desktop computer systems. In essence, that is the strategy behind Zenith's \$64.5 million purchase of the Heath Co. from Schlumberger Ltd. [*Electronics*, Nov. 8, 1979, p. 33]. Although Zenith has not touched the do-it-yourself electronic kit and retail store parts of the Heath business, it has restructured its Data Systems division. Final assembly and marketing, as well as administration, are in Chicago; Heath's subassembly operation remains intact in St. Joseph, Mich.

A weak financial position—1979 net earnings of \$19 million on sales of \$1.08 billion—and limited in-house research capability will force Roberts to operate his new company in a lean manner, unlike its resource-rich competition. Zenith will concentrate on supplying hardware to systems packagers and retail stores, using outsiders to augment its limited personnel ranks. Explains the former ski instructor, "We have great implementers, but we need outside design talent."

A nationwide repair network is crucial to success in consumer electronics, Roberts indicates, and the small-business computer user will get the same kind of protection. "We'll be the computer company



**Tight ship.** Zenith's Roberts will run a lean division using outside design talent.

that makes house calls," he boasts. In addition, the company is toying with the idea of offering loaners to users when in-the-shop repairs are needed.

Roberts and Zenith Data Systems are the advance party for the parent corporation's foray into personal computers, but the company will not rush into it. He acknowledges that "maybe we should have gotten into it sooner," and credits a debt the entire industry owes to Tandy Corp.'s Radio Shack and its TRS-80 home computer, for providing a market. But, adds Roberts the entrepreneur, "we'll be the best, not the first."

### Grand-Clément discovers he really isn't a ham

Why did Jean-Luc Grand-Clément leave the successful video game and microcomputer company, Société Occitane d'Electronique, that he and his wife created with their own resources in 1976? The 40-year-old Frenchman now heads Eurotechnique, the semiconductor joint venture being set up near Marseilles by National Semiconductor Corp. of Santa Clara, Calif., and the French industrial group St. Govain Pont à Mousson. He elaborates on his decision by telling the story of the ham and the egg. "When you are part of a big company, you are like the chicken, involved in making the egg," he explains. "But in a small company, you are like the pig: not



# LSI 11/2<sup>®</sup> LSI 11/23<sup>®</sup> COMPONENT PRODUCTS

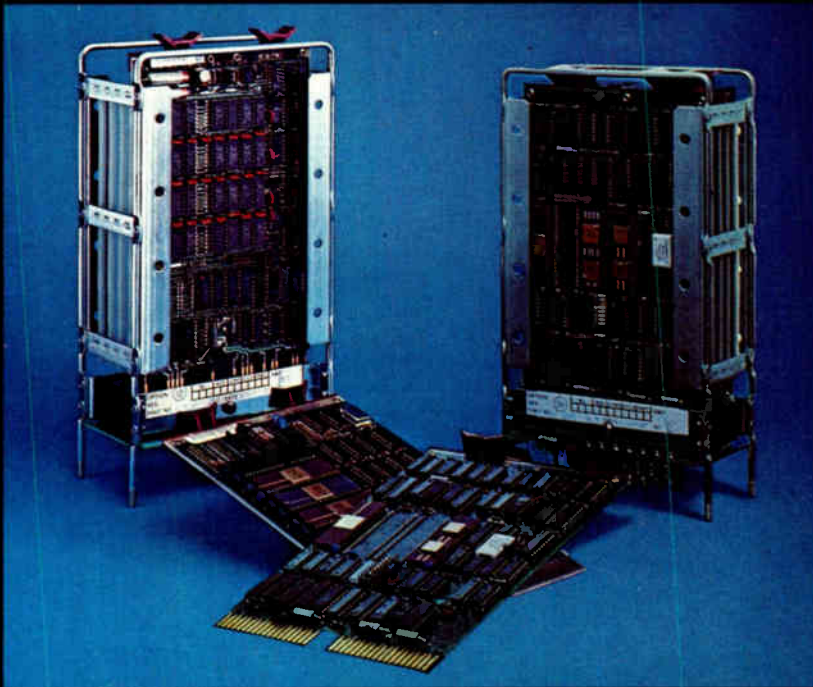

**WHY IS FIRST COMPUTER YOUR BEST SOURCE FOR DEC'S LSI-11/2 AND LSI-11/23 MICROCOMPUTER PRODUCTS?**

**FIRST COMPUTER IS THE WORLD'S LARGEST SPECIALIZED DISTRIBUTOR FOR LSI-11 AND LSI-23 MICROCOMPUTER PRODUCTS.**

No — We don't sell capacitors or resistors! We only sell products manufactured by Digital Equipment Corporation and other leading manufacturers which enhance the LSI-11/2 and LSI-11/23 Microcomputer Products.

**FIRST COMPUTER SAVES YOU VALUABLE DOLLARS!**

Because of our volume purchasing power we can acquire the products at the lowest possible cost. These savings enable us to offer the best price available anywhere. Before you buy, investigate our price and save dollars.

**FIRST COMPUTER SAVES YOU VALUABLE TIME!**

Because of our large inventory we can provide you with off-the-shelf delivery on the complete line of Digital Equipment Corporation's factory fresh Microcomputer Products. We are just a phone call away, or if you prefer you can TWX us your order. With pre-approved credit we can ship anywhere in the United States or Canada within 24 hours.

**FREE TECHNICAL AND APPLICATION ASSISTANCE.**

Because we specialize in LSI-11/2 and LSI-11/23s we can provide you with technical assistance to help you determine the products which best meet your application requirements. We utilize these products everyday in our own Commercial, Laboratory, Array Processor, and Image Processing Systems. Our application experience can help you avoid costly mistakes.

**FULL MANUFACTURER'S WARRANTY.**

When you purchase your LSI-11/2 and LSI-11/23 products from FIRST COMPUTER you receive the full manufacturer's Return to Factory warranty. All warranty claims will be handled by First Computer with courtesy & dispatch. FIRST COMPUTER stands behind each of the products we sell.

**WE ARE A RECOGNIZED LEADER IN THE DISTRIBUTION OF LSI-11/2 AND LSI-11/23 PRODUCTS.**

No wonder so many people are turning to FIRST COMPUTER to provide them with their Microcomputer requirements. You owe it to yourself to investigate what FIRST COMPUTER can do for you! We stand ready to serve you. You can bank on us.

Circle 15 on reader service card



TM

**computer corporation**

corporate square / 825 north cass avenue / westmont, illinois 60559 / (312) 920-1050

TWX NUMBER 910-651-1916

# OUR MOST RESOLUTE ALIAS STOPPER

Our new Precision 636 provides 3-digit resolution with 4092 cut-off frequency selections. If you need more, our 3½-digit option provides 6141. Either way, you get up to 16 programmable channels with convenient keyboard address and LED

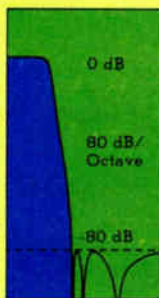

displays. Time delay filters superior to Bessel. Elliptics with 80 dB/octave attenuation. Phase match within 2°. Interface with mini, micro or GPIB. Call Don Chandler, 607-277-3550, or write for specs on all Precision anti-alias filters.



**PRECISION FILTERS, INC.**

303 W. Lincoln, Ithaca, N.Y. 14850

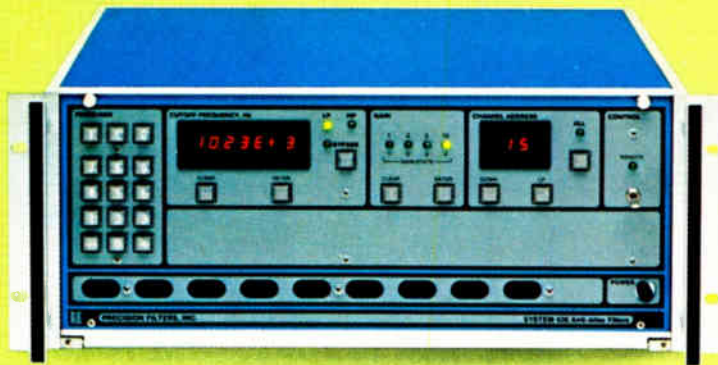

Circle 16 on reader service card

## FREE

Brochure describes Electronics editorial reprints, services, books...

- More than 70 article reprints in 15 subject categories
- Handy wall charts
- Custom-made reprint services
- Books especially for Electronics' readers
- Convenient postage-paid order cards

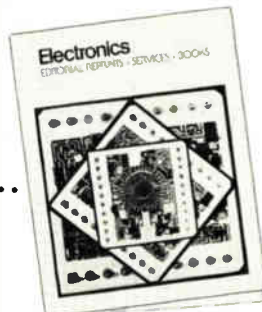

For your free copy, circle #275 on the reader service card.

## People



**Ambition.** Grand-Clément wants Eurotechnique to be a \$100 million company.

simply involved in making the ham, but thoroughly committed."

Which is not meant to cast any doubts on the nature of Grand-Clément's commitment to turn Eurotechnique into a \$100 million semiconductor designer and producer by 1985. Eurotechnique has already hired more than two dozen engineers and has received its first contract—to develop a pair of codecs for the French telephone company. "Our goal is to be a credible semiconductor supplier—on the open market," Grand-Clément emphasizes. "And within four years, we want to export 60% of our output."

Grand-Clément himself is no newcomer to the semiconductor field. Four years after obtaining his engineering degree, he joined the research and development division of Motorola Semiconductor Products division in Phoenix. In the following year, 1968, he was transferred to the company's French subsidiary in Toulouse. After five years there, Grand-Clément, then aged 33, was named president of Motorola Semiconducteurs SA in Paris.

In 1976, "*dans le style américain*," he founded his own small company. He handled the technical side, while his wife looked after the commercial end of the business. "It worked well, but after a few years it took over our whole lives," he says. "In a small company, you don't have time to step back and think things out. What's more, here in France, the government encourages only big companies. It is depressing, but that's the way it is." □

# Maglatch TO-5: The little relay that never forgets



That's literally true. Once set with a short pulse of coil voltage, Teledyne's magnetic latching TO-5 relay will retain its state until reset or reprogrammed – even if power falls completely. And because it never forgets its last instruction, holding power is not required.

This inherent power conservation makes the Maglatch TO-5 ideal for any application where power drain is critical. In addition, its subminiature size fits it perfectly to high density pc board packaging. And for RF switching applications, the low inter-contact capacitance and contact circuit losses provide high isolation and low insertion loss up through UHF.

The Maglatch TO-5 is available in SPDT, DPDT and 4PST versions, and includes commercial/industrial types as well as military types qualified to "L," "M" and "P" levels of MIL-R-39016.

If you need more information about the little relay with the non-destructible memory, call or write today.

 **TELEDYNE RELAYS**

12525 Daphne Avenue, Hawthorne, California 90250 • (213) 777-0077

U.K. Sales Office: Heathrow House, Bath Rd. MX, TW5 9QQ • 01-897-2501

European Hqtrs.: Abraham Lincoln Strasse 38-42 • 62 Wiesbaden, W. Germany • 6121-700811

Circle 17 on reader service card



**“I wanted to filter out EMI, but I didn’t want to redesign. AMP showed me the way.”**

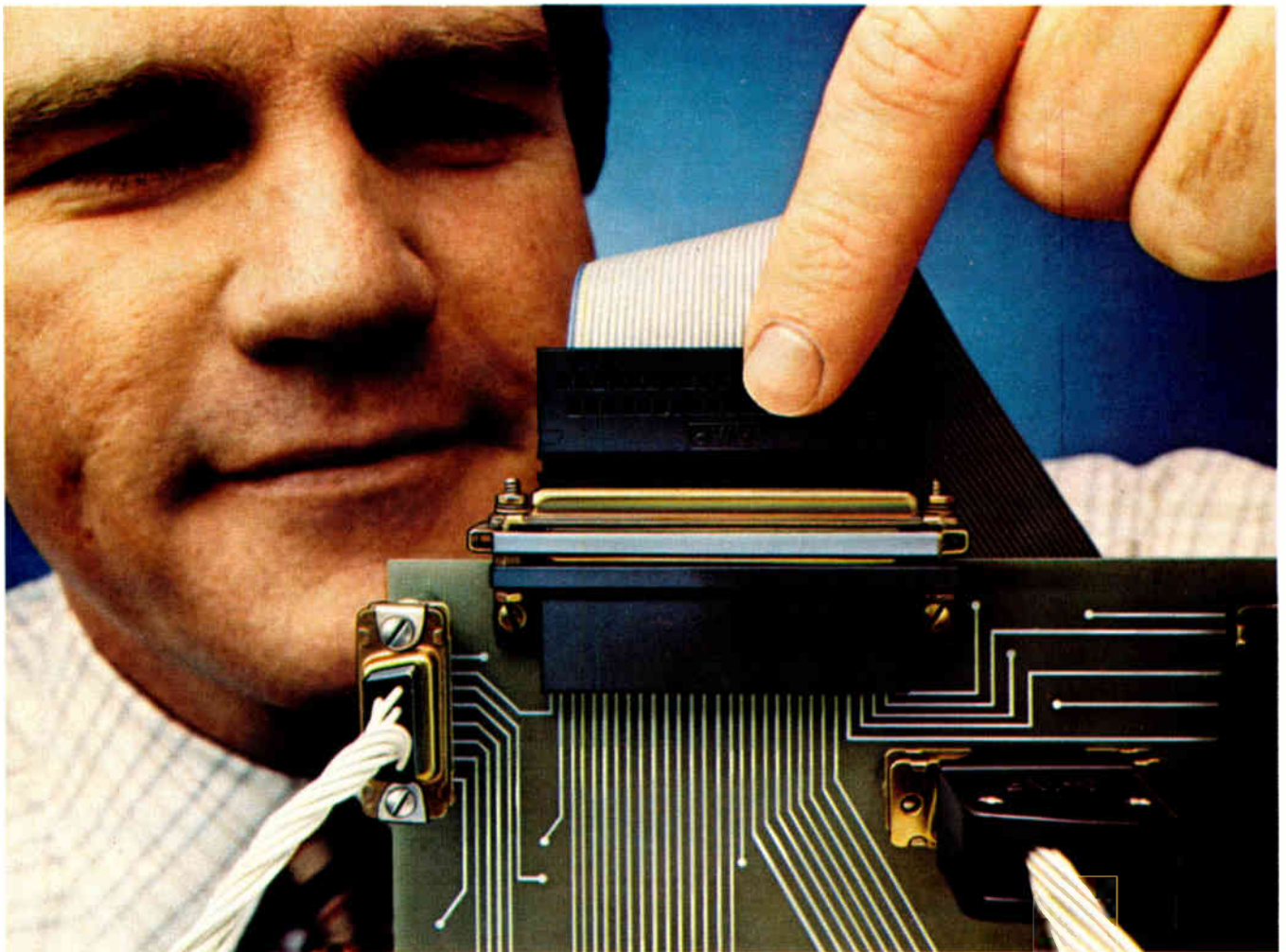

A better way. With AMP filtered pin headers, connectors and interfaces.

High performance Quiet Line Filters have been incorporated into an integral filter/contact design, and preassembled in popular, industry-standard connector configurations. Which means a simple retrofit can solve your interference problems, without extensive circuit redesign. And they can assist you in complying with the emission limitation requirements of VDE and the FCC.

AMP low pass filters operate on a unique principle. Unlike other filters, they're absorptive so instead of reflecting EMI and noise back into the system, they dissipate it harmlessly as a small amount of heat.

They also have no internal resonance, are insensitive to load and source impedance variations, and have high insertion loss ratings—features that combine to give you the highest performance possible.

And you're assured of a variety of application options. Feedthrough pin headers for example, are bulkhead mountable and intermateable with AMP-LATCH and AMPMODU receptacles, as well as other .100" centerline types.

For data communications specifications RS 232 and 449, AMPLIMITE subminiature D headers are board mountable, and both they and a similar filtered interface style intermate with all similar types. Circular configurations are also available.

This combination of connectors, headers, interfaces, and high performance filters is unique in the industry. And together they work for you. Because while our filters eliminate interference, our connectors eliminate the need for redesign.

AMP has a better way.



Facts worth knowing about AMP filtered connectors:

**Filtered AMPLIMITE connectors:**

- subminiature D type
- meets or exceeds RS 232 and 449
- mates with MILC 24308 connectors
- available in 9, 15, 25, and 37 position sizes
- supplied in right angle board mount and solder cup versions, or as a male/female interface for easy field retrofit.

**Filtered pin header:**

- 40 and 50 positions .100" centerline, double row configuration
- intermateable with AMPMODU and AMP-LATCH Connectors, as well as all existing similar types.
- bulkhead mountable

**Circular connector:**

- 8 position
- bulkhead feed-through receptacle with pin contacts



**Where to call:** For more information call the Filtered Connector Information Desk at (717) 780-8400.

**Where to write:** AMP Incorporated, Harrisburg, PA 17105.

AMP, AMPLIMITE, AMPMODU, and AMP-LATCH are trademarks of AMP Incorporated.

# AMP

## How STC speeds production testing by a factor of five to one . . .

Storage Technology Corporation's revolutionary 8650 Winchester disc subsystem for big, main-frame computers utilizes double-density recording to pack twice the normal amount of data in the same space as a conventional, single-density disc.

Critical to the success of this technology are complex, high-speed, analog read/write and servo boards. In fact, STC's read/write board contains more than 350 separate active and passive components.

When conventional methods were used, it took approximately 15 minutes to test each board. As this testing time became more and more unacceptable, the decision was made by STC to switch to automatic testing.

Paul Zieschang, Manager of Hardware Development, recommended that the company assemble its own system using 12 HP-IB compatible instruments, an HP 9835A Desktop Computer as system controller and a 9885 Disc. Zieschang reports that the 9835A was chosen because its large CRT display made it easy for an operator to interface with the system, and

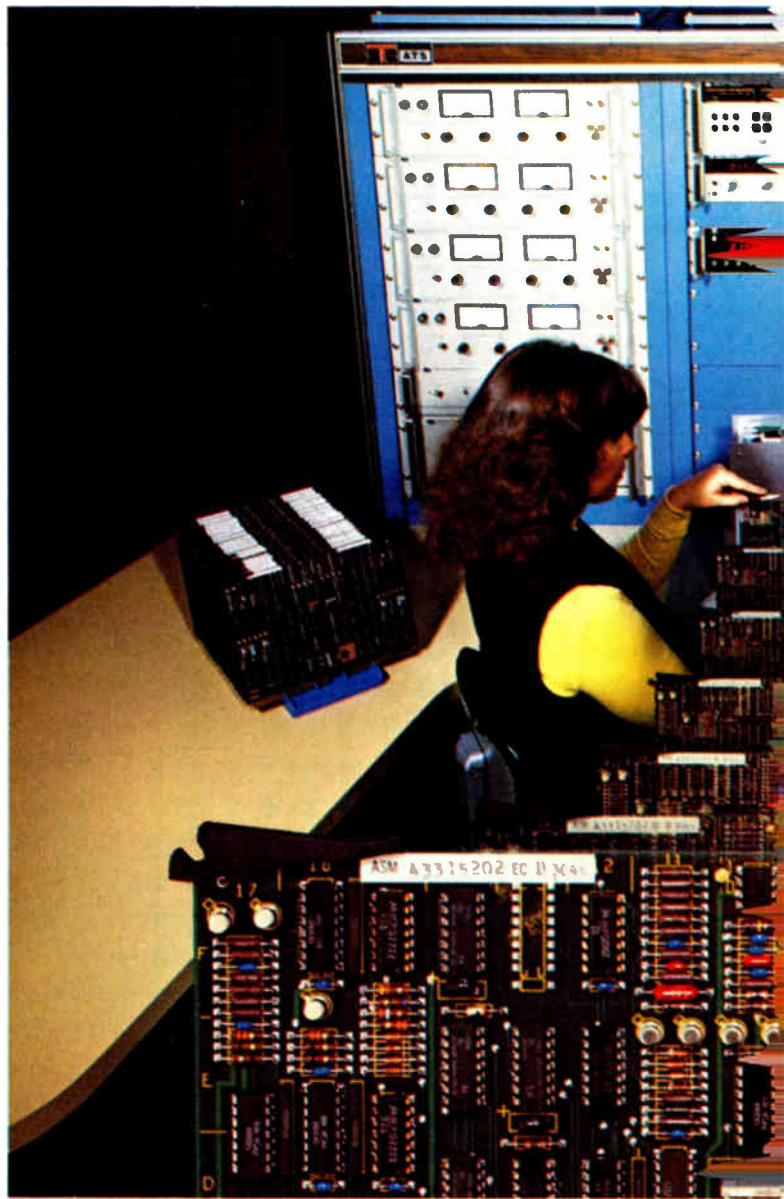

because of its programming ease. What's more, STC incorporated diagnostics into the system which help STC technicians better understand the testing procedure. This software even helps technicians locate — via a flashing cursor and a graphic display of the board's topology — the position of any component on the board. Finally, the 9835A also delivers a print-out of the component's value and STC part number.

### **Documentation simplifies system configuration.**

According to Zieschang, some of the many application notes supplied by Hewlett-Packard were helpful both in deciding the first configuration and speeding assembly of STC's first HP-IB system.

### **Flexibility that reduces the chance for obsolescence and speeds assembly.**

Twelve HP-IB compatible instruments were chosen for this system, according to Zieschang, because HP's bus architecture and programming ease permit the flexibility necessary to make changes within the system as STC's requirements change and, thus substantially reduce the possibility of system obsolescence.

HP instruments also provide STC with speed of assembly. The company assembled and programmed its first automatic

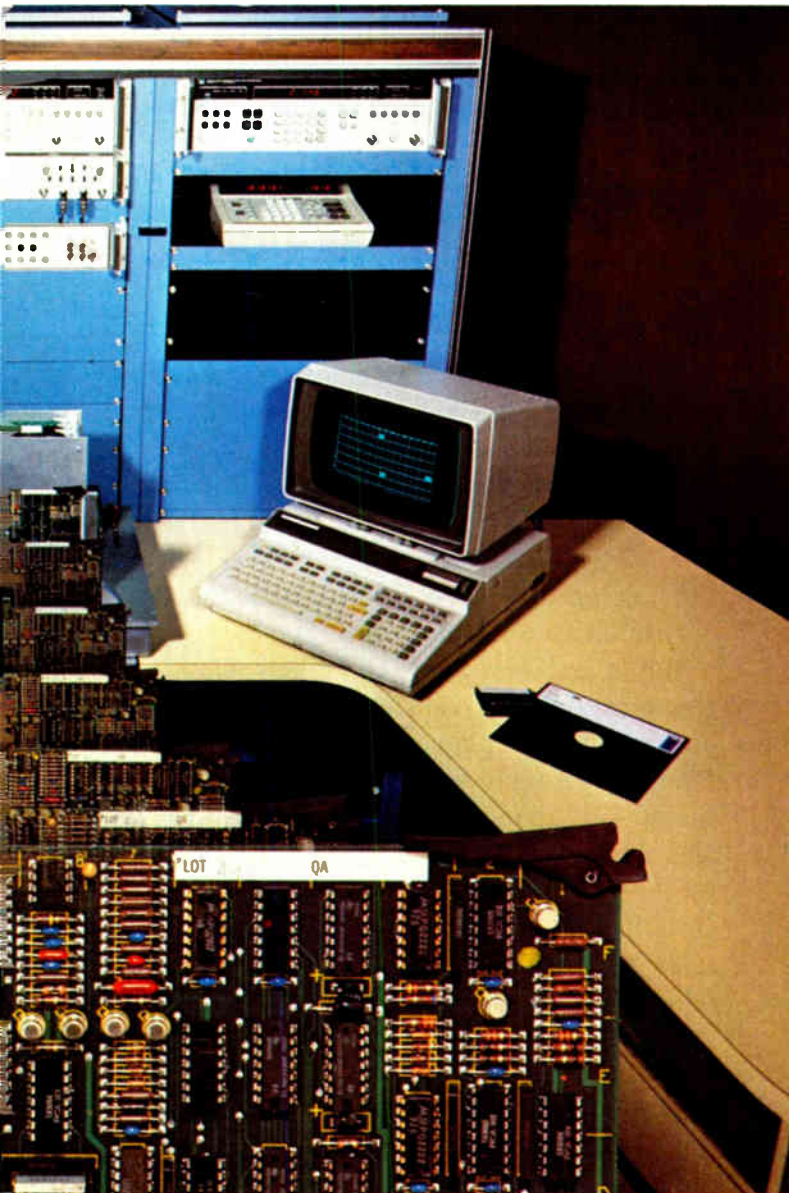

using HP-IB  
 “designed  
 for systems”  
 instruments  
 and computers.

test system faster than other comparable ways of solving its system test needs. Zieschang believes they will be able to assemble and program future systems even faster.

**The bottom line.**

Just as important, Zieschang says the STC HP-IB compatible system will reduce testing time from 15 minutes per board to approximately three minutes. A factor of five to one. The system is also expected to reduce the time required to debug faulty boards from 45 to 20 minutes. In short, STC’s HP-IB system will help the company turn out more boards per day.

Why not consider the HP-IB solution for your production test needs? For complete details, send for our brochure, “Do your own system design in weeks, instead of months.” Simply write to Hewlett-Packard, 1507 Page Mill Road, Palo Alto, CA 94304. Or call the HP regional office nearest you: East (201) 265-5000, West (213) 970-7500, Midwest (312) 255-9800, South (404) 955-1500, Canada (416) 678-9430.

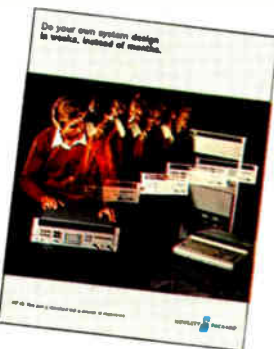

**HP-IB: Not just a standard, but a decade of experience.**



## R&D dollars and sense

As in the old saw, there's some good news and some bad. The good is that the United States is increasing its total research and development expenditures from \$51.6 billion in 1979 to \$61.8 billion this year, according to a new report from the Battelle Memorial Institute. That's an increase of 19.7%.

Unfortunately, when the Department of Labor's 13.3% dollar deflator for 1979 is applied, the real increase falls to about 6.5% or from \$10.2 billion to \$8.8 billion.

That's only part of the bad news. According to Battelle, the largest growth areas in 1980 R&D plans are in regulatory compliance and energy. Nobody would argue with the need for energy, but the idea of spending already scarce R&D money on compliance-oriented work must rankle with most executives, especially since, according to *The Wall Street Journal*, industry spends about \$100 billion yearly on compliance, almost twice the amount for R&D.

Some authorities estimate that regulatory compliance may take from a quarter to a half of every R&D dollar, and an outspoken but anonymous employee of the National Science Foundation points out that "the overall figures already look low . . . but decent, but by the time you apply monetary deflators and get a feeling of how much money is being allotted to pursuits other than that of knowledge, you find that the United States may be spending only about 45% to 65% as much on R&D as it thinks it is."

R&D has been on starvation wages since the late 1960s. In constant dollars, the U. S. now is spending only about 11% to 12% more on R&D than it did then. Meanwhile, the funding curve has dipped sharply in the 1970s, even as the cost of complying with an increasing number of Federal and state regulations has

been acting as what Adam Smith might have called a very visible hand, pulling dollars out of the R&D pot that might otherwise have spawned new jobs and industries. So if there were a "regulatory deflator" applied to R&D funding figures, as well as a monetary one, the funding curve for the past decade would drop at an accelerating pace.

But at least two things could help. One would be to take a realistic view of our R&D posture and then plan accordingly. It is worse than the raw figures indicate, and the country should face up to the fact. Both government and industry should invest more in R&D—especially industry, which as a whole chips in a miserable average of only 1.9% of sales. Even the high-technology average is only 4%, according to Standard and Poor's.

The other aid would be a realistic attempt by government to weed out the most damaging, least useful regulations and attempt ongoing reviews with an eye toward minimizing regulation, or at least shaping up the administration of those that are beneficial or we cannot do without.

Pending regulatory reform, it could be profitable, in all senses of the word, for industry to place more of its R&D activities on campus. The reasons are many: student labor is cheap and often leads to profitable hires; academics have broad interests and work in a fertile interdisciplinary environment; and, according to the Office of Science and Technology Planning, the cost-to-benefit ratio of industry-sponsored research on campus is very high.

And diverting R&D funds through universities means that the sponsor need hardly worry about compliance at all, and the researching academic need not worry about the strings that come with government money.



**Observe your Z80 or 8088 microprocessors in action with one of our two new analyzers.**

Our analyzers, designed for engineers and test technicians, let you observe your microprocessor program in ways consistent with your application. Either operate your microprocessor system at normal speeds and capture data without program interference, or walk through the program from breakpoint to breakpoint, from instruction to instruction, or from machine cycle to machine cycle.

**Synchronize hardware with software.**

Our analyzers can be used to trigger an oscilloscope or other

equipment such as an interval timer at pre-selected instruction cycles. This trigger enables you to observe the interaction between your hardware and your program.

**Ideal for debugging programs in development, testing on the production line, or field service.**

Address interrupt, trigger enable, Nth pass, address plus N instruction, and hold or refresh let you work with and manipulate your microprocessor's full capability.

Hexadecimal and binary data displays, hexadecimal address display, and 8 LED status displays give real-time system information.

Each analyzer costs only \$1,750 complete with DIP and low profile

connectors and portable attache case. And they're U.L. listed.

**Seeing is believing. Ask for a demonstration.**

We'll show you how simple microprocessor analyzing can be. For an analyzer demonstration or data sheet, or for information on our other microprocessor design products including STD BUS systems and PROM programmers, contact Pro-Log, 2411 Garden Road, Monterey, California 93940, phone (408) 372-4593.

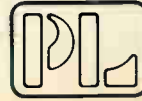

**PRO-LOG**  
CORPORATION

Circle 23 on reader service card

# Get inside your design with our microprocessor analyzer.



# Scientists and engineers find computer systems powerful tools and control.

## Why?

*Interfacing power.* Today's Hewlett-Packard desktop computers offer such features as buffered I/O, built-in I/O drivers, direct memory access (DMA), burst read/write, formatted read/write, and vectored priority interrupt. With DMA you can acquire up to 800K bytes per second. One model gives you up to 449K bytes of fully usable memory; another offers assembly language. Every one gives you a choice of four interface protocols on plug-in cards: HP-IB, Bit-Parallel, DCD and RS-232-C.

*Days, instead of weeks.* You can unpack a system and have it up and running on a production line, or in the lab in about one-third of the time you'd expect. Days, instead of weeks or even months.

*From lab to production line.* Once it's up, your test and control system can move with ease from one environment to another with no hardware or operating system changes. This kind of flexibility, coupled with the power and sophistication of today's models, makes an HP desktop computer the logical choice for your data acquisition and control needs.

*Friendly.* Together with the power to handle your big data acquisition and control problems, today's systems retain the reliability and ease of use that have always characterized HP desktop computers.



# today's desktop for data acquisition



**HP-IB: Not just IEEE-488, but the hardware, documentation and support that delivers the shortest path to a measurement system.**

HP-IB reaches beyond IEEE-488-78 to cover the operational area as well as the mechanical, electrical and functional specifications. For example, HP-IB systems incorporate a built-in, high level I/O language that saves you the time and expense of writing instrument drivers and configuring operating systems. It means powerful interfacing through a system in which a lot of the work has been done for you.

**Versatile front ends and peripherals expand your system.**

Several card-cage instrumentation subsystems are available from HP with more than 40 different cards for such tasks as analog and digital input and output, interrupt, counting, timing and stepper motor control. HP mass storage media include flexible discs capable of handling data at burst rates and fixed discs offering storage up to 120M bytes. These and other peripherals allow you to configure a system that meets your needs today and accommodates growth, as well.



**A wide selection.**

We build a broad range of desktop computers, with one just right for your data acquisition and control application. From the low cost HP 9815 through the HP 9825, the standard for HP-IB controllers; the HP System 35 with BASIC and assembly language; and the HP System 45B with advanced graphics capability, every HP desktop computer has superior interfacing characteristics in terms of human engineering, ease of use and power.

**A growth path.**

HP can meet expanding needs with communication links from desktop computers to HP 1000 series computers. For multi-user, multi tasking problems, HP 1000 systems offer a range of compatible RTE operating systems with software options for data base management, factory data collection and graphics.



**For more information.** Call 800-821-3777, extension 137, toll-free day or night (Alaska and Hawaii included). In Missouri, call 800-892-7655, extension 137. Or write 3404 E. Harmony Road, Fort Collins, Colorado 80525.

**For a demonstration.** Call the HP regional office nearest you: East 201/265-5000; West 213/970-7500; Midwest 312/255-9800; South 404/955-1500; Canada 416/678-9430.



**HEWLETT  
PACKARD**

Circle 25 on reader service card

# FREE

The newest in home computers, fine stereo components, color TV, HAM radio, precision test equipment, innovative electronics for the home—all in easy-to-build, money-saving kits.

Send today  
for your  
**FREE**  
**Heathkit®**  
Catalog



If coupon is missing, write  
Heath Co., Dept. 510-632,  
Benton Harbor, MI 49022

Send to: Heath Co., Dept. 510-632,  
Benton Harbor, MI 49022.

Send my free Heathkit Catalog now.  
I am not currently receiving your  
catalog.

Name \_\_\_\_\_

Address \_\_\_\_\_

City \_\_\_\_\_ State \_\_\_\_\_

CL-724A Zip \_\_\_\_\_

## Meetings

**Developments in Semiconductor Microlithography**, Society of Photo-Optical Engineers (Box 10, Bellingham, Wash. 98225), Hyatt House, San Jose, Calif., March 17-18.

**Computers in Manufacturing Conference**, American Institute of Industrial Engineers (P. O. Box 3727, Santa Monica, Calif. 90403), Ambassador West Hotel, Chicago, March 19-21; and New York Statler, New York, April 30-May 1.

**13th Annual Simulation Symposium**, IEEE Computer Society *et al.*, Holiday Inn, Tampa, Fla., March 19-21.

**Future Shock—Computers in the 1980s**, American Institute of Aeronautics and Astronautics (Dept. Comp 80, Box 91295, Los Angeles, Calif. 90009) *et al.*, Hyatt House Hotel, Los Angeles International Airport, March 24-26.

**Seventh Energy Conference and Exposition**, Electric Power Research Institute (Government Institutes, 4733 Bethesda Ave. N.W., Washington, D. C. 20014) *et al.*, Sheraton Washington Hotel, Washington, D. C., March 24-26.

**Seventh National Conference and Tutorial Exhibit, Powercon 7**, Power Concepts Inc. (P. O. Box 5226, Ventura, Calif. 93003), Town and Country Hotel and Convention Center, San Diego, Calif., March 24-27.

**Eurocon '80—Fourth European Conference on Electrotechnics**, Verband Deutscher Elektrotechniker (D-7000 Stuttgart 1, Lautenschlagerstr. 21, West Germany), University of Stuttgart, March 24-28.

**1980 Communications Techniques Seminar**, Princeton University and IEEE, Princeton University, Princeton, N. J., March 25.

**The IBM Evolving Network Strategy**, The Yankee Group (Box 43, Cambridge, Mass. 02138), Harvard Club, New York, March 25-26.

**Electro-Optics/Laser International**

**Show**, Kiver Communications SA (171/185 Ewell Rd., Surbiton, Surrey KT6 6AX, England), Metropole Convention Centre, Brighton, England, March 25-27.

**First Southwest Semiconductor Exposition**, Cartledge and Associates Inc. (491 Macara Ave., Suite 1014, Sunnyvale, Calif. 94086), Civic Plaza Convention Center, Phoenix, Ariz., March 25-27.

**International Electronic Components Exhibition**, International Trade Shows in France (1350 Ave. of the Americas, New York, N. Y. 10019) Parc des Expositions, Porte de Versailles, Paris, March 27-April 2.

**International Optical Computing Conference and Technical Symposium East**, Society of Photo-Optical Instrumentation Engineers (Box 10, Bellingham, Wash. 98225) *et al.*, April 7-11, Hyatt Regency Hotel, Washington, D. C.

**Second International Printed Circuits Conference and Exhibition**, International Printed Circuits Conference (2 Park Ave., New York, N. Y. 10016), Sheraton Centre, New York, April 8-10.

**International Reliability Physics Symposium**, IEEE *et al.*, Caesars Palace, Las Vegas, Nev., April 8-10.

**International Conference on Acoustics, Speech, and Signal Processing**, IEEE, Fairmont Hotel, Denver, Colo., April 9-11.

**58th Annual Convention**, National Association of Broadcasters (1771 N St., N. W., Washington, D. C. 20036), Convention Center, Las Vegas, Nev., April 13-16.

**Region 3 Conference and Exhibit**, IEEE, Opryland Hotel, Nashville, Tenn., April 13-16.

**Spring 1980 Conference of Common**, an IBM computer users group, Common (435 N. Michigan Ave., Suite 1717, Chicago, Ill. 60611), Sheraton-Atlanta, Atlanta, April 13-16.

---

*Ability is of little account  
without opportunity.*

—Napoleon



Recognizing ability and providing opportunity. The importance of both is more than a noble goal. It's smart business.

When a company can do both, its chances for success are enhanced dramatically. Employees begin to perceive their occupations as careers, not jobs. Creative juices flow. New, innovative ideas exchange freely. Motivation becomes inbred, not imposed. And pride surfaces in the form of more output and better products.

Lofty? Yes, but that's what a company should strive for. It's what we strive for everyday at Mostek.

That's why we are now the world's largest supplier of dynamic RAMs. Why our engineers have designed and continue to design many of the industry's leading microcomputers and systems. Why we are the first company to make a major impact in telecommunications. And why we clearly dominate that market with the broadest product line available.

Ability and opportunity. Show us yours and we'll share ours. Call or write: Mostek, 1200 West Crosby Road, Carrollton, Texas 75006, (214) 323-8806.

**MOSTEK®**

We are an equal opportunity employer m f h v.

# Introducing...

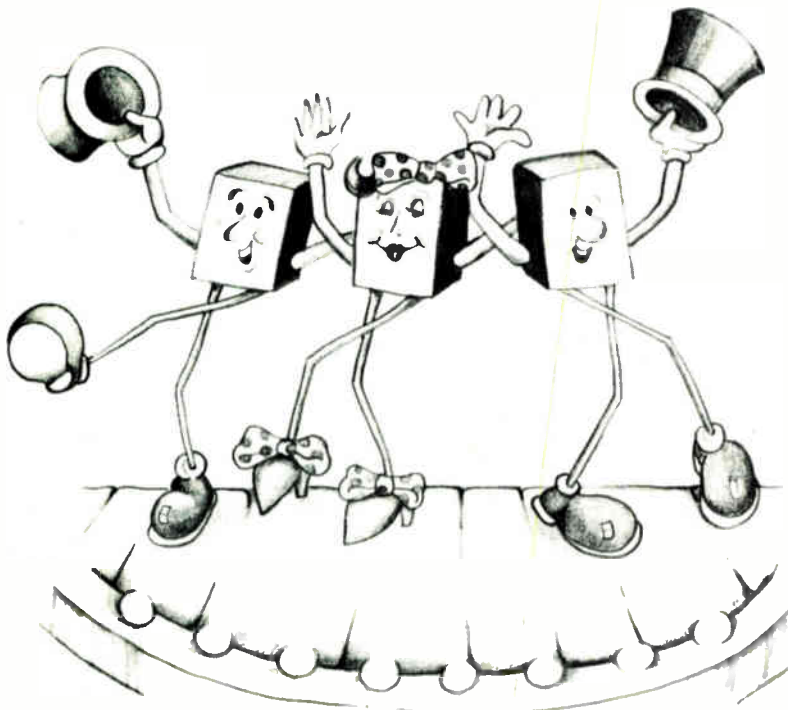

## new line of toroidal inductors

The new Series 2020 incorporate the stability of a toroidal winding on an iron core in a small size. All molded package configuration. The shielded design conforms to MS Spec #21422. Ruggedly constructed with heavy tinned copper radial leads, they are ideal for P.C. and all designs when stable inductive performance is essential. Available in 25 inductance values from .10 to 10.00 microhenries. Prototype quantities with current ratings up to 2200 milliamps are available for prompt delivery. Bulletin 2020-C has all the facts. Ask for your copy.

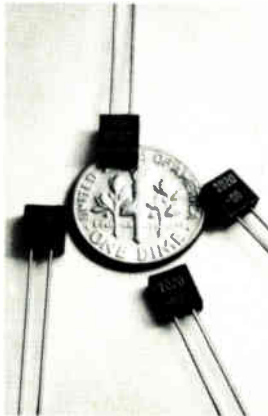

**Delevan**  
Division



**AMERICAN  
PRECISION  
INDUSTRIES INC.**

270 QUAKER RD., EAST AURORA, N.Y. 14052  
TELEPHONE 716/652/3600 TELEX 91-293

OTHER DIVISIONS & SUBSIDIARIES INCLUDE:  
APITRON, BASCO, DUSTEX, AMERICAN PRECISION  
INDUSTRIES (U.K.) LTD., DUSTEX OF CANADA, INC.

## Meetings

**"The DOD FY '81 RDT&E Budget—Outlook and Perspective" Symposium**, EIA (2001 Eye St. N.W., Washington, D. C. 20006), Shoreham Americana Hotel, Washington, D. C., April 15-17.

**Integrating Business Machines into Local Networks**, The Yankee Group (Box 43, Cambridge, Mass. 02138), Harvard Club, New York, April 16-17.

**Hanover International Fair**, German Trade Fair and Exposition Corp. (D-3000 Hanover 82, Messgelände, West Germany), Hanover Fairgrounds, April 16-24.

**18th International Magnetics Conference**, Magnetics Society of the IEEE, Sheraton-Boston Hotel, Boston, April 21-24.

**29th Annual Conference and Exposition**, National Micrographics Association (8719 Colesville Rd., Silver Spring, Md. 20910), New York Coliseum, New York, April 21-25.

**Electro-Optical Warfare III**, Cabrillo Crow Coven and Naval Ocean Systems Center (Dr. P. C. Fletcher, Naval Ocean Systems Center, Code 015, San Diego, Calif. 92152), Naval Ocean Systems Center, April 23-25.

**International Aerospace Exhibition**, German Trade Fair and Exposition Corp. (D-3000 Hanover 82, Messgelände, West Germany), Hanover Airport, April 24-May 1.

### Short courses

**Sixth Annual Reliability Testing Institute**, Ramada Inn, Tucson, Ariz., April 14-18. For information, write the institute's director, Aerospace and Mechanical Engineering Department, University of Arizona, Bldg. 16, Tucson, Ariz. 85721.

**Software Testing Technology**, Chinatown Holiday Inn, San Francisco, April 17-18. For information, write Software Research Associates, Box 2432, San Francisco, Calif. 94126.

## MOSTEK MILITARY UPDATE

# WORLD'S LEADING 16K DYNAMIC RAM RECEIVES QPL CERTIFICATION.

Now you can order a fully JAN qualified 200ns dynamic RAM from the world's leading supplier of dynamic RAMs. It's from Mostek, of course. Designated M38510/24001BEC, this 16K x 1 device is JAN specified over a -55°C to 110°C operating case temperature range and is available in a high density 16-pin hermetic dual-in-line package. Order now for June delivery from your authorized Mostek distributor.

The M38510/24001BEC is just one of the memory components from a full line of the densest and most advanced military memories available today — memories screened to MIL-STD 883B, methods 5004.4 and 5005.5. Besides dual-in-line packaging, Mostek Military offers high density, hermetic leadless chip carriers and flat packages as well.

It's all part of a long-range commitment from Mostek's Military Products Department. Their charter: To create state-of-the-art high density memory products exclusively for the military marketplace.

For more information, write: Mostek, 1215 West Crosby Road, Carrollton, Texas 75006. Or call (214) 323-6000. In Europe, contact Mostek Brussels; phone 660.69.24.

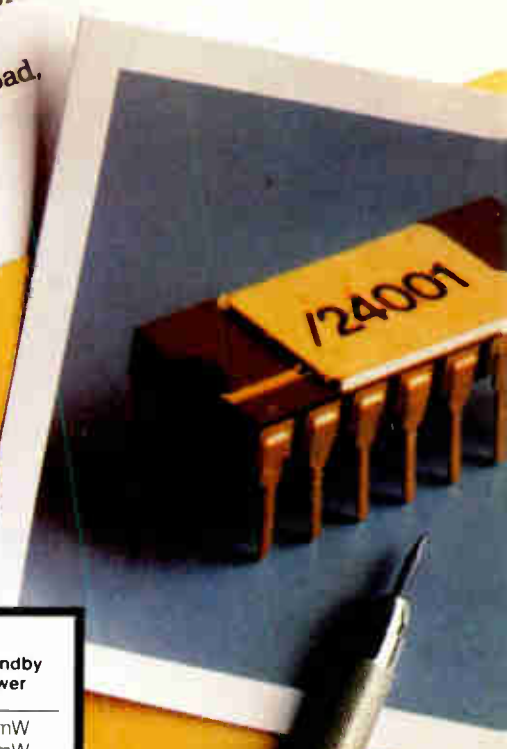

	Mostek Military Products	Organization	Temperature Range	Access Time	Active Power	Standby Power
<b>JAN DYNAMIC RAMS</b>	M38510 24001BEC	16K x 1	-55°C to 110°C*	200ns	462mW	30mW
	M38510 24002BEC	16K x 1	-55°C to 110°C*	250ns	462mW	30mW
<b>DYNAMIC RAMS</b>	MKB 4116-93	16K x 1	-55°C to 93°C	200ns	462mW	30mW
	MKB 4116-83	16K x 1	-55°C to 85°C	200ns	462mW	30mW
	MKB 4116-84	16K x 1	-55°C to 85°C	250ns	462mW	30mW
	MKB 4027-83	4K x 1	-55°C to 85°C	200ns	467mW	40mW
	MKB 4027-84	4K x 1	-55°C to 85°C	250ns	467mW	40mW
<b>STATIC RAMS</b>	MKB 4104-84	4K x 1	-55°C to 125°C	250ns	150mW	53mW
	MKB 4104-85	4K x 1	-55°C to 125°C	300ns	150mW	53mW
	MKB 4104-86	4K x 1	-55°C to 125°C	350ns	150mW	53mW
<b>ROMS</b>	MKB 36000-83	8K x 8	-55°C to 125°C	250ns	220mW	55mW
	MKB 36000-84	8K x 8	-55°C to 125°C	300ns	220mW	55mW
<b>EPROMS</b>	MKB 2716-78	2K x 8	-40°C to 85°C	450ns	633mW	165mW

\*Case operating temperature range

**MOSTEK.**

# Why telecom majors

## Commitment and experience.

All the major manufacturers of telephone station apparatus who have converted to IC dialers have designed in the Mostek dialer circuits. Why? One reason is commitment. Mostek's commitment to leading-edge integrated dialer technology and product availability.

The other reason is experience. Five years of practical experience understanding the critical specifications of the telephone industry. We know what's important in product performance. And what products the industry needs. That's why our broad family covers virtually every choice of network and keypad.

## It adds up to all the volume you need.

Put Mostek's commitment and experience to work for you. With our unparalleled production capability, we can meet your demands today. And tomorrow. To find out how, call (214) 323-6000. Or write Mostek, 1215 West Crosby Road, Carrollton, Texas 75006. In Europe, call Mostek Brussels, phone 660.69.24.

# MOSTEK.

## MOSTEK'S PULSE DIALER FAMILY

Product	Features
MK50981	Direct telephone line operation. Last number redial. Form A or 2-of-7 keyboard. 16-pin.
MK50982	Direct telephone line operation. Last number redial. Ceramic resonator for frequency reference. 16-pin.
MK50991	Direct telephone line operation. Last number redial. Mute output interfaces with bistable latching relay. 18-pin.
MK50992	Direct telephone line operation. RC oscillator for frequency reference. Last number redial. 18-pin.

## MOSTEK'S TONE DIALER FAMILY

Product	Features
MK5087	Direct telephone line operation. Muting and tone amplitude regulation on chip. Form A or 2-of-8 keyboard. 16-pin.
MK5089	Interfaces easily in electronic or $\mu$ P dialing applications. Output tone level is a function of supply voltage. Tone Disable input. 2-of-8 keyboard. 16-pin.



# chose Mostek dialers.

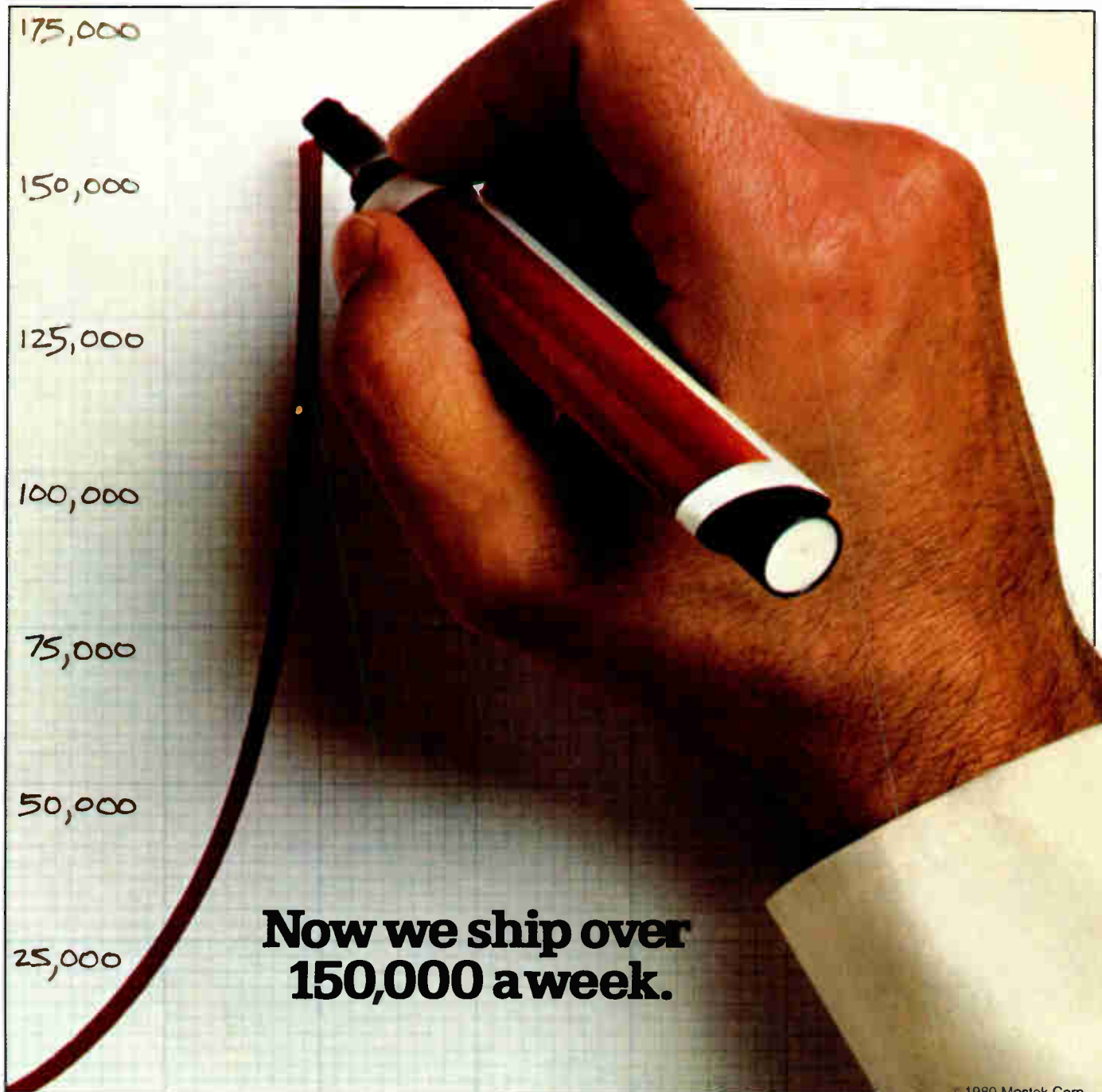

© 1980 Mostek Corp.

Circle 31 on reader service card



A corner of the final assembly room at Electromask... where maskmaking and wafer imaging systems are assembled side-by-side.

## ELECTROMASK MASKMAKING SYSTEMS... FROM 1961 THROUGH 1980 AND BEYOND.

Some people in our industry think that the maskmaker—like the Dodo bird—is a dying breed. Electromask thinks otherwise!

We've been in this business from the beginning and have been responsible for more innovations than any other company: environmental chambers, single-piece stage mirrors, automatic-focus, automatic reticle alignment, computer controlled step-and-repeat systems, laser controlled stages, interchangeable lenses, and combination pattern generators and image repeaters with criss-cross capability.

But now there are those who think that with the introduction of E-Beam and wafer imaging systems, it's time to put the maskmaker to pasture. So some of those people have already quit producing mask-making systems.

At Electromask, we were the first to offer a wafer imaging system with through-the-lens wafer-to-reticle



The Electromask Combination Pattern Generator/Image Repeater offers all the capabilities of a stand-alone PG and IR in one system—and with Criss-Cross, it is the most cost-effective reticle generating system available for ROM's, RAM's and Bubble Memories.

alignment and the same kind of field-proven laser-controlled staging that we use on our maskmaking systems. So today at Electromask, you will find both maskmaking and wafer imaging systems being assembled side-by-side as we take care of our new customers without turning our backs on our old ones.

We have been partners with the maskmaker for a long time, and we expect to continue that relationship even as we introduce the newly emerging systems for the wafer production departments.

If you're making masks and do not have a copy of "The Electromask MaskMaker Systems" brochure, send for yours today. You will be amazed at how cost-effective an Electromask Mask-Maker System can be for your applications.

Electromask, Inc., a subsidiary of the TRE Corporation, 6109 De Soto Avenue, Woodland Hills, California 91367. Phone: (213) 884-5050, Telex 67-7143.



# ELECTROMASK

## **IBM expected to unveil \$4,500 computer made in Japan**

IBM Corp.'s 5120, introduced last month at \$13,500 as the company's lowest-priced computer, may be just an interim product. That is the view of industry analyst Creative Strategies Inc. of San Jose, Calif., which expects to see a \$4,500 machine, the 5105, that will be made in Japan and will interface with the S-100 bus popular in personal computers. The machine, programmed in Basic, would have a main memory of 16 or 32 kilobytes, a microprocessor cycle time of 500 ns, a magnetic-tape cartridge, a cathode-ray-tube readout, and a 30-character/second thermal printer. Creative Strategies also anticipates a multiterminal version, possibly designated the 5130, that will be introduced at the same time.

## **\$688 million market for bubble memories foreseen by 1985 . . .**

With makers and users seeking information on bubble memory market trends for the 1980s, Charles V. Kovac of Rockwell International Corp., Pittsburgh, has offered his forecast. The vice president for business development says the worldwide market will reach \$30 million by the end of this year and \$688 million by 1985; the 1982 price for 1-megabyte systems will be 13 millicents per bit at the system level and 11 millicents/bit at the device level. The market—one of whose biggest segments will be telecommunications—will be capacity-limited through 1982, he says, but by 1983 it will mature. **Kovac also looks for the 4-Mb chip to materialize in 1983**, but says it will be built using the modified-chevron approaches in today's devices rather than the contiguous-disk structure.

## **. . . with 1-Mb models to be in spotlight at Intermag '80**

Using the International Magnetics Conference as a forum, Rockwell will describe its 1-megabit bubble memory **along with Texas Instruments, National Semiconductor, and Intel Magnetics**. Intermag '80, April 21-24 in Boston, also includes its usual mix of papers on new bubble materials, propagating structures, and fabrication and packaging techniques. Other sessions broach magnetic recording and thin-film heads, permanent magnets, and superconductors.

## **16-K demand to top capacity through 1980, says TI**

Worldwide shipments of 16-K dynamic random-access memories from all vendors totaled about 70 million units last year, a 340% increase over 1978, according to estimates by Texas Instruments Inc. Though they project an additional 200%-plus growth rate in shipments this year—to between 140 million and 160 million units—officials at TI's MOS Memory division in Houston expect demand for the 16-K parts to continue outstripping industry capacity through 1980. The overwhelming majority of 1980 shipments will be conventional 4116-type parts requiring three power supplies, **but TI expects shipments of advanced single-5-v-supply 16-K parts to reach 2 million units this year**, up from an estimated 100,000 units in 1979. However, TI continues to eschew that market, choosing to concentrate on the single-supply 64-K RAM.

## **CAD system for ICs cuts longest steps**

Engineers at Hewlett-Packard Co.'s General Systems division, Cupertino, Calif., have developed a breadboard of a computer-based system to support the design of large-scale and very large-scale integrated circuits. Called Sticks, the computer-aided design tool produces correct pattern-generating data that meets design rules—is camera-ready—from a topological IC diagram sketched freehand at a color graphics work station. Thus, **the IC**

**designer will be freed from the traditional rectangular layout and checking steps** that are, perhaps, the most time-consuming and error-prone aspects of current random-logic design techniques. HP expects the system, when fully developed, to reduce costs as much as 90%.

## **18-bit converter features registers, 16-bit linearity**

Hybrid Systems Inc. of Bedford, Mass., is about to announce the first digital-to-analog converter with storage registers, 18-bit resolution, and 0.0008% nonlinearity. The DAC-370-18 is a two-chip hybrid circuit in a hermetic dual-width dual in-line package. It will meet both commercial and military temperature requirements, **with a price as low as about \$210 in hundreds**. Interest is already coming from firms with digital-recording, automatic-test, and military applications.

## **National about to unveil speech-synthesis chips**

National Semiconductor Corp., Santa Clara, Calif., will soon make its anticipated entry into the speech-processing field with a voice-synthesis system consisting of multiple n-channel MOS devices. The chip set has a speech processor and a read-only memory that contains the compressed speech data as well as the frequency and amplitude data needed for speech output. When used with external filter, amplifier, and speaker, the kit will produce a system that generates high-quality speech, **with the natural inflection and emphasis of the original sound**. Available by the end of the first half of 1980, the system digitizes waveforms using pulse-code-modulation compression techniques to synthesize adult male and female as well as children's voices.

## **V-MOS power FETs promise threefold capacity increase**

While some manufacturers of V-groove MOS power transistors have been boasting about high-voltage (400-to-500-v) devices with a continuous current on the order of 7 to 10 A, Supertext Inc. has quietly developed a new series of V-MOS power field-effect transistors with a current-handling capability more than three times that of devices of equivalent die size and voltage. With modifications to its device structures and vertical double-diffused MOS (D-MOS) process, the Sunnyvale, Calif.-based firm has **lowered resistance to 0.25  $\Omega$  or less**, improving the efficiency of high-voltage devices so they can handle a continuous current upwards of 30 A.

## **Addenda**

Nippon Electric Co. has decided to sell its line of fiber-optic components and instruments directly through its U.S. distributors. **Until now the devices have only been available in Japan to U.S. customers with a buying agent**. The components usually come equipped with mounted connectors and are based on Nippon's Selfoc lens concept. This wave-focusing lens enables Nippon to use many classical optical principles in the components. . . . Exxon Enterprises Inc. has launched another office-equipment venture in Silicon Valley: Summit Systems. The Cupertino, Calif., operation is building a **software-development work station and a distributed-computer system**. . . . Alexandrite lasers will be added to Allied Chemical Co.'s commercial product catalog next year. The tunable solid-state high-power laser, which can operate in the pulsed- or continuous-wave mode, **might typically tune 700 to 800 nm with greater output than a yttrium-aluminum-garnet laser**.

# “How did we manage to be first with intelligent analog peripherals? By working like madmen.”

Fred Molinari, President

We worked days and nights, weekends and vacations to develop the intelligent analog peripheral.

It was time well spent.

Because now we can offer you a complete microcomputer data acquisition system on a single Multibus™ board.

Decentralizing your computer function has finally become a practical possibility.

You see, this intelligent analog peripheral pre-processes data without involving the host CPU.

And thanks to a unique DMA controller, this peripheral also acquires analog data independently, at rates up to 125KHz.

Our new peripheral can function as an intelligent A/D slave. Or as a stand-alone microcomputer with A/D capabilities. Or as a remote system, transmitting data via a serial line.

Convenient? Our peripheral even includes a system monitor in preprogrammed ROM to communicate with the board, debug, and access A/D conversions.



In short, we have brought high-speed capability down to low-end computers. And, we might add, we are the first to do so.

Working like madmen has its advantages. We hope you'll let us work like crazy for you.

We can be reached at 4 Strathmore Road, Natick, MA 01760. Or by phone at (617) 655-5300. Telex: 948474. In Europe: Data Translation Ltd., Reading, Berkshire/England. Phone (0734) 669-335; Telex: 847482.

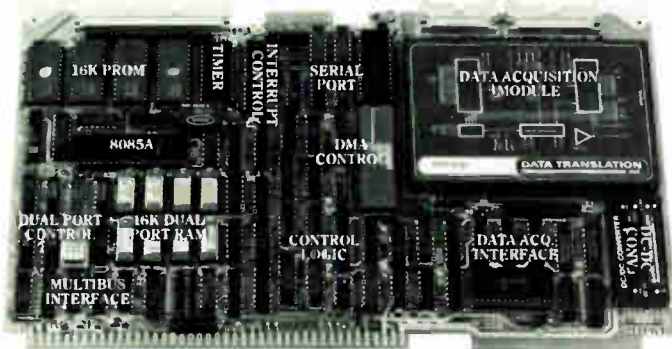

Our intelligent analog peripheral features: A dual port memory controller. A 8085 CPU. Four PROM sockets. Two programmable timers. A baud rate generator. A complete priority interrupt controller. 12 bit A/D with 125KHz throughput to memory. A 16K byte dual-ported dynamic RAM. A self-contained four-channel multi-mode DMA controller. And quite a bit more.

# DATA TRANSLATION

INTERNATIONAL SALES OFFICES: ARGENTINA, Buenos Aires 89-4594; AUSTRALIA, N.S.W. (02) 818-1166; BELGIUM, Brussels 02-352135; CANADA 416-625-1907; DENMARK (02) 80 42 00; ENGLAND, Stockport 061-442-9768, Reading (0734) 669335; FINLAND, Helsinki 90-377787; FRANCE, 6306839; GERMANY, Puchheim (089) 80 60 61 62; INDIA, Bombay 231040; ISRAEL, Ramat Hasharon; ITALY, Milano 34 93 041; JAPAN, Tokyo (03) 355-1111, (03) 437-5471; NETHERLANDS, Rijswijk 70-996360; NEW ZEALAND (4) 644-585; NORWAY, Oslo 0269 44 90; PORTUGAL, Lisboa 4 53 13; SPAIN, Barcelona (93) 301 78 51; SWEDEN, Vallingby 08-38 00 65; SWITZERLAND 01/730 48 48.

Multibus is a trademark of Intel Corp.

# "WHAT THIS COUNTRY HIGH SPEED, SUPER-

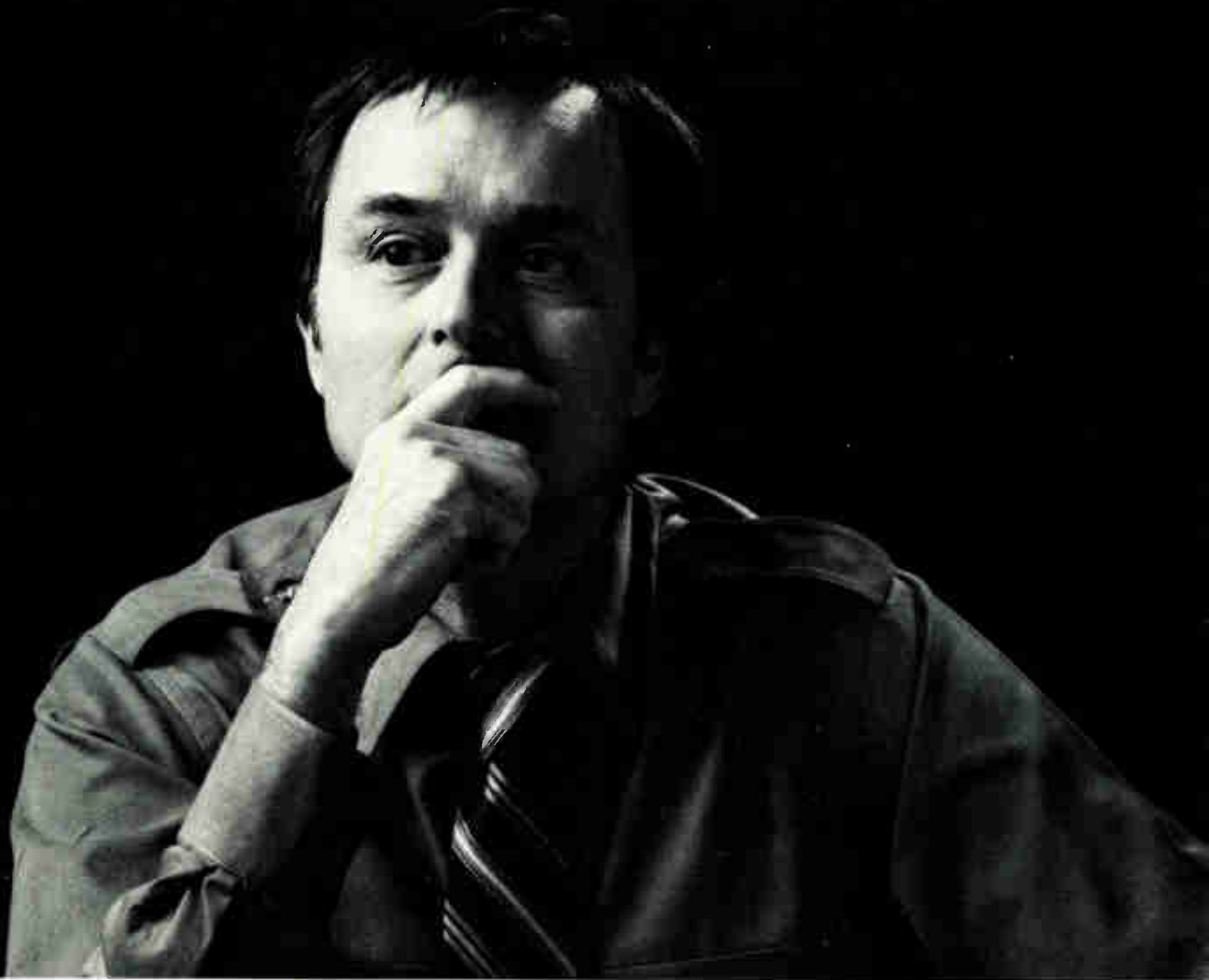

## YOU GOT IT.

It's called the IM7147. And Intersil makes it. It's a low-power, 4K static RAM with 55ns access times.

	Operating Power	Standby Power	Access Time
IM7147	125mA	20mA	70ns
IM7147L	100mA	10mA	70ns
<b>IM7147-3</b>	<b>125mA</b>	<b>30mA</b>	<b>55ns</b>
<b>IM7147L-3</b>	<b>110mA</b>	<b>20mA</b>	<b>55ns</b>
(military) IM7147LM	125mA	20mA	85ns

Now, you're probably thinking you'll have to pay an arm and a leg for that combination of performance. Not so. Intersil 4K statics are super competitive with anything even near to equivalent in the market today.

## SAVE BIG BUCKS.

Sure, you'll save when you buy from Intersil. But, you're going to see even greater savings when you start designing the 7147 into new systems. It's great for high-speed, large memory applications. Because it runs on a smaller power supply and it needs only a fraction of the cooling other RAMs require. Lower power dissipation also means greater reliability for the entire system.

# NEEDS IS A LOW-POWER 2147."

## A FAMILY THAT WON'T QUIT.

Don't get us wrong. We have the high-performance 4Ks, but we also have a raft of the regular 4Ks. So, if you need standard 2147s for existing sockets, we've got you covered. Same with 2114s and 7141s (2141s).

Any way you slice it — 1K x 4 or 4K x 1, low-power or industry standard, commercial or military — Intersil's got your part. At a competitive price. And we're quoting immediate delivery. Off the shelf. It you don't believe it, just try us with an order.

## COMING ATTRACTIONS.

Sounds like we have our act together, right? Well, we're not stopping there.

To give just a peek at the future, in first quarter 1980, we'll be bringing out the IM7148. It's a new high-performance, low-power 4K especially well-suited to mainframe memories.

## FROM THE LOW-POWER WHIZ KIDS.

Actually, it shouldn't surprise you that Intersil is doing all this. Since we're known for our innovation in CMOS technology. But it hasn't been by accident. We've focused on it. Because one of the things we thought this country needed was a good low-power technology company.

## INTERSIL SALES OFFICES:

CALIFORNIA: Sunnyvale (408) 744-0618, Long Beach (213) 436-9261 • COLORADO: Aurora (303) 750-7004 • FLORIDA: Fort Lauderdale (305) 772-4122 • ILLINOIS: Hinsdale (312) 986-5303 • MASSACHUSETTS: Lexington (617) 861-6220 • MINNESOTA: Minneapolis (612) 925-1844 • NEW JERSEY: Englewood Cliffs (201) 567-5585 • OHIO: Dayton (513) 866-7328 • TEXAS: Dallas (214) 387-0539 • CANADA: Brampton, Ontario (416) 457-1014

## INTERSIL FRANCHISED DISTRIBUTORS:

Advent (IND, IA) • Alliance • Arrow • Bell Industries • CESCO • Component Specialties • Components Plus • Diplomat (FLA, MD, NJ) • Harvey (upstate NY) • Intermark • Kierulff • LCOMP • Parrott • R.A.E. Ind. Elect. Ltd. • RESCO/Raleigh • Schweber • Summit • Wyle • Zentronics Ltd.

INTERSIL NMOS STATIC RAM FAMILY		Operating Power	Access Time
1K x 4	IM2114-2 (D2114-2)	100mA	200ns
	IM2114-3 (D2114-3)	100mA	300ns
	IM2114 (D2114)	100mA	450ns
	IM2114L2 (D2114L2)	70mA	200ns
	IM2114L3 (D2114L3)	70mA	300ns
	IM2114L (D2114L)	70mA	450ns
	IM7114L2	50mA	200ns
	IM7114L3	50mA	300ns
	IM7114L	50mA	450ns
	4K x 1	IM7141-2	70mA
IM7141-3		70mA	300ns
IM7141		70mA	450ns
IM7141L2		50mA	200ns
IM7141L3		50mA	300ns
IM7141L		50mA	450ns
4K x 1		D2147	160mA
	D2147L	140mA	70ns
	D2147-3	180mA	55ns
	IM7147	125mA	70ns
	IM7147L	100mA	70ns
	IM7147-3	125mA	55ns
	IM7147L-3	110mA	55ns
	MD2147	180mA	85ns
	IM7147LM	125mA	85ns

Military temperature available in all devices.

# INTERSIL

DIGITAL PRODUCTS — MEMORY  
10710 No. Tantau Ave., Cupertino,  
CA 95014  
Tel: (408) 996-5000 TWX: 910-338-0171  
(800) 538-7930 (outside California)

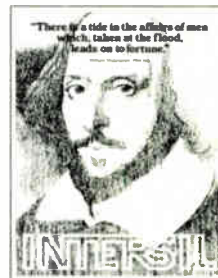

Wow! Am I ever interested in your 4K static RAMS.

\_\_\_\_\_ Please send me information on your RAM line.

\_\_\_\_\_ And include your 20 x 24" Shakespeare poster. I like that idea, too.

Name \_\_\_\_\_

Company \_\_\_\_\_

Address \_\_\_\_\_

City/State/Zip \_\_\_\_\_

# We have a pollution solution!

Corcom is the world leader  
in RFI pollution control.  
Our SP series filters have  
been designed to allow  
switching power supplies  
to comply with the  
new FCC rules as well as  
VDE 0875A. Write for  
complete technical data.

 **corcom**  
**RFI Power Line Filters**

Corcom Inc. 1600 Winchester Road, Libertyville, Illinois 60048 U.S.A.  
312-680-7400 TWX 910-684-3269



## Fiber-optic cable to go to sea for phone company

by Harvey J. Hindin, Communications & Microwave Editor

AT&T plans a lightwave link to span the Atlantic; sees vast savings over copper cable of like capacity

With fiber-optic cable appearing in phone company ducts, the next field for the burgeoning technology to conquer is underwater telecommunications. Just such a foray is in planning at Bell Laboratories' Holmdel, N. J., facility.

Speaking at Cleos—the Conference on Lasers and Electro-Optical Systems—late last month in San Diego, Peter Runge, head of Bell's undersea lightwave systems department, disclosed plans for a transatlantic submarine cable. He said its cost would be a fifth that of projected copper coaxial cable systems of the same capacity and one third of the cost of today's undersea cable systems.

**Setup.** The indium-gallium-arsenide-phosphide lasers in the system will operate at a 1.3-micrometer wavelength. Lasers in the 1.55- $\mu\text{m}$  region with still lower attenuations might be used if the technology advances fast enough, Runge says.

To keep the system's mean time before failure at eight years, each repeater in the cable will have an operating laser and three standbys. A Bell-developed, four-input, single-output switch will be able to jump automatically from a failing laser to a standby.

InGaAsP p-i-n diodes will be used as light detectors. Bell feels the part is more reliable than the avalanche photodiode and has a lower operat-

ing voltage. The cable will contain single-mode fibers.

The digital system will use time-assignment speech interpolation, which crams the usual pauses between words and syllables with additional data. Thus bandwidth is saved because more bits per second are packed in.

Bandwidth is one of the attractions of fiber-optic cables; in fact, Runge says the planned system will carry 4,032 conversations per fiber, compared with the 200 for a copper wire. Furthermore, transmission will be higher in quality because the all-digital systems will regenerate a nearly noise-free message at each repeater site.

An attenuation much lower than

copper's means that the expensive repeaters will be spaced at least 35 kilometers apart, rather than 9 km, over the 6,500-km run between the U. S. and a yet unchosen site on the other side of the Atlantic. As well as saving money, fewer repeaters are important in achieving the eight-year system MTBF, which is an acceptable figure for submarine cables.

**Installation.** Still another cost savings should stem from installation. Fiber cables are much lighter and smaller than comparable coaxial cables, so the cable-laying ship, which now must return several times to reload, can carry much more of them.

The lightwave system will have a

### Lead-salt diode operates at room temperature

General Motors Corp. researchers reported at Cleos that they have developed a lead-salt light-emitting diode operating at a 4.6-micrometer wavelength. The LEDs are in the 3-to-16- $\mu\text{m}$  far-infrared region of the spectrum and should produce fiber-optic communications systems with attenuation losses orders of magnitude lower than the few tenths of a decibel per kilometer expected in the coming 1.5- $\mu\text{m}$  fiber-optic generation.

Such lead-salt diodes do exist, but all previous examples have required cryogenic cooling. Wayne Lo and Don E. Swets of the physics department at General Motors Research Laboratories in Warren, Mich., fabricated their device from high-quality lead-sulfide-selenide single crystals that were grown from the vapor phase.

With improved crystals, the junction resistance of the diode rose to as much as 100 ohms at room temperature. Past lead-salt diodes have had a junction resistance of only a few ohms, which was insufficient for light emission unless they were supercooled.

So far, measured power output is only a few hundred nanowatts, but Lo expects improvements. "The high index of refraction [4.6] of the lead-sulfide-selenide produces substantial internal reflection at the semiconductor-air interface," he says. "This means most of the energy produced is sent right back into the diode."

He anticipates an output of tens of microwatts once the reflection problem is solved. Such a power will be practical for lightwave systems because of their extremely low attenuation at those wavelengths.

-H. J. H.

## Electronics review

projected life expectancy of 24 years, to match Bell's requirements for copper systems. The typical communications satellite is usable for about eight years and costs \$50 million in today's dollars to put up.

"For the first time, the cable will

be able to be easily branched into a Y configuration somewhere in the ocean," Runge notes. "You could connect to England, for example, and go on to the Continent." Also, fiber cable can handle links with differing cross sections.

## Production

### Electronics makers design out gold by substitution, selective plating

In the wake of zooming prices for gold and other precious metals, some designers of electronic products are trying to substitute cheaper materials and seek other ways to save gold. They are choosing this approach over the pricing jumps that many electronics manufacturers are already putting into effect.

Often they put these efforts in motion several years ago, but firms report the quests are intensifying as the price of gold surges to new highs. The makers of hybrids and connectors, whose products use so much gold, silver, and palladium, are

particularly active in the substitution game. Integrated-circuit manufacturers are less concerned, although there is some play there, too.

**Results.** One firm already getting results is Beckman Instruments Inc., in the hybrid microcircuit line of its Advanced Electro-products division. "In some cases, we got rid of 90% of the gold in a \$200 custom hybrid part," says William J. Miller, product marketing manager.

Such a reduction saves the customer about 10%. Miller cautions that not all replacement translates into bottom-line savings because of

the extra production steps.

Beckman's strategy is to use the metal only where absolutely necessary—in the leads, thick-film conductive paste, and bonding wires in the \$200 part, for example. Gold could have been used as sparingly years ago, but customers preferred it to be employed as generously as possible because it is easy to solder for leads, is a good conductor, and provides a corrosion-resistant case.

Other manufacturers report they are using selective gold plating, as well as materials substitution and reclaiming of precious metals from industrial waste. For instance:

- Connector maker Augat Corp. of Attleboro, Mass., is using tin-lead plating of contacts and outer sleeves on machine sockets, saving customers 20%. In some products, it is using gold inlays for interface points only. Jeffrey Mahall, manager of business sockets, reports that testing of the tin-lead versus gold plating gave such results as an increase in resistance under high humidity from 1.2 to 1.4 milliohms for the substitute and from 1.0 to 1.2 mΩ for gold.

- Robinson Nugent Inc. of New Albany, Ind., a manufacturer of dual in-line package sockets, has a new series with gold plate in the contact areas and tin plate for the leads. This avoids gold surcharges, it says.

- Amp Inc., the Harrisburg, Pa., connector maker, is employing similar strategies. "Another method is to more efficiently deposit and recover gold salts and scrap," says a spokesman. "For instance, one third of all the gold we buy now is recovered and sold back for credit because of improved recovery techniques."

- National Semiconductor Corp. of Santa Clara, Calif., is employing copper foil to bond chips and leads wherever possible. It substitutes a conductive epoxy for a silicon-gold eutectic die attach and selectively

**Substitution.** To save gold, Beckman Instruments substitutes the black ceramic package for the gold case (top middle) used in the hybrid at top right and uses nickel plating in place of gold for the case (bottom left) and package (bottom middle) in the hybrid whose former version is at bottom right.

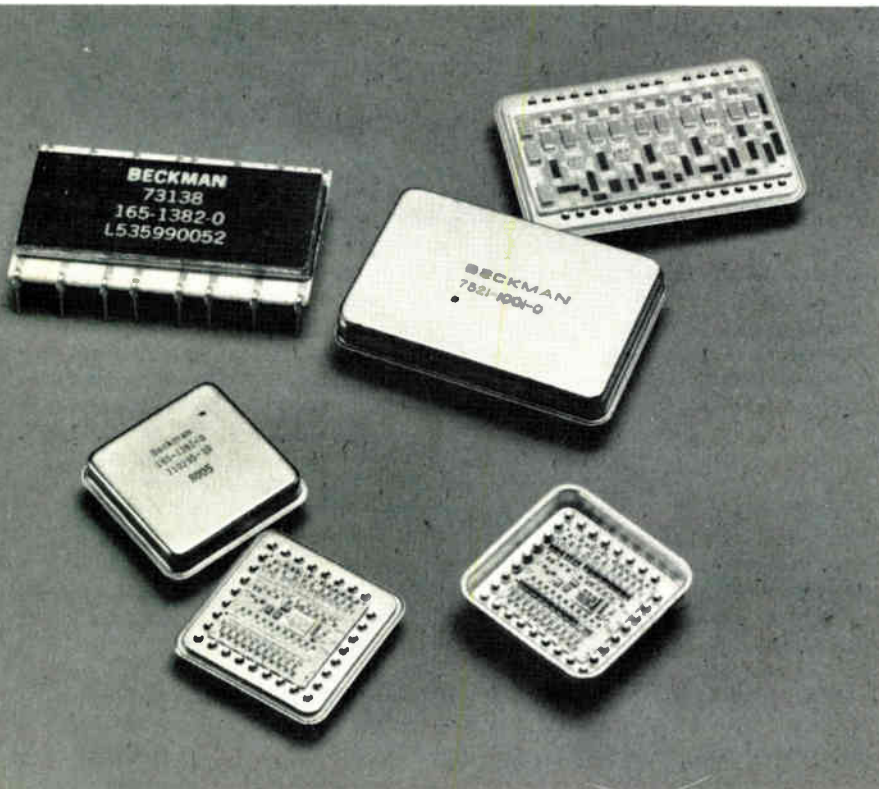

gold-plates lead frames.

■ Motorola Inc.'s MOS Memories group in Austin, Texas, is switching to ceramic packages from side-braze packages for its chips. The lid is glass or another ceramic in place of gold, and other metals than gold are used in the lead frames and solder rings.

At Beckman's Advanced Electro-products division in Fullerton, Calif., gold substitution involves picking the right cheaper material for each function. "None of them is the perfect substitute: each one has a tradeoff," says William H. Bardens, senior engineer in charge of the program.

**Tradeoffs.** Tin plating is fine for soldering, but not a good enough conductor for lead connections. Nickel is an adequate conductor, but experiences an oxide buildup while on the shelf.

Thus, selective substitution is the key. Also, Beckman is using epoxy bonding to mount parts in sealed packages, rather than the 80/20 gold-tin mix for soldering used before. To facilitate bonding with non-gold materials, the division is using an extra pin to ground the case instead of relying on a gold-to-gold ground.

-Larry Waller

## Components

### Data compression cuts driver lines

A novel data-compression technique from Telefunken Corp. promises to reduce radically the number of control and address lines in integrated circuits. Officials at the Heilbronn, West Germany-based firm say it can replace five or six lines with as few as two or three and for large numbers can cut the requirement by more than 90%.

Ever more complex ICs need ever more address and control lines, and for chips like display drivers, memories, and microprocessors, the increase in line complexity is affecting die size and yield. With more lines squeezed in, chips necessarily get larger, and the effort to minimize



**Compression.** Only 16 control lines (instead of the usual 31) can drive this 240-element LED array, thanks to a new data-compression technique in Telefunken driver integrated circuit.

chip growth can create production problems that lower yields.

Not a true trinary scheme, the technique (known as Datacomp) uses two binary states, plus an open-line state that acts as an active source of information. It uses conventional three-state output schemes, but here the passive third state conveys information.

Datacomp uses combinatorial principles of mathematics. A single extra "combit," or high-impedance line state *c*, can be implemented easily in existing systems. Positioned among the 1s and 0s, the combit increases the number of possible combinations. Three lines could send 00c, 0c0, c00, 01c, and so on; the result is 12 combinations instead of a binary system's 2<sup>3</sup> or 8. A true trinary scheme would yield 3<sup>3</sup> or 27 combinations [*Electronics*, Nov. 8, p. 39].

Designed initially to drive light-emitting-diode displays (see photograph), a bipolar IC in a 16-pin dual in-line package contains a static analog-to-digital converter and controller and driver electronics, as well as the data-compression circuitry. It will be able to drive 30 LEDs in a linear array with only eight control lines and will cost \$1.50 in quantity when introduced this summer.

"Datacomp can be used in one of

two ways," says Christopher Malinowski, Telefunken's U.S. product engineering and marketing manager. "For price-sensitive applications like calculators, the same information density can be obtained for less money. Or higher-level information density can be obtained—like driving a flat-panel display—for the same cost as a conventional decoder/driver circuit."

Malinowski also expects the technique to find use in input/output devices that use matrix coding/decoding schemes, such as fiber-optic gear and card and paper-tape readers, and in keyboard-entry codecs, printers, and the like. He is co-inventor of Datacomp, with Heinz Rinderle and Martin Siegle, who work for Telefunken in West Germany.

-Roger Allan

## Memories

### Bubble offerings start to balloon

Bubble memories are taking their time getting into production, but the makers of semiconductor memories clearly see them as a medium for low-cost, high-density storage. National Semiconductor Corp.'s recent

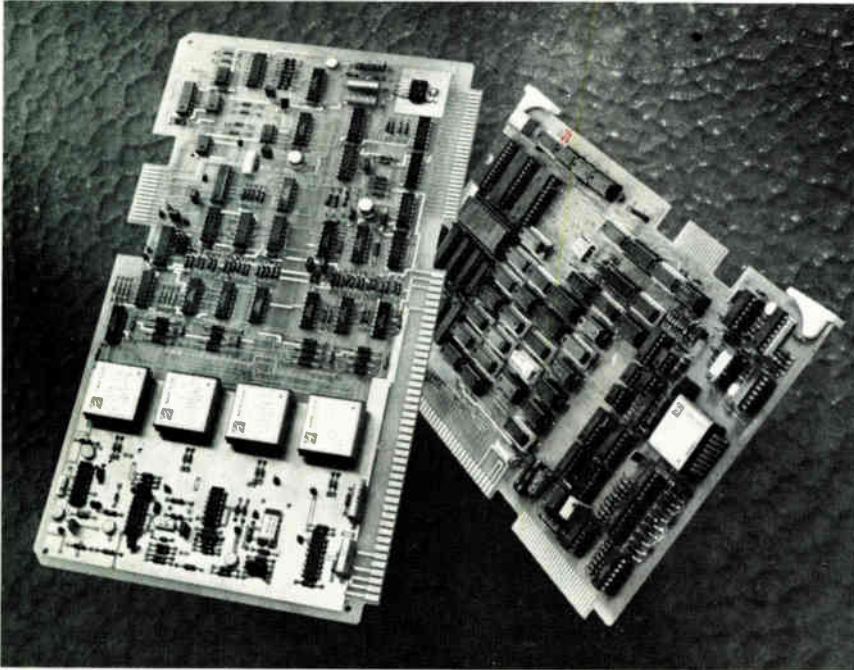

**Boards of bubbles.** National is offering its 256-K bubble chip on the NBS 100 evaluation board (right), which is also a controller for up to eight 1-megabit NBS 101 expansion boards.

announcement of its 256-K part brings the total number of bubble-memory makers to eight—all of them semiconductor firms.

What's more, the companies are expanding their board offerings, not just to familiarize original-equipment manufacturers with bubbles, but also to offer products for industrial-control applications, where bubble ruggedness and nonvolatility are desirable:

- National's chip [*Electronics*, Jan. 31, p. 129] comes on the \$1,300 evaluation board shown right in the photograph. Such boards are the first step for OEMs venturing into the bubble arena.

- Intel Corp. will soon announce the iSBC250, a Multibus-compatible board holding 128 kilobytes in its 1-megabit chip [*Electronics*, April 26, 1979, p. 105], along with error-correcting and power-down circuitry. The unit price will be \$4,750.

- Rockwell International Corp. plans to announce a single-board bubble system that is bus-compatible with 6500 and 6800 microprocessors. With error correction and power-down circuits, the RMS board family will come initially with two 256-K chips, with expansions up to 256

kilobytes once the company's forthcoming megabit chip is ready.

- Texas Instruments Inc. will soon have a board holding up to 768 kilobytes for its 990 microcomputer family [*Electronics*, Feb. 14, p. 40].

With all of the activity, there is still one major hangup on bubbles' road to popularity. No manufacturer yet offers the complex control function implemented in a large-scale integrated circuit, so OEMs must use TTL implementations.

The bubble makers are working on controller ICs, all shooting for production by year-end. They agree that these LSI circuits will sharply increase bubble-chip shipments, since their introductions coincide with current OEM design cycles.

With eight manufacturers in a wide-open field, there is a plethora of design approaches. However, National's NBM 2256 is organized much like the 256-K chips being shipped by Rockwell and TI.

**Geometries.** The Santa Clara, Calif., firm uses direct-step-on-wafer projection lithography for a 96,000-square-mil chip. The minimum feature is 1.5 micrometers, corresponding to a 3- $\mu$ m bubble diameter.

These geometries are comparable

to those of other manufacturers except for TI, which announced a 256-K device scaled to 2- $\mu$ m bubbles as part of its family of quarter-, half-, and full-megabit chips [*Electronics*, Sept. 27, 1979, p. 37].

Other companies with 256-K chips include Fujitsu Ltd., which offers samples, and Hitachi Ltd., which upgraded its 64-K bubble for shipment to Nippon Telegraph and Telephone Public Corp. Motorola Inc. and Siemens AG will have second-source versions of Rockwell's 256-K device, probably by the end of the year.

-Raymond P. Capece

### Solid state

## RAMs hit 512 K; production not in sight

As if 256-K dynamic random-access-memory MOS chips were not achievement enough, the Japanese contingent at last month's International Solid State Circuits Conference brought along news of a 512-K RAM. Although these developments clearly demonstrate Japan's integrated-circuit expertise, they are far from being production parts.

For example, the 512-K RAM (see photo, p. 44) uses 2-micrometer design rules that can be whittled to 1  $\mu$ m for a 2-megabit chip, according to its developer, the VLSI Technology Research Association's Cooperative Laboratories. But the access time is simulated—meaning that there are no fully functional chips.

**Processes.** Moreover, the fabrication processes for this IC and the 256-K RAM described by the NTT Musashino Electrical Communication Laboratory probably are not turning out viable production parts. A 256-K RAM described by NEC-Toshiba Information Systems Inc. seems the most realistic design.

The 512-K IC uses conventional photolithography, according to the ISSCC paper—but 2- $\mu$ m lines are so hard to achieve with projection equipment that the cooperative labs undoubtedly are using direct-step-on-wafer techniques. Such DSW

# BEST DESIGNER FEATURES IN DPM'S



**DM-4100N**  
4½ Digits  
Low Profile Case

**DM-3100L**  
\$50 (1-9)  
Short Depth Case

Imagine quality OEM Digital Panel Meters with all these features at such low cost!

## 3½ DIGIT DPM'S

	MODEL	INPUT	CASE STYLE	DISPLAY	POWER	FEATURES	PRICES
LED DISPLAY	DM-3100L	±2V, balanced differential	Short Depth	.56" High LED	+5 Vdc @ .28A	Ultra-low cost	\$50 (1-9)
	DM-3100N	±2V, balanced differential	Low Profile	.56" High LED	+5 Vdc @ .28A	Optional off-set pot	\$50 (1-9)
	DM-3100B	±2V, balanced differential	Short Depth	.56" High LED	115/230 AC, pin-selected	Low cost AC power	\$70 (1-9)
LIQUID CRYSTAL DISPLAY	DM-3100X	±2V, balanced differential	Short Depth	.6" High Liquid Crystal	+5V, 6mA or 9-15V	Battery Powered	\$66 (1-9)
	DM-3100U1	±2V, balanced differential	Low Profile	.5" High Liquid	+5V, 6mA or 9-15V	Programmable Descriptors	\$60 (1-9)
	DM-3100U2	±2V, balanced differential	Low Profile	.5" High Liquid Crystal	115AC(U2)	Programmable Descriptors	\$69 (1-9)
	DM-3100U3	±2V, balanced differential	Low Profile	.5" High Liquid Crystal	230AC(U3)	Programmable Descriptors	\$69 (1-9)

## 4½ DIGIT DPM'S

LED DISPLAY	DM-4100L	±2V, single-ended	Short Depth	.56" High LED's	±5Vdc @ .4A	Low cost 4½ digit	\$88 (1-9)
	DM-4100N	±2V, single-ended	Low Profile	.3" High LED's	+5Vdc @ .4A	Low cost, 4½ digit	\$93 (1-9)

Case Styles - Short depth Case: 1.760"H x 3.00"W x 2.150"D, cutout: 1.812" x 3.062"  
Low Profile Case: 0.94"H x 2.531"W x 3.25"D, cutout: 0.97" x 2.562"

Substantial OEM Discounts available

### OUTSTANDING SPECS COMMON TO ALL MODELS

- Autozeroing
- Ratiometric reference to reduce drift
- 1000 Megohm input impedance
- 5 pA input bias current

### User-added options:

- Internal attenuators for ranges up to ±1 kV
- Internal current shunts for ranges up to ±2A



11 CABOT BOULEVARD, MANSFIELD, MA 02048 / TEL (617)339-9341 / TWX 710-346-1953 / TLX 951340  
Santa Ana, (714)835-2751, (L.A.) (213)933-7256 • Sunnyvale, CA (408)733-2424 • Gaithersburg, MD (301)840-9490  
• Houston, (713)781-8886 • Dallas, TX (214)241-0651 OVERSEAS: DATEL (UK) LTD—TEL: ANDOVER (0264)51055  
• DATEL SYSTEMS SARL 602-57-11 • DATELEK SYSTEMS GmbH (089)77-60-95 • DATEL KK Tokyo 793-1031

CALL TODAY FOR YOUR FREE ENGINEERING PRODUCT HANDBOOK

Circle 43 on reader service card

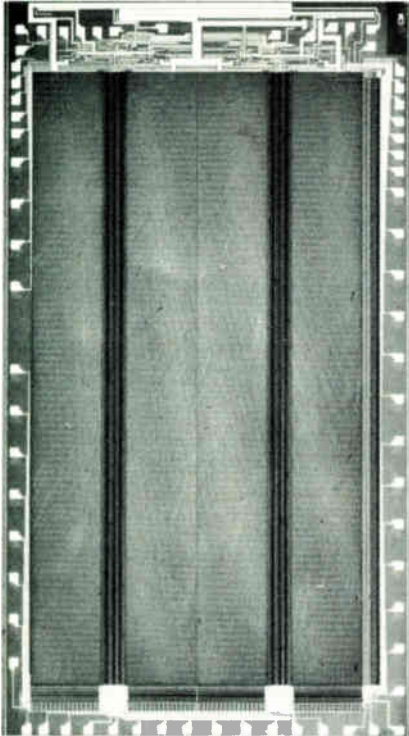

**Look out.** The VLSI Cooperative Laboratories in Japan reported on this 512-K dynamic RAM at this year's ISSCC. However, access time is simulated, so the device probably does not work—yet.

equipment exists, but even so the half-megabit chip has an area of more than 70,680 square mils and 66 bonding pads.

NTT-Musashino's 256-K RAM uses an even less viable technique for its 1- $\mu$ m lines: a direct-writing electron beam. Although good at producing such fine lines, this nonphotolithographic, next-generation process is slow and unproven in volume production.

The NEC-Toshiba 256-K RAM appeared in a 16-pin package with the ninth address line on pin 1. Die size is an ambitious but manageable 64,450 mil<sup>2</sup> with American-made DSW equipment fashioning the 1.5- $\mu$ m lines. A silicone coating keeps the mean time between alpha-radiation errors below 30,000 hours.

**Not production.** However, at a pinout standardization meeting just before the ISSCC San Francisco meeting, an NEC-Toshiba spokesman said that quarter-megabit RAM is strictly a laboratory device. Production of any kind is three years away

at the least, he told the meeting.

Why then were these and other advanced Japanese memories [*Electronics*, Jan. 17, p. 41] flaunted at the conference? One reason may be that the Japanese want to overcome their reputation as copycats and dumpers of commodity parts. Or perhaps the parts were exposed to draw attention away from Japan's designs on the worldwide computer industry—which, of course, is the impetus behind such efforts as the VLSI co-operative labs.

Moreover, the feeling at ISSCC was that as many U. S. manufacturers could give 256-K RAM papers, complete with die photos. But the hot competition in the U. S. militates against such disclosure. Another factor could be the embarrassingly overdue production of the long-since announced 64-K dynamic RAMs—a real-world problem in which the Japanese, too, are enmeshed, from all reports.

**-John G. Posa**

### Instruments

## Intel, TI upgrade their GPIB chips

Launching an attack on the design idiosyncracies that plague general-purpose interface-bus chips, Intel Corp. and Texas Instruments Inc. are upgrading their parts with mask changes. The new GPIB chips will be free of all earlier problems, the two integrated-circuit makers say.

Intel has created what it calls the Step C process for the A versions of its 8291 talker/listener chips, and TI is moving into volume production of its new version of the TMS 9914 prototype IC. The earlier versions—and similar GPIB chips from other IC houses—have been the target of complaints from instrument makers [*Electronics*, Jan. 31, p. 39], who want the parts because they simplify the interconnection of instruments with the IEEE-488 bus standard.

The first versions of the GPIB chips inevitably had bugs that users discovered. The manufacturers have made paper fixes in the form of

application notes, and at least one—Motorola—is confident that such bug lists are enough.

The A versions of the Intel chips should reach distributors' shelves before the end of the summer. The new mask "provides 100% compliance with the latest version of the IEEE-488 standard and fixes all known problems of the previous versions," says William R. Schillhammer, marketing manager for data-communications peripherals at the Santa Clara, Calif., company.

**Options.** The new chips have options for handling special commands. For example, the user will be able to stop bus activity until a subroutine is completed. This prevents two device-clear signals from occurring too closely together.

At Texas Instruments, volume production is under way of the TMS 9914. "We believe these are full-spec devices," says Alan Lofthus, strategic marketing manager for microcomputers.

The Dallas firm's new mask implements the GPIB release hold-off mechanism. This eliminates a buffer overrun problem in the prototypes, simply by shortening the hold-off period. A software fix for the prototype ICs had corrected the problem: during a hold-off-on-all-data period, the talker could release two types of information.

While TI and Intel are introducing mask upgrades, Motorola Inc. is standing pat with the second mask of its 68488 GPIB chip. Michael Newman, an applications engineer for the chip, says a project on a totally new GPIB part is on hold, but would give no details.

**No change.** The Austin, Texas, operation's decision to stay with its present version means that users must continue to compensate for the chip's bugs. In particular, they must be aware of the ghost interrupts that can occur in the serial poll and byte-out operations. They also must make sure that an end-of-interval signal is not inadvertently left in a memory buffer after completion of a transaction. Motorola plans to help them with extensive documentation on the problems that have been discovered.

# now! COST EFFECTIVE HIGH DOSE LEVEL ION IMPLANTATION

## MODEL 80-10

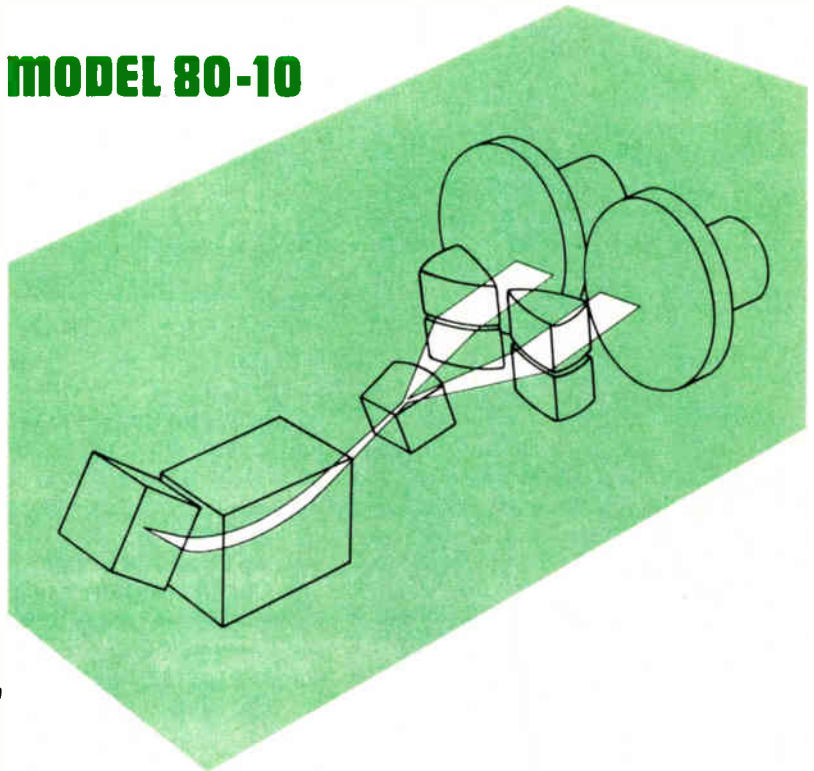

**Extrion  
High Current  
Ion Implanter  
Processes up to  
290 100 mm wafers/hr  
at  $5 \times 10^{15} \text{ As}^+/\text{cm}^2$ .**

The new Extrion Model 80-10 is a high-throughput production system designed for predeposition. The system produces beam currents in excess of 10 mA  $\text{As}^+$ ,  $\text{P}^+$  and 5 mA  $\text{B}^+$ . Maximum implant energy is 80 keV.

A unique dual end station maximizes wafer throughput. A neutral trap eliminates low energy contamination generated in the beam line.

Call or write Extrion, the world leader in ion implantation, for full specifications. Varian Extrion Division, Gloucester, MA, 01930, (617) 281-2000. Varian GmbH, Stuttgart-Vaihingen, W. Germany, (0711) 73 20 28; Tokyo Electron Ltd., Tokyo 160, Japan, (03) 343-4411.

Dose $\text{As}^+/\text{cm}^2$	Throughput (max) 100 mm Wafers/hr
$5 \times 10^{15}$	290
$1 \times 10^{16}$	170
$2 \times 10^{16}$	85



Meanwhile, new GPIB chips are waiting in the wings. Intel will introduce the 8293 bus transceiver IC this summer, complementing the 8291A and the 8292 controller parts. Philips is considering development of a controller IC supplementing its HEF 4738 GPIB chip, which is available in the U. S. from subsidiary Signetics Corp.

-Martin Marshall

---

**Peripherals**

---

## LSI is rampant in tape subsystem

Many of the size and performance benefits that large-scale integration is bringing to computers are appearing in peripheral devices, where LSI circuits are finding new applications. The latest, and in many ways most sophisticated, instance is the model 4500 tape-memory subsystem introduced late last month by Storage Technology Corp.

For example, STC is using custom LSI circuitry along with standard microprocessor parts in the 4500's controller. This unit can support eight tape drives, yet is small enough to fit into the cabinet of one.

**Processor.** A Z80 microprocessor is the controller's heart, along with 16 kilobytes of control storage. The write electronics includes a sequencer chip designed to process micro-instructions for a bit-slice microprocessor; here, however, it generates the error-checking and -correcting codes for incoming data.

The channel adapter contains another microsequencer, which handles all communication between the Z80 and the mainframe. The read electronics includes nine custom n-channel MOS chips, one for each of the tape channels. Part of the read-sequencer machine, these ICs replace 175 chips, says Lew Frauenfelder, vice president of tape engineering for the Louisville, Colo., company.

A custom emitter-coupled-logic chip is used in the analog-to-digital converters and in clocking and detection circuits. Frauenfelder notes that these ICs allow STC to use five cards

## TI to push its E-PROM pinout

Texas Instruments Inc. will not tuck tail and redesign its 28-pin high-density MOS memory package following rejection of that pinout by the JC-42 standardization committee of the Joint Electron Device Council. The Dallas semiconductor manufacturer will ship its 64-K erasable programmable read-only memory with the company pinout.

TI officials indicate the game plan now is to capture so many sockets for the part that the pinout will become a *de facto* standard. Then, the firm hopes, this standard will extend to other memory parts at the 64-K, 128-K, and 256-K densities.

The company failed in its bid to have its 28-pin approach approved as a dual standard [*Electronics*, Feb. 28, p. 96]. The committee-approved 28-pin standard, proposed by Intel Corp., covers 8-bit-wide E-PROMs, ROMs, static random-access memories, and pseudostatic RAMs at the 64-K and beyond densities. It is based on a 24-pin configuration used by Intel in its 32-K E-PROM; TI's proposal was based on its 24-pin 32-K E-PROM package, which is a dual standard along with the Intel pinout.

Since TI has already announced the 64-K E-PROM using its own pinout, the JC-42 committee will take a ballot that would establish that package as a dual standard for E-PROMs and ROMs at the 64-K level only. The vote, requested by TI, will be tabulated in late May.

-Wesley R. Iversen

instead of eight for these functions.

Each tape drive also has a Z80. These processors handle such key system tasks as acceleration and deceleration of the tape-transport mechanism.

**Maintenance.** Putting all this logic into the tape drive permits STC to go to remote diagnosis for the first time. The company sees so much custom LSI in its future that it is opening its own chip fabrication facility.

The 4500 is aimed at users of intermediate IBM computers like the model 4300. A typical configuration sells for \$143,000, which STC says is 15% less than a comparable IBM tape subsystem. -Anthony Durniak

---

**Consumer**

---

## Add-on + TV game = a home computer

Interested in self-improvement programs? Toymaker Mattel Inc. is supplying the software for several with its first personal computer—actually its Intellivision game upgraded into a processor by a keyboard and cassette add-on.

Announced late last month, the complete hardware package will sell for around \$800 (depending on the

retailer) and must hook up with the user's TV set. It enters a highly competitive field in which rivals like the Texas Instruments TI 99/4 and Atari 400 are already prominent.

But it is the software packages that will be emphasized in the nationwide advertising campaign the Hawthorne, Calif., company will begin in May. Some of them have already been written under license from the likes of exercise king Jack LaLanne and income-tax expert J. K. Lasser. Others scheduled to appear within the year include courses in speed reading and guitar playing. Children's learning games are also promised.

The success of this software in combining simplicity of use with enough sophistication to be stimulating will largely determine the success of the Intellivision computer among average TV owners. Mattel apparently has no wish to appeal to those interested in more elaborate machines like the Apple and Pet home computers.

Central to the Intellivision game and of course the computer built around it is General Instrument Corp.'s CP-1600 16-bit microprocessor. With 87 instructions, four addressing modes, and direct memory access, the processor juggles data from the 60-character keyboard and



# Our 64K ROM is like our 32K ROM is like our 16K ROM.

For new system designs and for upgrading existing systems, the flexibility of our totally static 64K ROM gives you that extra edge. And it's backed to the hilt with proven high performance.

The SY2364 is the latest addition to our family of 24-pin ROMs designed around a common industry standard pinout. That means maximum system flexibility. All three — 16K, 32K and 64K ROMs — can plug into the same socket. System upgrades are just a matter of substituting the new ROM for the old. With no increase in power.

We offer compatibility that's more than pin deep. All our ROMs are fully static (no clocks to worry about), so they all have the same timing waveforms. If speed is your concern, you can select one of our standard 450nsec versions or upgrade to our high performance 300nsec versions. All six are available now in quantity production.

	300ns	450ns
2K x 8	SY2316B-3	SY2316B
4K x 8	SY2332-3	SY2332
8K x 8	SY2364-3	SY2364

No matter what your needs, we have just the ROM for you. And that includes the SY2316A, SY4600 and SY2333 (pin compatible with the 2732/2732A 32K EPROM). For further information, contact Memory Product Marketing direct at (408) 988-5611. For Area Sales Offices and distribution references, call Headquarters Sales direct at (408) 988-5607. TWX: 910-338-0135.

**Synertek performs** as a major MOS supplier of high volume parts with advanced technologies and techniques behind everything we make. ROMs. Static RAMs. EPROMs. Custom circuits. Single-chip Microcomputers. Systems. 6500 Microprocessors and Peripherals.

## **S** SYNERTEK

3001 Stender Way, Santa Clara, California 95051  
(408) 988-5600. TWX: 910-338-0135

Circle 47 on reader service card

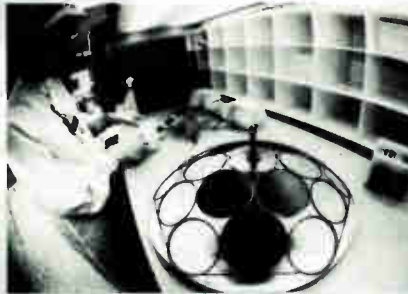

a digital cassette system. It is supported by GI's Gimini Deluxe 8900 programmable game system—five large-scale integrated circuits designed for video games.

Mattel is planning a series of peripheral devices for the Intellivision computer, but is saying little about them. A spokesman does look toward a "full information system tied to a central data bank and with the ability to store the kind of information consumers want or need for everyday living." —Gil Bassak

## Other makers eye RCA video disk

Now that Zenith Radio Corp. has selected RCA Corp.'s video disk technology, two other big names are probably going to climb aboard the bandwagon. They are General Electric Co. and General Telephone & Electronics Corp. The Zenith decision early this month is a major boost to RCA in its campaign to overtake Magnavox, whose already available video disk player is incompatible with the RCA technology. Still up in the air is a decision from the Japanese makers of consumer electronic products.

"RCA's system comes closest to our criteria," says Thomas R. Shepherd, general manager of the GTE entertainment products group in Batavia, N. Y. Both he and GE say a factor of major importance is the lower prices possible with the RCA technology—probably less than \$500 for a player, compared with \$775 for Magnavox's Magnavision player. They also point to the extensive library of programs that RCA and other firms will be offering. Both GE and GTE will make their decisions by mid-year, they say.

**Keys.** Since the video disk player is essentially a consumer product, cost and a rich variety of available disks are keys to success. RCA, when it introduces its Selectavision player later this year, can be expected to trumpet its lower price and vast library. Moreover, the introduction will be nationwide; Magnavision,

although introduced a year ago, is available in only a handful of U. S. cities.

Magnavision uses a helium-neon laser to read out pictures and sound etched into the disk during manufacturing by another laser. The simpler Selectavision uses a capacitive-pick-up stylus on a disk record that can be turned out with standard audio-recording processes.

**Pact.** Zenith and RCA say their agreement covers technology exchange with a common disk format. Zenith hopes to have players and disks on sale by mid-1981, about six months behind RCA.

However, Magnavox and its parent company, NV Philips Gloeilampenfabrieken of Holland, have allies in the race to establish a *de facto* video disk standard. Its records are made by the entertainment giant MCA Inc., which has an interest in players through a Japanese subsidiary with Pioneer Electronics Corp. Pioneer plans to enter the consumer market with a laser-based player compatible with Magnavision.

Complicating the race is a third technology: the video high-density process from Victor Co. of Japan and Matsushita Electrical Industrial

Co. Though other Japanese and European companies are working on capacitive and laser systems, VHD [*Electronics*, Oct. 26, 1978 p. 67] appears most likely to go into production—in fact, it is under scrutiny at GE and GTE.

Although a capacitive-pickup system, VHD is not compatible with RCA's Selectavision. It picks up its tracking information from capacitance-encoded information stored alongside the signal. There is a stylus, but the tone arm needs no grooves. RCA's stylus tracks in grooves, just like a phonograph.

It may well be that Sony, Hitachi, and other Japanese consumer-electronics manufacturers will join forces with Matsushita and JVC to present a united front against Magnavision and Selectavision. However, they have the software stumbling block to hurdle—some, in fact, are evaluating the RCA system.

RCA's determined efforts to build its library will be crucial. As well as its own NBC Television sources, it has made key agreements with other entertainment producers, notably arch-rival CBS Inc., but also firms like Walt Disney Productions.

—Larry Marion and Ben Mason

## News briefs

### Government OKs CIS Cobol

CIS Cobol has become the first microcomputer version of the business-oriented high-level language to be certified by the Government's General Services Administration. Developed at Micro Focus Ltd., London, and marketed in the U.S. by Micro Focus Inc., Santa Clara, Calif., the CIS Cobol system currently runs on the 8080/8085, Z80, and LSI-11 microcomputers under the ISIS-II, CP/M, and RT-11 operating systems.

### Electronics pioneer Dan Noble dies

Daniel E. Noble, a pioneer in fm radio and solid-state electronics and a long-time Motorola Inc. executive, died at 78 last month at his home in Scottsdale, Ariz. He is credited with the first practical mobile two-way fm telephone system, completed in 1940 for the Connecticut State Police. That same year, he joined Motorola Inc. as director of research. When he retired from full-time employment in 1979, he was Motorola's vice chairman and chief technical officer.

### AT&T may buy big from ITT

As part of an out-of-court settlement of an antitrust suit, American Telephone and Telegraph Inc. will buy \$2 billion in telecommunications equipment and services from International Telephone and Telegraph Inc. over the next 10 years. The first product considered will be ITT's 1240 digital switching system, on order by European telephone companies.

# THE TRUE TOUCH SCREEN... IT'S NOW WITHIN YOUR REACH

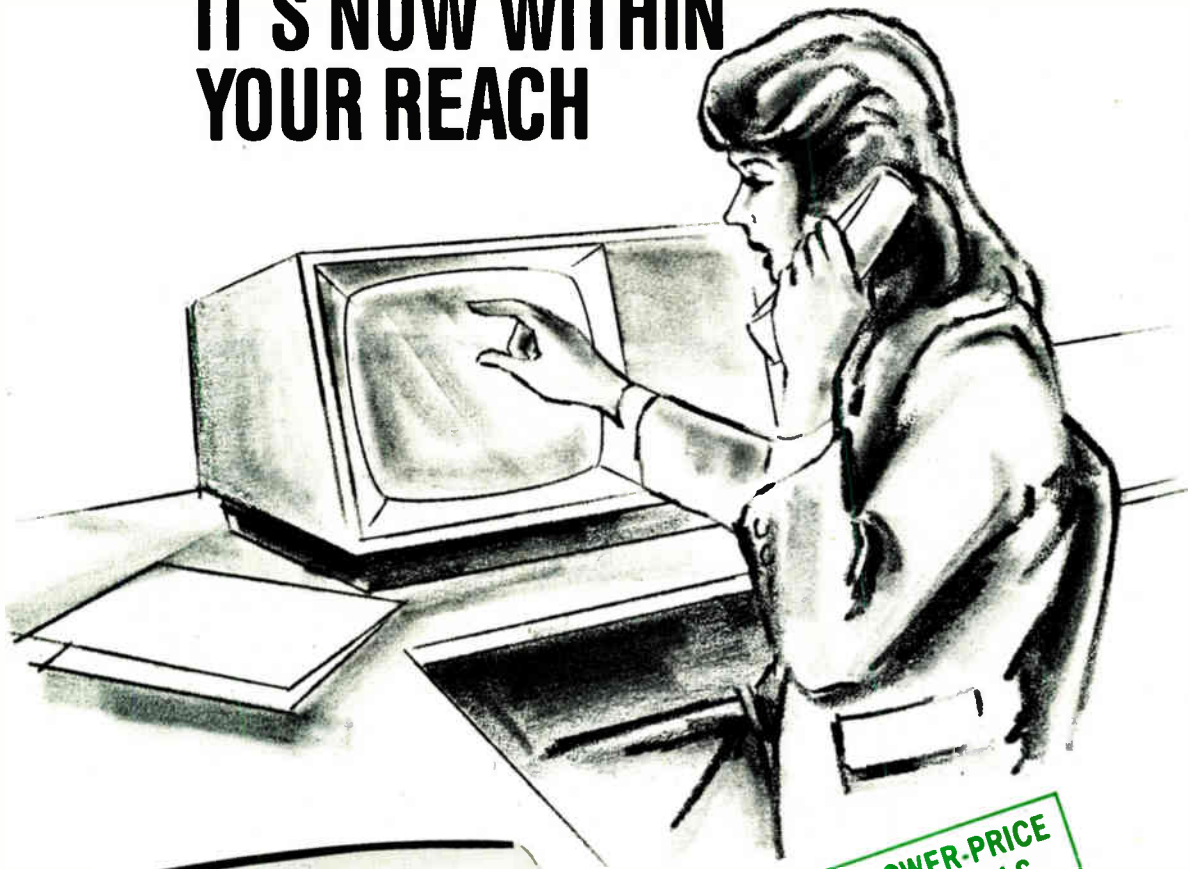

ASK ABOUT OUR LOWER-PRICE  
12- AND 15-INCH MODELS

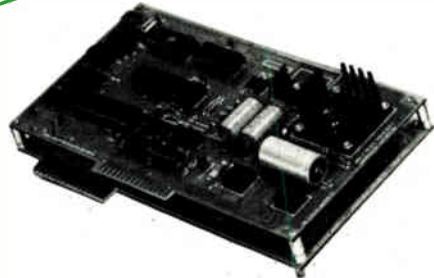

To put the personal touch within everyone's reach, TSD is now providing high- and low-resolution 12- and 15-inch Touch Screens. In many cases the more economical low-resolution models provide all the touch power required for your application.

And why should you select a TSD Touch Screen? Because it is the best unit on the market today that can be activated directly by the touch of a finger. No previous experience

necessary, no keyboard, no cumbersome light pens—just touch the screen to access a data base. And the screen matches the curvature of most CRT's.

To find out how the TSD Touch Screen can enhance the versatility and marketability of your product, contact Steven Sloan. He will gladly tell you more or have our local rep contact you.

## TSD

**TSD DISPLAY PRODUCTS, INC.**

35 Orville Drive • Bohemia, New York 11716/Tel. 516-589-6800 • Telex 14-4659

# Rockwell International is more than a builder of America's Space Shuttle.

## Much more.

*Designed for 55 separate firings.*

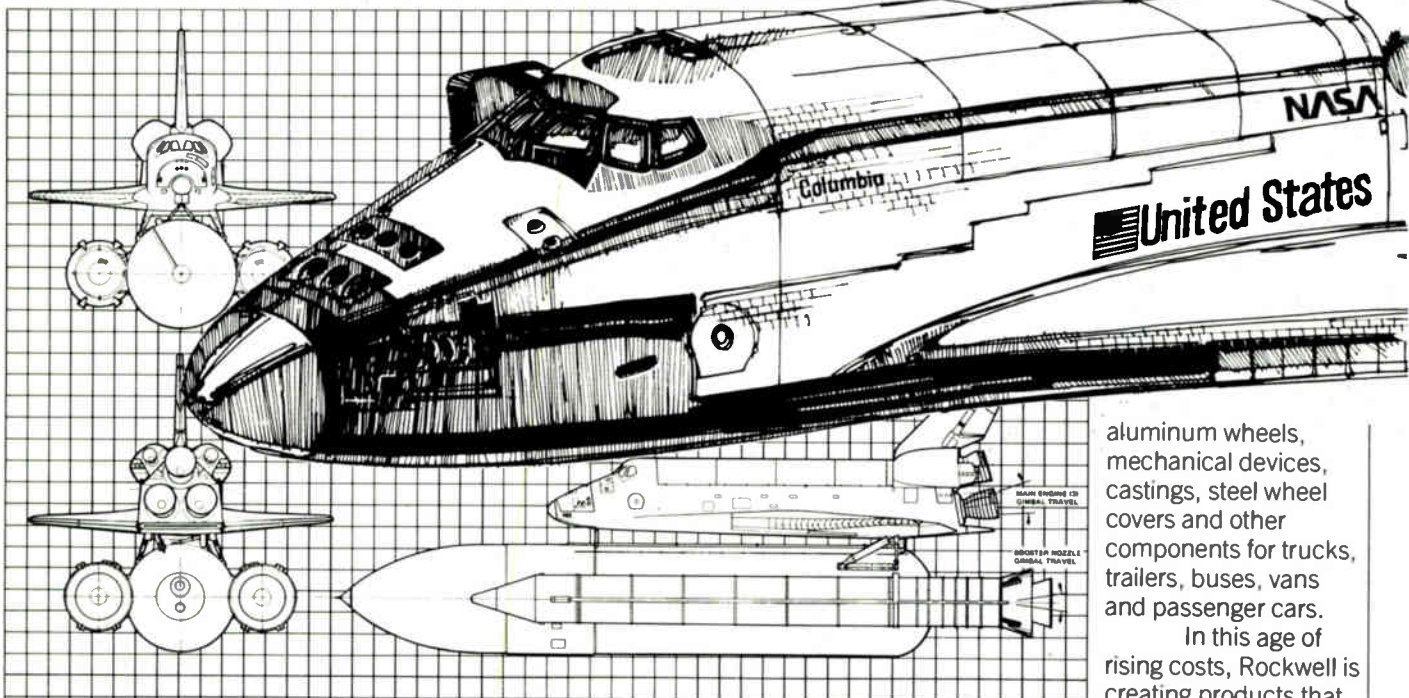

aluminum wheels, mechanical devices, castings, steel wheel covers and other components for trucks, trailers, buses, vans and passenger cars.

In this age of rising costs, Rockwell is creating products that

can help trucks and cars perform better. We've developed an electronic instrumentation system called Tripmaster<sup>™</sup> which can provide truck fleet operators with data that can improve vehicle utilization and operating

*Tripmaster helps a truck live longer — and a fleet operator manage his business better.*

If you think of Rockwell International as a company that makes spaceships, you have good reason. We are prime contractor to NASA for Space Shuttle orbiters and their main engines, and for integration of the entire Shuttle system and selected payloads. The Rockwell-built orbiter is the world's first reusable spaceship, capable of at least one hundred missions into space and back. It will launch like a rocket, haul like a truck, work like a space station, then return to Earth and land like a glider. But aerospace is only part of the Rockwell story.

Rockwell International is a major multi-industry company, applying advanced technology to a wide range of products — in automotive, aerospace, electronics and general industries. Following are some examples of our balanced diversification.

### **Aerospace.**

(Sales, fiscal 1979: \$1.6 billion.)

Rockwell aerospace involvement extends well beyond the Space Shuttle. Our rocket engines have been used to launch over two-thirds of all U.S.-manned space flights and satellites, and we're building the Navstar satellites that are bringing totally new standards of accuracy to world navigation.

For general aviation, we build Sabreliner<sup>®</sup> business jets and Jetprop Commander<sup>®</sup> 840 and 980 business aircraft. And we have a long, proud history as a designer and builder of military aircraft.

### **Automotive.**

(Sales, fiscal 1979: \$1.6 billion.)

One-half of the highway tandem tractors in North America are equipped with Rockwell axles — and more than half of the heavy-duty trucks stop with Rockwell brakes. We're also a major supplier of drivelines, steel and styled

efficiency. Some of our components that can help cut a trucker's fuel consumption and increase payloads include a new aluminum front axle beam, Taper-Leaf<sup>®</sup> springs and Stopmaster<sup>®</sup> brakes.

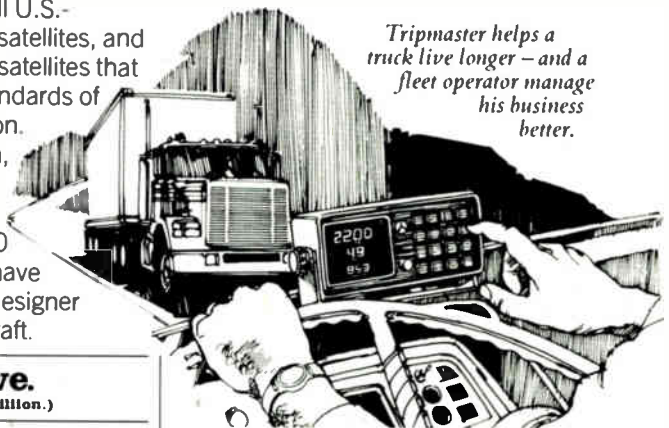

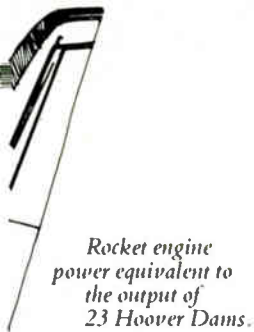

Rocket engine power equivalent to the output of 23 Hoover Dams.

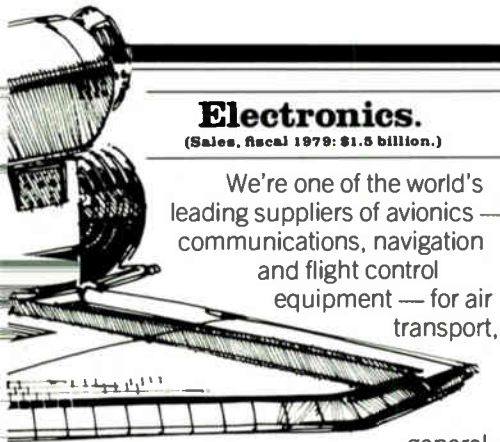

### Electronics.

(Sales, fiscal 1979: \$1.6 billion.)

We're one of the world's leading suppliers of avionics — communications, navigation and flight control equipment — for air transport,

general aviation and government aircraft. We also make microelectronic systems and devices and missile guidance and control systems. And we manufacture and install telecommunications systems for businesses and governments worldwide.

One of Rockwell's latest electronic achievements is the production of bubble domain memories. We developed and market a device measuring about two-fifths of an inch square that can store up to 256,000 bits of information. It has no moving parts and its memory is not erased when power is turned off.



Our quarter-million-bit bubble memory device.

Rockwell was the first company in the world to produce a 256,000-bit memory for commercial applications.

Mechanical mass storage computer memories can now be replaced by smaller, faster, more reliable, more energy-efficient systems.

### General Industries.

(Sales, fiscal 1979: \$1.2 billion.)

Most of America's major daily newspapers are printed on our Goss presses. We also make textile equipment, industrial sewing machines, power tools, water and gas meters and other products for utilities.

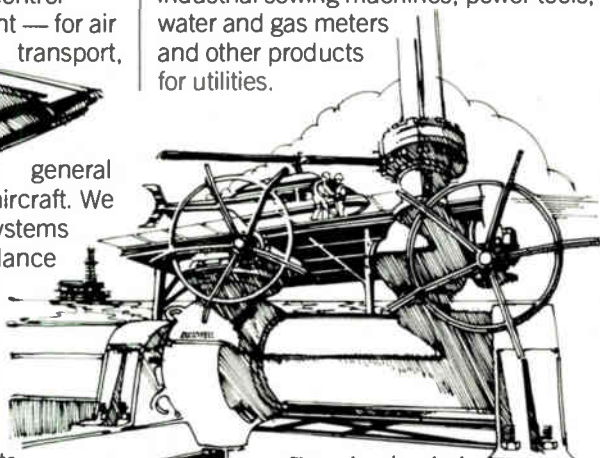

Everyday, hundreds of millions of cubic feet of gas flow through the Rockwell Hypresphere ball valves on this production platform in the Gulf of Mexico.

In addition, our extensive technology is being applied to the world's growing need for alternate sources of energy. We're involved in projects for nuclear energy, coal gasification, flue gas desulfurization, and solar, wind and geothermal power. We also manufacture valves — plug, pipeline ball, gate, globe, angle and check valves for America's power needs. Our Flow Control Division is one of the world's leading suppliers of high-technology valving for U.S. and international energy markets. Rockwell valves are used in oil and gas production, transmission and processing; natural gas

distribution pipelines; synthetic fuel processing plants; electric power plants; shipboard power plants; and in many other energy-related markets.

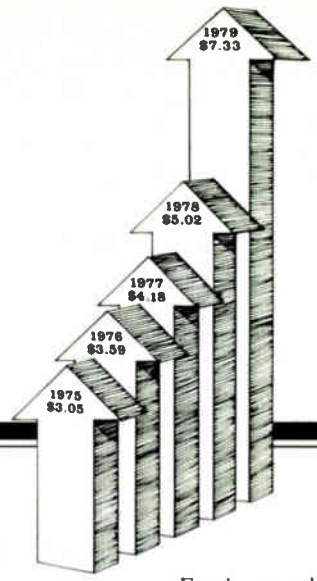

Earnings per share

### Earnings up in '79 4th consecutive year.

Rockwell International's total sales for fiscal 1979 were \$6.2 billion, up 16 percent over \$5.3 billion in the prior year. Net income totaled \$261.1 million, or \$7.33 per share, an increase of 48 percent over 1978 net income of \$176.6 million, or \$5.02 per share. Return on average equity has increased to 18 percent, which is a substantial improvement over

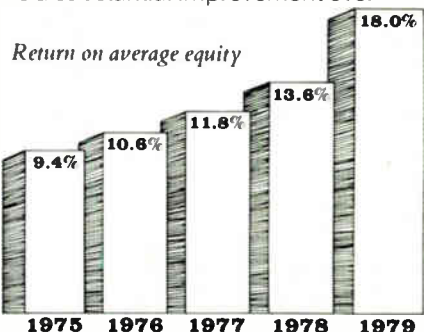

the previous year and nearly twice that of 1975. This should place the company among the top one-third of the 100 largest companies in the 1979 FORTUNE 500 Directory.

For more of the Rockwell story, or if you're interested in an Engineering career with us, please write: Rockwell International, Dept. 815G-23, 600 Grant Street, Pittsburgh, PA 15219.



**Rockwell International**

...where science gets down to business

Automotive / Aerospace  
Electronics / General Industries

Circle 51 on reader service card

# All electronic problems are



**MS-180 FREON® TF Solvent** – High purity, low surface tension and fast evaporation. For critical cleaning of electronic components.



**MS-190 FREON TMC Solvent** – Fast cleaning action removes all types of organic flux.

FREON is Du Pont's registered trademark for its fluorocarbon compounds.



**MS-165 FREON TMS Solvent** – Outstanding for removal of activated rosin flux, ionic soil and particulate matter.



**MS-176 FREON TES Solvent** – Offers long term compatibility with reactive metals and other solvent-sensitive materials.

# cleaning not alike...



That's why we offer 15 different solutions



MS-160 FREON T-P 35 Solvent — Excellent for precision cleaning and water film displacement.

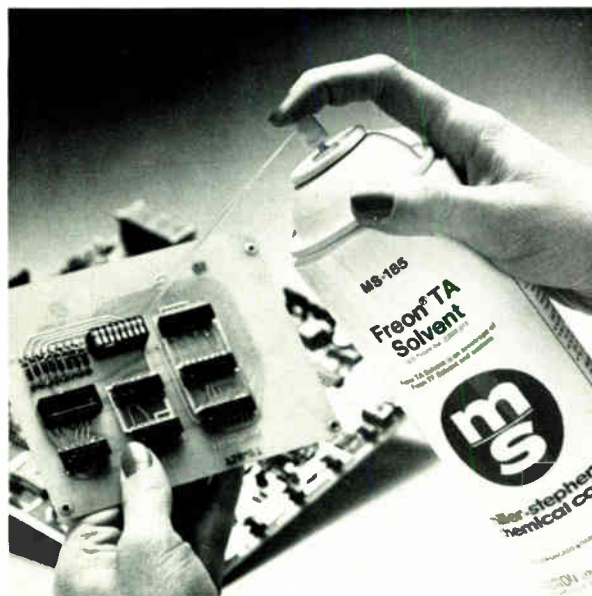

MS-185 FREON TA Solvent — Stronger solvent action for oil film removal and other tough cleaning applications.

We've developed and perfected 15 different precise solvent cleaners. Miller-Stephenson spray cleaners are specially designed to meet the toughest kind of cleaning problems you'll encounter on printed circuit boards or any other electronic application.

For years we've recognized industrial cleaning as a vital link in maintaining component and system reliability. That's why we take every possible precaution to make sure that every Miller-Stephenson product has the lowest residual contamination in the industry — some approaching 5-7 parts per million. The general industry range is 50-130 ppm.

We use only the highest grade manufacturer certified solvents and nonflammable propellants and we *double filter* our solvents and propellants, first with a 5 micron filter, then with a Millipore 0.2 absolute filter. The filtered product goes directly into seamless cans, eliminating any possibility of flux contamination from seamed cans. We have complete quality control, from tanker to customer.

## Send for free Solvent Selection Guide...

To help you quickly and easily find the precise solvent cleaner for your particular application, we're offering a FREE booklet. Simply circle the Miller-Stephenson reader service form in this magazine — or write to us.

 **miller-stephenson  
chemical co., inc.**

George Washington Highway, Danbury, CT 06810  
Phone: (203) 743-4447

• LOS ANGELES • CHICAGO • TORONTO • DANBURY, CT.  
WORLDWIDE DISTRIBUTION

EM-3Y

Circle 53 on reader service card

# ANRITSU HAS THE LINE ON PCM TEST EQUIPMENT



## Anritsu gives you A-A, D-D and everything in between.

When there's a problem on the line, you want a line of PCM test equipment that can get to the source of the problem, quickly and easily. That's why Anritsu offers a complete line of PCM test and measuring equipment.

When the problem is A-A, you can count on Anritsu's PCM Multiplex Tester MS339A to come up with the answer. With the MS339A main frame and PCM Noise Generator MH342A, measuring PCM primary multiplex equipment in accordance with CCITT recommendations can be done with pushbutton ease. If the job calls for A-D or D-A measurement, simply slide in Anritsu's PCM Digital Signal Analyzer MH340A or Digital Signal Generator MH341A. All three units feature plug-in modular design so you don't need a wall of test equipment to get the job done.

On the other hand, the problem might be locating a faulty repeater. In that case, what you need is Anritsu's PCM Line and Repeater Tester MS333A. Digital-to-digital testing of up to 24 repeaters can be done in a single glance with micro-computer ease. For on-site testing of local repeaters, there's the handy, lightweight portable PCM Code Error Detector MS337A.

So if you want a line of test equipment that can shortcut your PCM problems, get a line on Anritsu. It's the one electronics company for all your PCM needs.

• U.S.A. Anritsu America, Inc. Tel: (201) 569-4474 • West Germany Knott Elektronik GmbH Tel: (08178) 4085 • France Tekelec Airtronic Tel: (1) 946-96-48 • Italy Vianello S.p.A. Tel: (02) 54 40 41 • Spain Unitrónica, S.A. Tel: 242 52 04 • Holland C.N. Rood B.V. Tel: 070-99 63 60 • Belgium C.N. Rood S.A. Tel: 02-35 21 35 • Sweden Teleinstrument AB Tel: 08-38 03 70 • Singapore O'Connor's (Pte.) Ltd. Tel: 637944 • Australia NEC Australia Pty. Ltd. Tel: Melbourne 560-5233 • Malaysia O'Connor's (Malaysia) SDN. BHD. Tel: 51563/5 • Brazil Anritsu Eletrônica Comércio Ltda. Tel: Rio 221-6086

Circle 54 on reader service card

**Anritsu**  
ANRITSU ELECTRIC CO., LTD  
MEASURING INSTRUMENTS DIVISION  
SALES DEPARTMENT:  
10-27, Minamiazabu 5-chome, Minato-ku, Tokyo 106, Japan  
Phone: (03) 446-1111/Telex: 0-242 2353  
Cable: ANRITDENKI TOKYO



## **EIA urges lifting controls on exports of U. S. weapons**

U. S. electronic weapons makers are supporting a push by leading Senate Republicans to soften President Carter's 1977 policy of restraint on exports of conventional arms. A main rationale for the effort is the EIA's view of the program's evident failure. Fiscal 1980 exports could total \$15 billion, Federal officials report, even though the State Department continues to promote its \$9.5 billion annual ceiling as workable. "The substantive result" of Carter's "unilateral arms-control experiment," says the Electronic Industries Association's Government division, "**has been simply a loss of major U. S. market share and influence,**" instead of "reductions in worldwide trafficking in arms."

GTE Sylvania's Walter R. Edgington, speaking for the EIA before the Senate Foreign Relations Committee early this month, says direct commercial sales to customers are preferable to going through the Defense Department's Foreign Military Sales program "because they are quicker, simpler, and provide more direct contact with the foreign buyer," but do not diminish stringent U. S. government controls. The association also wants elimination of the annual dollar volume limit, removal of restrictions on sales of weapons not operational with U. S. forces, and development of weapons solely for export, plus permission for American companies to compete freely for contracts with friendly nations without prior State Department approval.

## **Airliners may need 10 pay phones, ATA, Arinc contend**

Two is not enough. That is one argument of the Air Transport Association, representing the nation's airlines, and the airlines' special carrier, Aeronautical Radio Inc., concerning Airfone Inc.'s plan to put air-ground pay telephones into commercial airliners [*Electronics*, Nov. 3, 1979, p. 57]. The ATA and Arinc say up to 10 telephones per plane, instead of Airfone's 2, could be required for widebody jets with up to 400 seats. The two groups urged the Federal Communications Commission to review 1964 and 1965 studies by the Radio Technical Commission for Aeronautics on the subject. **Airfone, meanwhile, pressed the FCC to award it the requested 4 MHz for the new service from land-mobile frequencies now held in reserve** without resorting to a prolonged rule making, arguing that the air-ground proposal falls within the scope of FCC's definition of a land-mobile service.

## **FCC chief scientist restructures operation, adds three divisions**

The Federal Communications Commission's Stephen J. Lukasik has strengthened his role as chief scientist with an internal reorganization that gives him **two deputy chiefs—one for policy, another for technology—plus three new operating divisions.** The divisions will be titled Authorization and Standards (for equipment examination and approval), Research and Analysis (to study spectrum propagation and innovations in the field), and Spectrum Management (to perform that function). The reorganization of the commission's Office of Science and Technology also includes three new offices—policy and management, technical planning, and international—that report directly to the chief scientist. The FCC's seven commissioners unanimously approved the plan by Lukasik, who says it will let him delegate more authority and give him more time for his role as scientific adviser to the commissioners.

## The IEEE breaks with the Popov Society

The decision by the Institute of Electrical and Electronics Engineers to suspend indefinitely further bilateral exchanges between the U. S. and the Soviet Union's Popov Society is getting less attention and praise than it deserves.

It was predictable that the similar action by the U. S. National Academy of Sciences suspending meetings with its Soviet counterpart would receive broader public notice than the IEEE move when both occurred coincidentally at the end of February. Nevertheless, there are some noteworthy differences between the two actions.

### Was it legitimate?

The principal difference between the two organizations is that the IEEE is a private international body—the world's largest engineering society with some 200,000 members—while the NAS is a U. S. institution with strong links to the Government. Even though an estimated 85% of IEEE's members are Americans, the issue of whether an international body could legitimately suspend exchanges between two member countries was a principal concern of the IEEE directors before they voted. Since the issue involved only bilateral exchanges between the U. S. and its Soviet counterpart, rather than internationally sponsored meetings, the IEEE decided that it could, explains Robert E. Larson, an institute vice president and technical committee chief.

A less critical distinction between the two groups' actions is that the NAS suspension of at least six months is tied principally to Russia's banishment of Nobel Laureate Andrei Sakharov and his wife from Moscow to the closed inland city of Gorki, while the IEEE break is based on the broader issue of "current world conditions." Larson, who is technical director for Systems Controls Inc. in Palo Alto, Calif., says that phrase includes the Soviet military invasion and takeover of Afghanistan on Dec. 29 as well as the Sakharov issue.

The immediate impact of the IEEE and NAS votes includes the cancellation of at least six scheduled meetings between the American and Soviet electronics and science groups. Among them are the May 13–15 meeting at Electro '80 in Boston between IEEE leaders and a Popov Soviet delegation, as well as a follow-on session in Moscow later that month. The NAS policy-making National Research Council has canceled four meetings, including an important one this month on laser-matter interactions. Other affected NAS sessions would have dealt with

basic research in physics and experimental psychology.

The suspensions by both institutions of bilateral exchanges with Russia is drawing almost total praise from those in Washington's hierarchy who know about them. The lone exceptions are some Cold War II warriors who express concern that the IEEE and NAS votes may deprive the U. S. of valuable intelligence data about new developments in Soviet science and electronics. But such mutterings within the military intelligence community can be disregarded, says one senior Defense Department official. "Russia rarely permits its people to present papers and discuss programs that it does not want us to know about—very rarely."

In any event, the reality is that neither the IEEE nor the NAS can totally block individual exchanges between its members and their Soviet counterparts. As the NAS cable told Soviet Academy of Sciences president A. P. Aleksandrov, "the cornerstone of NAS policy with respect to scientific advantage has been reliance on the sensitivity and voluntary decisions of individual U. S. scientists. This policy will remain." And IEEE's Larson points out that his institution's action will not prevent individual Popov Society members from attending the Electro '80 meeting.

### Why IEEE looks stronger

The worst that can be said about the IEEE and NAS protests is that they run counter to the ideal of the United States and other open societies where free exchange of information and ideas is encouraged. The best that can be said about them is that the protests are right for the time as reactions to the Soviet Union's December takeover in Afghanistan and January arrest of dissident scientist Sakharov.

In that context, the protest by IEEE may prove to be the more effective of the two since it is a private organization that cannot be misread as speaking for the U. S. Government. Certainly it is a stronger protest than the earlier waffling statements of U. S. electronics manufacturers' associations when President Carter put an embargo on high-technology exports to the USSR. At that time, manufacturers qualified their support of the embargo by arguing that it could not be effective without similar controls on the products of Europe and Japan. Knowing that the U. S. could not prevent sales of European and Japanese technology to the Soviets, the position of U. S. manufacturers was widely construed as "let us sell, too." **-Ray Connolly**

# Now from Sprague— the reel people...



## Type 173D solid-electrolyte TANTALEX<sup>®</sup> capacitors in bullet-nose molded cases.

- Lead-taped and reeled for use in automatic insertion equipment.
- Low leakage current.
- Low dissipation factor.
- Capacitance values from .1  $\mu\text{F}$  to 56  $\mu\text{F}$ .
- Voltage range, 6 to 50 V.
- Operating temperature range of  $-55^{\circ}\text{C}$  to  $+85^{\circ}\text{C}$ ; to  $+125^{\circ}\text{C}$  with derating.

For complete technical data, write for Engineering Bulletin 3533.10 to Technical Literature Service, Sprague Electric Company, 35 Marshall Street, North Adams, Mass. 01247.

**THE BROAD-LINE PRODUCER OF ELECTRONIC PARTS**



a subsidiary of **GK Technologies**  
incorporated

Circle 57 on reader service card

# SERIES F3870 F3872 F3876 F3878

**Now that our  
microcomputers  
have more  
memory options,  
so do you.**



DEVICE	RAM	ROM	I/O
F3870	64 x 8	2K x 8	32
F3872	128 x 8	4K x 8	32
F3876	128 x 8	2K x 8	32
F3878	64 x 8	4K x 8	32

We've just expanded our industry-standard F3870 line by adding three new microcomputers with increased on-chip memory options. Each is a complete 8-bit microcomputer on a single MOS chip and is 3870 pin-compatible.

### **Bigger ROM memories.**

The series begins with the multi-source 3870 that gives you up to 2K bytes of ROM. With our three increased-memory versions, you can now get more features, a more sophisticated controller and more design flexibility.

Starting with the F3876 which offers 2K ROM, and the F3872 and F3878 which offer 4K ROM. These give the designer the size versatility

he needs for almost every application, as well as allowing him to make smarter controllers.

### **More RAM with power-down protection.**

The F3872 and F3876 offer 128 bytes of RAM, with 64 bytes available for power-down protection. That means that if your system shuts down, there's no memory loss, because the RAM remains powered and protected, with low current demand.

### **A microcomputer for all reasons.**

No matter what your application needs, the F3870 series can meet them. It's an excellent choice for a wide variety of control applications, including terminals, communications, automotive and instruments. It's the perfect family of low-cost microcomputer circuits for the high-volume, cost-sensitive controller market.

So now, there isn't a more complete family of devices available that will let you build a new system, or upgrade an existing one. For more information, call or write F3870 Series, Fairchild Microcomputer, P.O. Box 880A, Mountain View, California 94042. Telephone: (408) 224-7000.

**FAIRCHILD**

A Schlumberger Company

**POWER DOWN      POWER SUPPLY**

NO	5V
YES	5V
YES	5V
NO	5V

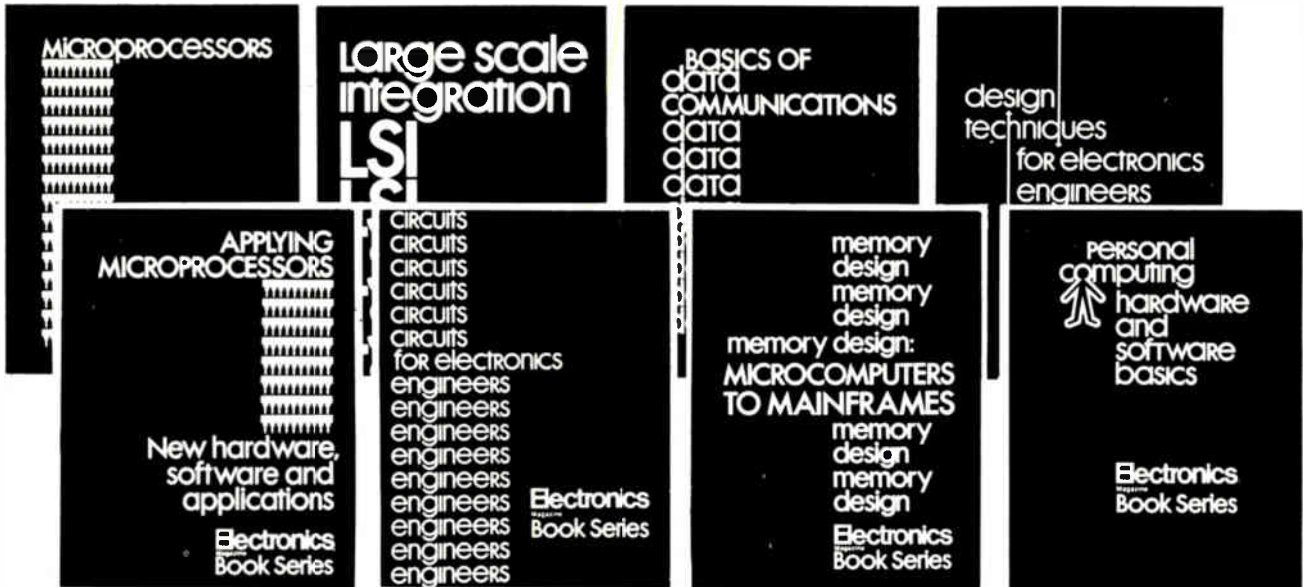

# Electronics Magazine Books

## 1. Microprocessors

What you must know about available microprocessor technology, devices, information, 4th printing. \$8.95

## 2. Applying Microprocessors

2nd and 3rd generation technology. 26 detailed applications from data networks to video games. \$9.95

## 3. Large Scale Integration

Covers the basic technology, new LSI devices, LSI testing procedures, plus system design and applications. \$9.95

## 4. Basics of Data Communications

Includes 47 articles from Data Communications magazine covering more than 11 key areas. \$12.95

## 5. Circuits for Electronics Engineers

Contains 306 circuits arranged by 51 functions from Amplifiers to Voltage Regulating Circuits. Saves design drudgery. \$15.95

## 6. Design Techniques for Electronics Engineers

Nearly 300 articles drawn from "Engineer's Notebook." A storehouse of design problem solutions. \$15.95

## 7. Memory Design: Microcomputers to Mainframes

The technology, devices, and applications that link memory components and system design. \$12.95

## 8. Personal Computing: Hardware and Software Basics

More than 50 articles from leading publications, including specifications, helpful hints, subject index. \$11.95

### Electronics Magazine Books

P.O. Box 669, Hightstown, NJ 08520  
(609) 448-1700, ext. 5494

No. of Copies	Title	Price
_____	1. Microprocessors	\$ 8.95
_____	2. Applying Microprocessors	\$ 9.95
_____	3. Large Scale Integration	\$ 9.95
_____	4. Basics of Data Communications	\$12.95
_____	5. Circuits for Electronics Engineers	\$15.95
_____	6. Design Techniques for Electronics Engineers	\$15.95
_____	7. Memory Design: Microcomputers to Mainframes	\$12.95
_____	8. Personal Computing: Hardware and Software Basics	\$11.95



If after my 10-day free-trial examination I am not fully satisfied I understand that my payment will be refunded.

Payment enclosed  Bill firm  Bill me

Charge to my credit card:

American Express  Diners Club  
 Visa  Master Charge\*

Acct. No. \_\_\_\_\_ Date Exp. \_\_\_\_\_

\*On Master Charge only, first numbers above name \_\_\_\_\_

Name \_\_\_\_\_ Title \_\_\_\_\_

Company \_\_\_\_\_

Street \_\_\_\_\_

City \_\_\_\_\_ State \_\_\_\_\_ Zip \_\_\_\_\_

Signature \_\_\_\_\_

Discounts of 40% on orders of 10 or more copies of each book.

Quality control. The manufacturing of integrated circuits requires an extremely exacting, vigilant quality control program. Perhaps the most stringent in industry.

Now, Nikon instruments are available to meet, and surpass, these tough standards.

The Nikon Micro-Pattern Analyzer, Model 2A is a case in point. It delivers automatic, precise measurement of line widths to an accuracy of tenths of a micrometer.

It employs a minicomputer, mirrored scanning slit, digital display and printer to achieve a guaranteed accuracy of  $\pm 0.1 \mu\text{m}$ , well beyond the capabilities of conventional visual techniques.

With this computerized optical system, positioning error, magnification error, image distortion and human error are virtually eliminated.

IC masks from 2" to 6" square can be scanned at the rate of 0.5–2  $\mu\text{m}/\text{sec}$ . The optical system incorporates a choice of green or blue interference filters. X and Y measurements are made conveniently without repositioning the mask since the optical image can be rotated by a single control.

There is no variation from observer to observer, or reading to reading as there is with conventional microscopes. Operator decisions, perceptions and fatigue are no longer a factor, thanks to Nikon.

An informative brochure is available to introduce you to the Micro-Pattern Analyzer, Model 2A and all of the other remarkable Nikon IC instruments.

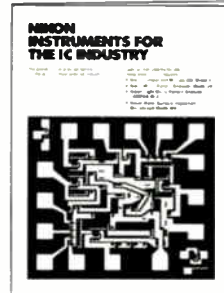

To obtain your copy, please contact:

**Nikon**

Nikon IC Instrument Division,  
623 Stewart Avenue,  
Garden City, NY 11530,  
(516) 222-0200

or 1051 Sneath Lane,  
San Bruno, CA 94066  
(415) 952-8188

# MEETING THE TOUGHEST STANDARDS IN A VERY TOUGH INDUSTRY.

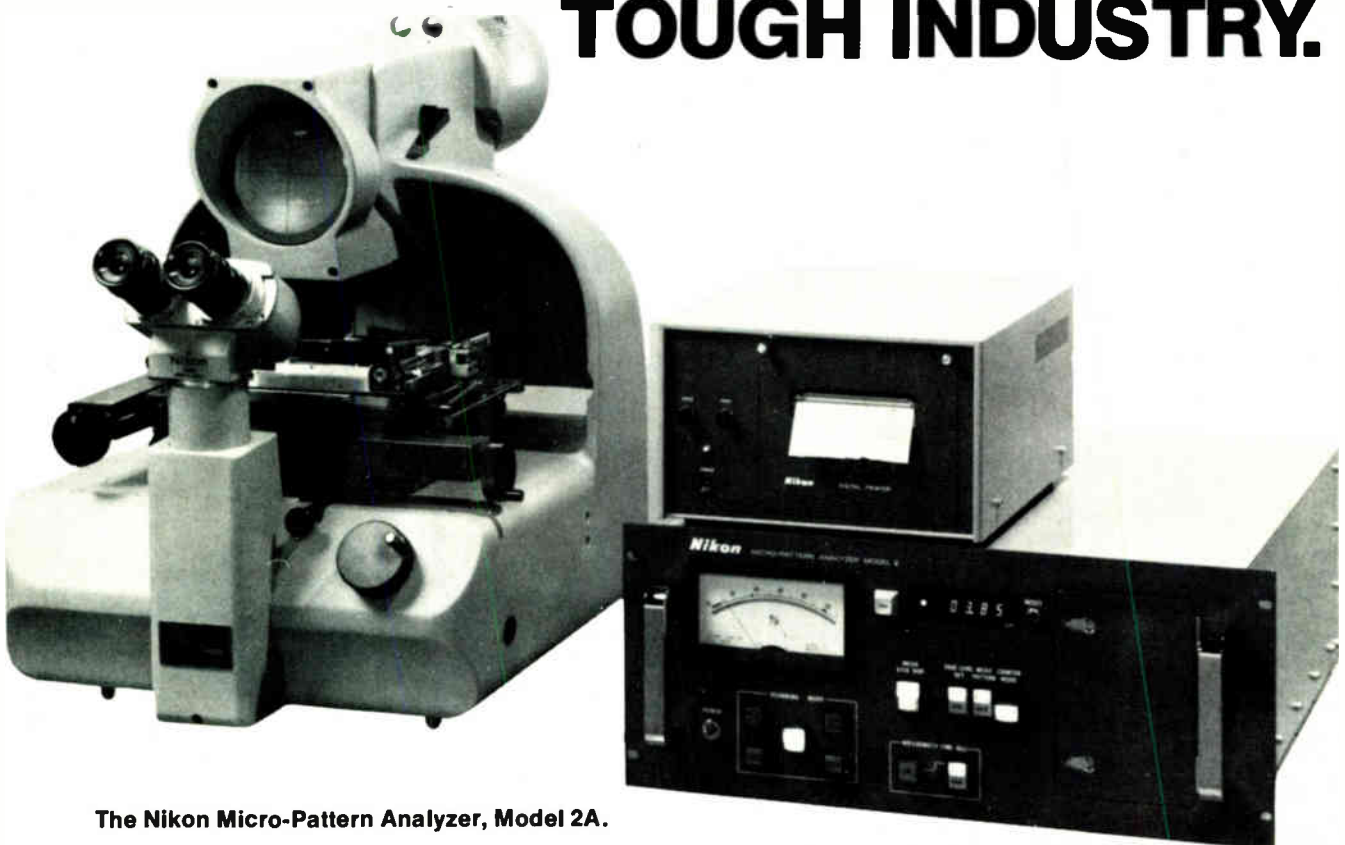

The Nikon Micro-Pattern Analyzer, Model 2A.

# BiMOS vs. BiFET op amps: The RCA alternate source for TI's 080 outperforms the original.



Our new CA080 BiMOS series is a pin-for-pin compatible alternate source for the TL080 BiFET family from Texas Instruments.

But that's where the similarity ends. When it comes to specs, in many cases the RCA device outperforms the original.

Our version has both lower input bias current and lower input offset current. This superior performance can save you money.

Your filter circuits will cost you less because you can increase resistor values and use less expensive, lower value capacitors.

The lower input bias and input offset currents of our devices also let you design circuits with input signal currents in the picoamp range.

Other features of the new CA080 series are: low power consumption, wide common mode input voltage range, fast slew rate, 5.0 MHz

(typical) bandwidth, low distortion, and large output voltage swing.

The CA080 and CA081 single devices are available in quantity now. Our CA082 and CA083 duals will be available by mid-1980.

For more information, contact your local RCA Solid State Distributor.

Or contact RCA Solid State headquarters in Somerville, New Jersey. Brussels, Belgium. Tokyo, Japan.

RCA  
BiMOS op amp:



Input bias current (25° C.): 50 pA.

TI  
BiFET op amp:



Input bias current (25° C.): 400 pA.



Input offset current (25° C.): 30 pA.



Input offset current (25° C.): 200 pA.

# RCA



## **Low-cost monochrome CCD sensor yields low-cost TV camera**

The price of charge-coupled-device imagers is starting to come down from the stratosphere. Japan's Matsushita Electric Industrial Co. has started sales of a black-and-white image sensor and also of a camera using the device. **The price of a standard-grade sensor is \$1,000; for the camera, it is \$2,200.** The camera consumes only 3.2 w, weighs 660 g (1.45 lb) including a standard lens, and is 64 by 85 by 148 mm (2.5 by 3.3 by 5.8 in.) exclusive of lens. The sensor itself is built on a chip 13.6 mm vertically by 10.3 mm horizontally (536 by 406 mils), with the optically active area 6.66 mm vertically by 8.43 mm horizontally (262 by 332 mils). It is sealed in a 28-pin dual in-line package. The 512 pixels vertically by 383 pixels horizontally provide a resolution of about 350 vertical by 28 horizontal test-pattern lines.

## **Dashboard and sensor system monitors wide range of car's functions**

An automotive instrument panel and sensor system that alerts the driver to needed maintenance tasks such as oil or spark plug changes has been developed by Veglia Borletti, a dashboard maker in Milan. A prototype shown at the Society of Automotive Engineers 1980 Exposition in Detroit late last month includes a series of light-emitting diodes **to alert drivers to a wide variety of malfunctions never before displayed on a dashboard—for example, brake-pad wear.** A 16-key pad on the dashboard is used to enter data to a trip computer, which also functions as a clock and a three-speed cruise-control system. The initial design, to be incorporated into a production automobile later this month, is run by an RCA 1804 single-chip microcomputer. The car will be used to demonstrate the variety of new sensors and display techniques Veglia has developed.

## **Instrument allows optical fibers to be characterized precisely**

A fiber-optic measuring system for characterizing optical fibers precisely—an increasingly important task—will be introduced in May by the Brookdale operation of EG&G Inc. in Bracknell, Berks. The model 9701 is microprocessor-controlled and can measure attenuation in the 600-to-1,600-nm range, thus covering most of the useful optical spectrum. Designed for operation by semiskilled personnel, the \$16,000 instrument (depending on the options chosen) is expensive enough to be purchased only by those with a full commitment to fiber optics. It allows the user to **control the emitter light spot size and launch angle and to measure the effective numerical aperture and the optical far-field profile**—all critical for the exact design of fiber systems. The IEEE-488-compatible system can send data to a printer, an oscilloscope, or a computer.

## **East Germany, USSR ready combined analog-digital switching**

If communications technology in Western Europe is undergoing major changes—conversion to digital switching techniques, for example—it is no less afoot in Eastern Europe. That is the impression visitors from the West are getting at East Germany's current Leipzig Spring Fair (March 9–16). The East German communication equipment combine VEB Kombinat Nachrichtenelektronik is exhibiting a switching system jointly developed with the Soviet Union that uses analog and digital techniques. Called Ensad, the acronym for the German words for “unified communications system for analog and digital switching,” the system is designed for both local and long-distance exchanges. **“We are hopeful that other countries in the Comecon bloc will adopt the system,”** a company official says.

## **Hitachi announces Japan's first all-color picture-in-a-picture TV**

Japan's first "color-in-color" television will feature 15 fast 4-K dynamic random-access memories rather than the analog devices used by other manufacturers of black-and-white picture-in-a-picture sets. The price of the TV, including its remote control, is \$1,520. Hitachi Ltd. engineers say that a custom complementary-MOS memory controller that replaces a board with 220 TTL devices used in the prototype makes the system practical. This large-scale integrated circuit, the HD44032, has 4,000 gates on a 6.2-by-6.0-mm chip (244 by 236 mils) encased in a 42-pin dual in-line package. Hitachi selected 4-K dynamic RAMs because 16-K devices are not fast enough and because the 4-K partitioning works out correctly for the 5-bit gradation of the system. **Other tricks the set can perform include shifting the inset to any one of the four corners and freezing the main picture.**

## **SEMS unveils top-of-the-line minicomputer**

French minicomputer maker SEMS (Société Européenne de Mini-informatique et de Systèmes) uses an 8-K cache memory to speed up the performance of the top-of-the-line addition to its Mitra series. Though the cycle time for the central MOS memory of the Mitra 525 is 750 ns, the cycle time for the cache is one third of that. Thus the company, a subsidiary of Thomson-CSF based in the Paris suburb of Louveciennes, boasts that **the average "apparent" cycle time is 400 ns.** Jean Bourgne, SEMS' marketing and products director, says the 16-bit machine can perform 600,000 operations per minute, making it roughly equivalent to Digital Equipment Corp.'s 1160. **The Mitra 525 uses Motorola 10800 bit-slice processors in its central processing unit,** which has six program-mable registers. With 256 K of central memory, it costs \$60,000. The largest central memory available for the new mini is 512 K.

## **Soviet fair looks to West for office, Information systems**

Should the East-West political and economic climate improve, the Soviet Union could become a big market for Western producers of information systems and office equipment. Providing an entry for Western firms into that market may well be Systemotechnika '80, a trade fair to be held in Leningrad Nov. 24 to Dec. 3 and sponsored by the Soviet Agency for Trade and Industry and the West German show organizer Nowea. According to the Soviets, Nowea says, their country's **need for information systems will grow two to three times within the next decade,** a need they can only partly meet on their own. Systemotechnika has already drawn much international attention. Thus far, more than 30 firms from nine Western countries have signed up and rented about 15,000 ft<sup>2</sup> of floor space—one third of the 45,000-ft<sup>2</sup> exhibition area.

## **Addenda**

A major European semiconductor maker is expected to announce later this month that **it will second-source Texas Instruments' 9900 family of 16-bit microprocessors.** . . . The U. S.'s General Electric Co. is among several firms negotiating with the UK's Thorn-EMI Ltd. on the future of its tomographic scanner business, which has accumulated losses of \$60 million over the last two fiscal years. **Being discussed are a joint venture with a U. S. firm or the outright sale of the total medical electronics business.** . . . Stratos AB of Gnosjo, Sweden, has come up with an **all-metal connector to accommodate any size optical fiber up to 1 mm** by means of internal chuck action by steel ball bearings.

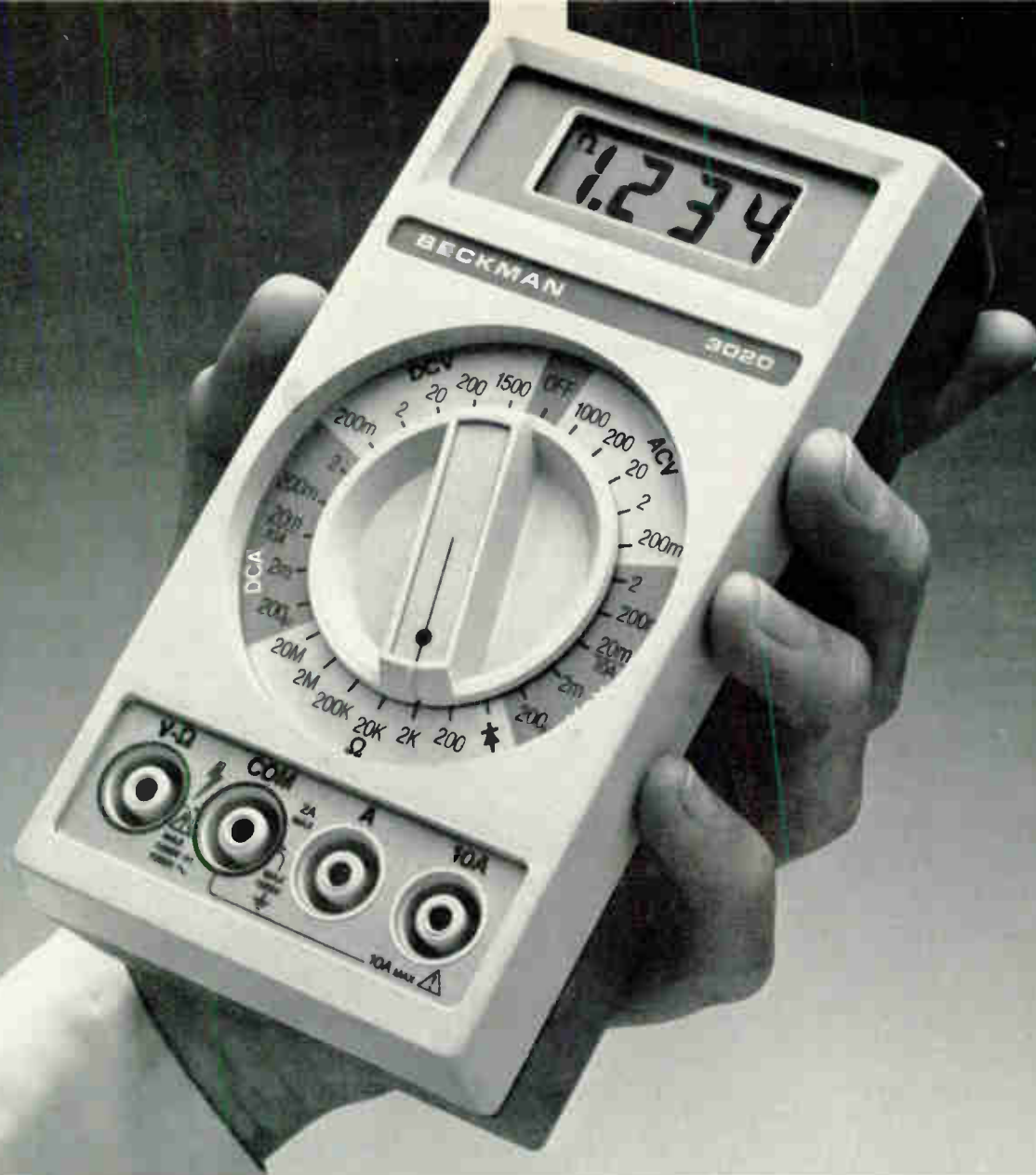

## Beckman's new digital multimeter is ready to handle any job you are.

Continuity checks. High current measurements. In-circuit resistance measurements and semiconductor tests. Whatever the job, if a multimeter is called for, call for a new

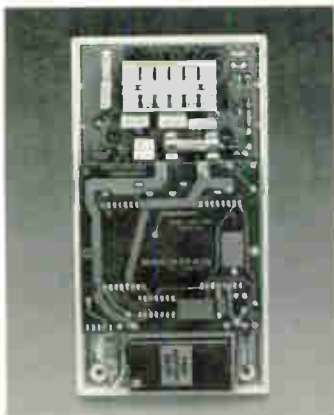

Beckman digital multimeter.

There are three models to choose from with a price tag as low as \$140.

All three feature Insta-Ohms™ quick continuity indicator, (exclusive to Beckman digital meters), 10-amp current ranges, in-circuit measurement capability in all six ohm ranges, a dedicated diode test function, and up to two years normal operation from a common 9V battery.

The Model 3020 has seven functions, 29 ranges, and 0.1% Vdc accuracy for just \$170.

For just \$140, there's the Model 3010 which has all the features of the 3020, but with Vdc accuracy of 0.25%.

Or, for measuring noisy,

non-sinusoidal signals, there's the Model RMS 3030. It features true RMS (ac and dc) voltage and current measurement capability with 0.1% Vdc accuracy for only \$200.

And every Beckman meter uses band-gap reference elements, thin-film resistor networks, gold switch contacts and custom designed CMOS LSI chips to assure long-term accuracy and reliability.

So, for ease of operation and reliability from your digital multimeter, choose Beckman. For information on the complete line and accessories, write or call your local distributor or the Advanced Electro-Products Division, Beckman Instruments, Inc., 2500 Harbor Boulevard, Fullerton, CA 92634, (714) 871-4848, ext. 3651.

# BECKMAN

Circle 65 on reader service card

# **SCIENCE / SCOPE**

A new weapon guidance system uses satellite radio signals to accurately guide medium-range tactical missiles to targets on land or at sea. The on-board system determines a missile's precise position and velocity anywhere on earth by calculating the time it takes signals from four NAVSTAR Global Positioning System satellites to reach the weapon. The information is used to correct the missile's inertial navigation computation. The technique offers several advantages over conventional guidance methods, including simplicity, stealth, and the flexibility to fly over any terrain. A missile launched beyond enemy defenses would be hard to detect on enemy radar because the missile would emit no tell-tale radar signal. Hughes is developing the system for use by the U.S. Air Force in the late 1980s.

A new liquid-crystal reticle for a gunner's telescopic sight is significantly smaller and less expensive than the mechanical devices now used in fire control systems on military vehicles. The computer-generated crosshairs move on two axes to provide an accurate aim point for the gunner. The all-digital device has no moving parts and has a flexible format for numerical displays. Hughes is developing the reticle under contract to the U.S. Army.

The cable television industry is reducing the cost of high-quality multichannel TV transmission by using microwave equipment. Hughes AML (Amplitude Modulated Link) systems are relaying TV signals (up to 40 TV channels per transmitter) across areas where construction of coaxial trunklines is too slow, too costly, or too difficult. These areas include rivers, mountains, and urban expanses crowded with freeways, airports, bridges, and parks. In addition to transmitting more channels at less cost, an AML system delivers a higher quality TV picture because it has much lower signal distortion than similar lengths of cable. Hughes AML systems are carrying more than 7500 video channels to receiving sites in the United States, Canada, Switzerland, Austria, Belgium, and Denmark.

Radar, air defense systems, electronic warfare, communications, anti-submarine warfare systems, and special-purpose and general-purpose computers -- these are among the programs being advanced at Hughes Ground Systems Group. That's why we're searching for electronics engineers, computer science graduates, mechanical engineers, mathematicians, and physicists. If you are one, and you want to move ahead of the industry tide, send your resume for immediate consideration to Hughes Aircraft Company, Ground Systems Group, Professional Employment, Dept. SE, 1901 W. Malvern Ave., Fullerton, CA 92634. Equal opportunity M/F/HC.

Two new IV-cameras-on-a-chip will serve as eyes for machines in a wealth of commercial and industrial applications. The devices, made possible by advanced charge-coupled technology, are called Hughes Omneye™ imagers. One chip consists of 1,024 light-sensing picture elements, the other of 10,000 picture elements for higher resolution. Typical uses of the imagers would be on assembly lines to help machines size, orient, and identify parts and objects. Compared to standard vidicon cameras, the devices are more reliable and rugged, and require less voltage and power.

*Creating a new world with electronics*

**HUGHES**

HUGHES AIRCRAFT COMPANY  
CULVER CITY, CALIFORNIA 90230

## Lithography system adds second E beam for accurate positioning

by Kevin Smith, London bureau manager

Experimental unit can hold registration errors to 0.1  $\mu\text{m}$  and correct for wafer distortions like bowing

An unconventional electron-beam lithography system that uses two beams instead of one may promise a solution to many of the alignment problems encountered when directly writing submicrometer features onto a wafer.

The first beam writes as in a conventional system. The second beam, placed vertically beneath it, works with registration marks on the wafer's under surface to position the wafer (see figure).

The machine, called CUMMS II, for Cambridge University microfabrication and mask-making system, model 2, is easily capable of registration accuracies to within 0.1 micrometer, says Haroon Ahmed, who developed it with G. A. C. Jones and R. A. McMahon. Further, he says, the registration marks can be used to compensate for wafer bowing and other distortions caused by high-temperature processing.

Though the ability to write features of less than 1  $\mu\text{m}$  onto a wafer during routine production is the still-distant goal, Ahmed sees other applications for his group's back-wafer registration technique.

**Zapping.** For one, the accuracy possible with the technique could be exploited to control electron-beam wafer zapping. In a parallel research program, the Cambridge group has demonstrated the feasibility of this zapping as an alternative to thermal

annealing. Its great virtue here is that there is no sideways diffusion of impurities, thus allowing better dimensional control.

Also, when mixing electron-beam writing—say, to make the final metallization layer of a logic array—and masked optical lithography, back-wafer registration offers the plus that distortions in the early optical stages can be compensated for.

A problem with conventional positioning systems using laser interferometry is their sensitivity to temperature. The table is aligned by means of a registration mark on the wafer's upper surface, then stepped from this mark under control of the interferometer. Though the theoretical maximum error of this method is 0.028  $\mu\text{m}$ , temperature-induced dimensional changes in the table and mirror misalignments, Ahmed says,

can increase registration errors to 0.33  $\mu\text{m}$ .

The group's answer to this problem is to form silicon nitride registration lines on the wafer's polished under surface. Silicon nitride was chosen because it gives a good optical contrast and fits with the nitride MOS process the technique has been applied to. For masks, the registration marks could be sets of four L-shaped lines delineating the corners of each chip.

To fabricate chips larger than the CUMMS II's 6.5-by-6.5-millimeter field, two or more fields must be "stitched" together. This process requires a precision registration grid on the back of the wafer (or on a master mask, for mask making).

When writing directly, wafer distortions such as bowing or warping can be determined from the registration matrix and corrections applied. "We have done the sums on this to prove it's possible, but we have not written any software," Ahmed says.

**More.** The double-beam technique has other benefits as well. Explains Ahmed, "We took care to make both electron-beam columns identical, and as a result drift errors in the deflection amplifiers and in the beam accelerators are self-canceling when common drive units are employed." There is an economic advantage, too, as the extra column is less expensive than the alternative laser-interferometer-controlled table, he says.

One criticism of the technique is that the processing required to lay down the nitride registration marks could damage the upper surface, but, Ahmed says, there is no evidence of this. In fact the group worked with the British Post Office to prove the

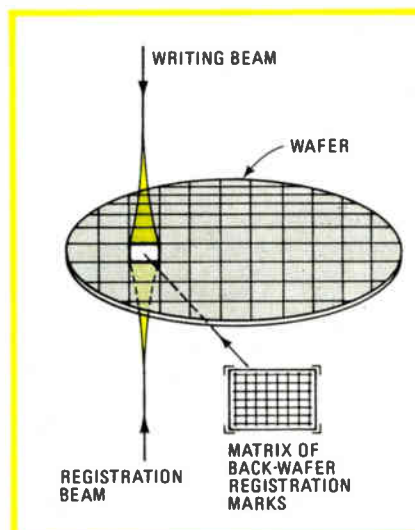

**Doubling up.** The use of a second electron beam to position wafers is more accurate than laser-interferometry systems, say the method's Cambridge developers.

technique for a nitride MOS process.

The group is now developing a square and a variable-dimension beam system needed to increase the writing speed at least tenfold (see also the next story). At present, the incrementing rate is 10 megahertz.

The university group occasionally collaborates with neighboring Cambridge Scientific Instruments Ltd., whose EBMF II machine is the center of Britain's electron-beam lithography program. Thus this work may eventually be taken up by the company.

### Japan

## Augmented raster speeds E-beam unit

Direct exposure of submicrometer patterns on wafers is a step closer to realization with a very fast direct-writing electron-beam lithography system developed by Japan's VLSI Cooperative Laboratories. The unit, which is more than 10 times faster than the labs' earlier machine, can write patterns with a minimum line width of 1 micrometer—for wafers up to 4 inches in diameter or masks up to 5 in. in diameter—on a 100-by-100-millimeter area in as little as 12 minutes.

The higher speed is obtained by augmenting the raster scan with vector-scanning techniques, including a variable-dimension beam [*Electronics*, Feb. 28, p. 63]. The reduced number of scans needed boosts the speed, which is further increased by skipping areas where there is a low density or an absence of features on the device.

**X and Y motion.** As with the previous system, the electron beam is deflected across the 250- $\mu\text{m}$  width of the scanning field, or frame. Motion of the table in the Y direction enables repeated scans to cover the length of the piece, at which point the table increments to the next frame and returns in the opposite direction.

Unlike the previous system, which uses a round beam with a diameter approximately one quarter of the

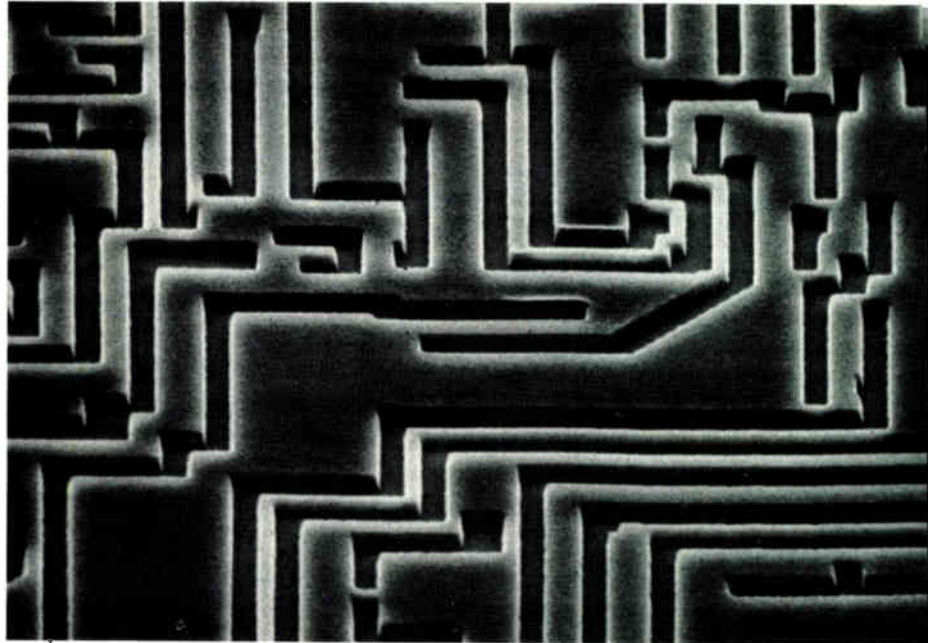

**Well-written.** This pattern, written with the VLSI Co-op Labs' speeded-up electron-beam machine using CP-3, a highly sensitive resist, features 1- $\mu\text{m}$  minimum line widths.

minimum feature dimension, the new unit uses a shaped rectangular beam with a variable length of up to 4  $\mu\text{m}$ . The beam width is fixed at about two thirds the minimum feature dimension of either 0.5 or 1  $\mu\text{m}$ . Also, the beam can be deflected forward or backward with respect to the direction of table motion, which is not so for the earlier system.

The table moves at a constant rate and the scans repeat at a constant rate, but the ability to deflect the beam forward and backward in the direction of table motion permits exposure of bands of unequal length. Basically, it is necessary only that (within limits) the average length of the region exposed together with the unexposed regions immediately preceding and following equal the average table speed.

Furthermore, the table speed may be optimized. Although the speed of the table cannot be varied during a pass, the fact that the table must be stopped and have its direction reversed between passes means that the speed on each individual pass is independent of the speed on the other passes. Thus the data for each pass can be scanned ahead of time and the table speed for that pass optimized at any value up to the

maximum of 100 mm per second.

The system includes a 160-mega-byte magnetic disk and a 2-mega-byte buffer memory for pattern information. The actual storage requirements are greatly lessened by redundancy reduction processing similar to that used in modern digital facsimile systems. The overall system is consequently suitable for devices with up to 5 million features per square centimeter.

The new system has a lanthanum hexaboride cathode that delivers a constant current density of more than 50 amperes per square centimeter regardless of spot size. The high current density contributes to the writing speed.

**Resists.** Also adding to the speed are two new highly sensitive positive resists. One of them, CP-3 (polymethylmethacrylate-co-t-butylmethacrylate), is a copolymer that has a sensitivity of 4<sup>-7</sup> coulomb per square centimeter and a resolution of 0.3  $\mu\text{m}$ . The other, EBR-9 (polytrifluoroethyl- $\alpha$ -chloroacrylate), is a molecular-engineered polymethacrylate compound, with a chlorine atom substituted in the alpha position, that has a sensitivity of 8<sup>-7</sup> C/cm<sup>2</sup> and a resolution of 0.1  $\mu\text{m}$ .

The minimum address increment



NATIONAL  
POWER PRODUCTS

---

# "Can you give me a Switcher with no derating from $-40^{\circ}\text{C}$ to $+71^{\circ}\text{C}$ ?"

---



#### Yes we can!

Let the ambient temperature inside your system climb to  $+71^{\circ}\text{C}$ . Our SA Series of single output, off-line switchers will keep delivering full output power with extremely low noise characteristics. We've developed this switcher series to cure your derating problems, and we've designed in features for maximum operating efficiency. Over-voltage and overcurrent input/output circuitry protects your system. Soft-starting and remote shut-down ensure safety and control. Every unit in the SA Series operates at greater than 75% efficiency over a full 2:1 input-voltage span. And our units are designed with unique integral channels for greater design flexibility in any of four mounting planes.

Reliability. Efficiency. Choice. 5V, 12V, 24V, and 48Vdc are available in 60W and 125W versions. The 60W

series is unit priced at \$229.95 and the 125W at \$259.95.

Each switcher and each unit in our long line of modular, encapsulated power sources proudly carries the "No Derating" feature... because you need cool operation. We are a Semiconductor Circuits Company. Call on us for problem solving. Look to us for innovation. See our product listings in EEM and Gold Book and ask for a free wall chart of our products.

#### Problem Solving Through Innovation



**SEMICONDUCTOR  
CIRCUITS**

218 River Street  
Haverhill, MA 01830  
(617) 373-9104

is 0.125  $\mu\text{m}$  for a minimum line width of 0.5  $\mu\text{m}$  and 0.25  $\mu\text{m}$  for a 1- $\mu\text{m}$  minimum line width. Pattern generation is accurate to within 0.1  $\mu\text{m}$ , and the registration accuracy is within about 0.2  $\mu\text{m}$ . -Charles Cohen

France

## Loose fit cuts fiber-cable loss

Researchers at the French government's telecommunications laboratory, the Centre National d'Etudes des Télécommunications, have come up with a way to squeeze every last bit of performance out of optic-fiber cables: they don't squeeze the fibers.

"Even the slightest pressure of the fiber itself can create transmission losses," explains Michel Tréheux, director of the CNET optic-cable research team. "Physical pressure on the fiber also shortens its life span," he adds.

**No loss.** For both its cylindrical and ribbon-shaped fiber supports, CNET therefore opted for structures in which fibers are housed in loose-fitting cavities. As a result, Tréheux says, cables using these supports match the performance of the individual fibers.

In designing the cylindrical support, researchers at the CNET optic-transmission lab in Lannion, Brittany, and at Thomson-CSF's LTT

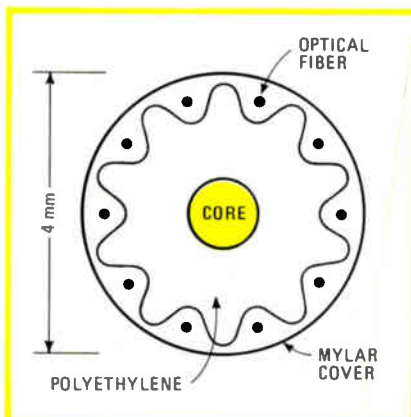

**Staying loose.** Optical fibers are loosely housed in a cylindrical support from CNET and LTT, to optimize the performance of optic cables. The core provides strength.

(Lignes Télégraphiques et Téléphoniques) subsidiary in Paris thought first and foremost of the problem of connectors. "From the very start, we wanted to be able to make multiple connections, instead of having to splice each fiber individually," says Tréheux.

**Mimic.** The solution is a plastic connector that mimics the cylindrical 10-fiber structure of the support (see figure). After stripping off a section of the Mylar outer coating and cutting the polyethylene and core, the fibers are positioned around the plastic connector body. The connector is molded around the body and cut in half with a diamond saw. At 15,000 revolutions per minute, the saw polishes the exposed fiber ends at the same time.

Since the two ends of the connector come from a single piece, the alignment between them is never more than 2 to 3 micrometers off. Attenuation for each connection is less than 0.5 decibel, CNET researchers claim.

To connect a pair of large Paris telephone exchanges, a project to be completed this fall [*Electronics*, Feb. 28, p. 64], LTT is making cables with 7-fiber supports, for a total of 70 fibers per cable. Each support is in helical form to ensure equal fiber lengths if the cable itself is curved or twisted. For the same reason, the seven supports are cabled with a slight twist.

**At the core.** In order to provide the cable with physical strength, each support contains a core. The CNET researchers tried copper first, then changed to a synthetic textile, Kevlar, made by Du Pont. LTT is now using another material, whose name it refuses to divulge.

The core material is a crucial element because it must be not only strong, but also relatively immune to temperature changes. If the core expands too much at high temperature, it will force the polyethylene out against the optic fiber. LTT's cylindrical cable offers attenuation of less than 3.5 dB per kilometer from  $-20^{\circ}$  to  $+80^{\circ}\text{C}$ .

Connectibility is less of a problem for the ribbon-type support jointly

developed by CNET and the Compagnie Lyonnaise de Transmissions Optiques, a subsidiary of the Compagnie Générale d'Electricité. The reason is that the fibers themselves are laid out in a plane, so that a simple clamp, equipped with positioning grooves, is all that is needed to ensure quick alignment.

**Ridged.** Each ribbon is formed by laying the fibers in the concave portions of a length of corrugated aluminum coated with polyethylene. A matching length of polyethylene-coated corrugated aluminum is laid on top. The ridges touch, leaving pockets for the fibers. When low heat is applied, the polyethylene coatings create a permanent seal.

Each 8-millimeter width of ribbon contains six optic fibers, and as many as 12 ribbons can be inter-twined into a single cable.

"The cost of the cabling is negligible compared with the cost of the fiber," says Arnaud Gobet, the Clichy firm's marketing manager. LTT produces its own fibers, and CLTO uses Corning products.

Gobet says his company offers ribbon-structure cables with an attenuation of 2 to 8 dB/km and a usable bandwidth of 200 to 1,500 megahertz/km. -Kenneth Dreyfack

West Germany

## Laser computer link transmits 1 Mb/s

In many cases, the transport of large amounts of data between remote computers presents problems. Conventional links like telephone lines have limited bandwidth, allowing transmission rates of 48,000 bauds at the most. Glass-fiber cables offer more bandwidth of course, but they must first be installed, and that can be costly. Pretty much the same holds for microwave links.

A way out of these difficulties is now being proposed by the University of Kaiserslautern in West Germany. At the department of computer sciences there, an engineering team headed by Prof. Ewald von Puttkam-



# A UNIQUE CHOICE OF DATA ACQUISITION SYSTEMS FOR THE LSI-11/2 AND 11/23. NOW FROM ADAC.

When it comes to data acquisition systems, there is nothing quite like the ADAC System 1000 and the new System 2000.

Both systems can operate as low cost peripheral expanders to any UNIBUS computer. When incorporating a DEC LSI-11/2 or 11/23 microcomputer the systems operate as stand alone control systems or as remote intelligent terminals.

The compact System 2000 is built to hold 13 half quad cards. If you need greater capacity, slave units can be utilized or you can go to the larger System 1000 which accommodates any combination of 11 quad size cards or 22 half quad size cards. Both systems can be bench top or rack mounted and have a universal power supply that can support up to 256 kilobytes of memory.

The real heart of both System 1000 and System 2000 is their incredible number of analog, digital, serial I/O, clock, bus and CPU/memory cards. Functional analog cards communicate directly with thermocouples, load cells, strain gauges, isolation amplifiers,

transmitters and strip chart recorders to name a few. Discrete cards communicate with switch contacts, relays, thumb wheel switches, pumps, motors and other devices. All cards can be purchased as separate items.

A single System 1000 can be supplied with up to 700 high level analog input channels, or 128 analog low level input channels, or 700 digital I/O functions. A typical System 2000 contains a CPU, 64 kilobytes of memory, floppy disc controller, 16 channel A/D, 4 channel D/A, 32 TTL I/O lines, two serial I/O ports plus room for another six cards of your choice.

Another nice thing about both systems is their prices. They start at \$995 for the System 2000 and \$1550 for the System 1000. So you can choose the combination of price and capability that's just right for your application. Contact ADAC for full details.

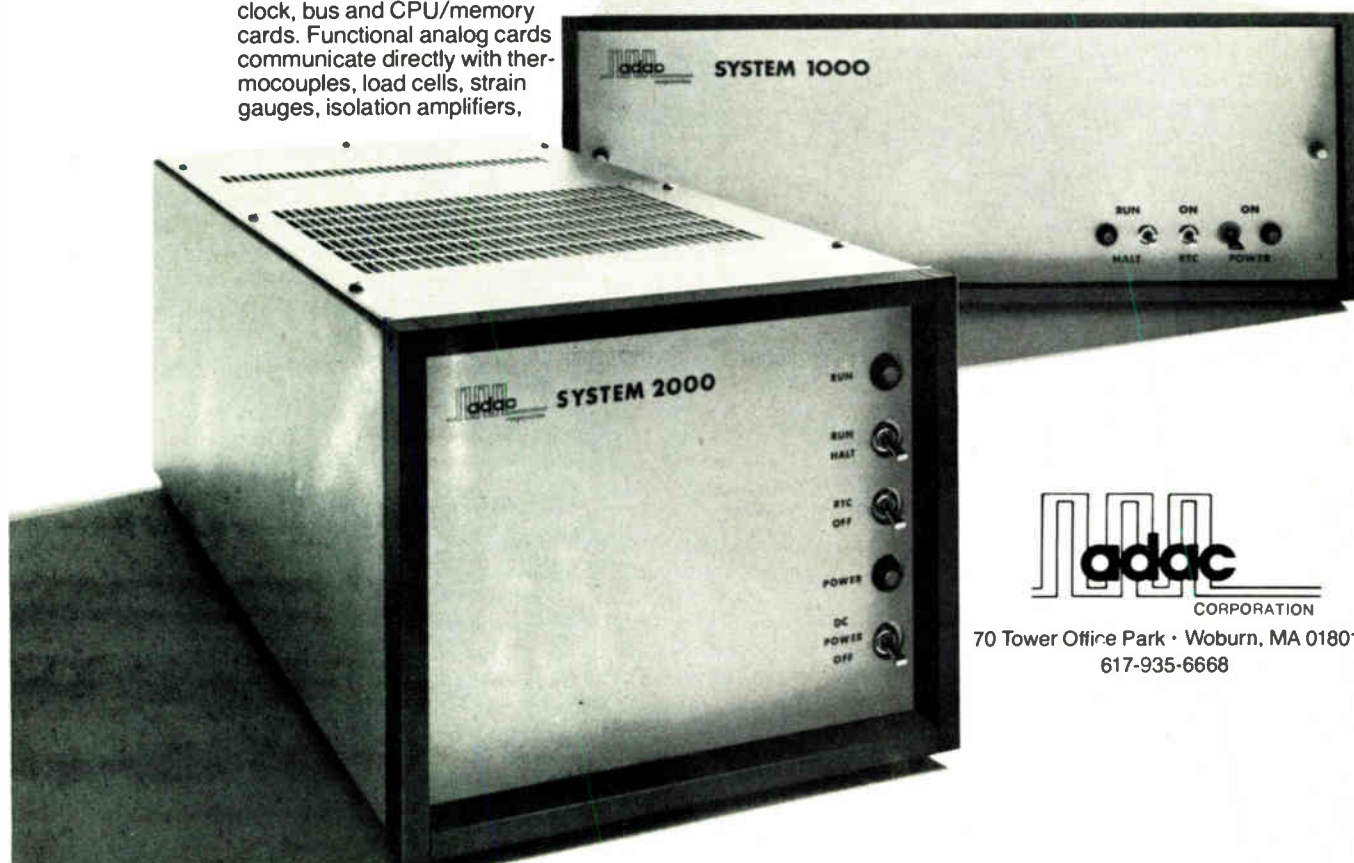

70 Tower Office Park • Woburn, MA 01801  
617-935-6668

er has developed a mobile laser-based optical transmission system that can currently handle data rates of over 1 megabit per second.

Laser transmission systems have already been developed that link, for example, portable telephones [*Electronics*, Aug. 2, 1979, p. 70], teletypewriters [Jan. 17, 1980, p. 46], and computers to traffic lights [Nov. 9, 1978, p. 41]. What's interesting about the Kaiserslautern system, however, is its truly fast computer-to-computer communications capability. Now that it is ready, it will be tried out in just such an application.

**Backup.** The system is laid out to bridge distances of up to 10 kilometers, or roughly 6 miles. It is intended mainly to add transmission capacity to existing conventional links or to take over when such links are temporarily out of action. Simply constructed and mounted on vehicles, it can be set up and aligned for operation in less than an hour.

On the system's line-of-sight transmission path, atmospheric conditions have "less effect than is generally believed," von Puttkamer says. Only in heavy rain, fog, or snow does the link break down.

"As long as the other end can be seen, the system can be used," he says. In recent tests on the university's campus, a system availability figure of 99.6% was obtained.

**Transmission.** At the heart of the system is a laser transmitting diode from Laser Diode Labs Inc. of Metuchen, N. J. A concave mirror concentrates its light into a sharp 15-centimeter-diameter beam. Radiating in the near-infrared light range—at a wavelength of 890 nanometers—the diode transmits the data in the form of 1-watt, 50-nanosecond-long pulses.

The data originating at the sending computer is supplied to the transmitting diode in parallel bytes, each byte consisting of 8 information bits and a start, a stop, and a check bit. It is converted into an 11-bit serial string and then transmitted. At the receiving end, a plastic 40-cm-diameter Fresnel lens concentrates the incoming light onto a silicon photodiode with an integrated

amplifier. From the latter's output, the serial data is extracted, converted to parallel bytes, and fed to the receiving computer.

**Inexpensive.** A cost and performance comparison between this optical setup and a conventional system can hardly be made because of their big differences, von Puttkamer says. The experimental system he has built costs the equivalent of slightly

less than \$3,000, which is way below the cost of the equipment involved in a wire or microwave link.

However, the fail-safe requirements imposed on a wire link by postal authorities specify a system down time of no more than 2 hours in 30 years of operation. That, von Puttkamer notes, is a specification that an optical system can hardly meet.

-John Gosch

## Around the world

### Outlook brightens for French TV projection tube

Titus, a high-power image projection tube that has had a hard time getting out of the laboratory since the first working model was shown in France a decade ago, finally seems on its way to becoming an industrial product. Laboratoires d'Electronique et de Physique Appliquée (LEP), in the Paris suburb of Limeil-Brévannes, developed Titus with mainly theater TV in mind [*Electronics*, July 11 1974, p. 53 or 6E]. The tube, which uses a slice of bideuterated potassium phosphate cooled to  $-50^{\circ}\text{C}$  to modulate light by the Pockels effect, can put a bright color image on screens as large as 50 square meters and holds its image between scans, whether synchronous or asynchronous. Although theater TV did not pan out, Titus has found a promising potential market in the United States as the display for flight simulators. Paris-based RTC-La Radiotechnique Compélec, like LEP a Philips unit, has begun work on preproduction high-resolution versions.

### ERNO to build second Spacelab

The European Space Agency has contracted West Germany's ERNO Raumfahrttechnik GmbH to build a second Spacelab for the U. S.'s National Aeronautics and Space Administration. It is scheduled for delivery to NASA by April 1984. The value of the contract is about \$173 million, but the amount to be apportioned to subcontracting firms in various European countries has not yet been determined. Bremen-based ERNO will deliver the first Spacelab to NASA next year [*Electronics*, June 27, 1974, p. 80]. The first flight of the joint space shuttle-Spacelab is set for April 1982.

### Optical cable dips its toe in the water

Tests are under way in Loch Fyne, Scotland, on a custom-designed undersea cable using optical fibers. The experimental 9-kilometer cable, developed by Standard Telephones & Cables Ltd., Greenwich, incorporates six-graded-index optical fibers each capable of a data rate of 140 megabits per second—the same as land-based systems already installed by STC—and has a potential capacity of 6,000 telephone channels. The loch is open to the sea, and the cable therefore incorporates a pressure-protective sleeve to protect it from the saltwater environment. The purpose of the tests is to prove the cabling technology, which at 1.3-to-1.5- $\mu\text{m}$  wavelengths could need repeaters every 50 km, not every 5 km as with conventional cable.

### DEC to expand minicomputer plant in Ireland

Digital Equipment Corp. has announced that it will more than triple the size and work force of its minicomputer plant in Clonmel, County Tipperary, Ireland. Its present 46,000-square-foot facility will grow to 150,000 ft<sup>2</sup> by 1981, and the number of employees should increase from 115 to about 450 within the next five years. The new facility will be built by Ireland's Industrial Development Authority with the understanding that DEC will lease the plant or eventually buy it back. Its increased production of the firm's mid-range minicomputer line will mesh with the Europe-bound output of the high-end minicomputers turned out at DEC's older installation in County Galway.

# SCOUT<sup>™</sup> MINICOMPUTER WITH ISOLITE<sup>™</sup> INSTANT SELF-TEST FOR VIRTUALLY ZERO DOWNTIME.

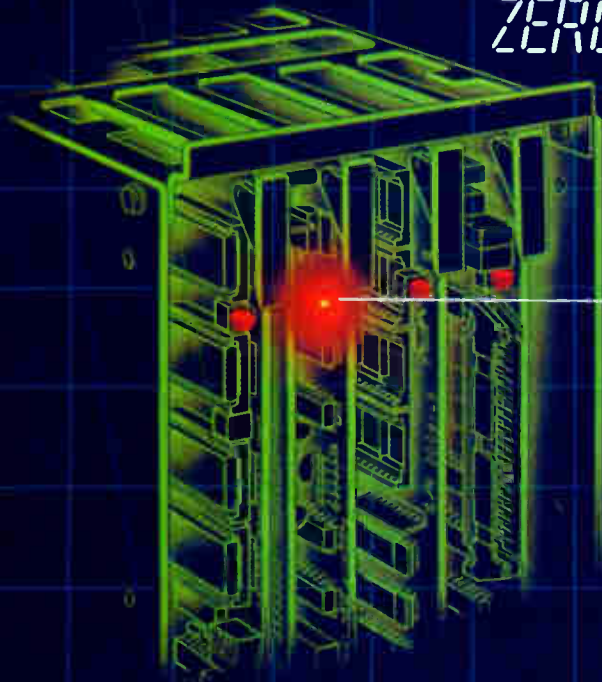

ISOLITE CIRCUIT AUTO-  
MATICALLY TESTS EACH  
BOARD IN SCOUT SYSTEM.

RED LIGHT SHOWS BOARD  
BEING TESTED. IF LIGHT  
GOES OFF, BOARD IS GOOD.  
IF LIGHT STAYS ON,  
BOARD IS BAD.

USER REPLACES BAD BOARD WITH  
SPARE 6.25" X 8.3" CARD IN  
3 MINUTES. NO TECHNICAL PER-  
SON OR OEM SERVICE ENGINEER  
REQUIRED TO MAKE REPLACE-  
MENT. MAINTENANCE COSTS DRAS-  
TICALLY REDUCED.



SAVE MONEY WITH SCOUT.  
GET 16-BIT CPU WITH 32K  
BYTE RAM, I/O AND CARD  
CAGE FOR \$985 LIST PRICE  
{VOLUME PURCHASE DIS-  
COUNTS APPLY}. CALL  
OR WRITE FOR MORE  
INFORMATION.

 **Computer Automation** NAKED MINI Division  
WHERE OEM'S COME FIRST.

18651 VON KARMAN, IRVINE, CA 92713, PHONE (714) 833-8630, EXT. 455.  
SCOUT AND ISOLITE ARE TRADEMARKS OF COMPUTER AUTOMATION, INC.

Circle 73 on reader service card

They've got all the power and versatility you need to make your wildest product dreams come true. They're already the fastest growing microprocessor family.

And we'll keep adding superior new members. So you can add futuristic features to dazzle your cus-

tomers and zap your competitors.

Some innovative newcomers include the brainy, omnipotent S6809. Our screen star, the cost-cutting S68045 CRT controller. Our low cost single chip MCU, the S6805. And the fastest MPU in this league, our 2.5 MHz S68H00. This

isn't just a bunch of individualists, either. They're part of the stellar AMI system. Instead of merely selling you parts, we'll look over your present design and, if we can, show you how to cut out some components with a custom peripheral. Or work out a more streamlined

# Meet the AMI S6800 Family:



S6800 system, including both standard and custom parts. Perhaps even customizing the MPU.

So let's put our heads together and find the best way to control your product without putting your budget into orbit. Call up your nearest AMI distributor. Or contact us at AMI

S6800 Marketing, 3800 Homestead Road, Santa Clara CA 95051. Phone (408) 246-0330.

However far-out your plans are, our family will make light work of them.

# stars of the 8-bit wars.

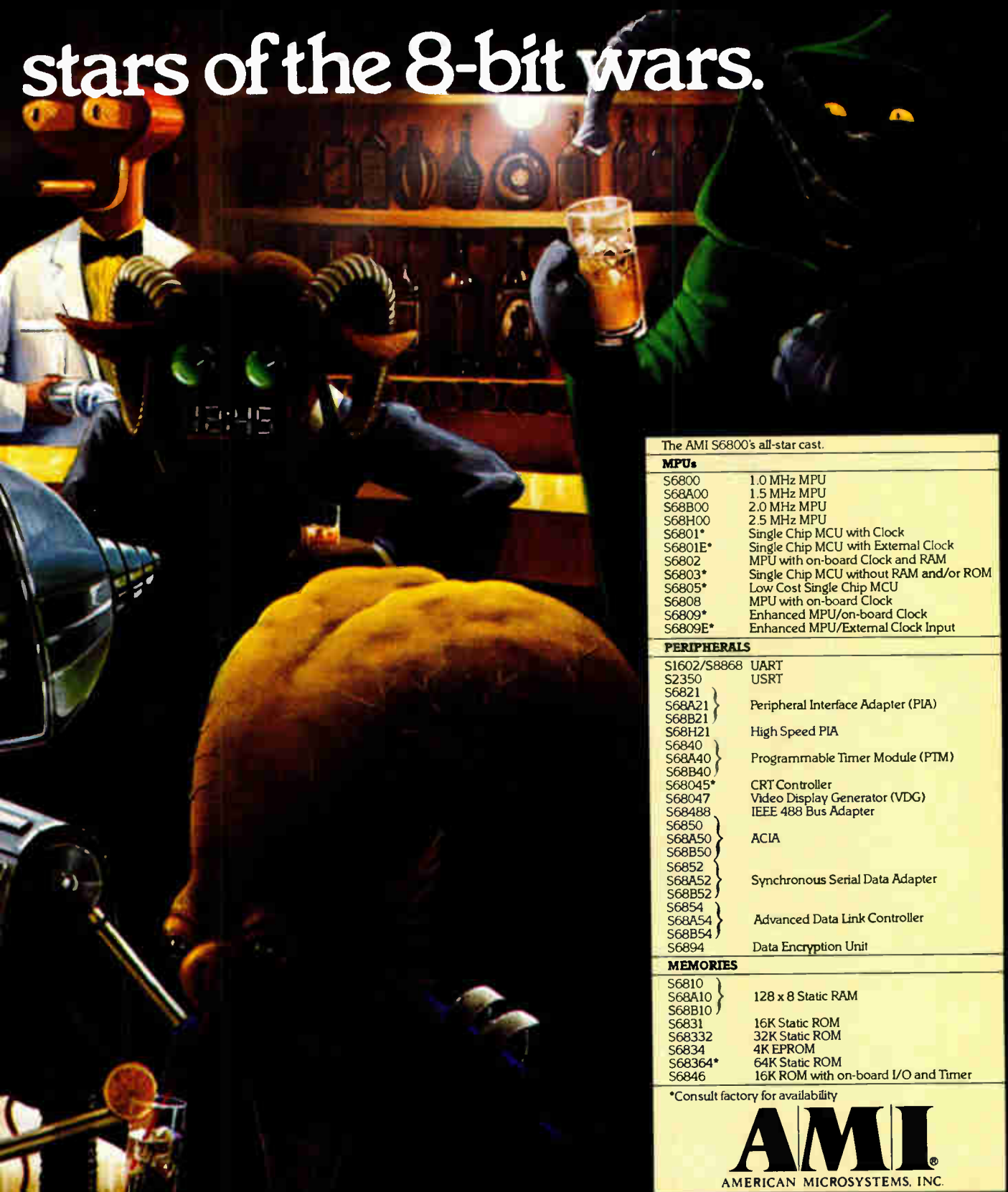

The AMI S6800's all-star cast.	
<b>MPUs</b>	
S6800	1.0 MHz MPU
S68A00	1.5 MHz MPU
S68B00	2.0 MHz MPU
S68H00	2.5 MHz MPU
S6801*	Single Chip MCU with Clock
S6801E*	Single Chip MCU with External Clock
S6802	MPU with on-board Clock and RAM
S6803*	Single Chip MCU without RAM and/or ROM
S6805*	Low Cost Single Chip MCU
S6808	MPU with on-board Clock
S6809*	Enhanced MPU/on-board Clock
S6809E*	Enhanced MPU/External Clock Input
<b>PERIPHERALS</b>	
S1602/S8868	UART
S2350	USRT
S6821	Peripheral Interface Adapter (PIA)
S68A21	
S68B21	High Speed PIA
S68H21	
S6840	Programmable Timer Module (PTM)
S68A40	
S68B40	
S68045*	CRT Controller
S68047	Video Display Generator (VDG)
S68488	IEEE 488 Bus Adapter
S6850	ACIA
S68A50	
S68B50	Synchronous Serial Data Adapter
S6852	
S68A52	
S68B52	
S6854	Advanced Data Link Controller
S68A54	
S68B54	
S6894	Data Encryption Unit
<b>MEMORIES</b>	
S6810	128 x 8 Static RAM
S68A10	
S68B10	
S6831	16K Static ROM
S68332	32K Static ROM
S6834	4K EPROM
S68364*	64K Static ROM
S6846	16K ROM with on-board I/O and Timer

\*Consult factory for availability

**AMI**  
AMERICAN MICROSYSTEMS, INC.

Circle 75 on reader service card

# FAIRCHILD

## To be a leader in digital switching, you need leading semiconductor technologies.

It takes innovative technologies today to produce semiconductor products that meet the telecommunication industry's needs.

Those are the kinds of technologies we've developed at Fairchild.

### We're concerned about your concerns.

Higher speeds, reduced power consumption, improved versatility and lower system costs are all fundamental considerations in the design of digital switching systems. Our new generations of semiconductor products are tailored to reflect your concerns.

New Monolithic 5116/5156 Codec, and scheduled filters and SLIC circuits dramatically impact size, power and system cost for Line/Trunk Interface.

The 3870 8-bit microcomputer adds cost-effective versatility in Signaling, Administration and Maintenance subsystems.

Isoplanar-S RAMs, PROMs and bit-slice microprocessors improve the performance in your Processor.

And, Fairchild's Advanced Schottky TTL (FAST) logic ups speed while reducing power consumption in Highway, Switching Network and Processor areas.

### That's not all.

We also have voltage regulators and rectifiers for power supplies. Op amps for filtering. Drivers, multiplexers and decoders for the Highway. And MOS microprocessors, memories, peripherals and standard logic families for control functions.

A major part of the future of digital switching depends upon these semiconductor products. That's why it makes good sense for you to depend on the name that has leading technologies and products.

Fairchild. A Schlumberger Company.

For more information, write Telecommunications Marketing, Fairchild Semiconductor Products Group, P.O. Box 880A, Mountain View, CA 94042. TWX: 910-379-6435.

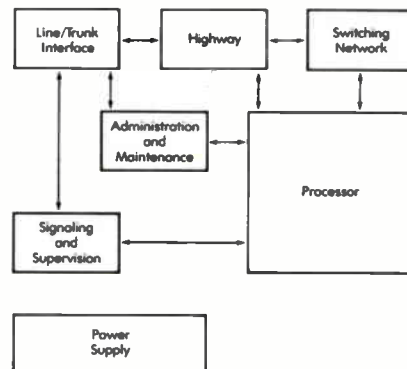



# HP announces a way to accelerate microcomputer development...





# and have a little fun while you're at it.

At last, there's a universal development system that frees you from mundane development tasks and lets you concentrate on challenging software and hardware problems . . . HP's 64000 Logic Development System. It brings minicomputer programming features to microcomputer development for faster, easier and more enjoyable software development, hardware emulation and system analysis. And because it's a universal system, you can use it with today's most popular microprocessors.

## ✓ - MICROPROCESSORS NOW SUPPORTED BY HP'S 64000

Microprocessor	Full Support*	Macro Assembler Support	Microprocessor	Full Support*	Macro Assembler Support
1802		✓	8085	✓	
6800	✓		9900/9940/9980		✓
6801/6802		✓	F8/3870		✓
6805		✓	Z80	✓	
6809		✓	8086		
8021		✓	68000		
8022		✓	Z8000		
8035/8039		✓			
8041/8741		✓			
8048/8748		✓			
8049		✓			
8080	✓				

\*Includes macro assemblers, linkers, emulation and analysis.

## Put your fingers on a "soft key"

One of the system's key features is its ability to help you make decisions. At power up, for example, soft keys (keys whose functions are defined by CRT labels) give you a choice of 17 development functions, including edit, compile, assemble, link, emulate, PROM program and more. Pressing the edit key and typing in the name of a previously stored file result in a program listing and soft-key choices that simplify program editing, (shown above right). The CRT even flashes momentary directed-syntax messages to guide you in proper command entry.

The combination of minicomputer power and directed syntax using soft keys means you spend less time memorizing syntax, referring to instruction manuals, doing routine searching and entering line-by-line program changes. The 64000 handles most of those routine tasks



so you can concentrate on the real problems. And that's true in assembling, linking, emulating and other development modes as well.

## Work with a friend . . . or five

With HP's 64000, serial development is a thing of the past. Now, up to six team members can do software development and/or real-time emulation simultaneously. And each has immediate access to the latest version of software. That's because the 64000 has a hard disc that provides a common data base for all operators.

To assure accurate, real-time emulation, the 64000 has separate buses and memory for both the host and target processors. In addition, we use high-speed memory. As a result, there's no contention problem and your system runs at operating speed with no wait-states.

Of course there's much more to the 64000, including a wide choice of PROM programmers, up to 128K of emulation memory, an optional analyzer that gives you a real-time, transparent view of bus activity, and architecture powerful enough to adapt to future processor trends such as increased speed and bus width. Price for a minimum operating system is \$18,500.\*

Find out how much fun microcomputer development can be. For a copy of the HP 64000 brochure, write to Hewlett-Packard, 1507 Page Mill Road, Palo Alto, CA 94304. Or call the HP regional office nearest you: East (201) 265-5000, West (213) 970-7500, Midwest (312) 255-9800, South (404) 955-1500, Canada (416) 678-9430.

\*Domestic U.S.A. price only.



**HEWLETT  
PACKARD**

0807

Circle 79 on reader service card

# RESOLUTION



## When and where you need it.

There are times when a 3½ digit multimeter just can't cut it.

When you really need resolving power, you need a 4½ digit DMM. To illustrate: When measuring a 15VDC supply—a 4½ digit multimeter lets you see each millivolt of change while a 3½ digit instrument would not display a change less than 10 millivolts.

As the leader in 4½ digit multimeters, Data Precision gave you that resolving power 7 years ago with the first truly portable 4½ digit multimeter...our Model 245. Then as your applications became more varied and demanding, we designed other units to meet them. The result is a line of tough, full function 4½ digit DMMs that have given almost 200,000 world-wide users more sensitive measurements.

Circle 80 for Demonstration

Circle 81 for Additional Information



### MODEL 245

The first of its kind, features high input impedance, 50kHz frequency response, 0.05% basic DC accuracy and a planar gas discharge display...\$345.

### MODEL 248

This high resolution instrument features 10µV and 10 nanoamp sensitivity, True RMS AC measurement, with a basic DC accuracy of 0.05% and an easy to read LED display...\$315.

### MODEL 258

Features True RMS AC measurement, 0.05% basic accuracy, 40 hour battery operation between charges and an LCD display ideal for outdoor as well as indoor applications...\$325.

If your needs are primarily for a bench instrument, Data Precision offers a truly versatile performer — the Model 2480R Bench/Portable with True RMS AC measurement and 0.03% basic DC accuracy. Wide measurement ranges on all functions and a benchtop case make it a logical choice for an in-house DMM...\$299 or the Model 2480 with AC average sensing...\$279. Both feature optional battery pack.

When you need more than a 3½ DMM can give, get a 4½ digit multimeter from Data Precision. We've made more 4½ digit multimeters than anyone else in the world.

For immediate delivery, demonstration, or further information, just contact your local Data Precision distributor or call:

(800) 343-8150

(800) 892-0528 in Massachusetts

Prices USA

 **DATA PRECISION**<sup>®</sup>  
A DIVISION OF ANALOGIC CORPORATION

Data Precision Corporation, A Division of Analogic Corporation, Electronics Avenue, Danvers, MA 01923, (617) 246-1600, TELEX (0650) 921819

# U. S. losing ground in the lab

Foreign nations and firms create and enjoy sunnier climates for R&D, and the difference is beginning to show

by James B. Brinton, Boston bureau manager

That the electronics industries in the U.S., like industry in general, are spending less each year on research and development is well known. But less well known is the extent to which this nation's trading partners, and rivals, are outstripping it in what is called the "advancement of knowledge" by the Organization for Economic Cooperation and Development (OECD).

The contrast is striking. Conversion to current dollars, using exchange rates, shows that France, Japan, and West Germany each spent more on advancement of knowledge than the United States, and the differences were not small. In today's dollars, France alone

spent the equivalent of more than \$970 million in 1975, Japan almost \$1.6 billion, and West Germany almost \$3.7 billion. Even the UK, with its much smaller Gross National Product, managed to allot almost \$540 million. And though the return on investment is slow, and risk high, basic research has traditionally been the most profitable, spawning entire industries.

Different national attitudes and government technology-support structures cause this divergence, but, even as our trading partners diverge, some of them are combining their efforts, as in the Common Market.

Though it has been troubled by national haggling and delays, the

European Common Market is building a strong R&D policy, as are its member nations.

**Common standards.** One of the newest programs is a \$35 million, four-year effort promoting common industrial standards throughout the community to create a uniform market for electronic equipment and software and to support data-processing R&D. This is a continuation of work ongoing for the past two years into Common Market-wide data-processing applications and software portability. A key development has been a European software language.

The European Commission now is assembling proposals for R&D on

**Diverse priorities.** The three major Western industrial nations spend very differently for defense and for advancement of knowledge.

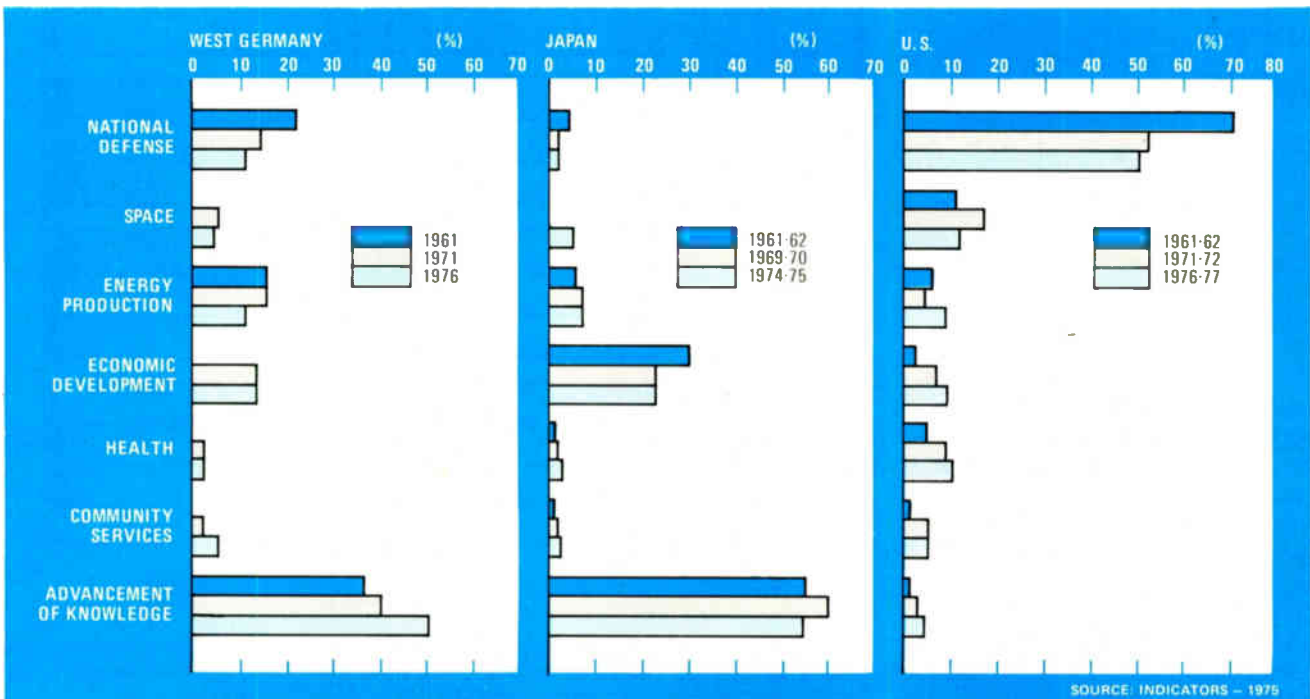

## Inside the news

microelectronics—specifically for very large-scale integrated circuits. Although the amount of funding has not yet been set, the proposals will be submitted to Europe's economics ministers next month; the program will concentrate on development of production equipment and computer-aided design and testing.

The European Economic Community now is beginning a new \$64 million energy program of which about \$2 million will go for solar-cell work. One end product of this new program will be a number of pilot photovoltaic generating systems throughout the community, capable of generating from 30 to 300 kilowatts. The stations are expected to be operational by the end of 1982.

And the advancement of knowledge is itself being studied. Long-term, think-tank research is getting under way on a program called FAST, for Forecasting and Assessment in Science and Technology. FAST is a five-year endeavor begun in 1979 to evaluate scientific and technological change in Europe, with three areas of special interest: electronics and data processing, new forms of energy generation, and biological and molecular engineering. For example, FAST would deal with the long-term effects of data processing on administration, employment, and even on such specialized areas as health.

**France advances.** Agencies of the French government, industry, and nonprofit institutions, it is estimated, will spend about \$12.4 billion in 1980 for R&D. French sources figure that is between 6% and 7% of the total world outlay for R&D, and in human terms it means employment for about 260,000 persons, about 100,000 of them scientists and engineers. Such personnel have increased as a proportion of the labor force by 40% to 50% over the past 10 years, an important indicator of French R&D intent. A substantial portion of French government funds is earmarked for high technology. The latest information available, that for 1977, shows that almost 22% of government R&D was done at electronics firms—which in turn

spent 2 francs on R&D for every 1 they got from the government.

The figure for French defense R&D in 1979 was higher than that for electronics-industry-oriented work at 27% of the government total, approximately half the percentage allocated by the U. S.

Meanwhile, in the same period, the Centre National d'Etudes des Télécommunications (CNET) spent more than \$260 million on R&D, most of it for electronics. In addition, the government sponsors or encourages special programs to strengthen France's posture in microelectronics, photovoltaics, data processing, and other areas. And a healthy French space program, conducted in concert with the U. S. and the USSR through the European Space Research Organization, adds importantly to electronics R&D. The French are interested in communications satellites, the Spacelab effort of

the 1980s, and broadcast satellites.

For a country with a Gross National Product just beyond the \$500 billion mark, as opposed to America's roughly \$2 trillion GNP, the French commitment is still not enough for some of the French, says physicist Pierre Aigrain.

Aigrain, secretary of state for research, points out that at about 1.8% of the GNP, the French R&D effort is behind that of West Germany and Japan, both of which exceed 2%. And as a percentage of GNP, the U. S. civilian R&D investment is less than France's.

According to Aigrain, the French are "drawing up a 10-year program that will get our spending up to the level of other industrial countries our size like West Germany" and Japan.

**Pushing innovation.** Technology transfer is another of Aigrain's concerns. France has an agency, Anvar (Agence Nationale pour la

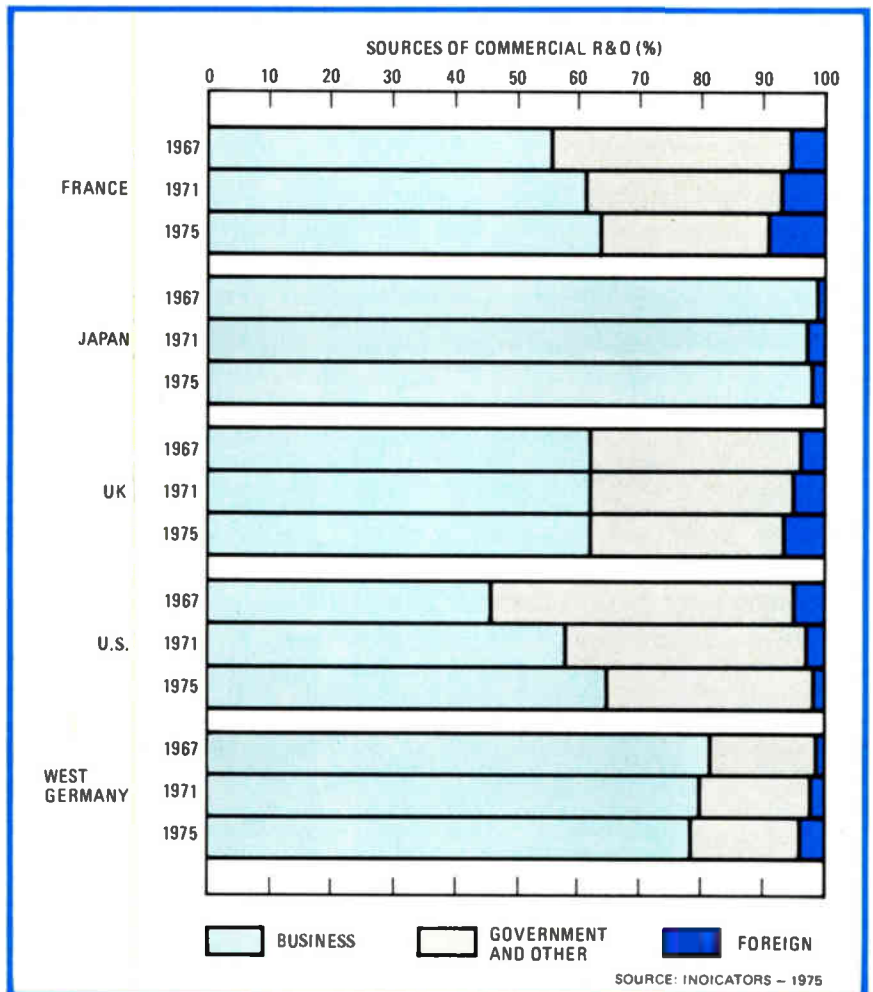

**Where the money comes from.** The chart above illustrates how much research and development is performed in the business sector according to the source of funds.

Valorisation de la Recherche), with the mission of pushing laboratory results out into industry. Anvar has a budget of about \$115 million to distribute as loans and grants, in an attempt to help industry turn research results into marketable products. Meanwhile, it is setting up branch offices throughout the country, to get closer to the companies it is to aid.

Typical of the largest of such firms is Thomson-CSF. Although it has the Gallic equivalent of Bell Laboratories in its central research laboratories, the company carries out 9% of its heavily development-oriented R&D efforts at its approximately two dozen operating divisions and subsidiaries.

Some 10,000 persons work in the various labs at Thomson, presently funded to the tune of about \$606 million yearly. This yields a funding ratio that an American high-technology firm would be proud of: Thomson puts about 20% of its nonmilitary sales income into R&D. Its parent company, Thomson-Brandt SA, is in a less R&D-intensive field, but brings the total to about \$727 million.

Three quarters of Thomson's R&D expenditures come from its own coffers, although "we get about 750 million francs [\$182 million] in government contracts yearly," says Michel Carpentier, the firm's chief technical executive. "We do no 'disinterested' research," Carpentier adds. "Our prime R&D goal is to reinforce our position where it's strong and develop the components we need to do that." Thus, Thomson invests heavily in feeder technologies for radar, air-traffic control systems, radio and television broadcasting systems, microwave links, and weapons systems.

**Across the Channel.** As might be expected, things are done differently in the UK. There, government R&D monies are mainly channeled through three conduits: the Department of Industry, concerned primarily with projects that will bring fast industrial returns; the Ministry of Defence, which uses its services' research centers to carry out basic research and which funds advanced industrial R&D; and the Science Research Council, which primarily funds research at universities.

Further funding comes from the government's Atomic Energy Research Establishment, plus the National Physical Laboratory and the post office's Marthlesham Research Centre. Finally, added government support for high technology comes from the National Enterprise Board, best known in the U. S. for Inmos, the new microelectronics maker, and Insac, the software marketer.

The enterprise board and another semigovernmental entity, the National Research and Development Corp. (NRDC), both support technology transfer. In the case of the board, this comes about as a result of its mission to promote small business and high technology. The NRDC has a more direct role: it exploits inventions based on publicly funded research and privately developed techniques that it feels are not being pursued with sufficient vigor or speed.

Taking a page from the Japanese book, the NRDC also is prospecting abroad for technology. It has just chartered Arthur D. Little Inc., Cambridge, Mass., and the Stanford Research Institute, Palo Alto, Calif., to seek out firms with marketable ideas that would be interested in licensing them to British companies. NRDC would act as matchmaker [*Electronics*, Feb. 28, p. 63].

**Slow growth.** Interestingly as well, despite all these outlets for R&D funding, the UK's economy grew through 1975 at a slower pace than that of any of America's six chief trading partners, with 2% per year a typical figure for the past 15 years. The UK's percentage of GNP invested in R&D has remained fairly constant—and low—since 1961, at about 1.5%, with a dip to 1.37% and a rise to 1.91% during that period, according to the OCED.

With a far smaller defense market than the U. S., it makes less sense for British electronics firms to do basic research than it does for their stateside counterparts. Thus, each military service must be on the lookout for the technologies it needs to explore at its research centers.

Britain's Science Research Council works both by supporting individual projects at universities and by identifying technologies worth pursuing in the national interest. An

example of the latter is a \$10 million research program to investigate advanced microprocessor applications. A governing panel is investigating image processing, automatic inspection, industrial robotics, and speech recognition.

Where a project is important enough, all three of the government's main funding bodies work together. An example is the electron-beam microcircuit fabrication program. In this case, several lithography systems have been purchased with common funds and placed at a variety of laboratory and industrial locations about the country. The government's goal is a domestic VLSI capability.

**Nation of its own.** The approach—and budget—of West Germany's giant Siemens AG, Munich, reminds one of European governmental systems where goals are set, methods are scrutinized, and funds are then allocated carefully.

Late last year, Siemens set up a council consisting of division heads and top technical executives to meet regularly to allocate R&D money to maximum effect. And there is a good deal to use; in the firm's 1977-78 fiscal year, its R&D budget was about 8% of world sales, or \$1.34 billion. The figure may rise to \$1.57 billion in fiscal 1979, once the accounts are tidied up; that is an increase to about 9% of the firm's approximately \$17 billion world sales, a rate well ahead of West German inflation.

Siemens' R&D efforts employ some 30,000 scientists, engineers, and technicians, about a tenth of the firm's work force. Basic research and what is called basic manufacturing technology account for about 15% of the R&D budget, and this work is conducted at the company's Munich and Erlangen central research laboratories. The remaining 85% of the budget goes for product and systems development. This activity is spread among about 10 development labs closely linked with Siemens' seven operating divisions.

At Siemens, product development is continual and fast moving. Nearly 50% of the company's total sales are of products five years old or less. This sort of market profile is one reason the firm is accelerating its

# CMOS/LSI LIQUID CRYSTAL DISPLAY DRIVERS

# EASY DRIVER

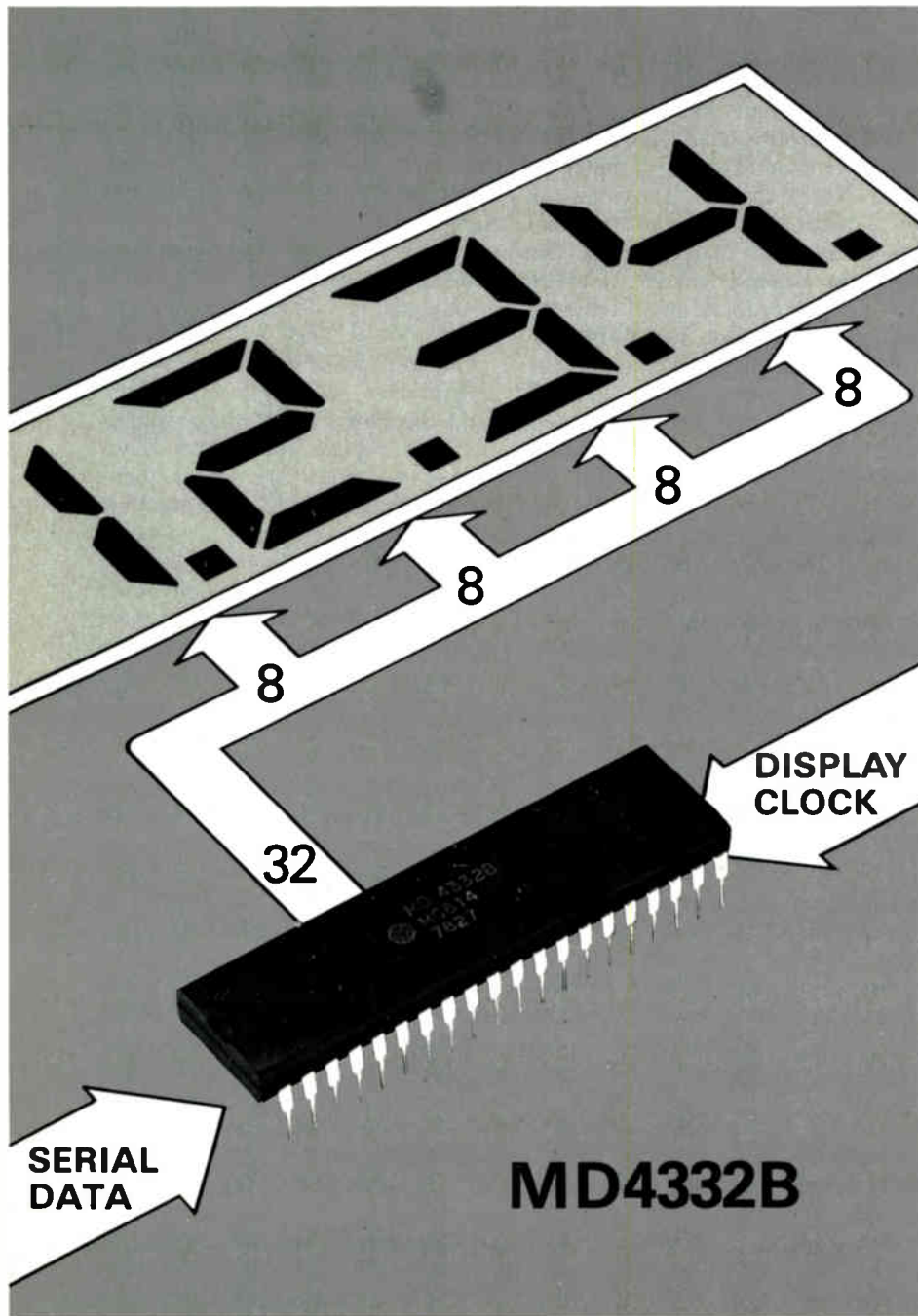

Until now you've needed an assortment of drivers, gates and buffers for your LCD Displays. That's all over. Mitel Semiconductor has designed a series of single chip CMOS LCD drivers. The MD4330B family: an easy, practical complement to your elegant, practical design.

The CMOS, MD4330B and MD4332B are 30 and 32 bit, Static Shift Registers. Each circuit can directly drive 30 or 32 LCD Segments. For example the MD4332B will drive two 16 segment characters. True and complementing output buffer control provides direct A.C. drive to the LCD. A single output pin allows cascading of devices for driving displays with a large number of characters.

#### MD4330B, and MD4332B Common Features:

- 1 $\mu$ A Low Power CMOS
- 3 to 15 volt Single Supply
- Waveshaping Clock Input
- 3MHz High Speed Shift Register
- 40 Pin Dual-in-Line package

Mitel also offers the following additional display drivers for a variety of applications:

#### Type

- |          |  |
|----------|--|
| MD 4055B | BCD to 7 segment, Level shifting and output clock LCD driver   |
| MD 4056B | Latched BCD to 7 segment, Level shifting LCD driver  |
| MD 4311B | Latched Hexadecimal to 7 segment, high current, Common Anode LED display drivers                     |
| MD 4511B | Latched BCD to 7 segment, high current, Common Anode LED display driver                              |
| MD 4368B | Hexadecimal to 7 segment, high current, Common Anode LED display driver. Pin for pin with 9368, TTL. |

All of the above circuits are available from stock.

For further information and data please contact your nearest Mitel office.



## MITEL SEMICONDUCTOR

United States: 1735 Jefferson Davis Highway, Suite 1009, Arlington, Virginia, U.S.A. 22202. Telephone (703) 243-1600  
1223 Westchester Pike, Havertown, Pennsylvania, U.S.A. 19063. Telephone (215) 449-5556.  
2321 Morena Blvd., Suite M, San Diego, California, U.S.A. 92110. Telephone (714) 276-3421.

Canada: P.O. Box 13089, Kanata, Ottawa, Ontario, Canada K2K 1X3. Telephone (613) 592-2122, Telex: 053-4596, TWX: 610-562-8529.

18 Airport Blvd., Bromont, Quebec, Canada J0E 1L0. Telephone (514) 534-2321, Telex: 05-267474.

Circle 84 on reader service card

Europe: Hamilton Road, Slough, Berkshire, England SL1 4QY. Telephone 0753-36137, 0753-36138, Telex: 847730  
Fredericiagade 16, Suite 309, 1310 Copenhagen K, Denmark. Telephone (01) 119302, Telex: 27246

Asia: TST P.O. Box 98577, Kowloon, Hong Kong, Telex: 64235-Mitel HX

## Inside the news

rate of investment in R&D.

When dealing with the West German government, Siemens' approach is almost that of a peer. According to a spokesman, Siemens refuses to take on government projects "if we feel the risks are too high or in doubt."

**Eye on exports.** But the government resides in Bonn, not Munich, and officials of the Ministry for Research and Technology have a more global view. "Exports are vital," says a ministry official; more than 25% of what West Germany manufactures is exported, forcing concentration on high technology both for its own sake and to help other West German industries stay competitive.

The research ministry has a three-level R&D funding policy. On one level, indirect funding in the form of federal and state tax breaks helps R&D-intensive firms and selected consortiums maintain high levels of R&D investment. Then there is direct support, where federal funds are allocated to companies doing government-sponsored work, as in the U. S.

Finally, there is a rich system of support for medium and small firms without the means to conduct R&D themselves. "This approach sets us apart from the rest of Europe," says the ministry official, adding that the scheme is viewed by other countries as a model.

The government is serious about R&D and, as evidence, points out that it spends about \$94 per capita yearly on the effort, about 46% of it from government and the rest from the private sector. The ministry figures that West Germany currently spends about 2.1% of its GNP on R&D, a higher ratio than that of the U. S.

**Japan forges on.** Long after the West German "economic miracle" appears to be tapering off, Japan's is going relatively strong, and that country's technology policies appear to be at the root of its success. There are some similarities between the two nations: both countries limit the participation of government in private R&D, Japan far more drastically than West Germany; both countries

are net importers of technology through license agreements, but Japan much more than West Germany; both countries' governments, though supportive, regulate private business less than does the U. S., Japan's perhaps least of any major trading nation.

The methods and meaning of Japanese R&D have been clouded for years by outside views of Japan's economy; its postwar boom was said to be due to a technology gap, which, after the country had reached parity with other nations, would tend to slow growth to a rate comparable with that of the West.

There is less faith in this scenario now and a clearer idea of Japan's national technology policy because of the appearance in the 1970s of a series of Japanese government reports on its economy and of recent work by Merton J. Peck of Yale University and Akira Goto of Seikei

University. As yet unpublished, drafts of the Peck-Goto study already are underground classics at American business schools. The study strongly suggests that Japan, and to a much lesser extent West Germany, have governments and economies almost ideally suited to technological progress.

Japan, especially since government restrictions were dropped in the late 1960s, has shown little reluctance to import technology. There was an almost fourfold jump in the number of licenses negotiated yearly between 1965 and 1973, and this large amount of incoming technology has affected Japan's R&D posture.

**Quick action.** One key effect has been to make Japan's R&D development-oriented; typically, imported technology is massaged in the laboratory, often improved upon, and a product—or a new technology export—generated quickly. (Japanese

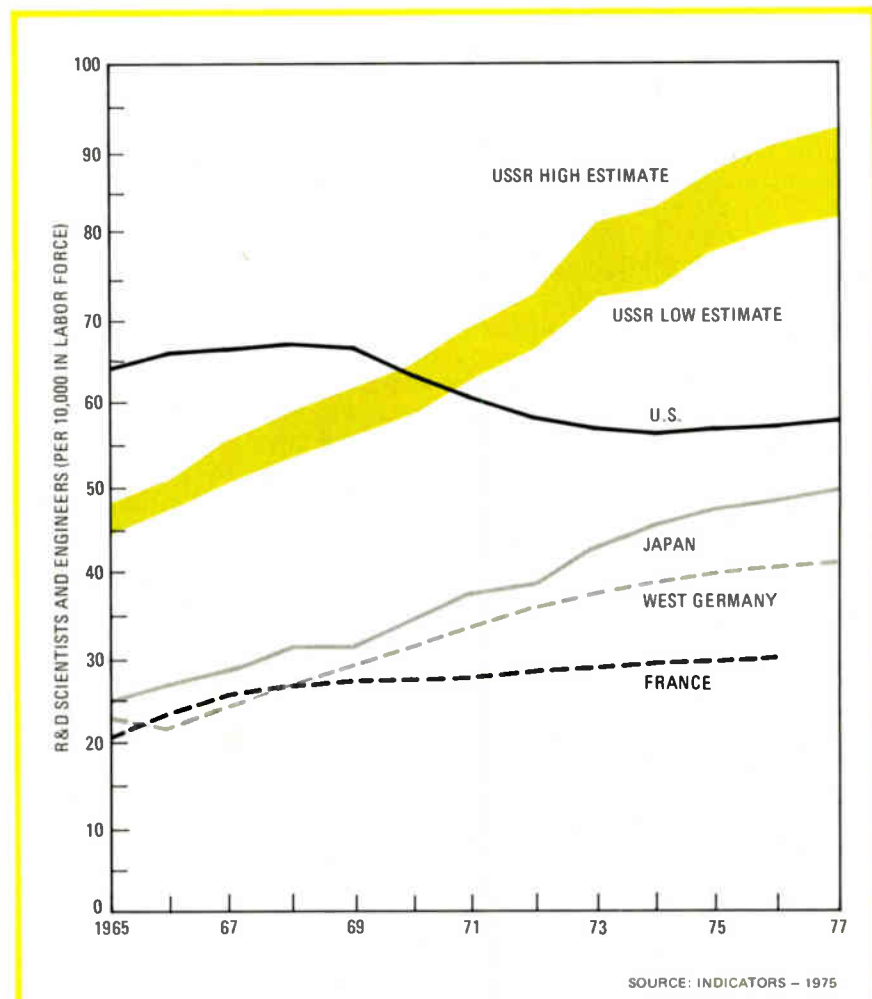

**Hard at work.** The number of scientists and engineers engaged in R&D per 10,000 members of the work force is shown. Japan had a total of 225,000 research personnel as of 1975.

---

## Inside the news

---

technology exports are growing and, according to Peck and Goto, were worth \$283 million in fees during 1977.)

Thus, Japanese industrial R&D is very efficient for two reasons. First, the high-risk, exploratory phases of R&D are generally conducted overseas or by Japan's government and universities. As a result there are few visible R&D failures. Second, because products and improvements based on licensed technology move rapidly into the marketplace, the money that pays for Japanese R&D comes back faster in profits and consequently feeds more R&D sooner than in other nations.

It is a form of positive feedback that tends to accelerate technological progress. Paraphrasing Peck and Goto, in Japan technological change promotes economic growth, which increases the payback on technology investment, which in turn promotes more technological change. Peck and Goto note that less capital is needed in Japan than in the U. S. for a given increase in GNP, and at the corporate level, additional investments generate high returns.

According to Peck and Goto, Japan did have a technology gap after World War II and capitalized on it by fostering technology importation and transfer. Not that Japan had to build an R&D establishment from the ground up; Japan's 1942 R&D effort was at the same level as in 1959, according to Peck and Goto, and has been growing ever since. By 1975, Japan's R&D spending as a percentage of national income was 2.1%, West Germany's was 2.5%, the UK's 2.3%, France's 2%, and that of the U. S. private sector about 1.4%.

**Coming on.** By 1975, Japan's R&D expenditures exceeded those of France and the UK, were about equal to West Germany's, and were outstripped only by those of the U. S. More illuminating, though, is the manpower Japan devotes to R&D; Japan had 225,000 research personnel at work in 1975, as opposed to 94,000 for West Germany, 62,000 in France, and 77,500 in the UK. And the Japanese are not

stopping there; according to the National Science Foundation, all the trend lines point upward, whether Japan's investments are viewed as a percentage of GNP, total personnel, or absolute amounts invested.

According to the Japanese Science and Technology Agency (STA), 98% of the R&D performed at Japanese firms is funded with their own money. This tends to make R&D product-, market-, and profit-oriented and may act as a technology accelerator, given the country's technology import policy.

But the technology importation process in Japan is evolving. According to Peck and Goto, the nation is bringing in more uncommercialized technology. STA figures show that in 1977 such imports made up about a quarter of the total, indicating that the nation's firms now are more willing to take the risks involved in commercialization.

And some Japanese R&D executives are even beginning to sound a little like their American counterparts. Hiroshi Watanabe, executive managing director for research, oversees the R&D efforts of Hitachi Ltd., a firm with sales of about \$6.3 billion in fiscal 1979. Of this amount, Hitachi spent about 5.75% on R&D, and if Watanabe had his way, there would be some government money to supplement it.

**Little aid.** Only 3% of Hitachi's R&D funds come from the government, a high ratio by Japanese standards and largely due to the firm's involvement in so-called national projects such as nuclear fusion, solar power, and VLSI. "Government support for R&D is very low," complains Watanabe: "Long-range, major projects are risky, so we want government help, but the government is very tight." Perhaps the government has history on its side.

Almost 11% of Hitachi's employees are involved in R&D, a total of about 8,000. Hitachi and other firms are trying to break the traditional Japanese mold of similarity and are searching for stronger individuals to bring more creativity to the R&D process.

These new-generation scientists and engineers will work more specifically on research, says Watanabe. Currently the split between research

and development at Hitachi is about 40/60 in funding terms, but that may change, as "research is important for finding targets, development for reaching them," Watanabe says. "From now on, it's more important for the Japanese to find targets. Until now we have just followed U. S. firms, now we have to pass them."

They may well do so. The Japanese government, for all its reluctance to directly fund private R&D, exercises a strong paternal influence. Despite the fact that Japan is, internally, very much a free market and highly competitive, the government continues to target areas of industrial weakness it wishes to overcome and make policy to suit. Heavy industry, such as steel, was fostered in the 1950s and early 1960s; now, as part of what Peck and Goto see as a long-standing policy of aiding market sectors with the greatest growth potential, the target is microelectronics and data processing.

**Help for computers.** In computers, the government has taken several actions. It has adopted a buy-Japanese policy for its data-processing procurements. It has created the Japan Electronic Computer Corp., majority-owned by the government, to buy Japanese computers at cost and lease them. This spares manufacturers the cost of leasing and enlarges the domestic market. Still, foreign firms hold 40%, and IBM Japan another 25%, of the domestic market.

Through Nippon Telegraph & Telephone Public Corp.'s National Telecommunications Laboratory, the government is developing a "super-computer" using Japanese firms as collaborators and contractors. After development, Japanese firms will manufacture the computer for telecommunications and other applications.

Finally, the Ministry of International Trade and Industry has tried to pull Japan's half-dozen computer firms into two research associations. Each association gets some government funding, which it parcels out to its members. The result is not any particular capability, but rather a loose association of competitors. □

---

This is the second part of a report on R&D.



# Reduce Custom Power Supply Time and Cost

With a handful of Powercube's Cirkitblock<sup>®</sup> modules and a few clip leads, you can quickly synthesize an infinite variety of custom power supplies.

Cirkitblock modules have demonstrated capability to meet most design needs and are packaged within a 1" x 1" x 2" basic building block format so you can assemble supplies of any complexity to any form factor appropriate in building block fashion.

Design time to operating prototype can be reduced by more than 50% because conventional breadboarding is eliminated. Your quickly assembled "breadboard" of modules becomes your operating prototype.

Cirkitblock modules utilize space technology but are specified and priced for industrial as well as military applications. They can substantially reduce the "as installed" power supply costs in airborne and ground based instruments such as receivers, navigational systems, displays, stores management systems, and communication gear.

Cirkitblock functional modules not only save design time and money; they are also a lot of fun to work with.

Circle the reader service number to learn more about Powercube's Cirkitblock functional modules. Send for free catalogues describing the entire Cirkitblock module family and packaging styles for complete power supplies.

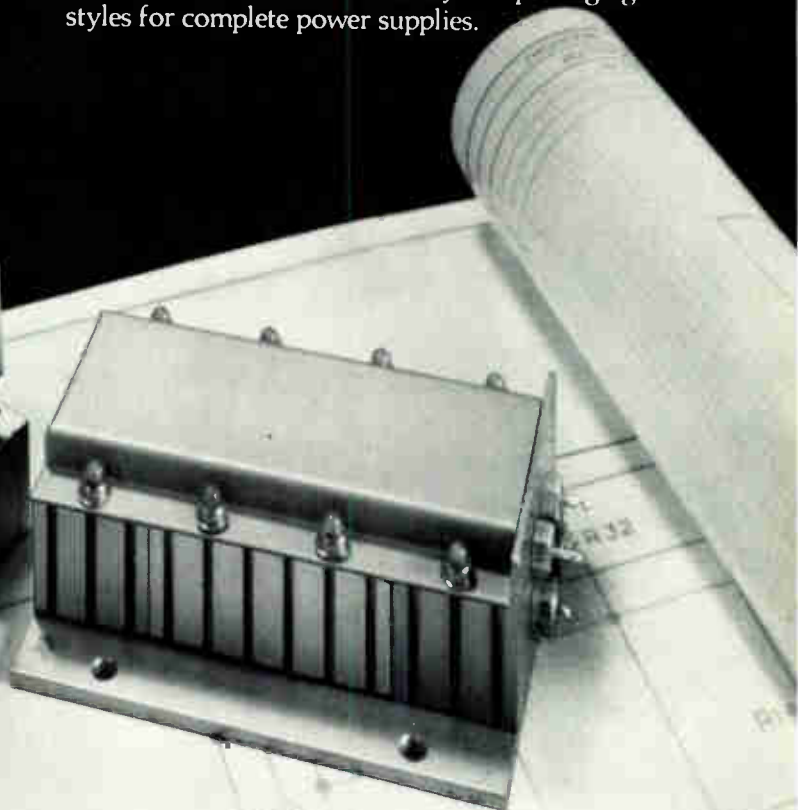

 **POWERCUBE**  
A SUBSIDIARY OF UNITRODE CORPORATION

POWERCUBE CORPORATION  
EIGHT SUBURBAN PARK DRIVE  
BILLERICA, MASSACHUSETTS 01821  
(617) 667-9500

## Components

# April in Paris has familiar feel

Annual international components show comes amid a sluggish entertainment products picture and a healthy computer outlook

*by the European editors of Electronics*

There is always plenty of hardware that is new on the stands, but the look of the annual Salon International des Composants Electroniques in Paris varies little from year to year. Veteran visitors who turn up this year at the Porte de Versailles fairgrounds for the March 27–April 2 components show will navigate handily around some 16 acres of exhibits using traditional landmarks like Thomson-CSF Alley, RTC–La

Radiotechnique-Compélec Row, the island of exhibitors from the U.S., and the imposing stands of heavy-weight suppliers like International Telephone & Telegraph Co. and West Germany's Siemens AG.

Like the show that symbolizes them, the \$10.4 billion components markets in Western Europe have much the same complexion this year as last. Makers of entertainment electronics equipment, the leading

customers of components suppliers in the 1970s, are up against a very sluggish color TV market and have therefore slowed their ordering of parts. The computer makers, in contrast, manage to keep moving upward reasonably well despite deteriorating business conditions overall. The communications gear producers, as well, continue to view their order books pleasurably.

Along with those two pluses, there is the proliferation of electronics technology, which is creating new classes of components buyers. On the whole, then, the outlook at the moment adds up to something like satisfactory—though integrated-circuits suppliers, it must be noted, can expect better than that.

Still, there is much to be prudent about for the year ahead. Every time official forecasters revise their economic growth estimates for 1980, they notch them downward. Except for West Germany, no major Western European country has inflation soundly under control, and the rolls of the jobless continue to rise.

**France's chances.** The Paris show this year will have wares on view from some 1,350 producers from 30-odd countries, so the "international" label its organizers give it can be considered earned. Yet more than anything else, the show mirrors the state of French components markets. This year their profile matches closely that for Western Europe.

Unlike other Northern European countries, France still has not reached growth-stunting saturation in color TV. As the year got under way, some 7.6 million of the country's nearly 19 million households had color sets, well below the level



**Sign of spring.** Attendees at Paris components show will be preoccupied with much the same problem as were those, shown above, at last year's version of the annual gathering.

for neighboring West Germany. All the same, set makers saw their sales curves flatten out in 1979. The market hovered around 1,530,000 units last year, essentially the same figure as for 1978.

Consequently, components suppliers cannot count on growth from French color TV producers. Luckily, they should find strong customers among computer makers. CII-Honeywell Bull, largest of the French mainframe makers, logged a sales gain of 15% last year to reach \$1.25 billion (at 4.15 francs per dollar).

Short of a real surprise, then, components suppliers in France should fare about as well this year as they did last. IC suppliers, though, will outrun their brethren in passive components and tubes. Although it is a special case because it is just getting into mass production of standard MOS products and starting from a low base, EFCIS, jointly owned by Thomson-CSF and the French atomic energy commission, has targeted a 70% growth for the year. For the IC market as a whole, a gain of 15% to 20% looks likely. Those are numbers that make suppliers of discrete semiconductors envious, since their gains should run only about 6% to 7% overall despite a strong market for power devices.

**Across the Rhine.** West German components makers will head for the Paris show this year with much the same *lieder* ringing in their ears as last year. Although the sounds from entertainment electronics makers are hardly audible, there is, luckily, compensating volume from the people who manufacture communications and data-processing equipment.

All told, the entertainment market will stabilize at the same low level it languished at last year, says Gernat Oswald, IC sales manager and head of microcomputer activities at Siemens. The Summer Olympic Games will not help much, whether West German athletes turn up in Moscow or are forced to stay home because of a boycott, some experts maintain.

However, the post office is ordering enough that there are near-boom times for its suppliers, and the demand for computers—both large and small—keeps on rising. Gerhard Liebscher, director of marketing ser-

vices at Intermetall GmbH, lead house of the ITT Semiconductors Group, figures that the need for semiconductor devices by these two strong-running sectors will surge by 20% this year, while those of industrial equipment makers will climb by 13%. All told, Liebscher predicts that integrated circuits will move up by at least 15%, but discrete semiconductors will gain only 2%.

**Squeezed island.** Margaret Thatcher's Conservative government has opted to squeeze the UK economy hard to rid it of inflation—now running at 18% or so. A long spell of cinching up is in store if the government holds fast, and that translates into dim prospects for components.

"Overall, there will be minimal real growth of the UK components market in 1980," predicts John Walker, managing director of Comstock Ltd., distributors, and chairman of the Association of Franchised Distributors. But in current money, Walker points out, "we are looking at a moving target. Inflation, plus the surcharges on components incorporating precious metals, could add 15%."

High inflation and rising labor costs will force manufacturers to trim their distribution overheads and that will channel business to distributors, Walker feels. As a result, the nominal growth for the distribution sector could go as high as 33% to 35%. At any rate, 1980 will be noteworthy for distributors because microprocessor systems for the first time will account for a significant part of their sales—about 10%.

Among the original-equipment manufacturers, the TV set makers are having a hard time of it. They entered the year with low expectations and they are not turning up any happy surprises. John Gregory, marketing manager of Mullard Ltd.'s consumer components division, says color TV set sales will be down somewhat from the 1.65 million units logged last year.

Equally ominous are the first signs of uncertainty in the computer sector. After record results in 1979 that saw sales rise 22%, Britain's indigenous computer manufacturer, International Computers Ltd., has warned that its growth for orders has started to slip. □

# Logical Solution.

Do you have testing problems in your manufacturing operations? Are productivity gains being eaten away by continuous new problems?



Perhaps you need to look at testing problems a lot earlier than you are now doing. We have just the tool for you to accomplish some significant cost savings and productivity gains in your company.

**DESIGN FOR TESTABILITY**, written by Jon Turino, is one of our Logical<sup>SM</sup> publications. It has become "The Bible" on design testability for over 350 companies like Litton, IBM, GTE, Sperry, GenRad, Fluke and TI. It is used in EE courses at universities including Stanford, Auburn and Ohio State. The US military services have purchased it for use in their vendor programs.

Send \$95.00\* for your evaluation copy of this comprehensive hard-bound report. Take 10 days to review it. Then either keep it and make use of its many cost saving recommendations and guidelines or send it back for a full refund, no questions asked.

Logical<sup>SM</sup> is a service mark of Logical Solutions, Inc.

**Books shipped pre-paid if check accompanies order.**

**Full refund if book is returned within 10 days.**

**Quantity discounts available plus seminars and workshops—contact factory.**

Order your copies today from:

**LOGICAL SOLUTIONS, INC.**  
96 Shereen Place  
Campbell, CA 95008  
(408) 374-3003 (408) 866-1797

Send \_\_\_\_\_ copies at \$95.00\* ea. to

NAME \_\_\_\_\_

TITLE \_\_\_\_\_

COMPANY \_\_\_\_\_

ADDRESS \_\_\_\_\_

CITY \_\_\_\_\_

STATE \_\_\_\_\_

ZIP \_\_\_\_\_

\*In California please add 6.5% sales tax (\$6.18)

Semiconductors

# 'Foundry' called answer to bigness

Carver Mead's idea for a new type of custom semiconductor house would help bridge the gap between design and product

by Larry Waller, Los Angeles bureau manager

**Much hand-wringing** in the semiconductor industry has nothing to do with current business, as demand continues to strain capacity. Instead, it concerns what has happened to that traditional source of ideas and technology: startup firms. Few have come along since the 1974-75 recession, for a good reason. The opening stake has skyrocketed from a few million dollars to \$10 million and up, fueled largely by what it takes to get into silicon fabrication.

While some look to Government funds as the answer, another idea, more attuned to free enterprise, is percolating through the industry. It comes from one whose reputation as a design authority approaches guru status: Carver A. Mead, professor of

computer science, electrical engineering, and applied physics at the California Institute of Technology, Pasadena. He advocates "silicon foundries."

Even industry figures cool to his idea are quick to give Mead credit for upgrading university training to the point where "his students walk off the campus and start designing for us," as one admirer puts it. Furthermore, his influence is compounded by an ex-student "old boy network" that not only occupies high research and development posts industrywide, but also organizes and teaches courses at a growing number of schools. Though Mead's schedule now keeps him from adding to a long list of patents, he is in demand as an

industry consultant on very large-scale integration.

His foundries, then, are would-be independent profit-making fabrication services, open for a fee to anyone who wants to translate an idea into silicon. "It's access for the little guy," says Mead, "without which he's at the mercy of the big companies." Right now, not only have fabrication facilities become capital-intensive, but few designers outside a major firm can find a place to build silicon hardware. Mead thinks such a roadblock threatens not just the future of the U.S. semiconductor industry itself, but all those businesses that have come to depend on a stream of ever better and cheaper devices for their new products.

To tie his view into the semiconductor business, the Caltech professor has a presentation he gives to groups like the congressional subcommittee on science and technology, engineering associations, venture capitalists, and others (see "Like a printing press," left).

**Small but productive.** "Historically, innovation in the industry has been spearheaded by small startup firms and later taken up by large existing organizations," he points out. "There are many examples: for one, major suppliers of vacuum tubes did not become major suppliers of transistors. More recently, companies dominant in the semiconductor memory business did not bring us the multiplexed address random-access memory. The microprocessor did not come from mainframe or minicomputer firms. Each of these innovations was brought to market fruition by a small startup

## Like a printing press

Their first exposure to Mead's silicon foundry proposal often confuses knowledgeable semiconductor people. "How does it differ from the custom semi houses?" they ask. Also, big firms from time to time take on such jobs. But the difference is crucial, explains Mead, who notes that the custom places with fabrication facilities like to design the circuits for customers, because of the value-added factor, and then try to make the products into a proprietary line, if possible. In other words, their fabrication is not an arm's length service.

Instead, the Caltech professor sees a similarity with publishing, likening the foundries to the presses themselves, which would "print" patterns on wafers. "Individual designers require access to fabrication in exactly the same way that individual authors require access to printing," he says.

Because the complexity of VLSI technology is so far off the scale in terms of LSI, Mead has polished a road-network analogy to grab listeners' attention. "At several points in the evolution of the [IC] technology, a typical chip has been scaled to make the spacing between conductors equal to one city block. The circuit can then be thought of as a multilevel road network." By the mid-1960s, complexity was like small-town roads; today's microprocessor is the entire Los Angeles basin. When 1-micrometer technology is in place, designing a chip will be like planning a street pattern covering all of California and Nevada—at urban densities. "The ultimate quarter-micrometer technology will be capable of producing chips whose complexity rivals an urban network covering the entire North American continent," says Mead.

firm that rapidly gained market share by virtue of its innovation."

Furthermore, the nature of VLSI, as seen by Mead, should make this innovative trend even more apparent. According to his definition, VLSI is "a statement about system complexity, not about transistor size or circuit performance." Since even today all the implications of this complexity are not fully understood, new levels of innovative technology that can create systems must be generated to cope with it. Possibilities are vast, with "many fundamental ideas yet to be discovered," he thinks.

Because these disciplines are basic to the difference between VLSI and the way semiconductor devices are now designed, Mead strongly believes that only the new startup houses can break away from institutionalized research thinking to realize them. "System design, not technology, is now the arena in which small firms outshine their giant mentors," he concludes.

**Firms reluctant.** As might be expected, major semiconductor firms do not see future VLSI development working quite this way. Mead says he has tried to talk several into setting up fabrication areas for both their own and the industry's benefit. "I tell them the advantage is that they get a first look at new ideas." But so far none has shown interest. "Why should we support it?" asks a spokesman at one company. "It's not in our interest to help something that could compete with us."



**Together.** Mead and Caltech are working to ease manufacturing interface rules.

Of course, just having "foundries" available does not eliminate failures of communication between designer and fabricator, which dog the process even when all hands are under one roof, Mead admits. But Mead and his associates at Caltech are pursuing what he calls "a clean interface between those creating designs and those printing them on wafers of silicon." The optimum information transfer, he says, is after the complete layout has been generated for the chip; "then the only information which needs to be transferred from one group to another is the patterns which represent the various layers."

At Caltech, where in 1971 he originated the first course on a simplified integrated system design methodology, work on this has proceeded. "In the process of implementing 30 or so chip designs, we have interfaced with 10 different fabrication areas and six mask shops." The result is that the requirements for an interface are now well defined, Mead says, and have three specific elements: geometric design rules, standard data format, and standard test chip.

**Key missing.** But the crucial third component, a standard test chip, is still only a goal. As the sole subject of contract between a fabrication line and its users, it would keep one side from blaming the other for device problems. On such a chip would be patterns for process control and characterizations of yield, reliability, and overall system performance. There would be a test chip for each standard process.

One small company that is trying to make Mead's foundry concept a reality is VLSI Technology Inc., now hustling to raise \$20 million. Located in Los Gatos, Calif., and founded by ex-Synertek Inc. executives, the firm is headed by president John G. Balleto, who admits the large stake required makes the going tough. "Inventors are very interested in the idea until they see the number," he remarks. But he expects to have the capital by June because the silicon foundry is "an idea working its way through the industry." As such, it is directly analogous to the microprocessor revolution of 10 years ago, he says. □

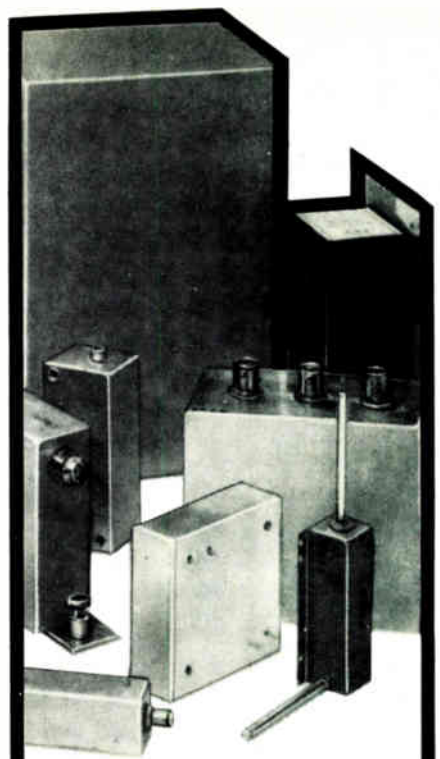

## FOR ANY TYPE OF LC FILTER

**CALL THE  
LEADER**

**LOW PASS, HIGH PASS,  
BAND PASS, BAND STOP,  
EQUALIZERS, WEIGHTING,  
ROOFING, C-NOTCH,  
C-MESSAGE AND  
JUNCTION FILTERS**

From 1.0 Hz to 1000 MHz, designed to commercial or MIL specs. Our competent staff of filter engineers has made us a top rated supplier in the Instrumentation, Communications, Telemetry, Telephony and Computer Industries.

No order too small. If you need one or one thousand, we will be happy to quote.

**CUSTOM FILTERS AT  
OFF-THE-SHELF  
DELIVERY AND PRICES!**

**For further information—  
call or write today:**

Dept. EL, 511 Victor Street  
Saddle Brook, NJ 07662  
Telephone: 201/845-6886

**CP**

**Chesterfield  
Products/Inc.**

Electronics abroad

# Siemens has big plans for Sipmos

New MOS power transistor technology is expected to lead its discrete business to 10% annual increases through mid-1980s

by John Gosch, Frankfurt bureau manager

In this age of microelectronics, when most semiconductor producers are investing in high-density memory and large-scale integrated-circuit activities, it may come as a surprise that a company has embarked on a multimillion-dollar project in discrete semiconductors.

But West Germany's Siemens AG has a good reason to act contrary to industry rules and to start up a \$12 million discrete semiconductor fabrication center: the Munich-based firm is determined to use its newly developed technology, Sipmos, to cash in on the big market it predicts for MOS power transistors and thereby to bolster its already strong position in discrete devices.

As Siemens sees it, this market is

in for spectacular gains. Worldwide annual sales, the company says, could hit \$300 million by 1985, 30 times last year's value. The rise will come at the expense of bipolar and Darlington types, whose share of the total power transistor market should drop to about 35% and 10%, respectively, by 1985, as the graph shows.

With its new technology, Siemens is convinced it can grab a substantial share of the emerging MOS power transistor market. Sipmos—for Siemens power MOS—allows the fabrication of devices that combine high voltage ratings with a low forward resistance [*Electronics*, Feb. 28, p. 63]. They can switch power levels of 5 kilowatts and more.

Further, since Sipmos components

operate at low inputs, they can be driven directly by microcomputers and other LSI circuits. In many cases, the cost of the amplifying circuitry that would otherwise be needed has stood in the way of LSI and microcomputer applications.

**Samples.** The first Sipmos products are now being offered as samples, with volume production at the new fabrication center to get under way early this summer. Among the prime customers, Siemens says, are manufacturers of household appliances, consumer and automotive electronics, industrial controls, measuring equipment, and data-processing peripherals.

What makes Siemens so sure that Sipmos will be a winner is the combination of good performance characteristics of the devices. The power transistors the company is now offering as samples have drain-to-source voltage ratings of up to 200 volts. In development are units that can handle as much as 1,000 v. That's twice the value of MOS power components from other producers, says Peter Tillmanns, sales manager for Sipmos devices.

Noteworthy, too, is the low forward resistance. For 50-v devices, for example, it is only 0.03 ohm, which compares with 0.1  $\Omega$  or so for competitive components. Such a low value, Tillmanns points out, means that power levels can be switched at "dramatically reduced losses." No less important are the low input requirements. The switch-on voltage range goes from a minimum of 2 to a maximum of 5 v, making the devices compatible with microcomputers and LSI circuits, as noted.

Siemens' new power device activi-

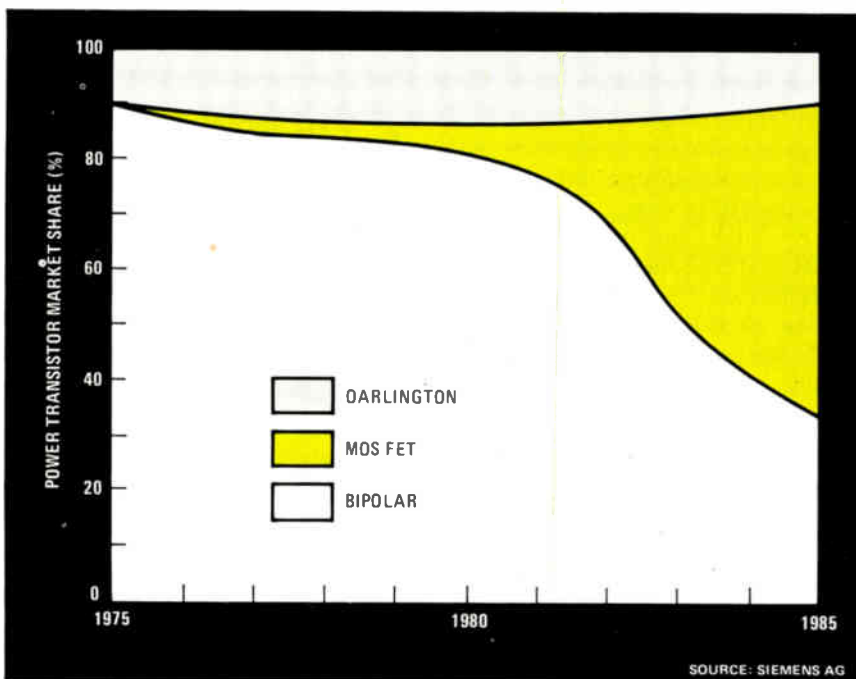

**Looking for gains.** Siemens expects MOS power transistors to increase in sales at the expense of bipolar and Darlington types, which it sees dropping 35% and 10%, respectively.

ties should considerably strengthen its position in discrete semiconductors, a field that the company, despite its heavy commitment to ICs, has not let slide. Last year, its worldwide sales in discretives came to \$340 million. That accounts for about one quarter of the company's total components business, says Alfred Prommer, vice president in charge of discrete semiconductors in Siemens' components group.

**Top three.** Ranking among the top three discrete semiconductor producers in the field—behind Motorola Inc. and about even with NV Philips Gloeilampenfabrieken of the Netherlands—Siemens claims a 7.5% share of the world market. Prommer predicts sales will rise to double the amount of last year—to nearly \$700 million—by the mid-1980s. That works out to an annual growth of almost 10%.

Siemens has 11 components plants around the world. With four in the U. S.—in Broomfield, Colo.; Cupertino, Calif.; Scottsdale, Ariz.; and Somerset, N. J.—“we have a good base for the American market,” Prommer says.

Strong impulses will come from optoelectronic devices, sensors, and electronic actuators used with microcomputers, and of course from Sipmos products. The almost 10% growth for Siemens compares with only 4% a year that the company forecasts for the industry as a whole. Worldwide, the market will rise from \$4.48 billion in 1979 to \$5.23 billion by 1984, the firm predicts.

The Sipmos samples are three families of n-channel devices with drain-to-source voltages from 50 to 200 v. Their turn-on and turn-off times go down to 30 and 95 nanoseconds, respectively. The devices come in either plastic or metal packages. The Sipmos product spectrum will gradually be expanded to include components such as thyristors, triacs, and power switches.

The new plant, in Munich's Freimann section, is an 11,000-square-foot facility, about 80% of it taken up by clean rooms. The plant is laid out initially to process some 3,000 4-inch wafers per week, each wafer containing roughly 400 transistors. The facility eventually will handle 6-in. wafers, as well. □

# The Secret of Document Scanning is RETICON

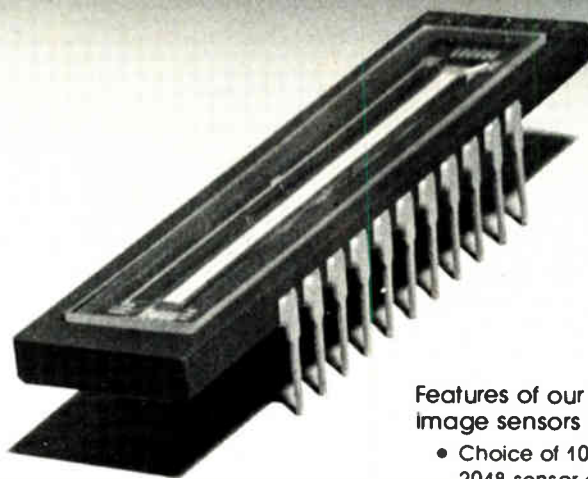

Features of our H Series image sensors include:

- Choice of 1024, 1728 or 2048 sensor elements on 15  $\mu$ m (0.6 mil) centers.
- Scan rates up to 3 MHz.
- Wide dynamic range.
- Suitable for applications in OCR, FAX, copy machines, etc.

If you look behind the nameplate of any OCR, FACSIMILE or POINT OF SALE equipment designed during the last several years, chances are that the solid state image sensors you'll find there were made by RETICON.

WHY? Because Design Engineers throughout the world have long recognized that using RETICON devices provides them with the latest, most advanced technology — the Secret of Success.

So, if you are still using old-fashioned lasers or scanning mirrors, or if you are waiting for some new magic in solid state imaging, you NEED NOT WAIT ANY LONGER.

RETICON is already shipping its high-resolution, H-series self-scanning photodiode arrays in volume and at prices more than competitive with other approaches.

 **EG&G RETICON**

345 POTRERO AVENUE  
SUNNYVALE, CA 94086  
TWX: 910-339-9343

For assistance call: Boston (617) 745-7400, Chicago (312) 640-7713,  
San Francisco (408) 738-4266, Tokyo, Japan 03-343-4411,  
Bracknell, England (0344) 53618

Electronics abroad

# UK calls for engineering elite

Report wants new engineering authority  
to oversee improved education and on-the-job training

by Kevin Smith, London bureau manager

For more than a hundred years, Britain has neglected its professional engineering stock and diminished the importance of the "engineering dimension" in its economic life. The effect at first was not too serious, but in a supercompetitive postwar world these chickens have come home to roost. Industry after industry has wilted since the 1960s in the face of international competition, and Britain has slithered rapidly from the top to the bottom of the European economic league. Some say its industrial decline now threatens to become absolute.

That hard-hitting diagnosis of one of the root causes of Britain's palsied industrial performance is contained in a 60,000-word report from a government committee of inquiry into Britain's engineering profession set up under the outspoken Sir Montague Finniston, onetime boss of British steel [*Electronics*, Jan. 17, p. 64]. To effect a cure, says the report, which was two years in the making, will require a new institution—an engineering authority charged with overhauling the education and training of engineers in the United Kingdom and of mobilizing governmental, educational, and industrial resources for the "promotion of the engineering dimension."

The report, listing more than 80 recommendations for action by government, industry, and educators, is now the center of a national debate; government action on its findings is expected later in the year. But, warns Finniston, a cure "will take a generation to accomplish."

Britain, the report argues, has failed to recognize the importance of engineering as a culture in its own

right. "What we are engaged upon is trying to change our culture, our way of looking at things," Finniston says. Just how difficult that is has been borne out by a long succession of reports on one or another aspect of Britain's engineering performance, the first of which appeared in 1852. All have failed to make engineering a first-choice profession for enough of the most able or to change the popular image of the engineer as little above a mechanic.

That's why the engineering authority is the central recommendation of the report. "From our first meeting I wrote a paper arguing the case for it and I have never changed my mind. The trouble is that without it nobody is accountable," says Finniston. "I want an engine of change, a forceful authority that pokes its nose in everywhere."

But Britain's culture block goes deep. "In the schools, engineering

fails to attract enough of the most able. Engineering training in Britain, unlike continental counterparts, failed to create separate elitist technical universities at the turn of the century. As a result, engineering has been looked on as a branch of applied science" and a poor one at that.

In industry, says the report, the engineer is perceived as a provider of a "technical service" rather than a "product champion" charged with the company's future prosperity. His or her low status is also reflected in pay scales. "Engineers are not the best paid and they are not the worst paid. But if my thesis is correct, they will become the best-paid profession," Finniston says.

The "engineering dimension," a phrase coined in the report, has been poorly represented in government decision-making, too. In France, the products of the elitist engineering schools have moved easily into high government positions. But in England, the country's elite aspire to the classics-oriented universities of Oxford and Cambridge as natural stepping stones to government and civil service. The financial community's lack of interest in high technology may have similar roots.

A better understanding of the engineering dimension, argues the report, could also act as a counterweight to Britain's archaic labor relations. "Close identification with a company's products can help break down hierarchic management structures," it argues.

**Low status.** A vicious circle now prevents a true evaluation of the engineer's role, the report maintains. "Many engineers are just not good



**Bad grades.** Sir Montague Finniston is author of a critique of British engineering.



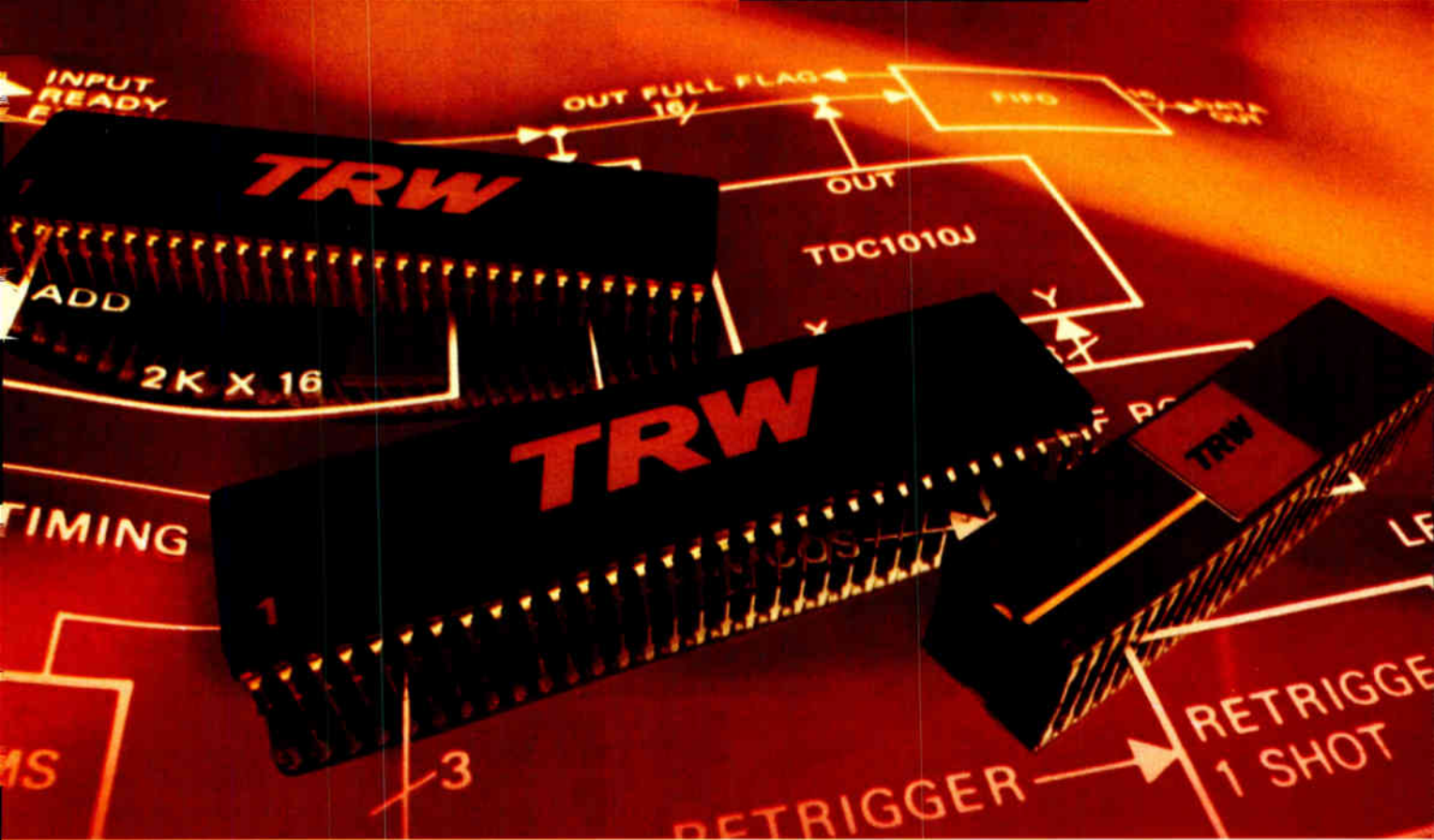

# 16x16-bit multiplication and 35-bit accumulation in 115nsec

(From a single chip.)

The easiest way to boost the number crunching ability of a microprocessor... or to build a high speed, low cost digital signal processor... is to use one of our MACs.

These bipolar, monolithic multiplier/accumulators give you dramatic savings in hardware and dollars. And their power demands are much lower than alternative devices.

The MACs are ideal building blocks for digital signal processing, particularly complex multipliers, filters, and FFT's. If you'd like to extend the capability of your micro/minicomputer, or if you're designing small yet potent signal processors for voice processing,

video processing, communications, or data analysis, look what we have for you:

- On-chip input and output registers with 3-state outputs.
- Subtract, as well as add, in the accumulator.
- Double precision arithmetic.
- Two's complement or unsigned magnitude.
- TTL compatible.
- Ability to operate as conventional n-by-n bit multipliers.
- Single power supply, +5V.

These super-fast multiplier/accumulators are in stock at Hamilton/Avnet.

**For immediate information, call us at (213) 535-1831 or send us the coupon or just attach your business card to this page and mail it back to us.**

Multiplier/ Accumulator	Word Size (Bits)	Sum (Bits)	Speed (nsec)	Power (Watts)	Unit Price (100s)
TDC1010J*	16x16	35	115	3.5	\$205
TDC1009J*	12x12	27	95	2.5	\$120
TDC1008J*	8x8	19	70	1.2	\$ 70

\*Guaranteed operation over  $T_c = -55^\circ\text{C}$  to  $+125^\circ\text{C}$  available for military applications.

**TRW LSI Products**  
 P.O. Box 1125  
 Redondo Beach, CA 90278

Please send data sheets on the family of multipliers/accumulators. (MAC's).

Name \_\_\_\_\_

Company \_\_\_\_\_

Div/Dept \_\_\_\_\_ Mail Code \_\_\_\_\_

Address \_\_\_\_\_

City \_\_\_\_\_

State \_\_\_\_\_ Zip \_\_\_\_\_

E3

TRW keeps you ahead in digital signal processing

**TRW LSI PRODUCTS**  
 An Electronic Components Division of TRW Inc.

## Probing the news

enough," says William Gosling, professor of electrical engineering at Bath University, one of the most progressive engineering schools. This, in turn, results in low average pay levels and low status and effectively deters many of the most able from entering the profession.

In the fashion of the continental model, the solution offered by Finn-

niston aims to create a clearly identifiable engineering elite embracing the top 25% of the university graduates. This top quarter, whose qualifications would be recognized in a voluntary professional register, would provide the innovative engineers and the industrial and commercial high flyers. The report adds that there would be bridges from the lower tiers for late developers.

The basic three-year bachelor's course would be tailored more to the

needs of industry, with greater emphasis on engineering practice and less on the academic aspects of advanced engineering science. It would be followed by a two-year structured period in industry involving a range of practical assignments and leading to a period of responsibility with progressively less supervision. The four-year master's course would cover ground in greater depth. It, too, would be followed by a period in industry.

Getting industry to foot the bill for its contribution to an engineer's formation will be the hardest part. A not too dissimilar requirement was demanded by the professional institutions in the 1960s but has fallen into disuse. "It was not supported and structured properly then," says Finniston, who sees this as a key role for the new authority.

**GEC effort.** Quite independently of the report, GEC-Marconi Electronics Ltd.—part of the General Electric Co. Ltd. empire, which is Britain's largest electrical and electronics group—has been concerned about the quality of graduate intake and has worked with the University of Bath to develop a new 4½-year course. It integrates structured periods in industry with academic work and could well serve as a prototype for Finniston. Ironically, GEC is heavily criticized in the report—though not directly named—for the cavalier fashion in which it discarded its supposed primary asset, its engineering manpower, laying off over 1,000 engineers in the 1960s.

Though borrowing heavily from overseas models, the 18-man committee drew back from pulling out the university engineering departments into separate technical universities. "There just is no time," Finniston says, "but when the new engineering authority is established, universities such as Manchester, Bath, Edinburgh, and Southampton could well emerge as the centers of excellence needed to teach the top master of engineering degree."

Finniston is also concerned by what he views as a signal omission in his report—an evaluation of the problem of technicians. In fact, one of his more important recommendations is the establishment of a committee to look into this. □

# BEGONE CURSED ALLIASES

The new Precision 616 cuts clean with programmable ease. 80 dB/octave attenuation slopes and time domain filters superior to Bessel. Up to 16 filter channels, programmable for gain and cutoff frequency. Interfaces with mini, micro or GPIB. Typical

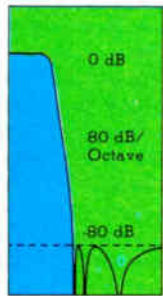

phase match is  $\frac{1}{2}^\circ$ , with worst case of  $2^\circ$ . You get performance that used to require a custom instrument, without paying a custom price. Call Don Chandler, 607-277-3550, or write for complete specs and a demonstration.



**PRECISION FILTERS, INC.**

303 W. Lincoln, Ithaca, N.Y. 14850



# In Europe, nobody offers a single package CEPT compatible DTMF receiver, 'cept us.

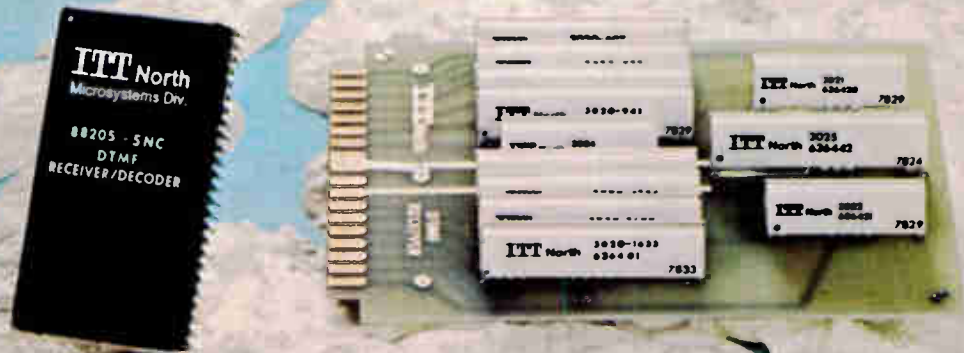

If you are a design engineer of telephone switching systems, we have some small news for you.

Tone receivers that meet the full range of your design needs.

The 88205-5NC is the only single package DTMF receiver available today that meets both CEPT and Bell specifications. A simple external adjustment is all that is necessary to meet individual gain requirements.

The 3000 Series tone receivers are based on a unique modular design for applications in DTMF (Bell specification only) as well as MF signalling applications including R1, CCITT#5, R2 Forward and R2 Backward. These tone receivers are field proven

(in use for nearly 4 years) and the modules form a complete receiver function.

Both provide an unparalleled combination of size, cost and performance. You will find these components to be of high quality and packaged with hybrid reliability that will meet your most stringent demands. Specify them for your next Central Office, PABX, Key System, Mobile Page System or end-to-end signalling application.

For more information, contact: ITT North Microsystems Division, 700 Hillsboro Plaza, Deerfield Beach, FL 33441. Phone (305) 421-8450, TLX: 51-2329 & TWX: 510-953-7523.

# ITT

**ITT North Microsystems Division**

Circle 97 on reader service card

# In the entire universe of ATE, only one board tester is truly universal.

Introducing Series 70 from Fairchild. The first true hybrid PCB test system. Most board test systems today are designed for either analog or digital testing. But Series 70 offers digital, analog, functional and bed-of-nails testing. All in one system.

And since most of today's PCBs contain both digital and analog components, it makes sense to get the system that does it all.

## **SERIES 70. UNCOMPROMISED FLEXIBILITY.**

There's virtually no limit to the flexibility of Series 70. It can test hybrid boards without compromise because it was designed from the ground up as a hybrid system. Not a system modified to test hybrid boards.

It also offers user-oriented software, a highly convenient fixturing system and superior fault-isolation techniques. All the things necessary for matching the performance of today's digital, analog and hybrid printed circuit board assemblies.

## **TEST THE BOARD, DON'T FIGHT THE SYSTEM.**

You don't have to fight to interface additional instrumentation to the Series 70. It has two IEEE 488 buses, so it accommodates more instrumentation than other test systems. And it's not restricted by instrument type or model. So you can use your favorite multimeter, spectrum analyzer or power source.

Series 70's high-level programming language helps the system adapt easily to all makes and models of instrumentation.

And with Series 70, you also get your choice of fixturing systems — universal, edge connector, or optional vacuum-operated bed-of-nails interface.

## **ALL THIS AND 5 MHz TOO.**

Most popular board testers run at relatively slow data rates. Series 70 operates at 5 MHz across all digital pins in parallel and collects probe data at full test speed.

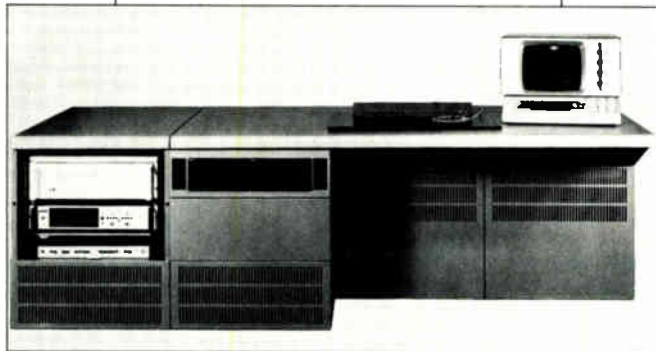

In addition to its super system speed, Series 70 offers faster, more accurate fault isolation. It features multiphase clocks, which let you program timing increments with 20ns resolution. And its new dynamic current measurement technique lets you track bus-related faults at full system speed.

## **SOFTWARE THAT SPEAKS YOUR LANGUAGE.**

Series 70 offers the most flexible, easy-to-use software of any board test system, thanks to MEDIATOR. It's a high-level English-like language that lets you write programs in a conversational test program language rather than lower-level code.

It's not only high-level, it's multilevel, so you can easily write board programs. And it's structured for modularity and

clarity to reduce programming time, simplify program maintenance and improve test quality.

All of which translates into substantial time and money savings for you.

## **COMPREHENSIVE SUPPORT — WHEREVER YOU NEED IT.**

Fairchild backs up Series 70 with hands-on training at any of our centers. Or, we'll have a training team come to you.

After training, our applications group gets you running. They'll apply their experience to your testing problems and help you develop your own programs.

To keep you going, we have the industry's largest field service organization, with over 20 major service centers throughout

the world.

For more information on our new Series 70, call or write: Fairchild Test Systems Group, 299 Old Niskayuna Road, Latham, New York 12110. Telephone: (518) 783-3600. TWX: 710-444-4968.

**FAIRCHILD**  
**TEST SYSTEMS GROUP**

**The  
first family  
of ATE.**

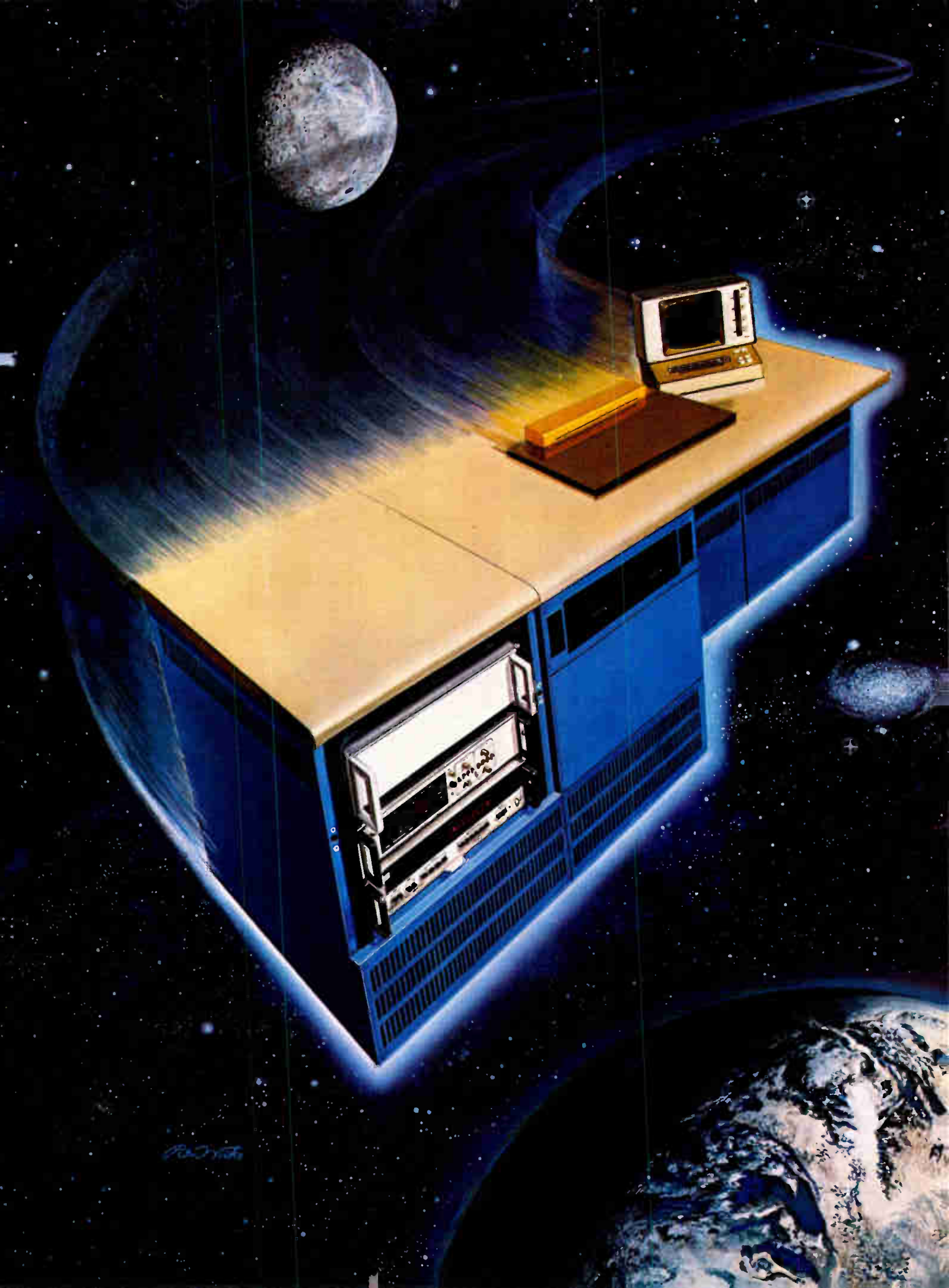

**At Penn State's Hershey Medical Center, they needed a sensor that would last a lifetime.**

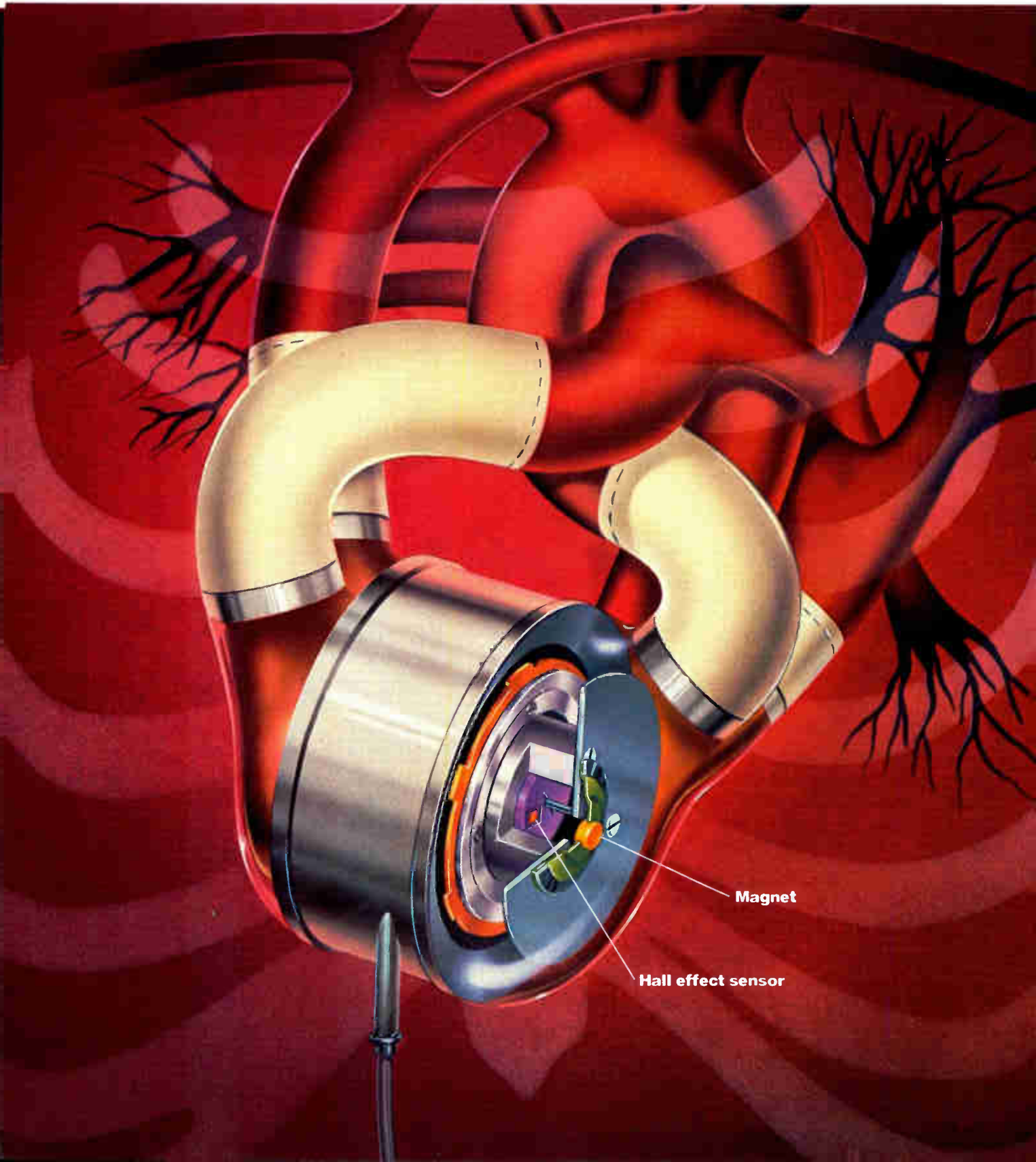

Until recently, the artificial heart was only a dream of modern medicine. A few medical pioneers at The Milton S. Hershey Medical Center of The Pennsylvania State University have made it a reality.

The first news came in 1977, when a mother of four underwent open heart surgery to replace a damaged heart valve. A heart/lung machine kept her alive during the operation. But after surgery, her heart failed, and specialists agreed she would die if removed from the machine.

Then they tried a small, experimental heart assist pump that today is controlled by our solid state Hall effect position sensor. It kept her alive for the eight days it took her to recover.

And yet, that pump is only part of what it takes to make a totally artificial heart.

Unlike the assist pump, the artificial heart is implanted inside the chest. So it has to be compact, and controllable. It must be made of materials that don't react with the body. And it has to beat without producing excessive heat.

Today the artificial heart is still experimental. But medical experts believe we have helped them solve one of their problems.

We gave them a heartbeat.

One of our Hall effect position sensors fit the requirements of Hershey's design. It controls the filling and emptying of plastic sacks that duplicate the natural motion of a healthy heart.

Already, a number of calves have been kept alive over 100 days. So far, one of our sensors has actuated over 18 million times in experiments at Hershey without a single failure.

And this is only the beginning.

Eventually, the artificial heart will be perfected for humans. Which means our sensor will operate about eighty times a minute. 115,000 times a day. 42 million times each year.

Working with customers early in their design process nearly always results in a better product. For them, and for us. That's one of the reasons why we have the widest variety of switches and sensors in the world. And, if we don't already have one that solves your problem, chances are we can design a solution together.

For information about how we can bring your project to life, write MICRO SWITCH, The Sensor Consultants. Freeport, Illinois 61032. Or call 815-235-6600.

MICRO SWITCH products are available worldwide through Honeywell International.

**MICRO SWITCH**  
a Honeywell Division





# Common interface. Common-English programming. Uncommonly good graphics.

Now Hewlett-Packard brings easy-to-use color graphics to your RS-232-C system.

With the new Model 7220A plotter (left) it's simple to add HP's multicolor graphic capability to your system, any time. Our HP-GL programming language is based on common-English abbreviations with a large inventory of plotter commands. And our graphics, in four programmable colors, are uncommonly good. Good enough, in fact, to be publication quality.

The plotter is so versatile that it can be easily used in both OEM and end-user applications. HP includes important features to let you implement graphics on your system easily and quickly. Features like automatic pen selection, internal scaling, digitizing, internal character set selection and dashed lines. There's

even an automatic paper advance model (7220S) that plots, cuts and stacks your graphics for unattended operation.



In addition to the A3 (11" x 17") 7220 Plotter, HP also offers the low cost Model 7225A, an A4 (8½" x 11") high quality plotter with RS-232-C hardware connection and the 7240A which produces long axis plots and combines graphics and text printing on the same page. And they use the same plain talking HP-GL language. A plug-in module customizes the plotter to your computer, desktop computer or intelligent instrument system.

OEM discounts are available on all HP plotters. For complete information, contact your local Hewlett-Packard sales office or write to Hewlett-Packard, Attn: Greg Diehl, 16399 West Bernardo Drive, San Diego, CA 92127; (714) 487-4100. 11903



 **HEWLETT  
PACKARD**

Circle 103 on reader service card



# Want high performance in a field-proven RAM tester?

## Then test drive the new 1980 Macrodata M-1!

The big industry news last year was the introduction of the Macrodata M-1 memory device tester. The big news this year is that the 1980 version of the Macrodata M-1 is even better and easier than ever to use.

Look at these outstanding features:

- with operator prompting, it's easy for anyone to use — product engineers, production test engineers, maintenance engineers, technical operators.
- one-year solid operating base of field experience.
- fully automatic software calibration (Auto-Cal) without the need

for special jigs or fixtures.

- available with water probe head or automatic handler interfaces.
- system now available with interactive shmoo package, 20-MHz Raster Scan System, extensive system diagnostics.
- same powerful DEC LSI-11 computer as used in the Macrodata MD-207/11 memory board tester.

That's why we say, if you haven't seen the Macrodata M-1 lately, you haven't seen anything in state-of-the-art memory device testers. Send for the new M-1 brochure, or arrange to bring in your favorite static RAMs (fast or slow), 16K or 64K dynamic RAMs, and test

drive the 1980 M-1 today.

Eaton Corporation, Semiconductor Test Systems Division, 21135 Erwin Street, Woodland Hills, CA 91365. Phone (213) 887-5550. Telex 69-8489.

Canada: (416) 678-1500

France: (01) 907 78 44

Germany & Switzerland: (089) 903 73 73

Italy: (02) 4154 141/2/3

Japan: (03) 591 2261

Scandinavia: (08) 87 94 90

UK & Benelux: (0628) 32 336

**EAT•N** Semiconductor Equipment

# On-board digital processing refines scope measurements

General-purpose unit with 400-MHz bandwidth stores waveforms digitally; its calculatorlike keyboard treats them as operands for one-keystroke functions like integration, differentiation, and smoothing—and it's programmable

by Val Garuts and Jim Tallman, *Tektronix Inc., Beaverton, Ore.*

□ The long-awaited truly intelligent oscilloscope has finally arrived. This benchtop analog instrument easily measures, compares, and transforms entire waveforms digitally and thus precisely, as if they were simple, single-valued parameters.

The Tektronix model 7854 is an evolutionary step in oscillography, combining in a single unit, to a degree never before achieved, the data density of analog waveform displays and the power of digital processing.

The concept of an oscilloscope able to do digital

waveform processing is not new; in the early 1970s, designers at another company were trying to build such an instrument but ran up against the problem of trying to design digital instruments before the invention of the right tools. They turned their attention to making those tools and succeeded, but their original goal was not achieved until now.

For systems use, Tektronix developed a digitizing oscilloscope in 1972. It is a combination 7704A oscilloscope and P7001 digitizer designed for use with an

**Evolutionary.** The 7854 is an important step in the progress of instrumentation, combining for the first time in a single unit the most powerful of analog instruments, the oscilloscope, with the present standard-bearer of digital processing, the 16-bit microprocessor. The result of this synthesis is a scope able to perform traditional and untraditional analog measurements simply and precisely by digitizing and storing waveforms.

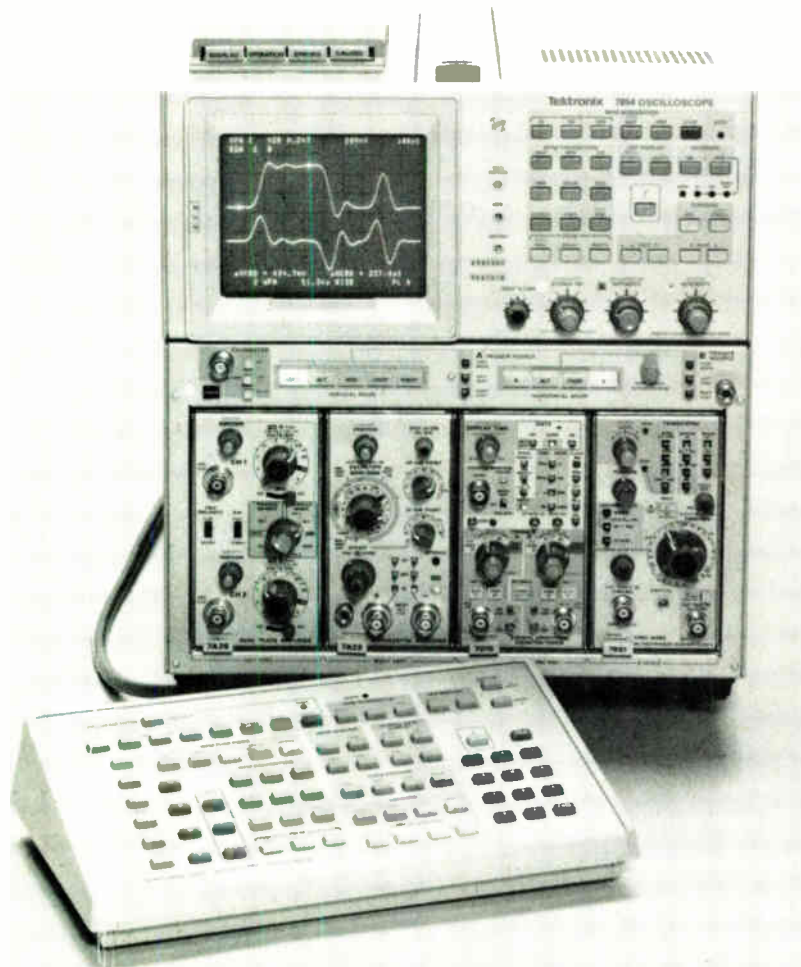

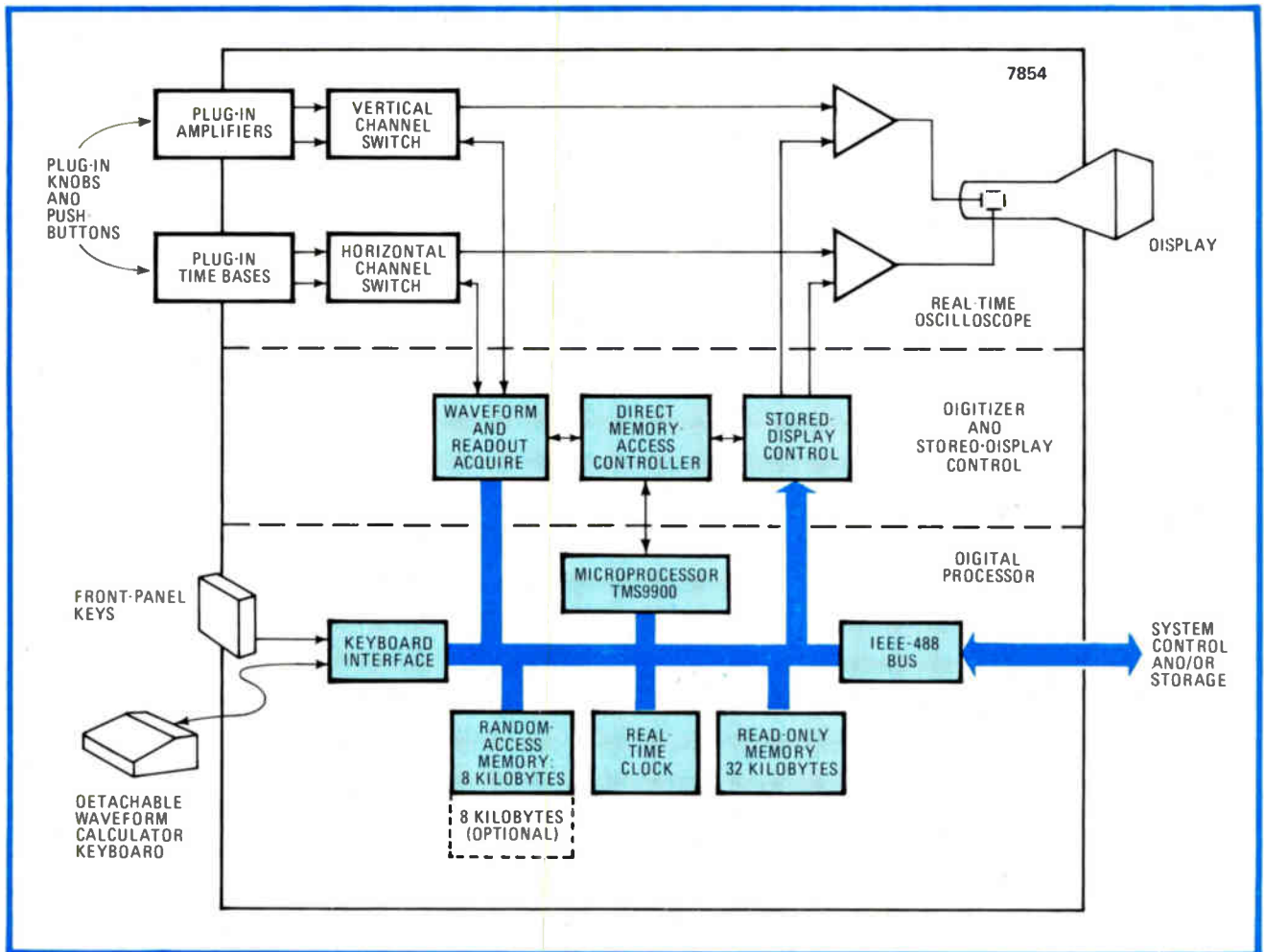

**1. Three tiers.** Circuits in the top section of the functional block diagram shown let the 7854 act like a general-purpose laboratory oscilloscope, those in the middle let it capture and display waveforms like a digital storage scope, and those at the bottom let it compute.

external minicomputer and works at frequencies to 175 megahertz or 14 gigahertz with a plug-in sampler. A total system costs anywhere from \$27,000 to \$40,000.

The goal of providing a design tool that could fit on a lab bench—with the power of a minicomputer and a scope in one package at a reasonable cost—could not be met until the advent of the 16-bit microcomputer. Only with a 16-bit processor could an instrument be made adequately “intelligent”—able to quickly perform complex tasks at the push of a single button, a paramount goal for lab use. Yet even after such processors began to become available, adding digital power to an analog scope was not a simple task.

### A scope's scope

An understanding of the significance of the 7854 and why it was difficult to design involves putting scope measurements into perspective—seeing what measurements are now made with scopes and what kinds users would make if they could.

All oscilloscopes deal with waveforms, or two-dimensional entities that consist of a practically infinite number of values and in the majority of instances are repetitive. The scope not only presents all waveform values simultaneously, but also does so in such a way

that the relationship between them is instantly visually apparent.

But though it may be easy to visualize relationships and values immediately with a scope, quantifying them is another matter. Any measurement results in a number or a yes/no decision.

There are, therefore, many numerical values that the user must often take from the scope's screen. Some typical measurements are maximum, minimum, and midpoint of a signal. Rather than try to eyeball these readings, a user can make them more accurately on the 7854 by simply pushing a single key. The value of the selected parameter then appears on the screen.

Other typical measurements usually involve more than simply reading a number directly off the screen. To measure the peak-to-peak value, frequency, or period of a wave, the user has had to read one or more points from the screen and then do some mental arithmetic (addition, subtraction, multiplication, or division) to get the desired number. With the 7854, all he or she need do is position a couple of cursors to define the measurement locale and push one key to get an accurate, decimal readout on the screen.

Pulse parameters are generally tough to measure with an ordinary oscilloscope. To measure the rise or fall time



```

000 L01
001 STORED 4 AUG
002 CRS1 0 >HCRD
003 UCRD 2 >CNS
>004 CRS2-1 HSCL 10 * ENTER
005 P/W / - >HCRD
006 MAX 2 CNS - UCRD / 1 - 100 *
007 1 >CNS
008 STOP 1 LBL GOTO

```

**4. From the calculator.** Measurement programs like the one shown here are written using the waveform calculator. Each line of a program executes separately, so results can be displayed with the program status. Labels are used for branching.

circuit's response to typical waveforms (sine wave, pulse train, ramp, etc.).

The output of this process can simplify the building of the real circuit. The ideal response can be stored in the scope, a real circuit built, and the response of that circuit compared with that of the ideal. Real components can be tweaked and the circuit output reexamined to optimize the real design.

The intelligent scope can be used in an automated test equipment environment. In incoming inspection and quality control, for example, a test equipment operator now visually checks an actual waveform to see that it falls within certain well-defined tolerances. Tolerance indications are usually placed over the scope screen, using anything from grease pencils to expensive custom overlays. Because trace width, parallax, and display distortion can affect the reading, the operator must be highly proficient.

But an intelligent scope can store tolerance waveforms and automate comparison so that the operator can perform complex tests in go/no-go fashion. Further, with a general-purpose interface bus, it can put out the results for further analysis or record keeping.

### Making possibilities real

In designing its new scope, Tektronix adopted a philosophy it calls progressiveness. The idea was not to shock the user by introducing a completely new and unusual instrument, unrecognizable as an oscilloscope to any engineer or technician. Rather, the user must be able to progress from the familiar to the unfamiliar easily. Applying the progressive philosophy to the 7854 meant that total redesign was avoided.

When used for real-time display of analog signals, the 7854 operates exactly like an oscilloscope in every respect. It accepts any of the existing 7000-series plug-ins: amplifiers, timebases, counters, timers, and spectrum analyzers, to name a few. It may not be a simple instrument, but it presents a familiar, friendly face to the

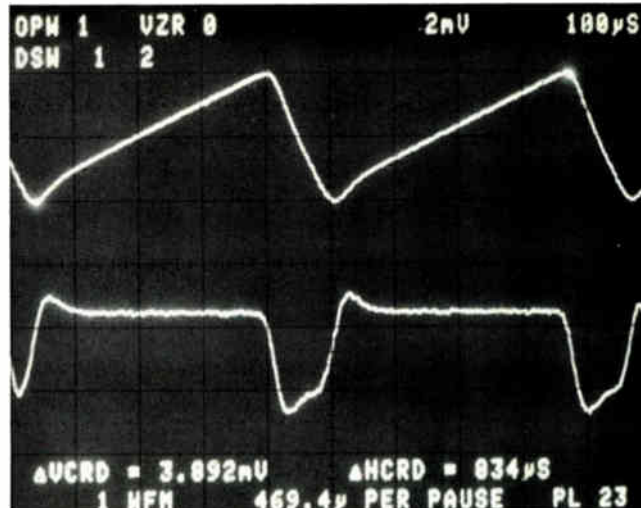

**5. From storage.** Four lines on digitally stored waveform display tell user what is happening. The top line says which wave is being worked on (1) and its scaling; next, which waves are shown. Last line gives measurement results (469.4- $\mu$ s period) and program status.

user, letting him or her use it even without an understanding of its digital capabilities.

This friendliness was kept by functionally segmenting the scope into three basic subsystems: the real-time oscilloscope, the waveform-acquisition (digitizer) and stored-display control subsystem, and the digital processor, shown in Fig. 1. As shown, the familiar, real-time controls remain separate from those that bring the digital processing capabilities into play in conformance with the basic functional design philosophy.

### Unlocking digital doors

Deciding how to give access to the processing capability was a major challenge. There were many choices to make: what language to use, what functions to provide, which algorithms to use, how to arrange the keyboard and label keys, and where to put information on the display. The progressive philosophy again provided the answer.

Access to the scope's digital capabilities was on three levels, to match the proficiency levels of various users. On the first level are the front panel keys that call into play some of the processing capabilities. They correspond functionally with those measurements called typical or would-be typical earlier: maxima and minima, peak-to-peak, pulse rise and fall time, rms, and so on. Since to measure a signal digitally it must first be digitized, there are keys to acquire the waveform digitally. Likewise, there are the keys for the cursors needed to set up those measurements.

For the second level, a separate, detachable keyboard was designed that would let a design engineer working at a bench more fully utilize the scope's capability. This part of the functional design influenced the other levels significantly and proved the most challenging.

For several reasons, the keyboard was built around a calculator, or key-stroke, language rather than a popular programming language like Basic. First, extending a language like Basic so that it would be able to perform

waveform operations would dilute its familiarity. Using a key-stroke language, each function is represented by a single labeled key. The system's capabilities are easy to learn and remember. Another advantage of a key-stroke language is that it permits one-finger push-button operation, which is more at home in the lab than two-handed typing.

### RPN's advantages

Having narrowed the field to a calculatorlike language, there were two choices: reverse Polish notation (RPN) or algebraic syntax. Here the choice was relatively easy—RPN had all the advantages.

RPN is a syntax-free language—each operation depending only on the operator and operand—that allows great freedom in tailoring a set of functions for waveform operation. Each operation is performed independently of all others and provides a result immediately. Thus, the name of the operation just performed and the result of that operation can be displayed together. Further, if a function cannot be executed because of an improper operand (the natural logarithm of a negative number, for example), the cause can be, and is, automatically frozen on the display to alert the operator. This capability eliminates the confusion that can occur when a long arithmetic expression results in an obviously wrong answer.

Further forcing the choice is the fact that more engineers are familiar with RPN. Several forms of the algebraic notation are used in calculators, and though they differ on how to perform simple arithmetic functions, they do manage to agree on how to perform one-operand functions—they all use RPN.

The backbone of an RPN calculator is its data register structure, and so the hardware design criteria (about which more will be said later) called for an abundance of them (Fig. 2). The stack and constant registers needed for any calculator were provided, as were waveform registers. Here waveforms are recorded in terms of the vertical scale factor (VSCL), vertical zero with respect to ground (VZR), horizontal scale factor (HSCL), and the digitized curve points, in that order.

So that users can trade off the number of waveforms stored for the resolution with which they are recorded, the number of digitized points per waveform (P/W) was made selectable. A user can pick 128-, 256-, 512-, or 1,024-point digitizing and that selection is stored in the P/W register.

Another pair of registers stores either the vertical and horizontal coordinates of a single displayed cursor (VCRD and HCRD, respectively) or the difference in coordinates between two displayed cursors ( $\Delta$ VCRD and  $\Delta$ HCRD).

As with any other calculator, the operands and the result of the operation should go into the stack. Though this procedure works perfectly well for constants, an entire waveform would take up more room than the stack could economically provide. For this reason the waveform number only is put in the stack as a pointer, and individual points are fetched from waveform memory as they are required.

To handle the results of the operation, a rule was

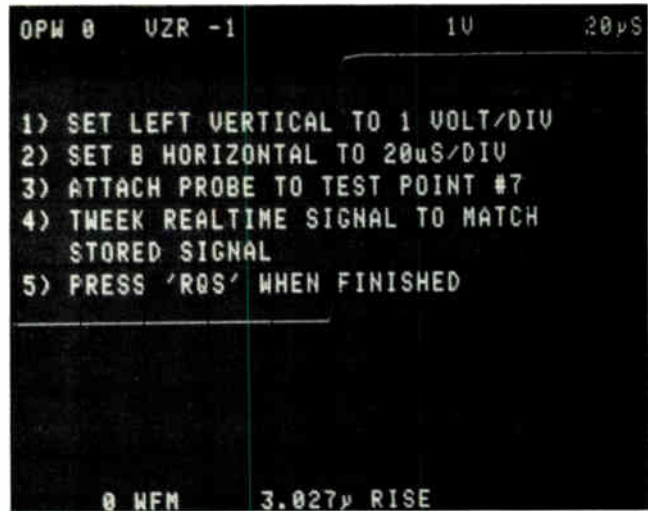

6. From afar. For an ATE environment, the 7854 can accept information and display instructional text like that shown through its IEEE-488 interface. Its ability to store tolerances simplifies testing, increases accuracy, and eliminates need for screen overlays.

adopted that new waveform data would be transferred into waveform memory 0. The rule was broadened to include all new memory data, even that acquired by digitizing, and since two waveforms can be digitized simultaneously, waveform memory 1 was also set aside. After an operation or acquisition is complete, the digitized waveform can be transferred to another memory area for more permanent storage.

The calculator concept also led to the introduction of the operational waveform (OPW): the waveform whose number has appeared most recently in the X register is designated the operational waveform by transferring its number to the OPW register too. Several operations are often performed in sequence on the same waveform operand, and designating the OPW waveform as the default operand minimizes key strokes. The OPW waveform is also kept on the display to prevent it from going blank and to give the measurement cursors a place to reside.

In addition to the register structure, the algorithms that could be provided to operate on waveforms strongly influenced the calculator design. The choice of algorithms and their implementation was by interpolation.

In implementing any measurement or operation on a digitized waveform, some assumption is made about what happens to the waveform between the sampled, digitized points—an assumption voiced in the interpolation method.

When samples are taken very frequently, the choice of interpolation method is less critical; waveforms tend to be regular in their wanderings, except in infrequent or specialized cases. Therefore a simple linear (connect-the-dots) interpolation method was implemented in the 7854. Easily visualized by the user, it matches the linear vector nature of the stored waveform display.

Using this method, algorithms for various measurements and operations can be based on previous visual techniques. Period and frequency measurements, for example, are simply the difference or reciprocal of the

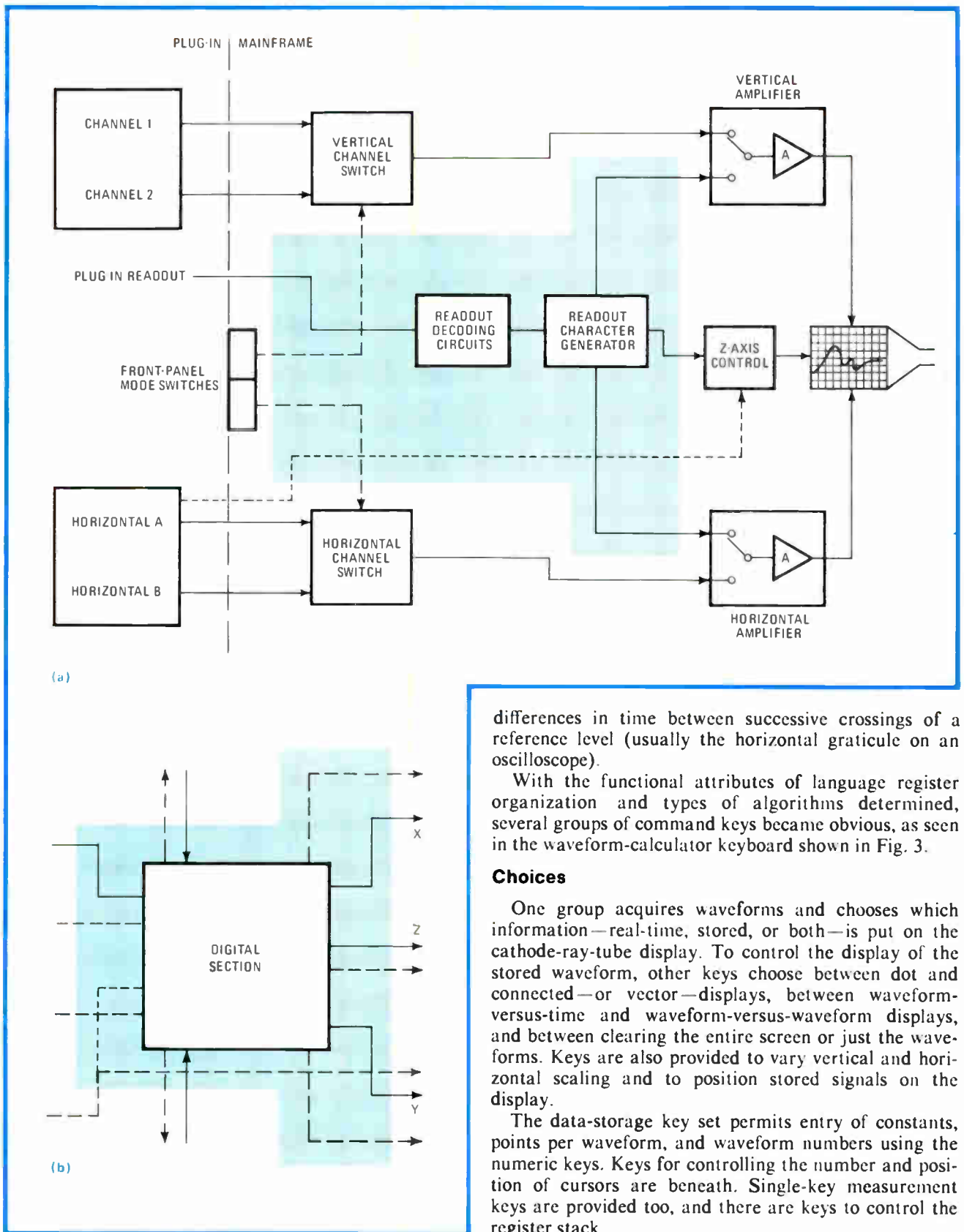

**7. A-d conversion.** Careful modification of channel switches, amplifiers, and Z-axis control retained scope's familiar analog operation while permitting control by digital section (b), which replaces shaded area in (a) of waveform capture, storage, and display.

differences in time between successive crossings of a reference level (usually the horizontal graticule on an oscilloscope).

With the functional attributes of language register organization and types of algorithms determined, several groups of command keys became obvious, as seen in the waveform-calculator keyboard shown in Fig. 3.

**Choices**

One group acquires waveforms and chooses which information—real-time, stored, or both—is put on the cathode-ray-tube display. To control the display of the stored waveform, other keys choose between dot and connected—or vector—displays, between waveform-versus-time and waveform-versus-waveform displays, and between clearing the entire screen or just the waveforms. Keys are also provided to vary vertical and horizontal scaling and to position stored signals on the display.

The data-storage key set permits entry of constants, points per waveform, and waveform numbers using the numeric keys. Keys for controlling the number and position of cursors are beneath. Single-key measurement keys are provided too, and there are keys to control the register stack.

There are simple arithmetic keys and some commonly used algebraic functions like natural log and exponential. There is a group of functions that relate solely to waveforms—integration, differentiation, smoothing, and



linear interpolation (for constructing waveforms from a few points). Horizontal expansion was included here, rather than with the display control keys, because it causes a new waveform to be computed from part of the old and the remainder to be lost.

Practical application of these individual functions, or commands, always involves performing them in sequence, that is, as a program. So one group facilitates generation of programs.

The waveform calculator's programming operation is modeled on that of other programmable calculators. Contiguous line numbers are assigned to lines of one or more commands, and editing is done line by line. Individual keys move a line-pointing cursor a line at a time or slew it through many lines.

Since line numbers can change as a program is edited, a facility was provided to label target points in the program so that the program could branch to different routines during execution.

The usual collection of calculatorlike execution control commands rounds out the program commands. These include a simple manual interrupt to make a running program pause for observation and then start again with no loss, as well as arithmetic comparison operators for conditional statements. The latter have been enhanced so that they work on waveforms as easily as on constants.

### No new language

All keyboard commands (except the edit commands) can be used in a written program, and any written program that is stored operates as if each command were entered manually. This not only makes it easier to debug or patch a program, but it also means that the user does not have to learn a new language to write a program—a progressive approach. A typical program is illustrated in Fig. 4.

The arrangement of all command keys minimizes hand motion. Although key-stroke sequence cannot be predicted for certain, the typical sequence with RPN is operand-operator. This led to grouping operands on the right and operators on the left, which keeps the next key in an operation visible to the user. Related keys are visually united by shading, and different colors and shapes distinguish functional groups.

Labeling individual keys was an important consideration. There was room on the panel for two- or three-word function descriptions, but it was an iron-clad design rule that command names—whether they appeared on the keyboard, on an IEEE-488-compatible controller, or on the scope's own display—would always appear in the same form. As a result, brief mnemonics were used.

The display in Fig. 5, generated by a stored program, contains the operands, function status, and results of the operation. The top line shows the number of the operational waveform—OPW 1, in this case—its offset from the vertical zero reference, and the scale settings. The second lists the waveform numbers of both of the signals displayed.

On the bottom of the screen, the difference between the positions of the two cursors' coordinates is shown. Below the coordinates are the contents of stack registers

Y and X (waveform 1 and the period of that waveform, respectively). Next to the register contents are the program status (PAUSE) and line number (23). Thus, using the keyboard mnemonics, the display provides the complete story of the scope's program status.

With intelligent instruments becoming part of larger systems in many applications today, this third level of scope application evolved naturally. Accordingly, it was the obvious next step to provide the 7854 with an IEEE-488 bus interface.

### At the system level

The 7854 will transmit and receive three types of information: program commands, data (waveforms or constants), and display text. Though the interface standard defines the control signals and hardware interconnection for bus systems, it does not define the language to be used in interdevice communications, so rules were necessary.

The first consideration was that any machine interface is ultimately a human interface—somebody has to construct or interpret the messages that flow through it. Secondly, to maintain the concept of progressiveness, the language used at the keyboard should apply identically to the interface. And finally, any output used as an input should re-create the original state it was derived from. This last consideration was necessary for operation with nonintelligent mass storage.

So it was decided that a program put onto the GPIB would be an ASCII representation of that program as it appeared on the display—command mnemonics separated by spaces—with line numbers replaced by line terminators to satisfy the final rule. The same mnemonics when received as input are handled by the 7854 as if they came from the keyboard, so the GPIB can press any key on the waveform-calculator.

Waveforms themselves are transmitted and received in the same format as they are stored in memory, as scaling data followed by point values, but point values are transmitted numerically, in terms of divisions on the display. Displayed text and constants are transmitted as displayed, and any EIA-compatible text input can be displayed on the screen also (Fig. 6).

### Making it work

As with most modern design, that of the 7854 was a top-down procedure, with measurement capability and the user's access to it forcing the hardware design.

In Fig. 1, it is apparent that in concept the scope was to be an analog measurement tool augmented with digital technology. Obviously, to provide this augmentation, the analog segment of the scope would have to be modified so that analog signals acquired by it could be accessed by the digital subsystem. Keeping to the goal of a familiar interface, the analog portion of the scope is very similar to other members of the 7000-series—the 7904 general-purpose single-beam dual-trace oscilloscope in particular.

Figure 7 shows the modifications of the mainframe to accommodate digital processing. An additional output port and control switch was added to both the vertical and horizontal channel so the signal could be acquired,

## Digitizing with display in mind

Like other 7000-series laboratory oscilloscopes, the 7854 was to operate in real time with any of the numerous plug-ins built for that familiar family. This meant that the new scope would have to digitize an input regardless of what plug-in was used. To provide this capability, Tektronix devised a display-oriented random-sampling technique.

For this technique, the display is regarded as consisting of 128, 256, 512, or 1,024 horizontal and 1,024 vertical locations, as shown at the left of the figure below.

In a real-time scope, these display locations are addressed with analog inputs from the horizontal and vertical plug-ins, which are amplified and used to drive the deflection plates. To capture the signal digitally, those signals are fed by the horizontal and vertical channel switches to separate sample-and-hold circuits.

A free-running clock controls the sampling process, turning on a Schottky diode bridge that lets the signal charge the sample-and-hold capacitor. Samples are taken at the clock's frequency so they generally appear to be random with respect to the signal.

The sample-and-hold circuits simultaneously acquire the vertical and horizontal deflection voltages and do so at each clock cycle. The values from the horizontal and vertical sample-and-hold capacitors are multiplexed in succession to a successive-approximation a-d converter, which digitizes the value and transfers it to the appropriate output latch.

Successive approximation was selected as the conversion method since it was not too expensive to implement, yet provided sufficiently rapid conversion. Dual-slope

conversion would have been too slow, and a flash (or parallel) conversion technique would have required too much space, power, and money. A multiplexing scheme was chosen because, though dual converters would have improved the total conversion rate by 30%, they would have increased the a-d conversion cost by almost 100%.

It takes 1 microsecond for the digitizer to perform a single 10-bit conversion. Both horizontal and vertical signals must be converted, which takes 2  $\mu$ s, and the information transferred to memory, which takes 1.5  $\mu$ s. This gives an overall digitizing rate of 3.5  $\mu$ s.

In the storage mode, the conversion process takes place continuously regardless of the horizontal location of the beam. Therefore, to prevent the storage of a retrace, the unblanking signal of the scope is used to gate the digitized signals onto their respective buses. It also initiates a direct-memory-access request.

The 10 bits that result from digitizing the horizontal signal are used to form part of the storage address. Additional bits are supplied by the microprocessor to designate a block of memory addresses for waveform storage and, together with the horizontal bits, form the complete storage address. To this address, the 10-bit result of the vertical signal conversion is written.

After each address is filled, a flag is set to indicate this. The process continues, with samples taken on each repetition of the signal until a minimum of 99% of the allocated waveform memory locations are filled. So memory now contains the vertical values of the waveform in the horizontal sequence in which they were displayed.

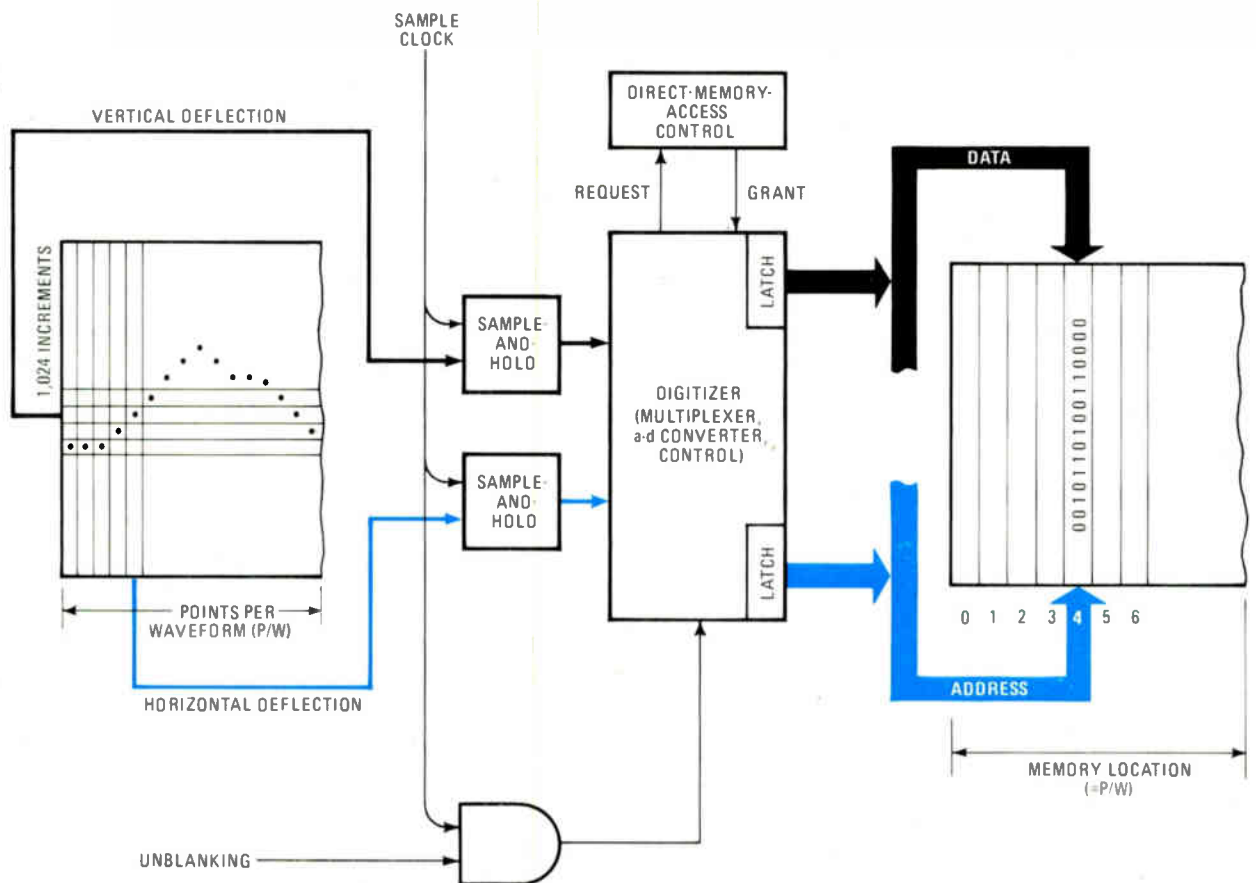

MEMORY-ADDRESS CODING SCHEME

Points/ waveform	Address-word bit source															Address range (hexadecimal)	
	0	1	2	3	4	5	6	7	8	9	10	11	12	13	14		15
1,024	R	R	R	R	R	D	D	D	D	D	D	D	D	D	D	0	A000 → A7FE
512	R	R	R	R	R	R	D	D	D	D	D	D	D	D	D	0	A000 → A3FE
256	R	R	R	R	R	R	R	D	D	D	D	D	D	D	D	0	A000 → A1FE
128	R	R	R	R	R	R	R	R	D	D	D	D	D	D	D	0	A000 → A0FE

R = bits assigned by processor to designate memory range    D = bits from digitized horizontal signal

and, similarly, an input port and control switch to the horizontal and vertical amplifier so that stored signals could be displayed.

The new scope was to accept all 7000-series plug-ins, and those plug-ins have always provided readouts of their control settings. The digital section needs these to give correct scaling information on stored signals, so they are routed to that section.

Front-panel mode switches (vertical left, right, alternate, chop and add; horizontal A, B, alternate, and chop) were also routed through and controlled by the digital section to make them programmable. In ATE environments, this provides a certain degree of control over the input format. Providing remote control of the horizontal and vertical channel ranges was also considered, but the cost and complexity of such a feature would not have been in keeping with a laboratory instrument and would have required redesign of the plug-ins. In view of the number of plug-ins in user inventories this was considered particularly inadvisable.

Equal design effort was required in modifying the analog portion and adding the digital section. Hard to satisfy were two functional design goals: providing the high-resolution display from the stored data and storing waveforms up to the full analog bandwidth—400 MHz—of the scope.

Earlier experience had shown that 8-bit digitization was insufficient for high resolution; 10 bits were needed to characterize accurately both the horizontal and vertical coordinates of a waveform. This would provide a maximum resolution of 1 in 1,024 in each axis or 1 in 1,048,576 for the entire screen.

With a 10-bit digitizing scheme chosen, the question of how to realize it remained. Real-time sampling, the technique used most for digital storage scopes, was out, because to do real-time sampling on a 400-MHz signal would require a 10-bit converter able to work at 1 GHz at the minimum.

The answer was a new digitizing scheme called display-oriented random sampling. In this scheme, samples are taken on the vertical and horizontal channels for different points in the waveform each time it repeats, until at least 99% of the points have been digitized. The digitized horizontal coordinate becomes an address in memory and the digitized vertical coordinate is the data stored there. The implementation of this

is discussed in "Digitizing with display in mind."

The choice of 10-bit digitization, along with the functional, computational capabilities to be provided, determined the choice of microprocessor. An 8-bit machine could not be used, for data would have to be broken into 2 bytes each time it was stored or operated on, thus slowing down the digitizing, computing, and display process. It would not provide sufficient address capability to store multiple waveforms, programs, and algorithms, nor would it provide the word width to ensure accurate computation. Therefore a 16-bit device was needed and at the time design began, such a device was available from Texas Instruments: the TMS 9900.

**Serendipitous processor**

The features of that processor were particularly advantageous for the 7854. It had 16 vectored interrupts, which permitted the fast switching between different operations needed to react to changes in instrument status, such as the receipt of a GPIB command or the completion of an assigned display task. Using RAM to switch to a new set of working registers while saving the old required only that a workspace pointer be set. It had 16 general-purpose registers that eliminated the need to save and load accumulators, speeding processing.

In addition, the TMS 9900 has request and grant lines that can be used to clear the data and address buses for direct memory access. Thus waveform data can be stored and retrieved quickly, reducing total digitizing time and providing fast display, respectively.

Firmware for the system resides in 32 kilobytes of ROM; field-programmable logic arrays and PROMs can be used for software patches. The system's RAM board, organized as 4,096 words of 16 bits, using 1,024-by-4-bit static RAMs, can be expanded to 8 kilowords when more waveform/program storage is needed. The 7854 can be configured with backup power for transportation, and codes entered into RAM when line power is removed are checked to be sure memory integrity is retained when line power is restored.

Blocks of RAM addresses for waveform data storage are assigned by the processor in response to the user's specification of points per waveform and waveform number, as shown in Table 1. Vertical coordinates are then entered into those addresses, with overrange bits filling the first two places in the 16-bit word, followed by

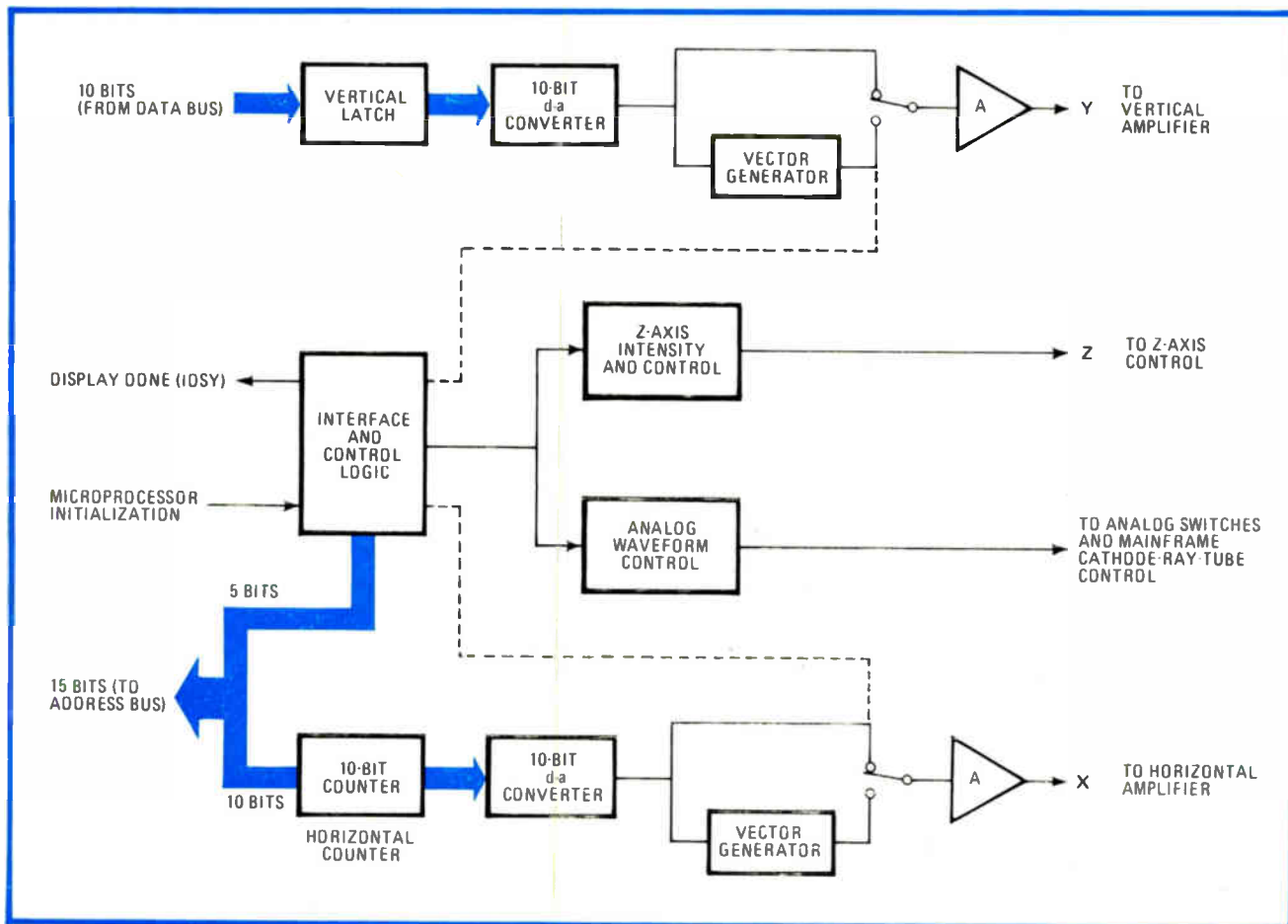

**8. Bits to pixels.** To translate stored waveforms into a display, the display board's interface and control logic is initialized by the processor for the area where the waveform is stored, and then calls the waveform point by point by incrementing a 10-bit counter

the 10 bits of point data and 4 guard bits (zeros) to make up the full word. Scaling information acquired from the horizontal and vertical plug-ins fills the first three address locations.

The display board shown in Fig. 8 puts stored data on the screen. When a waveform is to be displayed with respect to time, the microprocessor sends initialization information—the first address of the waveform in memory and the number of points stored—to the board's interface and control logic. It then starts the display to allow DMA control of the data and address buses so the display board can directly access memory.

The interface and control logic uses the initialization information to set the display board counter and pull the point from memory. The point and counter settings, which reflect the memory location, are converted to analog values and used to drive the scope's vertical and horizontal deflection plates, respectively. After the point is displayed, the counter is incremented and the next point fetched. This process continues until the counter value equals the number of points per waveform supplied at initialization. Then the interface and control logic signals the processor that the display is complete, and the processor resumes control of the buses. If multiple waveforms are displayed, the process is repeated for each.

A problem that had to be solved in the display board design was how to display a real-time waveform while

showing multiple stored waveforms, in order to achieve a flicker-free display. With a budget of 8 microseconds per dot and a minimum refresh time of 20 milliseconds for flicker-free display, 2,500 dots can be displayed, or approximately two stored waveforms of 1,024 points.

The actual time the beam must be on for a dot to show on the screen is  $5 \mu\text{s}$ , which leaves  $3 \mu\text{s}$  for a real-time waveform. But the time required to switch between stored and analog display, write the analog wave portion, and allow for settling between that switching is more than  $3 \mu\text{s}$ .

To allow multiple displays, the display board can be initialized by the processor to show odd-numbered memory contents on one scan and even on the next. This increases the time for real-time display by the budget for the omitted dot,  $8 \mu\text{s}$ , to a total of  $11 \mu\text{s}$ , which is more than sufficient.

Displays of one stored waveform against another can also be generated by the board, in which case two waveform points are called consecutively from memory to drive the deflection amplifiers. This increases the time to generate a dot to  $20 \mu\text{s}$ . The display also controls cursor display, halting the counter increment at the cursor's horizontal location when given that information by the processor. The vertical coordinate at the time the counter is stopped and repeated, creating a brighter spot at that location on the screen. □

# Good bits swapped for bad in 64-kilobit E-PROM

Ultraviolet-erasable memory has two redundant storage blocks to improve yield; two test modes spot cell threshold variations

by Vernon G. McKenny, *Mostek Corp., Carrollton, Texas*

□ Many memory announcements are little more than reiterations of a company's ability to shrink device geometries. In the case of the MK2764 ultraviolet-erasable programmable read-only memory, however, as much attention has been given to yield and device testing as to capacity. Its block-redundancy scheme allows most memory-array defects to be repaired, and it features two unique operational modes—deprogramming-stress and bit-check—that make accurate measurement of cell threshold shifts possible.

This is not to say that the new memory cannot claim

significant density advances. Not only is the per-bit power-delay product four times smaller than its predecessor, the 16-kilobit MK2716 E-PROM, but the packing density in the 8-K-by-8-bit array is more than doubled using 5-micrometer layout rules. A future version of the device will have channel lengths reduced to 3.5  $\mu\text{m}$ , resulting in twice the number of dice per wafer. The most recent measurements give the 2764 a typical access time of 200 nanoseconds, an operating power of 250 milliwatts, and a stand-by consumption of 50 mW.

The very small cell of the 2764 borrows from two

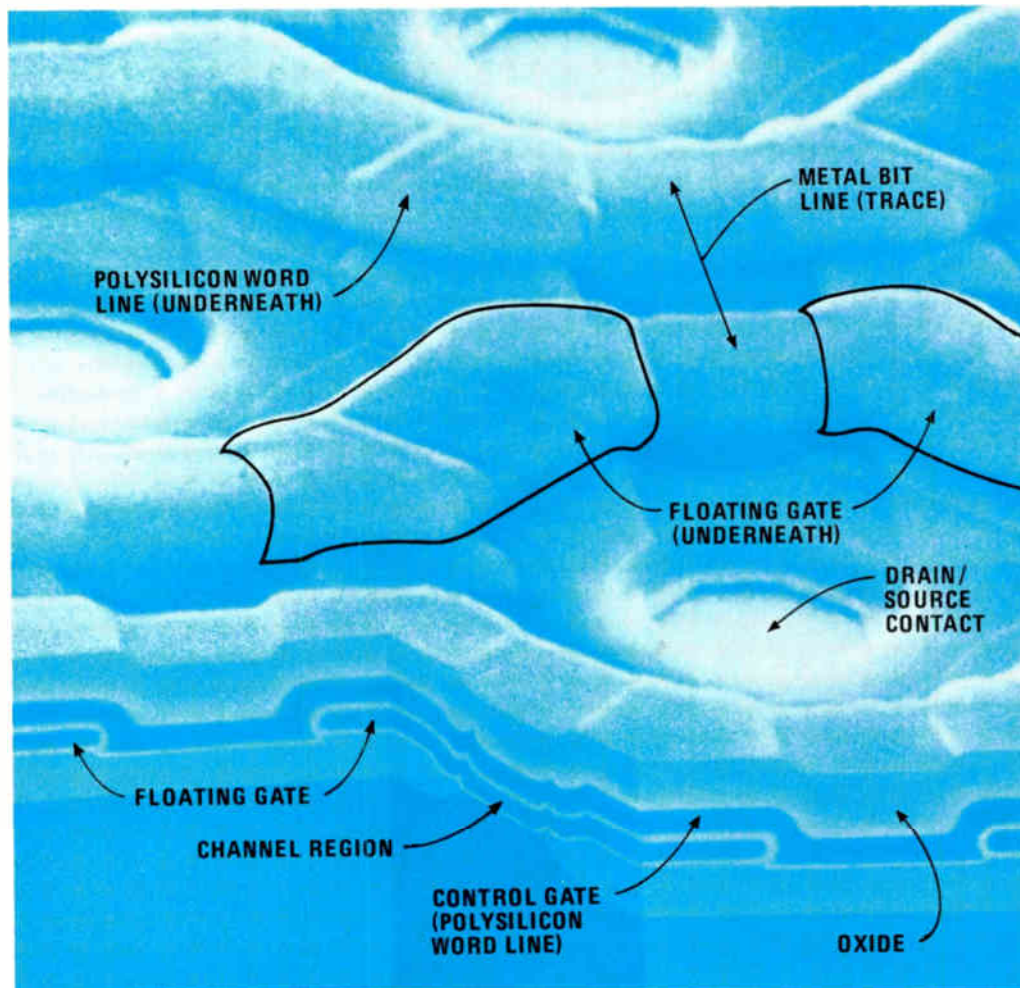

**1. Cutaway.** Emanating from each contact opening in the MK2764 64-kilobit E-PROM are four storage devices extending radially to four other contact openings. Although protective oxide and metal are removed, traces from the bit lines can still be seen running vertically over alternating rows of openings. Everything above the cleaved area is an actual scanning electron micrograph. The cleaved planes are air-brushed reproductions made from separate micrographs.

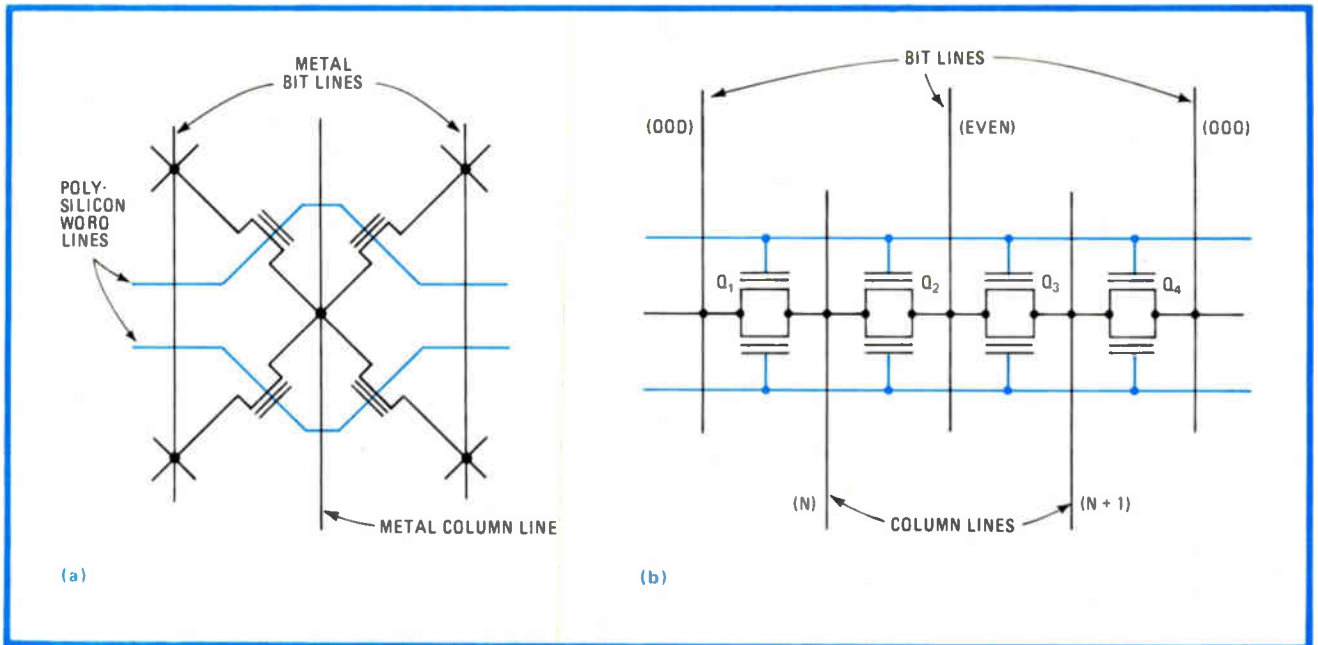

**2. Merged for density.** In (a), the four bits are represented in a manner akin to the actual X-shaped cell layout. The more easily visualized version in (b) is arrived at by bringing together two drains for each metal bit line. Twice the number of bits are shown in (b).

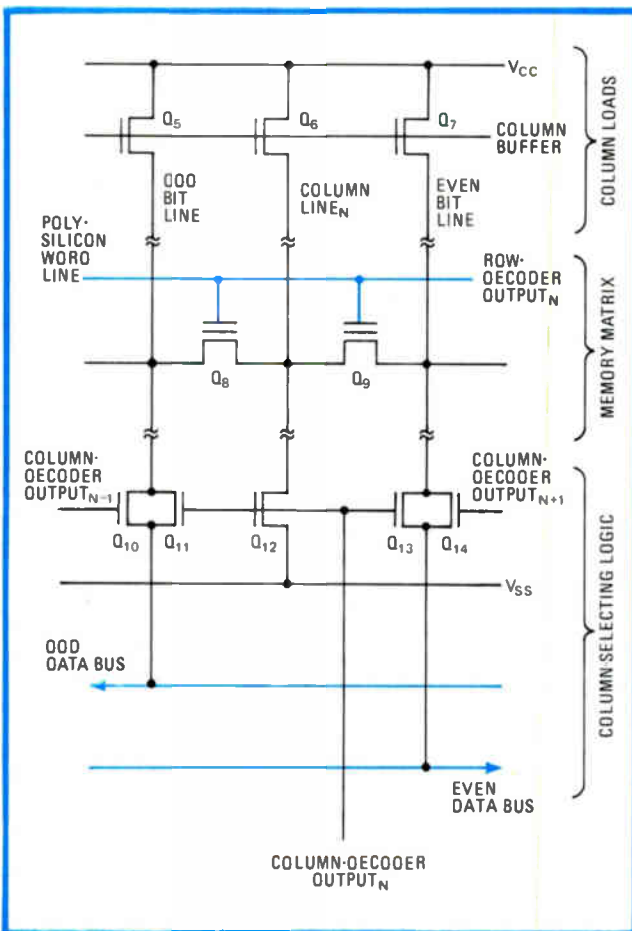

**3. Matrix accessing.** When column-decoder output N is low, column line N is grounded and the even and odd bit lines are connected to the even and odd data buses, respectively. The memory devices are then selected via the row-decoder output line.

other nonvolatile memories. Cell layout is identical to that pioneered by Mostek in 1976 for the MK36000 64-K ROM, and the self-aligned floating-gate structure is that used in the manufacture of the MK2716 16-K E-PROM. The photomicrograph in Fig. 1 shows the dense array layout; for the sake of clarity, protective glass and metalization have been removed. Still, traces of the removed metal can be seen running vertically over the drain and source contact openings. Perpendicular to the metal lines is the other set of conductive paths. These are the polysilicon word lines, which zig-zag horizontally to form the control gates of each floating-gate device in a given row.

**Small cells**

Key to the compact topology is the fact that each contact connects to the source or drain regions of four devices at the center of an X-shaped cell that contains four memory bits. Figure 2a shows a schematic of four bits, drawn in a manner similar to the layout. By bringing together two drains for each metal bit line, the schematic can be changed to the configuration of Fig. 2b, which is a little easier to visualize.

Since each bit line is shared by two columns of memory devices, data selected by two different column addresses will appear on the same bit lines. For example, in Fig. 2b, taking column line N to ground allows the state of Q<sub>1</sub> to be read on the left-most odd bit line and, at the same time, the state of Q<sub>2</sub> appears on BL<sub>EVEN</sub>. Similarly, when CL<sub>N+1</sub> is selected (pulled low) while CL<sub>N</sub> is left high, BL<sub>EVEN</sub> has data from Q<sub>3</sub> and BL<sub>ODD</sub> (on the right) has data from Q<sub>4</sub>.

The sharing of column and bit lines is largely responsible for the small cell size. Using 5-μm design rules, a cell measures only 14 by 14 μm, giving an unscaled area of only 0.31 mil<sup>2</sup> per bit. A 70% linear scaling would reduce the device length from 5.0 to 3.5 μm, bringing the area

taken up by each bit down to about 0.15 mil<sup>2</sup>.

Figure 3 shows how a pair of devices resides in the matrix. The column-decoder output  $C_N$  turns on devices  $Q_{11}$ ,  $Q_{12}$ , and  $Q_{13}$ , thereby discharging the column line  $CL_N$  to ground and providing a data path from the odd and even bit lines to the odd and even data-bus lines, respectively. The row decoder output  $R_N$  selects memory devices  $Q_8$  and  $Q_9$ . If  $Q_8$  has been programmed to a logic zero, it remains off and there is no signal transferred to the odd data bus. If  $Q_9$  has not been programmed, it will turn on and provide a current path from the even data bus to ground through  $Q_{13}$ .

Transistors  $Q_5$ ,  $Q_6$ , and  $Q_7$  keep all unselected column and bit lines biased to a voltage just slightly above the trip point of the sense amplifiers connected to the odd and even data buses. This bias prevents an unnecessarily large voltage transition when a bit line previously discharged to ground is accessed.

In the programming mode,  $R_N$  and  $C_N$  are charged to a value very near the programming voltage  $V_{PP}$ . If device  $Q_8$  is not to be programmed, the odd data bus is held low. The even data bus is taken to this same high voltage near  $V_{PP}$  to program  $Q_9$  to a zero.

### The sense amp

The sense amplifier (Fig. 4) is similar to that used in the 2716. It is self-biased to its own trip point via the action of  $Q_{18}$ ,  $Q_{19}$ , and  $Q_{21}$ . The trip point is set during the quiescent condition when no current is flowing from the data bus. At this point, the data bus is charged to  $V_T + \Delta V$  and node B to  $2V_T + \Delta V$  (where  $V_T$  is the threshold voltage) so that  $Q_{21}$  is on just enough to replenish leakage current into the data bus. This current is small enough that output node C is approximately at  $V_{CC} - V_T$ ; the sense amp is reading a logic 0 from the array. The quantity  $\Delta V$  is the turn-on voltage of  $Q_{19}$  required to discharge node B just far enough to turn off  $Q_{21}$ .

If an unprogrammed bit is accessed, there is a current path from the data bus to ground. This drops the data bus voltage below  $V_T + \Delta V$  and node B charges high turning on  $Q_{21}$ . Node C then drops from  $V_{CC} - V_T$  to approximately  $V_T + \Delta V$ , and the sense amp is therefore reading a logic 1 from the array.

As the data bus tries to discharge even further, it is clamped to a voltage between  $V_T$  and  $V_T + \Delta V$  by  $Q_{17}$ . Device  $Q_{17}$  is turned on at a slightly lower data-bus voltage than  $Q_{21}$ , because the gain of the  $Q_{15}$ - $Q_{16}$  inverter has been made slightly higher than the gain of the  $Q_{18}$ - $Q_{19}$  inverter.

Finally, the signal from the sense amplifier's output travels through a buffer to the multiplexer. Note that  $Q_{20}$  is a floating-gate device. It has the same geometry as the memory devices to ensure that the currents of the two devices track with all process variations.

### Block redundancy

The 2764's redundant circuitry improves yield and lowers die cost. The chip is organized as 8 K by 8 bits with 8-K by 4 bits on each side of the row decoder (Fig. 5). One block of redundant circuitry is also provided on each side of the die and includes a redundant memory matrix, column decoder, column-selecting logic, sense

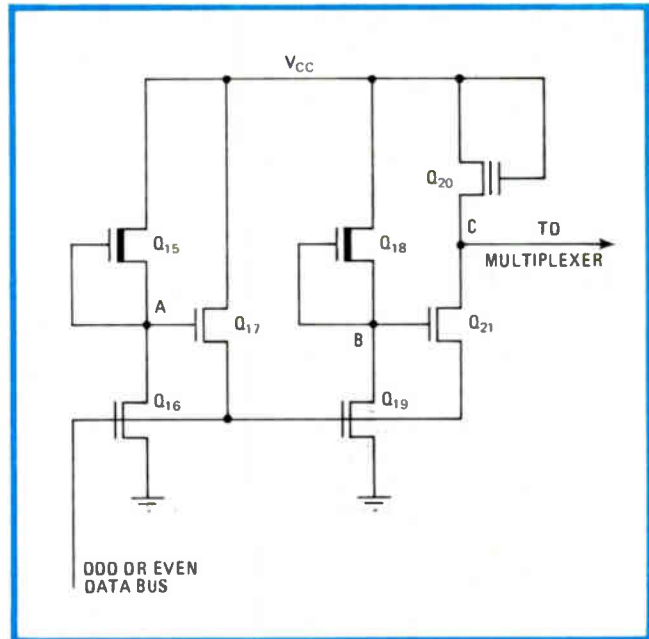

4. **Sense amp.** The sense amplifier in the 2764 is similar to that used in the 2716 16-kilobit E-PROM. As such, its trip point is self-biased. Transistor  $Q_{20}$  is a floating-gate device with the same geometry as the memory devices to ensure proper tracking with process variations.

amplifier, and data-input buffer. Note that the multiplexer, output buffer, and repair buffer are not included in the redundant circuitry. Any one of the four output buffers may be disconnected from its normal block and reconnected to the redundant block provided for that set of four normal blocks on one side of the row decoder.

If, during testing, an error is detected on an output, then the chip enable ( $\overline{CE}$ ) input is taken to 25 volts, causing repair signal RPR in Fig. 6 to rise 25 v and  $\overline{RPR}$  to fall from 5 to 0 v. Transistor  $Q_{22}$  is turned on by forcing the bad output pin to 25 v. This causes the repair buffer to blow the polysilicon fuse, which in turn changes the state of the signals controlling the multiplexers. Now input and output data flows through the multiplexer to and from the redundant matrix instead of to and from the defective memory matrix. Figure 7 shows how input and output data for the redundant block is bused to the multiplexer-output buffer-repair buffer groups that are included with each normal block.

This approach allows most memory-array defects to be repaired. In addition, it allows the replacement of bad column decoders, column-selecting circuitry, data-input buffers, and sense amps. Although many row-line defects cannot be repaired with this scheme, all individual memory-transistor problems and column problems can be eliminated. Careful yield studies of the MK2716, an E-PROM using very similar technology and architecture, indicate that the inability to fix row-associated problems does not seriously impair the effectiveness of the block redundancy.

Redundancy in a memory chip has previously been implemented by providing a few additional rows and/or columns. Though this approach uses a smaller redundant array, the overhead circuitry is large and defective column decoders or sense amps cannot be replaced, and

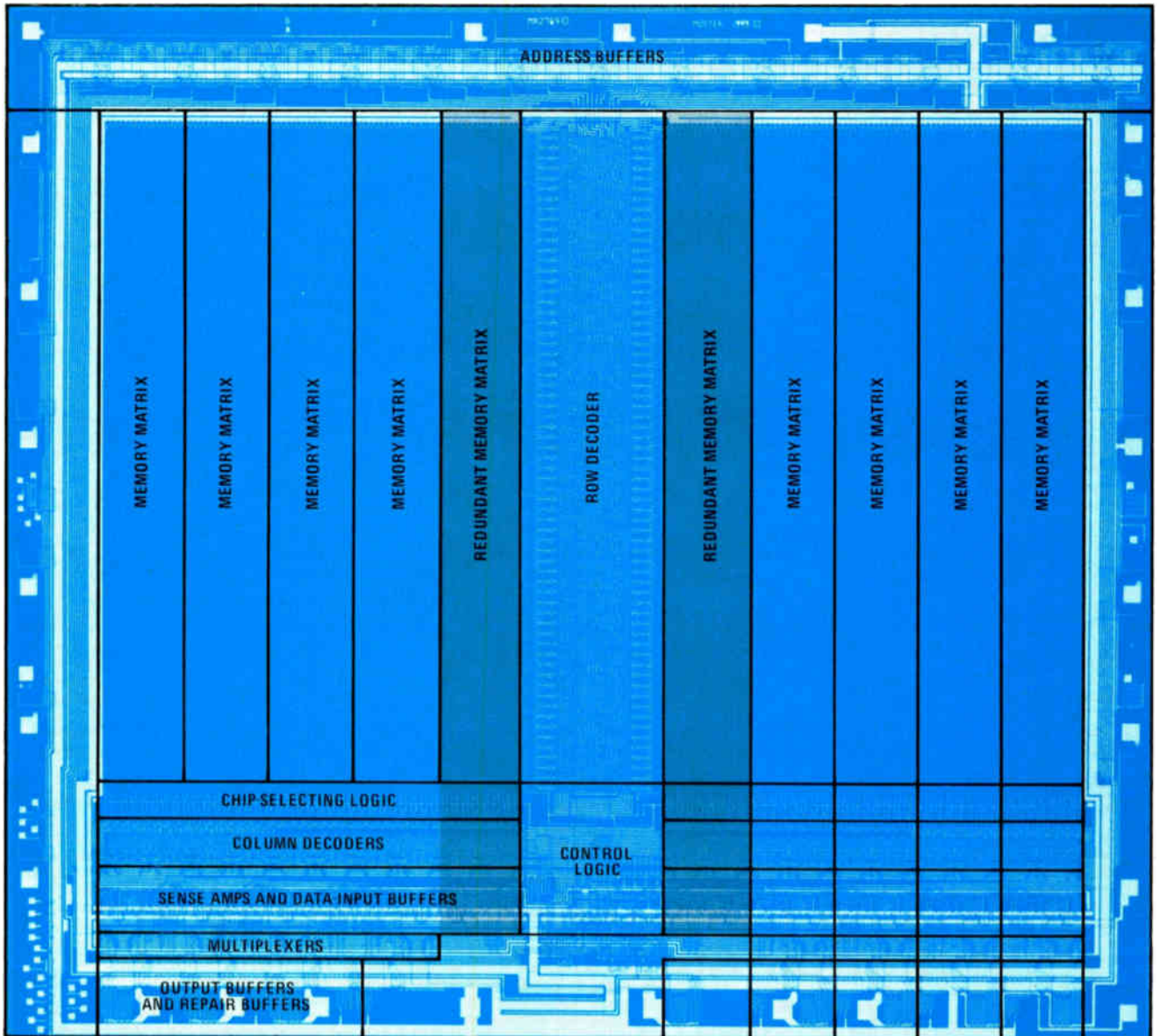

**5. Block redundancy.** The 2764 E-PROM is organized with 8-K by 4 bits on either side of the row decoder. Also on each side is an 8-kilobit block of redundant memory, as well as an extra column decoder, column-selecting circuit, and sense amplifier (darker areas).

the approach has some inherent problems of implementation. For instance, to replace a bad row or column line with a new row or column line, a decoder logic gate must be programmed to respond to the address of the bad line. The 2764 row decoder would require a NOR gate with 16 programmable transistors and the column decoders would require 10 programmable devices per redundant address line.

### Repair fuses

Polysilicon fuses are blown in the 2764 to supplant bad circuit blocks. It is not possible to use a floating-gate programmable device of the kind used in the array because the ultraviolet light used to erase the memory array would also erase the repair. The polysilicon fuse requires a series transistor to select it for programming, and since considerable power is required to blow the fuse, these series transistors must be quite large in area.

With the row-and-column approach, this adds considerable capacitance to the address line and might also add a prohibitive amount of area to each redundant decoder logic gate.

Since the 2764 cell uses a bit line that is common to two columns of data selectable by two different column addresses, a drain-to-source short or drain-to-floating-gate short in a memory transistor would be a non-repairable error unless the bad column address line is connected to ground at the same time that the new column address is activated. This would require a polysilicon fuse and considerable additional circuitry associated with each of the densely-packed column address lines. The same circuitry would also be required to repair a bit or column line shorted to either  $V_{SS}$  (the source supply voltage) or  $V_{CC}$ .

However, the redundant block approach replaces an entire array including its column decoder and sense amp,



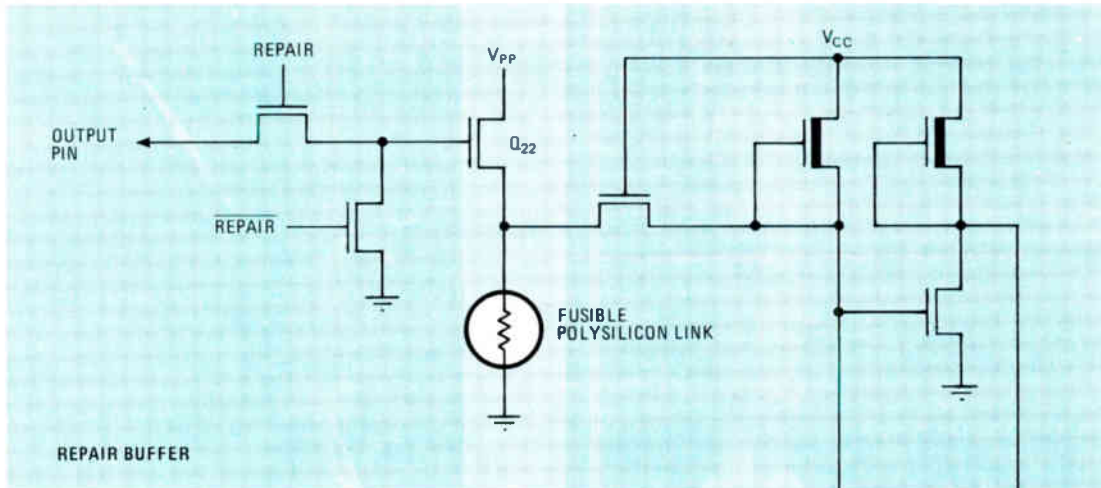

**6. Repair circuitry.** If, during testing, an error is detected on an output, the voltage of the bad output pin is raised with the repair signal active, and Q<sub>22</sub> comes on. This causes the polysilicon fuse to be blown, routing a redundant block to and from the multiplexer.

so there is no problem in repairing any of these types of defects or cluster-type failures, as they are called. Both row and column redundancy and block redundancy are capable of fixing open column and bit lines and individual bit defects.

Open row lines or row lines shorted to V<sub>SS</sub> cannot be repaired unless the decoder gate for the defective row line is permanently disabled and both ends of the row line are permanently shorted to ground. This would require two fuses and considerable additional circuitry associated with each of the densely packed row lines. Placing the row decoder in the middle of the array minimizes delay but also doubles again the circuitry required to implement row redundancy.

Although the block redundancy used in the 2764 increases the area of the array, column decoders, and sense amps by 25%, the amount of area required for a functional device does not include the redundant blocks. And though the increase in total chip area is 20%, the increase in chip area that must be operational is less than 2%. The die area required for one redundant column per output and four redundant rows significantly exceeds the area required to implement the block-redundancy approach of the 2764.

### Effect on yield

A theoretical yield analysis can be performed to evaluate the improvement in yield due to the redundant circuitry. The chip can be considered to consist of two groups of five blocks, where each block corresponds to the circuitry associated with one output. Of each group of five blocks, four are accessed in a defect-free die, and one is the redundant block. The chip is salvageable if only one of the blocks in a group of five contains defects (unless, as mentioned, row-line defects are involved).

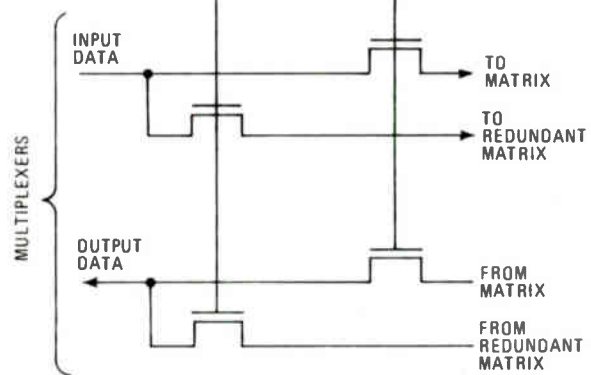

The area of each block (Fig. 3) is made up of a sense amp, a data-input buffer, half of one memory matrix, half of the column-selecting logic for that matrix, and half of that matrix' column decoder.

The uncorrectable defect-susceptible area outside the two groups of five blocks is 7.7 times the area of one block. Therefore, if one block has a probability  $x$  of being good, then the equation for the yield of the 2764 with redundancy is:

$$Y_{2764} = [{}_5C_4 x^4(1-x) + x^5]^2 x^{7.7}$$

since only four out of five blocks in each group are required to be good. The  $x^{7.7}$  term is the yield of the defect-susceptible noncorrectable area;  $x^5$  is the yield for five fully functional blocks; the  ${}_5C_4 x^4(1-x)$  expression is the yield for any four of the five blocks being good, taken from the theory of permutations and combinations; that is, the number of combinations of five blocks taken four at a time multiplied by the probability of having four good blocks and one bad block.

### Repair shop

Each redundant block in the 2764 can replace a defective block only in its group. If this restriction were lifted such that either redundant block could replace defective blocks in both groups, then the equation for the

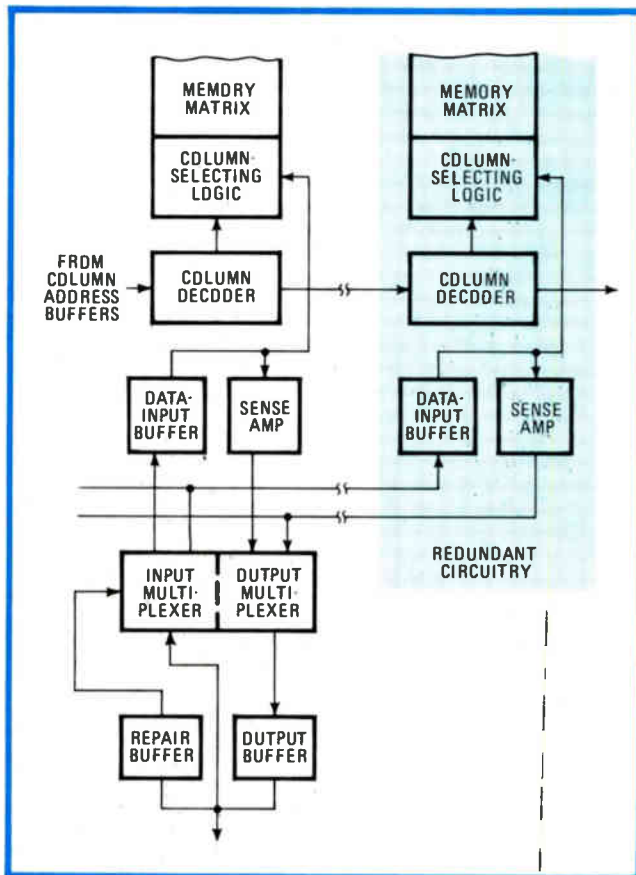

**7. Block swap.** The redundant circuit block, including column decoders, data-input buffers, and sense amp, is substituted in place of the bogus circuitry. The polysilicon fuse, having been blown as in Fig. 6, controls signal direction through the multiplexer.

yield of this hypothetical implementation would be:

$$Y_1 = [{}_{10}C_8 x^8(1-x)^2 + {}_{10}C_9(1-x) + x^{10}]x^{7.7}$$

If the 2764 were designed without redundancy, then there would be only eight blocks and the yield would become:

$$Y_2 = x^8x^{7.7} = x^{15.7}$$

To compare the yield of the 2764 to an existing part, consider the 2716, which, as mentioned, is similar in architecture, layout rules, and technology. The area of the 2716 is about 29,500 mil<sup>2</sup> and the area of the 2764 without redundancy would be about 47,500 mil<sup>2</sup>. If the same defect density in both the 2716 and the 2764 is assumed, then the yield of the 2716 would be:

$$Y_{2716} = x^{15.7(29.5/47.5)} = x^{9.8}$$

The graphic results of these four yield equations are shown in Fig. 8. Actual die size and wafer size have been taken into account so that the vertical (logarithmic) axis is the number of good dice per wafer. Note that there is a small penalty in yield due to the restriction that one block is able to replace blocks only within its own group of five. However, eliminating this restriction involves considerable circuit complexity and delay-time penalties and therefore was not implemented. The improvement in good dice per wafer—even with this restriction—over a

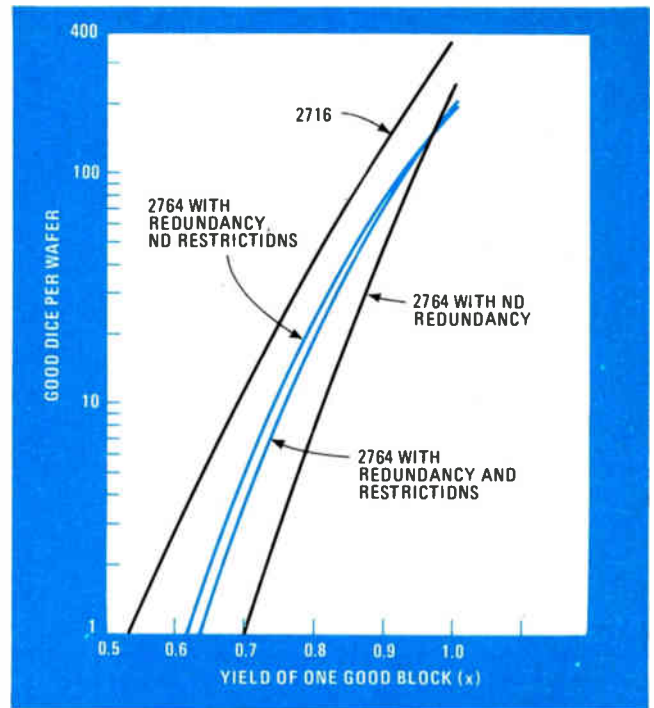

**8. Proof.** The yield of the 2764 with redundancy, based on the yield of one good block, is roughly half-way between the 2764 without redundancy and the 2716. A small penalty is paid due to the restriction that each redundant block only services its half of the chip.

design with no redundancy is very worthwhile.

E-PROM manufacturers have long ignored a major testing problem: the inability to tell how much of a threshold change has actually been programmed into a bit and how much of that threshold change has been retained. For example, if the threshold at which a bit is considered to be programmed to a logic 0 is 5.0 volts, it is difficult if not impossible to tell whether a bit has been programmed to a safe 10 v, or to a very marginal 6 v.

There is also a deprogramming problem associated with the programming mode. In any E-PROM, a memory transistor is programmed by applying a high voltage to its gate, 0 v to its source, and a high voltage through an impedance to its drain. The other memory transistors in the same row have their gates at a high voltage and their drains and sources at or near ground.

This is the deprogramming condition: with the control gate at a high voltage and with the negatively charged floating gate of a programmed transistor at a low voltage, there can be enough field strength to pull some electrons from the floating gate. Slight, otherwise undetectable variations in oxide thickness or oxide integrity can cause widely varying sensitivity to this stress condition. Although this is not generally considered a yield problem, it is important to subject each bit to its worst-case deprogramming stress so that weak bits can be detected.

In the 2764, there are 32 columns of data corresponding to each of the eight chip outputs. Thus, whenever one bit within a particular row is programmed for 50 milliseconds the other 31 bits are subjected to a deprogramming stress condition for that same time period. Moreover, by the time the 32nd bit is programmed, the first

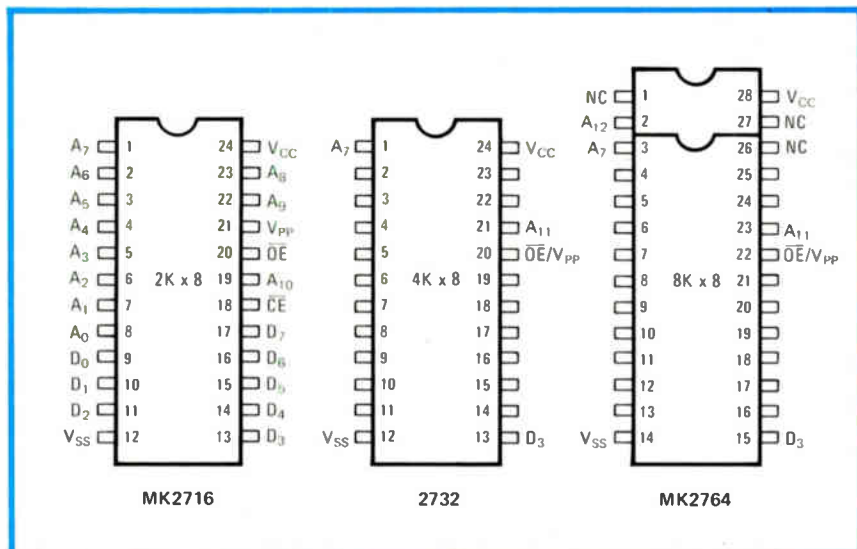

**9. Compatible.** The 2764's 28-pin DIP is a natural upward progression from the 2716 to the 32-K 2732 E-PROM to the 64-K level. Pin 1 is free, reserved for use as an address line on even higher-density devices. Pin 27 will be a write-enable line on future RAMs.

bit programmed will have been subjected to a total deprogramming stress of 31 times the programming period of 50 ms or 1.55 seconds. The second bit programmed experiences a total deprogramming stress of 1.50 seconds; the next-to-last bit only 50 ms; the last bit sees no deprogramming stress whatsoever.

If any of the last bits to be programmed are weak bits, normal test procedures may not be able to detect them. To subject all 32 bits to the worst-case deprogramming stress time, all 256 rows are programmed to all 0s, and then an attempt is made to program all 256 rows to 1s. The data should remain all 0s, however. The effect of this attempt to program a bit to a 1 is identical to the deprogramming condition. The total time required for this test adds up to about 6.6 minutes per chip.

If this test is not done, then the E-PROM user may find that some bits have marginal data retention even though the manufacturer believes all bits have plenty of margin. Some bits may fail even before the data-retention tests are made by the user. This could happen if the user's programming sequence is exactly the opposite of the manufacturer's programming sequence; that is, if the user subjects a bit to 1.55 seconds of deprogramming stress that the manufacturer had subjected to no deprogram stress at all.

The alternative chosen for the 2764 is to subject simultaneously all bits in the entire array to the maximum deprogramming stress of 1.55 seconds. This is always equal to or greater than the maximum stress time to which the user could ever subject any bit. And the total time required to test an entire chip is 1.55 to 3.10 s, instead of 6.6 minutes.

The deprogramming stress mode prompts a special logic condition within the chip that causes all address-true and -complement lines to go to a high voltage very near  $V_{PP}$ . In both the row and column decoders, the positive supply line is connected to  $V_{PP}$  while a gated ground line is opened. This forces all row- and column-decoder outputs to charge to the high voltage and all bit and column lines in the matrix to discharge to ground, thereby creating the deprogramming stress condition simultaneously for every transistor in the entire array.

Having made it possible to apply a worst-case deprogramming stress to all bits, it remains to measure exactly how much threshold voltage has been lost in each bit. A special test mode, called bit-check, has been added to accomplish this measurement. It is identical to the read mode with the exception of the voltages applied to the row decoder.

In varying  $V_{PP}$  from 0 to about 15 v (the trip point of the  $V_{PP}$  high-voltage detector), the selected row line can be varied from 0 to nearly 15 v. If  $V_{PP}$  is ramped relatively slowly over this range, each chip output will switch from a 0 to a 1 when  $V_{PP}$  exceeds the apparent threshold of the addressed bit. This data is automatically recorded immediately after programming.

The devices are subjected to a second data-retention test, including a deprogramming stress, and then run through the bit check mode again. The new data is then compared to the old data. It may be found that an apparent threshold of 10 v has dropped to only 6 v. Although this bit would read correctly in the read mode, it is obviously headed for disaster and should be rejected. After careful characterization and correlation, it is also possible to reject devices because the rate of change of the stored threshold is too high, even though the threshold itself still has plenty of margin.

### Packaging considerations

The 2764 was designed for a 28-pin package consistent with Mostek's byte-wide concept, which permits random-access memory, ROM, and E-PROM interchangeability. Figure 9 demonstrates the natural upward progression from 2716 to 2732 to 2764. Note that both the output-enable ( $\overline{OE}$ ) and chip-enable ( $\overline{CE}$ ) control functions are preserved at all densities.

ROM and E-PROM interchangeability has existed for some time. This convenience is used to reduce nonvolatile memory cost by substituting a ROM for an E-PROM in high-volume applications after system confidence has been established. For this reason Mostek is introducing a matching 8-k-by-8-bit ROM, the MK37000, with the same pinout as the 2764. The 37000 is a variation of the successful MK36000 64-k ROM.



TRUTH TABLE: SIGNAL-LEVEL INDICATOR

INPUT $V_{in}$	$A_4$								$A_5$								LED					
	D	C	B	A	$\overline{BI}$	$\overline{BI}$	a	c	e	g	D	C	B	A	$\overline{BI}$	a	d	e	f	2	3	4
below 10%	0	1	1	1	1	1	0	0	1	1	0	1	1	1	0	0	1	1	1			$\lambda$ (+6 dB)
10% to 20%	X	X	X	X	X	0	1	1	1	1	0	1	1	0	0	1	0	0	0		$\lambda$	( 0 dB)
20% to 40%	0	1	1	1	1	1	0	0	1	1	0	1	0	0	0	1	1	1	0	$\lambda$		(-6 dB)
40% to 60%	0	1	1	1	1	1	0	0	1	1	0	0	0	0	0	1	1	1	1	ALL OFF		(underrange)
60% to 70%	0	0	1	1	1	1	0	0	1	0	0	0	0	0	0	1	1	1	1	$\lambda$		(-6 dB)
70% to 90%	0	0	0	1	1	1	1	0	1	1	0	0	0	0	0	1	1	1	1		$\lambda$	( 0 dB)
above 90%	0	0	0	0	1	1	0	0	0	1	0	0	0	0	0	1	1	1	1			$\lambda$ (+6 dB)

X = don't care Input voltage  $V_{in}$  normalized to full scale at pin 5 of LM3914

output of  $A_2$  is equal to  $V_{in}R_2(k+1)/(R_1+R_2)$ . Thus positive and negative excursions of the ac signal will be detected by the LM3914. The scale factor is adjusted by applying the user-standard audio level to the input and adjusting  $R_1$  and/or  $R_2$  until the 0-dB LED just lights up.

The truth table outlines the overall operation of the circuit as a function of signal level. Note that the e segment of the low-order 6 shunts LED 2 in order to resolve a switching conflict between the 4 and 6 outputs. The 6 is also used to blank the high-order decoder when a negative-going 0-dB level is detected.

The values of the current-limiting and pull-up resistors depend on the logic family utilized; for TTL devices, 1-k $\Omega$  components will suffice throughout. Care must be taken

to ensure that the voltages developed at the e output satisfy the noise-margin requirements of the BI input of  $A_4$ ; that is, the total sink current at e must not raise the voltage above the maximum logic 0 level and the drop across LED 2 in series with the sink transistor must exceed the minimum logic 1 level.  $R_8+R_9$ , in parallel with  $R_7$ , set the sink current of the outputs of the LM3914.

The programmed current must be high enough to saturate the output transistors given the pull-up resistors used. The values of most of the other resistors are determined by the values of  $R_7$  through  $R_9$ . The value of  $C_1$  is determined by the value of  $R_4$  and the lowest frequency of  $V_{in}$ .  $\square$

## Low-level modulator sweeps generator over narrow range

by Ralph Tenny  
George Goode & Associates, Dallas, Texas

A typical function generator's ability to sweep over a 1000:1 range of frequencies by means of an externally applied 0-to-10-volt modulating signal certainly enhances its usefulness. But sometimes narrow-range sweeps on the order of kilohertz are also needed, to check the response of a precision resonant circuit, for example. The problem is that, in most cases, the unit's front-panel controls cannot provide the required resolution. The one-chip circuit shown here, however, enables the setting of any dc voltage and provides for sweeping the control signal over a minimum of  $\pm 0.1\%$  of its value so that modulation of the preset center frequency will yield a proportionally small frequency variation.

Operational amplifier  $A_1$  serves as a 6-v source for biasing the inputs of  $A_2$ - $A_4$  at half the supply voltage, enabling the circuit to operate from a single supply (a).  $A_2$ , an integrator, and  $A_3$ , a voltage comparator operating with heavy feedback, generate the 100-hertz triangle wave needed to sweep the generator and the x input of

the oscilloscope used to display the response of the circuit under test.  $A_4$  is a simplified Howland Pump<sup>1</sup>, or bilateral current generator, which takes part of the sweep signal and uses it to modulate the preset dc voltage that drives the function generator.

When switch  $S_1$  is placed in the manual position and  $R_3$ 's arm is positioned at its extreme end (toward  $R_2$ ), the signal at the modulation output is dc, its amplitude determined by the setting of potentiometer  $R_2$ .  $R_2$  is thus used to set the center frequency of the function generator.

The dc value is modulated by placing  $S_1$  in the sweep position and adjusting  $R_3$  for the desired frequency sweep. Note that  $R_3$  approximates a summing junction for the preset dc level and a fraction of the sweep voltage in this application.

The setup in (b) illustrates a typical application for the circuit, whereupon it is necessary to characterize the response of a quartz crystal that has resonant and antiresonant frequencies less than 3 kHz apart. The frequency counter should be driven by the trigger output of the function generator to avoid interference with the crystal drive. The function generator's output is isolated from the crystal by a large resistor. A low-capacity oscilloscope probe should be used, and the effect of the probe's capacity on the measured crystal frequency taken into consideration. A manual control switch allows the operator to measure the resonant and antiresonant frequencies

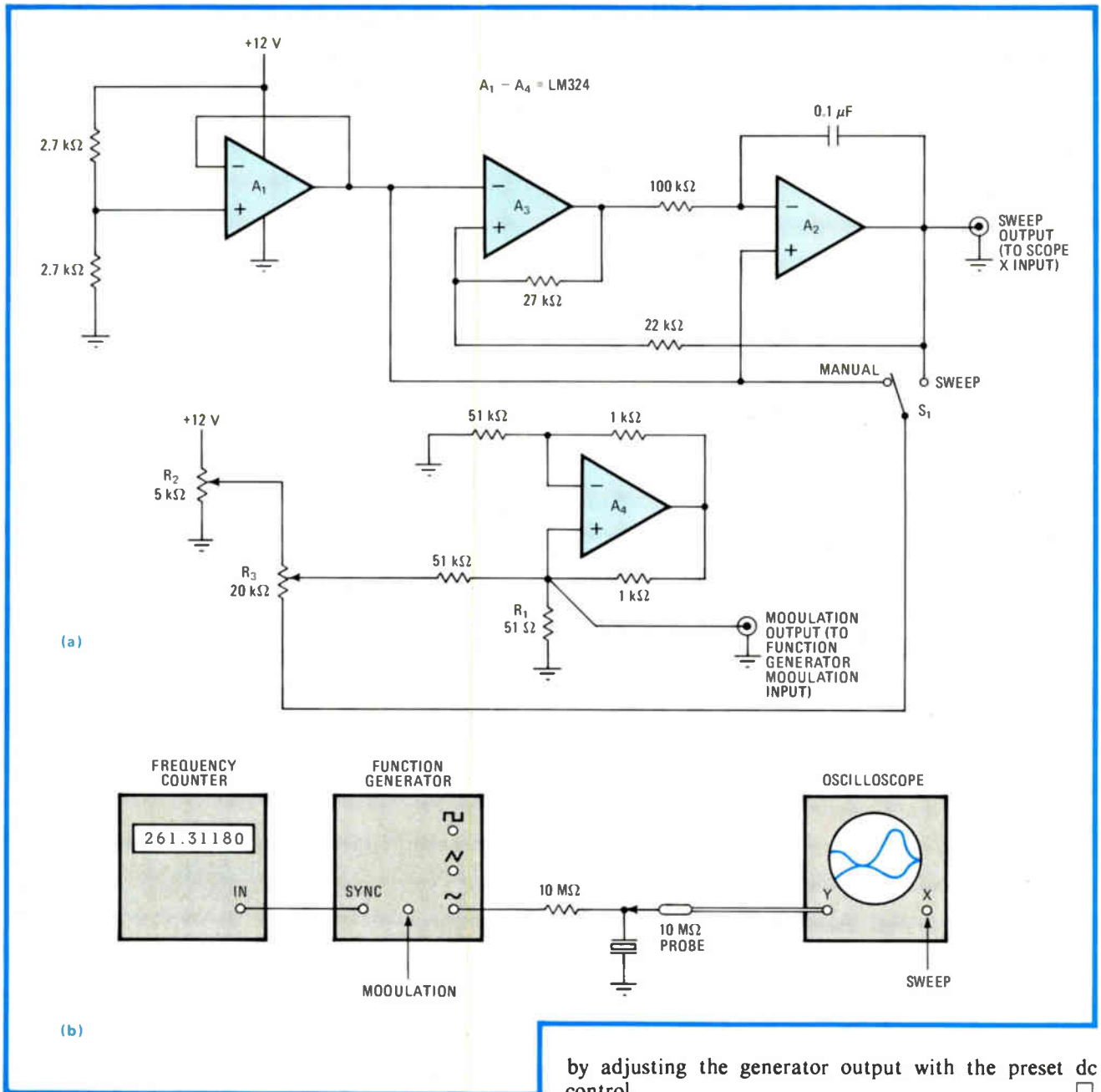

**Small scan.** Low-level modulator (a) superimposes small fraction of 10-V triangle wave on preset dc voltage so that externally driven function generator can be swept over very narrow ranges not normally within the resolving power of unit's front panel controls. In typical application (b), response of crystal and isolation of its resonant and antiresonant frequencies are displayed and recorded.

by adjusting the generator output with the preset dc control.

**References**

1. Applications Manual for Computing Amplifiers, III.6, p. 66, George A. Philbrick Researches Inc., 1966.

Designer's casebook is a regular feature in *Electronics*. We invite readers to submit original and unpublished circuit ideas and solutions to design problems. Explain briefly but thoroughly the circuit's operating principle and purpose. We'll pay \$50 for each item published.

## Module activates appliances at preset clock time

by Leslie D. Paul  
Madison, Wis.

An inexpensive alarm clock module and an appropriate interface let this circuit activate or shut off any system at a time preselected by the user. The hours and minutes readout of its clocked liquid-crystal display allows direct and precise setting of the desired time, a major advantage over many commercial electromechanical units.

The module used is the Archer 277-1005, available from Radio Shack for about \$20. The time of day is set



# Superior X-Y value.

**Now, a high performance X-Y recorder without a high price.** Introducing the Gould 3054, the X-Y recorder with value superior to any other analog recorder in its price or performance ranges. It's the first of an all-new series of high performance X-Y recorders designed to handle a broad range of applications in industrial, scientific, and biophysical measurement. For a much lower cost than you'd expect, the new Gould 3054 gives you the fast, sensitive response needed to provide precise, permanent records of the relationships between two analog variables.

The new Gould 3054 offers performance and features normally found only in much more expensive, less flexible instruments. The high speed drive system provides for high system fidelity with a minimum slewing speed of 85 cm/sec and

accelerations of 7700 cm/sec<sup>2</sup> in the Y-axis and 5100 cm/sec<sup>2</sup> in the X-axis. Advanced X- and Y-axis preamps with sensitivities down to 200 $\mu$  V/cm ensure recorder flexibility.

In use, a simple, disposable fiber-tip pen system provides a high quality fine line trace. Improved electronics servo protection ensures instrument reliability. Also included are calibrated zero offset, a switchable low pass filter, and switchable input polarity reversal. Plus, an optional time base is available.

Find out more today about what makes the new Gould 3054 superior to anything in its price or performance ranges by writing Gould Inc., Instruments Division, 3631 Perkins Avenue, Cleveland, OH 44114.

**For brochure call toll-free: 800-331-1000.  
In Oklahoma, call collect: 918-664-8300.**

 **GOULD**

An Electrical/Electronics Company  
Circle 126 on reader service card

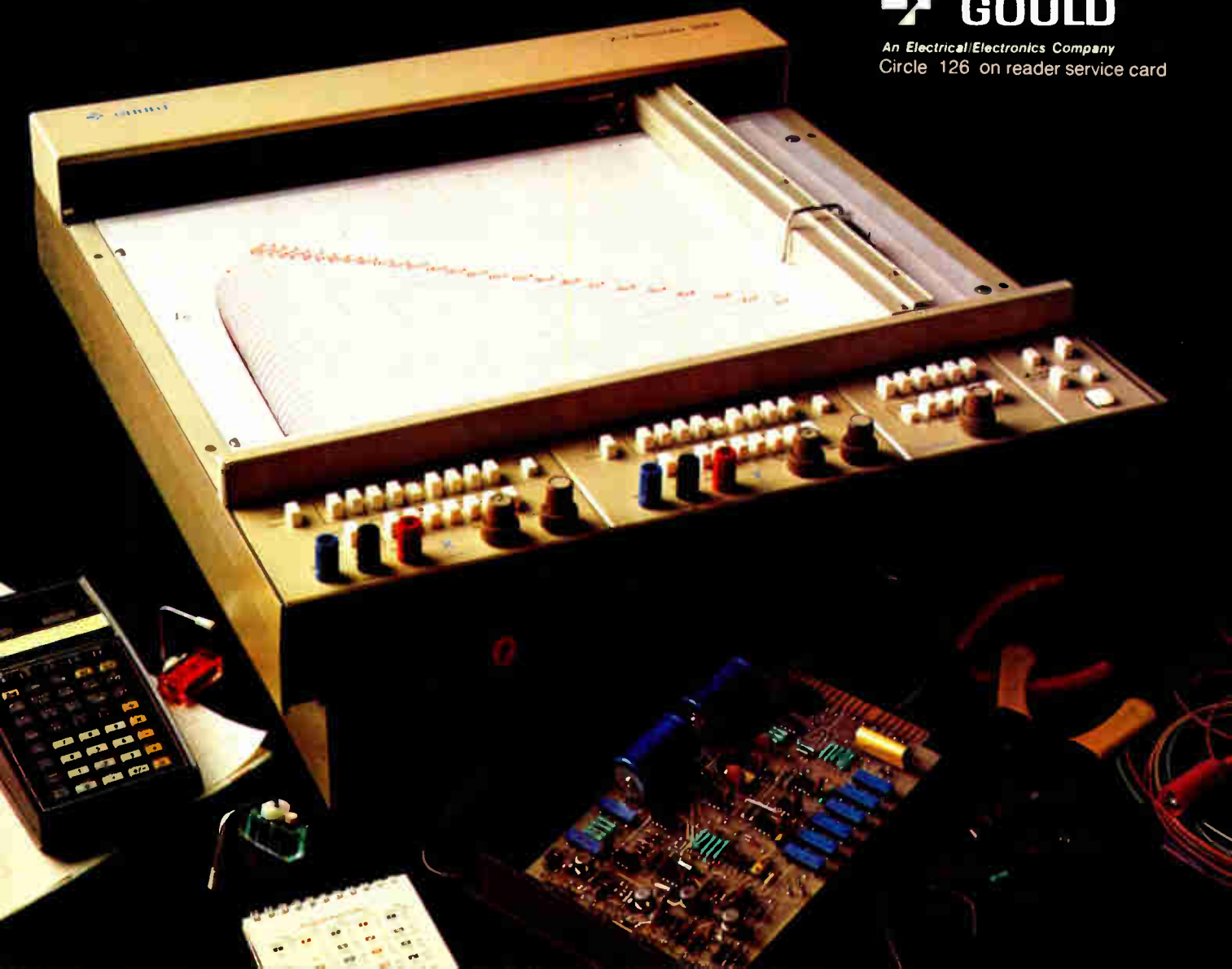



## Special report

# Display technologies offer rich lode for designers

Efficiencies, brightness levels, and the number of colors rise; panels grow larger, and systems gain microprocessor intelligence

by Roger Allan, *Components Editor*

□ *Developments abound in several alphanumeric display technologies. Many of the technologies that were struggling for a position in the marketplace during the 1970s have now come of age. Liquid-crystal, ac and dc plasma, vacuum fluorescent, ac electroluminescent, as well as the venerable light-emitting-diode displays are all crowding center stage. The LED, despite significant performance advances, no longer dominates the alphanumeric display market as it did back in the 1970s.*

*A cornucopia of digital alphanumeric display products is available in a variety of shapes, sizes, colors, and formats, from one or two to thousands of characters in picture-frame-thin flat panels. Even analog displays are proliferating in the form of bar graphs.*

Displays are being integrated upwards into intelligent subsystems, complete with power supply, driver and decoder circuitry, and interface and microcomputer electronics on the same printed-circuit board. And they're showing up in a host of new applications—word processors, gasoline pumps, automobile dashboards, point-of-sale terminals, and many electronic games and consumer appliances. Among the trends:

■ A maturing LED technology offers increasing intelligence, efficiencies, and power-handling capabilities. More and brighter colors, better multiplexing, and more intelligence (microprocessor-based control) in LED displays are now available.

■ Large strides are being made in improving liquid-crystal-display multiplexing, LCD operating-temperature range, and viewing angle. New dichroic LCDs can now display in colors. LCD panels are also coming on the scene.

■ Vacuum fluorescent displays are making inroads into highly competitive markets like auto dashboards, calculators, and electronic games, aided by their high brightness and multiple-color ability, their low power dissipation, and low cost.

■ Ac plasma panels have matured to the point where

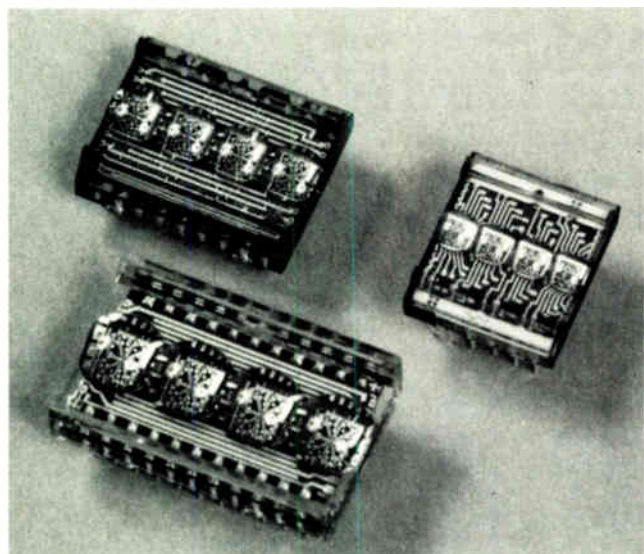

**1. Intelligent.** Memory and driver/decoder circuitry is integrated on the same chip with the light-emitting diodes in these modules. Litronix' DL2416 (left), DL1414 (right), and DL3416 (bottom) have character heights of 0.160, 0.112, and 0.220 inch, respectively.

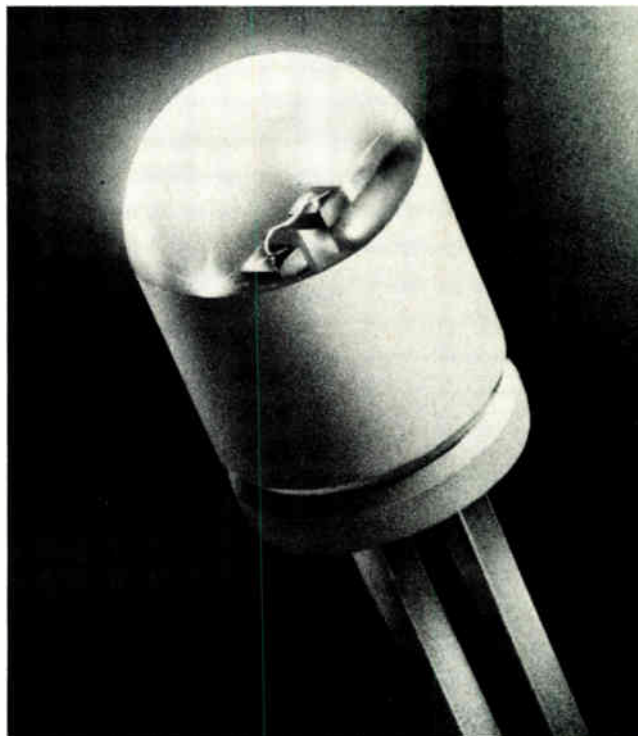

**2. Bright.** The light output of some gallium phosphide LED lamps is so great that they are comparable to incandescent bulbs. Each lamp in the Illuminator series from General Instrument Corp. is actually two LED chips mounted in a clear injection-molded plastic package.

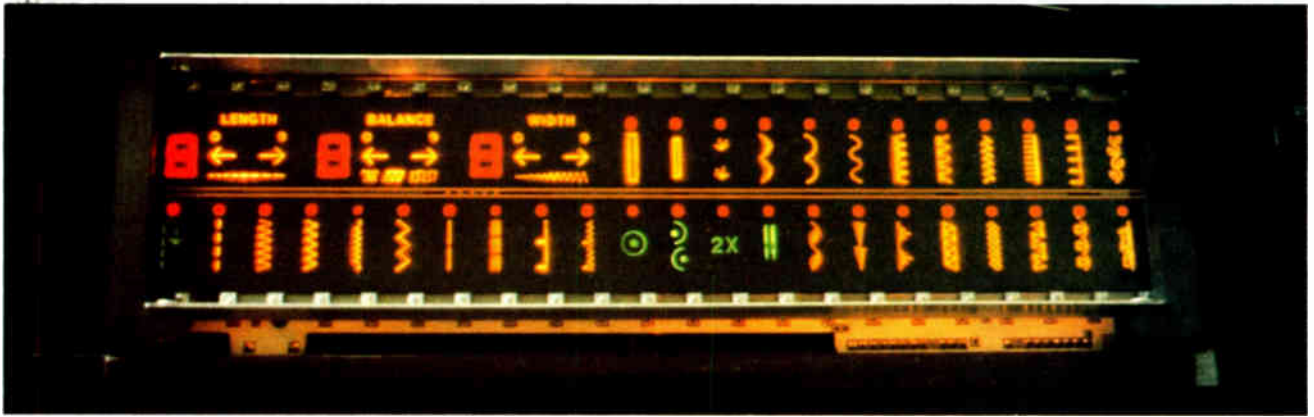

**3. Rainbow.** This spectrum of red, yellow, and green is found on the front panel of the Singer Touch Tronic 2001 sewing machine. These GaP LEDs, and the microprocessor-based controller that goes with them, are made by Opcoa.

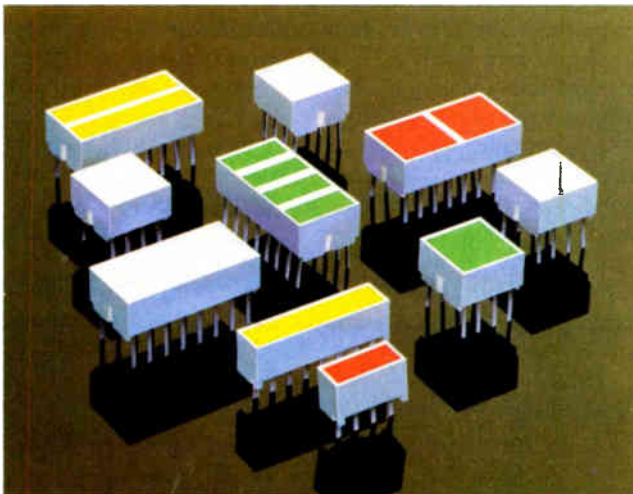

**4. Colorful shapes.** LED bar modules in several shapes with light output that is optically scattered for even backlighting make up the Bold family from Hewlett-Packard. Each has four or eight LEDs.

they are the leaders in the field of large-scale flat-panel displays capable of supporting a few thousand alphanumeric characters, along with graphics. Over a dozen companies, many of them large corporations, are actively engaged in ac plasma panel work, much of it for military applications.

- Dc plasma panels are rapidly establishing a strong market position in display applications requiring from a dozen to a few hundred characters. Complete panels with up to 480 characters are now available.

- Intensified research and development in thin-film ac electroluminescent displays is beginning to pay off. Recent product introductions and work in thin-film transistor matrix addressing promise that ac thin-film electroluminescent technology will be a major contender for future large-scale flat-panel displays.

- Work is continuing on electrochromic and electrophoretic displays for future multicolor large-scale panels. Recent developments point to the potential viability of electrochromic display technology within the next few years.

Despite the emergence of LCDs, gas-discharge and vacuum fluorescent displays as competitors, LEDs remain very popular for alphanumeric and trend displays, with

good reason. They can operate over a very wide temperature range (from  $-55^{\circ}$  to  $+100^{\circ}\text{C}$ ), emit light of a number of colors (principally red, green, yellow, and orange), have rapid response times (they can be switched in about 1 microsecond), and are logic-level-compatible, operating from a 5-volt supply. In addition, LEDs have proven their reliability in the field, with upwards of 100,000-hour lifetimes. Their availability in both dot-matrix and segmented forms together with on-board multiplexing and microcomputer electronics allows them to display highly versatile fonts.

At present, green, yellow, and orange LEDs are more expensive than standard red ones, but the price differential is narrowing. Blue LEDs not have yet been marketed commercially, but development efforts are under way to make them more practical at several laboratories, such as that of Siemens AG, Munich, West Germany.

#### LEDs gain efficiency

LEDs made with gallium phosphide and gallium arsenide on gallium phosphide, higher-efficiency devices than the first-generation gallium arsenide phosphide devices, are now readily available in many sizes, shapes, and colors. Their increased brightness levels and efficiencies are making it possible to pack LED chips closer together, giving rise to esthetically pleasing multisegmented displays.

Another example of the new brightness levels achieved by LEDs will be seen in a series of red and green units soon to be introduced by Stanley Electric Co., Tokyo. Made using a new liquid-phase crystal-growth process, the LEDs will have typical light-output levels of 160 millicandelas at a drive current of 20 milliamperes. The company reportedly developed the new LEDs as an outgrowth of its work in a research and development program, directed by the Japanese government, aimed at increasing the efficiencies of LEDs.

The trend is to intelligent LED displays under microprocessor control, like the HDSP-2440 from Hewlett-Packard Co., Palo Alto, Calif. It is available in 16-, 24-, 32-, and 40-character models put together from the firm's HDSP-2000 LED modules, each of which has four 0.15-inch-high characters in a 12-pin dual in-line package. The characters are five-by-seven-dot matrixes. The microprocessor allows alphanumeric text to be scrolled

either left or right and to be updated a block at a time.

General Instrument Corp.'s Optoelectronics division (formerly a part of Monsanto), Palo Alto, Calif., will shortly unveil a single-line 24-character intelligent alphanumeric LED display, with 16- and 32-character versions to follow. One version of this interactive unit interfaces with an 8-bit bidirectional data bus; another connects to a serial RS-232-C line for remote display applications such as data-entry terminals, interactive bus controllers, communication message centers, and instrumentation. The 0.135-inch-high, 14-segment characters are formed by red GaAsP LEDs. The serial version operates in full- or half-duplex transmission modes and with a parallel ASCII keyboard.

This intelligent display's features include left and right data entry, horizontal scrolling, carriage return (line feed), blinking cursor, editing capabilities, two levels of brightness, and a self-testing mode. Each character position is addressable by hardware and software commands. The display and its electronics are mounted on two printed-circuit boards, which can be sandwiched together or separated, communicating via a ribbon cable. The LEDs and driver/decoder circuitry are on one board, the microprocessor and interface electronics on the other printed-circuit board.

Several other companies offer intelligent LED assemblies, including Litronix Inc., Cupertino, Calif.; Texas Instruments Inc., Dallas; Industrial Electronic Engineers (IEE) Inc., Van Nuys, Calif.; Plessey Optoelectronics, Irvine, Calif.; and Opcoa Inc., Edison, N. J.

The concept of an intelligent display was introduced by Litronix Inc., Cupertino, Calif., in 1977, with a four-digit 16-segment alphanumeric chip with 1/4-inch-high characters and on-chip memory and driver/decoder circuitry for ASCII interfacing. The company makes three other intelligent displays (Fig. 1) and plans to have a 0.112-inch-high eight-digit version ready within five months; a 22-segment LED with 0.22-inch-high upper- and lower-case characters is also in the works, and development work is being done on an interactive microprocessor-based display system. The latter is a four-digit intelligent display assembly that can be stacked to make displays as long as 32 characters. A controller card with a microprocessor, decoder/drivers, and buffer electronics will have system software in read-only memory and self-diagnostic features.

The high brightness levels of new GaP LEDs is making them attractive for indicator lamps, competing in some cases with the venerable incandescent lamp. The newest such products are the Illuminator LED lamp series from General Instrument (Fig. 2). Designated the MK9150/MK9350, the GaP lamps offer light output comparable to that of incandescent bulbs and are reportedly 10 times brighter than other high-efficiency LEDs on the market. In addition, they offer higher reliability and longer life than incandescent lights. Each lamp consists of two LED chips mounted in a clear injection-molded nylon package.

Available in orange and yellow with green to follow, they can be filtered to produce a high-efficiency red. Up to half a watt can be dissipated by each lamp, allowing easy backlighting of panel areas up to 1 inch square.

The indicator lamps have a viewing angle of 140°.

The greater power levels at which LEDs can now operate also means more heat dissipation, a limitation for LEDs when large numbers of them are to be used close together for high display densities. Michael Bottini, marketing manager of General Instrument's Optoelectronics division, feels that "getting higher output luminance levels from LEDs than what is available in our Illuminator series is a problem, since heat has to be dissipated somewhere. The 0.5-W input power level of the Illuminator series is probably the practical limit for now."

### More LED colors

Methods used to increase the LED's color capability include wiring LED pairs in different ways. For indicator applications where dual colors are needed (red and green or yellow and green), a pair of GaP LEDs can be hooked up in antiparallel (the cathode and anode of one are connected to the anode and cathode of the other, respectively) to provide one color as current flows one way and another color as current flows in the other way. LED manufacturers like Opcoa and AEG-Telefunken Corp., Somerville, N. J., have begun offering two-color LED chips of this kind.

Another type of two-color LED makes use of a three-terminal arrangement in which the two LEDs are in a common-cathode configuration, allowing one or the other to be driven for two colors like red and green. Multiplexing the two LEDs allows a mixture of the two colors to be produced.

LED reliability and brightness have opened up new market applications. For example, Singer Co. uses Opcoa's GaP LEDs in the Touch Tronic 2001 electronic sewing machine to produce red, green, and orange colors on the machine's intelligent memory panel. In fact, Opcoa supplies Singer with the entire intelligent display

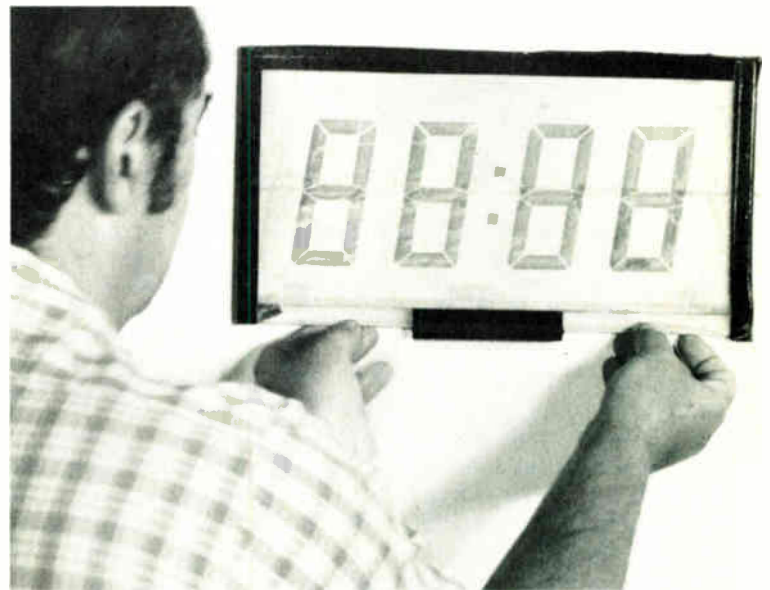

**5. Growing tall.** Because the height of a liquid-crystal display is a function of the glass plates used, extra-large characters can be made inexpensively. The LCD shown is from UCE Inc., which makes other gargantuan displays with characters up to 18 inches high.

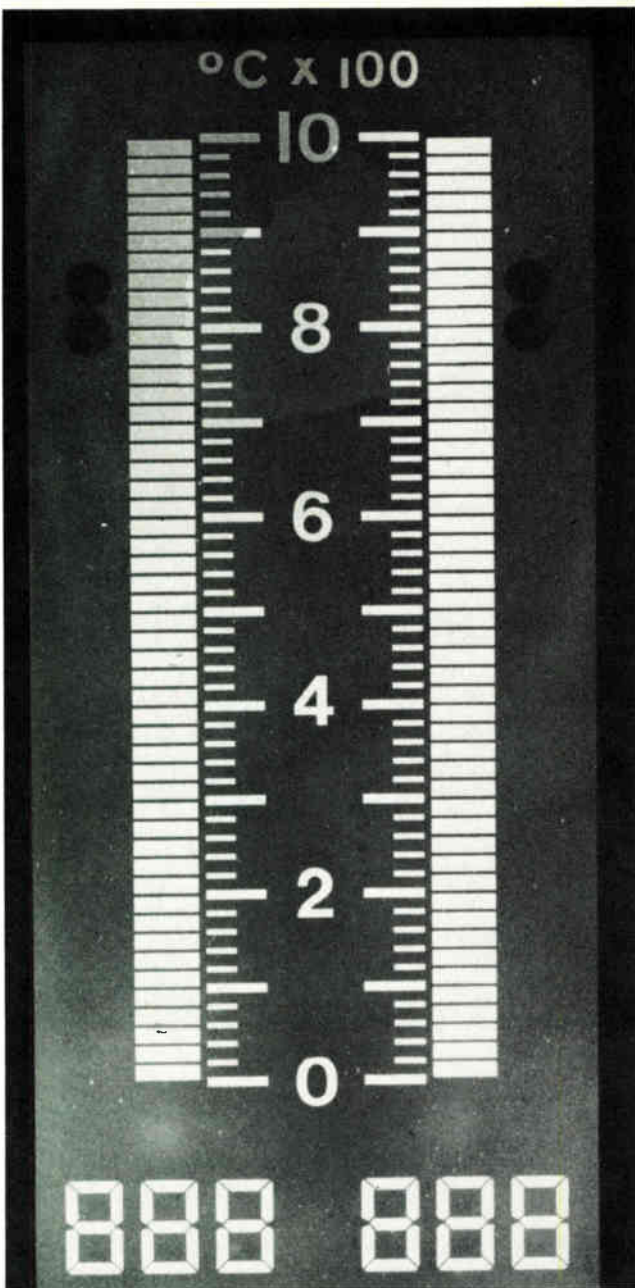

**6. Patterns unlimited.** LCDs are popular for bar graphs and other analog graphics because the silk-screen patterning process is flexible, providing resolution as high as 100 lines per inch. This thermometer bar is from Optel, a division of Refac Electronics.

assembly, complete with the microprocessor and driver/decoder electronics on the pc board, a trend toward systems integration of LEDs that many LED vendors are following (Fig. 3).

Opcoa is working on a multichip GaP LED for outdoor truck-cab applications in place of the present incandescent lamps. The firm has also made a prototype GaP 16-inch multidiode light bar that operates directly off 115 v ac for use in copying machines. According to Saul Lederhandler, Opcoa's general manager, the light bar's uniform high brightness (less than 1% variation in intensity) makes it an attractive replacement for incandescent lamps now being used in copying machines.

The light bar is just one of many shapes LEDs are finding themselves in as indicating devices. Other forms include light-bar modules, light sticks and even some panels (Fig. 4). Telefunken will be introducing a light-

stick LED array for an radio tuning indicator in which a row of closely spaced LEDs scan the radio's tuning range, turning on and off in a "flying dot" format.

In a related development, Telefunken will be introducing to the U. S. market an LED array driver that can drive up to 30 LEDs in a linear array with only eight control lines. A patent has been applied for in connection with the data-compression technique embodied by the device.

High LED brightness levels have made them useful for panel displays such as those in car dashboards and aircraft cockpits. General Instrument and Hewlett-Packard are supplying General Motors with yellow 3½-digit numeric displays for use in top-of-the-line dashboards. Litton Data Systems, Los Angeles, Calif., a division of Litton Industries Inc., has a number of military programs for developing LED flat-panel displays. Leon Bloom, Litton's director for advanced Army and Air Force programs, reports that Litton has been working on flat panels for military applications for the last six years and is now about a year away from its goal of developing a low-cost LED large-screen display for the military. "We're working on a 39-by-39-inch flat panel using a resolution of 22 LED pairs to the inch for the U. S. Army. Our primary obstacle is cost, which is not just the driver/decoder electronics, but the cost of labor. We're now working on trying to automate the labor-intensive process of making LED flat panels," he explains.

As to why Litton chose LED technology for flat panels when most other companies building flat panels have ruled them out (since LEDs tend to wash out in direct sunlight unless driven very hard), Bloom explains that Litton has looked at other flat-panel technologies, including plasma panels and electroluminescent panels, and has found that LEDs best suit their requirements, despite their high power-dissipation levels and subsequent heat generation. Litton's Toronto, Canada, division has built a 3-by-4-inch LED flat panel for the U. S. Air Force's Flight Dynamics Laboratory at Wright-Patterson Air Force Base. The 8-inch-deep display, with resolution of 64 LEDs per inch, includes map-moving mechanisms, electronics, and power supply.

#### Liquid crystals are coming on strong

For a display technology that had severe performance limitations little more than a year ago, LCDs are making tremendous strides in performance. This can be gauged by the sheer number of companies, many of them with the backing of large corporations, getting into the LCD business. On the other hand, the large competitive pressures of the LCD market have caused some companies, like Motorola Inc., Phoenix, Ariz., to drop out of the LCD business [*Electronics*, Feb. 28, 1980, p. 48].

The first-generation dynamic-scattering LCD material is rarely used any more, and the higher-performance twisted-nematic materials are now in favor. But still newer dichroic materials with color capability point to the possibility of LCDs competing in large-panel applications. The dichroic materials do not use polarizers, thus eliminating a cost factor.

The elimination of a polarizer also eliminates the restricted angle of viewing caused by the polarizer and

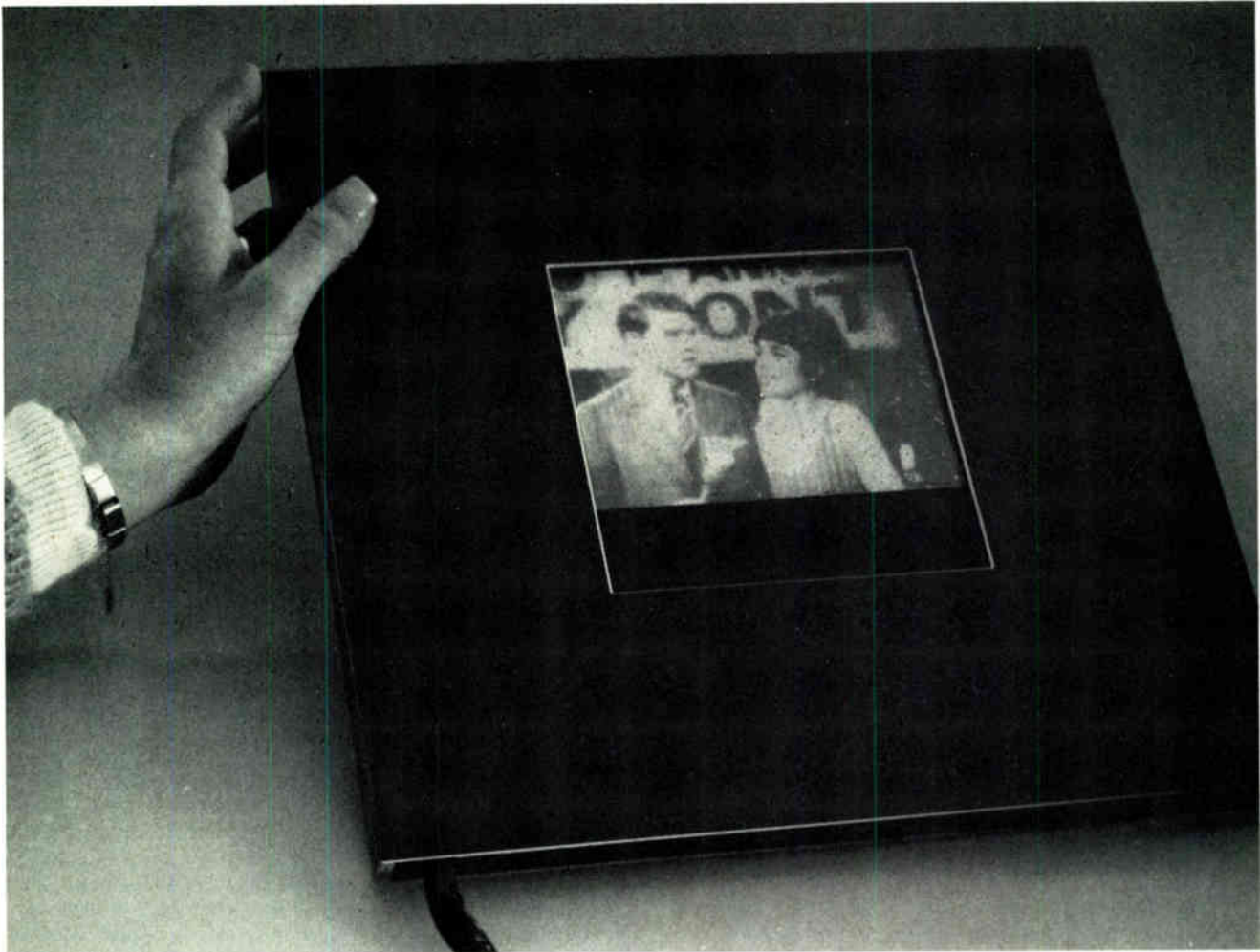

**7. Thin-film drivers.** This ac electroluminescent TV panel has elements addressed by a matrix of thin-film transistors. Built by Westinghouse for the Massachusetts Institute of Technology under a Government-sponsored program, the 5.5-inch-square panel has 165 by 128 elements.

alleviates the reliability problems related to it. A disadvantage of the new dichroic materials is that they have shorter lifetimes and require higher operating voltages than conventional twisted-nematic materials, typically about 1,000 hours and 22 v (compared to 50,000 hours and 3.5 v) and draw a few more microamperes of current per character, although this last difference is not considered significant by many display experts. And despite the lack of a polarizer, dichroic LCDs cost more to make than twisted-nematic LCDs. Dichroic LCDs are made by adding cholesteric and dye materials to the conventional twisted-nematic LCD material. The lifetime problem is related to dye bleaching caused by the ultraviolet component of sunlight.

The high-volume markets for LCDs are watch and calculator displays, formerly monopolized by LEDs. However, many smaller-volume applications are developing rapidly, as a result of the LCD's large size, low cost, and improving operating parameters, typified by practical operating-temperature ranges as wide as  $-10^{\circ}$  to  $60^{\circ}\text{C}$ , better multiplexing capability, enhanced contrast levels, and wider viewing angles. Because LCDs are easy to manufacture and character heights are a function of the size of the surrounding glass, tall characters (as high as several inches) can be made inexpensive-

ly. An example from UCE Inc. is shown in Fig. 5

New LCD applications include displays for gasoline pumps, consumer appliances, clocks, portable battery-operated instruments, wind-speed indicators, digital depth and fish finders in marine applications, point-of-sale terminals, word processors, hand-held light meters for photography, digital panel meters, and medical instrumentation. Looming on the horizon are automotive, avionic, and agrionic (tractors, farm implements, and so on) applications, which several LCD manufacturers are working on penetrating.

At the recent annual congress of the Society of Automotive Engineers in Detroit [*Electronics*, Feb. 28, 1980, p. 44], LCD manufacturers discussed systems intended for future use in automobile dashboards. Among the companies involved were the Crystaloid division of Samuel Moore and Co., Hudson, Ohio, and Mitsubishi Electric Corp., Tokyo. Mitsubishi reported on a new blend of liquid-crystal materials that has an extended operating-temperature range, from  $-40^{\circ}$  to  $85^{\circ}\text{C}$ . A key to its low-temperature performance was the addition of an antifreeze mixture, phenylcyclohexane-biphenyl-ester.

LCD applications break down into four main areas, each of which makes use of one or more of the LCD's unique operating characteristics: outdoor, where the LCD

competes with incandescent bulbs (automotive, marine, gas pumps, and so on); low-power and high-ambient-light applications where the LCD's microwatt power dissipation and readability in sunlight make it an excellent candidate for many portable instruments; medical instrumentation; and applications in need of high information density.

The fact that LCDs can be easily patterned with techniques like silk screening is making them a popular choice for bar graphs and panels (Fig. 6). Resolutions of 40 lines per inch are fairly easy to obtain and can be as high as 100 lines per inch, more than enough for any high-density information display. Thomas Boyer, general manager of the Optel division of Refac Electronics Corp., Princeton, N. J., feels that LCD flat panels will evolve as cathode-ray-tube replacements, given their low cost of manufacture.

"The present price of about \$100 for some 8 to 32 LCD digits makes them potentially competitive with the CRT," he says. "Two problems must still be solved, however, before this can happen. A wider operating-temperature range and a better angle of viewability are needed in standard twisted-nematic low-cost LCDs." The cold-operation problem can be partially solved with the use of heaters. This solution, however, means more power dissipation and is not acceptable in many applications, although the use of heaters does allow practical operation with ambient temperatures as low as  $-25^{\circ}\text{C}$ .

At the high end, some of the newer LCD materials have operated up to  $90^{\circ}\text{C}$ , but most standard low-cost materials only work up to  $55$  to  $60^{\circ}\text{C}$ .

### LCD difficulties

As for the viewing angle, the use of dichroic materials, as mentioned earlier, solves this problem, but dichroic materials are more expensive than standard twisted-nematic ones. On the other hand, for large-area displays, the cost of a polarizer in twisted-nematic displays goes up exponentially with display size.

There are other problems. Only more expensive glass-frit-sealed LCDs are immune to humidity. Lower-cost plastic-encased ones are not. And LCDs are slow-responding devices, particularly at low temperatures.

A number of firms make and supply LCDs. These include Hamlin Inc., Lake Mills, Wis.; Beckman Instruments Inc., Fullerton, Calif.; National Semiconductor Corp., Santa Clara, Calif.; and UCE Inc., Norwalk, Conn. Interest is high in making LCD panels, at least for applications in which the CRT is unacceptable. In many such applications, LCD panels are finding themselves in competition with a maturing ac plasma panel technology, dc plasma panels, and fast-moving ac thin-film electroluminescent technology.

As Walter Goede, a research engineer and display expert at the Northrop Corp.'s Electronics division, Hawthorne, Calif., put it, "no one is really trying to replace the CRT in the 10-to-25-inch diagonal size area, especially color CRTs. However, for diagonal sizes under and over these numbers, there are quite a few people trying to beat the CRT."

Goede had worked on the ac plasma panel at the University of Illinois, where it was invented, and has

## The military connection

Much of the research and development in ac thin-film electroluminescent displays is backed by funding from Eradcom, the U. S. Army's Electronics Research and Development Command, Fort Monmouth, N. J. At Eradcom's Electronic Technology and Devices Laboratory, Elliot Schlam heads the displays and peripherals team of the Beam, Plasma, and Displays division; the team has a mandate to develop a tactical flat-panel display. Such a display must be legible in direct sunlight, dissipate little power, be versatile, operate over a wide temperature range, and be rugged enough to withstand shock and high-altitude environments. This is a tall order for any display technology.

Ac thin-film electroluminescent technology appears the best suited to meet these requirements, according to Schlam. A major multiprogram campaign is under way at Eradcom to prove this. "Over the past 12 years, we've evaluated LED, LCD, plasma-panel, electrochromic, electrophoretic, and CRT displays, and evidence points to the conclusion that ac thin-film technology has the best future potential for the preponderance of our military panel objectives of highly mobile rugged displays," explains Schlam.

Eradcom's Electronic Technology and Devices Laboratory is in the process of developing a class of hand-held and portable flat-panel alphanumeric, graphic, and video thin-film ac electroluminescent displays, including:

- A two-digit numeric module. Characters are  $\frac{1}{4}$  inch high and the modules can be butted end to end.
- A Digital Message Device (DMD) panel. It is 6 by 3 inches and consists of 222 by 77 picture elements. The present DMD panel uses special Burroughs Self-Scan dc plasma displays, which are now being experimentally replaced by ac thin-film electroluminescent displays with a resultant power-dissipation reduction from 15 to 6 watts maximum (2 to 3 W typical), better reliability, and improved legibility in sunlight.
- A Digital Message Miniterminal (DMM) panel. This 2-by-3-inch display has resolution of 60 lines per inch.
- A version of the commercially available Hycom 320-by-240-element ac thin-film electroluminescent panel with improved viewing characteristics in sunlight. This is being done by incorporating a black light-absorbing layer (see figure). The concept of this black layer was developed in the late 1960s by Sigmatron, Santa Barbara, Calif. (now Sigmatron-Nova, Chatsworth, Calif.). The black layer absorbs 99.95% of incident light, make it readable even in direct sunlight.
- A tactical video display of 640 by 512 picture

done work on advanced flat-panel displays, including the Digisplay, a flat-panel video CRT that was developed at Northrop.

The Japanese are heavily involved in LCD panel developments. Matsushita Electric Industrial Co. Ltd. of Osaka, Seiko Denki Co. Ltd. of Tokyo, and Hitachi Ltd. of Tokyo have all demonstrated LCD panels for portable TVs. Matsushita demonstrated a 1.4-by-1.9-inch panel with 240 by 240 picture elements and Hitachi has shown a 3-inch diagonal panel with 240 by 380 elements [*Electronics*, Jan. 31, 1980, p. 67].

A recent trend is that of large corporations buying

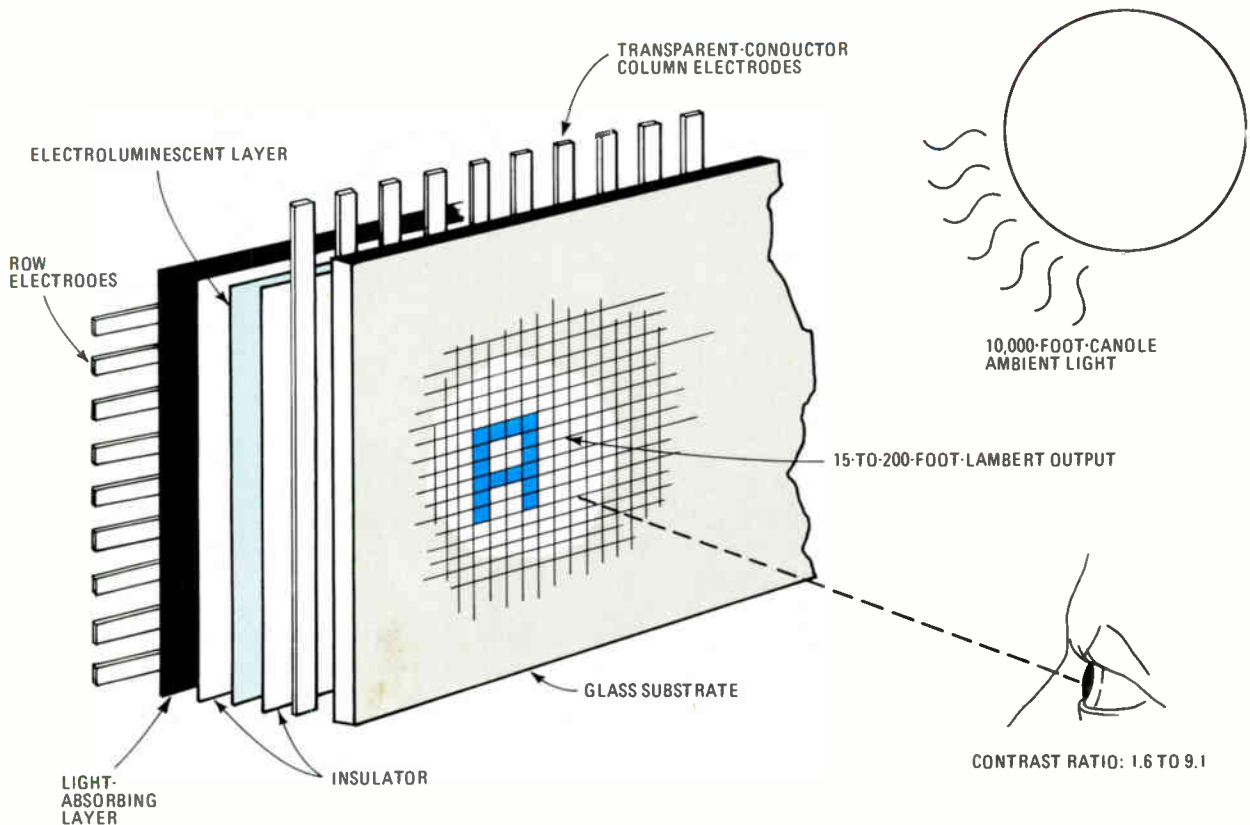

elements. Such a panel, being developed under contract to Sharp Corp.'s Hycom subsidiary, will have two operating modes: a 512-by-512-element graphic mode, and a 480-by-640-element television mode. A total power dissipation of 10 W maximum is one of the design goals.

A program is planned to develop color capabilities for all the aforementioned displays where requirements dictate it. At present, orange-on-black is the only color combination. Color development is about one year away.

Another program is planned to develop transparent panels with no black light-absorbing layers. Such panels would allow the superimposition of a display atop a map for military graphics and alphanumeric map applications. Two approaches are being investigated: making the back row electrodes very thin, and making them transparent.

Still another program is under way to improve drive circuitry. Supertex of Sunnyvale, Calif., is under sub-contract to Eradcom (through Hycom) to develop mono-

lithic drive chips for ac thin-film electroluminescent panels. Such panels require about 230 V ac in a pulsed mode. Thin-film drivers are also under development for Eradcom at the Aerojet ElectroSystems Co., Azusa, Calif. Eradcom had funded the Westinghouse Electric Corp., Pittsburgh, Pa., to develop thin-film driver circuitry.

"There is a need for a strong commitment to develop the right kind of drive circuitry for ac thin-film electroluminescent display panels, be it thin-film or monolithic drivers," emphasizes Schlam. He foresees development of drivers that are versatile (with alphanumeric, graphic, and video capability) and low in cost.

Although ac thin-film electroluminescent technology is being developed at Eradcom for military applications, where cost generally takes a back seat to performance, it is an inherently low-cost process to implement, and will thus have tremendous implications for commercial and consumer markets.

smaller LCD companies, for in-house LCD supply capability. Exxon Enterprises Inc. has an affiliate called Kylex Inc., Mountain View, Calif., which recently made a breakthrough in LCD multiplexing with a low-cost 40-character LCD system thanks to material and packaging developments [*Electronics*, Jan. 3, 1980, p. 151]. Schlumberger Ltd. owns Fairchild Camera and Instrument Corp., Mountain View, Calif. Recently, NV Philips Gloeilampenfabrieken of the Netherlands formed a 50/50 joint venture with Brown, Boveri and Co., Baden, Switzerland, to produce and sell LCDs. The latter firm already has LCD plants in Lenzburg, Switzerland, and in

Hong Kong. And as mentioned earlier, Optel Corp. is now a division of the larger Refac Electronics Corp., Winsted, Conn., a large maker of incandescent displays.

Last September, General Electric Co. purchased Liquid Xtal Displays Inc., Beachwood, Ohio. Xtal is a maker of large-area (from 2-by-1- to 6-by-2-inch) twisted-nematic LCDs for high-reliability applications. According to Xtal's general manager Hugh Mailer, "We will be supplying General Electric LCDs for its consumer appliance products, although at present we don't supply them with any LCDs. We are working with General Electric on prototype samples of dichroic LCDs for

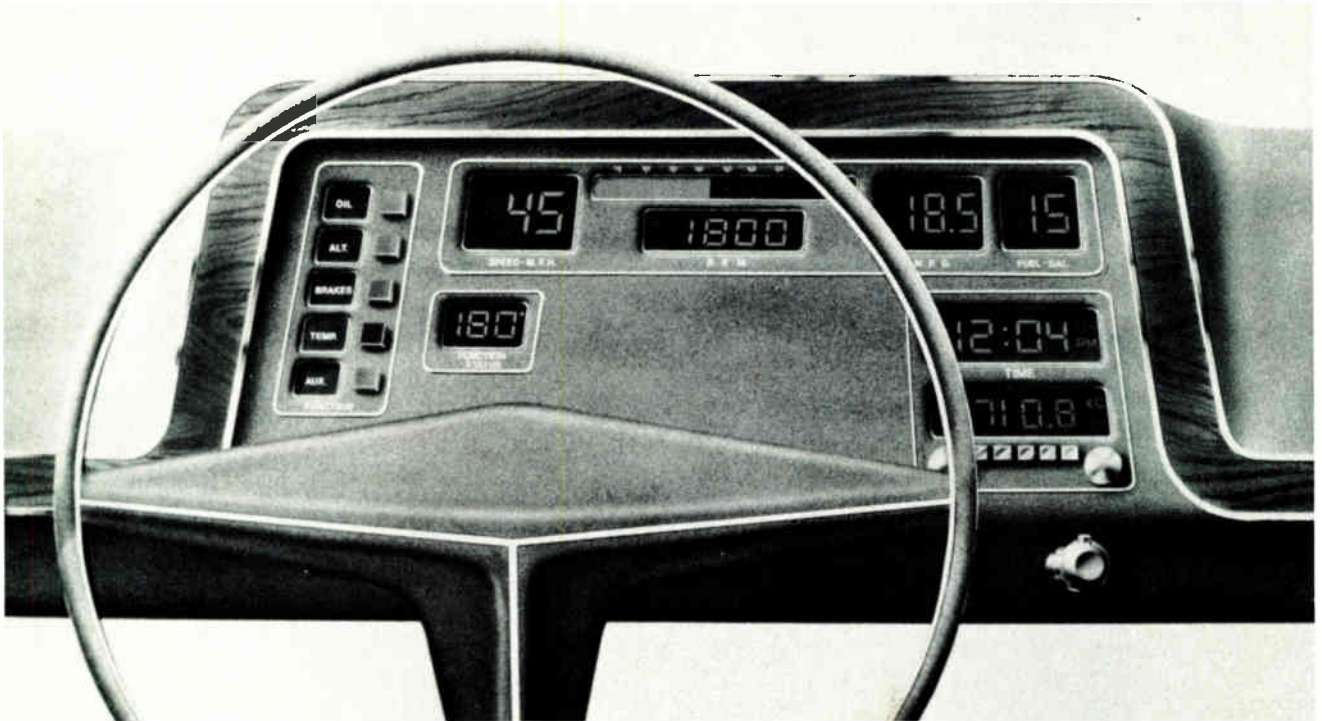

**8. Behind the wheel.** U. S. auto manufacturers are using vacuum fluorescent displays in dashboards already, thanks to their low cost, high brightness, and proven reliability. This mockup from Wagner Electric Corp. shows what a fully digital dashboard of the future might look like.

appliances and audio products, but have absolutely no intention of abandoning our present customer base."

Dichroic LCD panels with color capability are here. Integrated Display Systems Inc., Montgomeryville, Pa., has developed a 4-by-9-inch panel with densities on the order of 40 dots per inch. A 3-by-7-inch LCD prototype panel is currently being used in Volkswagen automobiles and will be in U. S. automobile dashboards by 1983. According to the firm's president, Thomas Saldi, "Without a doubt, dichroic multiplexible LCDs are the answer to future flat-panel replacements to the CRT. We can demonstrate them now, but it will take a few more years of development to bring the price down."

An even more optimistic viewpoint is expressed by Peter Brody, who pioneered thin-film matrix addressing techniques for displays while working at the Westinghouse Electric Corp., Pittsburgh, Pa., and is now president of his own firm, PanelVision, also in Pittsburgh. He says, "Thin-film-transistor addressing is a universal approach that can be applied to all display technologies. Few display technologies will get very far in size without thin-film-transistor addressing techniques."

While not belittling recent efforts to drive various large-screen display technologies with improved multiplexing techniques, Brody feels that all such efforts are not comparable to thin-film-transistor addressing techniques. "We've gotten resolutions of 256 lines per inch in the laboratory, driving thin-film ac electroluminescent displays [Fig. 7], and can do the same for LCDs, where thin-film-transistor addressing is even simpler. You don't need any more than 100 lines per inch of display resolution for a high-quality image."

PanelVision has built a LCD panel with dimensions of 5 by 3 $\frac{3}{4}$  by  $\frac{1}{8}$  inches (the active area is 4 by 2 $\frac{5}{8}$  inches),

with the capability of displaying up to 448 characters or symbols as well as full graphics. The thin-film transistor-driven panel dissipates a mere 45 milliwatts, including the power dissipated by the driver circuitry.

The ambitious French Télématic program for developing interactive flat-panel displays for French telephone subscribers is known to be considering using LCDs driven by thin-film transistors. The program is under the direction of the Direction Générale des Télécommunications, the telecommunications arm of the French Post Office. Thompson-CSF's Electron Tube division, Boulogne-Billancourt, France, is the prime contractor.

Garrett Stone, Kylex's president, feels that LCDs have much more room to grow than older display technologies. "LED, vacuum fluorescent, and gas-discharge displays have been pushed to their limits, whereas LCDs have a lot more room to grow. Word processors, office equipment, and electronic typewriters are just some of the new markets LCDs will grow in. The future is in multiline multiplexible LCD panels, where multiplexing advances will be the key," explains Stone. Kylex is also developing dichroic LCD panels.

#### **Vacuum fluorescents invade the car**

Vacuum fluorescent displays, devices similar in construction to vacuum tubes, are making inroads into 1980 Chrysler and Ford automobile dashboards. A large number of these displays are coming from Japan, where nearly all of them are made. The largest Japanese supplier is NEC America Inc., Santa Clara, Calif. A vacuum fluorescent display contains a filament, cathode, and phosphor-coated plate. Electrons emitted from the heated filament hit the plate, making the phosphor glow.

The principal advantages of this technology are its low



cost, low power-dissipation levels, high brightness, and a color capability that is well matched to the human eye's response curve. Disadvantages include the need for two-voltage power supplies, one for the plate and one for the filament (typically 5 v for the filament and 10 to 20 v for the plate), and shortened lifetimes when driven at maximum brightness.

The vacuum fluorescent display's low cost is making it a competitor for calculators and electronic games. According to NEC America's Wayne Stewart, product marketing manager for the firm's line of vacuum fluorescent displays, "vacuum fluorescent displays are very cost-competitive in the range of four digits or more. Their cost per digit is approximately 50¢ in OEM lots. And vacuum fluorescent display lifetimes are high, typically 50,000 to 100,000 hours." It should be noted, however, that these lifetime figures are valid only when the displays are not driven to maximum brightness.

NEC America will be making engineering samples available in April of this year of a 40-character dot-matrix vacuum fluorescent display with characters 0.197 inch high. The firm presently markets an 11-character dot-matrix vacuum fluorescent display with characters 0.315 inch high.

Not all vacuum fluorescent displays are made in Japan. Wagner Electric Corp., Whippany, N. J., is the sole U. S. manufacturer of vacuum fluorescent displays. In fact, the firm invented the Digivac, a nine-pin vacuum fluorescent display, back in the early 1970s when the firm was called the Tung-Sol Corp. During the mid-1970 recession, the firm stopped making such displays, and later revived its operations under the Wagner Electric name in 1978, when the lucrative automotive market began gobbling up vacuum fluorescent displays.

Richard Dubois, manager of display engineering for Wagner Electric, says that his firm's displays will be in 1980 and later Ford dashboards as frequency indicators for radios, clock readouts, and other applications the firm is presently working on (Fig. 8). He cites the advantage his firm has over Japanese suppliers of vacuum fluorescent displays in being a domestic supplier.

"U. S. automotive manufacturers are more comfortable with an experienced domestic supplier of displays that are relatively free from the dollar-to-yen fluctuations Japanese vacuum fluorescent displays must contend with," he says.

Although vacuum fluorescent displays are mostly made in Japan, a number of U. S. firms besides NEC America are major suppliers. These include IEE, the Digital Electronics division of the Chemetrics Corp., Burlingame, Calif., and Noritake Electronics Inc., Los Angeles, Calif., all of them sales outlets for Japanese companies. The Ise Electronics division of Noritake Electronics, in fact, invented the vacuum fluorescent tube back in 1966.

A mature flat-panel technology is that of ac plasma panels. The list of companies either developing these ac-driven gas-discharge panels or producing them is a long one. Many of them are Fortune 500 companies. International Business Machines Corp., White Plains, N. Y., has been making ac plasma panels since 1968, at an estimated annual production rate of 50,000 to

100,000 displays.

Very recently, Control Data Corp. formed a Plasma Display division, located at the firm's business and technology center in St. Paul, Minn., to manufacture and market ac plasma panels (including the driver electronics) capable of displaying up to 4,000 alphanumeric characters and graphics for original-equipment manufacturers.

### Ac plasma bandwagon

Other companies in the ac plasma panel business, many of whom are supplying or developing such panels for military applications, are the Norden division of United Aircraft Corp., Norwalk, Conn.; National Cash Register Co., Colorado Springs, Colo.; Nippon Electric Co. (NEC), Tokyo, Japan; Fujitsu Ltd., Tokyo, Japan; Texas Instruments; Thomson-CSF, Paris, France; Honeywell, Tampa, Fla.; Photonics Technology Inc., Luckey, Ohio; and Electro Plasma Inc., Millbury, Ohio. The last two firms are spinoffs from the original Digivue effort of Owens-Illinois Inc., which produced the first ac plasma panel. Even the Burroughs Corp.'s OEM Products division, Plainfield, N. J., a major dc plasma panel producer, is reportedly active in developing ac plasma panels.

There's no doubt that ac plasma panels can be built to show thousands of characters as well as graphics. Photonics Technology, jointly with Science Applications Inc., La Jolla, Calif., developed the world's largest ac plasma panel for the military, a 24-inch-diagonal unit that can display over 21,000 characters within its 1,024-by-1,024-element addressable matrix, at a resolution of 60 picture elements per inch. The firm is also developing a 39-by-39-inch panel that also will have resolution of 50 to 60 picture elements per inch. But such panels are quite expensive, since they require extensive and bulky



9. Big dc panels. Data-entry, point-of-sale, and word-processing applications are markets for large dc plasma panels like this 320-character Argus from IEE Inc. IEE and Burroughs make 480-character dc plasma panels (960 characters without drivers).



**10. Terminal display.** The bulky cathode-ray tube is facing competition from dc gas-discharge display technology in some applications, such as in this data terminal from Burroughs. The firm uses its own Self Scan II panel, which displays 12 lines of 40 characters each.

driver electronics. And the colors they produce are limited to orange and green.

According to Andre Duprey, president of Electro Plasma Inc., his firm is marketing through Interstate Electronics a 512-by-512-element ac plasma panel with resolution of 60 lines per inch. The 12-by-12-inch panel is for military applications and has an active area of 8.5 by 8.5 inches. Presently, Electro Plasma has no plans to market anything larger in size through Interstate.

Fujitsu has several ac plasma panels, the largest with a 21.7-by-21.7-centimeter display area with 512 by 512 picture elements.

In the CRT density range of about 2,000 characters, ac plasma panels are still more expensive than the CRT. However, Control Data's recent announcement that it will begin selling ac plasma panels as CRT replacements (for the 2,000-to-4,000-character range) at a cost only four times the CRT's is an indication of progress in reducing the price of ac plasma panels. A major reason has been the availability of monolithic driver chips that can drive many display lines. Control Data, which anticipates ac plasma panel prices being cut in half during the next five years, hopes to use a new 32-line drive chip under development at Texas Instruments.

### A niche for dc plasma panels

Dc plasma panels are very popular as displays for applications requiring from a few dozen to a few hundred characters. The explosive growth of word processors, point-of-sale terminals, and data-entry terminals has created a ready market for dc plasma panels. And new applications keep cropping up, for instance, displays for police-car dashboards or computerized numerical-control systems. And there are quite a few companies in this business. The two selling the biggest panels are Burroughs Corp. and IEE Inc. The former makes available the dot-matrix Self Scan II 480-character (12 rows of 40 characters each) panel, while the latter sells a similar 480-character panel known as the Argus (Fig. 9). Informed sources report that Burroughs will shortly unveil an improved version of the Self Scan

II panel. The new panel will reportedly display "many more characters than the present limit of 480." IEE makes available a 960-character Argus panel, but it does not include driver electronics. According to IEE's sales manager, Carl Doria, "we're working on supplying the 960-character dc plasma panel with driver electronics. However, we're waiting for the right monolithic drive device development that will make it economical for us to sell a 960-character Argus panel."

David Matthews, Burroughs' marketing manager says that there is a need for a 25-line 80-character/line display in word processors and computer terminals, and the dc plasma panel's thin profile presents a large space-saving advantage over the bulky CRT (Fig. 10). But "in a dc plasma panel, line length is limited to 40 characters, since the display's flicker rate caused by multiplexing for anything more than 40 characters would be too noticeable and objectionable. We're working on solving this problem."

Dc plasma panels are less expensive to drive than ac plasma panels, but driving dc panels capable of displaying the thousands of characters ac plasma panels can display becomes very expensive. In the few-hundred-character range, dc plasma panels are low enough in cost to make them attractive to use. "In 100-lot quantities, our Self Scan II 480-character panel costs 96¢ per character. This is the lowest price of any multiline alphanumeric display technology," explains Matthews. And dc plasma panels offer more color capability than ac panels.

### Complementing the CRT

Cherry Electrical Products Corp., Waukegan, Ill., has been cashing in on the limited-character dc plasma panel market with intelligent displays. The firm sells 14-segment alphanumeric display systems in a choice of their 16-character (W416-1051) or 20-character (W420-1051) styles (Fig. 11). Each is microprocessor-controlled and contains all driver circuitry, buffered input/output electronics, a serial-interface character generator, and a dc power supply on one pc board. "Multiline, multicharacter displays can get costly," says George Kupsky, Cherry's manager for displays. "There are many applications where information is needed in a small space, and the CRT's bulkiness is a drawback," he adds. As for the higher voltages dc plasma panels require (compared to some other display technologies), Kupsky says, "There's no need to reduce the high voltages normally needed to drive dc plasma displays. An on-board dc/dc converter that operates from 12 v and produces 180 v is sufficient." Kupsky was one of the original inventors of dc gas-discharge display technology while employed at Burroughs. He also made the first LED for RCA Laboratories, Princeton, N. J., in the early 1960s, before RCA decided to disband its LED efforts.

Other major dc plasma panel suppliers include Beckman Instruments and Dale Electronics, Columbus, Neb. Beckman makes two 14-segment alphanumeric gas-discharge displays, one a screened-image unit with 20 characters 1/2 inch high (Fig. 12) and the other a high-brightness raised-cathode display with 30 characters 0.28 in. high. Dale Electronics sells naked panels without

the driver electronics for users to configure to their own designs.

Although not yet manufacturing dc plasma panels, Lucitron Inc., Northbrook, Ill., plans to build very large panels (up to 30 to 40 inches in diameter), starting with a 10.5-inch-diagonal color panel, samples of which will be available by the middle of this year.

Lucitron's founders are ex-employees of the disbanded Zenith Radio Corp. research and development facility. They are working jointly with GTE Laboratories, Waltham, Mass. to produce large-screen dc plasma panels. Alan Sobel, Lucitron's vice president of operations, explains that Lucitron has already made experimental panels of about 3 by 3 and 4 by 4 inches and is convinced that it can be done on a production scale: "We've been at this technology since 1965, and even demonstrated to Zenith's management in the mid-1970s that monochromatic dc plasma panels can be produced at low cost. However, Zenith's management wanted a product that could compete with the CRT in a mass-market application immediately, not in stages as we had planned and still think."

"We think that our approach using conventional low-cost materials and production techniques, as well as a patented multiplexing scheme, will produce panels that will be the dominant large-screen display technology of the future within the next 10 years," says Joseph Markin, Lucitron's president.

There's quite a bit of dc plasma panel work going on in Japan. Fujitsu Ltd., NHK (Japan Broadcasting Corp.), and Hitachi Ltd. have all demonstrated 10-inch-diagonal

dc plasma panels with color capability. Some display experts feel that given the pace of Hitachi and NHK's dc plasma panel efforts, those two firms may have the best shot at producing practical color dc plasma panels for large-screen displays.

### Thin-film electroluminescent panels

Of all of the display technologies competing for application in large flat panels, none looks more promising than ac thin-film electroluminescent technology. There are basically four types of electroluminescent panels: ac thin- and thick-film ones, and dc thin- and thick-film ones. No one manufactures dc thin-film panels and apart from Smith Industries Ltd., London, England, no one else is known to make dc thick-film panels. Dc electroluminescent panels generally have shorter lifetimes than their ac counterparts due to diffused impurities in the electroluminescent material.

Thick-film ac electroluminescent panels are being produced principally for lighting and indicator applications. One of the largest producers of these displays is the Grimes division of Midland Ross Corp., Urbana, Ohio. There is more excitement in ac thin-film electroluminescent technology, however. Many advanced research laboratories in the U.S. and overseas have large programs to develop panels using this technology.

So far, only one company has produced samples for sale: the Sharp Corp. of Japan, through its Irvine, Calif.-based Hycom subsidiary, is sampling a 320-by-240-element panel with a 10-year lifetime to half-brightness levels and a 1,000 foot-lambert brightness specifica-

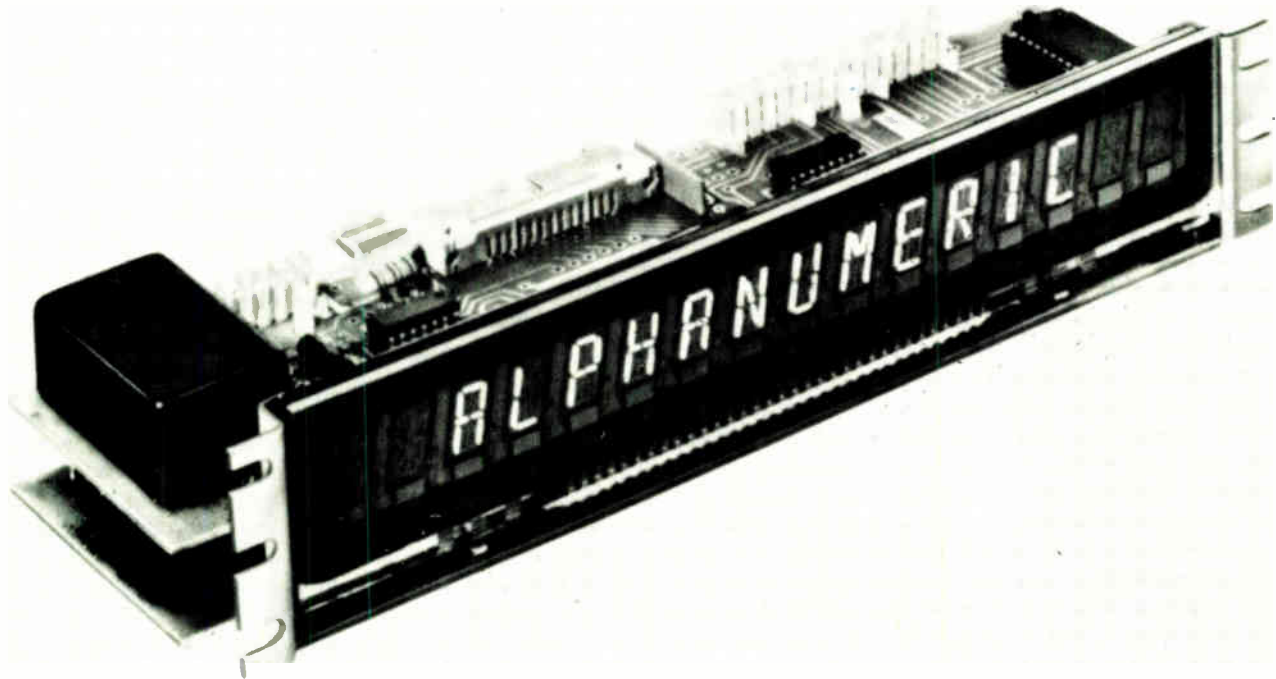

**11. All aboard.** Display assemblies are on the market that have all their smart electronics and even the power supply on the same printed-circuit board. The W416-1051 smart 16-character dc gas-discharge alphanumeric display from Cherry Electrical Products is an example.

**12. High visibility.** This screened-image dc gas-discharge display has 14-segment alphanumeric characters half an inch high that can be seen from 70 feet away. From Beckman Instruments, this model (SP-450-018) puts out 70 foot-lamberts and can be viewed over a full 120°.



tion. Such ratings are indications of progress in two traditional problem areas for this type of display—low brightness levels and short lifetimes.

A typical thin-film electroluminescent panel consists of an electroluminescent layer (generally zinc sulfide doped with manganese) sandwiched between two transparent insulating layers. This assembly is further sandwiched between row electrodes in back and transparent column electrodes in front in a grid arrangement. A layer of glass placed over the column electrodes forms the panel's front surface.

Some of the more recent ac electroluminescent panels employ a black light-absorbing layer between the row electrodes in back and insulating layer in front of it for enhanced visibility in environments with high ambient light levels.

An electroluminescent panel operates in response to an electric field caused by an applied ac or dc potential across its row and column electrodes. This electric field excites the doped zinc sulfide material, causing it to emit light.

The basic difference in the way thick- and thin-film panels are made is that the former employ powdery electroluminescent materials that are pressed into ceramic or plastic binders. The latter panels are made either by electron-beam sputtering, thermally evaporating or vacuum-depositing the electroluminescent material. Although thick-film panels are less costly, they are not useful for alphanumeric and graphics display.

Why all the excitement about ac thin-film electroluminescent displays? Probably the biggest reason is the simplicity of the thin-film process compared to other flat-panel technologies, giving rise to truly low-cost large flat panels capable of competing with the CRT. In addition, ac thin-film electroluminescent panels have a combination of operating characteristics that are hard to beat. They can operate over a temperature range of -55° to +125°C, require little power, are very bright and efficient (typical luminous efficiency is 4 lumens/watt), and are able to withstand high-shock and high-altitude environments.

Research efforts to perfect ac thin-film electroluminescent displays are intensifying at IBM's Thomas J. Watson Research Laboratories, Yorktown Heights, N. Y., and its San Jose, Calif., research facility; Rockwell International labs at Thousand Oaks, Calif., and Dallas; Sharp Corp., Osaka, Japan, and its subsidiary Hycom Inc., Irvine, Calif.; Bell Laboratories, Murray Hill, N. J.; Aerojet Electrosystems Corp., Azusa, Calif.; Sigmatron Nova, Chatsworth, Calif.; Tektronix Inc., Beaverton, Ore.; and Sierracin Corp., Sylmar, Calif. Westinghouse had a major ac thin-film electrolumines-

cent program going in Pittsburgh that it recently dropped.

Much of the research in the aforementioned organizations is being supported by funding from the U. S. Army Electronics Research and Development Command (Eradcom), Fort Monmouth, N. J., where a major effort has been underway since 1968 to speed the development of large flat-panel displays for military applications (see "The military connection," p. 132).

Problems researchers are trying to lick are reducing the high voltages needed to drive ac electroluminescent displays (about 150 to 200 v), reducing the cost of driver electronics for large panels, and improving color efficiencies. The primary color is an orange-yellow hue. Although doping materials other than manganese and various doping concentration levels allow red, green, blue, and white to be produced, display efficiency drops off radically with these colors.

#### **Electrochromic and electrophoretic research**

Electrochromism is the ability of a material to change colors when stimulated electrically. Although many organizations have dropped their investigations of electrochromic displays, two large ones (IBM and Bell Laboratories) remain in it. Recently, Bell Laboratories announced the discovery of a clear film material—an iridium compound—that can quickly change colors in response to electrical pulses. This material, Bell says, could be the basis for a low-cost alternative to LEDs and LCDs.

Electrochromic displays, like LCDs, require an illumination source to be visible. A major hurdle for electrochromic displays is the electrochromic material's slow response to electrical pulses, typically changing color about once per second. Other disadvantages include poor contrast ratios and the lack of matrix addressing, limiting their usefulness in large displays. For smaller displays, however, its advantages of wide viewing angle, low-voltage operation (a 1-v pulse can cause it to switch colors), and memory characteristic (once the electrochromic material is switched, it remains in that color until switched again) make it a potentially competitive technology to tall-character LEDs and LCDs. The low cost of fabricating large-area electrochromic displays is also important.

One more display technology looking to make a place for itself in the future is electrophoretics. Exxon Enterprises recently formed a new electronics venture in its EPID (Electrophoretic Information Display) division, Sunnyvale, Calif. In electrophoresis, a material containing suspended particles emits light as a result of the motion of the suspended particles caused by a voltage. □



One spec you seldom hear programmable instrument makers talk about is "carton-to-rack." We don't blame them. By the time you've figured out their programming format, you've lost a lot of the time an automatic system is supposed to save.

You don't have that problem with the Wavetek 172B Signal Source. Because our GPIB compatible programming is so versatile, your programming format is our programming format. Your language is our language. We also have a Group Execute Trigger that makes programming even faster. With the 172B, all commands are held until the new signal is fully

defined, then the signal is switched within 2 to 100 ms. During signal changes, the unit under test doesn't get all that garbage other instruments can dish out.

The best thing about getting the 172B into your system is what it does once it's there. One instant it's an oscillator, the next it's a 5½ digit synthesizer, a pulse

generator or a waveform generator. From 0.0001 Hz to 13 MHz. You can sweep, frequency modulate, trigger, tone burst, and vary the waveform symmetry. There's memory that holds up to 240 discrete settings and that can be swept at up to 500 settings per second.

But before you can get the 172B into a rack, you've got to get it into your hands. Contact us and we'll show you how fast that can happen.

Wavetek, 9045 Balboa Ave., P.O. Box 651, San Diego, CA 92112. Tel. (714) 279-2200, TWX 910-335-2007.

**WAVETEK®**

Circle #138 for literature  
Circle #139 for demonstration

**Model 172B  
will be testing your  
units while other  
programmable signal sources  
are still testing  
your patience.**

# How Japanese manufacturers achieve high IC reliability

Companies build in quality every step of the way, instead of merely screening out bad parts after the fact

by Tamatsu Goto and Nobukatsu Manabe  
*Nippon Electric Co., IC Division, Tokyo, Japan*

□ In order to measure the reliability of a semiconductor device, a manufacturer outside Japan generally counts the number likely to fail every  $10^5$  hours (percent per 1,000 hours). In Japan, the preferred unit of measure is failures in  $10^9$  hours (or FITs) because it is a more convenient way of reflecting the low failure rates of Japanese parts.

Indeed, Japanese semiconductors, ranging from discrete devices to large-scale integrated circuits, have earned an excellent and worldwide reputation for quality and reliability over the last few years. Yet because of the way their makers apply quality control, this quality has not raised their price.

Everyone from buyers of the parts to the owners of color television sets built with them confirms their superior reliability. For instance, one Japanese manufacturer of electronic systems reports significant differences in the failure rates of semiconductors from Japanese and foreign suppliers. The percentage of failures among devices made domestically was 0.11% at incoming inspection, 0.008% during equipment assembly, and 0.002% in the field. The comparable percentages for devices made abroad were 0.54%, 0.11%, and 0.008%.

As for color TV sets, an American—J. M. Juran, a consultant and author of "Quality Control Handbook"—told the 1978 International Conference on Quality Control in Tokyo that Western models during the mid-1970s had been failing in service about five times as often as Japanese sets. Even by 1978, the Western products were still failing twice to four times as often as the Japanese.

This state of affairs, which holds for many other Japanese industrial products, is a far cry from the years before and just after World War II when "made in Japan" was synonymous with cheapness: low cost, but poor quality. The turnabout was made deliberately. Finding their products unwelcome in many parts of the world, the country's leading industrialists decided to investigate quality control. It is no exaggeration to say that their decision played a most important role in the outstanding postwar revival of Japanese industry.

## The change begins

In 1950, therefore, W. Edwards Deming, a noted American consultant, was invited to Japan to lecture top managers on statistical quality control, his area of expertise. His seminar caused a sensation in Japanese industry, which promptly established the Deming prize to be awarded annually to the company and the individual doing most to apply quality control.

Then in 1954 Juran lectured the Japanese at their invitation on the importance of managing the quality control function effectively. Many enterprises thereupon adopted quality control as an important part of their business strategy. Finally in 1956, A. V. Feigenbaum introduced the notion of total quality control (TQC) permeating an entire organization—a concept that took root in Japan as nowhere else.

The study of integrated-circuit reliability in Japan is considered to have started in 1965 when Nippon Telegraph and Telephone Public Corp. began to develop high-reliability ICs for its electronic switching systems.



## How some Japanese ICs fail

MOS and bipolar integrated circuits returned by customers of the IC division of NEC for the period January 1976 to June 1979 underwent failure analysis. Some 40% to 50% were omitted from the analysis because they were found to have been either good devices within specifications or devices destroyed by misuse. But the rest were classified by the failure mechanisms listed in the table. This table relates each of the major IC failure mechanisms to its origin in a particular manufacturing step and to its consequent failure modes: open circuit, short circuit, and degradation of electrical characteristics.

The bar chart shows that oxide destruction is the dominant failure mechanism, particularly for MOS ICs with their very thin silicon oxides. Such failures are caused by static electricity generated by improper storage or handling as well as by poorly deposited oxides.

Handling precautions are still needed to protect the devices from static electricity despite the use of better built-in protection circuits. This is especially true because oxides are expected to become still thinner as designers strive to improve device performance.

In classifying oxide defects, pinholes (photo, left, p. 143) and faulty photoresist patterns were found to be the major cause of failure. These failures occurred despite the outstanding improvement of wafer fabrication processes. And newly developed devices, packed more densely, are vulnerable to the effects of even smaller defects.

Ionic contamination has also been a major cause of failure in semiconductor devices. Impurity ions introduced in the silicon oxide easily drift under the influence of an electric field, especially at elevated temperatures. Eventually, the drift degrades device parameters. However, contaminants have been eliminated through manufacturing process improvements and quality control. The use of passivation layers such as silicon nitride and phosphorus-doped silicon oxide has become common. Accordingly, this type of failure has become less important.

Some kinds of linear ICs are, however, the exception. This could explain why characteristic degradation occupies the second position in the failure mechanism distribution for bipolar ICs shown in the bar chart.

Failures related to wire bonding, including those from cut and peeled wires and wires touching the chip edge, comprise another major set of failure mechanisms. However, automation of the wire-bonding step has decreased this failure mode. Note that the distributions of the chart include the failures of devices encapsulated in metal can packages, for which wire bonding is still carried out manually.

Failures related to the metalizations for interconnections are third in frequency. They are typified mainly by three failure mechanisms: opens at the oxide step, corrosion, and electromigration. A photo taken with a scanning electron microscope (to right of earlier photo) shows a metalization open at an oxide step in a complementary transistor logic IC purchased by one of the system divisions of NEC. This kind of failure can be eliminated by reducing the step gap and smoothing the slope.

Aluminum corrodes easily in reaction to moisture and ionic contaminants. Corrosion is also hastened by the electrical bias applied to the device even though a corrosion-resistant oxide is formed on the metalization surface.

MAJOR FAILURE MECHANISMS OF INTEGRATED CIRCUITS		
Process	Failure mechanism	Failure mode*
Diffusion and oxidation	Oxide defect	S, O
	Contamination	D
	Surface state	D
	Faulty pattern	S, O, D
Metalization	Open at oxide step	O
	Corrosion	O
	Electromigration	O, S
	Open at contact	O
	Faulty etching	O, S
Assembly	Chip peel	O
	Chip crack	O, S
	Wire cut, peel	O
	Intermetallic formation	O, D
	Foreign material	S
	Scratch	O, S
Package	Package leak	D, O
	Moisture penetration	O, D
	Whisker	S
Use	Static electricity	S
	Overstress	S, O, D

\*S = short circuit, O = open circuit, D = electrical degradation

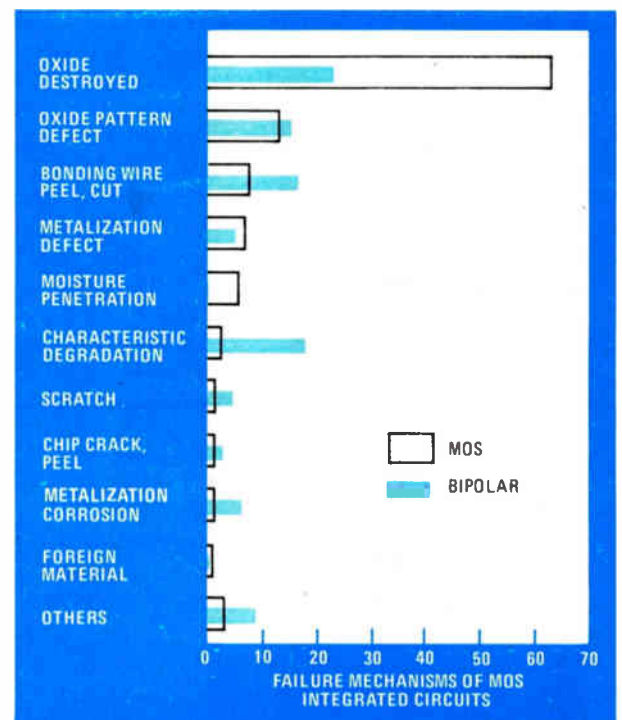



To reduce corrosion in hermetically sealed devices, it is important to control the water vapor content of the sealing gas as well as the hermeticity of the packages.

Plastic-encapsulated devices are more impervious to moisture than many people realize. As shown in the bar chart, failures due to moisture penetration have been relatively few. Moreover, most of these failures have occurred not in the field but during moisture resistance tests performed during qualification at customers' incoming inspection. This tendency also showed up in data collected in years before 1976.

To improve the moisture resistance of plastic-encapsulated devices, nonporous and crack-free passivation layers must be placed atop the metalization and, in addition,

good encapsulant materials must be used.

Electromigration is a phenomenon in which carriers of electric current in a conductor transfer their momentum to atoms in the conductor. This eventually gives rise to voids, hillocks, and whiskers.

Voids caused by electromigration have resulted in metalization opens like the one clearly distinguished in the scanning electron microscope photograph, taken in a voltage contrast mode. The lifetime of a metalization stripe is affected by the temperature, thermal gradient, current density, and materials. However, in actual use very few failures have resulted from electromigration. Apparently, the phenomenon has been studied so extensively that manufacturers are taking effective preventive measures.

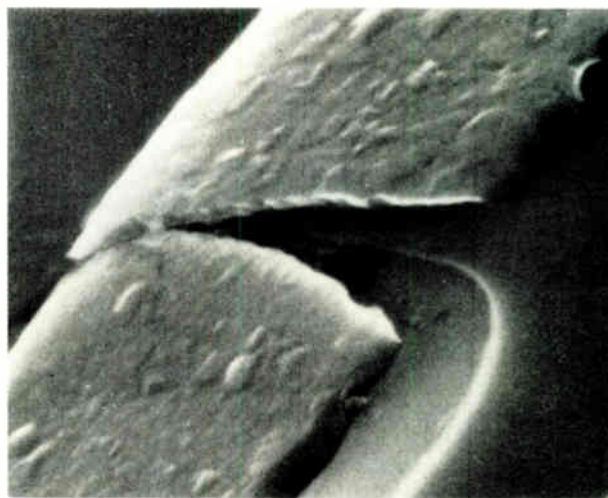
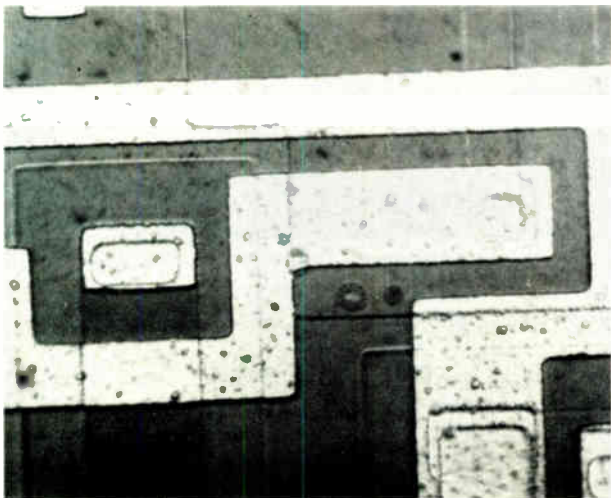

almost redundant. They sometimes even ask, "Is the quality control in your company so unsuccessful that you need such strict inspections?" Reliability is built in by always trying to fit the product design to the capability of the manufacturing process.

### Everyone is involved

In Japan, quality-control activities are companywide. Everybody in the company is involved with the concepts and methodology of total quality control, or TQC. Workers, engineers, and quality control staff, as well as managers, participate in training courses and seminars on quality control, which are frequently held both inside and outside the company. This is in sharp contrast to the approach to quality control taken in the U. S., where it seems to be thought of as a job limited to the quality control manager and his staff.

Also helping promote total quality control within a Japanese company is the frequent personnel exchange that goes on among design, manufacturing engineering, sales, and quality control departments. As a result, interdepartmental barriers to mutual understanding are eliminated, or at least lowered. Process capabilities and reliability in the field are taken into consideration at the time of device layout and structure and process designs. At the factory level, small improvements are continuous-

ly proposed by groups of workers participating in Zero Defect (ZD) activities.

Another factor promoting high quality is security of employment. Japanese industry is known for its lifelong employment, compared with the U. S. and other Western nations where an employee easily moves from one company to another.

In the lifelong employment system, an employee is regarded as the most important asset of the company. The company is eager to enhance his ability through training and education. On the other side, the employee feels loyalty to the company and recognizes that his own future depends upon the company's prosperity. And this prosperity cannot be attained without the reputation for high-quality products.

Finally, there is a language barrier that works in favor of Japanese industry. Most Japanese engineers can read and understand the many papers and publications on quality control and reliability written in English by American military and industrial organizations. A great many such publications are being produced in Japan, as well. But there are few Western engineers who can understand the papers and articles in Japanese.

To look outside the manufacturer's organization, a very big role in producing high-quality ICs in Japan is played by the close partnership that exists between users

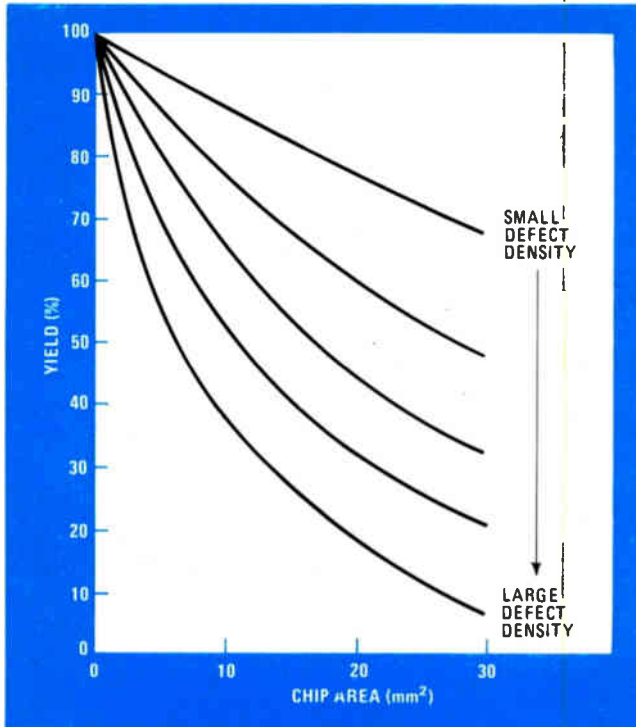

**2. Chip area vs yield.** Plotted curves show how defect density has an adverse affect on device yield. Manufacturing engineers must expend a maximum amount of effort to reduce the defect density.

and manufacturers. It may seem curious to Westerners that in Japan customers have business relations with their suppliers without any firm contract or agreement. But the customers expect implicitly that they will not be put to any trouble by the goods they purchase. The quality assurance program is left to the suppliers who are naturally obliged to do their best in responding to their partner's trust. They feel an obligation to meet their customer's expectations.

### What the customer expects

Customers are very concerned with results. They continuously monitor the quality of the devices they receive for use in their systems and equipment. They look at the failure percentages that show up at the acceptance inspections, during equipment assembly, and in the field. The numbers for different vendors are compared and discussed at joint meetings.

Some Japanese users express this defect rate in parts per million. For example, they expect 10 ppm for discrete semiconductors, 100 ppm for small-scale integrated devices, and 1,000 ppm for LSI devices. These numbers are not standards, but targets. Once they have been marked for poor quality, vendors have to submit a plan for corrective action to the customer and promptly carry it out. If not, they lose the customer's trust and, eventually, the business as well.

Most of the leading Japanese manufacturers of semiconductors are also the big manufacturers and suppliers of equipment and systems that use the semiconductors. This is a great advantage. The semiconductor makers can easily get quality and reliability information after their products are shipped. This can improve quality to a

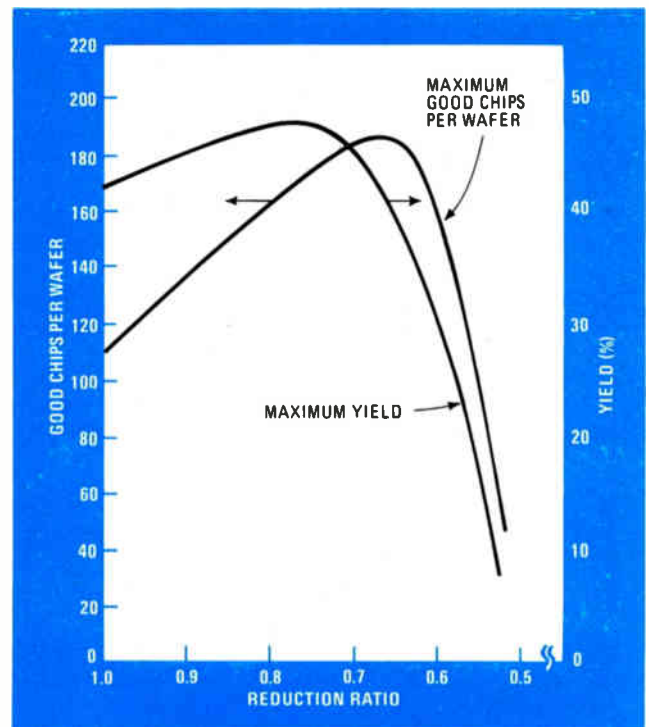

**3. Not so straightforward.** The design engineer must often face making a choice between a reduction ratio for a maximum number of good chips (lowest cost) and maximum yield (highest reliability).

striking degree. In the U. S., it seems, there is very little information, except for claims and complaints, that comes back from the customers.

The U. S. military, as one of the big IC users, has promoted many reliability studies of ICs. As a result, it established a reliability assurance program that extends to the manufacturing process and screening procedures, as well as to reliability testing methods. The military's program for reliability is the one that must be established by individual manufacturers.

This seems to have promoted a passive attitude toward reliability assurance on the part of the manufacturers. They do not work on things for themselves but follow the military's lead. Unfortunately, this state of affairs seems to have been accepted by the big American IC users. As previously mentioned, users in Japan tend not to specify the quality and reliability assurance procedures to be used by manufacturers. Instead, they emphasize results. Therefore, the manufacturers can develop their own efforts, implementing quality and reliability assurance programs based on considerations of cost-effectiveness.

### A different attitude to dust

For ICs, especially for LSI devices, dust control during manufacturing is extremely important for maintaining high product yield and reliability. Generally speaking, more attention seems to be paid to dust control in Japan than in the U. S. In particular, there seem to be big differences among dust control grades in assembly processes at Japanese and American manufacturers.

A reason for this is a custom peculiar to Japan. In their daily lives, Japanese do not wear shoes in their houses, where the floors are covered with straw mats, or

## How Japanese ICs are tested for reliability

Assume that a failure rate of 10 FITs has to be demonstrated by life test. Such a requirement means device tests lasting for at least  $1 \times 10^8$  device-hours, equivalent to 10,000 devices operating for at least 10,000 hours with no failures. As such a test is almost impossible to carry out, accelerated stress tests at elevated temperatures are performed instead.

As large-scale integration reaches higher levels of density, reliability test methods become more complicated. Simple static bias tests do not simulate the actual operation of the devices because this cannot activate all the elements in the internal circuits. Instead, different sets of commands might be needed for the life tests of microprocessors and microcomputers. Moreover, the degradation of internal elements in an LSI device is seldom detected by measuring characteristics across external pins. Rather, margin characteristics related to supply voltages or operating frequencies are often measured instead.

Temperature, humidity, and bias tests are frequently used for testing the moisture resistance of plastic-encapsulated ICs. The effects of temperature and humidity

depend on many factors, including the kind of chip passivation, the degree of contamination, and the quality of the plastic encapsulant.

Pressure cooker tests, in which humidity tests are carried out at temperatures over  $100^\circ\text{C}$ , are also widely used for the quick detection of anomalies. Electrical bias is sometimes applied to the devices during or after these tests to detect any susceptibility to electrolytic corrosion.

There are several other thermal and mechanical environmental tests that simulate the extreme environments encountered in the operation, storage, and transportation of semiconductor devices. Included in these are temperature cycling, thermal and mechanical shock, soldering heat, constant acceleration, and vibration. The procedures for these tests are established in U. S. military standards and in International Electrotechnical Commission and Japanese industrial standard publications.

To screen devices and eliminate potential failures, a burn-in at elevated temperatures is often used. The effectiveness of such burn-in is supported by the fact that IC failure rates usually decrease with time.

tatami. They are accustomed to changing their clothes and removing their shoes before entering. Accordingly, Japanese workers never complain when they must change their clothes and shoes upon entering specially enclosed work areas at IC plants.

Overseas assembly has also affected reliability. American IC manufacturers have been relying on assembly in developing countries to avoid the cost of the wage increases won by domestic workers. In consequence, quality and reliability have suffered because of the difficulty in controlling manual labor.

Japanese workers have also been obtaining high wage hikes. But the semiconductor industry has turned increasingly to manufacturing automation, which has contributed heavily to reliability improvement as well as cost reduction. For example, the automation of wire bonding has reduced to a great extent the failures related to this process. Previously, it had been one of the principal failure mechanisms. Recently, IC manufacturers in the U. S. have been changing their strategy in favor of manufacturing automation.

### How NEC makes reliable ICs

Nippon Electric Co., one of Japan's leading electronics manufacturers, relies heavily on the ICs it manufactures. The IC division to which the authors belong is charged with supplying more than 30 NEC divisions with high-performance and high-quality devices at competitive prices. The IC division's goal is to achieve the world's highest quality levels.

Because high production volume can reduce costs and, perhaps, boost reliability, the IC division has, since its establishment, concentrated on supplying products to users outside NEC. In fact, more products are shipped to outside users than are used within the company. In addition, these products are manufactured with no distinction in quality, whether they are for sale to outside users or for use in house.

From the point of view of life cycle costs, the reliability of present LSI devices still must be improved. But efforts to increase reliability are not directed to the reinforcement of screening and inspections. Rather, they are aimed at making reliable products. Screenings and inspections are added only when the reliability of the products as manufactured does not reach acceptable quality standards. However, for ICs and especially for LSI devices, 100% inspection and strict screening during the manufacturing process and at the time of shipping are still necessary because their quality has not yet reached the level customers require.

The first step for achieving high reliability is in the design. IC design engineers having a fundamental understanding of reliability should take charge here. Figure 1 shows typical procedures followed for the development of a new product.

Device design rules based upon experimental data are first carefully established. After the completion of the design, a design review to check compliance with the rules is performed by members of departments that include design engineering, manufacturing engineering, and reliability and quality control.

The targets of every IC design are the maximum process yield, the maximum reliability, and the minimum cost. There should be essentially no contradictions among these targets, and the design should be well-suited to the capabilities of the manufacturing process. At the same time, it is important that the manufacturing engineers do their best to achieve and maintain the maximum process capability.

As far as ICs and LSI devices in particular are concerned, process yield is determined largely by the faulty devices caused by defects produced during wafer fabrication (see "How some Japanese ICs fail," p. 142).

If the defect density is known in a production line, the percentage of faulty devices, as well as its complement, the process yield, are statistically obtained as a function



**4. Machine control.** Fully automated wire-bonding machines went into operation at Nippon Electric as early as 1975 to make plastic-encapsulated integrated circuits.



**5. Presenting results.** NEC holds special symposiums each month at which workers discuss the results of their Zero Defects efforts.

of complexity factor (chip size), as shown in Fig. 2. Manufacturing engineers should expend maximum effort to reduce the defect density because its reduction has a great effect on lowering costs and improving reliability. Design engineers, on the other hand, like to reduce chip size to achieve the most advanced performance and lowest cost. This is done with the expectation that not only will the number of chips per wafer be increased but so will the number of good chips because of the reduced chance of any one chip encountering a defect.

But a mask reduction must accompany the greater packing density and the finer layout. Even trivial defects in the shrunk mask can affect device performance to a significant degree.

In addition, as shown in Fig. 3, the reduction ratio corresponding to the maximum number of good chips does not correspond to the reduction ratio for maximum yield. (Yield is defined as the number of good chips

divided by the expected number of chips.) The former gives the minimum production cost, whereas the latter gives the maximum reliability. Hence, the design engineer must make a choice.

NEC, in this case, would choose the maximum yield rather than maximum number of good chips. NEC places so much importance on reliability in its design rules that its LSI designs have often been described as being too conservative. However, the company believes that a design based on process capability will eventually contribute to cost reduction, as well as reliability improvement, because continuous production will be maintained without major interruption.

Last year, when soft errors in dynamic random-access memories were big topics, NEC had a rush of orders from all over the world because it had no soft-error problems in its 16-K RAMs. A soft error is the transient upset of memory caused by an alpha particle emitted from the uranium and thorium that occur as impurities in the package materials. The charge loss by the hole-electron pairs produced by particles is essentially equivalent to that attributed to small defects in the vicinity of a pn junction. For products designed with enough margin, this effect could be neglected.

Following design, the second step during which reliability is built in occurs during the trial run, which is followed by trial mass production. At each of these steps, the problems related to production are thoroughly examined through failure analysis.

### The problems of failure analysis

Failure analysis is a key factor for clearing up the causes of failures in manufacturing, screening, testing, and field operation. The results must be fed back into the design and manufacturing processes and corrective actions taken. As devices go on to ever larger-scale integration, their failure analysis is becoming more and more difficult, troublesome, and time-consuming. Design and manufacturing engineers as well as the reliability engineers are asking for better analytic techniques.

At present, electron-beam and photo-induced cur-

rents, stroboscopic scanning electron microscopy, and scanning acoustic microscopy are important techniques for detecting faulty circuits or sites in the devices. Electron microprobe analysis and secondary ion mass spectroscopy and Auger electron microscopy are effective for detecting even a trace amount of impurities.

Nevertheless, simple observation of the failed chip with a conventional optical microscope, as well as scanning electron microscopy for more elaborate circuit analysis, are still frequently used as effective and comparatively easy tools for failure analysis.

Failure of a newly developed product to achieve the standard yield, as shown in Fig. 2, may indicate a critical fault in the design, and its transfer to the full mass-production stage should not be approved.

The final step for achieving built-in reliability is in mass production. In the wafer fabrication process, as previously mentioned, the effort is directed to the decrease of defect density. Among the various kinds of defects, dust is the most critical cause of deteriorating wafer yields. The dust in air, the dust brought about by manufacturing equipment, the dust from persons, the dust in metalization chambers, the dust in deionized water, the dust in chemicals, and the dust created by chipping substrates must all be eliminated.

Mechanical damage caused during wafer handling by tweezers or vacuum chucks must also be examined. The automation of wafer fabrication processes has now completely eliminated these tools, which had been used until about seven years ago. Since then, yield and reliability have greatly improved.

For assembly processes, workers' skill directly affects the process yield and reliability. In light of this, NEC developed the world's first automatic wire-bonding and die-bonding machines. Semiautomatic and fully automatic wire bonders have been used to make NEC's plastic-encapsulated ICs since 1973 and 1975 respectively. Figure 4 shows fully automatic wire-bonding machines in operation. The application of semiautomatic wire-bonding machines for ceramic ICs started in 1974.

Dust and other forms of contamination infiltrate assembly processes as well. For example, contamination introduced on the surface of chips before encapsulation seriously affects the moisture resistance of plastic encapsulated devices. At NEC, ICs are assembled in clean rooms where clean air is used and dust is controlled.

It is also imperative to keep process conditions within specified limits. These conditions are controlled by machines on a continuous basis or by workers on a daily basis. In addition, they are periodically inspected by process checkers specially appointed to the task of detecting anomalies, pursuing their causes, and correcting them.

Control charts are often effective tools for detecting a process abnormality. In such charts, the averages and the ranges of the data measured are plotted chronologically. Upper and lower limits are determined not merely by product specification but also by using statistics to detect process abnormalities. Thus, possible failures are pin-pointed statistically so that corrective action may be taken before actual failures occur.

Worker morale is also essential, for the workers are

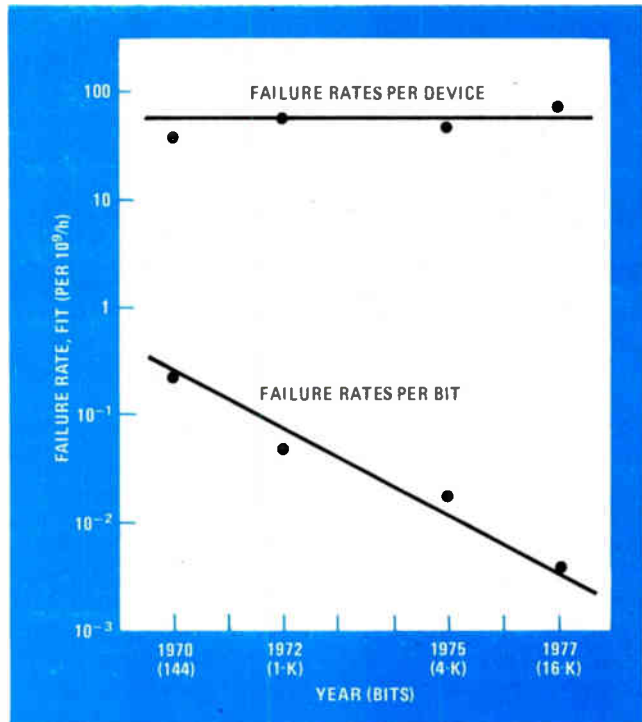

**6. Constant.** Failure rates for MOS random-access memories have remained almost constant, effectively dropping two orders of magnitude from the first 144-bit device to the latest 16-K RAM.

the ones who finally build reliability into products. To enhance morale at NEC, the Zero Defect movement applied to small group activities has been under way since 1965. The aim of ZD is to find the best ways of eliminating defects. But an indirect effect that seems even more important is that morale is enhanced because the workers realize they are participating in an extremely important activity. Their satisfaction comes in achieving their targets. The results of the ZD efforts are presented to their co-workers at special symposiums that NEC holds each month (Fig. 5).

### The reward

The care with which ICs are manufactured at NEC and elsewhere in Japan has paid off in measurable results over the years. It would seem that most basic problems affecting IC reliability have been solved by the long years of study and experience accumulated since the advent of transistors.

IC failure rates (defined as the number failing per unit time) in the field are now far lower than once expected. In fact, NTT has data for its electronic switching systems showing that ICs produced in the initial stage of mass production in Japan failed at a rate of only 1.1 FITs, which is less often than the transistors also used.

Another case is the MOS random-access memory. As Fig. 6 shows, its failure rate has remained almost constant over the years, regardless of its increasing bit capacity. Expressed in other terms, the failure rate per bit has dropped two orders of magnitude from the initial 144-bit device to the latest 16-K RAM. In many cases, the failure rates of LSI devices have proven much lower than the expectations based on MIL HDBK 217. □

## An acronym/abbreviation guide for electronics engineers

by Denny Frye and Jim Kientzy  
Probe-Tech Inc., Des Peres, Mo.

Integrated circuits, digital techniques, and microprocessors now invade the domain of those engaged in the classical fields of electronics. Though much available literature offers the classically educated engineer one way to catch up with the rapid advances of recent years, the acronyms and abbreviations of the terminology represent a serious obstacle to understanding. For anyone who is not familiar with the buzzwords of today, this alphabetized list of nearly 150 terms, compiled by this search/recruit organization with contacts in many corners of the industry, is a good cross section of those likely to be encountered and their meanings.

a-d	analog to digital	ECL	emitter-coupled logic
ALU	arithmetic and logic unit	ECM	electronic countermeasures
As	arsenic	EFL	emitter-follower logic
ASR	automated send/receive	emi	electro-magnetic interference
ATE	automated test equipment	EMR	electromechanical relay
BCD	binary-coded decimal	epi	epitaxial
BFL	buffered field-effect-transistor logic	E-PROM	erasable programmable read-only memory
bit	binary digit	EE-PROM	electrically erasable programmable read-only memory
CAD	computer-aided design	ESS	electronic switching system
CAM	content-addressable memory	Famos	floating-gate avalanche-injection metal oxide semiconductor
CCD	charge-coupled device	fdm	frequency-division multiplex
CCSL	compatible current-sinking logic	FFT	fast Fourier transform
CDI	collector-diffusion isolation	FIFO	first in, first out
Cerdip	ceramic dual in-line package	F-PROM	field-programmable logic array
CKT	circuit	FPLA	field-programmable read-only memory
CML	current-mode logic	Ge	germanium
C-MOS	complementary metal oxide semiconductor	GPIB	general-purpose interface bus
CPU	central processing unit	HCMOS	high-density complementary metal oxide semiconductor
CROM	control read-only memory	HIC	hybrid integrated circuit
CRT	cathode-ray tube	HiNIL	high-noise-immunity logic
CSL	current-sinking logic	HMOS	high-performance metal oxide semiconductor
CTL	complementary transistor logic	HTL	high-threshold logic
d-a	digital to analog	HV	high-voltage
DCFL	direct-coupled field-effect-transistor logic	IC	integrated circuit
DCTL	direct-coupled transistor logic	ICE	in-circuit emulator
DI	de-ionized water	IEC	infused emitter coupling
DIP	dual in-line package	IG FET	insulated-gate field-effect transistor
DMA	direct memory access	I <sup>2</sup> L	integrated injection logic
D-MOS	diffused metal oxide semiconductor	I/O	input/output
DUF	diffusion under epitaxial film	IR	infrared
DUV	data under voice	JFET	junction field-effect transistor
EAROM	electrically alterable read-only memory (same as EE-PROM)	JI	junction isolation
EBCDIC	extended binary-coded decimal interchange code	Laput	light-activated programmable unijunction transistor
E beam	electron beam	LASCR	light-activated silicon controlled rectifier
		LCD	liquid-crystal display
		LED	light-emitting diode
		LIC	linear integrated circuit
		LIFO	last in, first out
		LSB	least significant bit
		LSI	large-scale integration
		LS [TTL]	low-power Schottky [transistor-transistor logic]
		MCU	microprocessor control unit
		mcw	modulated continuous wave
		MDS	microprocessor development system
		MES FET	metalized semiconductor field-effect transistor
		MIS	metal insulator silicon
		MLA	microprocessor language assembler
		MLE	microprocessor language editor
		MNOS	metal-nitride-oxide semiconductor
		modem	modulator/demodulator
		MOS	metal oxide semiconductor

MOS FET	metal oxide semiconductor field-effect transistor	rfi	radio-frequency interference
mP	microprocessor	RIM	read-in mode
MPU	microprocessor unit	RMM	read-mostly mode
MSB	most significant bit	ROM	read-only memory
MSI	medium-scale integration	RTL	resistor-transistor logic
MTL	merged-transistor logic (same as P'L)	R/W	read/write
MUX	multiplexer	SBS	silicon bilateral switch
NDRO	nondestructive readout	SCR	silicon controlled rectifier
n-MOS	n-channel metal oxide semiconductor	SDFL	Schottky-diode field-effect-transistor logic
NRZ	non-return to zero	SDLC	synchronous data-link control
NRZI	non-return to zero inverted	S/H	sample and hold
OEM	original-equipment manufacturer	Si	silicon
PAR	program-aid routine	SIP	single in-line package
pc	printed circuit	SOS	silicon on sapphire
pcb	printed-circuit board	SSI	small-scale integration
PCM	pulse-code modulation	SSR	solid-state relay
P <sup>2</sup> C-MOS	double polysilicon complementary metal-oxide semiconductor	SUS	silicon unilateral switch
PIA	peripheral interface adapter	TRL	transistor-resistor logic
PIU	peripheral interface unit	TTY	teletypewriter
PLA	programmable logic array	UART	universal asynchronous receiver/transmitter
PLL	phase-locked loop	URCLK	universal receiver clock
p-MOS	p-channel metal oxide semiconductor	Usart	universal synchronous/asynchronous receiver/transmitter
PRACL	page-replacement algorithm and control logic	USRT	universal synchronous receiver/transmitter
PROM	programmable read-only memory	UTCLK	universal transmitter clock
PUT	programmable unijunction transistor	VHSIC	very high-speed integrated circuit
RALU	register and arithmetic and logic unit	VLSI	very large-scale integration
RAM	random-access memory	V-MOS	V-groove metal oxide semiconductor
RCTL	resistor-capacitor-transistor logic	VTL	variable-threshold logic
		XMOS	high-speed metal oxide semiconductor

## 6500 program automatically sets communications chip bit rate

by Michael R. Corder  
Compas Microsystems, Ames, Iowa

The 6551 asynchronous communications interface adapter (ACIA) made by Synertek and Rockwell is similar to Motorola's 6850, but with one important plus: its baud-rate generator is software-programmable. That feature can really be used to advantage by a 6500- or 6800-based board or terminal that is programmed to automatically adjust its baud rate to suit an incoming data stream.

One such program is listed here for the 6500 microprocessor, which could be part of a single-board computer incorporating the 6551 for hookup to a terminal. The routine, designed to be called immediately after system reset, essentially anticipates a maximum incoming data rate of 9,600 bits per second and samples a few characters at that speed; from the data obtained, it either

maintains the 6551 at 9,600 b/s or drops it down to a lower rate.

In operation, the user at the terminal chooses his baud rate and types the letter "O." The routine, having initialized the 6551's speed to 9,600 b/s, begins sampling the data at that rate. If the incoming data stream is 9,600 b/s, the letter "O" is recognized (CF<sub>16</sub> in the program, since in this case the most significant bit in the ASCII byte is still transmitted) and the routine terminates.

If the data stream is slower than 9,600 b/s, however, the 6551 keeps sampling for two more "characters." (Actually, the transmission of the letter "O" would not yet be complete.) The routine then invokes the table named STABL in the program listing in order to determine the rate of incoming data based on the information received from sampling for the two characters.

As the comment field in the table STABL shows, the program homes in on the data rate from the first character sampling. As it turns out, rates of 4,800, 2,400, and 1,200 b/s can be ascertained from the first sample. If a 0 is perceived as the first character, the program deduces that the data rate is 600 b/s or less. If that is the case, the 6500 will automatically drop the 6551 data rate down to 600 b/s and proceed to sample the second

# Oliver 'Tex' Germanium.

At GPD, our range of small-signal Germanium devices gets bigger, and bigger, and bigger.

Now, we can offer many types which you previously bought from TI: JAN 2N404-404A, JAN 2N1039, JAN 2N1041-2N1045, JAN 2N1302-2N1309 (NPN & PNP) and JAN 2N2553-2555-2557-2559.

All to Mil Spec of course, and all to the highest Germanium quality; defense contractors can buy from GPD with complete confidence.

At GPD we make devices to all the well-known specs: JAN, EIA, and PRO-ELECTRON AD, ADY, ADZ, ASZ, AY, AU, and ASY.

And we can replace practically all the Germanium products you used to buy from Motorola (MP500-506, 2N4276-4283, 4048-4053), Delco (DTG1100, 2N1100, DTG2000-2400A), GE (2N319-324, 524-526, 1370-1381, 1413-1415, 1924-1926), Siemens, Mullard, SGS-ATES, and Thomson.

From 150mW small signal to 100A power, in packages of all shapes and sizes; you could say our Germanium range now extends from Texas to Maine.

And in our corner of the prairie, Germanium is here to stay.

Send for our latest catalogue or let us know your specific problem.

Circle 150 on reader service card



## Germanium Power Devices Corporation

Austria Rieger GmbH, Mairverggasse 10, A-1030 Wien 3, Tel: 0222-734684, Tlx: 131087 rieger at Omni Ray GmbH, Vertriebsbüro Wien, Prinz Eugen-Strasse 36, A-1040 Wien, Tel: 0222-656431, Tlx: 132712 omray a  
Benelux B.V. Laboratorium Voor Electronentechniek Diode, Hollaanlaan 22, 3526 Am Utrecht, Holland, Tel: 030-884214, Tlx: 47388, Rue Picard Str. 202, 1020 Bruxelles, Belgium, Tel: 02-4285105, Tlx: 25903  
Denmark E. V. Johansen Elektronik A/S, Litangade 15, DK-2200 Copenhagen S, Tel: 0451-839022, Tlx: 16822, GDS-Henckel Elektronik ApS, Fyrevangen 4, DK-4622 Havdrup, Tel: 03-385716, Tlx: 43168  
France Davum Dept INIC, 11 Rue Racine, PO Box 28, 93121 La Courneuve, Tel: 836-84-01, Tlx: 210311F (PUBLI)  
West Germany Solcomp Elektronik GmbH, Mondstrasse 10, 8000 Munich 90, Tel: 089-461027, Tlx: 08-22870  
India Kirloskar Electric Co. Ltd., PO Box 5555, Malleshwarum West, Bangalore 560055, Karnataka State, Tel: 35311, Tlx: 230  
Italy Sycsom Elettronica Spa, Via Gran Sasso 35, 20092 Cinesello Balsamo, Milano, Tel: 02-6189159 and 02-6189251, Tlx: 330118, Euroelettronica Srl, Sede, 20145 Milano, Via Mascheroni 19, Tel: 049-81851, Tlx: 39102 THOMEL-EC  
Norway Nordisk Elektronikk (Norje) A/S, Mustadsvet 1, Postboks 91, Lalleaker, Oslo 2, Tel: 0752-13800, Tlx: 856-16963 (AJC ONM)  
Portugal Ditrax Componentes Electronica, Lda, Av. Miguel Bombarda 133, L.D., 1000 Lisbon, Tel: 545313  
Republic of South Africa Electron (Pty) Ltd., 704 Mann Pretoria Road/Hoofweg Wynberg PO Box 10544, Johannesburg 2000, Tel: 406290, Tlx: 8-2333  
Spain Kontron SA, Costa Brava, 13, Edificio Miraserra, Madrid-34, Tel: 7348413, Tlx: 23382  
Sweden Intergrad Elektronik AB, PO Box 43, S-182 51 Djursholm, Tel: (08)753-03-30, Tlx: 10282  
Switzerland Omni Ray AG, 8008 Zurich, Dufourstrasse 56, Tel: (01)478200, Tlx: 53239  
UK Representative Wintronics, Southon House, Edenbridge, Kent TN8 5LP, Tel: 0732-864488, Tlx: 848946  
UK Agents Jermyn Industries, Sevenoaks, Kent, Tel: 0732-50144, Tlx: 95142  
Consort Electronics Ltd., Rosbank Parade, Reading Road, Yateley, Camberley, Surrey, Tel: 0252-871717, Tlx: 858809

GPD, Box 65, Shawsheen Village Station, Andover, Mass 01810.

Tel: (617) 475-5982. Telex: 94-7150 GPD Andr.



6500 PROGRAM: ACIA AUTO-SPEED ROUTINE

```

LOC      CODE      LINE
0000      ACIA      =S6000
0000      HIST      =0
0000      :
0000      :          =S200
0200      D8      RSET      CLD
0201      A2 FF      LDX      =SFF
0203      9A      TXS
0204      :
0204      : NOW DO AUTO-SPEED RECOGNITION
0204      :
0204      A9 FF      LDA      =SFF
0206      8D 01 60    STA      ACIA+1      ; RESET 6551
0209      A9 0B      LDA      =%00001011 ; NO XMIT OR RCV INT.
020B      8D 02 60    STA      ACIA+2
020E      A9 1E      LDA      =%00011110 ; BAUD RATE = 9600
0210      8D 03 60    STA      ACIA+3
0213      A0 00      LDY      =0 ; COUNT OF CHARS
0215      : NOW WAIT FOR CHARACTER
0215      AD 01 60    SLOPP     LDA      ACIA+1      ; WAIT FOR KEY
0218      29 08      AND      =%1000
021A      F0 F9      BEQ      SLOPP
021C      AD 00 60    LDA      ACIA ; GET CHAR
021F      99 00 00    STA      HIST,Y ; SAVE IT
0222      C9 CF      CMP      =SCF ; IS IT 9600?
0224      F0 37      BEQ      SDONE ; QUIT IF SO
0226      : IF CHAR IS ZERO, SPEED IS 600 OR SLOWER
0226      : DROP SPEED AND CONTINUE
0226      C9 00      CMP      =0
0228      D0 0F      BNE      FAST
022A      A9 FF      LDA      =SFF
022C      8D 01 60    STA      ACIA+1      ; RESET IT
022F      A9 0B      LDA      =%1011
0231      8D 02 60    STA      ACIA+2
0234      A9 17      LDA      =%00010111 ; SPEED = 600
0236      8D 03 60    STA      ACIA+3
0239      C8      FAST      INY
023A      C0 02      CPY      =2 ; WANT TWO CHARS
023C      D0 D7      BNE      SLOPP
023E      A2 00      LDX      =0
0240      A5 00      LDA      HIST
0242      D0 04      BNE      F1 ; IS GREATER THAN 600
0244      A2 03      LDX      =3
0246      A5 01      LDA      HIST+1
0248      C9 FE      F1      CMP      =SFE
024A      F0 0B      BEQ      F90
024C      E8      INX
024D      C9 F8      CMP      =SF8
024F      F0 06      BEQ      F90
0251      E8      INX
0252      C9 80      CMP      =S80
0254      F0 01      BEQ      F90
0256      E8      INX
0257      8D 5D 02    F90     LDA      STABL,X
025A      8D 03 60    STA      ACIA+3
025D      : SDONE ; REST OF THE MONITOR
025D      :
025D      :
025D      : TABLE FOR SPEED RECOGNITION
025D      :
025D      1C      STABL     .BYT %11100 ; 4800 (FE,F8)
025E      1A      .BYT %11010 ; 2400 (F8,00)
025F      18      .BYT %11000 ; 1200 (80,00)
0260      17      .BYT %10111 ; 600 (00,FE)
0261      16      .BYT %10110 ; 300 (00,F8)
0262      15      .BYT %10101 ; 150 (00,80)
0263      93      .BYT %10010011 ; 110 (00,00) 2 STOP BITS
0264      .END

```

character. From the information for the second character, the program finds the correct entry in STABL and sets the 6551 to the proper bit rate.

Some changes may have to be made to the entries in the table to accommodate parity bits or interrupts used with the 6551, but such changes can easily be made in

accordance with the chip's data sheet. Also, though the routine is not optimal in its code size, it has proven very reliable with a number of different terminals. □

Engineer's notebook is a regular feature in *Electronics*. We invite readers to submit original design shortcuts, calculation aids, measurement and test techniques, and other ideas for saving engineering time or cost. We'll pay \$50 for each item published.

## Low-frequency multiplier measures power to 1 GHz

Engineers who have to measure electrical power between a source and a load at frequencies up to 1 MHz can readily do it with commercially available four-quadrant multiplier modules. All they have to do is measure instantaneous voltage and current and condition their levels to the multiplier with amplifiers. Above 1 MHz, directional couplers to pick off a calibrated sample of forward and reverse power can do the job, but this procedure is cumbersome and does not permit viewing of the instantaneous voltage, current, and power waveforms.

Working around this problem, John M. Anderson of General Electric Co.'s Research and Development Center in Schenectady, N. Y., uses a sampling oscilloscope and picks off the sensed voltage and current repetitive waveforms. Then he multiplies the low-frequency reconstructed waveforms—obtainable from the oscilloscope amplifiers—with the aid of a multiplier module.

**The waveforms are directly visible on the scope face, and instantaneous or average power can be obtained at the output of the multiplier for frequencies up to the capability of the sampling oscilloscope receiving heads, generally 1 GHz.**

## How to get into computer graphics

As a computer user or vendor, are you contemplating a move into graphics? The first directory devoted exclusively to computer graphics suppliers is now available from The Harvard Newsletter on Computer Graphics, a twice-a-month periodical published under the auspices of the Harvard University Laboratory for Computer Graphics.

According to the executive director, Allan H. Schmidt, the 1980 edition lists **more than 135 suppliers' names, addresses, and telephone numbers** and an individual to contact, as well as products and services. It also includes background information on sales, the year founded, officers, and the number of employees.

To order "The 1980 Director of Computer Graphics Suppliers: Hardware, Systems, Software, and Services," write to the Directory Department, The Harvard Newsletter on Computer Graphics, P. O. Box 89, Sudbury, Mass. 01776. It's \$17.00 in the U. S., Canada, and Mexico and \$19.00 elsewhere. Or call Allan Schmidt at (617) 495-2526 for further information.

## Third edition of relay handbook being readied

The Engineer's Relay Handbook has been known for years as the last word for designers responsible for the selection of correct relays for a given application. The third edition contains all the information of the second edition, plus four new chapters. "Relay Test Procedures (EIA Std., RS-407A)" and "Solid State Relays (EIA Std., RS-443)" have been added through the cooperation of Electronic Industries Association. "Precautions in Relay Applications" is **devoted to the do's and don't's of relay use**, and the fourth addition covers international relay standards. Chapters on relay operation and application considerations have been expanded as well. Copies of the handbook will be ready around April, according to executive director Albert Johnson, for \$20.00 post-paid. Write to Marcia Mitchell, National Association of Relay Manufacturers, or call her at (219) 264-9421 for further information.

**-Harvey J. Hindin**

# Aromat SE Amber Relays... a pure product of "relay efficiency."

$$\text{Relay efficiency}(\eta) = \frac{\text{The sum of all contacts' switching capacity (VA)}}{\text{Operating power(W) x Volume(cm}^3\text{)}}$$



## A breakthrough in relay efficiency.

The SE Amber relay's key to higher efficiency lies in greater miniaturization coupled with high reliability and greater switching capacity.

### • High sensitivity in small size.

$$\left[ \frac{\text{Operating power (W)}}{\text{x Volume(cm}^3\text{)}} \right]$$

The SE Amber relay's 4-gap balanced armature delivers a highly efficient polarized magnetic circuit—sensitive enough to be driven directly by an IC, in a space 28L x 12W x 10H mm.

### Sensitivity

Pick-up power	100 mW
Nominal operating power	200 mW

### Dimensions

Volume	28L x 12W x 10H mm	
	1.102 x .472 x .394 inch	
Header area	336mm <sup>2</sup>	.521 inch <sup>2</sup>
Height	10mm	.394 inch

### • Wide switching range.

$$\left[ \frac{\text{The sum of all contacts' switching capacity (VA)}}{\text{}} \right]$$

Switching is possible from 100 $\mu$ A 100mV DC to 4A 250V AC, thanks to the 4-gap balanced armature system and special multi-layer clad contacts. A single SE relay can

handle maximum and minimum switching simultaneously.

### • High reliability and long life.

The balanced armature system with permanent magnets gives larger contact pressure. Bifurcated contacts and lower contact bounce add to contact reliability and expected contact life.

### • Amber design and construction.

Designed for automatic wave soldering and cleaning, the sealed SE Amber relay performs reliably under conditions where hydrogen sulfide, silicone and ammonia fumes prevail.

### • High vibration/shock resistance.

The balanced rotating armature provides great resistance

to shock and vibration. Vibration resistance: 10 to 55G (amplitude: 3mm) Shock resistance: 50G (11msec.).

### • Varied contact arrangement.

SE relays are available with bifurcated contacts in 2a2b and 4a contact arrangements.

### • Multiple latching.

2-coil latching types are available, in addition to single side stable types. Single SE relays have a latching capability with multiple contacts, one contact can control the circuit while the other can switch the load simultaneously.

### • Low thermal electromotive force.

Because the SE relay has

completely separate coil and contact chamber areas, extremely low thermal electromotive forces are possible.

### • Dual in-line package arrangement.

This 2-track terminal arrangement allows easier component insertion, easier layout and identification of terminal locations, and simpler in-line checking.

Relays for  
Advanced Technology



**Aromat**

Member of Matsushita Group

Contact Your Aromat Representative  
or Distributor Today.

### Aromat Corporation:

250 Sheffield Street  
Mountainside, NJ 07092  
(201) 232-4260

### Mid-Western Office:

311 Lively Blvd.  
Suite 1  
Elk Grove Village, IL 60007  
(312) 593-8535

### Western Office:

10400 North Tantau Avenue  
Cupertino, CA 95014  
(408) 446-5000

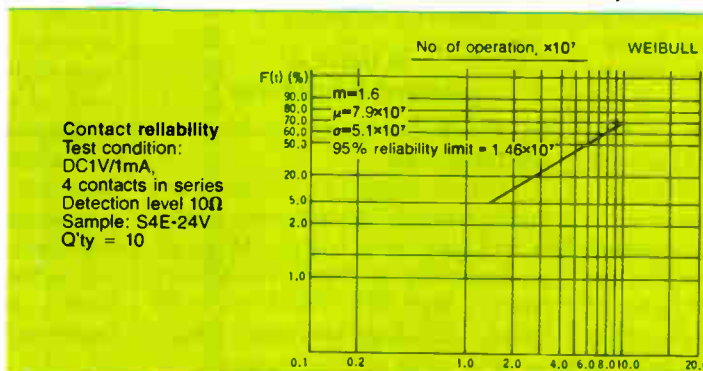

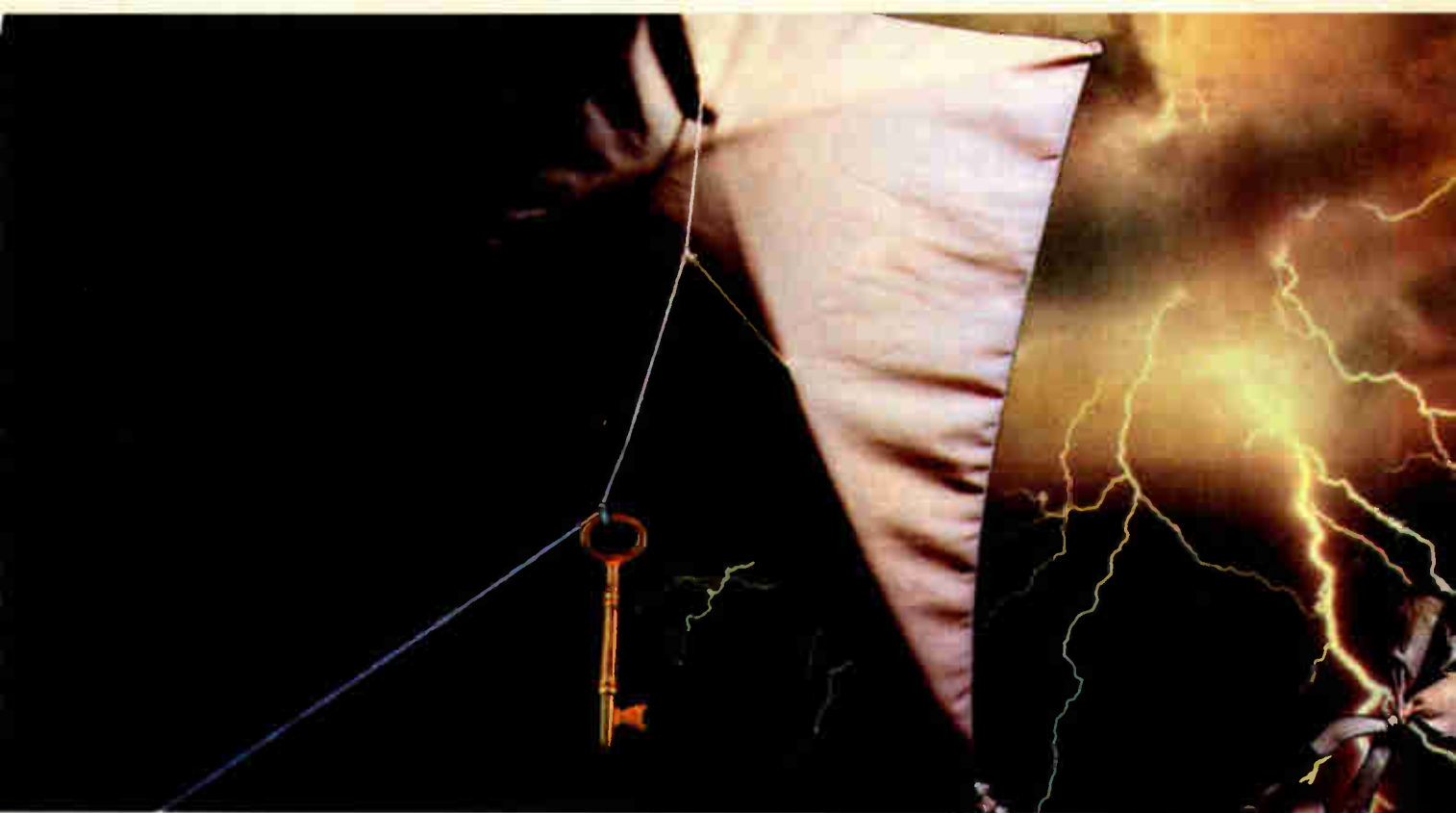

# If Ben Experimented Today, He Could Rent Any One Of 18,000 Test Instruments From General Electric.

Short of a kite and a key, a broad selection of the most wanted test instruments is available—like lightning!—from a GE Rental Shop near you. Biddle Megger Testers. Hewlett-Packard Signal Generators. Honeywell Oscillographs and Plug-in Amplifiers. Scopes from Tektronix. Recorders from Gould Brush and

Esterline Angus...and many more. So, whether you need a single scope, specialized instrumentation, a complex measurement system or application assistance, renting from GE is a breeze!



All rental instruments are maintained in tip-top shape, thoroughly checked and calibrated before each shipment. And it's on the way to you fast, normally the same day you call.

For your FREE RENTAL CATALOG call collect to the inventory center nearest you:  Los Angeles, CA (213) 642-5350  Atlanta,

GA (404) 457-5563  Chicago, IL (312) 854-2994  Detroit, MI (313) 285-6700  Schenectady, NY (518) 385-2195  New York City (201) 227-7900  Houston, TX (713) 672-3570. Or call (518) 327-9900.

---

GENERAL ELECTRIC COMPANY  
Apparatus Service Division  
Building 4, Room 210, 1 River Road  
Schenectady, NY 12345

---

GENERAL  ELECTRIC

# 5½-digit multimeter gets smart

Pair of microcomputers used in John Fluke DMM adds to measurement capability, enhances reliability

by Bruce Le Boss, San Francisco regional bureau manager

A 5½-digit multimeter that uses two microcomputers to enhance its reliability, keep its price down, and extend its measurement capabilities to the leading edge of the measurement art is pretty impressive. Add an optional IEEE-488 interface and a calculating controller and there sits the model 8860A from the John Fluke Manufacturing Co.

Even without the optional controller, the 8860A is a powerful computing DMM that measures dc voltage to within 0.01% for one year, true-rms voltage (either ac- or dc-coupled) to 700 V, and resistance to 20 MΩ using two- or four-terminal techniques. Manual and automatic ranging are also provided as are push-button zeroing for resistance and dc measurements.

The basic \$1,395 DMM has special modes that include offset, limits, and peak-to-peak, for storing the highest and lowest measurements made. The constants used in the offset and limits modes "can be stored in analog or digital fashion"—that is, they can be entered numerically or from the display, explains Lee Meyer, product manager for Fluke's General Test and Service division. The 8860A has two measurement modes—continuous trigger and single trigger. The continuous-trigger mode has two selectable rates, 2.5 readings/second on the 5.5-digit range and 12.5 readings/s on the 4.5-digit range. In the single-sample mode, the DMM can be triggered from the front panel or by an external contact closure.

**Guarded.** The 8860A, which will be on display later this month at the M.B. Electroniques-Fluke stand at the International Electronic Compo-

nents Exposition in Paris, has as its heart the two 8-bit single-chip microcomputers that are contained in the mainframe, one inside the analog circuit guard and the other outside the guard. The in-guard processor, Mostek Corp.'s 3870, is responsible for controlling all of the analog circuitry (analog-to-digital conversion, autoranging, and timing, for example) and for making the actual measurement.

The measurement is then communicated across the guard, using optical coupling, to the out-guard processor, an Intel Corp. 8039 (an 8049 minus read-only memory) that is used in conjunction with an externally programmed ROM. The 8039 is, in effect, the master controller of the DMM as it monitors the front panel, tells the 3870 what measure-

ment to make, processes the data, and displays the result. What's more, it also interfaces directly with the operator, by annunciators and diagnostics, to indicate instrument status and legal and illegal entries, Meyer explains.

The calculating controller, a \$500 option, is a keystroke-programmable scientific calculator that resides within the 8860A mainframe but is controlled by an external keyboard. "It ties the number-crunching power and program execution capabilities of a state-of-the-art handheld calculator to the analog measuring power of the 8860A," Meyer states. The result, he adds, is a computing DMM that can be programmed to measure such parameters as capacitance, inductance, temperature, pressure, and power with a minimum of extra

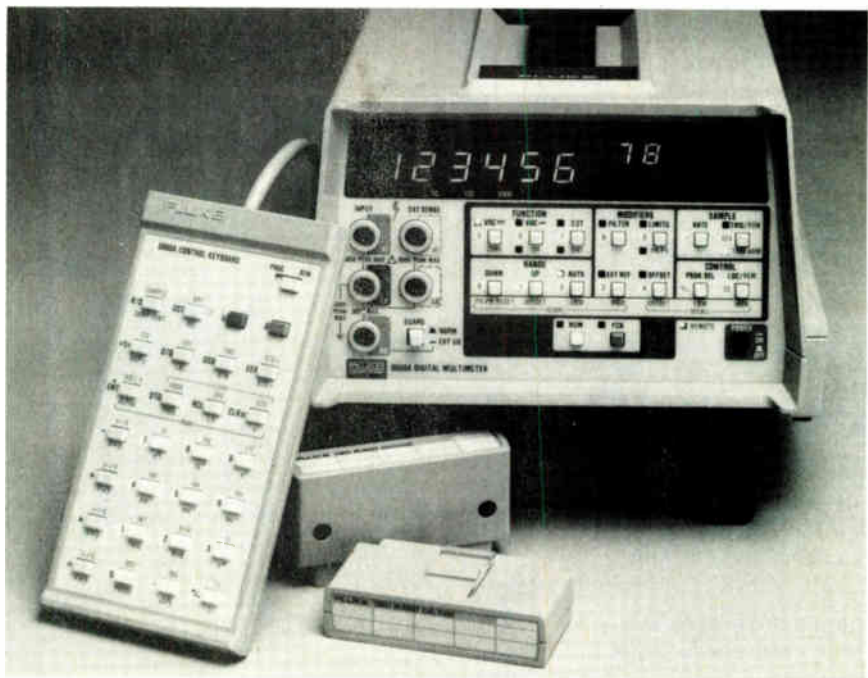

# Best selection of Dip, Panel, and PC Miniature Rotary Switches.

Your single source of supply for a wide variety of miniature rotary switches. Emphasis is on PC Mountable types including Dual-In-Line types with either BCD or Decimal Codes. Gold contacts where applicable are standard for low-level switching. Choice of screwdriver actuators, knob shafts or key-lock types and some are made for panel mounting. Fixed or adjustable types up to 10 or 12-positions and also in 2-pole 6-positions and 3-pole 4-positions. We have many more types than shown in this photo. Our engineering and production group will respond favorably to provide custom rotary switches, whether it be cut or milled shafts or an entirely new concept to meet your exacting needs. We urge you to call or write for details and ask for our new 160-page ALCOSWITCH catalog.



## ALCOSWITCH®

ALCO ELECTRONIC PRODUCTS, INC. a subsidiary of AUGAT, Inc.  
1551 Osgood St., N. Andover, MA. 01845 (617) 685-4371 TWX: 710 342-0552

Circle 158 on reader service card

## 1979 Electronics Buyers' Guide

The only book of its kind in the field. If you haven't got it, you're not in the market.

To insure prompt delivery enclose your check with this coupon.



Electronic Buyers Guide  
1221 Ave. of the Americas  
New York, N.Y. 10020

Yes, please send me \_\_\_\_\_ copy(ies) of 1979 EBG.  
 I've enclosed \$30 per copy delivered in the USA or Canada.  
 I've enclosed \$52 per copy for delivery elsewhere  
 Name \_\_\_\_\_  
 Company \_\_\_\_\_  
 Street \_\_\_\_\_  
 City \_\_\_\_\_ State \_\_\_\_\_ Zip \_\_\_\_\_

### New products

equipment or special fixturing.

Termed a "friendly instrument," the 8860A can talk directly to the calculator, making measurement data available for use in programs. Similarly, the calculator can talk directly to the DMM, thus making it possible to control the instrument from a program the user punches into a nonvolatile random-access memory, an optional \$50 battery-powered cartridge (module) that plugs in at the rear panel. The calculating controller has 100 fully merged steps with indirect addressing, editing, and branching. Calculator entry is in reverse Polish notation (RPN), and a complete set of preprogrammed functions is provided.

According to Meyer, the combination of scientific calculator and DMM "offers an integrated solution to a large number of application problems." All that is required, he adds, is the appropriate transfer function, equation, or look-up table. Specific applications include: statistical analysis of batches of components, component sorting, measuring capacitance or rf power with the appropriate adapters, temperature measurements with thermistors or thermocouples, and various kinds of transducer measurements.

Also available for use with the 8860A is an optional (\$295) IEEE-488 interface that provides both talk and listen capability so the 8860A can be completely programmable and can deliver measurement data as well as status information. Contained inside the 8860A mainframe, the fully isolated interface allows control of all instrument functions and ranges through individual commands or through a "learn mode" that memorizes the DMM's configuration as selected from the front panel. The interface has measurement rates of 2.5 and 12.5 readings/s, as noted earlier, as well as 45 readings/s on the 3.5-digit range. The IEEE-488 interface and the calculating controller cannot be in the mainframe at the same time. Delivery is in 60 days.

John Fluke Manufacturing Co., P. O. Box 43210, Mountlake Terrace, Wash. 98043. Phone (206)774-2211 [338]

Now, Quality in  
SND5027, 5037 & 5025

# DataCom LSI



Please attach this coupon to your company's letterhead with your name, title and mailing address. Send to:

Solid State Scientific,  
Montgomeryville, PA 18936

Please send more information.

I'd like a free evaluation sample.

call me at \_\_\_\_\_

E1 3/15

datacom

**Look at our DataCom LSI.** The SND5027 is the original Video Timer-Controller, and still very popular. For new designs, the SND5037 offers even more flexibility and can further reduce system costs. The SND5025 is our multi-protocol Universal Synchronous Receiver/Transmitter. This device has one of the fastest serial transfer rates in the industry. Applications include computer to modem interface, computer to computer links, and terminal I/O.

**SSS DataCom ICs can replace the following parts:**

SSS	DESCRIPTION	TI	SMC
SND5025	Multi-Protocol USYNR/T	—	COM5025
SND5027	Video Timer-Controller	TMS9927	CRT5027
SND5037	Video Timer-Controller	—	CRT5037

**Our quality standards are high.** Each device in the Solid State Scientific DataCom family receives complete and rigorous testing before we deliver it to you. Our standards are among the highest in the industry. To maintain these standards, all AC and DC parametrics are tested with some of the most sophisticated LSI test systems available.

Whatever you need in Video Timer-Controllers or USYNR/Ts—look for quality. Look to Solid State Scientific.

**Want more information?** Send in the above coupon or call Solid State Scientific at 215 855-8400, ext. 353.



**Solid State Scientific**

Montgomeryville, PA 18936/215 855-8400/TWX 510-661-7267

Circle 159 on reader service card

From the motion picture "The Graduate," ©1967 Avco-Embassy Pictures Corp.



**“I JUST WANT TO SAY  
ONE WORD TO YOU...”**



# “HITACHICMOSPLASTICS!”

## INTRODUCING HITACHI CMOS PLASTIC TECHNOLOGY

Now, more than ever before, the world depends on electronic technological advancement to reduce our energy problems. And, we've responded. Through Hitachi CMOS technology.

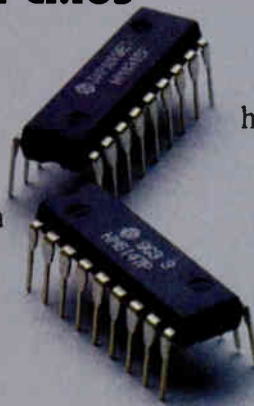

## “HI-CMOS”

A technology so unique, it's enabled us to combine the low power of CMOS and the high speeds of HMOS with cost-effective NMOS densities.

With the low power of Hitachi CMOS we can now offer high-speed static RAMs in plastic with densities up to 16K.

## CMOS PLASTIC VS. NMOS POWER LIMITS

Hitachi CMOS plastic technology allows plastic packaging of high-speed static RAMs to densities of 64K and beyond, whereas NMOS reaches the limit at 16K.

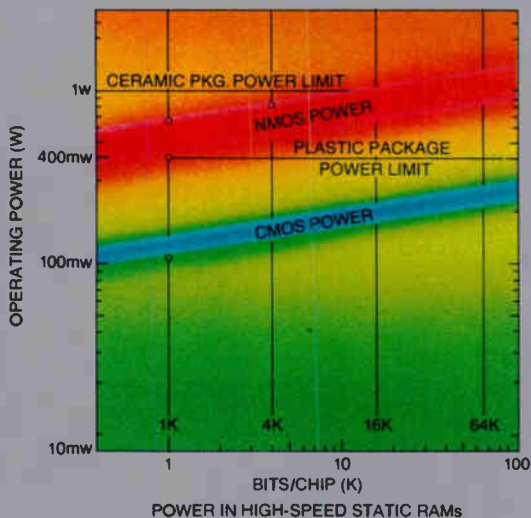

This advanced CMOS plastic technology means you'll need only 200mw to operate our 16K devices compared to the 700mw operating power required by standard 16K NMOS cerdip RAMs.

## MORE REASONS TO CHANGE TO CMOS PLASTIC

Pin-for-pin compatibility. Comparable high speeds. Radically lower-power dissipation. Lower operating temperatures. Reduced need for high-current power supplies. Prices competitive with NMOS cerdip RAMs.

The list goes on, but only you can make the comparison for use in your application.

Part No.	Organization	Speed	Operating Power	Availability
6147	4K x 1	55/70	75mw	Now
6148	1K x 4	55/70	150mw	Samples
6116	2K x 8	120/150/200	200mw	Samples
4334	1K x 4	300/450	20mw	Now
4315	4K x 1	350/450	20mw	Now

The IR100 award winning HM6147 CMOS memory exemplifies this line of state-of-the-art products. A unique combination of high-speed NMOS memory cells and low-power CMOS peripheral circuits yield fast (55ns) access times with the low-power dissipation (75mw) characteristic of CMOS technology.

Compare our plastic packaged HM6147, 4K x 1 CMOS RAM with your present 2147 device. You'll find ours offers unduplicated power advantages plus comparable speeds.

Then compare our HM6148, 1K x 4 with any 2148. Our 55ns access time meets that of your 4K high-speed NMOS static, but only Hitachi adds lower-power characteristics: including 150mw operation and only 5 $\mu$ W during complete standby.

And, our 16K HM6116, 2K x 8 has an address access time of 120ns with low-power dissipation during operation of 200mw, just 20 $\mu$ W during complete standby.

## SAY GOODBYE TO HIGH POWER DISSIPATION PROBLEMS

Just say “HITACHICMOSPLASTICS” to your Hitachi representative or distributor for data sheets, samples and prices. He'll make delivery, reduced power dissipation and lower cost a sure thing.



**Hitachi. The sure thing.**

Hitachi America, Ltd. • Electronic Devices, Sales and Service Division  
707 W. Algonquin Road • Arlington Heights, IL 60005 • (312) 593-7660 • TLX20-6825  
Stocking Distributors: Bell • Future • Jaco • Marshall • Milgray • Resco • RM Electronics • Sterling • Time

**You looked at the 11/34 and loved the price.  
You looked at the 11/70 and loved the features.**

**Now look at the  
PDP 11/44.**



# Digital introduces a mid-range mini with a megabyte of main memory, decimal arithmetic, and an expanded 11/70 instruction set.

Now for little more than the cost of an 11/34, our new PDP-11/44 gives you features previously found only on superminis. Like PAX, a physical address extension that gives you a full megabyte of main memory for more users, larger programs, greater throughput. A new MOS ECC memory with interleaving for faster access time. 8KB cache memory for faster program execution and greater DMA bandwidth. Sophisticated memory management. And an expanded 11/70 instruction set.

The 11/44 also offers significant performance advancements in two important languages. Our optimized FORTRAN IV-PLUS compiler and run time system, coupled with our floating point processor option, gives impressive performance advantages over conventional FORTRAN. And our enhanced COBOL compiler with our new optional Commercial Instruction Set processor, delivers powerful COBOL performance and data processing capabilities.

To keep the 11/44 on the job, you get plenty of reliability features, including a microprocessor-controlled ASCII console with extensive system diagnostic capabilities. A new built-in TU58 cartridge tape for easier servicing. Plus facilities for optional remote diagnosis for 24-hour-a-day, 7-day-a-week service with an average response time of less than 15 minutes.

Of course the 11/44 shares the design advantages of our entire PDP-11 family. Most importantly, it guarantees software compatibility the way only the world's broadest range of 16-bit compatible computers can. So your software investment remains intact no matter which system you choose. RSX-11M, the most versatile real time system in the industry. The new RSX-11M-PLUS. Or the new enhanced version of our proven general purpose

and timesharing system, RSTS/E. You can also tailor the 11/44 to your exact application by choosing from a broad line of interfaces and peripherals, like our new 20 megabyte RL02 disk subsystem.

No matter how you look at it, the PDP-11/44 provides an incredibly powerful base for your interactive and distributed processing applications.

And that's saying a lot for a system that costs so little.

Please send me more information about the PDP-11/44.

Please have a salesperson call.

Name \_\_\_\_\_

Company \_\_\_\_\_

Address \_\_\_\_\_

City \_\_\_\_\_ State \_\_\_\_\_ Zip \_\_\_\_\_

Phone \_\_\_\_\_

My application is:  Education  Medical  
 Laboratory  Engineering  Government  
 Resale  Manufacturing  Other

Send to: **Digital Equipment Corporation**, 146 Main Street, Maynard, MA 01754, Attn: Communication Services, NR-2/2, Tel. 617-481-9511, ext. 6885. Digital Equipment Corporation International, 12 av. des Morgines, 1213 Petit-Lancy, Switzerland. In Canada: Digital Equipment of Canada, Ltd. N-3-13-0

**digital**

Last year in Scotland,  
American management together  
with intelligent labor, graduated  
to the tune of \$4.5 billion.

That's the value of good communication.

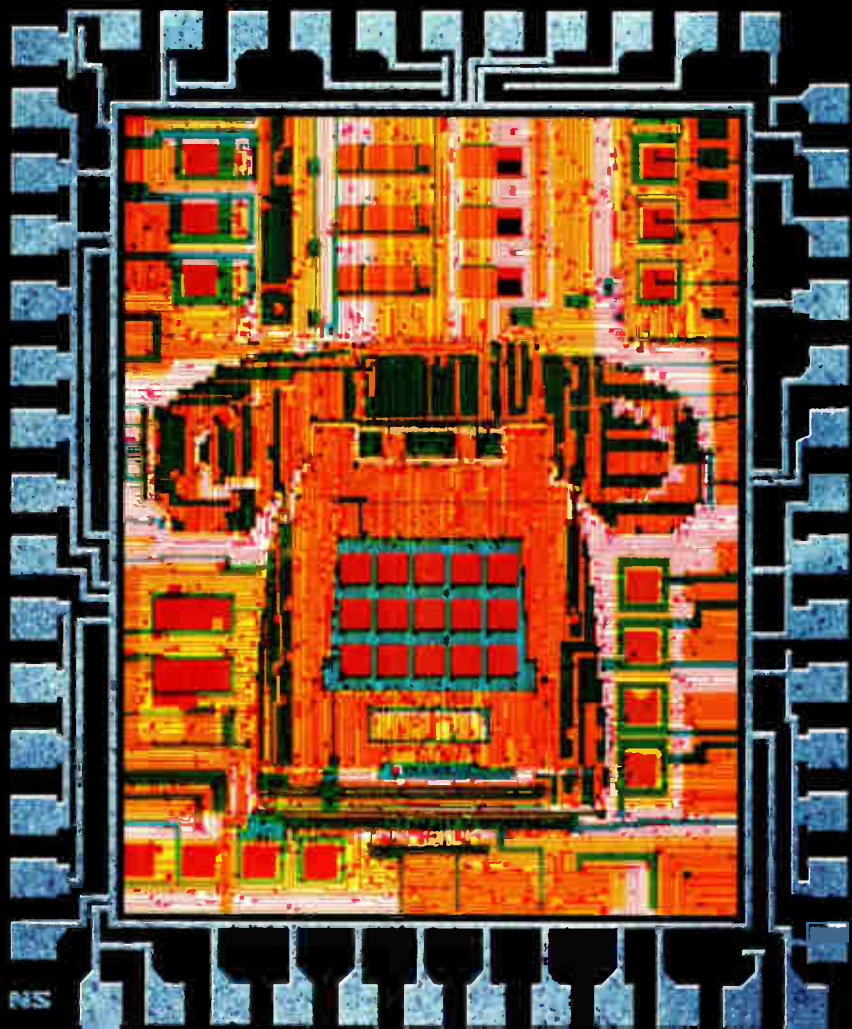

Last year good communication between American management and a well motivated Scottish workforce earned U.S. industry \$4.5 billion and pushed Scotland into the forefront of productivity minded and profit orientated industrial companies. Now Scotland offers a healthy profit incentive hand in glove with political calmness and stability. We clinched it last year with new evidence on our ability to produce quality work, faster and better.

But don't take our word for it, ask some of your own well known multinationals. Ninety percent of U.S. electronics companies placed Scottish plants in the top half of their world-wide productivity league. And they have a great deal to say about the high standard of quality production.

An intelligent look at our strike record in U.S. owned companies will show that eighty percent reported "No strike activity" throughout the past 18 months of operation and a staggering strike-free period of 5 years was quoted by every one of the U.S. electronics companies based here.

### People talking to people get things done

So what's the reason? We put it down to good communication. Talking the same language between management and staff. Getting ideas across. That way, management and staff get the best out of each other to the benefit of the company. That's the thing about the Scots; let them know what's happening and they work hard.



It's our "desire to learn" that results in Scotland's high educational level. Scotland's 8 Universities, 55 Polytechnics and Technical Colleges are responsible for a constantly refreshed nucleus of skilled people—producing proportionately more graduates than most European countries, 40 percent of them with degrees or diplomas in science or engineering.

An intelligent and skilled talent pool which has proved a primary attraction to IBM, National Semiconductor,

Honeywell and other American high technology corporations since the early 1950's.

### Communications in the best connected of lands

The United Kingdom telephone network with 23 million telephones and 48 million daily calls is the largest in Europe. In Scotland our services have expanded at a faster rate than the rest of the U.K. Well over half of Scottish homes are connected by telephone—a far higher proportion than the rest of Europe. Now four out of five Scottish telephones can dial direct to about 360 million telephones in 85 countries. 5,400 customers in Scotland can link direct with around 900,000 telex users in 120 countries throughout the world.



Computer terminal, word processor and teletype facilities can be directly linked using International Packet Switching Service (IPSS) through nine U.K. centers. And radiophone and confravision (conference transmitting) facilities. We benefit from express mail delivery services like Datapost and the supersonic Concorde service. Furthermore, incoming mail comes right to your office door six days a week.

Good communications are a part of every day life in Scotland. A highly developed airways system helps to make it possible with 4 major airports handling direct flights to and from important European industrial centers. Our seaway routes are well established with 4 major shipping ports on East and West coasts. Even Scotland's high roads and low roads have expanded into a network of highways including multi-lane motorways to make Scotland one of the world's best connected of lands.

All this, perfectly positioned a scant few miles from the rich consumer markets of the E.E.C.



### An electronically stimulating place to grow

With more than 120 electronic companies already here, you won't be blazing an entirely new trail but the Scottish Development Agency is here to help you settle in and reach your full productive capacity as soon as possible. The Agency's staff know the ins and outs of the electronics industry and have the experience of Scottish business life necessary to dispense enlightened marketing, technical and financial advice.

The Agency is able to provide an advantageously structured investment package while taking into account the high risks normally associated with advanced technology.

New plants establishing in most of Scotland's industrial belt qualify for regional assistance above or on a par with incentives available elsewhere in the European Economic Community.

There is one final incentive that is of considerable value when viewed in an E.E.C. context: energy self-sufficiency. Scotland has abundant energy resources of oil, coal, natural gas and hydroelectricity—enough to give industrialists the longterm assurance they need.

So come over. Let us talk to you about work and about relaxation. Our Highland and Island scenery is legendary, our golf courses internationally acclaimed. The salmon and trout are leaping. These are good waters to be fishing in just now. The Scottish Development Agency has the resources and financial muscle to help incoming industry. We can talk straight about your company's potential in Scotland, about land, finance, factories, labor, markets, energy and transport. Everything you need to make Scotland work for you.

Please send for our complete fully illustrated brochures on doing business in Scotland. Call us in New York (212) 867 1066 or San Francisco (415) 393 7703.



### Scottish Development Agency

US Offices: 9 West 57th Street,  
New York, NY 10019. Tel: (212) 867-1066

11th Floor, 465 California Street,  
San Francisco, CA 94104. Tel: (415) 393-7703/4.

Head Office: 120 Bothwell Street,  
Glasgow G2 7JP, Scotland. Tel: 041-248 2700.

London Office: 17/19 Cockspur Street,  
London SW1Y 5BL. Tel: 01-839 2117/8.

# Disk drive drops development cost

\$8,375 14-in. Winchester technology unit  
stores 12 megabytes, cuts 64000 base price by 25%

by Richard W. Comerford, Test, Measurement & Control Editor

When Hewlett-Packard introduced the 64000 Logic Development System last year [*Electronics*, Sept. 13, 1979, p. 41], certain rumblings were heard in the industry. Although some were impressed with the future-looking aspects of the universal multistation system, others grumbled that, at a single-station base price of \$24,875, it could never compete with other development systems. Yet at that time HP stressed the overall flexibility of system design and the company's commitment to the system's continuing evolution (for a period of 10 to 15 years), hinting at things to come.

Now, a little over half a year later, the company has managed to make good its commitment and at the same time still the voice of those critics. It has done so not only by adding a raft of assemblers for the LDS but also by dropping the price of its base system to \$18,500. The reason for that \$6,375 drop is a 14-

in. Winchester technology disk drive. Though it may not be the first to work with a development system, it does provide the largest storage—12 megabytes.

Priced at \$8,375, the model 7910H comes with power supply and controller in a tabletop cabinet; cartridge-tape storage, which can be used as backup, is provided in the system's station. Winchester technology drives are easily transportable, unlike other hard disks, so the LDS can now be moved around without having to realign disk heads.

The fact that HP introduced its system with hard disks whereas others are now working their way up to them from floppies is an important difference, says John Marshall, HP product manager. "Anybody who replaces a floppy with a Winchester drive still has the same operating system. Going to hard disk initially let us create a very elegant operating system. It works with the new drive

yet allows plenty of user storage."

The operating system for the LDS takes up several hundred kilobytes of storage, enough to fill a floppy totally. That program's soft-key feature puts syntax right on the screen, allowing a user to sit down and begin writing programs right away. This, Marshall points out, provides an on-line operating manual in effect and greatly increases real throughput.

The disk, which HP also uses in its 300 series computers, has an average seek time of 60 ms with track-to-track seek of 10 ms. The data-transfer rate is 100 kilobytes/s and latency time is a maximum of 10 ms. In operation, latency time is typically zero after first access because sector placement has been optimized.

With disks for other systems, logically consecutive sectors are also physically consecutive. But the file structure for this and other HP drives is interleaved, so that by the time the data read from one sector is transferred, the disk has revolved to the point where the next consecutive sector is ready to be read.

The company has also more than tripled the number of processors it supports by providing five more relocatable macro-assemblers. So in addition to the 8080, 8085, Z80, and 6800, the LDS is now able to support the 6805, 6809, 8048, 8021, 8022, 9900, 1802, F8, and 3870. Like the earlier assemblers, these can operate at 4,000 lines per minute, regardless of source file size.

Each assembler is priced at \$550. Deliveries of the assemblers as well as the Winchester technology disk drives are from stock.

Hewlett-Packard Co., 1507 Page Mill Rd., Palo Alto, Calif. 94304 [339]

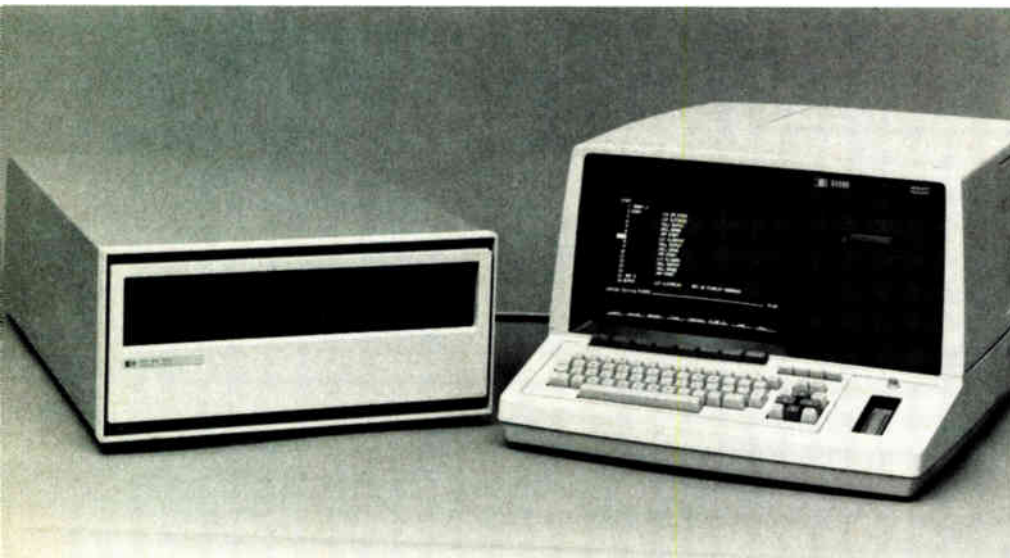

# Low Cost Mini-Disk Data Storage for EXORciser Bus Computers

- Compatible with EXORciser\* and other 6800/6809 computers based on EXORciser\* bus concept.
- 40- or 77-track drives in one-, two- and three-drive configurations add 102K bytes to 591K bytes of random access data on-line.
- 40-track LFD-400EX™ drives store data on both surfaces of mini-diskettes — almost 205K bytes per disk.
- EXORciser\* bus compatible controller includes 1K of RAM, provision for 3K of PROM. Mature design features explicit clock-data separator, drive motor inactivity time-out function, and more.
- Support software includes disk operating systems, a file manager, text editor, assembly language program development/debugging aids, an extended BASIC interpreter, an SPL/M compiler and business programs. Numerous programs available from other suppliers may be used with LFD-400/800EX mini-disk systems with little or no modification. Watch for FORTRAN & Pascal announcements.

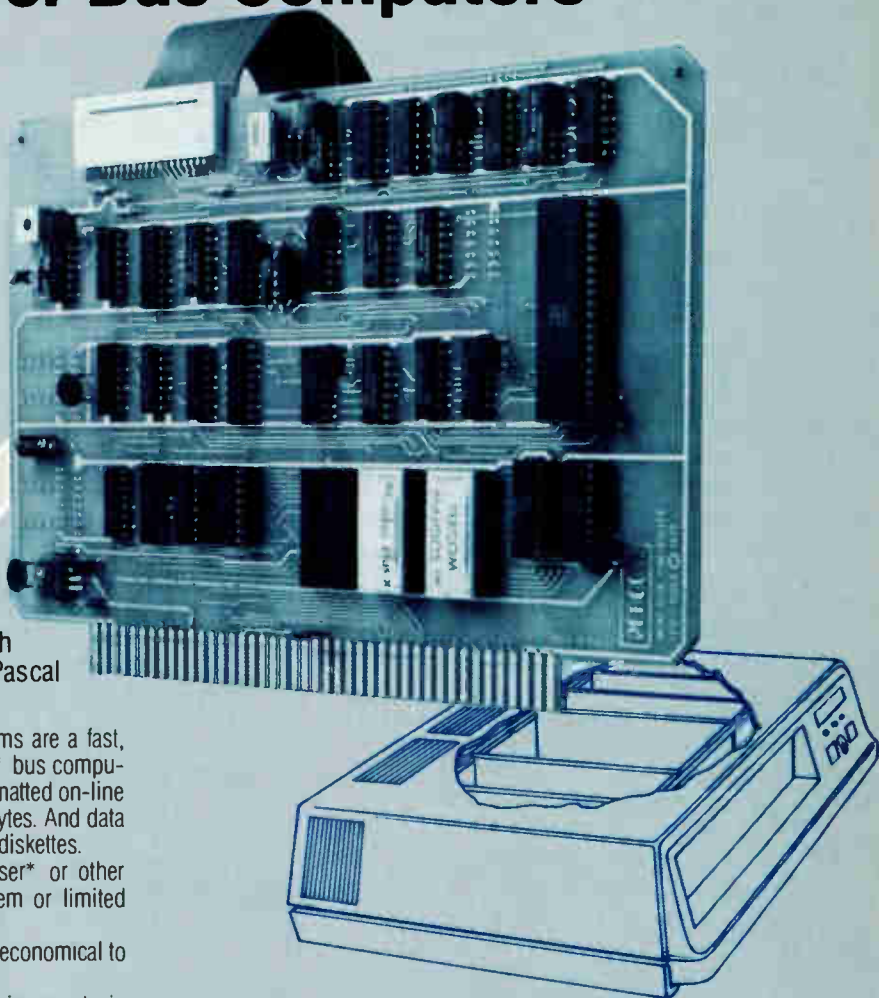

Low cost Percom LFD-400/800EX mini-disk data storage systems are a fast, dependable alternative to tape storage for 6800/6809 EXORciser\* bus computers. A single 40-track LFD-400EX™ drive adds 102K bytes of formatted on-line storage; a single 77-track LFD-800EX™ drive adds almost 200K bytes. And data may be stored and read from either surface of LFD-400EX™ minidiskettes.

Fast mini-disk data storage makes your Motorola EXORciser\* or other EXORciser\* bus computer more than just a development system or limited evaluation system.

For example, at the low LFD-400/800EX prices it becomes economical to use your development system as the final working system.

Data capture/retrieval in research, test and production environments is another application where versatile, random-access LFD-400/800EX storage can provide efficient operation.

Equipment control is yet another area where the speed and facility of mini-disk storage greatly expands application possibilities. Even if you use a mini-disk only to load and control programs you'll save simply by taking a lot less time than with slow, inconvenient tape storage. Moreover, by storing programs on fast-loading, low cost minidiskettes you eliminate the overhead of burning PROMs — an expense that quickly adds up to far more than the price of an inexpensive Percom mini-disk system.

The bottom line? An EXORciser\* or Micromodule\*, with percom LFD-400/800EX mini-disk data storage, is a remarkably adaptable microcomputer — a system that meets the quality and dependability demands of industry yet is competitively priced with personal computing systems.



## PRICES

Model	1-drive system	2-drive system	3-drive system
LFD-400EX™	\$649.95	\$1049.95	\$1449.95
LFD-800EX™	\$945.95	\$1599.95	\$2245.95

MPX Disk Operating System (2-chip ROM set)

Standard versions for most popular monitors . . . . \$69.95

LFD-400/800EX Users Instruction Manual:

Includes driver utility listings, controller schematic \$15.00

The system prices are single-quantity prices. A system includes (1) the drives, power supplies and enclosure, (2) the EXORciser\* bus compatible controller PC card with 1K RAM and provision for three 2708 EPROMs, (3) an interconnecting cable, (4) an 80-page users instruction manual, and (5) a system minidiskette. The Percom Software Services Group will customize the MPX DOS for a nominal charge if one of the standard versions is not suitable for your monitor. LFD-400EX™ systems use 40-track drives; store 102K bytes of formatted data per minidiskette side. LFD-800EX™ systems use 77-track drives; store almost 200K bytes on one side of minidiskette.

Orders may be placed by dialing 1-800-527-1592 (outside of Texas) or (214) 272-3421 (in Texas). For additional technical information dial (214) 272-3421.

PERCOM DATA COMPANY, INC.  
211 N. KIRBY GARLAND, TEXAS 75042  
(214) 272-3421



Circle 167 on reader service card

™ trademark of Percom Data Company, Inc.

• trademark of Motorola Corporation

Prices & specifications subject to change without notice

## New products

Microcomputers & systems

### Compact emulator simulates I/O

Four breakpoints and a large memory make stand-alone unit a powerful debugger

About 60% of today's microprocessor software is first written on a minicomputer, rather than on a microprocessor development system. For those who take the minicomputer route, the software capability resident in a \$15,000 to \$20,000 development system can represent an expensive redundancy when compared with the alternative combination of a minicomputer and a stand-alone in-circuit emulator, selling for \$5,000 to \$6,000. Thus, it is not surprising that the market for stand-alone emulators is expected to jump from \$3.5 million in 1979 to over \$17.5 million in 1983.

Looking for a share of that market

is the model 800 emulator from Advant Inc., the logic products marketing arm of E-H International, Inc. The model 800 weighs only 7 lb and is slightly larger than a lunch-box, but it packs considerable power into its small space. For openers, the model 800 offers a real-time trace memory that is 48 bits wide by 256 words deep. It also allows the user four breakpoints with which to trap the required information. The 800 can download or upload to either the host system or the system being developed. Its host system can be a smart or dumb terminal, as well as a development system or computer.

The 800 can communicate through either or both of its two RS-232 ports, or through a 20-mA current loop. It is also unusual in that its emulation software can run in three modes. The first, or system, mode simulates the I/O and employs the emulator memory. The second, or partial emulation, mode employs both user and emulator memory as well as user and simulated I/O. The third, full emulation, mode operates totally with user memory and I/O.

These combinations greatly ex-



ALABAMA: Huntsville, Hall-Mark (205) 837-8700.

ARIZONA: Phoenix, Kierulff Electronics (602) 243-4101; R.V. Weatherford (602) 272-7144; Tempe, Marshall Industries (602) 968-6181.

CALIFORNIA: Anaheim, R.V. Weatherford (714) 634-9600; Canoga Park, Marshall Industries (213) 999-5001; Chatsworth, JACO (213) 998-2200; Costa Mesa, TI Supply (714) 979-5391; El Monte, Marshall Industries (213) 686-0141; El Segundo, TI Supply (213) 973-2571; Glendale, R.V. Weatherford (213) 849-3451; Goleta, RPS (805) 964-6823; Irvine, Marshall Industries (714) 556-6400; Los Angeles, Kierulff Electronics (213) 725-0325; RPS (213) 748-1271; Mountain View, Time Electronics (415) 965-8000; Palo Alto, Kierulff Electronics (415) 968-6292; Pomona, R.V. Weatherford (714) 623-1261; San Diego, Arrow Electronics (714) 565-4800; Kierulff Electronics (714) 278-2112; Marshall Industries (714) 278-6350; R.V. Weatherford (714) 278-7400; Santa Barbara, R.V. Weatherford (805) 465-8551; Sunnyvale, Arrow Electronics (408) 739-3011; Marshall Industries (408) 732-1100; TI Supply (408) 732-5555; United Components (408) 737-7474; Torrance, Time Electronics (213) 320-0880; Tustin, Kierulff Electronics (714) 731-5711.

COLORADO: Denver, Arrow Electronics (303) 758-2100; Diplomat/Denver (303) 427-5544; Kierulff Electronics (303) 371-6500; Englewood, R.V. Weatherford (303) 770-9762.

CONNECTICUT: Hamden, Arrow Electronics (203) 248-3801; TI Supply (203) 281-4669; Orange, Milgray/Connecticut (203) 795-0714; Wallingford, Wilshire Electronics (203) 265-3822.

FLORIDA: Clearwater, Diplomat/Southland (813) 443-4514; Ft. Lauderdale, Arrow Electronics (305) 776-7790; Diplomat/Ft. Lauderdale (305) 971-7160; Hall-Mark/Miami (305) 971-9280; Orlando, Hall-Mark/Orlando (305) 855-4020; Palm Bay, Arrow Electronics (305) 725-1480; Diplomat/Florida (305) 725-4520; St. Petersburg, Kierulff Electronics (813) 576-1966; Winter Park, Milgray Electronics (305) 647-5747.

GEORGIA: Doraville, Arrow Electronics (404) 455-4054; Norcross, Wilshire Electronics (404) 923-5750.

ILLINOIS: Arlington Heights, TI Supply (312) 640-2964; Bensenville, Hall-Mark/Chicago (312) 860-3800; Elm Grove Village, Kierulff Electronics (312) 640-0200; Chicago, Newark Electronics (312) 638-4411; Schaumburg, Arrow Electronics (312) 893-9420.

INDIANA: Ft. Wayne, Ft. Wayne Electronics (219) 423-3422; Indianapolis, Graham Electronics (317) 634-8202.

IOWA: Cedar Rapids, Deeco (319) 365-7551.

KANSAS: Lenexa, Component Specialties (913) 492-3555; Shawnee Mission, Hall-Mark/Kansas City (913) 888-4747.

MARYLAND: Baltimore, Arrow Electronics (202) 737-1700, (301) 247-5200; Hall-Mark/Baltimore (301) 796-9300; Columbia, Diplomat/Maryland (301) 995-1226; Gaithersburg, Cramer/Washington (301) 948-0110; Rockville, Milgray/Washington (301) 468-6400.

MASSACHUSETTS: Billerica, Kierulff Electronics (617) 667-8331; Burlington, Wilshire Electronics (617) 272-8200; Newton, Cramer/Newton (617) 969-7700; Waltham, TI Supply (617) 890-0510; Woburn, Arrow Electronics (617) 933-8130.

MICHIGAN: Ann Arbor, Arrow Electronics (313) 971-8220; Oak Park, Newark Electronics (313) 967-0600; Grand Rapids, Newark Electronics (616) 241-6681.

MINNESOTA: Edina, Arrow Electronics (612) 830-1800; Plymouth, Marshall Industries (612) 559-2211.

MISSOURI: Earth City, Hall-Mark/St. Louis (314) 291-5350; Kansas City, Component Specialties (913) 492-3555; LCOMP-Kansas City (816) 221-2400; St. Louis, LCOMP-St. Louis (314) 291-6200.

NEW HAMPSHIRE: Manchester, Arrow Electronics (603) 668-6968.

NEW JERSEY: Camden, General Radio Supply (609) 964-8560; Cherry Hill, Milgray/Delaware Valley (609) 424-1300; Clark, TI Supply (201) 382-6400; Clifton, Wilshire Electronics (201) 340-1900; Fairfield, Kierulff Electronics (201) 575-6750; Moorestown, Arrow Electronics (609) 235-1900; Saddlebrook, Arrow Electronics (201) 797-5800.

NEW MEXICO: Albuquerque, Arrow Electronics (505) 243-4566; International Electronics (505) 262-2011; United Components (505) 345-9981.

NEW YORK: Endwell, Wilshire Electronics (607) 754-1570; Farmingdale, Arrow Electronics (516) 694-6800; Freeport, Milgray Electronics (516) 546-6000; N.J. (800) 645-3986; Hauppauge, Arrow Electronics (516) 231-1000; JACO (516) 273-5500; Liverpool, Cramer/Syracuse (315) 652-1000; New York, Wilshire Electronics (212) 682-8707; Rochester, Cramer/Rochester (716) 275-0300; Rochester Radio Supply (716) 454-7800; Wilshire Electronics (716) 235-7620; Woodbury, Diplomat/Long Island (516) 921-7920.

NORTH CAROLINA: Kerner/Charlotte, Arrow Electronics (919) 966-2039; Raleigh, Hall-Mark (919) 832-4465.

OHIO: Cleveland, TI Supply (216) 464-2435; Columbus, Hall-Mark/Ohio (614) 846-1882; Dayton, ESCO Electronics (513) 228-1133; Marshall Industries (513) 236-8088; Kettering, Arrow Electronics (513) 253-9176; Reading, Arrow Electronics (513) 761-5432; Solon, Arrow Electronics (216) 248-3990.

OKLAHOMA: Tulsa, Component Specialties (918) 664-2820; Hall-Mark/Tulsa (918) 835-8458; TI Supply (918) 749-9543.

OREGON: Beaverton, Almac/Stroum Electronics (503) 641-9070; Milwaukie, United Components (503) 653-5940.

PENNSYLVANIA: Huntingdon Valley, Hall-Mark/Philadelphia (215) 355-7300; Pittsburgh, Arrow Electronics (412) 351-4000.

TEXAS: Austin, Component Specialties (512) 837-8922; Hall-Mark/Austin (512) 837-2814; Dallas, Component Specialties (214) 357-6511; Hall-Mark/Dallas (214) 234-7400; International Electronics, (214) 233-9323; TI Supply (214) 238-6821; El Paso, International Electronics (915) 778-9761; Houston, Component Specialties (713) 771-7237; Hall-Mark/Houston (713) 781-6100; Harrison Equipment (713) 652-4700; TI Supply (713) 776-6511.

UTAH: Salt Lake City, Diplomat/Altland (801) 486-4134; Kierulff Electronics (801) 973-6913.

WASHINGTON: Redmond, United Components (206) 885-1985; Seattle, Almac/Stroum Electronics (206) 763-2300; Kierulff Electronics (206) 575-4420; Tukwila, Arrow Electronics (206) 575-0907.

WISCONSIN: Oak Creek, Arrow Electronics (414) 764-6600; Hall-Mark/Milwaukee (414) 761-3000; Waukesha, Kierulff Electronics (414) 784-8160.

CANADA: Calgary, Cam Gard Supply (403) 287-0520; Downsview, CESCO Electronics (416) 661-0220; Edmonton, Cam Gard Supply (403) 426-1805; Halifax, Cam Gard Supply (902)454-8581; Kamloops, Cam Gard Supply (604) 372-3338; Moncton, Cam Gard Supply (506) 855-2200; Montreal, CESCO Electronics (514) 735-5511; Future Electronics (514) 731-7441; Ottawa, CESCO Electronics (613) 729-5118; Future Electronics (613) 820-8313; Quebec City, CESCO Electronics (418) 687-4231; Regina, Cam Gard Supply (306) 525-1317; Saskatoon, Cam Gard Supply (306) 652-8424; Toronto, Future Electronics (416) 663-5563; Vancouver, Cam Gard Supply (604) 291-1441; Future Electronics (604) 438-5545; Winnipeg, Cam Gard Supply (204) 786-8481.





# The fastest 8K EPROM ever. TMS2508. Available now. From Texas Instruments.

High speed. Reprogrammability. Family compatibility. And availability.

Just a few of the many practical reasons why you should consider the newest member of TI's 5-V Family. TMS2508. An 8K EPROM specifically designed for high-speed.

#### For fast microprocessor systems

At 250-ns max access time, 180-ns typical, the TMS2508 is the fastest EPROM on the market. So fast, in fact, that you can design it in for all state-of-the-art microprocessors and not worry about sacrificing performance. The TMS2508 reduces wait states and virtually eliminates the need for any additional wait-state circuitry.

#### As a bipolar alternative

Because the TMS2508 is so fast, it also allows you to implement many memory applications previously served only by bipolar PROMs. Only minor board modifications are required to make the switch from bipolar to MOS. (For complete details see Applications Note MM-2508.) And, unlike PROMs, the TMS2508 can be easily and quickly erased and reprogrammed. At any time.

#### High performance

In addition, the TMS2508 offers you such outstanding performance features as 8-bit word configuration, automatic chip select/power down and fully static operation.

So, if speed is what you need, go ahead and design with confidence. Go ahead and specify TI's new TMS2508.

There's just no faster 8K EPROM available anywhere. And even faster versions are coming soon.

**For fast delivery** of fast 8K EPROMs, call your nearest authorized TI distributor. He has them on-the-shelf. Priced right. Ready to move.

**For free samples**, write to TI on your letterhead, briefly describing your proposed TMS2508 application. Write to Texas Instruments Incorporated, Dept. S2508, P.O. Box 1443, M/S 6965, Houston, Texas 77001.



**TEXAS INSTRUMENTS**  
INCORPORATED

## New products

pand debugging flexibility. The system mode, for instance, may be used even before the user's I/O devices are in place. When some but not all of these devices are installed, the second mode can be called. When the hardware is completely bug-free, mode three may be executed.

The model 800 has the power to break upon the failure of an event to occur. It can break on regions such as address ranges. It can also time instruction loops, count passes through a loop, and disassemble raw data back into instruction mnemonics. With a \$750 option, it can use eight external probes for logic analysis. User memory is normally 16 K by 8 bits, but a second option expands that to 64 K by 8 bits for \$2,495.

The model 800 does not contain its own cathode-ray-tube display, but it can work with any standard 24-line-80-character display. It also differs from at least one other emulator in that it has no signature-analysis capability. The model 800 does, however, have an array of commands, such as SET, which add greatly to its power.

In its initial versions, the 800 will emulate one of three processors, the 8080, Z80, or 8085. This basic unit sells for \$5,895 and is available now. Additional processors can be added for \$1,495 each, and, in October, modules for the Z8000 and 8086 processors will be added.

Avant Inc., 696 Trimble Rd., San Jose, Calif. 95131. Phone (408) 946-9300 [371]

## IEEE-488 bus expander optically isolates modules

Some IEEE-488 instruments or controllers, whether because of shortcomings in design or other factors, are sensitive to signal and ground noise on that bus. When these units reside in an IEEE-488 bus system, which also handles instruments generating more noise than they should, the resulting interference complicates matters even more. The solution is optical isolation between the bus and the modules. ICS Electron-



ics' model 4830 isolated bus expander not only does that, but it also allows a system designer to place more than 14 modules on the bus.

The 4830 appears as one bus load to the master IEEE-488 bus, but in fact it channels information to and from as many as 15 general-purpose interface-bus (GPIB) modules. That means that, instead of the prescribed limit of 14 modules, up to 28 modules can now be placed on the bus.

The 4830 provides up to 3,000 v of ground-and-signal isolation between two bus devices, and a line-to-line resistance of internal logic ensures that the master IEEE-488 bus always receives a response to the attention (ATN) signal within the time limit specified by the standard. In fact, the 4830 ensures a propagation delay of less than 150 ns for each bus signal. NFRD (not-ready-for-data) and NDAC (no-data-accepted) lines will go low in response to an ATN signal in 200 ns or less and are released in more than 150 ns after either isolated NFRD or NDAC signal goes low.

The 4830 also allows the selection of talker addresses for the isolated IEEE bus in order to prevent interaction of handshake lines between the primary IEEE bus and the isolated IEEE bus. Rocker switches on the back panel enable a talker address capability for any single address between 0 and 30, or any consecutive series of addresses. Reset switches for clearing both the main IEEE bus and the isolated IEEE bus are also available on the back panel.

The 4830 is priced at \$795, and the first units will be available in April. They can be ordered with special paint to fit the user's requirements, without ICS logos and titles,

## Grayhill Switches and Keyboards are distributed by

**ALABAMA**  
Huntsville—Powell Electronics

**ARIZONA**  
Phoenix—Kachina Electronic Distr.  
Tucson—Inland Electronic Supply

**ARKANSAS**  
Little Rock—Carlton-Bates

**CALIFORNIA**  
Los Angeles—Electric Switches  
Fisher/Brownell  
Riverside—Electronic Supply  
San Diego—Fisher/Brownell  
Richey Electronics  
Santa Clara—Fisher/Brownell  
Sunnyvale—Powell Electronics  
Sun Valley—Richey Electronics

**COLORADO**  
Denver—Electronic Parts  
Newark Electronics

**CONNECTICUT**  
Bethel—Heiland Electronics  
Greenwich—Wise Components  
Wallingford—Midan Electronics

**FLORIDA**  
Miami Springs—Powell Electronics  
Oakland Park—Peerless Radio  
Orlando—Hammond Electronics

**ILLINOIS**  
Addison—LCOMP-Chicago  
Chicago—Newark Electronics  
Elgin—Allied Electronics  
Elk Grove Village—Pioneer/Chicago  
Northbrook—Classic Components Supply  
Peoria—Klaus Radio

**INDIANA**  
Evansville—Hutch & Son  
Ft. Wayne—Ft. Wayne Electronics Supply  
Indianapolis—Graham Electronics  
Ra-Dis-Co  
South Bend—Radio Distributing

**IOWA**  
Cedar Rapids—Deeco

**KANSAS**  
Wichita—Radio Supply

**MARYLAND**  
Beltsville—Powell Electronics  
Gaithersburg—Pioneer/Washington  
Rockville—Capitol Radio Wholesalers

**MASSACHUSETTS**  
Dedham—Gerber Electronics  
Hingham—Sager Electric Supply  
North Adams—Electronic Supply Center  
Worcester—R M Electronics

**MICHIGAN**  
Livonia—Pioneer/Michigan  
R S Electronics  
Oak Park—Newark Detroit Electronics  
St. Clair Shores—Spemco

**MINNESOTA**  
Minneapolis—Newark Electronics  
St. Paul—Gopher Electronics

**MISSISSIPPI**  
Jackson—Ellington Electronic Supply

**MISSOURI**  
Kansas City—LCOMP-Kansas City  
Maryland Heights—LCOMP-St. Louis  
St. Louis—Olive Indust. Electronics

**NEBRASKA**  
Lincoln—Scott Electronic Supply

**NEW HAMPSHIRE**  
Hudson—Heiland Electronics

**NEW JERSEY**  
East Hanover—State Electronics Parts Corp  
Springfield—Federated Purchaser

**NEW MEXICO**  
Albuquerque—International Electronics  
Walker Radio Company

**NEW YORK**  
Binghamton—AST Electronics  
Bohemia—Car-Lac Electronic Industrial Sales  
Buffalo—Summit Distributors  
Farmingdale—Arrow Electronics  
Lynbrook—Peerless Radio  
Rochester—Simcona Electronics  
Vestal—Harvey/Federal Electronics

**NORTH CAROLINA**  
Greensboro—Hammond Electronics  
Pioneer Carolina  
Raleigh—Southeastern Radio Supply

**OHIO**  
Cincinnati—Hughes-Peters  
URI Electronics  
Cleveland—Pioneer/Cleveland  
Columbus—Hughes-Peters  
Dayton—ESCO Electronics  
Pioneer/Dayton

**OKLAHOMA**  
Oklahoma City—Electro Enterprises  
Tulsa—Oil Capitol Electronics

**OREGON**  
Portland—United Radio Supply

**PENNSYLVANIA**  
Erie—Mace Electronics  
Harrisburg—Cumberland Electronics  
Philadelphia—Almo Electronics  
Herbach & Rademan  
Powell Electronics  
Pittsburgh—Cam/RPC  
Pioneer/Pittsburgh  
Reading—George D. Barby

**RHODE ISLAND**  
Warwick—W H Edwards

**SOUTH CAROLINA**  
Columbia—Dixie Electronics  
Greenville—Hammond Electronics

**TENNESSEE**  
Nashville—Electra Distributing

**TEXAS**  
Dallas—Solid State Electronics  
TI Supply  
El Paso—International Electronics  
Fort Worth—Allied Electronics  
Houston—Harrison Equipment  
Kent Electronics  
Stafford—Southwest Electronics

**UTAH**  
Salt Lake City—Standard Supply

**VIRGINIA**  
Richmond—Sterling Electronics

**WASHINGTON**  
Seattle—Interface Electronics

**WISCONSIN**  
Milwaukee—Marsh Electronics

# Grayhill totally sealed DIP switches better than ever better than others

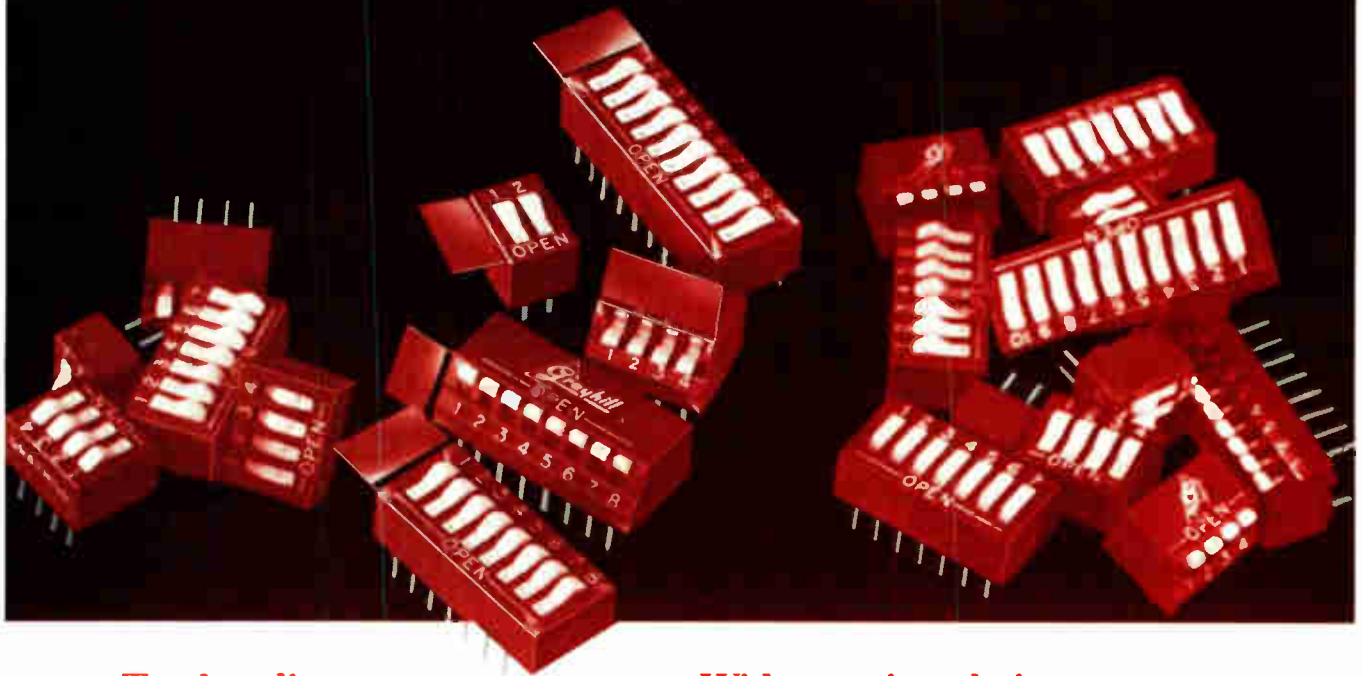

## Total sealing

Each Grayhill SPST Rocker DIP Switch is now potted as part of the assembly process, to provide a more professional and economical bottom seal, with maximum seal integrity. Flux entry during wave soldering is totally prevented; contamination is eliminated; reliability is enhanced; and prices are unchanged... there is no cost premium for this important new feature. Grayhill also offers 3 topside sealing options, for raised or recessed rockers—a tape seal, applied at Grayhill; cards of tape seals, for your application; or re-usable protective covers. Whichever you choose, you get complete freedom during PC Board cleaning.

## Exceptional reliability

All Grayhill DIP Switches incorporate our exclusive spring-loaded, sliding ball contact system. This highly reliable contact system provides positive wiping action, immunity to normal shock and vibration, and exceptional 50,000 cycle life.

## Wide ranging choice

Grayhill Sealed Base Rocker DIP Switches are available SPST, from 2 to 10 rockers, with raised or recessed rockers. Grayhill also provides the Piano DIP™ SPST side-actuated DIP Switch, sealed; the Toggle-DIP (SPDT or DPDT) for front panels, plus SPDT or DPDT back panel programming DIP Switches.

## Off-the-shelf distributor availability

Procurement made simple—call Grayhill or your local distributor, for off-the-shelf delivery of most types. Only Grayhill offers you this purchasing convenience!

*Make sure you have your copy of the most recent DIP Switch Catalog...free on request.*

**Grayhill** INC. *the Difference Between Excellent and Adequate*

561 Hillgrove Avenue • LaGrange, IL 60525 • (312) 354-1040

# Rent an H-P Desktop Computer and figure on big savings.



**Rental Electronics, Inc.**  
**(800) 227-8409**

In California (213) 993-7368, (415) 968-8845 or (714) 879-0561

Circle 172 on reader service card

## "When are you going to get yours?"



When are you going to get your very own, personal subscription to Electronics?

It could be very important to you.

And we're not just referring to your status in the office hierarchy.

You (and we) are in a quick-moving business. News breaks frequently. Change is the name of the game. Awareness is the way to win.

You've got to follow what's going on beyond your specialty. Your career may have to last longer than your specialty.

If change is the game, obsolescence is the penalty for losing. Obsolescence of products, of technology and, unfortunately, of people. We can't change this fact. But we can help you cope with it.

Give us one hour of reading time every two weeks and we will keep you aware of what's going on around you and around the changing world of electronics technology.

Move up. Fill out one of the subscription postcards in this issue.

**Electronics Magazine.**  
**The one worth paying for.**

### New products

and with the original-equipment designer's logo on the front panel.

ICS Electronics Corp., 1450 Koll Circle, Suite 105, San Jose, Calif. 95112. Phone (408) 298-4844 [371]

### Disk and tape controllers interface to Multibus

The MSC-1086 single-board disk controller is designed for microcomputer systems that use the industry-standard Multibus structure. They can be used in applications that would require two or more conventional controllers. There are three optional versions of the board, and they are priced from \$2,700 in single-unit quantities to less than \$2,000 in large quantities.

All three versions can control up to four Shugart SA4000 series Winchester technology drives that store up to 58 megabytes each. The model MSC1086A provides a storage capacity range of from 14.5 to over 200 megabytes. The model MSC-1086B can control four SA850 or equivalent double-sided, double-density, floppy-disk drives in addition to the four SA4000s. The MSC1086C can control the four SA4000s and a 3M HCD-75 70-megabyte tape unit. It also allows the use of tape cartridges for backup storage. All the controllers are based on a bipolar microprocessor for which the manufacturer will develop custom firmware if the controller is ordered by original-equipment manufacturers or in large volumes. All three versions are available for 90-day delivery.

Microcomputer Systems Corp., 432 Lakeside Dr., Sunnyvale, Calif. 94086. Phone Don Sumner at (408) 733-4200 [378]

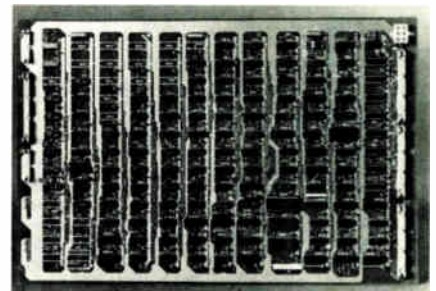

# FLEXIBILITY

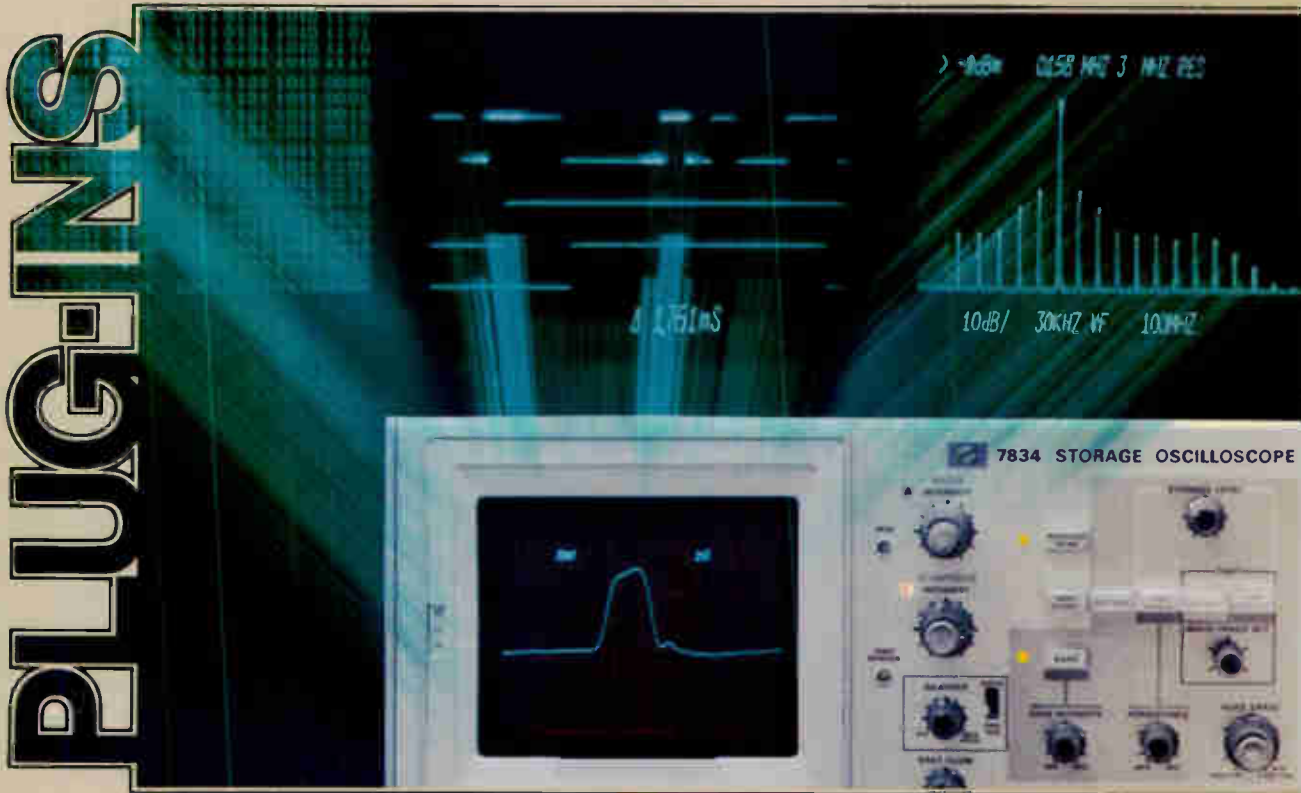

## One instrument. Multiple measurements.

Tektronix Plug-In oscilloscopes combine a number of diverse measurement functions in the same instrument. And in combinations you require. One instrument takes the place of many. You get maximum measuring power with a minimum of instruments.

How? By choosing from the continually evolving 5000 and 7000 families of Plug-Ins. Already there are 14 mainframes and 21 plug-ins in the 5000-Series; 19 mainframes and 35 plug-ins in the 7000-Series. (With them, you can also use compatible logic and spectrum analyzers plus other special purpose plug-ins.) Choose from a family providing up to 8 input display channels. Analog and digital delayed sweeps. Sampling displays. Digital interconnections. And differential inputs. Just to name a few.

No matter what your test and measurement situation, we offer a Plug-In oscilloscope that fits. From circuit design to plasma physics research. From balancing rotating machinery to measuring the accuracy of D to A converters. With every scope representing the same superior research and engineering you expect from Tektronix.

What about your own particular situation? Are your measurement capabilities confined by monolithics? Contact the Tektronix Field Office near you and get your hands on the kind of flexibility that only a Plug-In scope can deliver.

**Tektronix**<sup>®</sup>  
COMMITTED TO EXCELLENCE

For literature, call (800) 547-1512 toll free.

# VACTEC Photodetectors

Vactec can be objective in helping you design the correct detector for your application with the greatest variety in the industry. We also produce custom arrays and assemblies. Write for bulletins.

- BLUE ENHANCED Si Photovoltaic Cells

- STD. Si Photovoltaic Cells

- LO CAPACITANCE Si Photovoltaic Cells

- BLUE ENHANCED Si Photodiodes

- FAST Photodiodes

- CdS & CdSe Photoconductive (LDR's)

- Se CELLS

- NPN Si Phototransistors

VACTROLS  
(Opto-couplers)

- LDR/LED

- LDR/NEON

- LDR/LAMP

**VACTEC,  
INC.**

10900 Page Blvd.  
St. Louis, MO 63132  
(314) 423-4900  
TWX 910-764-0811

## New products

Data acquisition

### Accurate d-a unit spans 70°C

12-bit d-a converter that  
needs no adjustment  
uses only 195 mW

Even without user adjustments, the MN3348 12-bit digital-to-analog hybrid converter will maintain a high degree of accuracy, the manufacturer guarantees. All errors, including those of gain, offset, and nonlinearity, can total no more than  $\pm 0.075\%$  of the full-scale range. This maximum error is calculated for operating temperatures from 0° to 70°C. Combined errors in the military-grade model will not exceed  $\pm 0.1\%$  of the full-scale range between -55° and +125°C.

In the commercial version of the converter, linearity alone is to within  $\pm 0.024\%$  of full scale; in the model with an extended temperature range, linearity is to within  $\pm 0.048\%$ . For

finer accuracies, users can order optional gain- or offset-adjustment potentiometers.

Included in the MN3348's hermetically sealed standard 24-pin package are a 10-v internal reference and an internal output amplifier, complementary-MOS chips, and a precision thin-film resistor network that is laser-trimmed to the guaranteed operating accuracies. Monotonicity is guaranteed for the converter's full operating range.

The use of C-MOS chips keeps the unit's power consumption low—typically to 195 mW (375 mW maximum) from a 15-v supply. The device has five user-selectable analog output ranges: 0 to -5 or to -10 v unipolar and  $\pm 2.5$ ,  $\pm 5$ , or  $\pm 10$  v bipolar. Typical output impedance is 0.1  $\Omega$ . The MN3348 can drive a  $\pm 10$ -mA output load. Settling time is 6 to 8  $\mu$ s to 1/2 least significant bit (0.012% of full load), with an output slew rate of 10 v/ $\mu$ s.

According to Francis S. Shoreys, product planning and market-development manager at Micro Networks, the MN3348's excellent accuracy and low power requirements suit it to aerospace and avionics

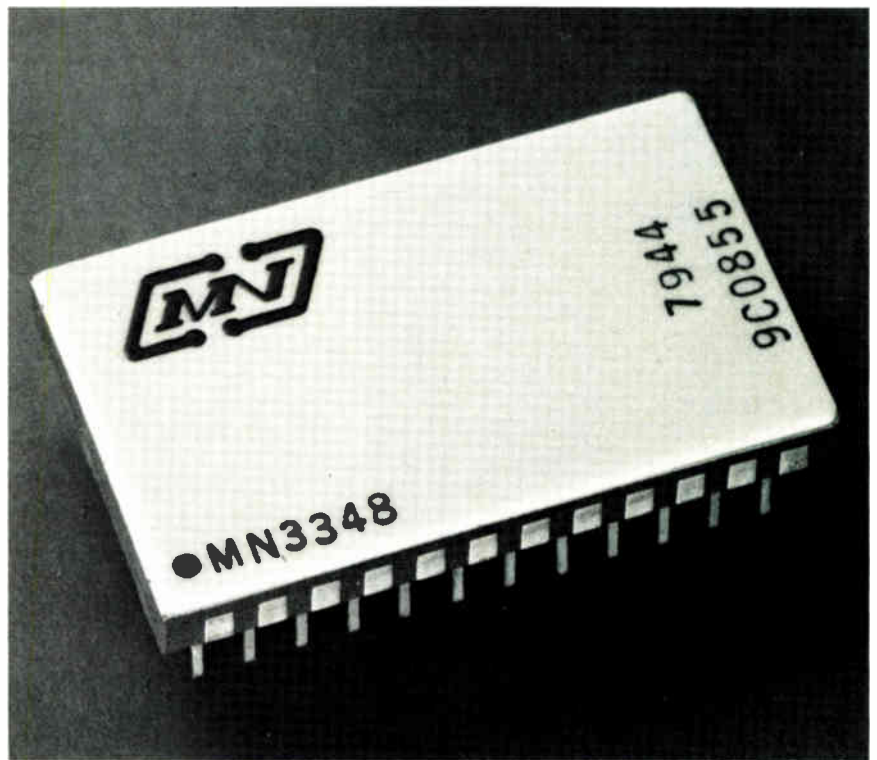

# Fluke answers tough calibration questions.

Three good ways to build confidence and control costs.



power. It weighs just 13 lbs. so it's easy to take along. At only \$2395\* it's an economical way to get top verification performance wherever you need it.

For more ways to build confidence and control costs, contact the Fluke office, representative or distributor in your area or call:

**800-426-0361**

If you prefer, just complete and mail the coupon below.

**Q:**

I need high-accuracy calibration that's directly supported by my primary standards. What can Fluke do for me?

**A:** When you need the highest levels of confidence, come to Fluke for the world's finest calibration equipment. The 7105A DC Calibration System, for example, provides voltage accuracy to 5 ppm, ratio accuracy to 0.1 ppm, and stability to 1 ppm per year, all fully-traceable to the National Bureau of Standards. For calibrating ac voltage, our 540B Thermal Transfer Standard is unequaled for traceable measurement, calibrating to 0.01%.

**Q:**

Most of my lab's workload consists of 3½- and 4½-digit meters, and I'm on a tight budget. Have any answers?

**A:** You can cut your measurement costs dramatically with our 5100-series Calibrators. They give you the performance of an entire cal lab—all in one box. And at \$7495\*, they cost a fraction of a traditional system's price. Each 5100 model provides

all the ranges and functions necessary to calibrate most meters—dc and ac volts, current, and resistance.

Reduced initial investment is only part of the story. Operation of the 5100's is both simple and fast. Error, volt/dBm conversions and other complex calculations are computed automatically by the hard-working microprocessor.

For further automation, model 5101B comes equipped with a mini-cassette tape feature that records your cal procedure. The knob-twisting drudgery is gone. Calibration time is reduced to minutes per meter.

To make a 5100 more powerful, team it up with the new 5220A Transconductance Amplifier and the 5205A Precision Power Amplifier. Together they create a high-current, high-voltage calibration system.

**Q:**

Can you show me a verification instrument that's easy to use in the field or on my production line?

**A:** Take a look at our 515A Portable Calibrator. With the rechargeable battery pack, you get eight hours of 30 ppm dc, plus ac and resistance calibration free of line

**FLUKE**®

\*U.S. prices only.

IN THE U.S. AND NON-EUROPEAN COUNTRIES:

John Fluke Mfg. Co., Inc.  
P.O. Box 43210, MS#2B  
Mountlake Terrace, WA 98043  
(206) 774-2481  
Telex: 32-0013

IN EUROPE:

Fluke (Holland) B.V.  
P.O. Box 5053  
5004EB Tilburg  
The Netherlands  
Tel: (031) 673973  
Telex: 52237

I'd like more answers.

- Please arrange for a demonstration.
- Please send the latest information on Fluke's calibration instruments.
- Send enrollment information for Fluke Calibration Seminars.

Name \_\_\_\_\_

Title \_\_\_\_\_

Mail Stop \_\_\_\_\_

Company \_\_\_\_\_

Address \_\_\_\_\_

City \_\_\_\_\_

State \_\_\_\_\_

Zip \_\_\_\_\_

Country \_\_\_\_\_

Telephone ( ) \_\_\_\_\_

Ext. \_\_\_\_\_

E1 3/80

For technical data circle No. 175

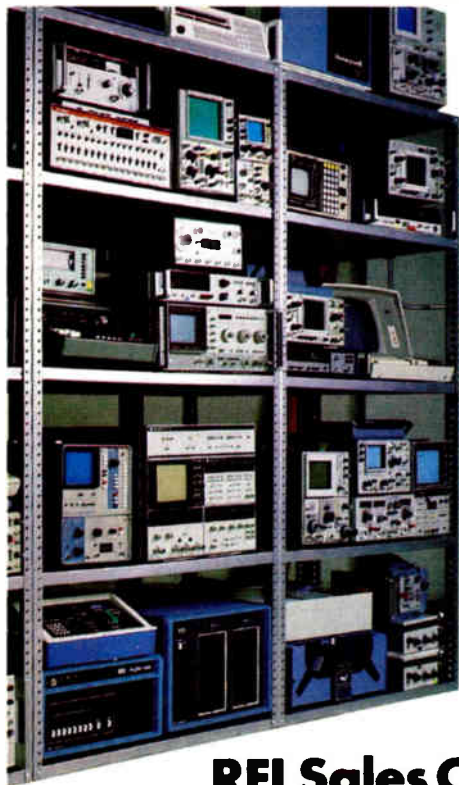

**Thousands  
of  
"like new"  
products  
with  
money back  
guarantees.**

**REI Sales Company  
(800) 227-8409**

In California (213) 993-7368, (415) 968-8845 or (714) 879-0561

Circle 176 on reader service card

## Say It In Sign Language There's No Better Way

**Ferranti-Packard alphanumeric display modules are ideal for visual communications. They're silent, easy-to-read modules you can count on for fast accurate information.**

And, there are good reasons for using Ferranti-Packard. These versatile electro-magnetic modules are economical to apply and operate. Power consumption is negligible. Remanent magnetism provides inherent memory so power is only required to change the display—not retain it.

The rotating fluorescent discs are the only moving parts—and are rated for over 100 million operations. Viewing is by reflecting light—so the visibility increases with the ambient light level. This makes them ideal in brightly lit conditions, indoors or out.

Modules are available in a range of colors and character sizes, from 3 inches (70 mm) to 18 inches (450 mm). They are ideal for industrial displays, digital readouts, advertising displays, score boards, bulletin boards, paging systems and traffic control signs.

**When clear displays count, specify Ferranti-Packard.**



**Ferranti-Packard Electronics Ltd.**



6030 Ambler Drive, Mississauga  
Ontario, Canada L4W 2P1  
Telephone: (416) 624-3020  
Telex: 06-961437

### New products

applications, as well as to such commercial functions as process control. The unit's high-performance operation, with no need for user adjustment, will make it particularly useful where space is restricted or where the converter would not be easily accessible, he adds. The MN3348 is compatible with both C-MOS and TTL circuitry.

Prices for the commercial and extended military temperature range models of the MN3348 are \$55 and \$66 each, respectively, in lots of 100 to 249. MIL-STD-883 processing is available for both. Delivery is in six weeks.

Micro Networks Corp., 324 Clark St., Worcester, Mass. 01606. Phone (617) 852-5400 [371]

### A-d converter yields 16 bits in 6 $\mu$ s

Capable of digitizing analog signals with frequency components as high as 80 kHz, the model ADC 1216F is a 16-bit analog-to-digital converter with a maximum conversion time of 6  $\mu$ s. The converter, which accepts standard full-scale inputs between  $\pm 10$  v, is accurate to within 0.003% of full scale and is linear to within 0.0015% of full scale. It achieves its combination of high speed (the equivalent of 375 ns per bit) and high resolution by using a single foldback technique in conjunction with successive-approximation conversion.

The unit's standard input is single-ended and has an impedance of 100  $M\Omega$ . A differential input is available. The TTL-compatible output is available in offset binary and 2's complement.

Designed to operate from 0° to





# Improve your memory with AVX multilayers

AVX multilayer ceramic capacitors are the perfect choice for decoupling today's greater density memory applications.

Newer high-speed dynamic RAM's, with faster edge rates require capacitors with lower impedance at high frequency to eliminate transient currents. This places a greater emphasis on the capacitor inductance and less emphasis on the bulk. board-level decoupling as in previous designs.

As a result, these conditions favor the use of MLC's in place of tantalum capacitors for the full range of decoupling needs.

Contact AVX today for more information on replacing tantalum with superior performance axial, radial and 2-pin DIP multilayer ceramics. Write to AVX Ceramics, Dept T-80, P.O. Box 867, Myrtle Beach, SC 29577.

AVX. We'll help you improve your memory.

**AVX** CERAMICS  
Technology for the times

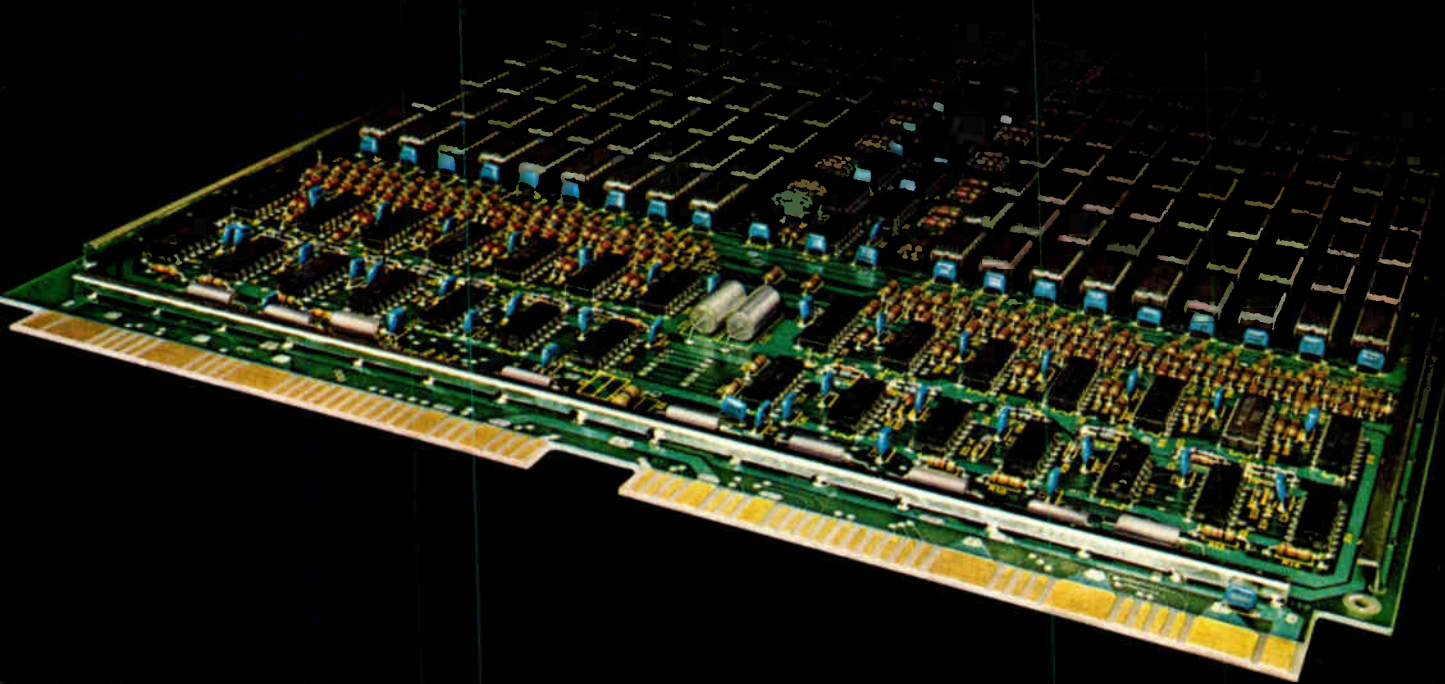

## New products

70°C, the converter measures 5.5 by 4.5 by 1.5 in. and mates with a standard 44-pin edge connector. It sells for \$1,995 in single units and has a delivery time of 30 to 45 days after receipt of order.

Phoenix Data Inc., 3384 West Osborn Rd., Phoenix, Ariz. 85017. Phone Srinu Lyer at (602) 278-8528 [383]

## Analog I/O subsystems now resolve 14 and 16 bits

High-resolution single-board analog interface systems that are fully hardware- and software-compatible with the DEC PDP-11 minicomputer

backplane offer 14- or 16-bit analog-to-digital conversion for applications requiring higher resolution than that afforded by Data Translation Inc.'s standard 12-bit analog-input systems. All analog-input and -input/output systems are available with fully expandable multiplexer inputs with either 8 differential or 16 single-ended channels. Further, these peripherals are fully compatible with the DEC RT-11 and RSX-11 operating systems. Both high-level and low-level analog I/O boards are available.

The analog-input systems deliver digital data outputs that are binary-coded for unipolar inputs and either offset binary or 2's complement for bipolar analog inputs. Three basic models are available with optional direct memory access (DMA) for faster data handling. They have a 100-M $\Omega$  input impedance, an 80-dB common-mode rejection ratio at 60 Hz with 1 k $\Omega$  of source imbalance, and  $\pm 2$  ppm/ $^{\circ}$ C linearity temperature coefficient over the 0 $^{\circ}$ -to-55 $^{\circ}$ C operating temperature range.

Pricing in quantities of one to nine is \$500 for 14-bit and \$900 for 16-bit performance in addition to the basic price of the standard 12-bit subsystems. Both the high-level and low-level software-programmable-gain options are priced at \$175. Optional on-card DMA adds \$900 to the base price. Availability is five days after receipt of order for all models.

Data Translation Inc., 4 Strathmore Rd., Natick, Mass. 01760. Phone Tricia Mills at (617) 655-5300 [384]

# DELTRON SWITCHERS are NO GLITCHERS

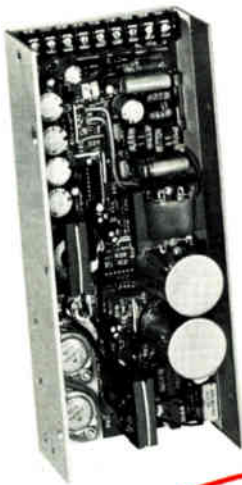

## The Quiet Ones

- Current fed drivers
- DM filters
- CM filters
- $\frac{dv}{dt}$  snubbers
- $\frac{di}{dt}$  limiting
- Shielded case
- Spike limiting varistors
- No fans

Get  Quiet!

## 1 TO 4 OUTPUT SWITCH MODE **POWER SUPPLIES**— TO 320 WATTS

- Stock
- UL 478
- All outputs highly regulated
- Exclusive Variable Power Partitioning
- Low cost
- 3 year warranty

### COMPLETE POWER SUPPLIERS

- ✓ Switcher
- ✓ Linear

- ✓ Ferro
- ✓ SCR

STANDARDS—CUSTOMS

**Deltron inc.**

Wissahickon Avenue • North Wales, PA 19454  
Tel: 215/699-9261 Twx: 510/661-8061

AC 34

## Interface cards expand Macsym system

Three new interface cards have been developed for users of Analog Devices' MACSYM 2 and MACSYM 20 measurement and control systems. The cards are the AIM04, a 16-channel flying-capacitor multiplexer board with programmable-gain amplifier; the AIM05, a 4-channel strain-gage board; and the FIN01 and FIN02, 8- and 16-chan-

# NEW STARS IN THE EXPANDING HEXFET™ UNIVERSE!

Revolutionary  
HEXFET technology  
now in medium  
power MOSFETs.

Off-the-shelf  
delivery at down-  
to-earth prices!

The ratings of six smaller but  
no less brighter new stars in the  
ever-expanding HEXFET line are  
highlighted in the table below.

This advanced set of medium power  
transistors features a new die size  
created to provide HEXFET technology  
and the established MOSFET design  
advantages of voltage control, ease  
of paralleling, freedom from second  
breakdown and ultra-fast switching  
at record low costs.

For example, the 1000 piece price  
for the 100V IRF520 is only \$5.95,  
and the 400V IRF720 is just \$6.30.  
At such low prices, chances are these  
new TO-3 or TO-220AB HEXFETs  
can make MOSFET advantages  
affordable for your application.

We're not a bit starry-eyed about  
delivery. All HEXFETs listed in the  
table are available NOW . . . from us  
or from in-depth stock of an IR  
Distributor near you.

Contact us, an IR Sales Office or  
Rep for Tech Data, today. HEXFETs  
will do a stellar job for you tomorrow!

VOLTAGE RATING	TO-3 PACKAGE		TO-220 PACKAGE		
100		IRF130 12 Amps	IRF150 20 Amps	IRF520 8 Amps	IRF530 10 Amps
200		IRF230 7 Amps		IRF620 3.5 Amps	IRF630 6 Amps
400		IRF330 4 Amps	IRF350 11 Amps	IRF720 2 Amps	IRF730 3.5 Amps
500		IRF430 3.5 Amps			IRF830 3 Amps

# INTERNATIONAL RECTIFIER

WORLD HEADQUARTERS: 233 KANSAS ST., EL SEGUNDO, CA 90245, U.S.A. PHONE: (213) 772-2000 TELEX: 66-4464

EUROPEAN HEADQUARTERS: HURST GREEN, OXTED, SURREY, ENGLAND. PHONE: 8833-3215. TELEX: 95219

Manufacturing Subsidiaries, Sales Offices, Representatives, Agents and Distributors Throughout the World.



Circle 179 on reader service card

# Bud's New Horizon

*The electronic  
components  
cabinet with  
unlimited  
versatility.*



Design requirements change, but whether you're housing micro processor systems, micro computers, PC boards, mother boards, power supplies or plug-in modules, Horizon is the only cabinet you'll ever need.

All exterior panels of its sturdy extruded frame slide out for full interior access. Options include: snap-in guides for perfect component alignment; an accessory chassis that mounts vertically or horizontally and adjustable mounting rails, connector rails and horizontal frame members.

For more information on Horizon, the cabinet that lets you create the electronic package to fit your design requirements, send for our 4-page brochure. Write: Bud Industries, Inc., 4605 East 355th Street, Willoughby, Ohio 44094, or Bud West, Inc., 3838 North 36th Avenue, Phoenix, Arizona 85019.



**BUY  
BUD**  
First...of all.

In Cleveland: 216/946-3200

Circle 180 on reader service card

In Phoenix: 602/269-3151

## The magazine you're reading now could be your own.

Drop off the routing list. Get your own fresh, unclipped copy mailed to your home or office. Turn to the subscription card in the back of the magazine. If somebody has beat you to it, write: Electronics, P.O. Box 430, Hightstown, N.J. 08520.

### New products

nel frequency-counter cards.

The AIM04 uses reed relays to implement the flying-capacitor multiplexer, enabling the user to make differential measurements in the presence of common-mode voltages up to 250 v rms. The 16 differential channels can be sampled at the rate of 130 samples/s.

The AIM05 four-channel strain-gage card provides bridge-completion resistors, excitation supply, calibration resistors, and switch-selectable gain. The FIN01 and FIN02 measure frequencies from 1.6 Hz to 1 MHz with 0.1% resolution.

The AIM04 is priced at \$800 and the AIM05 at \$700 in quantities of one to nine. The eight-channel FIN01 is priced at \$450 and the FIN02 at \$650 in the same quantities. Availability is from stock.

Analog Devices Inc., P. O. Box 280, Route 1 Industrial Park, Norwood, Mass. 02062. Phone Ed Soron at (617) 329-4700 [385]

### Sample-and-hold circuit has 30-ns acquisition time

A sample-and-hold circuit designed for use with ultrafast analog-to-digital converters with up to 10-bit resolution uses an open-loop design to achieve a 30-ns acquisition time and a 30-picosecond aperture uncertainty time. In addition to input and output buffers, the model SHM-UH3 has a diode-bridge sampling switch driven by a pulse transformer, which yields the very fast times.

The device has a full  $\pm 5$ -v input signal range, a constant near-unity gain ( $\pm 0.95$  to  $\pm 0.98$ ), and 0.05% maximum linearity error. The hold-mode droop is 50 v/s and hold-mode feedthrough is  $-66$  dB from dc to 10 MHz. The unit has a 100-k $\Omega$  input impedance, 50  $\mu$ V/ $^{\circ}$ C output offset drift, and  $\pm 30$ -mA output current. The output offset voltage may be zeroed by means of an external adjustment screw. In quantities of one to nine, the SHM-UH3 sells for \$230 apiece and is available from stock.

Datel Intersil, 11 Cabot Blvd., Mansfield, Mass. 02048. Phone (617) 339-9341 [387]

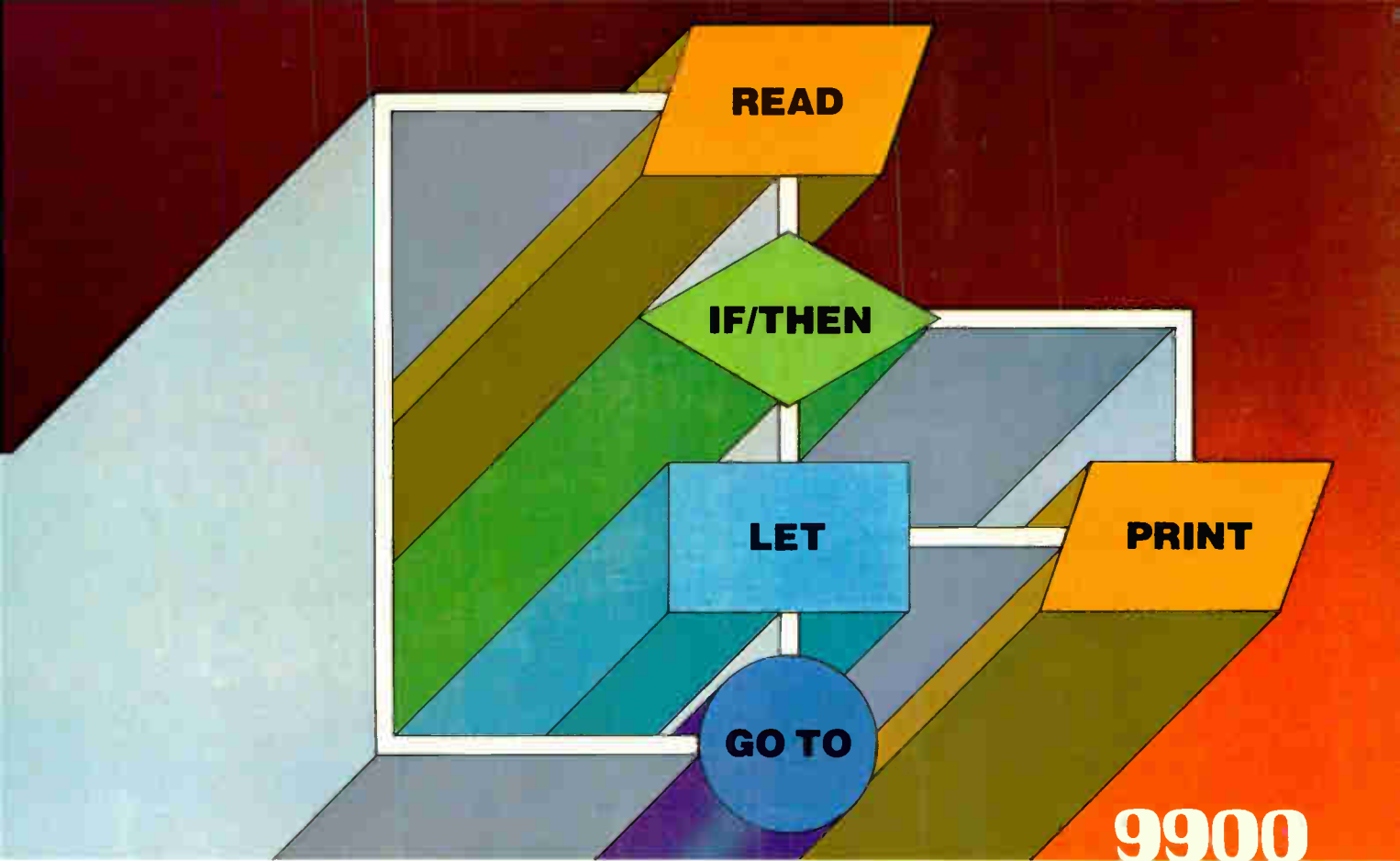

9900

# Power Basic

## TI's fast new language for industry. So easy you already understand it.

As readily as you read this ad, you can use Power Basic language. It's the nearest to English of any high-level language. Simple. Versatile. Low cost. Fast.

Developed by TI for the 990/9900 Family. Power Basic products are designed for those in industry who need the benefits of microprocessors but want to by-pass the difficulties of programming in assembly language.

### Fast, flexible industrial control

Power Basic language achieves a speed of execution and offers features ideally suited to industrial control needs: 11-digit accuracy • 24 hour time-of-day clock • Elapsed time measurements down to 1/25th of a second • Interrupt

capabilities • EPROM programming • String manipulation capabilities • 3-letter variables • User-oriented editor for program changes without rewriting entire program • Direct call of assembly language routines • Configurator for reduced memory overhead.

### Pick the package you need

Three Power Basic versions let you select the capability and cost best suited to your application. All versions make TI's 990/9900 Family even easier to use. Choose from:

- **Evaluation Power Basic** — 8K bytes of memory in four Solid-State Software™ ROMs. For single micro-computer module evaluation of Power Basic language.
- **Development Power Basic** — 12K bytes of memory in six Solid-State

Software ROMs. For medium to large-size applications. Provides full capability to design, develop and debug Power Basic programs — plus EPROM programming.

- **Configuration Power Basic** — Floppy diskette package provides a configurator which reduces programs to minimal memory by eliminating the portions of BASIC overhead not required by your target system.

For an easy-to-understand Reference Guide on the language you can write after an hour's instruction, call your nearest TI field sales office or authorized distributor. Or write Texas Instruments Incorporated, P.O. Box 1443, M/S 6404, Houston, Texas 77001.



TEXAS INSTRUMENTS  
INCORPORATED

# NEW!

**"INDUSTRIAL"**

## WIRE-WRAPPING TOOL

MODEL BW928

# \$49<sup>95</sup>

BATTERIES NOT INCLUDED  
BIT & SLEEVE NOT INCLUDED

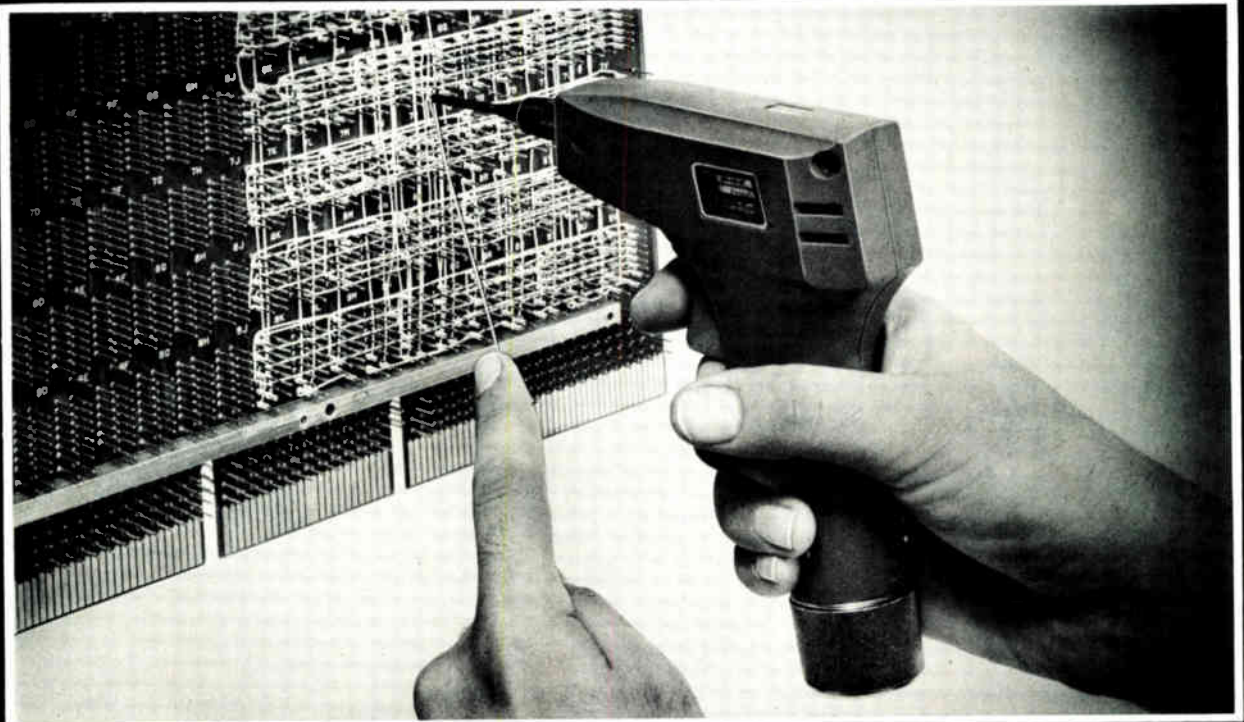

- **BATTERY OPERATED**  
(2) Standard "C" Ni Cad Batteries (not included)
- **INTERCHANGEABLE BITS & SLEEVES**  
(not included)
- **REVERSIBLE ROTATION**  
For unwrapping, reverse batteries

- **BACKFORCE OPTIONAL**  
Model BW928-BF \$52.95
- **POSITIVE INDEXING**
- **LEIGHT WEIGHT**  
\*LEXAN™ Housing

\*LEXAN™ GENERAL ELECTRIC



### OK MACHINE & TOOL CORPORATION



3455 Conner St., Bronx, N.Y. 10475 • (212) 994-6600 • TELEX 125091

# PROMISES PROMISES

**Don't settle for words when you need audio power amplifiers. Call Sprague.**

We do more than talk about deliveries when you order audio power amplifiers. We deliver

them. The table below gives you a preview of types currently available:

PACKAGE	TYPE	V <sub>cc</sub>	P <sub>out</sub> (typ.)	TYPICAL APPLICATIONS	ENGINEERING BULLETIN
 14-lead DIP	ULN-2274B ULN-2274B-1	9-22V 9-22V	1.5W > 1.5W	Dual amplifiers for stereo phonographs & radios; industrial equipment	27117.05D
	ULN-2278B ULN-2278B-1	9-26V 9-26V	2.5W > 2.5W		
 8-lead DIP	ULN-2280B ULN-2281B	9-26V 9-32V	2.5W 4.0W	Consumer, automotive, & communication products	27117.11
	ULN-2283B ULN-2283B-1	3-15V 3-18V	1.2W 1.2W		
 5-lead TO-220	ULX-3701Z ULX-3702Z	8-28V 8-40V	10W 10W	Auto radios, tape players, & CB sets	27117.31

For Engineering Bulletins on the types in which you are interested, write to: Technical Literature Service, Sprague Electric Company, 35 Marshall St., North Adams, Mass. 01247.

For application engineering assistance, write or call Roger Mailloux or Ray Dewey, Sprague Electric Company, Semiconductor Division, 115 Northeast Cutoff, Worcester, Mass. 01606. Telephone 617/853-5000.

For the name of your nearest Sprague Semiconductor Distributor, write or call Sprague Products Company Division, North Adams, Mass. 01247. Telephone 413/664-4481.

#### FOR FAST INFORMATION, CALL YOUR NEAREST SPRAGUE SALES OFFICE:

ALABAMA, Sprague Electric Co. 205 883-0520 • ARIZONA, Sprague Electric Co. 602 244-0154, 602 966-7233 • CALIFORNIA, R. D. Miner Co. 714 421-5586, Wm J. Purdy Co. 415 347-7701 • COLORADO, Wm J. Purdy Co. 303 777-1411 • CONNECTICUT, Sprague Electric Co. 203 261-2551, Ray Perron & Co. Inc. 203 268-9631, 203 673-4825 • DIST. OF COLUMBIA, Sprague Electric Co. (Govt. sales only) 202 337-7820 • FLORIDA, Sprague Electric Co. 305 631-3636 • ILLINOIS, Sprague Electric Co. 312 296-6620 • INDIANA, Sprague Electric Co. 317 253-4247 • MARYLAND, Sprague Electric Co. 301 792-7657 • MASSACHUSETTS, Sprague Electric Co. 617 899-9100, 413 664-4411, Ray Perron & Co. Inc. 617 969-8100 • MICHIGAN, Sprague Electric Co. 517 787-3934 • MINNESOTA, HMR Inc. 612 831-7400 • MISSOURI, Sprague Electric Co. 314 781-2420 • NEW HAMPSHIRE, Ray Perron & Co. Inc. 603 742-2321 • NEW JERSEY, Sprague Electric Co. 201 696-8200, 609 795-2299, Trinkle Sales Inc. 609 795-4200 • NEW MEXICO, Wm J. Purdy Co. 505 266-7959 • NEW YORK, Sprague Electric Co. 516 234-8700, 914 834-4439, 315 437-7311, Wm Rutt Inc. 914 834-8555, Paston-Hunter Co. Inc. 315 437-2843 • NORTH CAROLINA, Electronic Marketing Associates 919 722-5151 • OHIO, Sprague Electric Co. 513 866-2170, Electronic Salesmasters Inc. 800 362-2616 • PENNSYLVANIA, Sprague Electric Co. 215 467-5252, Trinkle Sales Inc. 215 922-2080 • SOUTH CAROLINA, Electronic Marketing Associates 803 233-4637 • TEXAS, Sprague Electric Co. 214 235-1256 • VIRGINIA, Sprague Electric Co. 703 463-9161 • WASHINGTON, Sprague Electric Co. 206 632-7761 • CANADA, Sprague Electric of Canada Ltd. 416 766-6123 or 613 238-2542

455-9135R2



a subsidiary of **GK Technologies**  
Incorporated

the  
**PUSH**  
toward  
*miniaturization*



# D6 KEY SWITCH

for digital  
electronic control

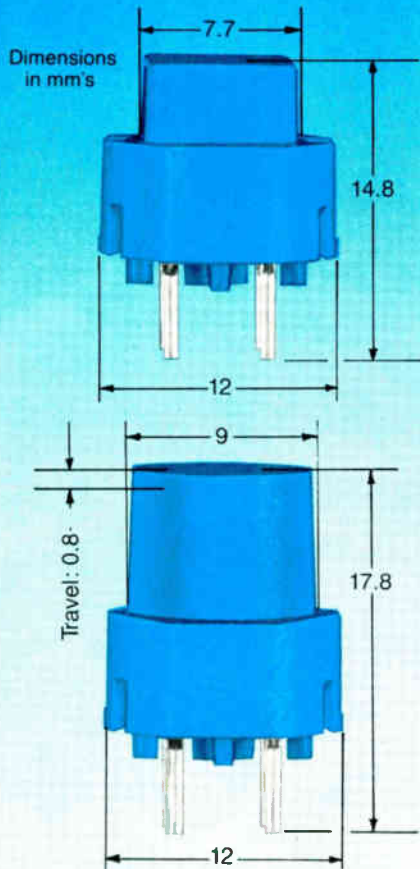

- Single pole, single throw, normally open key switch.
- Minimum center spacing of 12.7 mm's.
- Buttons (round or square) in black, yellow, white, green, red, blue, grey, ivory.
- Positive tactile feel with audible feedback.
- 1000 piece price: 27¢ each.

Fast service on samples, specs and other price quotations from ITT Schadow Inc. 8081 Wallace Road, Eden Prairie, MN 55344 612/934-4400 • TWX 910-576-2469

"Your personal  
switch designers"

**ITT Schadow**  
Circle 184 on reader service card

## New products

Power supplies

### 4.5-W supply is only 0.4 in. high

Dual-output unit combines  
switching front end with  
series-regulated outputs

The first member of Semiconductor Circuits's H series of power supplies measures only 0.4 in. high, making it the lowest-profile device of its kind, according to marketing director Richard MacKinnon. Its size allows the low-noise 4.5-w supply to be mounted on printed-circuit boards intended for densely packed data-acquisition systems in which boards are located on 0.5-in. centers.

The key to the module's small size and low noise is its proprietary hybrid design. This design combines a high-efficiency switching front end and dual series-regulated outputs. The front end takes the ac-line voltage and chops it at 50 kHz, making it possible to replace the customary power transformer with a compact toroid. The linear output regulators keep the  $\pm 12$ -v or  $\pm 15$ -v outputs within 1% of their nominal values, with typical root-mean-square ripple

and noise specified at only 2 mv.

The H series supplies measure 2 by 4 by 0.4 in. and deliver 150 mA from each output over the range from  $-25^\circ$  to  $+71^\circ\text{C}$ . Both the 12-v model H232504 and the 15-v model H333004 will work with line frequencies from 50 to 440 Hz and allow the user to pin-select input ranges of 105 to 125 v ac, 210 to 250 v ac, or 250 to 300 v dc. Input/output isolation is a minimum of 1,500 v ac, with I/O capacitance below 50 pF. The supply, which features current-foldback protection against overloads, has a typical temperature coefficient of 0.02%/°C. Pricing on small quantities of either supply is \$89.95. Delivery is from stock to six weeks.

Semiconductor Circuits Inc., 218 River St., Haverhill, Mass. 01830. Phone (617) 373-9104 [391]

### 375-W switching supply has five outputs

The 375-w Mighty-Mite MM-25 switching regulated power supply has five outputs. Thus it can be used where several low-wattage switchers would otherwise be required. The main output setting is 5 v dc at 75 A, with higher current available through masterless straight parallel-





# HP's Small Wonders

## Let you design systems fast

- Model 11713A Attenuator/Switch Driver
- Automatic control for 2 attenuators and 2 switches simultaneously
- HP-IB programmable—manual or remote
- Overload protected internal power supply.
- Price \$1200\* \*Domestic U.S. price only.



11713A Driver



8494G Attenuator



8761B Switch

More than 350 other measurement components are described in our new, 96-page microwave test catalog. For your copy call your nearby HP sales office, or write Hewlett Packard Co., 1507 Page Mill Road, Palo Alto, CA 94304.



Circle 185 on reader service card

## EASY, CLEAN AND EFFICIENT TIMING CHART PREPARATION



*Enquiries for distributorship are welcome.*

PAT. PEND.



How often have you had a basket full of crumpled paper or your table covered with eraser shreds because you had to rewrite your timing charts many times before it was just right? No more of such mess now because Xebec Trading Corporation has brought out the Logic Scale, which is just a simple A4-size plastic board with 320 sliders arranged in eight horizontal rows. These sliders can be moved vertically between two click-stop positions representing the two logic levels. All you need do for preparing your timing charts is to move the sliders in each row to represent the waveforms in your circuit and after you have fully checked your design just go to your office copying machine and take a copy for your files. A quick glance at the photograph will tell you more than all the description we could write here.

Material: ABS Plastic Dimensions: 297W x 210H x 7T mm

### XEBEC TRADING CORP.

No. 21-12, 4-Chome, Kasuya, Setagaya-ku, Tokyo, 157 Japan.  
CABLE: XEBEC JAPAN  
TELEX: 2324788 XEBEC J.  
TELEPHONE: (03)307-5641

Circle 238 on reader service card

# SUPERTEX IS FIRST IN CMOS ROM

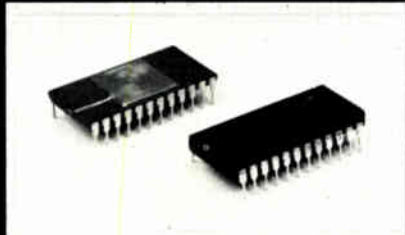
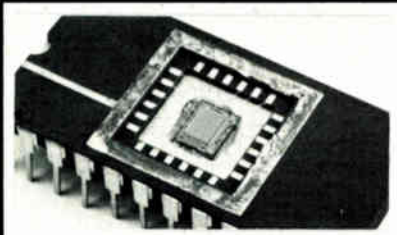

- FIRST to Achieve 32,768 Bit CMOS ROM (CM3200) in Production Quantities
- FIRST CMOS ROM That Seriously Challenges NMOS ROM in Both Price and Performance.
- FIRST to Offer Standby Power of Less Than 20nW per Bit, making the CM3200 Excellent for use in Microprocessor Based or Battery Operated Systems.
- FIRST to Break Price of \$0.0002 per Bit in CMOS ROM.\*
- FIRST to Offer 32K CMOS ROM with Industry Standard Pin/Function Configuration Compatible to NMOS ROM.
- FIRST to Offer 64K, 128K and 256K Bit Density in a CMOS ROM.\*\*
- FIRST Prototype Leadtime of 3 to 5 Weeks.

\* Prices quoted are based on the CM3200-2, packaged in a 24-lead plastic DIP and in quantities of 50,000 units. \*\* Available by Custom Design Only.

For High Volume, Low Power and Low Cost CMOS ROM  
Look to the Company with Superior Technologies:



1225 Bordeaux Drive • Sunnyvale, California 94086

(408) 744-0100 • TWX910-3399388

## SUPERTEX SALES REPRESENTATIVES:

### UNITED STATES

AL, GA, NC, MS, SC, TN — Macro Marketing (205) 883-9630 • AK, CA, ID, NV, OR, WA — Magna Sales (408) 985-1750  
AR, LA, OK, TX — West & Assoc. (214) 661-9400 • AZ, NM — EDS (602) 242-4988 • CA — Orion Sales (213) 240-3151  
CO, UT — Comtronics Sales (303) 597-5343 • CT, NJ, NY — Tri-Tek Assoc. (516) 221-7600 • DE, MD, MI, NJ, PA, VA  
— Kirk-Sandell (215) 643-2100 • FL, PR — Donato & Assoc. (305) 733-3450 • IL — Micro Sales (312) 956-1000 • IN, IA,  
KS, MO, NE — J.O. Schmitz Co. (816) 363-3414 • IN — SA1 Marketing (317) 241-9276 • MN, ND, SD, WI — Smiley-Scott  
Assoc. (612) 888-5551 • NE — Spectruin Assoc. (617) 444-8600 • OH, PA — J.C. Hofstetter (216) 725-4477 •

### INTERNATIONAL

CANADA — R.N. Longman Sales (416) 677-8100 • DENMARK — Advanced Electronic (01) 19 44 33 • ENGLAND —  
Dialogue Marketing Electronics 01144 6285 26729 • FRANCE — ASAP 604 78-78, International Semiconductor Corp.  
(1) 608 52 75 • WEST GERMANY — Infracron 040181 75 78, Scantec 089 13 40 93 • ISREAL — R.N. Electronics Agen-  
cies 03 471659 • ITALY — Giuseppe De Mico 02 65 31 31 • JAPAN — Microtek 03 363-2317, Systems Marketing 03 254-  
2751 • SOUTH AFRICA — S'electronics Ltd. 48-8718 • SWEDEN — Integrerad Elektronik AB 08/753 03 30 •

## New products

ing. For the remaining outputs, the ratings available are: 2 and 5 v at 5 A; 12, 15, and 18 v at 3 A; and 24 and 28 v at 2 A. All outputs are floating and independent.

Operating efficiency is 70%. Line regulation is rated at 0.4% over the entire input range, load regulation at 0.4% from no load to full load, with a 10% main output minimum. Maximum ripple and noise factors are 1% peak to peak or 50 mv, whichever is higher. Response time to a 25% change in the load is 200  $\mu$ s, to within 2%. Full power is maintained to 40°C and drops to 60% at 71°C. The unit is recognized by Underwriters Laboratories and certified by the Canadian Standards Associations. Overvoltage protection of 125% is standard, and the unit has remote sensing that compensates for load-cable losses of up to 250 mv. Hold-up time is 20 ms after loss of power.

The price of the MM-25 is \$630 in orders of 1 to 24 units, and delivery time averages four to six weeks. The supplies have a two-year warranty. LH Research, 1821 Langley Ave., Irvine, Calif. 92714. Phone (714) 546-5279 [393]

## Multiple power supply runs

### Winchester fixed disks

The model CP384 is a multiple-output dc power supply designed to power Winchester-technology fixed-disk memory systems, such as the Shugart SA1000 and -4000 series, the Century Marksman, and the Micropolis Microdisk 1200 series. In addition the supply may operate any controller circuitry required for the drives.

The power supply operates on 115 or 230 v ac,  $\pm 10\%$ , 47 to 440 Hz.

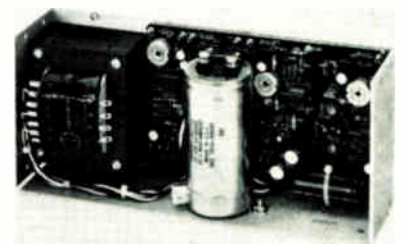

# LAST NOVEMBER, DATA GENERAL AND DEC ANNOUNCED NEW COMPUTERS. THE SIMILARITY ENDS THERE.

<b>COMPARE:</b>	<b>SPEED</b>		<b>PRICE</b>
	Thousands Whetstone instructions/second		
	Single Precision	Double Precision	
DEC PDP 11/44 System	<b>314*</b>	<b>231*</b>	<b>\$41,900*</b>
			Includes PDP 11/44 with 256 ERCC memory, 20.8 MB dual RL02 disc subsystem, floating point processor and LA120 console printer
Data General ECLIPSE S/140 System	<b>450</b>	<b>380</b>	<b>\$37,450</b>
			System including S/140 with 256KB ERCC MOS memory, Model 6100 25MB non-removable moving head disc with integral 1.26 MB diskette floating point hardware and Dasher TP2 180 CPS console printer
<b>ECLIPSE S/140 is:</b>	<b>43% faster</b>	<b>65% faster</b>	<b>10% lower price</b>

What more can we say? Our new ECLIPSE® S/140 is not only a great deal faster than the 11/44, it's also a great deal, period. Read the chart. Then you'll understand why our ECLIPSE S/140 is your only choice. Break the speed limit without paying the price. Send in the coupon.

Data General Corporation, Westboro, MA 01580, (617) 366-8911. Data General (Canada) Ltd., Ontario, Canada. Data General Europe, 61 rue de Courcelles, Paris, France, 766.51.78. Data General Australia, (03) 89-0633. ECLIPSE is a registered trademark of Data General. \*Data General Corporation, 1980.

**Data General**

Mail to: Data General Corporation, Westboro, MA 01580 E313  
 I can read. Send me complete information immediately.  
 I can read but I can't wait. Send a salesman now.

Name \_\_\_\_\_ Title \_\_\_\_\_ Company \_\_\_\_\_ Address \_\_\_\_\_ City \_\_\_\_\_ State \_\_\_\_\_ Zip \_\_\_\_\_ Tel. \_\_\_\_\_

The Computer of the 1980s  
 The Computer of the 1980s  
 The Computer of the 1980s

\* As reported in DATAQUEST Research Newsletter, Nov. 30, 1979; COMPUTER SYSTEMS NEWS, Dec. 3, 1979.

# You demand precision molded parts We produce them.



## MEDICAL

ITT Thermotech is a custom injection molder that has been involved in the design and development of precision molded plastic parts for more than a quarter of a century. ITT Thermotech is also serving the medical supply industry with

its expertise in plastic molding and postmolding operations, and has a FDA certified clean room. When your products are involved in the critical area of medical care—ITT Thermotech is the molder you can come to.

## ITT THERMOTECH

1202 SOUTH FIFTH STREET, HOPKINS, MN 55343 (612) 933-9400  
3200 TYRONE BLVD., ST. PETERSBURG, FL 33710 (813) 347-2191

Circle 188 on reader service card

## FREE

Brochure describes Electronics editorial reprints, services, books...

- More than 70 article reprints in 15 subject categories
- Handy wall charts
- Custom-made reprint services
- Books especially for Electronics' readers
- Convenient postage-paid order cards

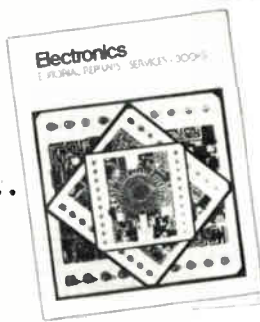

For your free copy, circle #275 on the reader service card.

## New products

The dc outputs supply +5 v at 9 A, +24 v at 4.5 A peak, and -12 v at 0.8 A. It has complete protection against short circuits and overloads. Line and load regulation is  $\pm 0.05\%$  for a 10% input change and a 50% load change, respectively. Output ripple is a maximum of 3.0 mV peak to peak. The unit has a transient response of 50 ms for a 50% load change and its stability is  $\pm 0.3\%$  for 24 h after warm up. For 0° to 50°C, the device operates at full current ratings, derating linearly to 40% at a temperature of 71°C.

In quantities of 1 to 9, the CP384 sells for \$120 apiece, with discounts for larger quantities. Delivery is from stock.

Power One Inc., Power One Dr., Camarillo, Calif. 93010. Phone (805) 484-2806 [394]

## Compact supply provides variable 5-to-15-V dc output

A power supply that measures 4 by 2.875 by 1.5625 in. provides variable output voltages ranging from 5 to 15 v dc. The compact unit operates on 105 to 132 v ac, 50 to 60 Hz, with an output current of 200 mA. It is useful for powering test circuits, breadboards, and instruments, and for running life tests.

The model 220-V's power regulation is precise to 0.1% line and 0.15% load, with a no-load ripple of 0.5 mV and a full-load ripple of 5 mV rms. Green and red light-emitting diodes indicate power-on and over-current



# 308 DATA ANALYZER

## Easily acquire the data you need.

1.  
2.  
3.  
4.

Select parallel state, parallel timing, serial, or signature operation. Simply press the appropriate key.

Choose synchronous or asynchronous sampling. Use the clock of the system under test or the 308's own internal clock. In either case, sampling rates up to 20 MHz are possible.

Enter the word you want to use as a trigger to acquire data. Other keys let you select an external trigger and trigger delay.

Press "start" and you're done. Now, you can view the acquired data in the format you want. Or, store the data in the reference memory by pressing the "store" key. Other function keys allow you to acquire new data and compare it with the reference memory.



In each data acquisition mode, all measurement parameters are displayed for your convenience.

**Minimum  
keystroking  
with the new  
308 Data  
Analyzer from  
Tektronix.**

Of course, the 308 Data Analyzer can do a lot more than we've shown here. For example, there's a self-test routine at power-up, plus seven diagnostics, to ensure accurate results. And the 308 weighs only 8 pounds (3.6 kg), for easy portability.

For the full story, contact your local Tektronix Field Office, or write us.

Tektronix, Inc.  
U.S. Marketing  
P.O. Box 1700  
Beaverton, Oregon  
97075  
Phone:  
(503) 644-0161  
Telex: 910-467-8708  
Cable: TEKTRONIX

Tektronix  
International, Inc.  
European Marketing  
Centre  
Postbox 827  
1180 AV Amstelveen  
The Netherlands

Copyright © 1979, Tektronix, Inc. All rights reserved. 843

**Tektronix**  
COMMITTED TO EXCELLENCE

For immediate action, dial our toll free automatic answering service 1-800-547-1512



# AFFORDABLE



## The New Robot Model 650 Image Processing Scan Converter

### For Interfacing Between Computers or Microcomputers and TV Cameras and Monitors.

The ROBOT Model 650 is a television scan converter with a 256 x 256 x 6 MOS frame-store memory that permits a picture to be frame-grabbed from a television camera in 1/60 second and supplied to the computer on a random access basis. One picture element (pixel) can be moved every 63.5 microseconds. Memory contents are viewed on a television monitor at all times. Memory contents may be accessed or replaced by the computer on a random access basis.

The Model 650 is arranged to interface with either 16 bit mini-computers or microcomputers by means of different optional interface boards.

The 650 can perform virtually any image processing function within its resolution capability. Possible application areas include: Education, medical and industrial research, industrial control, and automation.

- FRAME-FREEZES SCENE IN 1/60 SECOND FOR STOP ACTION.
- PROGRAM WITH ASSEMBLER OR HIGH-LEVEL LANGUAGES.
- EASY INTERFACE BETWEEN MOST COMPUTERS OR MICROCOMPUTERS AND STANDARD TV CAMERA AND MONITOR.
- 256 x 256 PIXELS.
- 64 GREY SHADES.
- MULTIPLE MODEL 650's MAY BE DAISY CHAINED TO A SINGLE COMPUTER FOR COLOR APPLICATION.
- MICROPROCESSING MAY BE BUILT-IN FOR STAND ALONE APPLICATIONS.

Call or write for FREE **\$3600** Brochure with complete information.



ROBOT RESEARCH, INC.

7591 Convoy Court • San Diego, CA 92111  
(714) 279-9430 • (800) 854-2057

World leaders in Phone Line Television and Image Processing Systems

Circle 190 on reader service card

### Leaders in Electronics

The only reference devoted solely to biographies of the most influential people in electronics

• corporate executives • technical managers • designers and developers • government and military officials • academics • editors/publishers • securities analysts • trade/professional group directors • consultants... plus an 80-page index of biographees by affiliation.

Prepared by the staff of Electronics magazine. 5,240 biographies. 651 pages, clothbound. \$39.50

#### Electronics Magazine Books

P.O. Box 669, Hightstown, NJ 08520  
(609) 448-1700, ext. 5494

Send me \_\_\_\_\_ copies of *Leaders in Electronics* @ \$39.50 plus applicable sales tax. McGraw-Hill pays regular shipping and handling charges on pre-paid orders.

Payment enclosed     Bill firm     Bill me

Name \_\_\_\_\_

Company \_\_\_\_\_

Street \_\_\_\_\_

City \_\_\_\_\_ State \_\_\_\_\_ Zip \_\_\_\_\_

Signature \_\_\_\_\_

### New products

warnings. The 220-V is priced at \$41.95 in small quantities, and delivery is in two to three weeks.

Cincinnati ElectroSystems Inc., 469 Ward's Corner Rd., Loveland, Ohio 45140. Phone (513) 831-4347 [395]

500- and 5,000-V supplies sell for \$200 and \$275

Two power supplies—a 500-v and a 5,000-v unit—have been added at the top and bottom ends of the PMT series of high-voltage regulated modules. The series is designed for original-equipment manufacturers and for laboratory use with photomultipliers, solid-state detectors, ultrasonic transducers, and other devices that require an accurate and stable dc source. Other available models provide outputs of 0 to 1,000 and 0 to 2,000 v.

All the units in the series are locally adjustable and remotely programmable over their full range. Line and load regulation is better than 0.001%. Short-term stability is 0.005% or better, and the ripple



varies from 2 to 10 mV, depending on the output voltage.

The model PMT-05A has an output of 0 to 500 v at 8 mA and sells for \$200 in single-unit quantities. The older models also sell at this price. The other new model, the PMT-50A, provides an output of 0 to 5,000 v at 0.5 mA and sells for \$275. All of the regulated high-voltage power supplies are available from stock.

Bertan Associates Inc., 3 Aerial Way, Syosset, N. Y. 11791. Phone (516) 433-3110 [396]

# Need 24 or 40-pin DIP's off the shelf?

## We're your source.

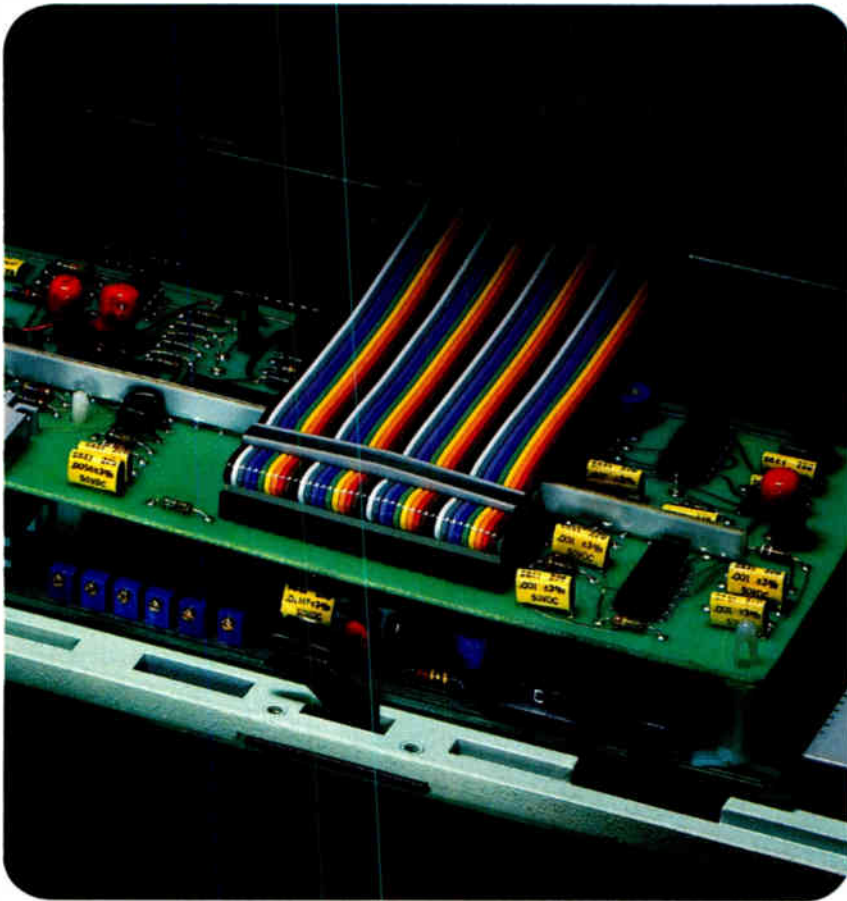

Want the speed, savings and reliability of mass termination with larger size D.I.P. connectors? Come to 3M. Our Scotchflex brand D.I.P. connectors in 24 and 40-contact sizes let you design quick, easy interboard jumpering with readily available parts. Their space-saving low-profile design makes them ideal for microprocessor applications. They also speed and simplify test jumpering or checkout of I.C. sockets.

Both connectors have .100" x .600" grid spacing and are available with either rectangular legs for use with standard I.C. sockets or round legs for use with high density packaging panels. They may be used with Scotchflex shielded, non-shielded or color-coded flat cable or with twisted pair or parallel lay woven cable.

Where frequent plugging and unplugging is necessary, strain relief bars and pull

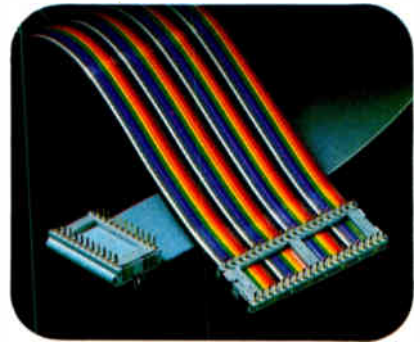

tabs are available for all Scotchflex D.I.P. connectors including 14 and 16-pin sizes.

Need some more ways to simplify wiring and increase circuit density? 3M's Scotchflex line offers you the widest choice of mass terminating cable, connectors and system components to accommodate your design packages. Plus proven reliability. Off-the-shelf availability. And the unmatched experience of the people who pioneered the concept of electronic mass termination.

Scotchflex connectors are recognized under the component program of Underwriter's Laboratories, Inc. 

"Scotchflex" is a registered trademark of 3M Co.

# Scotchflex<sup>®</sup> systems from 3M.

## The source.

# AIM 65. The professional's microcomputer.



Printer, display, full keyboard. Under \$500.00.

**Micro  
Power**

For professional learning, designing and work, Rockwell's AIM 65 microcomputer gives you an easy, inexpensive head start. That's Rockwell Micropower!

- 20-column printer and display
  - Dual cassette, TTY and general purpose I/Os
  - R6502 NMOS microprocessor
  - System expansion bus
  - Read/write RAM memory
  - Prom/ROM expansion sockets
  - Self-prompt interactive monitor firmware
  - Big terminal-style keyboard
- For more on AIM 65 and how

you can develop programs in assembly language or BASIC, write Rockwell International, Microsystems, RC 55, P.O. Box 3669, Anaheim, CA 92803 or contact your local Rockwell distributor. For application information call (714) 632-3729. For location of nearest dealer call 800-854-8099, in California 800-422-4230.



**Rockwell International**

...where science gets down to business



# Turn schematics into PC boards in one-third the time.

Nicolet's revolutionary new System 80 is the compact, complete electronic drafting table that fits into your design department and speeds work through faster than you can imagine. In only five days, you can become an expert on the System 80, because it is incredibly easy to operate.

System 80 instantly displays pads, lines, DIPs, component outlines, characters — and in up to 20 colors so you can work on all layers simultaneously. You have tremendous mobility in the design because you can pan around very large drawings, or zoom in on specific details.

You can "key in" elements to be repeated, and the system duplicates them as many times as you want at the touch of a button. Time spent on tedious detail work can now be used for creative designing. As you work, an auxiliary screen gives you a high resolution overview, helps you make changes fast. All your designs are stored on diskettes — more compact, less expensive and safer than storing tape-ups.

## Make changes and additions quickly

You can make revisions and see results right on the screen, as you work. System 80 lets you transfer parts of designs from stored drawings, which you can



## Nicolet introduces System 80.™

instantly rotate or reposition. You can move, erase or add whole groups of pads and traces for fast revisions.

### Artwork is always accurate

Your prototypes will be ready faster, and because the system always positions the pads and lines exactly on the grid you specify, you can be sure that your final art will be exactly what you had in mind. System 80 includes a Nicolet Zeta 3653SX pen plotter which produces clean, precise, camera-ready artwork that is far more accurate than tape-up.

### System 80 can pay for itself in a year

System 80, at \$73,200, is priced lower than any comparable CAD unit, yet it provides the features

and the capabilities of systems costing three or four times as much. It saves money and time by eliminating bottlenecks at the design stage. No other CAD system can increase your productivity so dramatically, or give you more accurate results while being so simple to operate. On a cost/performance basis, your average board cost over two years can drop by 50%. Check out System 80 today.

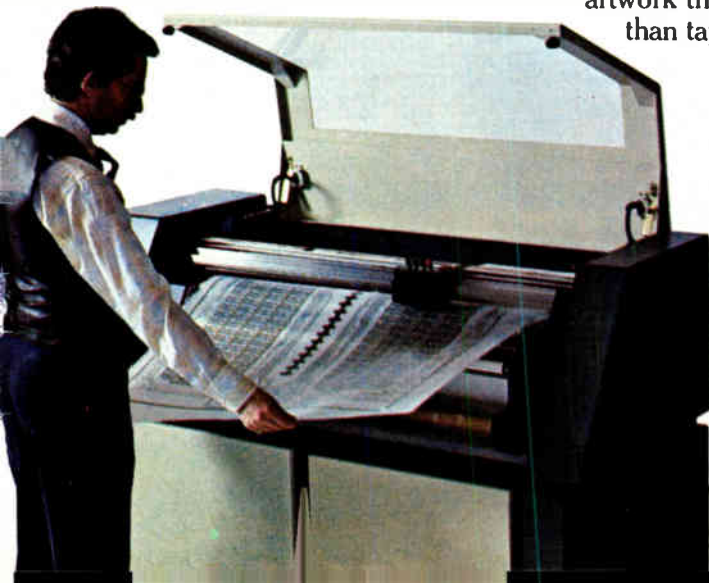

**NCC** NICOLET  
CAD  
CORPORATION

2530 San Pablo Avenue  
Berkeley, CA 94702  
415/848-6600. Ask for Mike Smith.

Circle 193 on reader service card

# matrox

microprocessor  
displays

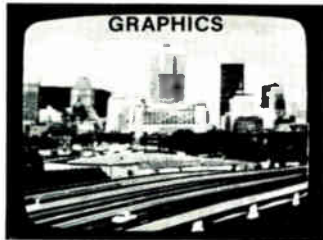

256 X 256 to 512 X 512

## ALPHA NUMERIC



8 X 16 TO 24 X 80

## COMBINED



ALPHA NUMERIC/GRAPHICS

## SINGLE CHIP CONTROL

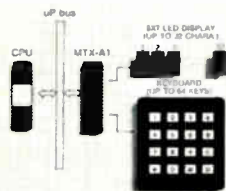

ALPHA CHIP

## COMPUTER TO TV MONITOR INTERFACE AMERICAN & EUROPEAN

- VIDEO RAM:** A complete family of alphanumeric CRT controllers with display formats from 8 X 16 to 24 X 80.
- GRAPHICS:** Resolutions from 256 X 256 to 512 X 512. Easily combined with alphanumeric VRAMs.
- COLOR:** Single board 256 X 256 X 4 bits pixel or multiboard to 512 X 512 X 8 bits pixel.
- ALPHA CHIP:** Single chip LED alphanumeric/keyboard display.
- ALPHA/GRAPHICS:** Single board aspect ratio combination board 24 X 80 alpha and 240 X 320 graphics.
- CUSTOM:** Designed to fit specific needs.

Matrox offers a highly diversified selection of modules and PC boards allowing customers to solve display problems rapidly and cost effectively. These ready to use sub-systems are available off the shelf in self-contained modules, for any uP, or on PC boards, bus compatible with DEC LSI-11, PDP-11, Mostek/Prolog STD, Intel/NSC SBC Multibus, Motorola Exorciser, and S100.

**matrox electronic systems**

The Visible Solutions Company

5800 ANDOVER AVENUE, T.M.R., MONTREAL, QUE. H4T 1H4  
TEL (514) 735-1192 TELEX 05-825651  
U.S. ONLY: TRIMEX BUILDING, MOORE'S, NY 12958

## New products

### Components

# LED display is interactive

24-character alphanumeric system interfaces with serial and parallel data I/O lines

The demand for greater interaction between user and display in point-of-sale terminals, remote data-entry terminals, communication message centers, and bus controllers is pushing the development of intelligent alphanumeric displays that simplify the terminal user's task. One such truly interactive display product is the BDS2724 24-character light-emitting-diode system. The unit is a single-line alphanumeric display consisting of 14-segment 0.135-in.-high LEDs. These LEDs are under the control of an on-board 8048 or 8748 microcomputer.

Data may be sent to the display, edited, and moved left or right. The contents of the display memory can be read on the input/output lines. The display features horizontal scrolling and carriage return, line feed, and cursor blinking and editing. It also has two levels of brightness and a self-test mode. Display features can be controlled either with hardware jumpers or under software commands.

Two versions of the display are available: a standard parallel 8-bit bidirectional unit (BSD2724P) that is compatible with standard 5-v microprocessor-system I/O lines (TTL, MOS, complementary-MOS, etc., levels), and a serial version (BDS2724S) for RS-232-C lines. The serial unit has baud-selectable rates for half- and full-duplex operation. In addition, it can be operated with a parallel ASCII input connected directly to a universal asynchronous receiver-transmitter section, where data is sent and received serially.

The interactive display is made up of two printed-circuit boards sandwiched together. One board contains the LED displays and driver electronics, and the other the microprocessor and interface electronics. The boards may be operated apart through a ribbon cable, for remote applications.

The display's gallium arsenide phosphide red LEDs are encased in cylindrical lenses that magnify the readout in the vertical direction only. This feature makes for a wide viewing angle. The approximate width of the 24-character section is 4 in.

The display operates from a 5-v supply and draws about 250 mA. The compact unit (7.5 in. wide by 2.375 in. high by 1.25 in. deep) is mechanically similar to the Hewlett-Packard HDSP 8716 intelligent 16-character 16-segment LED display with the same mounting dimensions.

The manufacturer also plans to introduce later the same kind of

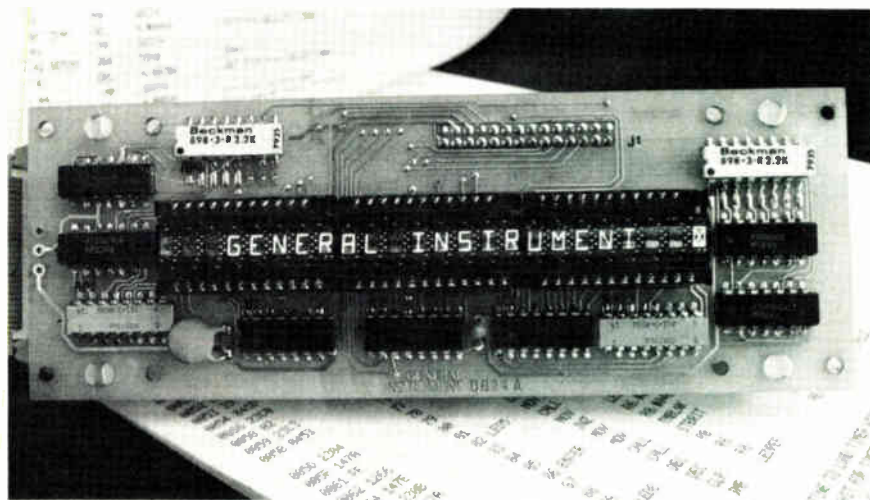

# The power of positive linking.



## Amphenol® 229 Series connectors. Qualified to MIL-C-22992, Class L. Preferred under MIL-STD-1353A.

Positively rugged—these high-power grounded connectors are constructed with high-impact aluminum and high-strength plastic. So they'll withstand rough use. Expect far fewer replacements and less downtime than with other connectors.

Positively waterproof, too. Mated or unmated. Capped or uncapped. Our environmental sealing system eliminates a major cause of connector failure.

Recessed socket contacts provide arc-quenching and personnel protection. Five-key shell polarization means these connectors can *only* be mated with connectors having the same voltage, current, frequency, phase, and grounding characteristics. And they are field repairable. Available in four connector shell sizes: 28(40-amp), 32(60-amp), 44(100-amp), and 52(200-amp).

Applications include mobile or fixed communications, radar, lighting, portable generators, power generation and distribution equipment, battery chargers, and more.

For complete information, technical data, dimensions, and prices, contact your nearest Amphenol North America sales office.

229 Series available in cable plug and receptacle as well as wall-mount plug and receptacle (photo 1/4 size)



**BUNKER  
RAMO**

## AMPHENOL NORTH AMERICA

A Division of Bunker Ramo Corporation

Amphenol North America Division Headquarters: Oak Brook, Illinois 60521

Sales Offices: Atlanta (404) 394-6298 • Boston (617) 475-7055 • Chicago (312) 986-2330 • Dallas (214) 235-8318 • Dayton (513) 294-0461  
Denver (303) 752-4114 • Greensboro (919) 292-9273 • Houston (713) 444-4096 • Indianapolis (317) 842-3245 • Kansas City (816) 737-3937  
Knoxville (615) 690-6765 • Los Angeles (213) 649-5015 • Minneapolis (612) 835-4595 • New York (516) 364-2276 • Orlando (305) 647-5604  
Philadelphia (215) 732-1427 • Phoenix (602) 265-3227 • St. Louis (314) 569-2277 • San Diego (714) 272-5451 • San Francisco (408) 737-8090  
Seattle (206) 455-2525 • Syracuse (315) 455-5786 • Washington, DC (703) 524-8700  
Canada: Montreal (514) 461-5220 • Toronto (416) 291-4401 • Vancouver (604) 278-7636 • International: Oak Brook, Illinois TELE X 206-054

Circle 195 on reader service card

# Choke Design Made Easy

Send for complete information on the DC and AC characteristics of low cost, high performance iron powder toroidal cores for EMI and power filters. New information includes energy storage curves with application notes to simplify choke design.

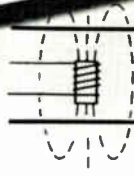
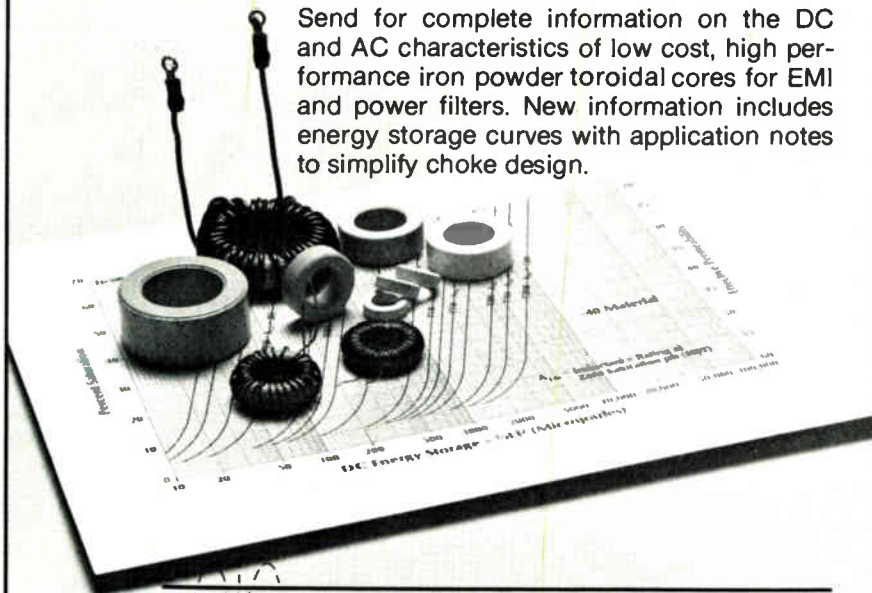

## MICROMETALS, INC.

1190 N. Hawk Circle, Anaheim, CA 92807 • (714) 630-7420 • TWX 910-591-1690

Circle 196 on reader service card

## ELEVAM DISCHARGE TUBES FOR RELAYS AND SERGEABSORBER

Introducing a new surge absorber in a low cost.

### ● CHARACTERISTICS

- (1) The stable character is always kept on avoiding at, being influenced by the environmental conditions.
- (2) Even if this type that has an advantage of gas discharge phenomena gets shocked and shocked a little later on, it is durable and renewable, however, a semi-conductor isn't.
- (3) Being able to know how the conditions go visibly.
- (4) For customers, this can be varied with their usage.

### ● FEATURES

Lamp Type	Starting Voltage (vac)	External Resistance (K-ohms)	Normal Current (mA)	Outline and Dimensions (%)	
				overall length	diameter
SA-80	70-90	33	1.6	20	6.5
SA-140	130-150	75	1.0	25	6.5
SA-200	160-240	100	1.7	20	6.5
SA-300	250-350	150	1.6	20	6.5
SA-350	350-400	150	2.0	20	6.5

### ● MAIN PRODUCTS

Glow Lamps,  
Color Light,  
Xenon Flash Tube,  
Black Light, and  
UV-Light.

**ELEVAM ELECTRONIC TUBE CO., LTD.**

◀For further information.▶

NO, 17-8, 2-chome, chuo, ota-ku, Tokyo, Japan.  
Telephone (03)774-1231 Telex : 246-8855 ELEVAM.

## New products

intelligent display in 8-, 16-, and 32-character widths, using 14-segment 0.135-in.-high LEDs, and in 8-, 16-, 24-, and 32-character widths, using 16-segment 0.5-in.-high LEDs.

The price for the BDS2724P parallel display version is \$11.50 per character. The price will be slightly higher for the BDS2724S serial version. Availability is from stock.

General Instrument Optoelectronics, 3400 Hillview Ave., Palo Alto, Calif. 94303. Phone (415) 493-3300 [341]

## Two LED lamps come in one low-profile package

Two differently colored, matched light-emitting diodes come in a single T1¼ short-dome (low-profile) package. The series comes in red, green, yellow, and international-orange LED color combinations for stop-go, on-off, yes-no, up-down, and other dual-status indications. The units have a typical luminous intensity of 2.0 mcd at 20mA and half-intensity viewing angles of 80°. Typical pricing for small quantities ranges from \$1.05 to \$0.84 each for 1,000. Delivery is from stock.

Opcoa Division of IDS Inc., 330 Talmadge Rd., Edison, N. J. 08817. Phone Jack Testerman at (201) 287-9355 [343]

## Transimpedance preamplifier has 5-nV/Hz<sup>1/2</sup> noise voltage

The model 9923 preamplifier comes in a dual in-line package and features a maximum spectral density of 5 nV/Hz<sup>1/2</sup> with a 1,000-GΩ input impedance. A 150-V/μs slew rate makes the unit useful in ultrasonic, sonar, audio, and communications applications, where it may perform as a transimpedance-type amplifier. The commercial-grade unit can also operate over the military temperature range of -65° to +125°C. The units have a 30-fA/Hz<sup>1/2</sup> current noise.

In orders of 1 or 2 pieces, the devices are priced at \$39 each; 3 to 9 pieces sell for \$35 each; and for 10 to

# So few in the world really make it in ROMs.

It's amazing, but there are only a few semiconductor manufacturers anywhere in the world with the needed mastery of MOS programming techniques required today to make it big in ROMs. Like Synertek.

We consider ROMs to be a custom product. Depending on your special needs, we offer three different points of entry into our ROM production flow. After careful evaluation, we recommend the one entry level best for you.

At diffusion mask you get lower cost and the highest volume 16K, 32K and 64K ROMs in the business. For fast turnaround to meet your prototype or preproduction needs, we offer a 16K ROM metal mask option and a 32K ROM contact mask option.

Time tested and customer proven results are what we're all about. You can see them in our industry standard bearers: SY2716 16K EPROM, SY2316A/B 16K ROM, SY2332/33 32K ROM, and the SY2364 64K ROM.

For samples, data sheets, reliability reports and our information packet on our comprehensive ROM capabilities, contact Memory Product Marketing direct at (408) 988-5611. For Area Sales offices and distribution references, call Headquarters Sales direct at (408) 988-5607. TWX: 910-338-0135.

**Synertek performs** as a major MOS supplier of high volume parts with advanced technologies and techniques behind everything we make. ROMs. Static RAMs. EPROMs. Custom Circuits. Single-chip Microcomputers. Systems. 6500 Microprocessors and Peripherals.



**SYNERTEK**

3001 Stender Way, Santa Clara, California 95051  
(408) 988-5600. TWX: 910-338-0135.

Circle 197 on reader service card



# METAL OXIDE VARISTORS from VECO

## Lower System Costs

Victory's new metal oxide varistors are designed to lower system costs and increase product safety through improved circuit and system reliability. It is very important to note that the published energy rating expressed in joules is after the application of 2000 pulses, where as many competitive devices are rated at only one pulse.

Veco metal oxide varistors exhibit improved response times, increased current capability, low standby power consumption and superior clamping characteristics in a compact, lightweight package that's UL recognized for "across-the-line" components.



**VICTORY ENGINEERING CORP.**

Victory Road, P.O. Box 559, Springfield, NJ 07081  
(201) 379-5900 TWX: 710-983-4430

Circle 198 on reader service card

### New products

39 units, the price is \$31.50 apiece. Delivery is from stock to four weeks. Optical Electronics Inc., P. O. Box 11140, Tucson, Ariz. 85734. Phone (602) 624-8358 [344]

1-teraohm resistors come in standard 1/8- to 1/2-W sizes

Resistors with 100-megohm to 1-teraohm (1 million MΩ) resistance values come in body sizes as small as a standard 1/8-W resistor. The high-resistance values are also available in the 1/4- and 1/2-W body sizes of the manufacturer's hot-molded carbon composition resistor line. Since the high-resistance units are made with the same basic material and manufacturing process as the standard resistors, they provide similar ruggedness and dependability.

Typical applications include smoke, infrared, and vacuum-leak detection devices; condenser microphones; photocopying equipment; and capacitive transducers so long as tight tolerances are not required.

The resistors are available in 10, 20, and 30% tolerances, with 5% tolerances available up to 1,000 MΩ. The type BBH resistor is in the 1/8-W size, the EBH in the 1/2-W, and the CBH in the 1/4-W. Prices vary according to size, resistance value, and tolerance. For example, a CBH 1/4-W unit with 20% tolerance sells for 21¢ to 52¢ each in 1,000-unit quantities, depending on the resistance value.

Allen-Bradley Electronics Division, 1201 South 2nd St., Milwaukee, Wis. 53204. Phone (414) 671-2000 [345]

Optically isolated units use logic to drive 400-V triacs

Two optically isolated drivers interface logic or microprocessors with 400-v triacs. The models MOC3020 and MOC3021 optocouplers are designed for use with resistive heaters, inductive motors and solenoids, relays, and consumer appliances. The optocouplers are suitable for controlling 220 v ac equipment.



## 3H ELECTRONICS

Looking for a Complete Power Supply Tester  
Easy to Use

### MODEL PT900 POWER SUPPLY TESTER

- Using PDP11/3 computer with 2 floppy discs
- Test operating system written in Pascal
- Up to 20 programmable loads (10/20 amps)
- Up to two 100 amps programmable loads
- AC resistor loads, 1 ohm to 64 Kohm
- DC programmable source 50 volts at 10 amp
- Single or three phase AC source
- AC Amplitude and frequency programmable
- High speed 16 bit A/D
- 16 point measuring matrix
- 16 relay drive lines

### TEST CAPABILITY

- DC output voltage measurement
- Line, load, and combined regulation
- Ripple
- Over voltage protection test
- Power fail hold up test
- Power fail bit set and reset test
- AC line current/voltage/power measurement
- Current limiting/short circuit test

### THREE METHODS OF PROGRAMMING

1. Issue primitive commands, ALDADI — to load an output: MRIPPLE — to measure ripple
2. Interact with existing test procedures, i.e.: What is AC input line voltage in volts? etc.
3. Write new test procedures in a simple testing language. Tell "What is AC input voltage in volts?" Ask ACV Lowlimit Highlimit.

For more information call:  
**3H ELECTRONICS**

Leader in simplifying linear IC testing and making it CHILD'S PLAY  
is now doing the same for Power Supply Testing

USA HEADQUARTERS: 1289 Hammerwood, Sunnyvale, CA 94086 / Tel: (408) 734-5970 Telex: 352022  
SOUTHERN CALIFORNIA: 32129 Lindero Canyon Road, Suite 210, Westlake Village, CA 91361 / Tel: (213) 889-1365  
EUROPEAN HEADQUARTERS: 27C Chemin Boissier, 1223 Coligny, Geneva, Switzerland  
FAR EAST: Sumitomo Corp., New Sumitomo Shoji 2-2, Hitotsubashi 1-chome, Chiyoda-ku, Tokyo, Japan  
REPRESENTATIVES ALL AROUND USA/EUROPE/FAR EAST

LOOK HERE



# YOU'LL FLIP OVER...



## IEE's latest.... FLIP !!

- The display that operates on +5VDC — only!
- The display that presents bright, beautiful 100fL .2" characters.
- The display with a total package depth **UNDER ONE INCH**
- The display that gives you a choice of red, yellow, green, or blue messages... all with only a filter change.
- The display with interchangeable ASCII and European ECMA font sets — on command!
- The display with a bi-directional TTL/ASCII data bus interface.
- The display with so much more!

Models available with:

- 1 line of 20 characters
- 1 & 2 lines of 40 characters
- 1 line of 80 characters
- 6 lines of 40 characters (MARCH 1980)

The vacuum fluorescent Series 3600 "FLIP" — newest family of *engineered* display modules from IEE.



**The  
Display  
Maker**

INDUSTRIAL ELECTRONIC ENGINEERS, INC.  
7740 LEMONA AVE., VAN NUYS, CA 91405  
TEL. (213) 787-0311 • TWX 910-495-1753

**Yes, I'm interested in FLIP displays!**

My application is: \_\_\_\_\_  
Please have your sales representative contact me:

Name: \_\_\_\_\_

Company: \_\_\_\_\_

Address: \_\_\_\_\_

City: \_\_\_\_\_

State: \_\_\_\_\_

Zip: \_\_\_\_\_

Area Code \_\_\_\_\_

Phone Number \_\_\_\_\_

Ext. \_\_\_\_\_

## Selected Applications

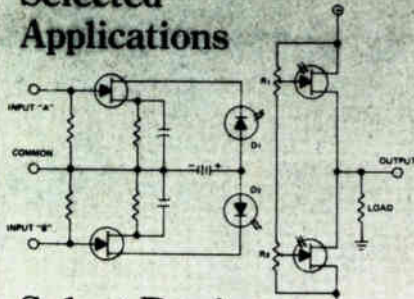

## Select Devices



# Field Effect Transistors Aerospace Military Medical

Crystalonics made FETs commercially available in 1960 and is still the leader in the field. We offer an array of excellent special devices, including:

- Low frequency, silicon, N-Channel, junction FETs (CM860/2N6550) with an ultra low input noise figure of 1.4 nV/√Hz typical at 1 kHz, for low frequency amplifier applications.
- RF FET for radio frequency amplifier applications (CP640/CP643), broad band, with wide dynamic range, through 500 MHz.
- A series of switching FETs (2N4445/2N5432) with under 15 ohms ON resistance. Standard types with  $R_{ON}$  as low as 2½ ohms (2N6568), and specials as low as 1 ohm (CM856).
- FOTOFETs®, light-sensitive, junction FETs in transistor cases with curved or flat glass lenses. Ideal for optical coupling applications demanding supersensitivity, fast response, low dark current and stability.

For further information send for our short form catalog.

## TELEDYNE CRYSTALONICS

147 Sherman Street  
Cambridge, MA 02140  
Tel: (617) 491-1670 • TWX 710-320-1196

## New products

Each comes in a six-pin plastic dual in-line package that contains a gallium arsenide infrared emitter and a monolithic chip that has the detector and bidirectional triac driver. The couplers have a minimum peak off-state voltage of 400 v and a 7,500-v minimum isolation voltage between input and output.

The maximum emitter current required to latch the output of the 3020 is 30 mA; 15 mA are required for the 3021. The 3020 sells for \$1.55 each in quantities of 100 or more and for \$1.25 in 1,000-unit quantities. The 3021 is \$1.75 and \$1.50 for corresponding quantities. Both models are immediately available.

Motorola Semiconductor Products Inc., P. O. Box 20912, Phoenix, Ariz. 85036. Phone Marty Levy at (602) 244-4306 [347]

## Panel-mount annunciator displays timed messages

The first member of a family of compact displays is a panel-mount annunciator that displays timed messages. The display is intended to be an alphanumeric prompter for industrial and medical applications.

The model SPA-402 stored-program annunciator uses an 8085 microcomputer to store up to 16 messages in permanent memory. Each 16-word message is displayed at a preset time for a specific period. A sonic alarm announces the presence of a new message. When the alarm is silenced manually, the time display is resumed.

The 16 custom messages and their on and off times are loaded into memory at the factory. The unit's real-time clock can be set or changed from the front panel by the operator.

The SPA-402 will be housed in a metal case with snap-on bezels. The display operates on 12 v ac or dc. It is available four to six weeks after receipt of order for \$595. Discounts are also available.

Adco Electronics, 2182 DuPont St., Suite 222, Irvine, Calif. 92715. Phone John Schuler at (714) 833-1528 [348]

# RS232C Paper Tape Transmitter



Computer entry, numerical control and data transmission. Includes X-on, X-off and parallel output, current loop optional. Desk top or rack mount. OEM model and spooler also available.



416 Junipero Serra Drive  
San Gabriel, California 91776  
(213) 285-1121

Circle 241 on reader service card



## CURRENT MONITORS

With our monitor and your oscilloscope, read fast pulsed currents (nsec to millisec) of any conductor. Prices range from \$70 for standard, in-stock models. Sensitivities from 1 V/A to .01 V/A; no physical connections required; readings without ground loops; BNC standard; specials upon request.

For further information write or call: Ion Physics Company, P.O. Box 416, Burlington, Mass. 01803. Tel. 617-272-2800.



ION PHYSICS COMPANY  
A DIV. OF DELTA ENGINEERING CORPORATION

Circle 242 on reader service card



# An important tip for PDP-11 users

## Play the blue-chip cards from Able.

### COMMUNICATIONS PRODUCTS

#### DMAX/16™ (16-LINE DH11 REPLACEMENT)

**INSTALLS IN:** All PDP-11's; in less than one half the space of DH11. **DATA RATES:** All 14 standard baud rates plus 19.2K baud and one user programmable data rate (16 baud rates). **PROCESSING ADVANTAGES:** Word transfers (in lieu of byte DMA) cut processing overhead by half. **OPERATING MODES:** Full or half duplex with full modem control via DM/16 option. **CAPACITY:** Up to 256 lines on a single PDP-11.

#### QUADRASYNC/B™ (4-LINE DL-11 REPLACEMENT/EIA)

**INSTALLS IN:** All PDP-11's; 4-lines per SPC slot at one unit load to Unibus. **DATA RATES:** 7 independently selectable baud rates for each of 4 channels (150-9600). **ELECTRICAL:** EIA standard RS232C (Modem control not supported). **VECTOR ADDRESS SELECTION:** Vector and address values to be set on boundaries of 008 or 408. 16 continuous word address for Vector or Address.

#### QUADRASYNC/C™ (4-LINE DL11 REPLACEMENT/CL)

**INSTALLS IN:** All PDP-11's; 4-lines per SPC slot at one unit load to Unibus. **DATA RATES:** 7 independently selectable baud rates for each of 4 channels (150-9600). **ELECTRICAL:** 20MA current loop (Send : Receive). **VECTOR ADDRESS SELECTION:** Vector and address values to be set on boundaries of 008 or 408. 16 continuous word address for Vector or Address.

#### QUADRASYNC/E™ (4-LINE DL11-E REPLACEMENT)

**INSTALLS IN:** All PDP-11's; 4-lines per SPC slot at one unit load to Unibus. **DATA RATES:** 7 independently selectable baud-rates for each of 4 channels (150-9600). **ELECTRICAL:** EIA standard RS232C - with modem control. **VECTOR ADDRESS SELECTION:** 16 continuous word address for Vector or Address - starting values selected on any boundary.

#### QUADRASYNC/LSI™ (4-LINE DLV11 REPLACEMENT)

**INSTALLS IN:** LSI-11 and PDP-11/03; 4-lines/card at one unit load to Unibus. **DATA RATES:** 8 independently selectable baud rates for each of 4-channels (110-9600). **ELECTRICAL:** 20MA active/passive current loop (Send : Receive) - also supports EIA standard RS232C. **VECTOR ADDRESS SELECTION:** Like DLV-11 - 3-channels must have contiguous addresses and 1-channel may be set to any address including console address.

#### QUADRACALL™ (4-LINE DN11 REPLACEMENT)

**INSTALLS IN:** All PDP-11's; 4-lines per SPC slot at one unit load to Unibus. **PERFORMANCE:** Interfaces up to 4 Bell 801 ACU's with Unibus enabling any PDP-11 to dial any DDD network number to establish data link. **INPUT/OUTPUT:** 5-input signals from ACU are handled by EIA RS232 receivers. 6-output signals are transmitted using EIA RS232 drivers. **VECTOR ADDRESS SELECTION:** Allows selection of device address and vector by use of pencil switches.

#### DV/16 (16-LINE DV11 REPLACEMENT)

**INSTALLS IN:** All PDP-11's; in less than one half the space of DV11. **DATA RATES:** 16-line throughput of up to 76,800 char/sec (19.2K baud full duplex for each line) total. **PROCESSING ADVANTAGE:** Word transfers (in lieu of byte DMA) permit user to operate within one half the DV11 bandwidth for data transfers. **OPERATING ADVANTAGE:** User may mix sync and async lines in combinations of 4 or 8 lines with modem control and full system software compatibility with all DV11 performance features.

### MEMORY PRODUCTS

#### SCAT 45™ (ADD-IN FASTBUS MEMORY)

**INSTALLS IN:** PDP-11/45, -11/50 and -11/55. **EXPANDS IN:** 32K word increments/board. One-half of the available Fastbus space will accept full 124K word complement. **ADDRESSES ON:** Any 4096 word boundary across entire 124K word range. User has full memory complement at 330 nsec cycle-time memory instead of 32K word limitation imposed by the computer manufacturer.

#### CACHE/45™ (CACHE BUFFER MEMORY)

**INSTALLS IN:** PDP-11/45, -11/50 and -11/55. **CAPACITY:** 2048 byte (1K word). **ENHANCEMENT FACTOR:** Run time reductions to 50% (100% speed improvement) are achievable. **CACHE PARITY:** Automatically goes off-line in event of any data error. **RANGE SELECTION:** User may optimize hit ratio by upper/lower limit switch settings. **SPECIAL FEATURE:** Cache/45 can be enabled via software or console switches.

#### CACHE/434™ (4K WORD CACHE MEMORY)

**INSTALLS IN:** PDP-11/34 and -11/34A without using any additional backplane space! **CAPACITY:** 8192 byte (4K word). **ENHANCEMENT FACTOR:** Run time reductions to 40% (70% speed improvement) are achievable. **CACHE PARITY:** Automatically goes off-line in event of any data or address error. **RANGE SELECTION:** User may optimize hit ratio by upper/lower limit switch settings. Cache action monitor indicates hit rate.

#### CACHE/440™ (4K WORD CACHE MEMORY)

**INSTALLS IN:** PDP-11/35 and -11/40 without using any additional backplane space! **CAPACITY:** 8192 byte (4K word). **ENHANCEMENT FACTOR:** Run time reductions to 40% (70% speed improvement) are achievable. **CACHE PARITY:** Automatically goes off-line in event of any data or address error. **RANGE SELECTION:** User may optimize hit ratio by upper/lower limit switch settings. Cache action monitor indicates hit rate.

#### EMULOADER™ (ODT/BOOTSTRAP LOADER REPLACEMENT)

**INSTALLS IN:** PDP-11/05, -11/10, -11/35, -11/40, -11/45, -11/50 and -11/55. **MECHANICAL:** Dual width card replaces standard Unibus termination; requires no additional backplane space. **OPERATING ADVANTAGE:** Provides fixed console emulator (ODT) and bootstrap loaders for DL11, PC11, RF11, RK06, RK11, RP04/05/06, RP11, RS03/04, RX11, TC-11, TM11 and TU16. **SPECIAL FEATURE:** Performs memory diagnostic each time a boot operation is done from ODT.

### GENERAL PURPOSE PRODUCTS

#### QNIVERTER™ (Q-BUS TO UNIBUS CONVERTER OR UNIBUS TO Q-BUS CONVERTER)

**INSTALLS IN:** LSI-11, LSI-11/23, PDP-11/03 and PDP-11/23 via quad-width card. **APPLICATIONS:** Allows Unibus-compatible controllers and memories to be used with LSI computer systems, or LSI-based peripherals to be used with PDP-11 computer systems. **FEATURES:** Supports features of LSI-11/23 including the full 128K address capability.

#### REBUS™ (BUS REPEATER - DB11 REPLACEMENT)

**INSTALLS IN:** All PDP-11's; without using any additional backplane space. **MECHANICAL:** One dual-width card plugs into the same pair of connectors as the Unibus extension cable which is then plugged into the REBUS connectors. **COMPATIBILITY:** Allows for 18 additional bus loads and 50 foot bus extension. Requires no software changes. Bus cycle time unaffected for devices on CPU side of REBUS - increased by 250 nsec max. for devices on outboard side.

#### DUAL I/O™ (GENERAL INTERFACE-DR11-C REPLACEMENT)

**INSTALLS IN:** All PDP-11's; in any SPC slot via quad-width card. **APPLICATION:** Dual I/O is equivalent to two (2) DR11-C's and provides the logic for program-controlled parallel transfer of 16-bit data between two (2) external user devices and a Unibus system. **OPERATING ADVANTAGE:** Provides user the hardware/software equal to a dual DR11-C in one-half the space and one-half the bus loading of DR11-C's.

#### UNIFACE™ (UNIBUS-COMPATIBLE, GENERAL-PURPOSE I/O)

**INSTALLS IN:** All PDP-11's in any SPC slot via hex-width card. **APPLICATION(S):** Limited only by user's ingenuity; can form additional intelligent Unibus I/O channel(s), communications processor(s), efficient KMC11 equivalent(s), or user-proprietary device(s). **OPERATING ADVANTAGE:** To PDP-11's, UNIFACE looks like a standard controller at one bus load; to devices served, UNIFACE acts as a powerful CPU.

#### BUSLINK/UNI, LSI OR U TO Q (CPU TO CPU LINK; UNIBUS TO UNIBUS, UNIBUS TO Q-BUS OR Q-BUS TO Q-BUS)

**INSTALLS IN:** All PDP-11's and/or LSI-11's via pairs of hex-width, hex/quad-width, or quad-width cards and supplied cables. **APPLICATION:** Provides full DA11-B (Unibus or Q-bus link) compatibility on single cards. BUSLINK operates at DA11-B transfer rates over distances of up to 50 feet. **OPERATING ADVANTAGE:** Requires only one card per CPU to effect link at minimal bus loading vs. full system unit per computer.

Able cards give you the best way to make your present PDP-11 run better than ever and avoid up-grading to a more expensive model. We give you time to plan ahead and to control your cash flow with the most sophisticated line on the market today. Our cards are priced competitively. They install in minutes. They provide immediate results. And they always out-perform the competition. They should. We are the only computer people in the computer-system-enhancement business. Our customers will tell you we are the best qualified to help you get the most out of your present PDP-11. Write for details. Able Computer, 1751 Lansley Avenue, Irvine, California 92714. (714) 979-7030, TWX 910-395-1729.

## Able, the computer experts

DEC, PDP, LSI UNIBUS, and FASTBUS are registered trademarks of Digital Equipment Corporation.

# The biographies of 5,240 of your colleagues...

## the most important people in the electronics industries worldwide

McGraw-Hill's

## Leaders in Electronics

Prepared by the Staff of Electronics

651 pages

This is the only reference devoted solely to biographies of the most influential people in electronics: corporate executives... technical managers... designers and developers of important products and processes... government and military officials... academics... editors and publishers... securities analysts... directors of trade and professional groups... and consultants.

### As easy to read as any professional publication in electronics

With LEADERS IN ELECTRONICS on your bookshelf, you no longer have to search through many different sources for biographical data on your colleagues. What's more, you don't have to strain your eyes reading minuscule type, nor do you have to waste valuable time trying to decipher seemingly endless paragraphs of abbreviations. Boldface type spotlights the various information categories so that you can scan entries rapidly to pinpoint what you need.

### Unique convenience feature... Index of biographees by affiliation

A special 80-page index lists individual organizations alphabetically, complete with the names and titles of top employees. By looking up the names in the general biography listing, you can get a complete profile of the organization's top management in a matter of minutes. Plus an easy-access listing of independent consultants in every electronics specialty.

### Order today using this coupon!

Return coupon to:  
Leaders in Electronics  
P.O. Box 669  
Hightstown, New Jersey 08520  
(609) 448-1700, ext. 5494

Send me \_\_\_\_\_ copy (copies) of Leaders in Electronics on a 10-day money-back guarantee. I understand that if I am not absolutely satisfied, I may return the book(s) within ten days at no further obligation. Otherwise, McGraw-Hill will bill me \$39.50 for each copy, plus applicable sales tax, shipping and handling charges.

SAVE MONEY! Enclose payment in full, plus local sales tax, and McGraw-Hill pays all regular shipping and handling charges.

Ten-day money-back guarantee still applies.

\_\_\_\_\_ Check enclosed \_\_\_\_\_ Bill me \_\_\_\_\_ Bill my company \_\_\_\_\_ Company purchase order # \_\_\_\_\_

This offer subject to acceptance by McGraw-Hill.

Name \_\_\_\_\_  
Title \_\_\_\_\_  
Company \_\_\_\_\_  
Address \_\_\_\_\_  
City \_\_\_\_\_ State \_\_\_\_\_ Zip \_\_\_\_\_

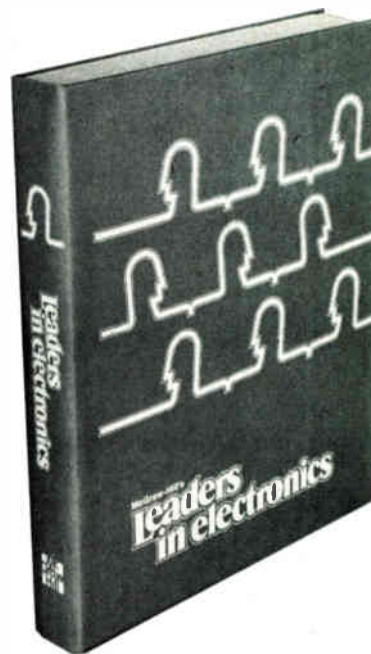

### Sample Listing

#### Jones, John J

Chmn & CEO, Microprocessor Div of Computers Inc, 1023 W Warner Ave, Dayton, OH 45479, Tel (513) 555-2000. **Born:** Mar 26, 1926, Philadelphia, PA. **Education:** MBA, Harvard Business School, 1950; BSEE, Univ of Ill., 1946; PhD (Hon), Yale Univ, 1977. **Professional Experience:** Natl Bur of Standards, 1956-74, Adm Eng; Litton Ind, 1954-56, Sr Eng; NCR Corp, 1950-54, Eng. **Directorships:** Computers Inc since 1975. **Organizations:** IEEE since 1946, Sec Head 1972-73; AAAS since 1971; Midwest Ind Mgt Assn since 1974. **Awards:** Fellow, IEEE, 1977; Public Service Award, City of Dayton, 1976. **Patents Held:** 8 in computer circuits, incl Special Circuit for Microcomputer Chip Design 1975. **Achievements:** founded Microprocessor Inc 1974; project manager of first application of microprocessors for standard interfaces 1975. **Books:** 4 incl *Small Circuits and Their Applications* (editor), McGraw-Hill, New York, 1975. **Personal:** married 1950 to Mary (Smith), children John Jr, Jane Anne, Kevin. **Residence:** 344 W 34th St, Dayton, OH 45403, Tel (513) 555-4343.



# NOW ZENITH GIVES YOU A BRAND NEW WAY TO MEASURE CRT DISPLAY QUALITY.

Now Zenith technology comes packed into a brand new CRT Display format. Introducing the D12-100. This new model in our expanding line has a diagonal measurement of 12 inches. But the story is much, much bigger.

## THE D12-100

To deliver maximum performance at lower cost, our new D12-100 is designed with a 4x5 aspect ratio rather than the currently used 3x4 aspect ratio. In those applications where the D12-100 is appropriate, it offers all the reliability and dependability of our fully featured, top-of-the-line 3x4 aspect ratio models.

No wonder. The D12-100 is designed and tested to meet the same quality and reliability

standards established for *all* Zenith CRT Displays. Thousands of test hours under extreme humidity, vibration, altitude and temperature conditions. And exhaustive analysis, including electron microscope and thermograph scans in the Zenith Reliability Lab.

## APPLICATION ENGINEERING

The D12-100, like every Zenith CRT Display, can be designed to meet your own specifications, as well. We'll meet with you to determine your exact requirements. And then custom build a D12-100 to fit. Since the D12-100 is also the start of a new series of CRT Displays, we'll be happy to talk about

other screen sizes as well.

## ZENITH TRADITION

At Zenith, we're building CRT Displays with the same commitment to excellence that's made us number one in the television industry. When you want a product that works, with delivery on *your* time schedule, plus proven reliability and dependability... you want what we've been giving our customers for over 60 years.

More big ideas are coming. For further information and specifications, write: CRT Display Engineering Division, Zenith Radio Corporation, 1000 Milwaukee Avenue, Glenview, Illinois 60025, or call (312) 773-0074.



The quality goes in before the name goes on.

# NEW

## 7 MIL\*

**"SIL-PADS 400":  
THE SUPERB  
SOLID STATE  
HEAT SINK  
INSULATORS...  
TEST 'EM!**

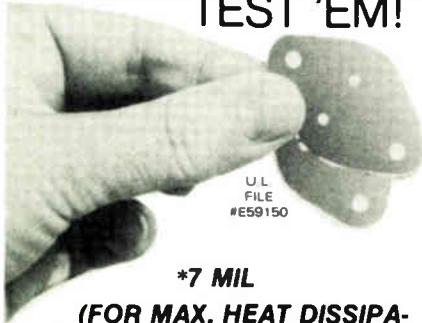

**\*7 MIL**

**(FOR MAX. HEAT DISSIPATION) REDUCES THERMAL RESISTANCE BY 35%**

Since 1973, Bergquist has helped overcome heat-sink problems with "SIL-PADS". Eliminate messy grease and fragile mica or plastic film by using this exclusive development.

"SIL-PADS 400" are thin, tough layers of thermally-conductive silicone-rubber and fiberglass (laminated). Cut-through, tearing, breaking problems are gone. Assembly time is reduced; no solder bath contamination; consistent heat transfer.

Perhaps you've tested or are using 9 mil. NOW . . . test both 7 and 9 mil, and you decide!

"SIL-PADS 400" are successfully used in thousands of applications. Many standard configurations, plus custom capability.

**FREE SAMPLES,  
TECHNICAL DATA,  
and LITERATURE!**

# BERGQUIST

5300 Edina Industrial Blvd.  
Minneapolis, MN 55435  
Phone (612) 835-2322  
TWX 910-576-2423

## New products

Communications

### Unit tests PCM channels

Channel demultiplexer  
extracts voice or data  
signals for examination

Making measurements on individual voice channels in pulse-code-modulation systems has not been cheap or easy for test engineers. But now, North American telephone companies and manufacturers can use the W&G Instruments PDC-1 PCM channel demultiplexer in conjunction with any standard voice-frequency test set to do the job in a cost-effective way.

The PDC-1 combines both measuring and monitoring functions in the PCM domain to permit designers or test technicians to make measurements on voice or data signals at a point in the system where only digital signals are present (the so-called DSX-1 point). As a result they can readily test the signaling characteristics of various voice channels. They can also check the transmitting terminal or codec to verify its

compatibility with the ATT 43801 or CCITT G733 specifications that govern such signals and communication devices.

Used in a field environment with manual or automatic voice-frequency test equipment, the PDC-1 lets users adjust PCM systems during or after installation. Thus it becomes an important tool for maintaining terminals at optimum performance.

With the PDC-1 PCM channel demultiplexer working much as a frequency-selective level meter does in the frequency-division-multiplexing communications domain, it is possible to characterize the transmitting side of a PCM terminal separately from the receiving side.

Bob Handrahan, marketing manager at W&G Instruments, says that "previously, in order to make in-service tests of the encoder on the transmitting side of the channel bank or codec, the user was confronted with an impractical and expensive solution. It was necessary to have a spare channel bank standing by for use at the time of those tests.

"Even worse than this, in addition to the extra expense of the spare channel bank, which represents several thousand dollars, the test procedure is hindered by the inaccuracies inherent in such banks."



For Wires  
printers

Seitz

Seitz, c'est sûr !

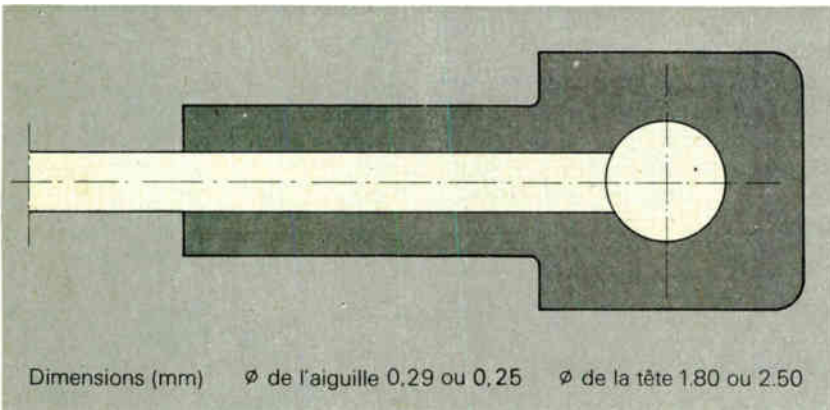
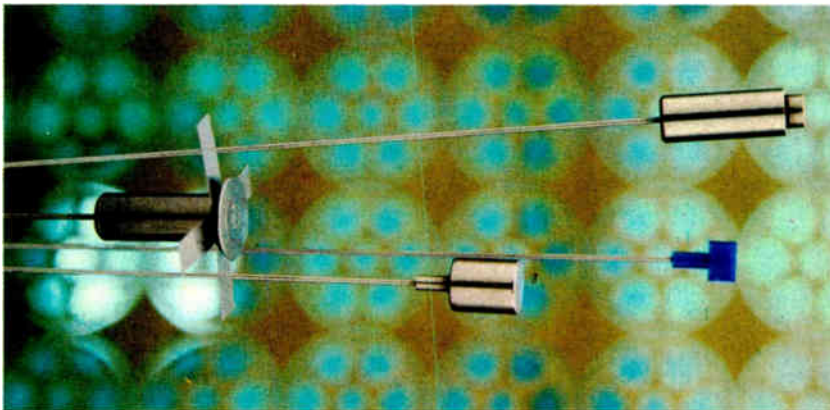

Dimensions (mm)  $\varnothing$  de l'aiguille 0,29 ou 0,25  $\varnothing$  de la tête 1,80 ou 2,50

#### Seitz technology

Seitz experience in the machining of hard materials has contributed to the realization of wires enabling to print characters of a perfect quality.

The materials used for these wires are extremely hard. They make it possible to obtain a highly polished surface and a great precision. They are resistant to wear (less than 0.1mm per 30,000,000 characters), to chemical agents and heat. Seitz research and developing departments co-operate closely with the manufacturers of printing heads.

The booklet «Wires for printers and their guides» will give you detailed information.



Pierres Holding, Faubourg du Lac 6, CH - 2501 Bienne  
Téléphone 032 / 22 65 11, Télex 34 566

Seitz SA, CH-2416 Les Brenets, Tél. 039/32 1112, Télex CH 35 505 SEITZ

# ASTRO-MED SUPERCORDER SERIES

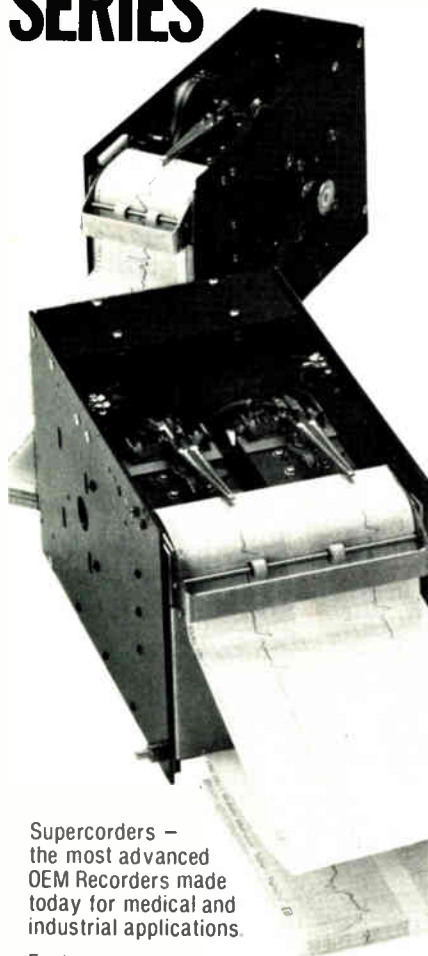

Supercorders — the most advanced OEM Recorders made today for medical and industrial applications.

Features are:

- **Instant Non-Skip Writing** — The Stylus writes instantly with almost no warm-up . . . accuracy and trace clarity are unparalleled.
  - **Z Fold Chart** — the ultimate in chart handling. For review, just flip the pack like the pages of a book.
  - **Position Feedback Galvanometer** — unexcelled accuracy, response, and linearity.
- Available in 1, 2, 3½, 4, 6, and 8 channel models.

I am interested in Supercorders —

- Telephone me
- Arrange demonstration.
- Send Literature

Name \_\_\_\_\_

Company \_\_\_\_\_

Address \_\_\_\_\_

Telephone \_\_\_\_\_



ASTRO-MED DIVISION

ATLAN-TOL INDUSTRIES, INC.

Atlan-tol Industrial Park/West Warwick, R.I. 02893  
401-828-4000

## New products

But there is little or no error added by the PCD-1 because it implements a low-noise digital-to-analog conversion procedure. The overall accuracy of the measurement system is actually determined by the voice-frequency test set.

In the manufacturing area, the PCD-1, used as a decoder, can test PCM terminals, channel banks, switches, and transmultiplexers. Moreover, it has remote-control capability, so it can be incorporated into various types of computer-controlled measuring systems.

When the PCD-1 is used with the company's PCM-3 automatic voice-frequency channel transmission test set and the PCG-1 PCM channel generator, complete transmission testing on an analog-to-analog, analog-to-digital, and digital-to-analog basis can be made. What's more, channel signaling can be monitored via the display on the PCD-1. And by hooking the PCD-1 to a spectrum analyzer, a spectral analysis of a transmitted voice channel is easy to obtain.

The PCD-1 can handle all standard channel bank groupings while it decodes to the  $\mu$ 255 law. The audio output frequency range is 50 Hz to 3,600 Hz, the level range is +3.17 dBm0 to -66 dBm0, the absolute level error at 1,010 Hz is 0 dBm0  $\pm$  0.05 dB; and the frequency response (0 dBm0, 1,010 Hz reference) is  $\pm$  0.05 dB. The instrument's output impedance is 600  $\Omega$  and the connection is compatible with a WECO 310 plug.

The 20-lb machine measures 7 by 9.5 by 15.5 in. Delivery time of the PCD-1 is 90 days.

W&G Instruments Inc., 119 Naylor Ave., Livingston, N. J. 07039. Phone (201) 994-0854 [401]

## Uhf TV transmitter tubes have efficiencies to 42%

Four new cavity klystrons that produce from 35 to 58 kw of peak-of-sync output power operate with peak-of-sync efficiencies of 40% to 42%, some 8% to 10% better than



## Wide Band, Precision CURRENT MONITOR

With a Pearson current monitor and an oscilloscope, you can measure pulse or ac currents from milliamperes to kiloamperes, in any conductor or beam of charged particles, at any voltage level up to a million volts, at frequencies up to 35 MHz or down to 1 Hz.

The monitor is physically isolated from the circuit. It is a current transformer capable of highly precise measurement of pulse amplitude and waveshape. The one shown above, for example, offers pulse-amplitude accuracy of +1%, -0% (typical of all Pearson current monitors), 10 nanosecond rise time, and droop of only 0.5% per millisecond. Three db bandwidth is 1 Hz to 35 MHz.

Whether you wish to measure current in a conductor, a klystron, or a particle accelerator, it's likely that one of our off-the-shelf models (ranging from ½" to 10¾" ID) will do the job. Contact us and we will send you engineering data.

## PEARSON ELECTRONICS, INC.

4007 Transport St., Palo Alto, CA 94303, U.S.A.

Telephone (415) 494-6444





# VLSI "THE LIMITLESS BOUNDARY"

Honeywell-Phoenix takes you beyond the 20th century with the advent of the VLSI Generation. The technology that will be utilized in the 1980's has been predicted for years. The ideas for 1990 are in progress. The power behind it is controlled only by the dimensions VLSI is allowed to achieve. This phenomenon will continue into the 21st century, breaking unmeasurable barriers in the computer field.

That the engineer will be the cornerstone of all levels of this computer technology is a fact which we at Honeywell-Phoenix are very aware. Therefore, the engineers we are seeking must possess the ingenuity to create computer concepts that are as unrestricted as the boundaries of their minds.

This awareness and progress in the field has generated the following positions:

- **SYSTEM ENGINEERS – LARGE SYSTEMS**
- **LOGIC ENGINEERS**  
(CPU, FIRMWARE & CONTROLLER DESIGN)
- **ELECTRONIC PACKAGING ENGINEERS**
- **DIAGNOSTIC ENGINEERS**
- **DESIGN AUTOMATION ENGINEERS**  
(SIMULATION & VLSI CHIP DESIGN)
- **SYSTEM TEST ENGINEERS**

The future of computers, and in essence our whole existence, is determined by us. If you have one or more years experience in the above areas with an imagination as limitless as we know VLSI can be, send your resume with salary history to:

**HONEYWELL LARGE INFORMATION SYSTEMS**  
Manager, Recruitment & Placement  
Mail Station Y-11  
P.O. Box 6000  
Phoenix, AZ 85005

# Honeywell

People,  
Our Competitive  
Edge

an equal opportunity employer m/f/h

# for the discriminating collector

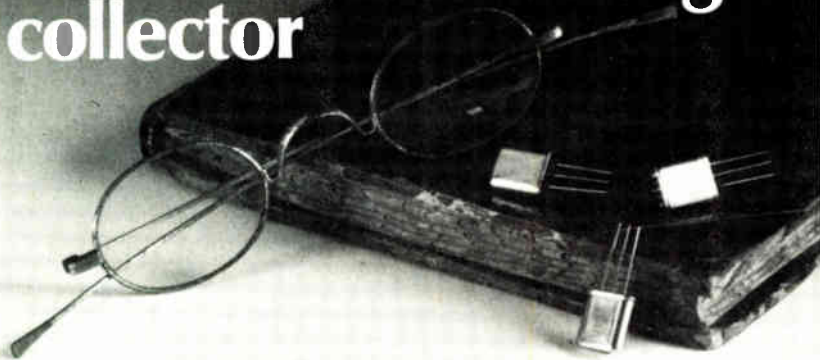

Our first edition model 2283-F monolithic crystal discriminator is a true classic. At 10.7 MHz, you can get 1% total harmonic distortion and up to 800mV of recovered audio when used with CA 3089E quadrature detector. Model 2378F offers the same at 21.4 MHz. If you are a collector of specifications, write for our data sheets.

The standard in monolithic crystal filters.

WE WROTE THE BOOK.

# Pi

Piezo Technology Inc.

2525 Shader Rd., Orlando, FL 32804  
(305) 298-2000

Circle 208 on reader service card

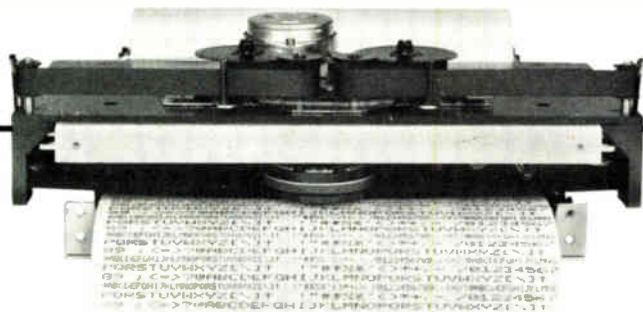

## Our Printer's Strength Of Character Is Enhanced By Its Self-Control

Don't let the low price tag fool you; our DMTP-6  $\mu$ P is stronger on capabilities than any printer in its class. Its unique matrix impact print head lets you program any desired character pitch. You can print data or text, single-stroke or enhanced from 36 to 132 columns. And, print up to four copies without adjustment on standard 8 $\frac{1}{2}$ " roll paper, fan-fold forms and labels.

What's more, it packs a built-in controller that includes all needle drivers and diagnostic routines, while providing a choice of interface functions—parallel ASCII, RS-232C/I-Loop, or switch-selectable baud rates from 110 to 1200. Now that's self-control worth having! Add the continuing economy of a 10-million character life ribbon and re-inking rollers, and you've got an unbeatable buy. Call or write for details. Ask for Bulletin 922A.



**PRACTICAL  
AUTOMATION, INC.**

Trap Falls Road, Shelton, Conn. 06484/Tel: (203) 929-5381

208 Circle 244 on reader service card

## New products

those of existing models, according to the manufacturer. The tubes, of which two work from 470 to 596 MHz and two from 596 to 710 MHz, have a minimum gain of 35 dB. They therefore require less than 10 w of rf drive power to reach their rated outputs.

The new Varian klystrons are directly interchangeable with standard ultrahigh-frequency TV transmitter tubes from such well-known manufacturers as General Electric, Ampex, Townsend, and CCA. According to Varian, no hardware modifications are required to accommodate the high-efficiency tubes, which can save stations anywhere from \$4,000 to \$100,000 a year. For a medium-sized TV station operating two 55-kw klystrons 18 hours a day, Varian estimates the savings at \$19,000 a year, assuming an energy price of 4¢ per kilowatt-hour.

The lower-frequency models 4KM100LA-H and 4KM100LF-H and the higher-frequency 4KM150LA-H and 4KM150LF-H are all highly linear and permit multiplexing of audio and video signals.

Varian Associates Inc., Microwave Tube Division, 611 Hansen Way, Palo Alto, Calif. 94303. Phone Varian UHF-TV marketing at (415) 493-4000, Ext. 3352 [402]

## Telephone-line concentrator suits small-town systems

A microprocessor-controlled concentrator for subscriber telephone lines has been designed for small communities. The Digital Line Switch (DLS-60) can serve up to 384 single or party lines at one to four remote locations. The telephone subscribers are interconnected by 48 trunk lines over two pairs of T-1 span lines and 16 links per remote location. The system provides equipment redundancy and performs traffic monitoring, automatic self-tests, and fault-diagnosis. It provides service and maintenance features equivalent to those of cable pairs. The DLS-60 employs pulse-code modulation and a codec that simplifies system opera-





# The biographies of 5,240 of your colleagues...

## Profiles the Top Management of Major Electronics Firms throughout the World —and more

This is the only reference devoted solely to biographies of the most influential people in electronics: corporate executives... technical managers... designers and developers of important products and processes... government and military officials... academics... editors and publishers... securities analysts... directors of trade and professional groups... and consultants.

### McGraw-Hill's **Leaders in Electronics**

Prepared by the Staff of Electronics  
651 pages

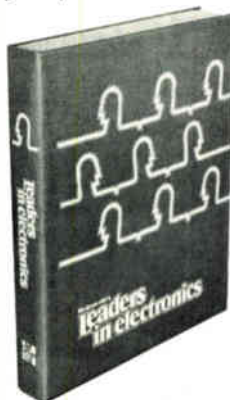

#### As easy to read as any professional publication in electronics

With LEADERS IN ELECTRONICS on your bookshelf, you no longer have to search through many different sources for biographical data on your colleagues. What's more, you don't have to strain your eyes reading minuscule type, nor do you have to waste valuable time trying to decipher seemingly endless paragraphs of abbreviations. Boldface type spotlights the various information categories so that you can scan entries rapidly to pinpoint what you need.

#### Unique convenience feature... Index of biographees by affiliation

A special 80-page index lists individual organizations alphabetically, complete with the names and titles of top employees. By looking up the names in the general biography listing, you can get a complete profile of the organization's top management in a matter of minutes. Plus an easy-access listing of independent consultants in every electronics specialty.

**Electronics Magazine Books**  
P.O. Box 669, Hightstown, NJ 08520

Send me \_\_\_\_\_ copies of *Leaders in Electronics* @ \$39.50 plus applicable sales tax. McGraw-Hill pays regular shipping and handling charges on pre-paid orders.

I must be fully satisfied or you will refund full payment if the book is returned after ten-day trial examination.

Payment enclosed    Bill firm    Bill me  
Charge to my credit card:    American Express  
 Diners Club    Visa    Master Charge

Acct. No. \_\_\_\_\_ Date Exp. \_\_\_\_\_

On Master Charge only,  
first numbers above name \_\_\_\_\_

Name \_\_\_\_\_

Company \_\_\_\_\_

Street \_\_\_\_\_

City \_\_\_\_\_ State \_\_\_\_\_ Zip \_\_\_\_\_

Signature \_\_\_\_\_

### New products

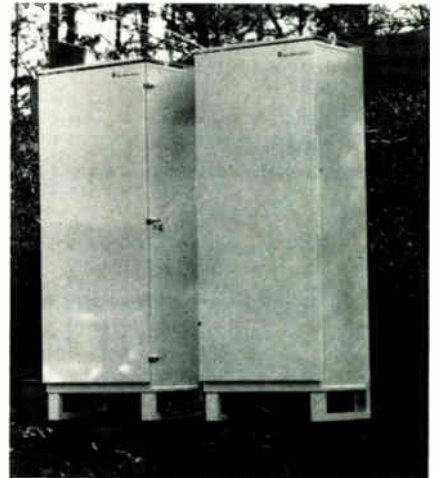

tion and maintenance

Prices depend on the configuration. At the low end, 64 lines interconnected by 24 trunks sell for under \$50,000. A large system—384 lines with 48 trunks—is priced at \$380 per line. The DLS-60 can be configured with two remote terminal cabinets for a 256-line capacity, or three cabinets for the full 384 lines.

Digital Telephone Systems Inc., Division of Farinon Corp., P. O. Box 1188, Novato, Calif. 94947. Phone (415) 427-2500 [404]

#### Concentrator multiplexes 16 asynchronous terminals

The TC-5 terminal concentrator statistically multiplexes 16 asynchronous computer terminals so they can communicate over a single telephone line. The concentrated line then transmits synchronously or asynchronously at a rate of 1,200 to 9,600 bauds. The concentrator has a front-panel alphanumeric display that permits continuous observation of its operating status and allows the programming of operating parameters. Those parameters may be

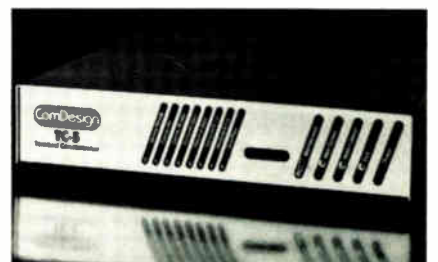

# THINK BAUSCH & LOMB VERSATILITY

When your research work depends on quality, precision, and reliability—think StereoZoom® microscope versatility.

Since BAUSCH & LOMB introduced the first zooming stereo microscopes in 1959, more researchers all over the world have put StereoZoom microscopes to work for them than any other instruments of their kind.

The reasons all relate to BAUSCH & LOMB versatility. An unparalleled variety of illuminators, stands, and accessories team up with optimum balance of resolution and depth of field, precision optics, highly reliable mechanical components, and precise photomicrographic exposure capabilities.

**BAUSCH & LOMB**  
**StereoZoom**  
microfilm.com

**20**  
**ANNIVERSARY**

From failure analysis to quality assurance to biological research, there's a BAUSCH & LOMB StereoZoom microscope precisely right for your laboratory. Write or call for a detailed catalog or demonstration. THINK BAUSCH & LOMB . . . Versatility since 1874.



**BAUSCH & LOMB** 

Scientific Optical Products Division

Rochester, New York 14602 USA  
716-338-6000, TWX 510-253-6189  
TELEX 97-8231, CABLE: Bausch & Lomb

For more information circle 210

Consult Yellow Pages under "Microscopes"

For immediate demonstration circle 211

In CANADA Bausch & Lomb Canada Ltd 2001 Leslie Street Don Mills, M3B2M3, Ontario, Canada (416) 447-9101

# XCITON WHO???

Xciton Corporation is an established manufacturer of high performance, quality light emitting diodes, infrared emitters and LED materials. We provide the broadest line of LED's available from one supplier and offer custom services such as power sorting, applications know-how, and product design assistance.

Xciton engineers and technical sales specialists have decades of combined expertise with LED materials, processes and applications. Our staff is readily accessible — we're as near as a telephone.

Xciton's emphasis on quality and performance assures you that only prime product reaches your loading dock.

Xciton products are available through a worldwide network of representatives and distributors

Call or write  
today for further  
information.

**Xciton**

**XCITON  
THAT'S WHO.**

Xciton Corporation  
Shaker Park, 5 Hemlock Street  
Latham, New York 12110  
(518) 783-7726, TWX: 710-444-4962



# STOP TRANSIENT NOISE

NOW  
UL  
LISTED

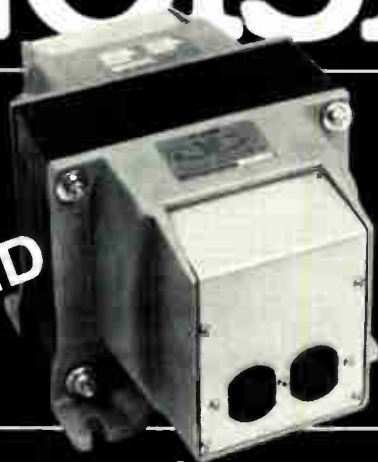

## Eliminate errors in your computer or instrument system with Deltec's Super Isolation Transformer

Deltec DT series isolation transformers drastically reduce memory and transmission errors caused by transient noise on commercial power lines. Common Mode Rejection is 140dB and interwinding capacitance is less than 1 femtofarad (0.001 pF). Stock models are available from 250 VA to 5 KVA 1  $\emptyset$  and 15 KVA 3  $\emptyset$ , 50/60 Hz. For detailed specifications write or call Deltec.

### AC POWER HANDBOOK



*This book should interest any executive, manager, engineer or technician who depends on electronic instrumentation to assist in meeting his objectives. This handbook of problems and solutions relating to AC Power is written in layman's language to the greatest possible extent. Now available at our cost of \$3.00 Write or call for a copy.*

# DELTEC

CORPORATION  
980 Buenos Ave., San Diego,  
CA 92110. Telephone (714) 275-1331

### New products

changed without disassembling the unit by using the controls on the front panel.

Each terminal's port characteristics are fully independent and the ports may be set to baud rates of 50 to 9,600 bauds or to recognize baud rates automatically. The concentrator's ports may be set to pass RS-232 control signals. Data flow can be controlled by using X-on/X-off or clear-to-send (CTS). Errors are eliminated by means of automatic transmission.

The TC-5, which is compatible with all computer systems that use asynchronous terminals, is available in 4- to 16-line units, starting at \$1,450 per unit. Delivery time is from 30 to 60 days.

Comdesign Inc., 340 South Kellogg Ave., Goleta, Calif. 93017. Phone (805) 964-9852 [406]

### Bandsplitting 9,600-bit/s modem multiplexes 4 channels

A 9,600-bit/s modem with a bandsplitting option allows up to four terminals to be connected to a single high-speed line. The DL 9600 unit can multiplex as many as four medium-speed channels with each channel operating independently. Inputs may be any combination of 2,400, 4,800, and 7,200 b/s. The modem equalizes automatically, so, without retraining, it can withstand line transients of up to 2 s. Error rates are less than 1 bit in  $10^6$  at 9,600 b/s on an unconditioned line having an acceptable signal-to-noise ratio of 22 dB.

The microprocessor-controlled DL 9600 features self-testing, which includes digital and analog loop back of remote unattended units. Local and system diagnostics can be performed, and all-mark or all-space transmissions can be made. The unit is priced at \$5,500, and the bandsplitting option may be added in the field for \$1,000. Delivery time is 30 to 60 days.

Infotron Systems Corp., Cherry Hill Industrial Center, Cherry Hill, N. J. 08003. Phone (800) 257-8352 [407]

# OUR WIDE CHOICE OF NEW DISCS WILL PUT OEMS IN FAT CITY.

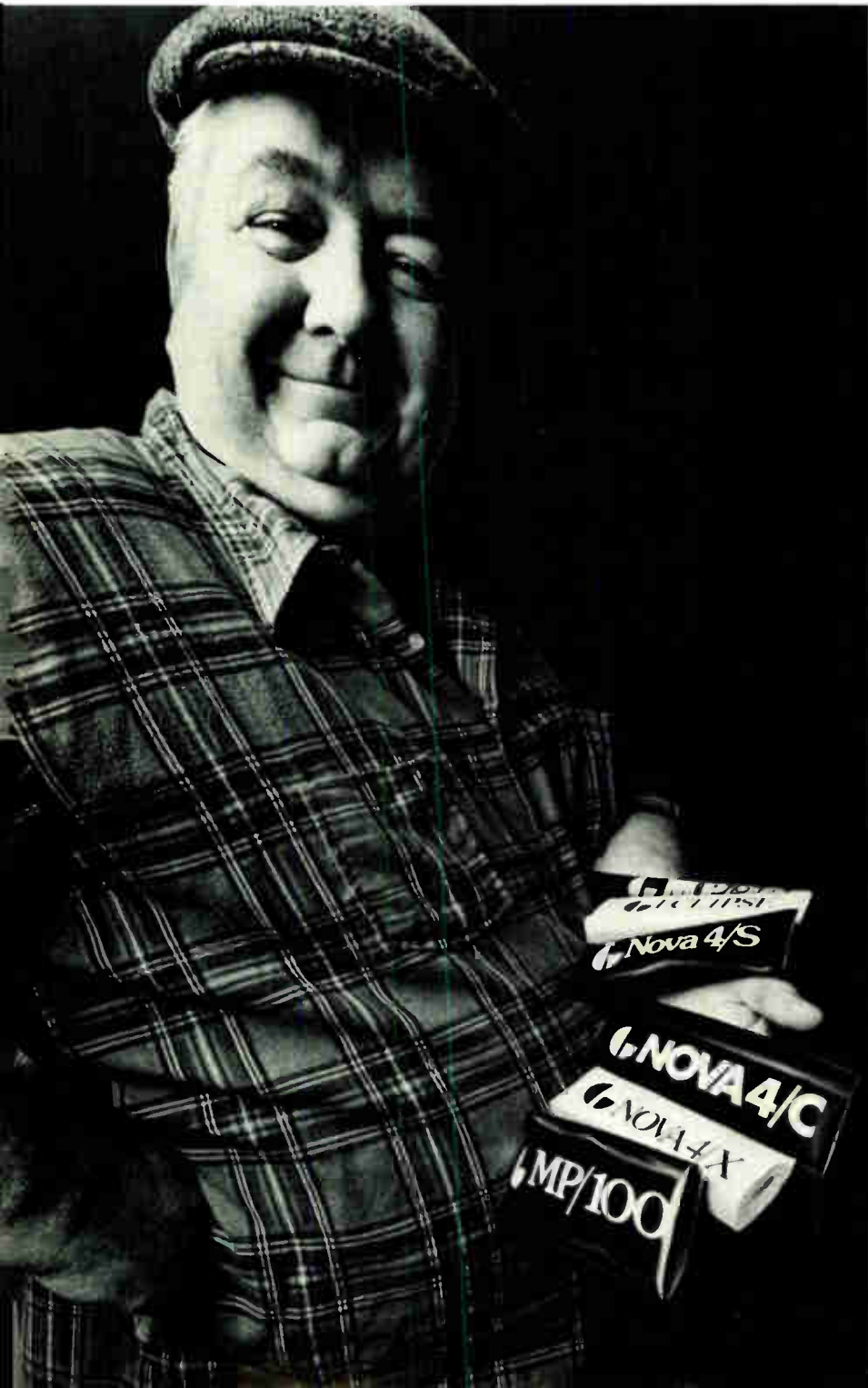

Data General announces a choice of new winchester discs in either 12.5 or 25 megabyte capacities (plus optional 1.26 megabyte diskette for backup and file exchange). This means our OEMs can now offer the widest range of compatible, low-cost disc-based systems available anywhere.

Dozens of new NOVA<sup>®</sup>, ECLIPSE<sup>®</sup> and microNOVA<sup>™</sup> configurations will help you fatten up sales with lower costs, higher reliability and easier maintenance.

Best of all the prices are lower than ever before. That means a change in your sales picture and change in your pocket. Let Data General fatten up your sales. Call, or write, or send in the coupon.

Data General Corporation, Westboro, MA 01580, (617) 366-8911. Data General (Canada) Ltd., Ontario, Canada. Data General Europe, 61 rue de Courcelles, Paris, France, 766.51.78. Data General Australia, (03) 89-0633. ECLIPSE and NOVA are registered trademarks and microNOVA is a trademark of Data General.  
 ©Data General Corporation, 1980.

**Data General**

Mail to: Data General Corporation, Westboro, MA 01580.  I'm hungry for more information. Send me full details on your new  ECLIPSE  NOVA  microNOVA systems for OEMs.  I'm starving. Send a salesman.

Name \_\_\_\_\_ Title \_\_\_\_\_ Company \_\_\_\_\_ Address \_\_\_\_\_ City \_\_\_\_\_ State \_\_\_\_\_ Zip \_\_\_\_\_ Tel. \_\_\_\_\_

The Computer of the 1980s  
 Olympic Sports Medicine Commission

# nVdc and nAdc on the Buss\* (488)

Our Model 501J main frame instrument meets the IEEE 488-1975 interface specs to let your mini or maxi computer call for:

- Voltages of  $\pm 10\mu\text{V}$  to  $\pm 10\text{Vdc}$
- Switching & Settling time:  $50\mu\text{ sec.}$
- Accuracy:  $\pm 0.005\%$  (certified traceable NBS) with Options: from  $\pm 100\text{ nV}$  to  $\pm 1000\text{ Vdc}$  and  $\pm 10\text{ nA}$  to  $\pm 10\text{ Adc.}$

#### Applications:

- Production Line, Automatic Calibration of A/D Convertors, Amplifiers, DVM's
- ATE System Standard
- Data Acquisition System Standard
- Process Control System Reference
- Prices from \$1,995.00 (export prices slightly higher)

\*Other programming formats also available



For more information call Bob Ross



**ELECTRONIC  
DEVELOPMENT  
CORPORATION**

11 Hamilton St., Boston, MA 02127; Tel: (617) 266-9626  
TLX: 955329 • TWX: 710 350-7544

## WASHERS!

## WASHERS!

## and more WASHERS!

### NYLON & FIBRE WASHERS (Flat • Shoulder • Bushings)

STANDARD FROM STOCK. Sizes from  $\frac{3}{16}$ " to 1" O.D. and  $\frac{1}{32}$ " to  $\frac{1}{16}$ " thickness with various hole sizes from  $\frac{3}{32}$ " to  $\frac{1}{8}$ " I.D.

**ECONOMICALLY IDEAL FOR MANY USES:**

Insulation, Sealing, Anti-Galling, Spacers, Shims and Thrust Washers. Excellent mechanical strength, electrical insulation and corrosion resistance. Other materials and sizes available upon request. Our precision stamping and molding facilities available to meet your specifications and prompt delivery.

NEW FREE CATALOG ON REQUEST



## KEYSTONE

ELECTRONICS CORP.

TWX 710-581-2861 CABLE-KEYELCO  
49 BLEECKER STREET, NEW YORK, N.Y. 10012 212-475-4600

# DEAR DEVELOPMENT SYSTEM:

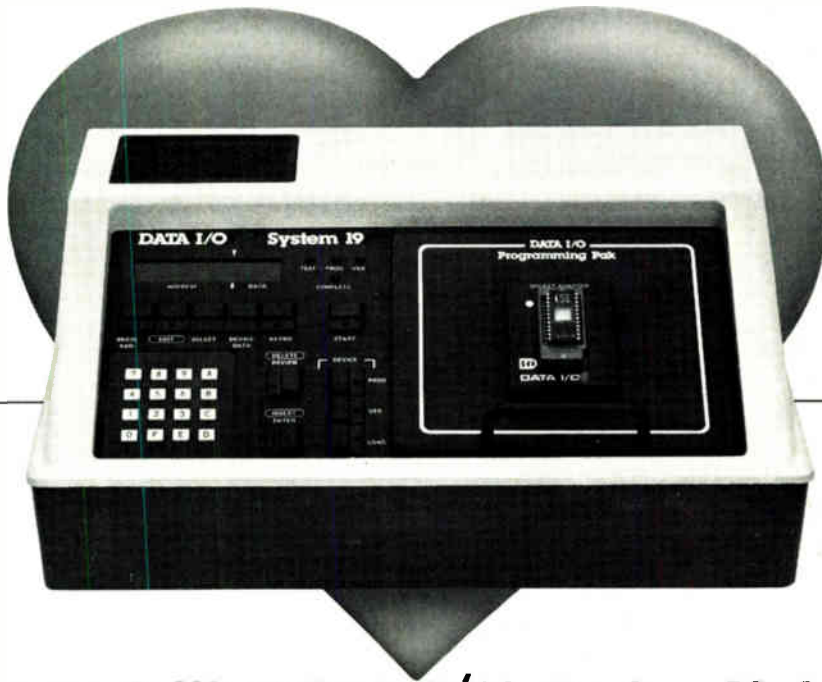

**You'll love letting Data I/O's System 19 do your programming while you do the important things.**

Once you've developed a PROM program on your development system, simply download it into a Data I/O System 19. This frees your development system for the next person who needs it.

Later, if you discover that a statement has been left out, or you need to edit the program, you can use the System 19 to make all the necessary changes without once interrupting work being done with the development system. And your System 19 can program every kind of bipolar and MOS PROM—not just the few MOS PROMs that most development systems program.

The System 19 saves you time by eliminating the need for you to build software

packages so your development system can transmit data to the programmer. System 19 offers all these development system object code formats in a single package:

RCA Cosmac, Motorola Exorcisor, Intel Intellec 8/MDS, Signetics Twin, MOS Technology, Fairchild F8 Formulator, Tektronix 8001, and Zilog MCZ-1.

Best of all, Data I/O System 19 is priced within just about everyone's budget.

You haven't shopped around until you've looked at Data I/O. Let us show you the difference. Circle the reader service number or contact Data I/O, P.O. Box 308, Issaquah, WA 98027. **For answers fast, call toll free: 800-426-9016.**

# Good idea! DATA I/O

Programming systems for tomorrow...today.

# R24. The first 2400 bps modular modem.

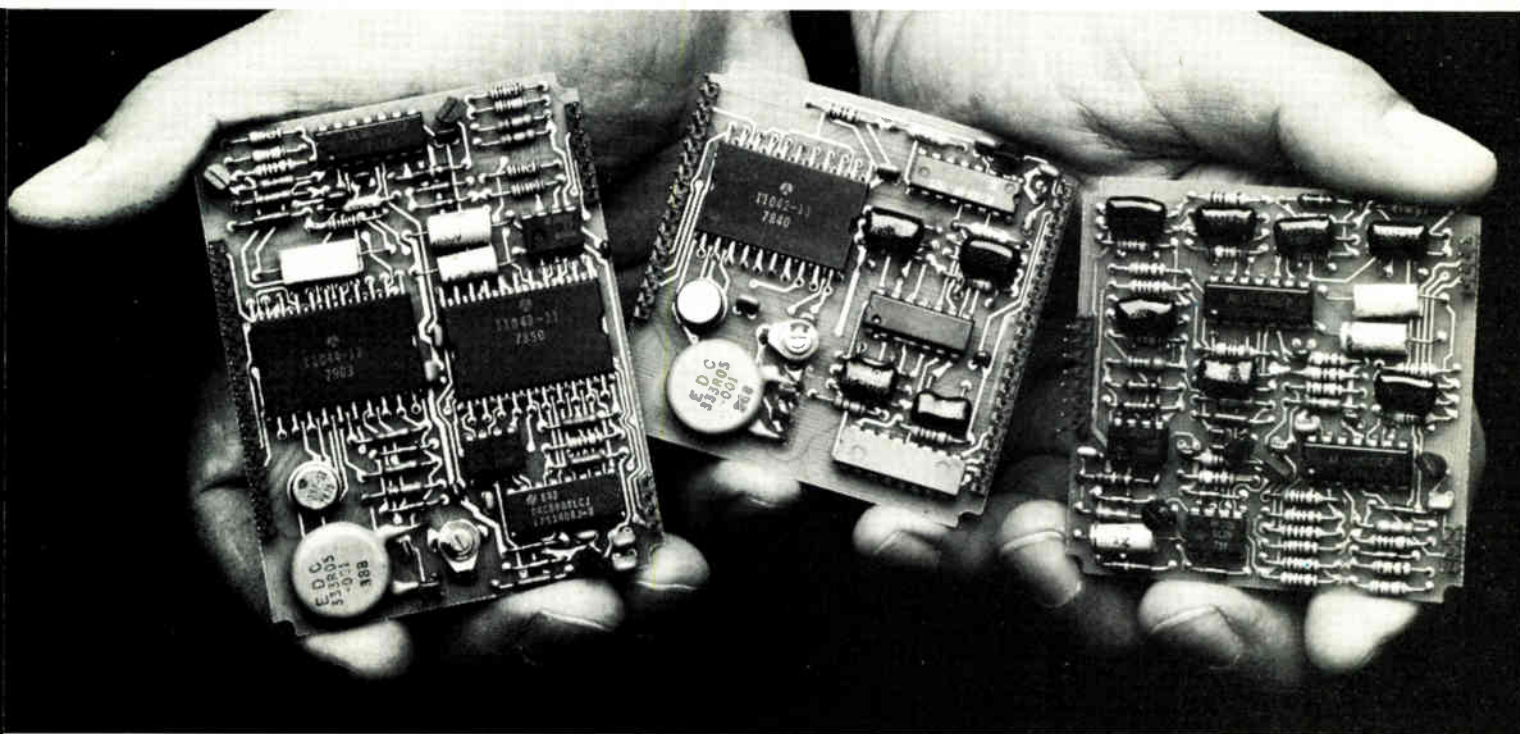

**Rockwell's compact MOS-LSI modem gives new physical design freedom.**

**MICRO  
POWER**

Rockwell's R24 Modem is the most compact 2400 bps MOS-LSI modem available today. Its small size and modularity give designers a whole new form factor flexibility. Requiring only 25 square inches of system area, the R24 is ideal for terminals and communications equipment.

The R24 provides functional flexibility also. Of its 3 modules,

one is the transmitter, two the receiver. Terminal designers can offer transmit-only or receive-only options. And, the R24 is Bell 201 B/C and CCITT V.26 and V.26 bis compatible.

With its major functions in LSI circuits, the R24 is solid-state reliable and economical. It can be configured for operation on either leased lines or the general switched network. And, each low-

profile module can be plugged into standard connectors or wave soldered onto system PC boards.

A new generation of modems from the company that's delivered more high-speed modems than anyone in the world. That's Rockwell Micropower!

For more information, contact Modem Marketing, Electronic Devices Division, Rockwell International, P.O. Box 3669, RC 55, Anaheim, California 92803. (714) 632-5535.



**Rockwell International**

...where science gets down to business



### **Intel improves development package for 8086 and 8088**

Intel Corp. has announced a new version of its 8086/8088 software development package. The new version adds such features as a high-level assembler with macroinstructions, conditional assembly, a higher-performance PL/M-86 compiler with a high-speed floating-point math library, and complete linkage and relocation utilities. The package, which will be provided at no charge to users of the Santa Clara, Calif., company's previous 8086 and 8088 software development package, runs under the ISIS-II operating system on Intellec series II and model 800 development systems. Users with extensive calculations in their programs will find that the new package's PL/M-86 module **executes floating-point arithmetic from 4 to 10 times faster** and produces 2½ times less code than the previous version.

### **PMI cuts prices on quad analog switches**

Effective immediately, the line of quad analog switches recently introduced by Precision Monolithics Inc., Santa Clara, Calif., is being significantly reduced in price. At the 100-piece level, the **price cuts range from about 19% for military devices to more than 33% for industrial parts**. The switches, which carry model numbers SW-01 through SW-04, are all single-pole, single-throw bi-FET components that interface directly with TTL and complementary-MOS logic circuits.

### **Mostek's 16-kilobit pseudostatic RAM goes into production**

Mostek Corp. has begun accepting large-volume orders for its model MK4816—a 2,048-by-8-bit dynamic random-access memory with on-chip refreshing circuitry that makes the part appear largely static when it is part of a system. **The pseudostatic part is offered in a 28-pin plastic package with access times of 300, 250, and 200 ns**. In 500-unit lots, the prices for the three versions are \$24.49, \$28, and \$32.95, respectively.

An advantage of the 4816 over truly static RAMs is its low power consumption: 150 mW when active and 25 mW in standby. A potential disadvantage is that cycle time for the edge-activated part tends to be about twice the access time, although Mostek says this presents little trouble if considered during design.

### **Parts handler speeds operation of laser trimmer**

Designed to become part of the CLS-33 laser trimming system made by Chicago Laser Systems, the H-838 step-and-repeat parts-handling system boasts a **positioning repeatability of 0.1 mil and a maximum speed of 15 in./s**. The H-838 gets its accuracy and speed from its use of a linear reluctance positioner, which eliminates the conversion of rotary to linear motion. The device rides on a flat stage using air bearings and moves as a result of microprocessor-controlled sequencing of coil-drive currents to what amounts to the planar equivalent of a motor armature. The Chicago-based company claims that, with the H-838, the CLS-33 is the highest-throughput thick-film laser trimming system available.

### **Optical fibers double in strength**

Valtec Corp., West Boylston, Mass., is doubling the strength of its graded-index MG05 optical fibers. **All graded-index fibers from Valtec are now being proof-tested at 100,000 psi**. According to the company, the stronger fibers will eventually lead to lower prices as they allow increased yields.

# Why satisfied users of Kerimid 601 Polyimide printed circuit boards won't let us brag about the low-cost improvements we made in their products.

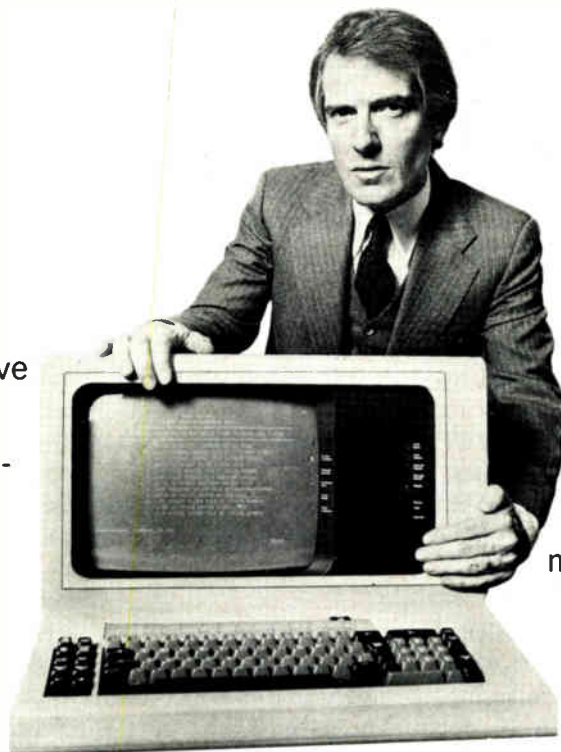

No company wants to give away their trade secrets.

And to a number of electronic equipment manufacturers, Kerimid 601 polyimide laminate offers advantages they'd rather not share.

The reason is economics.

You see, polyimide laminate may appear to cost more than epoxy. But informed companies know Kerimid 601 not only increases a product's reliability, it also increases a company's production yield. So in the long run, the higher price isn't really higher.

This is possible because Kerimid 601's lower co-efficient of thermal expansion dramatically reduces the rejects caused by smear and delamination you often get with epoxy and by allowing for the repair of boards that would otherwise be discarded.

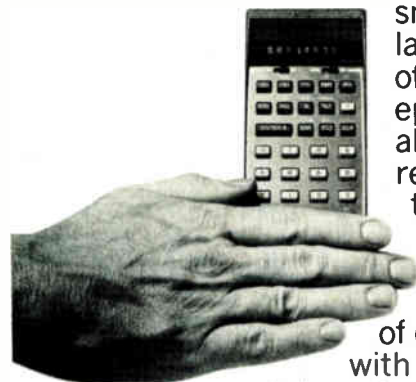

So instead of contending with rejected circuit boards, you'll be contending with increased productivity.

Kerimid 601 can be thermally compression bonded at temperatures of 350 degrees centigrade and higher. It also

has outstanding thermal and Z axis dimensional stability as well as a high degree of moisture resistance. For this reason, Kerimid 601 is approved for military use under military specifications, MIL-P-55617B, MIP-G-55636B and MIL-P-13949E. And in comparison to ceramic boards, Kerimid 601 not only costs less; it's

less brittle and makes finished products more durable. Circuit boards can also be multiple-punched instead of individually machined.

You can switch to Kerimid 601 for your watch, calculator, computer or other electronic package without adapting or adding to your present equipment. And once you do, you'll discover why users of Kerimid 601 are so satisfied. And so silent.

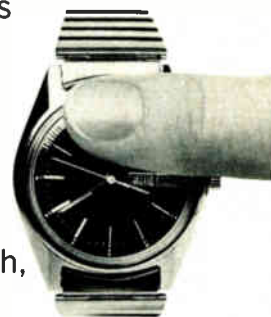

But we aren't. We're always ready to brag about Kerimid 601. Just give us a call.

## KERIMID® 601

Rhône-Poulenc Chemical Company, Chemicals Division  
P.O. Box 125, Monmouth Junction, N.J. 08852 · 201-297-0100  
Rhône-Poulenc Chimie Fine, Secteur Thermostables,  
21 rue Jean Goujon, F 75360 Paris Cedex 08 France



# 16<sup>th</sup> - 24<sup>th</sup> April: The Complete World Market Programme in Electrical Engineering and Electronics. Only Once a Year. And Only in Hanover.

- Electric Power Transmission
- Electrical Energy Supply
- Telecommunications
- Electroacoustics and Video Technology, Safety Technology
- Measuring, Testing, Control and Automation Equipment
- Electronic Components and Subassemblies
- Electrical Installation
- Electric Lighting
- Specialized Areas and Processes in Electrical Engineering

More than 1,700 exhibitors from 40 countries will be showing the latest technology for industry, public authorities, trade and commerce.

**The Common Market  
of Technologies.**

## **Index of Exhibitors. Free of Charge.**

To help you prepare your visit we will send you the necessary technical brochures with an index of exhibitors and information on the conference programme (despatch: February/March 1980).

- 05.1 Electric Power Transmission
- 05.2 Electrical Energy Supply
- 05.3 Telecommunications
- Electroacoustics and Video Technology
- 05.8 Preventive Safety Technology
- 05.4 Measuring, Testing, Control and Automation Equipment
- 05.5 Electronic Components and Subassemblies
- 05.6 Electrical Installation
- 05.7 Electric Lighting
- 05.9 Specialized Areas and Processes in Electrical Engineering
- 01 ENERGY 80
- Fair Planner with the programme of all the specialist markets at the Hanover Fair '80

Name

Company

Street

Town/Postal Code  05 02 630

Deutsche Messe- und Ausstellungs-AG · Messegelände,  
D-3000 Hannover 82, Tel.: (05 11) 89-1, Telex: 09 22 728

**Wednesday, 16th – Thursday, 24th April**



**Hanover  
Fair '80**

## New literature

**Precision mechanical components.** A 158-page pocket-sized manual cross-references Berg mechanical components with those manufactured by PIC Design Corp., Sterling, Allied Devices, Nordex, SEC, Dynamic, Atlas, Boston, Stock Drive, Barden, Thomson, Linear Ball Bearing Co., Heim, and S.K.F. Typical products

are: gears, shafts, linear components, bearings, sprockets, miniature drive systems, timing belts and pulleys, couplings, O-rings, helical gears, breadboard kits, and tools of many kinds. Winfred M. Berg Inc., 499 Ocean Ave., East Rockaway, N. Y. 11518. Circle reader service number 421.



**Lamps.** A 13-page catalog provides specifications of parameters like lumen output, color temperature, filament dimensions, lamp life, and electrical characteristics. An alpha-numeric index is included. The catalog can be obtained from Gilway Technical Lamp, 272 New Boston Park, Woburn, Mass. 01801 [429]

**Wires and alloys.** A 12-page booklet presents information on copper, nickel, and aluminum wire. It also covers physical and electrical properties of most of the major resistance and heating-element alloys, as well

as thermocouple, controlled-expansion, and magnetic alloys. Gauge-to-millimeter-conversion and temperature-conversion tables are also included. MWS Precision Wire Industries, 20732 Marilla St., P. O. Box 826, Chatsworth, Calif. 91311 [422]

**Liquid-crystal displays.** Two application notes on liquid-crystal displays are available from Beckman Instruments. "Interfacing LCDs in Digital Systems" provides designers with

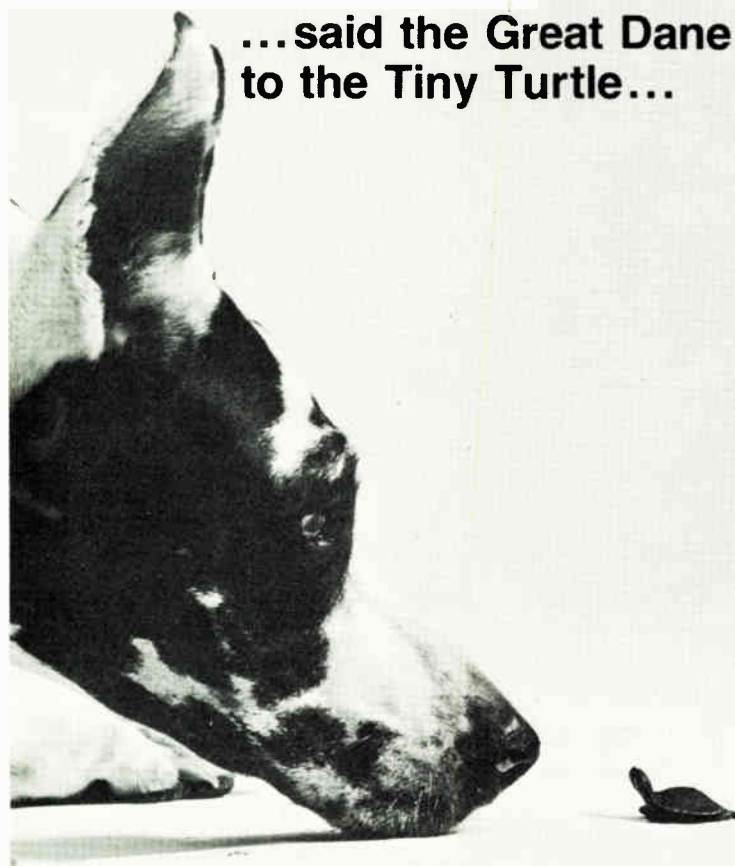

...said the Great Dane  
to the Tiny Turtle...

**"Like me, you get more  
bark for the buck out of  
ALNICO 8!"**

Or, to put it in *engineerise*: Alnico 8 delivers the *highest combination of energy product and coercive force of any economically available material* in the permanent magnet industry today!

And that's not all! Alnico 8 boasts the lowest magnetic thermal coefficient of any permanent magnet material and can be magnetized and calibrated in finished products with relative ease. It's available in cast form in a wide range of sizes and weights. If tooling costs are involved, they are minimal for most sizes and shapes.

As the Great Dane says, "You get more bark for the buck out of Alnico 8" . . . stability, reliability, proven performance. And from Thomas & Skinner you get quality, service and availability at the right price . . . this from the first commercial producer of Alnico 8 in the United States.

Why gamble with new materials when the attributes of Alnico 8 are tried, tested and true?



**Thomas & Skinner, Inc.**  
MAGNETICIANS

1120 EAST 23rd, ST., INDIANAPOLIS, INDIANA 46205  
MAIL P.O. BOX 150B, ZIP 46206 • 317/923-2501 • TELEX 27-335

information on available integrated circuits and common methods of driving LCDs. Some of the topics are: basic drives and considerations, complementary-MOS types and usage rules; single- and multiple-digit display drivers; and multiplexed light-emitting-diode to LCD interfacing. Applications of frequency counters and digital voltmeters using LCDs and commonly available drivers are also described in the note. "LCDs: Principles of Operation, Construction, and Applications" covers mechanical and electrical characteristics, applications, and mounting of the devices, plus circuit diagrams. Beckman Instruments Inc., Display Systems Division, 350 N. Hayden Rd., P. O. Box 3579, Scottsdale, Ariz. 85257 [424]

**Hand-crimping.** A two-page flyer on proper hand-crimping of standard terminal wire sized from AWG 14 to AWG 26 is available from Molex

Inc., 2222 Wellington Ct., Lisle, Ill. 60532 [423]

**GaAs FET Amplifiers.** A 16-page booklet provides technical information, product specifications, applications data, and drawings for gallium



arsenide FET amplifiers. The booklet also describes the five key characteristics of the amplifiers, which are: gain, noise figure, VSWR, power output, and intermodulation performance. The Narda Microwave Corp., 75 Commercial St., Plainview, N. Y. 11803 [426]

**Telephone equipment standard.** "Private Branch Exchange (PBX) Switching Equipment for Voiceband Applications" establishes performance criteria for interfacing and connecting with the various elements of the public telephone network. Developed by the Electronic Industries Association's Engineering Committee on Voice Telephone Terminals, standard RS-464 contains both "mandatory" and "advisory" criteria. The mandatory criteria apply to safety and protection, signaling, and compatibility, and specify the absolute minimum acceptable performance levels in areas such as

## THE CHAMPION!



## THOMAS & SKINNER'S VAST LINE OF LAMINATIONS!

Why? Because it's the largest line of any manufacturer in the industry and ranges from E1 — Ferroresonant and Cruciform Laminations to Thin (4 & 6 mil), Wide Window, Three Phase, Single Phase, Orthosil, Centra-Gap, Vari-Gap, Shunt, I and MIL-T-27.

Another first: T & S is the first manufacturer to certify the magnetic quality of each lamination shipment. Certifications provide volt amperes per pound, core loss and material lot number under ASTM A-346 testing specification.

Add this: T & S not only produces a wide selection of laminations to meet users' critical needs, T & S can also custom design to exacting specification. Manufacturing input includes all operations from slitting, punching, annealing, testing and certification to warehousing, packing and shipping.

Ask for the new MINI-LOG III. It tells the whole story with complete product specifications in English and metric units in English, French and German languages! It's a real working tool!



**Thomas & Skinner, Inc.**

1120 EAST 23rd, ST., INDIANAPOLIS, INDIANA 46205  
MAIL P.O. BOX 150B, ZIP 46206 • 317/923-2501 • TELEX 27-335

# Rent data entry and data exitry off-the-shelf.



## Rental Electronics, Inc. (800) 227-8409

In California (213) 993-7368, (415) 968-8845 or (714) 879-0561

Circle 222 on reader service card

### Reliable CSZ Environmental Chambers With Solid State Circuitry

You don't guess with CSZ's environmental test chambers. Solid state output indicating controllers provide exact set points and constant temperature. A separate solid state system quickly responds to protect the workload and unit.

This solid state circuitry combined with efficient mechanical refrigeration systems represents your best investment. Vapor tight stainless steel interiors, foamed in place insulation, and heavy gauge steel exteriors provide the dependable, sturdy test chambers you need. Sizes up to 64 cu. ft.

Write or call for detailed technical information.

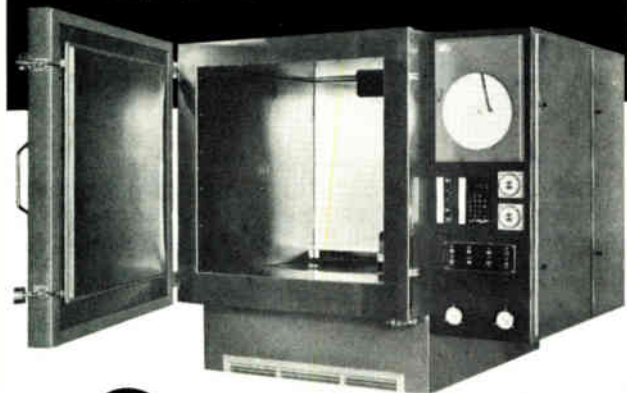

**CINCINNATI  
SUB-ZERO  
PRODUCTS INC.**

2612 Gilbert Ave., Cincinnati, Ohio 45206 (513) 751-8810

222 Circle 247 on reader service card

### New literature

transmission and equipment parameters and durability. The advisory criteria represent product goals. This 140-page document is available at \$27.50 each from the Standards Sales Office, Electronic Industries Association, 2001 Eye St. N.W., Washington, D. C. 20006.

**Low-pass filters.** An eight-page brochure on Micro-Coax low-pass filter cable and cable assemblies provides technical data, including tables that show characteristics of various configurations. Product features, appli-

## MICRO-COAX

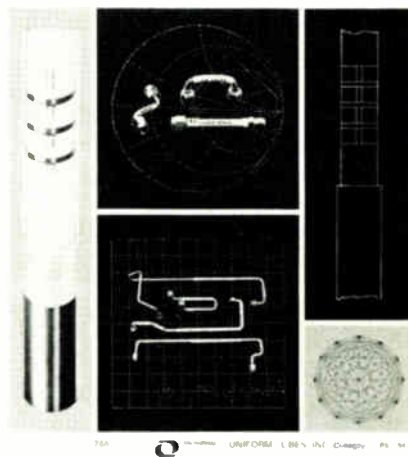

cations, and performance graphs are included. MicroDelay Division, Uniform Tubes Inc., Collegeville, Pa. 19426 [427]

**Computer reports.** Two surveys, "All about Plug-Compatible and Off-Line Printers" and "All about Computer Output Microfilm," provide up-to-date specifications and prices plus user ratings of installed equipment. The first discusses the relative advantages of impact and nonimpact printing and gives data on usage patterns. Comparison charts list the features of 58 printers. The second discusses the pros and cons of microfilm and the relative merits of using a service bureau instead of an in-house system. Each report sells for \$15. Datapro Research Corp., 1805 Underwood Blvd., Delran, N. J. 08075.

# He's one reason the electronics industry is taking off in Northern Ireland.

Sam Harper puts his skills to work for AVX, the world's largest manufacturer of multilayer capacitors. Other highly trained technicians staff a growing number of firms in Northern Ireland's electronics industry.

Companies headquartered in the U.S., Europe, and Great Britain have all opened plants here. Manufacturing is solidly supported by research and development services, including a specially dedicated unit at Queen's University. And generous grants are available to turn R&D into profitable products.

From Northern Ireland it is easy to do business in the Common Market or anywhere else in the world.

Transportation and communication links are first-class. Investment incentives have been judged

the best overall in the EEC and include provisions for joint ventures, buy-back equity, and licensing.

But the best reason for locating here is the work force. Experienced, productive, and loyal, with a good labor relations record.

Put our people to work for you. Talk to Reg Browne or Marcus Robinson at the Northern Ireland Industrial Development Office. They can quickly put together a package of incentives to fit your plans. Call (212) 593-2258. Or write: NIIDO, British Consulate-General, 150 E. 58th St., New York, NY 10022.

Sam Harper works. A service engineer at AVX, he restores and flies small airplanes in his spare time.



## Northern Ireland works.

Circle 223 on reader service card



# STRATHCLYDE

## the right environment for electronics.

There is already a thriving electronics industry in Strathclyde. Many international companies have established large plants in the region as a base for their European operations. Firms like IBM, Honeywell, Digital, National Semiconductor and Motorola.

The attractions for these companies include good labour relations and high productivity records. The region has a clean atmosphere and chemically stable freshwater supplies ideally suited to the manufacture of silicon micro-processor chips. There is also an ample pool of high quality and adaptable labour throughout the region, and several institutions within the central belt of Scotland with international reputations for research and development work in micro-electronics engineering. There are two international airports linking Strathclyde with the rest of Europe and the U.S.A. The region has excellent rail and motorway connections to the U.K. network.

Financial incentives are good too. Strathclyde's special development area status entitles industry to maximum U.K. Government assistance, and there are many excellent factories and sites readily available.

The environment is right for the electronics industry.

We've prepared a special report on the electronics industry in Strathclyde. Get your copy now. Telex 777237. Answer back SRC V.

**STRATHCLYDE**  
Scotland's biggest region for opportunity and development.

Name.....

Position.....

Company.....

Address.....

..... Tel.....



**Industrial Development Department, 21 Bothwell St., Glasgow G2 6NJ, Scotland. Tel.041 221 4296**

The silicon chip illustrated (type MM 1702 AQ) is manufactured in the Strathclyde Region by National Semiconductor (UK) Ltd.



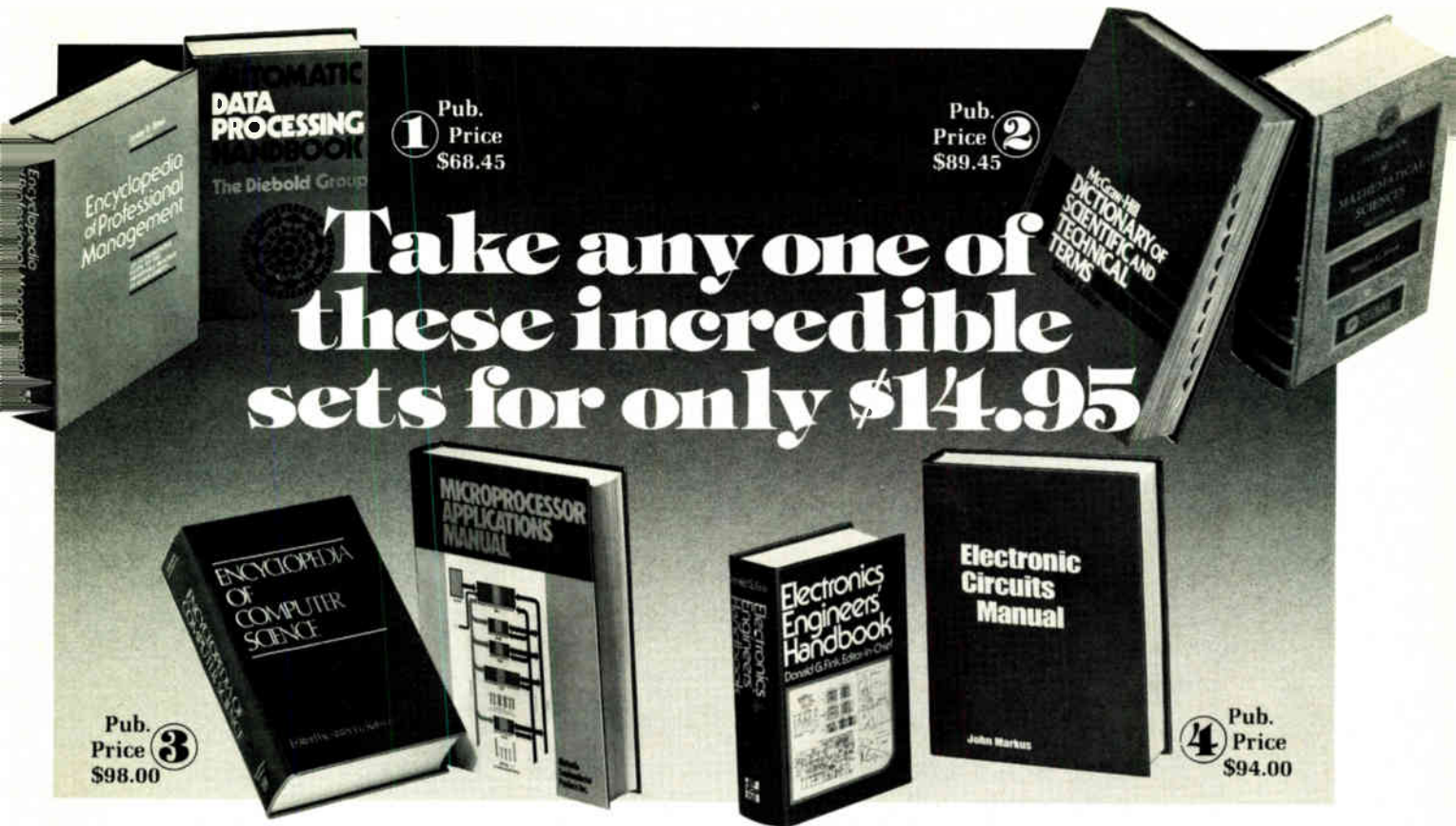

Take any one of these incredible sets for only \$14.95

Join the **Computer Professionals' Book Club** now— and get these professional reference sets you thought only libraries could afford—worth up to **\$98.00!**

Now these fundamental sourcebooks can be yours for only a fraction of their cost! Save up to \$83.00 by getting one of these sets for only \$14.95 when you join the Club.

These high quality publishers' editions are just a token of the opportunities the Club provides to help you build your professional library. As a Club member you'll watch your savings add up fast on the latest and best publications in the field—books on programming techniques, computer architecture, languages, distributed systems, data communications, and other vital areas you won't find covered in your local bookstore.

**Why YOU should join now!**

- **BEST BOOKS IN YOUR FIELD**—Books are selected from a wide range of publishers by expert editors and consultants to give you continuing access to the latest books in your field.
- **BIG SAVINGS**—Build your library and save money, too! We guarantee savings of at least 15% off publishers' list prices on every book. Usually 20%, 25%, or even higher!
- **BONUS BOOKS**—You'll *immediately* begin to participate in our Bonus Book Plan that saves you 70-80% off the publisher's price of many books.
- **CONVENIENCE**—Fourteen times a year you'll receive the Club Bulletin **FREE**, fully describing the Main Selection and alternate selections, together with a dated reply card. If you want the Main Selection, you simply do nothing—it will be shipped automatically. If you want an alternate selection—or no book at all—you simply indicate it on the regular reply card and return it by the date specified. You will have at least 10 days to decide. If, because of late mail delivery of the Bulletin, you should receive a book you do not want, just return it at the Club's expense.

As a Club member, you agree only to the purchase of four books over a two-year period.

- 1 **Automatic Data Processing Handbook** edited by The Diebold Group. 976 pages. 269 illustrations. **Encyclopedia of Professional Management** edited by Lester R. Bittel. Combined Publisher's Price, \$68.45. Code #789/304
- 2 **CRC Handbook of Mathematical Sciences** edited by William H. Beyer. **Dictionary of Scientific and Technical Terms** edited by Daniel Lapedes. 1,800 pages, 3,000 illustrations. Combined Publisher's Price, \$89.45. Code #789/339
- 3 **Encyclopedia of Computer Science** edited by Anthony Ralston and Chester L. Meek. **Microprocessor Applications Manual** by Motorola Semiconductor Products, Inc. 720 pages, illustrated. Combined Publisher's Price, \$98.00. Code #789/312
- 4 **Electronics Engineers' Handbook** edited by Donald G. Fink. **Electronic Circuit Manual** by John Markus. 988 pages. Combined Publisher's Price, \$94.00. Code #789/320

**Computer Professionals' Book Club**  
P.O. Box 582, Hightstown, New Jersey 08520

Please enroll me as a member and send me the set indicated, billing me for only \$14.95, plus local tax, postage, and handling. If not satisfied, I may return the set within 10 days and my membership will be canceled. I agree to purchase a minimum of four books during the next two years as outlined under the Club plan described in this ad. Membership in the Club is continuous but cancelable by me any time after the four-book purchase requirement has been fulfilled.

Write Code # of set you want here

Orders from outside the U.S. must be prepaid with international money orders in U.S. dollars.

Charge my  VISA  MASTER CHARGE\* Exp. Date \_\_\_\_\_

Credit Card # \_\_\_\_\_ \*MC Bank # \_\_\_\_\_

Signature \_\_\_\_\_

Name \_\_\_\_\_

Address \_\_\_\_\_

City, State, Zip \_\_\_\_\_

Corporate Affiliation \_\_\_\_\_

This order subject to acceptance by McGraw-Hill. All prices subject to change without notice. Offer good only to new members. A postage and handling charge is added to all shipments.

**P39444**



## **NOTEVERYCOMPANYTHATMOVESHERE WANTSTOLIVEINTHECOUNTRY.**

Although we're the second most rural state, moving here doesn't automatically put you in the hinterlands.

There's also a wide selection of city life.

Consider the crescent of North Carolina. A unique 150-mile strand of well-situated cities between Raleigh and Charlotte, the largest of all.

Combined population of this invisible metropolis makes it the nation's 18th largest metropolitan area. Larger, even, than Milwaukee, Denver or Atlanta.

Along with cities come citified amenities. Like 12 commercial airports and 22 full-service railroads. Five interstates and over 74,000 miles of toll-free roads.

But whether your company takes to urban or rural surroundings, both are preparing for your arrival.

It's part of the new Cities of Quality, Communities of Excellence programs. Cities and towns must meet certain competitive criteria to qualify. Including preparation of new plant sites. We can supply a list of towns already qualified.

To learn more, call 919-733-4151.  
Or return the coupon.

Whether you want the country or the city, after you hear our story, you will surely want North Carolina.

*Help me decide where to move in  
North Carolina. Send facts.*

NAME \_\_\_\_\_ TITLE \_\_\_\_\_

COMPANY \_\_\_\_\_

ADDRESS \_\_\_\_\_

CITY \_\_\_\_\_ STATE \_\_\_\_\_ ZIP \_\_\_\_\_

**NORTH CAROLINA**

North Carolina Department of Commerce  
Industrial Development Division, Suite N916 05  
430 N. Salisbury Street Raleigh, NC 27611

# CAMBION. THE RIGHT SOURCE FOR...

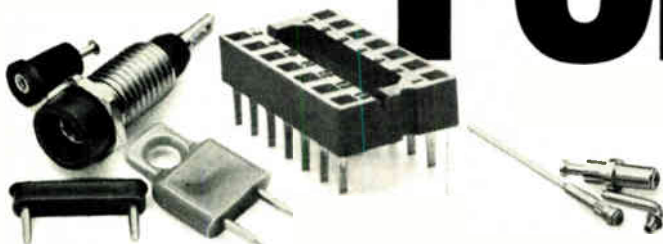

... over 23,000 different, useful electro-mechanical components including SOCKETS: low profile sockets, standard profile sockets, 6 to 64 pin sockets, solder tab sockets, wire-wrappable sockets, tin-plated sockets, gold-plated sockets ... and CONNECTOR JACKS: press mount jacks, solder mount jacks, swage mount jacks, thread mount jacks, combination pin jacks ... and IC PACKAGING: Cambi-Cards®, loaded socket cards, card files, power planes, frames, trays ... and TERMINALS: solder terminals, wire wrap post terminals, insulated terminals ... and HARDWARE: standoffs, battery holders, component clips, handles ... and COILS: shielded coils, unshielded coils, fixed coils, variable coils, custom coils, chokes ... and CONNECTOR PINS ... and CONNECTOR ASSEMBLIES ... and ... and ... and ... and ...

Get all the right connections in Cambion's Catalogs 800 and 121 – the right sources to implement your circuit design and purchasing plans!



**CAMBION®**  
**The Right Connection.**

Cambridge Thermionic Corp., 445 Concord Ave., Cambridge, MA 02238. Tel: (617) 491-5400. Telex: 92-1480. TWX: (710) 320-6399.  
New York State (201) 529-1030 Baltimore/Washington (703) 941-5470 Los Angeles (213) 326-7822  
San Francisco (408) 371-0585 Ontario (416) 671-1588 England 0433 20831

# Your Ideas Make The Pieces Fit!

National Semiconductor Corporation. Good Ideas have made us what we are today. An international designer, developer, manufacturer and marketer of semiconductor technology products.

Ideas have made us and marked us as an industry leader. We're a Fortune 500 company. And this year, our sales are approaching one billion dollars.

At National, you can share your ideas with some of the brightest and most creative minds in the industry. Here are some of the positions in which your ideas can make the pieces fit for us, and for you.

## Sr. Product Engineer—NMOS

You will be responsible for 4K Static RAM's, and must have knowledge of test equipment and/or processes of NMOS. Requires at least 2 years of experience—preferably in product engineering, and a BSEE/MSEE.

## Sr. Product Engineer—MOS/LSI

Your responsibility will include yields, new product and test program check-out, product quality and reliability. In addition, you will supervise a group of engineers and interface with various groups and satellite facilities. Requires at least 3 years as a product engineer and experience with MOS products and testers. Supervisory experience is preferred, along with a BSEE or other appropriate engineering degree.

## Sr. Product Engineers—SLIC

You will be responsible for specified linear products from fab to final test, will interface with customers and insure product reliability. Positions require 2 years in product engineering, preferably linear experience and a BSEE or Physics degree.

## Product Engineer—TTL

You will have wafer sort and final test yield responsibility for TTL products, and will be involved in yield improvement projects. Requires at least 1 year of product engineering experience and a BSEE/MSEE.

## Product Engineer—CMOS Logic

You will provide total product engineering support for radiation hardened development and sustaining, will support 883 and 38510 yield improvement programs, and will be involved in converting 3" to 4" wafers in our CMOS line. Requires at least 1 year in MOS product engineering along with a basic understanding of devices, processes and design and a BSEE/MSEE.

National offers excellent salaries and benefits, plus the opportunity to further your career in a highly sophisticated technological environment. For consideration, call Susan Kramer COLLECT at (408) 737-4881, or send your resume in confidence to her attention at: National Semiconductor, 1090 Kifer Road, MS 16255, Sunnyvale, CA 94086. We are an equal opportunity employer m/f/h.



**National  
Semiconductor**

*Putting It All Together!*

## Senior Electrical Engineers New England

If your experience is in high level digital design, keyboard interfacing, CPU design and troubleshooting, this position will interest you. You need an EE Degree with several years of experience and familiarity with mini-computers.

Our client is a major division of an advanced electronics systems company which has sales of over \$100 million. For over forty years the company has been a leader in Avionics, Marine and Industrial Control Technology. Steady and profitable growth has created career positions in Electrical Engineering.

Consider this—a high technology company with excellent benefits—minutes away from a beautiful medium-sized city—yet located in the middle of Vermont's Vacationland with facilities for year round activity.

Send letter and resume in confidence to:

**PowerSearch**

Executive and Technical Search Consultants

49 Longfellow Avenue  
Brunswick, Maine 04011

An Equal Opportunity Employer M/F

## SOFTWARE DEVELOPMENT PROGRAMMER

Start \$23-28,000

Must be a computer scientist who knows multi-process systems development in a small configuration. Low and mini technology, as PDP 11.

## SYSTEM PROGRAMMER

Company would like computer scientist who knows and appreciates hardware interface. Will code as well as some architecture on multi-process systems with small configuration.

We are retained by our client who pays all fees.

Send confidential resume to:



J. Robert Thompson, Inc.  
Search Division  
2200 W. Loop S., S. 800  
Houston, Texas 77027  
713/627-1871

## ENGINEERS

- Design
- Avionics
- Systems
- Test
- Communication
- Digital
- Analog
- Micro Processing

Our specialty is placing engineers with aerospace and agricultural machinery companies. Engineering positions available anywhere in the United States. Companies pay for interview, relocation and fees.

Send resume to either

ANTHONY-LAINE PERSONNEL  
505 1st Natl. Bank Bldg.  
Peoria, Ill. 61602 Ph. (309) 676-4042

or

ANTHONY-LAINE PERSONNEL  
235 S. Maitland Ave., Suite 113  
Maitland, Fla. 32751 Ph. (305) 628-2577

## Engineers

- Design
- Development
- Project
- Software

**\$20,000-\$50,000**

Riddick Associates' Engineering Division specializes in placement of electrical and electronics engineers with top companies in the Southeast and throughout the U.S. We provide advice on careers, resumes and interviews for a position tailored to your skills Client companies pay all fees For details call or send resume in strict confidence to Phil Riddick, President

**Riddick  
Associates, Ltd.**  
9 Koger Executive Center  
Norfolk, VA 23502  
Area 804-461-3994

## FACULTY POSITIONS VACANT

Associate/Professor Of Engineering Technology Full-time tenure track position in Electronic Engineering Technology and Chairperson, Department of Engineering Technology, subject to the terms of the Agreement between State University Board and the Inter-Faculty Organization/Minnesota Education State Association. Assignment will involve teaching Electronic Engineering Technology courses, including digital systems and computers. The Department Chairperson shall exercise academic and administrative leadership for the Department and will have the responsibility for internship program, maintaining a strong alliance with industry, advisement of majors and recruitment of faculty and students. Masters degree in Electrical Engineering, current background in digital electronics and computer design, teaching and/or administrative experience required. Doctorate, professional registration and industrial experience preferred. Salary range \$20,450 to \$37,620 depending upon qualifications. Appointment date August, 1980. Applications due by May 15, 1980. Reply to Mr. Robert J. O'Brien, Chairperson, Engineering Technology Department, Southwest State University, Marshall, MN 56258. Southwest State University is An Affirmative Action/Equal Opportunity Institution.

## Project Engineer

Unique opportunity to combine research with design and development. If you have at least a BSEE and expertise in analog, digital, and micro-processors, my client company would like the opportunity of proving that you will be allowed to produce in a creative, relatively unstructured environment where work is fun. Starting salary is up to \$35,000. Because of unprecedented growth our client also has needs for less experienced persons in the \$20,000 to \$30,000 range.

Richard Ray

## CAREER CONSULTANTS

540 Meadow St. Ext.  
Dept. 303  
Agawam, Mass. 01001  
413-789-0907 (days)  
413-567-7044 (eve.)  
Engineering Recruitment  
Specialists

### ELECTRICAL & MECHANICAL \$22,500-34,000

Major Manufacturer of automotive, industrial or aerospace offers fabulous coast opportunity to build a team of aggressive problem solving professionals. Candidates with a broad system-wide experience in automotive, aerospace or industrial needed. Location is a relaxed non-stress; semi-rural community. Paid overtime, paid relocation. Complete benefits including dental. For additional information, contact:

FRANK JONES  
313-352-3200

**GREENING-HOFFMAN  
ASSOCIATES**

All Fees Co. Pd. Recruit Agency

### EMPLOYMENT SERVICES

Electronic engineering growth positions with clients located nationally. Our service is enhanced by the fact that I am an EE with 20 years in industry and over 10 years in placing professionals on an employer fee paid basis. Send your resume to Joe Torcassi, Director, J. Anthony & Associates, PO Drawer AD, Lynchburg, OH 45142. 513/364-2305.

We have clients in need of engineers with microprocessor/digital, hard/software development, QC, reliability, packaging, military electronics, computer & peripherals, or other state of the art experience. Contact John Winter 302/575-1414

**The Placers Inc.**

PO Box 2555 Wilmington, DE 19805



The Telecommunications Division of Canadian Marconi Company is continuing to expand its design and development capability in high technology radio and cable communication systems. There are immediate openings for talented individuals to work in a stimulating environment involving state-of-the-art techniques and to pursue an active and challenging career with excellent opportunities for advancement to senior positions.

## ELECTRONIC DESIGN ENGINEERS

2 to 3 years' design experience in one or more of the following:

- Digital circuit design
- Analog circuit design
- Micro processor hardware/software design

## POWER SUPPLY DESIGNERS

Minimum of 5 years' experience in power supply design covering the following areas:

- DC to DC converters
- Low noise switching regulators
- DC to AC inverters

## SYSTEM ENGINEERS

Experienced communications system engineers with a background in equipment design using PCM and TDM techniques in both radio and multi-plex systems.

## TECHNICAL WRITERS

Required for the production of technical manuals including all levels of maintenance, operation and modification instructions; will support major programs of several projects.

Candidates must have a knowledge of specialized fields of electronics, and technical publication productions, maintenance and repair methods. Previous experience in writing, illustrating and publishing techniques.

Good salary and prospects for advancement in an expanding publications operation.

All positions offer excellent salaries and generous fringe benefits including flexible working hours, tuition assistance, group insurance, pension plan and Employees' Credit Union.

Personnel Administrator



## CANADIAN MARCONI COMPANY

380 Aberdare Road • Town of Mount Royal, Quebec, Canada, H3P 1Y9

## Senior Engineer

Working in an advanced instrument development group, you will have responsibility for all projects which address new technologies for future products. These technologies include, but are not limited to, analog and digital circuits, IC design and fabrication, display technologies and digitizing techniques. These projects will range from individual contribution to directing a few engineers.

You should have a broad experience in circuit design and the ability to work and manage diverse projects simultaneously. Specific experience in IC device design or fabrication, CCD technologies, or flat panel displays is desirable.

Tektronix, Inc., a Fortune 500 company, develops and markets internationally recognized electronic measurement instruments, computer graphic terminals and peripherals and other related products. Located in the Portland Metropolitan area, we are within two hours of the Cascade Mountains and Pacific Ocean.

Salary is open and benefits include liberal educational support, multiple insurance programs and profit sharing.

Please call Roy Epperson toll free at 1-800-547-1164 or send a complete resume with salary history to Tektronix Inc., Attn: Roy Epperson, MS 55-033, P.O. Box 500, C-42, Beaverton, Oregon 97077.

an equal opportunity employer m/f/hc.

**Tektronix**  
COMMITTED TO EXCELLENCE

### Electronic Engineers... We Invite You To Discuss Your Careers...

...with consultants who understand your particular qualifications and goals. Since F-O-R-T-U-N-E is staffed with specialists in every aspect of the electronics industry, this is an opportunity to take advantage of.

R.S.V.P. by calling or by sending your resume, in confidence, to:  
Manager, Electronics Division

Personnel Agency, Inc.

**F-O-R-T-U-N-E**  
A Nationwide Service

(212) 557-1000 - 505 Fifth Ave., NYC 10017  
"CORPORATE INQUIRIES WELCOME"

## Production Manager

### Your Ideas Make The Pieces Fit!

With annual sales rapidly approaching \$1 Billion, National Semiconductor, located on the San Francisco Peninsula, provides the ideal environment for talented professionals seeking superior challenge and matching rewards. Here is an opportunity where your ideas can make the pieces fit—for us, and for you.

As Production Manager of our Magnetic Bubble Memory Group, you will be responsible for all wafer fab manufacturing, operations including equipment maintenance, quality control and production control functions. Micro electronic manufacturing experience at the supervisory level is required; bubble memory fab manufacturing experience is desired. A BS degree or equivalent preferred.

We offer an excellent compensation package and true growth potential. Please call **Liz Schriever COLLECT at (408) 737-3178**, or send your resume to her at **National Semiconductor, 1090 Kifer Road, Sunnyvale, CA 94086**. We are an equal opportunity employer m/f/h.



**National Semiconductor**

*Putting It All Together!*

## DISCOVERIES

*for the Electrical Engineer*

Prime positions, fee paid, throughout the Sunbelt and nation. Your specialty, salary and location requirements will be met with assurance and confidentiality. Send your resume to:

P.O. Drawer 3088, Hilton Head Island, SC 29928  
(803) 785-8422

**Hilton Associates,**  
recruiters to industry — nationwide.

## RESEARCH ASSOCIATE MULTIPROCESSOR APPLICATIONS

Responsibility for the design and implementation of selected applications for Cm\*, a multiprocessor with 50 processors and 3 Mbytes of primary storage.

The successful applicant will initiate and coordinate a program of research to assess the performance capabilities of Cm\* as exhibited by selected application programs. This task will involve the selection, design, and implementation of applications, followed by analysis of their performance. In some cases, this task will require close interaction with researchers in the application disciplines.

A qualified candidate should have Ph.D. level experience in computer science, mathematics, electrical engineering or a physical science, plus experience working with distributed systems.

Salary will be commensurate with education and experience. For consideration, please send a resume together with a description of past projects involving distributed systems, and salary history/requirements, in strict confidence to:

W. Keppler, Computer Science Department  
Carnegie-Mellon University, Schenley Park, Pittsburgh, Pennsylvania 15213  
CMU is an equal opportunity/affirmative action employer

• Addmaster Corporation	200	• Citel	20E	Elevam Electronic Tube Co. Ltd.	196
Able Computer Technology	201	Chicago Switch Incorporated	236	Easton Semiconductor Test Systems Division	104
ADAC	71	■ Clairax Electronics	4thC	Fairchild (Semiconductor Operations Divisions)	58,59,76,77
• Adret Electronique	5E	Computer Automation Naked Mini	73	Fairchild Test Systems	98,99
Advanced Micro Devices	10,11	Computer Professional Book Club	224	• FEME S.P.A.	18E
• AEG Telefunken	17E	Control Data Corporation	9	■ Ferranti-Packard Ltd.	176
■ Alco Electronic Products (Sub. of Augat)	158	■ Corcom	38	■ First Computer Corporation	15
American Microsystems Inc.	74,75	Cromemco	2	• FIVRE S.P.A.	177
■ Amp Incorporated	18,19	Data General Corporation	187,213	• Fujitsu Limited	65
■ Amphenol North America Division	195	Data I/O Corporation	215	John Fluke Mfg. Co.	1,175
Anritsu Electric Co. Ltd	202	■ Data Precision	80	‡ General Electric Instrument Rental Div.	156
AP Products	12	■ Data Translation	35	Georgia Department of Industry & Trade	233
‡ Aromat	153	Datel-Intersil	43	■ Germanium Power Devices Co.	150
• Astralux Dynamics Ltd.	25E	■ Delevan Division American Precision Industries	28	■ Gould Inc./Instrument Oscilloscopes	7
Astro Med	206	Deltec Corporation	212	■ Gould Inc./Instrument Systems Div./T&M	126
‡ AVX Material Division	177	Deltron Incorporated	178	■ Gould Inc. Portable Battery Div.	3rdC
■ Bausch & Lomb Scientific Optical Products	211	Deutsche Messe	219	■ Grayhill, Inc.	170,171
‡ Beckman Instrument Advanced Electro Products	65	Digital Equipment	162,163	■ Hewlett Packard	20,21,24A,24,25,78,79,102,103,185
■ Berquist Company	204	• Dionex Gas Plasma Systems	161	‡ Hitachi America	160,161
• Bias	31E	• Ducati Elettrotecnica Microfarad	29E	Honeywell	207
BAFCO Incorporated	234	• ECM Motor Company	222	• Honeywell Information Systems Italia	60
■ Bourne Inc.	2ndC	EG&G Reticon	93	• Hakuto Co., Ltd.	30E
‡ Bud Industries	180	Electromask	32	■ Heath Co. Schlumberger	26
■ Cambion	227	Electronic Development Corporation	214	Hughes Aircraft	66
■ Cincinnati Sub Zero	222	■ Electronic Navigation Industries	6	IEE Industrial Electronic Engineers, Inc.	199
■ Cherry Electrical Products	13	• Enertec Schlumberger Saint Etienne	12E	• ITT Standard AG	19E
Chesterfield Products	91	3M Electronics	198	ITT Thermotech	188

ITT North Microsystems Div.	97	■ Piezo Technology	208	Strathclyde Industrial Development	224
■ ITT Schadow Incorporated	184	• Plessey Semiconductor	4E	Synertek	197,47
Ion Physics Co.	200	■ Powercube Corporation (Div. of Unitrode)	87	Supertex Incorporated	186
• Italtel/SIT	21E,24E	Practical Automation	208	Tektronix	173,189
International Rectifier Corp. Semi. Div.	179	■ Precision Filters	16,96	Teledyne Crystalonics	200
Intersil	37	■ Projects Unlimited	233	■ Teledyne Relays	17
■ Kepco Incorporated	5	Pro-Log	23	Texas Instruments Semiconductor	168,169,181
■ Keystone Electronics	214	• Raytheon ICO	164	Textool Products Department Electronic Div/3M	14
Logical Solutions Incorporated	89	RCA Solid State	62	Thomas & Skinner Incorporated	220,221
■ Matrox Electronic Systems	194	‡ Rental Electronics	172,176,222	• Thomson CSF/DCM	153
• Memory Devices Ltd.	32E	Rhone Poulenc	218	• Thomson CSF/DSC	9E,6E,7E
Micro Devices Division of Emerson Electric	234	• Rohde & Schwarz	11E,2E,3E	• Tokyo Sokuhan Co. Ltd.	30E
Micrometal, Incorporated	196	Robot Research	190	■ TRW LSI Products	95
Micro Link Corporation	233	Rockwell International	50,51	TSD Display Products, Inc.	49
■ Microswitch Division of Honeywell	100,101	Rockwell Microelectronics Device Division	216,192	■ Vectec Inc.	174
■ Miller-Stephens Chemical Co., Inc.	52,53	• SEPA S.P.A.	160	Varian Vacuum	45
■ 3M Co. Electronics Division	191	• Siemens AG	15E	■ Victory Engineering	198
Mitel Semiconductor Incorporated	84	‡ Scottish Development Agency	164,165	Wafios Maschinenfabrik Reutigen	236
Mostek Corporation	27,29,30,31	Seltz SA	205	■ Wavetek San Diego	139
• Murata Mfg. Co. Ltd.	172	■ Semiconductor Circuits Inc.	69	Wilhelm Westermann	8
■ National Semiconductor Ltd.	234	Sharp Corporation	209	Xciton	211
■ Nicolet Cad Corporation	193	• Sivers Lab (Philips Group)	23E	Xebec Company Limited	185
‡ Nikon Incorporated Instrument Div.	61	Solid State Scientific	159	Zenith Radio Corporation	203
Northern Ireland Devel. Organization	223	• Souriau	22E	• Zeltron	165
■ O.K. Machine & Tool Company	182	Specialty Composites Corporation	236	<b>Classified and employment advertising</b>	
■ Pearson Electronics	206	Sprague Electric	183,57	F. J. Eberle, Manager 212-997-2557	
Percom Data Company	167	SRI Lanka	154,155	Anthony-Laine Personnel	228
• Philips Industries (Gloeilampenfabrieken)	26E,27E	• Stanley Electric Co. Ltd.	156	Canadian Marconi Co.	229
■ Philips T&M	1E	State of North Carolina	226	Career Consultants	229
				Carnegie-Mellon	230
				Fortune Personnel Agency, Inc.	230
				Greening-Hoffman Assoc.	229
				Hilton Assoc.	230
				National Semi-Conductor	228,230
				Power Search	228
				Riddick Assoc. Ltd.	230
				Tektronix	230
				The Placers Inc.	229
				J. Robert Thompson Inc.	228
				■ For more information of complete product line see advertisement in the latest Electronics Buyers Guide	
				• Advertisers in Electronics International	
				‡ Advertisers in Electronics domestic edition	



# PLUG INTO THE RIGHT CIRCUIT.

You'll be in good company in Georgia... in the midst of a growing electronics community. Complete with a full range of support services from manufacturers in allied areas.

Your company will be able to take advantage of the engineering schools at Georgia Tech. For higher education. For research. For high quality engineering talent.

And Georgia's Quick Start training program will be working for you, too. With labor specifically trained for your operation. At our expense.

For more information, including confidential site selection assistance, call or write: W. Milton Folds, Commissioner, Georgia Department of Industry & Trade, 404/656-3556, P.O. Box 1776, Atlanta, Georgia 30301, Dept. EL-07.

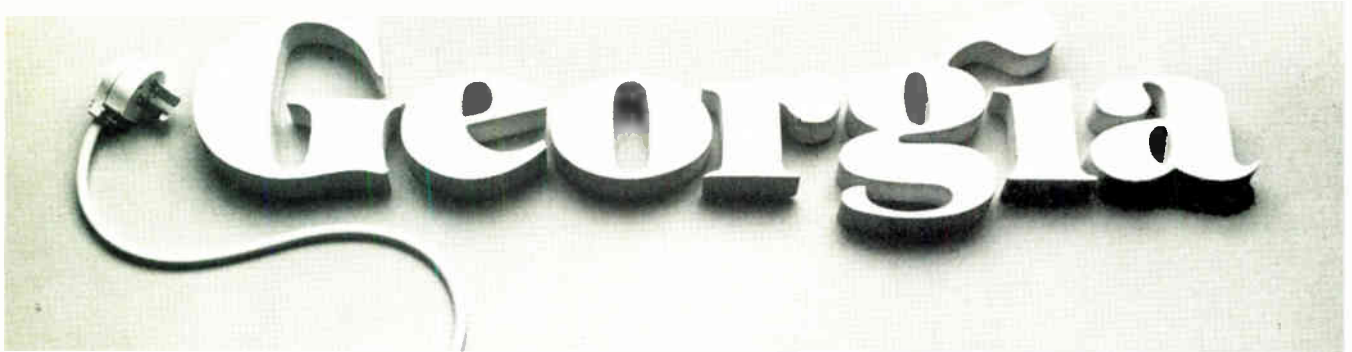

Circle 233 on reader service card

## ROMAID LETS YOU CONTROL YOUR SOFTWARE PROBLEMS

### • EASY TO USE

... Simply connect ROMAID's cable to the PROM socket in your circuit

• **VERSATILE** ... Capable of in-circuit PROM emulation while maintaining maximum reprogramming flexibility

### • COMPLETELY PORTABLE

Measuring only 7.5" x 3.5" x 1.6"

• **QUICK** ... User selects one of 5 modes of operation: Duplicate, Find, Verify, Edit or Run. Entries on Keyboard are then fast 'n easy



The ROMAID PROM Simulator lets you put downtime at a minimum when software problems arise. It features in-circuit emulations of the most popular 1K x 8 and 2K x 8 PROMS and has full 6 digit hexadecimal display for address and data information.

Ease of operation and program manipulation, portability and versatility will make the ROMAID PROM Simulator the answer to your software debugging problems.

And we're saving the best till last... Price! ROMAID costs less than other PROM Simulators on the market today. Let us tell you more about how this revolutionary software "debugger" can save you time and money.

Write today to



624 S. Range Line Road  
Carmel, Indiana 46032  
Phone (317) 846-1721

Circle 249 on reader service card

## Sound Alternatives



AI-380/381/382



AI-385

### Wide selection; 4 models.

New piezo audio indicators with varied performance ranges. 2000 to 2600 Hz frequency. Three voltages: 3-20 Vdc, 3-30 Vdc, 15-130V AC/DC. 62 to 104 dBA. Disconnect tabs or screw mount. Continuous and pulsing. Fit 1/8" diam. openings. Series models:

AI-380, 381, 382, 385. Write for specs: Projects Unlimited, Inc., 3680 Wyse Road, Dayton, Ohio 45414. Phone: (513) 890-1918. TWX: 810-450-2523.



projects®  
unlimited

Circle 250 on reader service card 233

# From 1400 watts to 0 in 2.2 seconds.

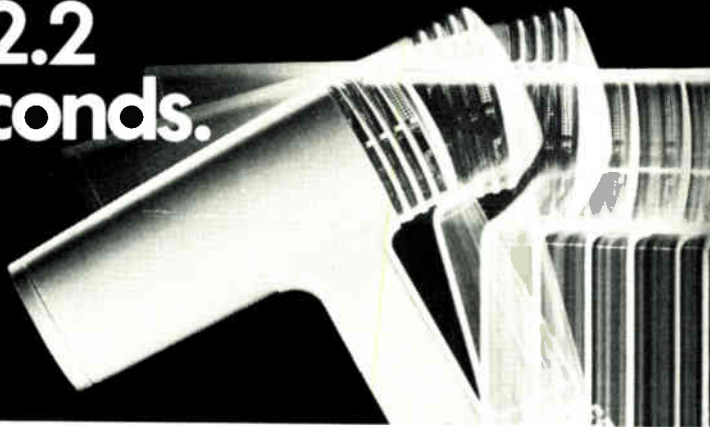

## From 60° to 240°C, the MICROTEMP® cuts off thermal hazards fast.

OEM's need a thermal cutoff they can rely on. Which is why they've relied on the MICROTEMP® over a billion times.

They know the MICROTEMP not only works fast. It's designed to protect the average product for its projected lifetime.

Circle 234 on reader service card



So if you're looking for a low cost thermal cutoff you can count on, look no further. Go with the one that's No. 1 around the world. The MICROTEMP.

**MD MICRO DEVICES**

DIVISION OF EMERSON ELECTRIC CO.  
1881 SOUTHTOWN BLVD. DAYTON OH 45439  
513 294 0581 TELE 78 9087  
HARRISON

## FREQUENCY RESPONSE ANALYZERS



Model 916 is an automatic or manual two channel, sweep Frequency Response Analyzer, providing all of the means necessary to measure, display and plot amplitude ratio (db) and phase shift vs. log frequency, (three Models covering 0.005 to 50,000 Hz) either point by point or in controlled sweep from any start to stop frequency between any two points in the system under test, with high noise and harmonic rejection thru fourier integral analysis. Other Models available.

**BAFCO, INC.**

717 MEARNS ROAD  
WARMINSTER, PENNSYLVANIA 18974  
TEL: (215) 674-1700 • TWX No. 510 665-6860

FROM THE WORLD OF RSL

STANDARD & CUSTOM PHOTO DETECTOR ARRAYS

**NATIONAL SEMICONDUCTORS LTD.**

331 Cornelia Street, Plattsburgh, N.Y. 12901; (518) 561-3160  
2150 Ward Street, Montreal, Quebec H4M 1T7; (514) 744-5507  
Stamford House, Altrincham WA141DR, England

### Advertising Sales Staff

**Advertising sales manager:** Paul W. Reiss

1221 Avenue of the Americas, New York, N.Y. 10020

[212] 997-3468

**Atlanta, Ga. 30308:** Peter Stien

100 Colony Square, 1175 Peachtree St., N.E.

[404] 892-2868

**Boston, Mass. 02118:** Frank Mitchell

607 Boylston St., [617] 262-1160

**Cleveland, Ohio 44113:** William J. Boyle

[716] 248-5620

**Fort Lauderdale, Fla. 33306:** Peter Stien

3000 N.E. 30th Place, Suite #400

[305] 563-9111

**New York, N.Y. 10020**

1221 Avenue of the Americas

John Gallie [212] 997-3616

Matthew T. Reseska [212] 997-3617

**Philadelphia, Pa. 19102:** Matthew T. Reseska

Three Parkway, [212] 997-3617

**Pittsburgh, Pa. 15222:** Matthew T. Reseska

4 Gateway Center, [212] 997-3617

**Rochester, N.Y. 14534:** William J. Boyle

Powder Mill Office Park, 1163 Pittsford-Victor Rd.,

Pittsford, N.Y. 14534

[716] 248-5620

**Advertising sales manager:** Norm Rosen

(Western)

3200 Wilshire Blvd., South Tower

Los Angeles, Calif. 90010 [213] 487-1160

**Chicago, Ill. 60611**

645 North Michigan Avenue

Jack Anderson [312] 751-3739

Robert M. Denmead [312] 751-3738

**Detroit, Michigan 48202:** Jack Anderson

1400 Fisher Bldg., [313] 873-7410

**Costa Mesa, Calif. 92626:** Edward E. Callahan

3001 Red Hill Ave. Bldg. #1 Suite 222

[714] 557-6292

**Dallas, Texas 75201:** John J. Uphues

2001 Bryan Tower, Suite 1070

[214] 742-1747

**Denver, Colo. 80203:** Harry B. Doyle, Jr.

655 Broadway, Suite 325

[303] 825-6731

**Houston, Texas 77002:** John J. Uphues

601 Jefferson Street, Dresser Tower

[713] 659-8381

**Los Angeles, Calif. 90010:** Chuck Crowe

3200 Wilshire Blvd., South Tower

[213] 487-1160

**San Francisco, Calif. 94111:** Don Farris,

Larry Goldstein, 425 Battery Street,

[415] 362-4600

**Paris:** Michael Sales

17 Rue-Georges Bizet, 75116 Paris, France

Tel: 720-16-80

**United Kingdom:** Simon Smith

34 Dover Street, London W1

Tel: 01-493-1451

**Scandinavia:** Andrew Karnig and Assoc.

and Simon Smith

Kungsholmsgatan 10

112 27 Stockholm, Sweden

Tel: 08 51 68 70 Telex: 179 51

**Milan:** Ferruccio Silvera

1 via Baracchini, Italy

Phone 86-90-656

**Brussels:**

23 Chaussee de Wavre

Brussels 1040, Belgium

Tel: 513-73-95

**Frankfurt/Main:** Fritz Krusebecker

Liebigstrasse 27c, Germany

Phone 72 01 81

**Tokyo:** Akio Saijo, McGraw-Hill

Publications Overseas Corporation,

Kasumigaseki Building 2-5, 3-chome,

Kasumigaseki, Chiyoda-Ku, Tokyo, Japan

[581] 9811

### Business Department

**Thomas M. Egan**

Production Director

[212] 997-3140

**Carol Gallagher**

Production Manager

[212] 997-2045

**Betty Preis**

Production Manager Domestic

[212] 997-2908

**Thomas Kazich**

Production Manager Related Products

[212] 997-2044

**Karen Walpole**

Production Assistant

[212] 997-2843

**Frances Vallone**

Reader Service Manager

[212] 997-6057

### Electronics Buyers' Guide

**H.T. Howland**, General Manager

[212] 997-6642

**Regina Hera**, Directory Manager

[212] 997-2544

### Classified and Employment Advertising

**Frank Eberle**, Manager

[212] 997-2557

# Just published!

Your guide into the fascinating world of...

## PERSONAL COMPUTING Hardware and Software Basics

A reliable, easy-to-use resource that tells you...

*What's available in hardware and software, including costs.*

*Who's using it, and what they've experienced.*

*How it all works.*

*Why it's caught on so fast, including practical applications to use now.*

Some of the most exciting advances in computing are taking place, not in research labs and commercial facilities, but in homes across the country. All sorts of people with a basic background in mathematics and electronics are taking the computer revolution into their own hands—experimenting with new equipment and technology, and devising their own *personal* applications.

If you've considered joining them, if you've thought about building or buying your own computer—this is a fast, up-to-date guide that answers all your questions precisely and reliably.

At your fingertips, all the most needed information on...

- what's available in personal computers
- the most popular microprocessor chips
- programming at microprocessor level and in high-level languages
- design hitches and how to prevent them
- where to buy
- plus a glossary of the most current terms in home computing

Drawn from major publications throughout the industry...

To get all the up-to-the-minute information and guidelines presented here, you'd have to read through numerous issues of...

- Electronics • Datamation • Mini-Micro Systems • BYTE
- Interface Age • IEEE Spectrum • Kilobaud • People's Computers

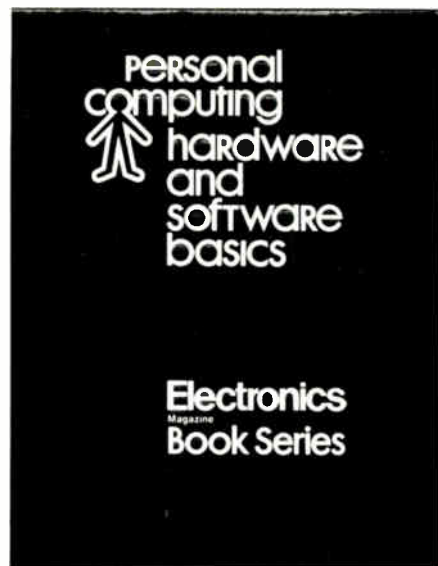

edited by

Raymond P. Capece, Solid State Editor,  
Electronics Magazine  
266 pages, \$11.95

### Table of Contents

**Part 1: Introduction to Personal Computing.**  
The term defined, equipment and components, costs, applications.

**Part 2: Basic Computer Theory.**  
Microcomputer architecture with the emphasis on memory.

**Part 3: Advanced Microcomputer Theory.**  
Board-level computers using the most popular microprocessor chips.

**Part 4: Reviews of Personal Computers.**  
Features and capabilities of the most widely used microcomputers.

**Part 5: Software for Microcomputers and Microprocessors.**  
Description and uses of both machine-level and high-level programming languages.

**Part 6: Specifications and Other Useful Information.**  
Glossaries, microprocessor specs, electronics symbols, buying used equipment.

#### Electronics Magazine Books

P.O. Box 669, Hightstown, NJ 08520  
(609) 448-1700, ext. 5494



No. of Copies	Title	Price
_____	Microprocessors	\$ 8.95
_____	Applying Microprocessors	\$ 9.95
_____	Large Scale Integration	\$ 9.95
_____	Basics of Data Communications	\$12.95
_____	Circuits for Electronics Engineers	\$15.95
_____	Design Techniques for Electronics Engineers	\$15.95
_____	Memory Design: Microcomputers to Mainframes	\$12.95
_____	Personal Computing: Hardware and Software Basics	\$11.95
_____	New Product Trends in Electronics	\$14.95

If after my 10-day free-trial examination I am not fully satisfied I understand that my payment will be refunded.

Payment enclosed  Bill firm  Bill me

Charge to my credit card:

American Express  Diners Club  
 Visa  Master Charge\*

Acct. No. \_\_\_\_\_ Date Exp. \_\_\_\_\_

\*On Master Charge only, first numbers above name \_\_\_\_\_

Name \_\_\_\_\_ Title \_\_\_\_\_

Company \_\_\_\_\_

Street \_\_\_\_\_

City \_\_\_\_\_ State \_\_\_\_\_ Zip \_\_\_\_\_

Signature \_\_\_\_\_

Discounts of 40% on orders of 10 or more copies of each book.

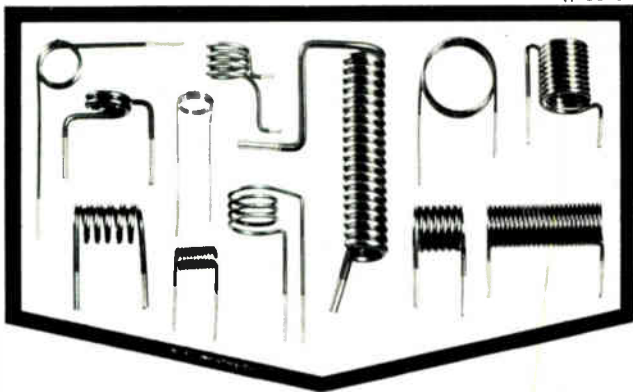

# WAFIOS

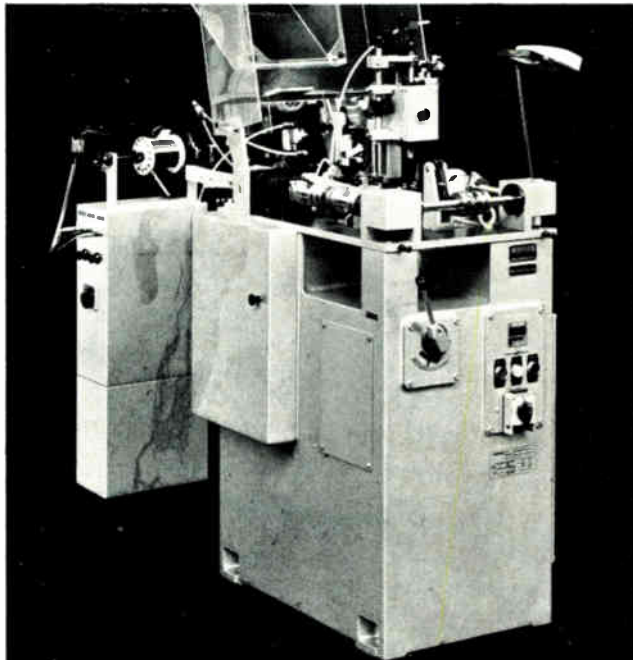

This automatic machine produces up to  
**50 coreless coils  
 per minute**

including stripping of both shanks

	FTU 0-97	FTU 1-97
wire diameter	0,2-1,0 mm	0,3-2,0 mm
inside diam. of coil	10 mm	15 mm
coil length	35 mm	45 mm
shank length	30x30 mm	48x50 mm
number of coils	55	70
maximum output	50 coils/min.	40 coils/min.

**WAFIOS MASCHINENFABRIK · D-7410 REUTLINGEN 1  
 TELEX 0729666/67**

**USA SALES OFFICE: WAFIOS MACHINERY CORPORATION  
 P.O. B. 148 · 25-35 NORTH EAST INDUSTRIAL ROAD · BRANFORD/CONN. 06405 USA**

**WAFIOS CANADA LTD. 1145 BELLAMY ROAD UNIT N° 19  
 SCARBOROUGH, TORONTO, ONTARIO M 1 H 1 H 5 · TELEX 065-25385**

**SELLING AGENCIES IN ALL IMPORTANT COUNTRIES**

236 Circle 236 on reader service card

## MR. CLEAN II The Cost Effective Solution To Contamination Problems

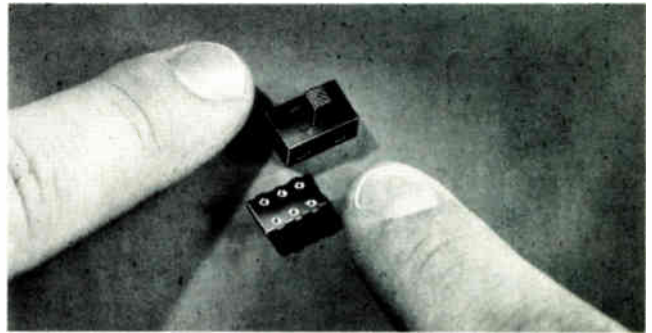

Mr. Clean II is our latest addition in our line of miniature, high quality, wave-solderable slide switches. This low cost switch is designed to work on our unique (patented and patents pending) 2-piece principle. This revolutionary design allows for soldering and cleaning of only the simple exposed base half of the switch. The switching mechanism in the upper half is never exposed to any possible contamination.

These switches are designed for high reliability at a low cost. Mr. Clean II features insert molded pin terminals in a high-heat temperature resistant base. Contacts are of hard gold over nickel barrier and recommended for low energy applications. Available circuit configurations include SPST, SPDT, DPST, DPDT, and Form "Z".



**CHICAGO SWITCH, INC.**

1714 N. Damen Avenue Chicago, Illinois 60647

Circle 253 on reader service card

## quietly profitable

**In Business Equipment, Noise Control  
 Should Be Everybody's Business...**

Specialty Composites family of noise control products, Tufcote® Foams, absorbers, barriers, and dampers offers a competitive edge to:

- Management** — looking for improved product appearance & acceptance
- Engineering** — looking for "predictable noise control" performance
- Purchasing** — looking for better value and true lower costs

Give us a shout and we'll send you a sample folder that will prove to you that Tufcote means business in sound control.



**SPECIALTY COMPOSITES CORPORATION**

Delaware Industrial Park, Newark, Delaware 19713

302-738-6800

Circle 254 on reader service card

# Gould powers any size idea.



Gould Gelyte®  
2.6 A.H. to 30 A.H. Multiples  
of 6 volts. Cyclic and float  
applications.

Gould silver-zinc  
4 A.H. to 250 A.H.  
High energy density.  
Mil-std. Field proven.

Gould Nicad®  
.070 A.H. to 7.0 A.H.  
Polytemp™ for high temperature  
applications and long life.  
P.C. board mounting capability.

Gould Activair®  
Highest energy density  
available. Flat discharge voltage  
profile. Non-hazardous.

From tiny hearing aids to massive communication systems, pocket calculators to giant computers, cordless shavers to submarines... whatever size your idea, look to Gould to make it go.

Because nobody manufactures more battery power than Gould.

Nicad® nickel-cadmium, Gelyte® sealed lead-acid, Activair® zinc-air, silver-zinc... only Gould makes all four. And Gould offers all the flexibility you need. With a wide variety of capacities and configurations.

Gould offers powerful support, too. With design and engineering professionals ready to pitch in and help bring your idea to reality.

Add a nationwide network of stocking distributors and you've also got fast delivery.

Good ideas come in all sizes.

Power up yours with the real performer. Go with Gould.

 **GOULD**

An Electrical/Electronics Company

# OPTO-ISOLATORS

## What kind do you need?



**Only Clairex makes them all!**

If we don't have a standard unit that meets your requirements, we'll make a custom unit that will. Our business is solving "light" problems.

and it has been since 1953. Call 914-664-6005 or write Clairex Electronics, 500 South Third Avenue, Mount Vernon, New York 10530.

# CLAIREX ELECTRONICS

A Division of Clairex Corporation

Circle 902 on reader service card