

NOVEMBER 8, 1979

IEEE MOVES TO POLISH ITS IMAGE/92

Densest bubble memory: meet the family / 123

Overlapping operation boosts microprocessor speed / 144

*Pg 89
Pg 215 PIC
Pg 192*



FOUR DOLLARS A MCGRAW-HILL PUBLICATION

Electronics®



1420 SW105 CASAO DEC80
SE SAWICKI
DATA ACQUISITION SYSTEMS
105 N CHAPEL ST
TORRINGTON CT 06790

**DELIVERING
A MORE
POWERFUL
MAINFRAME**

COUNTERACTING THE INCREASED COST OF LARGE DIGITAL CIRCUIT BOARD TESTING.

The amount of logic on today's average PC board poses some difficult problems for production test . . . bottlenecks and increasing costs of testing and rework, to name a few. Yet, many of these costs and problems can be minimized with efficient test techniques. Often, that calls for a simulator-based test system.

Simulator-based testing defined.

Board-test simulation is a technique in which the circuit to be tested is modeled—component by component and node by node—in the test system computer. From this model, the system can calculate the correct response to any input pattern, plus predict failure modes and their responses. This allows only those patterns which identify faults to be used as the test pattern stimulus.

A major benefit of simulation is that it provides an accurate measure of test effectiveness. You know to what extent you're exercising board components. Thus, you can determine test efficiency, and, just as important, you know when to halt test software development.

Another benefit of having the circuit and all of its failure modes stored in the computer is that you then have detailed information to aid in fault isolation. Finally, advanced simulation techniques allow circuit modeling in the test system so that engineering can test designs before they're built and thus eliminate many problems before they reach production.

The advantages of test flexibility.

HP's answer to simulation and to the reduction of testing costs and time is the DTS-70 Digital PC Board Test System (\$90,350* for standard operating system). It provides the benefits of a simulator and offers other advanced features as well.

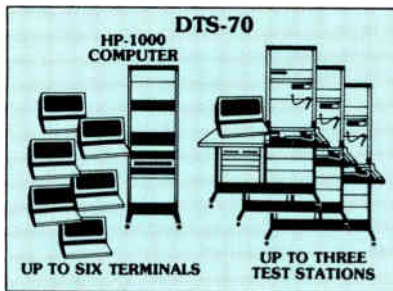

When you expand your production capacity, you can add test stations (to a total of three) without buying additional computing power. Need more test software development capability? Then simply add an inexpensive CRT terminal to your basic system. You can add up to six software development terminals, as shown, and they won't interfere with your production testing.

In addition, the DTS-70 software is compatible with data base management software to keep track of data and help you better manage your production. For example, the system can store test data and give you reports such as specific board or component failure rates and modes. The DTS-70 will easily fit into your long range computer network plans, too, providing distributed processing and communication to your data processing center.

Simplified troubleshooting.

Testing isn't the only problem. You also need a rapid and inexpensive way to locate the specific faulty component or components for replacement. Using HP's FASTTRACE software,

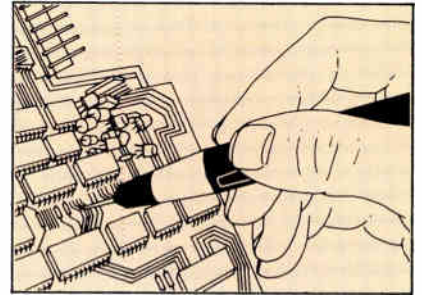

the DTS-70 accesses faulty board models developed by the simulator and guides the operator in a quick series of probe tests to isolate faults. Unlike many simulator systems, the DTS-70 catches intermittent faults. And it has zero delay capability, allowing you to detect races and hazards—a critical problem in logic circuit operation.

For more information.

There are other benefits to PC board testing with the HP DTS-70. And for analog and hybrid circuit testing, HP offers the 3060A with combined functional and advance in-circuit testing. To get complete details, send for our circuit test system data sheets. Or, contact your local HP field engineer.

*Domestic U.S.A. price only.

HP Circuit Testers— The Right Decision

099/52A

HEWLETT  PACKARD

1507 Page Mill Road, Palo Alto, California 94304

For assistance call your nearest regional office Eastern (301) 258-2000, Midwestern (312) 255-9800, Southern (404) 955-1500, Western (213) 877-1282

SURPRISE!

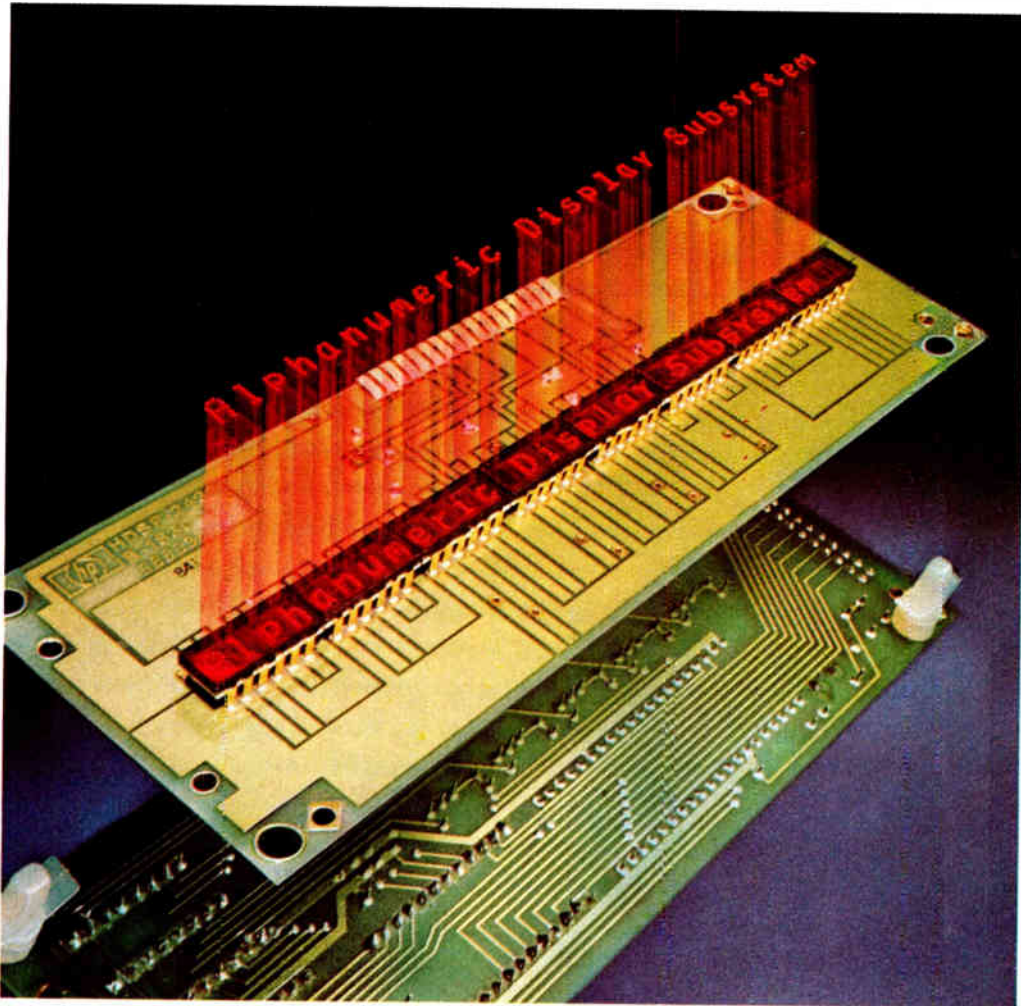

The first stand-alone LED alphanumeric display system is here.

Here's a completely supported alphanumeric display system that frees you from costly display maintenance, requires very low operating power, and minimizes the interaction normally required for alphanumeric displays. You get a choice of 64 or 128 ASCII characters and a choice of a 16-, 24-, 32-, or 40-element display panel. Each 5 x 7 dot matrix is bright, clear and easy to read. In addition, you get editing features that include cursor, backspace, forward, insert, delete and clear. The display system is TTL compatible, requires a single 5V supply, and easily interfaces to a keyboard or microprocessor. It is ideally suited for word processing equipment, instrumentation, desktop calculators, and automatic banking terminals applications. Prices for a complete system start at \$290* for the HDSP-2416 (16 character) display board and HDSP-2470 (64 character ASCII subset) controller board.

For more information on the HDSP-24XX alphanumeric system or immediate off-the-shelf delivery, call any franchised HP distributor.

In the U.S. contact Hall-Mark, Hamilton/Avnet, Pioneer Standard, Schweber, Wilshire or the Wyle Distribution Group (Liberty/Elmar). In Canada, call Hamilton/Avnet or Zentronics, Ltd.

*U.S. Domestic Price Only.

01902

HEWLETT  PACKARD

1507 Page Mill Road, Palo Alto, California 94304

For assistance call: Washington (301) 258-2000, Chicago (312) 255-9800, Atlanta (404) 955-1500, Los Angeles (213) 877-1282

Circle 1 on reader service card

1,000 MHz in one band -with IEEE-488 Bus.

S-D's 1702 Signal Generator.

Since many of today's test requirements go well beyond 520 MHz, Systron-Donner offers you the Model 1702 AM/FM Programmable Signal Generator—with 100 Hz resolution! The Model 1702 not only provides wide coverage but does it with the stability and accuracy of a synthesizer.

Furthermore, the 1702's typical level flatness of ± 1 dB is significantly better than other signal generators costing much more. The 1702 is one of a growing list of S-D instruments offering the IEEE-488 Bus interface.

New: Model 1618 Frequency Synthesizer. This 18 GHz Frequency Synthesizer is a state-of-the-art frequency source for the most demanding applications requiring high stability and accuracy. Using S-D's unique phase lock techniques, Model 1618 provides wideband coverage without the use of

Output multipliers.
IEEE-488 Bus interface is standard.

For details, contact Scientific Devices or Systron-Donner in Concord, CA.



S-D: The signal generator people.
And a lot more.



SYSTRON DONNER

PUT OUR PERFORMANCE TO THE TEST

39 Electronics Review

- SOLID STATE: Ternary gates support three logic states, 39
- TRADE: Japanese effect on U. S. RAM market disputed, 40
- Exports up, but . . . , 40
- INDUSTRIAL: New language simplifies coding, 41
- TELECOMMUNICATIONS: Microprocessor fills many phone roles, 42
- SPEECH SYNTHESIS: Module starts 990 family talking, 44
- COMPONENTS: Bipolar op amp takes on FET parts, 44
- MEDICAL: Device will aid deaf in reading lips, 46
- PACKAGING & PRODUCTION: Plastic gives solderless connection, 48
- ASTROCOMMUNICATIONS: Sun would be part of space radio scope, 51

63 Electronics International

- FRANCE: Lab crams 256 by 256 dots on 2-by-2-cm LCD, 67
- GREAT BRITAIN: Statistical multiplexer cuts data exchange costs, 68
- WEST GERMANY: Board-etching process reuses solution, 70
- JAPAN: Laser diodes go for long and short wavelengths, 72

85 Probing the News

- FACSIMILE: Standards key to fax's future, 85
- COMPANIES: Born-again GenRad roars into 1980s, 89
- YOU AND YOUR CAREER: Shinier image sought for EE, 92
- AUTOMOTIVE: Europe races to catch up, 94
- TESTING: Bubble memories pose a puzzle, 98

109 Technical Articles

- COMPUTERS: Putting together the new IBM mainframe, 109
- 4341's infrastructure is new from the substrate up, 110
- Support processor analyzes errors caught by latches, 116
- Streamlined architecture achieves software compatibility, 119
- MEMORIES: Trio of dense bubble chips has large supporting cast, 123
- DESIGNER'S CASEBOOK: Optic link handles 20-Mb/s data rates, 130
- Line-frequency converter transforms 50 Hz into 60 Hz, 131
- Electronic security lock has nonvolatile latch memory, 132
- MICROPROCESSORS: Unit has two minds to transfer data faster, 144
- ENGINEER'S NOTEBOOK: Counter measures cumulative error, 150
- Low-cost interface automates E-PROM loading, 151

165 New Products

- IN THE SPOTLIGHT: \$99 meter puts measurements in hand, 165
- Brainy controller sells for \$14,000, 174
- SEMICONDUCTORS: Display driver eases interfacing, 180
- PACKAGING & PRODUCTION: Zoner handles 4-in. rods, 198
- INSTRUMENTS: Logic tester sells for under \$45,000, 212
- INDUSTRIAL: Versatile chip controls motors, 228
- COMMUNICATIONS: Signal generator tests mobile receivers, 244
- MATERIALS: 262

Departments

- Publisher's letter, 4
- Readers' comments, 6
- News update, 12
- People, 14
- Editorial, 24
- Meetings, 26
- Electronics newsletter, 33
- Washington newsletter, 57
- Washington commentary, 58
- International newsletter, 63
- Engineer's newsletter, 154
- Products newsletter, 259
- New literature, 274

Services

- Employment opportunities, 282
- Reprints available, 294
- Reader service card, 295

Highlights

Cover: Uncrating the 4300 mainframe, 109

IBM's industry-shaking replacement for the System/370 preserves software continuity; gains new hardware, architectural improvements, a fault-tracing facility, and horsepower per buck.

Cover is by Robert Strimban.

Europeans join auto electronics race, 94

Car makers in Europe have revved up the effort in electronics research; engine sensors, fuel-injection systems, and dashboard features received attention at a London conference.

Bubble trio well supported, 123

An extensive set of custom chips makes a family of dense bubble-memory devices easy to interface with a computer; error-correction circuitry is optional.

Interface processor thinks twice, 144

Custom board-level processor executes two routines simultaneously to control fast data flow between computer and asynchronous mass memory.

. . . and in the next issue

A new complementary-MOS microprocessor . . . a smart TV prototype . . . Hamming-code error correction for microprocessor memory.

NOTE: Because of the withdrawal of a contributed article on press, page numbers 134 to 141 are missing.

EDITOR-IN-CHIEF: Samuel Weber

MANAGING EDITORS

Technical: Raymond P. Capece,
Alfred Rosenblatt

News: Gerald M. Walker

International: Arthur Erikson

ASSISTANT MANAGING EDITORS: Howard Wolff,
Margaret Eastman

SENIOR EDITORS: William F. Arnold,
Ray Connolly

ART DIRECTOR: Fred Sklenar

ASSOCIATE EDITORS: Benjamin A. Mason,
Michael J. Riezenman

DEPARTMENT EDITORS

Aerospace/Military: Ray Connolly

Circuit Design: Vincent Biancomano

Communications & Microwave:

Harvey J. Hindin

Components: Roger Allan

Computers & Peripherals: Anthony Durniak

Test, Measurement & Control:

Richard W. Comerford

New Products: Michael J. Riezenman,

Pamela Hamilton

Packaging & Production: Jerry Lyman

Solid State: John G. Posa

CHIEF COPY EDITOR: Margaret Eastman

COPY EDITORS: Mike Robinson,
Charlotte Wiggers, Jeremy Young

ART: Charles D. Clatto, *Associate Director*
Paula Piazza, *Assistant Director*

EDITORIAL SECRETARIES: Maryann Tusa,
Gail Walker

EDITORIAL ASSISTANTS: Penny Reitman,
Marilyn B. Steinberg

REGIONAL EDITORS

New York: Benjamin A. Mason (212) 997-2645

Boston: James B. Brinton,

Linda Lowe (617) 262-1160

Chicago: Larry Marion (312) 751-3805

Dallas: Wesley R. Iversen (214) 742-1747

Los Angeles: Larry Waller (213) 487-1160

Palo Alto: William F. Arnold, *Manager;*

Bruce LeBoss, *Computers & Instruments*
(415) 968-2712

Washington: Ray Connolly (202) 624-7592

Frankfurt: John Gosch 72-5566

London: Kevin Smith 493-1451

Paris: Arthur Erikson,

Kenneth Dreyfack 720-20-70

Tokyo: Charles Cohen 581-9816

McGRAW-HILL WORLD NEWS

Editor: Michael Johnson

Brussels: James Smith

Milan: Jeff Ryser

Moscow: Peter Hann

Stockholm: Robert Skole

Tokyo: Robert Neff

PUBLISHER: Paul W. Reiss

GENERAL MANAGER, DIRECT MARKETING
OPERATIONS: Horace T. Howland

CIRCULATION MANAGER: Herbert A. Hunter

RESEARCH MANAGER: Margery D. Sholes

MARKETING ADMINISTRATION MANAGER:
Frances M. Vallone

BOOKS & SPECIAL PROJECTS MANAGER:
Janet Eyster

Publisher's letter

Now that deliveries of the IBM 4300 series have begun, users will get their first opportunity to look "under the hood" of this innovative computer series. A detailed look at the new machines is also available in this issue in the three-part article starting on page 109.

So far, most of the information available about the series has been long on applications but short on the technology inside the computers, which makes this article particularly timely. When IBM announces anything, the electronics world is quick to take note. And in the 4300, it may be said, the giant computer company has once again established a position on the leading edge of technology.

Four authors from two IBM locations describe how the system is put together. Humberto Cordero Jr., manager of processor development at the Systems Products division in Endicott, N. Y., provides an overview of the 4341 hardware. Theodore J. Frechette, project engineer, and Fred T. Tanner, advisory programmer for the Systems Diagnostics section of the division, describe the unique diagnostics designed into the 4341.

To tell the story of the basic architecture there is Hartmut R. Schwermer from the Böblingen Development Laboratory in Böblingen, West Germany. This architecture is called Extended Control Program Support: Virtual Storage Extended, or ECPS:VSE in IBM parlance.

Unlike the Big Three U.S. auto makers, European car manufacturers have tended to depend entirely on their semiconductor suppliers for design work. As countries in Europe prepare tougher exhaust emissions and mileage requirements, the time has come for these semiconductor companies to perform.

Even the European Economic Community is drawing up new requirements, Kevin Smith, London bureau manager, reports. His story about European automotive electronics is on page 94.

Why not an editorial career?

Electronics has available challenging editorial positions for electronics engineers with a bent for journalism. Our editors observe and write or edit articles on the latest trends in electronic technology. Right now, we're strengthening our coverage of the exciting consumer and industrial fields, including the application and design of microprocessor-based systems in these areas. A bachelor's degree and experience in both hardware and software design are desirable. Excellent salary and benefits. Write a letter telling us about yourself to the Managing Editor (Technical) at *Electronics*, 1221 Avenue of the Americas, New York, N. Y. 10020.

November 8, 1979 Volume 52, Number 23 104,053 copies of this issue printed

Electronics (ISSN 0013-5070). Published every other Thursday by McGraw-Hill, Inc. Founder: James H. McGraw 1860-1948. Publication office 1221 Avenue of the Americas, N.Y., N.Y. 10020; second class postage paid at New York, N.Y. and additional mailing offices.

Executive, editorial, circulation and advertising addresses: *Electronics*, McGraw-Hill Building, 1221 Avenue of the Americas, New York, N.Y. 10020. Telephone (212) 997-1221. Teletype 12-7960 TWX 710-581-4879. Cable address: MCGRAW HILL N E W Y O R K.

Subscriptions limited to professional persons with active responsibility in electronics technology. No subscriptions accepted without complete identification of subscriber name, title or job function, company or organization, and product manufactured or services performed. Based on information supplied, the publisher reserves the right to reject non-qualified requests. Subscription rates: in the United States and possessions \$17 one year, \$29 two years, \$43 three years; company addressed and company libraries \$23 one year, \$41 two years, \$58 three years; APO/FPO addressed \$35 one year only; Canada and Mexico \$19 one year, \$32 two years, \$47 three years; Europe \$46 one year, \$78 two years, \$110 three years; Japan, Israel and Brazil \$70 one year, \$115 two years, \$165 three years; Australia and New Zealand \$95 one year, \$170 two years, \$240 three years, including air freight; all other countries \$50 one year, \$85 two years, \$125 three years. Limited quota of subscriptions available at higher-than-basic rate for persons allied to field served. Check with publisher for these rates. Single copies: \$4.00. Please allow four to eight weeks for shipment.

Officers of McGraw-Hill Publications Company: Paul F. McPherson, President; Group Vice-President: Daniel A. McMillan; Group Vice President Planning & Development: James E. Boddorf; Senior Vice President:

Editorial: Ralph R. Schulz; Vice-Presidents: Robert B. Doll, Circulation; James E. Hackett, Controller; William H. Hammond, Communications; Thomas H. King, Manufacturing; John W. Patten, Sales; Edward E. Schirmer, International.

Officers of the Corporation: Harold W. McGraw, Jr., President, Chief Executive Officer, and Chairman of the Board; Robert N. Landes, Senior Vice President and Secretary; Ralph J. Webb, Treasurer. Title registered in U.S. Patent Office; Copyright © 1979 by McGraw-Hill, Inc. All rights reserved. The contents of this publication may not be reproduced in whole or in part without the consent of copyright owner.

Where necessary, permission is granted by the copyright owner for libraries and others registered with the Copyright Clearance Center (CCC) to photocopy any article herein for the base fee of \$0.50 per copy of the article plus \$0.25 per page. Payment should be sent directly to the CCC. Copying done for other than personal or internal reference use without the express permission of McGraw-Hill is prohibited. Requests for special permission or bulk orders should be addressed to the publisher. ISSN 0013-5070/79\$0.50+.25.

Subscribers: The publisher, upon written request to our New York office from any subscriber, agrees to refund that part of the subscription price applying to copies not yet mailed. Please send change-of-address notices or complaints to Fulfillment Manager; subscription orders to Circulation Manager, *Electronics*, at address below. Change-of-address notices should provide old as well as new address, including zip codes. Attach address label from recent issue. Allow one month for change to become effective. Subscriber Service: call (609) 448-8110, 9 a.m. to 4 p.m. EST.

Postmaster: Please send form 3579 to Fulfillment Manager, *Electronics*, P.O. Box 430, Hightstown, N.J. 08520.

AM, FM, PHASE LOCK, SWEEP, 30MHz, AND MUCH MORE...

You've Wished For It All In A Function Generator

Once you've experienced the versatility of the new 2400 two-in-one function generator, others just won't measure up to your standards. Krohn-Hite has designed two truly independent generators in one package to make the 30MHz Model 2400 unique.

You can use the main and auxiliary generators individually to produce sine, square, triangle, ramps, and pulses.

You can combine them for phase lock outputs with phase shifting control. And you can also produce triggered, gated, pulse, and tone burst waveforms.

The versatile 2400 is priced at \$1495. (domestic price only). Put it to the test today. Call Krohn-Hite for further information and look up our complete product listings in EEM and Gold Book.

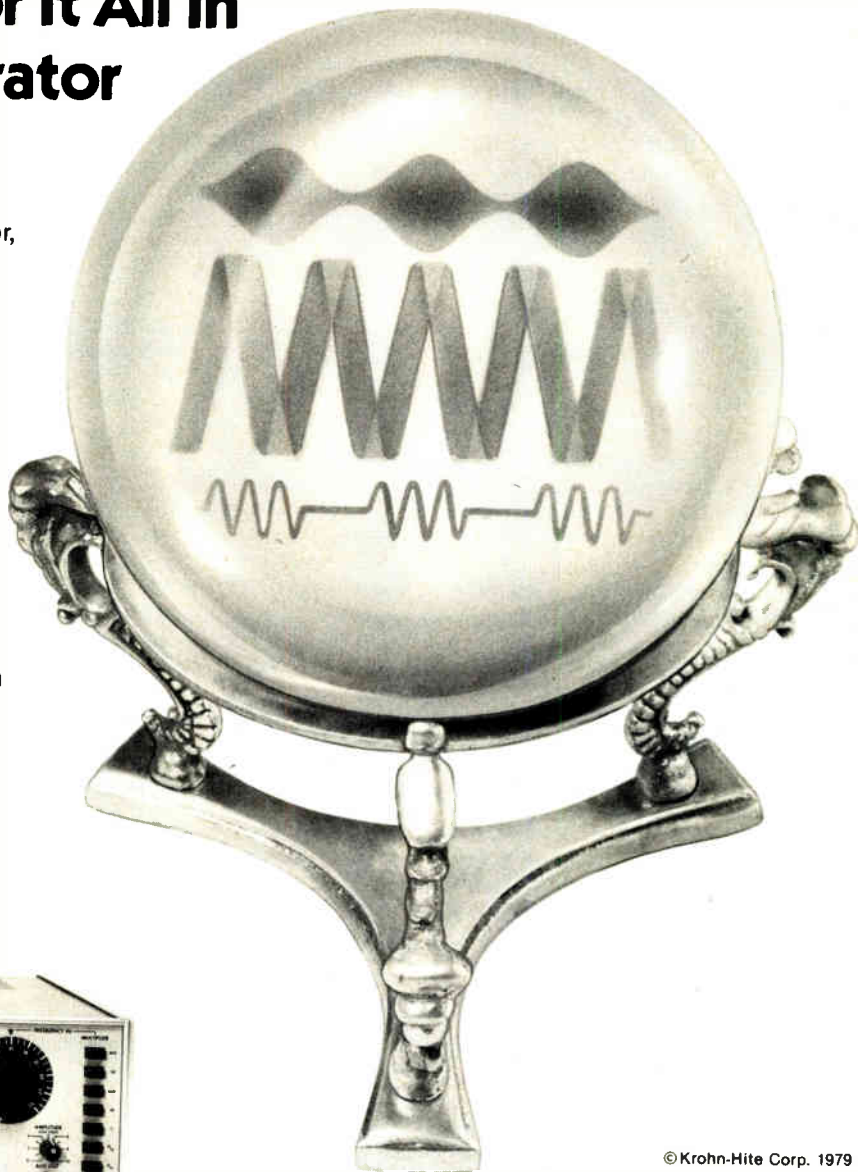

**KH KROHN-HITE
CORPORATION**

Avon Industrial Park, Avon, MA 02322 • (617) 580-1660 TWX 710 345 0831

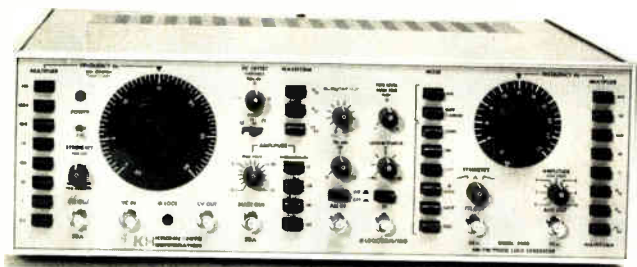

© Krohn-Hite Corp. 1979

Krohn-Hite . . . Benchmark of Value in Function Generators

SALES OFFICES: AL., Huntsville (205)534-9771; AZ., Phoenix (602)279-1531; CA., Inglewood (213)674-6850, San Jose (408)292-3220; CO., Denver (303)773-1218; CT., Canton Center (203)693-0719; FL., Orlando (305)894-4401; GA., Atlanta (404)455-1206; HI., Honolulu (808)941-1574; IL., Chicago (312)283-0713; IN., Carmel (317)844-0114; KS., Overland Park (913)649-6996; LA., Gretna (504)367-3975; MD., Towson (301)321-1411; MA., Wakefield (617)245-5940; MI., Detroit (313)961-3042; MN., Minneapolis (612)835-4818; MO., St. Louis (314)569-1406; N.M., Albuquerque (505)255-2330; N.J., Cherry Hill (609)482-0059, Englewood (201)871-3916; N.Y., Rochester (716)473-5720, Syracuse (315)437-6666, Vestal (607)785-9947; N.C., Burlington (919)227-3639; OH., Chesterland (216)729-2222; Dayton (513)294-2476; OK., Jenks (918)299-2636; OR., Portland (503)297-2248; TX., Dallas (214)661-0400, Houston (713)688-1431; UT., Salt Lake City (801)466-8729; VA., Falls Church (703)573-8787; WA., Bellevue (206)454-3400; WI., Milwaukee (414)545-8400; CANADA, Montreal, Quebec (514)747-9747, Ottawa, Ontario (613)725-1931, Toronto, Ontario (416)275-2270.

MULTIBUS compatible data acquisition and control systems.

The ADAC 700 Series of data acquisition systems plug directly into the MULTIBUS of single board computers from Intel and National. The 710 Series is the first low level analog to digital system available that includes such unique features as the capability to withstand common mode voltages of up to 250V while digitizing low level outputs from bridges, thermocouples and other low level transducers. A software programmable gain amplifier with optional cold junction compensation circuit can be programmed on a channel to channel basis. The low level analog to digital card and low level multiplexer expander card can be supplied with either 8 or 16 differential inputs per card. Resolution is 12 bits.

The 735 A/D high level analog to digital series is supplied with 16 to 64 single ended or pseudo differential inputs. It also is jumper selectable for 8, 16, or 32 differential analog inputs. The inputs can be either voltage or current loop. The 735 A/D features a 12 bit high speed analog to digital converter with throughput rates of 35 KHz basic and 100 KHz optional. The series include bus interfacing with a software selection of program control/program interrupt and a jumper selection of memory mapped I/O or isolated I/O. Up to 2 channels of 12 bit digital to analog converters can be supplied.

The extensive series of MULTIBUS compatible analog I/O boards is further complemented by the 735 DAC Series. They are supplied with up to 4 channels of 12 bit digital to analog converters, MULTIBUS interfacing, 2 scope/recorder pen control circuits, 8 discrete digital outputs with 8 high current sinks, 8 discrete digital inputs, and memory mapped or isolated I/O interfacing. Optionally available are third wire sense for ground noise rejection and 4 to 20 ma current loop outputs.

Send for full technical data:

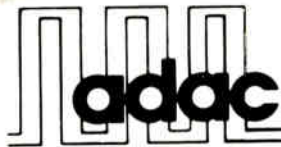
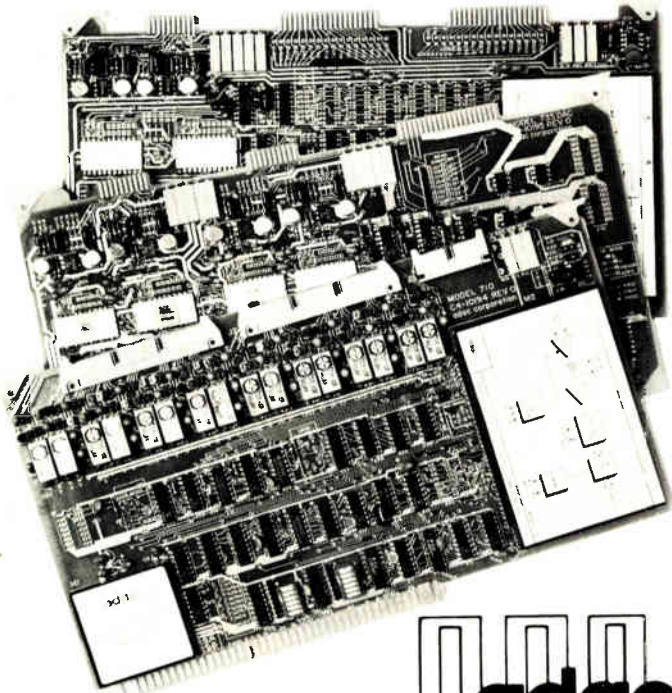

CORPORATION

70 TOWER OFFICE PARK • WOBURN, MA 01801 • 617-935-6668

Readers' comments

Creating more engineers

To the Editor: I recently read "EE shortage threatens growth" [Oct. 11, p. 96] with great interest. I have, for the last few years, been aware of this problem and have anticipated a decline in the electrical engineer population across the country. The problem seems to be acute in the integrated-circuit industry, and because of the attractiveness of salaries in this area it will cause shortages across the entire country.

It seems as though many of these companies spend much on research and development for long-term growth potential but do little to ensure long-term growth in the supply of engineering graduates. Some of the problems could be circumvented by applying some influence at the high school level, as, obviously, quality engineers can only be in supply if we encourage more students to enter the profession. Colleges can only do so much to recruit students, but industry can describe job opportunities and starting salaries and thereby recruit more individuals early on.

The problem will continue to worsen because fewer high school graduates are expected in upcoming years. I would like to see industry begin now to use its influence to lessen the shortage of qualified technical people.

Thomas W. David
Electrical Engineering Department
Milwaukee School of Engineering
Milwaukee, Wis.

More about LEDs

To the Editor: Regarding "Dual light-emitting diode synthesizes polychromatic light" [Aug. 16, p. 130], may I make three points?

First, the LED driver of Fig. 1 has a low output impedance. A current limiting resistor should be inserted between driver output and LED.

Second, the LED driver shown in Fig. 2 is unnecessarily complex. If the right-hand pin of the dual LED were connected to the output of a voltage divider made of two 820- Ω resistors and driven by the supply voltage, the right-hand half of the driver circuit consisting of one sixth of a 74C04, two 20-k Ω resistors, and

GOOD AS GOLD.

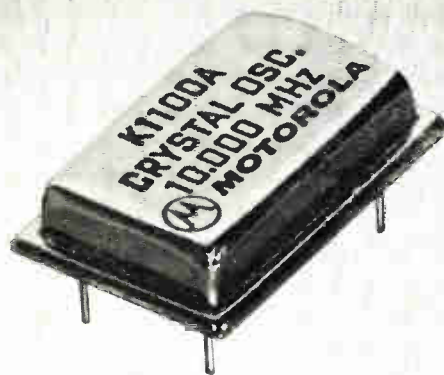

Gold keeps the Motorola 1100 Series crystal clock oscillators on frequency longer.

In our 1100 series, the Motorola hybrid crystal clock oscillator is best in its class because it performs better and lasts longer—from 250 kHz to 70 MHz with a tolerance of $\pm 1.0\%$ to 0.0025%.

We ensure that our oscillators stay on frequency by using gold plating. Gold doesn't oxidize as rapidly as most other metals, and oxidation changes the mass on the crystals. When the mass

changes, the frequency changes. You don't want that. Nor do we.

Because dust on a crystal will change the oscillator frequency, we assemble them in a Class 100 Clean Room. The atmosphere is controlled to keep dust out and hold the temperature and humidity at the correct level. And because we demand perfection, we grow our own perfect quartz. The result is an oscillator that stays on fre-

quency longer. All this at a price that's lower than you'd expect.

If only the best is good enough for you, we'll be happy to send you a price list, rep list, and more data than you'll find on any other oscillator data sheet. Call Barney III at (312) 451-1000, or write Motorola, Component Products Department, 2553 N. Edgington, Franklin Park, Illinois 60131.



MOTOROLA INC.

Component Products

Circle 7 on reader service card

Bud's New Horizon

The electronic
components
cabinet with
unlimited
versatility.

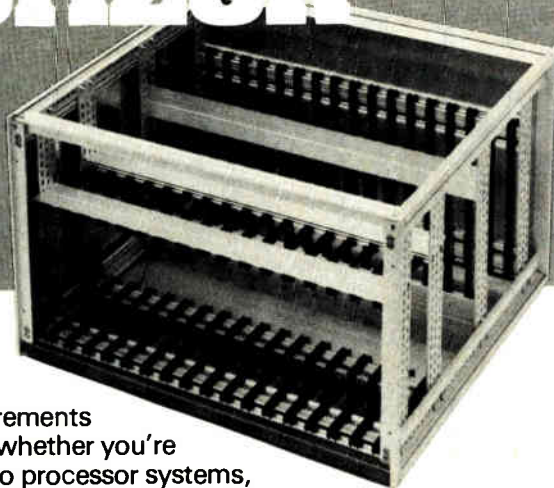

Design requirements change, but whether you're housing micro processor systems, micro computers, PC boards, mother boards, power supplies or plug-in modules, Horizon is the only cabinet you'll ever need.

All exterior panels of its sturdy extruded frame slide out for full interior access. Options include: snap-in guides for perfect component alignment; an accessory chassis that mounts vertically or horizontally and adjustable mounting rails, connector rails and horizontal frame members.

For more information on Horizon, the cabinet that lets you create the electronic package to fit your design requirements, send for our 4-page brochure. Write: Bud Industries, Inc., 4605 East 355th Street, Willoughby, Ohio 44094, or Bud West, Inc., 3838 North 36th Avenue, Phoenix, Arizona 85019.



BUY BUD

First...of all.

In Cleveland: 216/946-3200

In Phoenix: 602/269-3151

Circle 8 on reader service card

1979 Electronics Buyers' Guide



The only book of its kind in the field. If you haven't got it, you're not in the market.

To insure prompt delivery
enclose your check with
this coupon.

1979 edition available
in June.

Electronic Buyers Guide
1221 Ave. of the Americas
New York, N.Y. 10020

Yes, please send me _____ copy(ies) of 1979 EBG.
 I've enclosed \$30 per copy delivered in the USA or Canada.
 I've enclosed \$52 per copy for delivery elsewhere

Name _____
 Company _____
 Street _____
 City _____ State _____ Zip _____

Readers' comments

two transistors could be omitted, as well as the current-limiting 1-k Ω resistor.

Similarly, the circuit of Fig. 1 could be adapted for a single supply.

Martin Brendle

Tübingen, West Germany

Circuit ambiguities

To the Editor: P. V. Ananda Mohan, in his Designer's Casebook article "Tunable equalizers set amplitude and delay" [Oct. 11, p. 126], shows a simple circuit with two or three operational amplifiers to achieve variable envelope delay or delay and amplitude equalization. But his reference to "roll-off" in an all-pass network is confusing. We assume he means the shape of the delay versus frequency characteristic.

The transfer function shown would be an all-pass function only if the constant term in the numerator and the denominator were the same, but the equation shows an ω term in the numerator and an ω_0 term in the denominator; ω_0 is defined in terms of circuit components, but not ω .

In the formula for phase shift, in which the constant t is not defined, we might assume that ω is the frequency variable contained in the s terms, but the following sentence, as well as the formula in the last paragraph, seems to imply it is a network constant. It would help to clarify these ambiguities.

David C. Bidwell
Boonton, N. J.

■ The roll-off as defined by the author refers to the change in e_{out} with Q for a given e_m . Also, the last term in the numerator of the first equation should be ω_0^2 , not ω^2 . The term ω is indeed an independent variable. Finally, the formula in the last paragraph should indicate that the null frequency of the filter is $\omega_n = \omega_0 / (1 - K^2)^{1/2}$. —ED.

Correction

In "Telephone tester detects line distortion" [Sept. 27, p. 15], the input leads of the optically isolated circuit should be connected across the phone line, not to the same side of the line as shown. Also, capacitor C_2 has a value of 0.47 microfarad.

THIS IS KONTRON

NEW

48-Channel Model LAM 4850 Intelligent Logic Analyzer from Dolch.



Introducing . . . the world's first 48-channel logic analyzer.

Kontron offers you the complete line of Dolch logic analyzers ranging from 16 channels to 48. The new 48-channel LAM 4850 was designed to debug systems

built around the new 16-bit microprocessors. It has 6 independent 8-channel inputs which can be organized 7 ways for sequential and parallel recording. Our standard features include:

- 1024 bits recording and reference memory per channel

- Sampling rates — DC to 50 MHz
- 5 ns glitch latch capability
- 3-level simultaneous synch/asynch clocking
- 4-level sequential triggering

Write or call
Kontron Electronic Inc.,
700 South Claremont Street,
San Mateo, California 94402

LOGIC ANALYZERS:

FOR DATA ON KONTRON® MULTIMETERS, COUNTERS, PROM PROGRAMMERS AND PRINTERS, CALL (800) 227-6845. IN CALIFORNIA CALL (415) 348-7291.



Circle 9 on reader service card

Circle 11 on reader service card



Looking for Paper Caps?

ACUSHNET'S Your Best Shot

... for Any Specialty Need.

For many applications, metallized paper capacitors are still the answer. They have proven reliability for pulse applications and excellent self-healing properties. You can depend on them.

And Acushnet has them. Because we specialize in specialty capacitors. We manufacture films in all popular dielectrics, micas, and aluminum electrolytics. Our experienced application team is always available, designing specialized capacitors to solve unique problems.

For years we're the capacitor company that's been growing quietly. The OEM's we service are steady customers because we offer the successful combination of excellent, dependable products and hard-working people concerned about our customers' needs.

Next time you need paper caps or any others ... contact us.

Better yet, plan ahead for your specialized needs. Write for our new catalog today.



ACUSHNET CAPACITOR CO., INC.

720 BELLEVILLE AVE. • NEW BEDFORD, MA 02741 / (617) 999-3291
At Acushnet, We're *Accustomed* to Solving Capacitor Problems.

Circle 12 on reader service card

ASCII encoded keyboards as low as \$42.*



The RCA VP-601 keyboard has a 58 key typewriter format for alphanumeric entry. The VP-611 (\$10 additional*) offers the same typewriter format plus an additional 16 key calculator type keypad.

Both keyboards feature modern flexible membrane key switches with contact life rated at greater than 5 million operations, plus two key rollover circuitry.

A finger positioning overlay combined with light positive activation key pressure gives good operator "feel", and an on-board tone generator gives aural key press feedback.

The unitized keyboard surface is spillproof and dustproof. This plus the high noise immunity of CMOS circuitry makes the VP-601 and VP-611 particularly suited for use in hostile environments.

The keyboards operate from a single 5 volt, DC power supply, and the buffered output is TTL compatible. For more information contact RCA VIP Marketing, New Holland Avenue, Lancaster, PA. Telephone (717) 291-5848.

RCA

*OEM price.

12 Circle 28 on reader service card

News update

■ The highest direct-frequency measurement ever made on an electromagnetic wave has been recorded by Donald A. Jennings, Kenneth M. Evenson, and F. Russell Petersen of the National Bureau of Standards and Kenneth M. Baird and Gary Haines of Canada's National Research Council.

Their feat, accomplished with a cesium-beam frequency standard and a chain of microwave and laser oscillators, is important because measurements based on frequency can be up to 1,000 times more accurate than wavelength checks. They measured 520 terahertz (52×10^{13} hertz), which is in the visible region of the spectrum and is 50,000 times higher than the frequency of the cesium-beam oscillator at present used as the microwave frequency standard.

The 520-THz measurement needs a chain of 14 lasers and six klystrons (microwave tubes) to determine the frequency of a neon laser near 260 THz. When this is done, a helium-neon laser from Canada's research council and a frequency-doubling crystal is used to make the 520-THz measurement.

Mixing known, unknown. The system works by producing beat frequencies. At each step in the chain, a laser or microwave oscillator generates a known frequency that is mixed with a higher, unknown frequency to produce a beat frequency. That frequency is equal to the difference between the known and the unknown frequencies and is low enough to be measured with conventional instruments. Addition of the beat to the known frequency yields the unknown value, which then becomes the basis for the next step in the chain that is needed to produce the highly accurate measurement.

The next project, the researchers say, is to do the whole thing all over again with the best possible accuracy. Only feasibility has been of concern up to now. The lasers will be stabilized to allow the 520-THz measurements to be made with the same accuracy as the cesium frequency standard itself (1 part in 10^{13}).

-Harvey J. Hindin

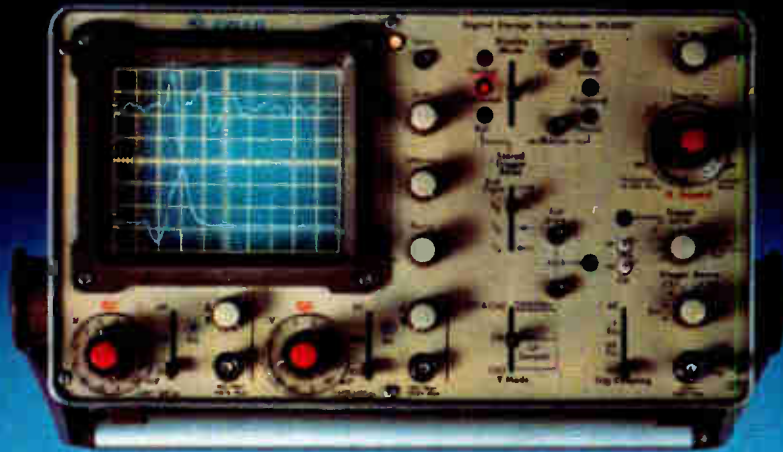

Now Gould offers a range of digital storage oscilloscopes that offer a world of advantages over conventional tube storage technology, beginning with being able to capture transient of "one-time" events and store them indefinitely for display or hardcopy printout. This makes them ideal for electronic, electromechanical, educational, and biophysical applications.

Both the OS4000 and the new OS4100 combine the capabilities of semi-conductor memory with a bright, stable, flicker-free display. This technique allows analysis of signal build-up and decay characteristics through pre- and post-trigger viewing. Expansion of the display after storage permits detailed study of specific areas of the trace.

The new model — OS4100 — also offers

you stored X-Y displays, channel sum or difference and a maximum of 100 V per cm sensitivity with noise suppression. A unique trigger window circuit assures capture of transients of unknown polarity.

Extend your storage capabilities beyond the conventional.

Other outstanding features include automatic operation, display of stored and real time traces simultaneously and hard copy memory output in digital or analog form. And IEEE488 is available for compatible interfacing.

And, remember that Gould scopes are backed by a two-year warranty of parts and labor, exclusive of fuses, minor maintenance and calibration. For further information, contact Gould Inc., Instruments Division, 3631 Perkins Ave., Cleveland, Ohio 44114. Or Call (216) 361-3315, Ext. 395, for a demonstration.

 **GOULD**

An Electrical/Electronics Company

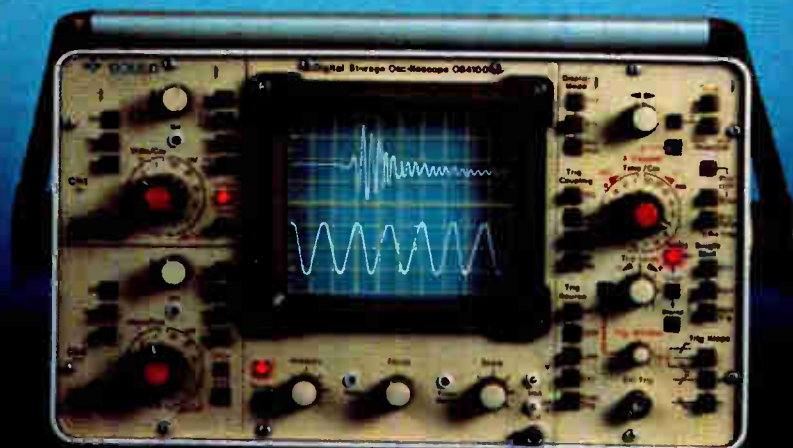



LOW COST HIGH RELIABILITY REFLECTIVE OBJECT SENSORS

New, low cost TRW Optron solid-state reflective object sensors offer high reliability for non-contact sensing applications.

TRW Optron's new high reliability OPB 708 and OPB 709 reflective object sensors provide excellent performance for non-contact sensing applications at an inexpensive price.

The OPB 708 is a plug-in replacement for the TIL139 reflective object sensor.

The new TRW Optron devices combine a high efficiency solution grown gallium arsenide infrared LED with a silicon N-P-N phototransistor (OPB 708) or maximum sensitivity photodarlington (OPB 709) in a molded plastic package. The photosensor senses radiation from the LED only when a reflective object is within its field of view.

With a LED current of 40 mA and with the OPB 708 positioned 0.150 inch from a reflective surface, typical output current is 50 μ A for a 90% diffuse reflective surface and 1.0 mA for a specular reflective surface such as aluminum foil. Under similar operating conditions, the output current of the OPB 709 is 7.5 mA and 100 mA.

Both devices are ideally suited for such non-contact sensing applications as paper or card edge detection, motor speed controls, EOT/BOT sensing, and proximity detection.

The OPB 708 and OPB 709 as well as other low cost, high reliability reflective object sensors are immediately available from stock. Custom versions are available on request.

Detailed technical information on the OPB 708 and OPB 709 reflective object sensors and other TRW Optron optoelectronic products ... chips, discrete components, optically coupled isolators, and interrupter assemblies ... is available from your nearest TRW Optron sales representative or the factory direct.

TRW OPTRON
A DIVISION OF TRW INC.

1201 Tappan Circle
Carrollton, Texas 75006, U.S.A.
TWX-910-860-5958
214/242-6571



Ullrich builds his dream house for International Harvester

Most electronics engineers only dream about being paid to develop state-of-the-art applications in which price is no object. But for John F. Ullrich, recently named vice president for science and technology at International Harvester Co., the dream has come true and it is only part of the deal.

Ullrich, formerly Ford Motor Co.'s executive engineer for power-train electronic engineering, is not only going to do that but is also now building, basically from scratch, a large technology development center in suburban Chicago for IH, a company with 1978 sales of \$4.8 billion. It is in a headlong rush to adopt new technology to increase sales by improving its line of tractors, trucks, and other heavy-duty construction and farm vehicles. And when each tractor has a price tag of \$45,000 and up, another \$1,000 for electronic controls is insignificant.

IH and its competitors are trying to incorporate microprocessor technology to improve driver monitoring and control of engines and attachments such as combines [*Electronics*, Jan. 4, p. 46]. However, notes Ullrich, "to date, the application of electronics at IH has been minimal."

But that will soon change, he says. The new tech center, which will house several hundred people within the next few years, will be responsible for applying electronic, chemical, hydraulic, and metallurgic technologies to its vehicles and is expected to develop subsystems to be sold to other companies. New applications of electronic technology, though, are expected to have the biggest short-term impact, says the 39-year-old Ullrich, who has several degrees, including a doctorate in nuclear engineering from the University of Michigan.

For example, Ullrich plans electronic dashboard monitoring systems for "across-the-board" applications in a variety of different trucks and other vehicles. An alphanumeric display may be a cost-effective substi-



Starting from scratch. John Ullrich has gone to IH to build a new technology center.

tute for discrete dials and gages on the instrument panel, he says, in an approach similar to that taken by Ford in its Lincoln Continentals.

In addition, cost-conscious long-haul truck drivers could save 50% of their fuel bills if an electronic module were available to sense and display the optimum moment for switching gears, Ullrich notes. But crucial to the development of such systems are better sensors and actuators, he adds.

Kravitz keeps Dionics on top by thinking small and fast

Take a 60-employee semiconductor company whose plant includes just 10,000 square feet and make it the top supplier in its market segment. That's what president Bernard Kravitz has done with Dionics Inc., a Westbury, N. Y., manufacturer of high-voltage driver integrated circuits and hybrid-circuit chips.

Kravitz, a modest 46-year-old with a master's degree in metallurgical engineering, attributes his company's success to the good fortune of being in the right place at the right time. Still, someone had to have the foresight to blend talent and innovative thinking into a leadership position. In fact, Dionics has had to make good twice—when it was started in 1969 with \$400,000 put up

LSI11/2[®] LSI11/23[®] COMPONENT PRODUCTS

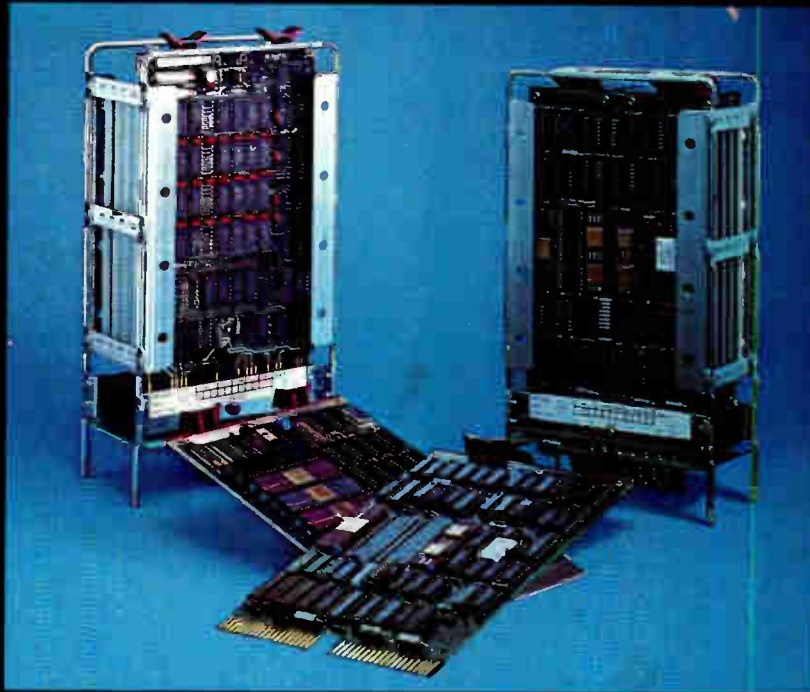

WHY IS FIRST COMPUTER YOUR BEST SOURCE FOR DEC'S LSI-11/2 AND LSI-11/23 MICROCOMPUTER PRODUCTS?

FIRST COMPUTER IS THE WORLD'S LARGEST SPECIALIZED DISTRIBUTOR FOR LSI-11 AND LSI-23 MICROCOMPUTER PRODUCTS.

No—We don't sell capacitors or resistors! We only sell products manufactured by Digital Equipment Corporation and other leading manufacturers which enhance the LSI-11/2 and LSI-11/23 Microcomputer Products.

FIRST COMPUTER SAVES YOU VALUABLE DOLLARS!

Because of our volume purchasing power we can acquire the products at the lowest possible cost. These savings enable us to offer the best price available anywhere. Before you buy, investigate our price and save dollars.

FIRST COMPUTER SAVES YOU VALUABLE TIME!

Because of our large inventory we can provide you with off-the-shelf delivery on the complete line of Digital Equipment Corporation's factory fresh Microcomputer Products. We are just a phone call away, or if you prefer you can TWX us your order. With pre-approved credit we can ship anywhere in the United States or Canada within 24 hours.

FREE TECHNICAL AND APPLICATION ASSISTANCE.

Because we specialize in LSI-11/2 and LSI-11/23s we can provide you with technical assistance to help you determine the products which best meet your application requirements. We utilize these products everyday in our own Commercial, Laboratory, Array Processor, and Image Processing Systems. Our application experience can help you avoid costly mistakes.

FULL MANUFACTURER'S WARRANTY.

When you purchase your LSI-11/2 and LSI-11/23 products from FIRST COMPUTER you receive the full manufacturer's Return to Factory warranty. All warranty claims will be handled by First Computer with courtesy & dispatch. FIRST COMPUTER stands behind each of the products we sell.

WE ARE A RECOGNIZED LEADER IN THE DISTRIBUTION OF LSI-11/2 AND LSI-11/23 PRODUCTS.

No wonder so many people are turning to FIRST COMPUTER to provide them with their Microcomputer requirements. You owe it to yourself to investigate what FIRST COMPUTER can do for you! We stand ready to serve you. You can bank on us.

Circle 15 on reader service card



computer corporation

corporate square / 825 north cass avenue / westmont, illinois 60559 (312) 920-1050

TWX NUMBER 910-651-1916

[®]Trademark First Computer Corporation

[®]Registered trademark of Digital Equipment Corporation

C2

People



Right combination. Bernard Kravitz has parlayed skill and know-how into top spot.

by a group including Kravitz and operations vice president Sherman Gross, and again after the 1975 economic slump.

"We're not doing something that cannot be done by others," insists Kravitz. "IC manufacturers could easily compete with us if they wanted to, but they usually look for large mass markets to get into." However, he says, "a small manufacturer like us has some advantages over larger firms. We can respond to customer demands faster. Customers don't even mind that we are a small, sole-source manufacturer—after all, we've been around for a number of years and have a good reputation."

All that is fine and necessary, but the bottom line is technology—and that's where Dionics shines. Of key importance is the company's ability to supply dielectrically isolated high-voltage ICs in a hurry. And, as Kravitz points out, it takes more than just expertise in dielectric isolation to be in the high-voltage IC business: "One also has to know how to make high-voltage components within the dielectrically isolated chips, and for that fabrication task we have a number of patents."

Also, a small company like Dionics—it will do close to \$3 million in business this year—must sometimes live by its wits. In one case, it was unable to supply enough drivers for one customer. So it studied the product's applications and found that the driver was underutilized. The solution: halve the driver chip's area and thereby double production capacity. It's that kind of thinking that keeps Dionics small but big. □

glitch \ˈɡlɪtʃ\ *n* |prob. fr. German *glitschen*, to slide| **1:** Originally, an unwanted, false electronic pulse. **2:** Now, any of a variety of problems that plague both hardware and software in digital designs. syn spike, snarp.

glitchfixer \ˈɡlɪtʃ ˈfɪks-er\ *n* |only from Gould| **1:** A Biomation logic analyzer with 8, 9, 16, 27 or 32 channels, sampling rates to 200 MHz, and memory lengths to 2048 words. **2:** The ultimate solution to troubleshooting digital logic.

Got a glitch?
Get a
**GLITCH
FIXER
FROM GOULD**



An Electrical/Electronics Company

4600 Old Ironsides Drive, Santa Clara, CA 95050
For a Glitchfixer catalog, call Bob Lorentzen
at (408) 988-6800

Circle 16 on reader service card

AN AD-MU MAGNETIC SHIELD IN A GLASS BOTTLE???



Yes, Ad-Vance is often asked to do the tough and/or unusual in magnetic shielding. But no one has asked us to put a shield in a bottle—yet!

Bring your magnetic shielding problems to Ad-Vance's Problem Solving Magnetic Shielding Specialists. Find out why customers say their shielding problems end at Ad-Vance.

Ask for NEW 48-PAGE Time-Saving Reference Data/Catalog on Magnetic Shielding Techniques & Problem Solving.



AD-VANCE MAGNETICS, INC.

625 MONROE ST., ROCHESTER, IND. 46975

(219) 223-3158 TWX 810 290 0294

The Magnetic Shielding Specialists



16 Circle 30 on reader service card

Why pay 81¢ for a Hall effect sensor when you can get one for \$2.21?

It all depends on your application.

For 81¢*, you can get a solid state Hall effect sensor from the people who invented it. Us.

And that may be all you need.

But, if your application requires precision, our fully engineered \$2.21* position sensor may be a better deal.

The Hall effect sensor and magnet are matched and adjusted to get operate and release points that are specified to tight tolerances.

All this can add up to a lot if you start out with the wrong sensor.

When you come to MICRO SWITCH, you're dealing with people who have made over 100 million Hall effect sensors. So you get experts to help fit each sensor to your application. And you always get the right sensor for the job.

Which means a \$2.21 sensor can turn out to be a lot better deal than one that costs 81¢.

For details, and the location of our sales offices and distributors around the world, write MICRO SWITCH, The Sensor Consultants. Freeport, Illinois 61032. Or call 815/235-6600.

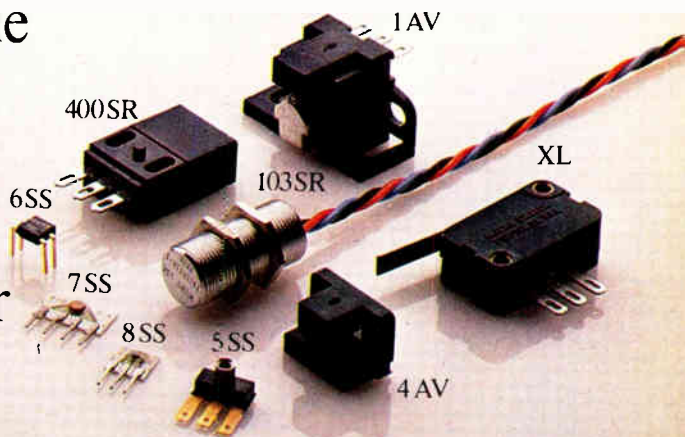

MICRO SWITCH
a Honeywell Division

Circle 17 for data

*One thousand piece pricing for 7SS and XL Series devices, respectively.

“Engineers find computer systems powerful designing products.”

Why?

Computation Power. Today's Hewlett-Packard desktop systems put big computer power under your personal control. You solve problems with up to 449K bytes of user-addressable read/write memory, all available for your programs and data. Built-in operating systems incorporate HP Enhanced BASIC, a powerful super-set of ANSI Standard BASIC. Coupled with optional assembly language, HP Enhanced BASIC gives you optimum performance for time-critical operations. Extensive libraries of HP software help turn weeks of setup and development time into days.

Powerfully Integrated. Each system is a functionally integrated work station, from the keyboard and CRT display to the built-in processors and quiet printer. It provides everything you need to manipulate data, check interim results, perform side computations, explore variations and produce alphanumeric and graphic hard copies of your solutions.

Systems Capability. Your system can be augmented with a broad range of HP peripherals or front-end measurement instruments. Interconnection is as easy as selecting interfacing cards and cables from one of four pro-

ocols available: HP-IB, Bit-Parallel, BCD or RS-232-C. Desktop computers incorporate direct memory access (to accelerate capture of real-time data from high speed devices) and vectored priority interrupt. One model utilizes dual processors for overlapped computation and I/O.

Friendly. Together with the power to handle complex computational problems, today's systems retain the reliability and ease of use that have always characterized HP desktop computers.

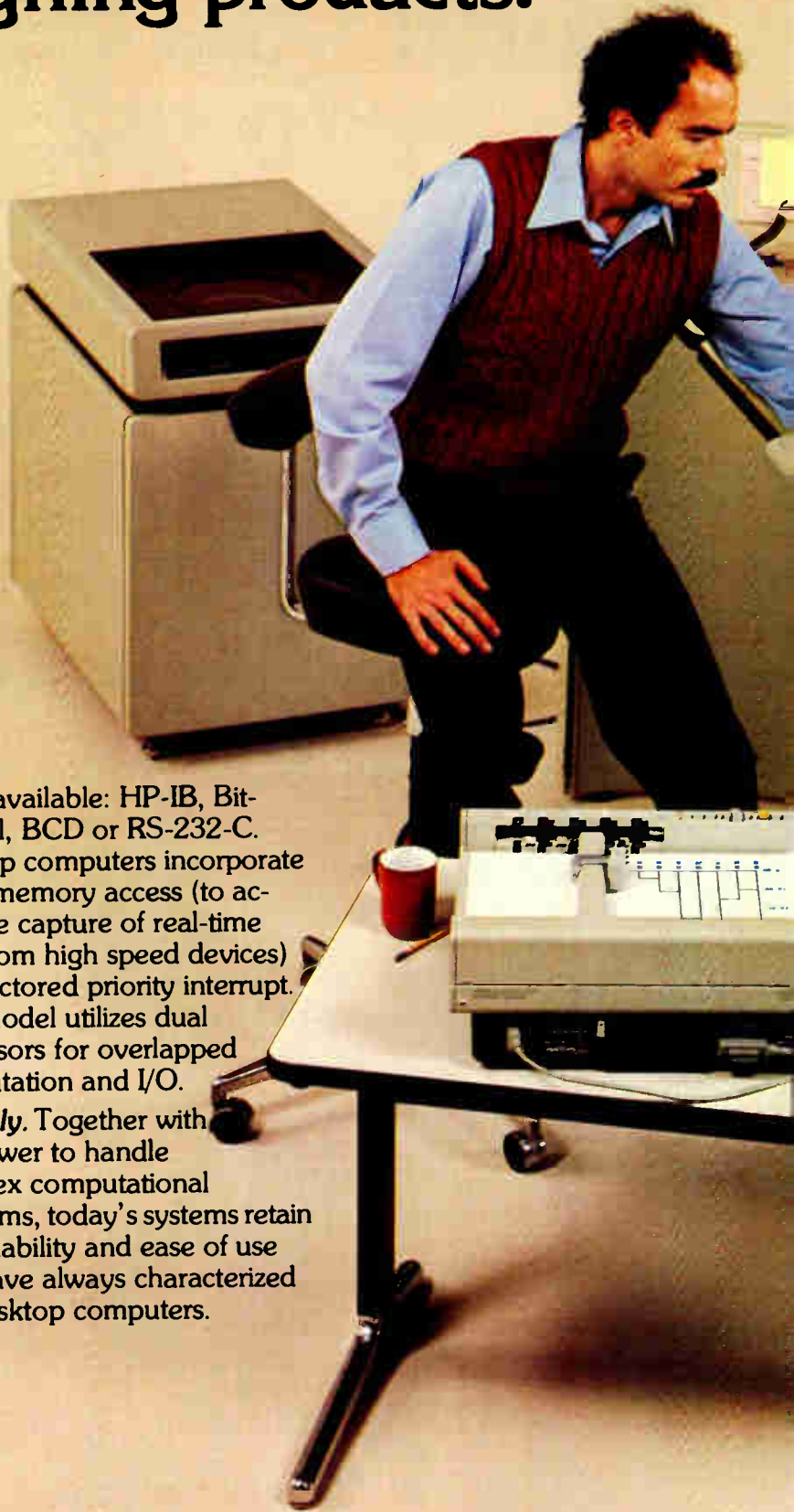

today's desktop tools for



Visual Solutions Through Graphics.



Digital Simulation

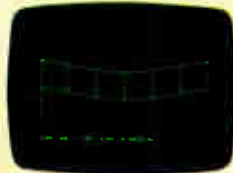

Structural Analysis

Graphic systems powered by HP desktop computers give you a wide variety of application possibilities. With graphics options, plotted data becomes visible practically as fast as it is generated.

Whether it's CRT graphics or hard copy from the printer or plotter, you work with advanced graphics software and unified commands through HP Graphics Language.

Expand Your System.



HP Desktop Computers have become the center of a growing family of input, output and storage peripherals. You can tailor a system to suit your needs by choosing HP printers, plotters, paper tape punches and readers, card readers, digitizers, flexible and hard disc

drives. Choose fast, quiet thermal printers or multi-copy impact printing and disc capabilities ranging from 500K byte flexible to 120M byte hard discs.

A Choice.



We build a broad range of desktop computers, with one just right for your computational applications. System 45B provides advanced graphics (including 3D), 449K byte read/write memory capacity and big system peripherals. System 35 offers a low cost 250K byte read/write memory capability with optional assembly language programming and powerful interfacing characteristics for automatic measurement and analysis.

A Growth Path.

HP can meet expanding needs with data communication links from desktop computers to HP 1000 computers. For multi-user, multi-tasking applications, HP 1000 computers offer a wide selection of compatible RTE operating systems with optional data base management, factory data collection and up to 64 user terminals.

For more information. Call 1-800-821-3777, extension 119, toll-free day or night (Alaska and Hawaii included). In Missouri, call 1-800-892-7655, extension 119. Or, call your nearest HP office for a demonstration.



HEWLETT  PACKARD

3404 E. Harmony Road, Fort Collins, Colorado 80525

For assistance call the HP regional office nearest you Eastern 301/258-2000, Western 213/877-1282, Midwest 312/255-9800, Southern 404/955-1500, Canadian 416/678-9430. Ask the operator for Technical Computer sales.

Circle 19 on reader service card

Early this year
Mr. Tom Armstrong
of ITT Electro-Optical
Products Division
approved the 3,000th
mile of optical fiber
for shipment.



It's one aspect of ITT's total optical fiber communications systems capability.

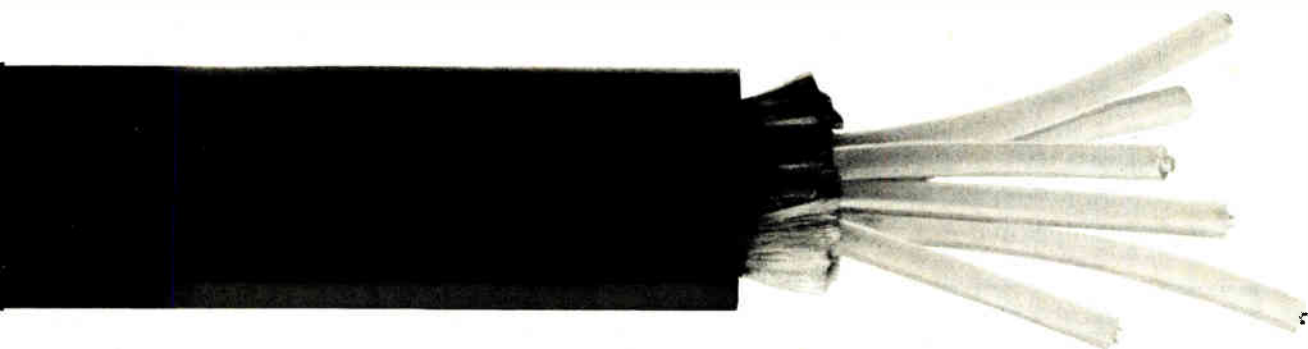

As our Quality Control Engineer, Mr. Armstrong is responsible for checking the quality of not only our fiber and cable, but of every optical component we make. Like so many before it, that milestone 3,000th mile went into the completion of another of the numerous complete systems built by ITT. To meet our standards, it had been proof tested over its entire length at 100,000 psi or greater to ensure high strength for ease of handling and assured long term durability.

For some time now, ITT has been able to supply design and application engineers with every fiber optic component their work requires. For two good reasons: First, we've had the lead time—our involvement with fiber optics communications goes back to 1964, when ITT's Dr. Charles Kao first

established their theoretical feasibility. Secondly, ITT recognized early that fiber optics represented a revolution in communications, and committed its resources to implementing it.

If you need star, tee, directional or bidirectional couplers, light sources and detector packages, electro-optical transmitter or receiver modules, connectors, or connector and splice installation equipment, we have them ready for you. And, if you want assis-

tance with a complete telecommunications system, or new computer, industrial, or military application, write to our Director of Marketing on your letterhead.

Imagine what we can do together.

ELECTRO-OPTICAL PRODUCTS DIVISION

7635 Plantation Road, Roanoke, VA 24019

ITT

Mostek's MD Series.™ 16 new boards.



Since its introduction, Mostek's MD Series of Z80-based, 4.5" x 6.5" microcomputer boards has received overwhelming acceptance. Engineers have found both MDX functional modules and MD single-board computers offer maximum versatility at minimum cost. And our 16 new boards will open the door to even more microcomputer applications.

Mostek MD Series

MDX-CPU1	Z80 CPU with 2 PROM sockets and 4 timers
MDX-DRAM 8	8K Dynamic RAM
MDX-DRAM 16	16K Dynamic RAM
MDX-DRAM 32	32K Dynamic RAM
MDX-EPROM/UART	Combination EPROM/UART
MDX-DEBUG	EPROM/UART with 10K ROM-based software
MDX-PIO	32 bit programmable parallel I/O
MDX-SIO	2 channel programmable serial I/O
MDX-SST*	Hardware single step
MDX-FLP*	Floppy disk controller
MDX-MATH*	High speed floating point math
MDX-A/D 8*	8 Bit A/D
MDX-D/A 8*	8 Bit D/A
MDX-A/D 10*	10 Bit A/D Converter
MDX-A/D 12*	12 Bit A/D Converter
MDX-D/A 12*	12 Bit D/A Converter
MDX-UMC*	Universal Memory Card
MDX-SRAM 4*	4K Static RAM
MDX-SRAM 8*	8K Static RAM
MDX-SRAM 16*	16K Static RAM
MDX-EPROM-4*	EPROM Module
MDX-CPU 2*	New Z80 CPU Board
MDX-SC/D*	System Controller and Diagnostic Board
MDX-INT*	Interrupt Expander and Timer Board
MD-SBC1	Z80, 8K PROM, 2K RAM, 40 I/O lines
MD DOS*	Dual Floppy Disk Operating System Software
MITE-80*	Multiple Independent Tasking Executive Software

* New

STD-Z80 BUS Flexibility

All our MDX cards are STD-Z80 BUS compatible. Just match the proper MDX modules to your design. Choose either 2.5MHz or 4MHz versions. Modify your system at any time by simply adding, exchanging or deleting MDX cards.

This allows you to buy only what you need, reduce hardware development time, and quickly respond to changing product definition and market conditions.

And with more and more manufacturers multi-sourcing the STD-Z80 BUS, you're assured of a long-lived industry standard.

Mostek's MD Series has the extensive support of our powerful Matrix Development System™, plus a wide range of software and accessories for quickly developing and prototyping your system.

Distributor Availability

The best way to evaluate the MD Series is to call your local Mostek distributor and ask about the MDX-PROTO kit. This powerful evaluation kit is available now for only \$1095.

For the complete MD Series update, see your local Mostek distributor. Or call or write Mostek, 1215 West Crosby Road, Carrollton, Texas 75006; phone (214) 242-0444. In Europe, contact Mostek Brussels, phone 660.69.24.

MOSTEK

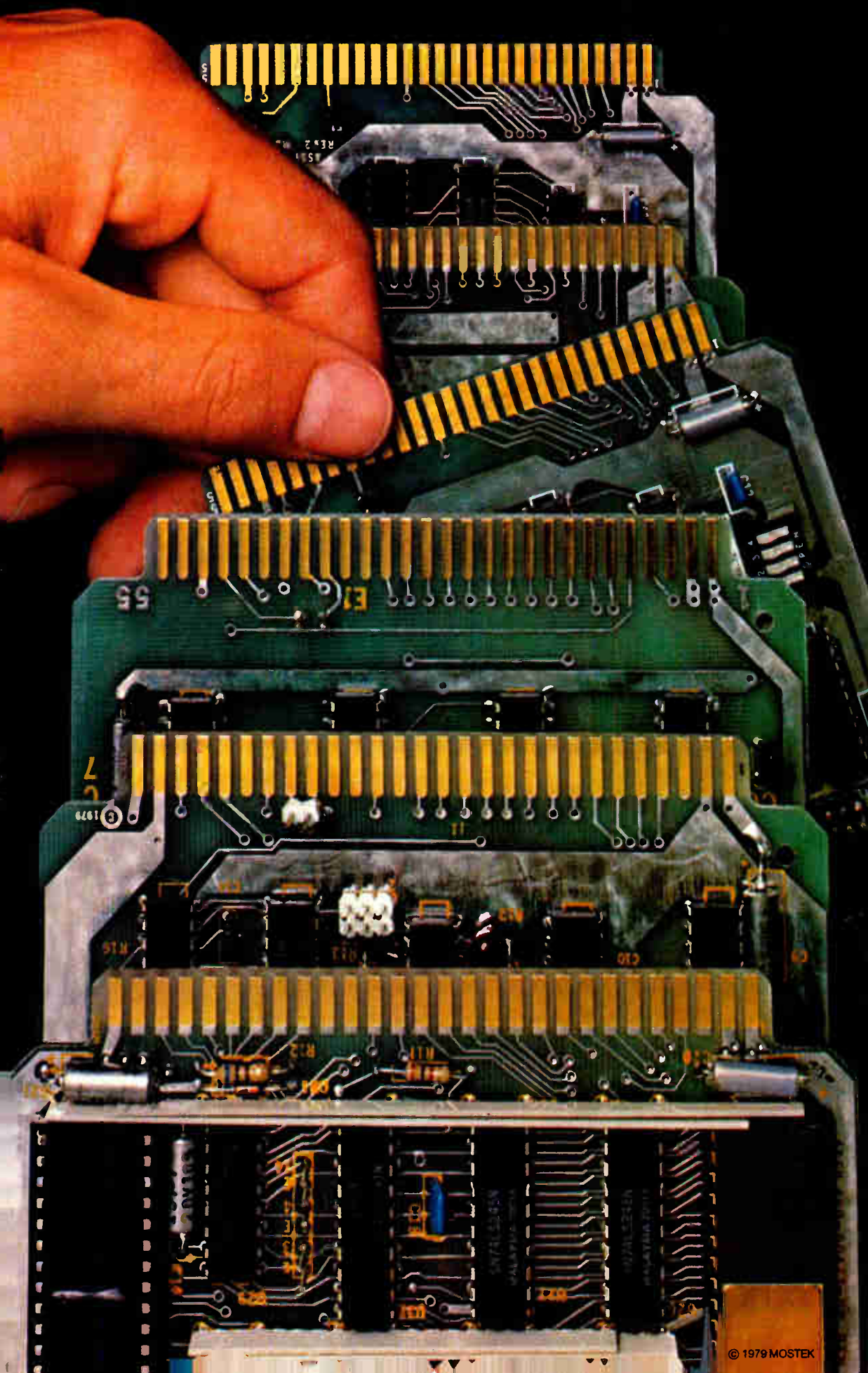

MDX-UMC

MDX-MATH

MDX-EPROM-4

MDX-SST

MDX-A/D 8

MDX-FLP

Polishing the engineer's image . . .

The decision of the Institute of Electrical and Electronic Engineers to put some real muscle, and money, behind an effort to improve the image of the engineer could prove a good thing (see p. 92). The effort to educate the public, as well as Congress, as to what technology and the engineer both can and cannot do is welcome.

The decision to go to professional public relations people is to be applauded, too. Volunteer and part-time public relations staffs, though well-intentioned, would be hard put to get the job done.

If there is a word of caution to be said to

. . . and paying for his research

"Products are the end result of technology, and are not technology in themselves." That's a good perspective, and it comes from J. Fred Bucy, president of Texas Instruments Inc., one of the United States' canniest executives.

Unfortunately, Bucy's point must be less appreciated outside TI. According to some industry observers, the U. S. is underfunding research and development and by so doing risks a technology gap—and therefore a product and an eventual trade gap.

To their credit, many industry executives recognize that more money should be spent on R&D to boost technology, efficiency, and productivity. So do key academics and many Government officials. But there are obstacles.

First are those peculiar to Washington. The best intentions of the Federal agencies are often foiled by the paralytic influences of single-issue politics, punitive tax laws, the gamesmanship of legislators like Sen. William Proxmire, and national priorities that favor exporting technology (which many in industry feel simply fosters stronger overseas competition) while putting research funding near the bottom of the list.

And the impossibility of obtaining patents

the institute, it is to remember that it is the engineer, and the role the engineer plays as a contributor to society's good, that is important here. Neither the IEEE as such nor any of the individuals who lead it is important in this context. And the public relations program should not in any way be viewed as a substitute for continuing efforts in professional activities to improve the IEEE members' working conditions and benefits. Creating a true image of what technology and the engineer do to contribute to the well-being of the nation should be uppermost in the minds of those in charge of the new program.

for Government research irritates both academic researchers, who would like some return from their research, and universities, which would like to supplement shrinking endowment and tuition income.

So Government, industry, and academe share a problem. But they are beginning to recognize it and talk about it. In Seattle last month the Association of Graduate Schools held its annual meeting with the theme of industry, academe, and governmental partnership. Unfortunately, Government and industry types were outnumbered four to one by academics, so the possibilities for problem solving were limited.

And at the Massachusetts Institute of Technology last month, a symposium on technology, innovation, and industrial development drew a broader audience. Again, though, there was some feeling of like talking to like within each group and sniping between the three groups rather than a bridging of their gaps in understanding.

But these conferences are good first steps, even if they are shorter steps than some might wish. What is needed now is more pressure from industry for increased Federal spending.

SENTRY[®] VII. IF IT WEREN'T SO FAR AHEAD, LSI WOULD BE A LOT FARTHER BEHIND.

Fairchild's Sentry VII is the most advanced general-purpose LSI test system available anywhere. There are more of them used in device development labs today than any other test system. And most important, virtually every LSI device designed over the past four years has been developed on one.

THE STUFF STANDARDS ARE MADE OF.

Sentry VII has truly become the industry standard. And for some pretty good reasons.

It's at home anywhere. Whether handling complex engineering characterization, keeping a close check on production standards at the manufacturer, or scrutinizing incoming components at the end user.

Its flexibility in testing a broad range of device types and technologies is unmatched. Sentry VII routinely handles microprocessors,

peripheral chips, bit slices, RAMs, ROMs, shift registers, UARTs and digital hybrids in technologies such as NMOS, PMOS, CMOS, HMOS, XMOS, SOS, ECL, DTL, TTL and I²L.

In addition, Sentry's exclusive modular architecture allows you to choose from a variety of high-

performance options to suit your needs. One module gives you real-time data logging and analysis. Another enhances the timing capability of the system. There's a module that expands the system's analog capability. And another that lets you perform subnanosecond time measurements with a resolution of ten picoseconds. Add to all this the IEEE bus for external instrumentation and you've got the most versatile LSI test system you can find anywhere.

LOTS OF EXTRA BENEFITS.

When you buy a Sentry VII, you get a lot more than just hardware. Like program compatibility within the Sentry family. Most Sentry software

developed over the past 10 years will run on a Sentry VII. That helps protect your software investment and allows you to draw from a vast number of programs for just about any LSI device ever made.

You also get a product with proven reliability and the best uptime record in the industry. Not to mention service, training and applications support unsurpassed by any other test system manufacturer.

But don't take our word for it. Just ask anyone who uses a Sentry VII. If it weren't so far ahead, they might not be, either.

For more information, give us a call at (408) 998-0123. Or write Fairchild Test Systems Group, Fairchild Camera and Instrument Corporation, 1725 Technology Drive, San Jose, California 95110. TWX: 910-338-0558.

FAIRCHILD

TEST SYSTEMS GROUP

**The first family
of ATE.**

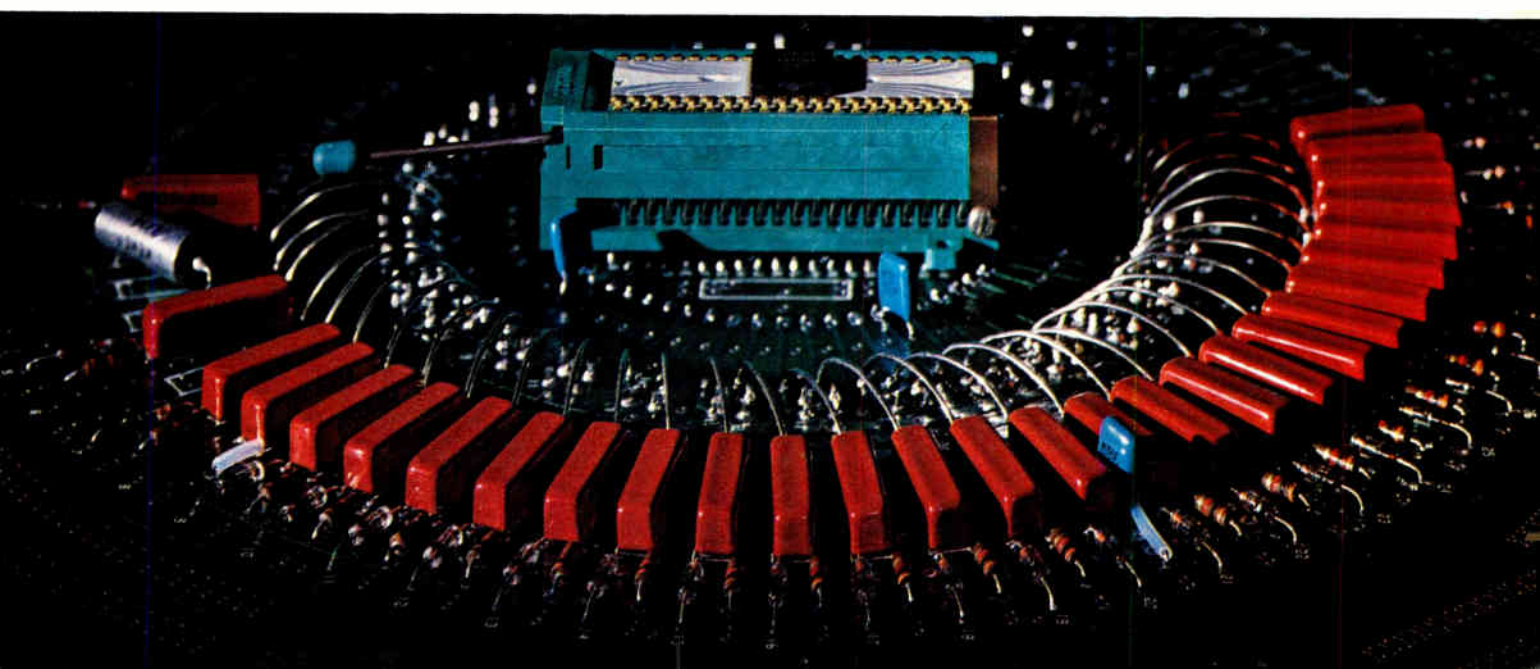
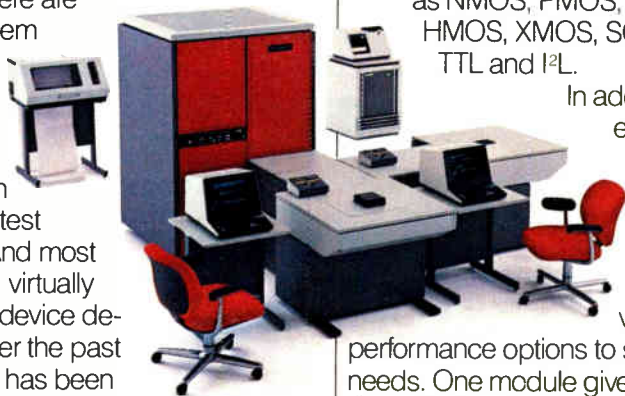

the
PUSH
toward
miniaturization

Shown actual size



D6
KEY SWITCH
for digital
electronic control

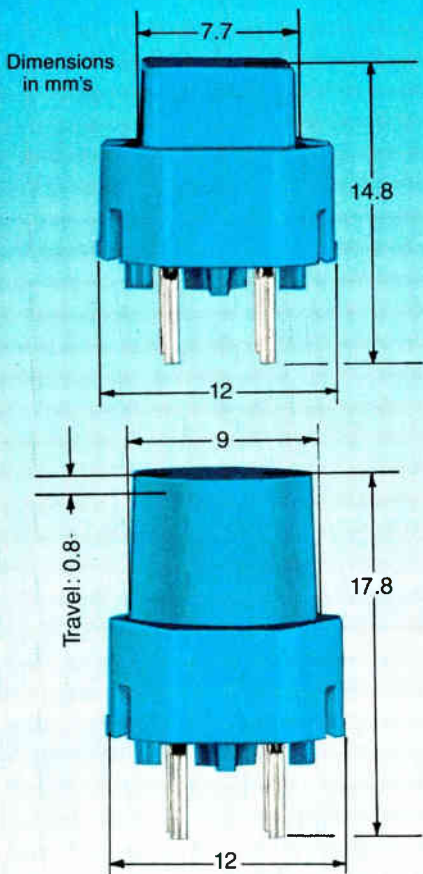

- Single pole, single throw, normally open key switch.
- Minimum center spacing of 12.7 mm's.
- Buttons (round or square) in black, yellow, white, green, red, blue, grey, ivory.
- Positive tactile feel with audible feedback.
- 1000 piece price: 27¢ each.

Fast service on samples, specs and other price quotations from ITT Schadow Inc.
8081 Wallace Road, Eden Prairie, MN 55344
612/944-1820 • TWX 910-576-2469

"Your personal
switch designers"

ITT Schadow

Circle 26 on reader service card

Meetings

Non-Ionizing Radiation Symposium, American Conference of Governmental Industrial Hygienists (2205 South Rd., Cincinnati, Ohio 45238), Capitol Hilton Hotel, Washington, D. C., Nov. 26-28.

Intelec '79—Second International Telecommunications Energy Conference, IEEE, Sheraton Park Hotel, Washington, D. C., Nov. 26-29.

National Telecommunications Conference, IEEE, Shoreham-Americana Hotel, Washington, D. C., Nov. 27-29.

Sixth Data Communications Symposium, Association for Computing Machinery *et al.*, Pacific Grove, Calif., Nov. 27-29.

Measurement Science Conference, IEEE *et al.*, California Polytechnic State University, San Luis Obispo, Calif., Nov. 30-Dec. 1.

High Temperature Electronics and Instrumentation Seminar, IEEE *et al.*, Marriott at the Astrodome, Houston, Texas, Dec. 3-4.

International Electron Devices Meeting, IEEE, Washington Hilton Hotel, Washington, D. C., Dec. 3-5.

Future Shock—Computers in the 1980s, American Institute of Aeronautics and Astronautics (Box 91295, Dept. Comp80, Los Angeles Calif. 90009) *et al.*, Ramada Inn—Rosslyn, Washington, D. C., Dec. 3-5.

VHSIC—A New Era in Electronics, American Institute of Aeronautics and Astronautics (Box 91295, Dept. VHSIC, Los Angeles, Calif. 90009), Washington, D. C., Dec. 6-7, and Boston, Jan. 21-22.

First Electronic Component and Telecommunications Apparatus Industry, Ente Fiera—Mostra di Componenti Elettronici (Viale degli Scalgieri—C.P. 805, 36100 Vicenza, Italy), Vicenza Fairgrounds, Dec. 8-10.

Second International Symposium on

Mini- and Microcomputers in Control, International Society for Mini- and Microcomputers (P. O. Box 248, Anaheim, Calif.), Galt Ocean Mile Hotel, Fort Lauderdale, Fla., Dec. 10-11.

Distributed Data Processing, Data Communications and Networks, and Minicomputers Conference, American Institute of Industrial Engineers, (P. O. Box 3727, Santa Monica, Calif. 90403), Jack Tar Hotel, San Francisco, Dec. 10-12.

Computer Networking Symposium, IEEE Computer Society (Box 639, Silver Spring, Md. 20901) *et al.*, National Bureau of Standards, Gaithersburg, Md., Dec. 12.

Conference on Decision and Control, IEEE, Galt Ocean Mile Hotel, Fort Lauderdale, Fla., Dec. 12-14.

Winter Consumer Electronics Show, EIA, Convention Center, Hilton and Jockey Club Hotels, Las Vegas, Nev., Jan. 5-8.

Second Design and Finishing of Printed Wiring and Hybrid Circuits Symposium, American Electroplaters' Society (Winter Park, Fla.), San Francisco, Hilton, Jan. 15-17.

Advanced Semiconductor Equipment Exposition, Associated Ad-Ventures Inc. (Suite V, 4546 El Camino Real, Los Altos, Calif. 94022), Convention Center, San Jose, Calif., Jan. 22-24.

Short courses

Structured Analysis, Design, and Testing of Computer Systems, Dec. 10-14, George Washington University, Washington, D. C. Write to the Director, Continuing Education Program, George Washington University, Washington, D. C. 20052.

Programming in Pascal, Mondays and Wednesdays, Dec. 3-19, and Tuesdays and Thursdays, April 8-24, 1980, Toronto. Write to Human Computing Resources Corp., 10 St. Mary St., Suite 401, Toronto, Canada M4Y 1P9.

Signetics ROM Service. Support from design through production.

Our new ROMGUIDE is just one way we help.

The time to save on ROMs is before you commit, not after. That's why we've prepared an information-packed ROMGUIDE that includes a complete ROM designer's checklist.

The ROMGUIDE can help you move from prototype to production, quickly and easily. Because it offers specific design tips for cutting development and system costs.

It's easy to get what you need in a ROM when you're backed by Signetics. Because we know there's more to a good ROM supplier than what goes on the chip. You need fast and accurate ROM code verification. With responsive delivery.

If you upgrade to a higher density later on, our generic pinout ROM family is ideal. From 8K to 64K, our ROMs are pin-compatible with each other.

So when you go to your next generation system, it's not a complete redesign. It's a simple plug replacement.

Get the ROMGUIDE for the full story. With it, we'll send our 24-page brochure, *Designing with Signetics' MOS ROM Family*. Together, these booklets make one of the best ROM idea kits you'll find.

Call the ROMLINE today at (408) 746-1756. Or contact your nearby Signetics sales office or distributor. We're waiting to show you how special a ROM supplier can be.

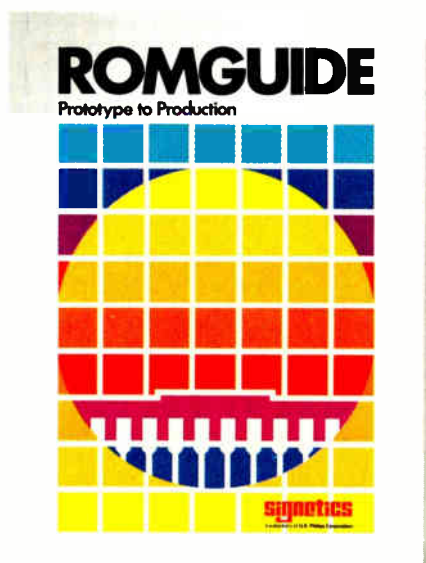

Signetics

a subsidiary of U.S. Philips Corporation

Signetics Corporation
811 East Arques Avenue
P.O. Box 409
Sunnyvale, California 94086
Telephone 408/739-7700

To: Signetics Publication Services, 811 East Arques Ave.
P.O. Box 409, Sunnyvale, CA 94086 118
Please send me your complete ROM idea kit. I'm particularly interested in:
 8K 16K 32K 64K 128K
in the following quantity _____
Name _____ Title _____
Company _____ Division _____
Address _____ MS _____
City _____ State _____ Zip _____
 I need help now, please have an MOS Memory specialist phone me immediately at: () _____



Multiple Choice Memory

Intel's new modular Series 90 system with BXP™ bus lets OEMs build to suit.

Choose your capacity. Choose your memory technology. Choose your speed. Now you can choose from a wide range of performance features that precisely match your product requirements—all with a single memory system.

Intel's Series 90 gives designers a ready-made family of memory modules and intelligent controllers that dramatically simplify and speed-up OEM memory design. Better yet, Series 90 eliminates the cost of designing new memory interface and control circuits for each new system and each new performance or density upgrade.

New bus standard for memory systems

The key to Series 90's design flexibility is our BXP bus. It's the first bus standard made exclusively for memory systems, and it's designed to make interfacing easy. Connect your system directly to the BXP bus or use our standard control interface.

Intel's BXP architecture lets you build to today's customer needs with flexibility for the future. The BXP bus will accommodate vastly increased capacity, including tomorrow's higher density memory technologies as they arrive. And you won't have to redesign even then. Intel's BXP bus adds up to more efficient memory system development and an extended life cycle for your entire product line.

*HMOS is an Intel patented process.

Performance to spare

Series 90 memory modules incorporate Intel's highest performance semiconductor memory components to give your systems the competitive edge. Our static memory modules use revolutionary HMOS technology to provide capacity from 32-64K bytes each with 100ns cycle times. Or build with Series 90 dynamic memory modules for 128-256K bytes and cycle speeds of 350ns.

Even better, our BXP bus allows you to interleave modules or combine both static and dynamic memory in the same system. However you configure, Series 90 lets you achieve the highest speeds with no performance penalty.

Address up to 2 billion bytes

Series 90 gives you plenty of memory for today's applications—plus wide open capacity for growth. Our BXP bus can accommodate word sizes from 16 to 80 bits plus Error Checking and Correction. It can easily address up to sixteen Series 90 memory modules for a maximum capacity of 4 megabytes. Entire Series 90 systems can be daisy-chained for even greater capacity.

Whether you're adding more of today's memory technology or upgrading to higher density components of the future, our BXP bus stays with you. It has addressing space already allotted for up to 2 billion bytes.

ECC for unimpeachable data integrity

A primary function of Series 90's optional control interface is our ECC feature. With single-bit

error correction and double-bit error detection, it gives your system the highest data integrity available. The controller also supports an optional error logger and display.

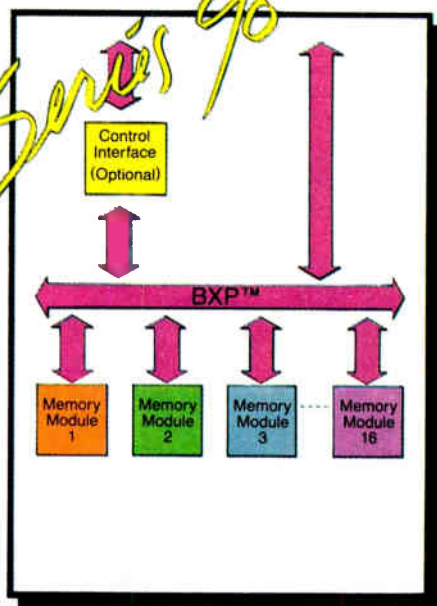

Intel's Series 90 lets you design as many as 16 static and/or dynamic memory modules totalling 4 Mbytes on the BXP bus. Connect your system directly to the bus or use our optional control interface.

Non-stop to market

Series 90 memory modules and controllers are available now, so you can start designing today. For complete information, plus our convenient Configuration Guide, contact your local Intel sales representative. Or write Intel Corporation, Literature Dept., 3065 Bowers Avenue, Santa Clara, CA 95051.

intel® delivers.

Europe: Intel International, Brussels, Belgium, Telex 24814.
Far East: Intel Japan K.K., Telex 781-28426.

Circle No. 29 for information

IMAGINE

Zilog rockets out in front again to launch a new generation.

For the first time, the architectural sophistication and data processing capabilities of large, main-frame computers has been captured in the cost-effective, easy to use format of the microprocessor. Now you can have the freedom to create entirely new, innovative systems, unhindered by the primitive architectures of previous microprocessors.

Flexibility soars to new heights.



The Z8000 allows you to directly address up to 8 MB of memory. All 16 registers are a full 16 bits wide and are completely general purpose. The powerful, problem-solving instruction



A revolution in sophistication.

The Z8000 has been designed from the ground up with options to fit your application needs exactly. For the full 8 MB addressing capability, choose the 48 Pin DIP

version. Its companion device, the Memory Management Unit, opens the way to dynamic relocation, memory protection and multi-tasking applications.

set supports 7 different data types from bits to 32 bit words, has 8 addressing modes and 418 usable opcode combinations.

The general register architecture helps avoid the well-known bottlenecks inherent in dedicated register designs. When this architecture is combined with the powerful instruction set, the Z8000 system throughput is an explosive 50% greater than any other 16 bit microprocessor available today.

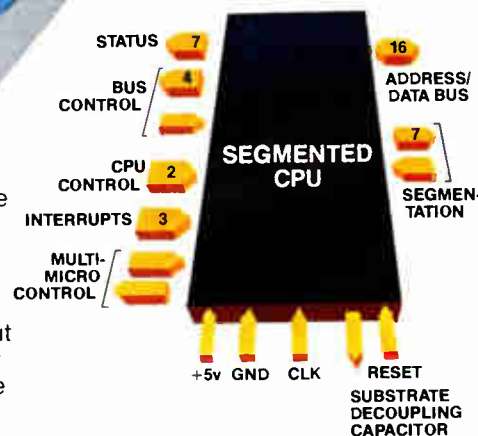

IMAGINE

A REVOLUTIONARY NEW WAY TO THINK ABOUT MICROPROCESSOR SYSTEMS. INTRODUCING ZILOG'S Z8000.

For smaller, less memory-intensive applications, select the 40 Pin version of the Z8000. It's software compatible with the 48 Pin Z8000 but addressing is limited to 64KB in each of its six address spaces. It comes in a standard 40 Pin package.

Wait 'till you meet the family.

We're starting off this new microprocessor era with a bang, but it's just the beginning. Soon to come are the Memory Management Unit, peripheral interfaces, FIFO buffer elements, universal peripheral controller and memories for any application you might have.

And, all the new I/O chips, memories and, of course, the companion Z8, take advantage of the flexible Z-BUS architecture to maximize performance, ease of interconnection and minimize PC board area.

Zilog delivers on the next generation of microprocessors. Again!

With the introduction of the Z8000, microprocessor technology explodes to new heights. Bursting with a rich and sophisticated architecture, the Z8000 not only opens the way to revolutionizing your next generation

PERFORMANCE/PRICE RATIO



of products, it has the built-in growth potential to carry your product development efforts out to totally new and unexplored horizons.

Imagine the possibilities, then light your own fuse!



Sound exciting? It is. Get your own fireworks blazing by placing your order today with your nearest Zilog distributor.

In the meanwhile, give your engineering staff a headstart on the fireworks by ordering the Z8000

literature package; in the U.S. order directly from Zilog, elsewhere from your Zilog distributor.



10460 Bubb Road, Cupertino, CA 95014
 (408) 446-4666 TWX 910-338-7621
 EASTERN REGION: (617) 667-2179
 MIDWESTERN REGION: (312) 885-8080
 SO. WESTERN REGION: (714) 549-2891
 NO. WESTERN REGION: (408) 446-4666
 EUROPE (ENGLAND): (0628) 36131/2/3
 WEST GERMANY: (08106) 4035
 JAPAN: 03-476-3010

An affiliate of
EXON ENTERPRISES INC.



Circle 31 on reader service card

The fireworks have just begun!



Three SHINING examples of CHERRY ingenuity



New: Lighted Thumbwheel and Pushwheel switches that do more than just put a little light on the subject.

Thumb a wheel or push a button. Either way you get incandescent lighted readout...*plus* electrical output in your choice of dozens of codes...*plus* your choice of sizes that should (and will!) fit your every application. What sizes? Take your pick:

T75 standard size thumbwheel. Front mount design with from 2 to 16 positions. Measures 1.300" high with .394" wide modules.

T20 miniature size thumbwheel. It's a back mount design, comes in from 2 to 16 positions and measures just 1.150" high with .500" wide modules.

T56 sub-miniature pushwheel rotary switch. Wheel indexing is controlled by two plungers—one above (—) and one below (+) the lighted legend to control up/down counting. Front mount, requires no hardware to gang. Just snap into panel cutout. Measures a small .945" high with .300" wide modules.

Next time you need a light, turn it on with a Cherry thumbwheel or pushwheel

switch. If you *don't* need light, ask Cherry, too. We'll tell you about our unlighted thumbwheels... leverwheels... and pushwheels in sizes from industrial to sub-sub-miniature. With your choice of mountings, terminations, colors, finishes and legends. In dustproof versions, pre-assembled gangs and more.

Get our complete catalog that tells all about our lighted thumbwheel and pushwheel switches...*plus* all the other multi-position switch examples of Cherry ingenuity. Just call... write... or TWX for your free copy.

CHERRY THUMBWHEELS

CHERRY ELECTRICAL PRODUCTS CORP. 3608 Sunset Avenue, Waukegan, IL 60085 • 312/689-7700 • TWX 912/235-1572

IBM offers system to process and transmit documents

International Business Machines Corp. is moving to tie together the components of its office of the future with its newly announced 5520 Administrative System, a **shared-logic system that combines advanced text editing and electronic document distribution via phone lines**. The 5520 comes from IBM's General Systems division in Atlanta and further blurs the boundaries between the computer giant's divisional product lines, with each now selling at least one product in the office-automation area.

The new 5520 can stand alone as a word processor or be attached—for document distribution ranging from one-page memos to entire manuals—to another 5520, the System/6, the 6670 information distributor, the 6640 document printer, the Mag Card II-Communicating, the 6240 Mag Card Typewriter-Communicating, the Word Processor/32, or the System/370. The system is available in four models. The shipments will be in two stages: advanced text-processing portions starting in February and the document-distribution portion beginning in November 1980. The 5520 will be made up of a system unit, two printer options, a magnetic-card reader, two display choices, and a licensed program.

Entry-level scientific computer due from Data General . . .

Watch for mid-November introduction of a new scientific Eclipse computer from the Data General Corp., Westboro, Mass., bearing an entry-level price. The S/140 will have a base price of about \$16,000 with 128 kilobytes of memory, built-in error detection and correction, and a cache-like pre-fetch memory port to speed throughput. Many other features like hardware floating-point processing will be optional. Similarly equipped, the new S/140 would have about the same price as the firm's existing S/130, but greater performance: Data General sources even say that the S/140 would have **about 70% of the performance of the much more costly Eclipse S/250**.

. . . as firm announces its networking strategy for 1980s

Data General is announcing what it calls its computer networking strategy for the 1980s this week, based on Xodiac, a communications package fully compatible with the X.25 packet-switching system. Company sources note that Decnet, the communications approach offered by Digital Equipment Corp., Data General's fiercest competitor, is not X.25-compatible, and they feel that **this gives Data General a network market edge that could last for up to a year**.

Zenith to become maker of computers for small businesses

Zenith Radio Corp., the last of the big consumer electronics companies to rely on virtually only one product—television sets—is diversifying. Now that it has acquired the Heath Co. of Benton Harbor, Mich., it plans to become a manufacturer and marketer of small-business computers. That move takes on added significance in the light of the resignation of chairman John Nevin after Zenith increased its market share but netted less profit this year.

For the \$64.5 million that Zenith paid Schlumberger Ltd. for Heath, it received, among other things, a line of **intelligent video terminals that will be the new Zenith Data Systems division's first products**. The company plans to become a broad-based supplier of small-business computers and peripherals and is recruiting design engineers.

Exxon's Kylex ready to market dense LCD display

Exxon Enterprises Inc. is about to unleash yet another tiger into the electronics marketplace. Its Kylex Inc. affiliate in Mountain View, Calif., formed in January 1978 to investigate the development of large liquid-crystal displays with high information density, is in the process of transferring its first product out of research and development and into production. The initial offering, due later this month, is understood to be a complete LCD system producing a **40-character line (5-by-10-dot matrix per character) that can interface with microprocessor systems.**

Energy search triggers big sale of array processors

One of the largest single purchases by an original-equipment manufacturer of array processors is to be announced this week by Seismograph Service Corp. of Tulsa, Okla., and CSP Inc. of Billerica, Mass. The buyer is a division of Raytheon Co. Neither firm would detail the dollar or unit amounts involved in the transaction. However, Seismograph is expected to sell its new seismic data-processing system—based on CSP's MAP-300 and Digital Equipment Corp.'s VAX-11/780—into its existing customer base, as well as using it internally. **Seismograph is said to have more than 200 seismic data-processing systems in place worldwide, all seemingly candidates for replacement.**

Mostek, SMC in licensing and second-source deal

Mostek Corp. of Carrollton, Texas, and Standard Microsystems Corp. of Hauppauge, N. Y., have agreed on a second-source and cross-licensing arrangement **that puts the New York firm into the market for standard telecommunications devices.** The deal covers SMC's CRT-5027, -5037, and -5057 Video Timing and Control (VTAC) cathode-ray-tube controllers and the FDC-7003 floppy-disk controller. Mostek products are the MK 36000 64-K read-only memory and a line of complementary-MOS telecommunication chips: the MK5116, 5116-1, 5150, 5151, and 5156.

Electronics stars in defense budget, says EIA forecast

Electronics spending by the Department of Defense will rise from \$19.2 billion in fiscal 1980 to \$26.6 billion in fiscal 1989, measured by total obligation authority in constant fiscal 1980 dollars, according to a 10-year forecast by the Electronic Industries Association. **Hot technology areas include software, large-scale integration, night vision, millimeter-wave communications, signal processing, fire control, sensing, and friend or foe identification (see p. 57).**

Addenda

Selected as the winner of a benchmark evaluation, Computer Automation Inc.'s Industrial Products division says its Capable 4000 series of logic board testers **will be the preferred test equipment for all International Telephone & Telegraph Corp. divisions.** The estimated worth of sales of the digital test systems by the Irvine, Calif., firm to ITT is more than \$4 million over the next three years. . . . Set for signing is a second-sourcing agreement for Siemens AG of West Germany to build Western Digital Corp.'s six-model FD179 floppy-disk controller line. The Newport Beach, Calif., firm expects this licensing arrangement **to expand into its data-communication chips and specialty 16-bit processor line.** . . . National Semiconductor Corp. will become a **second source for Motorola Inc.'s Macrocell family of emitter-coupled-logic array circuits.**

TRY THE 4K RAM YOU DON'T HAVE TO RETURN.

Reliability spells the difference between "just another commodity RAM" and the EA 2114 1K x 4 static NMOS RAM. Reliability built-in with extra heavy lead frames that shunt more calories of heat away from your chip. Or IC circuitry painstakingly designed to provide $\pm 10\%$ power supply tolerances. It's this kind of reliability that gives you more usable parts at incoming inspection, and measurably fewer field problems in your finished products.

There's more. The EA 2114 comes in a variety of access speeds, including one of the fastest on the market: 150 ns. Look 'em over. Then pick exactly the RAM you need, and buy it with confidence from Electronic Arrays. 550 East Middlefield Rd., Mountain View, CA 94043, (415) 964-4321; Philadelphia, (215) 643-1447; Chicago, (312) 858-8508.

Part Number	Access Time
EA 2114L	450 nsec
EA 2114L-30	300 nsec
EA 2114L-25	250 nsec
EA 2114L-20	200 nsec
EA 2114L-15	150 nsec

ELECTRONIC ARRAYS.

RAMs. QUALITY RAMs.



Compare our microprocessor design support with anyone's:

	72 hour Burned-in Reliability.		Factory Configured and Tested.		On-Site Installation.		On-Site Local Service.		Extensive Design Workshops.		Total Development Support.	
	Tek's	Theirs	Tek's	Theirs	Tek's	Theirs	Tek's	Theirs	Tek's	Theirs	Tek's	Theirs
8080A	✓		✓		✓		✓		✓		✓	
8085A	✓		✓		✓		✓		✓		✓	
8049	✓		✓		✓		✓		✓		✓	
8039	✓		✓		✓		✓		✓		✓	
8039-6	✓		✓		✓		✓		✓		✓	
8035	✓		✓		✓		✓		✓		✓	
8021	✓		✓		✓		✓		✓		✓	
8048	✓		✓		✓		✓		✓		✓	
6802	✓		✓		✓		✓		✓		✓	
6800	✓		✓		✓		✓		✓		✓	
F8	✓		✓		✓		✓		✓		✓	
3870	✓		✓		✓		✓		✓		✓	
3872	✓		✓		✓		✓		✓		✓	
Z80A	✓		✓		✓		✓		✓		✓	
TMS9900	✓		✓		✓		✓		✓		✓	
SBP9900*	✓		✓		✓		✓		✓		✓	
1802	✓		✓		✓		✓		✓		✓	

*Contact your MDL Sales Specialist for a quotation.

You'll find there's really no comparison.



Tektronix Microprocessor Development Labs offer the broadest range of quality multiple-microprocessor support available today. Tektronix won't lock you into one microprocessor family or vendor. Plus, every Tektronix MDL is backed with over 30 years of design experience. We test our Development Labs thoroughly to ensure maximum performance and reliability. Each one provides complete development capability and the Tektronix commitment that guarantees you'll keep abreast of the fast-paced microprocessor technology.

72 Hour Burned-in Reliability.

Every Microprocessor Development Lab shipped from Tektronix has been burned in at elevated temperatures for 72 hours.

**Tektronix
microprocessor
development labs.**

**Designed by
people on your side
of the bench.**

Factory Configured and Tested.

Your system is configured at the factory, then checked and doublechecked against your requirements and our specifications.

On-Site Installation.

Tektronix can send a trained technician to your company to install your Microprocessor Development Lab. You don't have to worry about getting the system running, since it will be set up and ready to work when you are.

Tektronix' full on-site warranty covers any system maintenance or part replacement for three months. Your new MDL is guaranteed to perform at top efficiency from the minute it's installed.

Service Like Nobody's Business.

Tektronix offers localized support in the largest network of MDL service centers throughout the United States and the world. You'll get fast on-site service, without waiting weeks for parts or repairs.

What's more, Tektronix will train your service personnel in system maintenance and troubleshooting. Two-week courses are offered at various service centers.

Week Long Design Workshops.

Tektronix also offers workshops that give your design personnel intensive, practical, results-oriented training. Request the courses that best suit your needs: The Microprocessor Design Workshop, Microprocessor Design Lab Operations Workshop, or the High-Level Language Software Design Workshop.

Your personnel can enroll in regularly scheduled sessions or Tektronix can schedule one or all of these workshops at any field location. Or even at your company.

Full Software and Hardware Support.

Once your MDL has been put in place, you have total development capabilities at your fingertips. Everything essential to software and hardware design is there when you need it—from our Modular Development Language (MDL/ μ), macro relocatable assemblers, text editor and debugging software to full in-circuit emulation and real-time prototype analysis.

Send for our free Systems Comparison Chart and compare our Microprocessor Development Lab with anyone's. You'll choose Tektronix because of our unmatched breadth of support, quality and reliability. So don't lock yourself into one microprocessor vendor when in all ways—performance, service and training support—Tektronix is your best choice.

Contact your local Tektronix Sales Office, or write:

Tektronix, Inc.
P.O. Box 1700
Beaverton, OR 97075

In Europe:
Tektronix International, Inc.
1180 AV Amstelveen
Amsterdam
The Netherlands

For immediate action, dial toll-free 1-800-547-1512.

Or in Oregon call collect, (503) 644-9051.

Tektronix
COMMITTED TO EXCELLENCE

Technological leadership.

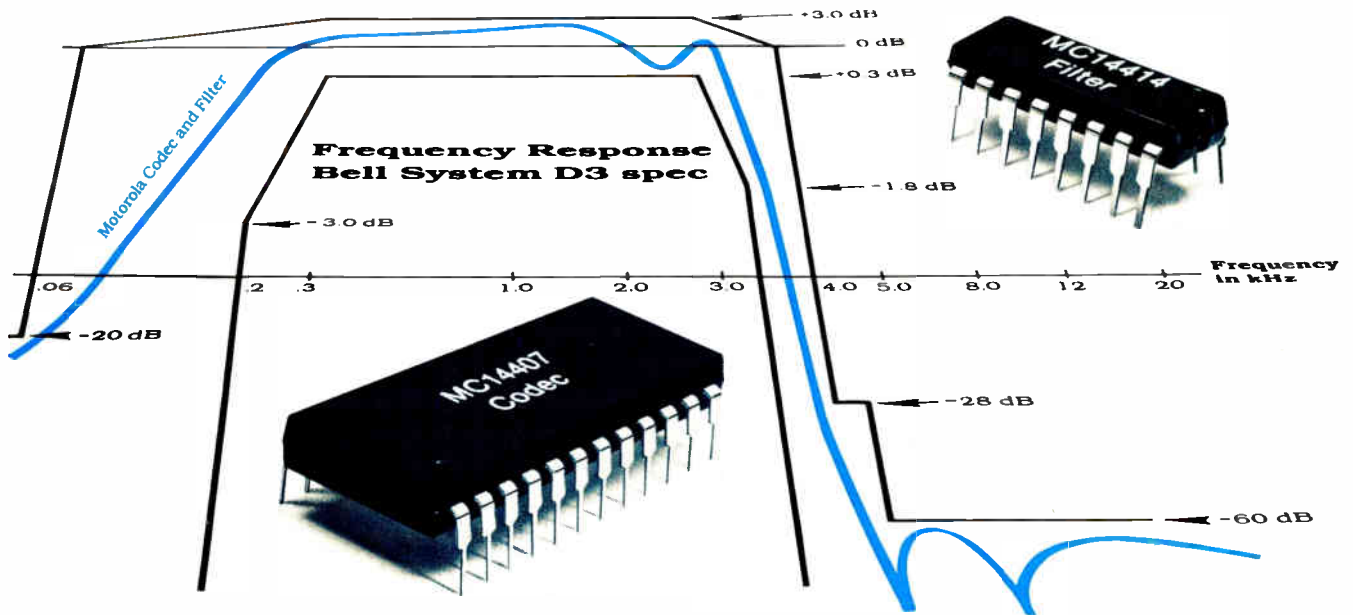

Motorola's LSI codec and filter team up to meet system specs.

Motorola's MC14406/7/4 PCM codecs and MC14414 PCM filter together meet or exceed all Bell System D3 voice frequency requirements and objectives*, and are compatible with G. 712 CCITT recommendations. *See Bell System technical reference PUB 43801

They're available from the factory now, so don't let your customers down. With Motorola codec and filter, they'll never again need to risk missing channel objectives.

Both the technologically advanced codec and filter are mass produced on our established, reliable metal-gate CMOS line, one of the most prolific and dependable CMOS manufacturing operations in the world. You know we'll be able to meet schedules with the quality you depend on. You know we'll be able to keep costs down. We're Motorola. You know we'll be here.

The 24-pin MC14407 codec provides pin-selection of A-law or Mu-law companding with D3 digital format, and the MC14404 does the same

with CCITT digital format. The 28-pin Mu-law MC14406 offers transmit and receive LSB signalling. All three are designed for 8K samples per second, and no other codec challenges the low on-hook power drain of just 1 mW.

The MC14414 filter has both transmit and receive low-pass filters on-chip, and on-hook power use is only 1 mW.

Later, when our MC3419 line feed and 2-to-4 wire conversion circuit is available, you'll be able to do the complete low-power, up-to-spec Subscriber Channel Unit including Subscriber Line Interface with reliable, space-saving, low-cost monolithic circuits.

In the meantime, see that your customers get what they have to have: systems that meet specs, including the sensitive idle noise spec of 23 dB_{BrnCO}. Motorola's codec-filter team is typically 17 dB_{BrnCO}.

For product data, write to Motorola Semiconductor Products Inc., P.O. Box 20912, Phoenix, AZ 85036. To inquire for products, contact your Motorola sales office.

State-of-the-art LSI for the telecommunications industry is just one of the many aspects of Motorola's commitment to providing components for

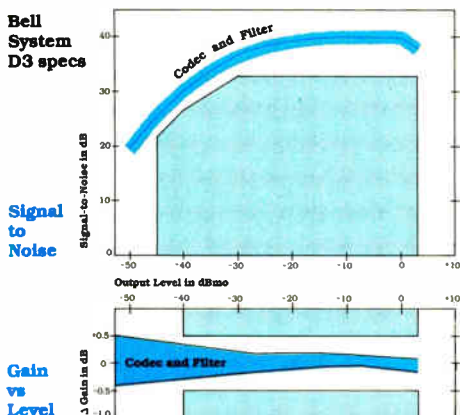

Circle 38 on reader service card

Innovative systems
through silicon.



MOTOROLA INC.

Ternary gates support three logic states

by John G. Posa, Solid State Editor

Scheme fits all three levels into 5-V swing, as well as saving real estate and power and halving propagation time

A ternary logic scheme from Signetics Corp. provides a way of achieving the throughput of very large-scale integration without shrinking device dimensions to VLSI sizes. Using standard n-channel depletion-load MOS processing, the company has developed circuits that operate on three logic states at a time—that is, in base 3 arithmetic instead of base 2.

Of course, ternary logic has a tough row to hoe in the binary-dominated solid-state world. But the Sunnyvale, Calif., subsidiary of the Netherlands' NV Philips Gloeilampenfabrieken is convinced of its future and is designing its first chips with the new logic gate.

Contrast. National Semiconductor Corp. also recently introduced a three-level logic scheme that it calls Tricode [*Electronics*, Sept. 27, p. 38]. Tricode's first two levels are the usual binary digits, represented by 0 and +5 volts respectively, and the third level comes from a chip's high-impedance state. The setup is primarily intended to reduce the pin count required to address a device.

In contrast, Signetics' approach squeezes all three logic states into a 5-v swing (see figure) and is used at the gate level rather than just at the chip level. Thus, the high-impedance state remains available for the usual application of driving a single bus from multiple sources.

As the table shows, for a hypothetical 16-bit arithmetic and logic unit, Signetics' scheme does more than just reduce the number of input and output pins. It also lessens internal circuitry and interconnections so that chip area is minimized.

Power consumption is reduced because "only half of the voltage range switches 66% of the time," that is, from 0 to 1 or 1 to 2 (or vice versa), according to John Woodman, electronic data-processing applications manager. Also, because the three logic levels are spaced within the same 0-to-5-v swing as binary logic uses, rise and fall times are cut short and propagation times are roughly halved. With cost proportional to chip area, I/O pins, and power usage, the upshot is more performance for the money.

National's Tricode requires a rather complicated encoder and decoder to recognize the three states, but Signetics engineers designed a gate that actually senses different threshold voltages between 0 and 2.5

v and between 2.5 and 5 v. Similarly, the gate's push-pull output stage can latch at three voltages.

With these gates, three different kinds of inverter can be built. One lets the 0 level pass right through while levels 1 and 2 are interchanged. Another inverter changes 0 to 2, 1 to 0, and 2 to 1; and the third type turns a 0 into a 1, a 1 to a 2, and a 2 to a 0. Thus, design of a chip can be further optimized simply by employing the inverter type suited to a particular logic problem, according to L. Keith Russell, manager of circuit research.

Signetics plans to exploit the ternary gates in at least two upcoming LSI devices. One will be a binary-to-ternary converter. "Until we can get transducers that can produce three levels, we'll use the two-to-three-level converter," Russell says. With the addition of a three-to-two-level converter, ternary chips could work in binary systems, and such a design is coming.

The other coming device will be a

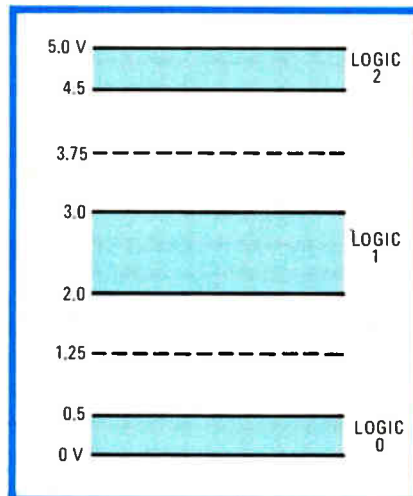

Ternary. Signetics' new depletion-load p-MOS gate can sense and drive three logic levels. The dotted lines at 1.25 and 3.75 V represent dividing lines between levels.

Item	Binary	Ternary	
Circuits	400	307	
Wire interconnections	2,000	1,334	
Input/output pins	40	28	
Speed	6- μ m dimensions	2.5 – 5 ns	1 – 3 ns
	4- μ m dimensions	1 – 4 ns	0.5 – 2 ns

Electronics review

multiplier capable of efficiently processing complex numbers. "This is exceedingly important for signal processing and real-time map reading and will help make fast Fourier filters and things of that ilk," Russell explains, adding that the lower cost will also make the innovation attractive to the word-processing, data-entry, and consumer markets.

Other schemes. This is not the firm's first bout with multilevel logic. Back in 1977, it designed a family of basic gates that used four-level integrated injection logic.

The idea did not go over so well,

admits Russell, because "I²L was slow back then." Another problem with multilevel bipolar logic like I²L is that, being controlled by current rather than voltage, each gate needs a replicator that senses the output current and feeds a control signal back into the input to keep that current constant, thereby making current latching work.

However, Signetics is eyeing a high-performance version of I²L developed by Philips called integrated Schottky logic, or ISL [*Electronics*, May 25, 1978, p. 42]. For fast four-level logic, ISL might do.

in Japan, including a representative of a U. S. semiconductor maker and others, say they are lower there for products from both countries, whereas Mostek Corp. chairman L. J. Sevin claims the Japanese charge more at home than in the U. S. [*Electronics*, Oct. 25, p. 40].

One Japanese distributor of integrated circuits reports that domestically made 200-nanosecond RAMs sell there for between \$3.43 and \$4.29 each in lots of 10,000 or more, with slower parts from Motorola and Texas Instruments going for about the same price. Mostek's asking price is about double that, he says.

Origins. The controversy began last month in Washington, D. C., where Sevin, representing the Semiconductor Industry Association, told a congressional committee that Japanese prices in the U. S. range from \$4.85 to \$5.40, whereas prices in Japan for American parts range from \$6.90 to \$8.10. The U. S. parts would not have sold there unless Japanese parts were going for comparable prices at home, the SIA argued. Prices in Japan may have

Trade

Effect of RAM imports into U. S. disputed; shortages may trigger increases in prices

Charges that Japanese makers of 16-K random-access memories have invaded the U. S. market with prices much lower than in Japan are reverberating in the markets of both countries. Moreover, supply in the

U. S. is so tight, some U. S. manufacturers are considering raising their prices.

At the heart of the controversy are the per-unit prices for the 16-K RAMs in the two countries. Sources

Exports up, but . . .

It looks like another good export year for U. S. electronics firms, with total exports rising 30% to \$6.9 billion in the first half, while imports increase by only 17% to \$5.6 billion, the U. S. Department of Commerce reports. The \$1.3 billion trade surplus was 162% higher than in 1978's first half.

However, some Government analysts see disturbing signs in the trade data, notably that imports in categories like computers and telecommunications equipment are increasing faster than exports. "In computers, the U. S. is still way out in front," says one trade specialist. "But in telephone equipment, imports are catching up as the U. S. market opens to competition. If imports keep growing by more than one third, while exports expand more slowly, imports are going to surpass exports in a few years."

-Ray Connolly

U. S. EXPORTS AND IMPORTS, JANUARY THROUGH JUNE (millions of dollars)

	Imports			Exports			Trade balance	
	1978	1979	% change	1978	1979	% change	1978	1979
Computers and related equipment	343	490	+42.9	1,877	2,549	+35.8	+1,534	+2,059
Calculating and accounting machines	254	256	+0.8	138	179	+29.7	-116	-77
Consumer electronic products	2,240	2,344	+4.6	341	374	+9.7	-1,899	-1,970
Telephone and telegraph equipment	102	141	+38.2	166	212	+27.7	+64	+71
Radio and TV communication equipment	383	443	+15.7	761	858	+12.7	+378	+415
Electronic components	1,238	1,631	+31.7	1,423	1,874	+31.7	+185	+243
X-ray apparatus, etc.	116	129	+11.2	255	347	+36.1	+139	+218
Electronic measuring and test instruments	152	192	+26.3	348	492	+41.4	+196	+300
Totals	4,828	5,626	+16.5	5,309	6,885	+29.7	+481	+1,259

SOURCE: BUREAU OF THE CENSUS, U. S. DEPARTMENT OF COMMERCE

dropped as a result of his testimony, he says. He and observers in both countries report that Japanese pricing is subject to much fluctuation.

Confusing the pricing issue are the variety of specifications available, which affect prices. For example, it is not always clear if two identical prices refer to the same specs.

An official at Nippon Electric Co., one of the firms singled out by Sevin, would not give prices. "But I can at least say that the price of 16-K RAMs is 10% to 15% lower in Japan than in the U. S.," said Keisuke Yawata, general manager of the International Electron Devices division, in Tokyo.

Nor would Hitachi Ltd., another of the companies singled out, comment on prices. However, Hiroshi Asano, executive managing director of the Electronic Devices group, Tokyo, said that the supply-demand gap is so great that any protectionist measures would hurt U. S. users of the 16-K RAMs.

An example of the problems created by the gap comes from Data General Corp., which recently posted its first-ever losing quarter. The Westboro, Mass., company said one of the two reasons was inability to deliver Nova 4 computers as planned and attributed the lag to a shortage of 16-K parts.

In fact, the Japanese pricing tempest is submerged by the high U. S. demand for memory bits. Demand will exceed supply by a factor of 4 in 1980 and of 2.5 in 1981, taking 1980 production capacity increases into account, says Bruce Threewitt, product marketing manager for Fairchild Camera and Instrument Corp.'s MOS Products division, in San Jose, Calif.

Hike. It is no wonder then, that some U. S. firms are thinking about price increases on their 16-K lines. Threewitt acknowledges that Fairchild is considering such a move.

Another company considering such a move is Motorola Inc. David Ford, MOS memory strategic marketing manager in Austin, Texas, says stable or rising prices are necessary to finance needed capacity increases. *-Electronics staff*

Industrial

New language simplifies coding

Convinced that the world of electronic industrial control needs a new language, Analog Devices Inc. has brought still another to the Tower of Babel. Its new A^{PLμS}, standing for "a programming language for microprocessor systems," is intended to simplify software writing in the field.

There are plenty of languages available, but, says the Norwood, Mass., company, none has the right mixture of high- and low-level features needed by industrial controllers. The firm now derives about 35% of its revenues from its line of industrial controllers, and A^{PLμS} is being introduced along with a versatile new controller, the Macsym 20. The unit talks to anything from Teletype to mainframe with its wide variety of interfaces, including RS-232-C, RS-422, and IEEE-488.

Commands. Working in a variety of configurations, from stand-alone measurement control to complex, interactive networking, the Macsym 20 comes with a basic command set that lets the user make high-level control statements easily in IF . . . THEN form and simple com-

mands like WAIT T, halting the program for interval T. The set includes two-character alphanumeric for data storage or indexes.

The upshot is simpler communication between a host computer and the Macsym 20 network modules, since control strings may be initiated with a simple two-character label. In addition, the command set unburdens the host.

Users who want to put together more intricate, interactive networks can buy the \$13,990 development system shown in the photograph. Its software aids include compiler, text editor, and utilities.

Once the program is generated, the development system will burn it into a 2716 programmable read-only memory, which may be substituted for the PROM containing the command set. Making this possible is the fact that the Macsym 20 is built around an A^{PLμS} interpreter.

Extensions. It also means that Analog Devices will extend the product line toward both the high and the low end, since it makes programs system-independent. If, for example, the present Z80 system microprocessor is upgraded to the Z8000, the programs written for the original board could still be used. Similarly, the programs could be transported to multi-user, multitasking systems as they become available.

The \$3,250 Macsym 20 can oper-

Partners. Development system for Macsym 20 industrial controller works with A^{PLμS} programming language, which is machine-independent, block-structured, and infinitely extensible.



ate as a stand-alone controller without a display or keyboard. It can measure analog or digital inputs and provide analog and/or digital control outputs.

To enhance its use in networking, the system configuration is user-determined. He or she can plug any of a number of different analog/digital input/output cards into the chassis's 16 slots. —Richard W. Comerford

Telecommunications

Microcomputer fills many phone roles

Seeking a single-chip microcomputer that could be put to work in equipment ranging from individual telephones to huge central-switching systems, Bell Laboratories first set about to find a commercially available unit. But the search was scrapped because the general-purpose devices on the market do not fill the bill. So the MAC-4 was born: a special-purpose low-power microcomputer dedicated to telephony.

Its instruction set has many low-level bit-manipulation facilities, but is compatible with the labs' well-regarded high-level C programming language. On-chip random-access and read-only memories can be configured for the job at hand, and 34 of the chip's 40 pins are used for input and output.

C-MOS. To hold down telephone-loop power consumption, the 4-bit chip [Electronics, Aug. 30, p. 32] is cast in silicon-gate complementary-MOS technology. The chip consumes only 200 milliwatts during operation, but upon activation of a special halt instruction everything except the RAM is turned off and consumption plummets down to microwatts.

Thus this microcomputer can run on the power available on a telephone line, and a battery can run the device for extended periods of time. Even a charged capacitor can keep information like phone numbers alive for days in RAM.

As the simplified block diagram shows, the MAC-4 has a 4-bit data bus. However, it can also process operands 8, 12, and 16 bits wide. Also, like the 9900 microprocessor

from Texas Instruments, the chip has no accumulator. Instead, four addressing modes, one direct and three indirect, allow any RAM location, two memory-pointer registers, and a group-pointer register to function as accumulators.

The MAC-4 instruction set has 43 instructions arranged in four groupings. Two cover single- and double-operand data manipulation, one is for program transfer, and a fourth is for miscellaneous commands.

The microcomputer has a 12-bit internal address bus, so on-chip RAM, ROM, and register space can total 4,096 locations. The ROM can vary in size from 1,024 to 3,840 4-bit nibbles, and the RAM's size can range from 80 to 192 nibbles. The respective memory sizes can be set at layout time.

Lots of software. "The MAC-4 has been supported by tons of software aids," says Lee Thomas, head of the microprocessor systems department at Bell Labs in Holmdel, N. J. One of them, he says, takes the output of the assembler and generates a tape to make masks for a proper complement of RAM and ROM on the chip "without human intervention." The tape also configures the MAC-4's programmable logic array, which "can be used for all kinds of high-speed combinatorial logic," he says.

Bell has already designed an 8-bit microprocessor called the MAC-8, but Thomas stresses that the MAC-4 is in no way intended to compete with or supplant the older chip. In fact, the new chip is intended to work with the MAC-8, in multiprocessor configurations, for example.

As for the future of the MAC-4, Thomas says that its dimensions will be shrunk for more speed and a smaller die. He also admits that the 12-bit, 4-K addressing range has already proved to be too restrictive, so a future version will provide for a wider internal address bus. Ironically, one commercial semiconductor company has approached the labs with the intent of producing the microcomputer. But that would require complicated in-house approval, says Thomas, and possible legal

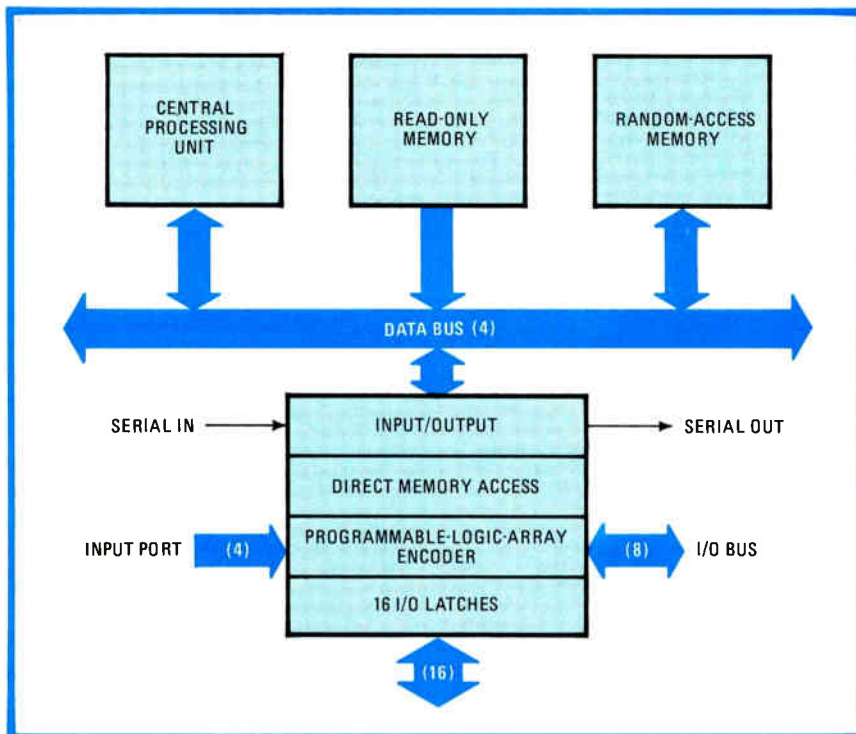

Adaptable processor. Bell Labs' 4-bit C-MOS microcomputer includes configurable memory and a programmable logic array. It will serve many functions in the phone system.

IMAGINE ... DESIGNER DPM'S \$34.*



DM-4100N
4½ Digits
Low Profile Case

***DM-3100L**
\$34 (100 quan.)
Short Depth Case

Imagine quality OEM Digital Panel Meters with all these features at such low cost!

3½ DIGIT DPM'S							
	MODEL	INPUT	CASE STYLE	DISPLAY	POWER	FEATURES	PRICES
LED DISPLAY	DM-3100L	±2V, balanced differential	Short Depth	.56" High LED	+5 Vdc @ .28A	Ultra-low cost	\$50 (1-9) \$34 (100's)
	DM-3100N	±2V, balanced differential	Low Profile	.56" High LED	+5 Vdc @ .28A	Optional off-set pot	\$50 (1-9) \$34 (100's)
	DM-3100B	±2V, balanced differential	Short Depth	.56" High LED	115/230 AC, pin-selected	Low cost AC power	\$68 (1-9) \$48 (100's)
LIQUID CRYSTAL DISPLAY	DM-3100X	±2V, balanced differential	Short Depth	.6" High Liquid Crystal	+5V, 6mA or 9-15V	Battery Powered	\$66 (1-9) \$43 (100's)
	DM-3100U1	±2V, balanced differential	Low Profile	.5" High Liquid	+5V, 6mA or 9-15V	Programmable Descriptors	\$76 (1-9) \$51.50 (100's)
	DM-3100U2	±2V, balanced differential	Low Profile	.5" High Liquid Crystal	115AC(U2)	Programmable Descriptors	\$76 (1-9) \$51.50 (100's)
	DM-3100U3	±2V, balanced differential	Low Profile	.5" High Liquid Crystal	230AC(U3)	Programmable Descriptors	\$51.50 (100's)
4½ DIGIT DPM'S							
LED DISPLAY	DM-4100L	±2V, single-ended	Short Depth	.56" High LED's	±5Vdc @ .4A	Low cost 4½ digit	\$87.50 (1-9) \$62 (100's)
	DM-4100N	±2V, single-ended	Low Profile	.3" High LED's	+5Vdc @ .4A	Low cost, 4½ digit	\$87.50 (1-9) \$62 (100's)

Case Styles - Short depth Case: 1.760"H x 3.00"W x 2.150"D, cutout: 1.812" x 3.062"
Low Profile Case: 0.94"H x 2.531"W x 3.25"D, cutout: 0.97" x 2.562"

OUTSTANDING SPECS COMMON TO ALL MODELS

- Autozeroing
- Ratiometric reference to reduce drift
- 1000 Megohm input impedance
- 5 pA input bias current

User-added options:

- Internal attenuators for ranges up to ±1 kV
- Internal current shunts for ranges up to ±2A



11 CABOT BOULEVARD, MANSFIELD, MA 02048 / TEL: (617)339-9341 / TWX 710-346-1953 / TLX 951340
Santa Ana, (714)835-2751, (L.A.) (213)933-7256 • Sunnyvale, CA (408)733-2424 • Gaithersburg, MD (301)840-9490
• Houston, (713)781-8886 • Dallas, TX (214)241-0651 OVERSEAS: DATEL (UK) LTD—TEL: ANDOVER (0264)51055
• DATEL SYSTEMS SARL 602-57-11 • DATELEK SYSTEMS GmbH (089)77-60-95 • DATEL KK Tokyo 793-1031

CALL TODAY FOR YOUR FREE ENGINEERING PRODUCT HANDBOOK

battles because the telephone industry is government-regulated at the state and Federal levels. But, he smiles, "I would love to see the things sold at K-Mart." -John Posa

Speech synthesis

Module starts 990 family talking

That low murmur from the speech-synthesis corner of integrated circuitry is working its way up to a shout. Texas Instruments Inc. is adapting its talking chip set to a variety of products, including a new module aimed at manufacturers of industrial control, test, and security systems. Also, other IC houses are planning to add their voices to the marketplace soon.

Complete products. In introducing its TM990/306 speech-synthesizing module at this week's Midcon show in Chicago, TI is continuing to offer complete products, rather than the synthesizer IC and associated chips. Houston-based MOS microprocessor marketing manager Jim Huffhines notes that the TM990 16-bit microprocessor family provides modules that are much easier than chips to assemble into systems.

The 306 module [*Electronics*, Oct.

25, p. 33] will offer a basic vocabulary of about 180 words, including letters A to Z and numbers 1 to 12. As the figure shows, the board comes with eight 2716 erasable programmable read-only memories, in which the vocabulary is stored.

Huffhines says the 128-K TM0350 p-channel MOS read-only memory will eventually store the vocabulary code, once the final word list is set. Then some or all of the E-PROM sockets may be used for chips with added words. Also, TI points out, words can be created by compounding sounds—for example, preceding "crease" with the sound of the letter N or D.

Circuitry setup. Priced at \$1,280 for one unit and available in production quantities early next year, the 306 module incorporates the TMC0280 synthesizer chip. It has a TMS1099 4-bit controller and other circuitry necessary for overhead-free interface with the control processor in a 990 system. Huffhines says the module will work with other microprocessors, but not on the same plug-in basis.

The first product to use the synthesizer chip was the highly successful Speak & Spell educational game introduced last year [*Electronics*, June 22, 1978, p. 39]. It also is in use in a language translator [*Electronics*, May 24, p. 44] and in a

speech-synthesis peripheral for the 99/4 home computer [*Electronics*, June 21, p. 93].

Other chip makers are working on synthetic-speech ICs. National Semiconductor Corp. plans to introduce a chip set early next year. The company is believed to be pursuing a different synthesizing technique from the linear predictive coding TI uses. There is, also, the two-chip programmable synthesizer from Telesensory Systems Inc. [*Electronics*, Oct. 11, p. 41].

Other competition will be coming from abroad. Intermetall GmbH, the Freiburg, West Germany, unit of the ITT Semiconductors Group, is readying a very large-scale IC with a 20-word vocabulary for consumer applications [*Electronics*, Oct. 11, p. 74]. In Japan, Hitachi Ltd. has designed a three-chip set in conjunction with the Nippon Telegraph and Telephone Public Corp [*Electronics*, Oct. 25, p. 63]. Like the TI chip set, it employs p-MOS technology and consists of a synthesizer chip, a 128-K vocabulary ROM, and a 4-bit microcomputer. -Wesley R. Iversen

Components

Bipolar op amp takes on FET parts

Most design engineers equate field-effect-transistor operational amplifiers with the ultimate in low bias current. But a new bipolar op amp from National Semiconductor Corp. could change that.

The LM11 precision instrumentation amplifier, with few exceptions, is an electrical equivalent to the industry-standard LM108. Notable among those exceptions, the input currents have been reduced by more than a factor of 10, and offset voltage and drift have also been improved (see figure on p. 46) over the full operating temperature range.

According to Robert Widlar, the renowned bipolar specialist who designed the part for National, FET op amps have been popular because of their low input bias currents, "but

Speak to me. TI's speech synthesis module includes synthesizer chip and vocabulary ROM, control processor, and E-PROM that also is used for vocabulary.

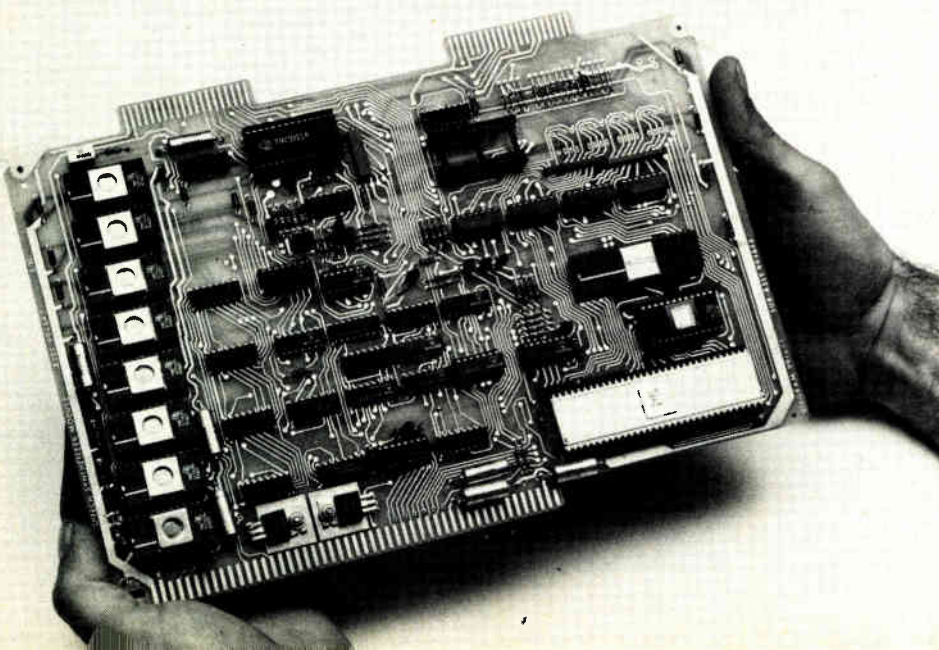

Technological Leadership.

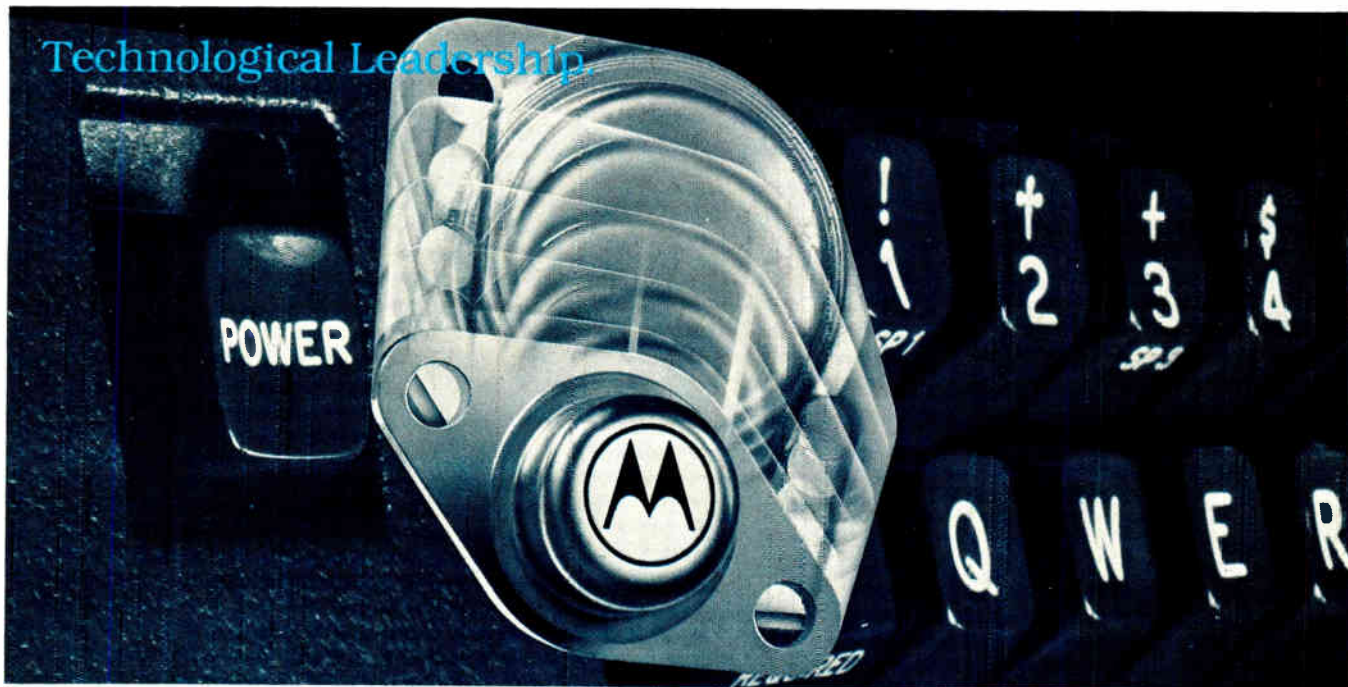

Shrink your switcher even further with the first 100 W Switchmode™ TO-66.

As equipment shrinks to desktop size and performance requirements balloon, the squeeze on designers to cut space and weight while retaining reliability has intensified.

Nowhere is this more true than in power supplies. Formerly elephantine linear units are compressed into bantam-sized, lightweight switching units and expected to perform head-and-shoulders over their predecessors.

Now Motorola introduces a family of high-voltage, TO-66 power transistors designed to optimize the demands of today's shrinking switchers.

TO-66. The 100W hermetic answer.

Normally, to get high voltage performance in a power switch you'd have to choose either a conventional TO-3 metal or a plastic TO-220. Either way a compromise with what you may truly want for your low-end supply.

With the MJ4360/4380/4400 TO-66s, the choice is obvious.

The family combines the hermeticity you'd expect from a TO-3 in one-third the volume plus good current capability: 1.5–5 A max IC... 300 and 400 V_{CEO}... max fall times of less than 0.9 μs. And rugged, reliably-packaged SOA that runs out to 100 W in the 5 A unit.

Best of all, Switchmode.

Switchmode is the Motorola-originated, Motorola-standardized method of designing and characterizing switching devices specifically for high-voltage, high-frequency applications. We completely define all necessary performance parameters of this state-of-the-power art. No unknowns, empiricals or vague, non-existent specs but solid, practical data from a pragmatic source... the Designers™ Data Sheet.

Electronics/November 8, 1979

Use these new units in smart terminals, small computers, electronic typewriters, point-of-sale electronics, portable oscilloscopes and wave analyzers, etc. to realize true savings in space and costs.

If plastic strikes your fancy . . .

We're expanding our very popular high-voltage line: new MJE5740–42 Power Darlington's... first of their kind in TO-220. Offering 8 A, 80 W, 300, 350 and 400 V capability with min gain of 200, prices start at just 99¢, 100-up.

Device Type	I _C Max	V _{CEO(sus)}	P _D	Price 100 999
MJ4360	1.5 A	300 V	40 W	\$.95
MJ4361	1.5 A	400 V	40 W	\$1.15
MJ4380	4.0 A	300 V	75 W	\$1.45
MJ4381	4.0 A	400 V	75 W	\$1.80
MJ4400	5.0 A	300 V	100 W	\$1.80
MJ4401	5.0 A	400 V	100 W	\$2.20

For our POWER LEADER contact your authorized distributor or Motorola Semiconductor Products Inc., P.O. Box 20912, Phoenix, AZ 85036.

Switchmode discretes, along with our ICs, will shrink what you need for your



Innovative systems through silicon.



MOTOROLA INC.

Circle 45 on reader service card 45

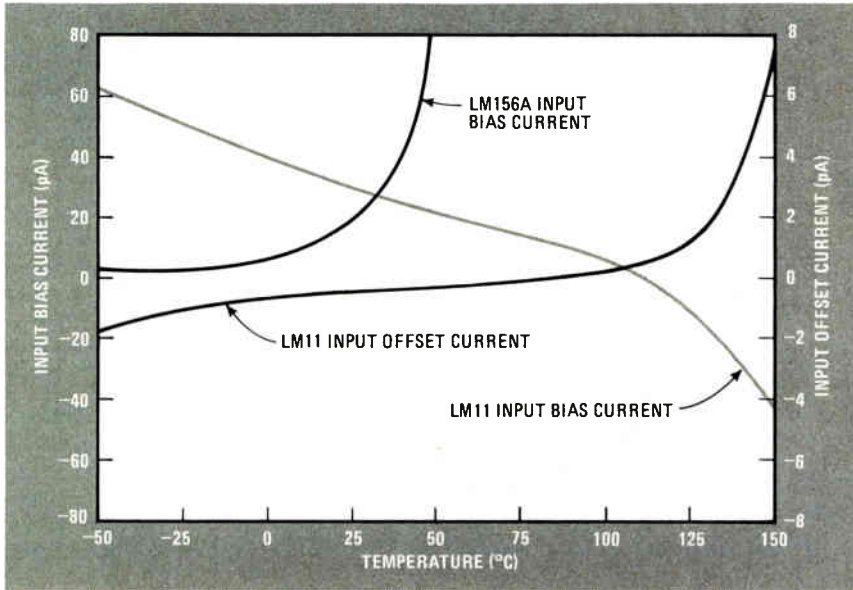

Best of both. New National op amp design has inherent bipolar stability, along with low input bias current usually associated with FET parts. Performance also is less heat-sensitive.

those currents tend to double with every 10° to 11°C increase.” What’s more, he claims, even if the offset voltage of a FET is trimmed, “drift does not come into line, and long-term stability is much worse than bipolar designs.”

Stable bias. In contrast, the 20-picoampere bias current of the LM11 “doesn’t double every 11°C. In fact, it is typically less than 50 pA over its rated -55° to +125°C operating range.” In a FET op amp, such bias-current performance comes with large errors in input offset voltage, but with the new bipolar part, “think again,” says Widlar. The LM11’s offset voltage starts at around 100 microvolts and drifts only about 1 $\mu\text{V}/^\circ\text{C}$. Long-term stability—about 10 μV a year—is at least an order of magnitude better than for FET op amps, he claims.

Although the offset current of the LM11 is usually under 10 pA from -55° to +125°C, the 150-pA maximum bias current may still be a nuisance, he points out. “But the bias current is well behaved with temperature,” he says, noting that National has on-chip circuits that can give maximum bias currents of 15 pA over a -55° to +100°C range “if a trim or two is allowed.”

Widlar notes that the development of the LM11 was something that

should have been done a long time ago. “It’s a matter of containing the leakage currents,” he explains. “But that means understanding the leakage phenomenon.”

Since leakage currents are proportional to how hard a transistor is driven, Widlar operates the devices in the input stage of his amplifier at very low levels. Bias currents for the differential input transistors are provided by a double-emitter punch-through transistor. This type of device is diffused for super-high gain, but it also has a dangerously low breakdown voltage.

This potential is regulated by cascoding; that is, its collector and emitter are connected to the base and emitter of another device. This scheme keeps the collector-emitter voltage to that of a diode drop, or near 0 volt. In addition, Widlar operates the punch-through device in a reverse-active mode for temperature compensation.

Manufactured with standard bipolar processing using super-gain transistors and zener-zap trimming, the LM11 is a redesign of the older LM112, a fully compensated version of the LM108 that includes offset balancing. Thus it is internally compensated, but external compensation can be added for improved frequency stability, particularly with

capacitive loads, Widlar notes.

As such, “it makes a good plug-in replacement for most op amps, as it can eliminate adjustments in most circuits along with improving performance, especially with large source resistances,” Widlar says. Production quantities will be available later this month, but prices are not set yet.

-Bruce LeBoss

Medical electronics

Device will aid deaf in reading lips

A microprocessor-run device that can analyze and display spoken words symbolically for deaf persons may one day fit into a pair of glasses. Prototypes, using Data General minicomputers for speech analysis, have improved syllable identification to an accuracy of 75%, compared with 25% for the trained lipreader.

The miniature Autocuer will be programmed to identify, analyze, and display only the tricky “look-alike” sounds that frustrate the lipreader, says Robert L. Beadles, project director for the Research Triangle Institute, Research Triangle Park, N. C. It will project the sounds as nine simple visible symbols, or cues, appearing in air alongside the speaker’s face. The symbols, which represent syllables, are formed with two seven-segment light-emitting diodes.

LED display. RTI’s earlier speech-cueing systems have used Data General Corp.’s Nova 210 and 820 minicomputers. Eventually, Autocuer will probably use a microcomputer to drive the pair of LEDs located on the bow of a pair of eyeglasses. An optical relay element in the lens of the glasses projects the LED-transmitted symbols to focus at a distance of about 4 feet, where they can be read along with a speaker’s lips.

The Autocuer could increase comprehension to about 90%, at least in clinical settings, says Michael C. Peck, project director for the National Aeronautics and Space Ad-

Current sensing resistors for multi-range instruments.

NEW

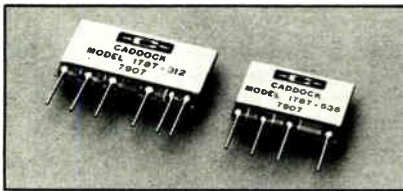

Caddock's Type 1787 Current Shunt Resistor Networks.

Absolute resistance tolerances of 0.25%, 0.1%, 0.05% and 0.02% make these 2-, 3- and 4-decade current shunt resistor networks the ideal replacement for expensive, bulky discrete resistors.

16 standard models are now available. The basic network design provides a series total resistance of 1000 Ω , 100 Ω , 10 Ω and 1 Ω . Other standard models provide commonly used variations of this basic design.

For Type 1787 data, circle Number 201.

Non-inductive precision resistors for power switching circuits.

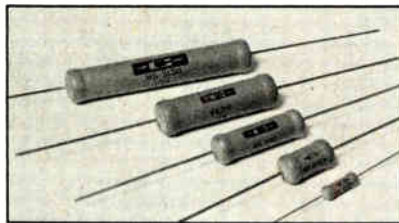

Caddock's Type MS Power Film Resistors.

Caddock's patented Non-Inductive Design in power ratings from 2 watts to 15 watts assures minimum voltage transients in all types of power switching circuits.

High stability Micronox[®] resistance films operate to +275°C and years-long load-life tests demonstrate extended-life stability better than 0.05% per 1000 hours.

For Type MS data, circle Number 203.

Off-the-shelf precision decade voltage dividers.

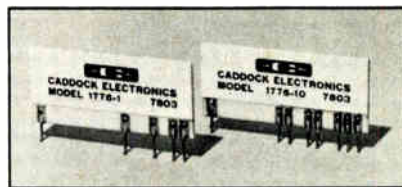

Caddock's Type 1776 Precision Decade Resistor Voltage Dividers.

When used as a 10 Megohm input voltage divider, the Type 1776 family can provide high accuracy voltage division in ratios of 10:1, 100:1 and 10,000:1.

Type 1776 Precision Decade Resistor Voltage Dividers are now available in 25 standard models with ratio TCs from 50 ppm/°C to 5 ppm/°C. Caddock's laser production techniques keep OEM quantity prices low, too.

For Type 1776 data, circle Number 205.

CADDOCK Resistor Technology solving problems across the board!

NEW

High stability resistors for very-high voltage control and measurement circuits.

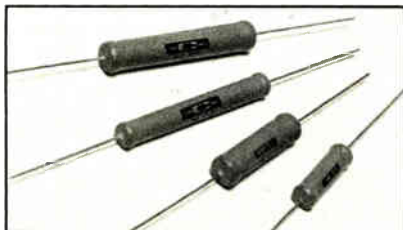

Caddock's Type MG High Voltage Resistors.

High voltage probes and control circuits make wide use of Type MG resistors for precision high voltage regulation and high voltage measurements.

Long-term stability — plus proven reliability — have also made these precision resistors first choice in communications satellite voltage control circuits.

For Type MG data, circle Number 202.

100 Megohms in a miniature package.

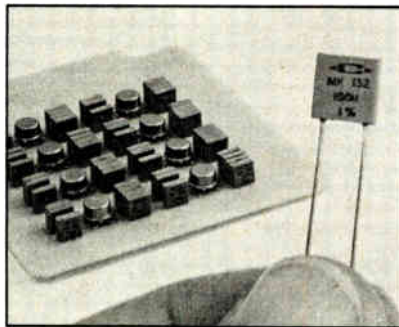

Caddock's Type MK Precision Film Resistors.

Precision values to 100 Megohms in a miniature CK 06 case make the Type MK ideal for low current designs.

These non-inductive resistors find wide application in high-impedance analog circuitry.

For Type MK data, circle Number 204.

Resistor pairs and quads with very low ratio TC.

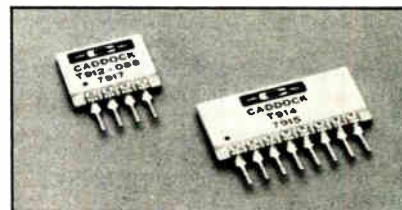

Caddock's Type T912 and T914 Precision Resistor Networks.

Ratio tolerances to $\pm 0.01\%$, ratio TCs of 2, 5 or 10 ppm/°C and ratio stability within $\pm 0.01\%$ at full load for 2000 hours provide exceptional stability in precision analog circuits.

Both pairs and quads have isolated resistors of equal value. Standard resistance values are 5 k Ω to 1 Megohm and custom variations with unequal values are available.

For Type T912 and T914 data, circle Number 206.

Caddock's latest General Catalog provides complete performance data and specifications on over 100 models of these outstanding 'problem-solving' resistors.

For your copy, just write or call to Caddock Electronics, Inc., 3127 Chicago Ave., Riverside, Calif. 92507 — Tel: (714) 683-5361

Circle 207 on reader service card

CADDOCK
HIGH PERFORMANCE FILM RESISTORS

Caddock will be at "Electronics '79 Olympia", Stand 132 in London, Nov. 20-23.

For Rent

Rental Electronics rents all kinds of Amplifiers, Analyzers, Calibrators, Counters, Couplers, Generators, Meters, Micro-computer Development Systems, Modulators, Oscillators, Oscilloscopes, Power Supplies, Printers, Probes, Recorders, Synthesizers, Terminals, Test Sets... and much more.

Rental Electronics rents equipment from ADDS, Ailtech, Associated Research, Beehive, Biomation, Boonton, Brush, Dana, Data I/O, Digitec, Doric, Dranetz, Elgar, Esterline-Angus, Fluke, GenRad, Halcyon, Hewlett-Packard, Honeywell, Hughes, Intel, Keithly, Krohn-Hite, Lambda, Lear Siegler, Marconi, Monsanto, Narda, Nicolet, Northeast, Power Design, Programmed Power, Singer, Sorenson, Tally, Techni-Rite, Tektronix, Tenney, Texas Instruments, Wavetek...and many more.

Rental Electronics, Inc. Rental Centers
In the U.S.: Anaheim, CA (714) 879-0561 • Mountain View, CA (415) 968-8845 • Northridge, CA (213) 993-7368 • Ft. Lauderdale, FL (305) 771-3500 • Orlando, FL (305) 351-3015 • Des Plaines, IL (312) 827-6670 • Burlington, MA (617) 273-2770 or (800) 225-1008 • Gaithersburg, MD (301) 948-0620 • Greensboro, NC (800) 638-4040 • Oakland, NJ (201) 337-3788 or (800) 452-9763 • Rochester, NY (800) 631-8920 • Cleveland, OH (800) 323-8964 • Dallas, TX (214) 661-8082 • Houston, TX (800) 492-9021 • Seattle, WA (206) 641-6444 • **In Canada:** Vancouver, BC (604) 278-8458 • Rexdale, Ontario (416) 675-7513 • Montreal, Quebec (514) 337-5575.

Call one of our rental centers today for immediate action. Or return this coupon to Rental Electronics, Inc., 19525 Business Centre Dr.

Northridge, CA 91324

- Send me your Rental Catalog.
 Send me your Equipment Sales Catalog — I may be interested in buying some of your "previously owned" equipment.
 I have an immediate need for the following rental equipment:

Please have someone from your nearest Inventory Center phone me at _____

Name _____
 Title _____
 Company _____
 Address _____
 Mail Stop _____
 City _____
 State/Zip _____
 Phone _____



Rental Electronics, Inc.

EL 11/8

GSA # GS-04S-21963 Neg. © 1979 Rental Electronics Inc.

Electronics review

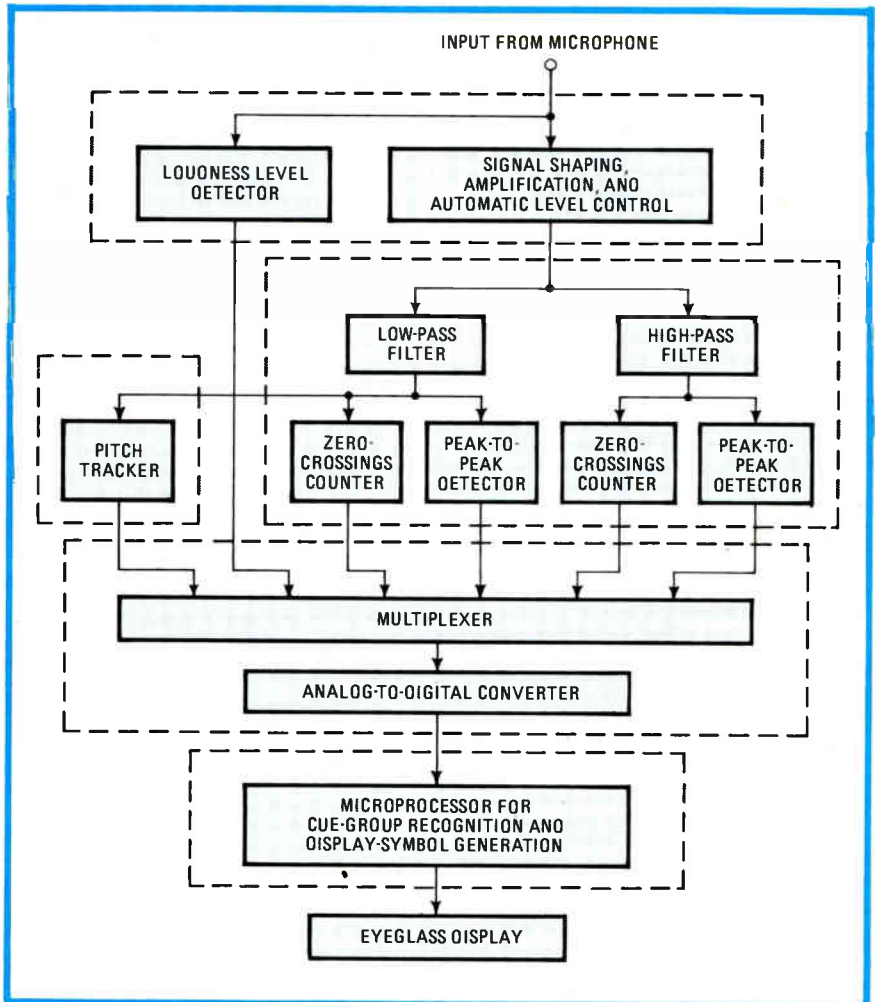

Hear, hear. Four custom LSI chips and a standard microprocessor may make up a speech-analysis device for the deaf. Block diagram is tentative.

ministration, which is supplying \$500,000 jointly with the Veterans' Administration for the project.

NASA will develop most of the hardware, using RTI's research results, and Gallaudet College, a Washington, D. C., school for the deaf, will test the equipment. The college and RTI have been developing computer models for mechanically cued speech since 1971.

According to Peck, Autocuer will use linear predictive coding. LPC allows algorithms applied at a very low data rate to simulate vocal-tract movements in speech. NASA is developing front-end LSI chips with capacities of 10 to 12 algorithmic coefficients each to handle the process (see figure). Beyond that, NASA and RTI are looking at new ways to implement Autocuer's other

functions, such as the relay element to project the image.

Beadles thinks a mass-produced Autocuer could cost about \$1,000 to buy. And, he says, once the system design is in place, it can easily be shrunk, all of it eventually fitting into eyeglass frames. **-Linda Lowe**

Packaging & production

Polyurethane gives solderless connection

The familiar soldered interconnection of components may be going the way of the vacuum tube, at least in the consumer electronics field. Helping to usher it out is a new interconnecting mechanism based on a cellu-

If All Rental Companies Look Alike, How Do You Choose?

Need an oscilloscope or logic analyzer in a hurry? Do you have a short term need for a microprocessor development system? Chances are you've already discovered that renting the electronic equipment you need makes sense. But which rental company?

When you call Rental Electronics, you're tapping a multi-million dollar inventory of electronic equipment from Hewlett-Packard, Tektronix, Intel and every other major manufacturer. So we're sure to have what you need—even the newest equipment.

Our on-line real-time computer lets us give you immediate availability information while you're still on the phone. Even if what you need is at another of our ten stocking centers across North America.

Renting from Rental Electronics makes good economic sense, too. We're big enough to be as flexible

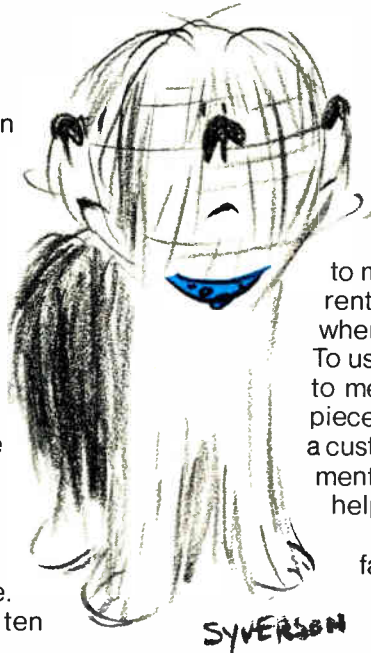

as you need us to be, with competitive short term rates, lower rates for extended periods, even a selection of rental/purchase plans.

But there's an even better reason to make Rental Electronics your equipment rental company. It's called service. It starts when our rental experts answer your phone call. To us, service means going that extra step to meet your particular needs—for a special piece of equipment, a tight delivery schedule, a customized rental or rental/purchase arrangement, or just straight answers and a helpful attitude.

When it comes to service we're positively fanatical. And it pays off. During the past twelve months, for example, 92% of our first-time customers have come back for more.

Next time you consider renting, consider Rental Electronics. Give us a shot at your business. We're confident we'll turn you into a repeat customer.

Test and Measurement Instruments

Here is just a small sampling of the test and measurement equipment available today from Rental Electronics. For a complete list, use the coupon opposite.

Hewlett-Packard 1640A Serial Data Analyzer.

Identifies and locates failures to the component level; RSC 232C; 2048 characters, monitor buffer, plus 1024 characters transmit message buffer; Sync or Async.



Biomation K 100 D Logic Analyzer. 16 channels; 1024 word memory; clock rates up to 100 MHz; signal timing resolution to 10ns; built-in display and keyboard control.

Honeywell 101 Recording System. 7 or 14 tracks depending on head assembly; ½ in. (7 tracks) or 1 in. (14 tracks) tape; 8 tape speeds from 0.937 ips to 120 ips; direct bandwidth to 2 MHz (wide band) and to 600 kHz (intermediate band); FM bandwidth to 80 kHz (wide band) and to 40 kHz (intermediate band); reel size 10½ to 15 in., coaxially mounted.



Tektronix 465 Oscilloscope. BW 100 MHz; display 8 x 10; 5 mV/div to 5 V/div sens.; sweep rate 50 ns/div to 0.5 s/div; x10 magnifier; dual trace; delayed sweep; x-y operation.



Hewlett-Packard 8565A/100 Spectrum Analyzer. 0.01 to 22 GHz with internal mixer; 14.5 to 40 GHz with 11517 external mixer; 100 Hz and 300 Hz resolution bandwidth; Absolute Amplitude Calibration: -110 dbm to +30 dbm.

Brush 260 Strip Chart Recorder. 1 mV to 500 V; chart speeds 125 mm/sec. to 1 mm/min., incl. four event markers; pressurized ink; response: DC to 100 Hz.

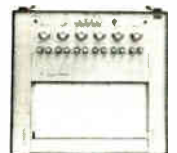

Rental Electronics, Inc.

An AMERICAL company

... a different breed.

Incredible, but true!

10 Watts 1 to 1000 MHz

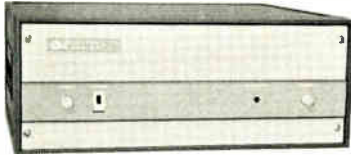

ULTRA-WIDEBAND AMPLIFIER

Amplifier Research again leads the way with its new Model 10W1000, an ultra-wideband amplifier that delivers 10 watts of linear power from 1 to 1000 MHz—more power and bandwidth than any other amplifier of its kind. In fact, as the “next generation” in ultra-wideband amplifiers, Model 10W1000 offers you 2½ times the power of its predecessor, the Model 4W1000.

Versatile and unconditionally stable, this high-performance amplifier can be used with frequency synthesizers or swept signal sources to provide high-level outputs for RFI susceptibility testing, NMR spectroscopy, antenna and component testing, general lab applications, and other uses.

For complete information on our 10W1000 and other W Series amplifiers, write or call:

Amplifier Research
160 School House Road
Souderton, PA 18964
Phone: 215-723-8181
TWX 510-661-6094



Electronics review

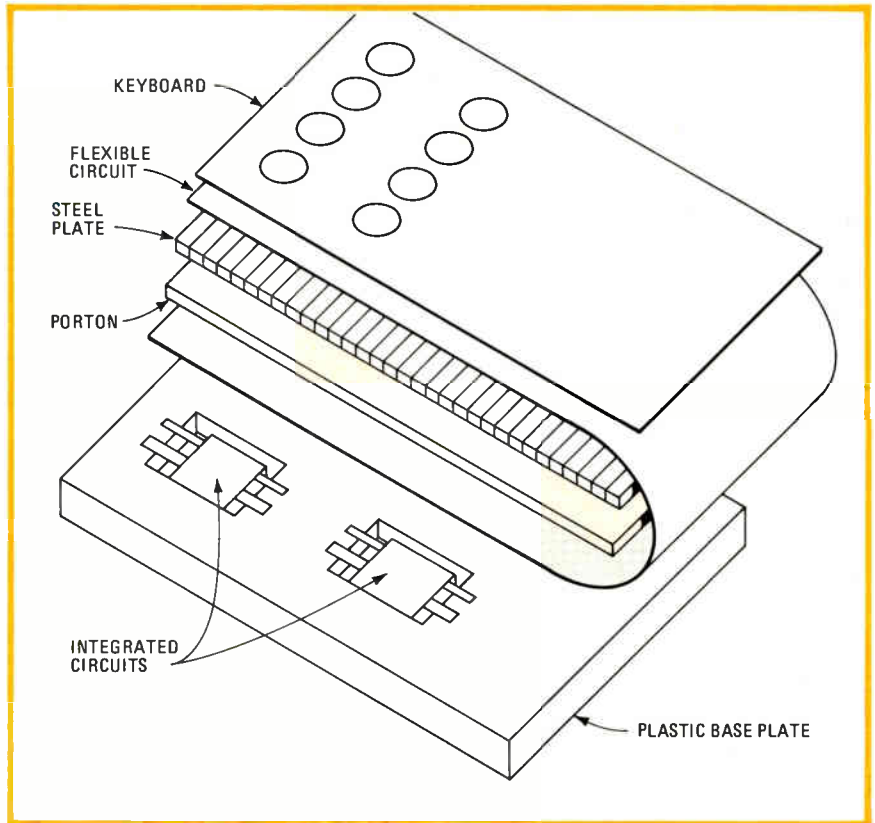

No movement. Portron holds flexible-circuit traces and component leads in place in a solderless package. In this keyboard application, the circuit is three-dimensional.

lar polyurethane material.

The material, called Portron, comes from Rogers Corp.'s Poron division in East Woodstock, Conn. It provides a uniform and long-lasting mating force in a sandwich of compressed layers.

The Rogers, Conn.-based corporation supplies a variety of industries with a wide range of plastic-based components and related materials. It says that its new scheme will cut assembly costs, increase reliability, and improve serviceability.

In the Rogers Solderless System, Portron is put to work with flexible interconnection circuitry from Rogers' Circuit Systems Group in Chandler, Ariz. RSS provides a structure that presses together circuit leads from the components and the electrical traces of the flexible circuit, with the Portron providing the uniform compressive force that maintains the contacts.

In a typical RSS structure (see figure), the bottom piece is a rigid plastic base with cavities that hold

and align the various components. The leads of the components are in a flatpack configuration and extend just beyond the edges of the cavities.

The flex circuit on top is aligned to provide the required interconnections, and a thin Portron layer and a rigid top pressure plate back it. The assembly is completed by compressing the four layers and holding them together with screws or spring clips.

“The idea of a solderless system clamped under pressure is not new. Lack of a material like Portron held it back,” says Stephen Etzel, assistant product manager at Poron. Unlike other plastics, Portron will not lose resilience over time and so continues to exert a spring force over the entire compressed area. The company cites one test of 50% compression for 48 hours at 149°F and 95% humidity, in which resilience loss was under 10%. These severe conditions are, of course, unrepresentative of consumer-electronics operation.

As it stands, the company

sees consumer products as the most likely candidates for RSS, first because it recommends a maximum constant-use temperature of 50°C to ensure that there is no long-term compression set to degrade contact integrity. Also, it is best suited for high-volume applications, where the design and tooling costs can best be amortized.

RSS is a bit tricky to adapt to production lines, but Portron already is used in several products, including a Milton Bradley game called Microvision. It holds an elastomeric connector against the game's large liquid-crystal display.

Potential savings in cost are considerable, Etzel contends, since there is no soldering equipment and no need for materials resistant to the high temperatures of soldering. Also, RSS is designed to provide automatic alignment of interconnections and simple mechanical assembly, further cutting production costs.

Portron is a good absorber of energy, he says, so it increases reliability by providing shock resistance for components and interconnections. Serviceability improves because the testing and replacement of bad components require no desoldering, he says.

-Jerry Lyman

Astrocommunications

Sun would be part of space radio scope

How about a giant millimeter-wave radio telescope using the sun's gravitational field as a focusing element and strategically placed satellites as the transmitter-receivers? Such a system could reach far into the universe, seeking, among other signals, coherent radio communication from other planets.

That is the claim Stanford University's Von R. Eshleman presented at a recent St. Louis meeting of the American Astronomical Society. He developed the idea for the Planetary Atmospheres Program of the National Aeronautics and Space Administration as a result of studying the focusing of radio signals using the planet Jupiter's atmosphere.

"The gravitational field of the sun

The Secret of Document Scanning is RETICON

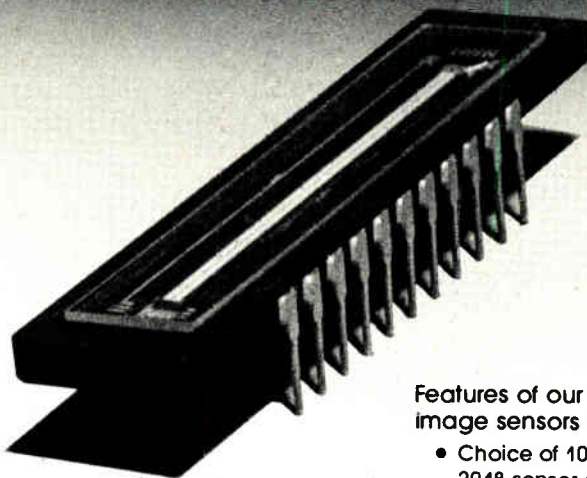

Features of our H Series image sensors include:

- Choice of 1024, 1728 or 2048 sensor elements on 15 μ m (0.6 mil) centers.
- Scan rates up to 3 MHz.
- Wide dynamic range.
- Suitable for applications in OCR, FAX, copy machines, etc.

If you look behind the nameplate of any OCR, FACSIMILE or POINT OF SALE equipment designed during the last several years, chances are that the solid state image sensors you'll find there were made by RETICON.

WHY? Because Design Engineers throughout the world have long recognized that using RETICON devices provides them with the latest, most advanced technology — the Secret of Success.

So, if you are still using old-fashioned lasers or scanning mirrors, or if you are waiting for some new magic in solid state imaging, you NEED NOT WAIT ANY LONGER.

RETICON is already shipping its high-resolution, H-series self-scanning photodiode arrays in volume and at prices more than competitive with other approaches.

 **EG&G RETICON**

345 POTRERO AVENUE
SUNNYVALE, CA 94086
TWX: 910-339-9343

For assistance call: Boston (617) 745-7400, Chicago (312) 640-7713,
San Francisco (408) 738-4266, Los Angeles (213) 995-4663,
Tokyo, Japan 03-343-4411, Bracknell, England (0344) 53618

TAKE THE SIGNAL GENERATOR INTELLIGENCE TEST

Today's signal generators offer clean, accurate, and stable cw outputs. But how faithfully do they convert intelligence into modulated rf? Check your intelligence needs against the published modulation performance characteristics of Boonton and two other leading generator manufacturers. Just check your answers.

1. Maximum FM deviation at carrier frequencies of

100 MHz: (a) 100 kHz (b) 640 kHz (c) 1 MHz
 10 MHz: (a) 80 kHz (b) 100 kHz (c) 1 MHz

2. FM distortion (100 kHz deviation at 100 MHz)

(a) 4% (b) 3% (c) 0.5%

3. Incidental AM (100 kHz deviation at 100 MHz)

(a) unspecified (b) 1% (c) 0.2%

4. AM distortion

At 30% AM: (a) 3% (b) 1% (c) 1%
 At 70% AM: (a) 3% (b) 3% (c) 2%
 At 90% AM: (a) unspecified (b) 5% (c) 3%

5. Incidental FM (30% AM at 1 MHz, 1 kHz mod.)

(a) unspecified (b) 150 Hz (c) 50 Hz

If most of your answers were (c), you need the superior modulation performance of the Boonton 102C/D.

And with this performance you get other advantages as well. Like the advantage of separate panel meters for both modulation and rf output. And, in the phase-locked Model 102D, a separate time base that allows display of the full 100 Hz resolution even when tuning between lock points.

Now it's your turn: put us to the test. Contact us or your local Boonton representative, and we'll send full specifications and a competitive analysis. We think it will convince you that Boonton signal generators respect your intelligence.

Boonton Electronics Corporation,
 Rt. 287 at Smith Rd., Parsippany,
 N. J. 07054; (201) 887-5110.

BOONTON

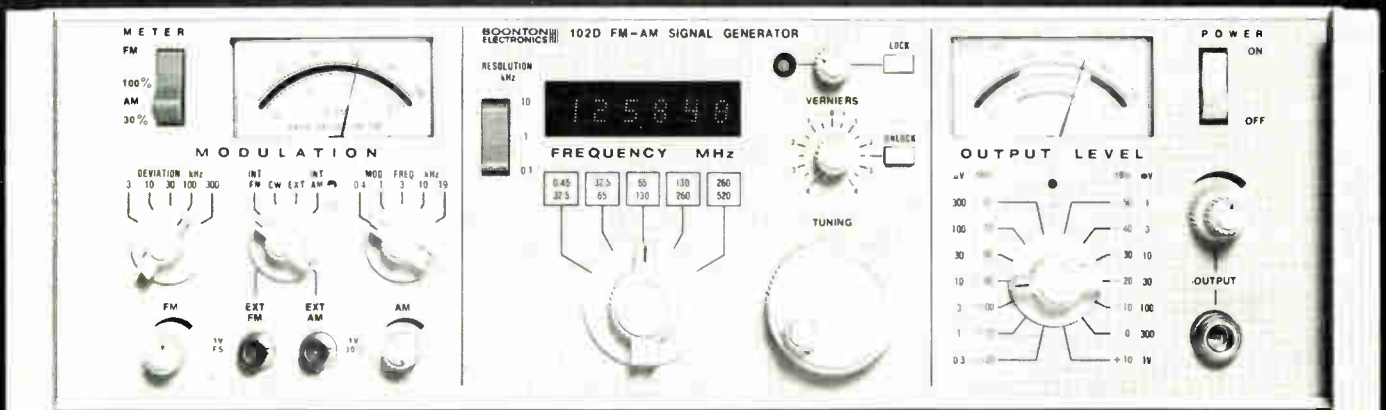

acts much like a spherical lens, magnifying the intensity of radiation from a source an extended distance away," he explains. This magnification effect allows the satellites to pick up much weaker signals than a comparably sized earth-based system and sharply reduces the power of the signal required to reach deep into space.

"Using only equipment with present-day capabilities, a spacecraft, if it were positioned properly, could pick up interstellar signals," he claims. The focusing requirements mean the distance from satellite to earth would be about 550 times the distance between earth and sun.

The focusing of electromagnetic radiation by a gravitational field is no new concept, remarks Eshleman, an electrical engineer at Stanford's Center for Radar Astronomy. "Einstein wrote that light could be focused by the gravitational field of a star if the positions were right."

Problems. Some formidable technical problems arise, he admits. For example, a separate spacecraft would be needed for each direction to be observed.

Moreover, the immense distances involved mean that signals would take two weeks to travel between satellite and earth, compared with the 90 minutes it takes Pioneer II to send information back to earth from Saturn.

In addition, the sun's gaseous corona degrades electromagnetic radiation and, at wavelengths greater than a millimeter, would seriously distort the signal and reduce the magnification effect. The magnification factor is inversely proportional to the operating wavelength (10^8 at 1 mm), but the submillimeter radio telescope equipment necessary to take advantage of the preferable lower wavelength is extremely costly to purchase.

"The great potential is obvious," says Eshleman. "We could, with current shortwave technology, detect coherent sources and communicate with a neighborhood of thousands of stars." He plans to continue to study the technical feasibility of his proposal.

-Harvey J. Hindin

Precision Resistance Ratios from Caddock.

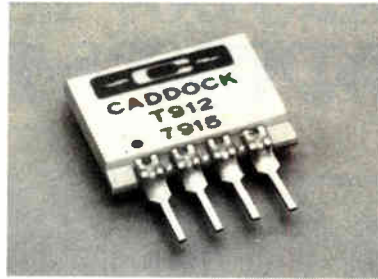

Caddock's Type T912 Precision Resistor Network is the cost-effective replacement for discrete resistor sets.

The ratio characteristics of these high-stability resistor networks make them ideal for applications in precision amplifier circuits, voltage reference circuits and precision bridge circuits.

- Ratio Tolerances from $\pm 0.1\%$ to $\pm 0.01\%$.
- Ratio Temperature Coefficients of 10 PPM/ $^{\circ}$ C, 5 PPM/ $^{\circ}$ C or 2 PPM/ $^{\circ}$ C.
- Ratio Stability of Resistance at Full Load for 2000 Hours within $\pm 0.01\%$.

Tetrinox™ — Caddock's unique high-resistance film — provides resistance values from 5 kohm to 2 Megohms in this package size.

Custom models with unequal values can provide resistance ratios as high as 250:1 and values from 1 kohm to 2 Megohms.

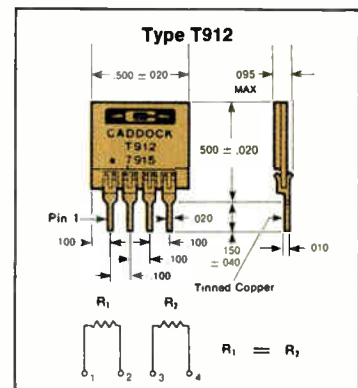

Standard Type T912 and T914 Precision Resistor Networks

Standard Resistance Values:

5K 50K 500K
10K 100K 1 Meg.
20K 200K
25K 250K
40K 400K

Special or mixed resistance values are available as custom networks.

Ratio Tolerance:

Maximum ratio difference between any two resistors in the network.

-100 = 0.10%
-050 = 0.05%
-020 = 0.02%
-010 = 0.01%

Ratio Temperature Track:

Ratio Temperature Coefficient between any two resistors in the network from 0 $^{\circ}$ C to +70 $^{\circ}$ C.

-10 = 10 PPM/ $^{\circ}$ C
-05 = 5 PPM/ $^{\circ}$ C
-02 = 2 PPM/ $^{\circ}$ C

Ordering Information:

To specify any of the standard Type T912 and T914 resistor networks, use this model number.

T912 - 500K - 010 - 02
Model No. | Resistance Value | Ratio Temperature Track* | Ratio Tolerance*

* (This information appears on the back side of the network)

The standard models of Type T912 resistor pairs and Type T914 resistor quads can be delivered in prototype and production quantities from stock to within 6 weeks ARO.

For additional technical information — and immediate confirmation of price and delivery on initial quantities — call or write directly to:

Caddock Electronics, Inc.,
3127 Chicago Ave., Riverside, Calif. 92507
Tel: (714) 683-5361

CADDOCK
HIGH PERFORMANCE FILM RESISTORS

Caddock will be at "Electronics '79 Olympia", Stand 132 in London, Nov. 20-23.

Data integrity

A write-protection notch prevents accidental erasure. A stepper motor gives accurate head positioning. A special head configuration ensures precise read/write operation. And a voltage sensing circuit prevents spurious writes.

Double track density design

The FD-50C employs a single-sided, double track density design for even higher capacity than a double-sided disk, with less maintenance headaches.

Brushless motor

The FD-50C uses a noiseless, reliable brushless motor which runs continuously, thus eliminating motor start-up time. Track-to-track access time is 25 ms, settling time is 10 ms.

Twice the Track. Half the Headache.

TEAC FD-50C Mini Disk Drive

Large capacity

The track density of 100 tpi provides greatly increased capacity in FM, mFM and m²FM recording modes, as compared to conventional mini disks.

And more

Up to four FD-50C mini disk drives can be daisy-chained to a single controller. And a door lock mechanism protects disks from accidental damage.

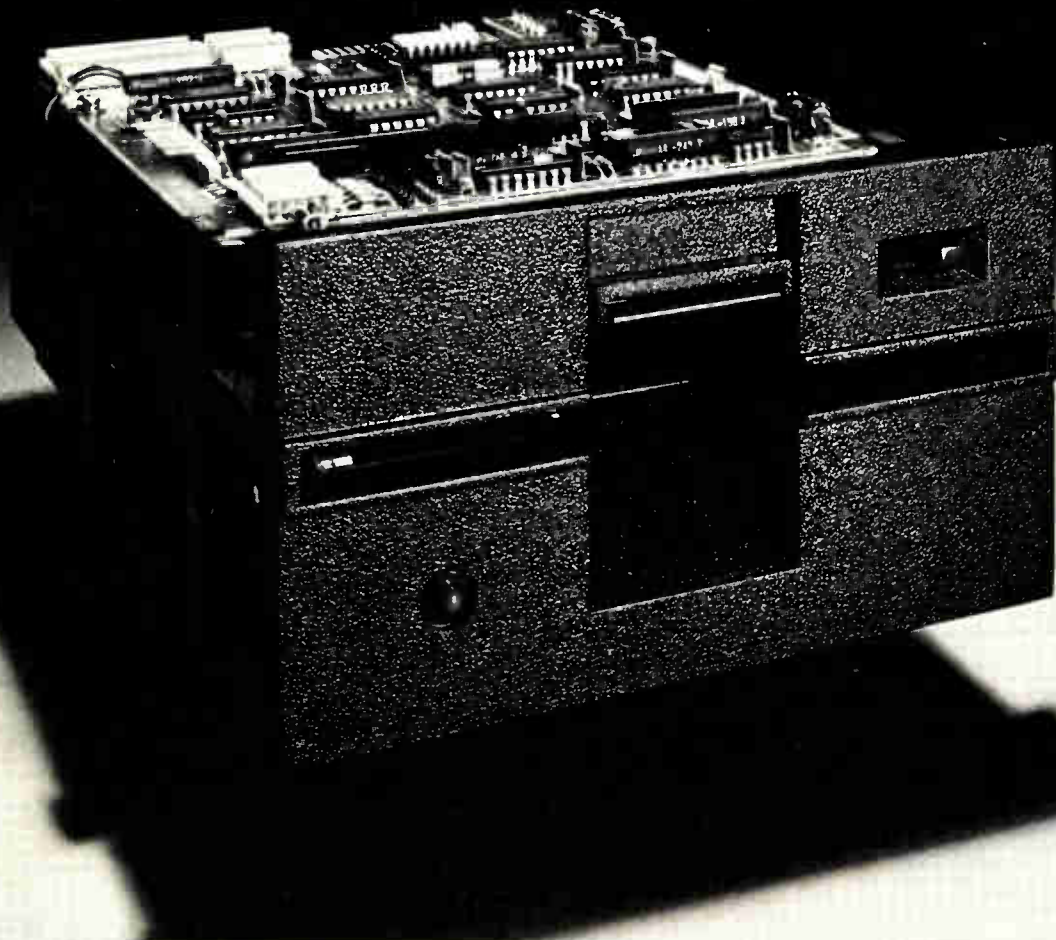

TEAC CORPORATION: 3-7-3 Naka-cho, Musashino, Tokyo, Japan Tel: (0422) 53-1111

TEAC

●U.S.A. TEAC Corporation of America, Tel: (213) 726-0303 ●Canada R.H. Nichols Co., Ltd., Tel: (416) 661-3190 ●Hongkong Dah Chong Hong Ltd., Tel: 5-261111, 5-226258 ●Australia & New Zealand Jacoby Mitchell Ltd., Tel: 6307400 ●South Africa Mayfair Sales (Pty) Ltd., Tel: 011-834-2131 ●Belgium & Luxemburg Simac Electronics S.P.R.L. ●Denmark Danbit, Tel: (03) 141515 ●France Tekelec Airtronic S.A., Tel: (027) 7536 ●Holland Simac Electronics B.V., Tel: 040-533725 ●Italy A.E.S.S.E. S.R.L., Tel: 54.64.741-2-3 ●Switzerland Wenger Datentechnik, Tel: 061-34 50 96 ●Spain Ataio Ingenieros S.A., Tel: (215) 3543 ●Sweden Scantel AB, Tel: 08-24 58 25 ●West Germany & Austria nbn Elektronik Starnberg, Tel: (08151) 13036

Electronics RDT&E to lead military budget growth

Fiscal 1981 military electronics money for production and research, development, test, and evaluation will be scheduled to increase at a far greater rate than other weapons systems when President Carter previews his new budget for Congress later this month. Overall spending for all weapons production and R&D are expected to be in the range of \$42 billion to \$43 billion. In his election-year drive to get Senate ratification of his SALT II strategic arms limitation treaty with the Soviet Union, Carter's early defense budget outline for the fiscal year beginning next October is expected to strike a **compromise between his 3% goal of "real growth" (discounting inflation) and the demands of Senate hawks.** Led by Sam Nunn (D., Ga.), they want a 5% growth rate in each of the next five years.

Office of Management and Budget sources say choices are now being made between "a straight 4% compromise in each year" or "3% next year and 5% in the years after that." The 4% option is believed the leading candidate at this point, supported by political arguments that a supplemental Pentagon budget for fiscal 1980 may be used to pump more money quickly into the economy if the recession deepens next year. **Growth rate of electronics outlays could jump between 10% and 15%,** officials say, because of the need to improve communications, command and control systems, satellite reconnaissance, all-weather aircraft fighting capabilities, ground and airborne tactical radars, and optical detection systems, as well as all-weather tactical weapons targeting and antisubmarine warfare systems (see p. 34).

Airliner pay phones proposed to FCC . . .

Pay telephones in airliners? That is a new service proposed to the Federal Communications Commission by Airfone Inc., a wholly owned subsidiary of Goeken Communications Inc. in Washington, D. C. The company is headed by John D. Goeken, who broke new telecommunications ground in 1969 by winning FCC approval after a 10-year fight to establish the nation's first specialized common carrier (now MCI Telecommunications Corp.) to compete with the Bell System. Airfone wants the FCC to release the 896-898-megahertz and 941-943-MHz frequencies for the up link and down link, respectively, of its proposed single-sideband service, **which would connect the in-flight telephone with one of 51 ground stations** for interconnection with American Telephone & Telegraph Co. lines. Goeken says AT&T has agreed to make interconnections.

. . . three carriers reportedly interested

Three air carriers, including Eastern Air Lines, have expressed interest in the Airfone service proposal, says Leo I. George, the company's counsel before the FCC. Airfone, he says, would acquire and pay for all aircraft equipment, including the antenna attached to the airframe and the airline's installation costs. Each plane would have two telephones—one in first class and another at the rear of the coach section. The proposed frequencies, now held in FCC reserve for "innovative services," **could also be used by other land-mobile services without interference.** The automatic full-duplex system would have a 6-kHz voice channel, a 20-w power output, and use a 200-kHz ground channel. Proposed charges, to be paid by telephone credit cards, would be \$5 for the first three minutes plus \$1 for each additional minute. First Capital Corp., the equity investment arm of the First National Bank of Chicago, said in a letter to the FCC that it saw no problem raising capital. Goeken says 2,000 airborne units are planned and that sites for the ground stations have already been lined up.

Air Force fires back at its industry critics

What began this summer as just one more flap between the Air Force Systems Command and its aerospace contractors over some procurement rule changes is escalating into a real fight. An AFSC letter to the Aerospace Industries Association claims the AIA's earlier protest "misrepresented the purpose and intent of AFSC policy" is designed "to set the record straight," according to its author, Maj. Gen. James W. Stansberry, AFSC deputy for contracting and manufacturing.

Stansberry's response, made available at the end of October, is in defense of his boss, AFSC commander Gen. Alton Slay, and his new "acquisition initiatives," which are designed to lower electronics and weapons program costs by increasing competition and developing second sources, stressing the use of standard components and modules, and substituting simpler commercial market practices where possible for mammoth Government documentation. Gen. Slay was not surprised when contractors did not applaud his initiatives at first, says one Air Force staff member, since "they represent a big change in the way we have been doing business." But the general did become upset when the AIA wrote him at length to protest that his plan would do more harm than good.

Contracts as 'auctions'

The AIA claims that overemphasis on price competition would lead to contract "auctions and result in product compromise and more cost overruns, as well as inadequate profits." Increases in standardization, the AIA contends, would inhibit competition and contribute to technological obsolescence. As for adoption of commercial practices, the AIA believes that these will not work without accompanying sharp reductions in paperwork. Moreover, the trade group is concerned that the Air Force underfunds early development work on programs.

The AFSC chief has already rejected an association proposal to establish an industry group to review his proposed changes in procurement practices on the ground that he lacks the authority to do so. But, "as General Slay has stated many times, he, his product division commanders, other members of AFSC staff, and I are willing to discuss our contracting practices with you at any time," Gen. Stansberry wrote. The AFSC deputy also rebutted the industry complaints one by one.

On profits: the AFSC "is not depressing profit nor forcing risk on industry without providing an opportunity for a commensurate return. Quite the contrary. Our negotiated profit rates

show a definite upward trend over the last two years." This is a result of the AFSC's effort to use firm, fixed-price contracts, with their higher profits, where costs are predictable, he says.

On the charge of underfunding development, Stansberry comes on strong. "I must note that contracts are two-party instruments, and we emphatically do not, as a matter of policy, engage in auctioneering. Competition for development is characteristically weighted most heavily toward the contractor's technical approach, not price." As for evaluating bids against independent estimates, "we assume corporate management attaches the same degree of importance to cost realism as we do."

The competitive 4%

Concerning price competition, he says: "Four percent of our business is accomplished under this method and we do not anticipate further increases. Thus, we believe your concern in this area is overdrawn." As for second-sourcing, Stansberry notes that "we will not attempt to develop second sources unless there will be an adequate payback," but reminds the AIA that "the reasons for competing programs are rooted in law and Federal policy." He adds that "increasing competition is AFSC policy and our track record is showing a modest improvement."

On introducing commercial market practices, Stansberry suggests that AIA concerns are exaggerated here, too. "We anticipate the ultimate result will be a blending of commercial and Government practices derived through frequent, open dialogue between the Air Force and its major suppliers," he says.

If generals Slay and Stansberry are correct, then why are the AIA's members uptight? They are uneasy because many of them see a decline in new military aircraft market opportunities in the years beyond 1980 despite the certainty of defense budget increases. Much of the new money is expected to go for electronics that will be used in large part to improve the operational readiness of U.S. tactical forces and their North Atlantic Treaty Organization counterparts. As a result, the demand for new aircraft platforms is expected to decline after several years of a high-volume business. And the increases in military satellite business will not begin to take up the slack.

Faced with those uncertainties, the aerospace industry is not eager to begin learning a new set of rules. Nevertheless, Gen. Slay's AFSC seems determined to make the change. How well he succeeds in the face of determined industry opposition remains to be seen. **-Ray Connolly**

Now from Sprague— the reel people...



Type 173D solid-electrolyte TANTALEX[®] capacitors in bullet-nose molded cases.

- Lead-taped and reeled for use in automatic insertion equipment.
- Low leakage current.
- Low dissipation factor.
- Capacitance values from .1 μ F to 56 μ F.
- Voltage range, 6 to 50 V.
- Operating temperature range of -55° C to $+85^{\circ}$ C; to $+125^{\circ}$ C with derating.

For complete technical data, write for Engineering Bulletin 3533.10 to Technical Literature Service, Sprague Electric Company, 35 Marshall Street, North Adams, Mass. 01247.

4SE-0122R1



THE BROAD-LINE PRODUCER OF ELECTRONIC PARTS

a subsidiary of **GK Technologies**
Incorporated

Circle 59 on reader service card

The most important data communications purchase you'll ever make isn't a device or component!

It's a timely, easy-to-follow guide that spells out exactly what you need to know to get the best possible deals on all data communications equipment. To turn data communications procurement into a smoothly running, cost-effective operation. And to **save you thousands** in data communications costs while delivering top-performance service!

Just published, this immensely important resource comes packed with the most authoritative and current information you need to make all your data communications purchasing decisions.

Plus step-by-step guidelines on the procurement process that speeds communications with vendors and assures that you get exactly the equipment you're looking for.

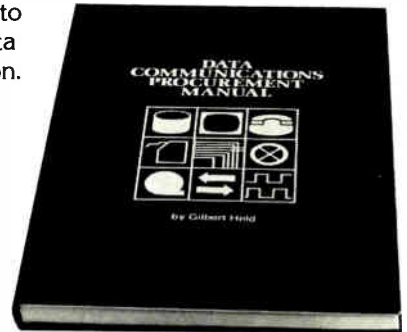

A first-of-its-kind working reference that puts right into your hands ...

- an alphabetical checklist of procurement document items to help you determine what's relevant to you and develop clauses or descriptions for the solicitation document
- sample solicitation format plus a compilation of solicitation clauses and forms most frequently used in procurement documents
- specifications for 38 devices, with a complete listing of both general and specific device specifications to consider when developing communications component requirements
- tabulation of Bell System data-set operating characteristics to help you develop a functional modem procurement
- vital facts to determine if special pin cross-connections are required to interface components with existing equipment
- tables of present value interest factors for yearly and monthly periods varying from 6 to 15%. Vital for evaluating proposals for future costs
- yearly energy costs of a continuously operating device in cents per Kilowatt hour
- checklist to develop a schedule of procurement activities
- plus invaluable guidance on the basic construction of a sample solicitation

Before you choose any data communications equipment, choose the **DATA COMMUNICATIONS PROCUREMENT MANUAL**. The before-you-buy buy for every data communications purchase!

Data Communications Procurement Manual

by Gilbert Held

150 pages

Contents

PROCUREMENT DOCUMENT ITEMS. SAMPLE SOLICITATION CLAUSES AND FORMS. Cover Sheet. Contact Form and Representations, Certifications, and Other Vendor Statements. Instructions, Conditions, and Notices to Vendors. Evaluation and Award Factors. Supplies/Services and Prices. Mandatory Specifications. Preservation/Packaging/Packing. Deliveries or Performance. Inspection and Acceptance. Special Provisions. Contract Administration Data. General Provisions. List of Documents and Attachments. **SPECIFICATIONS.** General Specifications. Specific Specifications (Acoustic Coupler, Analog Extension Unit, Analog Test Set, Automatic Calling Unit, Cable, Channel Service Unit, Code Converter, Concentrator, Controller, Data Access Arrangement, Data Compactor, Data Line Analyzer, Data Security Unit, Data Service Unit, Echo Suppressor, Facsimile Equipment, Frequency-Division Multiplexer, Front-End Processor, Interface Converter, Inverse Multiplexer, Limited-Distance Modem, Line Driver, MIL-STD-188C Adapter, Modem, Modem/Line-Sharing Unit, Multipoint Modem, Multiport Modem, Parallel Interface Extender, Port Selector, Port-Sharing Unit, Remote Batch Terminal, Speech/Data Unit, Speed Converter, Statistical Multiplexer, Switch, Time-Division Multiplexer, Transmission Test Set, Voice Adapter). **APPENDICES.** Bell System Data Set Compatibility Guide. Modem Options. EIA Terminal/Modem Interface. Modem Interface Description. Present Value Interest Factors. Energy Consumption Cost. Communications Procurement Plan. Sample Modem Procurement.

Order today using this coupon!

Return coupon to:

Data Communications Procurement Manual
P.O. Box 669
Hightstown, New Jersey 08520

Name _____

Send me _____ copy (copies) of the **DATA COMMUNICATIONS PROCUREMENT MANUAL** (606534-0) on a 10-day money-back guarantee. I understand that if I am not absolutely satisfied, I may return the book(s) within 10 days at no further obligation. Otherwise, McGraw-Hill will bill me \$24.50 for each copy, plus applicable sales tax, shipping and handling charges.

Title _____

Company _____

Address _____

City _____

State _____ Zip _____

SAVE MONEY! Enclose payment in full, plus local sales tax, and McGraw-Hill pays all regular postage and handling charges. Ten-day money-back guarantee still applies.

Check enclosed Bill me Bill my company

This offer subject to acceptance by McGraw-Hill and good only in U.S.



Quality control. The manufacturing of integrated circuits requires an extremely exacting, vigilant quality control program. Perhaps the most stringent in industry.

Now, Nikon instruments are available to meet, and surpass, these tough standards.

The Nikon Micro-Pattern Analyzer, Model 2A is a case in point. It delivers automatic, precise measurement of line widths to an accuracy of tenths of a micrometer.

It employs a minicomputer, mirrored scanning slit, digital display and printer to achieve a guaranteed accuracy of $\pm 0.1 \mu\text{m}$, well beyond the capabilities of conventional visual techniques.

With this computerized optical system, positioning error, magnification error, image distortion and human error are virtually eliminated.

IC masks from 2" to 6" square can be scanned at the rate of 0.5–2 $\mu\text{m}/\text{sec}$. The optical system incorporates a choice of green or blue interference filters. X and Y measurements are made conveniently without repositioning the mask since the optical image can be rotated by a single control.

There is no variation from observer to observer, or reading to reading as there is with conventional microscopes. Operator decisions, perceptions and fatigue are no longer a factor, thanks to Nikon.

An informative brochure is available to introduce you to the Micro-Pattern Analyzer, Model 2A and all of the other remarkable Nikon IC instruments.

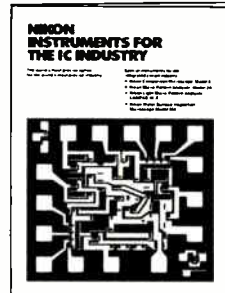

To obtain your copy, please contact:

Nikon

Nikon IC Instrument Division,
623 Stewart Avenue,
Garden City, NY 11530,
(516) 222-0200
or 1051 Sneath Lane,
San Bruno, CA 94066
(415) 952-8188

MEETING THE TOUGHEST STANDARDS IN A VERY TOUGH INDUSTRY.

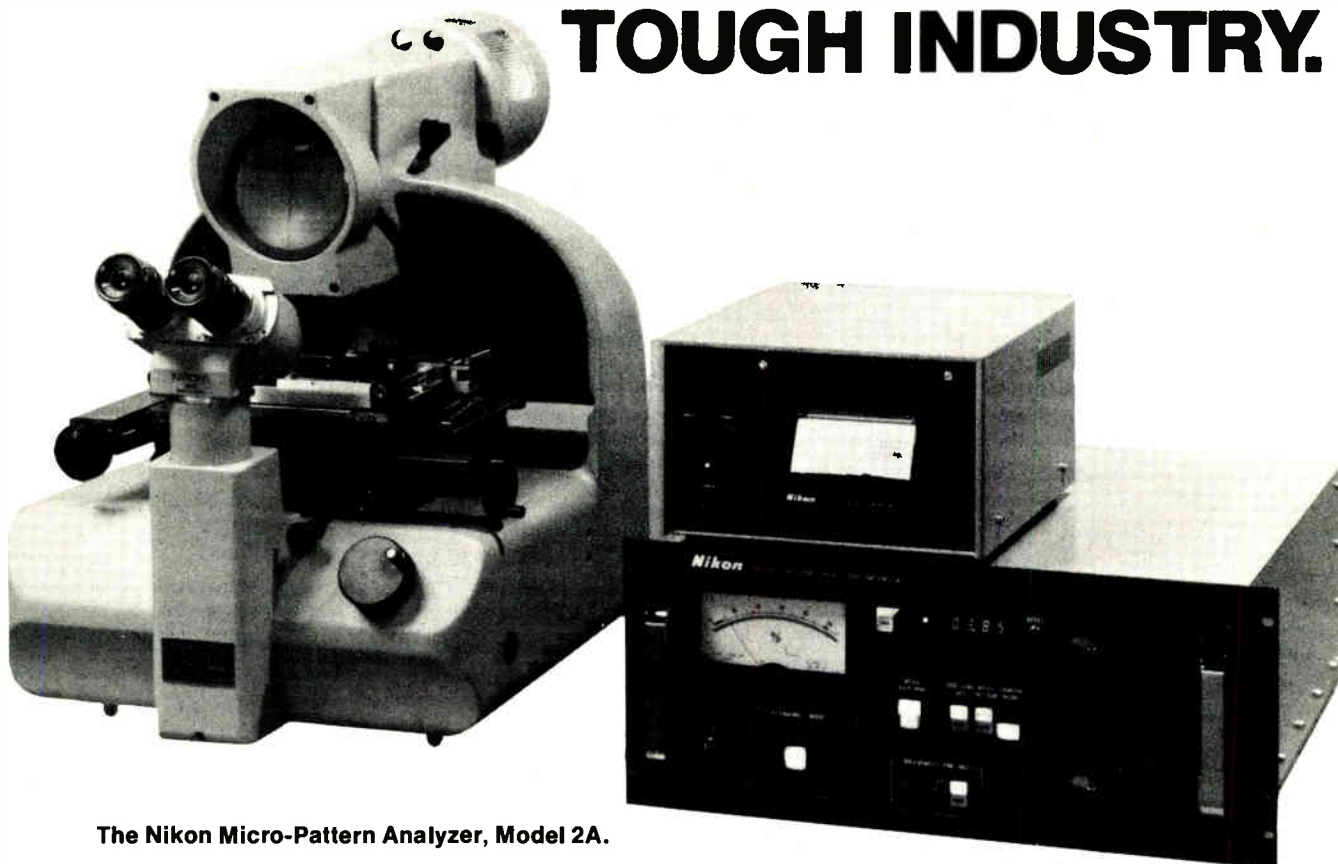

The Nikon Micro-Pattern Analyzer, Model 2A.

SCIENCE/SCOPE

A new ring and moon around Saturn were among the discoveries made by NASA's Pioneer 11 spacecraft during the historic first flyby of the giant planet in September. The spacecraft's electronic camera, an imaging photopolarimeter, also supplied close-up pictures of Saturn's banded cloud structure. Another instrument, an infrared radiometer, found atmospheric temperatures from -279° to -288°F on Saturn and its largest moon, Titan. The readings for Titan reduced the possibility of biologic activity in the organic gases of the moon's reddish smoglike atmosphere. The polarimeter and radiometer were built for NASA's Ames Research Center by the Santa Barbara Research Center, a Hughes subsidiary.

Secure and nonsecure voice communications can be handled simultaneously by an advanced radio-telephone switching system that provides channel-to-channel crosstalk isolation above 100 dB. The system, developed by Hughes for U.S. Navy shipboard use, eliminates the need for separate equipment for plain and secure voice channels. Hughes' advanced microcircuit technology, including extensive use of large-scale integrated circuits, has given the system a high packaging density, high reliability, and low power consumption.

An advanced goggle that allows soldiers to see at night has been developed by Hughes for the U.S. Army's Night Vision Laboratories. The device, called a holographic one-tube goggle, employs thin-film diffraction optics and advanced electronics. It amplifies dim visual light and near-infrared radiation, then superimposes the enhanced image over the wearer's view. Aided by studies on how the brain overlaps the field of view of each eye, human engineering specialists designed the goggle so that the image intensifier tube, which extends from above the bridge of the nose, would not block any portion of a person's view.

Hughes Radar Systems Group has career opportunities for engineers, scientists, and programmers. We design and build many of today's most complex airborne and spaceborne radar electronics systems, including data links, electronic warfare systems, and display systems. We need systems analysts, microwave specialists (antenna, receivers, transmitters), circuit designers (analog, digital, RF/IF), scientific programmers, mechanical designers, product design engineers, systems engineers. Rush your resume to Engineering Employment, Dept. SE, Hughes Radar Systems Group, P.O. Box 92426, Los Angeles, CA 90009. Equal opportunity M/F/H/C.

How a fighter aircraft's radar performs during exercises can be determined from data gathered by a new recording system. Hughes devised the equipment for use with its AWG-9 weapon control system on the U.S. Navy's F-14 Tomcat. The recorder stores up to an hour of data, pilot and voice communications, and a time base. The information is sufficient to analyze the radar's performance from search and detection through missile launch. In the past, only highly modified test aircraft could provide this data because tactical aircraft have little or no room for additional electronics. Space was found on the F-14 by removing an electronic countermeasures unit that goes unused on training missions.

Creating a new world with electronics

HUGHES

HUGHES AIRCRAFT COMPANY
CULVER CITY, CALIFORNIA 90230

International newsletter

British software runs 16 Intel 8086s as one

A system that allows up to 16 Intel 8086 16-bit microprocessors to work together as if they were a single machine is to be launched by Scicon Consultancy International Ltd., a London software house. **A version of the Demos multiple mini/microcomputer system** [*Electronics*, Sept. 14, 1978, p. 92], it was developed in collaboration with the National Physical Laboratory to provide a progressive expansion in computer power and a high level of fault tolerance in process control, transaction processing, communications, and interactive information systems. Up to 16 processing nodes can be connected by one main and one standby 16-bit parallel data bus, each with an effective data rate of 2 megabytes per second. At each node are two 8086s, one handling bus communications, the other executing segments of the compiled program. The operating system is written in Concurrent Pascal and applications programs in sequential Pascal. Demos was recently chosen by the European Space Agency for its experimental multiprocessor system. This version will initially be based on three Texas Instruments 990 minicomputers, but eventually up to 32 mini- or microcomputers will be able to be interconnected.

Roessle makes plans for ITT Europe's components makers

A consolidation of the passive components mix, a stronger orientation of such devices toward European needs, and more streamlined manufacturing operations—these are some of the strategies that industry observers expect Heinz Roessle to pursue as **the newly appointed group general manager in charge of all European component producers affiliated with the International Telephone & Telegraph Corp.** Roessle, who retains his position as head of ITT's worldwide semiconductor activities, will keep adhering to a policy of producing solid-state devices, including memories, for worldwide appeal, however. He will continue to work out of Freiburg, West Germany, the site of Intermetall GmbH, headquarters company for the ITT Semiconductors Group, and will report to John Chluski, ITT senior vice president, based in Brussels.

Mostek to sell aggressively in Japan through new firm

Mostek Corp. of Carrollton, Texas, is giving notice that it intends to be a strong competitor in the Japanese market by starting a wholly owned subsidiary, Mostek Japan KK, there. Initially the company will provide the expert sales help needed to sell advanced products; it plans to build a test facility in two or three years to ensure high reliability, which will make its devices more competitive with domestic ones. **Mostek's policy will be to emphasize leading-edge memories**, including its 64-K random-access memory, first commercial samples of which will be distributed worldwide late in the first quarter of 1980. (For a related story, see p. 40.)

Mostek has been selling in Japan since 1971 through two agents, which will continue to distribute its products. But sales have been well below expectations because of a 1970 decision to emphasize mature products.

Liquid-crystal-display addressing schemes vie for French approval

Two different techniques for addressing liquid-crystal displays are being proposed to the Direction Générale des Télécommunications, the telecommunications arm of the French post office, **for use in the small interactive terminals to be distributed to all French telephone subscribers over the next 12 years** [*Electronics*, July 5, p. 85]. Thomson-CSF's Electron Tubes division, located in the Paris suburb of Boulogne-Billancourt, suggests a display in which thin-film transistors are placed at each point making up

its grid, a technique developed in the U. S. by Westinghouse Corp. [*Electronics*, Oct. 31, 1974, p. 32]. The second proposal, from Sintra, a subsidiary of the Compagnie Générale d'Electricité in Asnières, outside of Paris, and the government's Laboratoire d'Electronique et de Technologie de l'Informatique (LETI) in Grenoble (see p. 67) involves multiplexing points on an X-Y grid made of wire 35 μm in diameter. Sintra may buy LETI's license for the technique, or it may form a joint subsidiary with the lab to develop and produce the LCDs, perhaps as early as 1982.

Britain gets fourth channel; transmitter sales boom

A fourth television channel for British viewers, scheduled for 1982, means big business for Marconi Communications Systems Ltd., Chelmsford, and Pye TVT Ltd., Cambridge. They will split equally a \$33.6 million dollar contract for a total of 48 high-power transmitters from Britain's Independent Broadcasting Authority. Delivery is spread over four years, with 30 transmitters, providing coverage for 80% of the population, to be operational on the first day of the new service. **The 15-kw transmitters feature new klystrons (microwave tubes) having an efficiency of 45%**, compared with the 25% to 30% efficiency of conventional klystrons. Microprocessor-based transmitter control will allow unmanned control from new regional operational centers. The use of surface-acoustic-wave filters as a passband-shaping device in its design, says Marconi, contributes to both stability and reliability.

France, Canada to cooperate on teletext research

France's Secrétariat d'Etat aux Postes et Télécommunications and Télédiffusion de France, the government broadcasting agency, have signed a memorandum of understanding with the Canadian Department of Communications on joint research into their common problems in designing a teletext system. However, the cooperation between the two countries seems unlikely to lead to any standardization at the system level, since the memorandum says that **the specific characteristics of the two systems—France's Antiope and Canada's Telidon—“will be respected.”** “High-priority” areas of mutual interest include coding, visual characteristics, transmission systems, human factors to be considered in designing the terminals, and network architecture.

IBM Japan continues to add kanji input/output

Kanji (Chinese-character) displays and line printers for its System/34 follow those recently announced by IBM Japan Ltd. for its mainframes as the company strives to catch up with Japanese manufacturers in the race to bring Japanese-language capability to electronic data-processing equipment [*Electronics*, Oct. 11, p. 73]. Deliveries of the \$6,850 displays, which include a keyboard similar to those used with mainframe displays, will start next August. The displays are actually work stations and replace those without kanji capability—up to a maximum of 16 for the System/34; **they have a capacity of 480 kanji characters or 960 kana or alphanumeric characters.** The two line printers, which can be used as either work-station or system units, will be delivered starting February 1981. One, having a speed of 85 lines per minute of text, including kanji, or 300 lines/min excluding kanji, sells for about \$17,200. The other, with rates of 140 and 475 lines/min, respectively, sells for some \$20,000.

THIS IS KONTRON

MULTIMETERS



DMM 3020
Digital Multimeter

DMM 4020
Digital Multimeter

CPV4 Calculating
Programmable Voltmeter

Kontron's family of multimeters ranges from our 3½-digit 3020 to our unique Calculating Programmable Voltmeter (CPV 4). Our multimeters feature elegant craftsmanship and rugged metal cases that provide excellent EMI shielding. No extra calibration equipment is required because the DMM 3020 and DMM 4021 have built-in function

checks for internal recalibration.

Our DMM 4020 features 0.02% accuracy. All 4½-digit units perform true RMS measurement and hold-probe capability. Some standard features of all our DMM's include:

- Built-in charger for Ni-Cad batteries
- 10A current measurement in DC and AC

- Built-in function check (3020, 4021)

Get our data sheets for all the technical details and the name of a Kontron sales and service organization near you.

Write or call
Kontron Electronic Inc.,
700 South Claremont Street,
San Mateo, California 94402.

MULTIMETERS:

FOR DATA ON KONTRON® MULTIMETERS, COUNTERS, PROM PROGRAMMERS
AND PRINTERS, CALL (800) 227-6854. IN CALIFORNIA CALL (415) 348-7291.



Circle 65 on reader service card

Now . . . a FAMILY of quiet printers from TELPAR

The new 20-column PL-20E



- Microprocessor controlled thermal printer
- 8 bit parallel interface
- 5x8 dot matrix ASC II character set with upper case, lower case and underline capability
- 2.5 lines per second (50 cps) printing speed
- Automatic carriage return and line feed
- Paper-out provision
- Self-test mode
- Invert mode
- \$249 in quantities of 100, \$297 in single unit quantities

the proven 48 column PS-48E



- Microprocessor controlled thermal printer
- Versatile interface (no added charge)
Serial: RS-232C, 20 mil loop, or TTL
Parallel: TTL interactive
- Upper/lower case, 96 ASCII characters
- Throughput rate — 24 characters per second
- Signalling rates
Serial mode: 110 or 300 Baud
Parallel mode: up to 960 cps
- Automatic carriage return and line feed
- Quiet, clean, no ribbons or ink
- \$380 in quantities of 100, \$465 in single unit quantities

. . . and the new 80 column printer/plotter PPS-80E

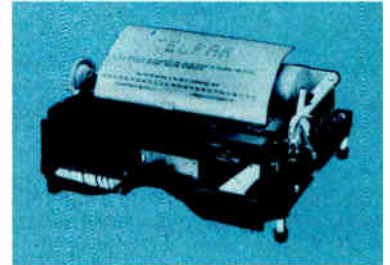

- Microprocessor controlled thermal printer
- Versatile interface (no added charge)
- Vector generator graphics
- Standard 96 character ASCII set plus external character generator
- Throughput rate — 30 characters per second
- Signalling rates
Serial mode: up to 9600 Baud with 300 Baud standard
Parallel mode: up to 960 characters per second
- Optional buffer memory 16K bytes
- Answer back
- Forms feed
- Self test
- \$600 in quantities of 100, \$750 in single unit quantities

Printing mechanisms without interface available on OEM basis.

For more information contact Telpar, (214) 233-6631,
4132 Billy Mitchell Road, Box 796, Addison, Texas
75001, Telex 73-256 (TELSERV) DAL.

telpar, inc.

French lab crams 256 by 256 dots on 2-by-2-cm LCD

by Kenneth Dreyfack, Paris bureau

Continuing research enables LETI to quadruple the number of elements and slim down the crystal

Having decided that in liquid-crystal displays as in electronics in general, denser is better, France's Laboratoire d'Electronique et de Technologie de l'Informatique (LETI) has made a 256-by-256-dot LCD measuring only 2 centimeters square. And since with LCDs the thickness of the crystal determines the speed with which images can be changed, the lab has gone in for thinness as well: the liquid crystal is a mere 5 micrometers thick.

The new display [*Electronics*, Oct. 11, p. 73] is a continuation of LETI's work for the Centre National d'Etude des Télécommunications, the research organ of the French postal and telecommunications administration [*Electronics*, Dec. 22, 1977, p. 55 or 5E]. The lab uses a 100-watt bulb behind the LCD and a lens to project the images onto a viewing screen.

Alignment. LETI's LCD technique is known as deformation of aligned phases. It uses crystal molecules that have large polarized heads and small, thin tails. The polarized heads attach themselves to the walls of the sheets of glass between which they are sandwiched. As a result, all the molecules line up perpendicular to the glass and not parallel with it, as in other techniques.

To produce images, an alternating electrical field is applied to the molecules to shift their orientation: 50

volts is applied sequentially to each of the rows of the matrix, and 6.5 v is applied simultaneously to all the columns at once.

When the row and column voltages are completely in phase, the molecules prevent light from passing through; hence the display is black. When the voltages are exactly out of phase, light passes through and the display is white. Degrees of phase difference produce shades of gray. The 32 possible variations thus yield 32 shades of gray.

In driving the display, the row and column voltages are multiplexed at a rate of 25 images per second—the largest LCD grid to be multiplexed thus far, LETI says.

Borrowings. To place the 35- μ m-diameter electrodes on the glass, the researchers have borrowed a sputtering technique from semiconductor processes. Heated indium is placed in a medium consisting of argon and oxygen and an electric field is applied to the gas, causing oxygen ions to combine with the indium to

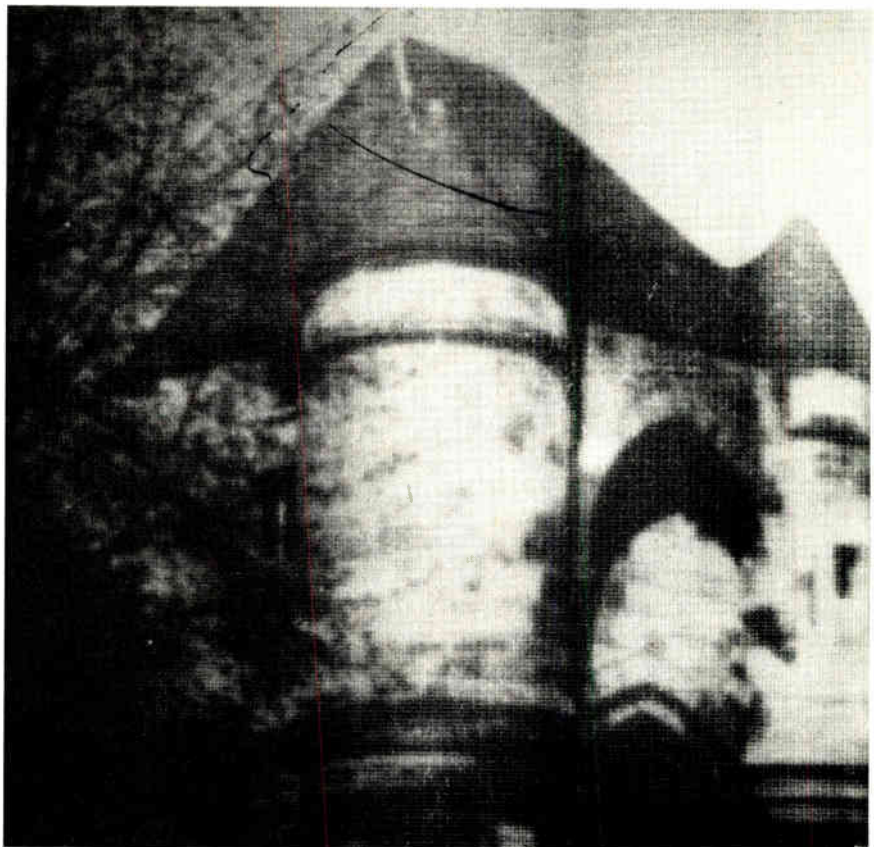

Denser. Grenoble-based LETI has managed to place a 256-by-256-element matrix on a liquid-crystal display only 2 centimeters square. The LCD produces 32 shades of gray.

form the indium-oxide electrodes.

Another semiconductor technique deposits a 5- μm -thick silicon-dioxide "wall" around the display surface on one of the two glass sheets. The wall is precise to within 0.1 μm , helping to ensure a uniform layer of liquid crystal.

Epoxy resin bonds and seals the two glass sheets together, and the crystal is then inserted between them in a simple vacuum. The seal is especially important, as liquid crystals—in this case a mixture of metoxybenzylidene butyl and etoxybenzylidene butyl—are extremely sensitive to contact with water or solvents. MBB-EBB crystal was chosen, LETI says,

because it has a relatively low viscosity, it is inexpensive, and its properties are fully documented.

Like its predecessor, the LCD displays up to 10 images per second. That is more than ample for alphanumeric applications, but too slow for television images, which generally change at the rate of 25 per second (the multiplexing rate). A crystal layer of 3.5 μm , though, would give the speed for satisfactory TV images, and that is one of the targets for which LETI is shooting. "We know how to go about it—it's a question of the time and means available to us," says Jacques Robert, head of the research team.

Great Britain

Statistical multiplexer based on microprocessors cuts data exchange costs

By making extensive use of microprocessor technology, one small British company, Computer and Systems Engineering Ltd. (CASE), has come up with a low-cost statistical multiplexer that can be upgraded to provide an inexpensive data exchange. With it, minicomputer users can assemble switchable data networks with facilities and features that have hitherto only been enjoyed by large-mainframe users.

Explains David Brown, systems support manager at CASE: "Statistical multiplexers brought the advantages of error-free transmission and a new level of economy to low-cost data networks." However, with very few exceptions they were limited to point-to-point usage and lacked a network switching capability. The new DCX series, Brown says, allows hubbed networks to be assembled in which a central station controls several remote sites, each with its own network.

Low-priced. Admittedly, agrees Brown, big mainframe companies, like IBM with its 3705 front-end processor or Digital Equipment Corp., have been able to create switched data networks of any complexity. But these systems can cost

up to 10 times more than the networks that can now be devised with switching statistical multiplexers. A typical price for hardware modules in the DCX series is \$12,000 for a 20-channel system.

Adds Nick Samuel, CASE's technical director: "With our previous 670 multiplexer, complex networks could be built up, but they were hardwired. If a user wanted the network changed because of a line outage or because of system growth, we had to send out an engineer to change the network PROMs at each node. Now a user can dial up each switching node in turn through the network and switch channels around."

Finding fault. Extensive diagnostics are built into the system, too. If there is a fault, each node can be accessed through the network and a test microprocessor instructed to enter a test routine.

"That way we know whether to send out a line, multiplexer, or modem engineer," Samuel says. "When a node cannot be raised through the network, our engineers have provided a standby line of defense. We can dial up the network control center over a public telephone line and access the diagnostic

processor via an external modem."

The DCX range is itself fully modular and can be built up to the required complexity from a set of five basic cards, each with its own microprocessor. The system starts with a simple four-channel point-to-point multiplexer and is expandable to data networks with almost 4,000 channel ends. Each DCX node in a channel can support up to 240 channels ends with up to 12 high-speed composite links.

To provide the needed flexibility, CASE engineers exploit microprocessor technology in a big way. They use Texas Instruments 9900 16-bit microprocessors on all the building-block cards except the buffer card. In that case, for speed they use Advanced Micro Devices bit-slice processors to create a 12-bit microprocessor. (A fully developed system, says Samuel, uses over 70 microprocessors.) As each of the constituent software modules is relatively small, the engineers were able to work in assembly language and thus write very efficient routines.

The DCX range extends from the 820 through the 850. The 830 is an intelligent statistical multiplexer system expandable up to 60 slow channels. Conventional multiplexers share time equally among channels. But in the 830 and rival products, the multiplexer adapts to the data rate on individual channels and since all channels are never working at full capacity simultaneously, leased lines of lower data rate than are conventionally employed can be used.

The 830 can handle a composite data rate of up to 19,200 bits per second and is assembled from up to 12 low-speed channel cards. Microprocessor-controlled, it works by checking the presence of data on all channels in turn and writes any data character into the buffer queue, together with appropriate channel address bits.

Cooperative. The 830 competes with products from companies like Micon Inc. and Codex Corp. Alone, it would have a hard time in a tough competitive market. But its ability to work with the DCX 840 network multiplexer and 850 switching multi-

Fastest EPROM Erasing!

WITH RELIABLE **SPECTROLINE**® SYSTEMS



Whether you're erasing one EPROM chip or a thousand, you'll want the latest and most advanced UV erasing system available. We have seven high performance systems to match your specific needs and your pocketbook. Prices start at \$69.50. You can erase safely and completely in as little as 7 minutes! And each system is backed by Spectronics Corporation...leader in ultraviolet technology since 1955. For more information, write or call Spectronics or your local stocking distributor.

System	Auto. Timer Shut-Off	Chip Erasing Capacity	Price
PE-14	No	6	\$ 69.50
PE-14T	Yes	6	94.50
PE-24T	Yes	9	134.50
PR-125T	Yes	16	289.00
PR-320T	Yes	36	475.00
PC-1000	Yes	72	995.00
PC-2000	Yes	144	1,495.00

IN STOCK NATIONWIDE...FOR IMMEDIATE DELIVERY!

ALABAMA
Huntsville
Pen-Tech Associates
(205) 881-9298

CALIFORNIA
Cupertino
Shepardson
Microsystems, Inc.
(408) 257-9900

Irvine
Adco Electronics
(714) 833-1528

Placentia
Raytronix
(714) 970-1703

San Diego
Astronics
(714) 278-5441

FLORIDA
Maitland
Seco Sales, Inc.
(305) 645-3444

Orlando
Hammond
Electronics, Inc.
(305) 849-6060

GEORGIA
Marietta
Pen-Tech Associates
(404) 424-1931

ILLINOIS
Arlington Heights
Dytec/Central, Inc.
(312) 394-3380

Bloomington
Technical
Representatives, Inc.
(309) 829-8080

Buffalo Grove
Claytronics
(312) 541-0387

INDIANA
Indianapolis
Dytec/Central, Inc.
(317) 247-1316

IOWA
Cedar Rapids
Technical
Representatives, Inc.
(319) 393-5510

KANSAS
Lenexa
Component
Specialties, Inc.
(913) 492-3555

Technical
Representatives, Inc.
(913) 888-0212

Wichita
Technical
Representatives, Inc.
(316) 681-0242

KENTUCKY
Lexington
Lowry & Associates
(606) 273-3771

MASSACHUSETTS
Woburn
Programmable
Devices, Inc.
(617) 935-9530

MICHIGAN
Brighton
Lowry & Associates
(313) 227-7067
Grand Rapids
Lowry & Associates
(616) 363-9839

MISSOURI
Hazelwood
Technical
Representatives, Inc.
(314) 731-5200

NEW HAMPSHIRE
Nashua
Programmable
Devices, Inc.
(603) 883-5993

NEW JERSEY
Clifton
Modutex Corporation
(201) 778-8888

NEW MEXICO
Albuquerque
Bell Industries
(505) 292-2700

NEW YORK
Rochester
Modutex Corporation
(716) 424-1620

NORTH CAROLINA
Greensboro
Hammond Electronics
(919) 275-6391

High Point
Pen-Tech Associates
(919) 883-9125

OHIO
Cleveland
Lowry & Associates
(216) 398-0506

Columbus
Lowry & Associates
(614) 436-2051

Dayton
Lowry & Associates
(513) 429-9040

OKLAHOMA
Tulsa
Component
Specialties, Inc.
(918) 664-2820

TPI Distribution
(918) 663-5100

PENNSYLVANIA
Pittsburgh
Lowry & Associates
(412) 922-5110

Warminster
Multi-Measurements
(215) 675-3082

SOUTH CAROLINA
Greenville
Hammond Electronics
(803) 233-4121

TEXAS
Austin
Component
Specialties, Inc.
(512) 837-8922

Dallas
Component
Specialties, Inc.
(214) 357-6511

Houston
Component
Specialties, Inc.
(713) 771-7237

TPI Distribution
(713) 777-9862

Plano
TPI Distribution
(214) 422-2858

WASHINGTON
Seattle
Seawell, Inc.
(206) 782-9480

CANADA
ONTARIO
Mississauga
Munro Electronic
Components Ltd.
(416) 676-1042



SPECTRONICS CORPORATION

956 BRUSH HOLLOW ROAD, P.O. BOX 483

WESTBURY, NEW YORK 11590

516-333-4840



Flexible. DCX 840's network control panel allows user to reconfigure switchable data network as needed. Systems built with DCX series multiplexers can handle up to 4,000 lines.

plexer have created an as yet untouched market, the Rickmansworth, Herts., firm says.

The 840 incorporates a user switching option card that provides a hubbing and onward-linking capability, local and remote supervisory control, additional diagnostics, and statistical reporting. The switching

microprocessor carries two network maps in its memory.

The 850 requires an additional microprocessor-based card. It provides facilities so that a specified user can dial up lines on the network by typing in a short address code. It also provides port-contention facilities. **-Kevin Smith**

West Germany

Etching process for pc boards reuses solution, retrieves copper

Production engineers engaged in printed-circuit-board fabrication will soon have a new etching method at their disposal: a continuous electrochemical method that is more economical to run than the conventional wet-etching processes used to remove copper from pc boards. Furthermore, it retrieves waste copper at no extra cost and etches more accurately, all but eliminating the problem of undercutting.

The process, called Elo-Chem, for

"electro-chemical," was developed at the Institute for Applied Physical Chemistry at West Germany's nuclear research establishment, Kernforschungsanlage Jülich GmbH—KFA for short. It is based on an electrolytic solution described as "permanent" because it is used over and over again. There is no poisonous waste water, no accompanying pollution, and none of the cleanup problems encountered with other wet-etching processes.

What's more, the etched-off copper can be retrieved immediately at no extra cost. In contrast, in conventional wet etching the removed copper either is lost or is recovered from the waste by expensive chemical processes. Copper retrieval and waste water cleanup can cost hundreds of thousands of dollars.

After years of government-supported development, KFA has built a pilot system. Laid out to handle pc boards 15 inches (about 36 centimeters) wide, the system has a throughput of some 65 square feet (6 square meters) of boards per hour. Smaller experimental systems for processing 5-in. boards (roughly 12 cm wide) have recently been shipped to potential licensees in the U. S., Japan and Europe, according to Wolfgang Faul, who has been instrumental in developing the new process.

Now that the technology is all worked out, KFA has turned it over to a small firm, Elo-Chem Ätztechnik GmbH, formed to exploit the process commercially and negotiate licensing deals with other companies. The Meersburg firm is demonstrating the process at this week's Productronica in Munich.

Continuous. As Faul explains it, the process takes place in a system of pipes, nozzles, and vessels in which the electrolytic solution constantly circulates. Consisting of diluted sulfuric acid at 50°C, the solution contains microscopically small, activated carbon particles at a concentration of about 15% by weight.

In an electrolytic cell, the 10-micrometer-diameter particles flow past a graphite anode and take on a positive charge. The solution then goes to the etching chamber, where nozzles squirt it onto a masked pc board. (Any normal type of mask can be employed.) The charge on the carbon particles is transferred to the copper, and the resulting copper ions enter the solution.

Ions and particles then return to the electrolytic cell, where the former pass through an ion-exchange membrane and are deposited on a copper cathode in the form of directly usable 99%-pure copper plates. The carbon particles, on the other

LOW COST MINI-DISK DATA STORAGE FOR YOUR EXORCISER OR MICROMODULE*

One-, two- and three-drive systems. Prices start at only \$649.95, complete. Software support includes a ROM DOS on the controller — at no extra cost, advanced DOS and file management systems, a data base manager, assembly language program development aids and Percom Super BASIC.

Fast mini-disk data storage and retrieval make your EXORciser* or Micromodule* an efficient general purpose unit that's far more than a development system.

And now you can get affordable mini-disk systems and support software from Percom. Add 102K bytes of formatted, on-line disk capacity for only \$649.95; add as much as 600K bytes for only \$2245.95. Moreover, programs on disk start as low as \$25.95.

With fast, random access storage you can put your development system to work in any of the myriad data capture or data retrieval applications of research, test and production environments.

Even if you use a mini-disk *only* to load control programs you'll save. Simply because loading programs from tape is awkward and time consuming. And the overhead of burning PROMs can quickly add up to far more than the price of an inexpensive Percom mini-disk system.

And consider this. At Percom's low hardware and software prices it becomes economical to not only develop your systems on an EXORciser* or Micromodule*, but to continue to use the same development system components as the final working system. The savings in training and documentation costs alone would be substantial.

An EXORciser* or Micromodule* with a low cost Percom disk system that's backed by Percom's low-cost software would also serve admirably as a rugged general purpose computer for individuals and small businesses. In other words, you'd have industrial quality at personal computing prices.

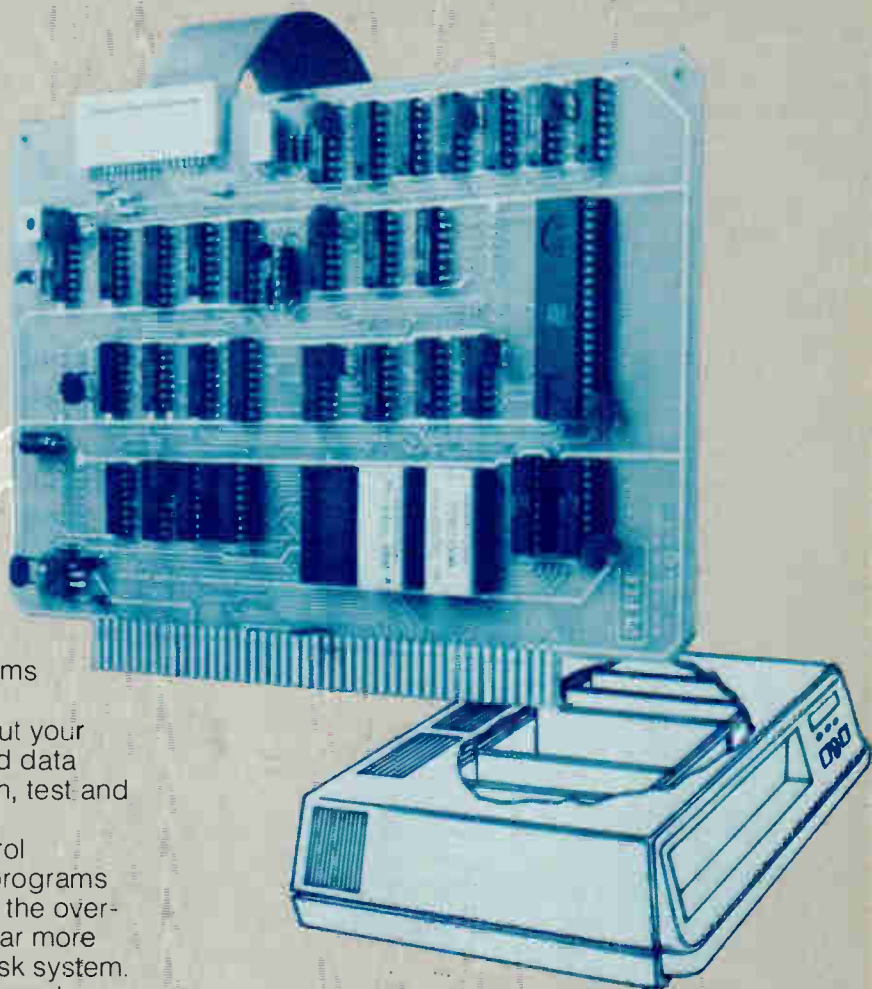

PRICES

Model	1-drive system	2-drive system	3-drive system
LFD-400EX™	\$649.95	\$1049.95	\$1449.95
LFD-800EX™	\$945.95	\$1599.95	\$2245.95

Single-quantity prices of mini-disk systems are set forth above. A system includes (1) the drives with integral power supplies — Percom's husky, open-frame PS-401 units — mounted in an enamel-finished enclosure, (2) the controller PC card for the EXORciser*/Micromodule* bus with an on-board ROM DOS, (3) an interconnecting cable and (4) a comprehensive users manual documenting operation, software and equipment. LFD-400EX™ drives have 40 tracks and store 102K bytes of formatted data. Both sides of a minidiskette may be used for storage with a -400EX model. LFD-800EX™ drives have 77 tracks and store 200K bytes.

Orders may be placed by dialing 1-800-527-1592 (outside of Texas) or (214) 272-3421 (in Texas). For additional technical information dial (214) 272-3421.

PERCOM DATA COMPANY, INC.
211 N. KIRBY GARLAND, TEXAS 75042
(214) 272-3421



Circle 71 on reader service card

hand, again flow past the graphite anode, take on a positive charge, and repeat the etching process. Thus the boards are continuously etched.

The solution does not change its chemical composition during the process, Faul says. As a result, the etching conditions are the same for an entire production run.

To ensure uniform etching, the potential of the etchant must be constantly controlled. This control is achieved simply by regulating the output of the system's dc generator.

No problem. Undercutting, a serious problem with conventional methods, is hardly encountered, Faul continues. The reason is that the solution with its charged carbon particles is squirted from the nozzles in a straight and sharp stream, removing the copper with great accuracy only from the desired areas.

Narrower and more closely spaced paths on the boards can therefore be etched—lines as fine as 70 μm , spaced 70 μm apart, are possible.

As for the savings, tests at the Jülich facilities show that with conventional wet-etching methods the chemicals and the energy needed to etch away 1 kilogram of copper cost about \$1.40. With the Elo-Chem technique, however, there is only the energy cost (beyond the initial cost of the chemicals), which comes to about 56¢ per kilogram of removed copper. To this savings, Faul notes, must be added the sales value of the regenerated copper—about \$1.40/kg—for a total savings of approximately \$2.24 per kilogram of etched copper.

An Elo-Chem system is expected to cost 10% more than a conventional system. **-John Gosch**

Japan

Single-mode-output laser diodes go for the long and short wavelength

Mitsubishi Electric Corp., Tokyo, is readying a short- and a long-wavelength laser diode that will provide engineers with improved performance in two very different applications. One, an aluminum-gallium-arsenide transverse-junction-stripe laser, provides a single-mode output at 780 nanometers for video disks and laser printers. The other, a conventional stripe device supplying a single-mode output at 1,300 nm, is designed to transmit hundreds of megabits of information per second over fiber-optic cables tens of kilometers long.

Although 780-nm light is near infrared, it is visible to the human eye (the beam, though, must be diffusely reflected to prevent damage to the retina). A visible laser-beam spot greatly simplifies the adjustment of optical systems. Also, the 780-nm light can be focused into a spot about 20% smaller than the usual 850-nm beam, providing higher information density. Furthermore, the sensitivities of many photosensitive

coatings increase greatly at the shorter wavelength.

The device has a threshold current of about 30 milliamperes and supplies a 3-milliwatt output at a forward current of about 40 mA. Its junction-up diode structure is similar to that of earlier Mitsubishi devices [*Electronics*, July 6, 1978, p. 39], except that the active stripe consists of $\text{Al}_{0.15}\text{Ga}_{0.85}\text{As}$ to shorten the wavelength. The two AlGaAs stripes that sandwich it contain a higher percentage of aluminum— $\text{Al}_{0.40}\text{Ga}_{0.60}\text{As}$ —to provide the higher index of refraction for the waveguide effect and the higher forward voltage that forces the current to flow through the active layer.

Close to optimal. Since even shorter wavelengths are desirable from the applications standpoint, Mitsubishi researchers will try for them in the future. But the present wavelength of 780 ± 15 nm may be near optimum: below 750 nm, efficiency decreases rapidly with decreasing wavelength, and the higher input

powers are apt to shorten diode life.

The diode has been designed for maximum life and reliability. A silicon submount, which has a temperature coefficient of expansion similar to that of the GaAs, is mounted between the device and the package. It greatly reduces thermally induced strain on the laser chip. Furthermore, passivation with a silicon nitride film applied by chemical vapor deposition after lead bonding to prevent degradation of the cleaved mirror surfaces by oxidation also protects the entire device; however, because the coating is precisely one-half wavelength thick, it has negligible effect on the optical characteristics. The guaranteed operating time will be about 10,000 hours, but Mitsubishi is confident that the average device will operate approximately 10 times longer.

The 780-nm ML-4001, in a TO-46 package, will initially be available in sample quantities in December for \$220 (\$260 in the U. S.); the price in large quantities will probably be about one tenth as much. Included in the package is a photodiode to provide a dc output for automatic power monitoring. The same laser without the power-output-monitor diode will be available mounted unpackaged on a heat sink as the ML-4307 at double the price.

Mitsubishi's long-wavelength laser diode is a more conventional stripe device in which the junction is mounted against the heat sink. It has a threshold current of 150 mA, with an average operating current of 170 mA for a 3-mW output. It comes in a pill-type package having a threaded stud, with a light guide extending through the stud to provide a monitor-light output. The ML-7205, which emits its beam through a window in the front of the package, will sell for \$1,760 each (\$2,100 in the U. S.) in sample quantities, also starting in December.

The ML-7205F has an optical fiber attached for connection to a fiber transmission line. Its output is only one quarter that of the 7205 as the coupling efficiency is 25%. Samples will cost \$2,200 (\$2,600 in the U. S.). **-Charles Cohen**

NATIONAL ANTHEM

Curing microprocessor overkill.

MICROCONTROLLERS THAT DO A LOT WITH A LITTLE.



Series 80
goes analog

Where to go
for custom
MOS/LSI



4K static RAMs
improved.

Free literature—
details inside

Data Acquisition
Microcomputers

Digital
Microprocessors

Discrete

Hybrid
MOS/LSI

Linear
Optoelectronics

Memory Components
Transducers

NATIONAL ANTHEM

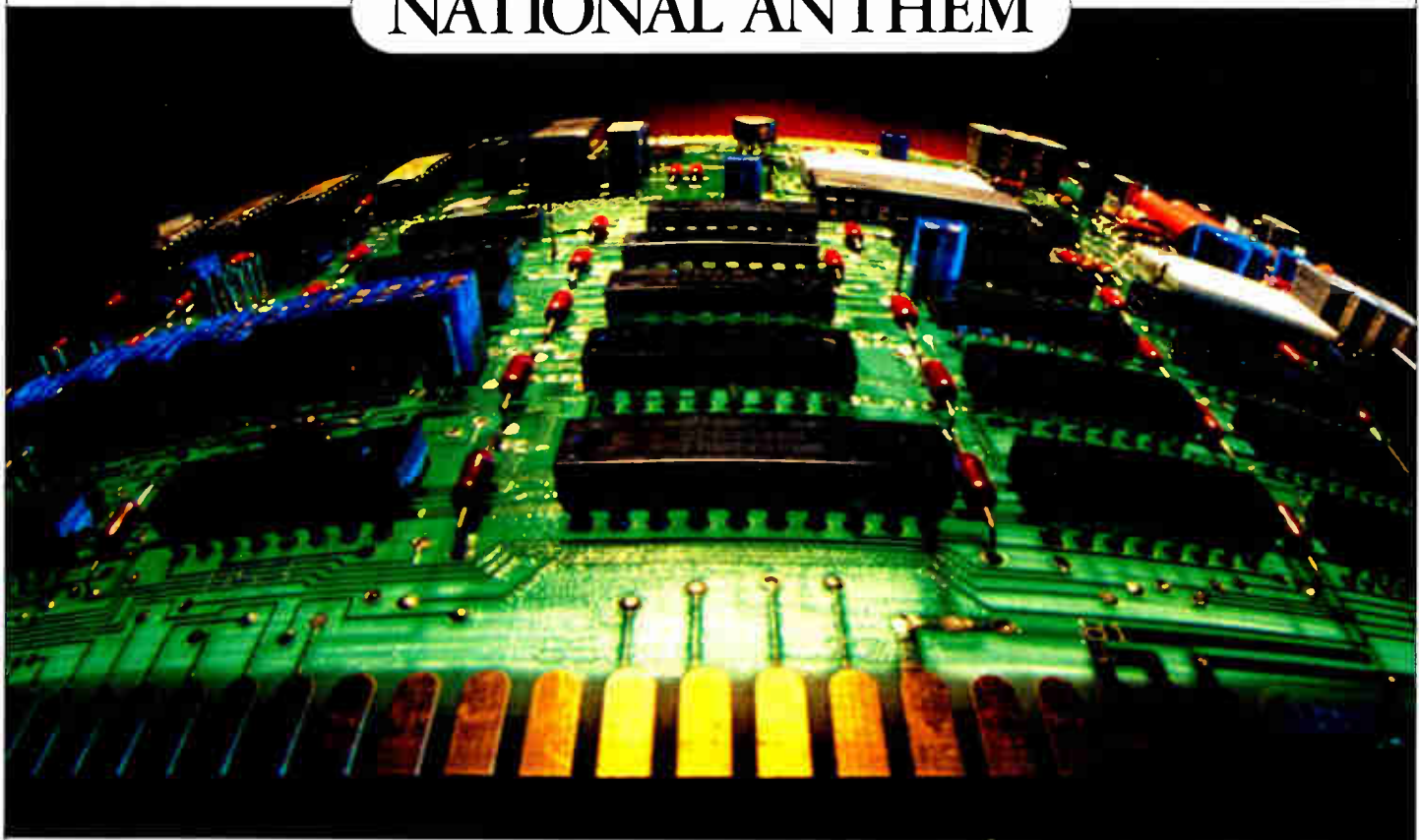

The BLC-8737. The analog I/O board they'll think of next.

The real world is analog. And National's new BLC-8737 analog I/O board gives you easy interface with that real world. The BLC-8737 is very easy to use because its built-in intelligence takes care of the analog functions automatically.

Onboard intelligence handles the complete analog conversion and scanning control. So you don't have to spend time writing conversion routines, for example, and run the risk of messing them up. You save considerable time, not to mention aggravation. Perhaps the best part, however, is that it saves you considerable development cost and gets you to market quicker.

It may be simple, but it handles a lot. Thanks to the BLC-8737's simplicity, the programmer need only tell the board what gains he wants for each channel. In fact, the BLC-8737 strongly resembles a simple memory board, with each input channel behaving very much like a memory address.

In addition, the BLC-8737 can handle a lot of data because it gives you 12-bit

With this new MULTIBUS-compatible board, National has simplified the design of microcomputer systems even further.

resolution. And it only requires a single 5 volt power supply.

When you get right down to it, the BLC-8737 represents impressive capability for designers of analog system applications such as industrial/process control, energy management, testing and instrumentation, to mention just a few.

The BLC-8737. Just part of a very large family. But the BLC-8737 is only the newest addition to National's broad board line. The fact is, National offers over 75 different products in the family, all of them MULTIBUS compatible.

And National also makes a number of unique boards (such as the BLC-8737) that design engineers find very useful. That's because National is putting more and more

intelligence on the board. And taking more and more of the tedious board design work off of you. The BLC-8737 is but one example among many.

National provides a broad spectrum of boards, including CPU's, memories, controllers, analog and digital I/Os, peripheral controllers, rack-mounted systems, a full complement of card cages, power supplies, cables, and other accessories.

A warranty four times as long. National knows how to build products that work. And they also know how to test their products, at the chip and board level.

That translates into better reliability. And explains why they're able to back this claim up with a warranty four times as long as the competition's: a full 12 months.

In addition to their guarantee, National maintains inventory levels that let them quote very competitive delivery schedules.

The bottom line is simple. If you're looking at MULTIBUS-compatible boards, you should be looking at National.

The COP 402 cures microprocessor overkill.

For those millions of repetitive tasks that don't need too much thinking capacity, National Semiconductor has come up with a timely solution.

Their COPS™ microcontrollers actually improve upon the performance of the microprocessors most people use in their place. That's because most microprocessors can do a lot very well, but they can't really do very little very well. Many repetitive jobs applications that are being handled with microprocessors are really cases of overkill.

National Semiconductor recognized the situation and took steps to fill an obvious gap.

Being single-minded has its advantages. The fact is that these many jobs being done by multiple discrete circuits and overly complex microprocessors require a lot of headaches before they're accomplished. Shoe-horning a complicated circuit into a situation that is in fact too simple can be more trouble than it's worth.

So, for under \$10, National is introducing two additions to the COPS family: their COP402 and COP402M. Both designed to handle simple tasks in an efficient way. Customers not only get devices that control little things, they get devices that control them inexpensively.

Introducing another microcontroller that handles little control processing jobs better than complex microprocessors.

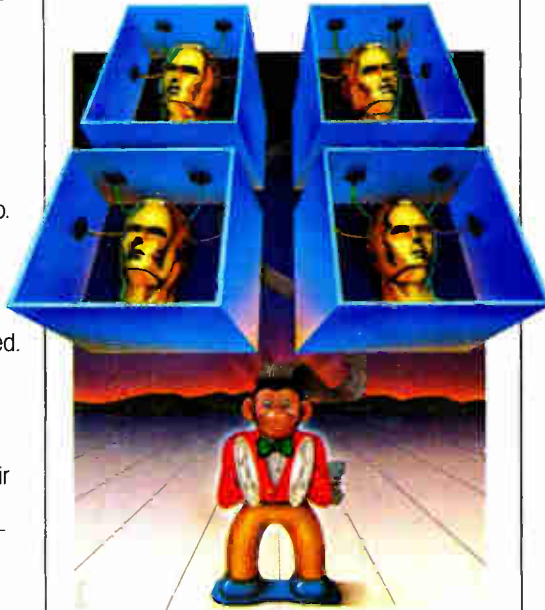

Benefits haven't been forgotten, either. The COPS alternative, though simple in theory and action, actually has quite a lot of thought behind it, as well as on it.

For example, each model features a RAM right on the chip, direct I/O instructions, direct LED drive, easy interface to COPS peripherals (like the COP470), binary and BCD operations, direct KBD scan, and built-in address decoder.

But National didn't stop there. In addition to the above benefits, the entire line can scan switches, maintain real time, display in LED or VF, use external data from a read/write memory, and even function as a computer peripheral. When you consider all the COP402 does, you begin to wonder why you ever thought you needed a complex microprocessor.

The COP 402. Simply competent. If you're currently handling tedious, repetitive, or single-minded tasks with a circuit that's just too over-qualified, you should look into this new National alternative. The bottom line is that the COP402 could be handling your chores for you with a lot less hassle, and a lot less money.

Practicality is the National philosophy.

SEE SPECS ON BACK.

No one puts more manufacturing muscle and engineering talent into custom MOS/LSI.

"Custom MOS/LSI gives you proprietary features that signify a competitive edge — which gets you the market sooner, with a better product, at less cost.

"When it comes to custom MOS/LSI, National Semiconductor offers the lowest cost solution for volume production. We also have dedicated production lines for custom products, so that you always have guaranteed capacity.

"National's capability in custom MOS/LSI is reflected in three key areas. First, we've got the necessary manufacturing capability.

Second, our engineering talent cuts across virtually all electronic design disciplines. And third, we've been in the custom business for years and intend to stay there as long as customers have needs.

"In terms of customer benefits, custom MOS/LSI is the best solution for minimizing system costs. It's the best solution for maximizing system reliability. It makes your product unique.

"And from design through production capability National Semiconductor is your best source for Custom MOS/LSI."



William Sanderson
Group Marketing Manager,
Custom MOS/LSI

Working wonders on the 2147 4K static RAM.

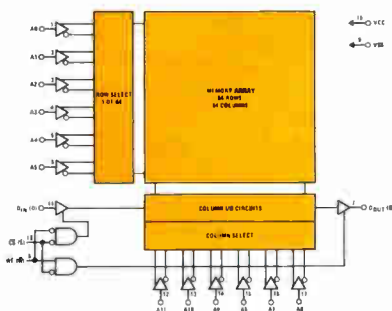

National's new MM2147 static RAM is a 4096-word by 1-bit random access memory that uses National's XMOS™ N-channel silicon-gate technology.

All of the 2147's internal circuits are full static. And they therefore need no clocks or other refreshing for operation. All data is read out non-destructively, and has the same polarity the input data has.

The 2147's separate chip select input automatically switches the part to its low power standby mode when it goes high. And

the output is held in a high impedance state during write in order to simplify your common I/O applications.

The 2147 has other impressive features as well. All its inputs and outputs are directly TTL compatible. It has automatic power down, and high speed — down to 55 ns cycle time. It has a TRI-STATE® output for bus interface, separate Data In and Data Out pins, and a standard 18-pin dual in-line package.

In addition to all this, the 2147 is available.

COP402/COP402M ROMless N-Channel Microcontrollers

General Description

The COP402 and COP402M ROMless Microcontrollers are members of the Control Oriented Processor (COP) family, fabricated using N-channel silicon gate MOS technology. Each part contains CPU, RAM and I/O, and is identical to a COP420 device, except the ROM has been removed; pins have been added to output the ROM address and to input ROM data. In a system, the COP402 or 402M will perform exactly as the COP420; this important benefit facilitates development and debug of a COP420 program prior to masking the final part. These devices are also appropriate in low volume applications, or when the program may require changing. The COP402M is identical to the COP402, except the MICROBUS™ interface option has been implemented.

The COP402 may also be used to emulate the COP410L, 411L, 420L or 420C by appropriately reducing the clock frequency.

Features

- Low cost
- Exact circuit equivalent of COP420
- Standard 40-pin dual-in-line package
- Interfaces with standard PROM or ROM
- 64x4 RAM, addresses up to 1kx8 ROM
- MICROBUS™ compatible (COP402M)
- Powerful instruction set
- True vectored interrupt, plus restart
- Three-level subroutine stack
- 4.0μs instruction time
- Single supply operation (4.5V to 6.3V)
- Internal time-base counter for real-time processing
- Internal binary counter register with serial I/O capability
- Software/hardware compatible with other members of COP400 family

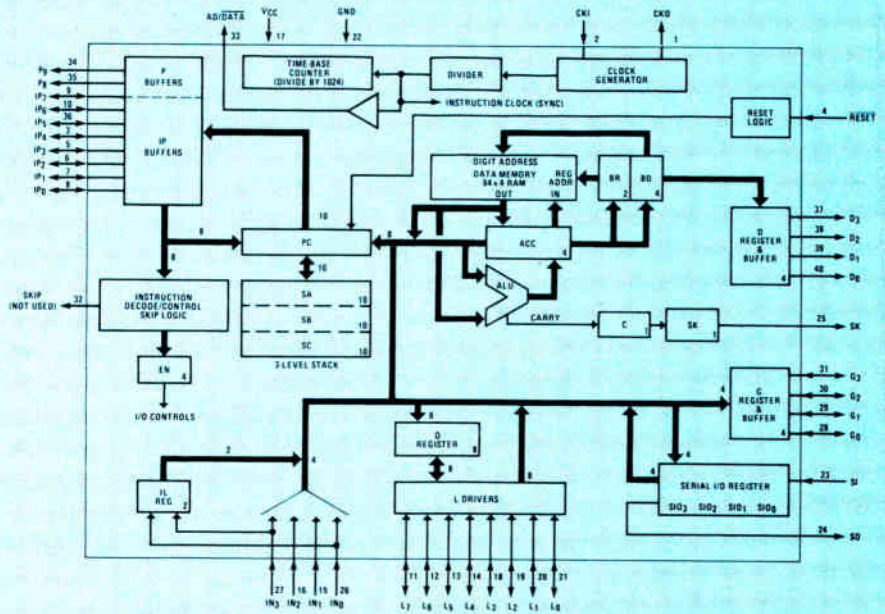

Figure 1. COP402/402M Block Diagram

What's new from the National archives.

- | | |
|--|---|
| 001 <input type="checkbox"/> BLC 8737 Data Sheet | 006 <input type="checkbox"/> Special Functions Data Book (\$6.00) |
| 002 <input type="checkbox"/> COPS 402 Data Sheet | 007 <input type="checkbox"/> Interface Data Book (\$6.00) |
| 003 <input type="checkbox"/> MM 2147L Data Sheet | 008 <input type="checkbox"/> Pressure Transducer Data Book (\$3.00) |
| 004 <input type="checkbox"/> The National Story | |
| 005 <input type="checkbox"/> Additional Custom MOS/LSI Information | |

Enclose check or money order based upon appropriate currency. Make checks payable to National Semiconductor.

NAME _____
 TITLE _____
 ADDRESS _____
 CITY _____ STATE _____ ZIP _____

For desired information, mail coupon to:

National Semiconductor Corporation
 2900 Semiconductor Drive
 Mail Stop 16250
 Santa Clara, California 95051

In Europe, mail coupon to:

National Semiconductor GmbH
 Industriestrasse 10
 8080 Fuerstenfeldbruck
 West Germany

OPTIMUM OPTO-ISOLATORS.

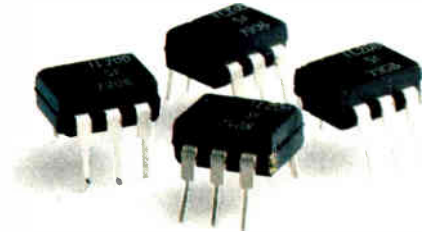

Not everyone needs specs like these. But for those who do, we got 'em.

5KV Opto-isolation

The new Litronix family of high voltage opto-couplers offers 5,000 volts of protection.

That's enough to isolate patients from x-ray machines...or delicate equipment from surges in high voltage power lines.

But what really sets these new products apart is their long term performance specs.

Long term stability

Typical 1,000 hour degradation is less than 20% (Competing products are closer to 50%).

Up to 450% CTR

Our IL-200 series is a 6-lead single coupler offering 5KV isolation at 10 mA IF. It's available in three current transfer ratios: 75 to 150%, 125 to 250%, and 225 to 450%.

Unusually low driving current

All IL-200 opto-isolators feature minimum CTR at 1 mA driving current. They are also guaranteed to operate over a temperature range of 0 C to 70 C. Currently there are three models in the new line.

Part Number	Current Transfer Ratio @ 10 mA	Current Transfer Ratio @ 1 mA	Isolation Breakdown Voltage	1000 Piece Price
IL-201	75 to 150%	10% min.	5000 volts	\$1.00
IL-202	125 to 250%	30% min.	5000 volts	\$1.08
IL-203	225 to 450%	50% min.	5000 volts	\$1.20

Improved Duals and Quads too.

Updated dual and quad optoisolators with the same high range specifications as the single channel IL-1.

Part Number	Channels	Current Transfer Ratio	Isolation Breakdown Voltage	BV _{CEO} @ 1 mA (V) Min	I _{CEO} (Dark) V 10V (nA) Max	1000 Piece Price
ILD-1	2	20% min.	2500	30	50	\$1.36
ILQ-1	4	20% min.	2500	30	50	\$2.90

For samples call or write Litronix, 19000 Homestead Road, Cupertino, CA 95014. Phone (408) 257-7910.

European Headquarters: Litronix, Inc., 23 Church Gate, Hitchin Herts SG5 1 DN, England, Phone: 0462-56-322, Telex: 851-825497. Sales Office: Litronix GMBH, Schoenglick 25, 8068 Pfaffenhofen, West Germany, Phone: 08441-4021, Telex: 841-55532.

litronix
AN AFFILIATE OF SIEMENS

Circle 77 on reader service card

THE LIGHTS FANTASTIC

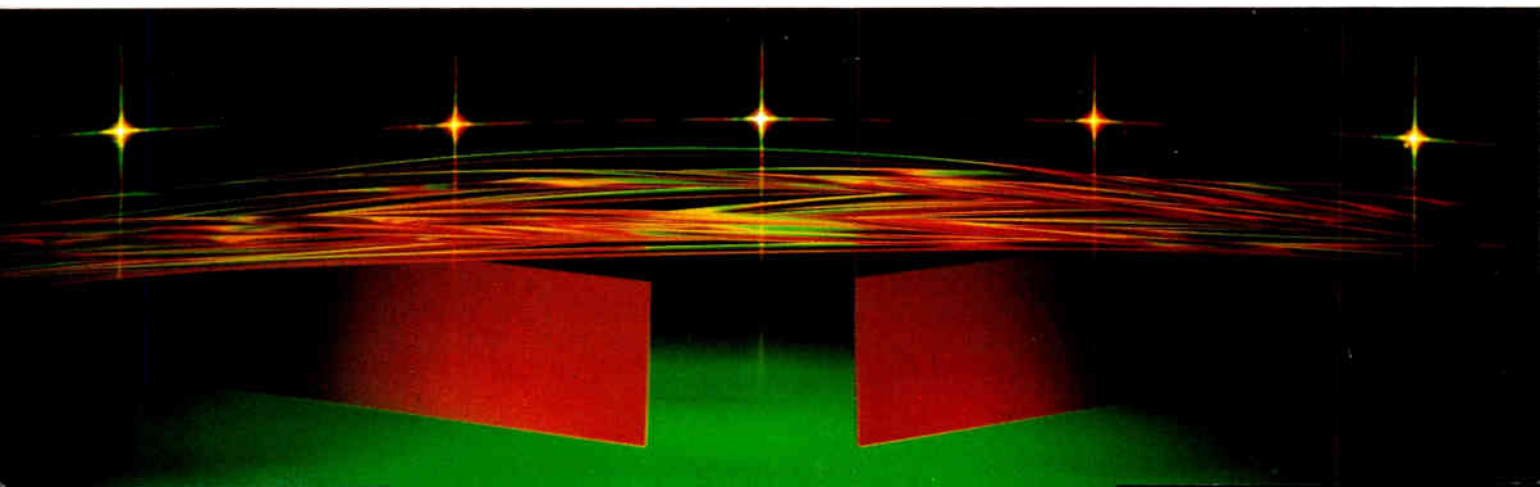

IN MINICOMPUTER SYSTEMS DEVELOPMENT

See how they run.



Design Production Service

HP—When you depend on logic

WHATEVER YOUR CALCOMP HAS

Whether your application is a general one like designing, mapping or schematics, or more specialized like 3-dimensional data presentation, structural analysis, contouring, piping isometrics or business charts and graphs, CalComp offers you the broadest line of plotters.

Nobody offers more ways to solve your graphics problems. Continuous roll, belt-bed and flat-bed plotters for cut sheet applications. Computer output to microfilm. On-line to your CPU. Off-line via tape-drive storage devices. And even on-line/off-line with floppy disk storage.

Add our extensive library of applications software packages to complement our operating software and you've got most of your problems solved.



1055
Drum Plotter/1012 Desk-Top Plotter

The best answers come from the best people.

Looking at the broadest line of computer graphics systems in the world may still present a problem to you.

Like choosing which solution is right for your particular needs; planning for growth and upgrades; and making sure your system delivers consistently excellent performance.

That's where CalComp's Sales Force can help. Because our sales

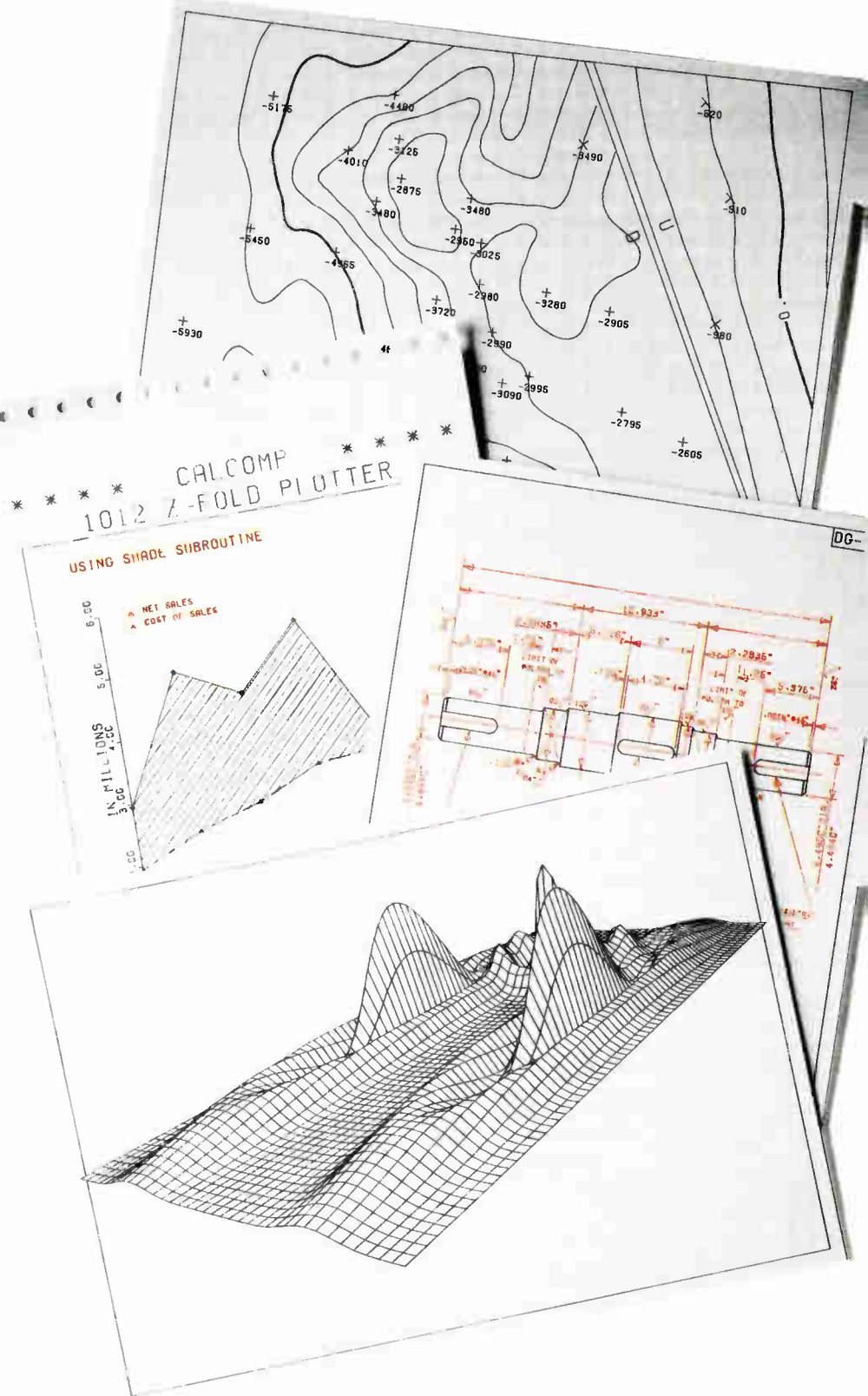

GRAPHICS NEEDS, THE ANSWERS.

representative is really a consultant. In every sense of the word.

They are, each and every one, expert listeners, too. Eager to understand all your special needs.

That's why you can expect in-depth answers to all of your questions. About system capabilities, controllers, software, delivery and more.

You can also expect to hear a lot of discussion about our systems analysts and field service engineers. And what makes them part of a support network that's truly worldwide and second-to-none.

At CalComp, part of the right answer is the right people.

At CalComp, hardware's a multiple choice question. Nobody offers a broader choice of answers.

Take our compact 1012 desk-top plotter, for example. You get crisp, clean 8½" x 11" or 11" x 17" size plots



748 Flat-Bed Plotter

at an impressive 10 inches-per-second. Four-pen versatility, and the convenience of Z-fold paper.

For bigger jobs, there are six other precision drum plotters to choose from. Including the largest, our new 1065, with an extra-wide 72" drum that plots at 30ips.

Or, for the best of high-end per-

formance, there's our 960 belt-bed plotter. It delivers big 33" x 60" vertical plotting for any "E" size plot and 30 inches-per-second speed with 4g acceleration.

And nobody handles computer graphics on a grander scale than CalComp. And that's where a top-of-the-line family of flatbed plotters — the 7000 System — literally draws away from the competition. In dozens

of applications and at hundreds of sites throughout the world.

We do some of our best work on film.

Pen and ink plotters aren't

all we make at CalComp.

In fact, for over a dozen years, we've also been designing, building, selling and servicing exceptional COM (Computer Output Microfilm) systems.

This year we're introducing two new high-speed, high-volume COM systems, the 1581 and the 1681. The former expressly for graphics-only environments. The latter for both graphics and alphanumeric applications.

At CalComp, COM systems are an important part of the big picture.

Nobody has more experience to draw upon.

CalComp pioneered computer graphics way back in 1960.

That gave us a significant head-start. Now, almost twenty years later, CalComp is still the leader and prime innovator in the field. With more experience and models to choose from, up and down the line,

than any other single source.

So contact CalComp today. And get the best possible answer to your specific graphics need.



1065 72" Drum Plotter

Sales Offices:

Tempe, AZ (602) 894-9468. Orange, CA: (714) 639-3690, (213) 430-2104. Santa Clara, CA: (408) 249-0936. Englewood, CO: (303) 770-1950. Norcross, GA: (404) 448-4522. Rosemont, IL: (312) 696-1770. Shawnee Mission, KS: (913) 362-0707. Waltham, MA: (617) 890-0834. Rockville, MD: (301) 770-1464. Federal Accounts Manager, Rockville, MD: (301) 770-4850. Southfield, MI: (313) 569-3123. Bloomington, MN: (612) 854-3448. St. Louis, MO: (314) 968-4637. Union, NJ: (201) 686-7100. Cleveland, OH: (216) 362-7280. Dayton, OH: (513) 276-5247. Tulsa, OK: (918) 663-7392. Beaverton, OR: (503) 646-1186. Bala Cynwyd, PA: (215) 667-2895. Pittsburgh, PA: (412) 922-3430. Dallas, TX: (214) 661-2326. Houston, TX: (713) 776-3276. Bellevue, WA: (206) 747-9321.



960 Belt-Bed Plotter

CALCOMP

California Computer Products, Inc.
2411 West La Palma, Anaheim
CA 92801, TEL: (714) 821-2011
TWX: 910-591-1154.

Circle 81 on reader service card

Assemble your own measurement system in weeks, instead of months ...

You can take months to design and assemble your own bus-compatible measurement system, and get just the system you need.

Or now, you can use HP system-designed instruments and computers, and get to your application in just a few weeks.

The reason is simple: All 119 HP system-designed components incorporate HP-IB (Hewlett-Packard Interface Bus). And HP-IB isn't just HP's implementation of IEEE 488-1978.

It's much, much more.

For example, HP has been designing and building HP-IB compatible products for more than a decade. We've put these 10-plus years of experience into bus architecture, and how it can best be designed into instruments and computers. Quickly and easily. Which means that when you choose HP-IB compatible system components, chances are you'll get your measurement system up and running weeks faster than if



you were to configure it the conventional way.

Because HP offers 119 different HP-IB instruments and computers, you choose just the bus compatible hardware that best fits your system needs.

HP also has developed over 104 application notes on HP-IB compatible products. One of these may be just what you need to get to your application. Quickly and effortlessly.

For that matter, every HP-IB compatible product comes with complete and comprehensive documentation. Many of our computers feature high-level I/O language that eliminates the need for an I/O driver.

Choosing to assemble your own bus-compatible system with HP-IB products also means that if you ever need service on your system, just call H-P. One of our hundreds of field service people will respond to your need.

Find out how much easier and faster

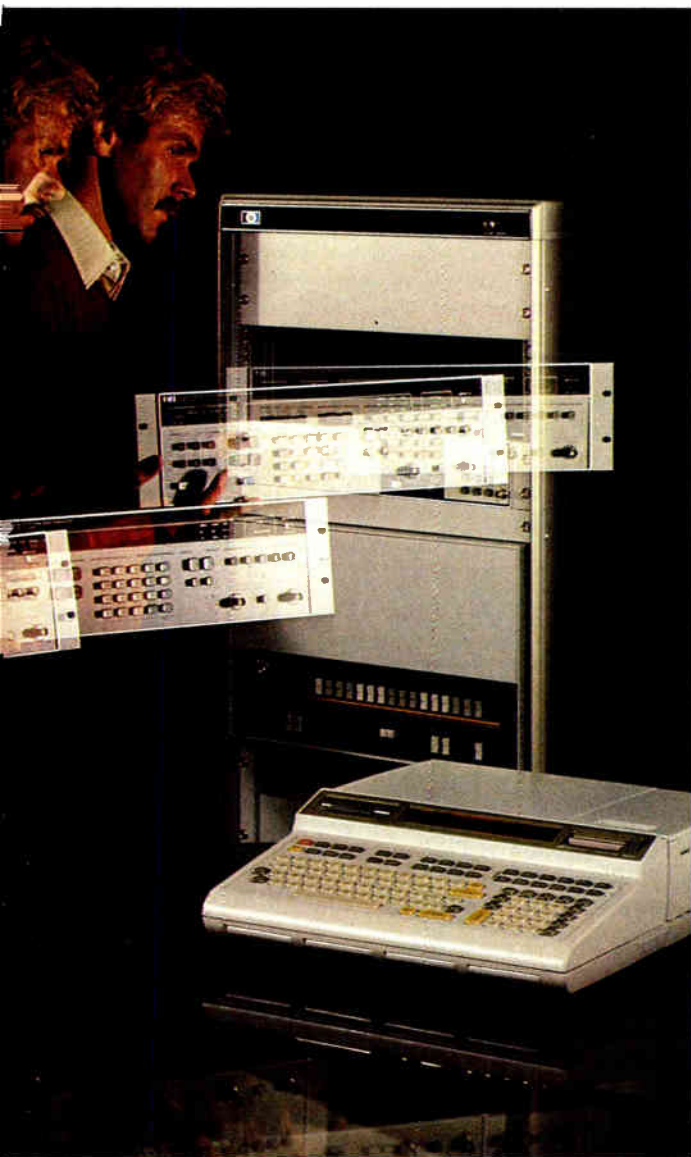

with HP's 119
different system-
designed instruments
and computers.

system design can be. Write today for our free, 16-page booklet, "Do your own system design in weeks, instead of months." It tells you everything you need to know about HP-IB compatible instruments and computers, about HP software and documentation support, and how to get more detailed information on specific kinds of applications. Or simply call your local HP field engineer.



HP-IB: Not just a
standard, but a
decade of experience.

HEWLETT  **PACKARD**

1507 Page Mill Road, Palo Alto, California 94304

For assistance call the HP regional office nearest you: Eastern 301/258-2000
Western 213/877-1282, Midwest 312/255-9800
Southern 404/955-1500, Canadian 416/678-9430

089/7

Laser trimming of monolithic circuits

Silicon valleys

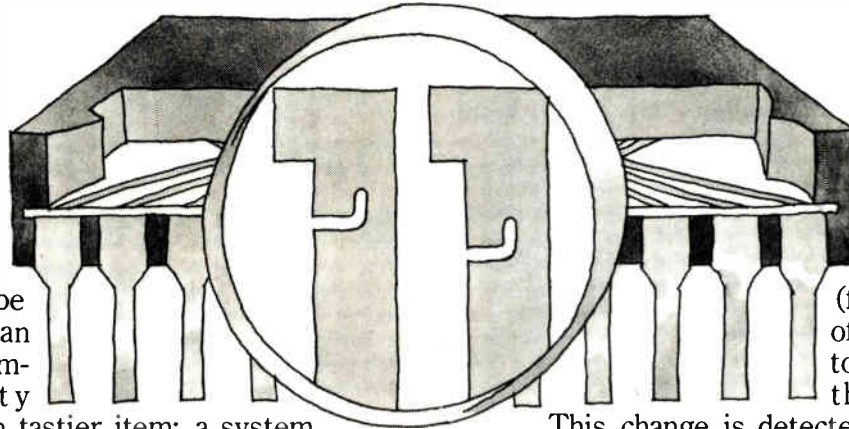

No sooner have we swallowed the fact that 86,000 thick-film resistors can be laser-trimmed in an hour than the trimming fraternity serves up an even tastier item: a system capable of trimming monolithic circuits with a laser beam only 6 micrometers in diameter.

Now, to put a spot size of 6 micrometers into focus (so to speak), the new trim system can very easily write your name inside the period at the end of this sentence, with room left over for a troupe of dancing angels.

Producing a spot this small is basically an optical feat, accomplished by lensmanship of the highest order. To be useful in monolithic trimming, however, beam reduction must be accompanied by equally remarkable positioning accuracy, there being no known application for a wandering 6-micrometer laser kerf.

Teradyne's closed-loop galvanometer beam positioner, used for some time on the W411 Laser Trim System, had already wiped out hysteresis and greatly reduced nonlinearity. That left geometry errors in the step-and-repeat table and registration errors from die to die as the principal error sources to be dealt with.

The solution to these problems is a new technique for nondestructive edge sensing, called "Laser Eye." Before the laser beam starts trimming, it is attenuated and brought to the leading edge of the circuit. When it encounters the circuit edge, there is

an abrupt change in the amount of laser energy reflected (from high reflection off the light substrate to low reflection off the dark circuit).

This change is detected by a photodiode, and the exact position is passed along to the computer, which adjusts the stored trim coordinates and the focus of the laser beam accordingly. The edge-sensing is typically repeated on every die to ensure positioning accuracy, with focus adjusted every inch or so to compensate for any wafer warp.

As further insurance against positioning errors, the entire mechanism is shock-mounted against the effects of vibration. The trim system is, after all, designed not as a laboratory instrument but as a machine to grind out parts on a factory floor.

The combination of closed-loop galvanometer positioning, Laser Eye, and solid systems engineering yields a bottom-line, no-strings positioning accuracy of 2.5 micrometers. That means that, on any given circuit, the laser beam will be within 2.5 micrometers of where it's supposed to be, period.

Monolithic trimming is currently of principal interest to makers of monolithic 12-bit D to A converters. But now that lasers have broken the IC, who knows what uses may be found for 6-micrometer holes, coming thousands per second, right on the money every time?

The first 12 essays in this series are now available in booklet form. For your copy, write to Teradyne, Department E, 183 Essex Street, Boston, MA 02111.

TERADYNE

Standards key to fax's future

CCITT to decide on data-compression code
to be used on digital networks by future machines

by Ana Bishop, McGraw-Hill Publications Co.

After many years of lackluster performance, facsimile equipment may regain the spotlight as a component of the all-digital electronic office of the future. But the industry's future is hanging on whether an international committee, meeting this week in Kyoto, Japan, can decide on standards for the digital transmission of facsimile images.

A study group of the Consultative Committee on International Telephony and Telegraphy is preparing to promote standards for facsimile transmission to the CCITT plenary session in Geneva next spring. The study group has pretty much agreed on a one-dimensional data-compression code—the modified Huffman code (see “Getting to the point”)—that will make all high-speed digital facsimile machines transmitting over conventional analog telephone lines (Group 3 machines) compatible.

However, a second data-compression code, this one two-dimensional, would be available on machines that meet the Group 3 CCITT recommendations, and there is no consensus on that one. Why all the fuss over an option? Whichever algorithm is chosen may become the precedent for a future generation of digital facsimile machines that would transmit over all-digital communications networks (Group 4 units).

For the option, seven algorithms have been proposed to the study group. Japan, the United Kingdom, and West Germany have one apiece, and the other four come from American firms—3M Co., IBM Corp., Xerox Corp., and American Telephone & Telegraph Co. But the U. S. has only one vote, and the decision must be unanimous.

Facing the unenviable task of uniting the American companies on this issue is Western Union Corp.'s vice president of corporate planning, Roy K. Andres, who heads the U. S. preparatory group. He says that the committee recommendation on the optional data-compression technique “has to be solidified six months before the plenary session.” Since the CCITT holds its standards-setting plenary sessions only every four years, the issue would wait until 1984 if there is no accord this week.

The manufacturers cannot wait another four years. Andres says time

is of the essence: “The quicker the standards come out, the quicker the manufacturers can settle into the market.” But a compromise on the algorithm has not been reached at other study group meetings because each company has been looking out for itself. The attitude has been that the firm that already has the hardware to implement whatever optional algorithm is recommended will have a head start on Group 4 machines. In fact, companies that already have sub-minute machines on the market are promising their customers that their units will meet

Getting to the point

In terms of data content, images are highly redundant. So, in a facsimile system a lot of information transmission can be eliminated with little or no effect on received picture quality. The basis for this redundancy reduction is proper coding of the symbols that represent the transmitted information. In the picture itself, transitions from black to white and vice versa appear with unequal frequency.

There are actually few transitions, with what amounts to runs of black or white of varying lengths. And the number of transitions in a typical scan of one document line by a raster scan system is smaller still. Therefore, encoding black and white run lengths between transitions and converting the run length and its position into a digital code seems to be a good idea if the code words are chosen to take far less transmission than raw informa

This can be done in many different ways and is the basis for the one-dimensional codes, such as the Modified Huffman, that have been developed. Depending on the coding scheme used and the ratio of white to image space on the document, these codes are capable of a wide range of compression ratios.

It is possible to expand the coding concept to take into account more than one line at a time. For example, the contents of two adjacent lines can be encoded so that additional compression is gained. But two-dimensional coding is capable of the most compression. Here, the data is also compressed on the basis of transitions occurring from one scan stroke to the next. The principle for the coding is the high probability that a transition occurring at one point in one scan stroke will be repeated at approximately the same point in the next scan stroke. Thus, if all the transitions in the first stroke are encoded, only the differences in the position of the transitions in the next stroke need to be encoded. And since difference codes are shorter than position codes, further compression results.

-Harvey J. Hindin

Probing the news

future CCITT standards, so the makers face a large retrofitting bill if the machines they are installing now use a nonstandard algorithm.

Compromise in all. An Electronic Industries Association committee has "worked very hard to come up with an American position and alternative compromises which all could accept," says Andres. The chairman of that committee, Chuck Jacobson, engineering manager for facsimile at the Xerox Office Products division in Dallas, says that "the majority of U. S. companies are going to the Kyoto meeting with an attitude of compromise" because "most are interested in reaching a standard as soon as possible."

According to Jacobson, most manufacturers feel that the two-dimensional algorithms in question "probably will be extended" to machines that would transmit over proposed public data-communications networks such as AT&T's Advanced Communications Service or Xerox's Xten [*Electronics*, June 7, p. 94].

Like most standards, these facsimile recommendations are expected to have a major impact on the market because they portend faster and more efficient machines. Some manufacturers break up the facsimile market along analog-digital lines; others go by transmission speeds. The Japanese companies have been transmitting digitally at high speed for years because their telephone system has a broader bandwidth, but U. S. companies have stayed in the mid-speed analog market.

Some contend that the market for medium-speed analog machines—those that transmit an average letter in 2 or 3 minutes—has reached a peak and that the market for sub-minute machines—those that do so in less than a minute—is just taking off. The manufacturers of medium-speed machines have aimed their marketing strategies at medium-sized companies that want the machines for convenient use at what Jack E. Cochran, president of Exxon Enterprises Inc.'s Qwip Systems, Orlando, Fla., calls "the point of need"—the desk and phone.

But some in the industry argue

Getting the picture

One of the major problems that facsimile faces is the quality of the copies. Use of voice-grade lines means that the transmission can be affected by noise, causing echoes of other distortions to appear on the transmitted copy. As the samples below show, facsimile machines can have problems, even transmitting over demonstration machines at company display sites.

The Qwip copy (top left) was transmitted interoffice at a rate of 2 minutes over telephone lines on a demonstration model. Even over such a short distance and at a speed that in theory offers better resolution, noise interference patterns were a serious problem.

The 3M copy (top right) was transmitted interoffice at 9,600 bits per second over telephone lines. Most of the copies from this machine were clear, but a graph reproduction revealed that the relatively few bits not being transmitted—which did not seriously affect the legibility of alphanumeric transmission or large diagrams—did cause significant distortion when transmitting a grid pattern. The vendor claimed that this was a malfunction of the particular machine and could be easily corrected by a repairman.

The cleanest copy (bottom) came from a Xerox 200 Telecopier transmitting from one terminal to another in the same display room at a rate of 2 minutes over analog telephone lines. The 200 uses a laser beam for scanning and reproduction and produces xerographic copy on plain bond paper. Even better resolution is possible with the 3-minute rate.

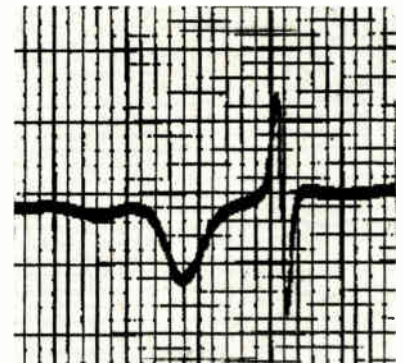

FORM 2776
TELLER'S STAMP

SAVINGS WITHDRAWAL

ACCOUNT NUMBER

3 9 0 - 3 4 - 1 0 5 6 9 6 - 3

16 17 5

14

DATE
27

33 BLOCK BALANCE 41

TWO HUNDRED SEVENTY FIVE
(AMOUNT IN WORDS)

42-43
H.W.

that special digital common carriers are needed to make the big, expensive, fast units cost-effective. So 3M and others in the facsimile business are keeping close tabs on such systems as ITT Domestic Transmission Systems Inc.'s forthcoming Faxpak. Faxpak, which combines a computerized store-and-forward capability with packet-switched data-communications technology, begins operation throughout the continental U. S. on Dec. 3. 3M, for one, sees

such technologies, rather than other firms, as the major competition.

Although Faxpak and other proposed communications networks would make the facsimile machines of different manufacturers and of different speeds compatible, they would not solve compatibility problems on international transmissions. For example, in order to serve its international Q-Fax customers, RCA Global Communications Inc. has to use machines made by six firms. □

Picture a line of low-cost fully-enclosed carbon-film trimmers...



And Its Circle of "Special" Friends.

Spectrol now offers a low-cost line of carbon-film trimmers that are fully-enclosed and available in two sizes – the 5/8-inch Model 77 and the 3/8-inch Model 76. They come in nine standard configurations, as shown in the photo, and they are also available in a great variety of special configurations with various spindles, panel mounts, and other optional features. Resistance range is from 100 ohms to 10 megohms. Send for a data sheet.

Call for a quote or a free sample.

Spectrol

SPECTROL ELECTRONICS GROUP

UNITED STATES Spectrol Electronics Corporation P.O. Box 1220, City of Industry, Calif. 91745, U.S.A. • (213) 964-6565 • TWX (910) 584-1314

UNITED KINGDOM Spectrol Reliance Ltd. Drakes Way, Swindon, Wiltshire, England • Swindon 21351 • TELEX: 44692

ITALY SP Elettronica SpA Via Carlo Pisacane 7, 20016 Pero (Milan) Italy • 35 30 241 • TELEX: 36091

GERMANY Spectrol Electronics GmbH Oberauerstrasse 15, 8000 Munich 70 West Germany • (089) 7145096 • TELEX: 05-213014



*John West, Executive
Vice President, Numeridex, Inc.*

“We’re making the Factory of the Future a reality— with Intel® Single Board Computers.”

West: “Productivity is on everyone’s mind these days. In manufacturing, it’s accelerating the trend towards automation of machine control. At Numeridex, we’re taking advantage of the demand for improved efficiency by harnessing microcomputer intelligence for computer-aided manufacturing applications.

“Intel Single Board Computers are the technological breakthrough that’s made the difference for us. Our special expertise is understanding customers’ needs—not designing microcomputers. From the earliest stages of product planning, relying on Intel’s fully assembled and tested board computers enabled us to speed up development, conserve capital, and focus our resources on designing the right product for our market.

“Our LC-5000 system for numerical control tape preparation is an example. Its intelligence

is based on the Intel iSBC 80/20-4™ Single Board Computer, providing features and capabilities never before available to the numerical control market. Smart machines like the LC-5000 are the tools our customers need to achieve high productivity.

“Starting with fully debugged microcomputer hardware meant we could concentrate on application software.

That’s where our real proprietary value is, anyway. With our limited experience, though, we might not have succeeded without the software development tools Intel provides. The Intellec® Microcomputer Development System and RMX/80™ Real-time Multitasking Executive software framework made it easy to write specific application-oriented modules. That’s another way Intel helps companies like Numeridex gain the market advantage with microcomputers.”

Intel Single Board Computers, microcomputer components, memory products and development systems have helped hundreds of companies, with applications ranging from industrial automation to data and word processing, get the competitive edge.

For more information on how Intel microcomputer intelligence can revolutionize your product line contact your local sales office or distributor, or write Intel Corporation, Literature Dept., 3065

Bowers Avenue, Santa Clara, CA 95051. Telephone (408) 987-6475.

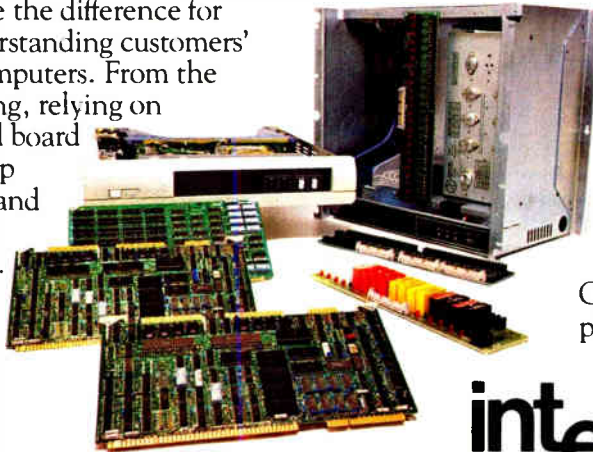

Companies

Born-again GenRad roars into '80s

\$2 million in the red in 1972, the company has bounced back by capitalizing on in-house capabilities and new markets

by James Brinton, Boston bureau manager

In the late 1960s, General Radio Inc.'s future was behind it. Its product introductions were sporadic, often unplanned, and sometimes unsuccessful. Its offices were musty, its management fusty. Lines on graphs showing earnings projections drooped and were to sag further in the next few years.

But things have changed. Now it's GenRad Inc., and there is an upbeat atmosphere about the Concord, Mass., firm's plant, people, sales, and its financial statement.

In mid-October, GenRad reported a record third-quarter net income of \$2.531 million on \$31.7 in revenues—increases of 48% and 45%, respectively, over 1978's third quarter. For the year, net income is up 52% to \$6.139 million and revenues have increased 34%, reaching \$82.079 million. That is almost what GenRad made in all of 1978.

Estimates vary, but GenRad could finish 1979 with net revenues of \$105 million to more than \$120 million, according to company spokesmen and financial analysts. Thus, it is performing more like a highballing young company than one of the country's oldest electronics firms. In fact, it is both.

The resurrection dates from 1972-73 when it lost its shirt and then gained William R. Thurston as president. The company lost \$2.303 million in 1972 on a net of \$33.35 million, and though 1970 and 1971 had theoretically been profitable, a small accounting change would have been enough to throw GenRad \$100,000 to \$200,000 into the red despite \$26 million to \$30 million in net revenues. Outwardly, the company was moribund.

But beginning in 1973, Thurston dumped its committee management system, wrote off a costly internal computer development, restructured top management, began weeding out marginal operations, and eventually started scouting for acquisitions [*Electronics*, July 20, 1978, p. 96]. Insiders, though, say his greatest effect has been on what is called GenRad's hit ratio—the ratio of successful new products to unsuccessful ones. Lately, some of them have not so much arrived as detonated in the marketplace.

Announced this spring, the micro-processor-based 1731 tester of linear integrated circuits allows unskilled operators to test 3,000 to 5,000 different IC types [*Electronics*,

March 29, p. 136], and it has been selling fast enough, say company spokesmen, to have already captured much more than 30% to 40% of 1979's benchtop-tester sales. By expanding the market and offering an attractive price-performance ratio, the \$22,900 product now is expected by GenRad to capture 80% to 90% of its market by year's end. It is selling at about 120% of the planned rate, deliveries have been stretched from 12 to 16 weeks, and plant capacity is being reserved for increased production next year.

Low figure. Product marketing manager G. Roy Rondeau admits to a classic case of underestimation: "Our research showed a total market of \$4 million to \$5 million." That

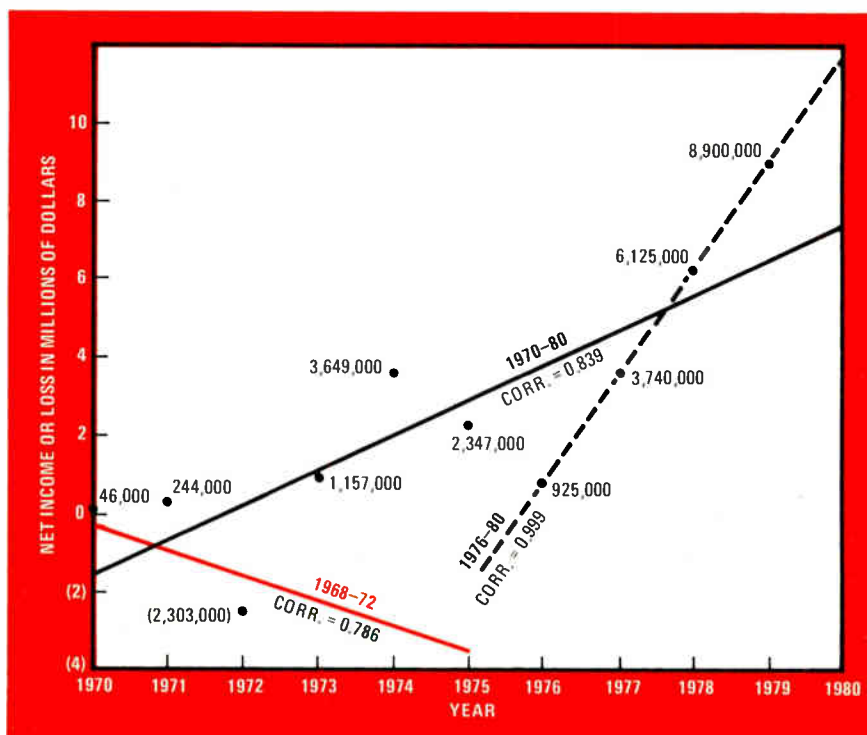

Probing the news

itself was low, but then the 1731 began selling in unexpected areas, too. Aimed at the incoming-inspection market, half the 1731's sales have come from semiconductor manufacturers instead, with a number going into offshore assembly operations and others backstopping large Sentry-class IC testers at firms like Fairchild Camera and Instrument Corp., Advanced Memory Devices Inc., and Signetics Corp.

The 1731's success story and Rondeau's reasoning both are supported by independent observers like Galen W. Wampler, vice president of market research firm Dataquest Inc., Cupertino, Calif. "Even GenRad's competition agrees that the 1731 is a very capable machine at the price," he says, adding that "it also was announced just as the growing sophistication of linear ICs had outmoded many existing testers. Finally, the 1731's competition is concentrated at the ends of the price-performance ratio spectrum while the 1731 is in the middle."

Treading the boards. GenRad's board tester business also is booming. Its line of functional test systems, launched in 1960 with the model 1790, logged \$17.5 million in sales in 1976 for 32% of net revenues. In 1977, the figures were \$31 million and 44% of net. Thurston breaks out 1978's figures, noting that GenRad sold \$42 million in board testers, taking about 48% of the worldwide market (reckoned at \$88 million) and accounting for 49.6% of net revenues. "Our next five largest competitors combined had \$42.5 million," he says, claiming that GenRad's share is steadily growing: "GenRad's systems business grew 38% in 1978 while our competition's grew less than 21%."

F. Eberstadt & Co., New York, manager of two mutual funds and broker for institutional clients, expects the growth to continue. Eberstadt estimates that GenRad's earnings will grow at 46.5% compounded from 1974 through 1979, faster than any other company in the test and measurement industry. Teradyne Inc., in contrast, will reach only about 8.2% compounded for the

same period, in Eberstadt's opinion. The rest of the major firms in the test and measurement field are expected to grow at 17% to 30%.

Eberstadt's estimate is probably conservative; analyses made nearer the end of 1979 by Dataquest and Morgan Stanley & Co., the New York investment firm, forecast 1979 growth between 28% and 37% for

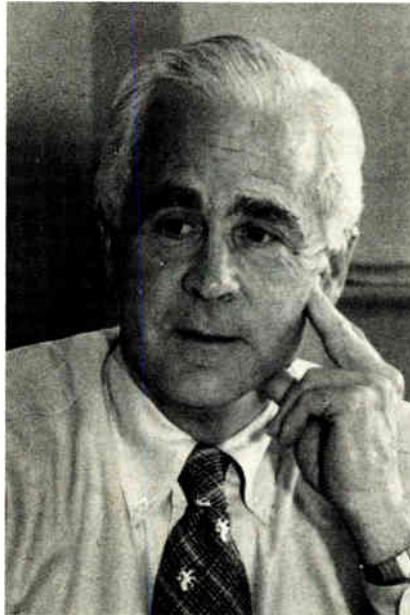

Turnaround leader. William Thurston arrived at GenRad to find a \$2 million loss.

firms like Teradyne, John Fluke Manufacturing Co., Tektronix Inc., Hewlett-Packard Co., and GenRad. And even these two market analysts are factoring in a mild recession for the first half of 1980.

Eberstadt estimates that the 1979 board tester market will grow by about 30%. Thus, if GenRad simply grows in proportion, it will have sold about \$55 million in board testers by year's end. Inside betting is that the figure will be much higher.

Looking ahead. Entrenched in the incoming-inspection and functional-board-test markets, GenRad is looking toward equipment servicing and the design process as future targets.

Its approach to servicing is characterized by the 2225 portable functional board tester; using software generated for GenRad's large in-plant systems, it moves board test (and repair) into the field, helping to cut the floating inventory of printed-circuit cards.

GenRad's investment in Los An-

geles-based Futuredata Computer Corp. may yield a larger payoff, though. GenRad/Futuredata makes multi-user, universal microprocessor software development systems [*Electronics*, April 26, p. 40], and market research figures put it in a good place at a good time. According to Dataquest, the microprocessor development system market is in for a 31%-compounded annual growth rate between 1977 and 1982. That's an increase from \$74 million in 1977 to \$285 million in 1982.

Further, by the end of 1978, there were some 32,000 such systems in use and Dataquest foresees 100,000 installed by 1982—a 212% increase. That means shipments, and Dataquest plots an increase from 8,900 in 1977 to 21,000 in 1982, for a 20%-compounded annual growth rate.

Finally, in 1978, the price of a development system averaged \$9,300; Dataquest figures the price will be \$11,200 in 1980 and \$13,000 by 1982. GenRad/Futuredata estimates that peripheral equipment raises average price about 50%.

Futuredata seems less an acquisition than a marriage. "Futuredata wanted some capital, but more specifically, they wanted our systems test software know-how," says Thurston. "GenRad wanted Futuredata's logic and microprocessor systems development expertise—we wanted to get a lead on testing the microprocessor-based products of the 1980s."

Bruce E. Gladstone, vice president of GenRad/Futuredata, estimates that the market for universal development systems (versus the dedicated types sold by semiconductor houses) will be about \$23 million in 1979, up from nothing in 1976. Semiconductor makers rang up about 85% of all development system sales in 1978, he says, but he foresees a switch by users away from dedicated to universal systems. And right now just a few companies offer universal systems in competition with GenRad.

Thurston says that GenRad/Futuredata already is exceeding the growth plan laid out before the acquisition, in both volume and profit, and "we want them to learn and grow as fast as possible"—which sounds like what the rest of the company is doing. □

Introducing mass storage for micros.

It costs like a tape, but thinks like a disk.

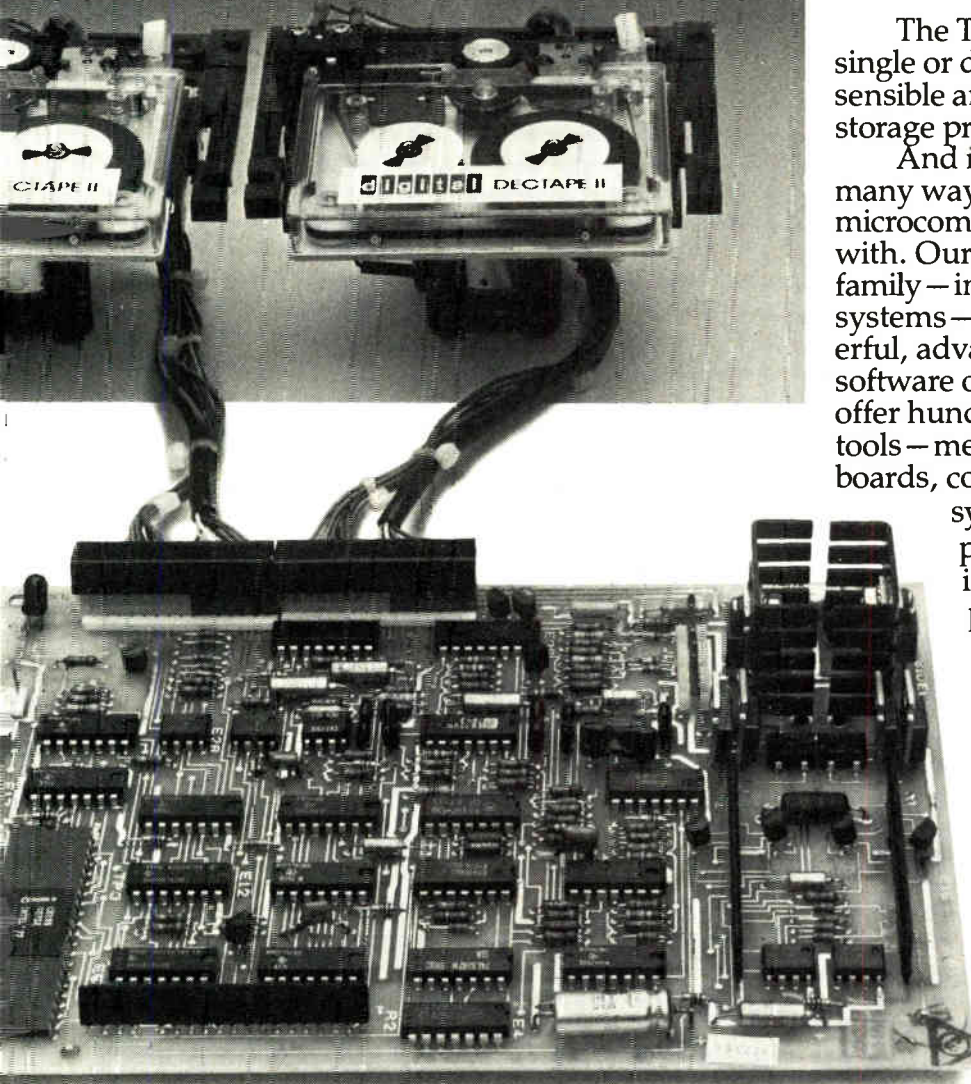

Digital's 512Kb TU58 cartridge tape subsystem. At \$562 in 100's, it's priced like a tape device. But with random-access block addressing, and EIA serial interfacing, it's like no other tape drive on the market.

That's because the TU58's controller board has a built-in MPU that makes it think like a disk. It reads, writes and searches for data in blocks, instead of running serially through the whole tape like conventional systems. And the TU58's small size—the board measures just 5.2" x 10.4" (13.2 cm x 26.5 cm)—makes it easy to design into your product.

The TU58 cartridge tape, single or dual drive. It's the first sensible answer to micro mass storage problems.

And it's just one of the many ways Digital makes microcomputers easier to work with. Our 16-bit microcomputer family—in boards, boxes and systems—offers the most powerful, advanced and proven software on the market. We also offer hundreds of hardware tools—memory and interface boards, complete development systems, terminals and peripherals. And we back it all with over 11,000 support people worldwide.

It's the total approach to micros, only from Digital.

For more information, contact **Digital Equipment Corporation**, MR2-2/M70, One Iron Way, Marlborough, MA 01752. Or call toll-free 800-225-9220. (In MA, HA, AL, and Canada, call 617-481-7400, ext. 5144.) Or contact your local Hamilton/Avnet distributor.

In Europe: 12 av. des Morgines, 1213 Petit-Lancy/Geneva. In Canada: Digital Equipment of Canada, Ltd.

It took the minicomputer company to make micros this easy.

digital

Circle 91 on reader service card

Shinier image sought for the engineer

Long-term IEEE effort under way to clarify role
of engineers and electronic technology

by Alfred Rosenblatt, Managing Editor

If doctors have Marcus Welby, M. D., to enhance their image, why can't electronics engineers have a TV series built around a friendly Joe Engineer, as sympathetic and knowledgeable about the real-life problems of modern technology, like Three Mile Island and public transportation, as Welby is about gastroenteritis and cancer?

The possibility of such a series is far-fetched, as Eric Herz, general manager of the Institute of Electrical and Electronics Engineers, after a decades-long career as an electrical engineer, is quick to admit. But the idea behind it excites him.

Why not a more sympathetic image for engineers in the mind of the general public, he asks, one that would counteract the negative attitude he perceives that it has toward engineers and technology? Why not a counterbalancing image of the engineer as a source of good for society, rather than of danger? as a respected professional contributing to the community?

Spending money. Herz and the other top-level members of the IEEE think the institute can change the engineer's image. It is spending \$200,000 for the effort in 1979 and has earmarked \$216,000 for 1980. The money has, in part, brought Joseph J. Codispoti to the institute in September as its new staff director for public relations and allowed it to retain an outside public relations counsel, the well-known New York firm of Ruder & Finn Inc. Still to be hired is a public relations staff member for the IEEE's Washington office to deal with members of Congress and their staffs. (In 1978; in contrast, the institute spent

\$46,000 on public relations, working mainly with an outside consultant.)

Codispoti, 35, comes to the IEEE from eight years as the public relations manager of Analog Devices Inc., the maker of converters and other electronic components. "I have no biases, no allegiances," he says. "I can bring a fresh approach to public relations."

So far, perhaps the most important role in the new program has been played by Ruder & Finn. For one thing, it helped select Codispoti from among several applicants responding to newspaper advertisements for the job. It also drafted a public relations program, drawing largely on interviews with IEEE staff and committee volunteers.

Broad target. According to Herz, the targets of the program "are the institute's members, Government opinion leaders, the technical press,

and, through the general press, the public." For Codispoti, this translates into promoting the public's understanding of technology and, in particular, of the role played by the electrical engineer. At another level, Codispoti will focus on internal communications within the organization itself to increase the membership's awareness of the activities being undertaken in its behalf.

All involved are agreed things will not change overnight. "I see this as a sustained, long-term effort," says IEEE president Jerome Suran. He is particularly concerned about working to influence Congress to pass laws of benefit to IEEE members. He points to laws that would seek to halt wage-busting efforts by certain companies and establish better pension rights for engineers. If the public regards engineers in a more favorable light, such legislation, and other issues as well, may have a better chance of being decided in favor of institute members, he points out.

To reach the public, Codispoti sees a lot more effort being made to inform the general press about IEEE activities, particularly about conferences and testimony before Congress. A lot more technical stories will be sent out to the press, he says. "We also want our conference organizers to concern themselves with the general press," he continues. "We want to have press people meeting with our technical experts who will explain difficult things in ways they can understand. It will help them to report technical events better."

Use experts. Off in the future, both Herz and Codispoti hope that members of both the technical and general press will come to regard the



Image builder. Joseph Codispoti has joined IEEE as staff director for public relations in effort to upgrade public's view of EE.

REALISM

4096 STAGE DELAY

IEEE as a source of information. "We'll have people on call who can answer questions in a whole range of technical disciplines," says Herz. "That way, the reporter will have the benefit of someone who is technically able." He hopes, too, that Congress will learn to call upon the IEEE for unbiased technical opinions.

As Henry Morgan, president of T-Bar Inc., Wilton, Conn., and chairman of the IEEE's all-volunteer public relations committee, points out, "We have a lot of renowned people in the organization who could provide background and explain the fundamentals. This need have nothing to do with taking a public stand on an issue."

It was Morgan's committee that formulated the plan to enhance the engineer's image. And it was he who brought Ruder & Finn, which also acts as a consultant to T-Bar, to the attention of the executive committee that engaged the firm and agreed to its fee (believed to be about \$60,000 from April through the end of the year).

Morgan stresses that Ruder & Finn will not be used to do the work the IEEE staff can do by itself but will do that for which it is uniquely qualified. "They won't do something like set up a press conference," he says. "Rather, they'll tell us whom we ought to invite, or how we might best approach the chairman of a congressional committee."

Fee questioned. However, some do question retaining Ruder & Finn and paying its monthly fee. "I don't understand why they need both a professional like Codispoti and Ruder & Finn," says a former member of the IEEE public relations committee, himself a public relations man. "They could put a little more in Joe Codispoti's budget and get the same things done for a lot less money."

Strong misgivings about the IEEE's new program are held by Irwin Feerst, long-time critic of the IEEE hierarchy. "This looks like a coat of PR paint they're trying to give us, when they should be carrying out positive actions," Feerst says. So disgruntled is Feerst that he filed suit in New York City's small claims court on Oct. 22 for \$1.13—"about the portion of my dues to the IEEE going to pay for the program." □



New model SAD-4096 Bucket Brigade Delay Line offers:

- Delays of 250 mS to 1 mS
- Wide Dynamic Range 70 dB
- Full wave output
- No insertion Loss
- Up to 200 KHz Bandwidth

Typical Applications:

- Reverberation/Echo effects
- Time Base Conversion
- Voice Scrambling/Pitch correction

For complete details on this broad line of standard delay lines and how they can improve your product and reduce costs, call your nearest RETICON field office now.

 **EG&G RETICON**

345 POTRERO AVENUE
SUNNYVALE, CA 94086
TWX: 910-339-9343

For assistance call: Boston (617) 745-7400, Chicago (312) 640-7713,
San Francisco (408) 738-4266, Los Angeles (213) 995-4663,
Tokyo, Japan 03-343-4411, Bracknell, England (0344) 53618

Automotive electronics

Europe races to catch up

Car makers lag behind U. S. counterparts in placing controls under the hood but are feeling the pressure of oil crises

by Kevin Smith, London bureau manager

Though European automotive manufacturers were left at the starting line by U. S. rivals in the race to electronic engine-control systems, they are beginning to make up ground. According to one of Europe's most successful manufacturers, Volkswagenwerk AG, a technology with a distinctly European flavor is emerging.

This opinion was expressed by K. Ehlers in an overview of European automotive electronics at the Second International Conference on Automotive Electronics held at the Institution of Electrical Engineers in London Oct. 29 through Nov. 2. Without the bludgeon of government-legislated emission and fuel-consumption standards, Europeans have been freer on economic and technical grounds to choose at which point new electronic car systems should be introduced.

Consequently, Volkswagen, for one, takes a more cautious view than

its U. S. or Japanese counterparts on the rate of growth of automotive electronics. By 1988, Ehlers says, electrical and electronics systems will represent about 15% (7% for electronics) of the car's manufacturing cost, compared with 10% (about 2% for electronics) today, and in absolute terms will mean a market of several billion dollars. By then, he adds, there could be between 5 and 10 microcomputers in a production car. And one of those—to control the car's route-guidance system—may not have its counterpart in an American car, although it has been talked about in the U. S.

Unlike the U. S., Europe has been forced all along—by fuel prices and congested urban centers—to design light, compact cars with small-displacement engines having low fuel-consumption and carbon-monoxide emission figures. But tougher regulations are on the way.

Even without them, successive oil

crises are concentrating European automotive design engineers' attention on efficiency. For example, in addition to phased European Economic Community emission-control standards, West Germany is considering the possibility of taxing cars according to their fuel consumption. Also, limits on top speed and obligatory fuel-consumption gages are being considered. Says Ehlers, "Electronic fuel- and air-metering systems will find mass application in Europe during the period from 1982 to 1985 and onwards."

Another difference is the relationship in Europe between the semiconductor suppliers and the car manufacturers. Few car makers have their own electric and electronics divisions. A result is that almost all the major semiconductor manufacturers in Europe have set up automobile engineering departments to develop electronic systems.

Motorola SA in France, for example, worked with Citroën to develop a completely electronic ignition system for its two-cylinder Visa introduced in 1978. The goal of the collaboration remains to develop a similar system for four-cylinder engines that eliminates mechanical breaker points and high-voltage spark distributors.

Freedom from in-house development groups, claims Ehlers, gives manufacturers greater leeway in selecting the right semiconductor technology. Various technologies could be tried initially, he says, and only in the second phase would one be selected. For Ehlers, the choice is complementary-MOS.

However, European semiconductor firms have contributed few

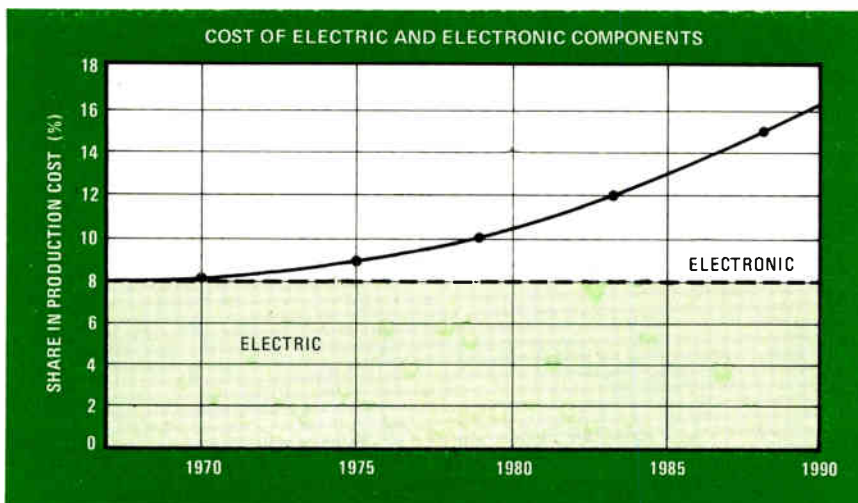

View from VW. According to Volkswagen, the cost of the electrical and electronic systems in cars will be about 15% of the total manufacturing cost by 1988.

Introducing the first complete, low-power, 12-bit hybrid DAC for \$9.95.



The next generation.

A packaging breakthrough from Hybrid Systems can help you make design history.

Check the specs: 12-bit resolution . . . ± 11.5 to ± 18 volts . . . total power consumption as low as 150mW . . . analog output of $\pm 10V$ @ $\pm 5mA$. . . $\pm 1/2$ LSB linearity . . . $25\mu S$ settling time . . . linearity tempco of $\pm 5ppm/^{\circ}C$. . . no external components needed to make this complete DAC fully operational.

And the price is at least 40% below anything comparable you've seen before.

The secret is in the packaging: a unique, proprietary 24-pin dual-in-line enclosure⁽¹⁾ designed to take more punishment than it's ever likely to get in actual use . . . including four hours in a pressure cooker, a weekend strapped to the hull of a sailboat on Nantucket Sound, and countless cycles in a standard dishwasher. It also stands up to the toughest conventional environmental tests; leak, temp cycle, temp storage, stabilization bake, solderability, 1000-hour burn-in. It's cost effective, rugged, complete, low power – and yes, it's clean.

⁽¹⁾U.S. Patent Pending

For fast turnaround, call or write.

Quantity	Price	Quantity	Price
1-9	\$19.95	100-249	\$13.50
10-24	\$17.50	250-999	\$12.00
25-99	\$15.50	1000+	\$ 9.95

For performance, experience and reliability, go with the leader.

Hybrid Systems CORPORATION

Crosby Drive, Bedford, MA 01730
Phone (617) 275-1570
(TWX 710-326-7584 HYBRIDSYS BFRD)

In Germany: Hybrid Systems GmbH
6100 Darmstadt, Luisenplatz 4, Germany
Tel. 6151-291595 (TELEX 419390 HYSY D)

In France: Hybrid Systems S.A.R.L.
14 Rue du Morvan SILIC 525
94633 Rungis CEDEX TLX: 250 969 HYSYS

In the United Kingdom:
Hybrid (Component) Systems U.K. Ltd.
12A Park Street, Camberley, Surrey
Tel. (0276) 28128 (TELEX 858720 HYBRID G)

"THE
AmZ8000
IS BETTER."



The AmZ8000 has more addressing modes, more general-purpose registers, larger addressing spaces, better capability and more powerful instructions than the 8086.

Call Advanced Micro Devices and get all the facts on the AmZ8000. It's the best 16-bit CPU there is.

**Advanced
Micro
Devices**



901 Thompson Place,
Sunnyvale, CA 94086
Tel: (408) 732-2400

Probing the news

process innovations, but one significant development in nonvolatile memories comes from SGS-ATES (UK), whose polysilicon metal-nitride-oxide-semiconductor technology looks ideal for odometers and other car applications.

Unlike previous technologies that have been tried, says R. C. Ambrose of SGS-ATES, the technology is process-compatible with n-channel MOS technology, provides an access time comparable with that of read-only memories, and a fast erase-and-write time of 100 milliseconds. Thus memory can be integrated on a chip together with logic functions and can be erased and written into by conventional chip voltages.

Display technologies for the new generation of driver information and instrumentation systems will also be of crucial importance to success in the automotive market, says Ehlers. With the automotive market heading for stagnant sales, and as cars look increasingly alike in pursuit of aerodynamic efficiency and fuel savings through weight reduction, "the battle for customers will take place in the car interior with particular attention focused on the instrument panel," he says.

Active displays such as light-emitting diodes are not suitable because they wash out in bright light. Ehler believes the choice, then, is liquid-crystal and electrocolloid technologies. But opinions expressed in several papers at the conference were sharply divided. Smiths Industries Ltd., for example, figures that dc electroluminescent displays are bright enough. It aims to introduce its first product using the technology next year [*Electronics*, Sept. 27, p. 75].

Sensors around the world. Though the impetus for the proliferation of electronic engine control has come from the U. S. and has been fueled by developments in microcomputer technology there, sensor development is in a state of rapid change worldwide, according to William G. Wolber of Bendix Corp.'s research laboratories in Southfield, Mich. Wolber singled out the development of the hot-wire anemometer used to

measure air flow in fuel-metering schemes.

Conference papers confirmed his assessment by describing a flurry of new sensor and transducer systems. One of the most striking was an ultrasonic fuel injector from Plessey Automotive Products Ltd. in Ilford, England. The system has been under development for 12 years, according to Plessey's Bill Martin. In its present form it would cost less than half the price of a conventional electromagnetic valve system, though more engineering still has to be done. The design is based on a ball valve that, under ultrasonic vibration, allows the passage of accurately metered atomized fuel. Martin maintains that most other efforts to produce an alternative, and less expensive, version of electromagnetic fuel-injection systems have thus far been accompanied by a deterioration in performance.

An alternative approach from Philips Research Laboratories in Redhill, Surrey, England, replaces the electromagnetic solenoid actuator with a piezoelectric rod fabricated from piezoceramic disks. It offers a 100-microsecond response time and a high degree of mechanical stiffness.

Multiplexing schemes. Several papers pointed to the technical feasibility of vehicle multiplexing systems. One of the most advanced is the Salplex system developed by England's Ward & Goldstone Ltd. in collaboration with the University of Salford. The system contains a coaxial cable linking several transmitter-receiver units, each capable of switching local loads and sending and receiving multiplexed data. The outer conductor carries the power, the inner conductor the signals. The system has been operating for a year in a test car without any failures.

It remains to be seen whether European car manufacturers will be perpetually struggling to catch up with their U. S. counterparts, as in the semiconductor or computer industries, or whether they can develop a brand of technology that is distinctly their own, as in the television field. On the evidence of this year's conference, the leading car exporters will not fail through lack of effort. □

How the smart companies

distribute power

and avoid multi-layer boards

THIS WAY

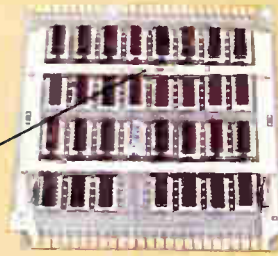

AND THIS

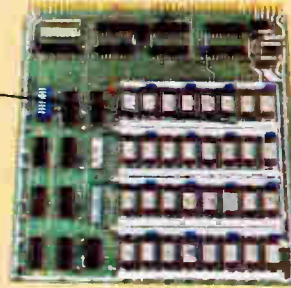

AND THIS

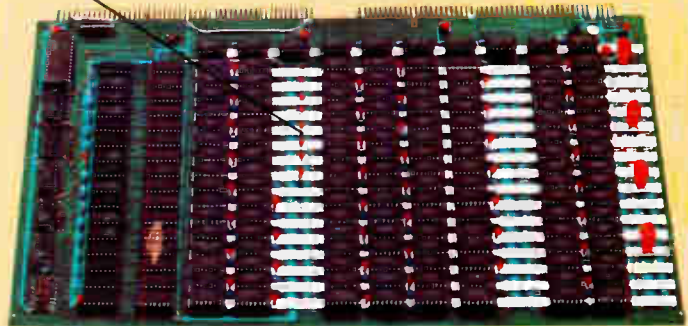

They use MINI/BUS® PC board bus bars to provide the power and ground system. This eliminates the need for on-board traces and/or multi-layer. Board density can be maximized.

The number of decoupling capacitors can be significantly reduced because a MINI/BUS® PC board bus bar is also a low impedance/low inductance device with inherent distributive capacitance.

You start production much faster than with multi-layer, because board design and layout are simplified with MINI/BUS® PC board bus bars.

and do all this—and more—at less cost than with a multi-layer board!

They do it with MINI/BUS® PC board bus bars, available in precise configurations from Rogers—the leader in the business, with worldwide manufacturing facilities.

For prompt applications engineering assistance—or just for samples and more detailed information—call or write the MINI/BUS product specialist at Rogers.

Rogers Corporation
Chandler, Arizona 85224
Phone: (602) 963-4584

EUROPE: Mektron NV, Gent, Belgium JAPAN: Nippon Mektron, Tokyo

MINI/BUS® by
PC Board Bus Bars

ROGERS

Testing

How are bubble memories to be tested?

Makers of devices and testers get together to find the answers at the first such session to be held at the Annual Test Conference

by Richard W. Comerford, Test, Measurement & Control Editor

Now that magnetic-bubble memories are emerging for commercial use, the creators of both chips and testers are working to smooth the road to new products. At last month's Annual Test Conference held at Cherry Hill, N. J., the first formal session on testing such memories was held in a direct effort to expose the accumulated knowledge of those with the most device experience: the manufacturers and test system designers. What experience has taught them is that although the means to ensure bubble device reliability is different from that for semiconductor devices, it can be accomplished without a lessening of yield. Further, the technology has defined what is needed in test systems to keep pace

with bubble innovations.

"The fact that you can mask loops to improve reliability without decreasing yield is very important," says David Cheng of Intel Magnetics Inc., Santa Clara, Calif., developer of the first 1-megabit bubble memory. The fact that block replicate and major-and-minor-loop devices are made with redundant loops gives the manufacturers this capability, he points out. "They can not only eliminate propagation loops that have outright defects, but also find weak loops, which may pass tests initially but do not have as good a longevity as the others," Cheng explains.

The way to find such loops is to test the packaged chip with the maximum and minimum drive fields

and temperatures specified and to inspect individual loops. Within the loop is a worst-case pattern of bubbles whose rotation is stopped and started so that the effect on it of nearby bubbles can be observed. Although start and stop testing does make it easier to find weak loops, in one instance increasing the error rate to 1 in 10^4 from 1 in 10^8 , Cheng admits that it drags out production test time. But both he and Farooq Quadri, chairman of the session and product engineering manager for National Semiconductor Corp.'s magnetic-bubble memory group also in Santa Clara, stress that it is now particularly important that manufacturers provide users with extremely reliable devices. So the extra test time represents an investment in the device's future.

The question of pattern sensitivity, a sore point for semiconductor memory, has a different significance for the magnetic devices. "I think the overall problem is easier to condense because of the localized nature of pattern sensitivity," Cheng states. He notes that semiconductor memories are matrix devices, so that what happens on one line of interconnected cells can conceivably affect other points in the matrix. Magnetic bubbles, on the other hand, affect only three or four sites in their vicinity. "Thus, at any given moment, the effect is localized to a group of sites in the neighborhood of the bubble," says Cheng. This localization applies to both propagation loops and the read gates and write gates.

Quadri cautions that design rules for the magnetic-bubble memory are not established, as they are for random-access memories. "In the

Test objective. Based on their experience with semiconductor memories, makers of bubble memories and of test systems are talking about test techniques. Shown is Intel's 1-Mb device.

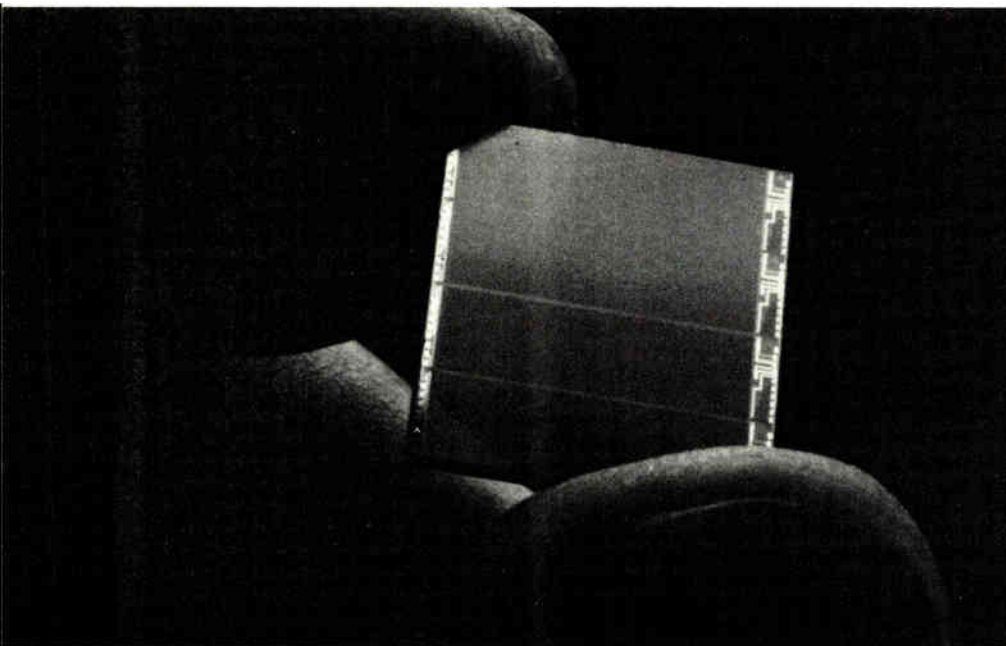

It's an unfair comparison. But let's do it anyway.



Device and heat sink may now be pre-assembled for treatment as a single component during PC board assembly.

Swage-mounted stud wave-soldered with .125" stand-off to permit circuit trace to run underneath.

Loose hardware used on both sides of board for mounting.

Requires hand-soldering and extra inspection.

Thermalloy's new solderable heat sinks cut assembly steps in half.

When you compare conventional heat sinks with the new Thermalloy Timesaver Solderable models, you'll see just how unfair that comparison is. With the Timesavers, you can now pre-assemble the transistor and heat sink, drop in the plated-through hole and treat it as a single component for production. All work is done on one side of the PC board. Then, it's wave-

soldered with the rest of the board. Makes three steps take the place of six.

Available "off the shelf" in Model 6108 for TO-3 cases and in Models 6109 and 6110 for plastic power cases. This patented technology is being adapted to other case styles and heat sink shapes.



New Timesaver Method

1. Board components, including heat sink/transistor, are pre-assembled.
2. Wave soldered, cleaned and trimmed.
3. Inspected once.



Conventional Method

1. Board components to be wave soldered are pre-assembled.
2. Wave soldered, cleaned and trimmed.
3. Inspected first time.
4. Heat sink mounted with loose hardware.
5. Hand soldered, cleaned and trimmed.
6. Inspected again.



Thermalloy, Inc.

Post Office Box 340839 • 2021 West Valley View Lane
Dallas, TX 75234 • (214) 243-4321 • TWX: 910-860-5542

Advanced technology in semiconductor accessories.

Contact your Thermalloy distributor or representative right away for complete product information, including thermal performance and recommended PC board layout and/or product samples.

Circle 99 on reader service card

A CRT Yoke for all reasons

Military

Airborne (HUD, HDD, VSD, HSD), shipboard, ground systems, missile systems.

Compact, lightweight, encapsulated to withstand physical stress. Special ferrite core designs.



Commercial

Computer terminals, monitors, medical applications, hard-copy machines, etc.

Engineered and tooled for volume production. Cost-effective and geometry corrected.



Special Designs

Phototypesetting, random graphics, flying spot scanners, mappers, vidicons.

Designed for low residual and superior resolution using special assembly techniques.



Send us your reasons for needing a better yoke. We'll supply technical data sheets, recommendations, engineering assistance.



syntronic

Syntronic Instruments, Inc.
100 Industrial Road, Addison IL 60101
Phone (312) 543-6444

Probing the news

magnetic-bubble memory field, everybody has a little bit of innovation. Any change you make in the input or output gates can change the pattern sensitivities of those gates."

To Phil Burlison, product marketing manager of bubble test systems for Fairchild Camera and Instrument Corp.'s Xincom Systems division, Chatsworth, Calif., this points to one aspect of the way testers must go. "It simply says that you have to have an easy way of generating and programming an arbitrary pattern and changing it interactively," he says. What complicates this, he adds, is that the results of parameter variation do not appear until much later and that the pattern in which data is written is not directly related to the pattern in which it is stored. The result, he says, is a tremendous emphasis on flexibility in structuring the programming.

Approaches vary. There are some differences in the way the tester manufacturers have gone about providing this flexibility, notes Steve Bisset, president of Megatest Corp., Sunnyvale, Calif. Having gained much experience in microprocessor testing, his company designed its tester with a parallel structure that Bisset says "takes into account the whole concept." The pattern processor allows the user to program a model of the architecture of any device into it. "The model is such that you can keep track of the status of all the internal locations in parallel during each field rotation cycle, rather than trying to unwind all the test sequences," Bisset says.

The approach taken by Xincom in its tester architecture is more serial in nature. With its background in testing memories at high speed, Burlison explains, the company found that "even at data rates of 1 megahertz, you still have one whole microsecond, which is years compared to semiconductor testing." So the approach taken was to design a pattern generator that, rather than perform one instruction per data cycle, had much more computing power so that it could do preprocessing of information before spitting it back to the controller. □

The new 8520A DMM: Fills your rack with math, memory and measurement capabilities.

Here's a new intelligent multimeter with the resolution, speed and accuracy that the most demanding system applications require - with powerful math and memory functions that you would expect to take up much more than a mere 3½ inches of rack space.

The 8520A is a precision system DMM, with dc, True RMS ac and ac + dc volts boasting a 50 ppm, 90 day, basic dc accuracy. Two and four wire ohms and conductance let you make resistance measurements to 10,000 Megohms. And because the 8520A was designed as a systems instrument, an IEEE-488 interface is standard. So are switchable front and rear inputs that

are fully protected from overloads.

The 8520A's speed and resolution run second to none. A 500 reading per second speed at 4½-digits resolution and 240 readings per second at 5½-digits with 60-Hz line operation (200 rps at 50 Hz) let you make fast, accurate, high-speed measurements.

With built-in intelligence this new DMM can run its own math programs - seven standard and seven optional - including limits testing, percent deviation, statistics, and dB. And a unique burst mode allows the 8520A to store up to 400 readings (Option

010) in a built-in memory instead of tying up the system controller.

To sum it up, the 8520A is a precise, powerful measurement computer. One that sets new standards of hard-working practicality. At a price that's hard to believe - \$2995 U.S.

Prove to yourself what this new intelligent multimeter will do for your system. Contact your Fluke Sales Engineer or Representative for a demonstration. For his name, call toll free 800-426-0361, or use the coupon below.

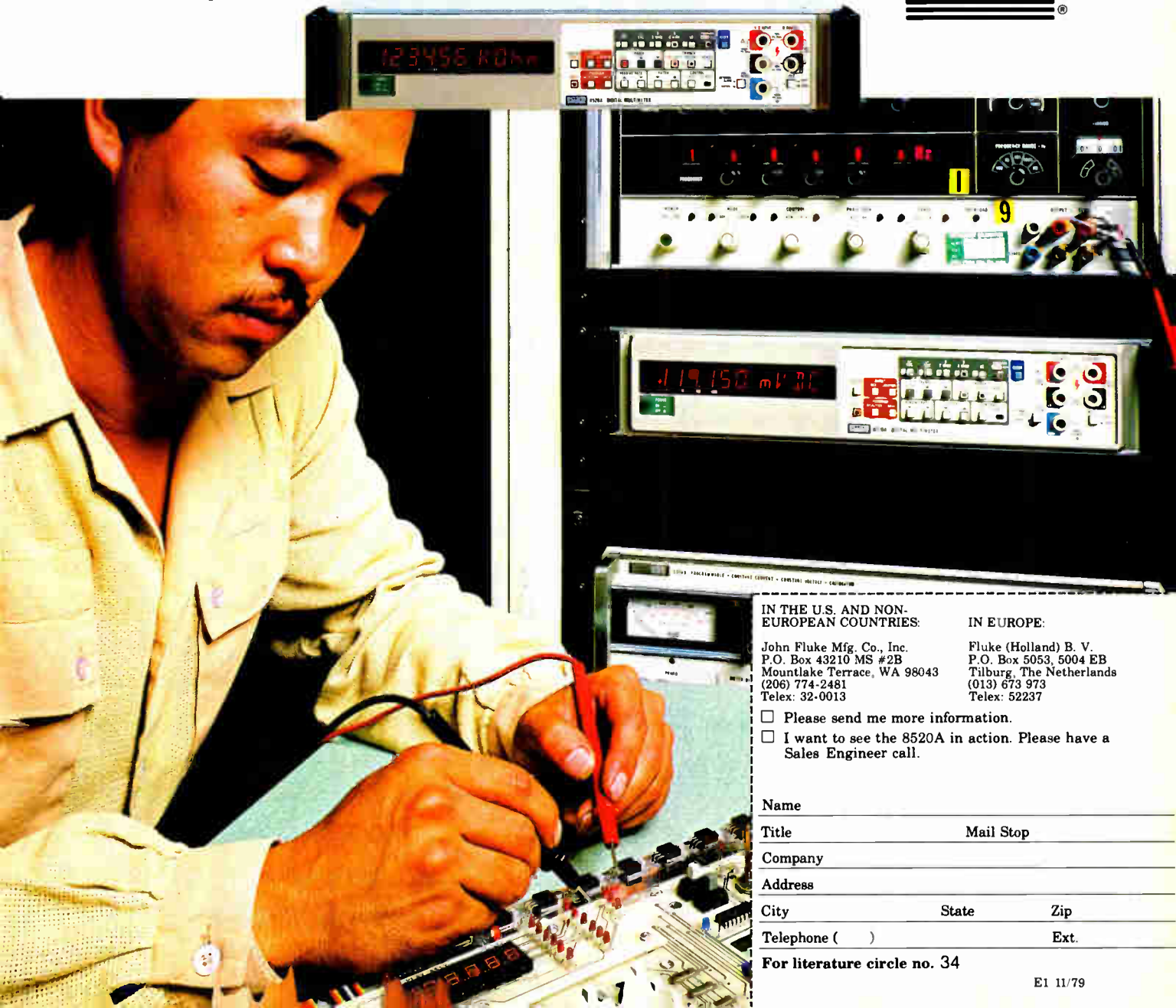

IN THE U.S. AND NON-EUROPEAN COUNTRIES:

John Fluke Mfg. Co., Inc.
P.O. Box 43210 MS #2B
Mountlake Terrace, WA 98043
(206) 774-2481
Telex: 32-0013

IN EUROPE:

Fluke (Holland) B. V.
P.O. Box 5053, 5004 EB
Tilburg, The Netherlands
(013) 673 973
Telex: 52237

- Please send me more information.
- I want to see the 8520A in action. Please have a Sales Engineer call.

Name _____

Title _____ Mail Stop _____

Company _____

Address _____

City _____ State _____ Zip _____

Telephone () _____ Ext. _____

For literature circle no. 34



Choose TI's 16-bit 9900 Family. For price. For performance. And because it's production-proven. You'll be in the best of companies.

By the hundreds, companies are staking new product designs on TI's 9900 Family. A wide diversity of products. By companies large and established. By those small and

growing. The brief recap on the opposite page lists just a few of the many innovators who have seen the future and chosen the 9900 Family. For a lot of good reasons:

Here-and-now compatible family

Unlike others who plan or promise, the 9900 Family is a fact. Available

from your TI distributor today. Microprocessors. Peripherals. Microcomputer modules. Development tools. All compatible to protect your software investment as you move from one product design to another.

From the beginning, TI has been the 16-bit leader. The 9900 Family has grown. Matured. Become second sourced.

We'd like to say it's complete. But that will never be. TI is firmly committed to the Family's expansion according to your needs and as new technologies develop.

Price/performance microprocessor choices

Utilizing the most advanced architecture on the market today, the microprocessors in the Family include the original NMOS TMS9900. The functional I²L equivalent, the SBP9900A, for harsh environments. The lower-cost TMS9980/9981 versions for smaller systems.

Now coming into production: TMS9940, the industry's first 16-bit single-chip microcomputer with on-chip memory and I/O.

In total, an unequalled choice that lets you more easily and quickly match price and performance to your designs.

Low-priced peripherals

At last count, 14 peripherals support these microprocessors. The LSI "nuts and bolts" needed to complete your system. Easily. Economically.

For memory expansion to 16 megabytes there's the new TIM99610 Memory Mapper.

To fill your communication needs: TMS9902 Asynchronous Controller, TMS9903 Synchronous Controller, TMS9911 DMA Controller, and the new TMS9914 GPIB Adapter.

Also of interest: The TMS9927 CRT Controller and the new color graphics TMS9918 Video Display Processor.

Cost-conscious microcomputer modules and minicomputers

For a headstart in systems design, look into the Family's series of 16-bit TM990 microcomputer modules for

evaluation, systems prototyping, and OEM applications.

The TM990 series includes stand-alone CPUs, memory expansion, and I/O expansion modules. And modules for program development. For learning and teaching.

TI's compatible 990 minicomputers extend the 9900 Family's level of integration to packaged host systems for distributed processing and a wide variety of other applications.

End products:

Where the 9900 Family is shining.

Every day, the 9900 Family is proving itself where it counts. In the marketplace. At the core of new products, new designs.

Many major companies, whose large resources and staffs allow them to weigh carefully all considerations and options, have elected to build products around the 9900 Family. Among them are Litton Aero Products, Allen-Bradley, Tektronix, Veeder-Root, Sweda International, John Fluke, Amoco, Fisher Controls, E.I. DuPont, Sun Electric, General Electric, Otis Elevator.

Also, a large number of young, aggressive companies have selected the 9900 Family... companies who cannot afford failure. Among them are Acuity Systems, Optronics Ltd., Harowe Systems, Micor, Cubic, Praxis Ltd., Nicolet, Delta Data.

Texas Instruments, where the bottom line is as important as anywhere else, uses the 9900 Family as the heart of its pacesetter home computer. In its Loran-C receiver. In minicomputers and terminals. In satellite navigation systems. In aircraft tracking and collision avoidance support systems.

The proof is convincing. For performance, economy, versatility, support, your first choice in 16-bits is the 9900 Family. You'll be in the best of companies.

Here-and-now Pascal

Just as many are playing catch up in 16-bit microprocessors, they're working overtime on high-level languages. Particularly Pascal. But TI has had operative Pascal for several years. Long enough to refine it for microprocessor applications.

TI's new Microprocessor Pascal offers the most extensive support available: Editor, compiler, host debugger, configurator, native-code generator, and run-time support.

Also: Compilers for Fortran and interpreters for Power Basic — all available on TI's floppy-based AMPL development system.

Versatile development systems

In addition to a broad family of hardware, you need reliable, available — and economical — development systems. These the 9900 Family has. To boost programmer efficiency while cutting costs.

The AMPL* prototyping lab is a complete set of software and hardware development tools for the entire 9900 Family. It provides real-time emulation and logic-state trace. It can be programmed for complex test and debugging sequences.

With this one versatile unit, you can not only develop software but also check out and verify software and hardware as you go.

Compared on a feature-by-feature, dollar-by-dollar basis, the AMPL lab is the best 16-bit microprocessor development system for your money.

Help is available

Whenever you have a tough question or need another opinion, talk with your nearest TI systems engineer or TI distributor applications engineer. If you want to learn more about the 9900 microprocessors, TM990 modules, Microprocessor Pascal and the AMPL lab, TI training courses are being held weekly. Call your TI field sales office or your authorized TI distributor for details and locations.

For a copy of the new brochure on the 9900 Family, contact your TI distributor. Or write Texas Instruments Incorporated, P.O. Box 1443, M/S 6404, Houston, Texas 77001.

*Trademark of Texas Instruments Incorporated

**TEXAS INSTRUMENTS
MOVING AHEAD
IN MICROPROCESSORS**



**TEXAS INSTRUMENTS
INCORPORATED**



Choose TI's 16-bit TM990 microcomputers. The right price/performance combination for industrial controls. You'll be in the best of companies.

To date, more than 500 companies are betting on TI's TM990 micro-computer modules. As indicated on the following page, the diversity of companies is great. The applications

are equally diverse. Why are these modular members of TI's 9900 Family the pick of the crop for so many? There are many reasons; here are several of the major ones:

The design headstart

A lot of work is done beforehand: Hardware design. PC board layout, manufacturing, testing. TM990 mo-

dules come preassembled, pre-tested. Shortening your design cycle. Getting you to market faster.

Burn-in-reliability

TM990 modules are specified to operate over the full commercial temperature range of 0° to 70° C.

All components must pass strict quality assurance criteria before assembly. Every assembled module is tested, temperature cycled, burned-in, and retested to assure highly reliable operation.

Precision performance

The TM990 modules incorporate TI's 16-bit microprocessors — already a standard in the world of process control. The architecture is more powerful, the instruction set richer. The modules are backed by high-level languages for easier, faster programming. Result: more programmer efficiency, more operational precision.

Wide choice available

TI distributors stock TM990 modules for off-the-shelf delivery.

Your broad choice includes modules for evaluation and OEM applications. Memory expansion. Data entry and display. Digital I/O expansion (see listing in the next column).

Interfacing to motors, generators, contactors, etc., is simplified by industrial ac and dc I/O modules, optically isolated for system protection. A series of A/D and D/A interface modules is also available.

On-going leadership: A floppy disk controller and a bubble memory module have just been added to the TM990 Series. Soon to come: A speech module. And industrial communication modules.

Forward-looking bus: From day one, all TM990 modules have communicated over the same fully documented bus which simplifies system integration and development of customized modules. The TM990 Bus definition supports memory expansion to 16 megabytes as well as multiprocessing applications.

Ready-to-use software support

The affinity of TI's 16-bit microcomputer modules for high-level lan-

guages contributes substantially to programmer efficiency. Ready for use immediately:

Power Basic: This English-like language speeds programming even for the novice. It is easy to learn, to

Way to Go

TM990 microcomputer modules are making a significant impact on the industrial market. They daily prove themselves the ideal means for quickly bringing 16-bit economy and performance to end products... to the production line. Choose the TM990 Series and you join the best of companies. To name a few: Varian, Analog Devices, Dow Chemical, ITT, Loral, Autotrol, U.S. Steel, Owens Corning, Gulf Oil, Chrysler, Lockheed, Boeing, Teledyne, Delco, Litronix... and, of course, TI.

TI's TM990 Microcomputer Series

Microcomputer Modules:

TM990/100M
TM990/101M

Evaluation Module:

TM990/180M

Educational Module:

TM990/189

Memory Expansion Modules:

TM990/201 EPROM/RAM
TM990/203 Dynamic RAM
TM990/206 Static RAM
TM990/210 Bubble Memory
TM990/303 Floppy Disk Controller

I/O Expansion Modules:

TM990/305
TM990/310

Industrial I/O Modules:

TM990/5MT Series

A/D and D/A Interface:

TM990/1000 Series (Analogic)
TM990/1240 Series (Analog Devices)

use, to document. It has I/O features for process control and enhanced speed for real-time applications. It is designed for use on a single microcomputer module or in an expanded module system.

TI Microprocessor Pascal: This new high-level language, which TI has pioneered, provides the most extensive support available. It enables you to solve application problems

without getting involved with the intricacies of machine architecture. You have fewer errors because the code is easy to write, document, read, and modify.

Ready-to-use development system

The AMPL* prototyping lab maximizes software productivity. It contains, in one versatile unit, everything required to develop your software and to check out your system hardware.

Available either as a floppy-based system or multi-user hard disk system, the AMPL lab supports Basic, Pascal, Fortran, and assembly language.

The very affordable modules

Considering the performance and reliability you get... the savings in design time and programming... and the elimination of those expenses associated with make-it-yourself modules, the TM990 modules are the best buy in the industry — 16 bits for the price of 8.

Choose your help

When you bog down, dial (713) 776-6632. That's the Houston hot line. TI application engineers stand by to answer your technical questions.

If you want a firsthand look at the TM990 modules, or the AMPL lab, call or visit your local TI distributor Systems Center where TI-trained applications engineers will arrange demonstrations.

TI Regional Technology Centers hold monthly courses on the TM990 modules, the 9900 Family microprocessors, Power Basic, Microprocessor Pascal, and the AMPL lab. Check your nearest TI distributor or TI field sales office for dates, locations, and fees.

For a copy of the latest brochure giving full details on the TM990 microcomputer modules, call your TI distributor. Or write Texas Instruments Incorporated, P. O. Box 1443, M/S 6404, Houston, Texas 77001.

*Trademark of Texas Instruments Incorporated

**TEXAS INSTRUMENTS
MOVING AHEAD
IN MICROCOMPUTERS**



TEXAS INSTRUMENTS
INCORPORATED

Facts from Fluke on low-



cost digital multimeters.

When you're looking for genuine value in a low-cost DMM you have a lot more to consider than price. You need information about ruggedness, reliability and ease of operation. Accuracy is important. And so are special measurement capabilities. But above all, you must consider the source, and that company's reputation for service and support.

Fact is, as electronics become more a part of our daily lives, dozens of new manufacturers are rushing to market their "new" DMM's. In theory, this is healthy; but in practice, crowding is confusion.

To help you deal with this flood of new products, here are some facts you should know about low-cost DMM's.

The economics of endurance.

Even the least expensive DMM isn't disposable. Accidents happen, and test instruments should be built to take the abuses of life as we live it.

Look for a DMM with a low parts count for reliability, and rugged internal construction protected by a high-impact shell. Make sure the unit meets severe military tests for shock and vibration.

Another feature to check out is protection against overloading, whether from unexpected inputs, transients, or human errors.

Just for the record, all Fluke low-cost DMM's meet or exceed military specs, and feature extensive overload protection.

The importance of being honest.

Just because a multimeter is digital doesn't mean it's automatically more accurate than a VOM — even though the LCD might give you that impression. The benchmark for accuracy in DMM's is *basic dc accuracy*. The specs will list it as a percentage of the reading for various dc voltage ranges.

Of course accuracy is more critical in some applications than others, and increasing precision and resolution in a DMM usually means increasing price. In the Fluke line, you can choose a model with a basic accuracy of 0.25% (the 8022A), others rated at 0.1%, or the new 8050A bench/portable at 0.03%.

Special measurements: getting more from your DMM.

Actually, for all the variations in size, shape and semantics, most DMM's perform five basic measurements: ac and dc voltage and current, and resistance. Prices vary according to the number of ranges and functions a DMM delivers.

	PRODUCT	FUNCTIONS	RANGES	DIGITS	BASIC DC ACCURACY	CONDUCTANCE OTHER SPECIAL FEATURES	PRICE
HANDHELD MODEL	8022A	6	24	3½	0.25%	Basic six-function DMM; lowest-priced	\$129
	8020A	7	26	3½	0.1%	X High accuracy; pioneer in conductance; exclusive two year warranty.	\$169
	8024A	9	26	3½	0.1%	X Direct temperature readings; continuity/ input level detector with selectable audible signal; peak hold capability.	Available soon
BENCH/PORTABLE	8010A	7	31	3½	0.1%	X True RMS; extra 10A range.	\$239
	8012A	7	31	3½	0.1%	X True RMS; two extra low resistance ranges.	\$299
	8050A	9	39	4½	0.03%	X True RMS; selectable reference impedances with direct readouts in dBm; offset feature.	\$329

The Fluke line includes DMM's with from 24 to 39 ranges, 3½ and 4½-digit resolution, and some unique functions you won't find in any other DMM. Additional measurement capabilities like temperature, dB, conductance and circuit level detection.

If your work involves temperature measurements, the new 8024A delivers direct temperature readings via any K-type thermocouple. This is especially useful in testing component heat rise and checking refrigeration systems.

Another talented instrument is our new 8050A bench/portable. The micro-processor-based 8050A features a self-calculating dB mode in which dBm readings are displayed automatically referenced to one of 16 selectable impedance ranges — a real timesaver when servicing audio equipment.

And of course no discussion of DMM's is complete without considering conductance — a Fluke exclusive featured on five of our low-cost DMM's — which allows you to make accurate resistance measurements to 100,000 Megohms. You can't do that with any ordinary multimeter, but it's a must for checking leakage in capacitors and measuring transistor gain.

A handful of efficiency.

When every minute matters, your schedule is tight and so is your work space, you need a portable DMM that's fast and easy to operate. We designed our handheld DMM's with color-coded in-line pushbuttons for true one-hand operation: no need to hang onto the meter with one hand while twisting a

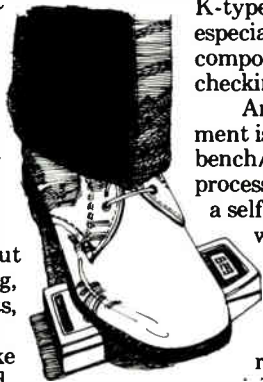

rotary dial with the other.

But there's more to convenience than fingertip control. The 8024A, for example, is also designed to function as an instant continuity tester, with a selectable audio tone to indicate shorts or opens. It also has a peak hold feature to capture transients.

A word about warranties.

Last but not least, look closely at the company that manufactures a low-cost DMM. Their service is just as important as their product. Look for no-nonsense warranties, a large family of accessories, an established network of service centers and technical experts you can rely on.

That's how you'll recognize a knowledgeable supplier of low-cost DMM's, a company with experience, resources and a commitment to leadership in the industry.

Incidentally, you'll find it all at Fluke.

Look for more facts from Fluke in future issues of this publication. Or call toll free 800-426-0361; use the coupon below; or contact your Fluke stocking distributor, sales office or representative.



IN THE U.S. AND NON-EUROPEAN COUNTRIES:
John Fluke Mfg. Co., Inc.
P.O. Box 43210 MS#2B
Mountlake Terrace, WA 98043
(206) 774-2481
Telex: 32-0013

IN EUROPE:
Fluke (Holland) B.V.
P.O. Box 5053, 5004 EB
Tilburg, The Netherlands
(013) 673 973
Telex: 52237

- Please send the facts on Fluke low-cost DMM's — specifications, applications information, and selection considerations.
- Please have a salesman call.

Name _____

Title _____ Mail Stop _____

Company _____

Address _____

City _____ State _____ Zip _____

Telephone () _____ Ext. _____

For literature circle no. 107

EL 11/79

Our CMOS ICs crossed the void to Jupiter. Next target: 1800 series to Mil-M-38510.

Voyager 1 brought to Earth the first close-up look at Jupiter.

RCA brought to Voyager 1 the high reliability CMOS IC logic that made the flight possible.

And we're bringing to you high reliability ICs that reflect the same excellence in dependability and performance.

Now we're in the process of qualifying our 1800 series of microprocessors and support circuits to

the toughest specs of all, MIL-M-38510. Our 1800 series is already available in high reliability versions processed to Mil-Std-883, Class B.

And we recently won a contract to provide radiation-hardened CMOS microprocessors and memories for the Galileo program, scheduled to land a probe on Jupiter in 1984.

Now, you can design in the 1800 series with complete confidence. And gain all the benefits of CMOS

technology. Low power consumption, high packaging density and low heat generation.

We have a 68-page booklet packed with information on our high reliability IC products.

To get your free copy, use the reader service card or contact your local RCA Solid State Distributor.

Or contact RCA Solid State headquarters in Somerville, New Jersey. Brussels, Belgium. Tokyo, Japan.

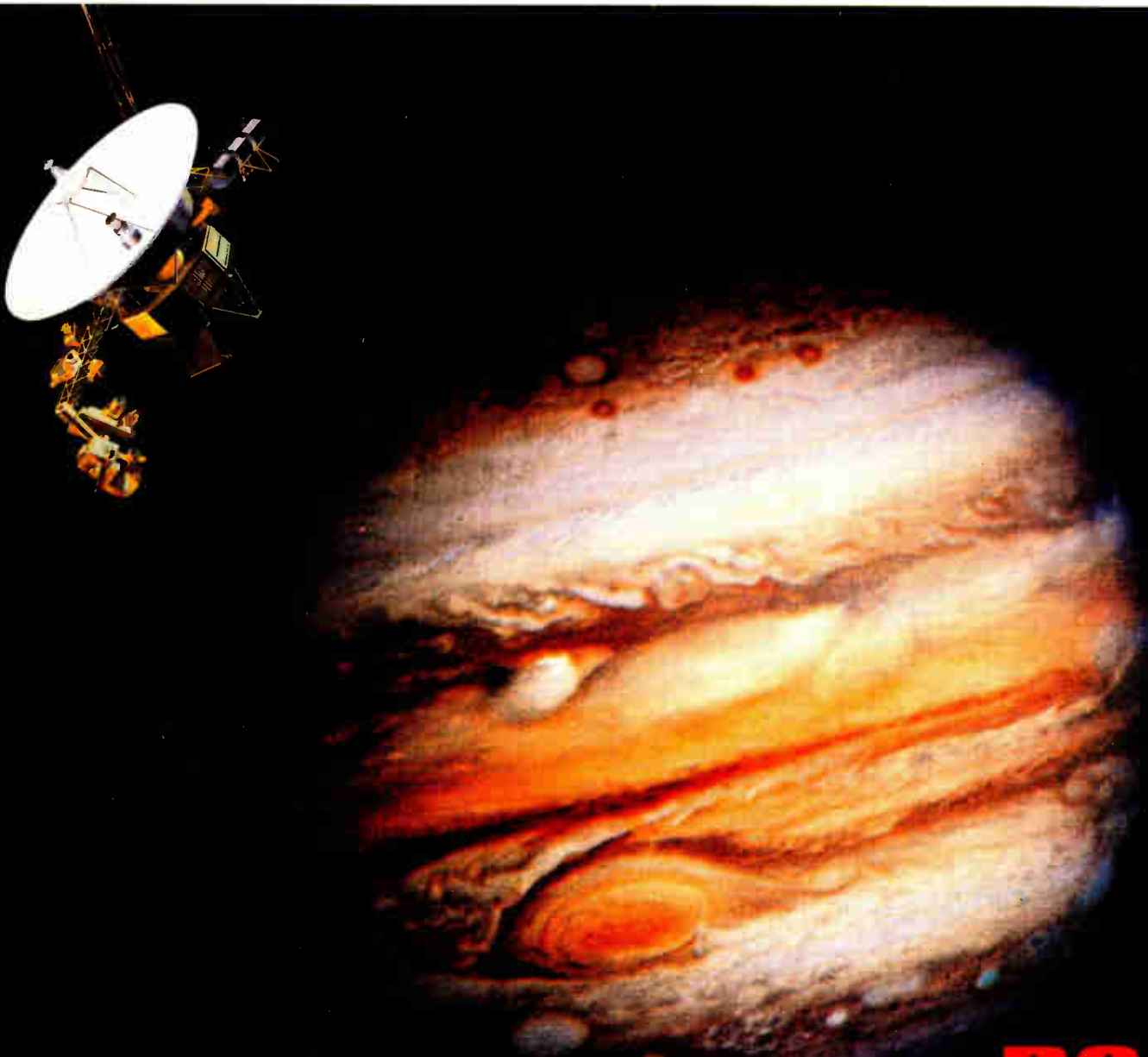

Putting together the new IBM mainframe

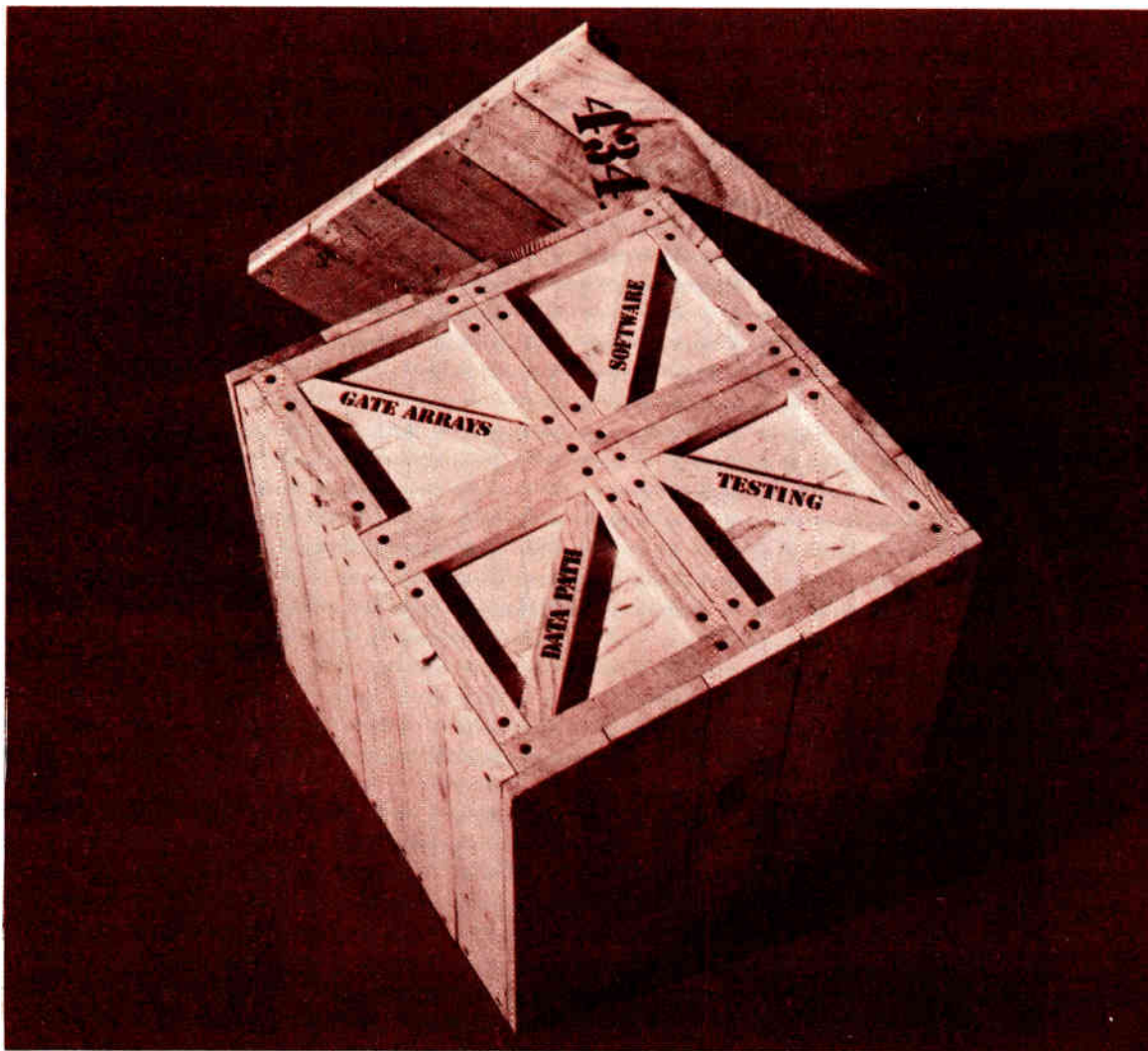

Error-catching latches and fast virtual memory give the 4300 a big edge over the System/370 while retaining compatibility

□ When International Business Machines Corp. introduced its 4300 computers in January, it upgraded its mainframe computer line with the first new designs and technology it had developed since the System/370 almost nine years ago. Long discussed in industry circles as the E-Series, the new computers established a surprising new level of price and performance by which the rest of the industry will measure itself. IBM also set new standards for functionality, reliability, and maintainability. At the same time it assured both its customers and its competitors that it will continue to support

the computer architecture introduced in the System/360 back in 1964. The System/370 uses almost the identical architecture, and the 4300s make only slight modifications.

This set of articles provides a view of the unique hardware and software design of the 4300s and includes some just-released photographs of the 4341 processor. In particular, they discuss the hardware design of the 4341, the larger of the two machines that IBM began delivering late last month, its new maintenance concepts, and its new architectural concepts.

-Anthony Durniak

4341's infrastructure is new from the substrate up

by Humberto Cordero, Jr.
IBM Corp., System Products Division, Endicott, N. Y.

The design objectives considered by IBM Corp. during the development of the 4300 processors were similar to those of many other computer manufacturers: to provide customers with growth opportunities for their current computers, with an improved price/performance ratio, and with higher reliability. IBM achieved just these goals with a highly innovative design based on unique high-density semiconductor technology that it dovetailed with improved microcode control, advanced data flow and buffering techniques, and an entirely new maintenance approach.

The larger of the two new intermediate-performance mainframe computers, the model 4341, is a good illustration of the new design. Available with 2 or 4 megabytes of main memory, the 4341 offers four times the memory capacity and 3.2 times the performance of the older System/370 model 138 it replaces—and all for a lower price. Logic and storage densities are so increased with a master-slice logic chip and 64-K memory chips that the entire 4341, with its full complement of memory and six input/output channels, is contained on just 35

circuit cards. Furthermore, IBM is able to fit this entire computer, with its channels, power supplies, system diskette drive, and separate maintenance and support processor into a compact cabinet that measures only 60 inches long, 29 in. wide and 38 in. high (Fig. 1). The older model 138 was not only about twice as large, but also required a separate power supply cabinet. The new 4341 also needs only half the electrical power and cooling required by the 138.

Speed above all

More important even than reducing the size, electrical power consumption, and heat dissipation of the computer, the new semiconductor technology adds to speed by facilitating a new and expanded hardware organization (Fig. 2). Central to this new organization is an 8-byte-wide bidirectional data bus that replaces the unidirectional 4-byte-wide buses used in previous intermediate-scale IBM mainframes. Also new to this class of machine is a cache memory—an 8-K-byte cache is standard on the 4341. Especially innovative is the fact that IBM placed two additional 8-bit buffers directly on each 64-K memory chip. To control this cache and the enlarged main memory, the storage controller was made more sophisticated through the addition of the directory look-aside table and cache directory.

A fifth block multiplexer input/output channel not available before can be attached to the 4341. The full complement of five block-multiplexer and one byte-multiplexer channels have an aggregate data transfer

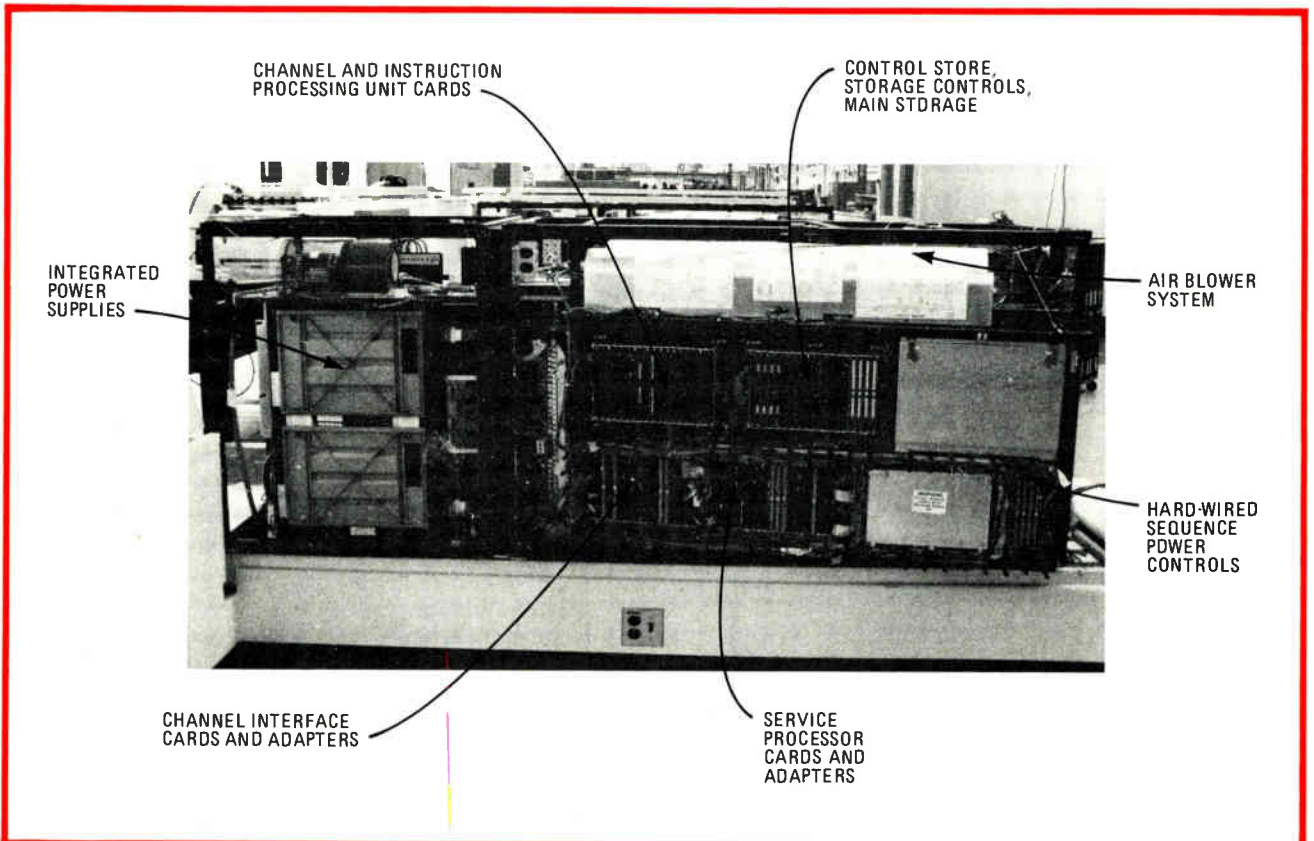

1. Petite package. This photograph of the model 4341's interior (the first released by IBM) shows how the entire computer with its full complement of 4 megabytes of memory, six channels, and power supplies fits into a cabinet measuring 60 by 29 by 38 inches.

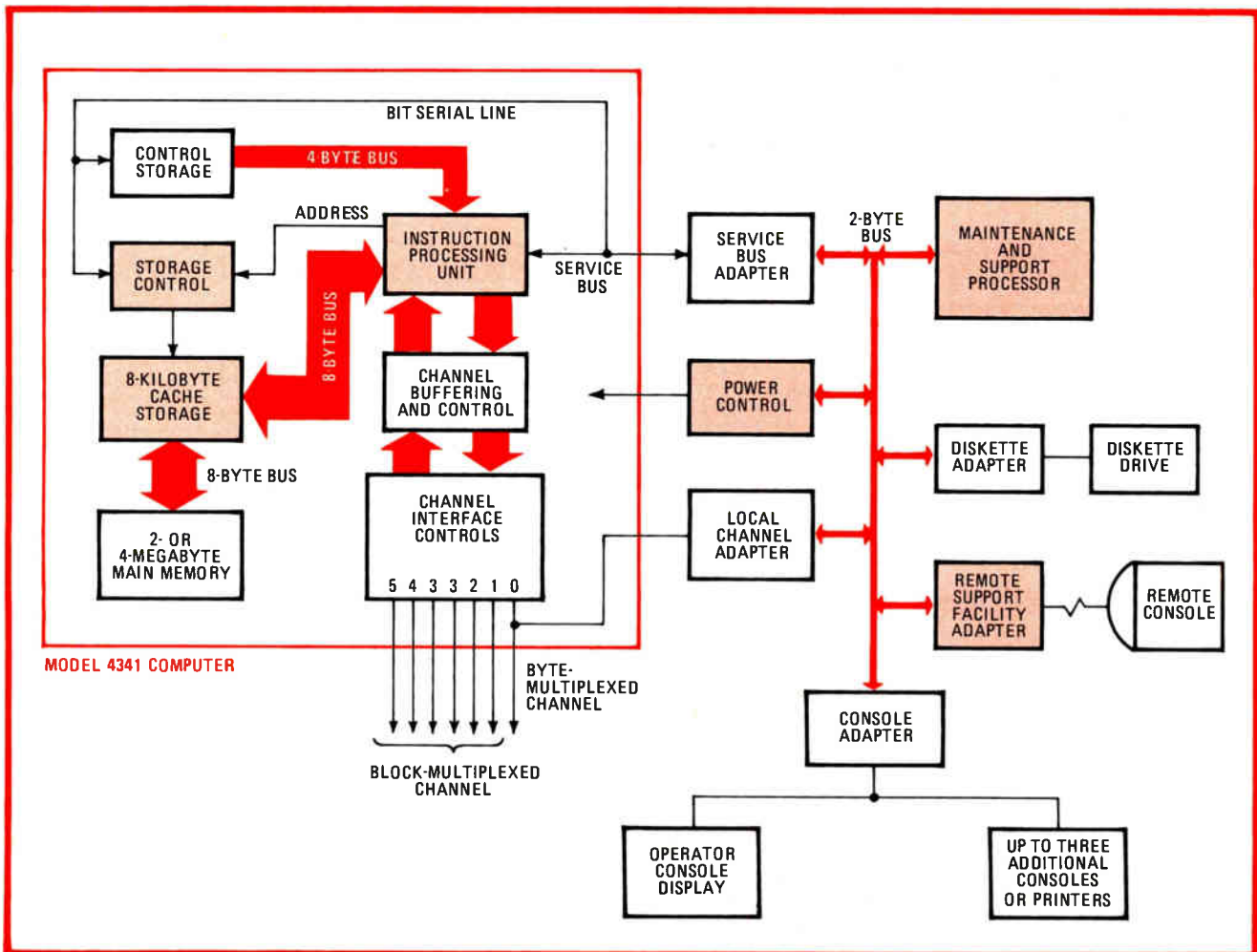

2. Wide. Most noticeable in the new 4341's hardware configuration is the use of 8-byte-wide data paths, instead of the 4 bytes used before, and the additions of a cache memory, extra channel, more main memory, more powerful support processor, and separate power controller.

rate of 10 megabytes per second, some 3.5 times that of the model 138. Furthermore, the channels were designed to have more circuitry in common than previously.

A new power controller, not used before, not only controls the distribution of electricity to the various circuit cards in the system, but on command of the maintenance and support processor can vary those voltages to aid the diagnostic process. The separate microprocessor-based support processor is also more powerful than its predecessors, primarily because of a new semiconductor design that makes previously inaccessible circuits available for testing.

As the second of this series of articles explains, this support processor also has the ability to log for later analysis both the condition of the central processing unit and environmental factors such as input voltages and temperatures. Instead of just the serial data link with the central processor used previously, the 4341's support processor has a high-speed parallel link through the local channel adapter. And because of the new remote support facility, a service technician can diagnose the machine from a remote site over telephone lines.

Last, but not least, the central processing unit, or instruction processing unit, has been improved both through the use of 8-byte-wide data paths and through

the addition of an 8-byte shifter. The new storage controller hardware automatically performs the virtual address translation needed by the virtual memory system and performed by software in earlier models. A new console adapter lets more consoles be connected to the system than before and gives each of them more control over the system.

Because of the wider data paths, decimal and floating-point arithmetic operations are now handled 8 bytes at a time instead of 1 or 2 at a time. Besides performing faster in business applications, the enhanced CPU also does scientific calculations more rapidly—as much as four times quicker than the System/370 model 148 computer in such applications. Because the time-consuming memory accesses can be performed in advance and the results stored in either the unique on-chip buffers or the 8-kilobyte cache, the system overhead during storage operations is reduced and the response time of memory is improved. In addition to being faster, the new channels with their common hardware offer greater configuration flexibility.

Another achievement of the new hardware is the improved reliability and serviceability of the computer. Intermittent problems that either went undetected or plagued a system but could not be found are now

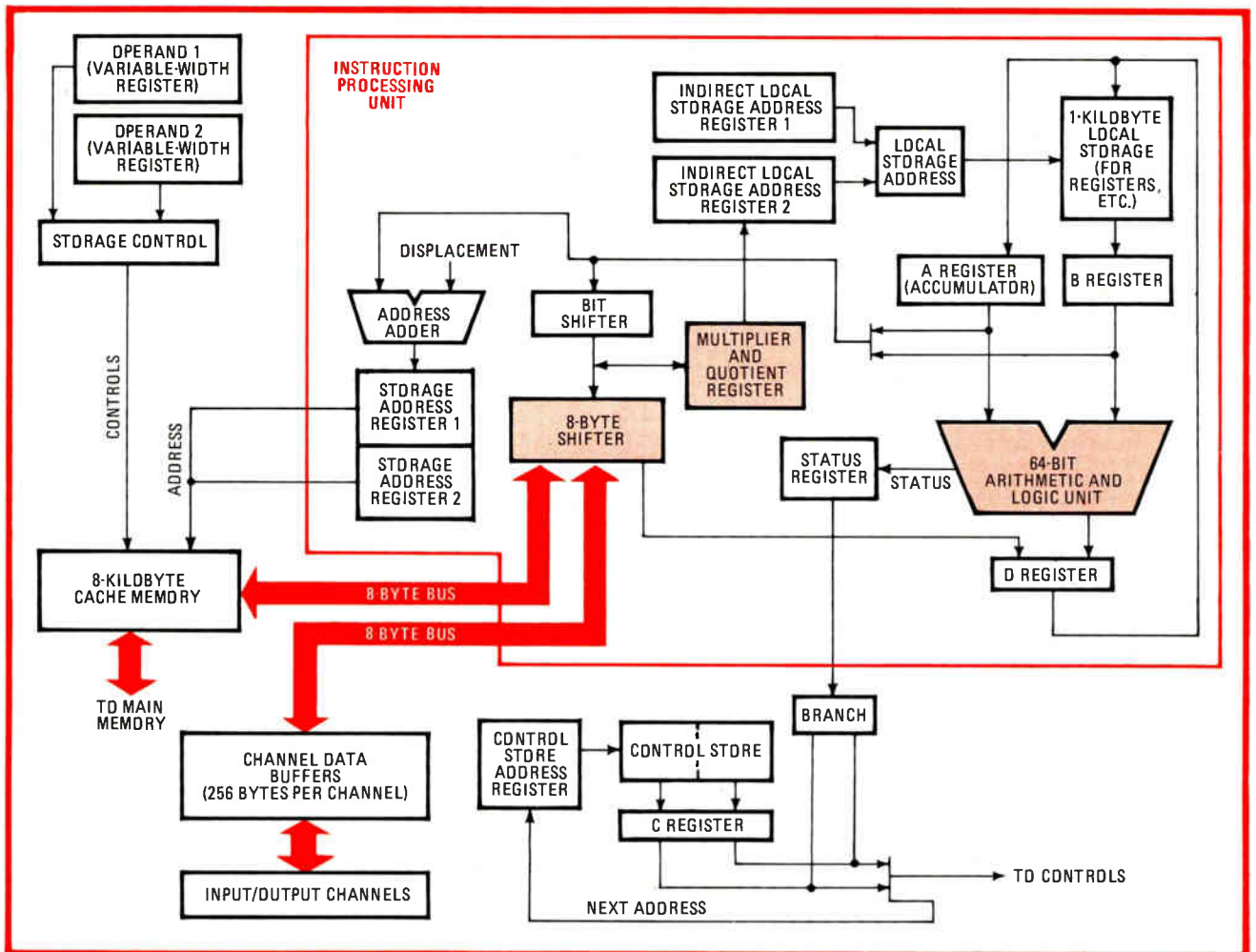

3. Master mind. The 4341's central processing unit, IBM's instruction processing unit, features an unusually wide 64-bit arithmetic and logic unit, 8-byte wide accumulator, and special multiplier and quotient register. An 8-byte shifter adds to the unit's power and flexibility.

captured as they occur, to be traced by the more sophisticated diagnostic microcode in the separate support processor.

The model 4341 makes more extensive use of microcode control than previous intermediate-scale IBM processors. In addition to controlling both the execution of software instructions by the CPU and the operations of the channels and main memory, a portion of this control microcode is dedicated solely to controlling the maintenance and support processor and performing the error-logging and diagnostic functions.

How microcode helps

An advantage inherent in such reliance on microcode control is architectural flexibility. The current architecture—that is, the instruction set and operational characteristics as seen by the programmer—can remain the same while new instructions and architectural features that take advantage of the improved hardware can be added. The 4341 processor can operate in one of two architectural modes: one identical to that of earlier System/370 computers, and a new mode that simplifies and improves on that popular architecture, but remains basically compatible.

The computer can operate in only one mode at a time

which is selected at the time the machine is turned on and the control microcode is loaded. Once a mode is picked, it cannot be changed by the operating system, only by starting the machine over.

The first of these modes, the IBM System/370-compatible mode, has Extended Control Program Support for the Virtual Machine or Virtual Storage operating systems. This program support for VM/370 is similar to ECPS:VM/370 offered previously on the model 138 and 148. The only functional difference between these program supports is the inclusion of new fixed block input/output devices. This software support can reduce the portion of the computer's time spent on supervisory software tasks by as much as 84%.

The Extended Control Program Support for VS/1 on the 4341 is similar to the same feature on the large-scale System/370 model 158, except for the addition of the Page Measurement instruction (which is on the models 138 and 148) and a new instruction called Set Direct Translate Limit. This software can reduce CPU busy time by up to 14%.

These improvements in this software's performance are primarily due to the speedy hardware execution of certain control program functions, such as first-level interrupt handlers and dispatching. When they are

carried out in software, more slowly, these functions require large percentages of the system's execution time.

The second architectural mode, called the Extended Control Program Support:Virtual Storage Extended (ECPS:VSE) is unique to the 4300 series processors. It is tailored to speed the execution of the new Disk Operating System/VSE and support its new features—primarily its new memory management scheme.

As described in the third of this set of articles, ECPS:VSE architecture substitutes a new single-level address translation scheme for the more complex two-level technique used on the System/370. This single-level memory uses a uniform set of virtual addresses in both the CPU and the input/output channels where the System/370 uses indirect addressing to reference the channels. Since the channels' virtual addresses no longer have to be translated separately, the operating system software can run faster. In fact, ECPS:VSE will yield up to a total reduction of 13% in the CPU busy time, making more machine execution time available.

A versatile processing unit

The heart of the hardware controlled by this micro-code is the central processing unit, or instruction processing unit (Fig. 3). Operating with a cycle time of 150 to 300 nanoseconds, the model 4341's CPU is as much as five times faster than the model 138's CPU (which has a cycle time of 275 to 1,485 ns). The chief difference in its design, when compared with earlier intermediate-scale processors, is that its data paths are all 8 bytes wide.

The arithmetic and logic unit (ALU) is an unusually wide 64 bits—it accepts 8-byte inputs from the A and B registers and generates an 8-byte output. The main advantage of this 8-byte data flow through the ALU is that the unit can handle an entire 64-bit floating-point register at one time for faster scientific calculations. The ALU can, however, operate on smaller, variable-width data. It will perform binary and decimal operations equally well, with any invalid decimal format result being detected. Automatic decimal sign handling is done by hardware by means of operand sign testing and dynamic selection of the required ALU function. In addition, the ALU can perform floating-point or logical arithmetic and automatically set condition codes.

Inclusion of an 8-byte accumulator (the A register) with an 8-byte extension (the multiplier and quotient register) allows the implementation of a hardware-supported algorithm for multiplication and division instructions. This is because the accumulator plus its extension provides a 16-byte register that can be used to retain an entire product from a multiplication or a quotient with remainder from a division operation.

Another significant part of the instruction processor's design is the 8-byte shifter that controls access to and from the system main storage and channels. Unusually powerful for this class of machine, the shifter has logic features that allow a full 64-bit shift range as well as extended shift, the automatic alignment of storage data or op codes, sign propagation, and data formatting through operations such as wrap, padding, and decimal pack and unpack.

The model 4341's main storage, in addition to being larger (up to 4 megabytes), has been redesigned to improve its performance. To begin with, the use of the high-density 64-K chip semiconductors in the 4341 processor increases storage packaging density to 72 chips, or 512 kilobytes, per card where previous models had only 64 kilobytes per card. But more importantly, this chip is unique in that it contains two 8-bit data buffers to hold the transient data output of the chip's field-effect-transistor storage array. Up to 32 selected bytes of data may be buffered on each card for movement in 8-byte blocks to other areas of the system via the 8-byte-wide data path. This buffering eliminates the need for multiple memory accesses to obtain large quantities of data.

Cache storage

In addition to these on-chip buffers, improved storage operation is provided by making 8-kilobytes of cache storage immediately available for the processor's use.

To manage these new buffers, the storage controller has been improved to decrease the processor and channel overhead due to the time-consuming storage operation (Fig. 4). The most important of these is the directory look-aside table (DLAT) that is available for both processor and channel storage accesses. This contains pretranslated virtual addresses and is interrogated during storage read-and-write operations to see if the desired virtual address has already been translated into a real address. This can alleviate the burden of translating a virtual address for each access. Control of the DLAT has been designed to ensure that the probability of finding the required address in the DLAT is quite high, thereby improving system operation by reducing address translation overhead.

To control addressing of the cache, a cache directory, whose operation is similar to that of the DLAT, is used. Once a storage address has been obtained by a translation operation, the cache directory is checked to see if the data is immediately available from the cache. If not (a situation called a cache miss), the storage control hardware loads the required data into the cache.

The cache directory control has also been designed to provide a high hit ratio—that is, a high probability that the required data is in the cache. This further reduces system overhead due to storage accesses.

Other improvements designed to increase system throughput include the addition of special storage read-and-write instructions that let the channels move data directly to and from main storage without first placing the data in the cache. During these channel data transfers, the instruction processing may continue.

Finally, a new 64-byte swap buffer temporarily holds data being moved to main storage from the cache or the channels. This permits the processor to use the cache during the time that data is being written into the main storage buffer from the swap buffer, further speeding its operation.

The common hardware design of the input/output channels of the new processor allows increased flexibility in configuring the channels. Six channels are available. Channel 0 operates only in a byte-multiplexer mode,

while channels 1 through 5 can operate in either block-multiplexer or -selector mode.

The mode of operation for channels 1 through 5 depends on the type of devices connected to each channel. This information is contained in a channel directory, which is modified from the system console and is used by the control microcode to set up channel Unit Control Words (UCWs). The channels are serviced by the channel control hardware in a predefined rotational cycle.

Servicing the channels

The order is set with channels 1 through 4 permitted two services per cycle and the remaining channels receiving only one processor service per cycle. The extent of the service allotted to each channel essentially predefines the maximum operating data rate. Nominal maximum channel data transfer rates are 1 megabyte per second for channel 5, 2 megabytes per second for channels 1 through 4. The byte-multiplexing rate of channel zero depends upon both the connected devices and the number of block-multiplexed channels that are active. The maximum rate for single-byte transfers is 8 kilobytes per second with no active block-multiplexed channels and 2 kilobytes/s, if all five block-multiplexed channels are active.

Providing access to and control over the entire 4341 computer is the operator's console. As with the rest of the system, the console features several improvements over System/370 models 115 through 148. Most obvious is the fact that up to four of the latest model 3278 cathode-ray-tube terminals can be connected as consoles to the 4341—previous systems had only one. This allows the operator, the system programmer, and the service engineer each to have a separate console.

For the operator there are more fixed-function keys to make life easier than were available on the previous machines. These keys handle functions like: insert characters; delete characters; scroll a display of storage ahead or backwards; and change the screen back and forth between system mode and operator mode without losing either display.

The system can be operated from any one of the four consoles. The various manual controls are now selected from these consoles, not the front panel of the machine as on the models 138 and 148. It is important, however, to show the status of these controls on the display. For example, the operator can always determine by a glance at the CRT the status of the address match controls regardless of the console used to operate the system.

Previous consoles required the entire screen contents

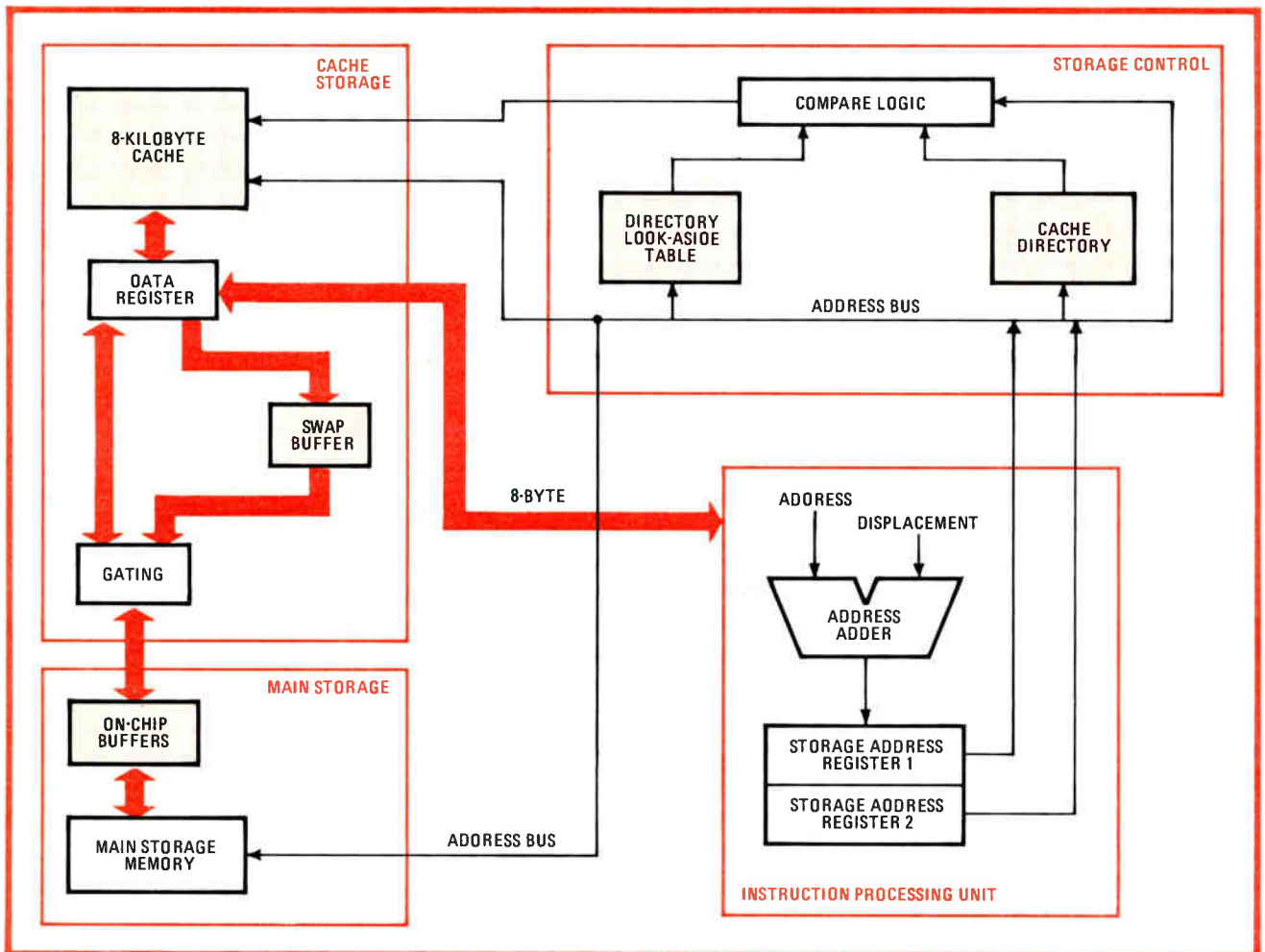

4. Hierarchy. A hierarchy of on-chip and cache buffers improves memory access, and the directory look aside table and cache directory eliminate redundant address translation. The swap buffer returns data to main memory while the cache is also in use.

to be redisplayed for any character change. However, with the model 3278 display, only one character at a time need be changed on the display. This also eliminates flicker.

Because the operator, system programmer, or service engineer can be at any of the four consoles, or at a remote site through a remote support facility, it is important to reflect the system-wait state not only through an indicator light on the Operator Control Panel at the primary console, but also on the display in the system status area (the last line of the screen).

Two extremely powerful additions have been made to the Address Compare function of the console that help the operator to manually control the computer and to debug software problems. The first of these is an instruction-trace command that traces all instructions that cause a reference to a given main-storage address. A data-compare command results in a match stop, which occurs when the data at the given address matches the given data; this power is increased by commands that yield matches on the not-equal case, on bit-level comparison, or on given characters (including "don't care" characters). These two functions can also be combined—so a request can be made for a data-compare trace.

Nearly all the functions can be selected by reading a displayed menu and entering the indicated character. This greatly reduces the time normally needed to look for the functions in a separate reference manual.

It is possible to display storage contents not only in hexadecimal notation but in Extended Binary-Coded Decimal Interchange Code, as well. This feature makes certain textual information more readily identifiable.

Among the other features of the 4341 console, which are unique when compared to previous IBM processors, are several that are specially intended for maintenance and service. For instance, the maintenance display formats have been tailored to reflect the new LSI chip technology (Fig. 5). The displays show individual strings of latches, called scan rings, that help the support processor to detect errors. Once an error is detected, specialized displays have been formatted to help in the analysis of a problem in a given area of the machine, such as storage.

To coordinate all of these new and old functions, a very powerful block function is included to permit all of the console commands to be entered into a file on the diskette and called out at a later time. This function is particularly useful to IBM in applying temporary or trial microcode fixes, in repeating several tedious commands, and in setting up monitoring tasks where specific information is recorded only if a given event occurs.

Many maintenance features

The on-chip diagnostic features of the new logic semiconductors, coupled with Level-Sensitive Scan Design and a separate microprocessor-based maintenance processor, give the 4341 processor a greater degree of control over error conditions than prior IBM systems had.

The separate maintenance processor performs self-diagnosis and assists in locating faults that cause both continuous and intermittent errors. The maintenance processor also monitors such environmental factors as

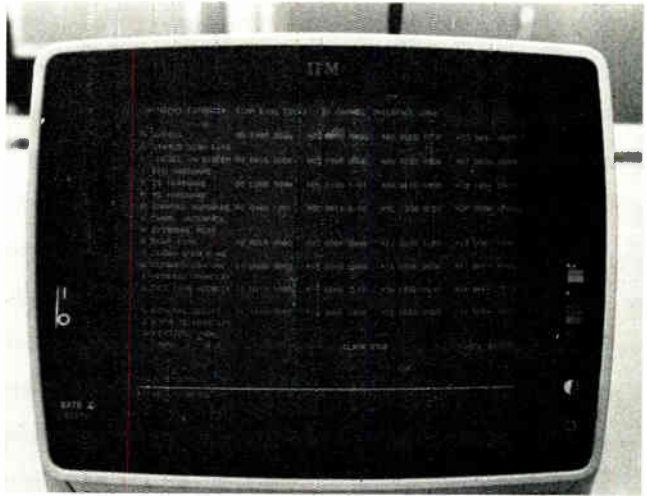

5. Show and tell. By displaying the contents of the scan rings (in this case in a channel interface) on the system console the 4341 helps the service engineer locate problems in the machine. Other new console features assist the operator.

input voltage and temperature both inside and outside the processor mainframe, controls automatic retry of failing instructions, and creates error logs to be stored for use by error-analysis microcode. These will be discussed in the following article.

In addition, the microcode for the support subsystem measures and displays logic input voltages. Power faults are identified by monitoring special points in the system every 500 milliseconds and comparing the monitored values with stored fault criteria. Digital and analog sensors help monitor the condition of circuit breakers, circuit protectors, over- and under-voltage conditions, thermal switches, and other information such as voltage and thermistor resistance values. Analog voltages are converted into appropriate digital values in the power adapter circuitry.

Other modules of the control microcode are designed to support the Level-Sensitive Scan Design operation used in the processing unit. Upon detection of an error, the maintenance processor interrogates the status of the Central Electronic Complex, consisting of the processing unit, storage, and channels, via a special support bus. Pertinent error information is loaded into the support processor, analyzed, and stored for future use by the error-handling routines or maintenance personnel.

The new Remote Support Facility (RSF) developed for use with the 4300 provides an added level of system maintenance support via the telephone network. The RSF is implemented using the support processor connected through an adapter and modem to the telephone network. To secure the computer's data and programs, RSF service can be initiated from the customer's location only when the system is in the maintenance mode. Once connected, the RSF permits the remote facility to have full console capability (except power control), but it also gives the local service personnel access to a data bank containing the latest maintenance information.

The author thanks the following for their contributions to this article: W. Campbell, D. G. Cate, T. I. Foster, J. T. Moyer, J. W. Rossier, E. M. Shimp, L. K. Terry, and F. A. Zurla.

Support processor analyzes errors caught by latches

by Theodore J. Frechette and Fred Tanner
IBM Corp., System Products Division, Endicott, N. Y.

Tracking down the source of intermittent problems in digital computers is often difficult and time-consuming, especially as most diagnostic programs are more suited to locate and correct continually occurring errors.

The IBM 4341 processor overcomes this problem by employing several new maintenance concepts. First, a special type of latch design has been added to the central processor logic. This design permits an external and independently clocked maintenance and support processor—another new feature—to capture the state of the logic when a failure occurs. This separate support processor also logs environmental factors such as the voltage and temperature. Finally, there also is innovative microcode that runs in the support processor and analyzes this error log information to isolate the problem to a circuit card. It will do this either automatically or under control of a service engineer.

In previous computer systems, isolating problems requires the service engineer to use diagnostic microcode that runs at machine speed and uses a building block testing technique. The technique tests function A, then uses A as a basis for testing function B, and continues thus through all the functions to be tested—a procedure that has little trouble finding continuous, or solid, failures but may not isolate intermittent problems correctly.

For example, if the intermittent fault with function A

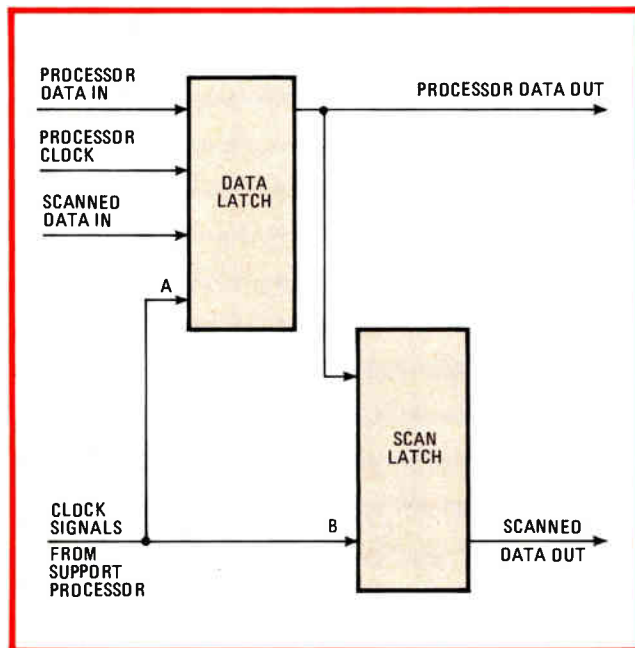

1. Split personality. A pair of polarity hold latches is the basis of IBM's Level-Sensitive Scan Design. The first latch can be used for both system design and testing requirements, hence its two signal and clock inputs, while the second is used solely for testing.

does not appear (and hence is not detected) until function B is under test, the diagnostic program will be unable to correctly determine which function is failing. If the fault is also infrequent, the diagnostic program may not detect any failure, even though one is known to exist. One service approach that can be used in this case is to replace circuit cards on a best-guess basis and return the system to operation on the assumption that the fault has been corrected.

If the problem persists, more extensive diagnostic techniques must be used. These include "freezing" the system when an error occurs, trapping suspect signals, or tracing through failing customer programs. Other techniques deliberately provoke the reappearance of the problem by putting worst-case physical stresses on the system—for example, varying input voltages or cooling or heating circuit cards and boards. All such activities, however, interrupt customer operations and require much extra time.

Capturing faults

The IBM 4341 processor, in contrast, may be described as capturing faults the first time they occur. It does this by logging the state of the system when a failure arises. All data pertaining to the failure is recorded on the system's diskette for later analysis, the results of which are displayed on the system console and dictate the repairs to be made.

This diagnostic approach makes repair faster because there is no need to recreate the failure. In addition, it tells the service engineer what spare parts to bring to the customer's site.

IBM calls its use of special latch circuits for diagnostics its Level-Sensitive Scan Design. These are actually shift-register latches consisting of a pair of (type D) polarity-hold latches connected to form a single stage of a shift register. These pairs are scattered throughout the logic to allow the state of the various circuits in the chip—many otherwise inaccessible—to be captured and read out by the separate support processor.

The first latch in a pair, or the data latch, is used for both system design and testing requirements. It therefore has two data inputs—processor-data-in and scanned-data-in—as well as two clock inputs—one from the CPU and one from the support processor.

The second, or scan latch, is used primarily for testing purposes. It has its input permanently connected to the output of the first latch and can be clocked only by the support processor. Figure 1 illustrates the relationship of the latch pair.

There are approximately 5,000 of these latch pairs in the central processing unit's logic. But only about 300 of them function solely as error checkers to aid diagnostics. The rest serve a dual purpose, doubling as storage elements like registers or accumulators or to retain the state of selected control lines. Because of their dual role, these latches are able to enhance maintainability without becoming overhead.

In this role the first latch has data moved into or out of it through the processor data-in and -out lines in time with pulses of the CPU clock. In the diagnostic role, the state of the first latch is transferred to the second latch

by pulsing the support processor clocks. That state can therefore be captured by the support processor, which sends a clock pulse to the second latch and shifts its information out through the pin for scanning data out.

These latch pairs are linked serially into several long shift registers called scan rings; the scanned-data-out line of one scan-ring latch pair is connected to the scanned-data-in line of another, and so on (Fig. 2). The support processor can now clock all the scan latches and shift their contents out as a serial bit stream through a single line. Since each bit in this serial bit pattern corresponds to a latch pair, the state of each latch in the string can be determined.

Thus, when any type of error occurs, the support processor can obtain the exact machine state at the time of failure. The state of each machine latch when an error occurs is then used by the error analysis microcode in the support processor to locate the defective component. The support processor can also scan a specific machine state into the central processor through the scanned-data-in line on these latch pairs so that if other diagnostic programs are needed, they can begin from a known starting point.

The actual monitoring of the CPU's data flow, control lines, timing circuits, and cables for errors is performed by combinatorial logic, also in the CPU, using parity, duplex, validity, and other error-checking techniques. When this logic detects an error, it activates one or more of the 300 scan-ring latches that are dedicated to functioning as error checkers, causing a condition called a machine check that stops the central processor. The machine check also signals the support processor in order to start CPU recovery or else, if required, to analyze the error log.

Divide and diagnose

These 300 dedicated error-checking latches are strategically placed so that they divide the computer logic into distinct portions called error domains. An error domain is composed of an error checker, the arithmetic or logic function being checked, and all of the circuitry associated with that function.

When an error is detected and a machine check signaled, the support processor begins the recovery procedures. Its recovery microcode initially reads the data in selected scan rings into the support processor and checks it to determine the type of failure. All scan-ring data pertinent to the failure is formatted and recorded on the system diskette as an error log. Also used with this log is environmental data like electrostatic discharge and power line voltage transients, internal machine temperatures, and time and date information. Whenever possible, a standard instruction retry is then attempted—the processor is returned to a known state and the failing instruction is executed again.

When an intermittent failure is involved, the retry usually succeeds and the main computer can resume operations. The error log is saved, however, so that during the next service call the service engineer may be made aware that intermittent problems are occurring—conditions that went unreported in previous systems. The new maintenance techniques really excel when retry is

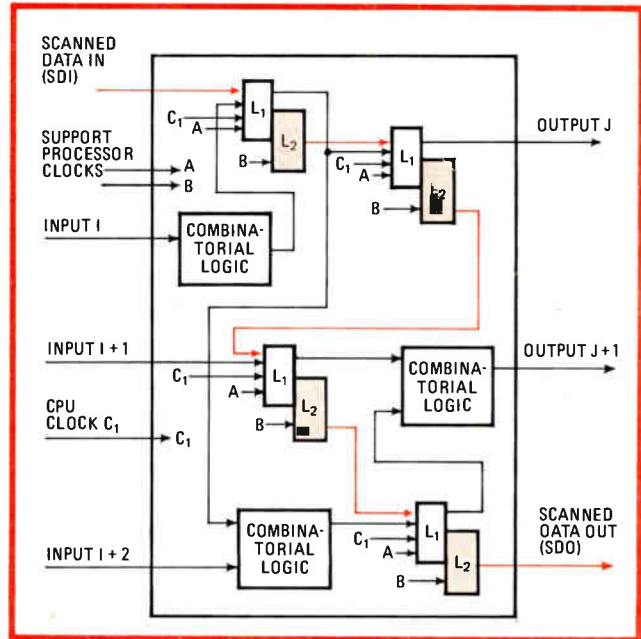

2. Ring around the data. By connecting the scanned-data-out line of one latch pair to the scanned-data-in port of the next a long shift register, called a scan ring, is created, allowing the state of each latch in the ring to be shifted out for analysis.

unsuccessful, however. Then the special Error Log Analysis diagnostic microcode is invoked in order to analyze the information contained in the error log.

The Error Log Analysis microcode, divided into several modules, contains approximately 17,000 bytes of code. Its purpose is to analyze the machine-check error logs and produce a reference code that identifies the failing field-replaceable circuit card or cards. The analytic program can be started manually by the service engineer or automatically when a retry of a machine check is unsuccessful.

The analysis is started by the microcode's root module, which controls the entire analytic procedure. This module is resident in the support system throughout the analysis of the error log. It reads the error log, calls other error log analysis modules as necessary and passes the reference code (which identifies any faulty cards) to the system console for display.

The other modules in the analytic microcode first isolate the specific areas of the processor that contain failures and then pinpoint the sources of failure within those areas. Some modules isolate failures in specific areas of the processor such as control storage, instruction processing unit, channels, and storage controller (which includes the main memory).

Two of the modules isolate failures across subsystem boundaries to trace failures occurring in more than one subsystem. They analyze false machine checks (errors in the maintenance hardware), clocks, duplicate hardware mismatches, and board-to-board cables. Then, by sectioning and establishing priorities for the tests of the more than 300 error checkers, the Error Logic Analysis microcode modules can isolate the fault to a particular error domain.

Once the failing domain has been determined, the

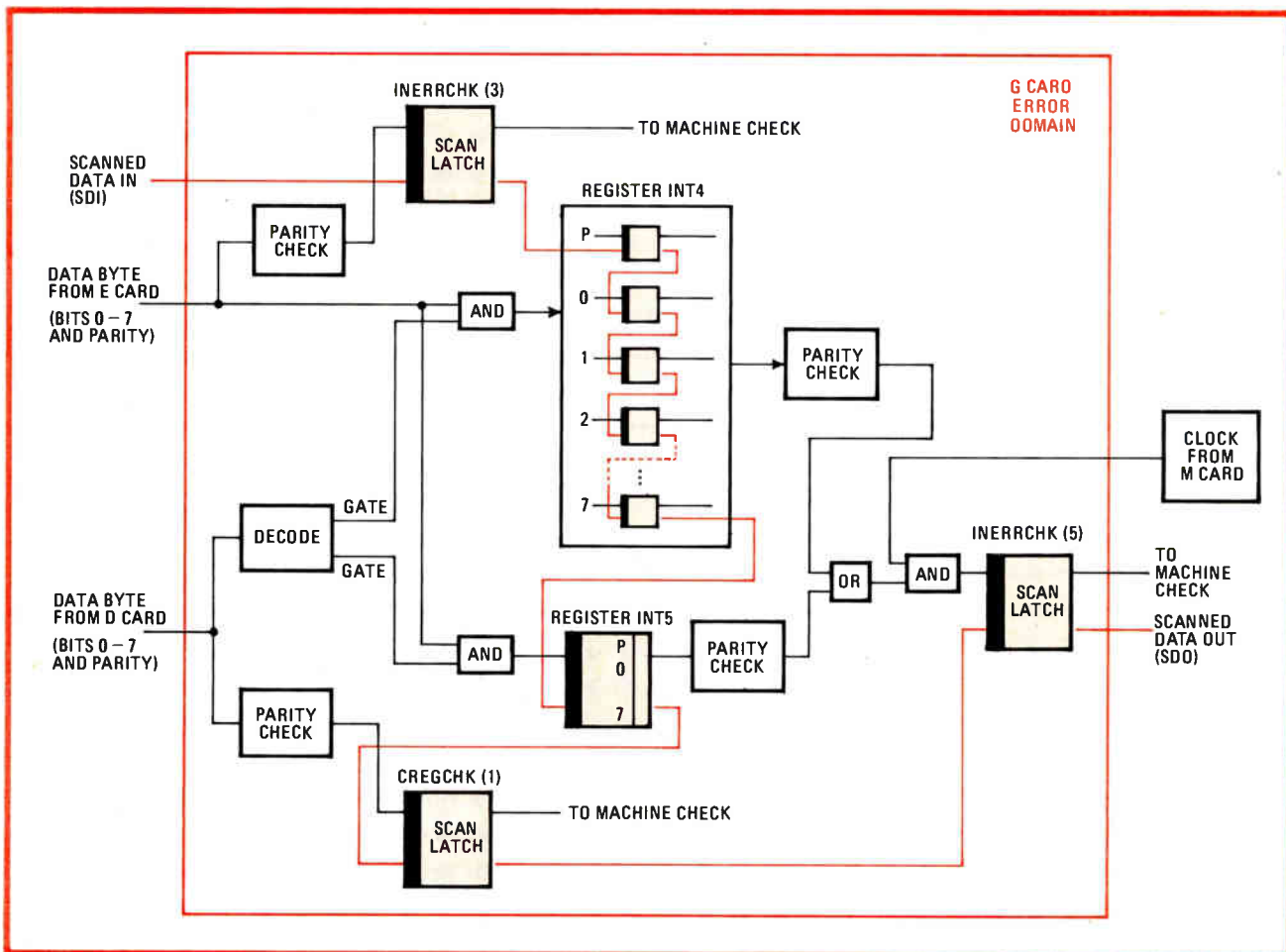

3. Diagnosing domains. Dedicated error-checking latches divide the computer into error domains. If, for example, a parity error is detected in register INT4, itself made up of nine latches, latch INERRCHK5 signals. If other latches are off, error did not come from another domain.

fault is isolated within the domain. By interrogating either one latch or a group of latches within and/or common to a particular error domain, it can usually associate the fault with between one and three field-replaceable cards.

After the error log analysis microcode determines the precise card or group of cards at fault, an eight-digit code is then retrieved from memory and displayed on the system console to tell the operator where the fault is located. The customer can now pass this reference code on to the IBM field-service engineer. Once supplied with the code, the service engineer can determine the card group required to repair the system and can bring it along on the service call.

To illustrate this procedure, consider the error domain shown in Fig. 3. The registers labeled INT4 and INT5 on circuit card G are being parity-checked by the error-checker scan latch INERRCHK(5). (The error checkers labeled CREGCHK(1) and INERRCHK(3) are checkers for other error domains on cards D and E.)

Domain example

For example, assume that a single-bit error in the INT4 register is producing a problem. The parity-check logic detects the single-bit error and causes INERRCHK(5) latch to come on, signaling a machine-check. If the

instruction retry is unsuccessful, the support processor starts to analyze the error log.

To isolate this error domain, the analytic microcode first determines that latches INERRCHK(3) and CREGCHK(1) are off and that INERRCHK(5) is on. This test ensures that the error did not propagate into this domain from the D or E card error domains.

Once the domain of the failure is determined, the fault is isolated to the smallest possible number of field-replaceable cards. In this case, a test is made of the INT4 and INT5 registers. Since the two 9-bit registers are each constructed from nine scan-ring latches, the internal conditions of the registers can be checked to determine if either has a bad parity condition.

Should bad parity exist, the reference code for the G card is the field-replaceable unit that is listed. If the parity is good in both registers, the G card and the system clock M card would be listed. But the G card is listed first, because it is still the most probable cause of this failure.

When necessary, additional diagnostic microcode can be used to isolate processor faults not covered by error log analysis or to enhance the fault isolation. These diagnostics also exercise the system, in order to verify that the system is working properly after the card has been replaced.

Streamlined architecture achieves software compatibility

by Hartmut R. Schwermer
IBM Corp., Böblingen Development Laboratory, Böblingen, West Germany

"Save our software!" is the cry heard from all computer users contemplating a new generation of hardware. In response, the 4300 computers have been designed with two operating modes. System software has been changed to take advantage of these modes in a way that allows application programs to perform better in the new mode without making them unable to run on the System/370.

One mode is in fact called the System/370 mode; in this mode the 4300 appears to be, for programming purposes, identical to the System/370. The System/370 mode also allows the 4300 to use the 370's operating system (Disk Operating System/Virtual Storage, or DOS/VS).

The second mode reconfigures the 4300 architecture, enhancing software performance most notably through more efficient virtual-memory management. There are some changes in instruction set, and the new operating system (Disk Operating System/Virtual Storage Extended, or DOS/VSE) must be used. This second operating mode is called Extended Control Program Support: Virtual Storage Extended, or ECPS:VSE for short.

Control program changes

The ECPS:VSE architecture is designed to make the control program of the operating system perform better. The architecture is problem-state compatible, but not supervisor-state compatible, with the System/370 architecture. Therefore application programs written for the System/370 need not be changed to run on a 4300 operating in the ECPS:VSE mode. Changes in the architecture require the use of the newer operating system, DOS/VSE, when the 4300 is in the ECPS:VSE mode.

The architecture—the machine as the programmer sees it, not its physical or logical design—can be modified by switching from one mode to the other thanks to the internal use of microcode. The architectural mode must be selected at the time of initial program loading; it cannot be changed during normal operation.

Eight of the 183 instructions of the System/370 architecture are dropped in the ECPS:VSE mode and a dozen new ones are added, among them a new status-saving instruction and others pertaining to the new single-level management scheme for virtual memory, or virtual storage, as IBM calls it. ECPS:VSE memory addressing is considerably faster; it allows the same virtual-memory addresses to reference main memory from both the central processing unit and input/output channels. The System/370 architecture uses separate addressing schemes for the two.

The ECPS:VSE addressing facility supports only one virtual memory of 16 megabytes maximum size, instead of the multiple virtual memories supported by the System/370, but the ECPS:VSE facility is easier to use.

As in all schemes of this kind, virtual storage (on disk drives, usually) is larger than the machine's actual main memory. Unused portions of data and programs are stored on disk until they are needed. When these portions of data are called for, memory management swaps 2,048-byte pages on disk with pages stored in main memory that are not currently in use.

Since the disk drives and main memory work together in the virtual-memory system, it is advantageous to have both of them able to address it directly, as they do under ECPS:VSE. As mentioned, both the central processing unit and the I/O channels use the same set of virtual addresses. Main storage is not directly addressable by CPU programs or channel programs—all references are through virtual memory. In the 370 architecture, the CPU and I/O channels each use separate address lists. One-level addressing improves both instruction processing and control-program performance because the control program does not have to spend time translating the virtual addresses of the channel programs.

Faster translation

This single virtual storage environment also avoids the process of translating the virtual-storage addresses into real addresses used to reference the usually smaller actual main memory of the machine. Instead of the more complex Dynamic Address Translation software used in the System/370, the ECPS:VSE lets machine hardware do the translation automatically and efficiently.

The virtual-storage size is established and can only be changed when initial program loading is performed. Once set, it cannot be changed by the control program. It is always a multiple of 2,048 bytes up to a maximum of 16,777,216 bytes (16 megabytes).

Addresses equal to or greater than the specified virtual-storage size are invalid addresses. Any attempt by the CPU to refer to storage with an invalid address is indicated by an addressing exception. An I/O operation using an invalid address is terminated by a channel-program check. When storage size is set to the 16-megabyte maximum, all addresses are valid.

Virtual storage is divided into pages, each consisting of 2,048 consecutive bytes. The address of the first byte

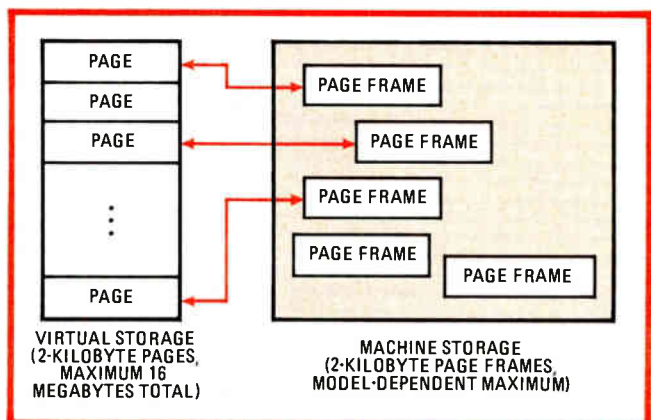

1. Frame up. Virtual storage (generally on disk) is divided into 2,048-byte pages that must be linked to a page frame in main memory before they can be directly accessed by the central processing unit or input/output channel programs.

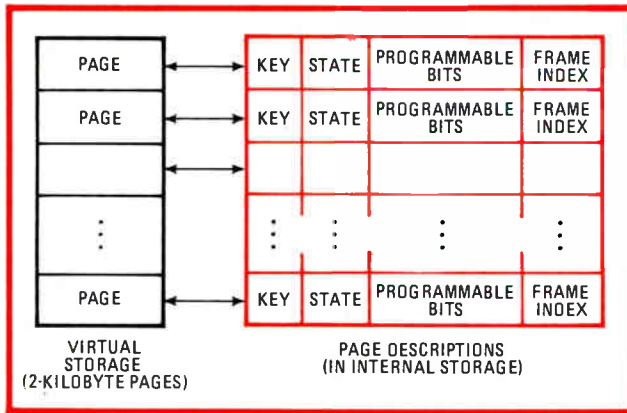

2. Bookkeeping. To help the 4300 CPU keep track of the pages in virtual storage, 28-bit page descriptions are held in main storage. The storage key is used for security and housekeeping; other bits in the description keep track of a page's location and state.

of each page is an even multiple of 2,048. Machine storage is divided into page frames, each capable of containing the data of one 2,048-byte page of virtual storage (Fig. 1). Each page can be in one of three states—disconnected, connected, or addressable.

Swapping pages

In order for a virtual-storage page to be accessible by CPU or channel programs, it must be associated with a machine-storage page frame. Therefore an instruction is provided in the ECPS:VSE instruction set that automatically connects a page frame to a page. When the control program issues that command, a page frame in machine memory is referred to by the virtual address of the corresponding virtual-storage page. Once the page has an associated page frame, it is in the connected state but is accessible only by the I/O channels. As long as a page I/O operation is being performed to or from external storage, the page is kept in the connected state by the control program. CPU and channel programs can address any part of virtual storage as if it were directly accessible even during the transfer operation.

When the contents of a page have been retrieved from external storage and placed in a page frame in machine memory to become ready for accessing by a CPU program, the control program uses another instruction to make the page addressable. Now it is accessible by both the CPU and the I/O channels. As the supply of free page frames diminishes, the control program makes room by disconnecting a page from its page frame. A replacement algorithm chooses to remove a page that has not been recently referenced.

If any byte in the page has been changed, the page contents will be written out to update the copy in external storage. If no changes were made, that copy is accurate and the time-consuming I/O operation is avoided. An instruction may then be issued to disconnect the page, thus freeing its page frame. That page is no longer accessible by the CPU or I/O channels—only the control program software can retrieve it.

Each virtual-storage page has an associated 28-bit page description that is maintained in internal storage (Fig. 2). It consists of a 7-bit storage key used for data

security and other housekeeping chores, 3 programmable bits used by the control program, 2 page-state bits, and the 16-bit frame index of the page frame currently assigned to the page, if any. The 3 programmable bits assist in managing pages in external storage: one of them, for example, indicates whether or not a version of the page in fact exists on external storage.

Identification

Each page frame in machine storage has a unique 16-bit integer, the frame index, assigned to it. The frame index should not be confused with the address of the frame in machine memory. The algorithm for assigning a frame index varies from model to model. This index helps the control program maintain compact tables of connected or addressable pages.

Special privileged instructions that are not in the System/370 instruction set have been defined to support the ECPS:VSE virtual storage. The connect-page command changes the state of a page from disconnected to connected. The make-addressable instruction changes the state of a page from connected to addressable, and the make-unaddressable instruction changes a page's state from addressable back to connected. A page's state is changed from connected to disconnected by the disconnect-page command. The deconfigure-page command also disconnects a connected page, but in addition it makes the corresponding page frame unavailable for further use. To test the state of a page and display its frame index, the load-frame-index instruction is used.

The clear-page instruction sets the contents of a page to zero; the set-page-bits instruction tests the reference and change bits of a page and sets them along with that page's 3 programmable bits. The programmable page bits, the reference bit, and the change bit are retrieved by the insert-page-bits command.

Diagnostics

As was discussed in the preceding article, the 4300 computers have better internal diagnostics than previous IBM computers. Each time a machine malfunction occurs, the cause of the failure is recorded on an internal diskette. After the recording has been completed, normal system operation is resumed if possible.

Because of these improved internal diagnostic facilities, machine-check, channel-check, and other model-dependent features contained in the System/370 architecture are superfluous. These parts of the architecture became model-independent for both operation modes of the 4300. As a consequence, the error-handling procedures of the DOS/VSE control program became simpler. Machine serviceability has been improved because internal diagnostic functions allow more precise identification of the cause of a machine malfunction.

The other big change to the System/370 and instruction set is the replacement of the store-status command with the new machine-save instruction. The ECPS:VSE mode's machine-save instruction preserves the entire CPU state and the first 2,048 bytes of storage; it is used by the operator to prepare a complete storage dump. It is easier to use than the store-status instruction, which altered some of the storage contents to be dumped. □

10 watch circuits, 6 clock circuits, and a headstart on your next design.

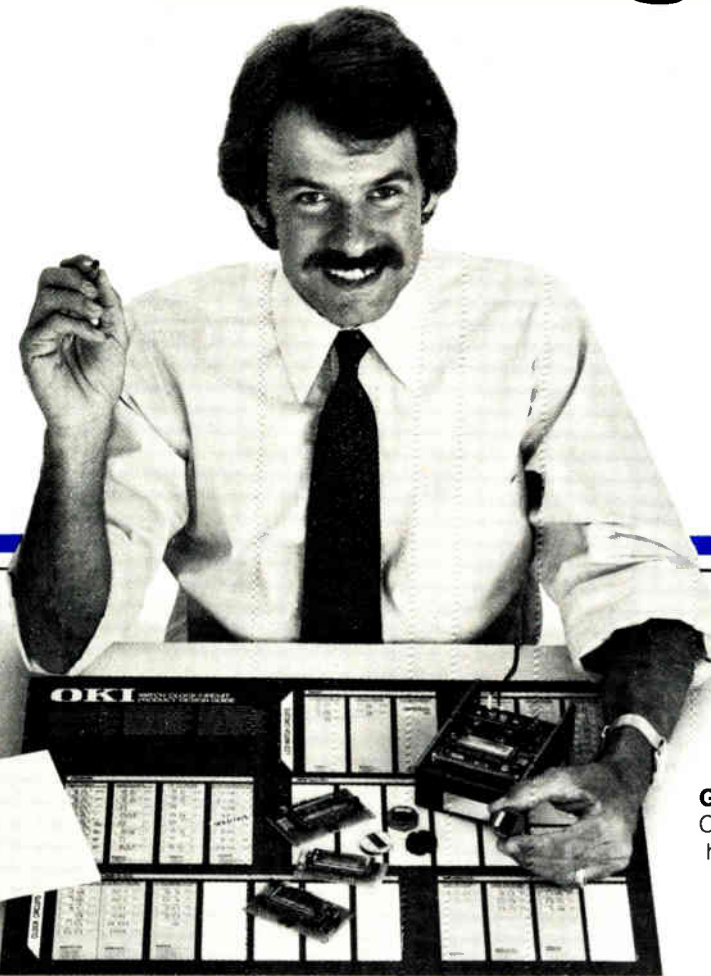

OKI's watch/clock design guide shows the industry's broadest line at a glance.

If you're designing LCD watches or clocks, OKI Semiconductor wants to make your next design job a lot easier. Every CMOS watch and clock circuit in OKI's broad line is displayed in a simple, easy-to-read format on our new wall chart. Functions are shown just as you see them on a watch, in simulated LCD displays.

From a simple 3½-digit, 4-function MSM-5977, up to the MSM-5081, which drives an 8-digit LCD digital watch with two time zones, two alarms, two stop watch functions, a countdown timer and a programmable on-the-hour chime, it's all there.

New CMUX technology.

Our chart also describes CMUX, a new multiplexing technique which provides more functions across fewer contacts. The result is fewer bonds, meaning lower manufacturing costs and improved reliability.

All the CMOS watch and clock circuits in OKI's family provide lower power consumption and meet standard specifications and performance requirements. In many cases, you

insert a variety of chips into standard modules. This helps reduce your tooling costs, while still meeting a wide variety of consumer demands for the latest functions.

Get your free design guide. Call or write today for your headstart on watch and clock design. OKI Semiconductor, 1333 Lawrence Expressway, Santa Clara, CA 95051. Telephone (408) 984-4842.

To: OKI Semiconductor, 1333 Lawrence Expressway, Santa Clara, CA 95051

Send OKI's Watch / Clock Product Line Wall Chart and Design Guide.

I'd like to know about other OKI LCD watch circuits. Send data sheets on:

BASIC circuits MULTIFUNCTION circuits CHRONOGRAPH circuits

Send me data sheets on OKI's new MSM-5080 and 5081 CMUX circuits.

Name _____ Title _____

Company _____

Address _____

City _____ State _____ Zip _____

Phone _____ EL 11/8/79



Seven Reasons Why Data General** Computer Users Prefer MDB Interface Products:

1. Superior Performance
2. Quality Workmanship
3. Comprehensive Product Mix
4. Competitive Pricing
5. Better Delivery
6. One-Year Unconditional Warranty
7. Worldwide Sales

Find your reason here!

■ PERIPHERAL DEVICE CONTROLLERS

MDB-4034 Line Printer Controller, programmed I/O

New! MDB-42XX Line Printer Controller, Data Channel (DMA), optional Programmable Interval Timer/Real-Time Clock (accommodate most major manufacturers models)

MDB-4011 Paper Tape Reader Controller

MDB-4012 Paper Tape Punch Controller

MDB-4016 Card Reader Controller

MDB-4017 Incremental Plotter Controller (controllers above include 15 foot cable)

■ GENERAL PURPOSE INTERFACE MODULES

MDB-4040 Basic Board includes BUSY and DONE logic, multiple device selection, provides for 105 logic IC positions, accepts all size DIP packages; options include 16-bit I/O registers (two each) with byte pack/unpack, Data Channel Connection, wire wrap pins inserted, and lo-profile sockets.

MDB-1021 All Wirewrap Interface Board, up to 198 positions of user IC logic; options include wire wrap pins inserted, lo-profile sockets, protective cover.

■ COMMUNICATIONS/TERMINAL MODULES

New! MDB-MIOB Teletype/RS232 Controller, 50 to 19.2K baud, switch selectable functions and addressing, includes RS232 or current loop interface; options include second device

controller, Real Time Clock, Modem Control
MDB-8063 Four or Eight Channel Asynchronous Communications Multiplexors, maximum 64 channel system capability

■ CHASSIS ASSEMBLIES/ACCESSORY HARDWARE

MDB-NEC-01 Expansion Chassis, six boards on 3/4" spacing

MDB-NTM-01 Chassis Bus Terminator

DGEB Extender Board

MDB-CPNL Communication Panel, four or eight channels

GPIO Cable Subassemblies for 20, 26, 34, 40 and 50 conductor ribbon cable; edge connector with 10 foot unterminated cable

MDB-120 & 250 Power Supplies, both linear and switching, five different configurations

MDB interface products always equal or exceed the host computer manufacturer's specifications and performance for a similar product. MDB interfaces are completely hardware compatible and software transparent to the host computer. MDB products are competitively priced, delivery is 30 days ARO or sooner. MDB places an unconditional one-year warranty on its controllers and tested products.

MDB also supplies similar interface modules for DEC PDP*-11 and LSI*-11, Perkin-Elmer (Interdata) and IBM Series/1 computers. Product literature kits are complete with data sheets, pricing and discount schedules.

MDB 1995 N. Batavia Street
Orange, California 92665
714-998-6900
SYSTEMS INC. TWX: 910-593-1339

*TM Digital Equipment Corp. **Data General is a computer manufacturer unrelated to MDB

Northern California 408/733-3950 □ Mid-Atlantic: 301/652-2173 □ New England: 617/444-1800 □ Mid-Western: 312/266-1032 □ Southeastern: 305/254-2511
Southwestern: 713/438-1238 □ Australia & New Zealand: (03) 543 2077 □ Belgium & Luxembourg: 02-720.90.38 □ Canada: 416/625-1907 □ Greece: 9514.944 9520.589
Hawaii: (808)524-8633 □ Hong Kong: 5-771768 □ India: 234343 □ Japan: 03-437-5371 □ Malaysia: 944 404 □ Netherlands: 03404-21344
Philippines: 89-10-96 □ Singapore: 295-2381-2389 □ Sweden, Norway & Finland: 08/94 04 90 □ Switzerland & Liechtenstein: 01/730 48 48 □ W. Germany: 0 89/80 60 61-62

Circle 122 for DG; 123 for PDP; 124 for LSI; 125 for P-E; 126 for IBM.

Trio of dense bubble memories has large supporting cast

Two sets of interface chips adapt three sizes of bubble memory to many applications, with or without error correction

by Gerald Cox, *Texas Instruments Inc., Dallas, Texas*

□ For a magnetic-bubble memory family to be successful, it must be complete: it must include bubble devices of varying capacity, and it must contain support circuits so that the designer can put a system together—yet forego a course in magnetics.

The TIB1000 family meets those requirements and more. The 1-megabit TIB1000 is electrically and physically interchangeable with two other new bubble memories: the 512-K TIB0500 and the 256-K TIB0250 (Table 1). And the family is fully supported by a comprehensive line of custom interface circuits.

Actually, the bubbles will be supported by not one set of interface chips but two: one for general applications and another that provides error correction and detection—a must for the disk-replacement market.

The TIB1000 is a 1,122,852-bit single-chip magnetic-bubble memory (Fig. 1, right). It features a new page-swap and -replicate architecture for speedy access and cycle times, and it has dedicated map loops for transparent handling of redundant minor loops. The memory is split into two 512-K sections, one of which is diagrammed in the left half of Fig. 1.

There are 300 minor loops per section, and each minor loop stores 2,049 bits. Of the 300 loops, 274 are available for storage and the remaining 26 are allowed to be defective to increase chip yields and lower cost. When using error correction, 18 of the 274 loops are used to store error-correction codes. If error correction is not elected, 272 loops are used to store data and two loops contain odd parity bits for two sets of 136 loops.

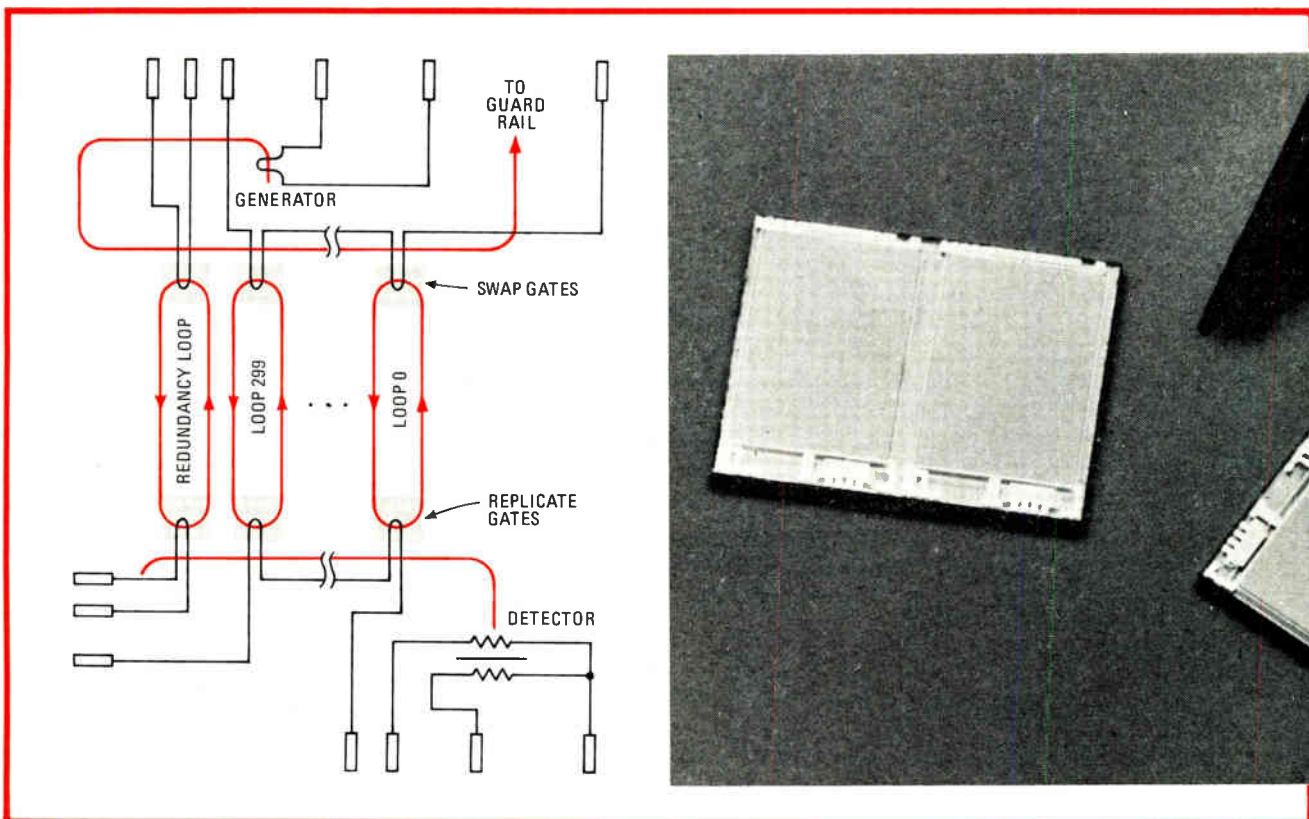

1. Page swap. On the right is a die photograph of the TIB1000 million-bit magnetic-bubble memory. On the left is a schematic of one of the two 512-kilobit sections in the chip. The swap gates transfer a page of data into the minor loops. The replicate gates feed a detector.

TABLE 1: THE TIB1000 DEVICE FAMILY

Device	TIB1000	TIB0500	TIB0250
Capacity (bits)	1,122,852	561,426	280,850
Organization (bits)	512-K-by-2	512-K-by-1	256-K-by-1
Total loops	300 (X2)	300	
Good loops	274 (X2)	274	
Loops with correction	256 (X2)	256	
Loops without correction	272 (X2)	272	
Bits per loop	2,049		1,025
Access time (ms)	11.2		5.6
Field rate (kHz)	100		
Burst data rate (kb/s)	200	100	
Average data rate (kb/s)	170	85	
Power dissipation (W)	1.2		

The minor loops are tangential at one end to swap gates and at the other to replicate gates. A bit of data enters or leaves each minor loop during a swap or replicate operation. Thus, the number of loops storing data determines the size of a data page. If 272 loops store data, for instance, a page is equal to 34 bytes.

The TIB1000 chip measures only 149,000 square mils (less than 1 square centimeter), resulting in the highest bit density for a commercial bubble memory product by a factor of more than two. The 8-by-8-micrometer cell supports 2- μ m bubbles. The small cell is made practical by the development of a truly planar process [*Electronics*, Sept. 27, 1979, p. 37] and by refinements in projection photolithography. The dice of the TIB0500 and TIB0250 are scaled in size by two and four, respectively.

A significant improvement in architecture is made possible by a double-period gate that moves bubbles two periods (cells) for every cycle of the rotating magnetic field. With this design, only one bubble generator and one pair of detectors are needed in each 512-K (or 256-K) section. Data need no longer be separated into odd and even banks nor merged into a common detector pair, as happened in previous designs.

In operation

The devices employ page swap and page replication of data. During a write operation, data is generated in every field cycle and shifted by the double-period gates until it is aligned with the respective minor loops. Then a swap current pulse simply exchanges old data in the top bit position of the minor loops with new data located in the input swap track. The old data in the swap track is shifted to a guard rail where it is destroyed.

A read operation is conducted at the opposite end of the minor loops where data is replicated a page at a time. Again, data travels two periods for every field cycle to the detector, which consists of two arrays of interconnected Permalloy patterns. The arrays are connected to constant-current sinks located in an external sense amplifier. The current sinks form a balanced bridge that becomes unbalanced in the presence of a bubble. A guard rail destroys the bubble before it can enter the second detector, in order to insure that common-code

signals are not encountered by the sense amplifier.

The time required to write or read data into or out of a magnetic-bubble memory consists of the time it takes for a desired page of data to circulate through the minor loops to the swap gate or replicate gate, plus any delay associated with the write and read tracks. The average access time, T_{av} , is usually considered to be the time it takes a page of data to propagate half the length of a minor loop plus the write- or read-track delay. For the TIB1000 this is calculated by adding one half of the number of bits per loop to 100 field cycles to find the delay from the replicate operation to the detector. This result is then divided by the field frequency. Hence:

$$T_{av} = \frac{2,049 \text{ bits/loop} \times 0.5 + 100 \text{ cycles}}{100 \text{ kilohertz}} \\ = 11.2 \text{ milliseconds}$$

The initial specification of 100 kHz for the field frequency will later be increased to 200 kHz. This will lower the average access time to 5.6 ms.

The rate at which data can be transferred to or from the bubble memory, once the desired page of data has been accessed, is determined by the bubble's field frequency and the number of field cycles required to transfer a page of data (including redundancy, error correction, and the interpage gap) out of the chip. The average data rate, DR_{av} , for the TIB1000's multipage read or write mode is derived as follows:

$$DR_{av} = \frac{\text{data bits/page} \times \text{field frequency}}{\text{loops/page} + \text{interpage gap}} \\ = \frac{256 \times 100 \text{ kHz}}{(300 + 20) \text{ field cycles}} \\ = 80 \text{ kilobits/s per channel} \\ = 160 \text{ Kb/s (both channels)}$$

If the user does not need error correction, the 16 additional bits of data per page increase the average data rate to 85 kb/channel.

The data rate of the TIB1000 bubble memory system is normally slower than for that of the host system. An

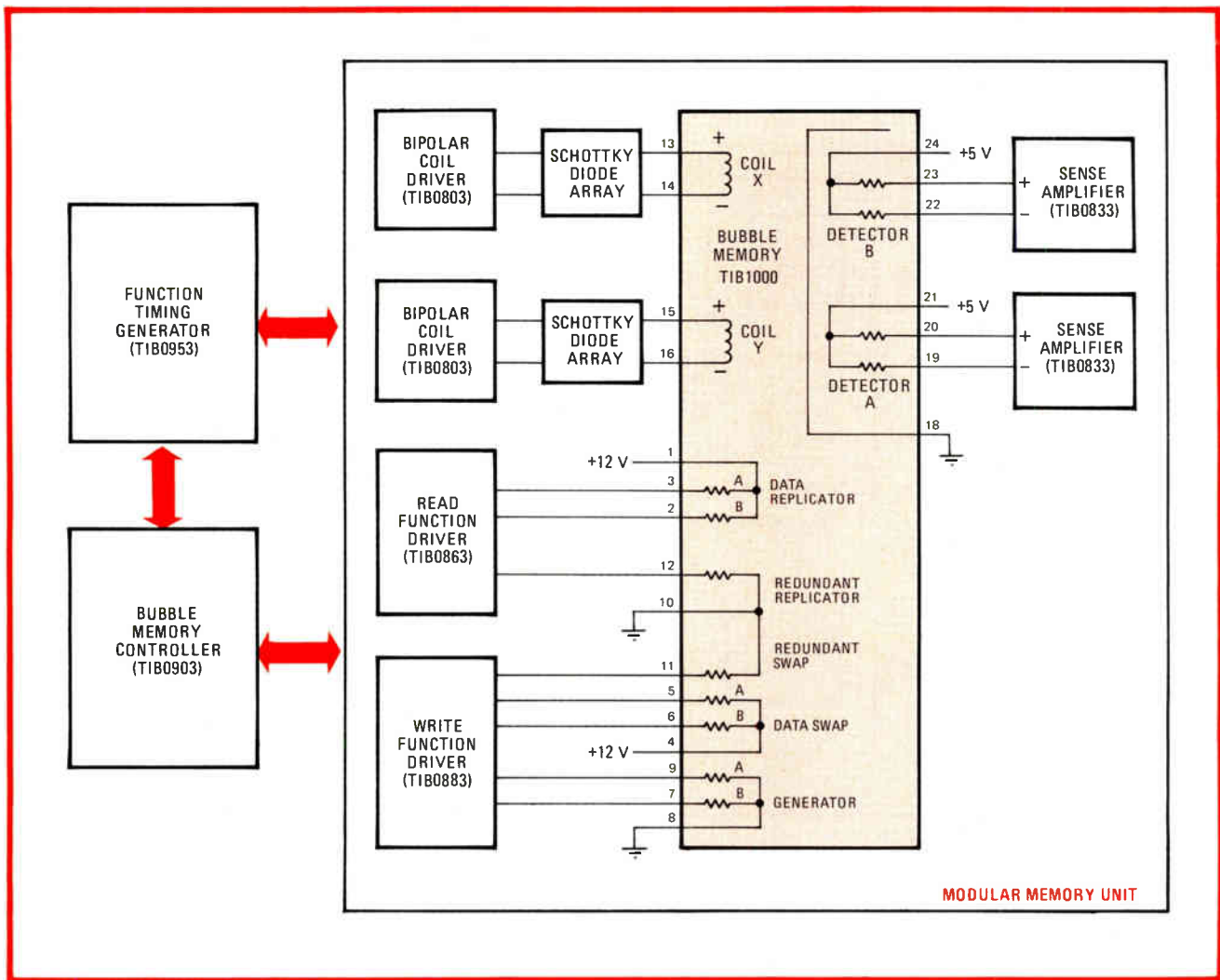

2. Modular. The bubble memory is surrounded by custom interface circuits to ease system design. The controller provides a general interface between the bubble device and the host microprocessor. The timing generator is capable of driving up to 10 modular units.

integrated circuit for correcting and formatting data (to be described later) double-buffers the data between the bubble device and the host system. This allows a totally asynchronous data interface that may operate up to a 4-megahertz burst rate.

The support circuits

As mentioned, the TIB1000 will be supported by two families of custom integrated interface circuits. The first family, to be available at the same time as the TIB1000, includes the TIB0903 bubble memory controller, TIB0953 function timing generator, TIB0804 bipolar coil driver, TIB0863 read function driver, TIB0883 write function driver, and the TIB0833 single-channel sense amplifier. Except for the controller and the timing generator, all of the interface circuits are required for each bubble memory in the system whether it is a TIB1000, TIB0500, or a TIB0250. Hence, the collection of these circuits and the bubble memory has been given a name: the modular memory unit (Fig. 2)

The TIB0903 controller provides a general interface between the memories and the host microprocessor system. Its basic functions are to start and stop bubble

movement, to maintain page position information, and to control generation and swapping of data, block replication, and initialization of redundancy (map loop) information. It also controls all bubble operations, including multipage reading and writing.

The TIB0953 timing generator will directly drive up to 10 modular memory units on a common bus, but can communicate with only one modular memory unit at a given time. More than 10 modular memory units can be driven with the addition of simple noninverting buffer gates. The read- and write-function drivers control the generation, swapping, and replication of bubbles for either or both sections of the TIB1000. Each output function is monitored by an internal time-out circuit to prevent damage to the bubble device even if a timing fault occurs elsewhere in the system.

The second family of support circuits, to be introduced in mid-1980, is especially designed for parallel bubble operation as well as error detection. The need becomes acute when challenging the disk-replacement market. A more advanced modular memory unit, the bubble modular array with correction, gives the most flexible and powerful answer. The system addresses the lower-

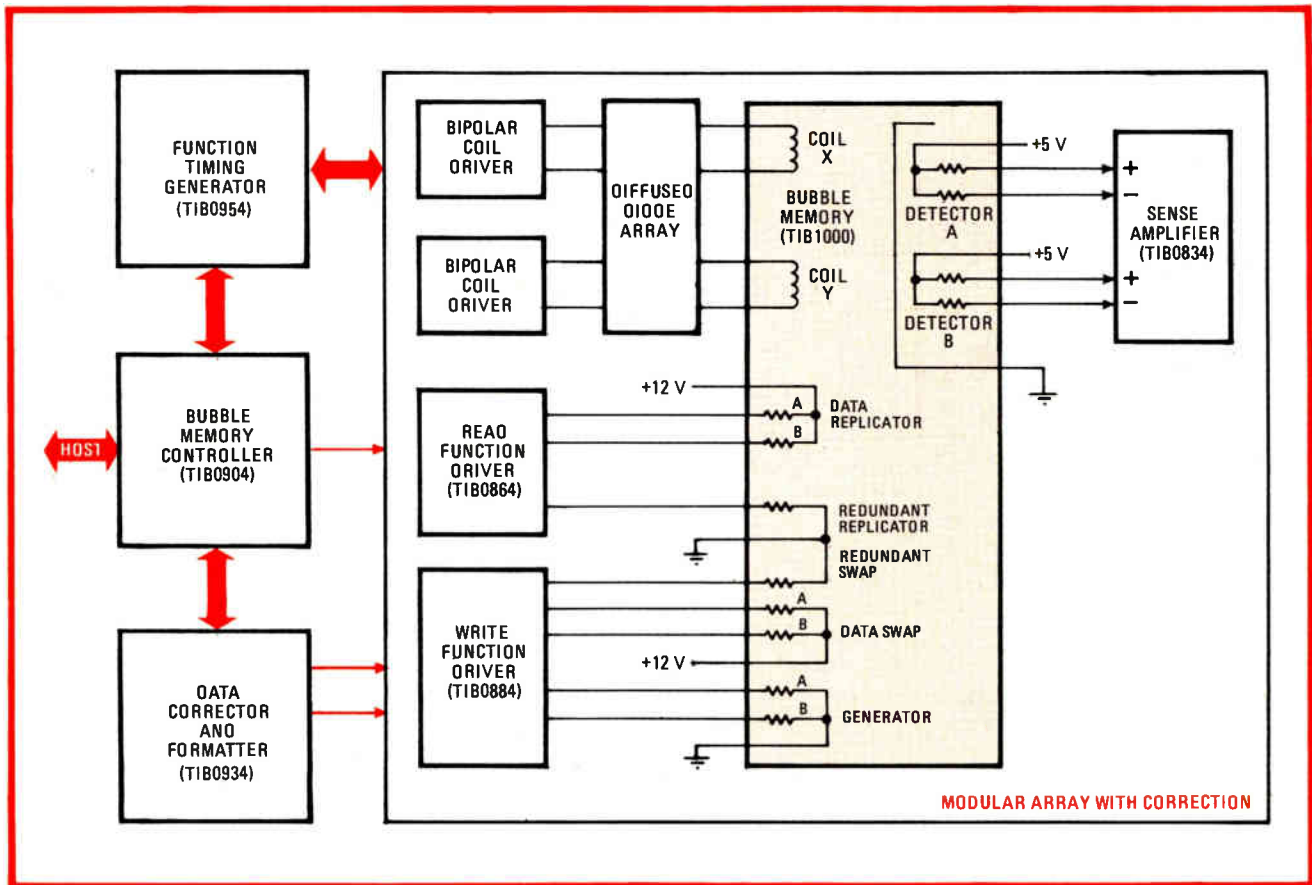

3. With correction. A second family of support circuits provides error detection and correction designed expressly for bubble memory systems. An advanced bubble memory controller, the TIB0904, and a data-corrector and -formatter chip make this possible.

performance—but cost-sensitive—application as well as the high-performance fixed-head-disk market with a single set of custom interface circuits.

The modular array consists of the TIB0864 advanced read-function driver, the TIB0884 write-function driver, and the TIB0834 dual-channel sense amplifier (Fig. 3). In addition, to interface the modular array with correction to the host processor, a more advanced controller, the TIB0904, and the data-corrector and -formatter circuit will also be introduced. This controller performs the same basic functions as the 0903, except it also contains several status registers for error monitoring and it has internal data accumulators to control up to four corrector and formatter circuits in parallel.

Correcting and formatting

The data-corrector and -formatter circuit (Fig. 4) combines two data buffers, each able to store up to 272 data bits, a RAM to store the map-loop information for one bank of 300 loops, error-correction circuitry for each data buffer, and a control and status section. Its four modes of operation let the user read or write 256 bits with transparent error correction, 272 bits with transparent parity detection, 274 bits for diagnostic purposes, or all 300 bits for off-line bubble-device testing.

The map-loop data is corrected for all four modes, and two identical copies of the map data are stored in the map loop along with an identification bit to tell them apart. This is necessary because the address-reference

pointer is also contained within the map data. If one of the two copies is ever found to be in error, the map loop may be rewritten automatically with a simple two-instruction sequence with no losses of the addresses in the map loop or data in the good minor loops.

The corrector and formatter circuit uses an error-correction code developed especially for magnetic bubbles. Table 2 ranks error probability in order of occurrence versus correction ability. A soft error is of a transient nature and is recoverable with another operation. A hard error, however, occurs within the minor loops and recurs on successive read operations; it may be removed only by rewriting the page containing the error.

The significance of the formatter's code for detecting and correcting burst errors is its ability to detect all randomly spaced double errors in a page of data and correct 50% of them. Moreover, the corrector and formatter automatically appends and strips off the error-correction bits, interrupting the host system only when an error goes uncorrected.

The corrector and formatter can transfer data to and from the host system at rates of up to 4 MHz per channel because the bubble device is handled through the other data buffer. However, operation of the corrector and formatter is fully static; data transfers can take place at any speed the processor prefers to run at.

Up to 16 modular arrays may share a common formatter, but only one array may be active at a time because the corrector and formatter contains only

TABLE 2: ERROR RATE ANALYSIS VERSUS ERROR CORRECTION ABILITY

Definition of error within a 256-bit page (in order of occurrence)	Probability of page in error	TI bubble code	
		Correction	Detection
Single soft error	3×10^{-4}	100 %	—
Single hard error	3×10^{-6}	100 %	—
Randomly spaced double soft error	3×10^{-8}	50 %	100 %
Soft error burst length 2	3×10^{-9}	100 %	—
Hard error burst length 2	3×10^{-11}	100 %	—
Soft error burst length 3 or 4	2×10^{-11}	—	100 %
Randomly spaced double hard error	3×10^{-12}	50 %	100 %
Soft error burst length 5	3×10^{-12}	—	100 %
Randomly spaced triple soft error	3×10^{-12}	—	87 %
Single soft and soft burst length 2	8×10^{-13}	—	100 %
Undetected and uncorrected system error escape rate per 256 bit/page	4×10^{-13}	—	—

enough storage for one map of 300 loops. This can be updated each time a new modular memory unit is selected, but a faster method is to store all map loops in the host system. After the map loops have been read sequentially and their contents transferred to the host system via the data channel, the map data may then be loaded from the processor to the corrector and formatter at rates of up to 4 MHz.

The TIB0954 timing generator, like the 0953, receives control signals from the controller and in turn provides timing signals to the function drivers, coil drivers, and sense amplifier. However, the 0954 has improved resolution to operate at bubble field rates exceeding 200 kHz. As the input clock frequency may be as high as 25 MHz for these extended field rates, the 0954 is built not with MOS but with low-power Schottky technology.

The coil drivers, in conjunction with a monolithic diode array, generate triangular current waveforms to drive the field coils. The TIB0804 coil driver uses all three power supplies in the system: +12, -12, and +5 volts. The bipolar drivers are the most cost-effective solution for driving a single bubble device. However, for systems with four or more memories in parallel, discrete V-groove MOS power transistors controlled by a predriver will cost less and use less power.

The TIB0834 dual sense amplifier detects signals from both sections of the 1-Mb bubble memory. The circuit uses negative and positive peak detection, which renders it phase-tolerant to variations in signal timing. As Fig. 5 indicates, a delayed output signal would otherwise result in a drastic reduction in the signal amplitude when using a conventional sensing technique. The dual sense amplifier will use window-searching methods to always maximize the signal amplitude (V_{th}). The circuit may also be temperature-compensated to provide a constant voltage amplitude to the threshold circuit for a wider temperature range.

During system operation, six registers within the TIB0904 controller provide communication with the host

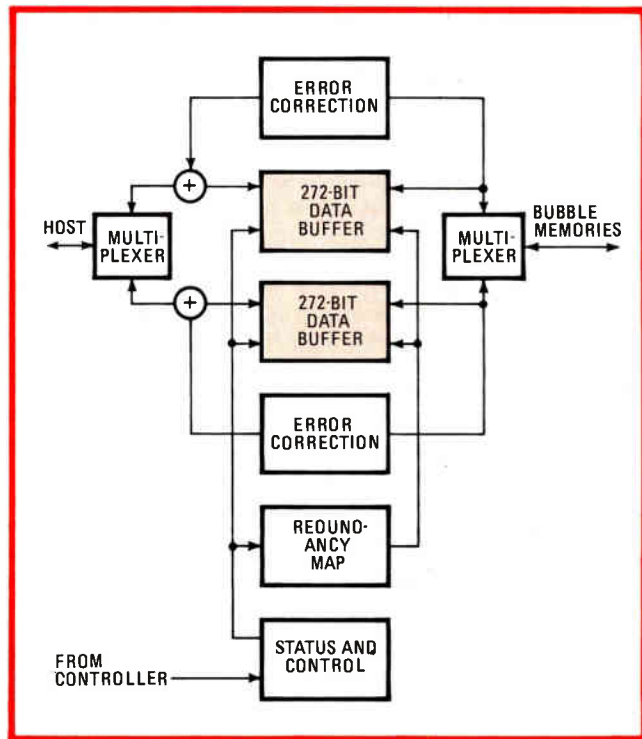

4. Correction. This data corrector operates by buffering data transfers between the host and the bubble devices twice. Its error code can detect all randomly spaced double errors in a page of data and correct 50% of them without interrupting the host.

system. They are the command, status, parameter, results, read-data, and write-data registers, and they are accessed by means of chip-select, address, read, and write signals.

The processor uses commands to initiate data transfers and to determine the status of the bubble memory subsystem. A wide variety of commands is available: read, write, restore (initialize), read redundancy RAM, write redundancy RAM, reset interrupt, read page-

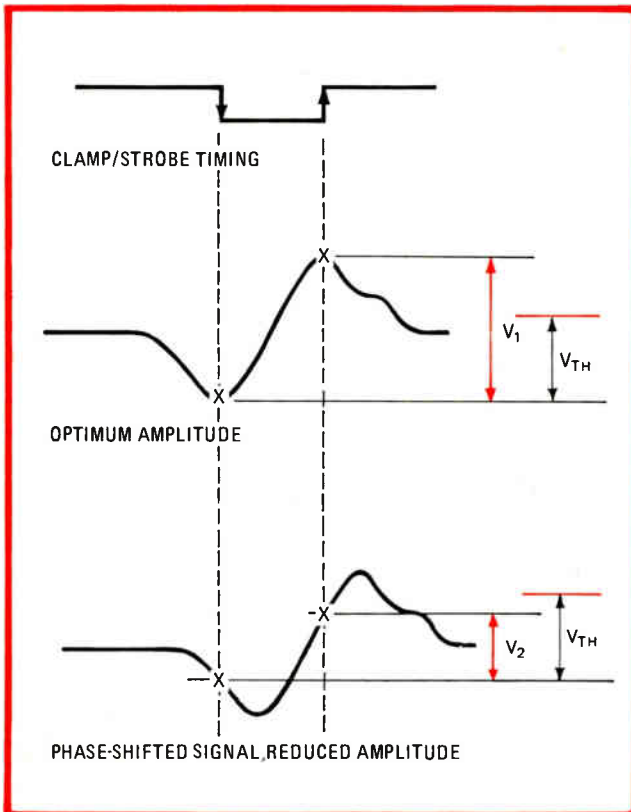

5. Phase-tolerant. The sense amplifiers in the bubble memory support family can make up for phase errors in the data. A phase-shifted signal will have a low amplitude, so the sense amplifier will look for the optimum value using window-searching techniques.

position counter, write page-position counter, read error status, read data errors (single, double or multiple), set DMA mode, write redundancy loop A or B, and read and write seek. The TIB0904 controller is compatible with the TMS9900, 8080, Z80, 6800, and 6502 series of microprocessors.

Reading and writing data may be performed via polled I/O ports, with interrupts, or by direct memory access. In the first mode, the processor polls the status registers in the controller, and when data is ready to be transferred, a read or write command is issued. The controller automatically halts to prevent any overflow of data in the corrector and formatter circuit. This operation further decouples the bubble system from the host.

Interrupt mode

In the interrupt mode, the controller activates the interrupt line when the data buffer is empty (during a write operation) so that more data can be transferred to the host system. After all operations are completed, the interrupt line is again activated. The processor may then issue the next command.

Direct memory access is generally required if eight or more bubble memory devices are operated in parallel because the data rate will be greater than 800 kilobytes per second. An external DMA controller can provide the timing and sequential addressing for the DMA transfers. The DMA burst length and the interval between the bursts are programmable to provide maximum system

flexibility. Communication with the DMA controller is performed via the usual DMA-request and DMA-grant signals, while actual byte transfers are clocked by the read or write signals.

The modular array has been partitioned to give the user total freedom in configuring one TIB1000 or a large array of the devices. The system may be expanded along any combination of the X, Y, or Z axes. Expansion along the X axis allows corrector and formatter circuits to be time-shared between up to 16 modular arrays, and more can be accommodated with TTL buffer gates. Chip-select lines common to all interface circuits within the modular array are controlled by I/O lines from the microprocessor.

System expansion

When expanding only in the X dimension, the data is normally routed from the corrector and formatter to the controller where it is then sent to an 8-bit accumulator and on to an 8-bit data bus. Since pages of data have already been buffered in the corrector and formatter, the data can be transferred at a 1-MHz burst rate to the controller to fill its accumulator rapidly.

For more data throughput, expansion in the Y dimension can be accomplished by repeating the number of corrector and formatter circuits. The number of available channels cannot be exceeded, however; the number of available channels is equal to twice the number of TIB1000 devices. The TIB0904 controller can control any number of channels up to a maximum of 32. For odd numbers of channels a TIB500 can be mixed with a TIB1000 system. For a 32-bit-wide system, the maximum burst data rate is 16 megabytes per second. Since data pages may be doubly buffered in the corrector and formatter circuit, 512 bits of error-corrected data can be transferred to or from the host system at a time.

The TIB0904 controller can receive data from one, two, or four corrector and formatter circuits in parallel and reformat it into 8-bit parallel data to interface with the microprocessor. In larger configurations, the I/O lines of the coil driver circuit may bypass the controller altogether and connect directly to the host data bus.

If expansion in the Y dimension still does not satisfy system requirements, expansion in the Z dimension is possible by multiplying the entire basic system to the point where the number of buffers in the corrector and formatter will allow continuous operation to and from the host. A chip-select input to the corrector and formatter decouples each memory subsystem from the host system bus but allows reading and writing of the bubble memory to continue. This data can be processed while the host system goes on to the next memory plane to read or write data into its corrector and formatter buffers.

Sixteen or more memory planes may be multiplexed via chip-enable lines to share a common address and data bus with the host system. The total system capacity equals 256 Mb per memory plane times 16 banks for 512 megabytes. Each corrector and formatter has a 512-bit buffer capacity (with error correction) that, with a 3-bit-wide data bus, provides the capability to read or write continuously at a rate of up to 16 megabytes per second. As discussed previously, the average access time is still 5.6 ms at a field frequency of 200 kHz. □

NOW, HALF-WAVELENGTH RECORDING FOR GREATER PACKING DENSITY.

Half-wavelength recording to 120 ips—it's a new option for the Model Ninety-Six that lets you pack your digital data well above 33 kbp. And you achieve these densities with no significant increase in error rate. Frequency response is 4 MHz at 120 ips. The payoff is impressive savings in system utilization, tape logistics and tape consumption.

If your applications are primarily analog, you'll also appreciate the new extended bandwidth capability of the Model Ninety-Six, 4 MHz at 240 ips. This frequency response lets you produce Wideband Group II compatible recordings.

Quite frankly, few users of the Model Ninety-Six really need the full 4 MHz bandwidth

at 120 or 240 ips. They buy the system because it gives them good solid data at *any* record or reproduce speed, standard or half-wavelength. Because every system comes with high-performance solid-ferrite heads; a capstan servosystem that holds flutter and TBE to extremely low levels; and an adjustment-free tape path for gentle, consistent tape handling and minimum skew.

For complete information on the Model Ninety-Six, just call Ed Haines at (303) 771-4700. Or write for a free illustrated brochure that describes all our magnetic tape systems and other instrumentation products. Honeywell Test Instruments Division, Box 5227, Denver, CO 80217.

WE'LL SHOW YOU A BETTER WAY.

Honeywell

Low-cost fiber-optic link handles 20-megabit/s data rates

by A. Podell and J. Sanfilippo
Loral Electronic Systems, Yonkers, N. Y.

Providing an inexpensive link for the transmission and detection of digital signals over short distances, this fiber-optic system handles data rates in excess of 20 megabits per second. The system, which can be built for about \$90, including cable, processes all types of data—a continuous-wave clock waveform, a burst of N clock cycles, handshaking signals, or a non-return-to-zero (NRZ) stream.

A TTL driver and a light-emitting diode serve well as the transmitter, shown in (a). The 5438 TTL driver is a two-input, open-collector NAND gate selected for its low power dissipation and 48-milliampere current-sinking capability. The LED is a gallium-arsenide device operating at 910 nanometers and provides 2 milliwatts of optical power at a forward current of 100 milliamperes.

The 130-ohm resistor sets the current through the LED at about 30 mA, and so the output power is about 0.6 mW in this circuit.

The receiver (b) is also simple and sensitive. The output from the p-i-n photodiode (labeled the PIN 3D device) is several microamperes. This current is converted into a voltage by a two-transistor transimpedance amplifier. The 2N2484 transistors selected give low input capacitance, an adequate gain-bandwidth product, and the ability to detect small currents. Amplifier output is about 25 millivolts.

The MC1590 video amplifier that follows greatly boosts signal levels over a wide band (c). Two 1N914 diodes drop the output offset voltage of the single-ended amplifier, nominally at 4 volts, to within the input range of the LM160 comparator. The comparator's threshold is set by a simple voltage divider. The capacitors, across pin 2 and ground, combined with the 100-kilohm resistor, form a low-pass filter providing a threshold that varies with the comparator's supply voltage.

As for the electro-optical interface, the LED, which is contained in a TO-46 package, is easily mounted in an inexpensive window bushing made by AMP, model 530563-1. The PIN 3D photodiode can be mounted in

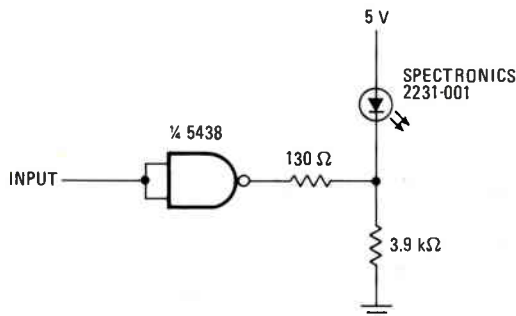

(a)

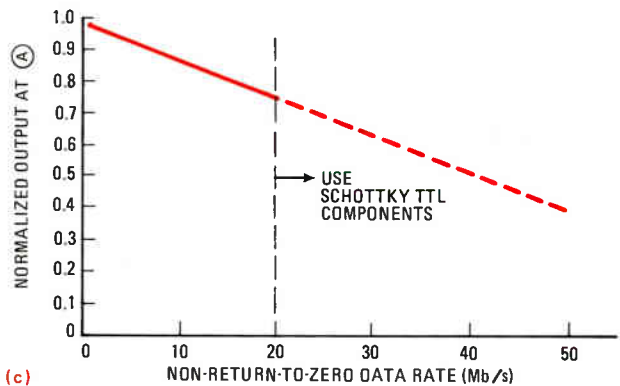

(c)

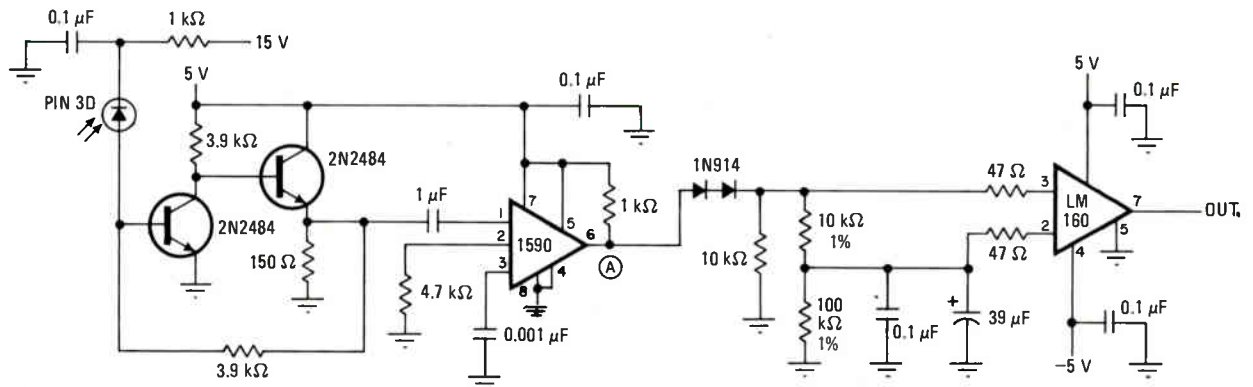

(b)

Light bits. Simple data transmitter (a) and a receiver (b) form the nucleus of a fiber-optic transmission system that is capable of handling all types of digital waveforms. Link operates over a wide band of frequencies (c). Cost of the 10-meter-long unit, including cable, is under \$90.

the same type of connector if desired. The need for delicate mounting adjustments is avoided here by using a fiber bundle of sufficient diameter, in this case 45 mils. Galite 2000 cable is satisfactory, and Valtec, Rank Industries, and others produce similar bundles.

The Galite cable has 210 fiber elements having an attenuation of 450 decibels per kilometer at 910 nm and a bandwidth-distance product of 15 megahertz/km. For a 10-meter-long link, therefore, the cable loss will be 4.5 dB and the bandwidth will be 1 gigahertz. With the measured loss of 1.5 dB in the LED-to-cable interface and a cable/detector interface loss of 3.9 dB, the total loss amounts to 10 dB. Thus, the 0.6-mW output of the LED is reduced to 0.06 mW at the receiver.

Transmitter layout is not critical in a one-way link. Duplex operation will require electrical isolation between transmitter and receiver components. There are several precautions to take in constructing the receiver. Notably, the lead from the anode of the detector diode to the transimpedance amp must be kept as short as possible. The output of the receiver should be isolated from all previous stages to prevent unwanted pickup. A ground plane is not a necessity, but is recommended for processing data rates greater than 10 megabits/s.

The link's signal-to-noise ratio is slightly less than 40 dB, implying a bit-error rate above 10^{-8} . The system is operational over a temperature range of -40°C to 100°C , and a supply variation of 4.5 v to 5.5 v. □

Line-frequency converter transforms 50 Hz into 60 Hz

by Juan E. Piquinela
Montevideo, Uruguay

Low-power equipment driven from the 60-hertz power line can usually be expected also to work properly at 50 Hz—that is, except for electric clocks and other time-keeping devices, to which many a traveler outside North America will attest. For such devices, a circuit that provides a multiplication ratio of 6:5 for generating a 60-Hz output from a 50-Hz input is required. Such a low-cost, low-power circuit is shown here.

The 555 timer, operating as an astable multivibrator at 300 Hz, provides the 4017 counter, A_1 , with six

count-pulses for every reset pulse from the 50-Hz line. The timer's period of oscillation—about 3 milliseconds—is not critical as long as six of its cycles are completed in less than 20 ms, the period of the 50-Hz line frequency.

On the sixth pulse, Q_6 of A_1 moves high and disables the timer through transistor Q_1 by shorting capacitor C . Thus, independent of the period set for the 555, its average frequency is $50 \times 6 = 300$ Hz. At the positive zero-crossing of the line voltage that occurs shortly after the sixth pulse, A_1 is reset through R_1 — R_2 , C_2 , and D_1 — D_2 , and the process repeats.

Counter A_2 provides a divide-by-five function at 300 Hz, thereby generating an output frequency of 60 Hz. C-MOS drivers or transistors can provide increased current capability as required. □

Designer's casebook is a regular feature in *Electronics*. We invite readers to submit original and unpublished circuit ideas and solutions to design problems. Explain briefly but thoroughly the circuit's operating principle and purpose. We'll pay \$50 for each item published.

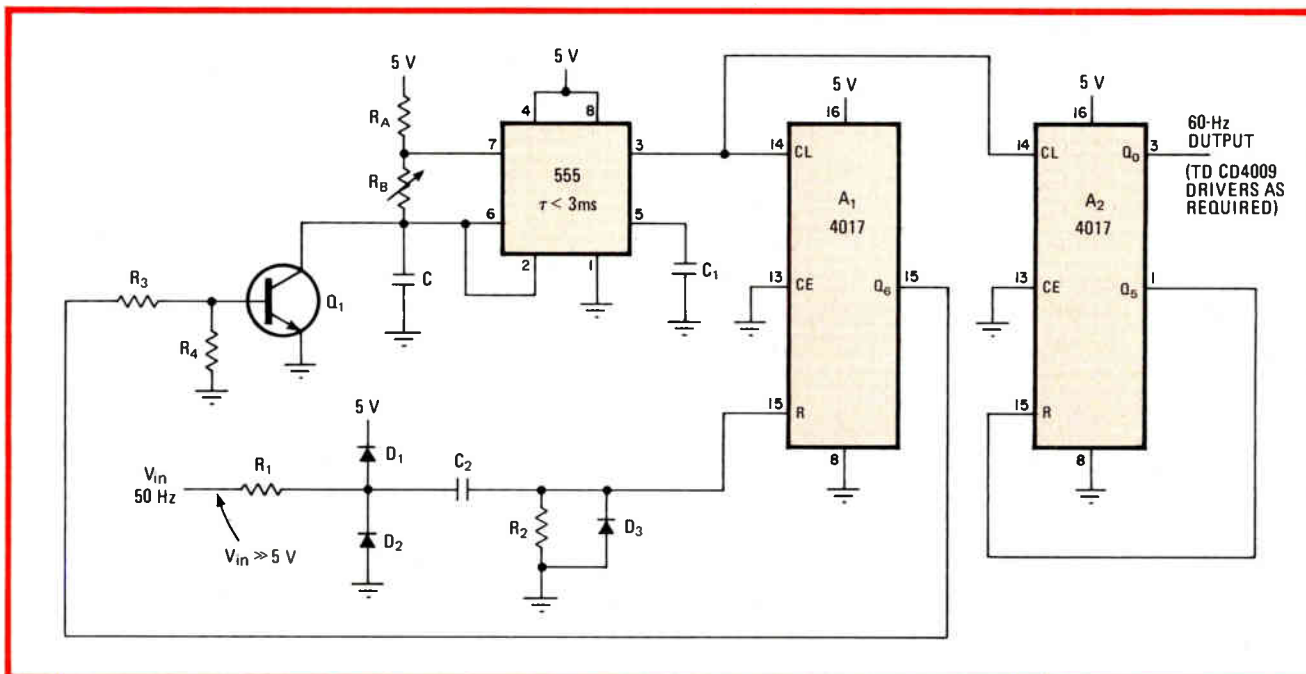

On time. Three-chip multiplier converts 50-Hz power-line frequency into 60 Hz for devices used in the U. S. A_1 generates six pulses for every 50-Hz cycle, forcing 555 timer to generate average frequency of 300 Hz. A_2 provides divide-by-five function on 555 waveform.

Electronic security lock has nonvolatile latch memory

by Ray Oakley
Plessey Semiconductors, Irvine, Calif.

Nonvolatile quad latches serve as the memory bank in this electronic security lock, which can be programmed with any one of more than 65,000 possible four-digit combinations. The number of combinations that can be selected for opening the lock can be greatly increased, simply by cascading the latches and their corresponding control circuitry.

The desired four-digit combination is stored in the Plessey MN9102 latches by first entering the number via the keyboard, which provides a hexadecimal output. If the code were 3579, digit 3 would first be introduced to the D input of flip-flop A. At the same time, the signal KEY, which indicates contact closure, is generated. KEY produces clock signal SRCLK, generated by a monostable multivibrator, which prevents keyboard bounce and which clocks 3 into A.

Because the outputs of each flip-flop, n , are connected to the D inputs of the next flip-flop in the line, $n + 1$, the successive introduction of the remaining digits translates the digit 3 from A to flip-flop D, with the end result that 5 will be in flip-flop C, 7 in B, and 9 in A at the conclusion of the sequence. The outputs of A to D are also connected to latches A' to D', respectively, and so by activating switch S_1 momentarily in order to generate the $\overline{\text{SAVE}}$ signal, the digits can be stored in their corresponding latches.

Data can be retained in the latches for at least one year in the absence of applied power (+5, -12 volts). Typically, 10 million save operations can be made before device performance is affected.

In actual operation, the first digit keyed in is compared with the 9 stored in A', at comparator A''. Assuming the first digit keyed is a 3, there will be no output from the A = B port of the comparator. Neither will there be any output from B'' or C'' as the digits 5 and 7 are entered.

As the final digit, 9, is entered, however, digit 3 is placed in D, 5 moves to C, and 7 is stored in B. All comparators therefore indicate A = B, and a door enable signal is generated, thereby activating K_1 after a user-selected delay provided by the 14528 one-shot. □

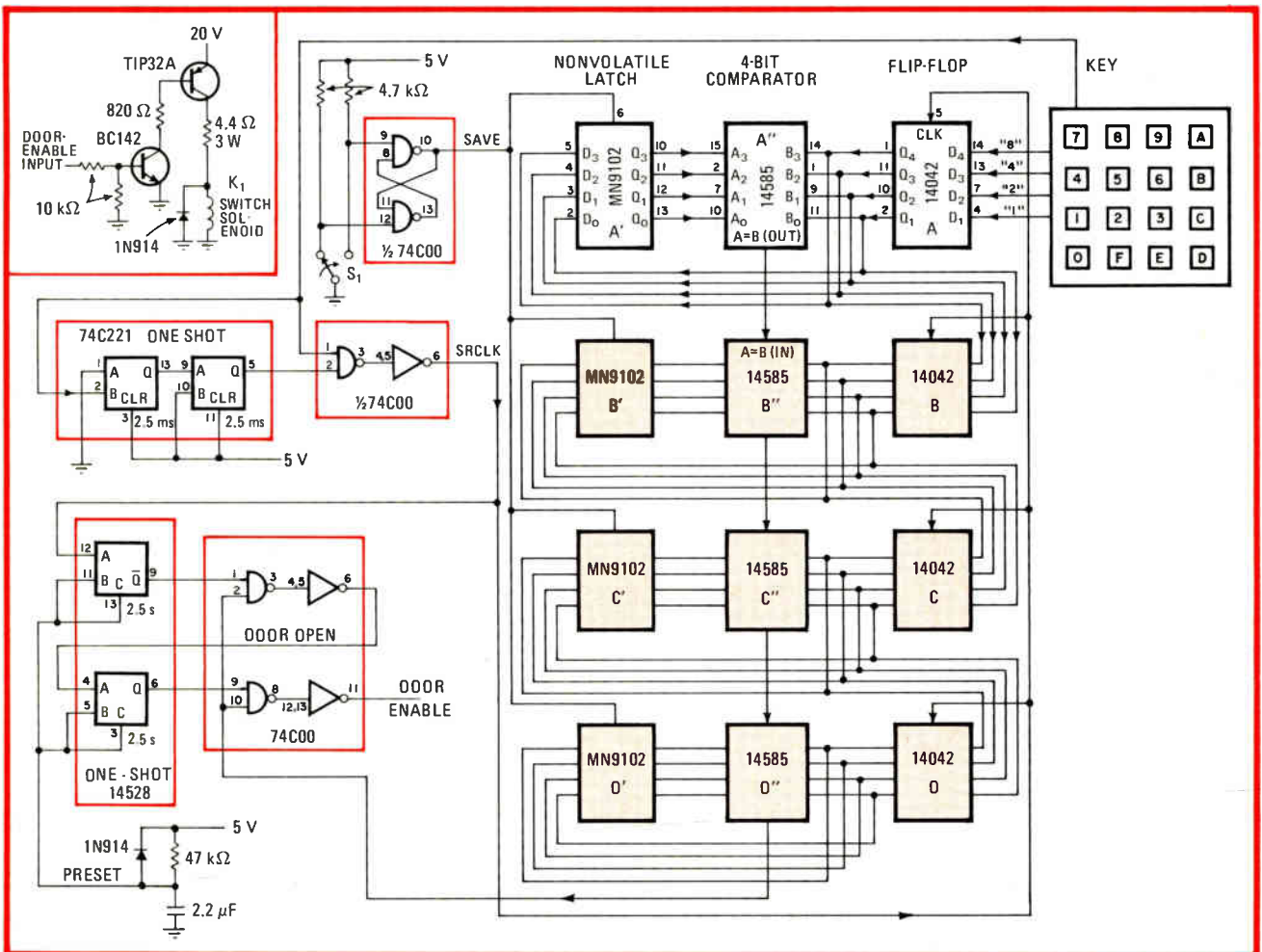

Hardened. Four-digit combination is kept in security lock's latch memory. Data will be retained in low-cost latches for at least one year in the absence of applied power. Matching input code entered via keyboard energizes relay K_1 after user-specified delay.

FOR A CLEANER, BRIGHTER PICTURE, TRY A TUBE OF MITSUBISHI.



Mitsubishi cathode ray tubes will do wonders for your image.

Because each of our high-resolution color CRTs actually discriminates among 64 distinct colors.

Our radar CRTs give your data systems the kind of pin point clarity that assures pin point accuracy.

And our black and white CRTs differentiate between shades of grey.

We begin with our own phosphors, specially developed for their brightness. They give our screens their notably short, or long flicker-free persistence.

Our precision electron gun system insures that each beam is perfectly aligned with the shadow mask.

And, combined with our ultra-fine pitched shadow mask, the gun system produces a picture so sharp, it actually encourages reading fine print.

Another Mitsubishi innovation is our internal magnetic shield. It not only more efficiently eliminates exterior magnetic forces, but makes the unit much easier to service. Not to mention what the magnetic shield does for a purer image, in both monochrome and color.

Mitsubishi's complete CRT line includes high-resolution flying spot scanner CRTs. Fiber optic recording CRTs. High-precision display, radar and beam penetration CRTs.

For more information on a display that's worthy of your data system, call our Display Products Group at 800-421-1132 (in California call 213-537-7132) or write Melco Sales, Inc., at 3030 East Victoria Street, Compton, California 90221.

We'll gladly show you a CRT for sore eyes.

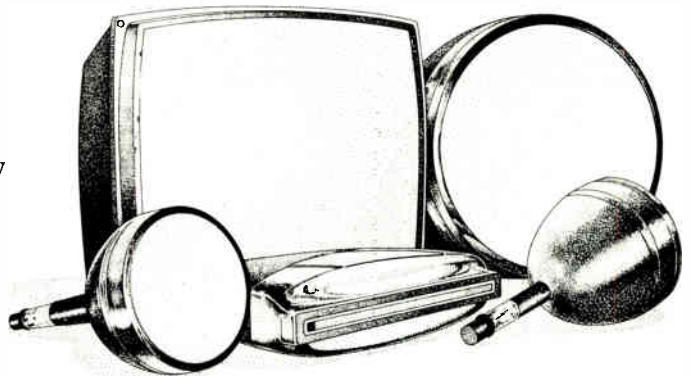

MITSUBISHI ELECTRIC COLOR CATHODE RAY TUBES

For other Mitsubishi Electric products such as general purpose motors, motor control devices, semiconductors, monitors, CRTs and other electronic apparatus, contact the above.

Moving 10,000 items



in 24 hours.



Problem

Digital Equipment Corp. has been growing tremendously. Last year the Accessories and Supplies Group found it was receiving orders in such volume that it needed a new system to handle them.

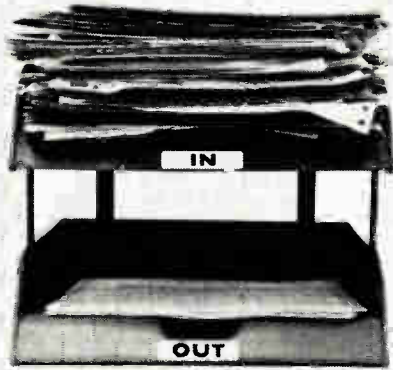

Sorting mail orders was slow and costly.

The group determined to speed up and simplify its order processing procedures. To save money and be more responsive to customers' needs were the goals.

Curious about the Bell System's focus on problem solving, Digital asked its Bell Account Executive for an opinion. He, in turn, summoned a team of Bell electronics industry specialists to survey the problem.

Solution

After a month of hard looking and talking, Digital reorganized its Accessories and Supplies Group. And Bell designed a communications system to fit the new structure.

A computer parts and supplies distribution center was established at the warehouse, with 800 Service and a staff trained by Bell in advanced techniques for selling by phone.

Customers can now call in orders direct, and in most cases get 24-hour shipment. A trained staff is also available to answer technical questions.

Results?

Digital is rapidly approaching 24-hour service on 10,000 off-the-shelf supplies and operational parts, keeping customers' systems on line. Order processing costs have been greatly reduced, and customers are receiving excellent service.



Trained staffers turn phone contacts into sales calls.

If you haven't talked with your Bell Account Executive lately, you're missing something.

The system is the solution.



Bell System

Interface processor has two minds to transfer data faster

Custom two-in-one processor shares bipolar logic to interface computer and asynchronous mass storage

by Alton B. Otis Jr., Xebec Systems Inc., Santa Clara, Calif.

□ As fast and as capable as microprocessors have become, applications continue to crop up that ask them to do too much too fast. Often the special demands of these applications can only be met by custom designs—such as the Xebec X2, a board-level control processor built from bipolar medium- and large-scale integrated circuits.

The X2 has most of the logical elements of two entire processors that execute two independent routines at the same time but share a single arithmetic and logic unit (ALU), a microinstruction sequencer, and common working storage. It has two accumulators and two program-address registers; while one processor uses the 8-bit ALU, the other is selecting its next instruction. The overlapped operation is fast. The X2 has a 125-nanosecond microinstruction cycle time—allowing it to execute 8 million instructions per second, 75% to 125% more than a comparable bipolar processor without the overlap.

This custom circuit arose from a decision by Xebec Systems Inc. in late 1977 to develop a new series of program-transparent mass-storage controllers for the computer peripherals market. The engineering depart-

ment reviewed the approaches taken in this area and went about developing a unified design philosophy that would be adaptable across a broad range of computers and peripherals.

Stated generally, the objective was to produce the optimum interface between two high-speed asynchronous devices. The specific product goal was to develop a set of single-card controllers that would marry disk and tape drives to computers.

The interface design for each peripheral and computer pair selected was to be sufficiently adaptable to allow the emulation of two or more existing controllers available from other sources. It was also hoped that the basic design would allow new controllers to be built with little or no hardware modification.

Modular design

If the portions of each design common to a given peripheral or computer type could be made to exhibit a high degree of similarity, the way would be open to a set of programmable building blocks that could be readily combined to create new controller products. Such blocks

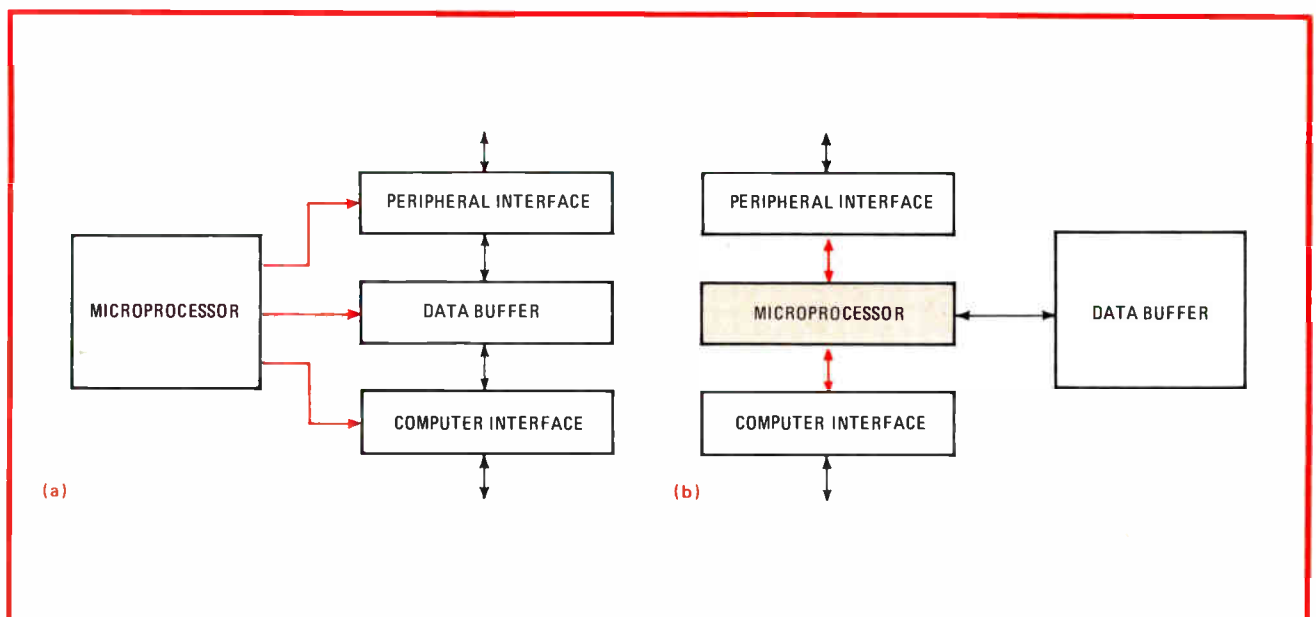

1. **Position-dependent.** The microprocessor in a peripheral controller could serve for overall control (a), in which case data-path switching is performed by discrete logic. Alternatively, it could be made central to all interface functions (b). The latter approach was chosen.

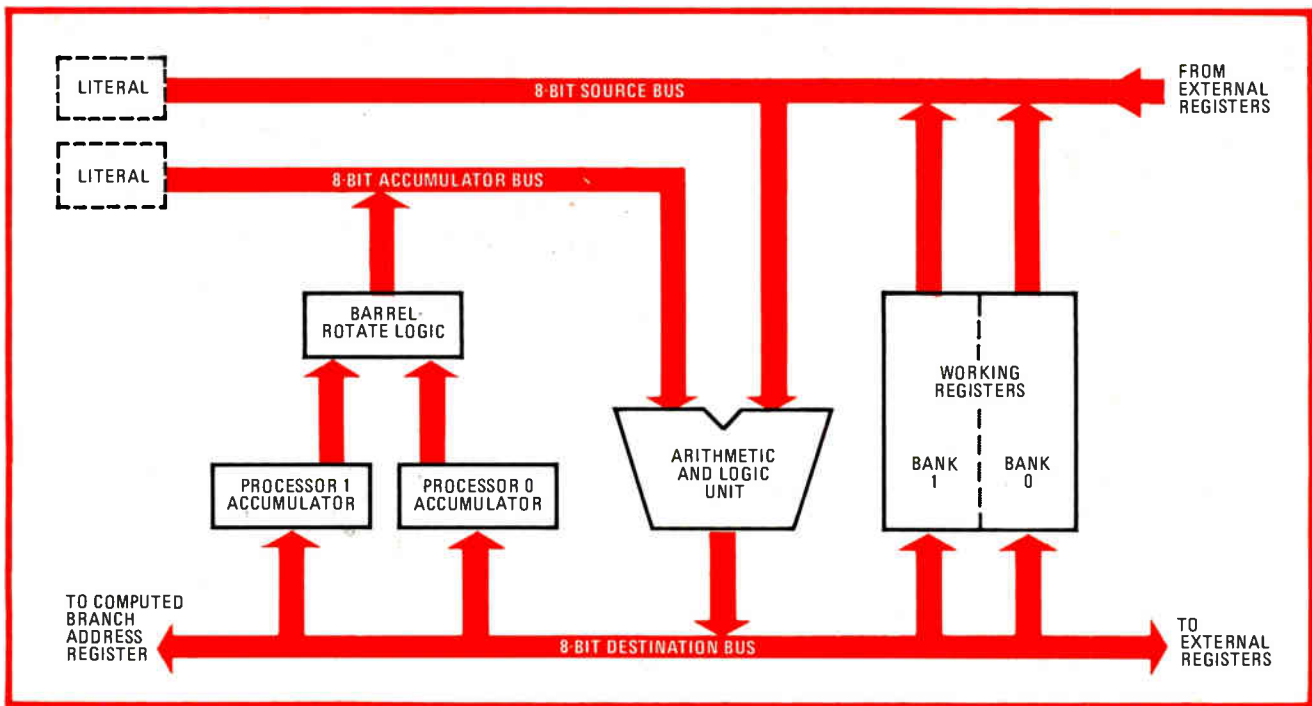

2. Shared ALU. The X2's two processors share one physical set of logic: while one uses the arithmetic and logic unit, the other uses the logic that selects next instruction. Shared working storage locations eliminate the need for an interprocessor communication channel.

or modules reduce engineering efforts for new product development and decrease training requirements for manufacturing and field-service personnel.

From the outset it was apparent that a microprocessor-based design would be required, but the microprocessor's precise role in the system was not immediately clear. It could, for instance, serve only for overall control, with data-path switching and other high-speed functions performed by discrete random logic (Fig. 1a). On the other hand, it could be made central to all interface functions (Fig. 1b).

Although the first approach promises an optimal design for each product, its building blocks are less general. In the second approach, however, each controller consists of three design modules: the peripheral interface, the computer interface, and the microprocessor. The interfaces communicate only with the microprocessor, so they can be independent of each other.

Having chosen the second route, the Xebec engineers looked around for a microprocessor fast enough to service the peripheral and computer interfaces simultaneously with data transfer rates as high as 300 kilobytes per second. Depending upon the instruction set, it was felt that an execution rate of 5 to 10 million instructions per second would be adequate. This rate was deemed necessary to allow each of the interface firmware service routines to execute 10 to 20 instructions per byte transferred and to allow control firmware to be switched between the service routines.

When it was discovered that the speed requirement could not be met by any single commercially available high-speed microprocessor, the idea surfaced to use two processors—one to service the peripheral and the other to service the computer. This appeared very promising with regard to speed but posed the problems of increased

cost and interprocessor communication. The two independent, asynchronous processors called for some form of communication channel between them having an associated firmware protocol to avoid access-contention problems. To take advantage of the increased speed from dual processors, the design needed an interprocessor communication protocol that was as simple as possible. The following seemed to be a simple solution to the communication problem:

- Divide the instruction cycle into two phases of equal length, with an ALU (arithmetic and logic unit) phase for data processing and another for the selection of the next instruction (the NIS phase).
- Synchronize and interleave the phases between the two processors so that while one is in its ALU phase the other is in the NIS phase.
- Allow both processors to share a common data bus; provide on this bus a working storage unit that can be read, modified, and rewritten in a single ALU phase.

The working storage of this scheme became the interprocessor communication channel, with either processor able to set and/or clear bits within an instruction cycle without contention with the other processor. Thus the hardware communication channel was eliminated.

Shared logic

This design made it possible to share the bulk of the ALU and NIS logic between the two processors due to the interleaved process by which the processors utilized the logic. That is, while one processor used the ALU logic, the other used the NIS logic, and vice versa. This technique, in fact, permitted the two processors to share one physical set of logic.

The interleaved dual processor approach appeared so promising that the search for a commercial microproces-

PROGRAM BRANCH CONDITIONS	
Code	Condition
0	Unconditional branch
1	Destination bus negative (high order bit = 1)
2	(unused)
3	ALU carry \neq 0
4	ALU carry = 0
5	Destination bus value \neq 0
6	Destination bus value = 0
7	No branch

processor was abandoned and the X2 custom dual microprocessor was designed from existing MSI and LSI circuits.

The X2 architecture (for which there is a patent pending) makes possible a system that executes 4 million instructions per processor per second. Its shared ALU, shown in Fig. 2, utilizes separate source and destination buses for data input and output, instead of a single three-state bus. The separate buses eliminate the time that a single bus needs to reverse its direction.

The processor-dependent accumulators in the figure are connected to the ALU via barrel-rotate logic. This logic provides a 0- to 7-bit rotation and improves throughput by allowing multiple-bit shifts within a single instruction cycle. The placement of the rotate logic between the accumulator and the ALU (rather than at the output of the ALU) increases the system speed. Also, each instruction word contains an 8-bit literal value that may be selected in lieu of either input to the ALU. This

permits the contents of the accumulators or the source-bus registers to be combined with a literal value prior to processing.

At the end of the ALU phase, the output of the ALU may be stored in the processor's accumulator, a selected working-storage location, a selected destination-bus register, or any combination of the three. This feature allows the firmware to maintain in working storage a current copy of the destination-bus registers, which cannot be read by the processor.

Decision making

In addition to the ALU function, each instruction word may specify a conditional or unconditional program branch. For conditional branches, the condition is tested at the end of the ALU phase (branch conditions are listed in the table). The branch address may be obtained either from the instruction word (a literal branch) or from the output of the ALU (a computed branch).

A total of 32 bytes of working storage is provided in two banks of 16 bytes apiece. The output of the storage is latched internally and the input is edge-triggered to allow for a complete read-modify-write cycle within a single ALU phase.

The instruction store consists of 512 56-bit words, divided equally between the two processors. This store can be extended via a bank-switching scheme.

Figure 3 shows the format of the X2's instruction word. The two high-order bytes select the source-bus input for the ALU. Direct 16-bit mapping is used (1 bit per device or register) rather than 4 bits and a decoder to

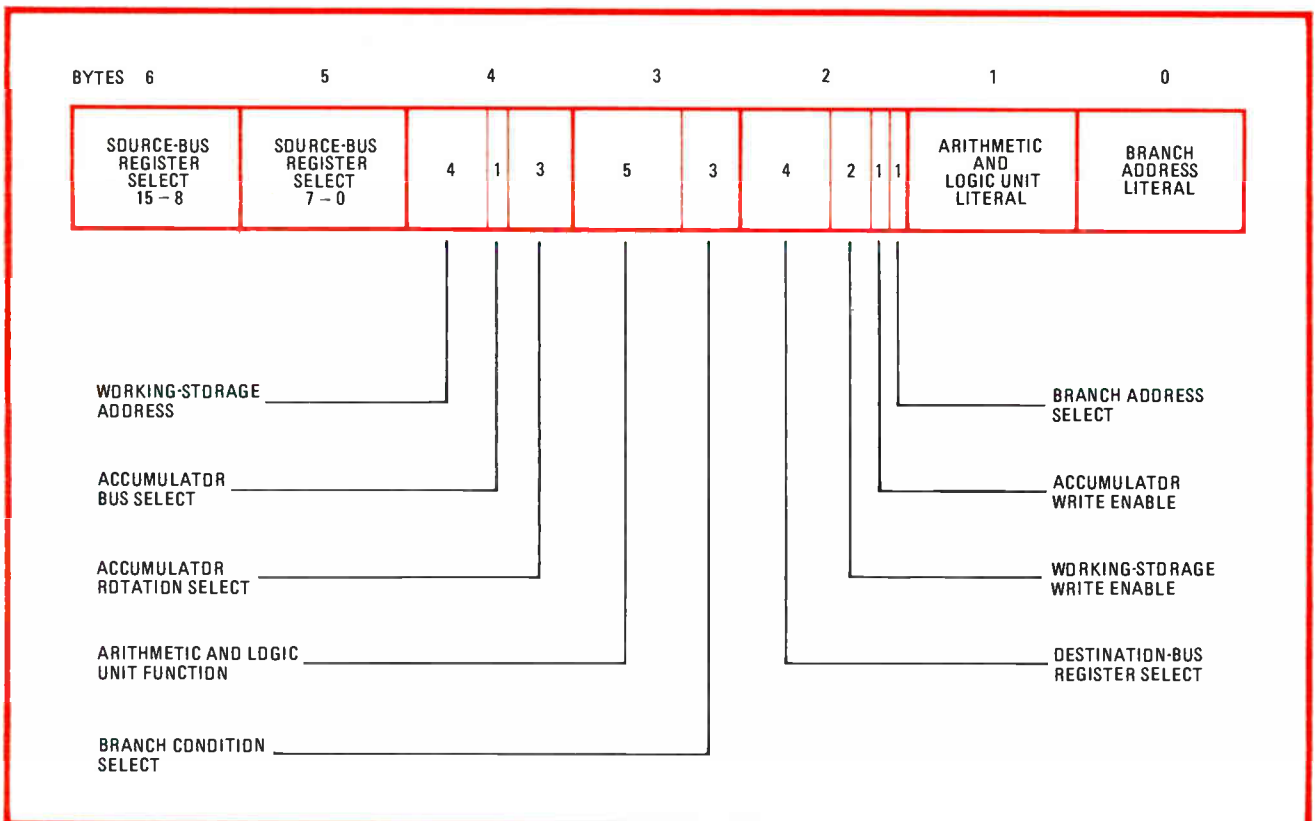

3. Instruction word. A word of the X2's microcode is similar to that of a typical bit-slice system. The word is 56 bits long, and it is partitioned into 7 bytes for register selection, ALU functions, branch conditions, addresses, and literal values for use in ALU operations or branching.

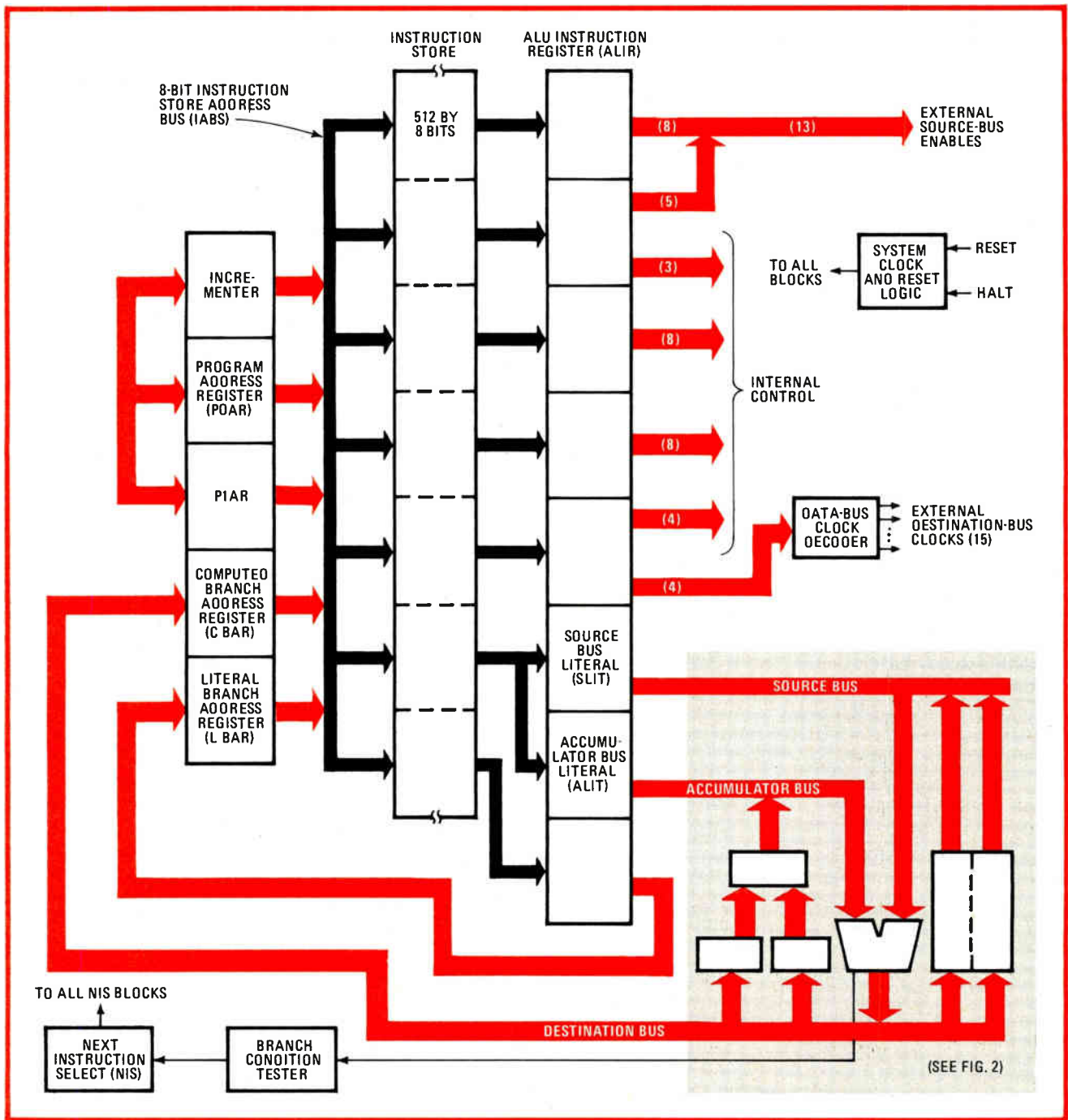

4. Custom. The entire X2 microprocessor requires 46 small- and medium-scale integrated circuits. When used as a peripheral controller, it resides between the peripheral and the computer. But it has many other possible applications in the control of fast asynchronous devices.

improve the system speed. Three of the bits are assigned to the working-storage banks and source-bus-literal devices within the X2, leaving 13 bits to be assigned to external devices.

The working-storage address is held in byte 4, along with 3 bits to specify the degree of accumulator rotation and 1 bit to signify whether the accumulator or the literal value will be the ALU's input.

Byte 3 specifies the ALU function and selects the branch condition; byte 2 specifies the destination of the ALU result (destination-bus register, working storage bank, accumulator, or combination thereof) and the

branch-address source (literal or ALU). Bytes 1 and 0 contain the ALU and branch-address literals, respectively. The destination-bus register is selected by a 4-bit address that is decoded into 15 clock lines, each assigned to an external destination-bus device.

Bus service

The X2 has four primary buses for data movement (Fig. 4). The source bus feeds the ALU with operands. It is a three-state bus and serves as the primary input for all registers and devices external to the X2. The destination bus is actively driven with ALU output data. It is the

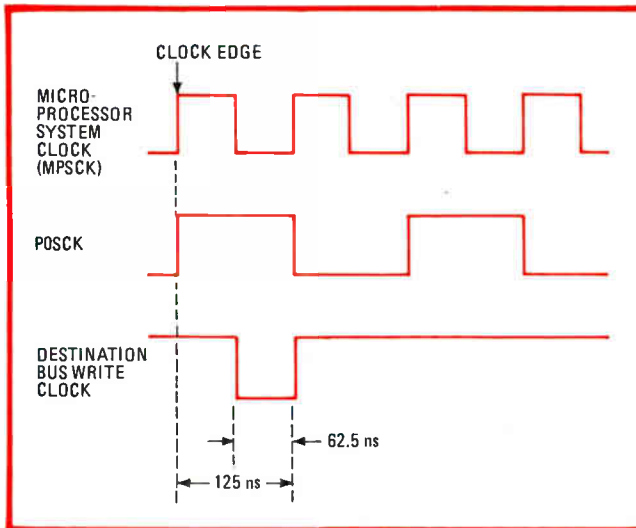

5. In step. The X2 system is controlled by an 8-megahertz single-phase system clock and a secondary half-frequency clock (POSCK). The latter determines which of the two processors is using the circuitry for next-instruction selection and which is using the ALU.

primary output path for all registers and devices external to the X2.

The accumulator bus is a three-state path that carries the operands into the ALU. The accumulator and source buses are combined by the ALU to create a single destination-bus output.

Finally, the three-state instruction-store address bus (IABS) is used to interface four registers with the instruction store. The high-order address bit fed into the instruction store (not shown) is derived from a clock signal that splits the store in half. Processor 0 accesses the first half, locations 0 to 255, while the other, processor 1, addresses 256 to 511.

The ALU instruction register, ALIR, holds the instruction word of the processor currently using the ALU. The ALIR includes source-bus and accumulator-bus literal registers (SLIT and ALIT).

The five registers at the left in Fig. 4 include an incrementer, a program-address register for each processor (PIAR and POAR), and two branch-address registers, LBAR and CBAR (literal and computed addresses).

During a processor's ALU phase, its program-address register contains the address of the instruction that follows the one currently executing in the program. The literal and computed branch-address registers hold branch addresses (whether they are used or not) during the NIS phase.

The system is controlled by a single-phase microprocessor system clock (MPSC) and a secondary, half-frequency clock called POSCK (see Fig. 5). POSCK determines which processor is utilizing which portion of the logic (ALU or NIS). From this signal is derived the high-order address bit used to partition the instruction store. The write clocks for the destination bus are generated in the last half of the MPSC cycle and have a positive-going edge that is synchronized with the edge of the MPSC. All system clocking occurs on the positive edge of the MPSC. The rest of the clock period is assigned to output settling and input setup time.

The events that occur at the clock edge are as follows. For the processor in its ALU phase, the ALU output is first stored at the selected destinations and in the CBAR of the NIS logic. Next, the branch-address-literal and branch-address-select bits are transferred from the ALIR to the LBAR and NIS control logic, respectively. Finally, the selected branch condition is tested and a bit is set in the NIS control logic if a branch is to occur.

This processor now enters the NIS phase with the clock edge. It uses the two branch-select bits to gate the contents of one of three registers onto the IABS. The selected register is the processor's program-address register (for no branch) or the CBAR or LBAR (for a computed or literal branch).

The instruction address, incremented by 1, settles at the inputs to the POAR (or PIAR) prior to the next clock edge. The instruction selected by the address also settles at the inputs to the ALIR prior to the next clock edge.

The output of the instruction store is transferred into the ALIR at the rising edge of the MPSC. The address of the instruction that follows the currently selected instruction in the program is stored in the processor's program-address register, and the processor enters the ALU phase.

The selected source- and accumulator-bus inputs are combined by the ALU and the result is settled on the destination bus prior to the next clock edge. The selected branch condition settles at the input to the NIS control logic. This occurs after the destination bus and ALU carry bit have settled but prior to the next clock edge.

Two external control lines are provided to reset and halt the processor. The reset line, when active, stops all clock signal generation and activates an internal reset signal used for register initialization. After the reset is deactivated, the internal reset signal remains active for the next two NIS phases and forces both processors to branch back to their respective starting locations.

The halt line is used in conjunction with a firmware debugging device and a manufacturing test fixture. It provides halt, step, and start functions for firmware and hardware debugging.

The real thing

A minimum implementation of the X2 requires 46 currently available parts (excluding a 16-megahertz oscillator module). Of these, two are 24-pin dual in-line packages while the rest have 20 pins or less.

When used as a peripheral controller, the X2 resides between the peripheral and the computer. The interfaces consist of registers that are read and written via the source and destination buses, respectively. If required, the interfaces could also incorporate logic to perform high-speed functions or provide additional storage beyond the requirements of a minimum implementation.

The X-2 can interface DEC's LSI-11 and PDP-11 minicomputers with cartridge and floppy disks. It is also available in a floppy-disk system compatible with the IEEE-488 bus. The use of the X2 architecture to optimize peripheral control is only one of many possible applications of this concept. The cost-effective control of two high-speed asynchronous devices is an oft-encouraged engineering objective. □

SYNERTEK SYSTEMS

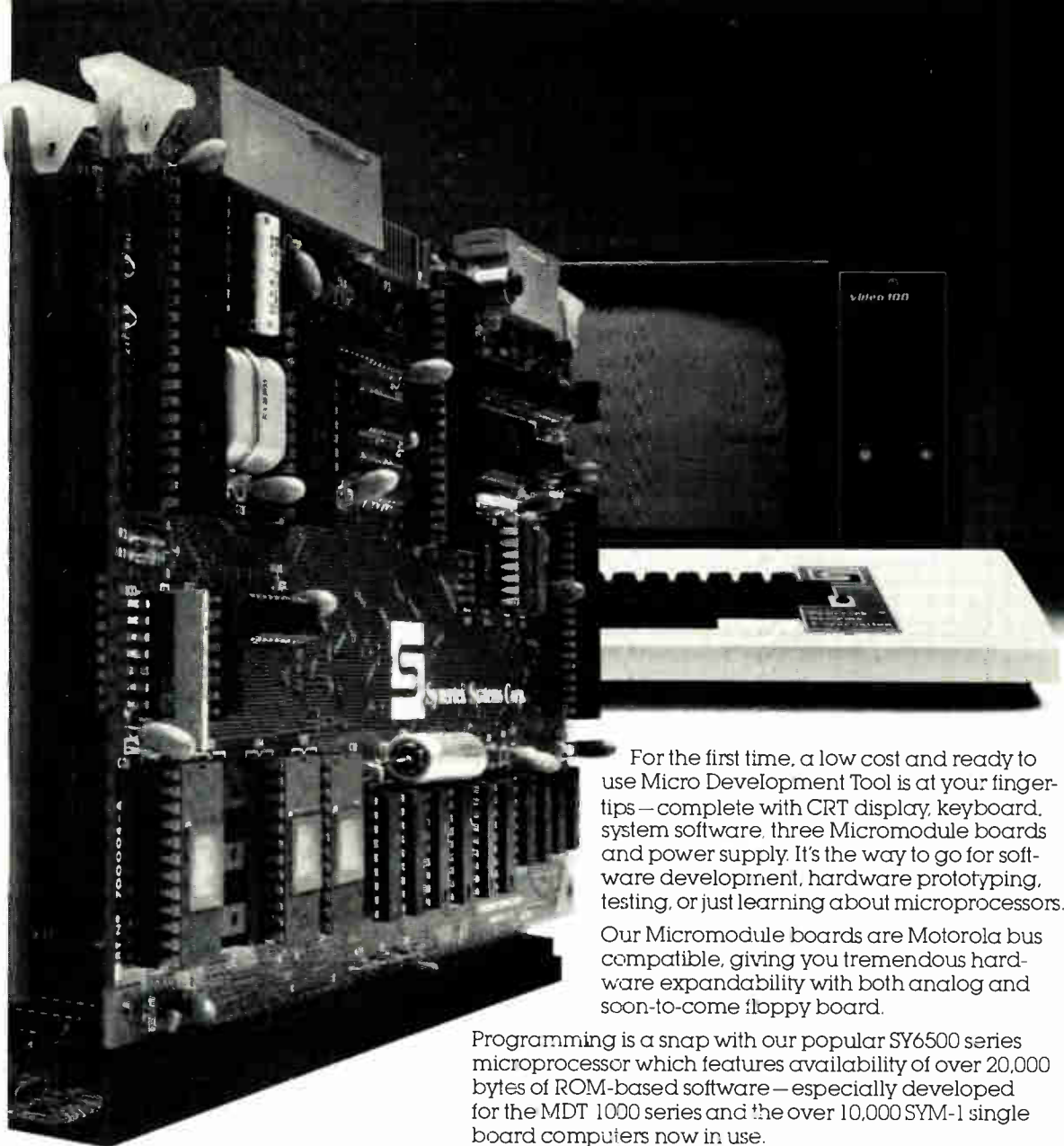

For the first time, a low cost and ready to use Micro Development Tool is at your fingertips — complete with CRT display, keyboard, system software, three Micromodule boards and power supply. It's the way to go for software development, hardware prototyping, testing, or just learning about microprocessors.

Our Micromodule boards are Motorola bus compatible, giving you tremendous hardware expandability with both analog and soon-to-come floppy board.

Programming is a snap with our popular SY6500 series microprocessor which features availability of over 20,000 bytes of ROM-based software — especially developed for the MDT 1000 series and the over 10,000 SYM-1 single board computers now in use.

Hardware and software — the MDT 1000 has it all!

**Introducing
a whole new world
of low-cost software
development:
the MDT 1000
series.**

- 12-inch CRT display for 25 lines of 80 characters each
- Typewriter-style keyboard (54 keys)
- Single +5V power supply
- 4K RAM board
- Backplane board
- CPU/video single board computer, the MBC020 Micromodule
- 4K ROM-based system monitor
- 8K ROM-based assembler/editor, RAE
- 8K ROM-based BASIC (optional), BAS-1

The MDT 1000 is available right now — in 4K, 8K and 16K RAM versions at prices you would expect to pay for a CRT display terminal alone — starting at \$1,495. We offer you a whole new source for systems and controller boards, including printer and cassette recorder peripherals. Let us introduce you to our wide variety of products. You'll like what we have to offer.

Synertek Systems

150 S. Wolfe Road
Sunnyvale, California 94086
(408) 988-5682 or 988-5689
TWX: 910-338-0135

Circle 149 on reader service card

Up-down counter measures cumulative frequency error

by A. M. Downing
Palomar Electronics Ltd., Victoria, Australia

Determining the cumulative error, in cycles, between the frequency of a test signal and that of a secondary standard, this simple circuit is particularly useful in monitoring the short-term stability of a power-line generator versus a quartz-crystal reference. The sign of the error (plus if greater than the reference frequency, minus if less) is also displayed.

Two counter chains are usually required to compare the corresponding frequencies, and often a third chain is needed to accumulate the error count. Here a single

up-down counter provides both functions, simplifying the circuit and cutting cost.

Signals f_1 and f_2 are initially synchronized by the 74C74 flip-flops at the input, which are clocked out of phase by a high-speed oscillator. The output of each signal-path flip-flop is therefore always separated by at least one half cycle of the oscillator frequency, depending on the actual frequencies of f_1 and f_2 .

The Q output of the flip-flop associated with f_1 drives the up port of the two-stage 74C192 up-down counter via a two-channel multiplexer. Similarly, the f_2 flip-flop drives the down input of the 74C192. Thus, if $f_1 = f_2$, the 74C192 alternately counts up from zero to some value in a given sampling period, then decrements back to zero. Therefore the display—which is latched at the beginning of the next sampling period so that a correct value is rendered without flicker—indicates a zero count.

If f_1 is greater than f_2 , the counter does not return to zero and the display will indicate a positive value. In the

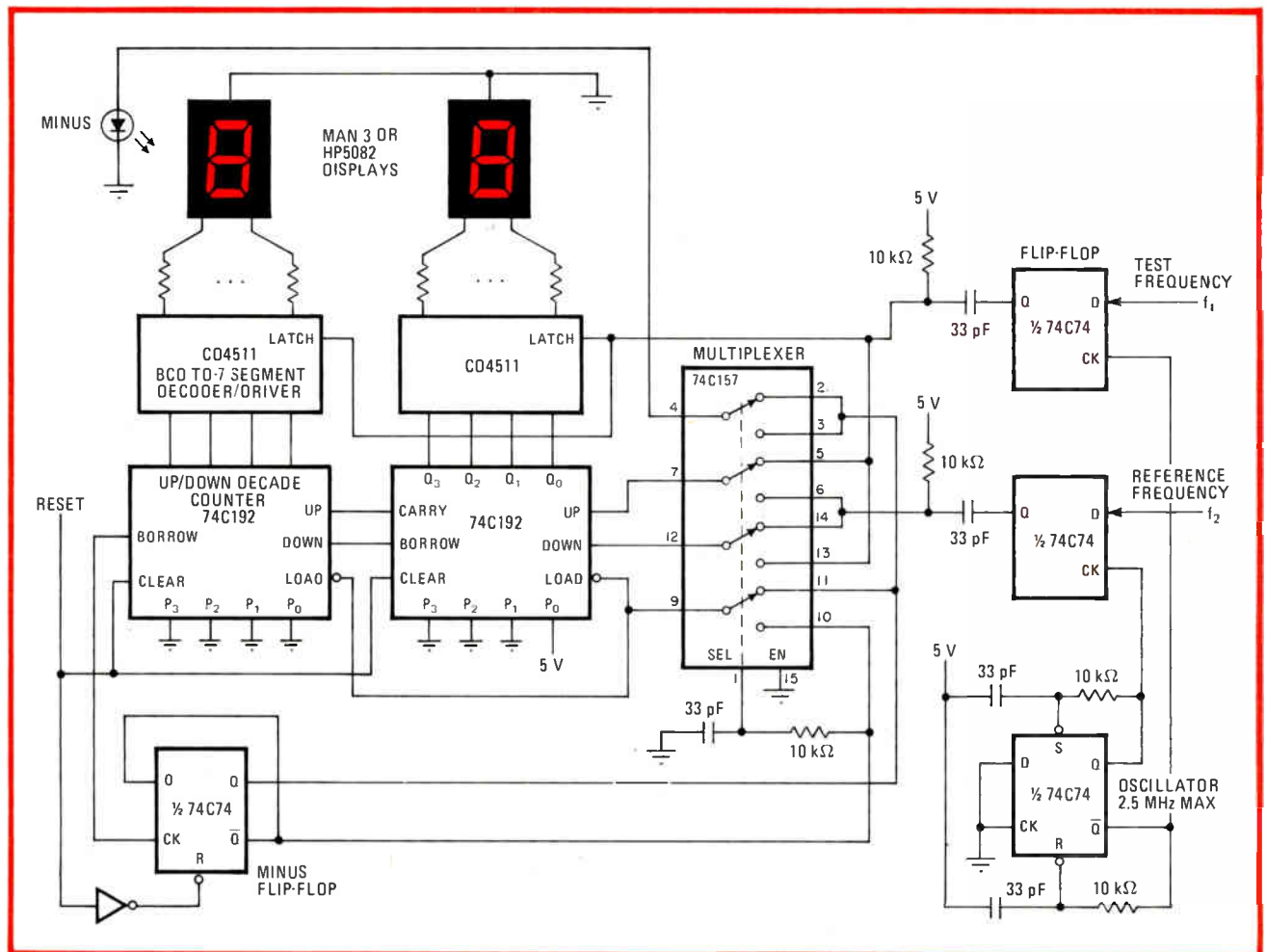

Accumulation. Single-chain counter finds the cumulative error, in cycles, between the test and reference frequencies. Signals f_1 and f_2 increment or decrement the counter, respectively, over a given sampling period; the result in the counter at that time represents the magnitude of the error. The light-emitting diode indicates the polarity of the differential count with respect to the reference.

opposite case, that is, for f_1 less than f_2 , the counter generates a borrow signal as it attempts to go below zero and thence to 99. In that event, the minus flip-flop is toggled so that the multiplexer is switched to its remaining channel. Thereafter, the f_1 flip-flop drives the counter's down port and the f_2 flip-flop drives the up input. Simultaneously, a counter-load pulse is generated, and the counter proceeds to count up from one, but with the

minus light-emitting diode activated.

Should the count go below zero in a subsequent cycle, a borrow pulse is again generated and the multiplexer switched back to its initial channel. The LED is thus turned off, indicating a positive count. □

Engineer's notebook is a regular feature in *Electronics*. We invite readers to submit original design shortcuts, calculation aids, measurement and test techniques, and other ideas for saving engineering time or cost. We'll pay \$50 for each item published.

Low-cost interface automates E-PROM loading

by Henry Jan Stec
Panama Canal Co., Panama

This on-board interface and the accompanying routine equip a microprocessor-based system with the ability to program erasable programmable read-only memories. A

specific circuit realization and program for the Motorola MEK6800D2 evaluation kit are presented here to illustrate the simplicity of this low-cost scheme, but in general any microprocessor system can be adapted for such a task.

The MEK6800D2 kit accepts two 2708 8-K E-PROMs that may be programmed with data stored in the microprocessor system's random-access memories. These 1-K-by-8-bit E-PROMs are most easily programmed in two operations that load half the memory at a time with upper and lower blocks of 512 bytes each. The loading is done with two quad latches, three transistors, and the

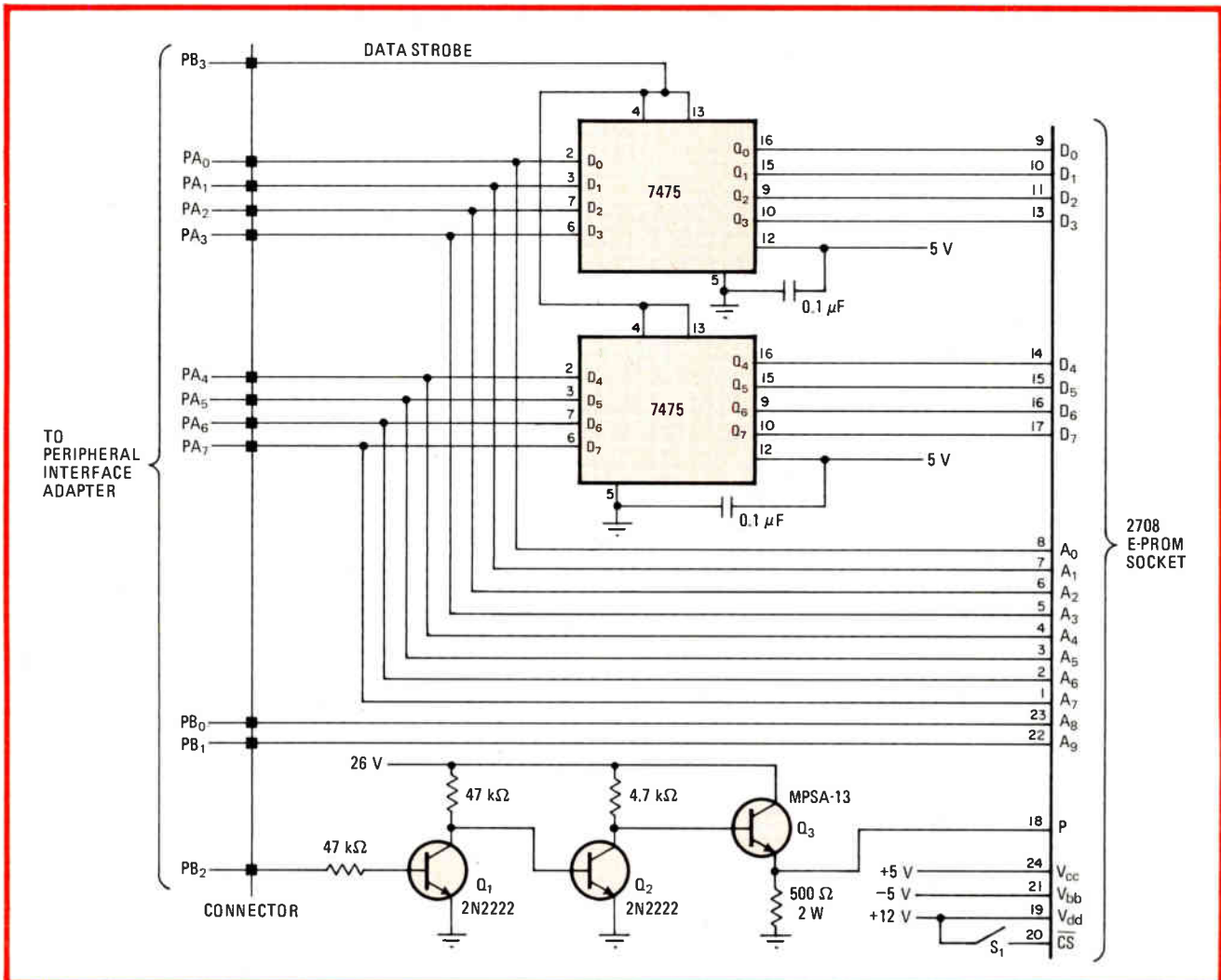

Loading blocks. Two-chip three-transistor interface and short software routine for MEK6800D2 evaluation kit simplify writing into an E-PROM. Under software control, the E-PROM is quickly programmed in 512-byte blocks with data transferred from random-access memory.

STRATHCLYDE

the right environment for electronics.

There is already a thriving electronics industry in Strathclyde. Many international companies have established large plants in the region as a base for their European operations. Firms like IBM, Honeywell, Digital, National Semiconductor and Motorola.

The attractions for these companies include good labour relations and high productivity records. The region has a clean atmosphere and chemically stable freshwater supplies ideally suited to the manufacture of silicon micro-processor chips. There is also an ample pool of high quality and adaptable labour throughout the region, and several institutions within the central belt of Scotland with international reputations for research and development work in micro-electronics engineering. There are two international airports linking Strathclyde with the rest of Europe and the U.S.A. The region has excellent rail and motorway connections to the U.K. network.

Financial incentives are good too. Strathclyde's special development area status entitles industry to maximum U.K. Government assistance, and there are many excellent factories and sites readily available.

The environment is right for the electronics industry.

We've prepared a special report on the electronics industry in Strathclyde. Get your copy now. Ring Glasgow (041) 221 4296.

STRATHCLYDE
Scotland's biggest region for opportunity and development.

Name.....

Position.....

Company.....

Address.....

..... Tel.....

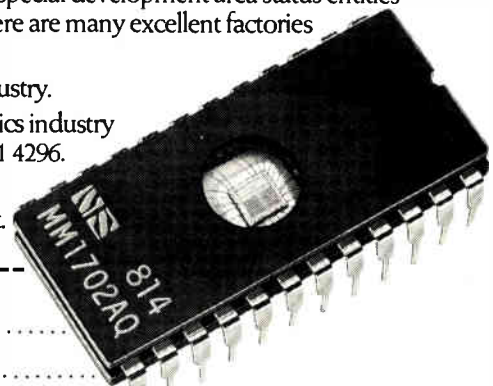

Industrial Development Department, 21 Bothwell St., Glasgow G2 6NJ. Tel.041 221 4296

The silicon chip illustrated (type MM 1702 AQ) is manufactured in the Strathclyde Region by National Semiconductor (UK) Ltd.

MEK6800D2 E-PROM PROGRAMMING ROUTINE

Location	Op code	Operand	Mnemonic	Comments
00	8E	A04F	LDS	
03	86	FF	LDAA	set up PIA's input/output lines
05	B7	8004	STAA DDRA	
08	B7	8006	STAA DDRB	
0B	86	04	LDAA	
0D	B7	8005	STAA CRA	
10	B7	8007	STAA CRB	
13	86	64	LDAA	number of loops = 100
15	B7	A041	STAA C1	
18	CE	03FF	LDX	
1B	8C	FFFF	CPX	end of current loop?
1E	27	4E	BEQ	to 6E
20	FF	A042	STX C2, C3	
23	FF	A044	STX C4, C5	
26	7A	A042	DEC C2	
29	7A	A042	DEC C2	
2C	2C	07	BGE	to 35 -- does highest E-PROM address point to lower E-PROM?
2E	FE	A044	LDX C2, C3	
31	A6	00	LDAA	
33	20	02	BRA	to 37
35	86	FF	LDAA	
37	B7	8004	STAA ORA	output accumulator to PIA
3A	86	08	LDAA	
3C	B7	8006	STAA ORB	strobe latches
3F	7F	8006	CLR ORB	
42	FE	A044	LDX C4, C5	
45	B6	A045	LDAA C5	
48	B7	8004	STAA	output address bits 0 through 7
4B	B6	A044	LDAA C4	
4E	B7	8006	STAA ORB	output address bits 8 and 9
51	01		NOP	delay for address setup
52	01		NOP	
53	01		NOP	
54	01		NOP	
55	01		NOP	
56	86	04	LDAA	raise program pulse 1 ms
58	BB	8006	ADDA ORB	
5B	B7	8006	STAA ORB	
5E	C6	65	LDAB	pulse length adjust
60	5A		DECB	
61	26	FD	BNE	to 60
63	86	FC	LDAA	lower program pulse
65	BB	8006	ADDA ORB	
68	B7	8006	STAA ORB	
6B	09		DEX	
6C	20	AD	BRA	to 1B
6E	7A	A041	DEC C1	
71	26	A5	BNE	to 18
73	3F		SWI	stop

program shown, which initially resides in system RAM.

The program is loaded into the microprocessor system by its own bootstraps when the power is turned on. Because the program is short, there is plenty of room for many other utility programs in even a small (8-K) utility E-PROM.

Under software control, data to be written into the desired half of the 2708 E-PROM is passed from each RAM location to the peripheral-interface adapter's PA_i lines. For each location, the PIA strobes the data into the 7475 quad latches and the D_i bus. The program then sends the desired byte address through the PIA to the E-PROM's A_i bus and applies a programming pulse (P) via transistors Q₁ through Q₃.

In this way, the lower half of the E-PROM is programmed. Logic 1s are then applied to the quad latches so as not to disturb any data previously stored in the upper half.

The actual mechanics of programming is simple. After the E-PROM is placed in its socket, the system is turned on and a system-reset pulse applied. The 26-volt supply required for E-PROM pulsing is then activated. Switch S₁ is closed and the program is executed, whereupon S₁ is opened and the 26-v supply turned off.

To program the upper half of the E-PROM, location 2C of the program must be modified so that it contains 2B and location 30, containing 42, is added to the listing. The time required to program an E-PROM is 2 minutes. □

Conductive adhesive meets copper foil

Copper foil with pressure-sensitive conductive adhesive coated on one side is a natural for use on flexible and rigid printed-circuit boards and cables. This material is now available, consisting of 2-mil copper foil with an adhesive called RPM 3142, an acrylic-based product with a 30-oz-in. peel strength.

The conductive component of the adhesive forms an electrical path from the copper to any conductive material it is stuck to. Its service temperature range is -40° to $+150^{\circ}$ F. For information write Richards, Parents & Murray Inc., 206 South 14th Ave., Mount Vernon, N. Y. 10550, or phone (914) 664-3464.

Handbook translates Basic Into Basic

The Basic computer language is basic to the operation of most computers—especially of the home and office type. But **Basic has never been standardized; there are more than 100 "dialects."** A guide called "The Basic Handbook: an Encyclopedia of the Basic Computer Language," written by David A. Lien, provides a good deal of help in coping with these assorted dialects.

This book covers 78 of the most popular versions of Basic in such a way that its readers can convert nearly any program to run on a computer that uses a different version of the language. The versions of Basic used with more than 50 computers from IBM, Cromemco, Apple, Exidy, Imsai, Heath, Ohio Scientific Instruments, Radio Shack, Commodore, Southwest Technical Products, Hewlett-Packard, and Wang, among others, are represented in the 360-page book. It is available for \$14.95 plus \$1.35 postage and handling from CompuSoft Publishing, a division of CompuSoft Inc., 8643 Navajo Rd., San Diego, Calif. 92119.

Music signals program completion for small computer

When running a long program on a home computer, it's handy to have an audible cue that signals the end of execution. The Radio Shack TRS-80 personal computer, for instance, is not normally equipped with an audio output, but can easily be set up with the equivalent.

This is accomplished by inserting a CSAVE command, which instructs the computer to save the program on tape; 100 CSAVE "X" will do the job. The tape recorder normally attached to the computer is left in the play mode with a music cassette loaded in it. The earphone jack must be unplugged, of course. When the computer encounters the CSAVE instruction, it will turn the tape recorder on. The sound of music serves notice that the program has finished running.

Cass R. Lewart of System Development Corp. in Eatontown, N. J., came up not only with this idea but also with a second one concerning tape loading. **Tape loading is one of the most critical operations for the TRS-80 user.** It often involves a lot of fiddling with the volume control on the tape machine.

Wiring a VU meter (such as a Calectro DI-930 without external shunt) across the earphone jack of the tape recorder and setting the output level with the volume control to -3 VU solves the problem for all but the poorest tapes. For bad tapes, Lewart says, you will need a scope to adjust the pulse height to approximately 0.7 v.

-Harvey J. Hindin

High-power triodes and tetrodes for scientific applications



- CW output power up to 1000 kW
 - Peak output power up to 5 MW
 - Operating frequencies up to 400 MHz
 - Incorporating the latest advances in power-grid tube technology: Pyrobloc[®] pyrolytic-graphite grids and Hypervapotron[®] anode cooling
 - Widely used in France as well as elsewhere in Europe, in the United States and in Japan
 - the right tube for your particular application
- Contact your national THOMSON-CSF Electron Tube Division representative for full details.



THOMSON-CSF

THOMSON-CSF ELECTRON TUBES

750 BLOOMFIELD AVENUE / CLIFTON NJ 07015 / TEL.: (1.201) 779 10 04 / TWX : 710 989.7149

BRAZIL - THOMSON-CSF COMPONENTES DO BRASIL LTDA.
C.P. : 4854 / BROOKLIN / SAO-PAULO / TEL. : (55.11) 61 64 83
FRANCE - THOMSON-CSF DIVISION TUBES ÉLECTRONIQUES
38, RUE VAUTHIER / 92100 BOULOGNE-BILLANCOURT / FRANCE
TEL. : (33.1) 604 81 75
GERMANY - THOMSON-CSF ELEKTRONENRÖHREN
LEERBACHSTR. 58 / 6000 FRANKFURT AM MAIN. 1
TEL. : (49.611) 71 72 81
ITALY - THOMSON-CSF TUBI ELETTRONICI SRL
VIALE DEGLI AMMIRAGLI 71 / I - 00136 ROMA / TEL.: (39.6) 638 14 58

JAPAN - THOMSON-CSF JAPAN K.K. / TBR BUILDING
KOJIMACHI 5-7 / CHIYODA-KU / TOKYO / 〒 102 / TEL. : (81.3) 264 63 41
SPAIN - THOMSON-CSF TUBOS ELECTRONICOS SA
CALLE ALMAGRO 3 / MADRID 4 / TEL. : (34.1) 419 88 42
SWEDEN - THOMSON-CSF KOMPONENTER & ELEKTRONRÖR AB
BOX 27080 / S 10251 STOCKHOLM 27 / TEL. : (41.8) 225815
UNITED KINGDOM - THOMSON-CSF COMPONENTS
AND MATERIALS LTD /
RINGWAY HOUSE / BELL ROAD / BASINGSTOKE RG24 0QG
TEL. : (44.256) 29155

Circle 155 on reader service card

ZEBRA[®] LCD CONNECTORS DEFEAT ENVIRONMENTAL OPPONENTS!

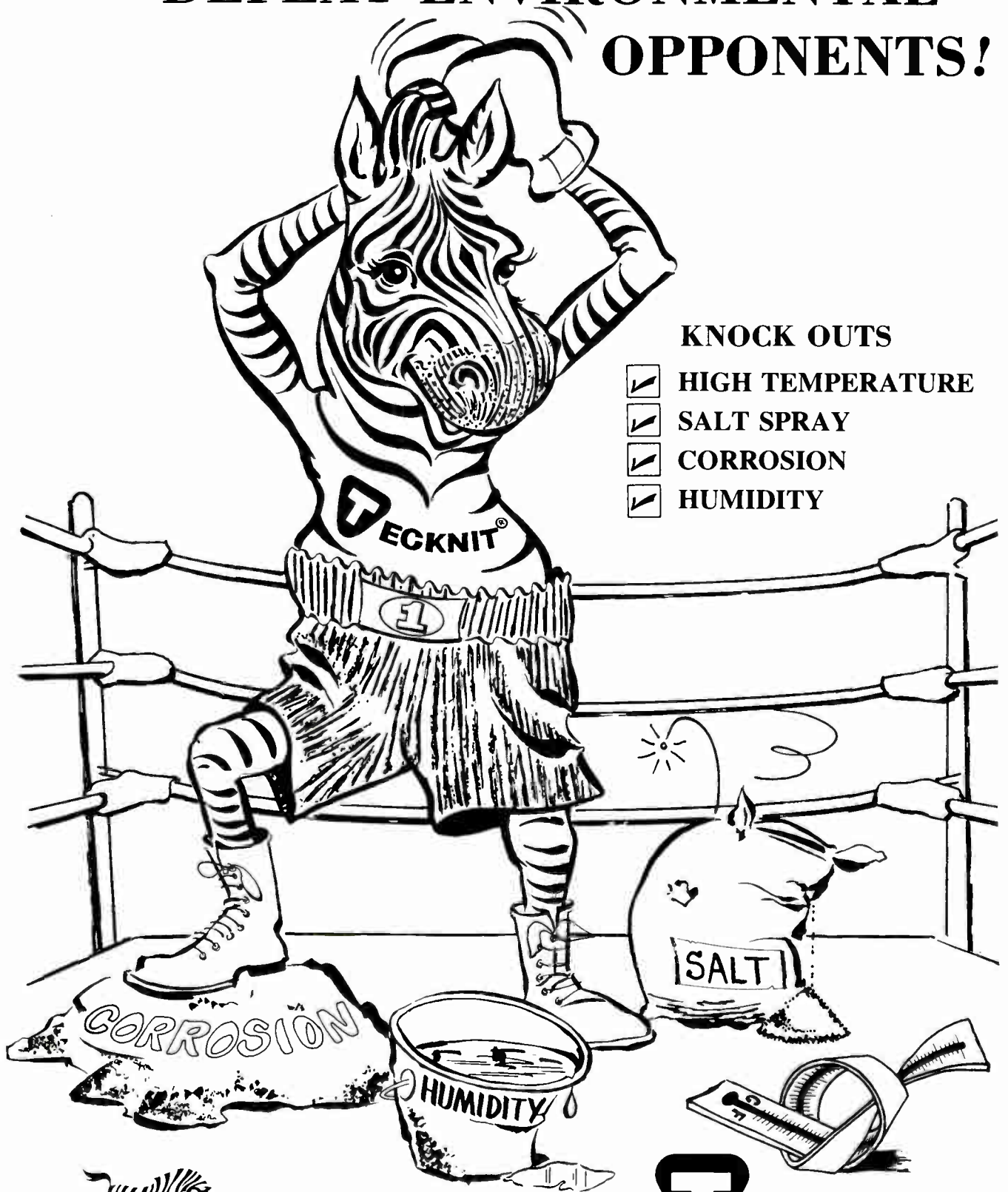

KNOCK OUTS

- HIGH TEMPERATURE
- SALT SPRAY
- CORROSION
- HUMIDITY



The Conductive People



129 DERMODY ST., CRANFORD, N.J. 07016 (201) 272-5500

Multiwire Optimizes ECL.

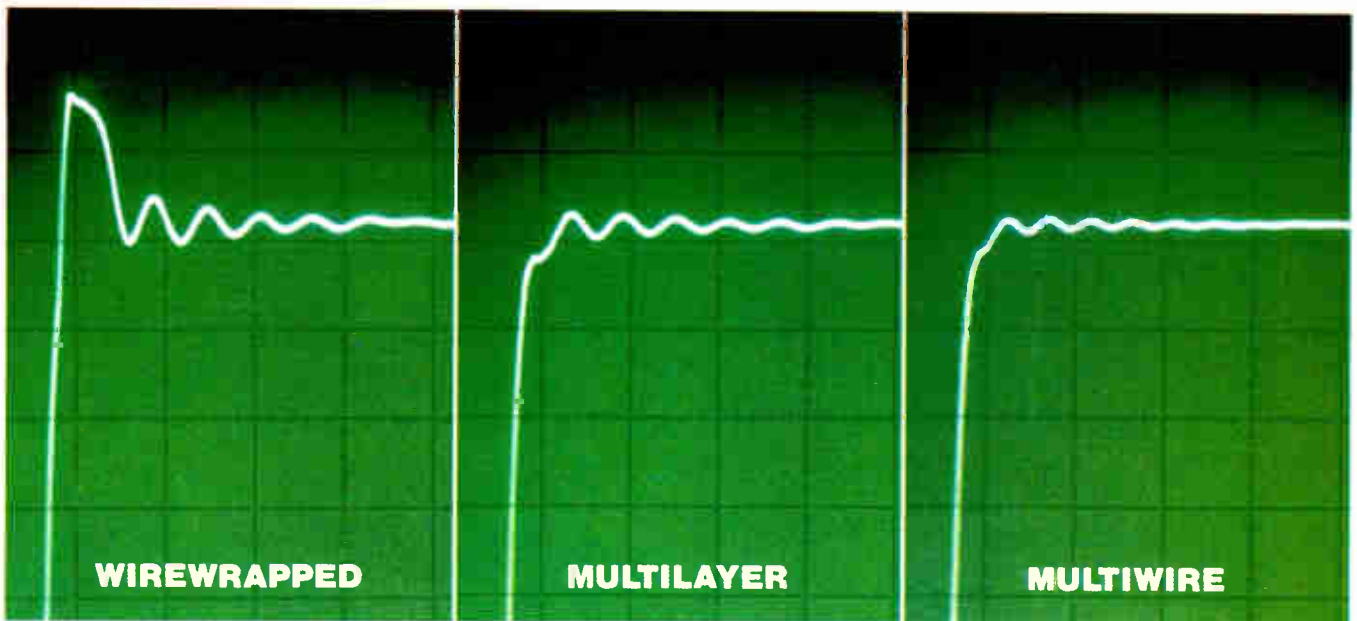

These traces tell the story.

Wirewrapped and multilayer circuit boards can handle the high speeds of emitter-coupled logic. But Multiwire does it better. With Multiwire, *board impedance is precisely controlled* to meet circuit specs and is *consistent from signal to signal and board to board*. The problem of signal reflections with wirewrapped and multilayer requires the use of discrete series-damping and terminating resistors. Multiwire reduces design problems, provides consistent electrical characteristics,

and results in lower cost and better circuit performance. Add to that other Multiwire advantages: less design time, shorter lead times, easy circuit changes, reduced inspection costs, and higher production yields. The choice is obvious. Multiwire is the way to go. Write or call today for details.

Multiwire, 31 Sea Cliff Avenue, Glen Cove, NY 11542. Phone (516) 448-1307

Multiwire is a registered trademark for Kollmorgen Corporation discrete wired circuit boards.



308 DATA ANALYZER

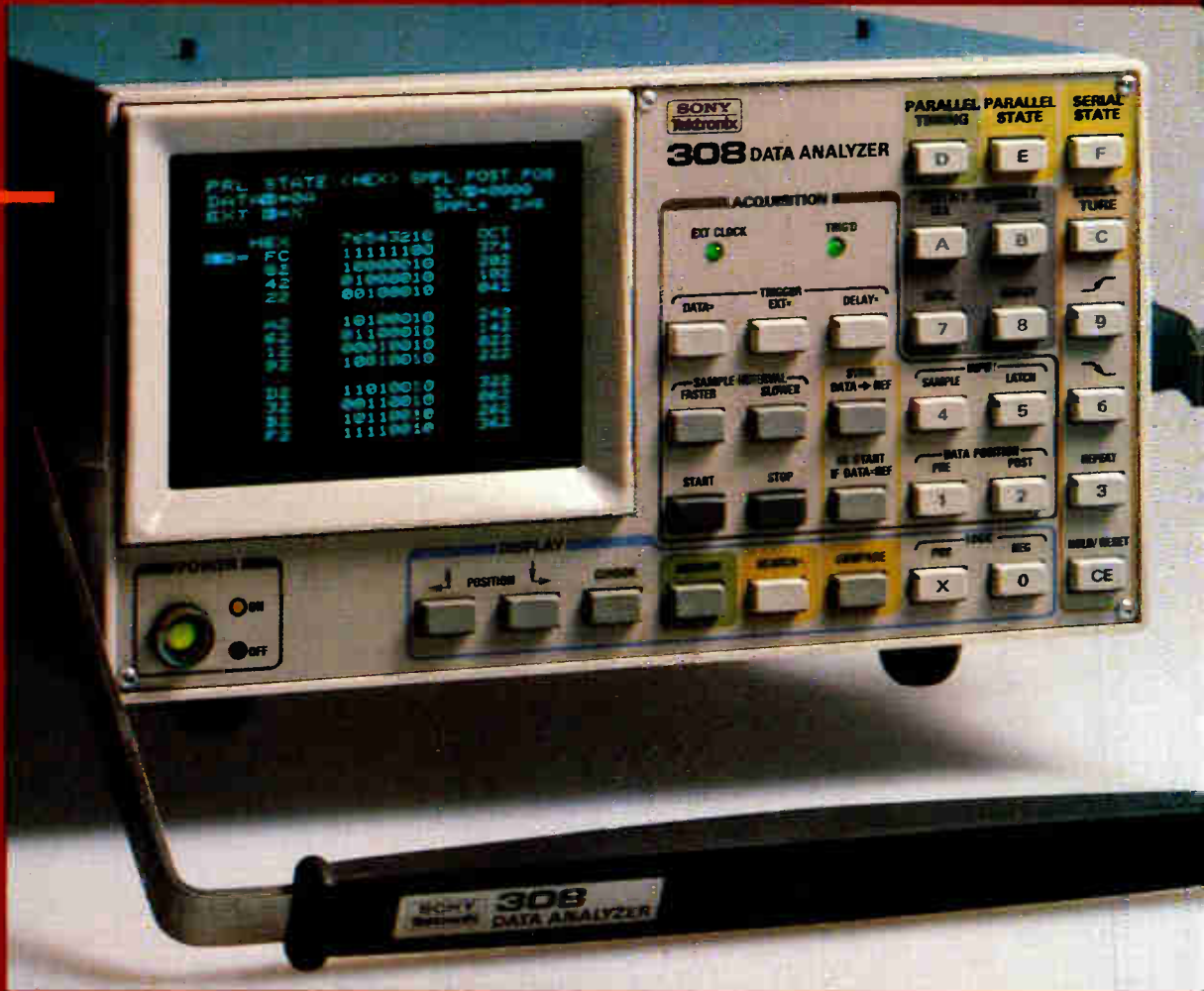

308 display of parallel state data.

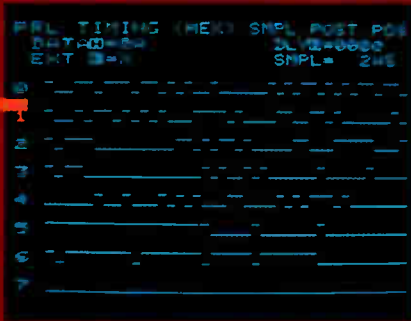

Parallel timing diagram can also be displayed as a state table in hex, binary and octal.

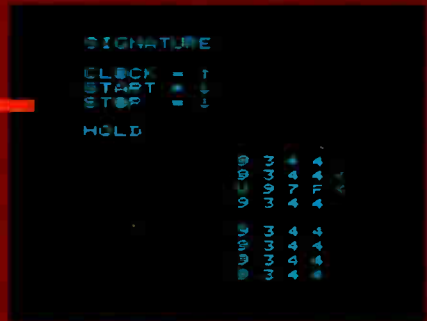

Signature display will hold and display up to 8 signatures at once.

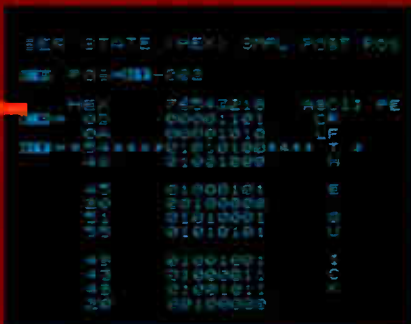

Serial display includes ASCII readout in addition to hex and binary.

The 308 is lightweight (3.6 kg/8 lb) and portable.



All logic analyzers handle parallel data. Only one also does serial and signature.



Introducing the 308 Data Analyzer:

Until now, logic analyzers have been confined to parallel state and timing data. Unfortunately, digital problems haven't. They might originate at a serial data port. Or appear as a faulty signature output.

So we've designed a logic analyzer that handles all four data formats: Parallel state. Parallel timing. Serial state. Signature analysis. Each with an impressive array of display and sampling features. All contained in a single lightweight (3.6 kg/8 lb) portable package. The 308 Data Analyzer, from Tektronix. A unique instrument. The first of its kind.

The 308 includes a reference memory for data comparison and word searches. Latch mode. Word recognition up to 25 bits. Pre- and post-trigger control. Synchronous and asynchronous sampling. Digital delay. Timing and state displays in hex, binary and octal. Plus ASCII and parity error in the serial mode. Plus optional accessories for easy probe connection.

And much more. All in a compact and convenient package. One that's cost-effective. And backed by the unmatched experience of Tektronix in the field of digital test instrumentation and service. Interested? Contact your local Tektronix Field Office, or write us.

Tektronix, Inc.
P.O. Box 1700
Beaverton, Oregon 97075
(503) 644-0161
Telex: 910-467-8708
Cable: TEKTRONIX

Tektronix International, Inc.
European Marketing Centre
Postbox 827
1180 AV Amstelveen
The Netherlands

Tektronix[®]
COMMITTED TO EXCELLENCE

For immediate action, dial our toll free
automatic answering service 1-800-547-1512

$$\sum_{k=1}^{\infty} A_k z^k = \frac{1 + a_1 z^1 + b_1 z^2}{1 + c_1 z^{-1} + d_1 z^2} = \frac{z^2 + a_1 z^3 + b_1 z^4}{z + c_1 + d_1 z^3}$$



$$= A_1 z^1 = \frac{z^2 + a_1 z^3 + b_1 z^4}{z + c_1 + d_1 z^3}$$
$$= \frac{z^2 + a_1 z^3 + b_1 z^4}{z + c_1 + d_1 z^3}$$

16 to 32-bit products in only 45 to 100nsec

(With TRW monolithic multipliers.)

If you design digital filters or FFT processors... or if you want to increase the computational speed of a microprocessor... take a look at our "HJ" line of bipolar, monolithic multipliers.

These super-fast chips give you

added performance at greater speeds. And save circuitry, power and money in the process. One of our customers used 4 of our MPY-16HJ's and tossed out 98 multipliers he'd previously needed for the same function. That's real saving!

One of these "HJ's" ought to give you real savings, too...

Multiplier	Word Size (Bits)	Speed (Nsec)	Power (Watts)	Unit Price (in 100s)
MPY-16HJ	16x16	100	3.0	\$157
MPY-12HJ	12x12	80	2.0	\$103
MPY-8HJ	8x8	65	1.0	\$ 59
MPY-8HJ-1	8x8	45	1.0	\$ 71

Plus such important features as...

- Zero-nanosecond input register hold time.
- Two's complement or unsigned magnitude.
- Controllable transparent output registers (except MPY-8).
- TTL compatible.
- Pin-compatible with our "AJ" series multipliers.

These super-multipliers are in stock at Hamilton/Avnet.

For immediate information, call us at 213/535-1831 or send us the coupon, or just attach your business card to this page and mail it back to us.

TRW LSI Products E-11

An Electronic Components Division of TRW Inc.
P.O. Box 1125
Redondo Beach, CA 90278

Please send data sheets on the MPY/HJ family of multipliers.

Name _____

Company _____

Div/Dept _____

Mail Code _____

Address _____

City _____

State _____

Zip _____

TRW keeps you ahead in digital signal processing

TRW LSI PRODUCTS

ANOTHER PRODUCT OF A COMPANY CALLED TRW

Circle 161 on reader service card

VAX Performance. Ask any user.

"VAX simply ran over the competition. In cost/productivity ratios, nothing even came close."

*Lou Crain, Mgr. of Software Products
Prototype Development Associates
Santa Ana, California*

PDA is an employee-owned engineering concern whose business ranges from fundamental research in structural analysis to the manufacture of critical aerospace components.

The VAX-11/780 is PDA's first in-house computer. Lou Crain, Manager of Software Products, tells us, "We've been doing all our computing through utilities using CDC 6600, Cyber 74 and Univac 1108 mainframes. The key elements in our decision to acquire the VAX-11/780 were cost and capability — compared to service bureaus, mainframes and competitive minis."

From the standpoint of capability, PDA considered traditional superminis like the Data General Eclipse and the Prime 400 and 500 series, plus a used 1108 mainframe. Lou Crain says, "Our benchmark showed VAX to be very powerful against the competition — up to a 2:1 performance advantage over both the Eclipse and the 1108."

"After installation," Crain concludes, "VAX has lived up to our expectations and has performed impressively. It's resulted in better

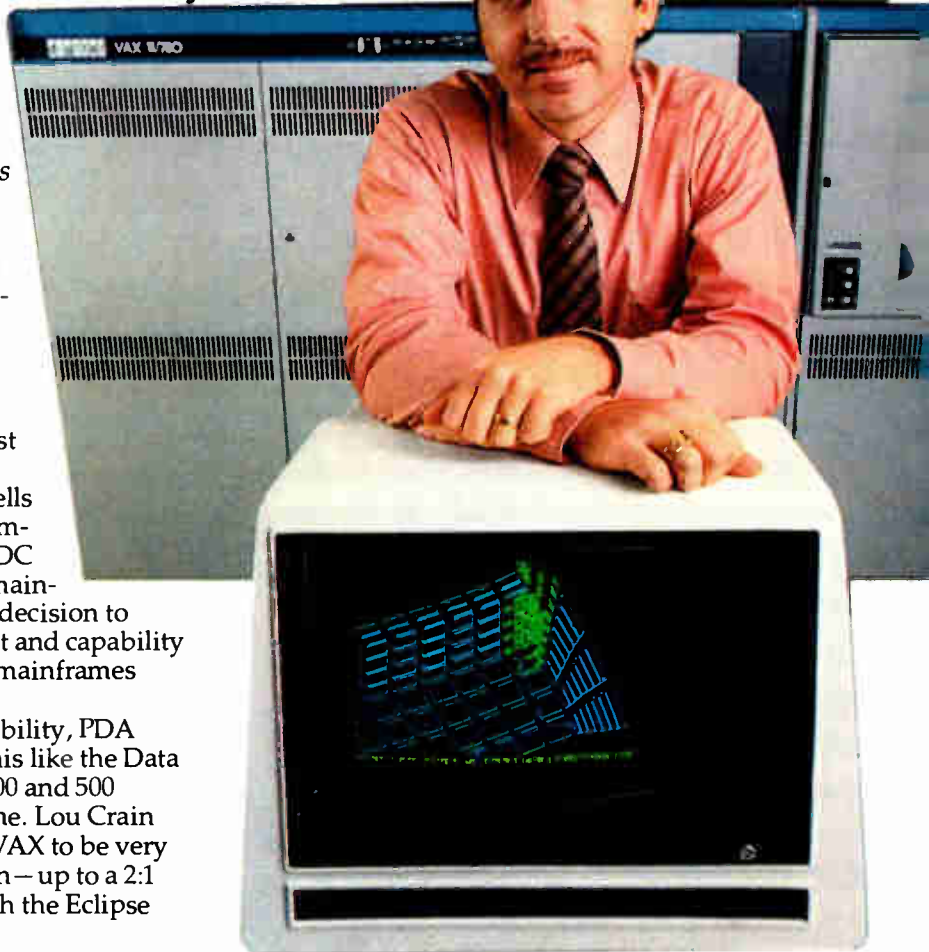

products for our customers, as well as improved cost-effectiveness. Having our own interactive capability in-house has meant an increase in engineering productivity of up to 300%."

"VAX turns out to be twice the machine for the same amount of money."

*Roger Vossler,
Section Manager and Systems Engineer
TRW Defense and Space Systems Group
Redondo Beach, California*

Sensor data processing and distributed processing systems in support of real-time embedded applications are among the specialties of TRW's Defense and Space Systems Group.

To find the right computer, TRW continues to evaluate numerous machines — including Digital's VAX-11/780. They've also conducted numerous FORTRAN and PASCAL benchmarks.

In every test, VAX stands out as a clear winner.

Roger Vossler, Section Manager and Systems Engineer, says, "VAX is one of the best implementations we've seen of a successful integrated hardware and software system."

Since TRW's sensor data processing applications require enormous memories — over a million bytes to store a single image, for example — VAX's true 32-bit address space is vitally important. In addition, says Vossler, "VAX's I/O bandwidth capabilities are extremely important for effectively moving large quantities of real-time data at very high data rates."

Because TRW already had an investment in Digital technology, Vossler is particularly impressed with the relative ease of moving PDP-11 series programs onto VAX.

"But," says Vossler, "Even if I were starting all over again — without our Digital experience — I would still pick VAX, on the basis of its architecture, both hardware and software, and its impressive performance."

"Implementation was faster on VAX than on 25 other machines."

*Brian Ford, Director
Numerical Algorithms Group
Oxford, England/
Downers Grove, Illinois*

The Numerical Algorithms Group develops and maintains mathematical and statistical software libraries for customers in industry, science and academia.



Before VAX, NAG had implemented their complex Mark 6 Library on 25 major machines, including the Burroughs 6700, CDC 7600, Univac 1100, and the IBM 370. The average implementation time was 13 man-weeks.

VAX took five.

In Dr. Ford's words, "A successful implementation requires the correct functioning of the 345 library routines to a prescribed accuracy and efficiency in execution of NAG's suite of 620 test programs. Whilst the activity is a significant examination of a machine's conformity to the ANSI standard of the FORTRAN compiler, its main technical features are file creation, file comparison, file manipulation and file maintenance."

And implementation performance was just the start. Dr. Ford comments on VAX's impressive record of reliability after the program was up and running: "No problems were encountered in the VAX/VMS software even though approximately 3000 files were being handled. The operational availability time for the machine was close to 100%, an outstanding statistic for new hardware and a new operating system.

"VAX," Dr. Ford concludes, "is an implementor's dream."

Digital's VAX-11/780 has re-defined the level of performance you can expect from computers in its price range.

If your application requires large number crunching capability, high floating point accuracy, or lots of high-speed real-time calculations, there is simply no better system.

But don't take our word for it. Send for our new brochure. And listen to our customers.

Please send me the new "VAX—Ask Any User" brochure and detailed Technical Summary.

Please contact me.

Name _____ Title _____

Company _____

Address _____

City _____ State _____ Zip _____

Phone _____

My application is: Education Medical Laboratory
 Engineering Government Resale Other

Send to: Digital Equipment Corporation, 146 Main Street, Maynard, MA 01754, Attn: Communication Services, NR-2/2, Tel. 617-481-9511, ext. 6885.

Digital Equipment Corporation International, 12 av. des Morgines, 1213 Petit-Lancy, Geneva, Switzerland

In Canada: Digital Equipment of Canada, Ltd. N-11-8-9

digital

YOU MAY NOT GET A HEWLETT-PACKARD CALCULATOR UNLESS YOU ASK FOR ONE.

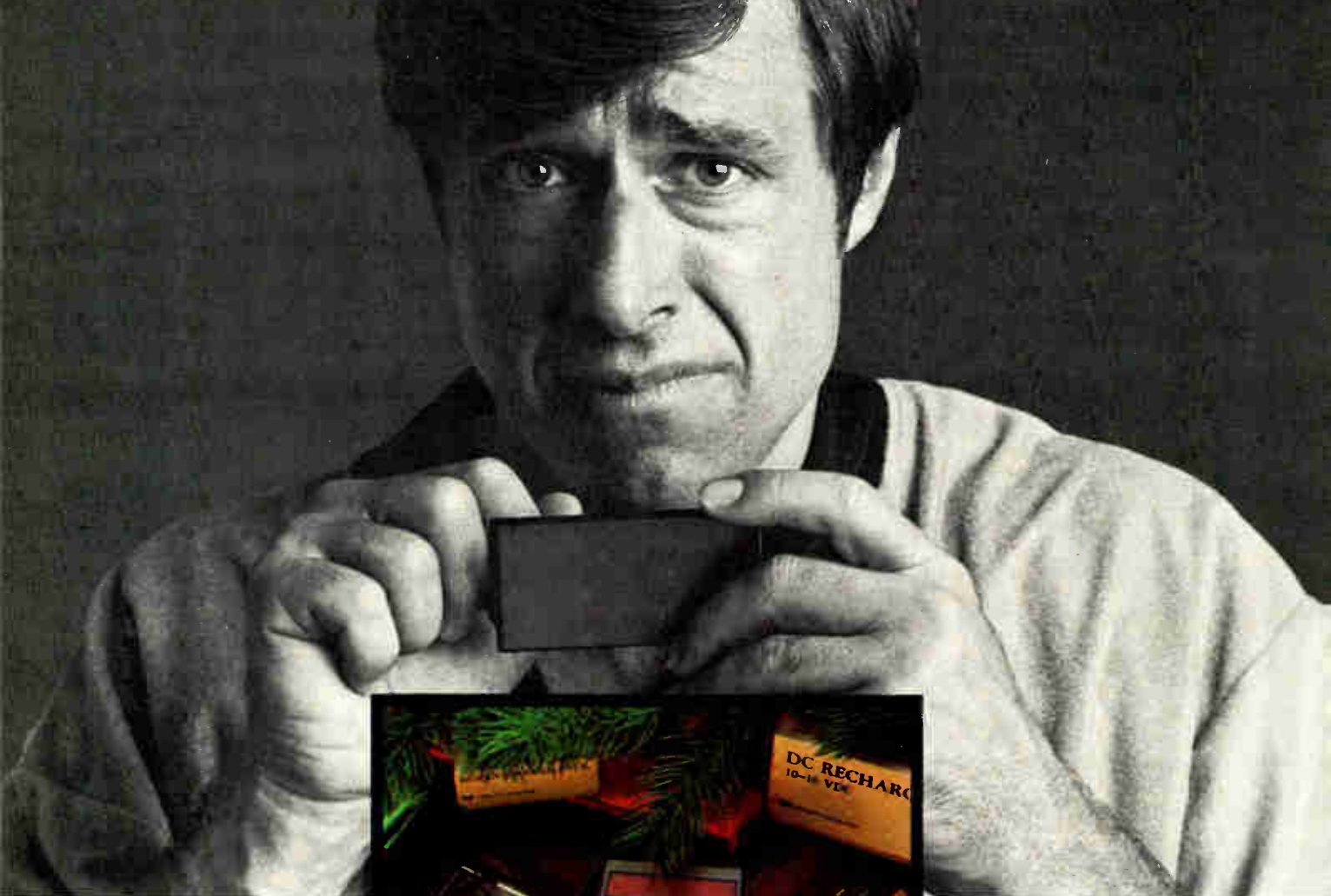

This Christmas get the calculator you really want. Ask for a Hewlett-Packard.

Whatever your particular calculator needs — business or science — Hewlett-Packard offers the professional's choice. There's a full range of advanced, programmable and printing calculators to choose from. Including the affordable Series E, that combines ease of use with HP quality. Series E gives you more power and features at a lower price than any comparable calculator HP has ever offered. And Series E suggested retail prices now start at just \$50*.

HP also offers a full array of accessories to go with your new HP calculator or to

Circle 164 on reader service card



619/19

augment the one you already have. From DC Adapter/Rechargers that work in a boat, a car or at home, to Reserve Power Pacs to Application Pacs and Solutions Books that give program solutions to thousands of problems.

So this Christmas ask for the calculator you really want. Ask for a Hewlett-Packard.

For the address of your nearest HP dealer, CALL TOLL-FREE 800-648-4711 except from Alaska or Hawaii. In Nevada, 800-992-5710. Or for more information write: Hewlett-Packard, 1000 N. E. Circle Blvd., Corvallis, OR 97330, Dept. 214 A

*Suggested retail price excluding applicable state and local taxes — Continental U. S. A., Alaska & Hawaii.



**HEWLETT
PACKARD**

\$99 meter puts measurements in hand

3½-digit DMM, aimed at service market, uses dual-dial scheme that offers single-finger switching and easy range reading

by Richard W. Comerford, Test, Measurement, & Control Editor

Beating the price down on instrumentation while keeping the performance high is not an easy feat with today's inflation. Yet Keithley Instruments Inc. has managed to do just that, producing a high-quality portable 3½-digit multimeter that sells for just \$99. Aimed squarely at the heart of what Keithley sees as the real market for such instruments—service—the model 130's price tag is truly the result of a thorough and practical design and development effort.

"We're not simply trying to buy the market with an artificially lower price; we couldn't make an honest profit if we did," asserts president Thomas G. Brick. He points to the effort that Keithley expended to bring the 130 to market, an effort that went from canvassing purchasers of generically similar meters to the construction of a dedicated high-volume production line, automated to assemble the portable's 35 components in the most efficient manner. The effort also underscores the direction that Keithley is taking into the 1980s. Traditionally known for serving research workers with high-technology instruments, Keithley plans to gain similar respect in the service field by continuing to apply its technical expertise there, too.

To do that, Keithley designed the model 130 not as a "solution" but as a hard-working tool. "When a guy wants to drive a nail into a board, he doesn't look for the 'nail-board solution,' he looks for a hammer," says Joe Reedholm, vice president for instruments. With that view point, Keithley studied just what servicemen wanted in a digital tool and embodied the desires they found in

the model 130. Paramount was ease of use. To fulfill this requirement, Keithley designed a novel switching scheme, the meter's most striking feature next to its price. Two rotary switches, one for range and one for function, are set at the meter's left edge. This configuration gives the user two ways to select range and function: with one finger (the thumb of the left hand or the index finger of the right) of the hand holding the instrument or in the conventional two-handed manner—holding the meter in one hand and turning the switches by means of their center

handles with the other.

Use of this scheme provides several benefits, Reedholm points out. First, it reduces selection of the color-coded range and function to a simple dial-setting process. Second, it clearly indicates them without need for annunciators in the 0.6-in. liquid-crystal display (which is about 60% larger than most), which helps keep cost down. And third, it also helps make the meter more rugged by reducing the number of components needed.

The goal of ruggedness was addressed in every other aspect of





**FOR A BROAD
FIELD OF APPLICATIONS:**

BROAD-BAND OSCILLOSCOPIC CATHODE-RAY TUBES (CRT)

	Type 16L0101A	Type 10L0103M	Type 10L0104A1
Bandwidth, GHz	1.2	1.5	5.0
Recording Rate (while registering on RF-3* X-Ray Film), km/s, not below	2×10^3	1.5×10^4	5×10^4
Working Field, mm	80 x 100	40 x 60	15 x 40
Overall Length, mm	420	700	700

*RF-3 Film sensitivity is 1200 Roentgen (or 400 GOST Units)
The objective used has 1 : 1.5 aperture

And there is the fine experience of employing this range of CRTs in nuclear physics, space research, communications and solid-state computer hardware.

Sole exporter -



32/34 Smolenskaya-Sennaya
121200 Moscow
USSR
Telephone 251-39-46, Telex 7586

New products

the design as well. The switches and all other components, except the 3½-digit liquid-crystal display, are mounted on one side of a single printed-circuit board. The board is rigidly attached to the front half of the case, thus capturing the LCD firmly in a shock mounting that reduces the motion between board and case in the event the meter is dropped. That event is unlikely to occur because the user's arm gets tired—the 130 weighs a mere 10 oz.

Like its physical parameters, the meter's electrical specifications also represent very practical design. Keithley's investigation showed that a plurality of users only needed a dc voltage accuracy within $\pm 0.5\%$, so, rather than trade cost for higher accuracy, they built the meter to that accuracy level. The best dc voltage resolution needed in most cases was only 1 mV, but Keithley found it could offer 100 μV resolution for about the same cost and satisfy 90% of potential customers, and so did. Using similar tradeoffs, they determined the meter's other specifications: for example, 750 v maximum ac range, a maximum current range of 10 A, a maximum resistance range of 20 M Ω , and a nonswitched ac or dc input protection of 1,000 v maximum peak.

The results of the study were disappointing in one respect. "We found that in the majority of cases there was no need for audible response," says Reedholm wistfully. "It was too bad, because we really wanted to put that in—we had even provided the space for it in designing the case." That space is still there, and who knows but that sufficient demand may lead to a low-cost audible meter.

But putting the future aside, the model 130 is available from stock now and comes with a battery and standard probes. High-voltage, radio-frequency, and clamp-on current probes are among the optional accessories offered, as are a kit of spare parts able to support a number of meters and a stand for bench use.

Keithley Instruments Inc., 28775 Aurora Rd., Cleveland, Ohio 44139. Phone (216) 248-0400 [338]

Traffic Control for GPIB

Intel's new Talker/Listener and Controller give you the green light for simplified IEEE-488 systems.

Microprocessors are revolutionizing the instrumentation marketplace. Thanks to GPIB, systems manufacturers have the first standard interface that allows intelligent instruments to communicate with each other. Now the leading supplier of microprocessors delivers two peripheral chips—a Talker/Listener and a Controller—that make it even easier to get on the IEEE-488 bus.

Instead of building your own interface logic, use Intel's 8291 Talker/Listener or 8292 Controller. They'll save you time, space and money. Used together they let you implement all the IEEE-488 Standard bus functions without additional hardware or software. There's no more efficient traffic control for microprocessor-based systems.

Implement the full interface standards

Our 16-register Talker/Listener operates within a 1-8 MHz clock range, so you can use it with a wide variety of microprocessors. It performs all the interface functions described by the IEEE-488 Standard: programmable data transfer rate, handshake protocol, talker/listener addressing procedures, device clearing and triggering and both serial and parallel polling schemes.

But the 8291 gives you even more control.

For flexibility beyond the call of duty, Intel's Talker/Listener has three addressing modes. According to your application, you can address 8291 as either a major or minor talker/listener with either primary or secondary addressing.

Selectable interrupts and EOS

8291 lets you initialize interrupt conditions, too. Any of 12 interrupt status bits can be enabled, giving the Talker/Listener full status

means added control in handling multi-byte transfers.

First GPIB controller-on-a-chip

Now the GPIB control function is in LSI form, too. Our 8292 Controller communicates with the Talker/Listeners in your system to complete implementation of the IEEE-488 Standard, including transfer control protocol. It also executes service routines as indicated by interrupts and allows for seizure of control and/or initialization of the bus without destruction of ongoing data transmission.

Intel gives you the go ahead

You can depend on Intel for the latest advances in microcomputer technology. Everything you need for tomorrow's instrumentation systems is here today, from microcomputers to the broadest range of memory and peripheral components available.

Now you can build with Intel's new IEEE-488 Talker/Listener and Controller chips. For detailed information, contact your local Intel sales office or write: Intel Corporation, 3065 Bowers Avenue, Santa Clara, CA 95051.



communication

with the microprocessor.

Finally, the 8291 is the only LSI device to offer EOS (end of sequence) message recognition. Working with a GPIB controller device, this EOS capability

intel delivers.

Europe: Intel International, Brussels, Belgium. United States and Canadian distributors: Arrow Electronics, Alliance, Almac/Stroum, Component Specialties, Cramer, Hamilton/Avnet, Harvey, Industrial Components, Pioneer, Sheridan, Wyle/Elmar, Wyle/Liberty, L.A. Varah and Zenronics.



(((Quick-rental
instruments

If Newton Were Measuring Today, He'd Probably Rent A Measurement System From General Electric.



Today, it takes more than a bonk on the bean to make test observations. When you need a measurement system, you can rent the equipment as a single unit from the GE Rental



system, or rely on competent GE technicians to configure a system to your requirements. They can rack mount and wire the units together for a turnkey operation; even run the

Shop nearest you. (There are 48 nationwide).

We'll select your equipment from our huge rental inventory of instrumentation from leading manufacturers, calibrated with standards traceable to the NBS. Our computerized inventory control provides instant information on availability and location of equipment for fastest delivery.

Your phone call sets in motion a convenient weekly or monthly rental program. You can specify components for your measurement

test and reduce the data for you.

Down-to-earth service. That's what you get when you "gravitate" to General Electric, your complete instrument rental source.

For your FREE RENTAL CATALOG call collect (518) 372-9900, or write General Electric Company, Apparatus Service Division, Bldg. 4, Room 210, 1 River Road, Schenectady, N.Y. 12345.

ALA. BIRMINGHAM (205) 925-9449 • ARIZ. PHOENIX (602) 278-8515, TUCSON (602) 294-3139 • CAL. LOS ANGELES (213) 642-5350, SACRAMENTO (916) 383-1324, SAN FRANCISCO (415) 436-9260 • COL. DENVER (303) 320-3252 • CONN. SOUTHINGTON (203) 621-4059 • FLA. JACKSONVILLE (904) 751-0615, MIAMI (305) 940-7723 • GA. ATLANTA (404) 457-5563 • ILL. CHICAGO (219) 933-4500, or (312) 854-2994 • IND. EVANSVILLE (812) 479-0248, FT. WAYNE (219) 484-9073, INDIANAPOLIS (317) 639-1565 • IO. DAVENPORT (319) 285-7501 • KY. LOUISVILLE (502) 452-3311 • LA. NEW ORLEANS (504) 367-6528 • MD. BALTIMORE (301) 332-4713 • MASS. BOSTON (617) 396-9600 • MICH. DETROIT (313) 285-6700, Ext. 208 or 209 • MINN. MINNEAPOLIS (612) 522-4396 • MO. KANSAS CITY (816) 231-4377, ST. LOUIS (314) 965-7115 • NEW JERSEY FAIRFIELD (201) 227-7900 • N.Y. BUFFALO (716) 876-1200, SCHENECTADY (518) 385-2195 • N.Y.C. FAIRFIELD, N.J. (201) 227-7900 • N.C. CHARLOTTE (704) 525-0311 • OH. CINCINNATI (513) 874-8512, CLEVELAND (216) 441-6111, TOLEDO (419) 691-3501 • ORE. PORTLAND (503) 221-5101 • PENN. PHILADELPHIA (609) 424-4450, or (215) 923-0383, PITTSBURGH (412) 462-7400 • S.C. GREENVILLE (803) 277-4093 • TENN. MEMPHIS (901) 525-5393 • TEX. DALLAS (214) 357-7341, HOUSTON (713) 672-3570 • UT. SALT LAKE CITY (801) 973-2253 • VA. RICHMOND (804) 232-6733 • WASH. SEATTLE (206) 575-2987 • W.V. CHARLESTON (304) 345-0920 • WISC. APPLETON (414) 739-7766, MILWAUKEE (414) 744-0110 • PUERTO RICO PONCE (809) 843-4225, or 4625.



GENERAL  ELECTRIC



1744A STORAGE OS

HEWLETT

ORE

RASE

ENCE
OR

VIEW
TIME

ERASE
(PUSH)

MAX

ESS

MAX

E

Y

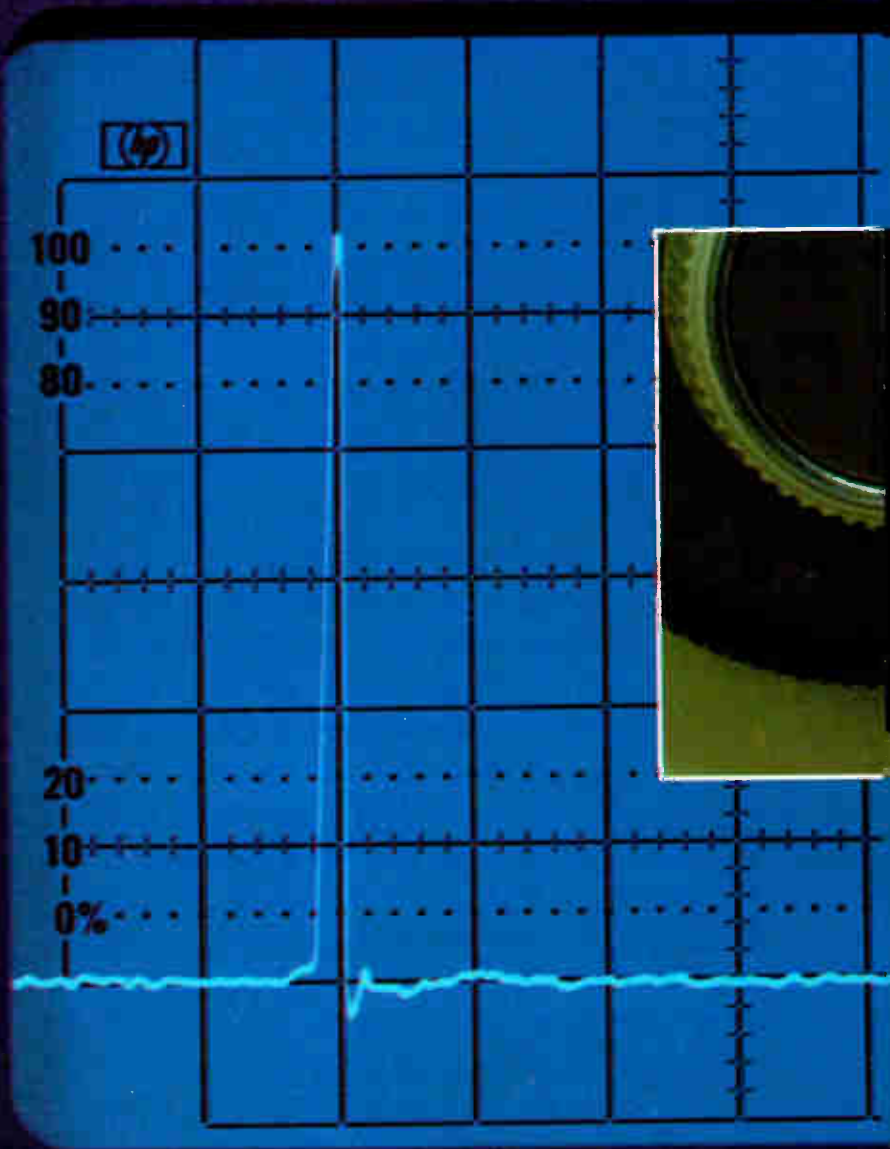

Storage trace as seen using a viewing hood.

ILLOSCOP
PACKARD

For a 100 MHz storage scope that can capture its bandwidth and display glitches this sharply...

HP's new 1744A is the Answer.

The key to this storage scope's superior performance is HP's advanced CRT design. It's called Expansion Storage. And this faster-writing technique lets you capture single-shot and low-rep-rate events over a larger display area with greater clarity.

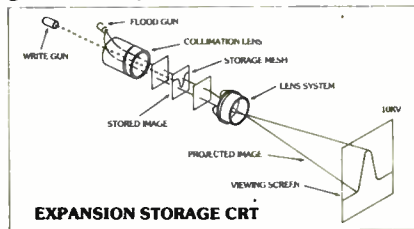

Take a good, hard look. Any input signal within bandwidth specification will be displayed cleanly by the 1744A, even at the maximum writing speed of 1800 cm/ μ sec when using a viewing hood. That provides the sharpness you need for detailed evaluation of hard-to-catch waveforms. Our Auto Erase/Auto Store modes simplify your pursuit of these elusive signals. Auto Erase provides hands-off operation while Auto Store prepares the scope to snare the troublemaker the instant it occurs. Both are powerful tools for capturing the spurious spikes that disrupt your logic circuitry.

Catch that glitch. Expansion Storage technology combines a small storage mesh (about the size of a postage stamp)

and an expansion lens system. This exclusive arrangement permits a writing speed of 1800 cm/ μ s and a fine spot size, which lets the 1744A write faster and further than any other 100 MHz storage scope. That gives you full-scan glitch capture capability over a broad range of sweep speeds and repetition rates.

A new view. Three channels are better than two. And with the 1744A you have pushbutton selection of a third-channel trigger view. Now you can view timing relationships between the trigger signal and the two vertical channels simultaneously.

Rounding out the 1744A's capabilities are these convenient measurement features: **Easy-IC Probes** to improve closely spaced probe connections and eliminate shorting hazards; a selectable input impedance (1 megohm/50 ohm) for general purpose probing or 50 ohm matching; and measurement sensitivity as low as 1 mv/div to 30 MHz on both channels without cascading. Priced at \$5250*, the 1744A furnishes the state-of-the-art technology and performance needed today in digital design and trouble-shooting applications.

Call your local HP field engineer for further details. And for a lower cost, high quality storage scope where an extremely fast writing speed isn't required, ask him about HP's 1741A 100 MHz storage scope.

* Domestic U.S.A. price only.



HEWLETT  PACKARD

1507 Page Mill Road, Palo Alto, California 94304

For assistance call: Washington (301) 948-6370, Chicago (312) 255-9800, Atlanta (404) 955-1500, Los Angeles (213) 877-1282

Circle 171 on reader service card

088/7A



Store Recorders have made



Flip a single switch on a dual standard recorder in the new Racal Store DS range, and you've changed instantly from Intermediate Band to Wideband operation on FM. A single switch that selects either recording standard – without the need to interchange plug-in modules. A single switch changes all the signal channels (four to fourteen) on all seven speeds.

FM Capability

The Store range of instrumentation recorders, well-renowned for research in the scientific, automobile, aerospace and medical fields, now offers an FM capability over the entire band DC to 40 kHz, and up to 300 kHz on Direct Recording.

Greater Flexibility

And even greater flexibility. Switch any channel to unipolar, and the full dynamic range becomes available to either positive or negative going signals. Switch any channel to offset, and you can record a 100 mV peak-to-peak signal on a 20 V step—without losing any dynamic range.

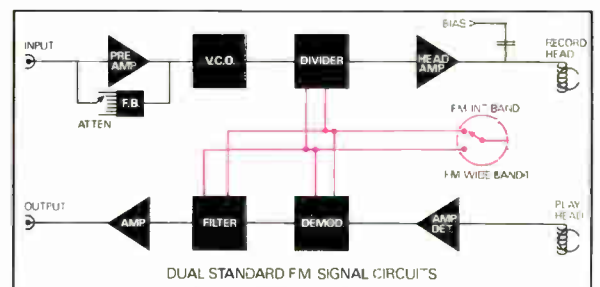



a quick switch to wideband.

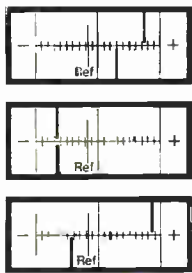

Proven Success

All these outstanding new advantages have been added to the host of features which have made the existing range such a success—like single switch seven-speed selection, full servo operation, dual peak-indicating meters, full remote control of all functions, portability, and operation from AC or battery power sources.

That's why, by switching to the Racal Recorders' new Store DS range, you can make a quick switch to a whole new wideband world.



Racal Recorders Limited Hardley Industrial Estate,
Hythe Southampton Hampshire SO4 6ZH England
Telephone: 0703-843265 Telex: 47600.

Racal Recorders Inc 5 Research Place,
Rockville Maryland 20850,
Telephone (301) 948 3085.

Racal Recorders Inc, 1109 West San Bernardino Road,
Suite 110 Covina California 91722
Telephone: (213) 967 2869.

Racal Recorders Always on the right track

RACAL

Brainy controller sells for \$14,000

High-level programming language and a plethora of options are keys to flexibility of LSI-11/2-based industrial control system

by James B. Brinton, Boston bureau manager

The largest system yet introduced by Adac Corp., PROSYS I is an industrial data-acquisition and control system, which its makers claim is the lowest-cost system of its type. Its lengthy list of accessories, plus an English-language software package, may make it also one of the most comprehensive.

Aimed at test and measurement applications as well as industrial control, PROSYS I is based on a DEC LSI-11/2 with 64 kilobytes of memory, a dual-port serial interface, a double-density floppy-disk drive, a cathode-ray-tube display terminal, and high-level software. These are the basics. There is also a laundry list of analog and digital input/output modules available to fit 18 card

slots in the system. Mounted in a roll-about cabinet that is 33 in. high, with the CRT terminal sitting on top, the whole basic package, including software, sells for \$14,000.

Software. Despite a list of 38 options—almost all I/O devices—Adac's vice president A. L. Grant seems proudest of the system's specially developed software package, called PRO. It is specifically targeted at industrial applications and allows users to program in abbreviated English regardless of how obscure their applications are. "We have field-tested this system with users having no prior software experience, and they have been on-line in one to two weeks," he says, adding that even users without programming training can modify PRO for their applications.

PRO is completely self-contained, says Grant. No auxiliary storage assemblers, loaders, or other utility software packages are needed to load and use it. PRO operates as a multi-task system, handling many jobs simultaneously; meanwhile, program statements may be added, changed, or deleted, while other programs are running and while process I/O points are being scanned.

Despite its flexibility, PRO takes up somewhat less than half the system's main memory and thus leaves about 32-Kbytes with which the user may customize the system. This may, of course, be augmented by the standard floppy drive. For memory-intensive applications, a second drive is available.

The options run the gamut from high- and low-level digitizers, to digital-to-voltage and digital-to-current converters. There are also

contact-closure detectors, standard TTL inputs, optically isolated ones, high-current latched outputs, optically isolated outputs, and standard TTL-compatible ones.

For example, among the 13 available analog I/O boards is the 1012 with eight differential inputs, 12-bit resolution, and the ability to handle signals of a volt or more, and the 1112RL-8CJT, an eight-channel, 12-bit thermocouple digitizer, with cold-junction compensation, a thermocouple panel, and the ability to operate with a wide variety of thermocouple types. There is a 16-channel version, too.

Though specific configurations are bound to vary from user to user, a typical "fully loaded" system, according to Grant, might contain as many as 32 thermocouple inputs, 16 high-level analog inputs, 16 current-loop drivers, 16 contact-closure detectors, 16 optically isolated inputs, 128 TTL inputs, 128 TTL outputs, 32 high-current outputs, and 16 optically isolated outputs.

Connection with the system is via sets of screw terminals on the rear of its cabinet. There is a special panel for thermocouple applications that allows thermocouple extension wires to be connected directly to the system's terminal blocks. Other accessories allow control and monitoring of ac power.

The PROSYS I costs \$14,000 in quantities up to four, with discounting beyond that point; deliveries are being specified at 45 to 60 days, though units are already on the shelf.

The Adac Corp., 70 Tower Office Park, Woburn, Mass. 01801. Phone A. L. Grant at (617) 935-6668 [339]



Your low cost way out of the impedance jungle.



Before they get on board,
fend off wild RCL components for \$745 (usa).



Those untamed components. They swarm over your circuit boards, eat into your resources, trap you in the impedance jungle.

But there is a low cost, reliable way out. Armed with the Model 252, you breeze through a wide range of values for resistance (R), capacitance (C), inductance (L) and conductance (G) at $\pm 0.25\%$ accuracy. The push of a button gives you dissipation factor (D).

At \$745, the 252 rivals instruments costing twice as much.

- 0.25% basic accuracy
- Wide ranges (0.1 pF resolution to 200 μ F)
- 3½-digit display (no manual balance)
- Dual analog outputs (C or L with D)
- External bias (to 50 VDC)
- Four measurements/second
- 4-terminal Kelvin Klips® (guarded)
- Input protection
- Easy calibration, servicing
- 1 kHz test frequency (120 Hz option)
- Low power design
- Lightweight, tiltstand handle

For systematic GO/NO-GO sorting, there's an optional limits comparator and sorting fixture.

Want autoranging? Gear up with the Model 253. And if you test at low frequency, check out the 120 Hz Model 254.

For over 25 years we've tamed the ways of the impedance jungle. A detailed 252 brochure shows you how.

The sure way
to innovation.

esi
ELECTRO
SCIENTIFIC



GENERAL INSTRUMENT OPTO

It's a name that is already well known in semiconductor products as well as in data systems, cable TV products, and industrial components. Now, we're taking it into another area of high technology.

In June, General Instrument acquired the total optoelectronics operations of Monsanto. Their broad product line. Their experienced people. Their modern production facilities. And most important . . . an outstanding expertise in optoelectronics.

*We are the
new name
in optoelectronics...*

TEN YEARS OF EXPERIENCE IS A GOOD PLACE TO START

Since 1969, the major thrust has been to apply high technological capability to product development. Result—a continuing series of “firsts” in LED lamps, displays and optoisolators. Today, you can select from over 150 high performance devices in our product line. And you are assured of high quality and top performance because of vertically integrated production . . . from LED crystal to finished LED product.

NO BREAK IN CONTINUITY OF CUSTOMER SERVICE

The same conscientious and dedicated people will continue to back up our product line.

With the same prompt product and technical assistance, order processing and after-sale service.

Even the product



ELECTRONICS

designations remain the same. The only change you will notice is a more aggressive attitude. General Instrument is committed to providing total resources to become the leader in optoelectronics.

OUR FIELD ORGANIZATION IS THE SAME TOP TEAM

Over 50 of the most competent distributors throughout the world will continue to provide our customers with immediate availability of our wide variety of optoelectronic products. And our sales representatives are strategically located to give on-the-spot assistance in design and product selection.

THE FUTURE IS EVEN BRIGHTER

During the past year we "enlightened" the industry with better ways to use alphanumeric, new approaches to panel design and how to get bigger, brighter digits in less space. And that's just the beginning. You'll soon see the result of constant research and development as we announce a number of creative new products in the months to come. As the "oldtimer-newcomer" in optoelectronics, we'll continue to design, produce and improve the products that best fill your design needs. That's a promise.

General Instrument Optoelectronics Division,
3400 Hillview Avenue, Palo Alto, California
94304, Telephone (415) 493-0400

GENERAL INSTRUMENT

and we will continue to make a name for ourselves.

Circle 177 on reader service card



**Adaptability.
Key to survival in
the production
test environment.**

Coping with production test costs as products and technology change can really be a matter of survival. Fairchild's Faultfinder® test systems will help you survive with built-in adaptability to help you manage costs as you manage quality.

In the Faultfinder 200 series, you'll find low-cost, microprocessor-controlled shorts and continuity testers for reliable incoming inspection of bare boards and for checking boards after component stuffing. And every model is designed for modular expansion to adapt to changes in your production test volume.

Our workhorse Faultfinder FF101C is the most adaptable in-circuit test system you can buy, with its unique capability for testing analog and hybrid boards. Its broad range of hardware options includes a mini-computer with I/O flexibility and expandable test capacity to 2400 points — more than any other in-circuit test system. You can add IEEE-488 compatible instruments, too.

High volume testing of complex hybrid PCBs presents special problems and the Faultfinder FF303 gives you the power and flexibility to solve them. Complete analog component testing. Testing of virtually all SSI and MSI devices. And LSI testing, including RAMs, ROMs, PROMs, UARTs and ALUs. Plus modular functional test capabilities through the IEEE-488 bus.

Faultfinder single-user BASIC makes test programming for the FF101C and FF303 simple. It's easy to learn and it permits fast, line-by-line editing. Datalogging and automatic program generation put high-powered software to work at the test station with real-time fault analysis and faster programming turnaround.

And wherever in the world your Fairchild in-circuit test system is installed, you can count on Fairchild service and engineering support to help you keep your test systems productive.

Fairchild in-circuit test systems can help you adapt to the changing production test environment. Let us show you how. Call or write:
Fairchild Test Systems Group,
299 Old Niskayuna Road, Latham,
New York 12110
(518) 783-3600



FAIRCHILD

Test Systems Group

**The
First Family
of ATE**

matrox

SBC-80 MULTIBUS

displays

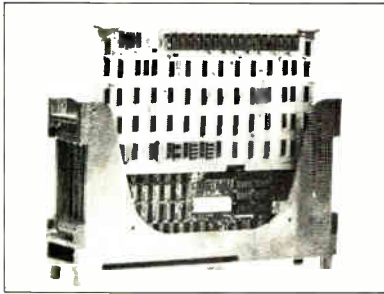

MATROX has the most complete line of CRT display boards for Intel's/NSC Multibus in the industry. We have alphanumeric; graphics; color; black and white; variable resolution; external/internal sync; 50/60 Hz; software and much, much more. Just plug the board in any Multibus chassis connect video to any standard TV monitor, and presto, you have added a complete display to your system at a surprisingly low cost.

MSBC-2480	24 lines x 80 character alphanumerics
MSBC-256	256 x 256 dot graphics
MSBC-512x256	512 x 256 graphics
MSBC-512	512 x 512 graphics
MSBC-1024	1024 x 256 graphics
MSBC-24/320	24 x 80 alpha, 320 x 240 graphics combined
RGB-256	256 x 256 x 4; 16 color or grey graphics

And we have other uP displays and display controllers. These include state of the art OEM alphanumeric LED displays, alphanumeric video RAM's and CRT graphics controllers. They come as complete, ready to use subsystems (single chips, modules, PCB's). Many of them are plug-in compatible with other buses PDP-11/LSI-11, S-100, Exorciser, STD as well as custom design capability.

matrox electronic systems

The Visible Solutions Company

5800 ANDOVER AVENUE, T.M.R. MONTREAL, QUE. H4T 1P4
TEL (514) 735-1132 TELEX 05-829651
U.S. ONLY TRIMEX BUILDING, YOOERS, N.Y. 12958

New products

Semiconductors

Display driver eases interfacing

IC for high-voltage gas-discharge displays offers programmable currents

A designer of alphanumeric displays must typically contend with several different drive currents, because segments of different length will produce different levels of brightness if driven with the same current. A 16-segment display, for example, can have three segments—horizontal, vertical, and diagonal lines—of differing length. In addition, punctuation marks like commas and periods must also be driven at different current levels to maintain uniform brightness. Typically, limiting resistors are placed in each current-drive line to adjust the individual segment currents. The model EI-232/242 driver—a monolithic integrated circuit for gas-discharge displays—now

greatly simplifies matters.

The high-voltage driver, made with Dionics' proven dielectric-isolation technology, delivers nine output-current lines, in two groups of four and five, with each output group having an independent, programmable current level. Programming is achieved by a single external resistor. Two such low-cost IC's can be ganged together for up to 18 outputs, in two groups of four and two groups of five lines, to satisfy any gas-discharge alphanumeric display requirement.

Two versions of this high-voltage driver IC are available: the model DI-232, which has an output-voltage compliance of 80 v, and the model DI-242, with an output-voltage of 125 v. Both provide programmable constant-current output sinks at a maximum of 5 mA and both are compatible with TTL and MOS inputs, with input ratings up to 40 v. Maximum power dissipation is 800 mW. The operating temperature range is 0° to 70°C, while the storage temperature range extends from -55° to +125° C.

The new segment driver is designed for use with gas-discharge

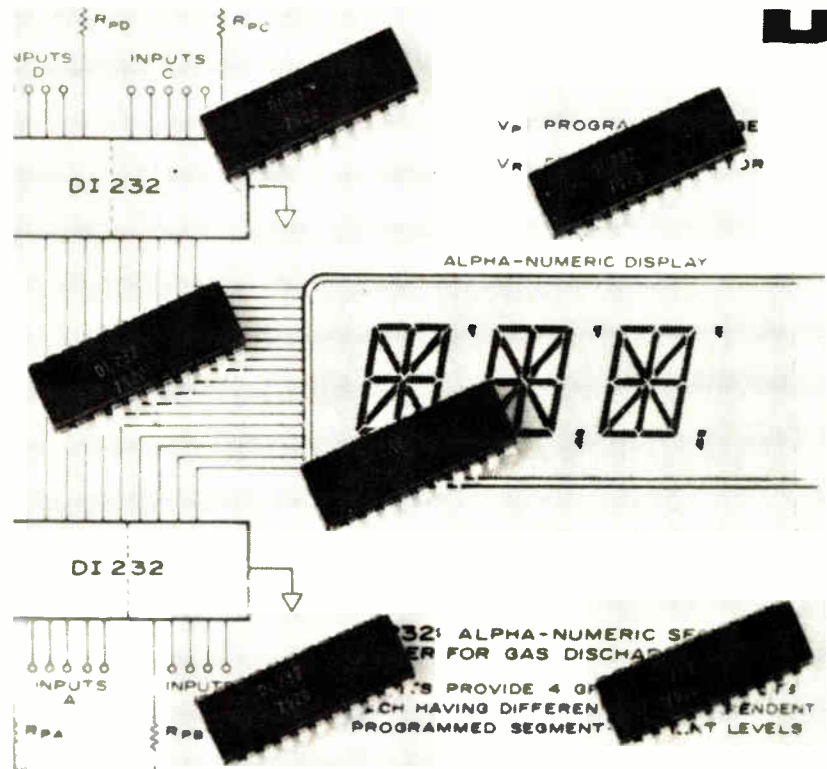

ENLIGHTENMENT

ADVANCED OPTOELECTRONIC PRODUCTS

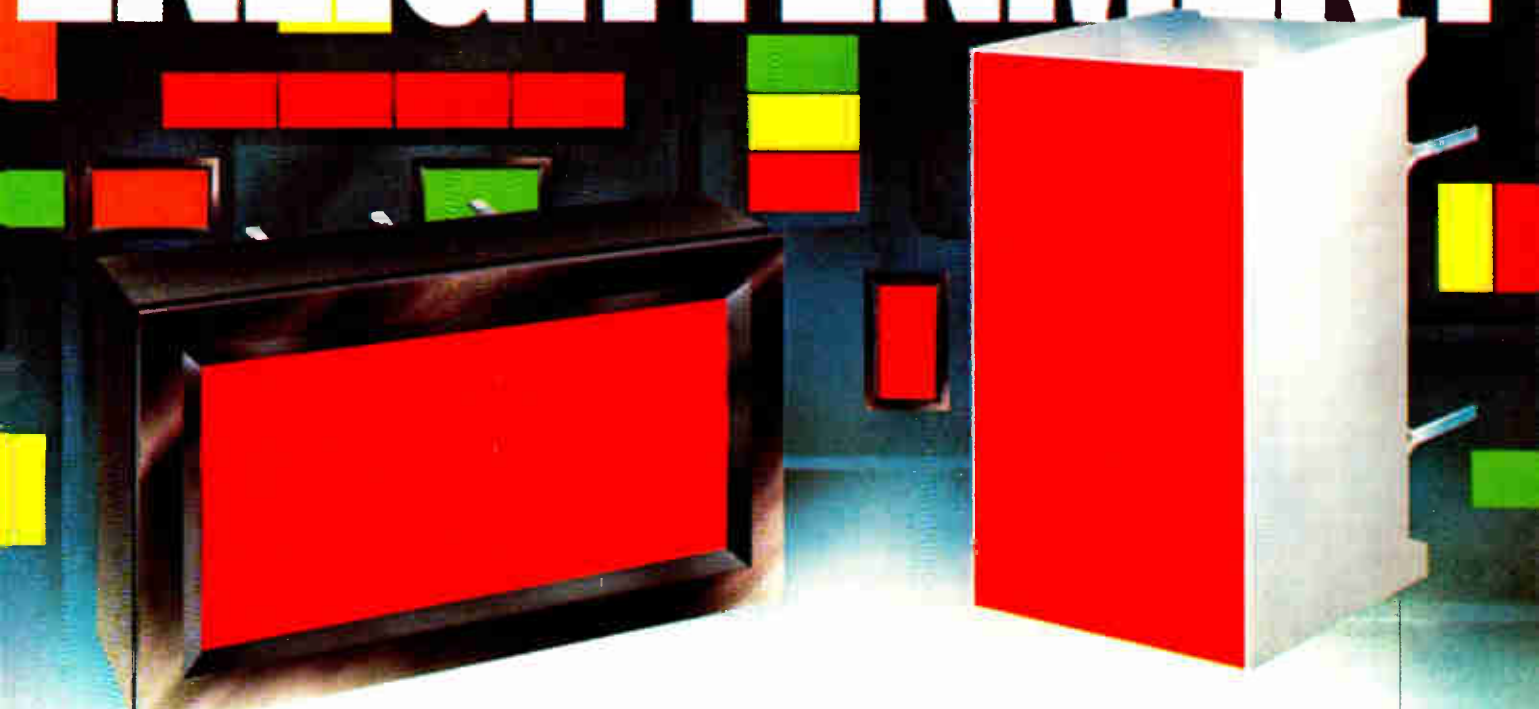

One-half inch of uniform brightness

General Instrument's new rectangular lamp gives panel indicators a larger, brighter look.

You get more than brightness. Our new MV57173 has a large rectangular emitting area, a wider viewing angle and more design flexibility than conventional lamps. It's a perfect lamp for panel indicator applications in appliances, vending machines, telecommunication equipment, instrumentation, or control panels.

The right size for backlighting legends. With a light emitting area of .50" x .25", this high efficiency LED lamp is large enough and bright enough to backlight legends. And they are categorized for brightness uniformity.

A convenient and compatible package. Mounted in a .2" dual in-line package, our new rectan-

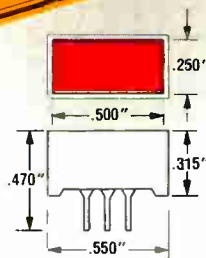

gular lamps are easy to install and are directly compatible with off-the-shelf IC's. And they are end stackable.

Mounting hardware available. A special mounting grommet (MP73) further simplifies

assembly and provides a professional look to your panel.

High efficiency red with more colors coming. The new General Instrument rectangular lamp is now available in high efficiency red (MV57173). With orange, yellow and green available in early 1980.

Another first from the new name in optoelectronics. For more technical data and pricing information on the MV57173 and MP73, see your local General Instrument distributor or contact General Instrument, Optoelectronics Division (Formerly Monsanto Optoelectronics), 3400 Hillview Avenue, Palo Alto, California 94304. Telephone: (415) 493-0400.

GENERAL INSTRUMENT



Microprocessor System Builders:

Here's how to improve your productivity

Clip on the interactive AQ8080Z Microprocessor System Analyzer.

- Buffered probe clips on in seconds. Your chip stays in its socket — can even be soldered in.
- Test your *complete* system, intact.
- Modify or examine all internal registers, memory, and I/O ports.
- Real-time hardware breakpoint or monitor
- Hardware breakpoint on contents of any selected register or memory location.

The portable AQ8080Z is ideal for:

- Hardware /software debugging
- Small scale software development
- QA and production testing
- Field service and depot testing

Field proven in over three years of regular use. Call or write today for a new six page technical brochure describing the AQ8080Z, for Z80A, 8080A, and 8085A systems. If you're a 6800 or 6802 user, request the AQ6800 brochure.

AQ SYSTEMS, INC.

1736 FRONT STREET, YORKTOWN HEIGHTS, N.Y. 10598
(914) 962-4264

New products

displays such as those manufactured by Beckman Instruments (model SP452), Cherry Electrical Products (model W416-1051), and Dale Electronics (model PD1-16A040).

At the 1,000-lot level, unit pricing is \$2.26 for the 80-v DI-232 driver and \$2.64 for the 125-v DI-242 driver. Delivery is within 8 to 10 weeks. Dionics Inc., 65 Rushmore St., Westbury, N. Y. 11590. Phone (516) 997-7474 [411]

Rectifiers recover in 35 ns, sell for \$1.55 each

The first of a line of high-efficiency rectifiers from Unitrode Corp. [*Electronics*, Sept. 13, 1979, p. 34] are designed for operation in switching power supplies at frequencies of over 100 kHz. Both the two-pin, single-diode UES1401 and the three-pin, twin-diode UES2401 series of rectifiers feature 35-ns reverse recovery

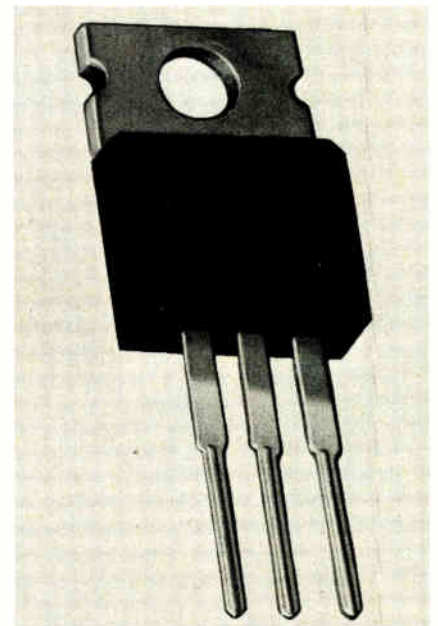

times and low forward voltage drops—0.8 to 0.9 v at 4 A or 0.895 to 0.975 v at 8 mA.

Unitrode is housing the diodes in TO-220 packages, which, according to Peter L. Jenner, product marketing manager, reduce the cost by one third and simplify circuit-board and heat-sink mounting. He expects the package to be the "low-cost rectifier

Quick-change artist vs. the thinker.

Either way you win.

Meet Fluke's new thermal instrument printers. They answer printing problems with intelligence and unsurpassed flexibility. Whether you choose the 2030A Computing Printer or the 2020A Universal Printer, you'll find that suddenly, printing is easy.

Five easy interfaces.

For printing flexibility or that one special job, the 2020A Universal Printer, starting at just \$745, is for you. Five interchangeable interfaces make it

compatible with IEEE-488, RS232C, parallel ASCII, BCD or PTI polling for Fluke's line of Portable Test Instruments (PTI). Choose one, or all five interfaces. With just a screwdriver you can reconfigure the quick-change artist in minutes.

The thinker in control.

For an intelligent printer to match up with Fluke's PTI voltmeters, counters, and thermometers, choose the 2030A Computing Printer. At just \$995, it's long on performance features, including multiple-instrument scanning, seven print modes, math computations and alarms. It even plots trends with a graphic trace.

Simple systems without software.

Both printers are part of Fluke's growing PTI family. Modular packages and simple interfacing let you quickly stack and latch single instruments into economical printing systems without writing software or buying an expensive IEEE-Controller.

The rest of the story.

For the whole story, give us a call at 800-426-0361 or complete the coupon below. We'll make printing easy for you.

*U.S. prices only.



IN THE U.S. AND NON-EUROPEAN COUNTRIES: John Fluke Mfg. Co., Inc. P.O. Box 43210 MS #2B Mountlake Terrace, WA 98043 (206) 774-2481 Telex: 32-0013

IN EUROPE: Fluke (Holland) B.V. P.O. Box 5053, 5004 EB Tilburg, The Netherlands (013) 673 973 Telex: 52237

- Tell me more about easy printing.
- Send me a literature package.
 - Let's not mess around - arrange a demo.
 - I'm a competitor - How'd you make printing so easy anyway?

Name _____

Title _____ Mail Stop _____

Company _____

Address _____

City _____ State _____ Zip _____

Telephone () _____ Ext. _____

For literature circle no. 183

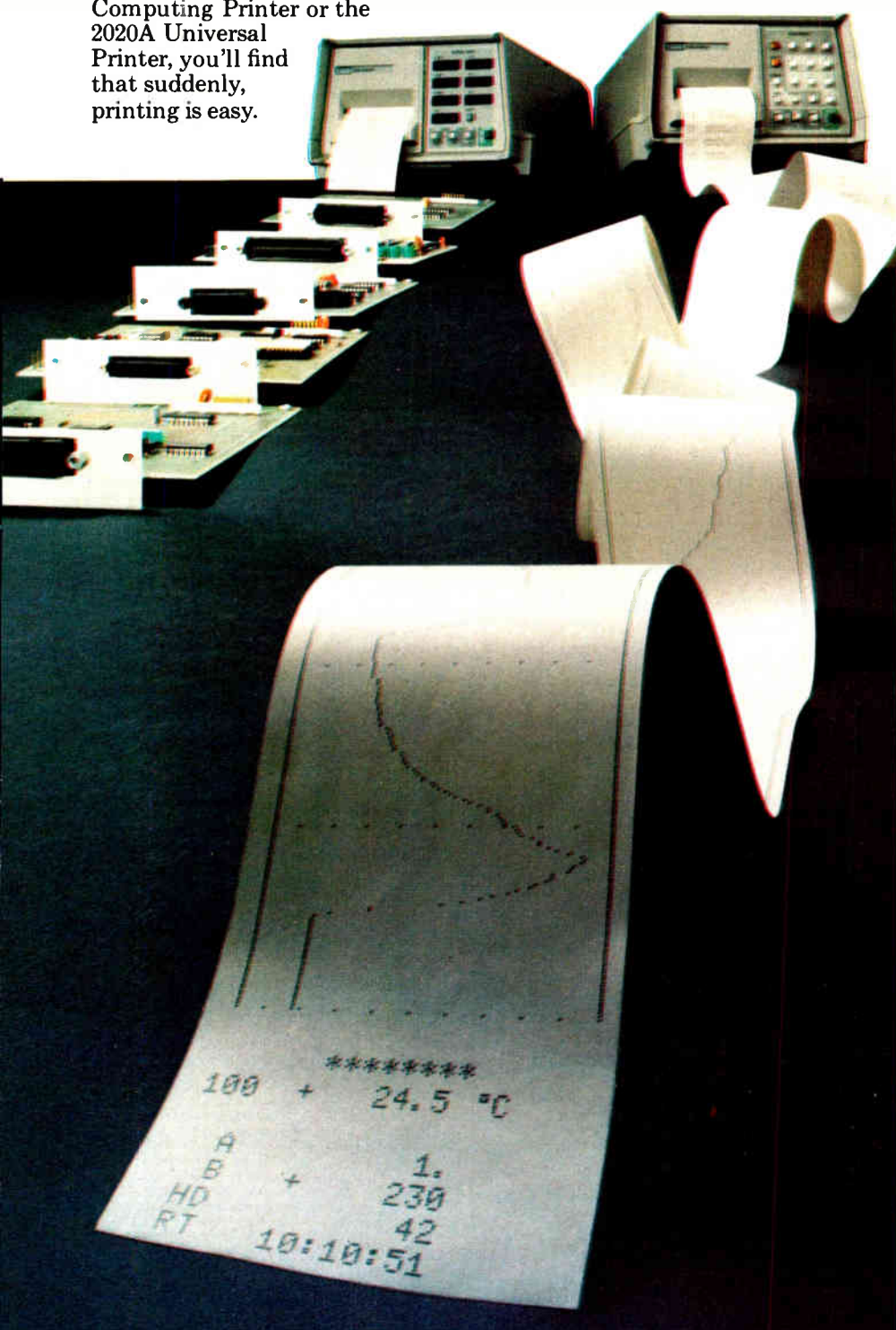

100 + 24.5 °C
A + 1.
B + 230
HD + 42
RT 10:10:51

You get more with Hamlin relays.

You get the quality of manufacture and the dependability performance you have come to expect from Hamlin. Dry reed, mercury-wetted, or solid-state; chassis, PCB or octal base mounting; there's a Hamlin relay to fit your logic level control circuits. Exactly!

And there's more. A single in-line unit requiring only 1/2 in² board space, and yet retaining all of the control features of conventional SSR's.

Hamlin relays* provide long life, modest cost, zero switching, 2500V isolation, 600V blocking and UL recognition.

Stocked by distributors the world over for immediate delivery, write or call for more information!

*Not all features available on all models.

Hamlin, Inc.
Lake & Grove Sts.
Lake Mills, WI 53551
414/648-2361

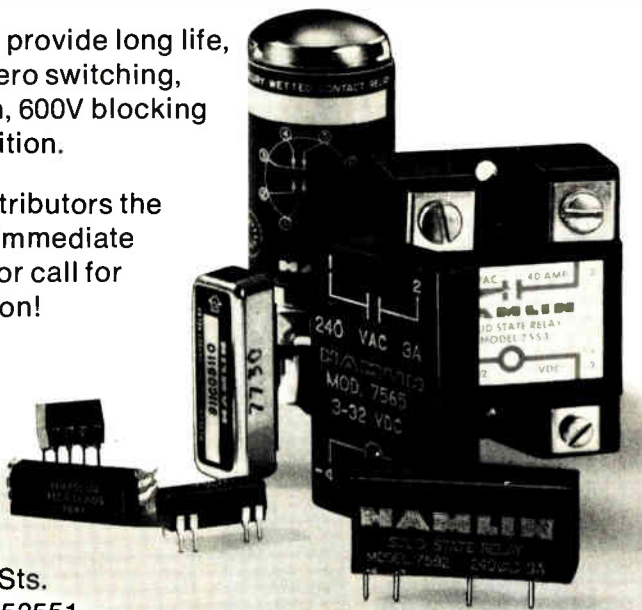

HAMLIN

INCORPORATED

1762

Circle 184 on reader service card

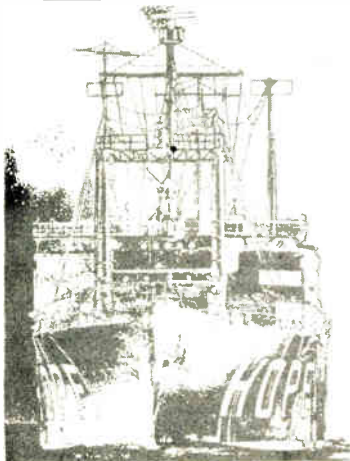

HOPE The project a ship launched.

First there was the hospital ship S.S. HOPE, now retired. Today HOPE is an established project which has carried its goal of improving health through education to 24 developing countries of the world and the United States.

Give to:

PROJECT HOPE Department R
Washington, D.C. 20007

New products

package of the future."

Both diode series contain three models—units with 50-v, 100-v, and 150-v peak-inverse-voltage ratings. Operating and storage temperature range for all models is -55° to +150°C. At 25°C ambient temperature, the UES1401 and UES2401 rectifiers have maximum outputs of 3 A. The use of a Wakefield-type 295 heat sink with convection cooling increases their respective outputs to 8 A and 10 A. At a case temperature of 125°C, the 1401's output is 8 A and 2401's is 16 A.

Prices range from \$1.55 to \$2.05 each (in 100-piece quantities) for the UES1401 and from \$2.32 to \$3.05 apiece (also in 100s) for the UES2401. Delivery is from stock.

Unitrode Corp., 580 Pleasant St., Watertown, Mass. 02172 Phone (617) 926-0404 [413]

Power transistors meet JAN specifications

The JAN 2N174A and JAN 2N1358 are germanium power transistors satisfying JAN specifications MIL-S-19500/13 and MIL-S-19500/122. The devices, which have high-current and high-power capabilities, are housed in hermetically sealed TO-36 packages.

The 2N174A and the 2N1358 are characterized by collector-to-emitter voltages of 55 v and 44 v, respectively, and saturation voltages of 0.9 v and 0.7 v at 12 A, respectively. Both display a minimum gain of 25 at 5 A.

In 100-unit quantities, the JAN 2N174A and the JAN 2N1358 sell for \$6.75 each. They are manufactured in house, and delivery is from stock.

Silicon Transistor Corp., Katrina Road, Chelmsford, Mass. 01824. Phone William Schromm at (617) 256-3321 [416]

Low-voltage silicon rectifiers recover in 150 ns

Featuring recovery times as brief as 150 ns, four new series of low-

How to put μ P with the mad, mad world of product development.

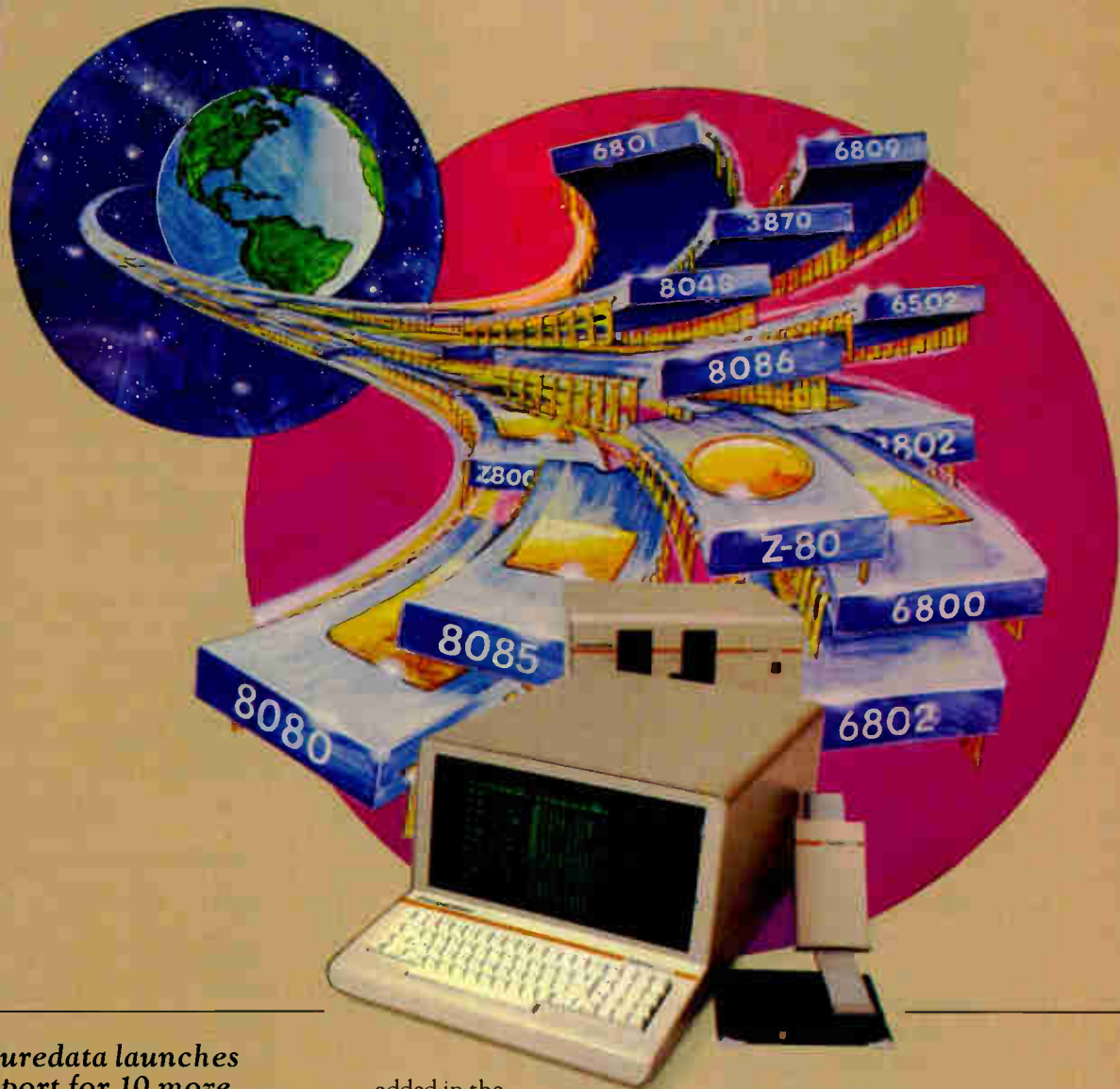

Futurdata launches support for 10 more processors.

We can help you stay ahead in the race for new microprocessor-based product designs. Our universal 2300 series Advanced Development Systems already support five chips . . . now we're adding support for ten more.

Assemblers are available now for all 15 processors. High level language compilers, relocating macroassemblers, disassembling debuggers, in-circuit emulators and logic analyzers are ready now for the 8085, 8080, 6800, 6802 and Z-80. This full level of software/hardware support will be

added in the coming year for ten more processors, giving you the widest choice of processors ever: 8086, Z-8000, 6809, 3870, 3872, 3874, 8048, 6502, 1802, 6801, 8080, 8085, 6800, 6802 and Z-80.

There is no finish line in this race. To stay ahead you need a flexible, expandable development system and a supplier with staying power: 2300 series advanced hardware/software development systems, stations and networks from GenRad/Futurdata. Sales office: 6151 West Century Boulevard, Suite 1124, Los Angeles, CA 90045. (213) 641-7200. TWX: 910-328-7202.



GenRad

futurdata

Circle 185 on reader service card

Who stole page 39?



This whodunit happens all the time. By the time the office copy of Electronics Magazine gets to your name on the routing slip, a page is missing. Or maybe the reader service cards. Or an entire article has been clipped. Sometimes you never get the magazine at all.

Other times the magazine is (glory be!) intact. But dogeared. Or otherwise abused. Or at the very least, you get it late.

O.K., we'll grant that a second-hand, third-hand, or maybe seventh-hand copy of Electronics is better than none. But it's no substitute for the copy that comes directly to you—to your home if you wish—with up-to-the-minute news and information of the technology in this fast-moving field.

To get your very own subscription to Electronics send in a subscription card from this magazine. And if they are missing, write to subscription department, Electronics, McGraw-Hill, 1221 Avenue of the Americas, New York, N.Y. 10020.

Electronics Magazine.
The one worth paying for.

New products

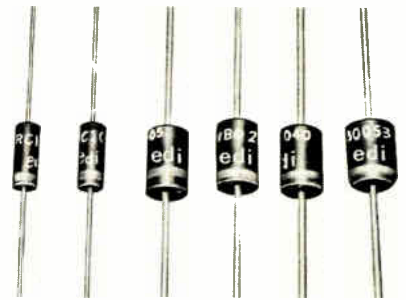

voltage silicon rectifiers are now available. The RC series is rated at 1 A, the RAB and RJB at 3 A, and the RWB at 5 A. With high surge capabilities up to 350 A, the diodes have peak reverse voltages as high as 1,000 v.

Diodes in the RAB, RJB, and RWB series are 0.38 in. long by 0.26 in. in diameter, with 1-in. leads that are 0.05 in. in diameter. The RC diodes are the same length, with a 0.16-in. diameter and 1-in. leads that are 0.03 in. in diameter.

In 100-piece quantities, with a 400-v rating, the diodes have the following unit prices: the RC series, 43¢; the RAB series, \$1.60; the RJB series, \$1.80; and the RWB series, \$1.85. Delivery is from stock.

Electronics Devices Inc., 21 Gray Oaks Ave., Yonkers, N. Y. 10710. Phone Dennis Dean at (914) 965-4400 [415]

Tl's 4-bit microcomputers have 4-, 0.5-K-byte ROM

Expanding the family of TMS 1000 devices, Texas Instruments has recently announced the addition of two new microcomputers. The TMS 1400 series is a 4-bit single-chip microcomputer with read-only mem-

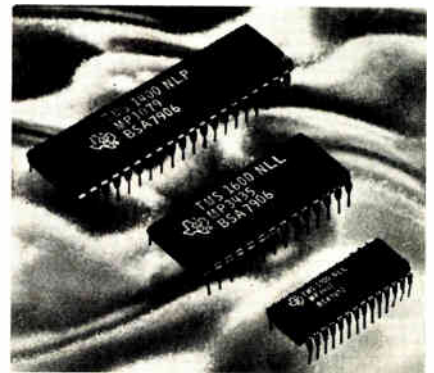

Credibility

**We do what we say we're going to do.
If that's what you want, you want us.**

**We're setting the pace for the '80s in the
semiconductor industry.**

Send us your resume.

**Signetics, MS 800, 811 East Arques Avenue,
Sunnyvale, CA 94086. (408) 739-7700.**

We're an equal opportunity employer m/f.

The Good People Company.

Signetics

a subsidiary of U.S. Philips Corporation



**FREE
SAMPLES.**

See for yourself
why design engineers
specify more CTS cermet resistor networks
than any other make.

There is one large overriding reason. Reliability! Each CTS SIP and DIP network is 100% value and tolerance tested before shipment. And, with more than 1 billion element hours of extended load life testing, CTS resistors have exhibited a failure rate of only 0.00047%/1,000 hours @ a 95% confidence level.

CTS networks are built reliable...using top quality materials, precision screening equipment, proprietary cermet formulations and computer controlled lasers for fine tolerance adjustment. Terminals are anchor-locked into the substrate

for maximum mechanical and electrical reliability.

CTS has been a leader in custom designed circuits for over 15 years. Ask us about customizing your special network requirements or choose from 400 standard part numbers available off the shelf from authorized CTS distributors.

For the utmost in cermet network reliability, quality and availability, you can't choose a better network source than CTS. Send for your free samples and resistor network catalog today. Write CTS of Berne, Inc., 406 Parr Road, Berne, Indiana 46711. Telephone: (219) 589-8220.

CTS CORPORATION
ELKHART, INDIANA



A world leader in cermet and variable resistor technology.

New products

ory organized as 4 K by 8 bits and random-access memory organized as 128 by 4 bits. This is twice the ROM and the same amount of RAM as is on the TMS 1100.

The TMS 1700, also a 4-bit single-chip microcomputer, features half the ROM (512 by 8 bits) and half the RAM (32 by 4 bits) of the TMS 1000.

The new microcomputers are manufactured using p-channel MOS technology and are architecturally compatible with other members of the TMS 1000 family. The entire family is made up of single-chip microcomputers that are mask-programmed for customers' functional applications. Operating voltage options include those for -15-v power supplies and a -9-v battery.

Design support for the entire TMS 1000 family includes: system evaluators with an external erasable programmable ROM, a development system for application-program development, and assemblers and simulators that are accessible through time-sharing.

The price for the TMS 1400 is less than \$3.50 in production-quantity volumes and for the TMS 1700 it is less than \$1.50 in similar quantities.

Texas Instruments Inc., P. O. Box 1443, Mail Station 6404, Houston, Texas 77001 [414]

V-MOS power transistors in TO-3 package sell for \$16.05

With voltage ratings from 300 to 450 v and a current rating of 4 A, the VN03 family of n-channel V-groove MOS power transistors is the first in a series of high-voltage V-MOS transistors to be announced by Supertex Inc. Transistors with both higher and lower current ratings will be available before the year's end; they, too, will be made with a high-voltage process.

Packaged in a TO-3 case, these transistors have a threshold range of 1-to-3-v and a high gate-input impedance that allows them to interface low-voltage analog or digital circuits directly with higher-voltage devices. With a typical on-resistance



NEW

RF CAPACITORS FOR A NEW MEASURE OF PERFORMANCE

ITT Jennings RF Capacitors may be a new name to you, but relax. We have been in the RF Components business for over 30 years. Our new line of RF titanate capacitors was specifically designed to provide the highest KVA ratings available for applications that demand long life and reliability.

The new 50, 57, and 58 Series of RF Capacitors offer capacitance ranges from 25 to 1000 pF, and voltage ranges from 5-15 KVDC. These new RF Capacitors also feature a variety of dielectric materials to provide you with maximum design flexibility. Our complete environmental and RF test labs will allow us to test these capacitors to any specifications you desire.

Check with our applications people and find out why our new line of capacitors will measure up to your highest expectations. After all, we have a 30 year reputation to maintain. Write us at 970 McLaughlin Avenue, San Jose, CA 95122, or give us a call at (408) 292-4025.

JENNINGS **ITT**

Circle 189 on reader service card

The magazine you're reading now could be your own.

Drop off the routing list. Get your own fresh, unclipped copy mailed to your home or office. Turn to the subscription card in the back of the magazine. If somebody has beat you to it, write: Electronics, P.O. Box 430, Hightstown, N.J. 08520.



flat cable

WIRE STRIPPERS

The finest electric, pneumatic and manual strippers available anywhere. Comes in four models . . . each designed to perform a specific task on flat cable of any type or size. Production proven, rugged and efficient. Flat cable cutter also available. Catalog upon request.

FREE WIRE STRIPPING SERVICE

Send a 3-5 ft. sample of your cable or wire and strip specifications. Stripped wire will be returned to you with a complete report and recommendations.

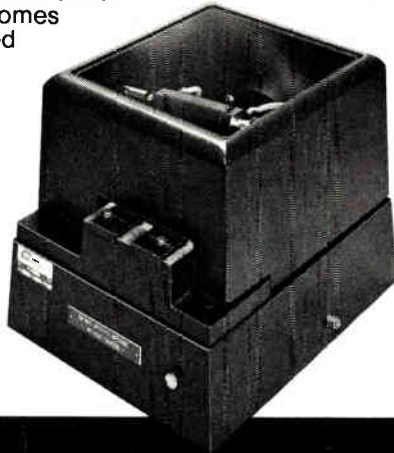

Fairgrounds Drive, Manlius, N.Y. 13104
(315) 682-9176

Circle 190 on reader service card

Achieve maximum cooling in minimum space.

High Fin Density heat sinks and extrusions from E G & G Wakefield Engineering provide over 50% greater heat dissipation in the same volume. This is greater heat dissipation per unit volume than is possible with any other extrusion. Ten standard configurations are available. Each based on a patented design concept that has made high fin density the leader in cooling efficiency. For use in both natural and forced convection applications. High fin density extrusions are in-stock and are competitively priced. That's why... if it has to do with heat dissipation... people throughout the electronics industry call us.



60 Audubon Road, Wakefield, MA 01880 617/245-5900

190 Circle 37 on reader service card

New products

of 1.5 Ω , this family of transistors should find use in many applications.

The TO-3 packaging allows the devices to be used in high-power-dissipation applications; the units are also available in the TO-39 package for lower-power applications, as well as in chip form for use in hybrid circuits.

The 400-v VN03 in the TO-3 package is priced at \$16.05 in 1,000-piece quantities. If housed in the TO-39 package, the VN03 sells for \$13.13 in 1,000-unit lots. The company expects to introduce VN03 devices in TO-220 packages during the first quarter of 1980.

Supertex Inc., 1225 Bordeaux Dr., Sunnyvale, Calif. 94086. Phone (408) 744-0100 [417]

Mask-programmable IC synthesizes 28 basic tunes

The AY-3-1350, a mask-programmable integrated-circuit tune synthesizer, can generate up to 28 different tunes or any combination of tunes consisting of up to 252 notes. This n-MOS device, operating from a 5-v power supply, will provide up to two minutes of music; it is well suited for battery applications because it can be wired into the

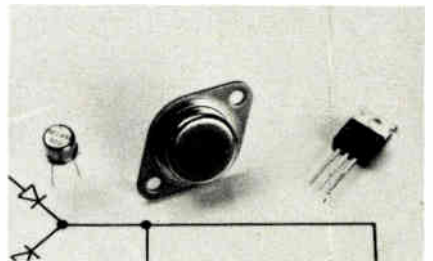

circuit so that it consumes practically no power when in the standby mode. The standard AY-3-1350 is available from stock in both sample and production quantities. The 1-to-24-piece price is \$11.25 each, with the price dropping to \$6.30 each in 1,000-unit volumes.

General Instrument Corp., Microelectronics Division, 600 West John St., Hicksville, N. Y. 11802. Phone Marty Burden at (516) 733-3120 [418]

Three new TM 500 Digital Multimeters give you more performance choice...

from Tektronix.



Introducing:

- **DM 501A**
4½ digits, true rms, dB, .05% accuracy, seven functions.
- **DM 502A**
3½ digits, true rms, autoranging including dB, seven functions.
- **DM 505**
3½ digits, five functions.

We've put the best combination of accuracy and convenience into compact, affordable DMM's. Simply put them to the test. These versatile DMM's are at home everywhere, making your electronics tests faster and easier.

Choose seven function capability, including dB and temperature, from the new DM 501A and DM 502A. Increase your accuracy with the 4½ digit DM 501A, featuring true rms capability and 10 μ V resolution. The 3½ digit DM 502A features autoranging in voltage, resistance, and dB, plus true rms capability. Add the all-around testing capabilities of our low-cost DM 505, and you've got a digital multimeter for practically every purpose.

They're all part of the TM 500 family. Just plug them into any TM 500 Mainframe to make on-site, rack, or bench measurements. Combine them with any other TM 500 instruments to build a compact test set just right for your application.

And, there's even more to these new DMM's. They give you Tektronix reliability, too. Add TM 500 configurability and modularity, and you get more testing clout for your dollar.

To learn more about these new TM 500 Digital Multimeters, contact the Tektronix Field Office nearest you. For a copy of our TM 500 Digital Multimeter Data Sheet, call our toll-free, automatic answering service: 1-800-547-1512. In Oregon, call collect: 644-9051. Or, send your request on your letterhead to Tektronix, P.O. Box 500, 76/260, TM 500 A6, Beaverton, OR 97005. In Europe: Tektronix International Inc., European Marketing Centre, Postbox 827, 1180 AV Amstelveen, The Netherlands.

TM 500
Designed for
Configurability

Tektronix
COMMITTED TO EXCELLENCE



How to find the hidden expenses in buying an ATE system before they find you.



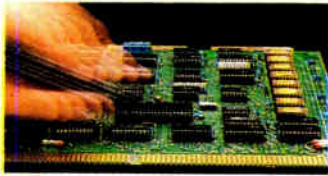

GenRad's in-circuit test systems employ a simple SCRATCHPROBING™ technique to quickly pinpoint faults—cutting labor costs up to \$50 a board.

The secret is to know what to look for.

Take digital in-circuit test systems, for example. Most of them cost roughly the same to buy as GenRad's.

But they don't cost the same in the long run. Far from it.

That's because only GenRad's test systems can easily differentiate between an interconnect failure and a faulty device. So you can pinpoint the problem to its exact location in seconds—not minutes. That cuts repair time and

labor costs dramatically. And saves you as much as \$50 a board.

Looking for a functional tester? Watch out for the set-up costs. They can really set you back. The answer? GenRad's functional testers. They run on our unique CAPS Interactive Test Generation system, with a library of over 1,000 complex devices. As a result, your programming time and set-up costs are reduced substantially. Often by \$100,000 or more.

Finding the hidden expenses in IC testing is easier. Basically, the problem is paying for a big test system with lots of diagnostic and programming capability that you'll never need. GenRad's solution is to give you the capabilities you really want—for one-fourth the price.

Shopping for a microprocessor development system? Then make sure you pay special attention to the emulation package. If it only operates at one-half speed, it may not catch a problem till you've reached the production stage. And that's expensive.

To detect every bug as early (and cheaply) as possible, you need a full-speed emulator. And we don't have to tell you who makes the only one in the industry.

Finally, there's field testing, where the biggest expense is spare board inventory. Turnaround time on a bad board can run 3 to 15 months. And tie up 5 to 10% of your gross sales.

GenRad's answer is a functional field tester that's small and inexpensive enough for any field office or depot. It cuts turnaround time to 5 minutes or less. And that can save you millions in financing alone.

So before the hidden expenses in ATE equipment find you, you ought to find out more about us.

For complete details, write GenRad, Concord, MA 01742.



GenRad digital IC test systems offer you big system capabilities—including MSI and LSI testing—at one-quarter the big system price.



GenRad's functional field tester lets you diagnose and repair bad boards in the field, reducing spare board inventory that can tie-up 5 to 10% of your gross sales.



Nicolet EXPLORERS

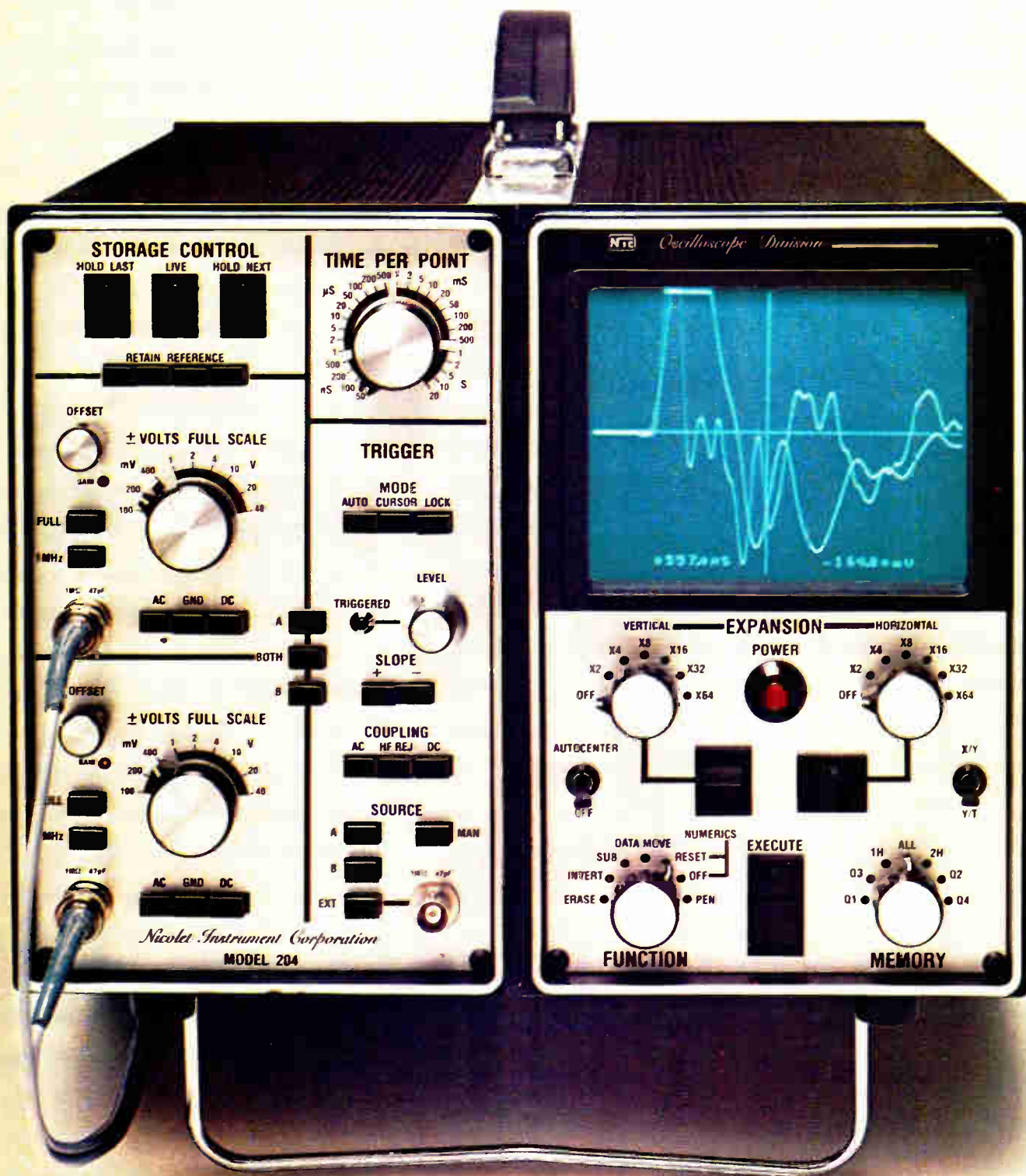

... as easy as I, II, III

Three precise, high resolution digital oscilloscopes for analog signals

- Easy operation—storage at the touch of a button
- High precision
- Clear, concise display with no bloom, fade or flicker
- Excellent hard-copy graphics
- Optional digital records via internal disk recorder
- Retroactive sweep trigger
- XY or YT operation
- 20 times better resolution
- Display expansion to 64X, both axes
- Superimposed stored & live, stored & stored or live & live waveforms
- Optional parallel 12 bit, RS-232C and IEEE-488-GPIB interfaces



**NICOLET
INSTRUMENT
CORPORATION**

OSCILLOSCOPE DIVISION

5225 Verona Road, Madison, Wisconsin 53711
Telephone: 608/271-3333
TWX: 910-286-2737

EXPLORERS OUTPERFORM:

- Low frequency analog scopes
- Low frequency storage scopes
- Transient recorders
- XY recorders
- Strip chart recorders
- Light beam recorders
- Other digital oscilloscopes

EXPLORER I is priced at \$3,990 (U.S. domestic list price).

NICOLET, WHO'S NICOLET?

Nicolet is a leading manufacturer of digital electronic measurement instruments (signal averagers and FFT spectrum analyzers), analytical instruments (FT-IR and FT-NMR spectrometers), biomedical computers and digital graphic plotters. Nicolet's expertise in high technology digital instrumentation led to the first digital oscilloscope in 1973.

To learn how the EXPLORERS can help you, call toll free, **1-800/835-2246** (in Kansas, **1-800/362-2421**) and request our new brochure. To discuss your application or to arrange a demonstration, call **608/271-3333**.

SALES AND SERVICE OFFICES WORLDWIDE

HP presents a computer Start today.

At Hewlett-Packard, we've participated in the growth of networking for distributed systems right from the start. So we've had time to iron out a lot of the problems that go with it.

One problem was how to implement a distributed network today without limiting the growth needs of your company tomorrow. The answer: HP's Distributed Systems/1000—an advanced, real-time interactive communications package that you can install today without worrying about what changes the future may bring. DS/1000 gives you full system-to-system communications with the design flexibility to preserve your software investment, as well as accommodate the rapid advancements in computer technologies.

Rings, strings, stars: you name it.

No matter what configuration you need, HP's "layered" software approach lets you structure your network in a way that makes sense for your applications. You can arrange HP 1000 systems in star, ring, or string configurations—or any combination of them. Information passes from one system to another through intervening network nodes on an automatic "store-and-forward" basis without special instructions in your application software. And because you can access any system by simply specifying its node number, you can use the network just as easily from a remote terminal as from a local station.

With DS/1000, you can link workstations with-

in a department as well as connect several departments on the factory floor (incoming inspection, final test, and quality control, for example). Or, you can link local manufacturing divisions to a host IBM mainframe or HP 3000 business system in your corporate EDP center. You can even create a nationwide network to coordinate geographically dispersed information.

All together. Now.

HP has a full range of real-time compatible hardware for implementing distributed computer networks—from terminals and interconnection hardware to sophisticated technical computers. A powerful data base management package with remote



network for manufacturers.

Expand tomorrow.

access capabilities will put the information you need right at your fingertips. And the modular software design will assure your orderly growth by allowing

you to add to, or reconfigure, your DS/1000 network without affecting your existing programs.

Our long experience as a supplier of distributed systems means that HP's advanced technology is available now. Since 1973, HP computers have been installed in distributed networks around the world, all backed by extensive support systems.



If you'd like to know more about the HP 1000 computer system in distributed networking applications, call your nearest HP office listed in the White Pages and ask for a hands-on demonstration. Or for more information, write Hewlett-Packard, Attn: Roger Ueltzen, Dept. 654, 11000 Wolfe Road, Cupertino, CA 95014.

HEWLETT  PACKARD

Circle 197 on reader service card



Wide Band, Precision CURRENT MONITOR TRANSFORMER

With a Pearson current monitor and an oscilloscope, you can measure pulse or ac currents from milliamperes to kiloamperes, in any conductor or beam of charged particles, at any voltage level up to a million volts, at frequencies up to 35 MHz or down to 1 Hz.

The monitor is physically isolated from the circuit. It is a current transformer capable of highly precise measurement of pulse amplitude and waveshape. The one shown above, for example, offers pulse-amplitude accuracy of + 1%, -0% (typical of all Pearson current monitors), 10 nanosecond rise time, and droop of only 0.5% per millisecond. Three db bandwidth is 1 Hz to 35 MHz.

Whether you wish to measure current in a conductor, an electron device or a particle accelerator, it is likely that one of our off-the-shelf models (ranging from ½" to 10½" ID) will do the job. Contact us and we will send you engineering data.

PEARSON ELECTRONICS, INC.

4007 TRANSPORT ST. / PALO ALTO, CA 94303
TELEPHONE (415) 494-6444 / TELEX 171 412

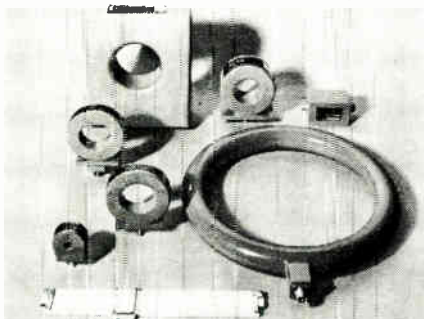

New products

Packaging & production

Zoner handles 4-in. rods

Rf furnace for preparing
single-crystal silicon
pays for itself in a year

Most single-crystal silicon used today is made by the well known Czochralski method, which yields crystals of sufficient purity for the manufacture of integrated circuits. When greater purity is needed—for

the manufacture of fast-switching power devices, for example—zone refining is usually employed. This process, in which a heated zone is made to travel the length of a polysilicon rod, has been limited until now to rod diameters of 3 in. or less.

After 2½ years of development, Siemens Corp. is changing this picture with its model VZA9, a float-zoner capable of turning out high-quality, high-yield single-crystal rods with diameters up to 4 in. The VZA9 has the potential for zone-refining 5-in. polycrystalline material, but this operation has yet to be perfected.

The machine takes a 1,500-mm feed rod (competitive units use

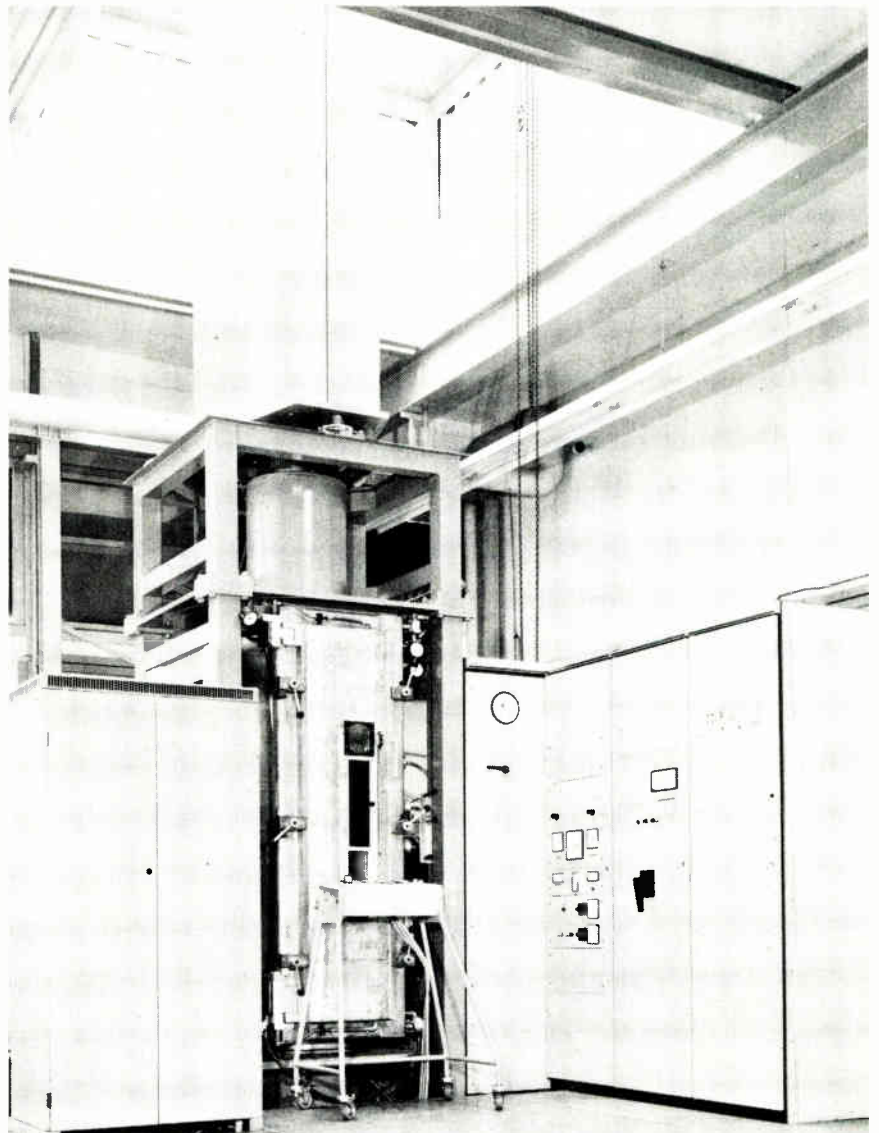



**YOUR
IMAGINATION
IS OUR ONLY
LIMITATION.
ITT CANNON
FIBER OPTICS.**

When it comes to developing a fiber optics system, we are the source to come to. Within ITT Cannon and the other ITT companies worldwide are the knowledge and the resources to get the job done. From connectors to fibers to connectors—we do it all.

ITT Cannon. For six decades you've been coming to us for your connector needs. Now, think of

us as your fiber optics connection.

For further information, contact Fiber Optics Marketing Manager, ITT Cannon Electric, 666 East Dyer Road., Santa Ana, CA 92702. Toll-free 24 hours (800) 854-3573; in California (800) 432-7063.

CANNON ITT

Six decades on the leading edge of interconnect technology.

Circle 199 on reader service card

6 NEW WAYS TO COST-EFFECTIVE CALIBRATION

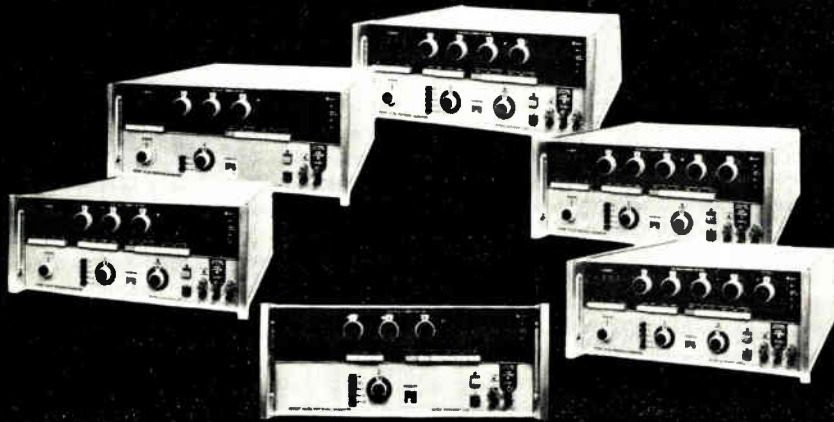

Why pay more than you need to for calibration? ROTEK's new series of precision calibrators lets you match the equipment to the job.

Each of ROTEK's six new 3900-Series models is a complete, stand-alone, multi-purpose calibrator for checking a broad range of digital and analog voltmeters, ammeters, ohmmeters and multimeters.

At the least expensive end of the series (*U.S. prices start as low as \$3195*), is the Model 3910, providing DC and AC current and voltage calibration with three decades of setting resolution. At the other extreme, the Model 3960 provides five decades of resolution, AC and DC current and voltage calibration, resistance calibration and percent error display. Other models include a fractional setting control and BCD readout of error for data logging.

ROTEK
INSTRUMENT CORP.

Send for the new
Series 3900 catalog.

220 GROVE STREET/BOX 504, WALTHAM, MASS. 02254/TEL: 617-899-4611

Circle 200 on reader service card

1979 Electronics Buyers' Guide



The only book of its kind in the field. If you haven't got it, you're not in the market.

To insure prompt delivery enclose your check with this coupon.

1979 edition available in June.

Electronic Buyers Guide
1221 Ave. of the Americas
New York, N.Y. 10020

Yes, please send me _____ copy(ies) of 1979 EBG.
 I've enclosed \$30 per copy delivered in the USA or Canada.
 I've enclosed \$52 per copy for delivery elsewhere
 Name _____
 Company _____
 Street _____
 City _____ State _____ Zip _____

New products

1,000-mm rods). Extremely smooth electronically controlled dc motors drive both the feed rod and the seed crystal support mechanisms. The same type of vibration-free motors are also used for the rotation drives of the pulling shafts.

Optimum heating of large-diameter rods required the design of a special thyristor-controlled radio-frequency generator as well as a (patented) rf coil.

The zoner itself, as the photo shows, is a major installation, which costs about \$500,000 to \$600,000. Studies conducted at Siemens indicate that going from 3 to 4-in. silicon rods can save about \$600,000 a year because of increased production of refined silicon. This savings almost writes off the cost of the machine in its first year of operation.

Siemens will soon install five of these systems in its IC facilities in Germany. Within a year, the company expects to have made several sales of the unit to U. S. firms.

With the advent of extremely dense circuit details on silicon wafers, IC manufacturers are now starting to look at the use of float-zoned material for VLSI and bubble memories. Float-zoned material has the advantage of a high level of homogeneity, which could result in higher yields for VLSI products.

Siemens Corp. 186 Wood Avenue South, Iselin, N. J. 08830. Phone (201) 494-1000 [391]

Connectors simplify, speed mounting of TO-220 devices

Designed to correct the overheating problems encountered when soldering TO-220 devices to printed-circuit boards, Amphenol series 146 mounting connectors offer simplified solderless attachment at speeds up to five times faster than with ordinary solder methods. The connector body, contacts, and other parts of the device are constructed of materials specified under UL 310 and other related standards.

The connector features crimp contact connections to allow faster,

Challenge any wave with electrifying confidence.

Now you can say good-bye to waveform jitter and triggering instabilities, with the new B&K-PRECISION Model 1535 dual-trace oscilloscope. The 1535 offers a full complement of features and high performance specs to more than meet your challenges.

The B&K-PRECISION 1535 is one of the few dual-trace scopes available with an alternate triggering mode. In this mode, the trigger source is sampled from channel A or channel B on alternate sweeps. With alternate triggering, you'll be able to display two stable signals that are unrelated in frequency. As in much more costly dual-beam scopes, the use of one channel is not dependent on the triggering signal at the opposite channel. Many other trigger source positions can be selected.

Other significant features include variable hold-off, for accurate display of pulse trains;

single sweep, for non-repetitive waveforms; and even UNCAL "reminder" LEDs for sweep and input level verniers. A video sync separator is standard, for use with video circuits or computer terminals.



With 2mV sensitivity and flat 35MHz bandwidth, the 1535 will display most any signal you're likely to encounter. For observation of the leading edge of fast digital pulse signals, a signal delay is built-in. The 1535 is especially well suited for microprocessor work.

Also new from B&K-PRECISION is the 1520 dual-trace scope. This 20MHz scope offers many of the features found on the 1535. It's a cost-effective substitute for more costly scopes, when a 20MHz bandwidth is all that's required. The 1520 offers a 10 times sweep magnifier, 5mV/cm vertical sensitivity and independent chop/alternate display selection.

The 1535 and 1520 scopes are available now. For immediate delivery, a ten-day free trial or in-plant demonstration, contact your local B&K-PRECISION distributor.

For Additional Information Circle #138
For Free Demonstration Circle #139

BK PRECISION DYNASCAN CORPORATION

6460 W. Cortland Street • Chicago, IL 60635 • 312/889-9087

In Canada Atlas Electronics Ontario International Sales Empire Exporters Inc. 270 Newtown Road, Plainville, L.I., N.Y. 11803

B&K-PRECISION
Model 1535 \$1240;
Model 1520 \$940.
Other oscilloscopes
from \$255.



Electronics Magazine Books Offers You:

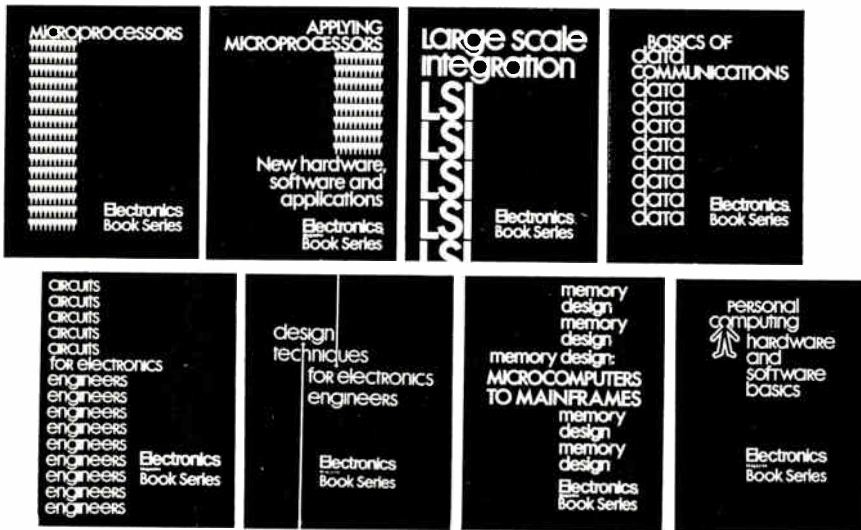

New products

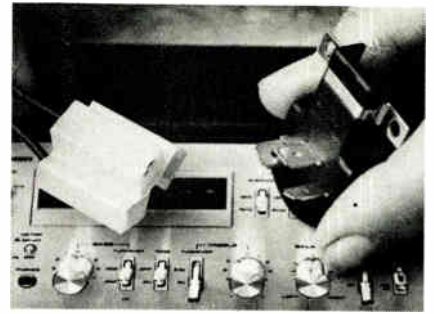

simpler, and more economical attachment of TO-220 leads than with soldering: all three leads are crimped simultaneously to allow high-volume assembly, and a metal mounting strap ensures simple, positive connection to a heat sink. The connector also features individual wires that attach to separate mating terminals; alternatively, the user may choose an optional polarized plug that accepts three mating terminals.

Traditionally, TO-220 devices have been difficult to mount and are prone to overheating because the devices' internal heat-sink plates are attached to one of three leads and are therefore electrically hot. But with the series 146 connectors, the unit's heat-sink back, when mounted, is pressed into contact with the external heat-sink surface. Positive contact between the heat-sink plate and the heat-sink surface is maintained by the metal mounting strap.

Each connector is priced at 40¢ in production quantities. The units are available as off-the-shelf items.

Amphenol North America, Bunker Ramo Corp., General Offices, 2122 York Rd., Oak Brook, Ill. 60521 [393]

Lossy wire attenuates microwave noise

Lossyline is a flexible wire designed to act as a filter for the suppression of noise and electromagnetic interference generated by such electronic equipment as computers and microwave tubes. By forcing unwanted electromagnetic energy into the Lossyline material, where it is absorbed and dissipated, the wire virtually eliminates mismatch and electro-

- 1. Microprocessors** What you must know about available microprocessor technology, devices, information, 4th printing. \$8.95
- 2. Applying Microprocessors** 2nd and 3rd generation technology. 26 detailed applications from data networks to video games. \$9.95
- 3. Large Scale Integration** Covers the basic technology, new LSI devices, LSI testing procedures, plus system design and applications. \$9.95
- 4. Basics of Data Communications** Includes 47 articles from Data Communications magazine covering more than 11 key areas. \$12.95
- 5. Circuits for Electronics Engineers** Contains 306 circuits arranged by 51 functions from Amplifiers to Voltage Regulating Circuits. Saves design drudgery. \$15.95
- 6. Design Techniques for Electronics Engineers** Nearly 300 articles drawn from "Engineer's Notebook." A storehouse of design problem solutions. \$15.95
- 7. Memory Design: Microcomputers to Mainframes** The technology, devices, and applications that link memory components and system design. \$12.95
- 8. Personal Computing: Hardware and Software Basics** More than 50 articles from leading publications, including specifications, helpful hints, subject index. \$11.95

Electronics Magazine Books P.O. Box 669, Hightstown, NJ 08520
I must be fully satisfied or you will refund full payment if the book is returned after ten-day trial examination. Send me:

- _____ copies of 1. *Microprocessors* @ \$8.95
 _____ copies of 2. *Applying Microprocessors* @ \$9.95
 _____ copies of 3. *Large Scale Integration* @ \$9.95
 _____ copies of 4. *Basics of Data Communications* @ \$12.95
 _____ copies of 5. *Circuits for Electronics Engineers* @ \$15.95
 _____ copies of 6. *Design Techniques for Electronics Engineers* @ \$15.95
 _____ copies of 7. *Memory Design: Microcomputers to Mainframes* @ \$12.95
 _____ copies of 8. *Personal Computing: Hardware and Software Basics* @ \$11.95

Discounts of 40% on orders of 10 or more of each book.

Payment enclosed Bill firm Bill me

Charge to my credit card:

American Express Diners Club
 Visa Master Charge

Acct. No. _____ Date Exp. _____

On Master Charge only, first numbers above name _____

Name _____ Title _____

Company _____

Street _____

City _____ State _____ Zip _____

Signature _____

Sharpen your competitive edge with A-B resistive components.

When you specify Allen-Bradley components, you put greater assurance of reliability into your products. You also share in A-B's nationwide reputation for high quality. In addition, our in-depth factory and distributor stocks (at competitive prices) make it easier for you to meet your delivery commitments. In short, our competitive edge can add to your competitive edge.

Fixed resistors hot-molded composition and cermet.

Resistor networks thick film (cermet) and thin film (precision).

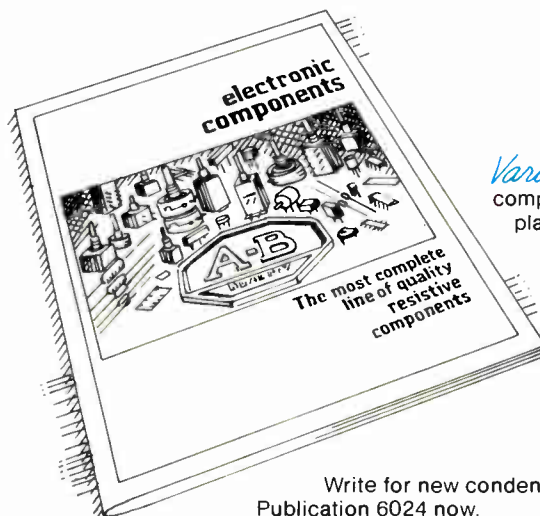

Variable resistors hot-molded composition, cermet and conductive plastic.

Trimmers hot-molded composition and cermet.

Write for new condensed catalog, Publication 6024 now.

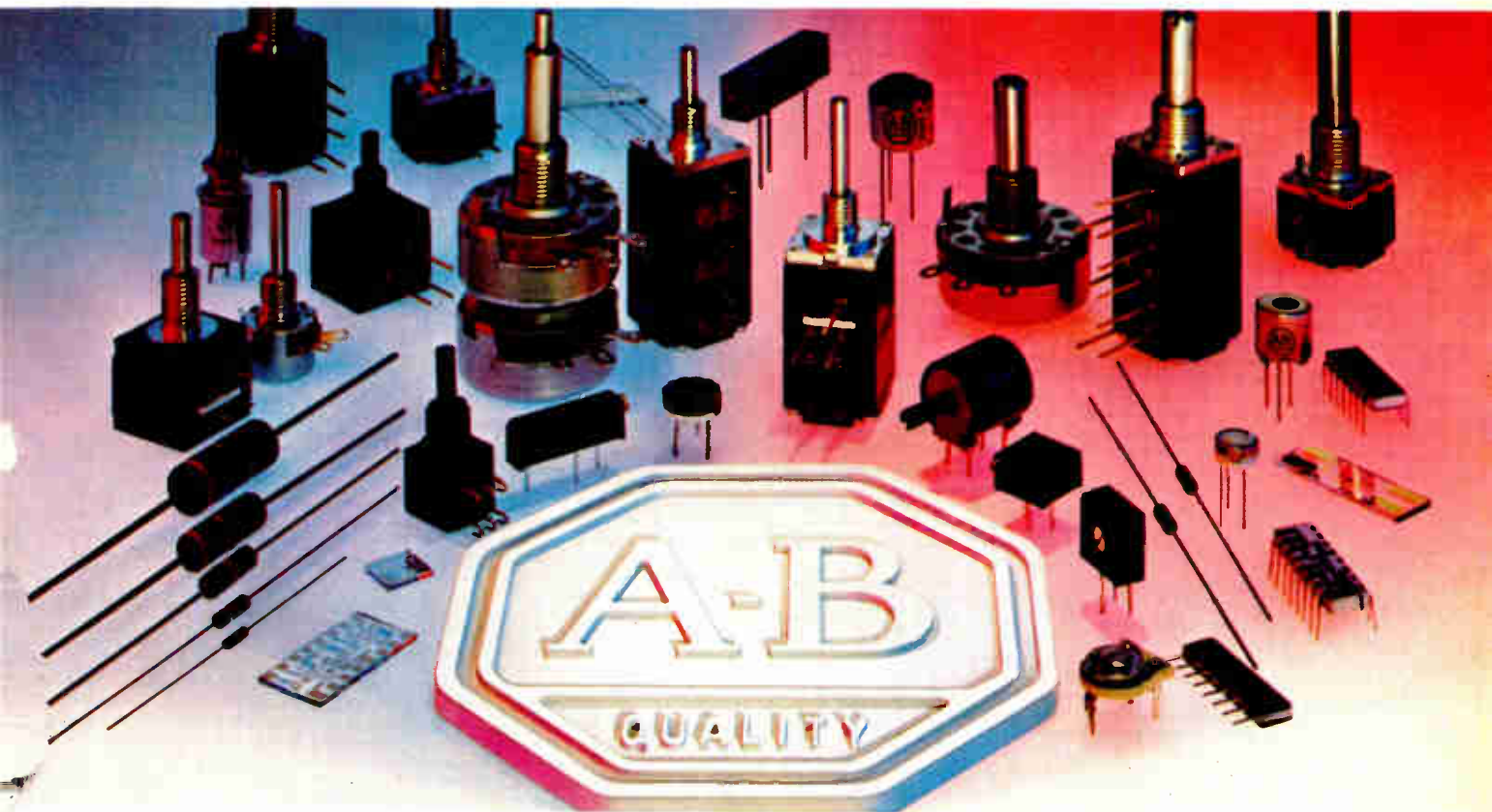

Quality in the best tradition.



ALLEN-BRADLEY
Milwaukee, Wisconsin 53204

Circle 40 on reader service card EC193

STOP TRANSIENT NOISE

ELIMINATE ERRORS IN YOUR COMPUTER OR INSTRUMENT SYSTEM

DELTEC DT series isolation transformers drastically reduce memory and transmission errors caused by transient noise on commercial power lines. Common Mode Rejection is 140dB and interwinding capacitance is less than 1 femtofarad (0.001 pf). Stock models are available from 250 VA to 5 KVA 1 ϕ and 3 ϕ , 50/60Hz. For detailed specifications write or call:

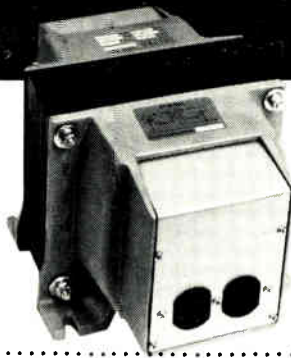

AC POWER HANDBOOK

gives you hard answers on how to solve AC Power problems. Now available at our cost of \$3.00. Write or call for a copy.

DELTEC

CORPORATION
980 Buenos Ave., San Diego, CA 92110
Telephone (714) 275-1331

Circle 41 on reader service card

New products



magnetic interference problems.

Lossyline acts as a low-pass filter providing over 100 dB of attenuation at microwave frequencies; it is available with cut-off frequencies from 10 MHz to over 45 GHz. Offered with many current, voltage, and power ratings, Lossyline will withstand operating voltages to 100 kv at temperatures from -67° to $+250^{\circ}\text{C}$. The filter wire is priced at \$1 per foot and up; the length of the wire can be trimmed to exact attenuation requirements and can be supplied in semiflexible tubes of copper, brass, or other metals. Delivery is within two to three weeks.

Capcon Inc., 145 West 25th St., New York, N. Y. 10001. Phone Dennis Henderson at (212) 243-6275 [395]

Assembly allows mounting of LEDs to pc boards

The P-C-Lite allows direct mounting of an LED onto a printed-circuit board, eliminating the need for hard wiring required in front-panel displays. Using a lens with striated lines and fresnel rings (which provides viewing from an 180° angle) combined with a nondiffused LED, the P-C-Lite forms an assembly that

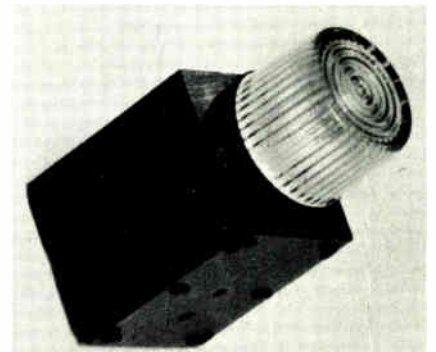

An AC line stabilizer -both efficient and distortion free.

Maintain constant input of power to your equipment with a portable AC line Voltage Stabilizer from KAI. This highly efficient stabilizer has 4% maximum energy loss and produces an output wave identical to the input wave. The KAI stabilizer tolerates a wide latitude of frequency changes and is competitively priced. Ideal for production line use and test equipment in aircraft, transformer, medical, plating, plastic, photographic, broadcast and numerous other industries.

Distributor inquiries invited.

Specifications:
Input: 50/60 Hz 98-136 V
Output: 117 V AC ± 4 V adjustable
Regulation: 117 V $\pm 1\%$
Ambient Temp: 0°C to 70°C (32°F - 158°F)



KA-101 1 KVA
\$399.00

KA-102 2 KVA
\$599.00

KA-103 3 KVA
\$769.00

Available for immediate delivery

For more information write or call:

Kobishi America, Inc.
228 East Star of India Lane
Carson, CA 90746
Phone (213) 538-4670

The Diamond Line
KOBISHI

Whatever you need in an IC socket... **RN has 'em all!**

—and with “side wipe” reliability

PRODUCTION SOCKETS

NEW! ICL Series

26% lower profile—.150"
Ideal for high density, high volume configurations, provides maximum vibration resistance. Solder type, single leaf “side-wipe” contacts. 8 to 40 contacts



BURN-IN, TEST SOCKETS

TS Series

very long contact life. Very low insertion force. Ideal for incoming inspection. With 14 to 40 contacts. Also strip sockets up to 21 positions.



IC Series

moderate cost, long life. Designed for general test and burn-in up to 350°C. With 14 to 40 contacts.

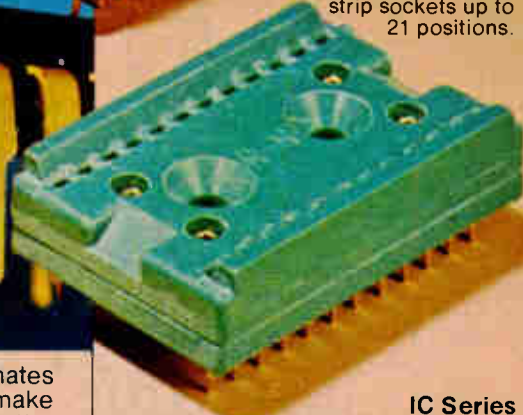

ICN/S2 Series

lowest cost burn-in socket available. Designed to accept IC extraction tool. With 8 to 40 contacts, with strip sockets up to 25 positions.

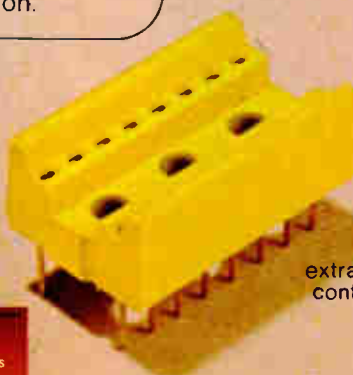

ICN Series high reliability general-purpose sockets. Low insertion force allows automatic IC insertion. In solder or wire-wrap. 6 to 64 contacts. Dual leaf “side-wipe” contacts.

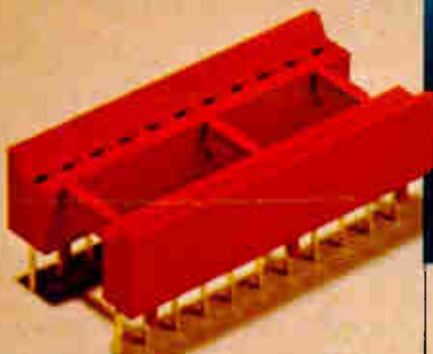

ICA Series high reliability pin socket contacts. Low profile in solder or wire-wrap. 8 to 40 contacts.

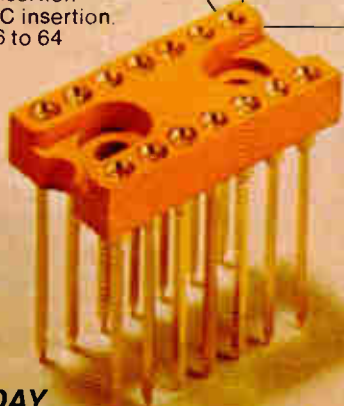

RN HIGH RELIABILITY eliminates trouble. “Side-wipe” contacts make 100% greater surface contact with the wide, flat sides of your IC leads for positive electrical connection.

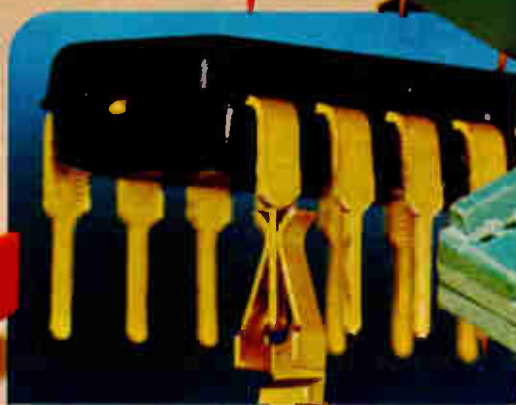

WRITE TODAY
for latest R-N “Short Form” Catalog...



... of R-N production DIP sockets. Contains full specs, dimensions and material data. Get yours now.

RN ROBINSON NUGENT, INC.

ROBINSON-NUGENT, INC. • 800 East Eighth Street • New Albany, Indiana 47150 • Phone: (812) 945-0211

Circle 44 on reader service card

Keep Up With Change

Ferranti-Packard Electromagnetic Modules Let You Create the System

Three new additions to the Ferranti-Packard 7 Segment Readout Displays—9, 12 and 18-inch characters are ideal for remote-controlled numeric readouts for gas pricing signs, time/temperature signs, speed limit signs, scoreboards and industrial displays.

The light-reflecting display components come in white or fluorescent fade-resistant colors. They're designed to ensure visual impact over an extreme ambient light range, even direct sunlight.

Our Modules are rated for 400 million operations and there are no lamps to burn out.

Save energy too! Magnetic latching retains the data displayed with *zero power input*.

Ferranti-Packard Modules. Visibility, Reliability and Economy no other readout component can match. Before you specify a display, call Ferranti-Packard.

The Pioneer in electromagnetic displays.



Ferranti-Packard Limited

Electronics Division
6030 Ambler Dr., Mississauga, Ontario
Canada L4W 2P1
Telephone: (416) 624-3020
Telex: 06-961437

Circle 47 on reader service card

New products

allows either vertical or horizontal mounting of any standard T1 3/4 LED to a pc board. The lens may be flush mounted, recessed, or extended through the panel for full visibility; the lens is at a standard height that is compatible with other switches and components mounted on pc boards.

The entire P-C-Lite and lens assembly encloses the LED and offers stability during packaging, and protection after assembly. The lens portion of the assembly is manufactured with butyrate plastics and is available in five colors: red, green, amber, yellow, and clear. The pc board mounting portion is constructed from nylon plastic. This complete assembly (but not including an LED) sells for 24¢ in 1,000-piece quantities. Delivery time is stock to two weeks.

Visual Communications Co., P. O. Box 986,
El Segundo, Calif. 90245. Phone (213) 822-4727 [398]

Enclosure houses three fans,
plus 19-in. card cage

Sturdily constructed to hold up to three fans of different types, the Fan-Cage incorporates a standard 19-in. card cage and a fan container. The compact design increases the cage size by less than one RETMA (Radio Electronics Television Manufacturing Association) unit, and therefore allows standard cabinet packaging to be retained. By placing the fans directly beneath the printed-circuit boards or power pack, an efficient, evenly distributed air flow is created throughout the entire cage. With three fans producing as much as 100 ft³/min. each, even the most difficult boards and power supplies can be cooled with ease. Unless otherwise specified by the user, the fan-mounting holes are placed on 4.125-in. centers.

Each Fan-Cage is priced at \$44, which does not include the fans. Availability is stock to two weeks.

Unitrack division, Calabro Plastics Inc., 8738
West Chester Pike, Upper Darby, Pa. 19082.
Phone (215) 789-3820 [399]

monolithics lexicon



Selectivity: The ability to accept signals within a specified frequency band while rejecting all others. Formerly a problem. See monolithic crystal filter.

Monolithic crystal filter: The solution to most selectivity problems in radio communication. See PTI. Their filters define the best and most economical in the field. Dozens of standard models, or custom production models from 5 to 180 MHz. Write for their catalog.

The standard in monolithic crystal filters.

WE WROTE THE BOOK.

Pti

Piezo Technology Inc.

2525 Shader Rd., Orlando, FL 32804
(305) 298-2000

206 Circle 54 on reader service card

Electronics / November 8, 1979



"We must find a way to stop LSI package lead damage during burn-in and testing."

Good news. AMP LIF Eject.

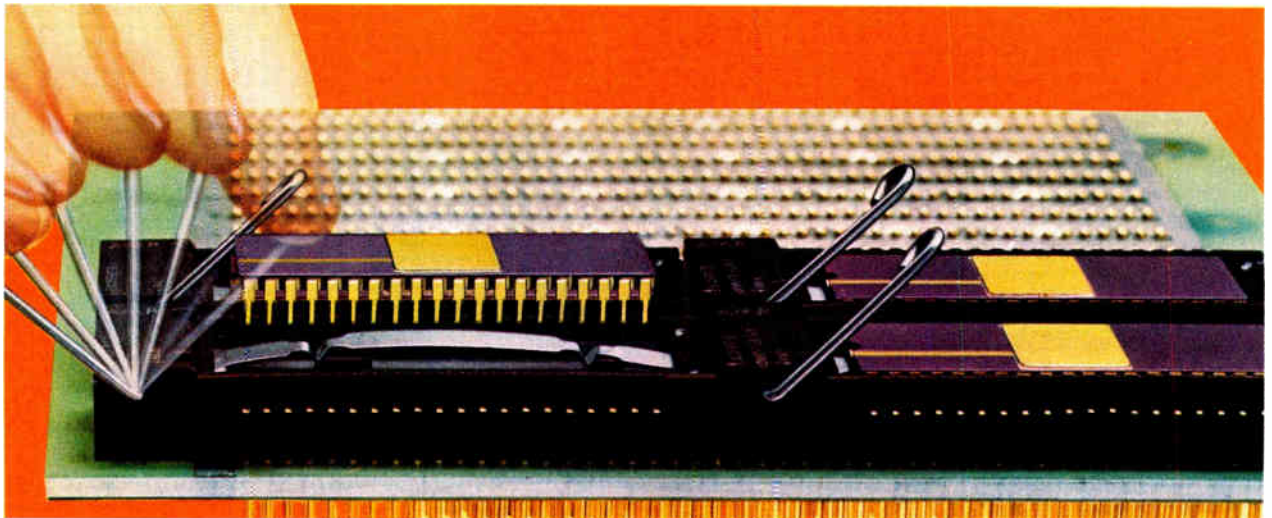

Give the kid glove treatment to the leads of your microprocessors, ROMs, PROMs and EAROMs during plugging and unplugging. The new AMP LIF-Eject Connector combines the advantages of a Low Insertion Force design with a unique eject mechanism that lifts the LSI for utmost handling ease. No screwdrivers. No prying up. Nothing else is needed to assure damage-free insertion and extraction.

A three-position arm handles everything. One cams the contacts open. Another position cams them closed with a contact force of 150 grams. And the third position activates a leaf spring that pushes the package out of the contact area.

Two types of LIF-Eject Connectors are available from 24 to 40 positions, one rated at 105°C maximum and 25,000 cycles for electrical testing and programming, and another rated at 150°C maximum and 1,000 cycles for burn-in applications.

Sound interesting? Call the AMP LIF-Eject Information Desk at (717) 564-0100, Ext. 8400. Or write AMP Incorporated, Harrisburg, PA 17105.

AMP is a trademark of AMP Incorporated

AMP has a better way.

AMP

Circle 117 on reader service card

Control Data: Committed to

Control Data people, systems and services are helping manufacturers prepare for the '80's.



Exemplifying what state-of-the-art CAD technology can do for manufacturers, Chrysler Corporation Chief Engineer Robert Brauburger reports dramatic gains in the speed and efficiency of their design process. Above: a Chrysler engineer uses a color graphics terminal to analyze piston performance. Below: the control room at Chrysler's Technical Computing Center, where an operator monitors four interconnected Control Data® CYBER 170 systems.



American manufacturers are challenged by spiraling inflation and increasing competition. They must keep pace with productivity gains abroad to maintain market share and protect the jobs of their employees.

In the U.S., the annual growth in productivity over the last ten years has been half of what it was over the previous two decades. Many manufacturers are turning to computer-based technology to reverse this trend.

Over half the FORTUNE 500 are using our products and services.

Large scale Control Data computers are recognized for their outstanding ability to perform complex scientific and engineering computations rapidly and with great accuracy. Our systems are installed in major manufacturing companies around the world. And Control Data's recently announced CYBER 170 Series 700 continues in this tradition by offering increased performance at reduced cost.

Control Data also offers manufacturers a wide range of data services through some of the world's foremost data processing networks.

Through our CYBERNET® Services we provide the benefits derived from processing on Control Data computer systems, along with sophisticated application programs

the Manufacturing Industry

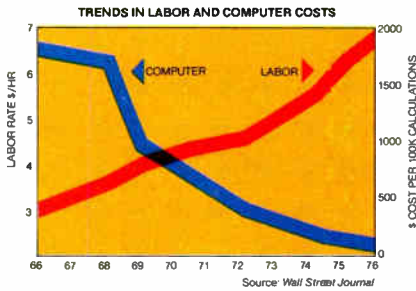

for structural, mechanical and electronic design and analysis. Through our Service Bureau Company, we provide a whole range of services for business planning, analysis and control, plus a complete interactive system for material requirements planning, production control and management information.

In addition, many companies are training their personnel with our PLATO® computer-based educational service.

A new automated design and drafting system

One of the most important ways Control Data is helping manufacturers make better use of human resources is through computer-aided design (CAD).

Recently, we announced AD-2000*, an automated design and drafting system which speeds the design process by eliminating many of the tedious, time-consuming tasks previously performed by hand. AD-2000 offers practical and up-to-date design and drafting capabilities while providing a link to numerical control and other computer-aided manufacturing (CAM) functions.

*Developed by Manufacturing and Consulting Services, Inc., Costa Mesa, CA.

Coming from Control Data— a fully integrated CAD/CAM system

The critical link between CAD and CAM is the effective control and flow of data among respective systems. Control Data has the products and expertise to allow the interface of design, analysis and manufacturing applications.

And when our new CAD/CAM technology is available, manu-

technologies. Through our Manufacturing Consulting Services organization we are helping manufacturers plan and implement their CAD/CAM strategies through training, consultation and technical assistance. And through Commercial Credit Company, an important part of Control Data, we provide manufacturers with a whole range of financial services, including capital equipment financing.



Boeing, a long time user of Control Data computers, recently installed two CYBER 175's in a CAD/CAM center to assist in the design of its new generation of passenger aircraft.

facturers will be able to go from a design on a CRT screen to a finished part—all with greater productivity and better use of resources than offered by the present technology.

Control Data is committed to helping industry bridge the gap between the old and new

Systems. Services. Solutions. Measures of Control Data's commitment to the manufacturing industry.

For further information, write: Control Data Corporation, Manufacturing Industry Marketing, HQW09F, Box 0 Minneapolis, MN 55440.

GD CONTROL DATA CORPORATION

More than a computer company

ADVANTAGE: FLEXIBILITY

Another way the Model 730 aces the competition!

Centronics' Model 730 miniprinter shatters the rules of the game. Greater flexibility than any printer is one of the reasons why.

APPLICATIONS FLEXIBILITY Now you can meet a wide range of applications requirements with just a single printer: the Model 730. Payroll checks on pre-printed continuous forms. Inventory listings on fanfold. Direct mail on company letterhead. General information on roll paper... and change from one to another quickly.

INVENTORY FLEXIBILITY Model 730's versatility means no more costly inventories of limited-use printers. Stock only one set of spares. One set of service tools. Train to service only one highly reliable machine.

INTERNATIONAL FLEXIBILITY To make your overseas marketing easier, international models of the 730 can print 96 character U.S., British, French, German, Italian, and Swedish/Finnish. Available in all standard international power requirements.

Here are more reasons why the Model 730 is the newest sensation on the circuit.

Its simple design ensures reliability. Combine that with an attractive purchase price and you have a very low cost of ownership.

Although it's surprisingly affordable, Model 730 sets new quality standards. Its 7x7 dot matrix produces crisp, clean characters, and its quiet, compact, and stylish design makes it welcome in any environment.

Best of all, because of Centronics' manufacturing capabilities, volume delivery is assured.

ADVANTAGE:MODEL 730 Model 730 leads the way to a whole new era. Naturally, it's from the leader: Centronics. No other company can match our strong serve in performance, selection, and value. And every Centronics printer is backed by one of the largest worldwide service organizations of any independent printer company.

On flexibility, features, price, and support, the Model 730 is a clear winner. For more information on products or employment opportunities, please write or call today: Centronics Data Computer Corporation, Hudson, New Hampshire 03051 (603) 883-0111.



CENTRONICS® PRINTERS
...the advantage

Superior Performance, Longer Life. The key to our Golden Touch[®] capacitive keyboard is our patented, hinged-moving-plate design. This unique feature gives our keyswitch greater capacitance, and that makes it virtually impervious to dust, debris and electrical noise. And that means better performance. It also means longer life — an MCBF rated at 250 million operations. That's why we guarantee a 1% AQL and give a two-year warranty. We design the Golden Touch exclusively for volume OEMs, so practically any combination of options, circuitry and configuration can be built-in. And with all this, the price is highly competitive. To learn more, just fill in the coupon or attach your card to this ad and mail it back to us.

DIGITRAN

The Digitran Company, a division of Becton, Dickinson and Company
 855 South Arroyo Parkway • Pasadena, California 91105
 Phone (213) 449-3110 • TWX 910-588-3794

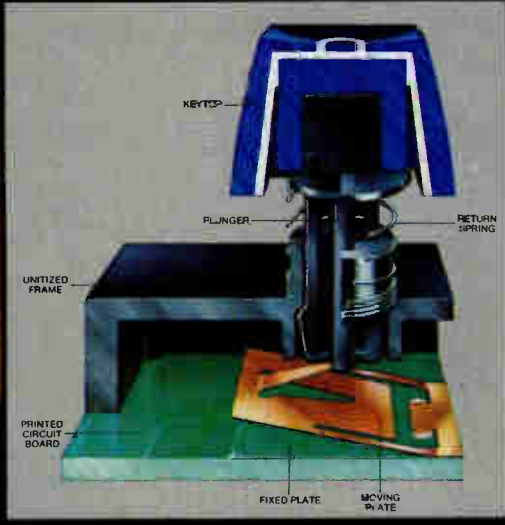

Keyboard Product Manager • The Digitran Company
 855 S. Arroyo Parkway • Pasadena, CA 91105

Please send brochure on Golden Touch[®] keyboard.

Name _____

Title _____

Company _____

Street Address _____

City _____ State _____ Zip _____

Instruments

Tester sells for under \$45,000

Programmable benchtop logic tester for digital pc boards offloads larger test systems

With a programmable, functional benchtop logic tester that it calls the Logic Test System (LTS), Omnicomp Inc. is introducing the concept of distributed testing. Capable of automatic high-speed testing and component-level fault isolation of digital printed-circuit boards, the LTS is designed for high-volume service and production, both as a stand-alone tester and as a means of offloading large production test systems to increase board throughput.

Incorporating many of the testing concepts that Omnicomp used in

developing its popular Portable Service Processor (PSP) for NCR Corp. [*Electronics*, Feb. 16, 1978, p. 41], the LTS is programmable in a high-level test language based on Basic. It provides pin-change rates to 2 MHz on a maximum of 384 programmable driver/sensor pins for boards containing up to 12 different logic families; it also performs guided-probe diagnostics. The LTS is program-compatible with the PSP. (GenRad Inc. of Concord, Mass., markets the PSP as its model 2225 portable, functional logic tester.)

The LTS, also to be marketed by GenRad under a recent agreement, will be priced between \$35,000 and \$45,000, depending upon quantity. That is approximately one quarter to one half the price of equivalent production test systems, depending upon the combination of features included in a comparison, says Omnicomp's vice president Robert E. Anderson.

Distributed testing. The relatively low cost, high performance, and

Call your Amphenol® Connector Distributor

ARIZONA
Celtec Moltronics
 Phoenix
 (602) 272-7951
Wyle Distribution Group
 Phoenix
 (602) 249-2232

CALIFORNIA
Bell Industries
 Sunnyvale
 (408) 734-8570
Kieruff Electronics
 Los Angeles
 (213) 725-0325
 San Diego
 (714) 278-2112
Wyle Distribution Group
 Santa Clara
 (408) 727-2500
Wyle Distribution Group
 El Segundo
 (213) 322-8100
 San Diego
 (714) 565-9171
Celtec Moltronics
 San Diego
 (714) 278-5020
 South Gate
 (213) 757-6521
Sterling Electronics
 Santa Clara
 (408) 985-7411

COLORADO
Newark Electronics
 Denver
 (303) 757-3351
Wyle Distribution Group
 Commerce City
 (303) 287-9611

CONNECTICUT
Connector Co.
 New Haven
 (203) 624-0127
Wishire Electronics
 Hamden
 (203) 281-1166

FLORIDA
Arrow Electronics
 Palm Bay
 (305) 725-1480
Kieruff Electronics
 St. Petersburg
 (813) 576-1966
Schweber Electronics
 Hollywood
 (305) 927-0511

GEORGIA
Arrow Electronics
 Doraville
 (404) 455-4054

ILLINOIS
Bell Industries
 Chicago
 (312) 982-9210
Klaus Radio, Inc.
 Peoria
 (309) 691-4840
Newark Electronics
 Chicago
 (312) 638-4411
Ohm Electronics, Inc.
 Palatine
 (312) 359-5500
Schweber Electronics
 Elk Grove
 (312) 593-2740

INDIANA
Genesis Electronics
 South Bend
 (219) 287-2911
Graham Electronics
 Indianapolis
 (317) 634-8202

KANSAS
Wichita Aircraft
 Wichita
 (316) 838-1421

MARYLAND
Arrow Electronics
 Baltimore
 (301) 247-5200
Cramer Electronics
 Gaithersburg
 (301) 948-0110
Pioneer Electronics
 Gaithersburg
 (301) 948-0710

MASSACHUSETTS
Cramer Electronics
 Newton
 (617) 969-7700
Industrial Components Corp.
 North Wilbraham
 (413) 596-3854
Kieruff Electronics
 Billerica
 (617) 935-5134
Schweber Electronics
 Bedford
 (617) 890-8484
Wishire Electronics
 Burlington
 (617) 272-8200

MICHIGAN
RS Electronics
 Livonia
 (313) 525-1155
Wedemeyer Electronic Co.
 Ann Arbor
 (313) 665-8611

MINNESOTA
Arrow Electronics
 Edina
 (612) 830-1800
Newark Electronics
 Minneapolis
 (612) 331-6350

MISSOURI
Olive Electronics, Inc.
 St. Louis
 (314) 426-4500
Walters Radio Supply
 Kansas City
 (816) 531-7015

NEW JERSEY
Radio Electric Service Co.
 Pennsauken
 (215) 925-6900
Schweber Electronics
 Fairfield
 (201) 227-7880
Wishire Electronics
 Clifton
 (201) 340-1900

NEW YORK
Arrow Electronics
 Farmingdale
 (516) 694-6800
Genesis Radio Parts Co.
 Buffalo
 (716) 873-9661
Harvey Electronics
 Binghamton
 (607) 748-8211
Progress Electronics
 Plainview
 (516) 433-1700
Schweber Electronics
 Westbury
 (516) 334-7474
Simcona Electronics
 Rochester
 (716) 328-3230
Summit Distributors
 Buffalo
 (716) 884-3450

NORTH CAROLINA
Cramer Electronics
 Winston-Salem
 (919) 725-8711

OHIO
Pioneer Electronics
 Cleveland
 (216) 587-3600
 Dayton
 (513) 236-9900
Schuster Electric Co.
 Cincinnati
 (513) 984-1600
Schweber Electronics
 Beachwood
 (216) 464-2970

OKLAHOMA
Electro Enterprises
 Oklahoma City
 (405) 478-1752

PENNSYLVANIA
Almo Electronics
 Philadelphia
 (215) 698-4000
CAM/IPC Indus. Electronics
 Pittsburgh
 (412) 782-3770
Pyttronic Industries
 Montgomeryville
 (215) 643-2850

TENNESSEE
Electra Distributing Co.
 Nashville
 (615) 329-3971

TEXAS
Allied Electronics
 Ft. Worth
 (817) 338-5401
Hamilton/Avnet
 Dallas
 (214) 661-8661
Sterling Electronics
 Dallas
 (214) 357-9131
 Houston
 (713) 627-9800
Texas Instrument Supply Co.
 Dallas
 (214) 238-6821

UTAH
Diplomat/Alta
 Salt Lake City
 (801) 486-4134
Standard Supply Co.
 Salt Lake City
 (801) 486-3371

WASHINGTON
Bell Industries
 Bellevue
 (206) 747-1515
Wyle Distribution Group
 Seattle
 (206) 453-8300

WISCONSIN
Electronic Expeditors
 Milwaukee
 (414) 228-8100

CANADA:
 Distributors in major cities



The fuss-free, fast flat cable connector.



The new Amphenol® IDC Connector.
Fuss-free because it locks when it mates.
Fast because there's no wire stripping.

Simply insert the socket into the header and push gently. Click! The connector locks. No doubt about it. You heard it lock. You can see it's locked.

These connectors also have integral polarizing keys. There is no chance of mismatching.

To unlock, just flip the ears and pull the connector apart.

The insulation-displacing contacts mean there's no wire stripping. So assembly is faster. And that cuts costs.

The socket and header bodies are made of UL-recognized 94V-O thermoplastic. Which should make it easier for you to get UL approval.

Additional coding and keying guides are available if several connectors of similar configuration are on an assembly.

New Amphenol IDC Connectors are offered in six sizes, with from 20 to 60 contacts. Also offered are matching cutting tools for flat cable and tools for connector termination.

For complete information, technical data, dimensions, and prices, contact your nearest Amphenol North America sales office or distributor.

Termination tool.
(Base: 6½" x 9¾")

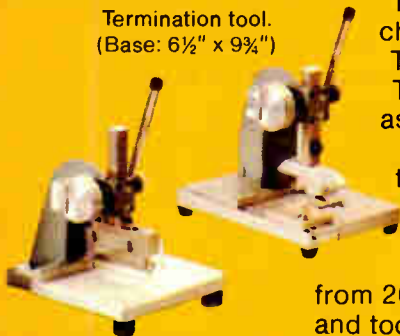

Cutting tool.
(Base: 7½" x 10½")

**BUNKER
RAMO**

AMPHENOL NORTH AMERICA

A Division of Bunker Ramo Corporation

Amphenol North America Division Headquarters: Oak Brook, Illinois 60521

Sales Offices: Atlanta (404) 394-6298 • Boston (617) 475-7055 • Chicago (312) 986-2330 • Dallas (214) 235-8318 • Dayton (513) 294-0461
Denver (303) 752-4114 • Detroit (313) 722-1431 • Greensboro (919) 292-9273 • Houston (713) 444-4096 • Indianapolis (317) 842-3245
Kansas City • (816) 737-3937 • Knoxville (615) 690-6765 • Los Angeles (213) 649-5015 • Minneapolis (612) 835-4595 • New York (516) 364-2270
Orlando (305) 647-5504 • Philadelphia (215) 653-8750 • Phoenix (602) 265-3227 • St. Louis (314) 569-2277 • San Diego (714) 272-5451
San Francisco (408) 732-8990 • Seattle (206) 455-2525 • Syracuse (315) 455-5786 • Washington, DC (703) 524-8700
Canada: Montreal (514) 482-5520 • Toronto (416) 291-4401 • Vancouver (604) 278-7636 • International: Oak Brook, Illinois TELEX 206-054

Circle 213 on reader service card

Amazing AIRBRASIVE[®] "Wonder Tool"

It can cut or etch. Or strip and clean. Or drill and deflash. Amazing!

Try it. You'll wonder why you waited so long. You'll see why the versatile S.S. White Airbrasive tool is *the* low cost production tool for precision work on small electronic parts and components. It works on metals or glass, quartz or ceramics, the most delicate-to-handle semiconductor and crystalline materials. Airbrasive's stream of micro-abrasive particles gives you cool, shockless jet machining to the most critical tolerances. And at real savings in production time *and* labor costs. Wonder how much Airbrasive costs? Just \$1015 for Model K — ideal for lab work, pilot runs, and similar light-duty, limited production. Model H, at \$2050, can deliver jet-machined production parts in high-volume to meet your most demanding production schedule.

Write for our illustrated brochure today. Or arrange for a demo and try the Airbrasive Wonder Tool on your parts. Write or call Jim McDonald, S.S. White Industrial Products, Pennwalt Corp., 151 Old New Brunswick Road, Piscataway, NJ 08854 (201) 752-8300.

*Trademark of Pennwalt Corporation

S.S. WHITE INDUSTRIAL PRODUCTS

PENWALT
EQUIPMENT • CHEMICALS
HEALTH PRODUCTS



Precise and shockless enough to cut intricate patterns in an eggshell.

Circle 214 on reader service card



Equipto Enclosures

... the highest quality electronic cabinets you can buy!

Here's why:

1. Designs are handsome and functional
2. Cabinetry is durable, rugged
3. Service — prompt and dependable

Whatever you're looking for in cabinetry or desk systems, we have several lines of modular enclosures available to effectively display and protect your instrumentation. Or, we'll custom design enclosures to suit your individual needs. Choice of color at no extra charge.

Ask about our Engineering Evaluation program.

WRITE FOR FREE CATALOG



Equipto For Quality
EQUIPTO ELECTRONICS CORPORATION
403 Woodlawn Ave. • Aurora, Illinois 60507
Phone: 312/897-4691

214 Circle 60 on reader service card

New products

small size (29 by 20 by 17 in.) of the LTS, Anderson says, introduce the concept of distributed testing "because production testing can be performed at multiple locations throughout a board-assembly area for the same or lower cost than a single, larger, and more expensive tester." The LTS can easily be deployed at board areas in the factory, at off-site board-production locations for vendors, as well as at large field engineering-rework depots, engineering labs and test-programming areas, he adds.

Furthermore, the software compatibility between the LTS and PSP (or GenRad's 2225) allows the consistency of a single test program to be used from engineering, through production and the larger rework centers with the LTS, to local board repair on the earlier, portable PSP logic tester, Anderson explains. The LTS, he continues, also makes an ideal programming station for the smaller tester.

The LTS can provide a complete functional test of the board, displaying a pass/fail result in seconds, regardless of board complexity, according to Anderson. The unit's test rate is faster than those of most commercial static test systems. Therefore, he adds, the functional test time is shorter, brief one-shots can be tested, and marginal dynamic failures can be detected.

The LTS contains a custom bipolar processor that provides the 2-MHz pin-change rate so that boards containing dynamic microprocessors and memories can be tested without removing them from the boards. Built around this custom microprocessor with the power of Digital Equipment Corp.'s LSI-11, the LTS's hardware features include a cathode-ray-tube display, dual floppy-disk drives with a total of 2 megabytes of storage capacity, 96 kilobytes of random-access memory, a 16-character light-emitting diode display, a low-profile keyboard, a thermal printer, and high-speed-printer, RS-232-C, and IEEE-488 bus interfaces. Collectively, these new features let the operator interact faster and more conveniently with the LTS during

The Place To Be

Oregon is a very special place, with a pace and a flavor that can be found nowhere else.

We are proud of our home state.

It offers a pleasant alternative to the pressures of a crowded megalopolis.

It is also a place to discover new horizons in personal and professional development. At our

R&D and manufacturing complex

in Beaverton, we are continually testing

the limits of technology in

electronic instrumentation, graphic computing systems, and computer peripherals.

We chose to build an electronics community in Oregon for a very special reason.

Our motive is people.

Creative men and women who can help us continue an exceptional growth program, and a

commitment to excellence.

Tektronix and Oregon. THE Place.

If you have the technical or marketing skills we need, contact us.

Professional Placement, TEKTRONIX, INC.,

P.O. Box 500, 9E,

Beaverton, Oregon 97077.

A full color print of this scene is available at no obligation. Just drop a note to

Bill Eppick at the above address.

An Equal Opportunity Employer

Tektronix[®]
COMMITTED TO EXCELLENCE

FREE

TEN-TEC ENCLOSURE CATALOG

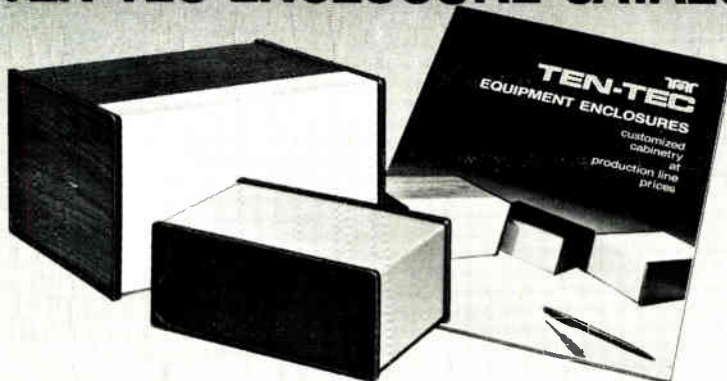

CUSTOMIZED CABINETRY AT PRODUCTION LINE PRICES

TEN-TEC's OEM cabinet line gives you *affordable* customizing freedom. 51 different sizes. Two construction styles: all-aluminum or aluminum and molded Cyclocac. Two color styles: beige with walnut-grain end panels or gray with black pebble-grain (or choose your own). Custom chassis punching. Custom silk-screening. Your cabinets arrive ready for your product. For less than you think. Ask for a quotation.

Write or call:



TEN-TEC, INC.

Hiway 411 E., Sevierville, TN 37862
(615) 453-7172

Circle 216 on reader service card

You'll probably need the **best** self-contained memory available!

Here's a true non-volatile module with no need for back up battery.

Our new self-contained PDP-LSI fully compatible memory systems feature totally adaptable plug-in boards. Accuracy. Reliability. Indefinite retrieval of data. And all of this using plated wire! Available at competitive prices in 4K/18bit to 64K/18bit capacities.

For more information, just write or call:



TOKO AMERICA, INC.

5520 WEST TOUHY AVENUE
SKOKIE, ILLINOIS 60077

(312) 677-3640 • TELEX 72-4372

in the long run,
Toko makes
it better
for you.

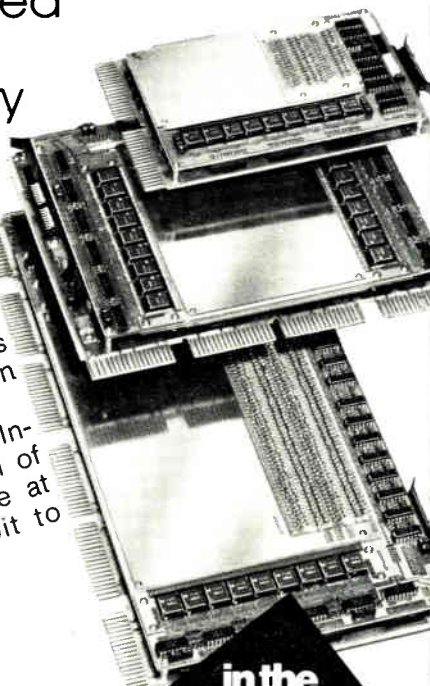

216 Circle 62 on reader service card

New products

programming, testing and fault isolation, says Anderson.

Among other conveniences the LTS offers the operator are a lateral test position for the board under test, a 90° rotatable board fixture, and a command key that can enter most system commands and programming statements by itself. A line- and character-editing capability with the CRT cursor simplify any program changes, and an "immediate" execution mode minimizes debugging time.

Initial production units of the LTS will be shipped later this month. NCR and Great Britain's ICL Ltd., two of the major users of Omnicomp's PSP, are believed to be among the first customers. This programmable logic tester will be available within six to eight weeks after receipt of order.

Omicomp Inc., 5150 N. 16th St., Phoenix, Ariz. 85016. Phone (602) 264-2475 [351]

3 1/2-digit DMM responds with beep to five testing ranges

With its audio response capabilities, the model 6100 Roadrunner 3 1/2-digit multimeter will permit go/no-go testing of fuses, capacitors, diodes, resistors, transistors. All of these components can be tested using the five ranges of audio response—less than 1 V, less than 2 V, less than 1 Ω, less than 10 Ω, and less than 100 Ω. This audio-response function allows incoming dc pulses to be



Electronics / November 8, 1979

ELEC-TROL BLUE BOY REED RELAYS



NOW TWO GRADES OF LOW-PRICED SEALED RELAYS

Elec-Trol now offers its Blue Boy Reed Relays in both an instrument and a commercial grade. The instrument grade provides low and stable contact resistance over a large number of operations, for use in such applications as ATE systems, data acquisition and telecommunications.

The new commercial-grade units have a higher contact resistance and a lower life expectancy but are well suited for applications where contact resistance is not critical, such as switching into high impedance loads, for use in such end-products as microwave ovens, water heaters, and TV's.

Both grades are totally encapsulated in rock-hard epoxy, and the reed switch contacts and coil are secured to a rigid internal lead frame which incorporates the PCB terminals. These little inch-long units incorporate a 1 Form A hermetically-sealed reed switch, and can switch low-levels up to 10W with 5-48 VDC coils. For prices or samples, contact your local Elec-Trol distributor.

Elec-Trol, Inc., 26477 N. Golden Valley Road, Saugus, CA 91350, (213) 788-7292 (805) 252-8330, TWX 910-336-1556.

ELEC-TROL

Circle 63 on reader service card

ELEC-TROL RELAYS

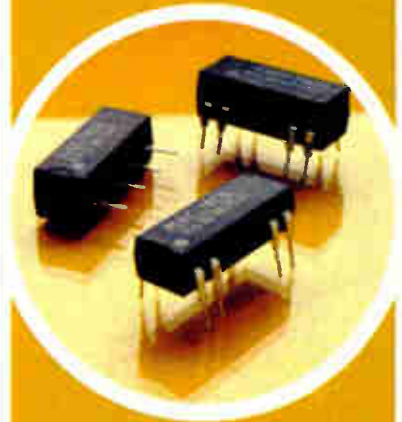

140 STANDARD MODELS

Elec-Trol now offers one of the broadest lines of DIP Reed Relays available, 140 different standard models. You can select 1A, 2A, 1B, and 1C dry reed contacts with either 3-watt or 10-watt ratings or 1A mercury-wetted with 50-watt rating. All of them are available with or without clamping diodes and with a choice of 5, 6, 12, or 24 VDC coils. For off-the-shelf delivery or to ask about samples, contact your Elec-Trol distributor.

AUTHORIZED DISTRIBUTORS

ALABAMA HUNTSVILLE
Component Distributors, Inc. (205) 883-7501

ARIZONA TEMPE
Acacia Sales, Inc. (602) 894-2874

CALIFORNIA IRVINE
Acacia Sales, Inc. (714) 549-0954,
(213) 971-2423

CALIFORNIA SAN DIEGO
Acacia Sales, Inc. (714) 565-4365

CALIFORNIA SUNNYVALE
Acacia Sales, Inc. (408) 745-7200

CALIFORNIA VAN NUYS
Patane Avionics, Inc. (213) 988-4455

CANADA DOWNSVIEW, ONT.
Semad Electronics Ltd. (416) 663-5650

COLORADO LAKEWOOD
Acacia Sales, Inc. (303) 232-2882

FLORIDA CLEARWATER
Diplomat Electronics, Inc. (813) 443-4514

FLORIDA FORT LAUDERDALE
Component Distributors, Inc. (305) 971-4950

ILLINOIS BENSENVILLE
Diplomat Electronics, Inc. (312) 595-1000

MASSACHUSETTS HOLLISTON
Diplomat Electronics, Inc. (617) 429-4121

MICHIGAN FARMINGTON
Diplomat Electronics, Inc. (313) 477-3200

MINNESOTA MINNEAPOLIS
Diplomat Electronics, Inc. (612) 788-8601

NEW JERSEY EDISON
Brothers Electronics, Inc. (201) 983-3000

NEW YORK MT VERNON
Kin Tronics Inc.
(914) 688-9885

OHIO SOLON (CLEVELAND)
Recco (216) 248-8900

PENNSYLVANIA HUNTINGDON VALLEY
Shap Electronics, Inc. (215) 322-7150

TEXAS DALLAS
Solid State Electronics Co. of Texas, Inc.
(214) 352-2601

TEXAS HOUSTON
Harrison Equipment Co. (713) 652-4750
Solid State Electronics Co. of Texas, Inc.
(713) 772-8510

UTAH SALT LAKE CITY
Diplomat Electronics, Inc. (801) 486-4134

Circle 217 on reader service card

PLUG YOUR COMPANY INTO A BRIGHT ECONOMY. OMAHA'S.

Successful companies get that way by being profitable. That's what brings them to Omaha. For starters, Omaha has some of the lowest energy rates in the nation—perfect for computer/electronics manufacturing facilities that need inexpensive energy. And because of our colleges, universities, technical and high schools, Omaha's labor pool increases by 4,000 annually—perfect for computer/electronics businesses that need a skilled work force to draw from. On top of that, worker productivity in Omaha has been growing at more than *twice* the national rate for over 15 years. There are other reasons to ground your company in Omaha. So mail this coupon for our free booklet, "The Case For Omaha." Or call Rod Moseman at (402) 341-1234.



I'm interested. Please mail me your booklet "The Case For Omaha."

Name _____

Address _____

City _____ State _____ Zip _____

Title _____

Type of Business _____

Telephone Number _____

Mail to: Omaha Economic Development Council, Suite 2100, Dept. 50, 1620 Dodge Street, Omaha, NE 68102



Circle 218 on reader service card

Choose from two new piezo ceramic Audio Indicators. Get softer, more comfortable sound on low power with high reliability. The new, more compact AI-380 operates from 3 to 30 VDC with a 2.7 KHz tone, 83 to 103 dbA at 1.0 ft. The new AI-385 delivers a softer, less shrill 2.0 KHz tone on 3 to 20 VDC, with an 80 to 95 dbA. Low current drain and panel mounting make these ideal for low power usage. For details and full line catalog, write Projects Unlimited, Inc., 3680 Wyse Road, Dayton, Ohio 45414. Phone: (513) 890-1918. TWX: 810-450-2523.



WARNINGS YOU CAN LIVE WITH.

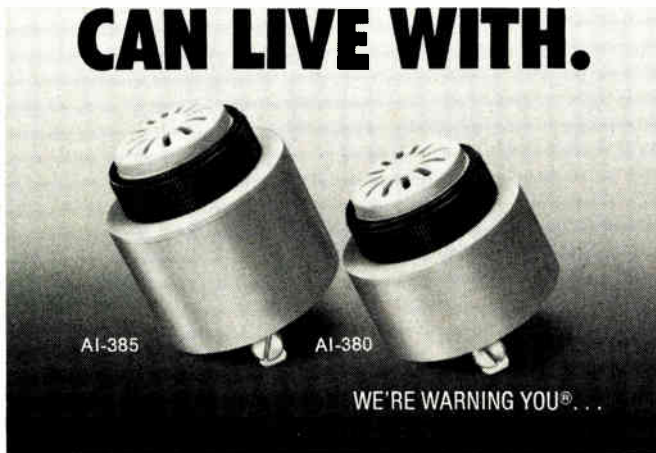

WE'RE WARNING YOU®...

218 Circle 64 on reader service card

New products

monitored by acknowledging the presence of the pulse with an audio signal. Continuity tests on printed-circuit boards, wire-wrapped cables, transformer windings, and light bulbs can also be performed.

The model 6100 features five testing functions: ac and dc voltage, ac and dc current, and resistance. The basic accuracy of the meter is within 0.5% of reading ± 1 count for the dc voltage mode. Hand-held, the \$139 unit is packaged in a ruggedized case for field use.

Weston Instruments, a division of Sangamo Weston Inc., 614 Frelinghuysen Ave., Newark, N. J. 07114. Phone (201) 242-2600 [354]

\$39.95 temperature probe works with any voltmeter

The TP-20, a temperature probe that can be used with almost any voltmeter, measures temperatures ranging from -55° to $+150^{\circ}\text{C}$ (in the Celsius model) or -67° to $+302^{\circ}\text{F}$ (for the Fahrenheit version). This probe operates up to 500 hours on a single 9-v battery.

The accuracy of the probe is within $\pm 2.7^{\circ}\text{F}$ or $\pm 1.5^{\circ}\text{C}$; when it is used with a digital multimeter with a 200-mV full-scale sensitivity, the TP-20 has a resolution of 0.1° . The probe's tip is electrically isolated so that temperatures of electrically "live" components can be measured even if they are operating 500 v above the meter circuit.

Useful for measuring integrated-circuit, resistor, and transistor temperatures; for checking enclosure



Electronics/November 8, 1979

DIP switches can deprogram. Berg's Mini-Jump™ can't. Our design guarantees it.

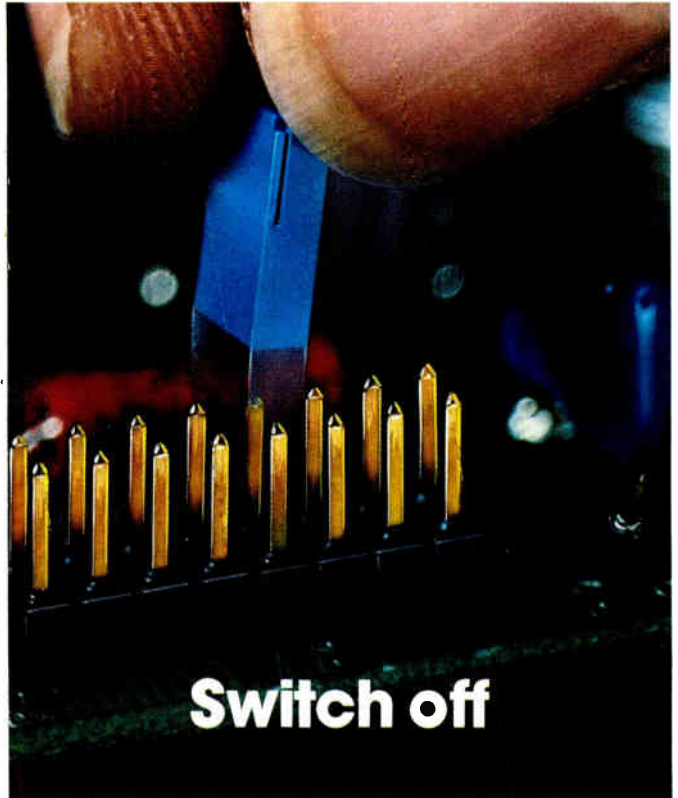
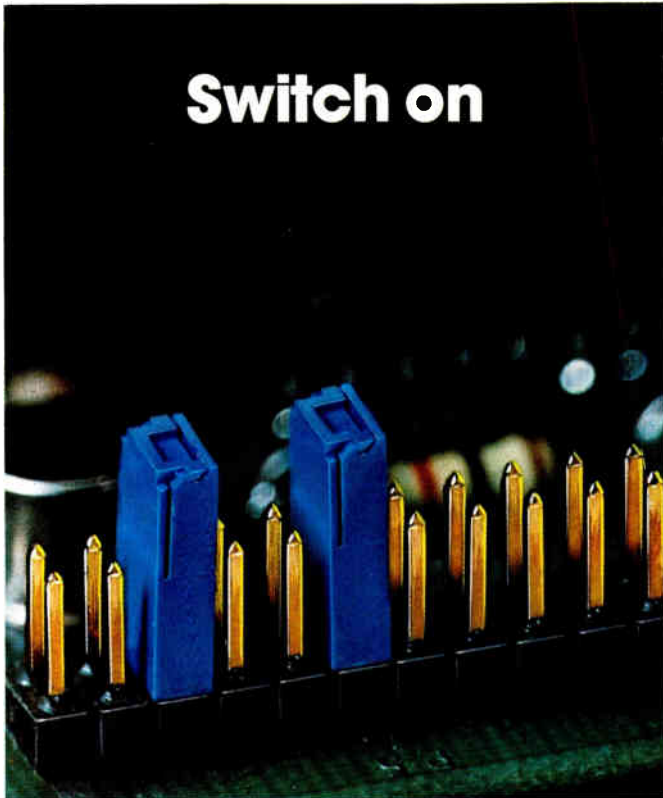

Far more reliability. Far less field service. Accidents, vibration — anytime you'd expect a DIP switch to fail, you can count on Mini-Jump* to stay programmed. Careless fingers can't deprogram it because there's no switch to hit. Only a deliberate action can change the circuit.

The interior spring of the "Mini-Jump" maintains a high normal contact force for reliability during vibration — even severe vibration. And, because you install the "Mini-

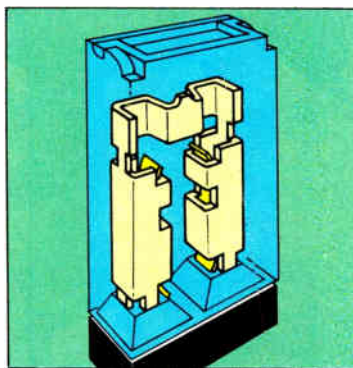

Inside the "Mini-Jump", dual metal PVt contacts provide excellent electrical and mechanical performance.

Jump" after soldering, you avoid contamination which can lead to corrosion.

Permits higher density packaging. The "Mini-Jump" is available in single position, stackable on 0.100", 0.125", 0.150" and 0.200" centers. Also in two positions on 0.100" centers and three and five positions on 0.150" centers.

Write for literature. The Du Pont Company, Berg Electronics Division, New Cumberland, PA 17070. Telephone (717) 938-6711.

*Du Pont trademark for its .025" disconnect jumper.

†Du Pont trademark for its .025" dual metal female disconnect.

Berg Electronics



SE 7000: Multiband performance — Multi-channel check-out

SE 7000 Series Instrumentation Recorders give you 8 speed recording up to 2MHz Direct, 500 kHz FM and up to 30 k bpi HDDR. The SE 7000 has in addition a unique range of features essential to lab quality recording, with a convenience, simplicity and reliability that no other recorder can offer.

Consider, for instance, the versatile built-in calibrator module with DVM for "set and forget" control, and the unique simultaneous all-channel FM electronics to electronics facility, without tape movement — the higher reliability of hard-wired, all speed active filters, equalisers and other

tape speed sensitive components — the proven dependability of co-planer format resulting in more gentle tape handling and lower tape wear. Don't accept second best. We would like to show you how the SE 7000 can match your requirements in instrumentation recording. Call us or send reader card for details.



EMI EMI Technology

EMI Technology Inc.,
100 Research Drive,
Stamford C.T. 06906.
Tel: 203 356 1300 TWX 710-474-0128

SE 7000M — the only wideband portable with built-in 14 channel electronics to electronics FM calibration and pre-record checkout.

A member of the EMI group. International leaders in music, electronics and leisure.

Circle 67 on reader service card

Leaders in Electronics

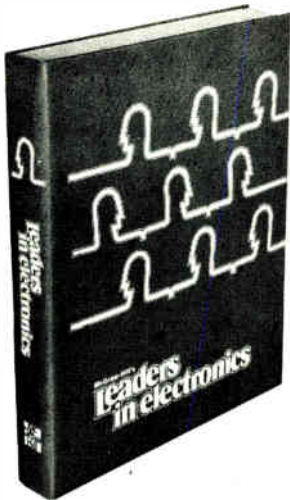

The only reference devoted solely to biographies of the most influential people in electronics

- corporate executives • technical managers • designers/developers • government and military officials • academics • consultants • editors/publishers • trade/professional group directors • securities analysts

Plus an 80-page index of biographies by affiliation, including independent consultants in every electronics specialty.

Prepared by the staff of Electronics magazine. 5,240 biographies. 651 pages, clothbound. \$39.50

Electronics Magazine Books

P.O. Box 669, Hightstown, NJ 08520

Send me...

_____ copies of *Leaders in Electronics* @ \$39.50 plus applicable sales tax. McGraw-Hill pays regular shipping and handling charges on pre-paid orders.

I must be fully satisfied or you will refund full payment if the book is returned after ten-day trial examination.

Payment enclosed Bill firm Bill me
 Charge to my credit card: American Express
 Diners Club Visa Master Charge
 Acct. No. _____ Date Exp. _____

On Master Charge only, first numbers above name _____

Name _____

Company _____

Street _____

City _____ State _____ Zip _____

Signature _____

New products

temperatures and heat-sink efficiencies; and for monitoring environmental-test temperatures, the unit also has industrial applications. These include: measuring the temperature of liquids, checking stored-grain temperatures, and checking insulation efficiencies.

The TP-20 sells for \$39.95 and is available from stock.

The Hickok Electrical Instrument Co., 10514 Dupont Ave., Cleveland, Ohio 44108. Phone Tom Hayden at (216) 541-8060 [356]

Station stands alone for AFIT software development

A stand-alone programming station providing off-line software development for Fairchild Camera and Instrument Corp.'s Testline AFIT family of in-circuit printed-circuit-board testers is now available. Programmers can develop, edit, and duplicate test routines on the station, independently of a system test operation. By freeing production system testers from such programming chores, the unit can increase testing throughput by 23%.

Capable of generating programs for all Testline AFIT products on minicassettes, minifloppy disks, and standard disk media, the programming station can develop programs for up to 20 integrated circuits per hour.

Controlling the system is a 6800 microprocessor. The front panel contains three disk drives that will accept standard, hard-sectored disks. A keyboard incorporates six accessory outlets for a cathode-ray-tube display, a line printer, a cassette duplicator, a synchronization line, two standard ac lines, and a reset button.

The basic system includes a CRT-display interface for RS-232 or current-loop operation, a line printer interface, and a disk interface for the three standard disk drives. The base price of the system is \$22,000.

Fairchild Camera and Instrument Corp., Subassembly Test Systems Division, 1400 White Dr., Titusville, Fla. 32780. Phone (305) 267-7212 [357]

NEW PRESENTATION DIELECTRIC MATERIALS CHART

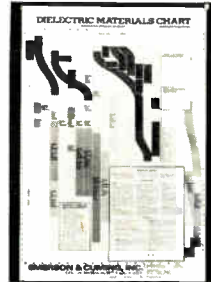

This colorful chart is a standard reference for electronic engineers. Shows Dielectric Constant (κ') and Loss Tangent ($\tan \delta$) for many E&C products and common materials plotted on 11" x 16½" graph. For notebook or wall mounting.

Circle 72 on reader service card

ELECTRICALLY CONDUCTIVE ADHESIVES AND COATINGS



ECCOAMP products offer high performance and savings for bonding, coating, sealing electrical/electronic components with conductive plastic. They include "cold" solders, anti-static, reflective and absorptive coatings. Some have electrical and thermal conductivity equivalent to metals.

Circle 73 on reader service card

ECCOSORB® ANECHOIC CHAMBERS

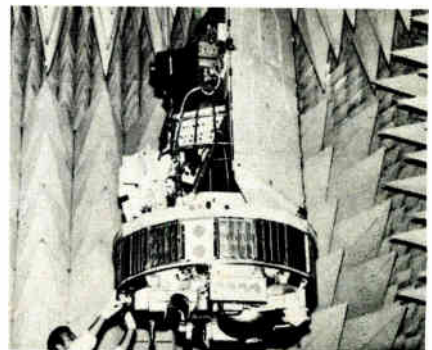

The most advanced anechoic and shielded chambers... used worldwide for antenna pattern, radar cross-section, VSWR and RF compatibility measurements. Send for data.

Circle 221 on reader service card

EMERSON & CUMING



Dewey and Almy Chemical Division
 W. R. Grace & Co.
 Canton, Massachusetts 02021 U.S.A.
 Telephone (617) 828-3300

American Optical gives you a big stage...for a really big show.

The AO® Series 1860 Industrial Microscope offers a 12½" x 8" stage with a full 6" x 6" X-Y stage travel, for quality control, failure analysis, fabrication or general inspection of masks, wafers and other microelectronic components.

With exclusive AO nosepiece focusing, the stage height remains fixed for excellent stability and easier use of ancillary equipment.

And the stage will accept carousels or any other commercially available stage hardware.

If you'd like to see how an AO Series 1860 Industrial Microscope can fit into your production number, contact your American Optical dealer for a demonstration. Or call or write: American Optical, Scientific Instrument Division, Buffalo, NY 14215; (716) 895-4000.

AO
American
Optical

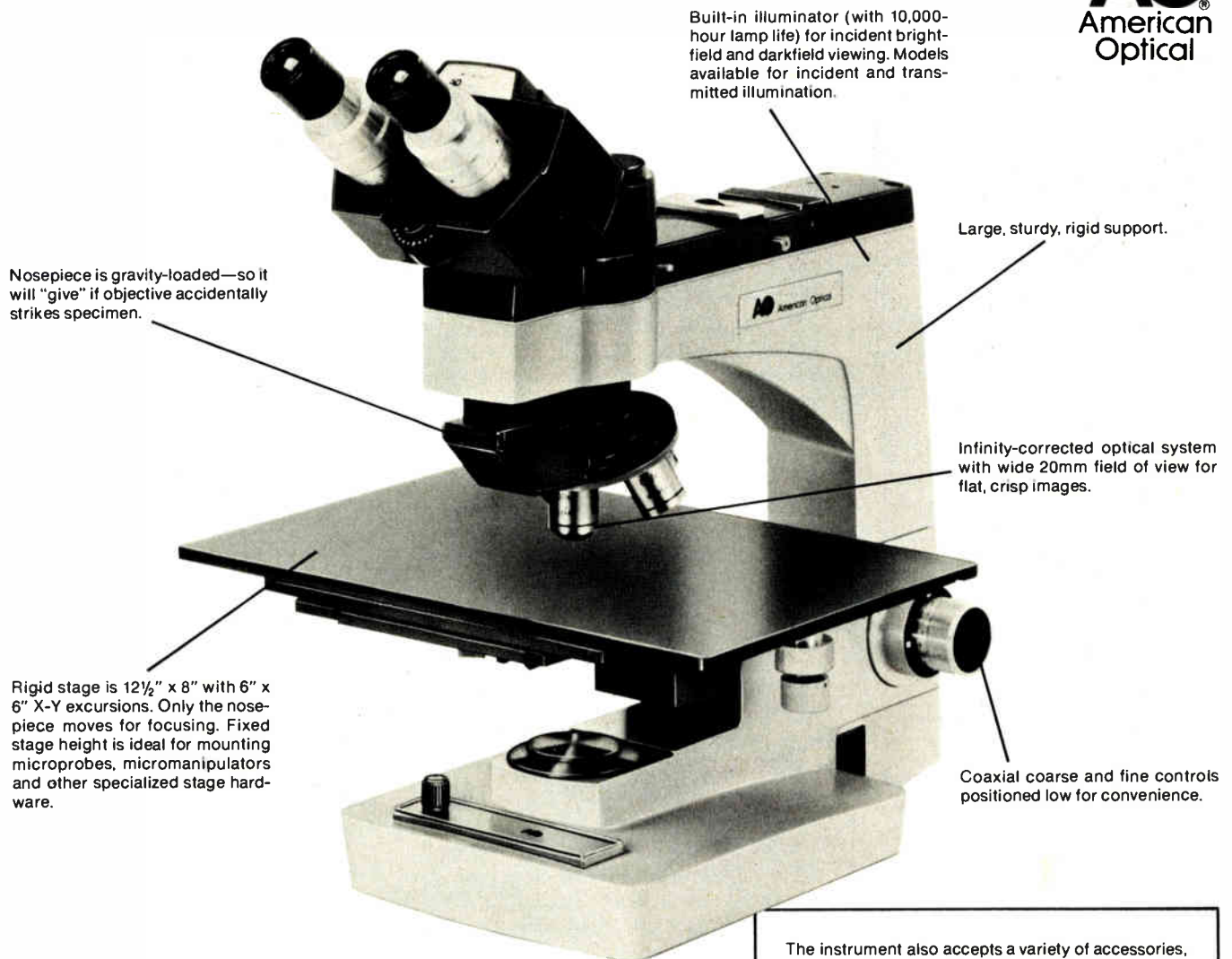

ALL THE PARTS YOU NEED FOR A 4½ DIGIT CASCADABLE COUNTER/DECODER/DRIVER:

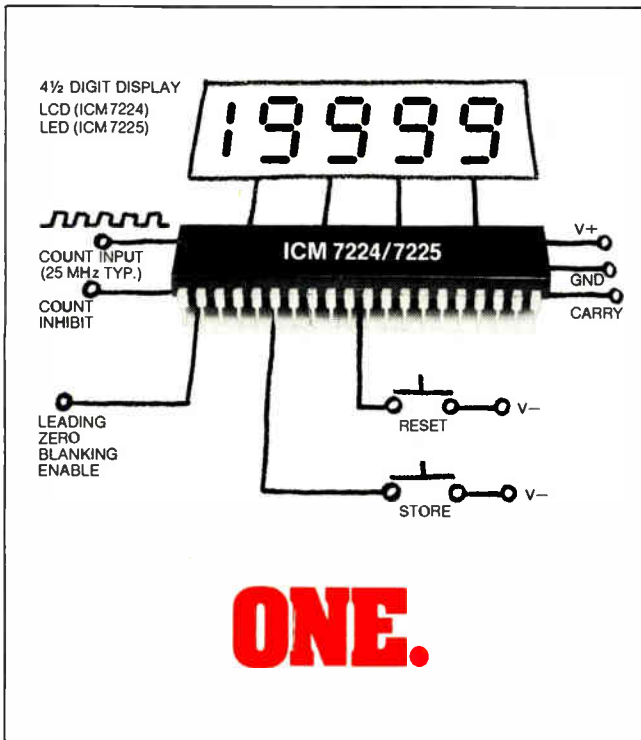

LCD or LED. One chip.

The ICM7224 (LCD) and ICM7225 (LED) counters offer 19999 maximum count, or 15959 maximum count in version "A" (timer). In both versions, the display is not multiplexed and, RF interference is eliminated. Bright digits are assured (with a guaranteed minimum of 5mA per segment on the ICM7225 LED version).

High frequency. Low frequency.

MAXIMUM COUNT FREQUENCY (TYPICAL)
AS A FUNCTION OF SUPPLY VOLTAGE

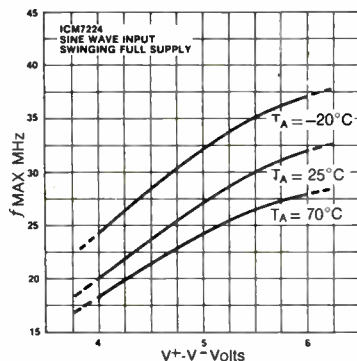

The ICM7224 offers high frequency counting, (15MHz guaranteed; 25MHz typical at 5V). For those applications that require low frequency counting, down to DC, a Schmitt trigger on the count input allows accurate operation in noisy environments or with slowly changing inputs.

Low power.

Current requirements of the ICM7224 are 10µA up to 1KHz and 1mA at 10MHz with a 5V supply. That means less than 10mW power consumption when counting from DC to 15MHz...terrific for long battery life operation.

Cascadable.

Cascade in four-digit blocks. The ICM7224/7225 family of counter/decoder/drivers provides a carry output which allows cascading to 8, 12 or 16 digits. Leading zero blanking control pins provide correct blanking on cascaded devices.

MAXCMOS:® More for less.

Greater reliability. Lower component count. Super performance. Less design and manufacturing cost. At prices like these:

	ORDER PART NUMBER	COUNT OPTION	1-24	25-99	100-999
LCD DISPLAY	ICM7224IPL	19999	\$9.80	\$8.40	\$7.00
LED DISPLAY	ICM7225IPL	19999	\$8.90	\$6.35	\$5.30
	ICM7224AIPL	15959			
	ICM7225AIPL	15959			

Available now.

Call your Intersil Sales Office or Franchised Distributor for full information. Or, return the coupon below for complete product information on all the parts you'll need for a 4½-digit cascadable LCD/LED counter/decoder/driver: One.

®MAXCMOS is a registered trademark of Intersil, Inc.

INTERASIL SALES OFFICES: CALIFORNIA: Sunnyvale (408) 744-0618, Long Beach (213) 436-9261 • COLORADO: Aurora (303) 750-7004 • FLORIDA: Fort Lauderdale (305) 772-4122 • ILLINOIS: Hinsdale (312) 986-5303 • MASSACHUSETTS: Lexington (617) 861-6220 • MINNESOTA: Minneapolis (612) 925-1844 • NEW JERSEY: Englewood Cliffs (201) 567-5585 • OHIO: Dayton (513) 866-7328 • TEXAS: Dallas (214) 387-0539 • CANADA: Brampton, Ontario (416) 457-1014

INTERASIL FRANCHISED DISTRIBUTORS: Advent/Indiana • Alliance Electronics • Arrow Electronics • Bell Industries • CESCO • Component Specialties Inc. • Components Plus • Diplomat Electronics Inc., (FLA) • Diplomat Electronics Inc., (NJ) • Harvey Electronics • Intermark Electronics • Kierulff Electronics • LCOMP • Parrott Electronics • R.A.E. Ind. Elect. Ltd. • RESCO/Raleigh • Schweber Electronics • Summit Distributors Inc. • Wyle Distribution Group • Zentronics Ltd.

INTERASIL

Analog Products — Low Power
10710 No. Tantau Ave., Cupertino, CA 95014
Tel: (408) 996-5000 TWX: 910-338-0171
(800) 538-7930 (Outside California)

E 11/8/79



One?

Send me the details on: ICM7224 (LCD) counter.

ICM7224A (LCD) timer. ICM7225 (LED) counter.

ICM7225A (LED) timer. Send me your Mark Twain Poster.

Name _____

Company _____

Address _____

City _____

State _____

Zip _____

Plessey 'FASTOR' Ultrafast 100ns modules.

Complete with box, backplane and power for memory systems up to 512K bytes.

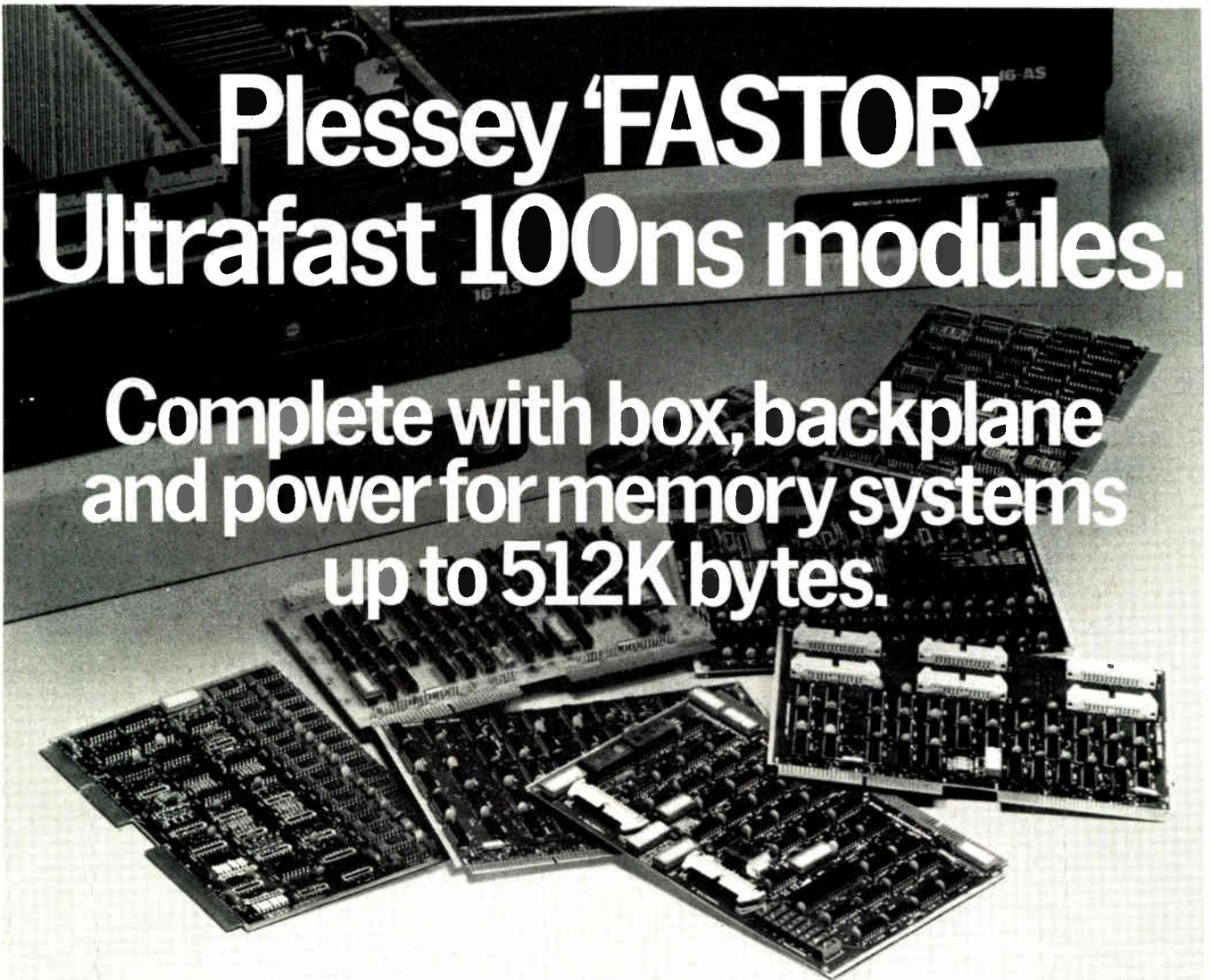

Plessey 'FASTOR' provides fast access memory for high-speed computing, in a highly convenient package. Designed around double Eurocards with 16K bytes each of the fastest memory available anywhere.

The 19-inch rack mounting chassis is complete with power supplies and a parallel backplane with all signals available in all positions to make your interfacing easy. It is the ideal main storage for applications where data are collected or delivered at 20 megabytes/second.

If you don't need the full system, the cards are available individually as the PSM 3234.

The simple-to-use interface provides:

- block-select control bits.
- read/write control flag.
- additional data/source sink control, if more than one I/O port is provided.
- additional clock source control, if memory is required to cycle at different rates at different times.
- the block-select signal permits read/write and output-select signals to be applied to the appropriate 64K memory block.

If you're seeking a ready-built memory system, and need it pretty quickly, then move fast! Contact us for full details of Plessey 'FASTOR'.

OUTLINE SPECIFICATION of 128 Kbit module

Capacity:

8K words, 16 bit

Access time:

100 ns max

Device type:

4K static RAM (2147 type)

Power supply:

5V \pm 3%

Power consumption max.:

19W selected

8W deselected

Options:

Depopulation to 4K words

Temperature range:

0 to 70°C ambient



PLESSEY MICROSYSTEMS

Plessey Microsystems Inc, 19546 Clubhouse Road, Gaithersburg, Maryland 20760 Telephone: (301) 948 2791 TW X: 710 828 9708
1641 Kaiser Avenue, Irvine, California 92714 Telephone: (714) 540 9931 TW X: 910 595 1930
France: Paris (01) 776 43 34 Holland: Noordwijk 01719 19207 Germany: Munich (089) 23 62 270
Japan: Eiji Kitahara, Tokyo 244 3782 UK: Towcester (0327) 50312.

0654-2-0100



Single line 5 x 7 dot matrix — 9 models —
10, 16, 20, 32, 40 character line lengths

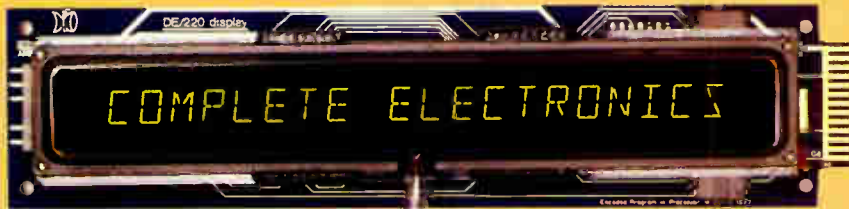

Single line 14 segment — 6 models —
10, 20, 32 character line lengths

NEW MULTI-LINE MODULES

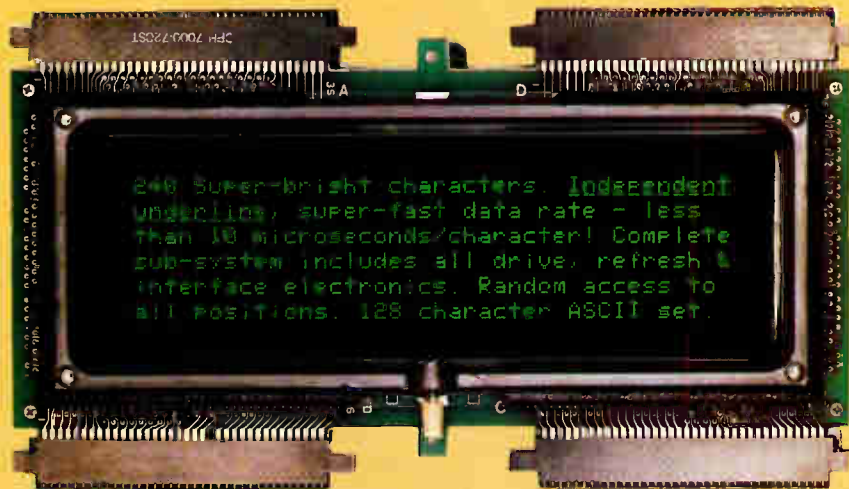

2 x 40 and 6 x 40 modules, 5 x 7 dot matrix —
latest innovations from DECO's display systems engineers!

CALL NOW FOR A DEMONSTRATION

CHEMETRICS CORPORATION



DIGITAL ELECTRONICS
DIVISION

197 AIRPORT BLVD
BURLINGAME, CA 94010
(415) 342-8333

TELEX: 334422 CHEMETRIC BRGM

UNITED STATES

Digital Electronics Corp.
(415) 342-8333

Local representation throughout the U.S.

ITALY

Auriema Italia SRL
02/430 602

AUSTRALIA/N.Z.
Romtech Pty. Ltd.
(02) 601-4511

SCANDINAVIA
Auriema AB
08-730-5160

BRAZIL/ARGENTINA
AD Auriema Inc.
(212) 938-0930

FRANCE

Alfatronic S.A.
791.44.44 ext. 5735

U.K./BELGIUM
Dialogue Microsystems Ltd.
011-44-6285-26729

SPAIN

Unitronics S.A.
242 52 04

GREECE/TURKEY
AD Auriema Inc.
(212) 938-0930

CANADA

John G. Weiss Co.
(514) 489-6887
(416) 236-1701

W. GERMANY/AUSTRIA
bitronic GmbH
(089) 470-2098

SWITZERLAND
Memotec AG
(063) 28 11 22

NETHERLANDS
Auriema Nederland BV
040 444470

ISRAEL
Talviton Electronics Ltd.
444 572

MORE THAN

16

MODELS TO
CHOOSE FROM!

**SUPER
SMART**

ALPHANUMERIC DISPLAY SUB-SYSTEMS

Completely Designed
and Ready to Use

WHY DO ENGINEERS SPECIFY DECO DISPLAY SUB-SYSTEMS?

Readability - Bright sharp, highly readable characters even in daylight with proper filtering. Natural, eye-pleasing blue-green color filters to blue, green, aqua, amber, orange, red

Variety - Full range of sizes available from 10 to 240 character positions. 5mm to 15mm character heights.

Reliability - Vacuum fluorescent tube technology offers tube MTBF up to 100,000 hours, shock resistance to 100 G's

Low Power - As low as 65 milliwatts per character. Much lower power dissipation than LED or gas discharge displays. No need for 250 volt high voltage typically used in gas discharge displays

Self-contained - All drive, refresh and interface circuitry included at no extra charge. Many models also feature on-board power conversion circuitry — only +5VDC input required!

Complete Software - manual, mounting diagrams and interface electronics furnished in evaluation kits. Kits also include full assortment of filters, bezels and mounting hardware.

5x12 DOT MATRIX DISPLAY NOW AVAILABLE

New format allows decenders,
accents, umlauts, etc.
40 character line length.

Introducing the 5610 Automated Network Analyzer System...

**Fast, Automatic and
Accurate from
10 MHz to 18 GHz.**

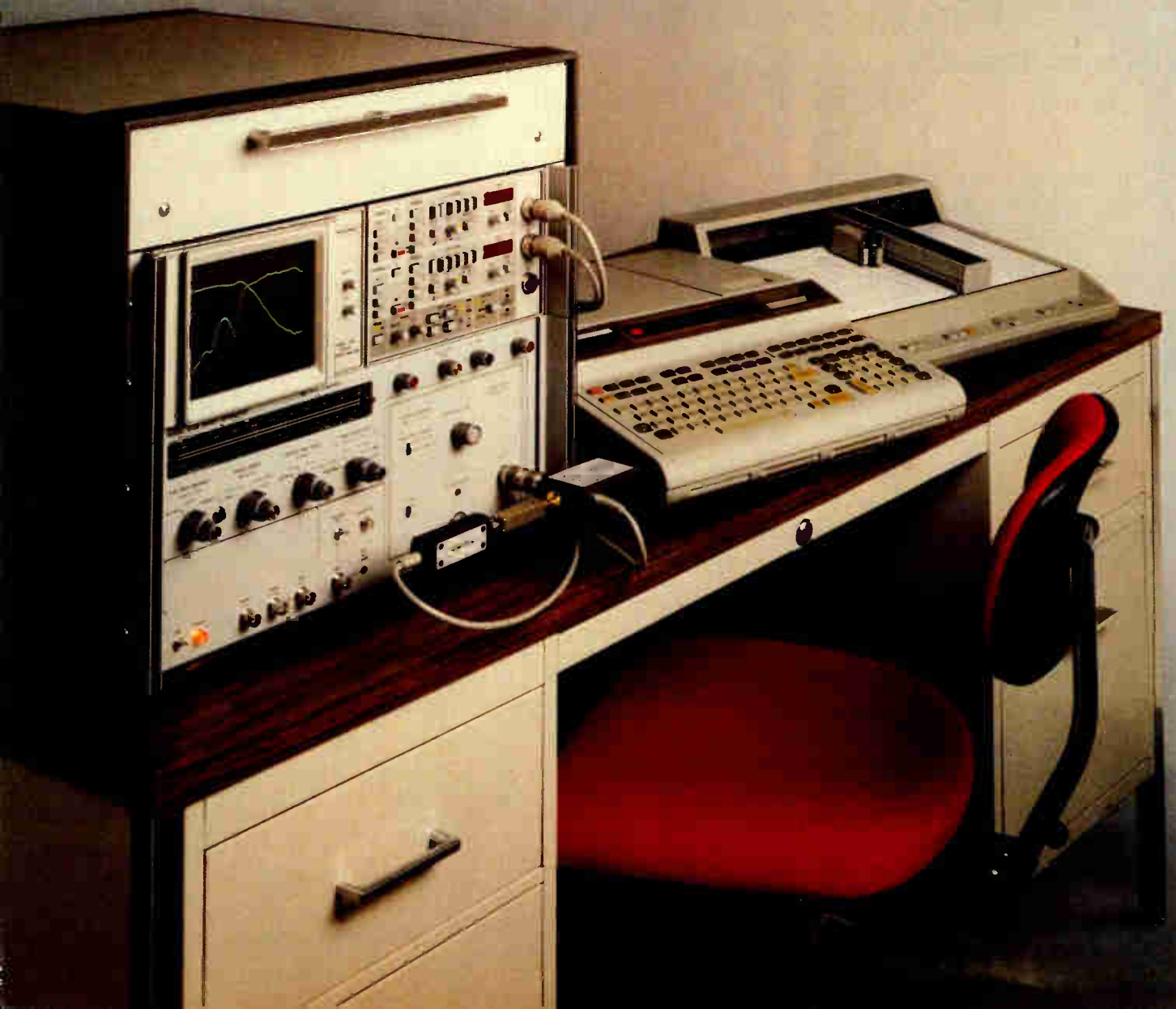

It's a Wiltron.

Now you can automatically make the most important microwave measurements...return loss (SWR), transmission loss or gain and absolute power...quickly and accurately over the 10 MHz to 18 GHz range with hard copy output. Straightforward program-guided inputs are easy to follow.

Wiltron's new 5610 desktop computerized system gives you a new level of accuracy, convenience and cost savings. You simply plug in the preprogrammed cartridge that comes with each system, enter a few simple inputs through the controller, then get hard copy test data over a 66 dB (+16 dBm to -50 dBm) dynamic range from 10 MHz to 18 GHz. No other scalar system is remotely comparable.

Turnkey system includes programming.

Wiltron's 5610 system is delivered complete and ready to work. The system includes a 560 Scalar Network Analyzer, 610D Sweep Generator, 560-97A50 (GPC-7) SWR Autotester, 560-7A50 Detector, HP 9825A Desktop Computer and HP 7225A Plotter. We also include the preprogrammed measurement software cartridge, as well as all cables and accessories. Option 3 provides a WSMA test port connector. Option 4 is Type N. Special versions are available for operation up to 40 GHz.

A new era in microwave measurement.

0.01 dB resolution. • SWR measurements with better than 40 dB directivity. • 66 dB dynamic range. • One sweep generator covers the 10 MHz to 18.5 GHz range. • A new WSMA (SMA compatible) connector with improved return loss measurement accuracy and life expectancy. • Digital memory techniques which substantially improve measurement accuracy. • Calibration techniques which correct for variations caused by frequency response variations and test port mismatch errors. • Refreshed display of memory-corrected measurement results.

Wide Application.

The 5610 is well suited to both laboratory and production line applications. Almost every kind of RF component or system can be tested. For instance:

Test amplifiers to measure gain, power, isolation and return loss over 66 dB dynamic range.

Test filters to plot insertion loss and return loss individually or together on a single page with 0.01 dB resolution.

Test antennas to make precise return loss measurements with 40 dB directivity accuracy and memory-corrected test data.

In the lab, on the line, payback is fast.

Even if you're only testing a single device, substantial savings are yours with the new Wiltron 5610 system. And, on the production line, you'll get your initial investment back even faster.

For an early demo or full data, phone Walt Baxter, (415) 969-6500, or address Wiltron, 825 East Middlefield Road, Mountain View, CA 94043.

Easy 4-step operation

```
DATE?: AUGUST 1, 1979
DEVICE UNDER TEST?: HIGH PASS FILTER
OUT SERIAL NUMBER?: 4782
START FREQUENCY IN GHz?: .01
END FREQUENCY IN GHz?: 10
FREQUENCY STEP SIZE IN MHz?: 100 MHz
WHAT TYPE OF MEASUREMENT - TRANSMISSION (T),
REFLECTION (R), OR BOTH SIMULTANEOUSLY (S)? : S
```

Enter test parameters on controller

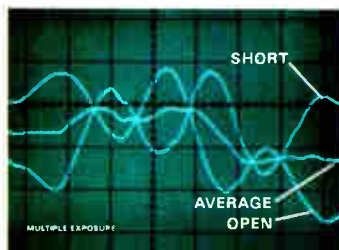

Store system residuals in memory for later correction of test data

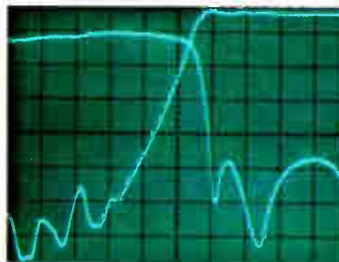

Use CRT display to confirm proper operation of system and to adjust device under test

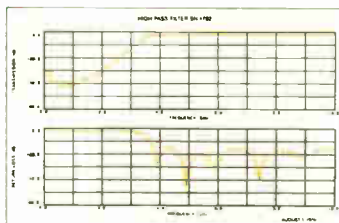

Initiate automatic measurements and hard copy printout

WILTRON

Circle 226 on reader service card

HI-VOLTAGE CERAMIC CAPACITORS

to
30kV

in configurations
to suit your
application

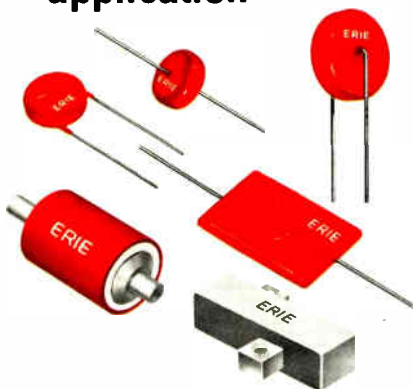

ERIE offers a broad range of high quality components with physical styles, leads, capacitance . . . and voltages to suit your needs. These popular capacitors are widely used in electric utility transformers, power supplies, voltage multipliers for CRT displays, image intensifiers for night vision apparatus, navigation equipment and electro-optic equipment . . . literally any application involving high voltage ceramic capacitors.

Write on your company letterhead for our new catalog 3900-R1 . . . or call 814-237-1431.

ERIE

ERIE TECHNOLOGICAL PRODUCTS, INC.
State College, Pa. 16801
814-237-1431

New products

Industrial

Versatile chip controls motors

Programmable device has
repertoire of 21 instructions,
sells for \$95

The control of stepper motors, especially in complex systems, promises to become far simpler in the near future with the introduction of a user-programmable control chip by Cybernetic Micro Systems Co. Currently available stepper-motor controllers have essentially one operating mode: for each pulse supplied through the controller, the motor is moved one step. "But with our chip that [single-stepping] is the very minimal function provided," notes Edwin E. Klingman, president of the Los Altos, Calif., company. The chip's on-board read-only memory contains a repertoire of 21 instructions, while its random-access memory allows the user (or a computer) to program specific instruction sequences and to enter values for such parameters as acceleration, speed, and position.

To ease the task of developing programs for the CY-500 chip by users who do not have a computer handy, the device has been made compatible with an ASCII keyboard that may be used in conjunction with a high-level language. Users who do their program development on a computer will probably find it better to communicate with the CY-500 in binary. They may do so with any machine operating at up to 1,200 bauds in an 8-bit parallel or serial format. Either binary or ASCII-decimal coding may be selected by the user in the field.

The 21 high-level function-oriented instructions are easily called up by single-letter labels such as P for position, S for slope, and R for rate. In addition to the standard instruction set, the user may choose to have his own set of instructions

loaded into the controller at the factory as an option.

Among the key features that give the CY-500 its great flexibility are: half- or full-step operation; absolute- or relative-position mode; the ability to control rates as fast as 3,500 steps/s; both hardware and software control of the direction of movement, as well as starting and stopping; a home-direction capability; single- and multiple-step modes; ramp-up, slew, and ramp-down modes; triggered operation; and the ability to execute DO-WHILE commands. Moreover, programmable input pins allow the user to synchronize external events with the operation of the CY-500, and programmable output lines permit the CY-500 to provide synchronization and control signals to external devices.

Although the CY-500 is currently being manufactured in n-MOS, Klingman asserts that complementary-MOS, as well as military-grade, versions of the device will be available in the future. The present CY-500 is priced at \$95 and will be available from stock in January.

Cybernetic Micro Systems Co., 445-203 So. San Antonio Rd., Los Altos, Calif. 94022. Phone Ed Klingman at (415) 949-0666 [371]

Pressure cells measure up to
10,000 lb/in.² within 0.5%

Beta pressure cells, with rated capacities from 300 to 10,000 lb/in.² and a compensated temperature range from -40° to +260° F, are readily applied to commercial and industrial uses. These pressure transducers have an overall measurement





Put an end to it all.

IDC mass termination never had it so good, because now you can get all the connectors you need from a single source.

And, if we don't have the standard IDC connector you need to solve your mass termination problem, we'll invent one that will.

We'll take total responsibility for all your interconnect needs from jumpers and flat cables to IDC connectors and ready-to-go custom and standard planar assemblies, so check us out. You'll quickly see why so many happy endings begin

with a call to us.

For the name and number of our nearest distributor or rep, write Spectra-Strip, an Eltra Company, 7100 Lampson Avenue, Garden Grove, CA 92642. Or call (714) 892-3361 today.



When you're down to the wire

Circle 229 on reader service card

Fast, accurate temperature measurement between -196°C and +450°C

In virtually any application where thermal measurements must be made speedily and accurately, you'll find Thermometrics Thermistors doing a job worldwide.

Our comprehensive line of low-cost thermistors and assemblies is available from stock or short delivery.

Beads—glass enclosed; .005" to .055" dia.
Probes—glass enclosed; .012" to .100" dia.
Rods—beads in glass rod; .060" to .100" dia.
Flakes—.020" x .020" x .001" to .120" x .120" x .004"

Ultrafasts—response times to 3 milliseconds
Assemblies—all kinds of special and standard housings

Temperature Standards—0°C to 60°C calibrated every 0.01 °C

Ultrastable—guaranteed to 0.005 °C/year

Write or call for more details on our line of thermistors and to keep abreast of new thermistor developments and applications.

THERMOMETRICS INC.
808 U.S. Highway #1,
Edison, N.J. 08817, (201) 287-2870

Circle 230 on reader service card

Numeric Printer

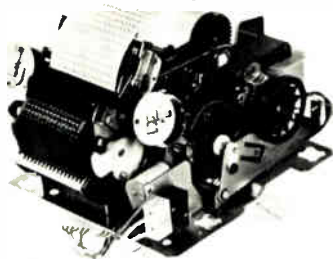

Data logger for medical and physical instruments, telephone toll call monitor. Limited alpha available. Small in size. Prints 3 lines per second.

ADDMASTER
CORPORATION

416 Junipero Serra Drive
San Gabriel, California 91776
(213) 285-1121

230 Circle 75 on reader service card

New products

uncertainty of 0.5%—including non-linearity, hysteresis, and repeatability—and provide a 3-mV/V full-scale output. Below 300 lb/in.², the output is 0.01 mV/V per lb/in.²

The devices are easily interchanged with no need for system recalibration. Measuring 2 in. in length and 1 in. in diameter, the cells have a 1/2-20 UNF-type pressure-port connector with an O-ring seat.

On quantity orders, the user may specify custom full-scale pressure values within the range of 300 lb/in.² to 10,000 lb/in.² at no additional cost. Unit-priced at \$96, the pressure transducers sell for much less in production quantities.

BLH Electronics, 42B Fourth Ave., Waltham, Mass. 02254. Phone Harry Owens at (617) 890-6700 [373]

Digital thermometer provides analog output for recorder

Series 44 digital thermistor thermometers linearize their probes over the thermistors' full temperature range and display the temperature reading to the nearest 0.1°F or C. The thermometers have an analog output signal suitable for recorders, alarms, and controllers. The signal level at 0° is 0 mV and increases (or decreases) by 1 mV for every 1° increase (or decrease) in temperature. Maximum error is ±(0.5% of reading + 1.4°F).

A wide variety of probes is available for the series 44 thermometers, making the instruments useful for applications in agriculture, research, quality control, heating, air conditioning, field engineering, food



Instant Access to All American and International

Data Communications Standards

Presents all 89 relevant
data communications
standards promulgated by:

- CCITT • ISO
- ANSI • EIA • FTSC

Plus... descriptions of each of the standards groups
And... relational charts of similar interfacing standards produced by each group



1133 pages
Edited by
Harold C. Folts
and
Harry R. Karp

Order today using this coupon!

Return coupon to:
Data Communications Standards
P.O. Box 669
Hightstown, New Jersey 08520

Send me _____ copy (copies) of **DATA COMMUNICATIONS STANDARDS** (099782-9) on a 10-day money-back guarantee. I understand that if I am not absolutely satisfied, I may return the book(s) within ten days at no further obligation. Otherwise, McGraw-Hill will bill me \$165. for each copy, plus applicable sales tax, shipping and handling charges.

- _____ Check enclosed
_____ Bill me
_____ Bill my company
_____ Company purchase order #



SAVE MONEY! Enclose payment in full, plus local sales tax, and McGraw-Hill pays all regular shipping and handling charges. Ten-day money-back guarantee still applies

Name _____
Title _____
Company _____
Address _____
City _____ State _____ Zip _____

This offer subject to acceptance by McGraw-Hill ELT

FLEXIBILITY

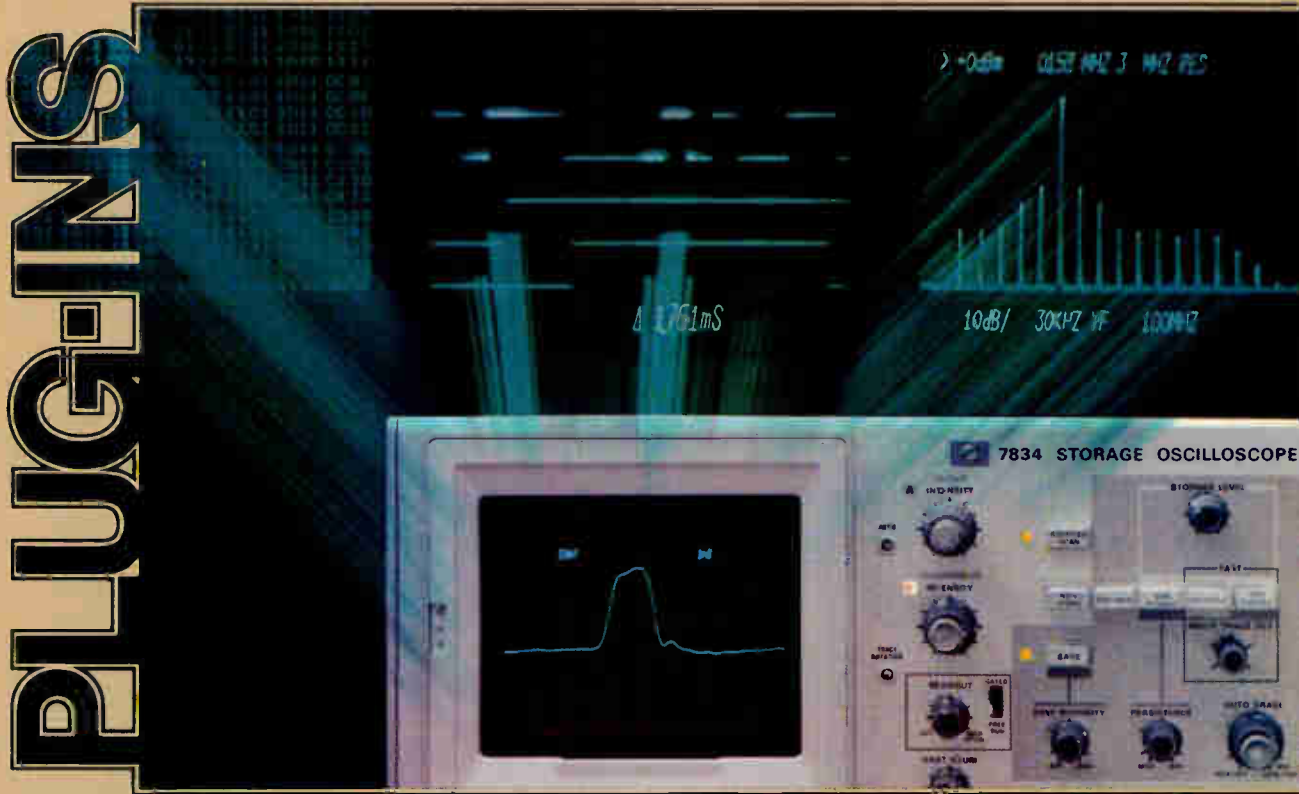

One instrument. Multiple measurements.

Tektronix Plug-In oscilloscopes combine a number of diverse measurement functions in the same instrument. And in combinations you require. One instrument takes the place of many. You get maximum measuring power with a minimum of instruments.

How? By choosing from the continually evolving 5000 and 7000 families of Plug-Ins. Already there are 14 mainframes and 21 plug-ins in the 5000-Series; 19 mainframes and 35 plug-ins in the 7000-Series. (With them, you can also use compatible logic and spectrum analyzers plus other special purpose plug-ins.) Choose from a family providing up to 8 input display channels. Analog and digital delayed sweeps. Sampling displays. Digital interconnections. And differential inputs. Just to name a few.

No matter what your test and measurement situation, we offer a Plug-In oscilloscope that fits. From circuit design to plasma physics research. From balancing rotating machinery to measuring the accuracy of D to A converters. With every scope representing the same superior research and engineering you expect from Tektronix.

What about your own particular situation? Are your measurement capabilities confined by monolithics? Contact the Tektronix Field Office near you and get your hands on the kind of flexibility that only a Plug-In scope can deliver.

Tektronix[®]
COMMITTED TO EXCELLENCE

For literature, call (800) 547-1512 toll free.

LOOK! programmable microvolts dc calibrator/standard

EDC model 501 Series J



Programming
IEEE 488 (GP/IB),
or
Binary
or
Parallel/Serial

Range Control
 $\pm 0.1 \mu\text{V}$ to $\pm 1000 \text{Vdc}$
 $\pm 10 \text{nA}$ to 10 Amps dc

Resolution (1ppm)
24 Bits (BCD)
or
20 Bits (Binary)

Local/Remote
Program lines
remain connected.
Uninterrupted
program up-date.

Prices* start at
\$1895

Output Specifications

Range: $10 \mu\text{V}$ to 10Vdc
Accuracy: $\pm 0.005\%$
Speed: $50 \mu\text{s}$
Isolation: $10^{12} \Omega$, 130pf, 500 Vdc
Stability: $\pm 0.0005\%$

Optional Functions

100 mV Range: $0.1 \mu\text{V}$ to 100mVdc
200 V Range: $10 \mu\text{V}$ to 200Vdc
1000 V Range: $10 \mu\text{V}$ to 1000Vdc
100 mA Range: $10 \mu\text{A}$ to 100mA
10 Amp Range: $10 \mu\text{A}$ to 10Amps dc

Programming Options

BCD or Binary, Parallel or Serial entry,
ASC II Code, IEEE 488 (GP/IB)

*U.S. Basic Price, Options, Accessories and
Auxiliary Instruments additional.

Call Bob Ross for additional information.



**ELECTRONIC
DEVELOPMENT
CORPORATION**

11 Hamlin St., Boston, MA 02127, Tel: (617) 268-9896

New products

processing, and energy studies.

The Celsius model, which provides for one thermistor probe, sells for \$174 in unit quantities. It spans -50° to $+150^{\circ}\text{C}$ in increments of 0.1°C . The single-probe Fahrenheit version covers -60° to $+300^{\circ}\text{F}$ in 1° increments and sells for \$199; it may be switched to 0.1° resolution at temperatures below 199.9°F .

Three-probe versions are also offered for applications in which it is necessary to measure temperatures at several points at a time. They are priced at \$215 (Celsius) and \$235 (Fahrenheit). All units are battery or ac-operable.

Atkins Technical Inc., 3401 S. W. 40th Blvd., Archer Interchange (I-75) Industrial Area, Gainesville, Fla. 32608. Phone (904) 378-5555 [374]

Incremental encoder offers 21-bit resolution

A bidirectional, incremental encoder, the Digisec RI_106(S)-QPZ offers resolutions of up to 21 bits (2^{21} parts per turn). The total root-mean-square error, including quantizing, is 0.7 arc-second. The unit has an operating temperature range of -40° to $+70^{\circ}\text{C}$.

This encoder is most suitable for use as a rate- or position-feedback generator directly placed on the azimuth and elevation axes of telescopes, theodolites, radars, and rotary tables, as well as in precision machine-tool controls and in other military and commercial applications.

Housed in a package 10 in. in





MICROSOFT. FANTASY ISLAND FOR MICROCOMPUTERS.

Microsoft is fulfilling the ultimate fantasy of microcomputers with excellent, reliable, tested software. Not just one or two items for certain computers, but a complete, integrated line of system software for all major microprocessors. Isn't it nice to know you can find a little island with such a big array of software? To microcomputers everywhere, we're a dream come true.

BASIC-86 and BASIC-80 Interpreters. BASIC for the 8086 and 8080/Z80. Both support the extensive language features that have made Microsoft™ BASIC the world standard—including PRINT USING, PEEK and POKE, RENUMBER, WHILE/WEND, CHAIN with COMMON, long variable names, protected files, error trapping, double precision arithmetic and dynamic string space allocation. Disk BASIC-86 for Intel SBC 86/12, \$600. Disk BASIC-80 for CP/M, ISIS-II or TEKDOS. \$350.

BASIC Compiler. With the same extensive language features—plus fast, relocatable object code—the Microsoft™ BASIC Compiler is ideal for all types of commercial applications and microcomputer development systems. This single pass compiler performs extensive optimizations that maximize speed and minimize space of the object code. Available for CP/M or ISIS-II operating systems. \$395.

COBOL-80 Compiler. Indisputably the best compiler for powerful use of disk files, data manipulation facilities and interactive ACCEPT/DISPLAY. COBOL-80 is an ANSI-74 standard COBOL that supports indexed and relative files, including DYNAMIC access. FILE STATUS, START, READ NEXT, DELETE and REWRITE. In versions for CP/M or ISIS-II. \$750.

FORTRAN-80 Compiler. More 8080/Z80 computers are using FORTRAN-80 than any other FORTRAN in the

world. With good reason. Microsoft™ FORTRAN-80 is the most complete micro FORTRAN you can buy. It has all of ANSI-66 FORTRAN (except COMPLEX data), plus unique enhancements for use in the microcomputer environment. An extensive library of single and double precision scientific functions, too. Available for CP/M, ISIS-II, OASIS or TEKDOS. \$500.

And every Microsoft compiler comes with the MACRO-80 assembler and LINK-80 loader, giving the flexibility to generate, load and run any combination of relocatable modules.

We can also fulfill the most unusual microcomputer fantasies with custom software or consultations. OEM licensing and purchasing agreements are available.

Microsoft. An island unto itself.

MICROSOFT



10800 NE Eighth, Suite 819
Bellevue, WA 98004
206-455-8080 Telex 328945

VECTOR MICROSOFT
Research Park
B3044 Haasrode
Belgium
016-23-08-94 Telex 61978 JEWEL B

ASCII MICROSOFT
502 Hi Torio
5-6-4 Minami Aoyama
Minato-ku
Tokyo 107, Japan
03-409-7351 Telex 2426875 ASCII J

We set the standard.

Prices quoted are U.S.A. domestic only.

Circle 233 on reader service card

THE 60-SECOND PLANT TOUR.

BUILDING #1602-216

20,736 sq. ft., 2 acres. Insulated metal construction, 12' ceiling at eaves, 14-1/2 ft. at center. Fully sprinklered. Community size: 4,940. Eastern Region.

BUILDING #1602-222

37,780 sq. ft., 7-1/2 acres. Brick and block construction, 16 & 18 ft. ceiling. Excellent condition. Fully sprinklered and air conditioned, 12 miles from commercial airport. Community size: 3,200. Eastern Region.

BUILDING #1602-217

40,000 sq. ft., 13 acres. Metal construction, 22' ceiling, 30' ceiling in center of main build-

ing. 20 minutes from major airport. Community size: 148,450. Piedmont Region.

BUILDING #1602-274

54,000 sq. ft. Brick construction, 682' x 80' with 15' ceiling. Partially air conditioned, 100% sprinklered. Natural gas, rail, and municipal services. Minutes to interstate and one hour from 2 major airports. Community size: 25,270. Piedmont Region.

BUILDING #1602-245

300,000 sq. ft., 40 acres. Brick and block construction, 18' ceiling. Partially air conditioned, 100% sprinklered. Natural gas and propane. 25 minutes from major airport

and interstate. Community size: 13,690. Piedmont Region.

BUILDING #1602-265

49,152 sq. ft., 5-1/2 acres. Brick and masonry construction. 18' ceiling, clear span, 6" concrete floor. Ten minutes to interstate, forty minutes to major airport. Community size: 4,300. Western Region.

BUILDING #1602-273

42,156 sq. ft., 4-1/4 acres. Brick and block construction. 10'-11' ceilings, 4" concrete floor. Fully air conditioned and 100% sprinklered. Municipal water/sewer and natural gas connection. Community size: 2,350. Western Region.

North Carolina has plant facilities in all sizes and shapes that are available for immediate occupancy. Here, you see just a sample. For more facts on these or other buildings or sites, write to: North Carolina Department of Commerce, Industrial Development Division, 430 N. Salisbury St., Raleigh, NC 27611. Or call (919) 733-4151.

NORTH CAROLINA

Circle 234 on reader service card

New products

diameter, with a through hole 6 in. in diameter, the system keeps its electronic components separate, permitting field maintenance of the system. A 10-in. interconnecting cable between the optical unit and the electronics package is supplied. Depending on the resolution and options selected, the encoder is priced at \$9,000 to \$15,000 with delivery in 90 to 120 days.

Itek Measurement Systems Division, 27 Christina St., Newton, Mass. 02161. Phone Harry Lowell at (617) 969-7300 [376]

I/O terminal digitizes, transmits industrial data

The SE100 terminal, for process-data input/output, measures, digitizes, isolates, and transmits industrial process data to computers, microcomputers, and data terminals. Accepting a wide range of transducer scanners, converters, and interfaces, the unit directly scans thermocouples and platinum resistor sensors for voltage and current. This terminal interfaces directly with Intel, Motorola, and Mostek microcomputers, as well as with larger computers and data terminals. The user may choose from among direct byte serial, isolated RS-232-C serial, or 20-mA current-loop interfaces. Featuring remote self-calibration, automatic cable-break protection, and complete optical isolation, the SE100 is microprocessor-based. Mainframe prices start at \$1,490, with delivery within 8 to 10 weeks.

San Diego Instrument Laboratory, 7969 Engineer Rd., San Diego, Calif. 92111. Phone (714) 292-0646 [377]

Tiny digital actuator offers 4.5 lb of linear force

Providing up to 4.5 lb of linear force, a miniature digital linear actuator can be used in such applications as valve actuation and variable-displacement pump regulation in process control and medical equipment, in magnetic-pickup-head positioning



LARGEST RADAR INVENTORY IN THE WORLD

<p>SYSTEMS & SPARES</p> <p>AN/ALT-6-7-8 AN-APG-33 AN/APG-51 AN/APN-69 AN/APN-102 AN/APN-169 AN/APQ-50 AN/APQ-55 AN/APS-20 AN/APS-31A AN/APS-42-45 AN/APS-64 AN/ASB-4/9 AN/CPS-6B AN/CPS-9 AN/DPN-32 AN/FPS-6-8 AN/FPS-14-18 AN/FPS-20-75 AN/FRC-39 AN/FRT-15 AN/GPA-30 AN/GPA-126 AN/MPQ-4A-10 AN/MPQ-29 AN/MPS-19 AN/MPX-7 AN/MSQ-1A AN/SPA-4A AN/SPA-8 AN/SPN-5 AN/SPS-5B AN/SPS-6C AN/SRW-4C AN/TPN-12/17 AN/TPS-1D, E AN/TPS-10D AN/TPS-28 AN/TPS-34B AN/TPS-37 AN/TPX-21 AN/UPA-25-35 AN/UPX-4-6 AN/UPX-14 HIPAR MK-25 Nike Ajax Nike Hercules SCR-584</p>	<p>AUTOTRACK ANTENNA SCR-584 RADAR SYSTEM</p> <p>360 deg AZ 210 deg EL. 1 mil. accuracy. Missile vel. accel. and slew rates. Amplidyne control. Handle up to 20 ft. dish. Compl. control chassis. ALSO in stock 10 cm. van mounted rad. system. Conical scan. PPI. 6 ft. dish. 300 pg. instr. bk. on radar. \$50.</p> <p>RF SOURCES</p> <p>17-27 KHz 200 W CW 125-450 KHz 4 KW CW 2-30 MHz 3 KW CW 4-21 MHz 40 KW CW 24-350 MHz 100 W CW 80-240 MHz 500 W 2-5 uS 175-225 MHz 300 KW 1, 20 uS 200-2000 MHz 40 W CW 210-225 MHz 1 MW 5 uS 385-575 MHz 1.5 KW CW 400-700 MHz 1 KW .03 DC 950-1500 MHz 1 KW .06 DC 900-1040 MHz 5-10 KW .006 DC 1.2-1.35 GHz 500 KW 2 uS 1.5-9.0 GHz 150 W CW 3.2-3.3 GHz 10 KW .002 DC 2.7-2.9 GHz 1 MW 1 uS 3.1-3.5 GHz 1 MW 1.3 uS 2.7-2.9 GHz 5 MW 2-3 uS 4.4-5.0 GHz 1 KW CW 5.4-5.9 GHz 5 MW .001 DC 6 GHz 1 MW 1 uS 6.2-6.6 GHz 200 KW .37 uS 8.5-11 GHz 200 W CW 9.375 GHz 40 KW .5-1-2 uS 8.5-9.6 GHz 250 KW .0013 DC 15.5-17.5 GHz 135 KW .33-1-3 uS 24 GHz 40 KW .15 uS 35 GHz 50 KW .1 uS</p> <p>MODULATORS</p> <p>25 KW 5.5 KV 4.5 A; .0025 DC 144 KW 12 KV 12 A; .001 DC 250 KW 16 KV 16 A; .002 DC 405 KW 20 KV 20 A; .1 DC 500 KW 22 KV 28 A; .001 DC 1 MW 25 KV 40 A; .002 DC 3 MW 50 KV 60 A; 30 uS 10 MW 76 KV 135 A; .001 DC 66 MW 160 KV 400 A; .00</p>	<p>TRACKING SYSTEMS</p> <p>K BAND MONOPULSE 40 KW E-34 X BAND NIKE AJAX/HERCULES X BAND HI-RES MONOPULSE MOD IV X BAND GCA PAR II X BAND FIRE CONTROL 250 KW M-33 X BAND MOBILE 40 KW AN/MPQ-29 X BAND BEACON 100 W AN/DPN-62 S BAND 10' DISH 500 KW AN/MPQ-18 S BAND 250 KW AN/MPQ-10A S BAND 250 KW AN/MPS-9 X BAND HAWK MPQ-34 X BAND HAWK MPQ-33 C BAND 1.5 MW MPS-19(C) S BAND 14' DISH PRELORT</p> <p>SEARCH SYSTEMS</p> <p>KU BAND AIRBORNE 135 KW B-58 X BAND WEATHER 250 KW AN/CPS-9 X BAND WEATHER 40 KW AN/SPN-5 X BAND 7 KW AN/TPS-21 X BAND CW DOPPLER AN/PSS-9/12 C BAND HGT FINDER 1 MW TPS-37 C BAND 285 KW AN/SPS-5B/D S BAND HGT FINDER 5 MW AN/FPS-6 S BAND COHERENT 1 MW AN/FPS-18 X BAND 1 MW NIKE AJAX/HERC L BAND 40' ANT 500 KW AN/FPS-75 L BAND 500 KW AN/TPS-1D/GSS-1 UHF 1 MW HELIHUT TPS-28</p> <div style="border: 1px solid black; padding: 5px; margin: 5px 0;"> <p>C BAND TRACKER</p> <p>Pwr: 1.5 MW Range: 250 miles Recv: param Display 5" "A" scopes, 10' dish w/linear or circ. polarization.</p> </div> <div style="border: 1px solid black; padding: 5px; margin: 5px 0;"> <p>NIKE HERCULES SPARES/MAINTENANCE</p> <p>Over 10,000 major components in stock w/repairs and overhaul facilities incl: SHOP 1 & 2 MAINTENANCE VAN.</p> </div> <p style="text-align: center; font-weight: bold;">SEND FOR FREE 24 PAGE CATALOG</p> <div style="text-align: center; margin-top: 10px;">  <p>Radio Research Instrument Co., Inc.</p> <p>2 Lake Avenue Ext., Danbury, CT 06810 (203) 792-6666 • Telex 962444</p> </div>
--	---	--

234 Circle 106 on reader service card

Electronics/November 8, 1979

For multiple choice in alphanumeric displays...

**LOOK TO IEE
FOR SIZE, QUALITY
AND ECONOMY!**

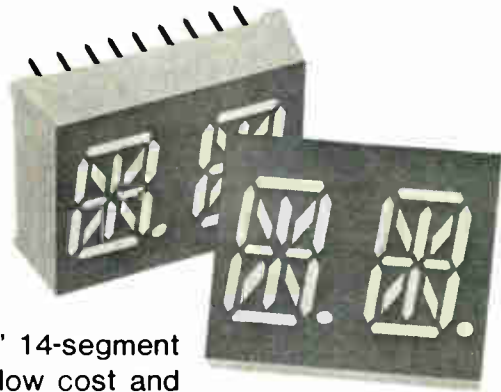

LR3784R/85R is a red, dual .54" 14-segment LED display; it is low power, low cost and end-stackable

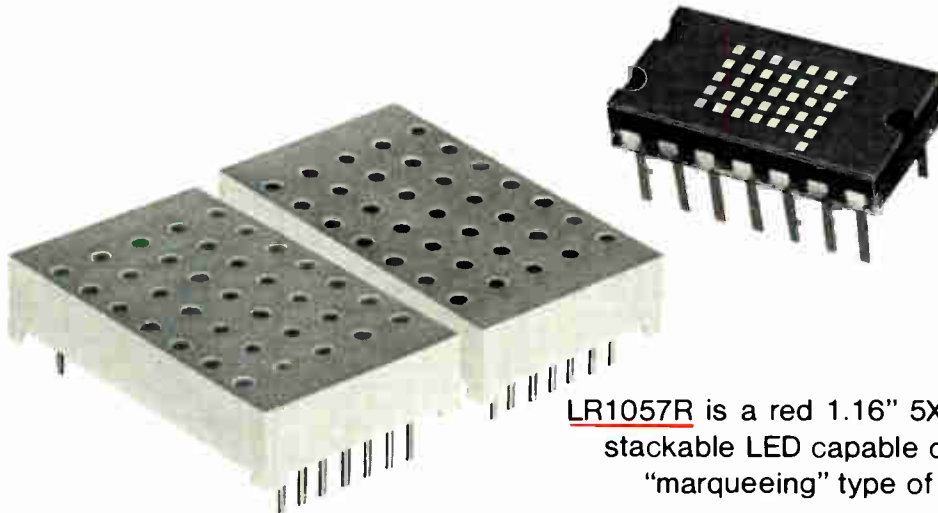

LR1057R is a red 1.16" 5X7 dot matrix, side-stackable LED capable of creating a "marqueeing" type of display effect

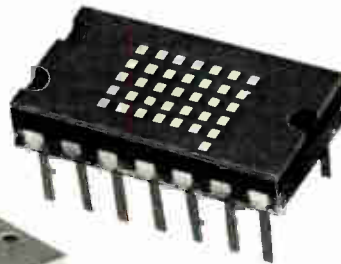

LR1704R is a red .3" 5x7 LED array

Please request additional information on your business letterhead,
or call your local sales representative listed below:

UNITED STATES

AL	(205) 883-7893	MN	(612) 927-4361
AZ	(602) 995-9455	MO	(314) 569-1220
CA	(408) 727-2050	NC	(704) 527-3070
CA	(213) 541-2515	NM	(505) 881-1006
CO	(303) 758-9033	NY	(516) 822-9890
CT	(203) 239-0212	NY	(518) 489-7408
FL	(305) 857-3760	NY	(607) 723-8743
FL	(305) 942-0774	NY	(716) 271-2230
IA	(319) 362-9177	NY	(315) 732-3775
IL	(312) 433-2375	OH	(216) 526-2535
IN	(317) 844-8462	OH	(614) 457-8472
IN	(219) 432-5553	OR	(503) 245-2342
KS	(913) 381-0004	PA	(215) 265-5211
KS	(316) 684-4141	TX	(214) 349-9940
KY	(502) 239-2747	UT	(801) 534-1500
MA	(617) 862-8230	VA	(804) 973-5874
MD	(301) 460-6100	WA	(206) 883-6690
MD	(301) 252-7111	WI	(414) 377-6837
MI	(313) 353-8210		

CANADA

AB	(403) 276-9844
BC	(604) 581-7611
ON	(416) 669-2262
PQ	(514) 487-3434

INTERNATIONAL

AUSTRALIA	ITALY
95-9566	039-360021
BELGIUM	JAPAN
03183.33.50	400-8511
DENMARK	NETHERLANDS
02-863888	04998-4295
ENGLAND	NORWAY
(01) 690-1914	047-02-157550
FINLAND	SOUTH AFRICA
90-882044	28-2662
FRANCE	SOUTH AMERICA
(1) 609-92-00	(215) 624-1049
GERMANY	SPAIN
06235-5662	93-230-55-07
INDIA	SWEDEN
373544-373545	08-890435
ISRAEL	SWITZERLAND
248231	062-515757



**The
Display
Maker**

OPTO-COMPONENTS DIVISION

The Personal Computing Book



Take the computer revolution into your own hands!

More than 50 articles are presented from leading publications in the field to give you this up-to-date guide that answers all your questions on personal computing precisely and reliably.

Hardware • Software • Theory
• Applications • Helpful Hints

Order today, and don't forget the other valuable Electronics Magazine Books listed in the coupon below.

Electronics Magazine Books
P.O. Box 669, Hightstown, NJ 08520



Send me...

- _____ copies of *Microprocessors* @ \$8.95
- _____ copies of *Applying Microprocessors* @ \$9.95
- _____ copies of *Large Scale Integration* @ \$9.95
- _____ copies of *Basics of Data Communications* @ \$12.95
- _____ copies of *Circuits for Electronics Engineers* @ \$15.95
- _____ copies of *Design Techniques for Electronics Engineers* @ \$15.95
- _____ copies of *Memory Design: Microcomputers to Mainframes* @ \$12.95
- _____ copies of *New Product Trends in Electronics, No. 1* @ \$14.95
- _____ copies of *Personal Computing: Hardware and Software Basics* @ \$11.95

Discounts of 40% on orders of 10 or more copies of each book.

I must be fully satisfied or you will refund full payment if the book is returned after ten-day trial examination.

- Payment enclosed Bill firm Bill me
 Charge to my credit card: American Express
 Diners Club Visa Master Charge

Acct. No. _____ Date Exp. _____

On Master Charge only,
first numbers above name _____

Name _____ Title _____

Company _____

Street _____

City _____ State _____ Zip _____

Signature _____

New products

in floppy-disk computer operations, and in many others.

The series 92200 is a modified stepper motor using an internally threaded rotor fitted with a lead-screw shaft. When a voltage is applied to the actuator's coils in the proper sequence, the shaft moves in or out of the rotor in precise linear increments of 0.001 or 0.002 in. per pulse. It remains in a fixed position when the current is removed. The actuator shaft travels a nominal 0.75 in. Digital control allows full extension within 0.75 s for the 0.002-in. step unit and within 1.5 s for the 0.001-in.-step unit. The operating voltage is 12 v dc.

In quantities of 100, the 6-oz digital actuators sell for \$33 each. Small quantities are available within four to six weeks and production lots within 12 to 14 weeks. Applications that require different step increments, force output, or travel needs are handled on a custom basis.

Airpax, North American Philips Controls Corp., P.O. Box 768, Cheshire, Conn., 06410. Phone Larry Torok at (203) 272-0301 [379]

Glass-coated bead thermistor is smaller

A smaller version of the standard THM 0.043-in.-diameter glass-coated bead thermistor, the series B35 consists of a small ellipsoid of metal oxides that is sintered about a pair of 0.0004-in.-diameter platinum alloy wires. Designed to meet MIL-T-23648 specifications, these Thermobeads are available with adjacent or opposite leads in resistance values ranging from 30 Ω to 300 megohms. In quantities of 100 to 249 units, the devices sell for \$1.40 each. (This price is for a unit with a 1-to-2-k Ω resistance value and standard 20% tolerance; actual price varies with the resistance value and tolerance selected.) Scheduled deliveries of the thermistors are from stock to four weeks after receipt of order.

Thermometrics Inc., 808 U.S. Highway 1, Edison, N.J. 08817. Phone (201) 287-2879 [378]

Logical Deduction.

Are bills turning your life story into "The Case of the Disappearing Paycheck"? Does all your hard-earned money seem to vanish without a trace left to save?

Then perhaps you should investigate United States Savings Bonds.

Because saving with Bonds is so simple, it's elementary. Especially if you join the Payroll Savings Plan.

Once you sign up, you see, a small part of each paycheck is automatically set aside to buy Bonds.

Which means as soon as you're paid, you save. Before you're left trying to deduce where it all went.

Buy U.S. Savings Bonds through the Payroll Savings Plan. And take the mystery out of saving.



Take stock in America.

Ad Council A public service of this publication and The Advertising Council.

Electronics / November 8, 1979

Samtec Electronic Hardware

SAM SHINE, PROP.

NEVER A GOLD SURCHARGE

GUARANTEED PRICING
— no surprises

NO MINIMUM ORDER SIZE

GOOD DELIVERY
— when promised

"We'll give you old-fashioned personalized service."

The customer comes first at Samtec... and our growing OEM and distributor accounts really appreciate it. We believe that service follow-up, delivery and pricing promises are meant to be kept — and we work hard to see that they are.

Why not give us a try and see how trouble-free *personalized service* can be?

Get our New 32-page catalog today—complete with all specs and ordering data. See what a difference *personalized service* can make!

samtec

810 PROGRESS BOULEVARD, NEW ALBANY, INDIANA 47150
PHONE (812) 944-6733



© 1978-Samtec, Inc.

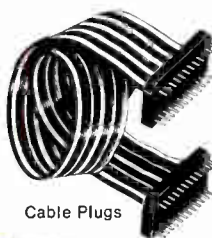

Cable Plugs

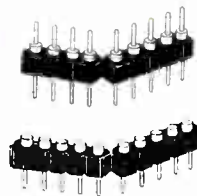

Socket/Terminal Strips

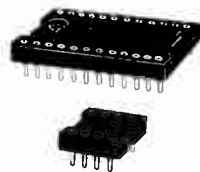

DIP Sockets



TO Sockets

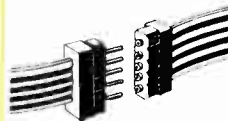

Cable Strip Connectors

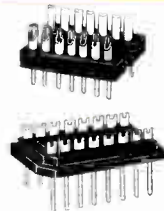

Adaptors

NON-VOLATILE ANALOG MEMORY!

HAVING PROBLEMS WITH AUTOMATIC ZERO AND SPAN CALIBRATIONS?

Why not try our modules XE-120, 121 and 122? They are so convenient you'll be glad to let them handle your problems.

Specifications

Items	Model	XE-120	XE-121	XE-122
Input & Output		0 — +5V or 0 — ±5V		
Input Impedance		1M ohm		
Accuracy		±0.5%/FS	±0.1%/FS	±0.05%/FS
Power Supply		DC ±15V ±35mA		
Dimension		50W x 50D x 16H mm		

Usage

- Automatic zero & span calibration of pollution analyzers
- Automatic zero adjustment of medical instruments
- Automatic zero adjustment of strain amplifiers
- Automatic zero adjustment of electronic balances
- Automatic zero adjustment of logarithm amplifiers



Awaiting your request for catalogs.

(We are now actively seeking sales agents all over the world.)

Circle 238 on reader service card

XEBEC CO., LTD.

4-21-12, Kasuya Setagaya-ku,
Tokyo, 157 Japan.
CABLE: XEBEC JAPAN
TELEX: 2324788 XEBEC J.
TELEPHONE: (03)307-5641

Our business has the energy to help your business.

We generate and transmit dependable electric power to Northwest Florida. As leaders in energy efficiency research, we will show you how to get the most from the energy you buy. When you're ready to build a new plant we can provide design input that will cut costs now and in the future, utilizing co-generation, solar applications, heat recovery, and innovative technology. We also have plenty of clear, concise demographics that describe Northwest Florida, a powerfully attractive place to live, work and play. For the whole story in just a few words, phone or write us today. We'll show you why Northwest Florida makes good sense.

Gulf Power Company
P.O. Box 1151 E
Pensacola, Florida 32520
(904) 434-8371



Gulf Power
the southern electric system

abbott

POWER SUPPLIES

Come to the specialist.

We started out pretty small back in '61. But we were big on product quality and reliability. Had to be. Uncle Sam was our only customer. Over the years we stuck with our own technology. We grew. Became specialists. And we kept on improving our power supplies.

It all paid off. Just look at Abbott today.

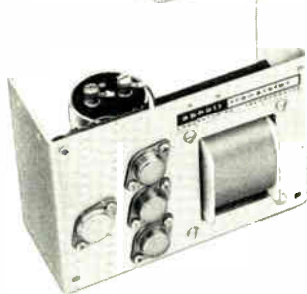

Militarized Power Supplies — Our early bread-and-butter line has grown to over 1500 versions. Some we stock. Yet we're equipped to provide fast delivery on any number of high efficiency, hermetically sealed, single or dual output power supplies and switcher modules. That includes our popular 60 and 400Hz and DC versions with outputs from 3VDC to 740VDC, 1 to 250 Watts. And prices go as low as \$174 for 2-4 units.

For Catalog Circle Card Number 100

Industrial Power Supplies — You won't find a better quality of OEM power modules anywhere. Our "D" line universal switching power modules, for example, offer 1.3 watt per cubic inch. Our KN, PN, and LN line of low cost DC to 60 Hz sine wave inverters provide exceptional efficiency when converting DC battery voltage to regulated 60 Hz power to drive any AC equipment. And the entire OEM line is competitively priced. As low as \$35 for up to 24 units.

For Catalog Circle Card Number 101

Transformers — We specialize in custom transformers to meet your exact power supply design requirements for military, industrial and pcb applications. Our Transformer Catalog offers detailed instructions on how to specify for your custom units. Or just give us a call. We also offer over 800 standard transformers, including 60 and 400Hz, single phase input versions. Prices for standards start as low as \$5.10 for up to 9 pieces.

For Catalog Circle Card Number 102

See Power Supply Section 4000, and Transformer Section 5600, Vol. 2, of your EEM catalog; or Power Supply Section 4500, and Transformer Section 0400, Vol. 2, of your GOLD BOOK for complete information on Abbott products.

abbott transistor

LABORATORIES, INCORPORATED

General Offices
5200 W. Jefferson Blvd., Los Angeles 90016
(213) 936-8185 Telex: 69-1398

Eastern Office
1224 Anderson Ave., Fort Lee, N.J. 07024
(201) 224-6900 Telex: 13-5332



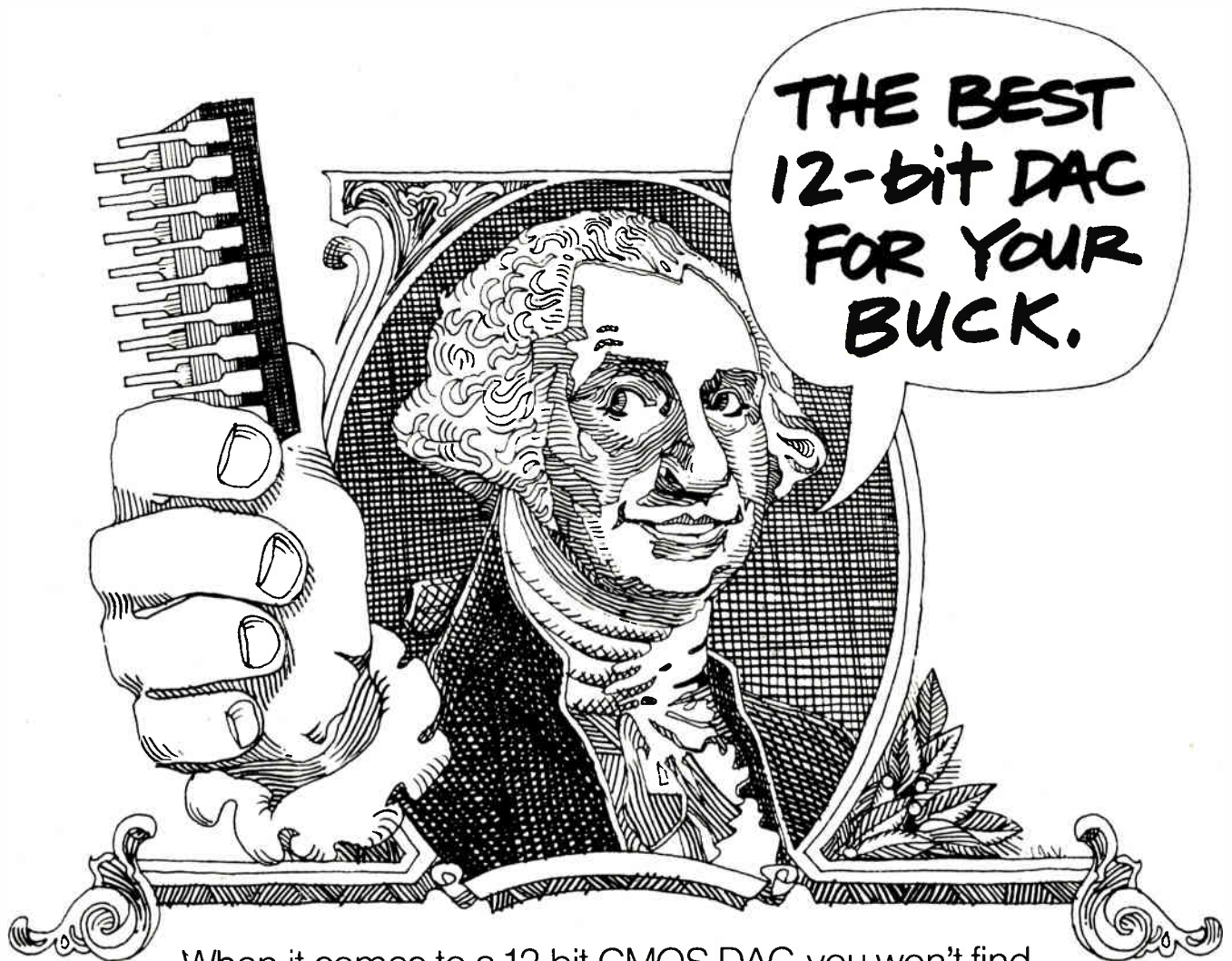

When it comes to a 12-bit CMOS DAC, you won't find a better buy than Teledyne Semiconductor's new 8641.

Performance-wise, there's none better. The 8641's guaranteed linearity of 0.01% ($\pm \frac{1}{2}$ LSB) is accomplished without trimming of any kind. So it's less expensive to make.

We also added compensating CMOS switches to the feedback resistors and at the end of the resistive ladder. The result is a gain error tempco of 2 ppm/ $^{\circ}$ C max.

What's more, the 18-pin DIP 8641 is a pin-for-pin replacement for AD7541. However, ours has improved supply rejection, lower variation of linearity and gain error with V_{DD} , and improved temperature stability. And even with its premium specs, the 8641 costs less: only \$17.70 at 100 quantity for 0.01% guaranteed linearity.

Contact us for more information on why the 8641 is the best 12-bit CMOS DAC for your buck. Teledyne Semiconductor, 1300 Terra Bella Avenue, Mountain View, CA 94043; Phone: (415) 968-9241, ext. 241.

 **TELEDYNE SEMICONDUCTOR**
The Data Conversion Specialist

Need 24 or 40-pin DIP's off the shelf?

We're your source.

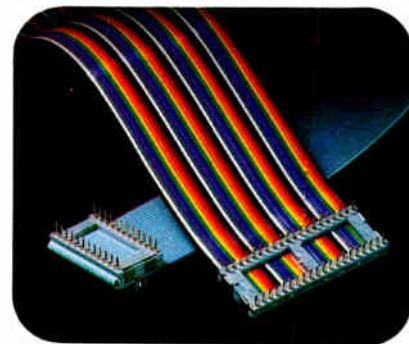
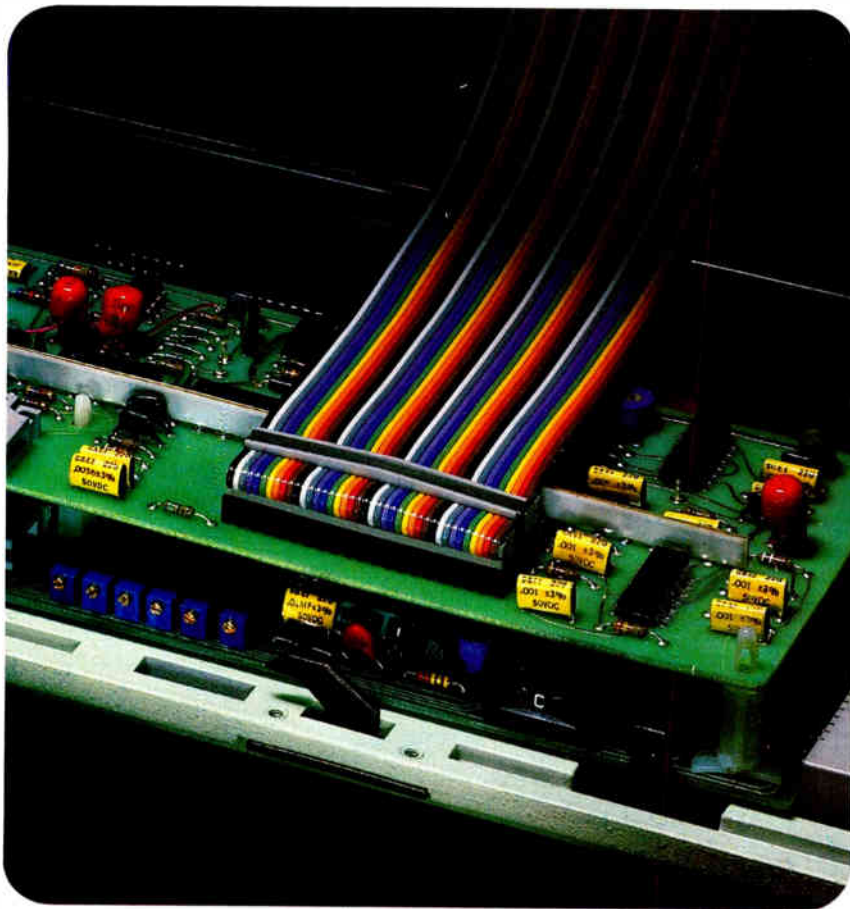

tabs are available for all Scotchflex D.I.P. connectors including 14 and 16-pin sizes.

Need some more ways to simplify wiring and increase circuit density? 3M's Scotchflex line offers you the widest choice of mass terminating cable, connectors and system components to accommodate your design packages. Plus proven reliability. Off-the-shelf availability. And the unmatched experience of the people who pioneered the concept of electronic mass termination.

Scotchflex connectors are recognized under the component program of Underwriter's Laboratories, Inc. 

"Scotchflex" is a registered trademark of 3M Co.

Want the speed, savings and reliability of mass termination with larger size D.I.P. connectors? Come to 3M. Our Scotchflex brand D.I.P. connectors in 24 and 40-contact sizes let you design quick, easy interboard jumpering with readily available parts. Their space-saving low-profile design makes them ideal for microprocessor applications. They also speed and simplify test jumpering or checkout of I.C. sockets.

Both connectors have .100" x .600" grid spacing and are available with either rectangular legs for use with standard I.C. sockets or round legs for use with high density packaging panels. They may be used with Scotchflex shielded, non-shielded or color-coded flat cable or with twisted pair or parallel lay woven cable.

Where frequent plugging and unplugging is necessary, strain relief bars and pull

Scotchflex[®] systems from 3M.

The source.

This layout could
take all week...



...or be
finished today!

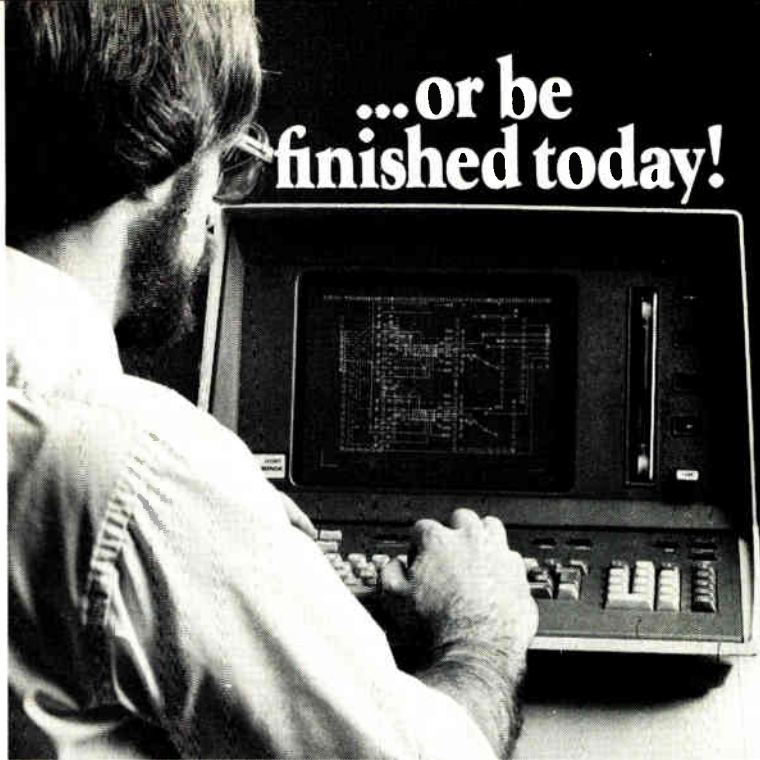

Nicolet System 50.™

Nicolet System 50 stores designs in its memory and displays them on a screen. Your designers can draft layouts quickly and without effort. When the final layout is finished, System 50's pen plotter inks a clean original automatically.

Takes away the tedium. System 50 performs all the tedious, repetitive work on command. It can revise layouts, repeat traces and pads throughout a drawing and do lettering. It can even take designs from one layout and drop them into another, positioning and rotating them as required. Your designer can define any number of lines and pads as a group and System 50 will re-position them on command.

More results, less effort. System 50 helps make original designs and any revisions fast and easy. Because it makes your design staff more efficient, more productive, you'll get prototypes faster and get your product to the marketplace sooner.

Your designers will be happier, too, because System 50 is so easy to use. It makes their work less tedious and more rewarding. They'll be free to spend more time on the design aspects of their work. They can

The new automatic drafting system that cuts revision time drastically.



use System 50 on the kind of work they are doing right now. With the many models and options to choose from, you'll tailor the system to fit your situation exactly.

Investment spending. System 50's price will fit right into your budget because it's not a complex computer system costing hundreds of thousands of dollars. It's a computer-aided drafting tool that you just plug in and use.

System 50 is not only easily affordable by all drafting departments but it can actually pay for itself in a year through increased production efficiency. System 50 is being successfully used in departments with only a few designers as well as in departments with over a hundred.

Find out how Nicolet System 50 can make your department more efficient. Just write Mike Smith, Nicolet CAD Corporation, 735 Addison Street, Berkeley, CA 94710. Or phone 415/848-6600 to arrange a demonstration soon.

NGC NICOLET
CAD
CORPORATION





RELAX...it's amazing how an easy mind puts you in touch.

We're the easy mind people, TRW Capacitors. Our new X659F can solve your packaging problems. We call it "the new dimension capacitor". It's the smallest possible size—at the smallest possible price. The advanced design of the new TRW X659F utilizes very thin gauges of metallized polyester with design highlights such as capacitance values to 20.0 MFD, dissipation factors less than 1.0%. Electrically, the new X659F is interchangeable with our X663F. Same rugged durability and long stable life.

Oval shape allows either vertical or flat, horizontal

board-hugging mounting. It's ideally suited to small portable equipment for commercial and instrument grade products.

So if you have a packaging problem, relax and send for complete specifications and applications information on the new X659F Capacitor. Call or write: TRW Capacitors, An Electronic Components Division of TRW Inc., 301 W. "O" St., Ogallala, Nebraska 69153. Tel: (308) 284-3611.



Actual size 022 MFD 400VDC

TRW CAPACITORS
ANOTHER PRODUCT OF A COMPANY CALLED TRW

Circle 243 on reader service card

ABOUT MAILING LISTS...

an important notice to our subscribers.

In recent years we have made the list of subscribers to McGraw-Hill publications (names and mailing addresses only) available to carefully screened companies whose products or services might be of interest to you.

These companies enter into an agreement that permits them to mail information to you without placing you under any obligation.

We have always considered such direct marketing activities to be legitimate and important in the American system of free trade—and we're confident that the majority of subscribers share this position.

However, we respect the interests of those who for some reason may wish to have their names restricted from such use by companies either affiliated or not affiliated with McGraw-Hill, Inc.

If you wish to delete your name from lists we make available to other firms, please fill in the information requested below exactly as it appears on your mailing label on the cover of this issue. Or, if you prefer, attach the label itself to the coupon and return.

McGraw-Hill, Inc.

P.O. Box 555
Hightstown, N.J. 08520
Attn: Mailing List Dept.



Please remove my name from your mailing lists.

Title of this publication

Name

Address (exactly as shown on mailing label, please)

City/State/Zip

New products

Communications

Generator tests mobile receivers

Synthesized a-m/fm unit with Sinad capability covers 10 to 520 MHz

Designed to measure, test, and align radio communications equipment, especially mobile receivers and pocket-paging receivers, Krohn-Hite Corp.'s model SSG520 a-m/fm synthesized signal generator maintains high accuracy and stability over the frequency range from 10 to 520 MHz. Its standard 2-MHz crystal-controlled oscillator is accurate to within 2 parts per million and drifts less than 2 ppm per year.

Unusual for instruments in its class is the SSG520's SINAD (signal plus noise and distortion) measurement capability, which gives an indication of the expected intelligibility for a given signal strength. This type of measurement is taken by applying a signal of a known amplitude and modulation to the receiver input. The audio output—consisting of the

recovered modulation, the distortion products produced by receiver non-linearity, and the amplified thermal noise of the signal source and receiver—is then measured. A narrow band-rejection filter, tuned to the modulation frequency, is then placed between the receiver output and the power meter. A second reading—from the distortion plus noise output—is now taken. The ratio of the first power to the second is called the Sinad ratio.

Based on a built-in 1-kHz automatic distortion analyzer, the Sinad capability makes possible improved alignment of band-pass filters and other tuned circuits, helping to avoid false response peaks. The Sinad input level is adjustable from 50 mV to 3 V rms; measurement range is 6 to 30 dB.

Seven thumbwheel switches provide 100-Hz resolution over the generator's full frequency range. They comprise an unambiguous seven-digit display of the output frequency, making a frequency meter unnecessary.

The generator's output level is adjustable and controllable over the range from 0 to -119 dBm in 1-dB steps by means of two step attenuators. One, which has increments of 1 dB, has a maximum error of



When your design calls for SCR's or triacs...no one gives you the choice that Teccor does.

And — our electrically isolated packages are U.L. recognized.



Teccor is a name you can specify with confidence. It's the company that pioneered electrically isolated SCR and triac packages. Teccor was well ahead of the times in development of thyristors for use in energy efficient applications — long before energy became a major design consideration.

Glass passivated device junctions insure long-term reliability. Devices are available with current ratings from 800 mA to 40 amps and voltage ratings up to 1000 volts.

And, when you specify Teccor, you know

the products will be readily available when it's time for production runs. About one out of every three triacs made this year . . . will be made by Teccor.

So, no matter what case style best fits your design — chances are Teccor has it. Get your free copy of the Teccor catalog. It'll make it quick and easy to get the device you want in the package you need to fit your design.

How about SSR's in your choice of "normally open" or "normally closed" configurations? You'll find those in your Teccor catalog too.

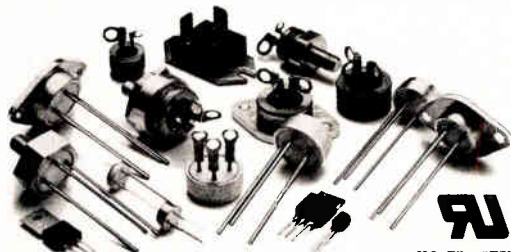

U.L. File #E71639

TECCOR
TECCOR ELECTRONICS, INC.
P.O. Box 61447 Dallas, Texas 75261
214/252-7651

Circle 245 on reader service card

New products

0.2 dB for any step; the other, a 10-dB-per-step device, is accurate to within 2 dB per step. Effective rf shielding allows sensitivity measurements to be made down to -119 dB ($0.2 \mu\text{V}$ across 50Ω).

The instrument has internal and external a-m and fm capability, with a-m depth and fm deviation displayed on an analog meter. A-m

depth ranges from 0% to 90%; four fm ranges have full-scale peak deviations of 3, 10, 30, and 100 kHz. For both a-m and fm, modulation rates range from 20 Hz to 50 kHz.

Options for the SSG520 include a high-stability crystal-controlled time base with an error of less than two parts in 10^7 and a temperature coefficient of less than 1 ppm/ $^{\circ}\text{C}$;

a rack-mounting kit; and remote programming capability for frequency, attenuation, and modulation. The instrument has outputs for synthesizer lock, overrange and underrange lamps, a Sinad automatic-gain-control lamp, and supply of +5, +24, and ± 15 v.

The SSG520 lists at \$5,000 and has a delivery time of 60 days.

Krohn-Hite Corp., Avon Industrial Park, Bodewell St., Avon, Mass. 02322. Phone (617) 580-1660 [401]

GOODBYE ALIAS, HELLO GAIN

The new Precision 416 combines filter and amplifier in 16 programmable channels. You save 35% by buying one instrument instead of two for conditioning analog data for digital conversion. Time delay filters superior to Bessel. Elliptics with 80 dB/octave attenuation. DC differential input stage with



100 db CMRR. Both pre-filter and post-filter gain are programmable for optimum signal quality. Both include overload indicators. Interfaces with mini, micro or GPIB. Phase match is less than 2° . Call Don Chandler, 607-277-3550, or write for demonstration and complete specs.



PRECISION FILTERS, INC.

303 W. Lincoln, Ithaca, N.Y. 14850

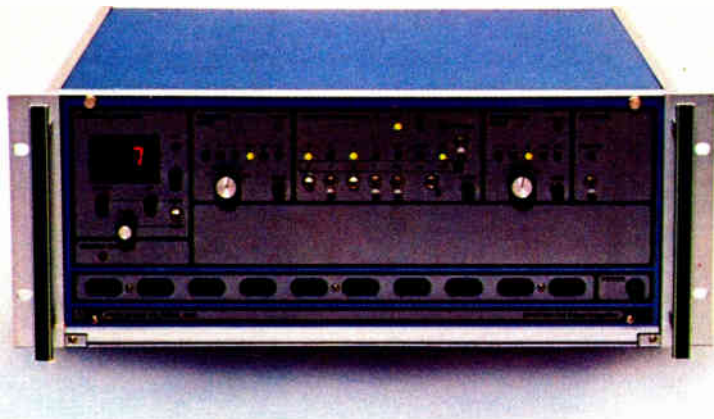

Bipolar transistor delivers 27.5 dBm at 4 GHz

The model AT-7510/AT7511 bipolar silicon power transistor is a 4-GHz device capable of delivering an output power of 27.5 dBm at its 1-dB gain-compression point. The associated gain is 9.5 dB. Available in both chip and packaged form, the medium-power device combines diffused emitter ballast resistors, platinum-silicide contacts, and a thick gold metal system for high reliability even when operating at high temperature and high current density.

The packaged version of the npn epitaxial device—the AT-7510—is housed in a hermetically sealed metal-beryllia stripline case with a



heavy copper flange. The high thermal conductivity of the beryllia, combined with good thermal design, results in an overall junction-to-case thermal resistance of only $40^{\circ}\text{C}/\text{w}$.

The unpackaged AT-7511 is offered with both single and multiple base and emitter pads. The former are easier to install; the latter provide lower series inductance. In either case, the 12-by-16-mil chip features quartz scratch protection for reliable application in thick- and

thin-film circuits. Maximum junction temperature is 200°C, and storage temperature range is -65° to +200°C.

Avantek Inc., 3175 Bowers Ave., Santa Clara, Calif. 95051. Phone Mary Ann Hollen at (408) 249-0700, Ext. 181 [402]

Fiber-optics link works with interface bus

Hewlett-Packard Co., the originators of what has become the general-purpose interface bus described in IEEE Standard 488-1978, has developed a fiber-optic link that allows the bus to transfer data around power plants and factories, where ordinary electrical communication is a problem. Called the HP 12050A, the link offers complete immunity from electromagnetic interference and ensures safety even when the cable runs through explosive environments.

With the 12050A, users can gain access to clusters of bus-compatible instruments up to 100 m from the controlling computer. By using a dual-channel fiber-optic cable, the link can transfer data in both directions at speeds as high as 20,000 bytes/second.

In application, two link units must be used at each remote site. The units each contain a silicon-on-sapphire microprocessor that performs self-testing automatically whenever it begins operation or upon request from the user program. For transmission, the link automatically converts data from the standard bit-parallel format to a bit-serial format, which is better suited for optical communication. At the receiving end, the data is converted back to the parallel format for normal processing. A checksum algorithm is used to check all transmissions for errors. If one is found, the data is retransmitted automatically and repeatedly, if necessary, until it is received correctly.

Few special procedures are necessary to install the 12050A.

Hewlett-Packard Co., 1507 Page Mill Rd., Palo Alto, Calif. 94304 [406]

Fiber-optic cable has 0.4 numerical aperture

A high-numerical-aperture, large-core optical cable, well suited for data-link applications at distances of up to 500 m, has just been introduced by Siecior. The Super Fat

Fiber cable comes in two versions: the single-fiber type 155 and the two-fiber type 255. Each has an all-glass 200- μ m core. Attenuation for the cable is 35 dB/km, and length-bandwidth product is 5 MHz-km.

The 0.4 numerical aperture and large core allow low-cost light sources and photodetectors to be used. Low-cost connectors may be

OUR MOST RESOLUTE ALIAS STOPPER

Our new Precision 636 provides 3-digit resolution with 4092 cut-off frequency selections. If you need more, our 3½-digit option provides 6141. Either way, you get up to 16 programmable channels with convenient keyboard address and LED



displays. Time delay filters superior to Bessel. Elliptics with 80 dB/octave attenuation. Phase match within 2°. Interface with mini, micro or GPIB. Call Don Chandler, 607-277-3550, or write for specs on all Precision anti-alias filters.



PRECISION FILTERS, INC.

303 W. Lincoln, Ithaca, N.Y. 14850

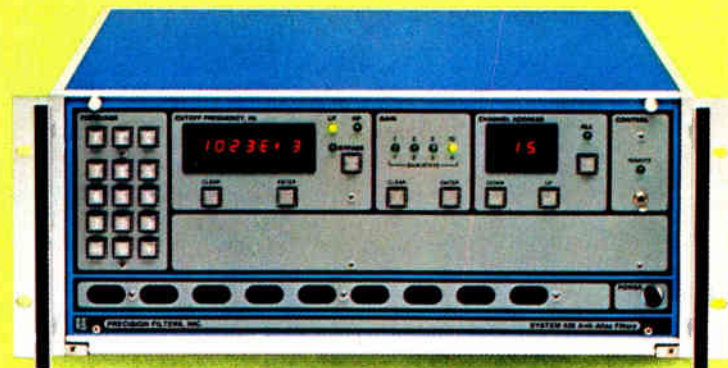

WE JUST RE-INVENTED THE THUMBWHEEL.

AD7525. THE WORLD'S FIRST SINGLE CHIP DIGITAL POT.

Anyone who uses expensive and cumbersome 10-turn pots or thumbwheel-switch voltage dividers will welcome the accuracy, reliability and ease of use of the AD7525. It's a new solution to an old problem. That is the setting of AC or DC signal levels digitally and usually remotely. The AD7525 replaces the noise, inaccuracies and expense with a reliable, economical monolithic CMOS $3\frac{1}{2}$ digit BCD digitally-controlled potentiometer. The world's first single chip digital pot and the only high resolution CMOS multiplying DAC available

with BCD coding.

The AD7525 is perfect for controlling DC voltage levels or AC signal amplitude directly from the front panel. With step-resolution of 0.05%. A full-scale output range of 0.000 to $1.999V_{IN}$. A maximum linearity error of $\pm \frac{1}{2}$ LSB (AD7525LN, CD and UD) over the temperature range guarantees monotonicity.

$3\frac{1}{2}$ DIGIT BCD RESOLUTION PLUS IC RELIABILITY.

Combining the highest resolution of 13 input bits or $3\frac{1}{2}$ digits BCD with monolithic reliability results in a digital pot that ends the mechanical unreliability and erratic performance of "dialing up" AC or DC voltage levels.

A NEW LOW PRICE.

\$8.50

Only \$8.50 in 1000's (AD7525KN). It means you can build an entire attenuator circuit for about \$22. That includes the AD7525KN, an op amp, the trimming potentiometer (which allows gain accuracy to be precisely set), resistors and the thumbwheel-switch assembly. That's a lot less money for a lot more performance and reliability than the "old" way.

But prove it to yourself. Check out one of the six available performance grades of the AD7525, the world's first single chip digital pot. Call Doug Grant or Don Travers, (617) 935-5565. Or write Analog Devices, P.O. Box 280, Norwood, MA 02062.



ANALOG DEVICES

WAY OUT IN FRONT.

Analog Devices, Inc., Box 280, Norwood, MA 02062, East Coast (617) 329-4700, Midwest (312) 894-3300, West Coast (213) 595-1783, Texas (214) 231-5094, Belgium 031 37 48 03, Denmark (02) 845800, England 01 94 10 46 6, France 686-7760, Germany 089-53 03 19, Japan 03-26 36 82 6, Netherlands 076 879 251, Switzerland 022 319704, and representatives around the world

Circle 248 on reader service card

New products

used because of the large fiber diameter and the actual mechanical configuration of the cable. The small bend radius—15 mm—allows permanent bends. And with its temperature rating to 85° C, its high tensile strength, and its small size, the cable may be installed directly within many different types of military, industrial, and commercial equipment used in data-link applications.

The same cable may be installed in above-ground conduit outdoors, where it can withstand temperatures as low as -40°C. In fact, this is fiber cable that may replace miniature coaxial cable when long distances must be covered, or when there are problems of electromagnetic interference and ground loops.

Applications for the cable may be found in process control, industrial automation, power utility instrumentation, data transmission within a building, and military short-distance systems.

The price for the 155 cable is \$1.30 per meter in 3-to-10-km lengths and delivery is within three to four weeks after receipt of order. The 255 cable is available on a special-order basis.

Siecor Optical Cables Inc., 631 Miracle Mile, Horseheads, N. Y. 14845. Phone (607) 739-3562 [403]

Programmable preamplifier interfaces with computers

The model 1201 preamplifier has been designed for interfacing with computers and calculators for remote control and for use in systems applications. The computer control and programmability of the 1201 are made possible because of two custom LSI chips. Offering full gain control and gain status indication, the 1201 has control outputs to indicate overload status, remote operation, and for high- or low-pass filter selection.

Preamplifier gating (also controlled through the computer) is through a TTL-compatible input or any other waveform input; this permits the user to control the input signal transmissions in a wide variety

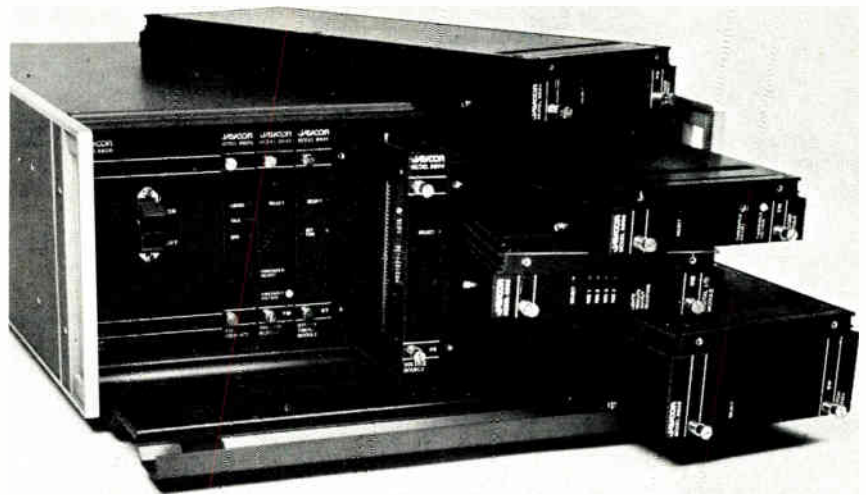

What the GPIB did for automatic testing, we've done for the GPIB.

The GPIB lets you connect and control a tremendous variety of instruments. Provided you stay within the 14-port limitation. And provided you don't get hopelessly confused by all the different programming formats.

But now, building a system can be as simple as plugging modules into a mainframe—the Jaycor Signal Director mainframe. Our System 8600 accepts up to 10 plug-in units, yet it occupies a single address on the IEEE-488 bus (GPIB). You can plug in modules for triggers, timing, and switching, and the Jaycor Signal Director will route your commands. Each module uses the same programming convention to simplify setup.

Also available is a programmable Digital I/O module, a programmable voltage source, and more. So if you want to get more out of your GPIB system, use this address: JAYCOR, 1401 Camino Del Mar, P.O. Box 370, Del Mar, CA 92014. Phone (714) 453-6580.

JAYCOR

Circle 110 for demonstration.
Circle 249 for literature.

Leaders in Electronics

The only reference devoted solely to biographies of the most influential people in electronics

• corporate executives • technical managers • designers and developers • government and military officials • academics • editors/publishers • securities analysts • trade/professional group directors • consultants ... plus an 80-page index of biographees by affiliation.

Prepared by the staff of *Electronics* magazine. 5,240 biographies. 651 pages, clothbound. \$39.50

Electronics Magazine Books
P.O. Box 669, Hightstown, NJ 08520
(609) 448-1700, ext. 5494

Send me _____ copies of *Leaders in Electronics* @ \$39.50 plus applicable sales tax. McGraw-Hill pays regular shipping and handling charges on pre-paid orders.

Payment enclosed Bill firm Bill me

Name _____

Company _____

Street _____

City _____

State _____

Zip _____

Signature _____

New products

of systems applications.

Gains are selectable from 10 to 25,000 with a gain accuracy of at least 1% and a gain stability of at least 0.03%/°C. Other features of the 1201 include: dc stability of better than 6 $\mu\text{V}/^\circ\text{C}$, a common-mode rejection ratio of 140 dB, a common-mode input voltage rating of 10 v peak to peak, an input



current of less than 10 pA, a bandwidth of 400 kHz, and distortion of less than 0.01%. The 1201 also offers a unity-gain output, two 600- Ω outputs, and a choice of battery or line operation.

The 1201 sells for \$1,525 with delivery in 45 days. The remote-programming option is an additional \$450, with delivery in 90 days.

Ithaco Inc., 735 W. Clinton St., Ithaca, N. Y. 14850. Phone (800) 847-2080 or (607) 272-7640 [405]

\$8.50 mixer handles inputs of 1 to 1,000 MHz

Priced at \$8.50, the MLP-109 mixer handles local-oscillator and rf frequencies from 1 to 1,000 MHz, with a dc-to-1,000-MHz i-f range. Worst-case conversion loss for the mixer is 8 dB with mid-band performance typically 2 dB better, specified with a LO input of +7 dBm.

Minimum LO-rf isolation is 25 dB; LO to i-f is 15 dB worst case, with typical mid-band isolation 10 to 15 dB greater. Contained in a standard eight-pin relay header, the unit is available from stock. Models for +17- and +23-dBm LO inputs are also available.

Engelmann Microwave Co., Skyline Drive, Montville, N. J. 07045. Phone Carl Schraufnagl at (201) 334-5700 [404]

Who puts 25 problem-solvers in seamless white cans?



Miller-Stephenson does!



We offer 25 different solvent combinations for electronic cleaning, contact cleaning, tape head cleaning, flux removal, freezing and release agents for epoxy potting and for injection molding.

We double filter our solvents and propellants and the filtered product goes directly into seamless cans, eliminating any possibility of flux contamination from seamed cans. Our spray cleaners have the lowest residual contamination in the industry, some approaching 5-7 parts per million. The general industry range is 50-130 ppm.

We know that you demand system purity and reliability and that's why Purity comes first in our laboratory testing. We insist on controlled clean room conditions for our loading of every Miller-Stephenson product. We are dedicated to the idea that the purer our product, the better the performance and reliability of your product.

Let us help you find the right cleaning combination for your particular application.

Purity...it's something we never forget

1 Solvent Cleaning

MS-180 Freon® TF Solvent
MS-190 Freon TMC Solvent
MS-160 Freon T-P 35 Solvent
MS-185 Freon TA Solvent

MS-175 Freon TE Solvent
MS-165 Freon TMS Solvent
MS-176 Freon TES Solvent
MS-170 1,1,1 Trichloroethane Solvent

2 Flux Removal

MS-190 Freon TMC Solvent — Flux Remover & Cleaner
MS-190HD Flux Remover & Cleaner — Heavy Duty

3 Contact Cleaning

MS-230 Contact Re-Nu®
MS-238 Contact Re-Nu & Lube*®

4 Tape Head Cleaning

MS-200 Magnetic Tape Head Cleaner

5 Freezing

MS-240 Quik-Freeze®

6 Release Agents

MS-122 Release Agent — Dry Lubricant For Cold Molds
MS-136 Release Agent For Injection Molding & Hot Molds

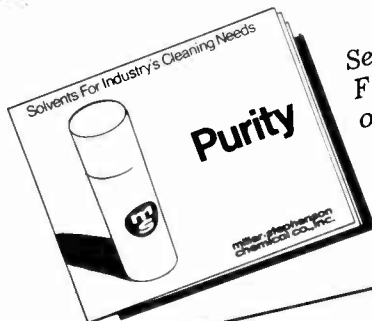

Send for your FREE copy of our new catalog . . .



miller-stephenson chemical co., inc.
George Washington Highway, Danbury, CT 06810 / (203) 743-4447

Please send FREE catalog and prices on MS Products.
 Enclosed is \$2.00 (each), please send trial unit(s) of —
MS, MS, MS, MS

Intended Use
Name
Company
Address
Dept./Title

For Industrial Use only. Trial Unit must be sent to company address.
LOS ANGELES • CHICAGO • DANBURY, CT • TORONTO

Circle 251 on reader service card 251

*Freon® is Du Pont's registered trademark for its fluorocarbon compounds.
© Registered trademark of Miller-Stephenson.

WE CALL IT BECKMAN'S INTELLIGENT DISPLAY SYSTEM

BECAUSE IT'S SO BRIGHT!

That's visibly bright and microcomputer smart!
In fact, it's more than two times brighter than comparable gas discharge display systems. Beckman's SM-810-001 alphanumeric display system is the apex of the five-year development of the Screened Image technology. That's what makes it so bright. And, makes it flexible enough that you can do your own customizing. The microcomputer gives it the control and versatility that only a microcomputer can.

The SM-810-001 will give you 40 — count 'em 40 — high brightness characters in a 5 by 7 matrix of large, uniformly illuminated dots. Each of the quarter-inch characters provides a minimum of 100 footcandle of brightness. Think what 40 of them will do for the overall illumination. In addition, the unit offers a remarkable viewing angle (for a subsystem) of 130°, plus a flicker-free 94 Hertz refresh rate. And, it's all in one compact,

microcomputer-controlled assembly . . . smaller than a carton of cigarettes.

The SM-810-001 is currently being evaluated by several major users. Obvious applications include: medical/scientific instrumentation, process control and point-of-sale. More importantly, the almost limitless flexibility of the Screened Image concept makes it possible to adapt this display system to your system . . . without the usual, high engineering design and development charges.

Significant Features of the SM-810-001

- High Viewability.
 - High Brightness.
- Versatile, Microcomputer Control.
 - Direct User Access.
 - Right, Left & Random Entry.
 - Character & Block Blinking.
 - Data Write Time = 310 nS.
 - Expanded ASCII — 98 Character Set.
- Compact, self-contained assembly.
 - 10.75" x 3.0" x 2.0"
- Standard Interfaces.
 - Single, 5 Volt Supply.
 - 8 Bit Parallel Bidirectional Bus.

Beckman Displays. The Visible Edge.

For more information concerning your standard or custom requirements, write: Displays Systems Division, Beckman Instruments, Inc., 350 North Hayden Rd., Scottsdale, AZ. PHONE: (602) 947-8371. TWX: 910-950-1293. In Europe, write: Beckman Instruments (Belgium) S. A., 14, Avenue Hamoir, 1180 Bruxelles, Belgium. PHONE: (02) 275.44.30. TELEX: 23577

SM-810-001 JOINS THE SA-252.

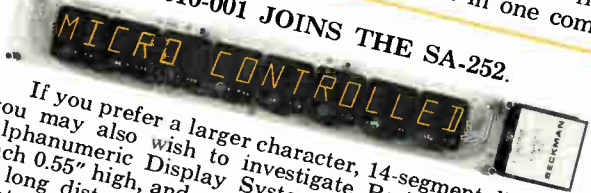

If you prefer a larger character, 14-segment display, you may also wish to investigate Beckman's SA-252 Alphanumeric Display System. Its 16 characters are each 0.55" high, and provide excellent viewability, even at long distances. The SA-252 is also microcomputer controlled, with direct user access. And, it's ideal for biomedical, process control and general electronics applications.

BECKMAN

Here are three electromagnetic X-Y display scopes that have a lot in common: each has a big 12-inch diagonal CRT, is economically priced, and is ideal for applications requiring continuous monitoring of response signals with bandwidths up to 15 kHz.

The one in front is specifically for use in OEM systems. With the Model 1951, you can have controls mounted on the rear panel, or they can be pre-set on an easily accessible PC board. And the unit's power supply can be removed and installed

elsewhere in your system. The 1951 is particularly well suited to medical electronic systems.

The scope on the left is our Model 1901C which can be used with our (or anybody's) RF or microwave sweepers. The unit has a sensitivity of 1 mV per division which is ideal for low-level detection requirements. Features such as Z axis intensity modulation, Y marker adders and a blanking protection circuit contribute to the unit's versatility.

Finally, the scope at right is our

Model 1910. It's basically the same as the 1901C except that it provides dual trace capability.

So just decide which of these low-priced scopes has the most in common with your operation. We'll be happy to ship as many as you want. WAVETEK INDIANA, P.O. Box 190, Beech Grove, Indiana 46107, Telephone (317) 783-3221, TWX 810-341-3226.

WAVETEK®

Scope City!

Model 1901C: \$700



Model 1910: \$875



Model 1951: \$560 (in small quantities)

Circle #111 for literature
Circle #253 for demonstration

**THE INSTRUMENTS
IS SATISFYING THE NEED FOR
FOR PEOPLE ALL**





DIVISION OF GOULD INC. QUALITY INSTRUMENTATION OVER THE WORLD.



LOGIC ANALYZERS



**DIGITAL MULTIMETERS
AND COUNTER TIMERS**

For more information on Gould recording, graphic display, signal analysis and measurement instruments and automatic test equipment, write Gould Inc., Instruments Division, 3631 Perkins Ave., Cleveland,

Ohio 44114. Or call toll-free:
800-331-1000. In
Oklahoma, call collect
918-664-8300.



An Electrical/Electronics Company
Circle 255 on reader service card

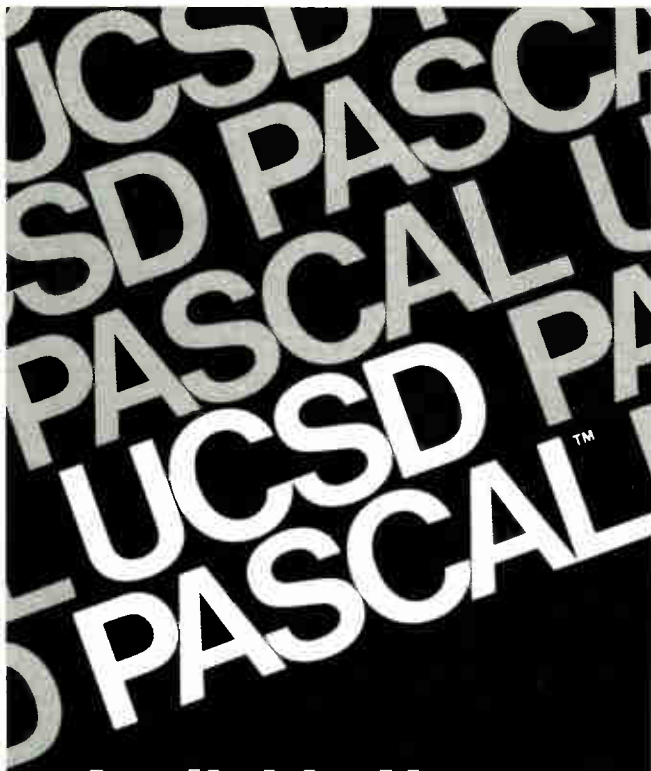

Available Now

The most widely used Pascal system. Compilers to complete development software. For most popular microcomputer systems. With full documentation and support. From one source.

SOFTech
MICROSYSTEMS
A SUBSIDIARY OF SOFTECH

9494 Black Mountain Road
San Diego, CA 92126 714/578-6105

UCSD Pascal is a trademark of the Regents of the University of California.

Find out more. Send this coupon.

- Please send UCSD Pascal description and order form.
 Please send distributor and volume license information.

Name _____

Title _____

Company _____

Address _____

City/State/Zip _____

Computer system _____

Send to: SofTech Microsystems
9494 Black Mountain Road
San Diego, CA 92126

"E1-11-8"



NEW BOOKS FROM PETER PEREGRINUS PRESS

CONTROL ENGINEERING

A HISTORY OF CONTROL ENGINEERING 1800-1930

S. Bennett

Traces the growing awareness of the importance and significance of the concept of feedback in engineering and treats in detail, the technical developments that contributed to this awareness.

ISBN: 090 6048 07 9, \$35.00

MODERN APPROACHES TO CONTROL SYSTEM DESIGN

N. Munro

Presents a unique collection of recent developments in analysis and design techniques for control systems.

ISBN: 090 6048 06 0, \$35.00

CONTROL OF TIME-DELAY SYSTEMS

J. Marshall

Covers the methods currently available for the analysis and automatic control of engineering and other systems which have unavoidable time delays.

ISBN: 090 6048 12 5, \$26.00

BIOLOGICAL SYSTEMS, MODELLING AND CONTROL

D. A. Linken

Deals with the mechanical, electrical, biochemical and systems models which have been developed to describe the dynamic functioning of the living body.

ISBN: 090 6048 15 X, \$40.50

TELECOMMUNICATIONS

SIGNALLING IN TELECOMMUNICATIONS NETWORKS

S. Welch

Presents and analyzes the various possible signalling techniques in a network.

ISBN: 090 604804 4, \$28.00

ELEMENTS OF TELECOMMUNICATIONS ECONOMICS

S. Littlechild

Introduces the telecommunication manager, engineer, administrator and regulator to the wide and rapidly expanding range of ideas in telecommunication economics.

ISBN: 090 640817 6, \$30.50

SOFTWARE FOR STORED-PROGRAM-CONTROL SWITCHING SYSTEMS

S. Takamura, et al

Explains the D 10 programs currently being used in the Japanese telephone network.

ISBN: 090 6048 18 4, \$31.50

ELECTROMAGNETIC WAVES

WAVEGUIDE TAPERS, TRANSITIONS AND COUPLERS

F. Sporleder & H. Unger

Treatment of the mathematical analysis, design and performance prediction of waveguide tapers, transitions and couplers, dealing with both microwave and optical components.

ISBN: 090 6048 16 8, \$35.50

REFLECTOR ANALYSIS AND DESIGN

P. Wood

Examines the mathematical design and analysis of reflector antennas which now has to be increasingly sophisticated to meet the demands of modern installations.

ISBN: 090 6048 21 4, \$35.00

Send all orders (U.S., South America and Canada) to:

PETER PEREGRINUS LTD.

P.O. Box 813

Somerset, N. J. 08873

N. J. residents add 5% sales tax. Credit Card orders accepted by telephone (201) 981-0060

Orders for the rest of the world to:

PETER PEREGRINUS LTD.

IEE/ Station House

70 Nightingale Road

Hitchin, Herts SG5 1RJ England

When you need illuminated switches, or more than illuminated switches...



Dialight is the first place to look. We make just about any kind of illuminated push button switch that anyone could want . . . Single lamp, dual lamp, neon, incandescent, LED lighted, you name it.

Perhaps you're looking for snap action switches with silver or gold contacts, or wiping action switches with gold contacts for low level application.

And if you're looking for rear panel or front bezel mounting switches, switches with momentary or alternate actions, or high quality switches for computer applications, we have them.

You'll find that Dialight switches are not only available at a reasonable price, they're also available with some very attractive features. Lamp removal is from the front so you don't have to remove

an entire switch just to change a lamp. And you never have to use anything more complicated than your fingers for replacement or installation.

Along with outstanding variety and design, you get superior Dialight quality. Most Dialight switches are Underwriter's Laboratory listed and CSA approved.

And Dialight distributors are widely located throughout the United States, Canada and worldwide.

Call or write Dialight today. We'll send you our free switch catalogs so you can select a quality switch that's American made and Dialight guaranteed.

DIALIGHT
A North American Philips Company

Dialight meets your needs.

Dialight, 203 Harrison Place, Brooklyn, N.Y. 11237 (212) 497-7600

Circle 257 on reader service card

PCB Simplicity with Bendix Brush Connectors.

- Fewer damaged boards.
- One connector instead of multiple, fixture-mounted connectors.

Bendix Brush Connectors—a broad product line.

- Mother Board, Daughter Board, Input/Output, PC receptacle body styles.
- 2, 3 and 4 row configurations.
- 90° and straight PC, solderless wrap, crimp removable terminations with multiple lengths and plating options.

Bendix Brush contacts improve electrical characteristics.

- Highly redundant contact sites with multiple electrical paths and wiping action.
- Gold plated wire bristles mesh together intimately with gas-tight junctions.
- Stable contact resistance even after extreme mechanical durability abuse to 20,000 matings.

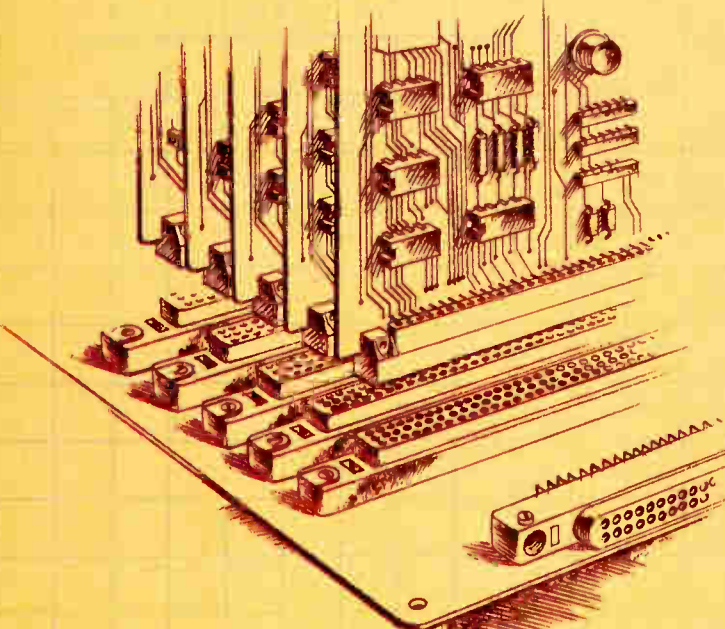

Bendix Brush Connectors can streamline your printed circuit board designs. They don't require the extra board support necessary with conventional, higher mating force connectors and they eliminate the need for secondary actuation systems or procedures used with zero-insertion force connectors. Here's how:

Bendix Brush Connectors increase circuit count per board.

- Reduce number of boards by allowing more circuits per board.
- Greater board effectiveness by providing exact circuit counts up to 400 contacts in only one connector!

Bendix Brush Connectors reduce mating force 70% to 90%.

- Less complex board supports.
- Secondary actuators eliminated.
- Extended mechanical life. Up to 20,000 mates/unmates.

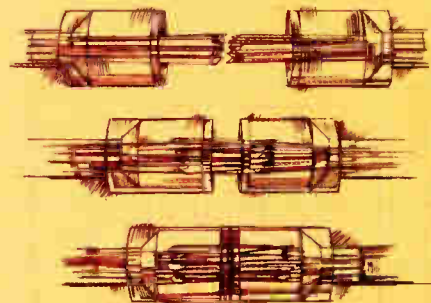

For full information, call (607) 563-5302, or write The Bendix Corporation, Electrical Components Division, Sidney, New York 13838.



We speak connectors.

Products newsletter

Analog Devices lets the chips fly

After dipping its toes for years, Analog Devices Inc. is diving headlong into the business of selling uncased chips. The Norwood, Mass., firm is about to unveil a line of more than 50 generic types of monolithic integrated circuits, in multiple grades, with guaranteed specifications, and all conforming to MIL-STD-883. The available chips include analog-to-digital, digital-to-analog, voltage-to-frequency, frequency-to-voltage, and root-mean-square-to-dc converters, as well as precision operational amplifiers, instrumentation amplifiers, precision references, analog switches, and multiplexers. Delivery is expected to be from stock to two weeks.

Analog expects competition mainly from Harris Semiconductor, Precision Monolithics, and National Semiconductor, but, claims Jeffrey R. Riskin, manager of microcircuits applications engineering, Analog is the only vendor of analog chips "with such a combination of product variety, temperature testing, premium versions, laser-trim accuracy, and technical support."

Shared-logic system offers data and word processing

Adding still further enhancements to its CPT 8000 family of stand-alone and shared-logic word-processing systems [*Electronics*, Sept. 27, p. 210], CPT Corp. of Hopkins, Minn., is now offering data-processing capabilities. The CompuPak software package serves as an interface between the user's own data-processing applications programs and the CPT processor, so that the same hardware can process both words and data.

The company has developed its own interface software, but is using the CP/M operating system software from Digital Research Inc., as the basis for the new data-processing capabilities. Initial deliveries of CompuPak are scheduled to begin next month, with pricing set at \$800.

Logic analyzer comes to U. S.

The Sony/Tektronix model 308 data analyzer, which went on sale in Japan last month for \$3,700 [*Electronics*, September 13, p. 71], will be offered in the U. S. in December. Base price for the combination state and timing logic analyzer, serial data analyzer, and signature analyzer will be \$3,000, according to Oregon-based Tektronix Inc.

Price changes





Texas Instruments Inc., Houston, Texas, has cut the prices of three of its Silent 700 data terminals by approximately 15%. The model 743 keyboard send-receive (KSR) unit has been reduced from \$1,395 to \$1,195; the 743 receive-only (RO) printer has been lowered from \$1,195 to \$995; and the 745 portable data terminal has been cut from \$1,995 to \$1,695. All new prices are for the U. S. in quantities of one. . . . Owens-Illinois Inc., Toledo, Ohio, is raising the price of all of its glass containers by 6% as of Dec. 1. The company's last price increase on glass containers, announced on April 14, was also for about 6% . . . Xebec Systems Inc., Santa Clara, Calif., has recently cut the price of its model 7600 controller for SMD-type drives for the PDP-8, PDP-11, and LSI-11 computers from \$6,950 to \$4,975. . . . Continental Specialties Corp., New Haven, Conn., has raised prices on just about every item in its line of electronic test and prototyping equipment, effective immediately. One important exception is the model 3001 digital capacitance meter [*Electronics*, August 2, p. 141], which is not scheduled to go from its introductory price of \$190 to its new price of \$250 until Jan. 1, 1980.

POWER-ONE D.C. POWER SUPPLIES

Now available for small systems applications

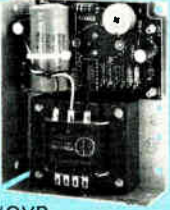
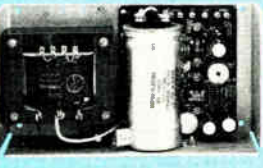
Power-One, the leader in quality open-frame power supplies, now offers a complete line of single, dual, and triple output models for small computer systems. Also available are special purpose models for Floppy Disk and Microcomputer applications.

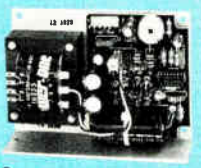
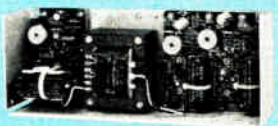
Below are just a few popular examples of the over 90 "off the shelf" models now available from stock.

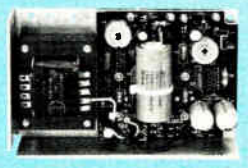
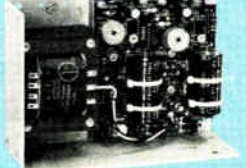
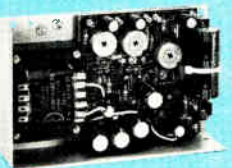
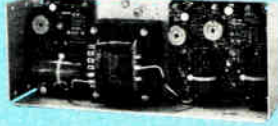
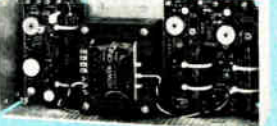
<p>SINGLE OUTPUT & LOGIC POWER SUPPLIES</p> <ul style="list-style-type: none"> • 56 "off the shelf" models • 2V to 250V, 0.1A to 40A • $\pm .05\%$ regulation • 115/230 VAC input 	<p>5V @ 3A, w/OVP</p>  <p>HB5-3/OVP \$24.95 single qty.</p>	<p>5V @ 12A, w/OVP</p>  <p>HD5-12/OVP \$79.95 single qty.</p>	<p>5V @ 40A, w/OVP NEW</p>  <p>SK5-40/OVP Switching Model \$250.00 single qty.</p>
<p>FLOPPY-DISK SERIES</p> <ul style="list-style-type: none"> • 8 "off the shelf" models • Powers most popular drives • Single/dual drive applications • 2-year warranty 	<p>5V @ 0.7A, w/OVP NEW 12V @ 1.1A/1.7A PK</p>  <p>CP340 For one 5.25" Media Drive \$44.95 single qty.</p>	<p>5V @ 1A, w/OVP -5V @ 0.5A, w/OVP 24V @ 1.5A/1.7A PK</p>  <p>CP205 For one 8.0" Media Drive \$69.95 single qty.</p>	<p>5V @ 2.5A, w/OVP -5V @ 0.5A, w/OVP 24V @ 3A/3.4A PK</p>  <p>CP206 For two 8.0" Media Drives \$91.95 single qty.</p>
<p>DUAL OUTPUT MODELS</p> <ul style="list-style-type: none"> • 15 "off the shelf" models • $\pm 5V$ to $\pm 24V$, 0.25A to 6A • I.C. regulated • Full rated to $+ 50^{\circ}C$ 	<p>12V/15V @ 0.25A NEW</p>  <p>HAD12-.25/HAD15-.25 \$32.95 single qty.</p>	<p>5V @ 2A, w/OVP 9 - 15V @ 0.5A</p>  <p>HAA512 \$44.95 single qty.</p>	<p>$\pm 12V$ @ 1.7A or $\pm 15V$ @ 1.5A</p>  <p>HBB15-1.5 \$49.95 single qty.</p>
<p>TRIPLE OUTPUT MODELS</p> <ul style="list-style-type: none"> • 10 "off the shelf" models • 5V plus $\pm 9V$ to $\pm 15V$ outputs • Models from 16W to 150W • Industry standard size 	<p>5V @ 2A, w/OVP $\pm 9V$ to $\pm 15V$ @ 0.4A</p>  <p>HTAA-16W \$49.95 single qty.</p>	<p>5V @ 3A, w/OVP $\pm 12V$ @ 1A or $\pm 15V$ @ 0.8A</p>  <p>HBAA-40W \$69.95 single qty.</p>	<p>5V @ 6A, w/OVP $\pm 12V$ @ 1.7A or $\pm 15V$ @ 1.5A</p>  <p>HCCBB-75W \$91.95 single qty.</p>



NEW 79' CATALOG!

Get Your FREE Copy Now!

Phone us direct or circle the reader service number below.

 **POWER-ONE** INC.
D.C. POWER SUPPLIES



Power One Drive • Camarillo, CA 93010 • (805) 484-2806 • TWX 910-336-1297

260 Circle 260 on reader service card

Electronics / November 8, 1979

There are solid engineering reasons why you should have Cambion on board.

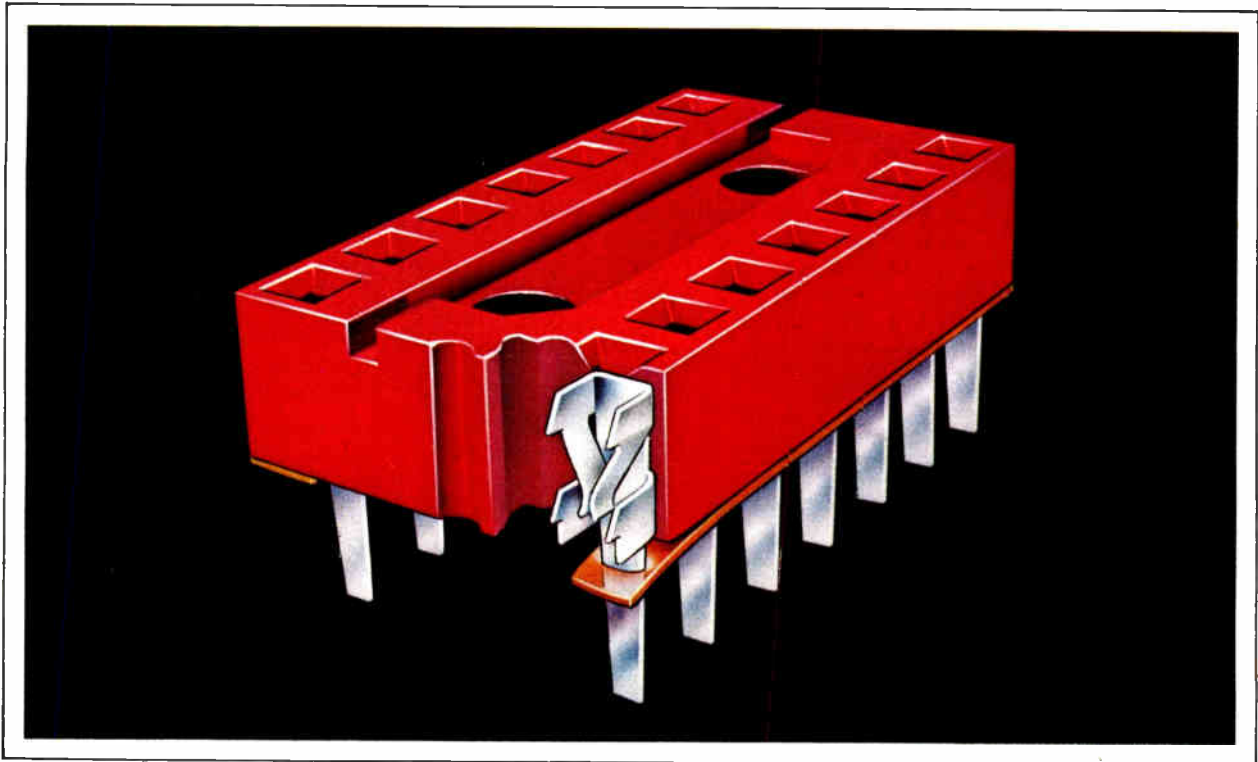

Four Times the Reliability With Dual-Leaf Inverted Contacts

Low profile solder tab sockets are now made by scores of manufacturers around the world. *But there's only one CAMBION – with Kapton film.*

- Unique inverted spring design overcomes insertion force resistance
- Dual leaf spring for redundancy of contacts – reliability increases as the square of number of contacts
- Excellent DIP retention (low insertion, high extraction forces)
- Long guided lead-in delivers DIP tail directly into contact throat and prevents lead bending and hang-up
- Buttable end to end and side to side

Kapton™ Secured

- All contacts sealed tightly on board side with Kapton – DuPont's polyimide film which inhibits solder or flux entry. Kapton withstands temperatures of -269°C to $+400^{\circ}\text{C}$, is flame retardant, resists organic solvents
- All popular types in tin or gold plating: 8, 14, 16, 18, 22, 24, 28, 40 and 64-pin

And massive availability, too!

Send for our latest Socket Brochure and Catalog 121 for the straight engineering story.

Cambridge Thermionic Corporation,
445 Concord Avenue, Cambridge,
Massachusetts 02238. (617) 491-5400.

CAMBION®
The Right Connection.

KAPTON – Trade Mark of DuPont Corp.

Still The ***MOST USEFUL*** and
MOST USED Handbook on the
Design of Reliable Equipment!
*Especially Written for Design Engineers
and their Managers!*

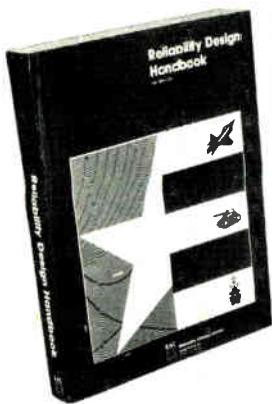

RELIABILITY DESIGN HANDBOOK (RDH-376)

- Reliability Theory and Application
- State-of-the-Art in Avionics Reliability
- Reliability Design Data and Guidelines
- Part Selection and Control
- Design Simplification and Analysis
- Design-to-Cost Goals and Achievement
- Over 400 pages: Ordering No. RDH-376, \$30 per copy (\$36 non-U.S.)

RAC



Reliability Analysis Center

RADC/RBRAC • Griffiss AFB, NY 13441 • Tel. (315) 330-4151; Autovon: 587-4151

RAC is a DoD Information Analysis Center Operated by IIT Research Institute

Circle 262 on reader service card

MICROSOFT 8086 DEVELOPMENT SOFTWARE

- 8086 Cross-Assembler
 - Linking Loader
- Cross Reference Facility

XMACRO-86 assembles 8086 code on any 8080 or Z80 running the CP/M, ISIS-II, or TEKDOS operating system.

FAST: Assembly rate of over 1000 lines per minute.

EFFICIENT: Assembler includes Intel-compatible macros, full set of conditional pseudo-ops, comment blocks, variable input radix, PRINTX for assembly or diagnostic messages, and octal or hex listings.

Linking loader loads and executes object modules, resolving all external references.

Cross reference utility program lists all variable names alphabetically, with line numbers where referenced and defined.

Use today's hardware to write tomorrow's software.

Single copy price: \$300.00

MICROSOFT

10800 NE Eighth, Suite 819
Bellevue, WA 98004
Phone: 206-455-8080 Telex: 328945



262 Circle 113 on reader service card

New products/materials

A conductive coating, X-Coat 225, may be used for radio-frequency shielding and electrostatic-discharge applications, as a ground coat for electrostatic spray overcoating, as a base coating for metal plating of plastics, or as a conductive anticorrosive paint. It can be applied to substrates such as ABS, acrylics, epoxy-glass, nylon, phenolics, polycarbonates, sheet-molding compounds, aluminum, copper, nickel, steel, or tin. It may also be used on ceramics and on porous materials such as hardboard, Masonite, particle-board, plaster, plasterboard, and wood.

A special feature of X-Coat 225 is its chemical resistance: it may be overcoated with conventional solvent-based paints with no change in electrical resistance or shielding characteristics.

Electro-Kinetic Systems Inc., 1000 Herald Square, Aston, Pa. 19014. Phone (215) 358-3440 [476]

Polyvinyl-fluoride film, a releasing agent for epoxy and phenolic printed-circuit boards, can be safely exposed to 200°C for 24 hrs between clean chrome plates at 800 lb/in.² According to Du Pont, this 100SM30MR material's higher temperature tolerance over the previous 100SM30PC film will reduce pc board costs, since production rates can be stepped up with shorter cycle times to reduce unit costs.

Two other advantages of the film are that epoxy residue on the plates and the transfer of phenolics through the film to the plates are reduced and that it gives pc boards a consistent matte finish. The Tedlar material does not contain any plasticizers or moisture and is also chemically inert.

The PVF film stands up to harsh weathering, ultraviolet radiation, most solvents, and corrosive chemicals.

Du Pont, Room 37480, PA, Wilmington, Del. 19898 [477]

A **silver-filled epoxy compound** for bonding and sealing applications, Tra-Duct 2902 can be used with such materials as metals, ceramics,

Your Marketing department wants a new black box design. They want it to handle 37 bytes of information. It has to be solar energized. It has to fly. It has to speak. It has to reproduce. Naturally, it'll need special cable configurations. Call Belden.

We've developed workable wire, cable and cord answers for a lot of extraordinary new products. In fact, a lot of designers have found that working with Belden in the early stages of a design project usually pays dividends in compatibility, workability and lower overall costs.

And once your product is rolling, we're ready to dig in to wire processing, assembly and installation

problems to help insure that your idea makes it to market economically.

You see, Belden's capabilities in wire, cable and cord are comprehensive. Sure, we make thousands of standards, but we can also provide just about any custom that you can imagine. And our technical knowhow ranges from innovative packaging to in-depth value analysis.

Just imagine a wire, cable or cord—and we'll come through with it. Belden Corporation, Electronic Division, P.O. Box 1327, Richmond, IN 47374; 317-966-6661. Out West, contact our Regional Sales Office in Irvine, CA at 714-833-7700.

8-7-9A

Your special designs need a special wire source



*Imagine
what we
can do
for you*

BELDEN 

Coming through...

with new ideas for moving electrical energy

© 1979 Belden Corporation

Circle 263 on reader service card

Z8, Z8000
Updates available now

MC68000
Update available as soon as the product is real

2900 Chip Slice
The first thorough analysis. Available now

Subscribe to the Update series for **An Introduction to Microcomputers: Volume 2 — Some Real Microprocessors**. You will receive complete descriptions of all new microprocessors and dedicated support devices as soon as the products are available.

Updates available now: TMS1000*, 8048*, 8022; 9902; 9903; 9940*; 2900; COPs; 6801; SY6551; R6531; PPS4; Z8; 6809; Z8000

Future updates: S2000/2150; MKS886; 3872; 3873; MC68005; IM6103; MC68000

Am9511 Arithmetic Processor
The first thorough analysis

Serial I/O Devices
Coverage now complete

D-to-A and A-to-D converters
The new revolution

For general support parts, subscribe to the Update series for **An Introduction to Microcomputers: Volume 3 — Some Real Support Devices**.

Updates available now: Serial I/O - 2851, 2852, F3843, F3846, MC6854; D/A converters, A/D converters; Am9511; Floppy disk controllers; Busses - Heath HB, STD, IEEE 488

Future updates: S100 Bus*; Memory Devices; Multiply/Divide Devices; Video Controllers; Keyboard/Display Controllers; Telecommunication Devices; IEEE 488 Interface Devices

*Revision Noteworthy new coverage from previous edition of Volume 2

An Introduction to Microcomputers: Volume 2 — Some Real Microprocessors and Volume 3 — Some Real Support Devices are two unique books. They are the only independent sources of complete information on microprocessors and support devices. Each book has six updates a year. To accommodate updates, the books are printed loose-leaf, with a handsome binder available.

Order Form

NUMBER	TITLE	PRICE	QTY	AMT
15-2	Volume 2 — Some Real Microprocessors, 1978 Edition without binder	\$25.00		
16-0	Volume 2 binder	\$ 5.00		
18-7	Volume 3 — Some Real Support Devices, 1978 Edition without binder	\$15.00		
19-5	Volume 3 binder	\$ 5.00		
99	Volume 2 and 3 Updates 1978-1979 (Subscription to six issues of each series)	\$40.00		
97	1978-1979 Volume 2 Updates (six issues)	\$25.00		
98	1978-1979 Volume 3 Updates (six issues)	\$25.00		

Sales Tax
 8 1/2% SF Bay Area residents only
 6% California residents outside SF Bay Area } No tax on update subscriptions

Subtotal _____
Sales Tax _____
Shipping Charges _____
TOTAL AMOUNT _____

Payment in advance must be enclosed for purchases of up to \$70.00. Invoicing for purchases of \$70.00 or more in the U.S.A. available upon approval of your account. All foreign orders must be prepaid in U.S. dollars drawn on a U.S. bank.

Shipping Charges: Shipping for large orders to be arranged

BOOKS:
 All foreign orders, \$4.00 per book for air shipment
 4th class \$0.45 per book (allow 3-4 weeks within USA)
 \$0.75 per book, UPS (allow 10 days) in the U.S.
 \$1.50 per book, special rush shipment by air in the U.S.

UPDATE SUBSCRIPTIONS:
 All foreign orders \$4.00 per 6-issue subscription for airmail
 No extra charge in the U.S. - 4th Class Mail ONLY

Name _____
 Address _____
 City _____ State _____
 Zip _____ Phone _____

Please send information on:
 Other Osborne publications
 Becoming an Osborne dealer
 School discounts
 List of foreign distributors

OSBORNE/McGraw-Hill
 630 Bancroft Way, Dept. E13
 Berkeley, California 94710 U.S.A.
 (415) 548-2805 • TWX 910-366-7277

New products/materials



glass, and plastic laminates. Cured at room temperature, this electrically conductive material can be used for heat-sensitive components where hot-soldering is impractical. It can also be used for the assembly and repair of electrical modules, printed circuits, wave guides, flat cable, and high-frequency shields. It is free of solvents and copper or carbon additives.

Tra-Duct 2902 comes in different predispensed Bipax package sizes. Delivery is from stock.

Tra-Con Inc., 55 North St., Medford, Mass 02155 [478]

A general-purpose resin system displays low shrinkage and high tensile and compressive strength and can operate at temperatures from -50° to 180°C. This epoxy casting, potting, and encapsulating compound can be cured at room temperature for 8 to 12 hours when used with catalyst 90. When catalyst 110 is used, the material should be cured for 2 to 3 hours at 210° to 220°F. For castings larger than 1/2 lb, the time and temperature varies. PR-2205 has a viscosity of 6,000 centipoises at 25°C. The material has good physical properties, notably a tensile strength of 7,500 psi and a compressive strength of 16,000 psi. It displays an Izod impact of 0.30 ft-lb/in. Two important electrical properties are a dielectric constant of 4.6 at 60 Hz and a dielectric strength of 460 v/mil. Prices depend upon several factors, including the quantity ordered and the catalyst chosen.

Formulated Resins Inc., P. O. Box 508, Greenville, R. I. 02828 [480]

The Intel Notebook

Careers in Technology at Intel

Field Sales Engineers Field Applications Engineers

- Maintain your engineering skills at state-of-the-art levels by applying the leading edge family of Intel components and systems
- Use your technical expertise and ingenuity to create new applications for processor technology
- Expense account
- Company car
- Interface with customers' decision makers in defining new microprocessor based systems
- Excellent benefits including fully company-paid retirement program

The Age of the Microcomputer

Our world is changing fast. Sophisticated electronic devices, in one form or another, are now found in virtually every household and industry—inside refrigerators, automobiles, traffic signals, industrial process controllers, and laboratory equipment—providing better communication and more efficient energy usage. No single invention has so radically influenced this evolving life style as the microcomputer.

We were first from the beginning and remain the world's leading supplier of microcomputer products. This commitment to maintain our technological leadership is now stronger than ever. Looking ahead, we see the advent of even more powerful, more useful, and more economical microcomputers.

To meet these challenges, we'll have an increasing demand for talented Field Applications and Field Sales Engineers in every major city in the United States and eastern Canada.

If you are an aggressive, innovative individual with a BSEE or equivalent, and at least 3 years of microcomputer systems design experience interested in exploring

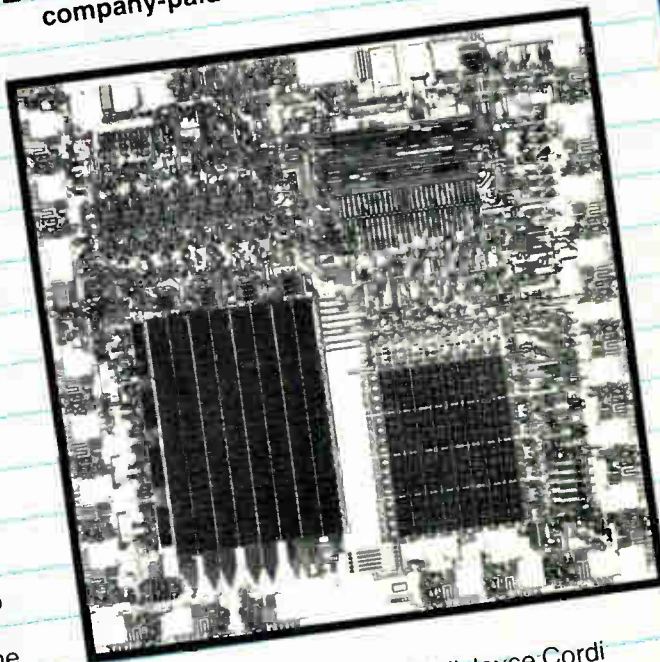

these opportunities, please call Joyce Cordi at (800) 821-2280, ext. 905. Previous electronics sales experience, technical project management experience and/or an MBA are desirable but not required. If you are unable to call, please send your resume to her attention, Intel Corporation, Dept. 45BD, P.O. Box 3078, Santa Clara, CA 95051.

An Equal Opportunity Employer M/F/H

intel®

A little Vector Graphic computer goes

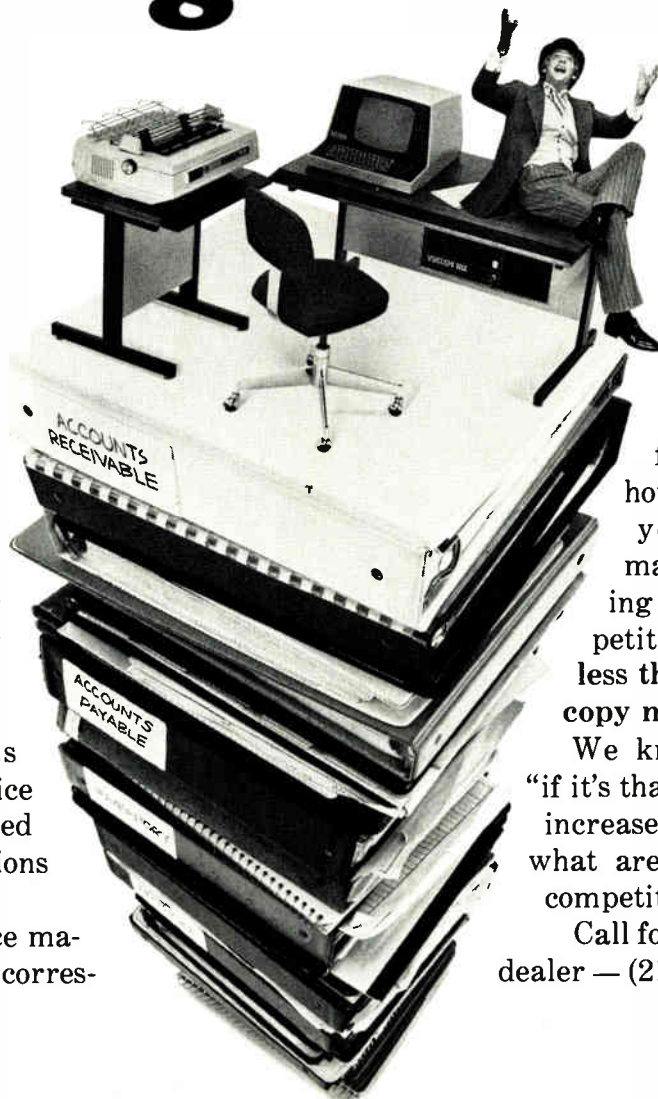

Picture if you will, an office machine that relieves routine paperwork, speeds the flow of information, keeps up with your growing volume of accounting procedures, analyzes difficult sales or engineering data and has ready at a moment's notice any information you need for your business decisions — totally up-to-date.

And what if this office machine manages your corres-

pondence — letter perfect every time no matter how many times you change your mind, generates manuals, proposals, mailing lists and any other repetitious documents but costs less than the average office copy machine?

We know you're going to say "if it's that efficient, cuts our costs, increases our productivity then what are we waiting for?" Your competition won't.

Call for your nearest authorized dealer — (213) 991-5740.

a long way

VECTOR GRAPHIC INC.

31364 Via Colinas, Westlake Village, CA 91361

Taking Care of Business

By **SESCO...**
it works!



128K
WORD
CARD

512K
WORD
SYSTEM

Love at First Byte

A versatile 128K by 22 semiconductor memory
on a single card... multi-card systems, too.

Not Ruggedized, but Rugged

Our hard nosed EMM/SESCO inspector has fallen in love with the new Model 3500 NMOS semiconductor memory... and so will you.

Although designed and priced for the commercial user, the 3500 is built with the same exacting care that has made EMM/SESCO's ruggedized memories so popular. It's fast, too, with 300ns access and 400ns cycle time. Even faster in the page mode.

Options Abound

Many options are available to make your task easier. These include ECC (single and multiple bit error correction), word or byte parity generation and checking, page mode, byte mode, error stop, LED failure isolation and display, and battery backup.

More Words or Less Words

The 11.75" x 15.4" card can be configured with 128K words of up to 22 bits or 256K words of up to 11 bits. It can be depopulated down to 32K if that fits your immediate needs.

512K Word System

A 5 1/4" high rack holds up to 4 memory cards, providing capacities to 512K x 22 bits, plus custom interface, self-test, cooling fans, and power supply.

Plenty of Memories

There are plenty of memories in store for you at EMM/SESCO. Such as a non-volatile Megabyte core memory system. A complete line of ruggedized memories for military and industrial use. Even a ruggedized version of Intel's popular iSBC* 80/10A microcomputer.



*Trademark of Intel Corporation

EMM **SESCO**

A Subsidiary of Electronic Memories & Magnetics Corporation

20630 Plummer Street • P.O. Box 668 • Chatsworth California 91311
Telephone: (213) 998-9090 • Telex: 69-1404

So when you're looking for
memories... Buy
SESCO... they work!

Circle 267 on reader service card



An introductory Electronics

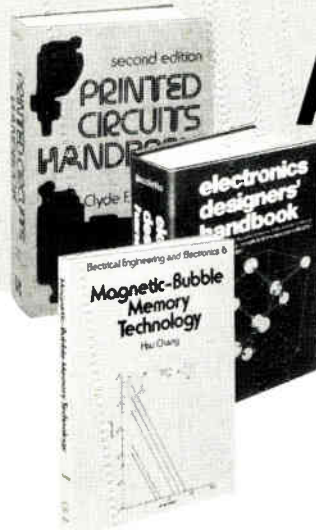

ENGINEERING FUNDAMENTALS FOR PROFESSIONAL ENGINEERS' EXAMINATIONS, Second Edition. By L. M. Polentz, 416 pp., 326 illus. Here—in this single volume—you'll find all the latest, most essential material you need to prepare for and pass your state's engineering registration exam. Hundreds of examples and practice problems are all drawn from actual P.E. exams and were selected because they are representative of the problems that will appear on your exam. 503/80X Pub. Pr., \$23.50 Club Pr., \$16.95

STANDARD HANDBOOK FOR ELECTRICAL ENGINEERS, 11/e. By D. G. Fink and H. W. Beaty, 448 pp., 1,414 illus. A giant in every sense of the word, today's most widely used source of electrical engineering information and data serves you as no other single work available anywhere when you need detailed, accurate, timely, and reliable facts and how-to on the generation, transmission, distribution, control, conversion, and application of electric power. 209/74X Pub. Pr., \$49.50 Club Pr., \$38.00

APPLICATIONS OF DIGITAL SIGNAL PROCESSING. Edited by A. V. Oppenheim, 499 pp., illus. Digital processing of speech, images, sonar signals, signals in the field of geophysics, and many more are gone into in full detail. The book explains the important similarities and differences in the ways in which basic techniques and technology are applied, and it takes you into such different assumptions and constraints as data rate and real-time requirements. 787/263 Pub. Pr., \$25.00 Club Pr., \$18.95

MICROPROCESSORS AND MICRO-COMPUTERS AND SWITCHING MODE POWER SUPPLIES. By Texas Instruments, Ltd., 216 pp., illus. The book has information on power supplies, deflection systems, new consumer systems, microprocessors, and third-generation microcomputers. It is quickly being snapped up by engineers seeking updating in their design skills in the fast-moving area of semiconductor devices and relying on the TI people for the facts, figures, and circuit designs that help them pinpoint solutions instantly. 637/563 Pub. Pr., \$21.50 Club Pr., \$16.95

ELECTRONIC DISPLAYS. By E. G. Bylander, Texas Instruments Incorporated, 172 pp., illus. The book describes current electronic displays by family types, discussing all aspects of their operation, application, and circuit requirements. You cover photometry and contrast enhancement, together with the fundamentals of such critical components as mounts and drives, interface requirements, and other necessary engineering information. 095/108 Pub. Pr., \$19.50 Club Pr., \$15.95

DIGITAL FILTERS. By A. Antoniou, 524 pp., illus. This all-inclusive, up-to-date treatment guarantees your thorough understanding of today's digital filters and the theories, techniques, and procedures you'll be using in their analysis, design, and implementation. The book gives you many design examples, together with the numerous possible approaches and engineering tradeoffs relating to their hardware implementation. 021/171 Pub. Pr., \$23.95 Club Pr., \$18.50

BUCHSBAUM'S COMPLETE HANDBOOK OF PRACTICAL ELECTRONIC REFERENCE DATA. By W. H. Buchsbaum, 2nd Ed., 645 pp., 371 illus., 70 tables. It gives you all the technical electronic information you need—from the factual foundations of electronics to the latest technical advances in optoelectronics, large scale integrated circuits, digital logic, microprocessors, and computers. Hundreds of formulas, graphs, charts, and tables. 786/550 Pub. Pr., \$19.95 Club Pr., \$16.95

RADIO HANDBOOK. By W. I. Orr, 21st Ed., 1,135 pp., 1,364 illus. Now completely updated, expanded, and more deserving than ever this profusely illustrated reference gives you everything you need to know to understand, design, use, and experiment with every circuit and piece of equipment. (All recent technological breakthroughs are covered). 772/630 Pub. Pr., \$21.50 Club Pr., \$16.60

TRANSFORMER AND INDUCTOR DESIGN HANDBOOK. By W. T. McLyman, 428 pp., illus. User-oriented throughout, it covers everything from transformer design and inductor design with dc, power inductor design, designing for regulation, inductor design without dc, constant voltage transformer, current and three-phase transformer, to application of magnetic components in power electronics. 786/755 Pub. Pr., \$35.00 Club Pr., \$26.50

BE SURE TO CONSIDER THESE IMPORTANT TITLES AS WELL:

INTRODUCTION TO MICROPROCESSOR SYSTEM DESIGN
By H. Garland
228/71X Pub. Pr., \$17.95 Club Pr., \$13.95

MICROPROCESSORS AND SMALL DIGITAL COMPUTER SYSTEMS FOR ENGINEERS AND SCIENTISTS
By G. A. Korn
353/670 Pub. Pr., \$29.50 Club Pr., \$18.95

MASTER OP-AMP APPLICATIONS HANDBOOK.
By H. W. Fox
784/477 Pub. Pr., \$16.95 Club Pr., \$13.50

CRYSTAL OSCILLATOR DESIGN AND TEMPERATURE COMPENSATION. By M. E. Frerking.
784/973 Pub. Pr., \$16.95 Club Pr., \$13.50

GUIDEBOOK OF ELECTRONIC CIRCUITS. By J. Markus.
404/453 Pub. Pr., \$41.50 Club Pr., \$30.50

GROUNDING AND SHIELDING TECHNIQUES IN INSTRUMENTATION, 2/e
By R. Morrison
786/666 Pub. Pr., \$16.50 Club Pr., \$12.25

NOISE REDUCTION TECHNIQUES IN ELECTRONIC SYSTEMS
By H. Ott
769/63X Pub. Pr., \$21.25 Club Pr., \$15.50

DISCRETE/TRANSISTOR CIRCUIT SOURCE-MASTER
By K. W. Sessions
786/720 Pub. Pr., \$24.95 Club Pr., \$19.50

IC SCHEMATIC SOURCEMASTER
By K. W. Sessions
784/922 Pub. Pr., \$27.95 Club Pr., \$21.00

LOGIC DESIGNERS' MANUAL
By J. D. Lenk
784/671 Pub. Pr., \$18.95 Club Pr., \$15.75

PRINTED CIRCUITS HANDBOOK, 2/e. By C. F. Coombs, Jr. 256 pp., 327 illus. Blueprints every important phase of printed circuitry. Provides the information you need to establish a production facility and control the processes. A virtual encyclopedia in the field, five major sections cover engineering, fabrication, assembly, soldering, and testing. 126/089 Pub. Pr., \$32.50 Club Pr., \$24.50

DIGITAL INTEGRATED CIRCUITS AND OPERATIONAL AMPLIFIER AND OPTOELECTRONIC CIRCUIT DESIGN. Edited by B. Norris. 206 pp., 400 illus. Having this vast amount of case-tested data, proven shortcuts, worked-out circuit designs, and circuit diagrams handy saves you valuable time for your other, more vital, areas of creative design—and cuts down costs in all areas! 637/539 Pub. Pr., \$21.50 Club Pr., \$15.95



offer to new members of the and Control Engineers' Book Club

OPTOELECTRONICS Theory and Practice.

By Texas Instruments Incorporated. Edited by A. Chappell. 442 pp., 475 illus. Right here is where you'll find all the knowledge and know-how you need to take any of today's optoelectric components and develop your own circuits and uses. You get both the background and the technical specifics (with all the proven circuits you want!)

637/555 Pub. Pr., \$26.50 Club Pr., \$20.95

HANDBOOK OF OPERATIONAL AMPLIFIER CIRCUIT DESIGN.

By D. F. Stout. Edited by M. Kaufman. 434 pp., 223 illus. Compact, concise, highly concentrated, and containing a storehouse of information, this one-stop volume will help you solve any op amp circuit problem!

617/97X Pub. Pr., \$29.65 Club Pr., \$17.50

MICROELECTRONICS

Digital and Analog Circuits and Systems

By J. Millman. 881 pp., 700 illus. This giant book takes you step by step from a qualitative knowledge of a semi-conductor, to an understanding of the operation of devices, and finally, to an appreciation of how these are combined to form micro-electronic chips.

423/27X Pub. Pr., \$24.50 Club Pr., \$19.50

MINICOMPUTER SYSTEMS Organization, Programming, and Applications (PDP-11) Second Edition.

By Richard H. Eckhouse, Jr., and L. Robert Morris. Clearer than you ever hoped a book could be on the organization, programming, and applications of current small computer systems, it gives you—in enjoyable, readable discussions and explanations—the fundamental ideas of computer architecture and structure, both hardware and software, and the uses of these concepts in producing programs for data acquisition and manipulation. It examines the interaction of algorithms, programs, and data structure to produce the desired results.

787/026 Pub. Pr., \$21.95 Club Pr., \$17.75

ELECTRONICS DESIGNERS' HANDBOOK.

Edited by L. J. Giacoletto. 2nd Ed. 2,344 pp., 1,686 illus. Now doubled in size and with 90% of its material new, this famous classic (first edition by Landee, Davis, Albrecht) has been thoroughly revised and updated to give you not only the *how* and the *why* of all your design work but also the *how much* of every design step you take!

231/494 Pub. Pr., \$56.50 Club Pr., \$41.50

ELECTRONICS DICTIONARY.

Edited by John Markus. 4th Ed., 768 pp., 1,173 illus., 17,090 terms. With the new edition of this world-renowned dictionary you'll be able to quickly find the meaning and correct usage of any electronics term, no matter how obscure!

404/313 Pub. Pr., \$24.50 Club Pr., \$19.50

ELECTRONICS ENGINEER'S HANDBOOK.

Editor-in-Chief, D. G. Fink. 2,104 pp., 2,026 illus. Huge in every sense, this instant-reference volume gives you every latest essential in the field, 2,100 formulas and equations, a 2,500-item bibliography, and every illustration you need to clarify all of modern electronics!

209/804 Pub. Pr., \$52.50 Club Pr., \$37.50

OSCILLOSCOPES. Applications and Uses in Electronics

By R. Van Erk. 270 pp., 248 photos and diagrams. The amount of technical information it contains is stupendous, beginning with the oscilloscope's basic operations (plus additional features and their functions) and continuing with the special oscilloscopes and variants, oscilloscope probes, and measurement pitfalls.

670/501 Pub. Pr., \$19.50 Club Pr., \$14.50

MICROCOMPUTER-BASED DESIGN

By J. B. Peatman. Expanded 4th printing, 604 pp., over 400 photos and other illustrations. Do all your best day-to-day designs, as well as your supercreative and special designs, around the new microcomputers and the specific "how-to" help you get here!

491/380 Pub. Pr., \$26.95 Club Pr., \$18.95

Special \$1.89 bonus book comes to you with your first club selection

Books are selected from a wide range of publishers

ELECTRONICS AND CONTROL ENGINEERS' BOOK CLUB saves you both time and money!

Here is a professional book club designed to meet your on-the-job engineering needs by providing practical books in your field on a regular basis at *below publisher prices*. If you're missing out on important technical literature—if today's high cost of reading curbs the growth of your library—here's the solution to your problem.

The *Electronics and Control Engineers' Book Club* was organized for you, to provide an economical reading program that cannot fail to be of value. Administered by the McGraw-Hill Book Company, all books are chosen by qualified editors and consultants. Their understanding of the standards and values of the literature in your field guarantees the appropriateness of the selections.

How the club operates: Fourteen times a year you receive free of charge *The Electronics and Control Engineers' Book Club Bulletin*. This announces and describes the Club's featured book for that period as well as alternate selections available at special members' prices. If you want to examine the Club's featured selection, you do nothing. If you prefer one of the alternate selections—or if you want no book at all—you notify the Club by returning the card enclosed with each Bulletin.

As a Club member, you agree only to the purchase of four books (including your first selection) over a two-year period. Considering the many books published annually, there will surely be at least four you would want to own anyway. By joining the Club, you save both money and the trouble of searching for the best books.

MAIL COUPON TODAY

ELECTRONICS AND CONTROL ENGINEERS' BOOK CLUB
P.O. Box 582, Hightstown, New Jersey 08520

Please enroll me as a member and send me the two books indicated. I am to receive the **PREMIUM BOOK** at the introductory price of \$1.89 plus my first selection at the discounted price to members, plus tax, postage and handling. If not satisfied, I may return the books within 10 days and request that my membership be canceled. If I keep the books, I agree to take a minimum of three additional books during the next two years. I will receive the Club Bulletin 14 times a year. If I want to examine a featured selection, I need take no action. It will be shipped automatically. If I want an alternate selection—or no book at all—I notify the Club by returning the card enclosed. A postage and handling charge is added to each shipment. I will have a minimum 10 days in which to return the card, and you will credit my account fully, including postage, if this is not the case. Membership in the club is continuous but cancellable by me at any time after the four book purchase requirement has been fulfilled. *This order subject to acceptance by McGraw-Hill.*

WRITE BELOW:

Write Code # of \$1.89 premium book selection here Write Code # of first selection here

NAME
ADDRESS
CITY
STATE ZIP

Orders from outside the U.S. must be prepaid with international money orders in U.S. dollars. E33401

MOTOR-ANALYSIS SYSTEM

with

NEW 3-WAY READOUT



FRICTIONLESS DYNAMOMETER

Power-absorption dynamometers utilize friction-free hysteresis brakes for longest life, precise repeatability, smooth torque application independent of speed. Models from 2.50 oz.in. to 200 lb.in., with English, metric, or SI calibration.

ALL-NEW INTERCHANGEABLE READOUT

Simultaneously and continuously displays speed, torque, and horsepower, with display hold for operator convenience. Simple plug-in operation, virtually error-proof.

All dynamometers and readouts offer many exclusive features and capabilities. Request information today.

see our catalog in
THOMCAT
or call us toll-free at
800-828-7844
(except New York State)



MAGTROL, INC.

70 GARDENVILLE PARKWAY WEST BUFFALO, NEW YORK 14224 716-668-5555

Circle 272 on reader service card

OVENAIRE...

...now, more than ever, your best bet for crystal oscillators.

Ovenaire's oscillator capabilities have been enhanced by the acquisition of W.H. Ferwalt, Inc.

- **STATE-OF-THE-ART HIGH STABILITY CRYSTAL OSCILLATORS** with stabilities to $5 \times 10^{-10}/\text{day}$ and $7 \times 10^{-11}/^\circ\text{C}$.
- **OVENIZED CRYSTAL OSCILLATORS** $3 \times 10^{-9}/^\circ\text{C}$ at low cost.
- **TCXO's** with temperature stabilities to $\pm 1 \times 10^{-7}$ 0 to 50°C .
- **DIP HYBRID CIRCUIT CRYSTAL OSCILLATORS** with temperature stabilities to ± 20 ppm.

...and, as always, your best bet for crystal and component ovens.

- **ELECTRONIC CONTROL MINIATURE OVENS FOR:** HC-18U, HC-25U, HC-42U, HC-43U crystals TO5 & TO8 crystal, transistor or IC 14 Pin & 16 Pin DIP IC.

Plus a complete range of ovens for commercial and military applications.

OVENAIRE-AUDIO-CARPENTER

Division of Walter Kidde & Company, Inc.

706 Forrest St., Charlottesville, Va. 22901
804/977-8050 TWX 510-587-5461

KIDDE

Circle 114 on reader service card

TRUE RMS Only \$20 More.

When you buy a Data Precision Model 2480 for just \$279, you get a full function, $4\frac{1}{2}$ digit digital multimeter with 0.03% basic accuracy. Its wide measurement ranges on all functions ($10\mu\text{V}$ to 1000V , ac or dc, 10nA to 2A , ac or dc, and $100\text{m}\Omega$ to $20\text{M}\Omega$), make it an ideal benchtop DMM, and its built-in battery charger allows you to drop in an optional battery pack and carry this same meter into the field.

And when you buy the Model 2480R for only \$20 more at \$299, you get all this, plus true RMS. It's far and away your best deal on true RMS.

It's only what you'd expect from Data Precision.

Available from stock at all Data Precision distributors.

PRICE USA



DATA PRECISION
...years ahead®

Data Precision Corporation, Electronics Avenue, Danvers, MA 01923. Telephone: (617) 246-1600, Telex 921819.

HELP BEAT THE RECESSION!

Buy Used or Surplus!

The slightest economic recession generates tremendous surplus in the computer industry for both new and used equipment.

Our inventory and customer listings are expanding daily. Save 20% to 70% on used and new surplus minicomputer equipment, fully warranted.

- BUYERS — Call with your requirements
- SELLERS — Call with your listings for sale
- CASH available for immediate purchases
- SOFTWARE services available

MINICOMPUTER EXCHANGE INC.
Sunnyvale, California

TEL (408) 733 4400  TWX 910 339 9272

DEC — DG — INTERDATA — HP — ALL PERIPHERALS

Circle 274 on reader service card

**DIP/SIP
Shunt Networks**
(they're programmable)



CTS Series 198 programmable shunt networks replace jumper/buss wiring with one error-free package available in complete matrix or parallel connections. You program them by breaking a visible connection with a stylus. Or we'll program them for you. Nothing we know of could be more economical.

SIP and DIP styles on .100" centers and 300" side-to-side. SIP's available in 2-12 pins. DIP's in 4-24 pins. Machine insertable, too. Get complete data from CTS Keene, Inc., 3230 Riverside Ave., Paso Robles, CA 93446. Phone: (805) 238-0350.

CTS CORPORATION
ELKHART, INDIANA



New literature

Power Basic language. "Product Reference Guide for Power Basic" describes the products available for Texas Instruments' Power Basic language. Designed for individuals who have had no previous experience with computer programming, Power Basic is fast and requires little memory overhead. The 15-page guide explains Evaluation Power Basic (TM 990/450), Development Power Basic (TM 990/451), Development Power Basic enhancement package (TM 990/452), and Configurable Power Basic (TMSW510F). The guide also includes Power Basic statements, commands, and functions. A copy of the reference guide may be obtained from Texas Instruments Inc., P. O. Box 1443, M/S 6404 (Attn: MP713), Houston, Texas 77001. Circle reader service number 421.

CTR degradation. "Consideration of CTR Variations in Optically Coupled Isolator Circuit Designs" discusses the causes of current-transfer-ratio degradation of optocouplers. The main cause of this degradation is the reduction in efficiency of the light-emitting diode within the optocoupler. The 16-page application note also develops a degradation model, describes second- and third-order effects of emitter degradation, and explains practical applications of an optocoupler. Application Note 1002, Publication no. 5953-0385, can be obtained from Hewlett-Packard Co., 1507 Page Mill Rd., Palo Alto, Calif. 94304 [422]

Reliability databook. "Digital Failure Rate Data, 1979," a new addition to the Reliability Analysis Center's Microcircuit Device Reliability series of handbooks, presents data that reflects the reliability experience of small-scale and medium-scale integrated devices currently used in active Government and industry programs. The data covers a wide range of functions and device technologies that include TTL, complementary-MOS, p- and n-channel-MOS, Schottky TTL, and emitter-coupled logic. The 430-page publication contains information on generic

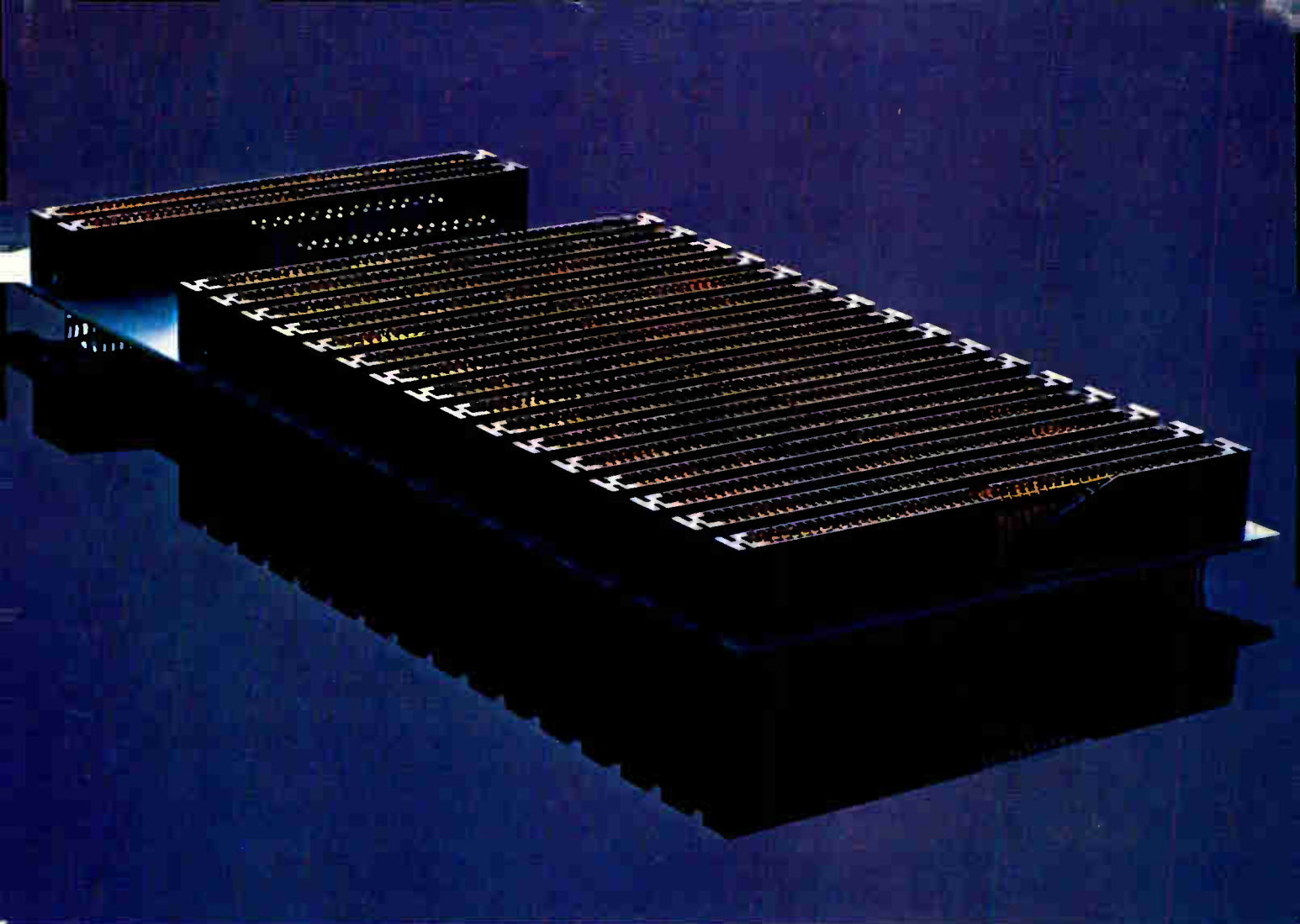

Pressure gets our family uptight.

Press-fit is the way to go for reliable solderless backpanels. And we've gone a step further.

We've put press-fit contacts into a one-piece discrete connector. That means your only assembly work is to press our connector into your board.

We can give you a complete choice of post grid dimensions as well as connector length. You specify the plating—selective gold or solder, gold dot or overall. With our system you can replace individual contacts without disturbing others.

GTE Sylvania has over two decades of backpanel experience. As your single source with total system responsibility for completely assembled, wire wrapped and tested backpanels, we offer maximum reliability at the lowest total applied cost. That's why we're uptight about press-fit.

GTE Sylvania, CPO, Box 29, Titusville, Pa. 16354. Phone 814-589-7071.

Remember, good interconnection systems run in our family.

SYLVANIA

GTE

Better Miniatures With NO Hidden Costs.

We urge you to compare features vs cost. Our MST Series have pinned toggles and high torque bushings with shoulders.
NO ADDED COST!

Switch cases are molded of DAP to withstand high soldering temperatures & physical abuse. A complete family of 1, 2, 3 & 4 pole sizes to choose from.
NO ADDED COST!

We offer a variety of terminals including PC types having epoxy seals to prevent flux contamination. Choice of gold or silver at the same price. Compare and we're sure you'll agree that
ALCO IS YOUR BEST BUY!



ALCOSWITCH®

ALCO ELECTRONIC PRODUCTS, INC. a subsidiary of Augat®
1551 Osgood St., No. Andover, MA. 01845 USA
Tel: (617) 685-4371 TWX: 710 342-0552

Circle 18 on reader service card

Silicon Bridge Rectifiers

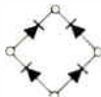

- 1.5A (I_0)
- 50V to 1000V (V_{RRM})
- 50A peak one-half cycle surge
- Epoxy pkg. (.335" Dia.)



22¢ ea. (25,000 qty. — 200V)
Delivery from stock

1N4001-1N4007 Silicon Rectifiers

- D0-41 pkg.
- 1A (I_0)
- 50v to 1000V (V_{RRM})
- 50A peak one cycle surge
- Low forward voltage drop
- Epoxy pkg. with UL 94V-0 flame retardant rating



3.2¢ ea. (50,000 qty. — 200V)
Delivery from stock

For information, call toll free:
800-527-0251

COLLMER SEMICONDUCTOR, INC.

4100 McEWEN, SUITE 244 • DALLAS, TX. 75234 • 214 / 233-1589



276 Circle 20 on reader service card

New literature

failure rates, observed failure rates vs MIL-HDBK-217B predictions, field replacement rates, and generic replacement rates, all of which are vital for reliability decisions. It also contains tabulations, charts, an index, and a user's guide that includes definitions of terms and statistical methods employed in analyzing data. A copy is available for \$50 in the U. S. (\$60 outside the U. S.) by ordering No. MDR-12 from Reliability Analysis Center, Griffiss Air Force Base, N. Y. 13441.

Printed-circuit techniques. "Eliminating Printed Circuit Design Problems" by James Wheeler is a reprint of a four-page story that appeared in *Insulation/Circuits* magazine. It deals with various design techniques that can be used to reduce printed-circuit-board production costs and difficulties. It also points out that circuit designers should work closely with pc board manufacturers in developing board designs that are easily and economically produced. A copy can be obtained from Reprint, The Sibley Co., Bridge Street, Had-dam, Conn. 06438 [424]

Solders. A 17-page brochure, "Indalloy Specialty Solders," discusses Indium's technical and production capabilities and describes solders for microelectronics, solders incorporating flux, special solders for special applications, and the soldering of nonmetals. It contains a special section on solder creams formulated with spherized alloy particles that make it superior to conventional creams and provides a guide to Research Solder Kits listing 28 solders, their special characteristics, compositions, and physical properties. The Indium Corp. of America, P. O. Box 269, Utica, N. Y. 13503 [425]

Timer-flashers. "Solid State Timers and Flashers" describes a broad line of such products. The 130-page catalog presents application information and a glossary of terms of the timer-flasher language and contains charts that help the designer select the correct control. It also explains and

TRI-COLOR

WIRE CUTTING AND STRIPPING DISPENSER

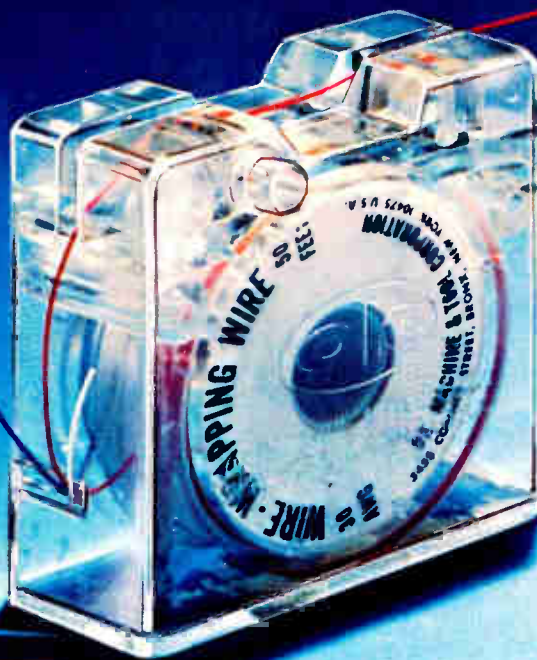

- 3 Rolls of wire in one convenient dispenser
- 3 Colors, Blue/White/Red, 50 ft. (15m) of each color
- AWG 30 (0,25mm) KYNAR® insulated wire
- Built-in cutting plunger cuts wire to desired length
- Built-in stripper strips 1" of insulation
- Easily refillable
- For wire-wrapping and other applications.

Model No. **WD-30-TRI**
Patent Pending

WD-30-TRI	DISPENSER WITH WIRE	\$5.95
R-30-TRI	TRI-COLOR REPLACEMENT SPOOLS	\$3.95

Kynar® Permetall

MINIMUM BILLING \$25.00/ ADD SHIPPING CHARGE \$1.00/ NEW YORK STATE RESIDENT ADD APPLICABLE TAX



MACHINE & TOOL CORPORATION 3455 CONNER ST. BRONX, N.Y. 10475 (212) 994-8600 Telex: 125071

Circle 21 on reader service card

The biographies of 5,240 of your colleagues...

Profiles the Top Management of Major Electronics Firms throughout the World —and more

This is the only reference devoted solely to biographies of the most influential people in electronics: corporate executives... technical managers... designers and developers of important products and processes... government and military officials... academics... editors and publishers... securities analysts... directors of trade and professional groups... and consultants.

McGraw-Hill's **Leaders in Electronics**

Prepared by the Staff of Electronics
651 pages

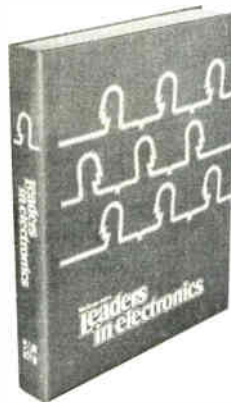

As easy to read as any professional publication in electronics

With LEADERS IN ELECTRONICS on your bookshelf, you no longer have to search through many different sources for biographical data on your colleagues. What's more, you don't have to strain your eyes reading minuscule type, nor do you have to waste valuable time trying to decipher seemingly endless paragraphs of abbreviations. Boldface type spotlights the various information categories so that you can scan entries rapidly to pinpoint what you need.

Unique convenience feature... Index of biographees by affiliation

A special 80-page index lists individual organizations alphabetically, complete with the names and titles of top employees. By looking up the names in the general biography listing, you can get a complete profile of the organization's top management in a matter of minutes. Plus an easy-access listing of independent consultants in every electronics specialty.

New literature

compares mechanical, resistance-capacitance, and digital methods of time control. For a free copy, write to SSAC Inc., P. O. Box 395, Liverpool, N. Y. 13088 [426]

Digital meters. "Digital Instrument Guide," an eight-page catalog, describes Data Tech's range of digital panel meters, digital multimeters, and data-conversion subsystems. It discusses 3½ and 4½ digit panel meters; a family of portable or benchtop digital multimeters with a choice of gas-discharge, light-emitting-diode, or liquid-crystal displays; data-conversion subsystems using a modular approach; and two logic-card series, blue-chip modules and M series digital and analog modules. Data Tech, Division of Penril Corp., 2700 South Fairview St., Santa Ana, Calif. 92704 [427]

Video tape library. The Genesys Video Tape Library contains more than 200 video courses in engineering and science. Recently, the company announced the addition of 50 new video courses that help teach and train engineers and technicians. The subjects covered include lasers, microprocessors, computers, computer science, amplifiers, networks, systems, microelectronics, integrated circuits, programming analysis, design, industrial engineering, mechanical engineering, mechanics, combustion, heat transfer, energy, materials, structures, quality control, reliability engineering, economy, communications, modulation, mathematics, physics, chemistry, chemical engineering, and much more. The courses, ranging in price from \$400 to \$11,000, were produced by such organizations as: the Massachusetts Institute of Technology; the universities of Rochester, Kentucky, Delaware, and Wisconsin; Oklahoma State Univ., Purdue, and the University of Southern California; and Texas Instruments Inc., the Society of Manufacturing Engineers, and Lawrence Livermore Laboratory. For a free listing of the courses, write to Genesys Systems Inc., 1180H East Meadow Dr., Palo Alto, Calif. 94303 [428]

Electronics Magazine Books
P.O. Box 669, Hightstown, NJ 08520

Send me _____ copies of *Leaders in Electronics* @ \$39.50 plus applicable sales tax. McGraw-Hill pays regular shipping and handling charges on pre-paid orders.

I must be fully satisfied or you will refund full payment if the book is returned after ten-day trial examination.

Payment enclosed Bill firm Bill me
Charge to my credit card: American Express
 Diners Club Visa Master Charge

Acct. No. _____ Date Exp. _____

On Master Charge only,
first numbers above name _____

Name _____

Company _____

Street _____

City _____ State _____ Zip _____

Signature _____

The Pick 'N' Choose Relay

972 variations of a 12 amp miracle from your Guardian Angel



PICK Series 1510 AC or 1515 DC.

PICK .187" or .205" quick connect/
solder lug, or PC termination.

PICK push-to-test button versions.

PICK neat and shock resistant
polycarbonate dust cover or open style
(without cover).

PICK voltages from 6 to 240VAC,
6 to 110VDC.

PICK the 1510 that's ideal for your application—
and get it directly from Guardian... or from your
Guardian Distributor.

CHOOSE SPDT, DPDT or 3PDT.

CHOOSE bracket, stud, stud-on-
end or tapped core mount.

CHOOSE indicator lamp versions.

CHOOSE sockets with solder lug,
.187" QC, PC or screw terminals.

CHOOSE contact materials from
silver-cadmium-oxide to tungsten and
gold alloy silver and silver alloys for special
applications.



Your Guardian Angel has a free
technical application bulletin waiting
for you. Send for your Series 1510
data today.

See us at Midcon
Booths: 1022-1024

GUARDIAN®

GUARDIAN ELECTRIC MANUFACTURING COMPANY • 1550 W. Carroll Avenue, Chicago, IL 60607 • 312/243-1100

Circle 22 on reader service card

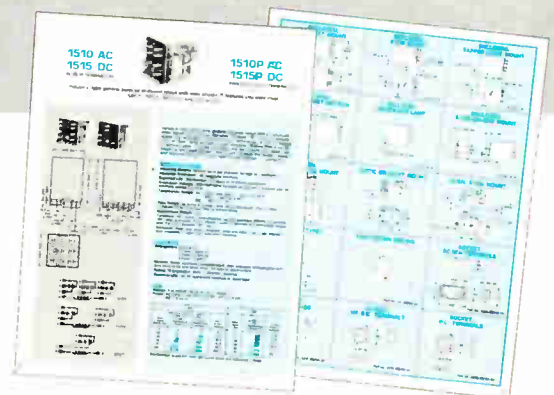

Just published!

Your guide into the fascinating world of...

PERSONAL COMPUTING Hardware and Software Basics

A reliable, easy-to-use resource that tells you...
What's available in hardware and software, including costs.
Who's using it, and what they've experienced.
How it all works.
Why it's caught on so fast, including practical applications to use now.

Some of the most exciting advances in computing are taking place, not in research labs and commercial facilities, but in homes across the country. All sorts of people with a basic background in mathematics and electronics are taking the computer revolution into their own hands—experimenting with new equipment and technology, and devising their own *personal* applications.

If you've considered joining them, if you've thought about building or buying your own computer—this is a fast, up-to-date guide that answers all your questions precisely and reliably.

At your fingertips, all the most needed information on...

- what's available in personal computers
- the most popular microprocessor chips
- programming at microprocessor level and in high-level languages
- design hitches and how to prevent them
- where to buy
- plus a glossary of the most current terms in home computing

Drawn from major publications throughout the industry...

To get all the up-to-the-minute information and guidelines presented here, you'd have to read through numerous issues of...

- Electronics • Datamation • Mini-Micro Systems • BYTE
- Interface Age • IEEE Spectrum • Kilobaud • People's Computers

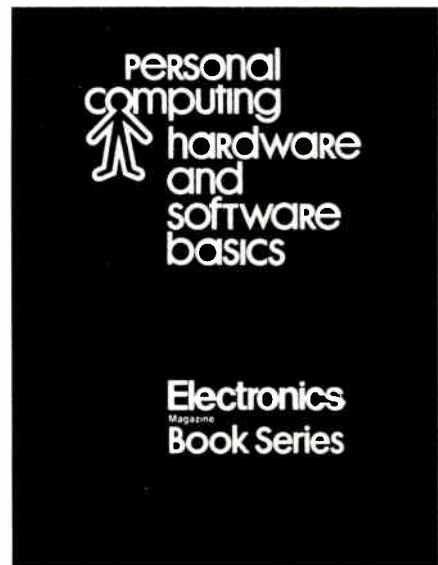

edited by
Raymond P. Capece, Solid State Editor,
Electronics Magazine
266 pages, \$11.95

Table of Contents

- Part 1: **Introduction to Personal Computing.**
The term defined, equipment and components, costs, applications.
- Part 2: **Basic Computer Theory.**
Microcomputer architecture with the emphasis on memory.
- Part 3: **Advanced Microcomputer Theory.**
Board-level computers using the most popular microprocessor chips.
- Part 4: **Reviews of Personal Computers.**
Features and capabilities of the most widely used microcomputers.
- Part 5: **Software for Microcomputers and Microprocessors.**
Description and uses of both machine-level and high-level programming languages.
- Part 6: **Specifications and Other Useful Information.**
Glossaries, microprocessor specs, electronics symbols, buying used equipment.

Electronics Magazine Books

P.O. Box 669, Hightstown, NJ 08520
(609) 448-1700, ext. 5494

No. of Copies	Title	Price
_____	Microprocessors	\$ 8.95
_____	Applying Microprocessors	\$ 9.95
_____	Large Scale Integration	\$ 9.95
_____	Basics of Data Communications	\$12.95
_____	Circuits for Electronics Engineers	\$15.95
_____	Design Techniques for Electronics Engineers	\$15.95
_____	Memory Design: Microcomputers to Mainframes	\$12.95
_____	Personal Computing: Hardware and Software Basics	\$11.95
_____	New Product Trends in Electronics	\$14.95

Discounts of 40% on orders of 10 or more copies of each book.



If after my 10-day free-trial examination I am not fully satisfied I understand that my payment will be refunded.

Payment enclosed Bill firm Bill me

Charge to my credit card:

American Express Diners Club
 Visa Master Charge*

Acct. No. _____ Date Exp. _____

*On Master Charge only, first numbers above name _____

Name _____ Title _____

Company _____

Street _____

City _____ State _____ Zip _____

Signature _____



**Tomorrow's
SLIC idea
may not be
a SLIC at all.**

Today, you require Subscriber Line Interface Circuits.

Tomorrow? Who knows?

Although we are working with design engineers on exotic new concepts to meet the requirements the industry will have tomorrow, we offer reliable 3081 and 3082 circuits in production quantities today.

Keeping up is the idea. "Forward Integration" is the concept.



We set the standards for the industry, and we will continue to do so through forward integration.

Next time, specify ITT North SLICs. Get the latest in technology today. The newest developments tomorrow.

More information? Write or call: ITT North Microsystems Division, 700 Hillsboro Plaza, Deerfield Beach, Florida 33441. Phone (305) 421-8450, TELEX & TWX: 510-953-7523.

ITT North
Microsystems Division

Classified section FOR ENGINEERING/TECHNICAL EMPLOYMENT OPPORTUNITIES

CLASSIFIED SALES REPRESENTATIVES

Atlanta Maggie McClelland 404/892-2868
 Boston Jim McClure 617/262-1160
 Chicago Bill Higgins 312/751-3733

Chicago Linda Nocella 312/751-3770
 Cleveland Mac Huestis 216/781-7000
 Dallas Mike Taylor 214/742-1747
 Denver Shirley Klotz 303/837-1010

Sales Manager—Mary Ellen Kearns—212/997-3306

Detroit Mac Huestis 313/873-7410
 Houston Mike Taylor 713/659-8381
 Los Angeles Ana Galaz 213/487-1160
 New York Larry Kelly 212/997-3594

Philadelphia Dan Ferro 215/568-6161
 Pittsburgh Jack Gardner 412/227-3658
 San Francisco Peter McGraw 415/362-4600
 Stamford William Eyd 203/359-2860

VLSI Leaders

To spearhead
 NCR's massive
 new push in
 custom microelectronics R&D.

Qualified to assume a leading role in a team being created to do advanced process development in VLSI? Contact NCR Microelectronics in Colorado Springs at once.

We're establishing a group of process engineers who between them have the expertise and vision needed to blaze new trails in VLSI process development and circuit design. Positions in this fast-expanding project are as big as the engineers who fill them.

Moreover, you'll be joining a mature microelectronics organization with the kind of resources behind it that have already established 3 full-scale multi-million dollar MOS/LSI production facilities. The massive R&D undertaking you'll be joining will have the solid commitment of the world's second largest computer company behind it.

And finally, not only will you have the largest order of challenges and opportunities, and a fully commensurate salary, but our location offers congestion-free, smog-free, stress-free Rocky Mountain living at its best. Benefits, including relocation, are also tops.

All inquiries will be regarded in strictest confidence. Send complete resume and salary history to: Mr. Armand van Velthoven, R&D Manager, Dept. K78, NCR Microelectronics Operations, NCR Corporation, 2850 N. El Paso Street, Colorado Springs, Colorado 80907.

NCR

An Equal Opportunity Employer

Complete Computer Systems

ENGINEERS/ MANAGERS choice new opportunities

ENGINEERS, \$20K-\$40K. Our client companies have many positions in computer & business equipment telecommunication, marine & aero systems plus hard/software development. Contact J. Mann, ARTHUR PERSONNEL, 8 Forest Ave., Caldwell, NJ 07006 (201/226-4555).

ELECTRONICS ENGINEERS, \$18,000-\$40,000. Nationwide positions in digital, analog, microprocessor, microwave & instrumentation technology. For immediate confidential response, send resume w/ salary history to Glenn English, President, GLENN ENGLISH AGENCY, 7840 Mission Center Ct., San Diego, CA 92108 (714/291-9220).

ENGINEERS to \$40K. Get results from the oldest private employment service (est. 1946) in the heart of New England with the best clients in the industry. Contact LANE EMPLOYMENT SERVICE, 405 Main Street, Worcester, MA 01608 (617/757-5678).

DESIGN ENGINEERS to \$38K. Central Penna & nationwide. Design connectors/terminals, microprocessors, controls. Reply in confidence to Z. A. Gonglewski, MECK ASSOC PERSONNEL, 1517 Cedar Cliff, Camp Hill, PA 17011 (717/761-4777).

BSEE / ELECTRONIC DESIGN ENGINEERS, \$15,000-\$35,000. Immediate, desirable upstate New York & nationwide. Junior to senior project management. In confidence send resume or call James F. Corby, President, NORMILE PERSONNEL ASSOC., INC., 5 Leroy St., Box 110 Westview Station, Binghamton, NY 13905 (607/723-5377).

all positions fee-paid

npc NATIONAL PERSONNEL CONSULTANTS

NATIONWIDE ELECTRONICS PLACEMENT

Digital Ckt Dsgn * Hardware Sys Dsgn
 Analog Ckt Dsgn * Software Sys Dsgn
 Quality Reliability * Test Equipment Mntnc

Entry Level through Management
 All Fees are Exclusively Employer Paid

E. J. STEPHEN ASSOCIATES
 1601 Concord Pike, Suite 86
 Wilmington, DE 19803

ELECTRONIC PROFESSIONALS

- Manufacturing
- Engineering
- Administrative
- Management

Completely confidential recruiting.

SHS of Allentown (emp agcy)
 1401 N. Cedar Crest Blvd.,
 Allentown, PA 18104
 Contact: G. Ferro (215) 437-5551

Electronic Engineers

General Electric-Television

The right company for the 80's

- TV technological and business innovators for over 50 years.
- Producers of high-quality, high-performance consumer products.
- Leader in electronics.
- Steadily expanding division of the General Electric Company.
- Excellent opportunities for growth

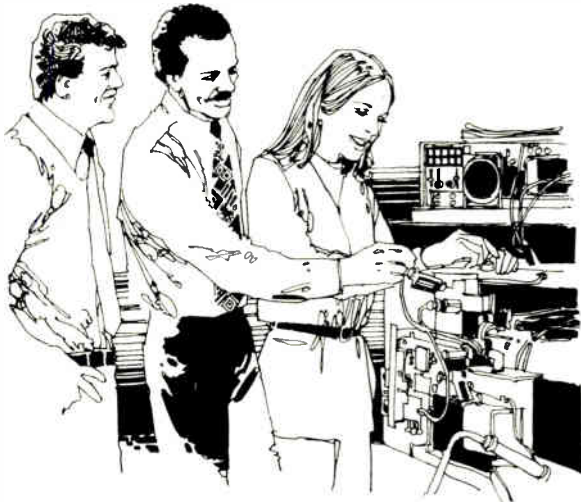

The right location anytime

- Near ocean and mountain resorts.
- Mild climate, year round.
- Full range of cultural attractions (theatres, museums, art, music).
- Excellent educational facilities at all levels.
- No traffic headaches.
- Reasonable taxes and cost of living.



On the job, off the job, you'll find all the advantages you want at GE Television.

We're moving aggressively into the 80's. Building our future on a past that includes a first home television receiver (1928) . . . the first in-line color tube system . . . the first color portable . . . Emmy Award winning VIR . . . and the first self-contained Widescreen 1000 color.

Get more details on the career you can have with us. Immediate openings are for BSEE's with experience in one of the following areas:

- Signal Processing
- Chroma
- Video
- Microprocessors
- High Frequency
- Servo Systems
- IF
- Video Disc
- Deflection and other appropriate technologies.

Apply by sending your resume and salary history to Robert N. Shapiro, Ref. 75, General Electric, Television Business Department, P.O. Box 875, Virginia Beach, VA 23464. An equal opportunity employer m/f.

We bring good things to life.

GENERAL  ELECTRIC

WE CAN OFFER YOU LESS THAN THIS



Located in the heart of the Midwest, Wilcox Electric has established a solid reputation as a great employer in a city that still surprises many. Kansas City's beauty, convenience, and culture have grown rapidly. And within this big city vibrance, there is still small town charm.

At Wilcox, one of the foremost manufacturers of instrument landing systems and ground installed navigational systems, we can offer you a highly productive work environment. Because almost half of our projects are commercial and the remainder long-term contracts, we can assure you the secure framework on which to build your future.

Our dedication to creating new products and developing markets for them has made possible these exceptional openings. We offer an excellent salary/benefits package and high visibility within our dynamic company. For immediate consideration, send your resume or brief letter, including salary history or call us today.

DESIGN ENGINEERS

Immediate & Senior Positions; BSEE required; 3 yrs. experience in 1 of the following:

- RF circuitry • Analog logic • Digital logic
- Power supply • Microprocessors

DESIGN TECHNICIANS

Senior positions; breadboarding, preliminary testing and assembling prototype units. Must be graduate of accredited technician training (civilian or military); 2 yrs. experience in 1 of the following:

- PC board layout • RF design • Analog logic • Digital logic • Power supply

JEAN LOVE, EMPLOYMENT MANAGER
WILCOX ELECTRIC, INC.

1400 Chestnut, Kansas City, Mo. 64127

816/231-0700

an equal opportunity employer, M/F

NORTHROP

WILCOX

NAVAL RESEARCH LABORATORY

is seeking a

RESEARCH PHYSICIST

GS-11 — \$20,611 to \$26,794 per annum

GS-12 — \$24,703 to \$32,110 per annum

(Salary dependent on qualifications, experience, and present salary.)

We are seeking an individual to perform research and development on semiconductor device fabrication techniques. The duties of the position include the design and development of measurement apparatus; experimental studies of impurity and defect states in bulk semiconductor and semiconductor interface; electrical measurements; data reduction, analysis and reporting.

A major portion of the work will be in addressing material and device problems encountered in advanced military high-density, high-speed integrated circuit technologies.

This is a career Civil Service position with all the normal fringe benefits. Travel and transportation expenses, including shipping of household goods, may be paid for selected applicant.

Interested applicants should submit Standard Form 171, Personal Qualifications Statement, or detailed resume, by December 15, 1979 to:

NAVAL RESEARCH LABORATORY
CIVILIAN PERSONNEL OFFICE
ATTN: 1813,5200-040-13/78
4555 Overlook Avenue, S.W.
Washington, D.C. 20375



An Equal Opportunity Employer

SYSTEMS ENGINEER

Conceptual design of advanced avionics systems. Requires experience with controls, sequencing, and power distribution systems. Must be willing to assume managerial responsibilities in one year or less.

and

PROJECT ENGINEER

Prominent electronic manufacturer offers project position that requires engineering and managerial experience. Must be willing to accept full department responsibilities in two years. Requires CMOS and logic design experience.

Contact In Confidence:



An expansion program at our client, a major non-military division of a leading international technology company, has created the following career opportunities.

MANAGER ELECTRONIC TECHNOLOGY \$40,000-45,000

Working manager of a growing group, responsible for new concepts and systems in international Research & Development of advanced technology programs for consumer and industrial products.

Should have R&D management experience in automatic controls, microprocessor and PC board technology, circuit design, servomechanisms and electro/mechanical power transducers, in addition to electronics or physics degree. This position leads to definite further management growth.

GROUP LEADER LSI DESIGN \$30,000-35,000

Working leader of small group involved in developing digital MOS chips. Some knowledge of analog and hybrid design helpful for future work. Electronic packaging expertise would also be useful. Must be able to use simulation techniques to verify design. EE or equivalent degree plus 5 years applicable experience necessary.

ASHWAY LTD (agency)

"Science & Technology
Specialists"

295 Madison Ave.
New York, N.Y. 10017
(212) 679-3300



ENGINEERS!

**Minutes
to
work =
more
leisure
time**

When you live only 15-20 minutes from work, as many do at Boeing Wichita, you can add days and weeks per year to your leisure time . . . especially when so many recreational and cultural activities are also only minutes away. Couple this increased leisure time with the satisfaction of working on one of our significant, long-range projects and you have an enviable life-style. We really believe you will like one of the challenging positions we have to offer and the informal atmosphere and smog-free, four seasons of Wichita.

The opportunities include:

Air Launched Cruise Missiles Integration . . . Offensive Avionics Systems . . . Countermeasures Systems . . . Electronic Agile Radar Systems . . . Electronic Steerable Antenna Systems . . . Weapon System Trainers . . . Aircraft Winglets . . . and Automated Test Equipment. Join these high technology programs now while program assignments are growing.

Immediate requirements include the following which call for U. S. Citizenship and BS or higher degree in Engineering, Physics or Math.

- STRUCTURAL DESIGN
- STRESS ANALYSIS
- SOFTWARE DEVELOPMENT - DESIGN ANALYSIS
- PRODUCT SYSTEMS ENGINEER
- ELECTRICAL/ELECTRONIC INSTALLATION DESIGN
- GROUND SUPPORT REQUIREMENTS ELECTRICAL-ELECTRONICS
- INSTRUMENTATION DESIGN
- TECH WRITER - ELECTRONICS/MECHANICAL
- ELECTRONICS/ELECTRICAL TESTING
- FLIGHT SYSTEM TESTING
- INSTRUMENTATION TEST
- TEST PLANNING
- CONTROL SYSTEM ANALYSIS
- ELECTRONIC SYSTEM ANALYSIS
- SYSTEM SAFETY
- POWER DISTRIBUTION ANALYSIS
- FACILITIES ENGINEERS - ELECTRICAL/MECHANICAL
- MANUFACTURING RESEARCH & DEVELOPMENT ENGINEERS
- TOOL ENGINEERS

Send resume (including salary history and requirement) to:
JIM SNELLING, BOEING WICHITA COMPANY
4300 E. MacArthur Road, Dept. E11,
Wichita, KS. 67210
or Call Collect (316) 687-3057

BOEING
WICHITA COMPANY

An Equal Opportunity Employer M/F

JOIN OUR A.T.E. TEAM

NORTHROP

If You Share Our Commitment to Excellence...

...consider a career with Northrop Defense Systems Division, the renowned leader in the research, development and manufacture of sophisticated electronic countermeasures. If you're trained and experienced in one of the following areas, investigate the potential at Northrop:

ATE Systems Engineering

Digital Test-Systems analysis, Development and Integration of ATE for Digital Test including Automatic Test Generation, Test Instrumentation/Software.

Analog Test-Systems Analysis, Development and Integration of ATE for Analog Test including Waveform Analysis/ Test Instrumentation/Software.

RF (Microwave) Test-Systems Analysis, Development and Integration of ATE for Microwave Test including RF Spectral Analysis/Test Instrumentation/Software.

ATE Design Engineering

Electrical-Analysis, Design, Development, and Integration of special Test Instrumentation and Interface Adapters including validation of Test Packages.

Mechanical-Packaging Design, Development, and validation of Test Instrumentation/Test Adapters.

ATE Software

Analog Test-Design, code, debug, verify and document diagnostic procedures for component level fault isolation. Use BASIC, FORTRAN IV and HP Assembler.

Digital Test-Design, code, debug, verify and document diagnostic test procedures for component level fault isolation. Use ATLAS, TESTAID, FASTER, BASIC FORTRAN IV and HP Assembler.

We offer an outstanding compensation package including complete benefits, unlimited growth potential and the opportunity to combine the career of a lifetime with off-hours enjoyment in a suburban setting, one of the most exciting and liveable areas in the nation. For further information, please forward your resume or a summary letter in confidence, to:

Professional Employment Manager

NORTHROP CORPORATION
Defense Systems Division
600 Hicks Road • Rolling Meadows, IL 60008
equal opportunity employer m/f

all positions fee-paid

ENGINEERS/ MANAGERS

choice new
opportunities

ELECTRONICS ENGINEERS, \$18,000-\$45,000. For the electronics engineer, New England offers the widest diversity of positions available anywhere. As one of the largest, long established (15 years) technical placement organizations in the area, we can represent you with a wide variety of clients, large and small, for positions ranging from entry level to senior management. Nationwide representation is also part of our service. Contact Bob McNamara, E. P. REARDON ASSOCIATES, 888 Washington St., Dedham, MA 02026 (617/329-2660).

ELECTRONICS ENGINEERS, \$18,000-\$50,000. Choice entry level to management positions immediately available in Pennsylvania & national locations. Reply in strict confidence to J. G. Weir, President, WEIR PERSONNEL SERVICES, 535 Court St., Reading, PA 19603 (215/376-8486).

ELECTRONICS ENGINEERS, Excellent New England lifestyle out of high cost of living major metros, or selected cities nationwide. Prompt response in professional confidence. F. Raisner, SEARCH, INC., Providence, RI 02903 (401/272-2250).

ELECTRONICS ENGINEERS. Our clients, defense/non-defense, seek talent in digital, analog, microprocessor, microwave, etc. All Fee-paid. ACCESS GROUP, Dr. Bill Kan, Box 3267, Stamford, CT 06905 (203/356-1168). Eric Grossman, 179 Allyn Street, Suite 500, Hartford, CT 06103 (203/527-9107).

npc NATIONAL PERSONNEL CONSULTANTS

PHYSICS DEPARTMENT
TEXAS A&M UNIVERSITY
is seeking a
SCIENTIFIC INSTRUMENT MAKER II

to fabricate prototype devices for teaching and experimental research programs. We are expanding our Departmental Mechanical Instrument Shop and want to fill this position with a person who is able to produce quality craftsmanship. Please send resume to:

Employment Manager
Room 211, YMCA Building
Personnel Department
Texas A&M University
College Station, Texas 77843
713-845-5154

EQUAL EMPLOYMENT OPPORTUNITY THROUGH AFFIRMATIVE ACTION

SOUTH & SOUTHWEST POSITIONS
Engineering and Management positions throughout the South, Southwest and U.S. Employers pay all fees. Send resume in confidence to: Bob Hogue, *personnel consultants*

SouthWest Technical
P.O. Box 33070,
San Antonio, Texas 78233

The Placers, Inc. Engineering Technical Professional

Nationwide career opportunities for degreed and non-degreed candidates in power, avionics, digital, computer, QC/QA, and all disciplines. All are fee paid. Contact in confidence, John Winter, 302-575-1414, Suite 201, 2000 Penna. Avenue Wilmington, Delaware 19806

Engineers

- Design
- Development
- Project
- Software

\$18,000-\$40,000

Riddick Associates' Engineering Division specializes in placement of electrical and electronics engineers with top companies in the Southeast and throughout the U.S. We provide advice on careers, resumes and interviews. We are retained by our client companies and they pay all fees. For details call or send resume to Phil Riddick, President.

Riddick Associates, Ltd.

9 Koger Executive Center
Norfolk, VA 23502
Area B04-461-3994

DESIGN ENGINEERS

- Power Supplies
 - Terminals
 - PCB • ATE
 - Microwave
 - Analog/Digital
- \$20,000—\$45,000**

Career Associates, Inc.—The leading engineering placement firm in S.E. Mass.—has more than fifty exclusive national openings for the above design specialties. Our computerized retrieval system will match your objective(s) to our clients requirement(s). Our clients pay all fees. Call collect or send your resume in strict confidence to John E. Ruck, V.P. Engineering.

Career Associates, inc.

583 State Road
P.O. Box 86
North Dartmouth, MA 02747
Area 617-997-3311

ENGINEERS

Salaries to \$40,000

- Computer Design
- Hardware & Software Design
- Office Equipment
- Computer Simulation Systems
- EW & ECM Systems
- Microwave/Antennas
- CAD/CAM Design
- Quality Control
- Manufacturing Engineers
- QC/Manufacturing Engineers

We have over 800 jobs nationwide. Call or send 2 resumes w/salary info.

SD Staff Dynamics, U.E.
REGISTERED PROFESSIONAL ENGINEERS

110 Post Rd., Darien, Conn. 06820
DEPARTMENT "E"
(203) 655-9499 Agency

“Solving some of the world's toughest problems is what we do at E-Systems in Dallas.”

E-Systems is a major developer of complex electronic systems for worldwide applications. At E-Systems Garland Division in Dallas, we have some of the world's toughest problems to solve. Problems that require some of the world's most advanced technological solutions. To keep pace, we need problem solvers. . . . Software, Electronic and Mechanical Engineers, and R&D Technicians.

The problems needing solutions involve:

- High speed logic design
- Special purpose digital processing
- Analog and synthesizer design
- Electronic reconnaissance
- Passive electronic warfare
- Product software embedded in electronic systems on IBM-370, Perkin-Elmer 3220, HP-21 MX, and microprocessors
- Communication and data-base management systems on DEC and TANDEM
- Advanced digital communications
- Audio/digital voice processors
- Command and control systems

If you're ready to make problem solving your career, just fill out the coupon and send it to: **Tom J. Shepherd, Manager of Professional Placement, E-Systems, Inc., Garland Division, P. O. Box 226118, Dallas, Texas 75266. Or call COLLECT (214) 272-0515.**

I'm ready to start solving some of the world's toughest problems.

- Please send more information about E-Systems Garland Division.
 Please have Employment Manager call.

NAME _____

ADDRESS _____

CITY _____

STATE _____

ZIP _____

PHONE _____

E 10-25



E-SYSTEMS

Garland Division

The problem solvers.

An equal opportunity employer M/F, H, V

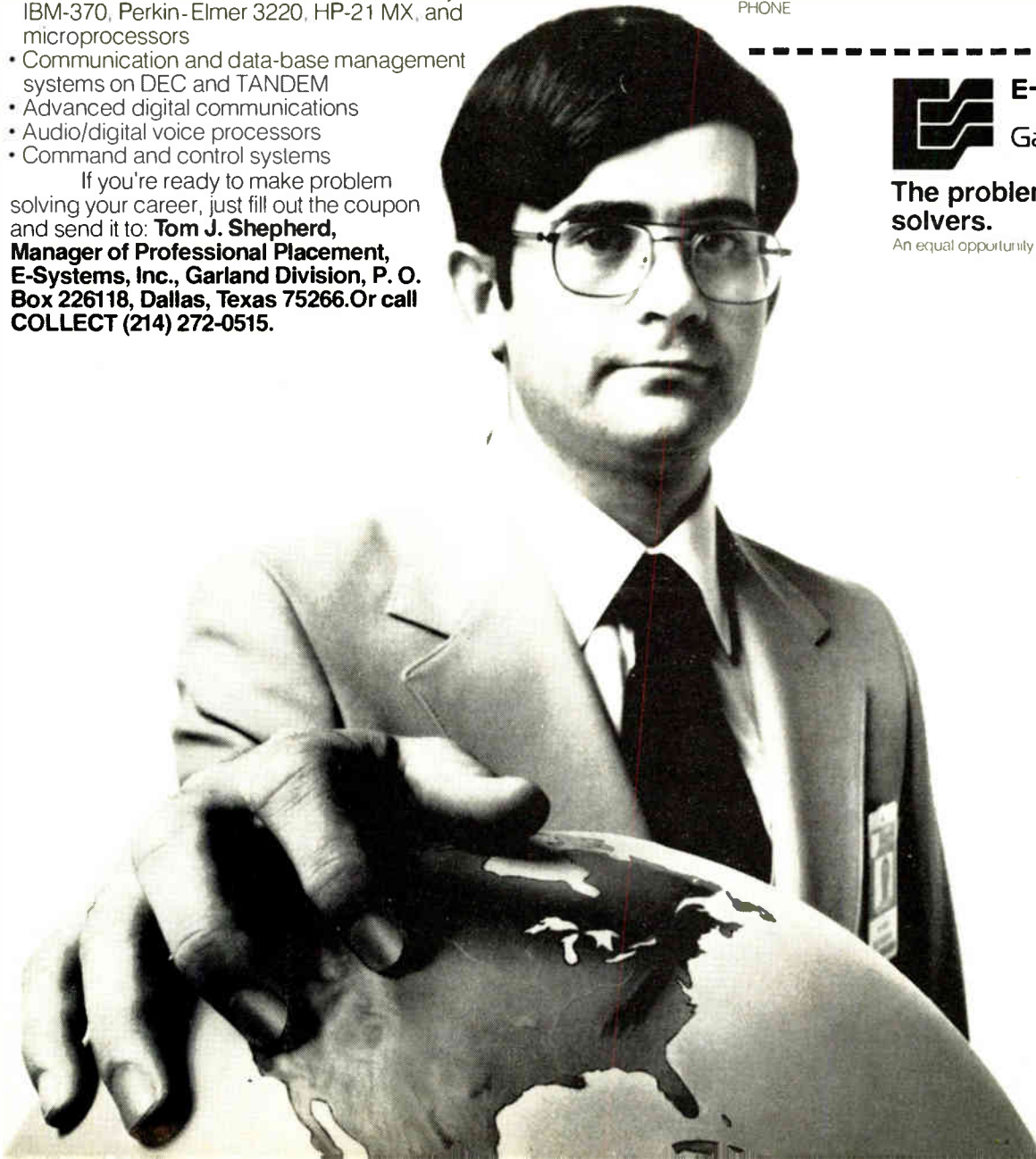

ELECTRONIC ENGINEERS

Live and work in Colorado

Manufacturer of television reception equipment has job opportunities for engineers and highly skilled technicians to design advanced products for the telecommunications market. Must be willing to assume individual responsibility for all phases of product development from conceptual design to manufacturing. Opportunities available in the following areas:

- Broadband RF design to 1000 MHz.
- Narrowband RF design to 1000 MHz.
- Microwave design to 18 GHz, including frontends, mixers, oscillators and multipliers.
- Software and hardware development for microprocessors systems.
- Experience in RF design or CATV technology helpful.
- BSEE preferred but not required.

Research and Development lab in the foothills of Colorado's Rockies is situated 30 minutes from metro Denver. Mountain environment offers outdoor recreation—hunting, fishing, hiking and winter sports.



Send resume to:
Engineering Mgr.
Winegard Company
P.O. Box 940
Evergreen, CO. 80439

MANAGEMENT SOUTH Solicits Resumes

From All Disciplines For Submission
To Our Regional and National Clients.
Employers Pay All Fees
Unit G3, Management South
PO Box 11367
Charlotte, NC 28220

POSITIONS VACANT

Chemical Instrument Technician—University of Florida—To maintain, improve and instruct users of a wide range of chemical instrumentation, including VV, IR, NMR, ESR and GC equipment. Experience with analog electronics and optical spectrometers is required; acquaintance with digital electronics, magnetic resonance spectrometers and chromatographs is desirable. Applicant should have a B.S. in chemistry, physics, or electrical engineering and 1-2 years instrument experience. Salary commensurate with ability. Excellent fringe benefits. Send resume with salary requirements to: Connie Fort, University of Florida, Central Employment Center, 2nd Floor HUB, University of Florida, Gainesville, FL 32611. Equal Employment Opportunity/Affirmative Action Employer.



★★ ENGINEERS ★★

- Computer Design
- Pwr. Supplies
- Controllers
- Missile Sys.
- Radar
- Management
- Sales

★★ TECHNICIANS ★★

- Missile Sys.
- Instructors
- Writers
- Radar Sys.

127 Client Companies
with Nationwide Open-
ings. Send resumes to:
Key Assoc. Inc.
Suite 205
6296 Rivers Ave.
No. Chas., SC 29406

POSITIONS VACANT

Systems Design Engineer—We seek degreed engineer with several years experience in the application of variable speed motor drives to plastic wire machinery and textile machinery. This is a challenging position and opportunity with a rapidly expanding company. Salary commensurate with experience. Complete benefit program. Call or send resume to: Ray Legault, V.P., Burton Industries, 535 Prospect St., Pawtucket, RI. 02860. 401-728-9650.

Electronic Design Engineers—Medical electronic instrumentation design. Hybrid microelectronics. Work with small university-related medical engineering research group. Opportunity for paid graduate study. Four years' experience. Send resume to M. R. Neuman, Engineering Design Center, Case Western Reserve University, Cleveland, Ohio 44106. or call (216) 368-2926.

RESUMES

Resumes—Complete instructions and examples; \$4. Consultants, Box 567—J. Bergenfield, N.J. 07621.

NOTICE TO EMPLOYERS:

Why we can recommend our readers for the top jobs

The subscribers to this magazine have qualified professionally to receive it. They are also paid subscribers—interested enough in the technological content to have paid a minimum of \$15 for a subscription.

As subscribers to ELECTRONICS, our readers have told you several things about themselves. They are ambitious. They are interested in expanding their knowledge in specific areas of the technology. And they are sophisticated in their need for and use of business and technology information.

Our readers are now in senior engineering or engineering management, or they are on the road toward those levels. In either case, they are prime applicants for the top jobs in almost any area.

If you are interested in recruiting the best people in electronics, these pages are open to you for your recruitment advertising.

Our readers are not "job-hoppers". To interest them you will have to combine present reward with challenge and opportunity for future career advancement.

The cost of recruitment advertising on these pages is \$65 per advertising inch. For information call or write:

Electronics

Post Office Box 900, New York, NY 10020
Phone 212/997-2556

You may not recognize the name. But the dream is familiar.

Because everyone's dream is to work towards a goal of success and fulfillment in an environment of majestic natural beauty.

That's the INMOS vision. We are creating a new facility in Colorado Springs designed for research, development and prototype manufacturing of new products. Dedicated to discovery, INMOS is involved in extending the frontiers of VLSI technology. We are developing new products in the memory and microcomputer area concentrating on devices at the 50,000 to 100,000 transistors per chip level. Through our research we expect to move to the forefront of the worldwide semiconductor industry.

We have a dream of success in this land of dreams where mountain streams once ran with gold. We need creative and innovative thinkers to share our visions and our mountain views.

Product Engineering Manager

BA, MS preferred with five years experience in memory component engineering. Recruit staff for product engineering organization and supervise product test, development, characterization and yield improvement.

Senior Product Engineer

BS, MS preferred with experience in device physics, memory test and characterization, semiconductor processing. Responsible for product test definition, test programming, memory component characterization, yield analysis and enhancements.

Quality Assurance Manager

MSEE, Physics or Chemistry with 5 years experience as a Quality Assurance Manager in a semiconductor environment preferred. Manage a group of approximately 15 people involved in the QA activities. Involves heavy interface with development, manufacturing and product reliability procedures.

MOS Device Engineer

An MS or PhD degree in Physics or Electrical Engineering is preferred and experience in computer programming is essential. Responsibilities will include developing theoretical models for state-of-the-art scaled MOS devices for

use in VLSI circuits and developing simplified device models to be used in computer simulations of the circuits.

CAD Engineers

BS or MS in either EE or Computer Science with knowledge of circuit design as well as modelling and circuit analysis software. Will support computer aids to design software. (circuit design and layout software)

Senior Memory Circuit Designers

BS or MS with 3-5 years experience in MOS memory circuit design. Will be responsible for designing MOS memory circuits.

Wafer Process Engineer

BS in Physics, Chemistry, Electrical Engineering, and will consider candidates with comparable experience. Responsibilities include developing and sustaining state-of-the-art processing in step and repeat photolithography, high pressure oxidation, plasma etching, ion implantation, LPCVD and D.C. magnetron sputtering of metal film.

Senior Applications Engineer

BSEE preferred plus experience working with MOS memory devices as a memory systems Designer including exposure to microprocessors. Responsibilities will include memory product specification and customer support for memory and microprocessor devices.

We offer four perfect seasons a year... bring your fishing rod, your skis and your dreams to Colorado Springs. There is housing to suit every lifestyle and INMOS pays relocation expenses. The cost of living is lower and the beauty is free.

Please send resume to Stanley Bloom, Director of Personnel, Dept. EM/1, INMOS Corporation, 2860 S. Circle Drive, Colorado Springs, Colorado 80906.

For employment opportunities in the UK, write to Michael Wright, INMOS Ltd., Whitefriars, Lewins Mead, Bristol, England.

Honoring human resources in every respect... we are an equal opportunity employer M/F/H

inmos

We're going to build a great company. Together.

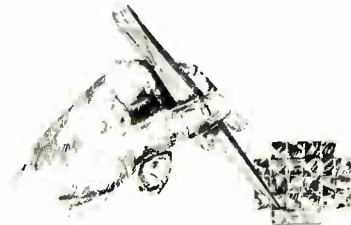

SOFTWARE DEVELOPMENT ENGINEERS

Join the leader in "Systems Technology for the 80's...ALLEN-BRADLEY SYSTEMS GROUP"

As a division of a long established world leader in industrial controls, we have a strong history and growth in the development, manufacturing and marketing of computerized programmable controllers and numerical control systems. Our products are vital to increasing productivity throughout the world.

IF You're degreed in electrical engineering, computer science, or computer engineering and thrive in an environment of advanced software technology, we have the perfect challenge for you!

We are presently seeking Software Development Engineers/Seniors in the following areas:

NUMERICAL CONTROL SOFTWARE DEVELOPMENT

Apply your 1-3 years of assembler language programming to develop real-time software that meets specific customer requirements. You will have the opportunity to develop, program and test your own software. If you have 3-5 years of experience in this area, you may move into new concept development in our state-of-the-art industry.

DATA HIGHWAY DEVELOPMENT

You can apply your 3-5 years of assembler and higher level software expertise to integrate mini-computer and peripheral equipment with programmable controllers, developing new concepts in control functions. Develop sophisticated software by combining your Electrical/Computer Engineering degree with experience in data structuring and systems programming.

COMPUTER AIDED MANUFACTURING SOFTWARE DEVELOPMENT

Develop software systems that can control an entire manufacturing process by interlinking programmable controllers and numerical controls. Initiate programming strategies, translator systems, interfaces and establish host computer/peripheral networks. Your Electrical/Computer Engineering degree and 3-5 years related experience have prepared you for the responsibilities of this position.

These are key technical positions offering outstanding career growth possibilities, excellent compensation and generous benefits. COME AND GROW WITH US! Start by sending your resume and current salary history requirements to:



Duane C. Smith, Salaried Employment Manager

ALLEN-BRADLEY CO.

SYSTEMS GROUP

747 Alpha Drive, Highland Heights, Ohio 44143

Quality in the best tradition.

An Equal Opportunity Employer M/F

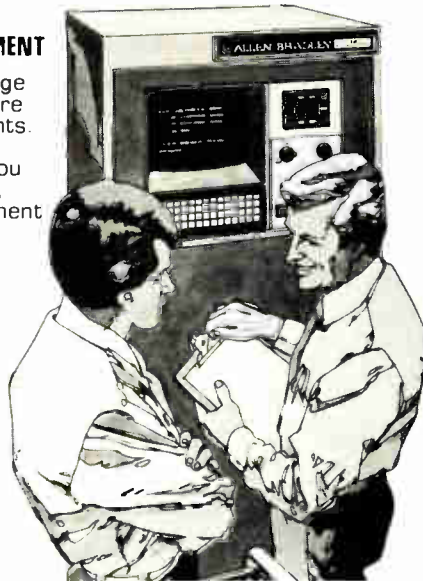

POSITIONS VACANT

Design Engineer—required for St. Louis company to design D.C. power supplies and digital computer equipment. Requires a Masters Degree in Electrical Engineering with 1 year experience designing D.C. power supplies and digital systems, including micro-processor based systems using the Z80 micro-processor. Should be able to program in assembly language as well as high level language including Pascal. Must be able to follow design through production, insure reliability and design test equipment needed for manufacturing. Salary \$17,000 annually. Contact Mylee Digital Sciences Inc., 155 Weldon Pkwy., Maryland Heights, MO 63043. An Equal Opportunity Employer.

Engineers and Designers—All disciplines needed. We are seeking experienced individuals to work in our consulting engineering office on industrial projects. Send resume to: Mr. Newman, Chemstress Consultant Company, First National Tower, Akron, OH 44308.

POSITION WANTED

Radiation Biophysicist Ph.D. Work with soft x-ray cithography, microscopy, spectroscopy using synchrotron radiation source; ideal for LSI-VLSI. M. J. Malachowski, P.O. Box 9315, Berkeley, CA 94709.

EMPLOYMENT SERVICES

Electronic engineering growth positions with clients located nationally. Our service is enhanced by the fact that I am an EE with 20 years in industry and over 10 years in placing professionals on an employer fee paid basis. Send your resume to Joe Torcassi, Director, J. Anthony & Associates, PO Drawer AD, Lynchburg, OH 45142. 513/364-2305.

SCHOOLS

World Open University—A Non-Resident Graduate School—Division of Electrical, Electronics & Computer Engineering offers full graduate courses in areas: Applied Mathematics & Physics; Electronics Engineering; Electrical Circuits; Computers & Advanced Programming; Communications Systems; Control Systems; Energy-Power Systems; Nondestructive Testing—leading to M.S., Ph.D., Sc.D., Eng. D., Tech. D.—guided by full professors having a series of original contributions to international learned societies. Request complete information to WOU, PO Box 5505, Orange, CA 92667, USA, enclosing \$5 in US, or US \$7 outside of US, for airmailing. Self-authored original paper reprints from national learned societies may get proper credits. WOU is racially nondiscriminatory. To mention Electronics in request, specify strong or weak current.

BOOKS

Fastest Piano Course in history! Uses system patented by aerospace logician. Method published in Dec. 1977 Music Educators Journal. Free info: P.O. Box 751-TR, La Canada, CA 91011.

Why should I pay for Electronics When other magazines in the field are free?



Think of it this way: Would the other publishers in the field give away their magazines if they could sell them?

Another question: Would 93,364* worldwide subscribers pay to read Electronics if it weren't a far better magazine than the "giveaways"?

And finally: If Electronics is worth your time (which you are investing in the magazine

right now), isn't it worth 65 cents? That's the cost per copy based on a one year U.S. subscription. Based on our long-term subscriptions, the cost is even less.

Send in a subscription card from this magazine. If someone has beat you to them, write subscription department, Electronics, McGraw-Hill, 1221 Avenue of the Americas, New York, N.Y. 10020.

*ABC Publisher's Statement—December 1978

Electronics Magazine. The one worth paying for.

Abbott Transistor Labs	239	■ Data Precision	272	■ GenRad Inc.	54, 55, 192, 193
Acushnet Capacitor	12	Datel-Intersil	43	‡ GenRad/Futuredata	185
ADAC	6	Deltac Corporation	204	Gould	9
Addmaster Corporation	230	■ Dialight	257	■ Gould Inc./Instruments Oscilloscopes	13
■ Ad-Vance Magnetics Inc.	16	Digital Electronics Corporation	225	■ Gould Inc./Instrument Systems Div.	254, 255
Advanced Micro Devices	10, 11, 52	Digital Equipment Components	91	Gould Biomation	16
Alco Electronic Products	276	Digital Equipment PPG	162, 163	GTE Sylvania Connector Products Operation	275
■ Allen-Bradley	203	‡ Digitran Company	211	Guardian Electric Mfg. Co.	279
■ American Optical Scientific Instrument Div.	222	• Dionex Gas Plasma Systems	13E	Gulf Power Company	238
American Telephone & Telegraph	142, 143	• Draloric	60	■ Hamlin	184
■ Amp Inc.	207	E. G. & G. Reticon	51, 93	‡ Hewlett-Packard	2ndC 1, 18, 19, 78, 79, 82, 83, 164, 170, 171, 196, 197
‡ Amphenol North America Bunker Ramo Corp.	212, 213	E. G. & G. Wakefield	190	• Honeywell Information Systems Italia	215
Amplifier Research	50	• EIP Div. of Danalab	168, 169	■ Honeywell TID	129
Analog Devices	248	Elec-Trol Inc.	217	Hughes Aircraft	62
AQ Systems Inc.	182	Electro Scientific Industries	175	Hybrid Systems	95
‡ Beckman Instrument Display Systems Div.	252	Electronic Arrays	35	IEE Industrial Electronic Engineers Inc.	235
Belden Corporation	263	Electronic Development Corporation	232	Institute of Electrical & Electronics Engineers	256
• ■ Bendix Corporation Electrical Comp. Div.	258	■ Electronic Navigation Industries	3rd C.	Intel Corporation	265
Berg Electronics	219	Elorg Electronorgtecnica	166	Intel OMS	88
B & K Precision	201	Emerson & Cuming Inc.	221	Intel Microcomputer Components	167
■ Boonton Electronics	132	EMI Technology	220	Intel CSO	28, 29
■ Bourns, Inc.	4th C.	EMM SESCO	267	Intersil	223
‡ Bud Industries	8	• Enertec Schlumberger Velizy	3E	• Italtel/SIT	181, 185
• ■ Burr Brown Research Corporation	199	■ Equipto Electronics Corp.	214	‡ ITT Cannon Electric	199
Caddock Electronics Inc.	47, 53	■ Erie Technological Products	228	ITT Electro Optical Products	20, 21
California Computer Inc.	80, 81	Fairchild SATS Div.	178, 179	ITT Jennings	189
■ Cambridge Thermionic Corp.	261	Fairchild Test Systems	25	ITT North Microsystems Div.	281
Carpenter Manufacturing Co.	190	■ Ferranti-Packard Ltd.	206	■ ITT Schadow Inc.	26
‡ Centronica	210	■ First Computer Corporation	15	• Iwatsu Electric Co. Ltd.	8
■ Cherry Electrical Products	32	Fluke, John Mfg. Co.	101, 106 107, 183	Jaycor	249
Collmer Semiconductor Inc.	276	• Frischer Electronic S.A.	8E	• Jepico Co. Ltd.	48
Control Data Corp.	208, 209	• Fujitsu Limited	188	KAI	204
CTS Corporation	274	‡ General Electric Instrument Rental Div.	168, 169	‡ Kollmorgen Multewire Div.	157
‡ CTS Corporation, Berne Div.	188	‡ General Instrument Opto Electronics Div.	176, 177, 181	‡ Kontron Electronic Inc.	9, 65

■ Krohn-Hite Corporation	5	• Plessey Semiconductor	2E	‡ Tektronix	215
Litronix	77	Power One Inc.	260	• Tektronix	1E, 16E
Magtrol	272	■ Precision Filters	246, 247	Teledyne Semiconductor	240
■ Matrox Electronic Systems	180	■ Projects Unlimited	218	Telpar	66
MDB Systems	122	RAC Reliability Analysis Center	262	‡ Ten-Tec Inc.	216
Microsoft	233, 262	• Racal Dana Instruments Ltd.	157	Teradyne Inc.	84
■ Microswitch Div. of Honeywell	17	Racal Recorders Ltd.	172, 173	Texas Instruments	102-105
■ Miller Stephenson Chemical Co. Inc.	250, 251	• Radio Materials Corporation	49	Thermalloy Inc.	99
Minicomputer Exchange Inc.	274	Radio Research Instrument Company	234	■ Thermometrics Inc.	230
Mitsubishi Industrial Div.	141	RCA Solid State	12, 108	Thomson CSF	155
■ 3M Co. Electronics Div.	241	‡ Rental Electronics	48, 49	• Thomson Sescosem	10E, 11E
Mestek Corporation	22, 23	Robinson Nugent Inc.	205	‡ Toko America	216
Motorola Inc. Component Products	7	Rogers Corporation	97	TRW LSI Products	160, 161
Motorola Semiconductor Products	38, 45	• Rohde & Schwarz	9E, 65, 69	TRW Optron	14
• Murata Mfg. Co. Ltd.	216	Rotek Instrument Corporation	200	TRW Capacitors	243
Electronics & Control Engineers Book Club	268-271	Samtec	237	Vector Graphics	266
■ National Semiconductor	73-76	• SEPA S.p.A.	164	■ Wavetek Indiana	253
• NEOHM SPA	211	• Sternice	12E	White Industrial Products S.S.	214
Nicolet Cad Corporation	242	Signetics	187	Witron	226, 227
■ Nicolet Instrument Corporation	194, 195	Signetics Corporation	27	Xebec Co. Limited	238
• Nikon Inc. Instrument Div.	61	Softech	256	Zilog	30, 31
State of North Carolina	234	Spectra-Strip	229		
■ O.K. Machine & Tool Co.	277	■ Spectrol Electronics	87		
OKI Semiconductor	121	‡ Spectronics Corporation	69		
Omaha Economic Development Council	218	Sprague Electric	59		
Osborne & Associates	264	■ Stackpole	273		
Ovensare	272	Strathclyde Industrial Development	152		
■ Pearson Electronics	198	Synertek	149		
Percom Data Company	71	■ Syntronic Instruments Inc.	100		
• Philips ELA	14E	Systron-Donner Data Products Div.	2		
• Philips Elcoma Market Promotion	15E, 4E	TEAC Corporation	56		
■ Philips TMI	1E	Teccor Electronics Inc.	245		
■ Piezo Technology	206	Tecknit	156		
Plessey Co. Ltd.	224	Tektronix	36, 37, 158, 159, 191, 231		

Classified and employment advertising

F. J. Eberle, Manager 212-997-2557

Allen-Bradley Company	290
Ashway Search	284
Boeing Wichita Company	285
Career Associates, Inc.	286
E - Systems Garland Division	287
Fortune Personnel	284
General Electric	283
Inmos	289
Key Associates, Inc.	288
Management South	288
NCR Corporation	282
Naval Research Lab	284
National Personnel Consultants	282, 286
Northrop Corporation	286
Riddick	286
The Placers	286
SHS International	282
Southwest Technical	286
Staff Dynamics	286
Stephen, E.J.	282
Texas A & M University	286
Wilcox Electric Inc.	284
Winegare Company	288

■ For more information of complete product line see advertisement in the latest Electronics Buyers Guide
 • Advertisers in Electronics International
 ‡ Advertisers in Electronics domestic edition

REPRINTS AVAILABLE FROM *ELECTRONICS*

No. of
copies
wanted

Charts

- ___ R-823 Communications satellites \$3.00
- ___ R-516 Electronic symbols \$2.00
- ___ R-213 Electromagnetic spectrum (updated 1976) \$3.00
- ___ R-326 Optical spectrum (6-page report and chart) \$3.00

Articles

All articles are \$3.00 each. Quantities of 5 or more in any combination are \$2.00 each.

- ___ R-923 A burst of energy in photovoltaics 18 pp
- ___ R-921 LSI-based data encryption discourages the data thief 14 pp
- ___ R-919 Special report—VSLI shakes the foundations of computer architecture 24 pp
- ___ R-917 Memory products 20 pp
- ___ R-915 The race heats up in fast static RAMs 12 pp
- ___ R-913 Lithography chases the incredible shrinking line 12 pp
- ___ R-911 Transmitting data by satellite calls for special signal handling 8 pp
- ___ R-909 Special market series—Electronics abroad 8 pp
- ___ R-907 Touch-tone decoder chip mates analog filters with digital logic 8 pp
- ___ R-901 1979 world market survey and forecast 24 pp
- ___ R-829 Special report: New networks tie down distributed processing concepts 16 pp
- ___ R-827 Tackling the very large-scale problems of VLSI: a special report 15 pp
- ___ R-821 Codex answer the call 18 pp
- ___ R-817 How bit-slice families compare 18 pp
- ___ R-816 Packaging technology responds to the demand for higher densities 9 pp
- ___ R-815 Higher power ratings extend V-MOS FETs' dominion 8 pp
- ___ R-813 Data-link control chips: bringing order to data protocols 10 pp

- ___ R-811 Multiplexing liquid-crystal displays 10 pp
- ___ R-809 New methods and materials stir up printed wiring 10 pp

Books

- ___ R-903 Personal Computing: Hardware and Software Basics—Electronics Book Series 266 pp \$11.95
- ___ R-803 New Product Trends in Electronics 1977—Electronics Book Series 333 pp \$14.95
- ___ R-732 Memory Design: Microcomputers to Mainframes—Electronics Book Series 180 pp \$12.95
- ___ R-726 Design Techniques for Electronics Engineers: 293 time-saving ideas in 48 chapters—Electronics Book Series 370 pp \$15.95
- ___ R-711 Circuits for Electronics Engineers: 306 circuits in 51 functional groups—Electronics Book Series 396 pp \$15.95
- ___ R-31D Designer's Casebook Number 1 106 pp \$5.50
- ___ R-704 Thermal Design in Electronics 52 pp \$5.00
- ___ R-701 Applying Microprocessors—Electronics Book Series 191 pp \$9.95
- ___ R-608 Basics of Data Communications—Electronics Book Series 303 pp \$12.95
- ___ R-602 Large Scale Integration—Electronics Book Series 208 pp \$9.95
- ___ R-520 Microprocessors—Electronics Book Series 154 pp \$8.95
- ___ R-011 Computer-aided Design 135 pp \$4.00

Payment must accompany your order

Make check or money order payable to Electronics Reprints. All orders are shipped prepaid by parcel post. Allow two to three weeks for delivery. We will make any editorial reprint to order in quantities of 500 or more. For price list and additional information call (609) 448-1700 ext. 5494.

USE THIS PAGE AS YOUR ORDER FORM

Cost of orders \$ _____
 Plus 10% handling charge \$ _____
 TOTAL AMOUNT ENCLOSED \$ _____

Mail your order to:
 Janice Austin
 ELECTRONICS REPRINTS
 P.O. Box 669
 Hightstown, N.J. 08520

SEND REPRINTS TO

Name _____
 Company _____ Dept. _____
 Street _____
 City _____ State _____ Zip _____

Advertising Sales Staff

Advertising sales manager: Paul W. Reiss
 1221 Avenue of the Americas, New York, N.Y. 10020
 [212] 997-4371

Atlanta, Ga. 30309: Michael Charlton
 100 Colony Square, 1175 Peachtree St., N.E.
 [404] 892-2868

Boston, Mass. 02116: Frank Mitchell
 607 Boylston St.
 [617] 262-1160

Chicago, Ill. 60611
 645 North Michigan Avenue
 Jack Anderson [312] 751-3739
 Robert M. Denmead [312] 751-3738

Cleveland, Ohio 44113: William J. Boyle
 [716] 248-5620

Costa Mesa, Calif. 92626: Robert E. Boedicker
 3001 Red Hill Ave. Bldg. #1 Suite 222
 [714] 557-6292

Dallas, Texas 75201: John J. Uphues
 2001 Bryan Tower, Suite 1070
 [214] 742-1747

Denver, Colo. 80203: Harry B. Doyle, Jr.
 123 Speer Blvd. #400
 [303] 837-1010

Detroit, Michigan 48202: Jack Anderson
 1400 Fisher Bldg.
 [313] 873-7410

Fort Lauderdale, Fla. 33308: Michael Charlton
 3000 N.E. 30th Place, Suite #400
 [305] 563-9111

Houston, Texas 77002: John J. Uphues
 601 Jefferson Street, Dresser Tower
 [713] 659-8381

Los Angeles, Calif. 90010: Chuck Crowe
 3200 Wilshire Blvd., South Tower
 [213] 487-1160

Minneapolis, Minn. 55435: Robert M. Denmead
 4015 W. 65th St.
 [312] 751-3738

New York, N.Y. 10020
 1221 Avenue of the Americas
 John Galle [212] 997-3616

Matthew T. Reseska [212] 997-3617

Philadelphia, Pa. 19102: Matthew T. Reseska
 Three Parkway
 [212] 997-3617

Pittsburgh, Pa. 15222: Matthew T. Reseska
 4 Gateway Center
 [212] 997-3617

Rochester, N.Y. 14534: William J. Boyle
 Powder Mill Office Park, 1163 Pittsford-Mendon Rd.,
 Pittsford, N.Y. 14534
 [716] 248-5620

San Francisco, Calif. 94111: Don Farris
 425 Battery Street,
 [415] 362-4600

Paris: Patrick Mouillard
 17 Rue Georges Bizet, 75116 Paris, France
 Tel: 720-16-80

United Kingdom & Scandinavia: Simon Smith
 34 Dover Street, London W1
 Tel: 01-493-1451

Scandinavia: Andrew Karnig and Assoc.
 Kungsholmsgatan 10
 112 27 Stockholm, Sweden
 Tel: 08 51 68 70 Telex: 179 51

Milan: Ferruccio Silvera
 1 via Baracchini, Italy
 Phone 86-90-656

Brussels:
 23 Chaussee de Wavre
 Brussels 1040, Belgium
 Tel: 513-73-95

Frankfurt/Main: Fritz Krusebecker
 Liebigstrasse 27c, Germany
 Phone 72 01 81

Tokyo: Akio Saijo, McGraw-Hill
 Publications Overseas Corporation,
 Kasumigaseki Building 2-5, 3-chome,
 Kasumigaseki, Chiyoda-Ku, Tokyo, Japan
 [581] 9811

Business Department

Thomas M. Egan
 Production Director
 [212] 997-3140
Carol Gallagher
 Production Manager
 [212] 997-2045
Betty Preis
 Production Manager Domestic
 [212] 997-2908
Thomas Kazich
 Production Manager Related Products
 [212] 997-2044
Marianne Meissner, Production Assistant
 (212) 997-2843
Frances Valtone
 Reader Service Manager
 [212] 997-6057

Electronics Buyers' Guide

H.T. Howland, General Manager
 [212] 997-6642
Regina Hera, Directory Manager
 [212] 997-2544
Thomas Kazich, Production Manager
 [212] 997-2044
Marianne Meissner, Production Assistant
 [212] 997-2843
Frances Valtone, Reader Service Manager
 [212] 997-6057

Classified and Employment Advertising

Frank Eberle, Manager
 [212] 997-2557
Mary Ellen Kearns, Sales Manager (212) 997-3306

Electronics

Reader Service

For additional information on products advertised, new products or new literature, use these business reply cards.

Complete entire card.

Please print or type.

Circle the number on the Reader Service postcard that corresponds to the number at the bottom of the advertisement, new product item, or new literature in which you are interested.

To aid the manufacturer in filling your request, please answer the three questions.

All inquiries from outside the U.S. that cannot reach Electronics before the expiration date noted on the Reader Service postcard must be mailed directly to the manufacturer. The manufacturer assumes all responsibilities for responding to inquiries.

Subscriptions & Renewals

Fill in the subscription card adjoining this card. Electronics will bill you at the address indicated on the card.

Electronics November 8, 1979 This reader service card expires February 8, 1980

NAME _____ TITLE _____

PHONE (_____) _____ COMPANY _____

STREET ADDRESS (Company or home check one) _____

CITY _____ STATE _____ ZIP _____

Was This Magazine Personally Addressed to You? Yes No

Industry classification (check one):

- a Computer & Related Equipment
 b Communications Equipment & Systems
 c Navigation, Guidance or Control Systems
 d Aerospace, Underseas Ground Support

- e Test & Measuring Equipment
 f Consumer Products
 g Industrial Controls & Equipment
 h Components & Subassemblies

- 5 Source of Inquiry—DOMESTIC
 j Independent R&D Organizations
 k Government

Your design function (check each letter that applies):

- x I do electronic design or development engineering work.
 y I supervise electronic design or development engineering work.
 z I set standards for, or evaluate electronic components, systems and materials.

Your principal job responsibility (check one)

- t Management
 v Engineering

Estimate number of employees (at this location): 1. under 20 2. 20-99 3. 100-999 4. over 1000

1 16 31 46	61 76 91 106	121 136 151 166	181 196 211 226	241 256 271 348	363 378 393 408	423 438 453 468	483 498 703 718
2 17 32 47	62 77 92 107	122 137 152 167	182 197 212 227	242 257 272 349	364 379 394 409	424 439 454 469	484 499 704 719
3 18 33 48	63 78 93 108	123 138 153 168	183 198 213 228	243 258 273 350	365 380 395 410	425 440 455 470	485 500 705 720
4 19 34 49	64 79 94 109	124 139 154 169	184 199 214 229	244 259 274 351	366 381 396 411	426 441 456 471	486 501 706 900
5 20 35 50	65 80 95 110	125 140 155 170	185 200 215 230	245 260 275 352	367 382 397 412	427 442 457 472	487 502 707 901
6 21 36 51	66 81 96 111	126 141 156 171	186 201 216 231	246 261 338 353	368 383 398 413	428 443 458 473	488 503 708 902
7 22 37 52	67 82 97 112	127 142 157 172	187 202 217 232	247 262 339 354	369 384 399 414	429 444 459 474	489 504 709 951
8 23 38 53	68 83 98 113	128 143 158 173	188 203 218 233	248 263 340 355	370 385 400 415	430 445 460 475	490 505 710 952
9 24 39 54	69 84 99 114	129 144 159 174	189 204 219 234	249 264 341 356	371 386 401 416	431 446 461 476	491 506 711 953
10 25 40 55	70 85 100 115	130 145 160 175	190 205 220 235	250 265 342 357	372 387 402 417	432 447 462 477	492 507 712 954
11 26 41 56	71 86 101 116	131 146 161 176	191 206 221 236	251 266 343 358	373 388 403 418	433 448 463 478	493 508 713 956
12 27 42 57	72 87 102 117	132 147 162 177	192 207 222 237	252 267 344 359	374 389 404 419	434 449 464 479	494 509 714 957
13 28 43 58	73 88 103 118	133 148 163 178	193 208 223 238	253 268 345 360	375 390 405 420	435 450 465 480	495 510 715 958
14 29 44 59	74 89 104 119	134 149 164 179	194 209 224 239	254 269 346 361	376 391 406 421	436 451 466 481	496 701 716 959
15 30 45 60	75 90 105 120	135 150 165 180	195 210 225 240	255 270 347 362	377 392 407 422	437 452 467 482	497 702 717 960

Electronics November 8, 1979 This reader service card expires February 8, 1980

NAME _____ TITLE _____

PHONE (_____) _____ COMPANY _____

STREET ADDRESS (Company or home check one) _____

CITY _____ STATE _____ ZIP _____

Was This Magazine Personally Addressed to You? Yes No

Industry classification (check one):

- a Computer & Related Equipment
 b Communications Equipment & Systems
 c Navigation, Guidance or Control Systems
 d Aerospace, Underseas Ground Support

- e Test & Measuring Equipment
 f Consumer Products
 g Industrial Controls & Equipment
 h Components & Subassemblies

- 5 Source of Inquiry—DOMESTIC
 j Independent R&D Organizations
 k Government

Your design function (check each letter that applies):

- x I do electronic design or development engineering work.
 y I supervise electronic design or development engineering work.
 z I set standards for, or evaluate electronic components, systems and materials.

Your principal job responsibility (check one)

- t Management
 v Engineering

Estimate number of employees (at this location): 1. under 20 2. 20-99 3. 100-999 4. over 1000

1 16 31 46	61 76 91 106	121 136 151 166	181 196 211 226	241 256 271 348	363 378 393 408	423 438 453 468	483 498 703 718
2 17 32 47	62 77 92 107	122 137 152 167	182 197 212 227	242 257 272 349	364 379 394 409	424 439 454 469	484 499 704 719
3 18 33 48	63 78 93 108	123 138 153 168	183 198 213 228	243 258 273 350	365 380 395 410	425 440 455 470	485 500 705 720
4 19 34 49	64 79 94 109	124 139 154 169	184 199 214 229	244 259 274 351	366 381 396 411	426 441 456 471	486 501 706 900
5 20 35 50	65 80 95 110	125 140 155 170	185 200 215 230	245 260 275 352	367 382 397 412	427 442 457 472	487 502 707 901
6 21 36 51	66 81 96 111	126 141 156 171	186 201 216 231	246 261 338 353	368 383 398 413	428 443 458 473	488 503 708 902
7 22 37 52	67 82 97 112	127 142 157 172	187 202 217 232	247 262 339 354	369 384 399 414	429 444 459 474	489 504 709 951
8 23 38 53	68 83 98 113	128 143 158 173	188 203 218 233	248 263 340 355	370 385 400 415	430 445 460 475	490 505 710 952
9 24 39 54	69 84 99 114	129 144 159 174	189 204 219 234	249 264 341 356	371 386 401 416	431 446 461 476	491 506 711 953
10 25 40 55	70 85 100 115	130 145 160 175	190 205 220 235	250 265 342 357	372 387 402 417	432 447 462 477	492 507 712 954
11 26 41 56	71 86 101 116	131 146 161 176	191 206 221 236	251 266 343 358	373 388 403 418	433 448 463 478	493 508 713 956
12 27 42 57	72 87 102 117	132 147 162 177	192 207 222 237	252 267 344 359	374 389 404 419	434 449 464 479	494 509 714 957
13 28 43 58	73 88 103 118	133 148 163 178	193 208 223 238	253 268 345 360	375 390 405 420	435 450 465 480	495 510 715 958
14 29 44 59	74 89 104 119	134 149 164 179	194 209 224 239	254 269 346 361	376 391 406 421	436 451 466 481	496 701 716 959
15 30 45 60	75 90 105 120	135 150 165 180	195 210 225 240	255 270 347 362	377 392 407 422	437 452 467 482	497 702 717 960

Electronics Reader Service

If the cards below have already been used,
you may obtain the needed information
by writing directly to the manufacturer,
or by sending your name and address,
plus the Reader Service number and issue date,
to Electronics Reader Service Department,
P.O. Box No. 2530, Clinton, Iowa 52734.

Affix
Postage
Here

Electronics

P.O. Box No. 2530
Clinton, Iowa 52735

Affix
Postage
Here

Electronics

P.O. Box No. 2530
Clinton, Iowa 52735

The Power Elite



ENI truly is the Power Elite. In fact, when you want the ultimate in power flexibility, there's simply nothing finer in all the world. And our instrumentation can meet all your application needs, for RF signal generator amplification, RFI/EMI testing, signal distribution, RF or data transmission, NMR/ENDOR, ultrasonics and more.

ENI's selection of Class A power amplifiers is unsurpassed, combining a frequency spectrum

of 10 kHz to 1 GHz with power outputs that range from 300 milliwatts to over 4,000 watts. Rugged, compact and versatile, these power amplifiers can be driven by virtually any signal source. They're completely broadband and untuned, amplifying inputs of AM, FM, TV, SSB and pulse modulations with minimum distortion. The unconditional stability and failsafe design make them impervious to severe load conditions (open or

short circuit), delivering their rated power to any load, regardless of match.

Clearly, when it comes to meeting your power amplification needs, ENI is in a class by itself.

For detailed technical specifications, a demonstration or our latest full-line catalog, write: ENI, 3000 Winton Road South, Rochester, New York 14623. Call (716) 473-6900, or Telex 97-8283 ENI ROC.

ENI

The World's Leader in Power Amplifiers

Circle 901 on reader service card

Time-Proven Cermet Trimmers...

**Still the
best way to
trim a circuit.**

Over the last decade, Models 3006, 3299 and 3386 Trimpot® trimming potentiometers have set the standards for cermet trimmers. And, because these dependable models offer the best performance per dollar around, they'll be standards for a long time to come.

All models are sealed for board processing. Bourns exclusive Swage-Bond™ termination process virtually eliminates pin termination failure. Cermet elements offer essentially infinite resolution. Multi-fingered wrap-around wiper design reduces contact resistance variation and open circuit problems. Here are the specs:

	3006	3299	3386
Std. Res. Range	10 Ohms to 2 Megohms	10 Ohms to 5 Megohms	10 Ohms to 2 Megohms
Res. Tolerance	10%	10%	10%
Power Rating	.75 W @ 70°C	.5 W @ 70°C	.5 W @ 85°C
Tempco	100 ppm/°C	100 ppm/°C	100 ppm/°C
CRV	3%	3%	1%
Adjustment	15 turns	25 turns (top or side adj.)	Single-turn (top or side adj.)
Size	3/4" rect.	3/8" square	3/8" square
Pin Patterns	3 styles	5 styles	14 styles

Time-proven trimmers, backed by the Bourns reputation for leadership, performance and quality at cost-effective prices. Call or write today for your new 94-page TR-1 trimmer catalog. Or, see the EEM directory, Volume 2, pages 3726, 3736 and 3746.

A Timely Offer: Write to Trimmer Application Engineering on your company letterhead. While supply lasts, we'll send you a free trimmer design aid kit detailing all specifications and drawings.

TRIMPOT DIVISION, BOURNS, INC., 1200 Columbia Avenue,
Riverside, CA 92507. Phone: 714 781-5320. TWX: 910 332-1252.

European Headquarters: Bourns AG, Zugerstrasse 74 6340 Baar, Switzerland.
Phone: 042 33 33 33. Telex: 78722.



BOURNS®